

KODAK PIXPRO FZ152

DIGITAL CAMERA

User Manual



Before You Start

Declaration of Conformity

Responsible Party: JK Imaging Ltd.

Address: JK Imaging Ltd., 17239 So. Main Street, Gardena, CA 90248 USA

Company website: kodakpixpro.com

For Customers in the U.S.A.

Tested to Comply with FCC Standards FOR HOME OR OFFICE USE

This device complies with part 15 of the FCC Rules. Operation is subject to the following two conditions: (1) This device may not cause harmful interference and (2) this device must accept any interference received, including interference that may cause undesired camera operation.

For Customers in Europe

 "CE" mark indicates that this product complies with the European requirements for safety, health, environment and customer protection. "CE" marked cameras are intended for sales in Europe.

 This symbol [crossed-out wheel bin WEEE Annex IV] indicates separate collection of electrical waste and electronic equipment in the European countries. Please do not throw the equipment into domestic refuse. Please use the return and collection systems available in your country for proper, safe disposal of this product.

 Batteries: Please dispose of used batteries at designated collection centers.

 Packaging: Please follow local regulations for the recycling of packaging.

About this Manual

Thank you for purchasing this KODAK PIXPRO Digital Camera. Please read this manual carefully and keep it in a safe place for future reference.

- JK Imaging reserves all rights of this document. No part of this published manual may be reproduced, transmitted, transcribed, stored in a retrieval system or translated into any language or computer language, in any form, by any means, without the prior written permission of JK Imaging.
- All trademarks mentioned in this manual are used for identification purposes only and are properties of their respective owners.
- This manual will instruct you on how to operate the KODAK PIXPRO Digital Camera. JK Imaging has tried its utmost to ensure the correctness of the user manual contents, but reserves the right to modify as necessary. All of these contents are subject to change without prior notice.
- Throughout this manual, the following symbols are used to help you locate information quickly and easily:



Indicates useful information.

- The following symbols are used throughout this manual to facilitate better understanding of how to operate the camera:

[Item properties] : The optional properties in the camera interface are indicated by the [] symbol.

Safety Notes

Safety Notes for this Camera

- Do not drop the camera or allow it to hit solid objects.
- Do not attempt to disassemble or repair the camera.
- Do not use or store the camera in dusty places or on a beach to help prevent dust or sand from entering the camera, causing possible damage.
- Do not use or store the camera in a hot environment or under or in direct sunlight.
- Do not use or store the camera near powerful magnetic fields, for example near a magnet or transformer.
- Avoid touching the lens of the camera.
- Do not expose the camera to direct sunlight for a long period of time.
- To prevent the camera from being damaged by moisture, do not use or store the camera in very humid environments, such as in rain or near bodies of water.
- If water accidentally comes in contact with the camera, turn the camera off immediately. Remove the battery and the memory card and dry it completely within 24 hours.
- When you take the camera from a cold environment to a warmer environment, condensation may occur. Please wait for a reasonable period of time before you turn the camera on.
- Before you remove the battery and memory card, the camera should be turned off.
- When you clean the body of the camera, do not use abrasive, alcohol-based or organic cleansers or solvents.
- Use a professional lens cleaning cloth and appropriate cleaner to wipe and clean the lens.
- Download your photos and remove the memory card when you are going to store the camera for long periods of time.
- If this camera is not in use for a long period of time, please keep it in a dry and clean storage location.
- Our company will not pay compensation for any failure of playback including: pictures or videos damaged or unrecoverable by improper operation.

Safety Notes for Battery

- Please use a battery that is the same type as the one included.
- Please use the attached charger to charge the battery.
- If battery fluid leaks inside the camera, contact our customer service department immediately. If battery fluid leaks onto your skin, rinse your skin immediately with clean water and seek immediate medical attention.
- Disposal of used batteries should be carried out in accordance with your local (national or regional) regulations.
- To prevent the battery from being damaged, do not drop the battery or allow it to hit solid objects or to be scratched by foreign objects.
- Do not let the battery come in contact with metal objects (including coins) to avoid short circuiting, discharging, excessive heat or possible leakage.
- Do not attempt to disassemble the battery.
- Do not expose the battery to water. Always keep the battery contacts dry.
- Do not heat the battery or throw it into a fire to avoid a possible explosion.
- Do not store the battery in a hot environment or in direct sunlight.
- If the battery overheats during charging or use, stop charging or use immediately. Turn off the product, remove the battery carefully, and wait until it cools down.
- When the camera is stored for a long period of time, remove the battery and keep it in a safe, dry place that is not accessible to infants and children.
- In colder environments, the performance of the battery could be noticeably reduced.
- When you install the battery, align the battery markings according to the positive and negative markings inside on the camera battery compartment. Never force the battery into the battery compartment.

Safety Notes for Memory Cards

- We highly suggest buying only well-known, name brand memory cards to ensure peak performance and reliability.
- Format the memory card using the camera before you use it or insert a new one.
- Do not drop the memory card or allow it to hit solid objects to avoid damaging it.
- Do not attempt to disassemble or repair the memory card.
- Do not expose the memory card to water. Always keep it dry.
- Do not remove the memory card when the camera is turned on. Otherwise, the memory card and photo/video files could be permanently damaged.
- Do not directly edit the data on the memory card. Copy the data to your computer before you edit the files.
- When the camera is stored for long periods of time, be sure to download your photos and remove the memory card. Store the memory card in a dry environment.
- Do not modify the name of the files or folders of the memory card using your PC. Modifying the file names may cause the files to not be recognized on the camera or a possible permanent error may occur.
- A photo taken with the camera will be stored in the folder that is automatically generated on the memory card. Do not store photos that are not taken using this camera in these folders as the pictures cannot be recognized during playback.
- When you insert the memory card, make sure the notch of the card matches the markings on the top of the camera card slot.

Other Safety Notes

- Do not disconnect the power or turn the camera off during the update process. Doing so may cause incorrect data to be written and the camera may not power on later.
- When using your camera on an airplane, observe the relevant rules specified by the airline and FAA regulations.
- Due to the limitations of manufacturing technology, the LCD may have a few dead or bright pixels. These pixels do not affect the quality or performance of the camera, photos or video.
- Do not expose the camera's LCD to water. In a humid environment, only wipe it with a soft, dry, cleaning cloth.
- If the LCD screen is damaged, pay particular attention to the liquid crystal in the screen. If any of the following situations arise, immediately take the steps listed below:
 1. If liquid crystal comes in contact with your skin, please wipe with a dry cloth, wash thoroughly with soap, and rinse with plenty of clean water.
 2. If liquid crystal gets into your eye, flush the eye immediately with plenty of clean water for at least 15 minutes and then seek medical assistance.
 3. If liquid crystal is swallowed, immediately rinse your mouth thoroughly with clean water and induce vomiting. Seek medical assistance.

Contents

Before You Start.....	1
Safety Notes	3
Contents	7
Getting Started	11
Accessories Included.....	11
Part Names	12
Installing Battery and Memory Card.....	14
Charging Battery	16
Turning Camera On and Off.....	17
How to Take Pictures.....	17
Set your Language, Date/Time	18
Mode Overview	21
LCD Screen Display	21
Overview of the Screen Icons in Photo Shooting Mode	21

Overview of the Screen Icons in Movie Mode	22
Using the Mode Button	23
Panorama Mode	24
Scene Mode	25
Basic Operation	29
Using the Zoom Function.....	29
Display Setting	30
Macro Mode.....	31
Self-Timer Setting.....	32
Flash Mode	33
EV Setting	34
Using Quick Recording	36
Playback Mode	37
Overview of the Screen Icons in Playback Mode	37
Viewing Photos and Videos	38
Thumbnail View	39
Using Zoom Playback (for still pictures only).....	40

Slideshow	41
Deleting Photos and Videos.....	42
Using the Menus.....	43
Shooting Menu.....	43
Shooting Setting Menu	49
Movie Menu	53
Movie Setting Menu	56
Playback Menu	57
Playback Setting Menu	60
Setup Menu	63
Sound Settings.....	64
Power Saver.....	64
Language.....	65
World Time	65
Date & Time.....	65
LCD Brightness.....	65

File Setting.....	66
Format	66
Copy to Card.....	67
File Numbering.....	67
Reset.....	68
Firmware (FW) Version	68
Connection Settings	69
Connecting to a Computer.....	69
Connecting to a PICTBRIDGE™ Compatible Printer	71
Using the PICTBRIDGE™ Menu	73
Video System	77
Set Eye-Fi Card Connection Mode	78
Appendices.....	79
Product Specifications.....	79
Prompts and Warning Messages	83
Troubleshooting	87

Getting Ready

Accessories Included

Your camera box should contain the camera model you purchased along with the following accessories. If anything is missing or appears to be damaged, please contact your retailer first or our customer service center. (Based on sales in different countries or regions, the shape of the AC adapter will vary).

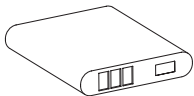

Rechargeable
Li-ion Battery

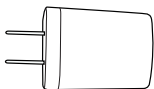

AC Adapter

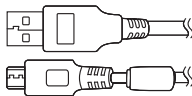

Micro USB Cable



Wrist Strap



Quick Start Guide



Warranty Card



Service Card

Part Names

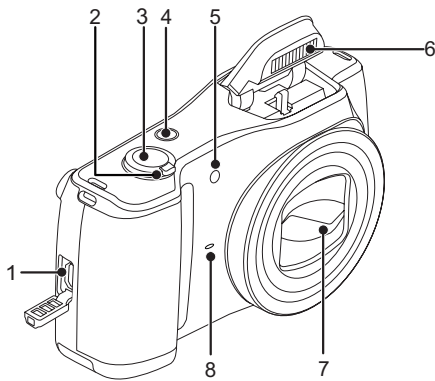

1. Micro USB Port
2. Zoom Lever
3. Shutter Button
4. Power Button
5. AF Assist Beam/Self-Timer Lamp
6. Flash Lamp
7. Lens
8. Microphone

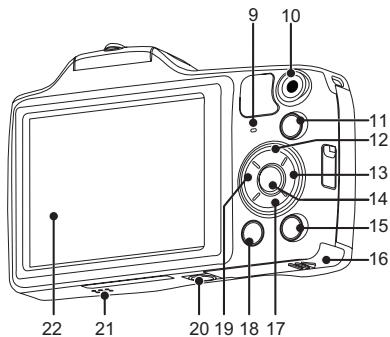

- 9. Indicator Lamp
- 10. Fast Video Recording Button
- 11. Mode Button
- 12. **[DISP.]** Display Button/Arrow Button (Up)
- 13. Flash Button/Arrow Button (Right)
- 14. SET Button
- 15. Playback Button
- 16. Battery Cover
- 17. Delete Button/Arrow Button (Down)
- 18. Menu Button
- 19. Macro Button/Self-Timer Button/Arrow Button (Left)
- 20. Tripod Socket
- 21. Speaker
- 22. LCD

Installing Battery and Memory Card

1. Open the battery door cover.

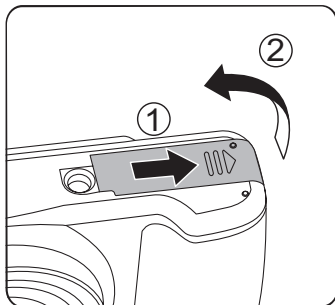

2. Insert the battery into the battery compartment according to the negative and positive marks as illustrated in the picture below. Push the battery down until it locks in place.

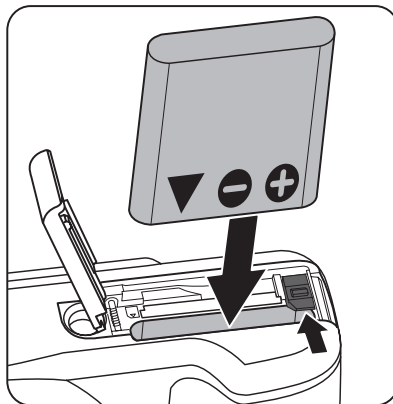

3. Insert the memory card into the memory card slot as shown in the diagram below:

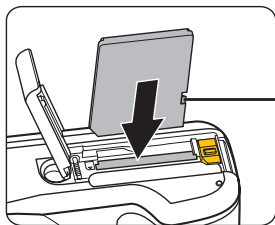

Write
Protection
Toggle
Switch



A standard SD memory card is not included in the camera packaging and needs to be purchased separately. This camera takes a standard (SD/SDHC) memory card. We recommend using a name brand memory card that is Class 4 or higher and has a capacity of 4GB to 32GB. The camera is not compatible with Micro SD, Ultra, Ultra Plus, Extreme, XC, or adapters for any of these other memory cards.

4. Close the battery door cover.

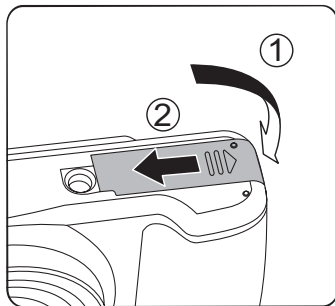



To remove your memory card, open the battery cover door, gently press the memory card to eject it and remove it carefully.

Charging the Battery

Please insert the battery and charge it in “OFF” mode.

1. Connect the camera and the power charger using the supplied Micro USB cable.
2. Insert the plug of the power charger into the power outlet to charge the battery.
3. When the camera is turned off, you can also connect the camera to your PC using a Micro USB cable to charge the battery.

 After the battery is stored for long periods of time, use the supplied power charger to fully charge the battery prior to use.

 **Charging Indicator Lamp:**
Steady orange indicates charging.
The indicator will go out once charging is finished.

To maximize battery life, charge the battery for at least 4 hours before first use.

 Please charge the battery indoors between 0°C and 40°C (32°F and 104°F).

 The camera will only charge while powered off. If the camera is turned on while connected to power, normal camera functions will be available for use, but the camera will not charge until it is turned off.

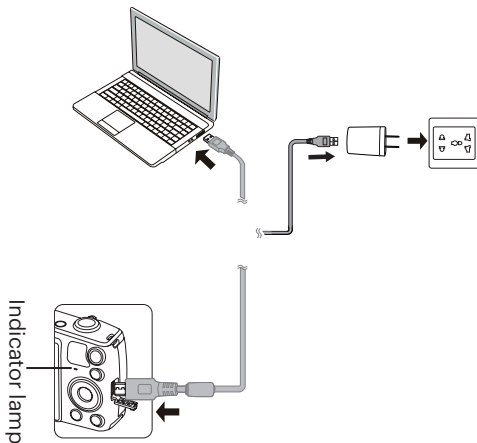

Turning Camera On and Off

Press the Power button to turn the camera on. To turn the camera off, press the Power button again.

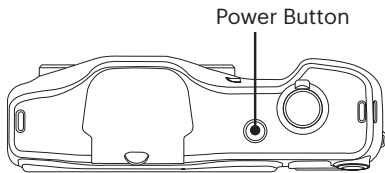

When the power is off, press and hold the play  button to power on and enter Playback mode.

How to Take Pictures

1. Hold the camera securely with both hands, being careful not to block the flash and lens with fingers.
2. Point the lens toward the object you want to take a picture of.
3. Use the zoom lever to select Tele or Wide position to zoom in or out on your subject.
4. Press the shutter button down half-way to allow the camera to focus on your subject.
5. When the frame around your subject turns green and the LCD is focused to your liking, push the shutter button down completely to take the picture.

Set your Language, Date/Time









Set your Language, Date/Time After the First Power-On

1. When you turn the camera on for the first time, the language selection screen appears.
2. Press the direction buttons to select your desired language.
3. After you press the (SET) button to confirm your language selection, the Date/Time settings screen will appear.
4. Press the left/right button to select the Date/Time to be adjusted: Time is displayed in YYYY.MM.DD/HH:MM.
5. Press the up/down button to adjust the value for the desired Date/Time.
6. Press the (SET) button to confirm the time settings and the snapshot screen will appear.



Resetting your Language





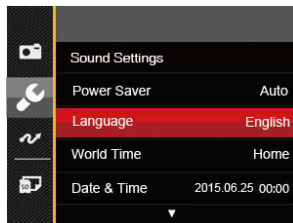



After you set your language for the first time, follow the instructions below to reset your desired language.

1. Press the  button and press the up/down button to select . Press the  button to enter the menu.
2. Press the up/down button to select  and press the  button or right button to enter the menu.
3. Press the up/down button to select [Language] and press the  button or right button to enter the menu.
4. Press the direction buttons to select your desired language and press the  button to confirm.
5. Press the  button and the snapshot screen will appear.



Resetting Date/Time

After you set your Date/Time for the first time, follow the instructions below to reset date and time.

1. Press the  button and press the up/down button to select . Press the  button to enter the menu.
2. Press the up/down button to select  and press the  button or right button to enter the menu.
3. Press the up/down button to select [Date & Time] and press the  button or right button to enter the menu.
4. Press the left/right button to select the Date/Time to be adjusted: Time is displayed in YYYY.MM.DD/HH:MM.
5. Press the up/down button to press the value for your selected entry. After you finish your settings, press the  button to confirm.
6. Press the  button and the following snapshot screen will appear.

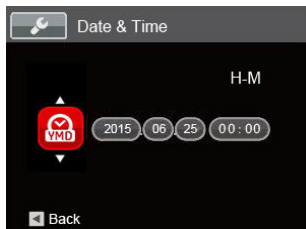
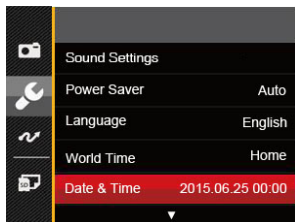

Mode Overview

LCD Screen Display

Overview of the Screen Icons in Photo Shooting Mode

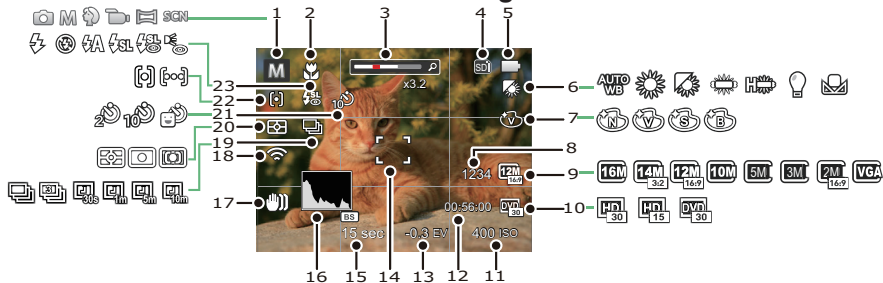



1	Shooting Mode	9	Image Size	17	OIS (Optical Image Stabilization)
2	Macro Mode	10	Video Quality	18	Eye-Fi ON (with signal)
3	Zoom Display (By turning the Zoom Lever)	11	ISO Value	19	Continuous Shot
4	Memory Card/Built-in Memory	12	Remaining Recording Time	20	Expo Metering
5	Battery Status	13	Exposure Compensation	21	Self-Timer
6	White Balance	14	Focus Frame	22	AF Mode
7	Color Effect	15	Shutter Speed	23	Flash Mode
8	Number of Remaining Shots	16	Histogram		

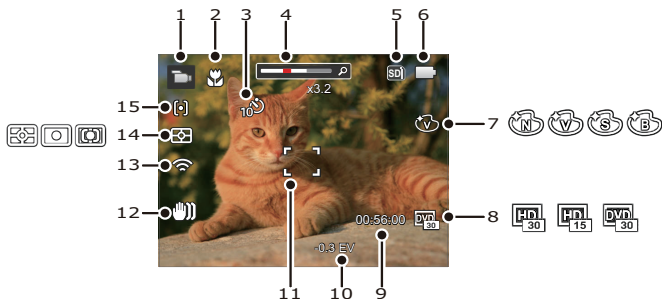





Overview of the Screen Icons in Movie Mode



1	Movie Mode	6	Battery Status	11	Focus Frame
2	Macro Mode	7	Color Effect	12	Image Stabilization
3	Self-Timer	8	Video Quality	13	Eye-Fi ON (with signal)
4	Zoom Display (By turning the Zoom Lever)	9	Remaining Recording Time	14	Expo Metering
5	Memory Card/Built-in Memory	10	Exposure Compensation	15	AF Mode

Using the Mode Button

This camera provides a convenient Mode button that allows you to switch easily between different modes. After pressing the  button to enter the Mode Selection Menu, press the left/right button to choose the selected mode. Press the  button to confirm your selection. All the available modes are listed below:

Mode Name	Icon	Description
Auto Mode		In this mode, the optimal conditions for taking pictures will be set based on the subject and environment. It is the most commonly used mode for taking pictures.
Manual Mode		This mode is for manually setting EV, shutter speed and ISO value.
Portrait Mode		The best setting for portrait shooting, enables AE/AF for faces. The camera is set to automatically adjust exposure for realistic capture of skin tones.
Movie Mode		Record videos.
Panorama Mode		In this mode, up to 4 frames (or 180°) can be stitched together to create a single panoramic photo.
Scene Mode		Choose from 20 different pre-set scene types and effects for your photos.

Panorama Mode

Panorama Mode allows you to create a panoramic picture up to 180°. The camera will automatically compose a panoramic picture by stitching together individual shots that you take.

Follow these easy steps to create a panoramic picture:

1. Press the **(MODE)** button to select Panorama Mode ()
2. Press the direction buttons to select a desired shooting direction. Should you not select a direction, the default shooting direction is “right.” 2 seconds later, the camera will be ready to take pictures. You can also press the **(SET)** button or press the shutter button down halfway to be ready to take pictures.
3. Compose the first view of the panoramic picture on the LCD and press the Shutter button to capture the image.

4. After the first shot is taken, the semi-transparent image of the first shot will appear at the edge of the screen. You can use this image to compose and align your picture before you press the Shutter button to capture and finish manual stitching.

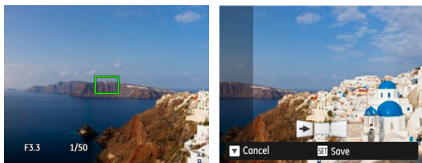

5. If continuous pictures are less than 4 shots, when you press the **(SET)** button, the camera will automatically stitch the pictures together. Press the Playback button to enter Playback mode to see the finished effect.
6. If you take 4 pictures, the camera will stitch the pictures together automatically. Press the Playback button to enter Playback mode to see the finished effect.

When shooting in Panorama Mode, the Flash, Self-Timer, Macro Modes and Exposure Compensation are not available. Focus Adjustment is also not available at this time.

In Panorama Mode, up to 4 photos can be captured when the image size is set at 2M.

During Panorama Mode shooting, press the **(SET)** button to interrupt shooting and save the current pictures taken. Press the down button (**⏏**) to cancel shooting and delete the previously taken pictures.







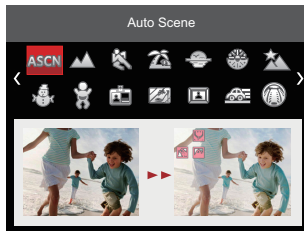





Scene Mode **SCN**









You can select your desired scene from the 20 preset modes according to the type of environment you are shooting. The camera then automatically configures the most appropriate settings for the best possible photos.

1. Press the **(MODE)** button to select scene mode (**SCN**). The LCD will display a menu like the example below:



2. Press the direction buttons to select a scene, and press the **(SET)** button to confirm.
3. If any need of changing the scene, please press the **(MENU)** button and then the **(SET)** button and finally the direction buttons to reselect the scene.







Scene	Description
 Auto Scene	Identifies the scene automatically; Person, Backlighting, Landscape, Macro, Night Scene, Night Scene Person and Auto.
 Landscape	For landscapes and outdoor shots. Vivid reproduction of greens and blues.
 Sport	For fast-moving subjects. Captures sharp, action shots with minimal blur. This mode is not recommended for shooting indoors.
 Beach	For taking pictures in areas with strong sunlight.
 Sunset	For sunsets. Captures subjects in strong sunlight.
 Fireworks	For fireworks at night. Adjusts slower shutter speed for brilliant images. The use of a tripod is recommended with this setting.
 Night Landscape	For night scenes. The use of a tripod is recommended.
 Snow	For snowy conditions. Reproduces natural, clear, white scenes.
 Children	Turns flash off automatically. Avoids disturbing the subject, and is suitable for taking photos of children and pets.
 ID	For shooting ID size photos. (It is recommended to print using 6-inch 4R (6X4) photographic paper).
 Glass	For objects behind transparent glass.
 Photo Frame	For adding interesting frame effects to the photo.

Scene	Description
 Panning Shot	Captures fast moving objects clearly with a blurred background.
 Fish Eye	For an interesting fish eye effect.
 Party	Suitable for taking indoor party pictures, even under complicated lighting conditions.
 Indoor	For indoor settings. Reduces blur and improves color accuracy.
 Leaf	For plants. Captures brilliant shots of greenery and blossoms.
 Museum	For museums or flash-free areas. Retains color and reduce blur.
 Night Portrait	For portraits against night scenery.
 Sketch	For taking photos with a pencil sketch effect.

Auto Scene Mode (ASCN)

In “ASCN” Scene Mode, the camera can intelligently detect different environments and automatically select the best scene and photo settings for you.

“ASCN” can intelligently detect the following scenes:

Mode Name	Description
 Landscape Mode	For landscapes, automatically adjusts the exposure and reproduces vivid greens and blues.
 Portrait Mode	Most suitable for capturing people with focus on their faces.
 Night Portrait	When you take portraits at night or in low light conditions, automatically adjusts the exposure for people and night scenes.
 Backlit Portrait	When the sun or any other light source is behind you, automatically adjusts the foreground exposure to produce the best pictures possible.
 Night Landscape Mode	For night scenes, automatically increases the ISO value to compensate for low light.
 Macro Mode	The Macro setting is ideal for shooting small objects or close-up photos.
 Auto Mode	The camera automatically adjusts the exposure and focus to ensure the best possible pictures.

Basic Operation

Using the Zoom Function

Your camera is equipped with two types of zoom functions: Optical Zoom and Digital Zoom. Toggle the Zoom Lever of the camera to zoom in or out of the subject while taking pictures.

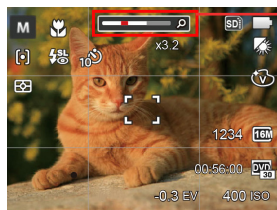
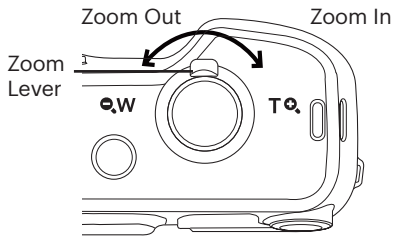

Zoom Indicator

When Optical Zoom reaches the maximum threshold as Digital Zoom, release and turn the Zoom Lever to T to switch between Optical Zoom and Digital Zoom.

Display Setting

Press the **DISP.** button to display the settings: Classic, Full, Off.

Classic: Displays the camera parameters on screen

Off: Does not display any additional icons on screen

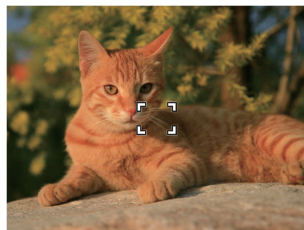
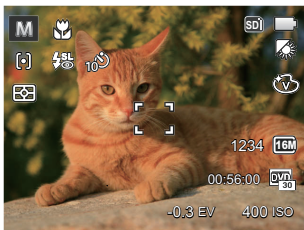

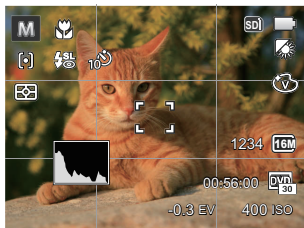

Full: Camera parameters with Grid and Histogram





Macro Mode

The Macro setting is ideal for shooting small objects or close-up photos. This mode allows you to focus on subjects very close to the camera.

1. Press the left button ( ) to enter the Macro Menu.





2. Press the left/right button to select the following 2 modes:

-  **Macro Off**
Select this option to disable macro.
 -  **Macro On**
Select this option to make focusing on the object closer to the lens (At the W side, the shooting distance should be more than 3 cm).
3. Press the  button to confirm the settings and enter the shooting screen.



Self-Timer Setting



Use this function to take pictures at pre-set intervals. First choose 2 seconds, 10 seconds or Smile Detection.

1. Press the left button ( ), and then press the down button () to enter the Self-Timer Menu.







2. Press the left/right button to select the following 4 modes:

-  Self-Timer Off
Disables the Self-timer.
-  Self-Timer 2 sec
A single picture is shot 2 seconds after the shutter button is pressed.

-  Self-Timer 10 sec
A single picture is shot 10 seconds after the shutter button is pressed.
-  Self-Timer Smile
Press the shutter button and a picture will be taken immediately after a smile is detected.

3. Press the  button to confirm the settings and enter the shooting screen.

-  When enabling the Self-Timer, pressing the shutter or the () button can disable the Self-Timer and return to the shooting screen while keeping the Self-Timer setting.
-  When enabling the Smile Detection, pressing the shutter or the  button can disable the Self-Timer and return to the shooting screen without keeping the Self-Timer Smile setting.

Flash Mode

The flash provides supplemental light for a scene. The flash is usually used when shooting against the light to highlight the object. It is also suitable for metering and shooting in darker scenes to improve the exposure.

1. Pop the flash up manually as shown below (as shown in the figure).

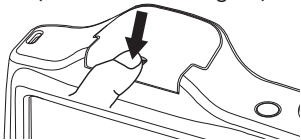







2. Press the right button (⚡) to enter the flash settings menu.



3. Press the left/right button to select the following 6 modes:

-  Force Off
Flash is turned off.

-  Flash Auto
Camera flash goes off automatically based on existing light conditions.
 -  Fill Flash
The flash will engage with each shot even if there is enough available light to take the photo without flash.
 -  Slow Sync.
This allows you to take pictures of people at night that clearly show both your subjects and the night time backdrop. The use of a tripod is recommended when shooting with this setting.
 -  Slow Sync. + Red-Eye
Use this mode for slow synchrony shots with red-eye reduction.
 -  Red-Eye Reduction
The camera emits a brief pre-flash before the picture is taken to reduce red-eye effects.
4. Press the  button to confirm the settings and enter the shooting screen.

EV Setting

The EV Function Menu of the camera includes functions, such as EV, Shutter Adjustment, ISO. Using the appropriate function settings can improve your pictures.

To select the best settings for optimum photos, follow these steps:

1. Press the **(SET)** button to display the settings screen.
2. Press the left/right button to select the setting options.
3. Press the up/down button to adjust the option values.
4. Press the **(SET)** button to confirm the settings and enter the shooting screen.

Exposure Compensation

Set up Exposure Compensation to adjust the picture brightness. If there is very high contrast between the photographed object and the background, the brightness of the picture can be adjusted as necessary. (This can be adjusted in **[M]** Mode)

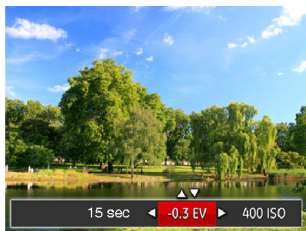

The adjustable range of exposure value is from EV -2.0 to EV+2.0.

ISO

The ISO function allows you to set the sensitivity of the camera's light sensor based on the brightness of the scene. To improve the camera's sensor performance in darker environments, a higher ISO value is required. A lower ISO value is needed when shooting in brighter conditions.

Pictures taken at higher ISO settings will generally have more noise than those taken at lower ISO settings. (Adjustable in  Mode)

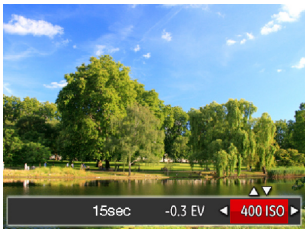

The camera's ISO settings include: Auto, 80, 100, 200, 400, 800, 1600.

Shutter Adjustment

For shutter speed, the camera may automatically set the aperture value corresponding to the manually set shutter speed so as to obtain a most suitable exposure value. The movement of object may be shown by adjusting the shutter speed. High shutter value can help you more clearly capture fast moving objects while low shutter value can better show the movement of objects. (Adjustable in  Mode)



Using Quick Recording

In Photo Shooting Mode, press the  button to begin recording video.

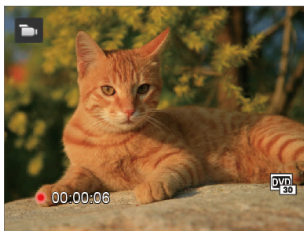

After recording, press the  button or the shutter button to stop recording. The camera will store the video and return to the shooting screen.

Playback Mode

Overview of the Screen Icons in Playback Mode

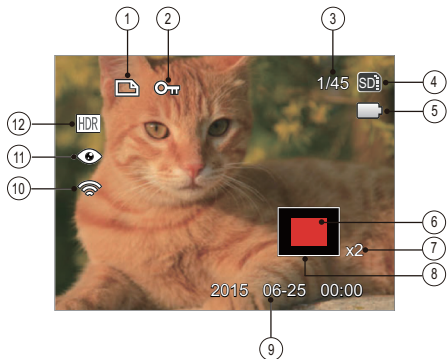

1	DPOF File	7	Image Zoom Ratios
2	File Protection	8	Image Zone
3	Memory Space (indicating the current number of photos and total number of photos)	9	Shooting Date
4	Memory Card/Built-in Memory	10	Eye-Fi ON (with signal)
5	Battery Status	11	Red-Eye Reduction
6	Zoom Magnification Area	12	HDR

Viewing Photos and Videos

To view the captured photos and video clips on the LCD:

1. After pressing the **(▶)** button, the last photo or video clip taken will be displayed on the LCD.
2. Use the left/right navigation buttons to scroll through the photos or video clips stored on the camera's internal memory or on the Memory Card.
3. To play a selected video clip, press the **(SET)** button to enter the movie playback mode.

An operation guide appears on the screen when playing back a video. Press the appropriate buttons to enable the corresponding functions.

Under Playback

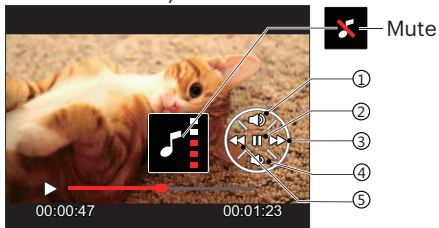

1	Increase volume
2	Pause
3	Fast forward
4	Decrease volume
5	Rewind

Paused

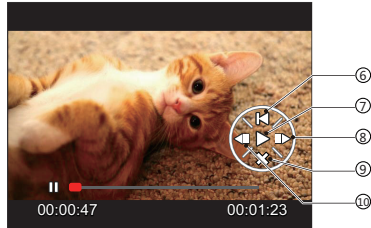

6	Return to the beginning of the video
7	Play
8	Play video forward
9	Cancel playback
10	Play video backward

Thumbnail View

When in Playback Mode, rotate the Zoom lever counter to the **W** position to display thumbnail images of the photos and videos on the screen.

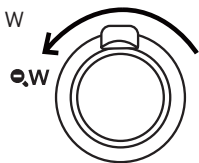

1. Slide the zoom lever to switch between 3 x 3 and 4 x 4 thumbnails.

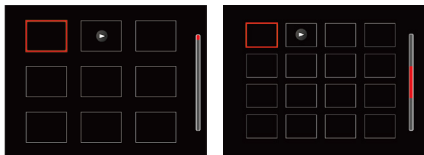

2. Press the direction buttons to select a picture or video clip to view and press the **SET** button to restore it to the original size.

 When the icon  appears, it means this is a video file.

Using Zoom Playback (for still pictures only)

When playing back photos, you can also use the Zoom Lever to zoom in on the photos 2x to 8x their original magnification.

1. Press the  button to switch to playback mode.
2. Press the left/right button to select a picture on which to use the zoom feature.
3. Rotate the zoom lever to **T+** to zoom in.

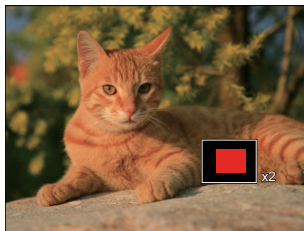
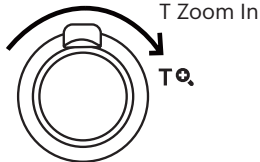



4. The screen will display the number of times the image is magnified and area of the photo shown.
5. Press the direction buttons to navigate and select a portion of the photo to be zoomed in on.
6. Press the  button to return the image to its original scale.







Movie images cannot be magnified.

Slideshow

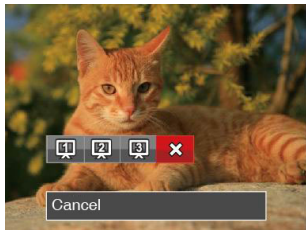
This setting allows you to view all the stored images as a slideshow.

1. Press the  button to enter playback screen.
2. Press the  button to enter slide option.
3. Press the left/right button to select slideshow playing or [Cancel] to return to the playback screen.



4. Press the  button to confirm the setting.
-  Slide playing function supports movie playing.
 -  Images don't rotate in the slideshow playback.

Deleting Photos and Videos

In Playback Mode, press the down button (⏏) to delete your photos and videos.

To delete photos or videos:

1. Press the (▶) button to switch to Playback Mode.
2. Press the left/right button to select the photos and videos to be deleted.
3. Press the down button (⏏) and the deletion screen is displayed.
4. Press the up/down button to select [Delete One] or [Exit] and press the (SET) button to confirm.



Erased photos/video clips cannot be recovered.



Please refer to page 61 for instructions on deleting more than one image at a time.

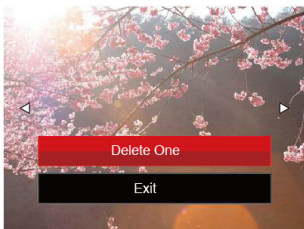



Using the Menus

Shooting Menu

Functions that can be enabled are different under each mode.

Mode:  **M**  **SCN**

1. In Photo Shooting Mode, press the  button to enter the Shooting Menu.
2. Press the up/down button to select the Shooting Menu and settings.
3. Press the left/right button to select the shooting menu to be set and press the  button to confirm.

Refer to the following pages for more details about each setting.

Expo Metering (Exposure Metering)

Use this setting to select the “target” size of the camera’s field of view to be metered.





-  **AiAE (Artificial Intelligence AE)**
Automatically selects the central and peripheral metering, to calculate the reasonable value of metering by weighting.
-  **Spot**
For metering targets a small area in the center of the camera's field of view.
-  **Center**
For metering targets a slightly larger area in the center of the cameras field of view.

Image Size

The size setting refers to the image resolution in pixels. A higher image resolution allows you to print that image in larger sizes without degrading the photo image quality.



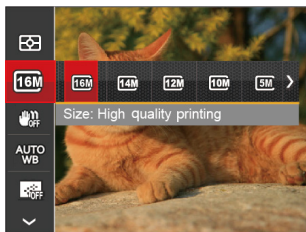

The larger the number of recorded pixels, the larger the file size and note that fewer files can be saved on your memory card.

OIS (Optical Image Stabilization)

This mode can help reduce photo blur caused by unintentional hand shake, low light.



-  OIS: Off
-  OIS: On



Use this Image Stabilization Mode in dark environments.









Shooting in a windy or unstable environment (such as a moving vehicle) may cause blurry images.

White Balance Setting

The White Balance Setting allows you to adjust the color temperature for different lighting scenes to ensure the most accurate color reproduction.





-  AUTO WB AWB
-  Daylight
-  Cloudy
-  Fluorescent
-  Fluorescent CWF
-  Incandescent
-  Manual WB (Fully press the shutter button to detect the white balance value)

Continuous AF (Auto-Focus)

Enable the Continuous AF Setting to be able to continuously focus automatically when taking pictures.





-  Cont. AF: Off
-  Cont. AF: On

Focus Setting

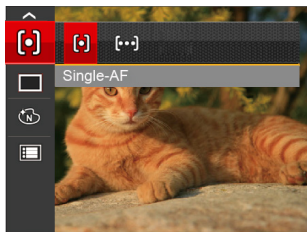
In different Photo Shooting Modes, you can select different focus methods.



-  Single-AF
The focus frame appears on the center of the LCD to help you focus on the subject.
-  Multi-AF
The camera automatically focuses the subject in a wider area to find the focal point.

Continuous Shot

Use this setting to perform continuous shooting. After entering this mode, you can shoot multiple images by continuously holding the shutter button down.

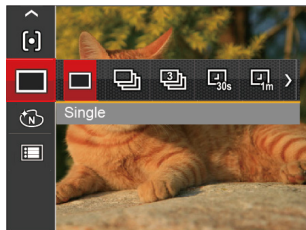



-  Single
-  Continuous Shot
-  3 Shots
-  Time-Lapse 30sec
-  Time-Lapse 1min
-  Time-Lapse 5min
-  Time-Lapse 10min







The flash is disabled in the Continuous Shooting Mode in order to achieve quick succession of shots.

Color Effect

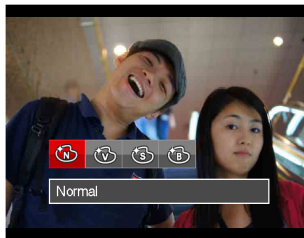







The Image Color Setting allows you to select different effects.

1. In Photo Shooting Mode, press the  button to enter the Shooting Menu.
2. Press the up/down button to select the Image Color Setting Menu, press the  button to enter the menu.
3. Press the left/right button to select the image color setting options.



-  Normal
-  Vivid
-  Sepia
-  Black and White

- Options in the Shooting Modes (○: Available x: Unavailable)

Options	Shooting Modes			
		M		SCN
	○	○	○	○
16M	○	○	○	○
	○	○	×	×
	○	○	○	×
	○	○	○	×
	○	○	×	×
AUTO WB	×	○	×	×
	×	○	×	×
ASCN	×	×	×	○

Shooting Setting Menu

Mode: M SCN

1. Press the button in Photo Shooting Mode and press the up/down button to select .

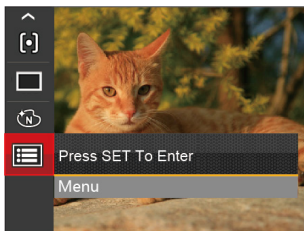

2. Press the button to enter the menu.
3. Press the up/down button to select and press the button or right button to enter the menu.
4. Press the up/down button to select the item to be selected and press the button or right button to enter the menu.
5. Press the up/down buttons to select an option and press the button to confirm.

Quality

The quality setting can be used to adjust the image compression ratio.

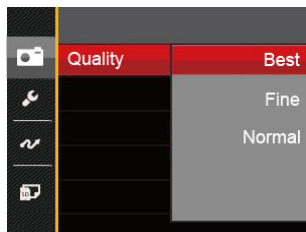

- Best (16M Average File Size: 4.0MB)
- Fine (16M Average File Size: 2.5MB)
- Normal (16M Average File Size: 2.0MB)

AF Assist Beam (Auto-Focus Assist Beam)

In a darker environment, the AF Assist Beam setting can be turned on for better focus.



- Off
- On

Digital Zoom

This setting is for adjusting Digital Zoom. If this function is disabled, only Optical Zoom can be used.

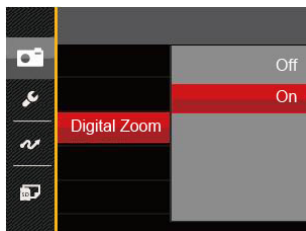

- Off
- On

Date Imprint

Include a Date/Time stamp on the photo image.

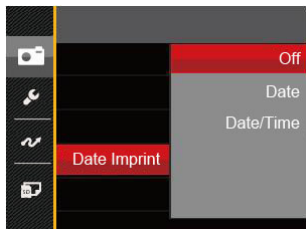

- Off
- Date
- Date / Time

Quick Review

This option allows quick review of the photos immediately after they are taken. Each photo is displayed on the LCD screen for the selected time.

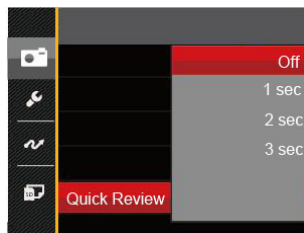

- Off
- 1 sec
- 2 sec
- 3 sec



A shorter Quick Review time will improve battery life.

Face Detection

Detects and focuses on faces to make all faces as clear as possible in Photo Mode.

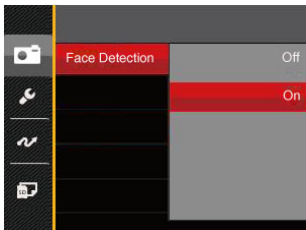

1. Hold the camera steadily and then focus on your subject to detect their face. A focus frame will appear around the face when a face is detected.

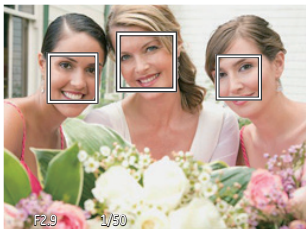

2. Press the shutter button half-way down to focus. The LCD will show a green focus frame when the subject is in focus.

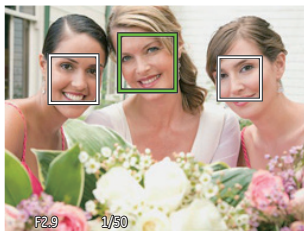





3. Press the shutter button all the way down to take pictures.



The Blink Detection Setting is usually on. If the camera detects in the course of quick review there is a face with eyes closed, a prompt of closed eyes will appear .

Movie Menu



Mode: 

1. Press the  button, select the  Mode and press the  button to enter the movie menu.
2. Press the up/down button to select the movie menu to be set.
3. Press the left/right button to select the movie menu to be set and press the  button to confirm.

Expo Metering (Exposure Metering)

Use this setting to select the “target” size of the camera’s field of view to be metered.



-  AI AE (Artificial Intelligence AE)
Automatically selects the central and peripheral metering, to calculate the reasonable value of metering by weighting.
-  Spot
For metering targets a small area in the center of the camera’s field of view.
-  Center
For metering targets a slightly larger area in the center of the cameras field of view.

Video Quality

Set the image resolution used during video recording.

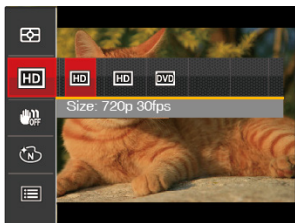

The speed requirements for reading and writing high resolution image pixel images to a memory card are as follows:

No.	Image Pixel	Frame	Recommendation	Approximate Recording time (4GB)
1	1280 x 720 *	30	Class 4	19 Minutes
2	1280 x 720	15	Class 4	37 Minutes
3	640 x 480	30	Class 4	33 Minutes



* The longest recording time is 29 minutes at one time.





When recording in higher pixel resolutions for extended periods of time, this can cause the camera to generate heat. This is not a camera malfunction.

OIS (Optical Image Stabilization)

This mode can help reduce images blur caused by unintentional shaking or low light.



-  OIS: Off
-  OIS: On

 Use this Image Stabilization Mode in dark environments.





 Shooting in a windy or unstable environment (such as a moving vehicle) may cause blurry images.

Color Effect

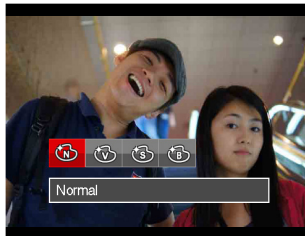
The Image Color Setting allows you to select different effects.





1. Press the **SET** button to select the Image Color Setting menu.
2. Press the left/right button to select the Image Color Setting options.







-  Normal
-  Vivid
-  Sepia
-  Black and White

Movie Setting Menu

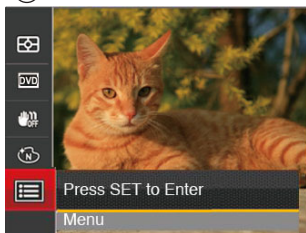
Mode: 

1. Press the  button, and select  to enter the video recording screen.
2. Press the  button, press the up/down button to select  and press the  to enter the menu.



3. Press the up/down button to select  and press the  button or the right button to enter the menu.
4. Select the items to be set and press the  button or the right button to enter the menu.
5. Press the up/down buttons to select an option and press the  button to confirm.

Digital Zoom



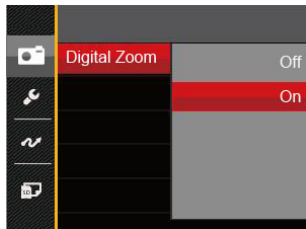

This setting is for adjusting Digital Zoom. If this function is disabled, only Optical Zoom can be used.



- Off
- On

Playback Menu

Mode: 

1. Press the  button to display the playback screen and press the  button to enter the menu.
2. Press the up/down button to select the playback desired and press the  button to enter.
3. Press the left/right buttons to select an option and press the  button to confirm.



Refer to the following pages for more details about each setting.

HDR (High Dynamic Range)

With the HDR function, pictures that are overexposed may be corrected to optimize the highlights and lowlights captured to more accurately represent the actual scene.

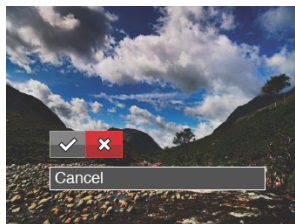

 : HDR



 : Cancel

 After using the HDR function, the image will be saved as a new file and the original file is still stored in the memory.

Red-Eye Reduction

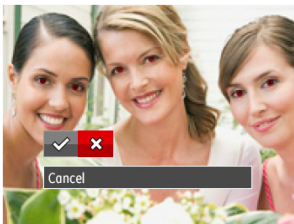
You can use this setting to reduce the chance of red-eyes in a picture.





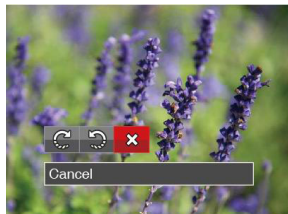

-  : Red-Eye Reduction
-  : Cancel

Rotate

You can use this setting to change the orientation of the picture.



-  : Turn Right
-  : Turn Left
-  : Cancel

 Videos and panoramic pictures cannot be rotated.

 The rotated picture file will replace the original photo.

Resize

This setting allows you to resize a picture to a particular resolution and saves it as a new picture.

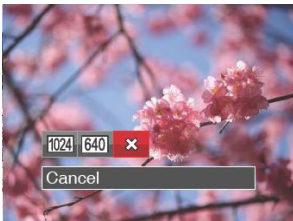

 : Resize to 1024 x 768

 : Resize to 640 x 480

 : Cancel



Only for adjusting pictures with high resolution to a low resolution.

Color Effect

This setting allows you to change the picture color effect. The file is saved as a new photo and stored in memory together with the original photo.

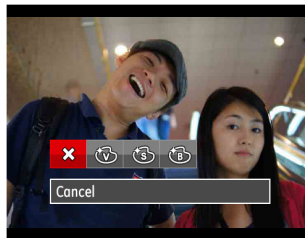

 : Cancel





 : Vivid

 : Sepia

 : Black and White



Playback Setting Menu

Mode: 

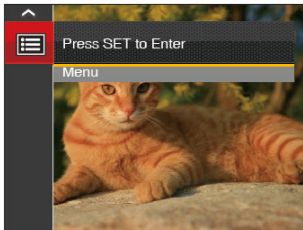
1. Press the  button to show the playback screen, press the  button, and press the up/down button to select .
2. Press the  button to enter the menu.



3. Press the up/down button to select  and press the  button or right button to enter the menu.

4. Press the up/down button to select the item to be set and press the  button or right button to enter the menu.
5. Press the up/down buttons to select an option and press the  button to confirm.

Refer to the following pages for more details about each setting.

Protect

To prevent any pictures or videos from accidentally being erased, use this setting to lock one or all of the files.

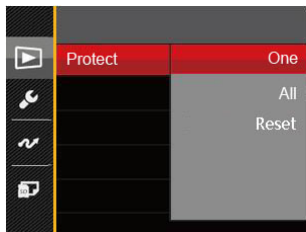

- One: Lock the selected photo or video if they are unprotected; unlock the selected photo or video if they are protected.
- All: Lock all photos or videos.
- Reset: Cancel all locked photos or videos.

Delete

You can delete one or all photo/video files.

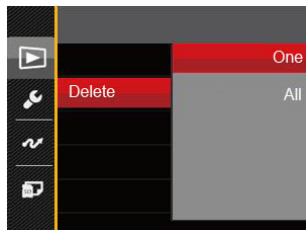

- One: Delete one photo or video.
- All: Delete all photos or videos.

- ① The “” indicator means a file is protected. File protection must be removed first before a file can be deleted.
- ① Deleting files will cause DPOF (Digital Print Order Format) settings to be reset.
- ① Deleted files will be permanently deleted and will not be able to be recovered or restored.

DPOF (Digital Print Order Format)

The DPOF feature allows you to compile and select a group of pictures that you would like to print and will save your selection on the memory card so that you can use the memory card to print without having to individually specify the photos you want to print.

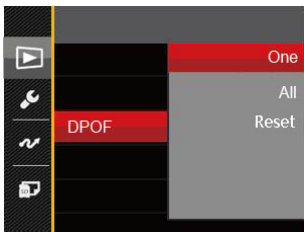

A printer that supports DPOF is needed for photo printing.

Trim

The Trim Setting allows you to crop photos and save them as new pictures.

1. Select [Yes] to confirm trim. Select a section of the photo to be trimmed using the zoom lever and direction buttons to trim a photo.

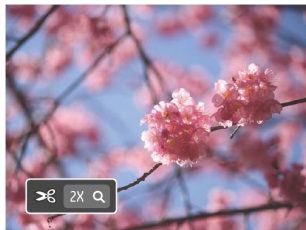







2. Press the **SET** button and the [Save Change?] prompt appears. Select [] to change and save the picture. Select [] to cancel changes and return to the trim prompt screen.



The image cannot be clipped/trimmed again once it has been clipped to 640 x 480.

Setup Menu

Mode :      

1. Press the  button in any mode and press the up/down button to select .
2. Press the  button to enter the menu.
3. Press the up/down button to select  and press the  button or right button to enter the menu.
4. Press the up/down button to select the item to be set and press the  button or right button to enter the menu.
5. Press the up/down buttons to select an option and press the  button to confirm.

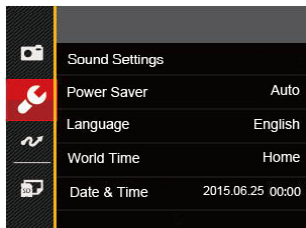

Refer to the following pages for more details about each setting.

Sound Settings

With this setting you may adjust the sound and volume.

Press the left/right button to adjust the volume and Press the (SET) button to confirm.

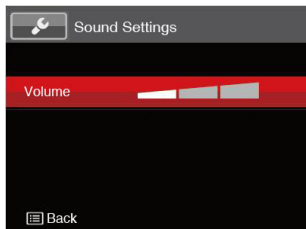

Power Saver

This setting allows you to save power and get the maximum possible running time for your camera's batteries. This setting will also turn the LCD and camera off automatically after a consecutive period of inactivity.

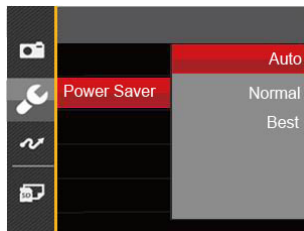

- Auto
- Normal



• Best Power Saver	LCD Power Off Time	Turn Off Time
Auto	3 min	5 min
Normal	1 min	3 min
Best	30 s	1 min

Language

Refer to the “Reset your language” section on page 19.

World Time

The world time setting is a useful function for your overseas trips. This feature enables you to display the local time on the LCD while you are abroad.

1. Press the up/down to select the departure place () and destination () fields.
2. Press the left/right button to select a city located in the same time zone as that of the field. Press the  button to confirm settings.



Date & Time

Refer to the “Reset Date/Time” section on page 20.



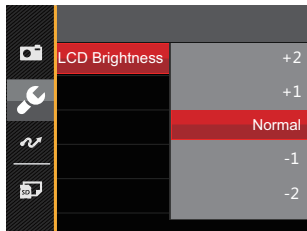

LCD Brightness

Use this setting to adjust the brightness of your LCD.





File Setting

Mode :  **M**   **SCN**  

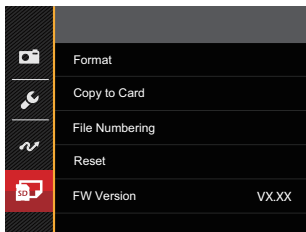
1. Press the  button, press the up/down button to select  and press the  button to enter the menu.
2. Press the up/down button to select  and press the  button or right button to enter the menu.





4. Press the up/down button to select the item to be set and press the  button or right button to enter the menu.
5. Press the up/down buttons to select an option and press the  button to confirm.

Format

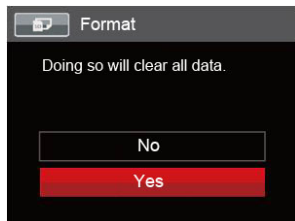
Please note: formatting enables you to delete all contents on the memory card and built-in memory, including protected photo and movie files.



-  If you select [Yes] the camera will format its memory.
-  If there is no memory card in the camera, the built-in memory will be formatted; if there is a memory card, only the memory card will be formatted.

Copy to Card

Use this setting to copy the files stored in the camera's built-in memory to a memory card.

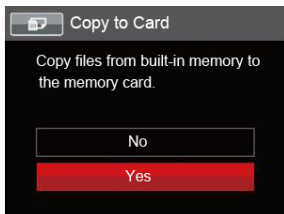

If there is no card available in the camera, this function will not be displayed.

File Numbering

After you take a picture or video clip, the camera will automatically save it with a sequential number. You can use this to reset the file numbering to 0001.

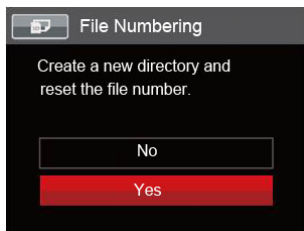

Reset

Use this setting to restore the camera to its original factory default settings.

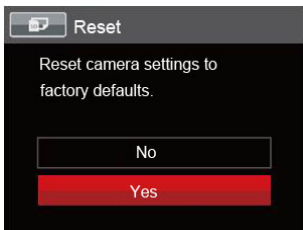

Firmware (FW) Version

Use this setting to view the current camera firmware version.

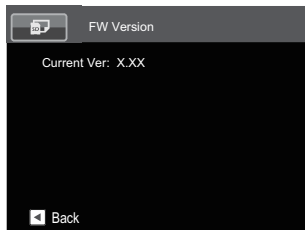

When there is a new firmware version in the memory card, select [Yes] to update.

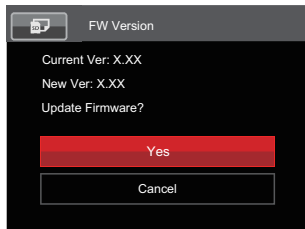







Connection Settings

Connecting to a Computer

You can use a Micro USB cable to connect the camera and copy (transmit) photos to a computer, printer or other device.

Setting the USB Mode

The camera's USB port can be used to connect to either a computer or a printer. The following steps will allow you to ensure that the camera is correctly configured to connect with a PC.

1. Press the  button, press the up/down button to select  and press the  button to enter the menu.
2. Press the up/down button to select  and press the  button or right button to enter the menu.
3. Press the up/down button to select [USB] and press the  button or right button to enter the menu.
4. Press the up/down buttons to select [PC] and press the  button to confirm.



Transferring Files to your Computer

The computer will automatically detect the camera as a removable drive. Double-click the “My Computer” icon on the desktop to locate the removable drive and to copy folders and files in the drive to a directory on your PC as you would copy any typical folder or file.

Follow the steps below to connect the camera to a computer:

1. Make sure the computer is turned on.
2. Connect one end of the supplied Micro USB cable to the USB port on your camera.
3. Connect the other end of the Micro USB cable to an available USB port on your computer.
4. After the transmission is complete, disconnect the Micro USB cable according to your computer manufacturer’s instructions specifying how to safely remove USB devices.

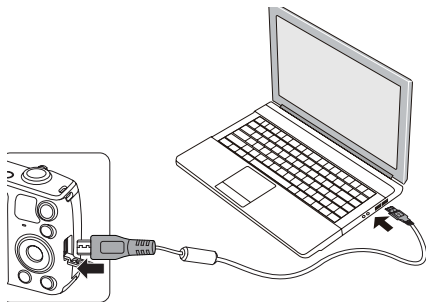







Connecting to a PICTBRIDGE™ Compatible Printer

PICTBRIDGE™ technology allows printing of the photos saved on a memory card by a printer.



To find out if a printer is PICTBRIDGE™ compatible, simply look for the PICTBRIDGE™ logo on the packaging or check the owner's manual for specifications. With the PICTBRIDGE™ function on your camera, you can print the captured photos directly to a PICTBRIDGE™ compatible printer using the supplied Micro USB cable, without the need for a PC.

Setting the USB Mode

The camera's USB port can be set to connect with either a PC or a printer. The following steps will ensure that the camera is correctly configured to connect with a printer.

1. Press the  button, press the up/down button to select  and press the  button to enter the menu.
2. Press up/down button to select  and press the  button or right button to enter the menu.
3. Press the up/down button to select [USB] and press the  button or right button to enter the menu.
4. Press the up/down button to select [Printer] and press the  button to confirm.



-  After the camera is reset, it will switch to PC mode automatically from USB mode.
-  See "Using the PICTBRIDGE™ Menu" section on page 73.

Connecting to your Printer

1. Make sure the printer is turned on.
2. Connect one end of the supplied Micro USB cable to the USB port on your camera.
3. Connect the other end of the Micro USB cable to the USB port on the printer.

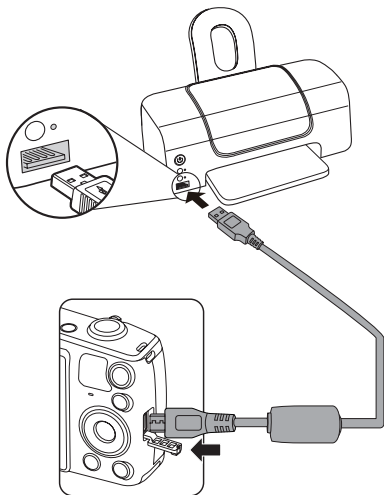

If the camera is not connected to a PICTBRIDGE™ compatible printer, the following error message will appear on the LCD.

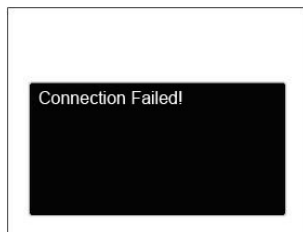

The error message above will also appear if the USB mode is set incorrectly, in which case you should disconnect the Micro USB cable, check the USB mode settings, ensure that the printer is turned on, and then try connecting the Micro USB cable again.

Using the PICTBRIDGE™ Menu

After setting the USB mode to Printer, the PICTBRIDGE™ menu will appear.

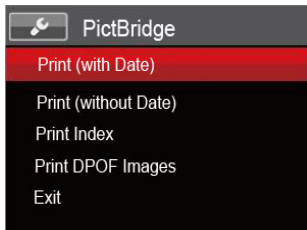

Press the up/down button to select a menu item and press the **SET** button or right button to enter the item.

Refer to the following sections for more detailed information on each setting.

Print (with Date)

If you have set the date and time on your camera, the date and time will be recorded and saved with each photo you take.

1. In the PICTBRIDGE™ menu, select [Print (with Date)] and the screen as shown below appears.

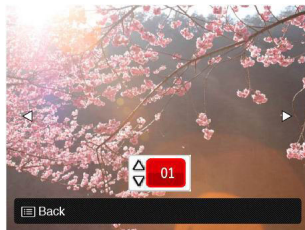

2. Press the left/right button to select the photo to be printed.

3. Press the up/down button to select the number of copies for the currently displayed photo.
4. Press the **(SET)** button and the following screen will appear.

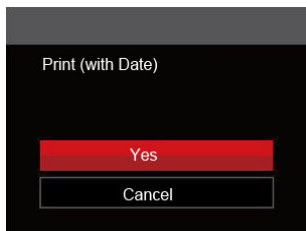

5. Select [Yes] and press the **(SET)** button to confirm printing; select [Cancel] and press the **(SET)** button to cancel printing.

Print (without Date)

Use this setting to print the photos without dates on them.

1. In the PICTBRIDGE™ menu, select [Print (without Date)] and the screen as shown below appears.

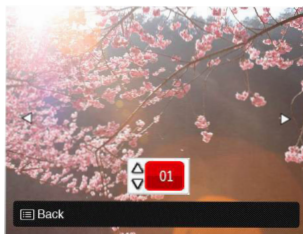

2. Press the left/right button to select a photo to be printed.
3. Press the up/down button to select the number of copies for the currently displayed photo.
4. Press the **(SET)** button and the following screen will appear.

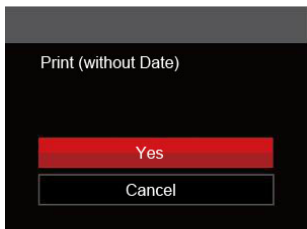

5. Select [Yes] and press the **(SET)** button to confirm printing; select [Cancel] and press the **(SET)** button to cancel printing.

Print Index

You can print all photos in the camera via this function.

1. In the PICTBRIDGE™ menu, select [Print Index] and the screen as shown below appears.

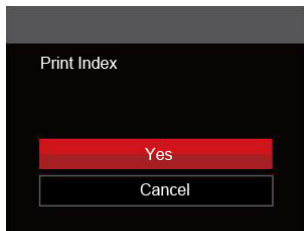

2. Select [Yes] and press the **(SET)** button to confirm printing; select [Cancel] and press the **(SET)** button to cancel printing.

Print DPOF Images

To use DPOF printing, you must select your photos for printing using the DPOF settings beforehand. See “DPOF” section on page 62.

1. In the PICTBRIDGE™ menu, select [Print DPOF Images] and the screen as shown below appears.

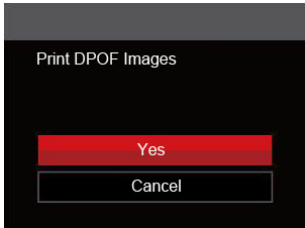

2. Select [Yes] and press the **(SET)** button to confirm printing; select [Cancel] and press the **(SET)** button to cancel printing.







Exit

Select [Exit] to exit the PICTBRIDGE™ menu. At this time, the message [Remove USB Cable!] will appear on the screen.

Disconnect the Micro USB cable from the camera and printer.

Video System

You can use the AV cable (which should be purchased separately) to connect the camera and the television for setting up the video output. Connect one end of the AV cable to AV port of the camera, and connect the other end to AV-OUT port of the television. To adjust the format of the video output system according to your requirements:

1. Press the  button, press the up/down button to select  and press the  button to enter the menu.
2. Press the up/down button to select  and press the  button or right button to enter the menu.
3. Press the up/down button to select [TV-System] and press the  button or right button to enter the menu.
4. Press the up/down button to select [NTSC] or [PAL] and press the  button to confirm.

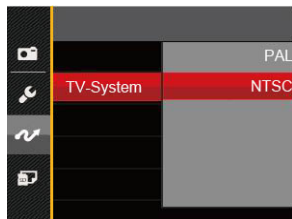

NTSC: English, Chinese (Traditional), Japanese, French, Korean, Russian, Vietnamese, Greek, Hungarian







PAL: German, Spanish, Italian, Chinese (Simplified), Portuguese, Swedish, Danish, Finnish, Indonesia, Norwegian, Dutch, Turkish, Polish, Thai, Croatian, Czech, Arabic, Hindi



The video output system changes based on the selected language.

Set Eye-Fi Card Connection Mode

This camera supports wireless connection for Eye-Fi cards. Enable the Eye-Fi connection by following the steps below:

1. Press the  button, press the up/down button to select  and press the  button to enter the menu.
2. Press the up/down button to select  and press the  button or right button to enter the menu.
3. Press the up/down button to select [Eye-Fi] and press the  button or right button to enter the menu.
4. Press the up/down buttons to select [On] or [Off] and press the  button to confirm.

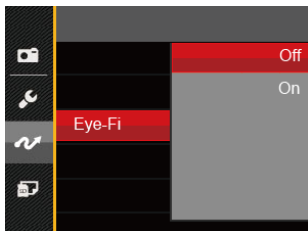

If the Eye-Fi card is not available in the camera, this feature is not displayed.

Appendices

Product Specifications



Design and specifications are subject to change without notice.

Image Sensor	Type	1/2.3"CCD
	Effective Pixels	16.15 Megapixels
	Total Pixels	16.44 Megapixels
Lens	Focal Length	4.3mm (Wide) — 64.5mm (Tele)
	35mm film Equivalent	24mm (Wide) — 360mm (Tele)]
	F Number	F3.3 (Wide) — F5.9 (Tele)
	Lens Construction	9 Groups 10 Elements
	Optical Zoom	15x
	Focusing Range	Normal: (Wide) 60cm ~ ∞ (Tele) 250cm ~ ∞ Macro: 3cm ~ ∞ (Wide Only)
Autofocus System		TTL Autofocus
Anti-Handshake		Optical Image Stabilization (OIS)
Digital Zoom		4x Digital Zoom (Combined Zoom: 60x)

Number of Recording Pixels	Still Image	(4:3) 16MP: 4608×3456 10MP: 3648×2736 5MP: 2592×1944 3MP: 2048×1536 0.3MP: 640×480	(3:2) 14MP: 4608×3072	(16:9) 12MP: 4608×2592 2MP: 1920×1080
	Movie	1280×720 (15/30fps), 640×480 (30fps)		
Image Compression		Best, Fine, Normal		
DCF, DPOF (Ver1.1) Support		Yes		
File Format	Still Image	Exif 2.3 (JPEG)		
	Movie	MOV [Image: Motion JPEG; Audio: G.711 (Monaural)]		
Shooting Modes		Auto Mode, Manual Mode, Portrait Mode, Movie Mode, Panorama Mode, Scene Mode		
Scene Mode		Auto Scene, Landscape, Sport, Beach, Sunset, Fireworks, Night Landscape, Snow, Children, ID, Glass, Photo Frame, Panning Shot, Fish Eye, Party, Indoor, Leaf, Museum, Night Portrait, Sketch		
Detection Features		Face, Smile, Blink		
Red-Eye Removal		Yes		
HDR		Yes (Post-Processing)		

Panorama	Up to 180° (Horizontal)
LCD Display	3.0inch (230k Pixels)
ISO Sensitivity	Auto, ISO80/100/200/400/800/1600
AF Method	Single AF, Multi-AF (TTL 9-point), Face-Detection
Exposure Metering Method	Artificial Intelligence AE (AiAE), Center-Weighted Average, Spot (Fixed to Center of Frame), Face AE
Exposure Control Method	Program AE (AE-Lock Available)
Exposure Compensation	±2EV in 1/3 Step Increments
Shutter Speed	1/2000 ~ 4 Seconds (Manual: 30 Seconds)
Continuous Shooting	Yes
Playback Modes	Single Photo, Index (9/16 Thumbnails), Slide Show
	Zoom (Approx. x2-x8)
White Balance Control	AWB, Daylight, Cloudy, Fluorescent, Fluorescent CWF, Incandescent, Manual WB

Flash	Flash Method	Pop-up (Manual)
	Flash Modes	Force Off, Flash Auto, Fill Flash, Slow Sync., Slow Sync. + Red-Eye, Red-Eye Reduction
Recording Media		Internal Memory: Approx. 8MB
		SD/SDHC Card (Up to 32GB Support) (MMC Card Not support)
Multi-Language Support		27 Languages
Jacks		AV-OUT/USB 2.0 (Micro 5 pin USB)
Eye-Fi Support		Yes
Power		Rechargeable Li-ion Battery LB-052, 3.7V 890mAh, In-Camera Charging
Shooting Capability (Battery Performance)		Approx. 210 Shots (Based on CIPA Standards)
Operation Environment		Temperature: 0 ~ 40°C, Humidity: 0 ~ 90%
Dimensions (W×H×D)		Approx. 108.4×69.9×32.8mm (Based on CIPA Standards)
Weight		Approx. 185g (Body Only)

Prompts and Warning Messages

Message	Description	Action
Warning! Battery exhausted.	The camera battery is depleted. It is a warning indicating that the camera is going to shut off.	Charge the battery.
Lens obstruction, Re-start Camera.	The lens is jammed or some foreign object is preventing the lens from functioning properly.	Turn the camera off and restart it to reset the lens.
Suggest using tripod.	The message will appear when shooting in low light/illuminated scenes.	Use of a tripod or other support is suggested.
Battery temperature is too high.	The battery temperature reaches 58°C (136°F).	Let the battery cool before attempting to use the camera again. This message will disappear after 2 seconds.
Built-in memory error!	An error has occurred in the internal memory.	Format the internal memory.
Slow shutter is on: may easily cause overexposure.	When the B shutter is on, the prompt appears on the screen after you go back to the photo shooting screen.	This message will disappear after 2 seconds.

Message	Description	Action
Improper alignment. Please try again.	The offset is too big for panorama shooting.	This message will disappear after 2 seconds.
Connection Failed!	In the case of failing to connect to a PC or a printer.	Remove transmission line to stop connection, and the message is removed.
Warning! Do not turn off your camera during update!	This message appears during the firmware update process.	This message disappears after the camera update and restart.
Remove USB Cable!	Indicates that you can disconnect the Micro USB cable.	This message disappears after you disconnect the Micro USB cable.
Write Protect!	The memory card is locked.	Unlock the write-protect switch of the memory card.
Card Full !	Indicates that the memory card is full.	Insert a new memory card or delete unwanted images.

Message	Description	Action
Memory Full !	Indicates that the internal memory is full.	Insert a new memory card or delete unwanted images.
Card Error !	The memory card cannot be recognized after being formatted.	Insert a new memory card or format the card with this camera.
Card is not formatted.	The inserted memory card is unformatted or has been formatted on a computer or other device and is not compatible with this camera.	This message disappears after 2 seconds and the camera enters the formatting process.
Slow access	When a memory card lower than Class 4 is used to record a HD movie, the writing speed will be slower and recording will not continue.	Use an memory card with Class 4 or higher.
No Red-Eye Detected!	Red eyes have not been detected in the image.	This message will disappear after 2 seconds.

Message	Description	Action
This image cannot be edited.	The file format does not support editing or the edited file cannot be edited again.	This message will disappear after 2 seconds.
Exceeded maximum folder number.	Prompt message when the archives or file folders in the memory card have reached the maximum (9999 for archives, 999 for file folder).	Copy the images to your PC and format the memory card with this camera.
Too many pictures for quick processing.	During the playback by date, the images exceed specifications so that it is not possible to play by date.	This may be solved by deleting unnecessary images.
Unable to recognize files.	The format of the file to be viewed is not supported or the file is corrupted so it cannot be properly read.	You may be able to play it back on another brand of camera or on your computer.
No Picture!	When you press the playbutton, no image files exist in the camera or memory card.	This message disappears after 2 seconds and returns to the photo shooting screen.
Protected! Undeletable!	The file is protected. The message appears when you go into delete mode.	Unprotect the file before deleting.

Troubleshooting

Problem	Possible causes	Solution
Camera does not turn on	<ul style="list-style-type: none">■ The battery has been depleted.■ The battery is not inserted correctly.	<ul style="list-style-type: none">■ Recharge the battery.■ Correctly reinstall the battery.
Camera turns off suddenly during operation	<ul style="list-style-type: none">■ The battery has been depleted.	<ul style="list-style-type: none">■ Recharge the battery.
The picture is blurry	<ul style="list-style-type: none">■ Camera shakes while taking a picture.	<ul style="list-style-type: none">■ Turn on OIS Feature.
Images and video files cannot be saved	<ul style="list-style-type: none">■ The memory card is full.■ The memory card is locked.	<ul style="list-style-type: none">■ Use another memory card or delete unnecessary files.■ Unlock the memory card.
Images will not print from the connected printer	<ul style="list-style-type: none">■ The camera is not connected to the printer correctly.■ The printer is not PICTBRIDGE™ compatible.■ The printer is out of paper or ink.■ The printer paper is jammed.	<ul style="list-style-type: none">■ Check the connection between the camera and printer.■ Use a PICTBRIDGE™ compatible printer.■ Load paper into the printer or replace the ink cartridge in the printer.■ Remove the jammed paper.

Problem	Possible Causes	Solution
Saving data to memory card is slow	<ul style="list-style-type: none"> ■ Using a memory card below Class 4 may result in slower recording times. 	<ul style="list-style-type: none"> ■ Use a memory card with write Class 4 or higher to improve performance.
Cannot write to the memory card	<ul style="list-style-type: none"> ■ The memory card has been locked. 	<ul style="list-style-type: none"> ■ Release the write lock of the memory card or replace with another card.
Too many movies to process	<ul style="list-style-type: none"> ■ The number of pictures or folders in the memory card exceed the specifications, so the playback of data folder can not be displayed. 	<ul style="list-style-type: none"> ■ Delete unwanted files.
The flash  flashes on the LCD screen.	<ul style="list-style-type: none"> ■ Current shooting environment requires flash. 	<ul style="list-style-type: none"> ■ Turn on flash.

© 2019 JK Imaging Ltd. All Rights Reserved.

The Kodak trademark, logo and trade dress are used under license from Eastman Kodak Company.

All other logos, products or company names that are referred to in this document are trade names, trademarks or registered trademarks of their respective owners and holders. The owners and holders are not affiliated with JK Imaging Ltd., our products or our website.

JK Imaging Ltd., 17239 So. Main Street, Gardena, CA 90248 USA

kodakpixpro.com

Made in Myanmar



Ver. 7