

MASONRY CONSTRUCTION PRODUCTS

P: +61 3 9870 4242 • sales@masonrycp.com • www.masonrycp.com

Catalogue Issue

20



Concreting • Plastering • Rendering • Brick Laying • Construction Tools
Mining • Formwork • Civil • Waterproofing • Concrete Jointing Systems

Universal Cut - 999 Series



999
SERIES



- Reinforced concrete/steel
- Extreme speed, extreme long life, lowest cost per cut
- Will cut: Building materials, concrete products, granite and natural stone, iron and steel

Code	Diameter Metric	Diameter Imperial	Bore mm	Pack
UC230	230	9	22.3	10
UC350	350	14	25.4/20	10
UC400	400	16	25.4/20	5

All Material Diamond Blade - 888 Series



888
SERIES



- Precision cut
- Hole design for high visibility through blade whilst cutting
- Armoured blade core for safety
- Will cut: building materials, concrete products, granite and natural stone

Code	Diameter Metric	Diameter Imperial	Bore mm	Pack
888105	105	4	20/16	10
888115	115	4.5	22.3	10
888125	125	5	22.3	10
888230	230	9	22.3	10
888350	350	14	25.4/20	10

Cured Concrete - 555 Series



555
SERIES



- Laser welded
- 12mm segment for long life
- Will cut: cured concrete, reinforced concrete

Code	Diameter Metric	Diameter Imperial	Bore mm	Pack
LCONC12	305	12	20/16	10
LCONC14	350	14	25.4/20	10
LCONC16	400	16	25.4/20	5
LCONC20	500	20	25.4/20	5
LCONC24	600	24	25.4/20	5

Asphalt/Green Concrete - 333 Series



333
SERIES



- Laser welded
- 12mm segment for long life
- Will cut: asphalt, green concrete

Code	Diameter Metric	Diameter Imperial	Bore mm	Pack
LAGC9	230	9	22.3	10
LAGC12	305	12	20/16	10
LAGC14	350	14	25.4/20	10
LAGC16	400	16	25.4/20	5

Concrete Block - 444 Series



444
SERIES



- Laser welded
- 12mm segment for long life
- Will cut: concrete block

Code	Diameter Metric	Diameter Imperial	Bore mm	Pack
LBLOCK14	350	14	25.4/20	10
LBLOCK16	400	16	25.4/20	5
LBLOCK20	500	20	25.4/20	5

Clay Bricks/Pavers - 777 Series



777
SERIES



- Laser welded
- 12mm segment for long life
- Will cut: clay bricks, pavers

Code	Diameter Metric	Diameter Imperial	Bore mm	Pack
LCLAY14	350	14	25.4/20	10
LCLAY16	400	16	25.4/20	5
LCLAY20	500	20	25.4/20	5

Whisper Silent Block - 444 Series



444
SERIES



- Laser welded
- 12mm segment for long life
- Will cut: concrete block
- Silent blade

Code	Diameter Metric	Diameter Imperial	Bore mm	Pack
BCS14BLOCK	350	14	25.4/20	5
BCS20BLOCK	500	20	25.4/20	5

Whisper Silent Clay - 777 Series



777
SERIES



- Laser welded
- 12mm segment for long life
- Will cut: concrete block
- Silent blade

Code	Diameter Metric	Diameter Imperial	Bore mm	Pack
BCS14CLAY	350	14	25.4/20	5

Super Turbo - 222 Series



- Professional quality, excellent value for money diamond blade
- 10mm segment
- Will cut: cured concrete, reinforced concrete, clay products and general building materials



Code	Diameter Metric	Diameter Imperial	Bore mm	Pack
ST4	105	4	20/16	10
ST45	115	4.5	22.3	10
ST5	125	5	22.3	10
ST9	230	9	22.3	10

Diamond Blade - Gold Series



- The best diamond blade you can buy at this price point
- 10mm segment
- Will cut: cured concrete, reinforced concrete, clay products and general building materials



Code	Diameter Metric	Diameter Imperial	Bore mm	Pack
GOLD230	230	9	22.3	25
GOLD350	350	14	25.4/20	10

Cup Grinding Wheels - Double Row



- Double Row for longer life and a smoother finish
- Perfect for flat grinding
- For removal of imperfections



Code	Diameter Metric	Diameter Imperial	Bore mm	Pack
GCW100-DR	105	4	20/16	10
GCW115-DR	115	4.5	22.3	10
GCW125-DR	125	5	22.3	10
GCW180-DR	180	7	22.3	10

Cup Grinding Wheels - Turbo Style



- Perfect for shaping concrete/stone
- For removal of imperfections



Code	Diameter Metric	Diameter Imperial	Bore mm	Pack
GCW100-TB	105	4	20/16	10
GCW115-TB	115	4.5	22.3	10
GCW125-TB	125	5	22.3	10
GCW180-TB	180	7	22.3	10

Electro Plated Diamond Blade



- Electro plated diamond blade for fine cutting
- Will Cut: Marble, Fibreglass, Plastics, Slate, GRP



Code	Diameter Metric	Diameter Imperial	Bore mm	Pack
DBEP100	105	4	16	10
DBEP125	125	5	22.3	10

Best Cut Grinding Plate



- Use with CUB Grinders



Code	Size mm	Segments	Grit	Colour	Box
GP-10SEG30	250	10	30	White	5

Crack Chasing Diamond Blade



- Crack chasing blade
- 6.5mm V Segmented



Code	Diameter Metric	Diameter Imperial	Bore mm	Pack
BCVC125	125	5	22.2	6

Flap Discs - Mega-Line Blue R828

Features

- Long life, superior performance
- No backing pad required

Applications

- Suitable for use with portable angle grinders and sanders, on stainless steel and carbon steel
- Ideal for grinding and finishing



Code	Diameter mm	Grit	Bore mm	Pack
9800040	102	40	16	5
9800060	102	60	16	5
9800080	102	80	16	5
9800120	102	120	16	5
9801040	115	40	22	5
9801060	115	60	22	5
9801080	115	80	22	5
9801120	115	120	22	5
9803040	127	40	22	5
9803060	127	60	22	5
9803080	127	80	22	5
9803120	127	120	22	5

Cut Off Wheels - Metal

Ideal for general purpose cutting of ferrous metals and steel, this Flexovit cutting wheel fits circular saws and is suitable for both DIY and trade use.



- For cutting ferrous thin gauge sheet steel, plate and small section
- Made in Australia

Code	Diameter Metric-mm	Bore-mm	Pack
M458	105	16	100
M4578	115	22.3	100
M578	125	22.3	100
M978	230	22.3	50
M141	355	25.4	10
M161	405	25.4	10

Cut Off Wheels - Masonry

The Flexovit Masonry wheel is suitable for general purpose cutting of most masonry products. It is ideal for cutting brick, concrete pavers, ceramic and stone.



- Also suitable for non-ferrous metals
- Reliable brand
- Fits all 100mm angle grinders

Code	Diameter Metric-mm	Bore mm	Pack
S458	105	16	100
S4578	115	22.3	100
S578	125	22.3	100
S978	230	22.3	50
S141	350	25.4	10
S161	405	25.4	10

Ultra Thin Cut Off Blades - 1mm

Ultra thin and fast cutting. Suitable for cutting stainless steel or ferrous hard metals.

- For cutting stainless steel and hard ferrous metals
- Premium grade, clean burr free cutting and excellent life
- Free of iron, sulphur and chlorine



Code	Diameter Metric	Blade Thickness mm	Bore mm	Pack
15102010	105	1	16	100
15115010	115	1	22.3	100
15127010	125	1	22.3	100
15230019	230	1.9	22.3	50
15230020	230	2	22.3	50

MAXX Ultra Thin Cut Off Blades - 1mm

- Premium grade NorZon Plus grain
- Ideal for cutting stainless steel, alloy steels & hard ferrous metals
- Fast, burr free cutting & long life
- ZA60Y-BF41 M/Inox
- Made in Australia



Code	Diameter Metric	Blade Thickness mm	Bore mm	Pack
66252837153	105	1	16	25
66252841589	115	1	22.3	25
66252837155	125	1	22.3	25

Cable Ties

RANSOM
TOOLWORKS

Black UV Cable Ties:

- High quality 66UL nylon
- UL94V-2 flammable rating
- UV stabilised to resist material breakdown and increase service life



Code	Size-mm	Description	Pack Qty	Pack Box	Max Loop Diam (mm)	Min Loop Tensile Strength (Kg)
CT15036	150 x 3.6	Black UV	100	230	39	18
CT20048	200 x 4.8	Black UV	100	130	53	22
CT20080	200 x 8.0	Black UV	100	75	52	55
CT25048	250 x 4.8	Black UV	100	120	68	22
CT30048	300 x 4.8	Black UV	100	100	83	22
CT30080	300 x 8.0	Black UV	100	50	80	55
CT37048	370 x 4.8	Black UV	100	90	105	22
CT37080	370 x 8.0	Black UV	100	45	101	55
CT45080	450 x 8.0	Black UV	100	35	128	55
CT55080	550 x 8.0	Black UV	100	25	160	55
CT55013	550 x 12.7	Black UV	100	16	159	114
CT122090	1220 x 9.0	Black UV	100	10	372	80

Portable RCD Power Box

- Portable power box
- Consists of 4 outlets - 2 on front, 2 on back
- 10amp
- 1.5m lead and plug



Code	Description	Pack
ESG10	Power Box RCD - 10AMP - 4 Outlet	6
ESG15	Power Box RCD - 15AMP - 2 Outlet	6

Heavy Duty Electrical Leads

- Industrial quality leads
- 15amp lead
- 10amp clear glow plugs
- Heavy duty



Code	Description	Pack
EL10	10m - 15 AMP Lead/10AMP Plugs	5
EL15	15m - 15 AMP Lead/10AMP Plugs	5
EL20	20m - 15 AMP Lead/10AMP Plugs	5
EL30	30m - 15 AMP Lead/10AMP Plugs	5

Marx Spot and Survey Marking Paint



Features & Benefits

- Premium upside down marking out paint
- Toluene-free formula
- High opacity, high quality, true colour
- Vast selection of bright colours for highly visible marks
- Applications include construction, landscaping, civil works and surveying
- Colour identification dots on outer cartons for quick and easy bulk order picking

MARX Spot and Survey Paint.

Exclusive distributors Masonry Construction Products

Code	Colour	Size	Pack Qty
MXB	Blue	350G	12
MXW	White	350G	12
MXY	Yellow	350G	12
MXO	Orange	350G	12
MXR	Red	350G	12
MXG	Green	350G	12
MXBLK	Black	350G	12
MXFP	Fluro Pink	350G	12
MXFB	Fluro Blue	350G	12
MXFY	Fluro Yellow	350G	12
MXFO	Fluro Orange	350G	12
MXFR	Fluro Red	350G	12
MXFG	Fluro Green	350G	12
MXV	Violet	350G	12



Marx Spray Marking Dispensers



Code	Description	Pack
SMD	Spray Marx Hand Dispenser	2

Marx Cold Galvanising Spray & Silver Galvanising Spray

MXCOLD

- MXCOLD Contains 95% zinc in dry film.
- Excellent adhesion properties
- Excellent touch-up for damaged galvanized surfaces.
- Allows spot welding.
- No chlorinated solvents. Totally lead and chromate free.
- Excellent corrosion resistance through cathodic protection even when the coating is scratched or damaged.
- Good mechanical resistance due to the excellent adhesion on metal.
- Can be over painted by most commonly used finishes.

MXSILVER

Ideal for re-galvanising & repairing damaged spots on galvanised parts. Suitable as a top coat for Marx Coldgal. It offers corrosion protection, fast drying, as well as an ideal colour match to newly galvanised metal.



Code	Colour	Size	Pack Qty
MXCOLD	Matt Grey	400G	12
MXSILVER	Bright Silver	400G	12

Marx Carpenters Pencil

MARX

- Medium pencils are ideal for marking on smooth surfaces such as timber and plaster.
- Hard pencils are ideal for rough surfaces such as concrete and brickwork



Code	Description	Pack
314MED	Medium - Red (72pcs per box)	1
314HARD	Hard - Green (72pcs per box)	1

Permanent Marking Pens - Maxx 130

Schneider Write it

- Permanent marker with bullet tip 1-3mm
- For metal, cardboard, paper, plastic, glass, wood, etc.
- Quick-drying, light and water resistant
- Odourless ink without addition of Toluol and Xylol
- Cap-off ink does not run dry even if the cap is removed for 2-3 days
- Made in Germany



Code	Colour	Tip Type	Pack
113001	Black	Bullet 1-3mm	10pcs
113002	Red	Bullet 1-3mm	10pcs
113003	Blue	Bullet 1-3mm	10pcs
113004	Green	Bullet 1-3mm	10pcs

Lumber Crayons

LEVIATHAN

- Industrial marking crayons
- Ideal for marking metal, lumber, rubber, paper, ceramics, concrete and cardboard



Code	Colour	Description	Pack
LL-3NBLKP	Black	12pcs per Colour box	1
LL-3NREDP	Red	12pcs per Colour box	1
LL-3NBLUP	Blue	12pcs per Colour box	1
LL-3NWHIP	White	12pcs per Colour box	1
LL-3NYELP	Yellow	12pcs per Colour box	1

Paint Pens - Maxx 270

Schneider Write it

- Bullet Tip for a strong line width 1-3mm
- For rough and smooth surfaces
- High coverage, lightfast, water and weather-resistant
- Without Toluol and Xylol
- Made in Germany



Code	Colour	Tip Type	Pack
127001	Black	Bullet 1-3mm	10
127002	Red	Bullet 1-3mm	10
127003	Blue	Bullet 1-3mm	10
127004	Green	Bullet 1-3mm	10
127005	Yellow	Bullet 1-3mm	10
72707	White	Bullet 1-3mm	5

Maxx 130 - 80pcs Display

Schneider Write it

- Permanent marker with bullet tip 1-3mm
- For metal, cardboard, paper, plastic, glass, wood, etc.
- Quick-drying, light and water resistant
- Odourless ink without addition of Toluol and Xylol
- Cap-off ink does not run dry even if the cap is removed for 2-3 days
- Made in Germany



Code	Colour	Quantity	Tip Type
300802	Black	40pcs	Bullet 1-3mm
	Red	10pcs	Bullet 1-3mm
	Blue	20pcs	Bullet 1-3mm
	Green	10pcs	Bullet 1-3mm

Lumber Crayons - Large

LEVIATHAN

- Industrial marking crayons
- Each crayon is 18mm in diameter by 115mm in length.



Code	Colour	Description	Pack
LIMCR	Red	12pcs per Colour box	1
LIMCB	Blue	12pcs per Colour box	1
LIMCW	White	12pcs per Colour box	1
LIMCY	Yellow	12pcs per Colour box	1

Builders Buckets



- Strong poly buckets
- An essential for all building sites



Code	Description	Pack
PB	Orange 12L Heavy Duty	10

Builders/Mortar Buckets



Code	Size-mm	Description	Pack
J32	640 x 490 x 170	32 litre	12
J40	470 Round x 330 High	40 litre	12

Measuring Jugs & Funnel

- Raised graduations
- UV stabilised
- Highly chemical resistant
- Strong, robust construction
- Excellent pouring control
- Made in Australia



Code	Description	Size	Pack
FJ025	Measuring Jug	250ml	10
FJ050	Measuring Jug	500ml	10
FJ100	Measuring Jug	1 Litre	10
FJ200	Measuring Jug	2 Litre	10
FJ300	Measuring Jug	3 Litre	10
FJ500	Measuring Jug	5 Litre	10
FUNNEL230	Funnel With Filter	230mm	6

Hammer Tacker - Freund



Code	Description	Pack
F3425	Fast & Fix 11 - Hammer Tacker Stapler with Storage Pouch	5

Hammer Tacker Staples



Code	Type	Size mm	Pack	Box
RT140-06	Type 140/T50	6	5000pcs	20
RT140-08	Type 140/T50	8	5000pcs	20
RT140-10	Type 140/T50	10	5000pcs	20

Hand Stapler - Freund



Code	Description	Pack
F3423	#53 Hand Stapler Heavy Duty	5
RT53-08	Staples Type 53 - 8mm - Box of 5000pcs	12

Handsaws

- Soft grip handle
- Diamond ground 3 point teeth



Code	Description	Pack
HS16	Hard Point - 400mm	6
HPS22	Hard Point - 600mm	6

Wallboard Saw



- Keyhole saw to cut plasterboard, cellular concrete, wooden panels, etc...
- Triple bezel blade
- Teeth on both sides for multi directional cutting
- Soft grip handle
- Holster included



Code	Description	Pack
67055	Triple Bezel Blade Drywall Saw - 150mm	6

Snap Blade Knife - 18mm



- Rubber grip reduces hand slipping
- Attractive display box of 24 knives



Code	Description	Pack
RT349	Snap Blade Knife - 18mm Blades	24

Pocket Folding Knife



- Comes with 5pcs of spare blades
- Safe, tough, and compact



Code	Description	Pack
RT363	Pocket Folding Knife	6

Spare Blades



RT615



RTK1S

Code	Description	Pcs	Pack
RTSB8	18mm Snap Blade Knife Blades	10	12
RTK1S	Utility Knife Blades	10	12
RT615	Utility Knife Blades Dispenser	100	12

Utility Knives - Ransom



- Classic die cast design and construction
- Blade storage in knife body
- Display box of 36 knives



Code	Description	Pack
RT356	Utility Knife - Push Button - Metal Body	36

Marco Pesaro Caulking Guns



MSG



MSGP



Code	Description	Size-mm	Pack
MSG	Orange - Metal	230	12
MSGP	Metal Professional	230	12

Marco Pesaro Sausage Gun



- Trade quality
- Strong construction
- Metal end caps to prevent them popping off



Code	Description	Size-mm	Pack
MSGS	Aluminium Gun	600ml	12
NOZZLE	Nozzle to suit #MSGS		20
MSGSPLG	Plastic Plunger		6

Wasp Floor Scrapers



- Blades are made of spring steel

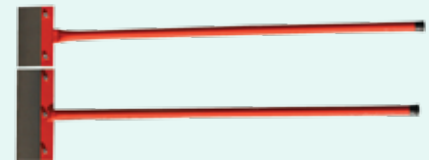

Code	Blade Size-mm	Description	Pack
FS200	200	Complete	6
FS300	300	Complete	6
FS200SB	200	Spare Blade	6
FS300SB	300	Spare Blade	6

Marco Pesaro Pointing Gun



- 10mm nozzle
- Leakage protection for vertical applications
- Quick, precise and accurate
- Great for mortar pointing works around window and door frames, sash frames, horizontally and vertically
- Ideal for plaster compounds



Code	Description	Size-mm	Pack
MPMGUN	Mortar Gun	600 x 10mm	12

Masking Tape With Drop Sheet

- High quality masking tape & film
- Self static plastic
- Indoor/Outdoor use
- Reusable dispenser



Code	Description	Size	Pack
DS650	Complete	16mm Tape - 650 x 33m	24
DS650R	Replacement	16mm Tape - 650 x 33m	24
DS1400	Complete	16mm Tape - 1400 x 33m	24
DS1400R	Replacement	16mm Tape - 1400 x 33m	24
DS1800	Complete	16mm Tape - 1800 x 33m	24
DS1800R	Replacement	16mm Tape - 1800 x 33m	24
DS2100	Complete	20mm Tape - 2100 x 33m	24
DS2100R	Replacement	20mm Tape - 2100 x 33m	24
DS2700	Complete	20mm Tape - 2700 x 17m	24
DS2700R	Replacement	20mm Tape - 2700 x 17m	24

Canvas Drop Sheets

- 100% 8oz quality cotton canvas drop sheet
- 2/1 weave ensuring minimal strike-through



Code	Description	Size	Pack
CDC02	Canvas Drop Sheet	1.52m x 3.65m	12
CDC03	Canvas Drop Sheet	1.52m x 1.52m	24
CDC12	Canvas Drop Sheet	3.65m x 3.65m	6

Drop Sheets - Plastic Heavy Duty

- Bio degradable in landfill
- Super strong LDPE
- Independently tested for tensile strength
- Heavy duty 2.3ml thickness



Code	Description	Size	Pack
BD02	Blue Plastic	2.6m x 3.5m	24

Premium Black Cloth Tape - Gaffa



- Ultra tough heavy duty tape
- Easy tear
- Strong adhesion
- Ideal for securing, sealing, holding, repairing, binding and much more...



Code	Description	Size-mm	Pack
GAFFA	Black Gaffa Tape	48mm X 25m	30

Kraft Brown Masking Rolls



- Auto grade masking paper
- Protects against paint and render mess
- Used to cover up windows, window sills, rooftops and pathways



Code	Description	Size	Pack
KM15050	Brown Kraft Paper	150mm x 50m	42
KM30050	Brown Kraft Paper	300mm x 50m	21

Pre-Folded Masking Film

- Works great with tape applicators/maskers
- Unfolds easily
- Clings to surface for easy application



Code	Description	Size	Pack
MT42	Pre-Folded Masking Film	1.21m x 54.8m	12
MT43	Pre-Folded Masking Film	1.81m x 27.4m	12
MT44	Pre-Folded Masking Film	2.41m x 27m	12

Foam Sanding Blocks

- Manufactured in the UK
- Anti clog
- Aluminium oxide
- Solvent free
- Comes in a display pack of 24pcs



Code	Description	Grit	Size-mm
ASB01C	Angled Edge	Fine/Medium	98 x 69 x 26
ASB03C	Angled Edge	Medium/Coarse	98 x 69 x 26
ASB30A	Beveled Edge	Fine	98 x 69 x 26
ASB31A	Beveled Edge	Medium	98 x 69 x 26

Blue Cloth Render Tape

- Premium Render masking cloth with a grade 70 mesh
- Coated with a special UV resistant adhesive for rendering and painting applications
- Waterproof backing with excellent initial tack and adhesive power at low and high temperatures
- Clean removal at least 14 days from application

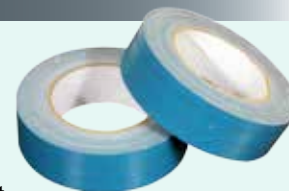

Code	Description	Size-mm	Pack
BRT24	14 Day Render Tape	24mm X 25m	60
BRT36	14 Day Render Tape	36mm X 25m	48
BRT48	14 Day Render Tape	48mm X 25m	30

Masking Tape - Blue 14 Day

- Removes cleanly for up to 14 days
- Medium adhesion
- Interior/Exterior
- Ideal for protecting skirting boards, architraves and window frames
- Paint type: Water based, oil based, varnish and stains
- Surface type: Bricks, blocks, concrete, cabinets, doors, plaster, windows, trims, aluminum joinery, metal, glass laminates, plastic, porcelain and carpet



Code	Description	Size-mm	Pack
MT07	14 Day Masking Tape	24mm X 25m	36
MT08	14 Day Masking Tape	36mm X 25m	24
MT09	14 Day Masking Tape	48mm X 25m	24

Filament Tape - 2 Way

- Cross woven fibreglass strands enhance the strength of filament tape even further to eliminate stretch in any direction
- Aggressive adhesive makes this tape suitable for heavy duty bundling and binding applications



Code	Description	Pack
FILT2W48	Filament Tape - 2 Way - 48mm x 45m	24

Paint Brushes

- Synthetic filament
- Stainless steel ferrule
- Flagged and tapered filaments



Code	Description	Pack
PB25	Paint Brush - 25mm	12
PB40	Paint Brush - 40mm	12
PB50	Paint Brush - 50mm	12
PB65	Paint Brush - 65mm	12
PB75	Paint Brush - 75mm	12
PB88	Paint Brush - 88mm	12

Masking Tape - General Purpose

- Removes cleanly for up to 1 days
- High adhesion
- Interior use
- Ideal for plastic sheeting on floors or areas where removal is not required and packing
- Paint type: Water based, oil based
- Surface type: Bricks, blocks, concrete, cabinets, doors, plaster, windows, trims, aluminum joinery, metal, glass laminates, plastic, porcelain and carpet



Code	Description	Size-mm	Pack
MT24	GP Utility Masking Tape	24mm X 25m	36
MT36	GP Utility Masking Tape	36mm X 25m	24
MT48	GP Utility Masking Tape	48mm X 25m	24

Flat White Disposable Brush

- Pure Hog bristle
- Tin plated ferrule
- Raw wooden handle
- Suitable for paints, resins and glues



Code	Description	Pack
FLATB25	Paint Brush - 25mm	12
FLATB38	Paint Brush - 38mm	12
FLATB50	Paint Brush - 50mm	12
FLATB75	Paint Brush - 75mm	12
FLATB100	Paint Brush - 100mm	12

Industrial & Protective Coating Brush

- 100% Synthetic filament
- Plastic handle
- Ideal for single use applications



Code	Description	Pack
34550	IPC Brush - 25mm	12
34567	IPC Brush - 40mm	12
34574	IPC Brush - 50mm	12
34581	IPC Brush - 65mm	12
34598	IPC Brush - 75mm	12
34604	IPC Brush - 100m	12

Lambswool Roller Covers



- These lambswool covers have a phenolic core with two pack epoxy adhesive to withstand Xylene and other aggressive solvents used in concrete coatings
- Can be used with all paint types



Code	Size-mm	Nap Length	Pack
LW230	230	16mm	12
LW03L	230	20mm	12
LW270	270	16mm	12
LW4609MM	460	9mm	12
LW46016MM	460	16mm	12
LW46022MM	460	22mm	12

Mini Frames - 100mm for Rollers

- to suit 100mm mini rollers



Code	Size mm	Description	Pack
UPHBC4	75	Mini Slide on Frame - 405mm	6

Roller Frame Poles - Extension

- Strong and lightweight
- 5 sizes available
- Universal thread



Code	Description	Size-mm	Pack
PR77S	Alum Roller Frame Pole	350 - 700	6
PR77	Alum Roller Frame Pole	600 - 1200	6
PR78	Alum Roller Frame Pole	1200 - 2400	6
PR79	Alum Roller Frame Pole	1800 - 3600	6

Roller Frame Poles - Screwed Fitting

- Aluminium
- Screwed end fitting



Code	Description	Pack
PR72	Alum Roller Frame Pole - 1.2m Long	12

Pro Ultracover Roller Cover

- Polyester roller covers
- Suitable for water based and acrylic paint
- Used on walls, ceilings, fences and semi rough surfaces



Code	Size-mm	Nap Length	Pack
RC938	230	12mm	12
PR14	270	12mm	12

Industrial Coatings Rollers

- Woven Nylon, ideal for epoxy, industrial & marine anti fouling coatings.
- Thick multiply phenolic cardboard core



Code	Size mm	Nap Length mm	Pack	Ctn Qty
UP410N	100	12	10pcs	6
UIM230	230	12	1pcs	12
UIM270	270	12	1pcs	12
UIM460	460	12	1pcs	12

Heavy Duty Adjustable Frame

- Can be used for 270, 305, 360 and 460mm roller covers
- Strong as steel but half the weight
- Universal threaded handle for extension poles



Code	Size-mm	Description	Pack
PR30	270-460	Heavy Duty - Adjustable	6

Paint Roller Frames

- Solid 8mm wire frame
- Universal threaded handle for extension poles
- Easy roll bearing
- Chrome plated frame



Code	Size-mm	Description	Pack
PR01	75	Medium Duty - Plastic Handle	6
PR3	230	Heavy Duty - Plastic Handle	12
PR05S	230	Heavy Duty - Soft Grip Handle	12
PR06S	270	Heavy Duty - Plastic Handle	12

Paint Roller Trays

- High quality contractor roller tray



Code	Description	Pack
PR45	270mm HD Roller Tray	12

Paint Roller Kit

- Complete kit with HD roller frame
- 11mm nap roller
- Plastic paint tray



Code	Description	Pack
PK1	230mm Roller Kit	12
PR57	270mm Roller Kit	12

Ancora 501/S Paint Scraper



- Heat treated, hardened and tempered; annealed for an even hardness throughout the blade
- Sintesi soft grip
- Carbon steel for perfect balance and feel
- Made in Italy



Code	Art. No.	Size-mm	Description	Pack
PE0000206	501/S	30	Carbon Steel	12
PE0000212	501/S	50	Carbon Steel	12
PE0000221	501/S	80	Carbon Steel	12
PE0000227	501/S	100	Carbon Steel	12

Marshalltown Stainless Putty Knives



- Heat treated, hardened and tempered; annealed for an even hardness throughout the blade
- Full tang through the handle
- Oversized EMPACT hammering head for quick, effective hammering



Code	EDI	Size-mm	Pack
MTPK764SSD	10764	51	12
MTSK880SSD	10766	76	12
MTSK882SSD	10768	102	12
MTJK884SSD	10769	127	12
MTJK886SSD	10782	152	12

Scissors - Stainless Steel



Code	Description	Pack
MHSS	Stainless Steel Scissors	12

Bucket Opener - Plastic Heavy Duty

- Open buckets with ease
- Strong plastic construction



Code	Description	Pack
DW110	Black Plastic	12

Plunge Mixer

- Steel
- Perfect for mixing paint and coloured sealers



Code	Description	Pack
PR91	10/20L Plunger Paint Stirrer	6

Cotton Cleaning Rags

- Cotton cloths for staining, cleaning and paint spills
- 100% recycled, lint-free cotton
- High absorbency
- Irregular dimensions
- All bags are vacuum sealed



Code	Description	Pallet
CR10KG	Cotton Rags Coloured - 10kg	50

Steel Tape - Short - ABS Case



- Nylon coated blade
- Heavy duty ABS case
- Metric Markings



Code	Size	Description	Pack
RT8025	8m x 25mm	Double Nylon Coated Blade	12

Steel Tape - Short



- Nylon coated blade



Code	Size	Description	Pack
MHFL25M	8m x 25mm	Metric	12
MHFL25SP	8m x 25mm	Metric/Imperial	12

Kwikgauge Tape

- Estimate brick quantities prior to & during building construction
- Chase bonds on concrete on footings & concrete slabs for setting door jambs & opening to suit brickwork
- Get correct placement of windows, sliding doors and door jams in frames prior to commencement of brickwork
- Avoid unsightly 3/4 cuts
- The Original - Made in Australia



Code	Size	Description	Pack
KG	8m x 25mm	Double Nylon Coated Blade	12

Hand Tally Counter

- 4 Digit
- Counts 0-9999



Code	Description	Pack	Carton
HTC4	0-9999 Tally Counter	12	144

Tile/Rafter Square

- Metal construction



Code	Size	Description	Pack
1624	600 x 400mm	Steel	6

Chalk Powder



Code	Colour	Weight	Pack
8CRED	Red	8oz / 226g	12
8CBLUE	Blue	8oz / 226g	12

Steel Tape - Long



09238 / 09240

39243



Code	Size	Description	Pack
09238	13mm x 30m	Steel	6
09240	13mm x 50m	Steel	6
39243	13mm x 100m	Steel	6

Drywall Scoring Square



- Fast and neat straight cut
- Max 62cm
- Perfect for scoring and cutting
- Accept all types of utility knife
- Double measurement unit inch/mm



Code	Description	Pack
RT173055	515mm Wide x 625mm Long	6

Chalk Lines



60097



Code	Description	Length	Pack
60097	Jumbo Chalk Reel Heavy Duty Line - 2.5mm	50m	6
LCR30M	30m Chalk Line & Chalk Combo		

Stabila Box Frame Level - Series 96



- Extra Stiff aluminium rectangular profile with reinforcing ribs
- Measuring accuracy in normal position 0.5mm/m and in reverse position 0.75mm/m
- Two milled measuring surfaces of up to 122cm
- Shock-absorbing end caps protect the spirit profile if it falls
- 10 year warranty



Code	Size-mm	Description	Vial No.
96-2/60	600	HD Box Ribbed	3
96-2/80	800	HD Box Ribbed	3
96-2/120	1200	HD Box Ribbed	3
96-2/180	1800	HD Box Ribbed	3
96-2/200	2000	HD Box Ribbed	3
96-2/244	2440	HD Box Ribbed	3
96-2M/60	600	Rare Earth Magnet	3
96-2M/120	1200	Rare Earth Magnet	3
96-2M/200	2000	Rare Earth Magnet	3

Stabila Die Cast Level



- Strong aluminium die-cast profile
- Measuring accuracy in normal position 0.5mm/m and in reverse 0.75mm/m
- 10 year warranty



Code	Size-mm	Description	Pack
02501	250	Die Cast + Holster	6
02511	250	Die Cast Magnetic + Holster	6

Metrica Die Cast Level - Magnetic Base



- Made in Italy
- Aluminium die-cast body
- Acrylic vials, shock resistant
- Specially shaped for easy working even in corners
- Magnetic base



Code	Size-mm	Description	Pack
31062	250	Die Cast Magnetic Base	10

Folding Rules - Metric



- Bevel edge and clear metric markings
- 1 metre length, 4-fold

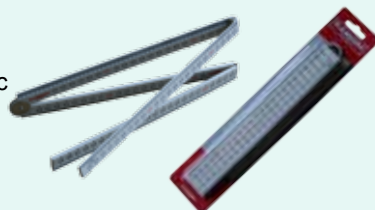

Code	Size	Description	Pack
FRM	1m	White - Bevel Edge	10

Stabila Box Frame Level - Series 70



- Smooth aluminium rectangular profile
- Ideal light spirit level
- Easy to clean
- Measuring accuracy in normal position 0.5mm/m
- 10 year warranty



Code	Size-mm	Description	Vial No.
70/60	600	Smooth Flat Sides	2
70/80	800	Smooth Flat Sides	2
70/100	1000	Smooth Flat Sides	2
70/120	1200	Smooth Flat Sides	2

Stabila Box Frame Level - Series 80AS



- The ribbed aluminium rectangular profile provides for secure grip
- Standard end caps
- Measuring accuracy in normal position 0.5mm/m
- 10 year warranty



Code	Size-mm	Description	Vial No.
80AS/60	600	Ribbed Box Frame	2
80AS/80	800	Ribbed Box Frame	2
80AS/100	1000	Ribbed Box Frame	2
80AS/120	1200	Ribbed Box Frame	2
80AS-2/100	1000	Ribbed Box Frame	3
80AS-2/120	1200	Ribbed Box Frame	3

EDMA Vertical Support



PRESS PLAC PRO

- Minimum working required space for cutting, drilling or planing
- Perfect extra hand on any work site
- Holding height: 32cm
- Locking screw for perfect holding



Code	Description	Pack
RT161055	Foot Peddle and Locking Screw	2

Black Nitrile Gloves



- Nitrile gloves
- Durable
- High grip
- 100% comfort grip



Code	Size	Hem Colour	Pack	Carton
BK7	7 Small	White	12	120
BK8	8 Medium	Green	12	120
BK9	9 Large	Brown	12	120
BK10	10 X-Large	Yellow	12	120
BK11	11 XX-Large	Grey	12	120

Black Nitrile Disposable Gloves



Black Nitrile Disposable Gloves are the ultimate trade person's glove

Withstands: Petrol, oils, hydraulic fluids, diesel, strong cleaners, acids, alkalis, solvents and paint thinner plus many more...

- Trade Tough Quality
- Amazing dexterity and feeling
- 100% Nitrile
- High puncture and chemical resistance
- Powder and Latex free
- Box of 100pcs (90pcs in XXL)

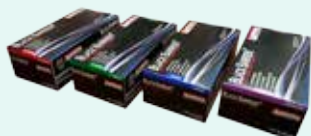

Code	Size	Box Colour	Pack	Carton
BNG100-M	8 Medium	Purple	100	10
BNG100-L	9 Large	Blue	100	10
BNG100-XL	10 X-Large	Green	100	10
BNG100-XXL	11 XX-Large	Red	90	10

Red PVC Dipped Gloves

- Red PVC single dip fully coated glove
- Handling materials coated with grease oil, caustics, acids and solvents, fishing, mining, construction.
- Resistance to mild chemicals, solvents, oils and acids.



Code	Size	Cuff Length	Pack	Carton
601	One size fits all	270mm	12	120
601L	One size fits all	350mm	12	60
601XL	One size fits all	450mm	12	60

Latex Coated Gloves



- Seamless knitted poly cotton shell with latex coated palm
- All purpose glove, long lasting where superior grip is required
- Abrasion resistant



Code	Size	Hem Colour	Pack	Carton
GR9	9 Large	Brown	12	120
GR10	10 X-Large	Yellow	12	120

Nitrile Orange Coated Gloves



- Seamless knitted poly cotton shell with nitrile coated palm
- All purpose glove, long lasting where superior grip is required
- Abrasion resistant
- Sold as pack of 5 gloves



Code	Size	Hem Colour	Pack	Carton
RT1486-9	9 Large	Brown	5 Pack	48
RT1486-10	10 X-Large	Yellow	5 Pack	48

Leather Rigger Gloves

- Leather riggers/drivers glove
- Driving construction equipment, operators, farm equipment, forklifts, utility work and general purpose



Code	Size	Colour	Pack	Carton
GR1	10 X-Large	Grey	12	120

Glass Gripper Gloves

- Rough textured natural rubber, yellow latex
- Open back. Knit wrist
- Ideal for handling sharp edged materials such as metal, glass, concrete blocks and timber



Code	Size	Colour	Pack	Carton
GG	10 Large	Yellow Latex	12	120

Flocklined Rubber Gloves

- Latex rubber
- 300mm in length



Code	Size	Colour	Pack	Carton
603DG9	9 Large	Yellow	12 Pairs	144
603DG10	10 X-Large	Yellow	12 Pairs	144

Safety Picket Caps

A rounded plastic cap used to cover the sharp ends of the star picket posts to minimise injury risk in construction fields, whilst protecting the safety of people working on-site



Code	Size-mm	Box Qty	Colour
SPCAPS	Round	100	Yellow

Safety Barricade Tape

- Heavy duty plastic
- Red and white stripe



Code	Size	Description	Pack
ST100	75mm x 100m	Red/White Stripe	30
ST300	75mm x 300m	Red/White Stripe	4

Safety Cones



Code	Size-mm	Description
CONE450	450	Non Reflective - Orange

Glove Clip

- High clamp force jaw for better grip
- Double swivel cord for greater movement and flexibility
- Never misplace your gloves again with these convenient glove clips



Code	Description	Pack	Carton
GCLIP	UV Plastic	12	144

Bunting Flags

- Easily erected area delineation option
- Hi-Viz PVC fluoro flags on polyethylene rope
- Double-stitched
- Minimum support posts needed
- Economical, reusable
- UV Stabilised



Code	Description	Pack
BUNTING	30m - 45 Flags per length - Orange	10

Bollards & Barrier Fence Mesh

Mesh is:

- Stretched virgin polyethylene for strength
- Extruded Orange
- UV stabilised

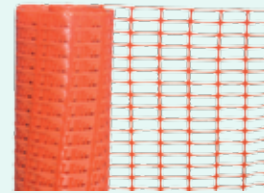

Code	Description	Colour
MESH	1m x 50m - Orange	Orange
BOLLARD6	6kg Base and Bollard	Orange
BOLLARD8	8kg Base and Bollard	Orange

Knee Pads

- Foam liner to absorb pressure on knee joint
- Liner held in place by four studs
- Secured by two easy to adjust straps



Code	Description	Pack
KP5	Heavy Duty with 4 Straps	12

Electrical Lead Stand & Lead Hooks

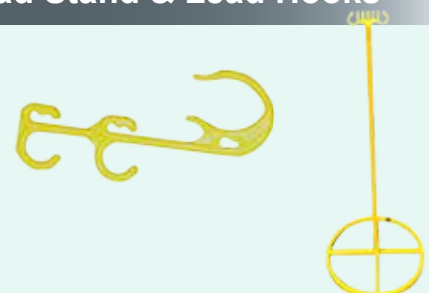

Code	Description
LEADHOOK	Lead Hook - Yellow - Pack of 20pcs
LEADSM	Electrical Lead Stand - Telescopic

Redback Boots - Bobcat - Soft Toe



- The classic Redback
- Derby-cut, elastic-sided boot
- Thicker, tougher leather
- Air cushion midsole
- Hard-wearing TPU outsole
- Anatomical fit and torsional heel support



Code	Size Available UK	Colour
RBUBBA	6-13	Banana Suede
RBUBOK	6-15	Claret Oil Kip

Redback Boots - Bobcat - Steel Cap



- The classic Redback
- Derby-cut, elastic-sided boot
- Thicker, tougher leather
- Air cushion midsole
- Hard-wearing TPU outsole
- Anatomical fit and torsional heel support
- Steel toe



Code	Sizes Available UK	Colour
RBUSBBA	6-13	Banana Suede
RBUSBOK	6-15	Claret Oil Kip

Redback Boots - Cobar - Steel Cap



- Fast-release side zipper
- Elastic inner gusset
- Leather clasp with press stud
- 3D-weave, breathable air mesh lining
- Light-weight design
- Air cushion midsole
- Hard-wearing TPU outsole
- Steel toe with scuffcap



Code	Size Available UK	Colour
RBUSCWZS	6-13	Wheat

Safety Glasses

- Hard coated
- UV treated
- Available in clear or smoke lens



Code	Description	Pack	Carton
900074	Clear Lens	12	144
900075	Smoke Lens	12	144

Kiewa Gumboot - Soft Toe

— THE —
KIEWA
— GUMBOOT —



-40° Thermo-insulated



40% Lighter than rubber & PVC boots



Last up to 3 times longer than other boots



Slip resistant soles



Code	Size	Description
GB480163	EU39/AU6	Soft Toe
GB480184	EU40/AU6.5	Soft Toe
GB480205	EU41/AU7	Soft Toe
GB480236	EU42/AU8	Soft Toe
GB480257	EU43/AU9	Soft Toe
GB480278	EU44/AU10	Soft Toe
GB480290	EU45/AU10.5	Soft Toe
GB480315	EU46/AU11	Soft Toe
GB480331	EU47/AU12	Soft Toe
GB480355	EU48/AU13	Soft Toe
GB480553	EU39/AU6	Safety Toe
GB480574	EU40/AU6.5	Safety Toe
GB480595	EU41/AU7	Safety Toe
GB480626	EU42/AU8	Safety Toe
GB480647	EU43/AU9	Safety Toe
GB480668	EU44/AU10	Safety Toe
GB480689	EU45/AU10.5	Safety Toe
GB480715	EU46/AU11	Safety Toe
GB480736	EU47/AU12	Safety Toe
GB480747	EU48/AU13	Safety Toe

Howard Light Banded Ear Plugs

- Smooth, ergonomic pods fit in the ear for maximum protection
- Patented band design prevents ear pods from touching dirty or contaminated surfaces
- Lightweight and portable – designed especially for environments with intermittent noise hazards
- SLC80 21dB/Class 3

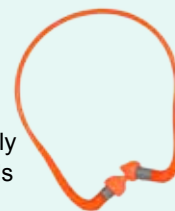

Code	Description	Pack
QB2	Howard Light - Reusable with Neck Collar	10

Ear Plugs

- Certified to AS/NZS 1270:2002
- Class 5 - SLC80 - 27db
- Soft PU Foam for comfort
- Hi Vis colour
- Individually packaged and barcoded



Code	Description	Pack
MAX200	Foam Disposable - Box 200	1

Auscreen SPF 50+ Sunscreen



Auscreen's SPF 50+ has been formulated to provide very high protection from the sun. PABA, oxybenzone and fragrance free. Suitable for face and body. Dermatologically tested

- A non greasy, quick absorbing formulation, Auscreen SPF50+ Ultra Protect Lotion is easy to apply and won't leave a sticky residue on your skin
- Contains Vitamin E in a moisturising base to counteract the drying effects of the sun
- Assists with smoothing your skin and maintaining skin hydration

Very high protection sunscreen lotion

A dry touch formula that applies smoothly, leaving no unsightly white film on your skin.



SUITABLE FOR SENSITIVE SKIN



DERMATOLOGICALLY TESTED



EASY TO APPLY



UP TO 4 HOURS WATER RESISTANT

THIS PRODUCT

CONFORMS WITH THE

AUSTRALIAN STANDARD

FOR SUNSCREEN PRODUCTS

AS/NZS2604:2012



Code	Product	Size	Pack
AS106973	Auscreen Ultra SPF 50+ Pump	1 Litre	6
AS106974	Auscreen Ultra SPF 50+ Pump	500ml	6
AS106975	Auscreen Ultra SPF 50+ Tube	250ml	6
AS106976	Auscreen Ultra SPF 50+ Tube	100ml	6

Ear Muffs - Class 5 SLC80 29.4DBA

- Certified to AS/NZS 1270:2002
- Class 5 - SLC80 - 29.4db
- Soft PU Foam for comfort
- Folding style
- Individually packaged



Code	Description	Pack
EM3	29.4 DBA SLC80 Class 5	12

Ear Muffs - Class 5 SLC80 34.6DBA

- Certified to AS/NZS 1270:2002
- Class 5 - SLC80 - 34.6db
- Soft PU Foam for comfort
- Insulative plastic
- Individually packaged



Code	Description	Pack
EM4PRO	34.6 DBA SLC80 Class 5	12

Dust Masks - P2

- For use with marble, ferrous metals, timber work, pollen, chemicals, foundry work, agriculture etc.
- With the inclusion of exhalation valve for easier breathing



Code	Description	Pack	Carton
DM2704	P2 Valve	10	144

Bushman Repellent



Bushman Repellent 'PLUS'

A versatile, universal and highly effective range of insect repellents. It is suitable for every member of the family, and fine for anyone with sensitive skin. With unique time release properties it continues to protect against insects when other-brands resistance would have faded. Featuring sunscreen makes Bushman Plus the complete solution for everyone. Because of its sweat, water and rub resistant it's great for exercise, warmer climates, holidays and outdoor activities

Bushman Ultra Repellent

Utilising high concentrations of DEET to ensure protection in the harshest of environments, even with extremely high levels of intense insect activity. It encompasses all the characteristics expected of a Bushman Repellent product. It is comfortable to wear, with a pleasant odour and is sweat, water and rub resistant.

Code	Product	Size Gram	Type	Deet %	Pack Qty
BP75G	PLUS	75	Dry Gel	80%	12
BP1000G	PLUS	1000	Dry Gel	80%	6
BP50A	PLUS	50	Aerosol	20%	24
BP150A	PLUS	150	Aerosol	20%	12
BP350A	PLUS	350	Aerosol	20%	12
BU75G	ULTRA	75	Dry Gel	80%	12
BU1000G	ULTRA	1000	Dry Gel	80%	6
BU60A	ULTRA	60	Aerosol	40%	24
BU130A	ULTRA	130	Aerosol	40%	12
BU225A	ULTRA	225	Aerosol	40%	12

HD Wheelbarrows



Code	Description	Handle
WBPOLYHD-T	HD PRO - 5mm Poly Tray	Timber
WBPOLYHD-S	HD PRO - 5mm Poly Tray	Steel
WBSTEELHD-T	HD PRO - 1.2mm Steel Tray	Timber
WBSTEELHD-S	HD PRO - 1.2mm Steel Tray	Steel

Hessian Sand Bags



Code	Size-mm	Material	Pack/Bail
SANDBAG	845 x 350	Hessian	50/1000

Waterproof Bitumen Paint

POLYMER MODIFIED BITUMEN MEMBRANE

- Retaining walls, underground waterproofing
- Bondbreaking membrane for dowel bars
- Pruning, grafting and various horticultural applications
- Seal coat between old and new concrete abutments
- Protective coating for corrosion of metals and wood rot
- Damproofing
- General purpose waterproofing
- Soundproofing
- Sealing failed or aged bitumen surfaces



Code	Size	Colour	Box
TC-130301	4lt	Waterproof Bitumen Paint	4
TC-130302	20lt	Waterproof Bitumen Paint	1

Bitac® Bitumen Impregnated Tape

Bitac® is a composite membrane of nonwoven geotextile and a self-adhesive rubberised bitumen with high strength and high elongation properties. Bitac® is designed as a joint sealant and reflective crack inhibitor, providing stress relief and waterproofing in concrete and asphalt pavements. Bitac® is also used to seal the joints of concrete culverts and bridge decks.



Code	Width mm	Length m	Rolls Per Box	Meters Per Box
GFABIT15	150	20	6	72
GFABIT25	250	20	3	36
GFABIT30	300	20	3	36
GFABIT50	500	20	2	24
GFABIT90	900	20	1	12
GFABTP-PRIMER	20lt			

Malthoid

- 2-Ply Bitumen Fibre Damp-course



Code	Description	Pack
MAL110	110mm x 20m	3
MAL150	150mm x 20m	3
MAL230	230mm x 20m	3
MAL300	300mm x 20m	3
MAL450	450mm x 20m	3
MAL1000	1000mm x 20m	3

Corflute Protection Board

Coreflute is a corrugated plastic sheet used to protect waterproofing and membranes on retaining walls and other below-ground structures.

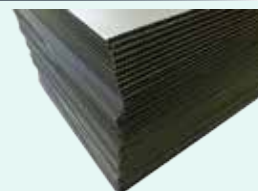

Coreflute is placed against the structure prior to backfilling and eliminates damage from falling rocks and gravel.

Code	Size-mm	Thickness	Colour
CORFLUTE	1220 x 1830	2.5mm	Black

Nonwoven Geotextile

TerraStop® F Range is a nonwoven needle punched geotextile made from polyester that provides separation, filtration, protection or reinforcement functions in engineering projects. It is the most cost effective solution to engineering problems including cracked roads, weak soil, as well as liquid and gas leaks from landfill sites.



TerraStop® F Range nonwoven geotextiles enhance the performance and design life of granular layers by providing the filtration and separation functions. They also come with the added advantage of a natural UV resistance enabling the material to withstand the harsh Australian environment. Typical uses for TerraStop® F Range geotextiles include ground stabilisation (between the sub-base and subgrade) around drainage materials and underwater applications.

Code	Size-m	Colour
TSA1F-2M	2 x 100	Non woven Needle Polyester Punched Geotextile
TSA1F-4M	4 x 100	Non woven Needle Polyester Punched Geotextile

Concrete Canvas®

Concrete Canvas® is part of a revolutionary new class of construction materials called Geosynthetic Cementitious Composite Mats (GCCMs). It is a flexible, concrete impregnated fabric, that hardens on hydration to form a thin, durable, water proof and fire resistant concrete layer. Essentially, it's concrete on a roll. Concrete Canvas® GCCM (CC) allows concrete construction without the need for plant or mixing equipment: just add water.



Code	Size-m	Description
CC5-HANDY	1 x 10	Concrete Canvas 5mm
CC5-BULK	1 x 200	Concrete Canvas 5mm
CC8-HANDY	1.1 x 4.55	Concrete Canvas 8mm
CC8-BULK	1.1 x 113.64	Concrete Canvas 8mm

Plasticiser - 504

Plasticiser 504 is a formulated honey coloured anionic surfactant solution used as an air entraining agent designed to improve the water retention and workability of cement based mortars or when extra plasticity is required when harsh sands are used.



Plasticiser 504 is suitable for use in all types of mortars using Portland type cement. It will help enhance pigment colour used in coloured mortars, unlike hydrated lime, which can fade coloured mortars.

PLASTICISER 504 ADVANTAGES:

- Allows for easy placement of brickwork.
- Full Colour achieved in coloured mortars.
- Improves workability.
- Reduces segregation and bleeding.
- Replaces the need for lime.

Code	Litres	Description	Pack
5045	4	Plasticiser #504	4
50420	20	Plasticiser #504	1

Waterproofer - 104 - Pink

Waterproofer 104 is a ready to use quality Waterproofer. It is formulated for use in improving the water resistant properties of Portland type cement brick mortars and renders. It also improves the workability and plasticity and does not impart any colouration.



- Improves the water resistance of brick mortars and renders
- Improves workability and plasticity

Code	Litres	Description	Pack
WP5	4	Waterproofer #104	4
WP20	20	Waterproofer #104	1

Hydrochloric Acid - 32%

Used in Construction (brick cleaning)
For use in electroplating, construction (brick cleaning), aquatic centres and private swimming pools, boiler scale removal and for effluent treatment.



* Victorian Customers Only.

Code	Litres	Description	Pack
H5	5	Hydrochloric Acid	3
H20	20	Hydrochloric Acid	1/32

BEST-BOND Bonding Agent

P.V.A Bonding Agent and Mortar additive
The trusted name in bonding agents

Suitable for many uses, which include: Cement toppings, rendering, sealing, plaster/hard plaster, dust proofing, binding, bonding new to old concrete, woodwork and carpentry adhesive.

Note: This product is not suitable to be used in permanently wet areas.



Code	Litres	Description	Pack
BEST500	500ml	Bonding & Mortar Additive	10
BEST1	1	Bonding & Mortar Additive	12
BEST2	2	Bonding & Mortar Additive	6
BEST4	4	Bonding & Mortar Additive	4
BEST10	10	Bonding & Mortar Additive	1
BEST20	20	Bonding & Mortar Additive	1/32

Waterproofer - 404 - White

Waterproofer 404 is a ready to use high quality ammonium stearate based waterproofing liquid. When used in Portland cement based mixtures it forms calcium stearate, a highly water repellent material. This coats the capillary pores of the cement, substantially increasing the water resistance. Waterproofer 404 greatly minimises the absorption and permeation of water in concretes, renders, bagging mixes and mortars both above and below ground level.



Code	Litres	Description	Pack
4045	4	Waterproofer	4
40420	20	Waterproofer	1

Rapid Setter - 704

RAPID SET 704 is a formulated additive that accelerates the drying time of concretes and mortars. This can be very useful in a number of ways, such as early removal of formwork and faster setting of fence posts.

RAPID SET 704 ADVANTAGES

- Faster curing time of cement and mortar.
- Allows for earlier removal of formwork.
- Faster construction of fences.



Code	Litres	Description	Pack
7045	4	Rapid Setter #704	4
70420	20	Rapid Setter #704	1

Fully Forged Claw Hammer



- Fully forged one piece steel construction
- Precision balanced
- Soft grip handle



Code	Weight	Overall Length-mm	Face	Pack/Carton
FH20	20oz / 560g	340	Smooth	6/24

Forged F/G Claw Hammer - Soft Grip



- Forged head and injection moulded soft grip handle



Code	Weight	Overall Length-mm	Face	Pack/Carton
FG20	20oz / 560g	340	Smooth	6/24

Estwing Claw Hammers



- Fully forged one piece steel construction
- Unsurpassed balance and temper
- Fully polished head



Code	Weight	Length mm	Handle Type	Pack/ Carton
EWE20C	20oz/560g	318	Leather	4/20
EWE24C	24oz/672g	343	Leather	4/20
EWE320C	20oz/560g	343	Nylon Vinyl	4/20
EWE328C24	24oz/672g	343	Nylon Vinyl	4/20

Estwing Rip Hammers



- Fully forged one piece steel construction
- Unsurpassed balance and temper
- Fully polished head



Code	Weight	Overall Length-mm	Pack/Carton
EWE320S	20oz / 560g	343	4/20

Estwing Framing Hammers



- Fully forged one piece steel construction
- Unsurpassed balance and temper
- Fully polished head



Code	Weight	Length mm	Handle Type	Face
EWE322S	20oz/560g	406	Nylon Vinyl	Smooth
EWE322SM	20oz/560g	406	Nylon Vinyl	Milled
EWE328S	28oz/784g	406	Nylon Vinyl	Smooth
EWE328SM	28oz/784g	406	Nylon Vinyl	Milled

Wasp - Pro Claw Hammer



- Fully forged one piece steel construction
- Precision balanced
- Large striking face
- Soft grip handle



Code	Weight	Overall Length-mm	Face	Pack/Carton
W1806	20oz / 560g	360	Smooth	6/24

Estwing Hammertooth Hammers



- Fully forged one piece steel construction
- Unsurpassed balance and temper
- Fully polished head



Code	Weight	Length mm	Handle Type	Face
EWE622T	22oz/616g	343	Nylon Vinyl	Smooth
EWE622TM	22oz/616g	343	Nylon Vinyl	Milled

Estwing Rock Picks - Pointed



Code	Weight	Length mm	Handle Type	Pack
EWE314P	14oz/392g	279	Nylon Vinyl	4
EWE322P	22oz/616g	330	Nylon Vinyl	4
EWE323LP	22oz/616g	419	Nylon Vinyl	4
EWE30	22oz/616g	318	Leather	4
EWE624PC	24oz/672g	330	Nylon Vinyl	4

Estwing Geologist Pick

ESTWING



Code	Weight	Length mm	Handle Type	Pack
EWGP100	4lb/1.8kg	625	Nylon Vinyl	1

Estwing Latthammers

ESTWING



- Fully forged one piece steel construction
- With milled face and magnet
- German style roofing hammer, also used in the scaffold industry

Code	Weight	Length mm	Handle Type	Face
EWE3239MM	21oz/600g	343	Nylon Vinyl	Milled

Wasp Bricklayers Hammers

Wasp
TRADE TOOLS

- Forged heat treated heads



Code	Weight	Length mm	Handle Type	Pack/ Carton
MHBRICK	24oz/672g	343	Solid Steel	6/24
MHF24	24oz/672g	343	Fibreglass	6/24

Estwing Bricklayers Hammers

ESTWING

- Fully forged one piece steel construction
- Unsurpassed balance and temper
- Fully polished head



Code	Weight	Length mm	Handle Type	Face
EWE320BLC	20oz/560g	279	Nylon Vinyl	Smooth
EWE324BLC	24oz/672g	279	Nylon Vinyl	Smooth

Estwing Drilling Hammer

ESTWING

- Fully forged one piece steel construction



Code	Weight	Length mm	Handle Type	Face
EWB32LB	2lb/910g	267	Nylon Vinyl	Smooth
EWB33LB	3lb/1300g	279	Nylon Vinyl	Smooth
EWB34LB	4lb/1800g	292	Nylon Vinyl	Smooth
EWB34LBL	4lb/1800g	406	Nylon Vinyl	Smooth

Estwing Bricklayer BIG BLUE

ESTWING

- Fully forged one piece steel construction
- Wider blade and large hammer face



Code	Weight	Length mm	Handle Type	Face
EWE622BLC	22oz/616g	254	Nylon Vinyl	Smooth

Wasp Club/Mash Hammer

Wasp
TRADE TOOLS

- Forged head and injection moulded soft grip handle



Code	Weight	Length mm	Handle Type	Pack
238F	3lb/1300g	279	Fibreglass	6/24

Wasp Demolition Hammers

Wasp
TRADE TOOLS

- Forged head and injection moulded soft grip handle



Code	Weight	Length mm	Handle Type	Pack
DH4F	4lb/1800g	400	Fibreglass	6/12
SLEDGE6	6lb/2721g	450	Hickory	4/16

Sledge Hammer - Fibreglass



- Strong fibreglass handles



Code	Weight	Length mm	Handle Type	Pack
E1252F	8lb/3628g	900	Fibreglass	2/6
E1254F	10lb/4536g	900	Fibreglass	2/4

Wasp Sledge Hammer - Hickory



- Strong USA Hickory handles
- Rubber overstrike protectors



Code	Weight	Length mm	Handle Type	Pack
SLEDGE8	8lb/3628g	900	Hickory	2/6
SLEDGE10	10lb/4536g	900	Hickory	2/4
SLEDGE12	12lb/5443g	900	Hickory	2/4

Estwing Replacement Sheaths



Code	Description	To Suit
EW23	Blue Pointed Rock Picks	E322P, E314P, E323LP
EW24	Blue Chisel Edge Picks	E622BLC, E320BLC, E324BLC

Mallet - Fibreglass Handle



- White heads are non marking for light coloured pavers



Code	Weight	Length mm	Handle Type	Pack
MALLET32	32oz/907g	390	Fibreglass	6/24

Estwing I-Beam Construction Bar



- Estwing's Lightweight I-Beam Construction Pry Bar has beveled nail slot. It's I-Beam construction gives added strength while removing weight. Rocking head provides maximum leverage

Code	Size-mm	Description	Pack
EWPB18	457	I-Beam Bar	2

Estwing Handy Bar



- Estwing's 381mm/15" Handy Bar is forged half round, for added strength and less weight. Wide, thin blade for easy prying

Code	Size-mm	Description	Pack
EWHB15	381	Handy Bar	4

Estwing Pro Claw Bars



EWPC300G

EWMP300G

Code	Size-mm	Description	Pack
EWMP250G	254	Moulding Puller	4
EWMP300G	305	Moulding Puller	4
EWPC210G	228	Nail Puller	4
EWPC250G	269	Nail Puller	4
EWPC300G	317	Nail Puller	4
EWPC360G	381	Nail Puller	4

Estwing Pro-Claw - Roofing



- Truly a unique patented roofing, siding, contractor bar. Drop forged from fine tool steel, one end has a thin blade with a 64mm fulcrum giving it a higher lift than other bars. For removing shingles, downspouts, gutters and nails with ease. The other end has a Japanese pattern nail puller with rounded head to improve leverage and pull even the most difficult nails

Code	Size-mm	Description	Pack
EWRSC	427	RSC Bar	4

The ORIGINAL American Made Hot Cast Polyurethane Dead Blow Hammers

OUTSTANDING FEATURES

- One Piece Polyurethane Construction.
- No Exposed Metal on Handles or Heads.
- No Mark, No Spark, Completely Formulated to Set a New Standard for Soft Face Performance and Durability. Eliminates Mushrooming, Splitting, Absorption of Liquids, Contamination and Chip Pick-up in Faces.
- Outlasts Rawhide, Rubber, Brass, Lead, Nylon and Other Plastic Type Heads by 10-20 Times.
- Exclusive Textured, Nonslip, Comfort Contoured Handle & Safety Flanged Butt Provide Sure Grip and Reduces Worker Fatigue.



- 1 Steel canister and rod are welded together for greater strength and safety.
- 2 Shot filled canister provides dead blow action in head for sustained impact, maximum power and striking force.
- 3 Canister in head and heat treated rod in handle are fully encased in hot cast custom formulated polyurethane.
- 4 Convex faces on heads are designed for maximum dead blow non-bounce action and are cut resistant.



Trusty-Cook Standard Dead Blow



Code	Weight Ounce / Lb / Kg	Model	Length mm
TCDB21	21oz / 1.3lb / 595g	Model 1	285
TCDB26	26oz / 1.6lb / 737g	Model 2	324
TCDB45	45oz / 2.8lb / 1.28kg	Model 3	365
TCDB53	53oz / 3.3lb / 1.5kg	Model 4	387

Trusty-Cook Sledge Dead Blow



Code	Weight Ounce / Lb / Kg	Length mm	Model No.
TCDBSH88	88oz / 5.5lb / 2.5kg	508	7
TCDBSH144	144oz / 9lb / 4.08kg	762	10
TCDBSH152	152oz / 9.5lb / 4.31kg	508	TCMM9
TCDBSH168	168oz / 10.5lb / 4.76kg	762	12
TCDBSH192	192oz / 12lb / 5.44kg	914	14

Trusty-Cook Flat-Flat Dead Blow



Code	Weight Ounce / Lb / Kg	Face	Length mm
TC26BPF	26oz / 1.6lb / 737g	Flat-Flat	324
TC36BPF	36oz / 2.2lb / 1Kg	Flat-Flat	330
TC43BPF	43oz / 2.7lb / 1.2Kg	Flat-Flat	260
TC47BPF	47oz / 2.9lb / 1.3Kg	Flat-Flat	346
TC50BPF	50oz / 3.1lb / 1.4Kg	Flat-Flat	420

Trusty-Cook Ball Peen Dead Blow



Code	Weight Ounce / Lb / Kg	Face	Length mm
TC26BP	26oz / 1.6lb / 737g	Ball-Flat	324
TC36BP	36oz / 2.2lb / 1Kg	Ball-Flat	330
TC43BP	43oz / 2.7lb / 1.2Kg	Ball-Flat	260
TC47BP	47oz / 2.9lb / 1.3Kg	Ball-Flat	346
TC50BP	50oz / 3.1lb / 1.4Kg	Ball-Flat	420

Spud/Fence Bars - Hexagon



- Used for digging holes, breaking clay and concrete
- Forged from tough high tensile carbon steel
- Blade is heat treated for long service life and better performance
- Hexagon bar profile for greater control

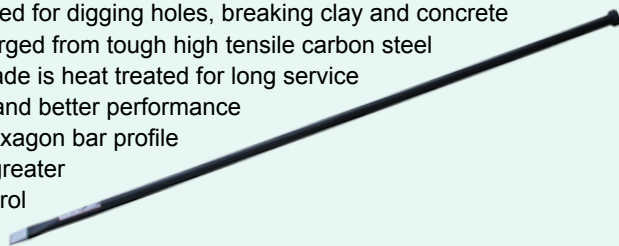

Code	Size-mm	Description	Pack
M3362	1800 x 25	Hex - Chisel & Knob	2
M3368	1800 x 30	Hex - Chisel & Knob	2

Crow Bars - Hexagon



- Used for digging holes, breaking clay and concrete
- Forged from tough high tensile carbon steel
- Both ends are heat treated for long service life and better performance
- Hexagon bar profile for greater control

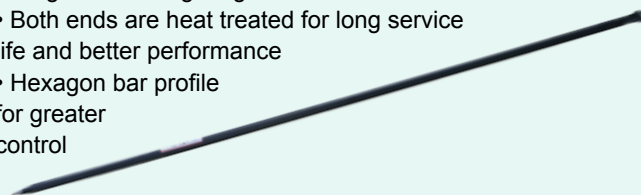

Code	Size-mm	Description	Pack
M3410	1800 x 25	Hex - Chisel & Point	2

Wrecking Bars



Code	Size-mm	Description	Brand	Pack
EWEWB12	304	Goose neck	Estwing	6
EWEWB18	457	Goose neck	Estwing	6
EWEWB24	610	Goose neck	Estwing	6
EWEWB30	762	Goose neck	Estwing	6
EWEWB36	914	Goose neck	Estwing	6
M2818	450	Goose neck	Wasp	6
M2824	600	Goose neck	Wasp	6
M2830	750	Goose neck	Wasp	6
M2836	900	Goose neck	Wasp	6

Steel Fence Posts/Star Pickets



Code	Size-mm	Description	Sling
SP450	450	1.58kg Black Steel Post	400
SP600	600	1.58kg Black Steel Post	400
SP900	900	1.58kg Black Steel Post	400
SP1350	1350	1.58kg Black Steel Post	400
SP1500	1500	1.58kg Black Steel Post	400
SP1650	1650	1.58kg Black Steel Post	400
SP1800	1800	1.58kg Black Steel Post	400

Steel Post Remover - Jack Jaw



This product is made from high grade steel and has replaceable bisalloy 360 laser cut jaws. The base plate can be screwed to timber to spread the weight and allow removal on soft ground. Australian Made

- This is an ideal tool for formworkers and concreters
- Safe operations
- Easy to handle
- Star picket 20-30 round or stakes.
- Wooden pegs
- Survey stakes
- Removes marquee stakes
- Narrow diameter peg



What Jack Jaws removes

- Concrete form pins & stakes
- Star Pickets
- String line stakes
- Flat stakes
- Tent stakes & rebar
- Sign posts, u picket, square & round posts
- Utility grounding rods

Code	Opening	Braced	Size
JJAW10MM-SML	10mm	No	Small 42cm
JJAW10MM-LARGE	10mm	Yes	Large 90cm
JJAW-10MM-JAWS	Spare Jaws - 4 pcs set		

Steel Post Rammer - 8kg



- Heavy duty construction
- Australian Made



Code	Description	Pack
STAR	8kg - Heavy Duty Rammer	1

USA Hickory Handled Shovels



- Strong genuine "A" Grade American hickory handles
- Heavy Duty 2mm thick tempered steel heads



Code	Description	Handle	Pack
W4097	Post Hole	Hickory	6
W4103	Round Mouth Point	Hickory	6
W4110	Square Mouth	Hickory	6
W4127	Round Mouth Point	Dee Hickory	6
W4134	Square Mouth	Dee Hickory	6

Wasp Fibreglass Post Hole Shovel



- A good general purpose shovel for digging and clearing deep holes, narrow pits, for fencing and shallow trench digging



Size-mm	Size	Description	Handle	Pack
PHFG	1500	Post Hole	Fibreglass	6

Cyclone Shovels

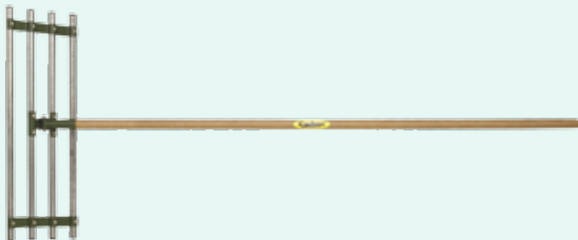

Code	Description	Handle	Pack
640-001	Post Hole Shovel	Timber	3
642-241	Square Mouth Shovel	Timber	3
640-216	Trenching Shovel	Timber	3
633621	Top Soil Spreader	Timber	3

All Steel Square Mouth Shovels



- Strong thick steel
- Powder coated for protection and easy clean up
- Square mouth is perfect for shifting and spreading of light and heavy materials



Size-mm	Colour	Length-mm	Handle	Pack
GT75	White	955	Dee	6
GT80	Orange	1105	Dee	6
GT240	Red	1240	Dee	6
GT90	Blue	1500	Long Handle	6

Landscape Rake

- Heavy duty rake for clearing and raking soil, stones and leaves
- Solid one-piece head for added strength

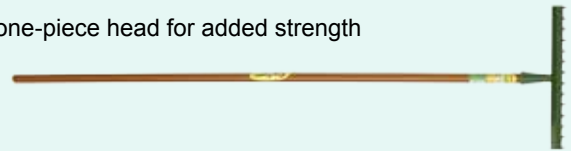

Code	Description	Pack
636-554	16 Tooth Rake - Timber Handle	6

Post Hole Cleaner



- Steel construction
- Has a solid 'T' handle grip so it can be easily turned to dig into loose soil and then be lifted out of post holes
- 30mm lip around head



Code	Diameter	Description	Pack
PHC	270mm	1.65m T Handle	3
PHC350	320mm	1.65m T Handle	3
PHC450	420mm	1.65m T Handle	3

Mortar Hoe



- Great for mixing of mortar and small amounts of concrete
- 'D' Handle



Code	EDI	Description	Pack
MT14281	14281	Wood Handle with Dee Grip	6

Picks & Mattocks



- Drop forged
- Use with #840 or #840FG Handles



GT30

Code	Weight	Description
GT30	6lb	Chisel and Point with F/G Handle
GT12	6lb	Chisel and Point - Head Only

Replacement Handles



* Images shown are not to scale

Code	Size-mm	Description	Type
840	900	Road Pick/Mattock	Hickory
840FG	900	Road Pick/Mattock	F/G
844	1350	Single Bend Shovel	Hickory

Steel Strapping - Strapping Tools

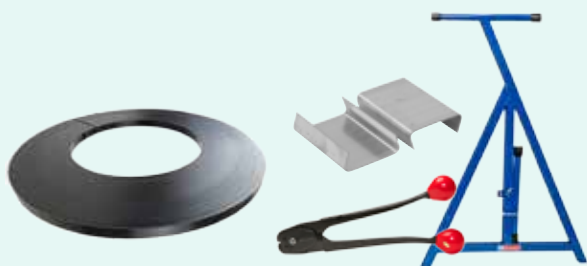

Code	Description
STM19C	19mm x 0.56 - 15kg - Ribbon Wound
BKM19	Metal Clips - 19mm Steel Strapping Box 1000pcs
DSMCR19	Crimping Tool - 19mm
DMTN-TLS20B	Steel Strap Tensioning Tool
DSMSS	Strapping Cart - Ribbon Wound

Stretch Wrap



Code	Description	Size-mm	Pack
SWCLEAR	Clear	25UM X 500mm X 360m	4
SWBLACK	Black	25UM X 500mm X 360m	4

Hoop Iron



Code	Thickness mm	Width mm	Length m
25615M	0.6	25	15
25630M	0.6	25	30
25830M	0.6	25	30
30815M	0.8	30	15
30830M	0.8	30	30

Aviation Snips



Cutting capacities :

- 1.2 mm (16 ga ; 0.047") : sheet metal, galvanised, zinc
- 0.8 mm (20 ga ; 0.031") : stainless steel
- Drop forged chromium molybdenum steel jaws
- Powerful and long lasting handle spring
- One hand automatic latch release
- Fast cut with minimum effort of 42 mm



Code	Description	Pack
RT010755	42mm Long Blades	10

EDMA - MAT Pliers for Slate



- 2 in 1 = cuts and punches slate
- No breathable dust, no crumbling
- Ergonomic and anti-slip plastic handles for an optimum comfort
- Cuts and punches 7 mm thickness natural and man made slate

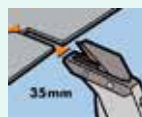
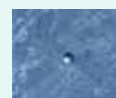

Code	Cut Length	Description
RT031055	35mm Blade	Slate Cutter and Hole Punch

Stackable Stillage

Stackable stillages are an excellent form of warehouse and yard storage. Designed to store long awkward objects for easy transport, these units may be stacked to make use of the vertical space in your warehouse Capacity: 1500kg



Code	Description	Size-mm
STILLAGE	Hot Dip Gal Finish	1395L x 1060W x 1200H

EDMA Ring Pliers with Magazine



TOP GRAFER 20/22

- Light and handy tool
- 2 built-in wire cutters up to 3 mm thickness
- 50 staple magazine
- Easy fit screw for fast removal of magazine
- Compatible with 22mm 'D' Staples and 20mm 'M' staples

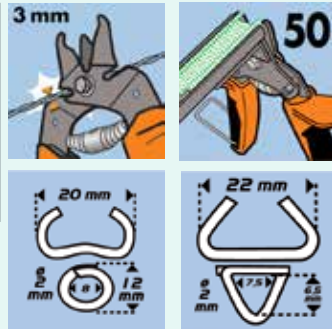

Code	Description	Staples to Suit	Pack
RT041155	Hand Hog Ring Plier	22mm 'D' & 20mm Omega	12

EDMA Automatic Hog Ring Pliers



POWER GRAFER

- Fits all types of drills
- For stapling chain-link fence
- High speed execution = time saving
- 50 staple magazine
- Made in France
- Compatible with 22mm 'D' Staples and 20mm 'Omega staples

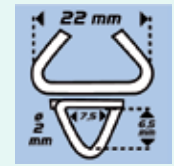
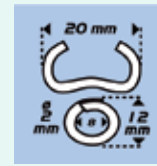

Code	Description	Staples to Suit	Pack
RT041455	Automatic Hog Ring Plier	22mm 'D' & 20mm Omega	6

Staples - Hog Ring Pliers

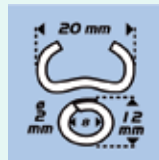

Code	Style	Coating	Size-mm	Pack	Box
RTSM20	'M'	Hot Galv	20mm	1000	20

EDMA Fencing Tension Claws



- Set of 2 universal chain link fencing tensioner for round posts
- Makes for easy installation by one person
- Holds the netting in position while stapling it
- 2 Claws per pack

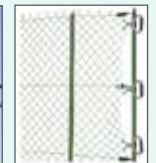

Code	Description	Size-mm	Pack
RT048455	Fencing Tension Claw	175mm	12

Ratchet Tie Down Assembly

• Ratchet assemblies comply to Australian Cargo Restraint System Standards AS/NZS 4380.

RTD Straps are 100% polyester which is heat set, stretched and polyurethane (PU) impregnated, resulting in low strain, long life, wear resistance, and durability demanded in flatbed tie-down requirements



Code	Hook Type	Width mm	Length m	LC Kg
349025RSB-BB	S	25	4	450
349035RB-BB	Hook & Keeper	35	6	1500
RTD055PL-BB	Hook & Keeper	50	9	2500

Grade "S" Bow Shackle - Gal

These hot dipped galvanised screw pin bow shackles are manufactured by Beaver. Screw pin shackles are recommend for use in long-term or permanent applications, or where the load may slide on the pin, causing a rotation of the pin



Code	Size mm	Working Load Limit	Qty Per Bucket	Bucket Kg
242306P-BB	6 x 8	0.50t	100	3
242308P-BB	8 x 10	0.75t	50	4.3
242311P-BB	11 x 13	1.50t	20	4.4
242313P-BB	13 x 16	2.00t	14	4.62

Masonry Splash Brush - Tampico Fibre



- Bristles made of white Tampico fibre
- 89mm bristles are set securely in hardwood block



Code	EDI	Bristle/Fill	Size-mm	Pack
MT829	16520	Tampico Fibre	163 x 44	12

Masonry Splash Brush - Tampico Fibre



- Tampico Fibre
- 5 row Brush



Code	Description	Bristle/Fill	Size-mm	Pack
BL526	Red Handle	Tampico Fibre	163 x 44	12

Brickies Brushes - Tampico Fibre



- Tampico Fibre
- Can be used with Broom Handle



Code	Size-mm	Bristle/Fill	Stock Head	Pack
BL677		Tampico Fibre	Timber	10

Concrete Finishing Brooms



- Designed for creating a rough surface after concreting



Code	Size mm	Size in	Bristle	Stock Head	Pack
38120	600	24	Poly	Timber	6
38125	750	30	Poly	Timber	6
38130	900	36	Poly	Timber	6

Concrete Finishing Brooms - Strip



- Designed for creating a rough surface after concreting



Code	Size mm	Bristle	Stock Head	Pack
BF9SOFT	900	Soft Poly	Aluminium	6
BF9MED	900	Medium Poly	Aluminium	6
BF9HARD	900	Hard Poly	Aluminium	6

Replacement Filaments



- To suit the Aluminium strip BF9 items



Code	Size mm	Bristle	Description	Pack
BF9SOFT-R	900	Soft Poly	Replacement	6
BF9MED-R	900	Medium Poly	Replacement	6
BF9HARD-R	900	Hard Poly	Replacement	6

Bannister Brushes

- Made from dyed coco fibre
- Solid wooden handle



Code	Size	Bristle	Stock Head	Pack
BA131	Large	Black Coco	Timber	12

Wire Brushes



Code	Description	Stock	Pack
39	4 Row Carbon Steel	Wood	12
39P	4 Row Carbon Steel	Plastic	12

Hard Centre/Soft Skirt Brooms



A general purpose broom in wet and dry conditions. It has a combination of hard and soft poly bristles which means this broom easily cleans up fine and coarse material in the same sweep

Code	Size-mm	Bristle	Stock Head	Handle to suit	Pack
24450	450	Poly	Poly	25mm	6
24600	600	Poly	Poly	25mm	6
24900	900	Poly	Timber	25mm	6

Soft Bristle Brooms



Densely filled in soft PVC, suitable for smooth floors, slate, timber and vinyl in wet and dry

Code	Size-mm	Bristle	Stock Head	Handle to suit	Pack
22450	450	Poly	Poly	25mm	6
22600	600	Poly	Poly	25mm	6

Hard Bristle Brooms



Extra stiff polypropylene fill is ideal for heavy duty sweeping of coarse material in wet and dry environments

Code	Size-mm	Bristle	Stock Head	Handle to suit	Pack
28450	450	Poly	Poly	25mm	6
28600	600	Poly	Poly	25mm	6

Extremely Stiff Scavenger Broom Heads



A heavy duty industrial scrub broom filled with stiff polyester fibre. Chemical and heat resistant to 120C. An essential product for concreters and brickies

Code	Size-mm	Bristle	Stock Head	Handle to suit	Pack
29450	450	Poly	Poly	25mm	6
29600	600	Poly	Poly	25mm	6

Hard Centre/Soft Skirt Brooms



A general purpose broom in wet and dry conditions. It has a combination of hard and soft poly bristles which means this broom easily cleans up fine and coarse material in the same sweep

Code	Size-mm	Bristle	Stock Head	Handle to suit	Pack
BR600	600	Poly	Poly	25mm	6

Yard/Council Brooms



- A Polypropylene extra stiff fill and steel frame
- Perfect for outdoor, councils, road/civil and landscaping

Code	Size-mm	Bristle	Stock Head	Handle to suit	Pack
72350	350	Poly	Metal Strip	25mm	6

Yard/Council Brooms



- A Polypropylene stiff fill
- Use for outdoor, councils, road/civil and landscaping

Code	Size-mm	Bristle	Stock Head	Handle to suit	Pack
73350	350	Poly	Timber	25mm	6

Replacement Broom Handles



Code	Size-mm	Material	Pack
U149	1350 x 22	Timber	25
U155	1500 x 25	Timber	25
RH	1800 x 28	Timber	25

Budget Broom Head



- Standard household indoor broom, lightweight and affordable



Code	Size mm	Bristle	Stock Head	Handle to suit	Pack
2010	250	Poly	Plastic	22mm	12

Concrete Sealer Broom Head



- Used to apply concrete sealer, can be re-used. Plastic stock with poly fill



Code	Size mm	Bristle	Stock Head	Handle to suit	Pack
2025	250	Poly	Plastic	22mm	12

Dairy Scrub



- Hard wearing poly fill, perfect for all types of wet scrubbing
- Great for cleaning up tools and machinery



Code	Size-mm	Bristle	Stock Head	Pack
BL974	180 x 65	Stiff Poly	Plastic	10

Brick Acid Brush



- Hard wearing poly fill, perfect for all types of wet scrubbing
- Handle keeps hand away from scrubbing surface
- Great for cleaning up tools and machinery



Code	Size-mm	Bristle	Stock Head	Pack
BL119	230 x 80	Stiff Poly	Plastic	10

Boot Cleaning Brush



- Excellent for building and construction sites, sports ovals and golf courses
- Sturdy construction for long life
- UV Stabilised bristles
- Can be bolted down



Code	Description	Pack
BL4059	Stiff Bristle Boot Cleaning Brush	6

Squeegees - Neoprene Rubber



- Strong Neoprene Rubber
- Complete with adaptor fitting for telescopic handle (#MP1076)
- Adaptor can be removed to fit normal 25mm handle #U155



Code	Size-mm	Description	Pack
BL230	450	Red Neoprene Rubber	6
BL247	600	Red Neoprene Rubber	6
BL254	900	Red Neoprene Rubber	6

Floor Sweeper

- Two front side brushes
- One centre main brush
- Sweeps all kinds of large & fine sand both wet and dry
- Capacity: 40L
- Sweeping width: 920mm
- Performance: 3680m2 per hour



Code	Description	Size
SW920	Floor Sweeper	1400L x 1030W x 1200H

Tennis Court Water Squeegee



- Durable Stainless Steel for large flat areas
- Size:101H x 135L x 10Wcm
- Solid tube frame design



Code	Description	Carton
TCWS	Tennis/Concrete Squeegee	1

NOTES

The notes section is a large rectangular area with a decorative border. It contains a grid of horizontal and vertical lines, creating a series of columns and rows for writing. The grid is composed of 12 vertical lines and 24 horizontal lines, forming a series of columns and rows. The lines are evenly spaced and extend across the width and height of the notes section.

Marco Pro - Premium Line Finishing Trowels



Very durable and flexible
Chromium-molybdenum
Stainless steel

Perfectly formed,
ergonomic handle

Handle screwed on
from rear

Sturdy, high-quality
lightweight aluminum
alloy bracket

Chamfered edges and
polished traverse
lower leaf surface

- Made in Germany
- Perfectly formed ergonomic handles made out of cork
- Golden stainless steel blades



Marco Pro - Pointed Trowel



- Ergonomic bi-component grip with 96% cork
- Blister-free work due to the cork handle, very comfortable in the hand
- No swelling due to moisture
- Made in Germany



Code	Size-mm	Description	Pack
MP5636	355 x 100	Golden Stainless Steel	8
MP5643	405 x 115	Golden Stainless Steel	8
MP5650	455 x 115	Golden Stainless Steel	8

Marco Pro - Rounded Front Trowel



- Ergonomic bi-component grip with 96% cork
- Blister-free work due to the cork handle, very comfortable in the hand
- No swelling due to moisture
- Made in Germany



Code	Size-mm	Description	Pack
MP5612	405 x 100	Golden Stainless Steel	8
MP5629	455 x 100	Golden Stainless Steel	8

Pointed Flooring Trowels



- Used for trowelling concrete surfaces
- Stainless steel rivets
- High carbon steel blade
- Comfort grip handle



Code	Description	Size-mm	Pack
MP101	Standard Gauge	120 x 355	6
MP103	Heavy Gauge	120 x 355	6
MP109	Standard Gauge	100 x 355	6
MP191	Standard Gauge	115 x 405	6
MP192	Standard Gauge	115 x 460	6
MP193	Standard Gauge	115 x 510	6
MP165	Standard Gauge	115 x 600	6

Marco Pro - Cork Grip - Square



- Ergonomic bi-component grip with 96% cork
- Blister-free work due to the cork handle, very comfortable in the hand
- No swelling due to moisture
- Made in Germany



Code	Size-mm	Description	Pack
MP5711	280 x 120	Golden Stainless Steel	8
MP5728	330 x 120	Golden Stainless Steel	8
MP5735	356 x 120	Golden Stainless Steel	8
MP5759	405 x 120	Golden Stainless Steel	8
MP5216	460 x 120	Golden Stainless Steel	8
MP5223	508 x 120	Golden Stainless Steel	8

Ancora Pavan Stainless Pool Trowels



- Made from the highest grade stainless steel
- Blade is flexible enough to bend to almost any radius
- Made in Italy

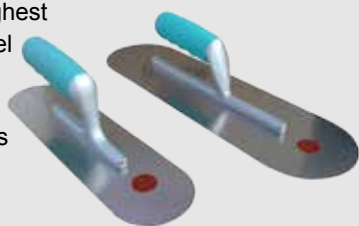

Code	Size	Description	Pack
PE1814353	250 x 80	Stainless Steel	6
PE1814354	300 x 80	Stainless Steel	6
PE1814355	350 X 100	Stainless Steel	6
PE1814356	400 x 120	Stainless Steel	6
PE1814357	460 x 120	Stainless Steel	6

Marco Pesaro Magnesium Floats



- Heavy duty extruded magnesium blade
- Soft grip handle

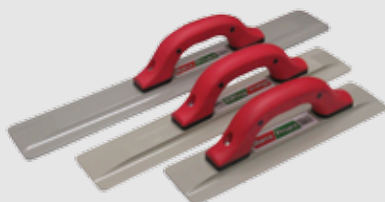

Code	Size-mm	Description	Pack
MAG12	300 x 79	Bevelled End	6
MAG16	405 x 79	Bevelled End	6
MAG20	510 x 79	Bevelled End	6

Marshalltown Cast Magnesium Float



- Cast from the finest magnesium
- Designed for just the right broken-in shape
- Cast construction allows more knuckle clearance

Code	EDI	Size-mm	Description	Pack
MT148D	14613	406 x 79	Cast Magnesium	6

Marshalltown Magnesium Darbie



- Made from the same lightweight, durable extrusion as our magnesium floats



Code	EDI	Size-mm	Description
MT4626D	14626	914 x 79	Two handles for extra control

Marshalltown Golden SS Pool Trowels



- Made from hardened and tempered golden stainless steel, properly shaped and fastened with stainless steel rivets
- Short aluminium alloy Xtralite mounting is lightweight but very strong
- Blade is flexible enough to bend to almost any radius

Code	EDI	Size-mm	Description
MTSP10GSD	13150	254 x 76	Golden Stainless
MTSP12GSD	13152	305 x 89	Golden Stainless
MTSP14GSD	13153	356 x 102	Golden Stainless
MTSP16GSD	13154	406 x 114	Golden Stainless

Marshalltown Round Front Trowel



- Made from hardened and tempered spring steel blade, properly shaped
- Aluminium alloy Xtralite mounting is lightweight but very strong



Code	EDI	Size-mm	Description
MTMXS64RED	13899	356 x 102	Carbon Steel
MTMXS66RED	13511	405 x 102	Carbon Steel
MTMXS81RED	13513	457 x 102	Carbon Steel
MTMXS20RED	13515	508 x 102	Carbon Steel
MTMXS224RD	12217	559 x 102	Carbon Steel
MTMXS244RD	12219	610 x 102	Carbon Steel
MTMXS245RD	12223	610 x 127	Carbon Steel

Marshalltown Magnesium Float



- Extruded from very hard durable, lightweight magnesium
- Magnesium floats produce a smoother finish than wood
- "THE HOG" MAGNESIUM FLOATS Has a wide blade that covers more surface area and wears longer



Code	EDI	Size-mm	Description	Pack
MT142D	14609	305 x 79	Bevelled End	6
MT145D	14610	406 x 79	Bevelled End	6
MT146D	14611	508 x 79	Bevelled End	6
MT143D	14612	406 x 79	Round Ends	6
MT738D	14638	406 x 95	"The Hog"	6
MT740D	14640	508 x 95	"The Hog"	6

Marco Pesaro Wood Floats



- Rubber Handle
- Hardwood



Code	Size-mm	Description	Pack
MP801	300 x 115	Hard Wearing Timber	6
MP802	380 x 115	Hard Wearing Timber	6
MP804	460 x 60	Hard Wearing Timber	6

German Abachi Wood Floats



- Made from laminated Abachi wood
- Made in Germany



Code	Size-mm	Description	Pack
436048	280 x 140	Poly Handle	6
436049	320 x 180	Poly Handle	6

Marco Pesaro Edgers - Stainless



- Stainless Steel Blade
- Ergonomic durable and comfortable handle



Code	Size-mm (L x W)	Radius	Lip	Pack
MP401	150 x 75	5	12	6
MP402	150 x 75	6	12	6
MP406	150 x 100	6	19	6
MP406F	150 x 75	10	40	6
MP408	150 x 75	19	19	6
MP702	175 x 112	12	22	6
MP703	175 x 112	25	19	6
MP706	150 x 100	10	14	6
MP708	200 x 140	20	19	6

Marshalltown Redwood Floats



- Made from clear, seasoned redwood - 19mm thick
- Item # MT144D has a beveled front edge



Code	EDI	Size-mm	Description
MT44D	14503	305 x 127	Square
MT144D	14505	406 x 89	Bevelled front edge

Safety Step Edger/Groover



- Creates a safety tread effect on steps
- Cuts 4 grooves, 19mm apart
- Resilient DuraSoft handle provides a soft feel, reduces fatigue and offers excellent durability



Code	EDI	Size-mm	Radius	Lip	Description
MT4280D	14280	152 x 127	13	16	Stainless

Concrete Edgers - Straight Ends



- Heavy Gauge Stainless Steel
- Resilient DuraSoft handle provides a soft feel, reduces fatigue and offers excellent durability
- Used to produce a radius at the edge of a concrete slab to help prevent the edge from chipping

Code	EDI	Size-mm	Radius	Lip	Material
MT164SSD	14221	152 x 108	6	10	Stainless
MT165SSD	14227	152 x 115	10	13	Stainless
MT166SSD	14229	152 x 110	13	16	Stainless
MT188SSD	14288	203 x 152	13	16	Stainless

Concrete Edgers - Curved Ends



- Both ends are curved up for use in either direction
- Curved ends help prevent edger from digging in to wet concrete
- Heavy gauge stainless steel
- Used to produce a radius at the edge of a concrete slab to help prevent the edge from chipping

Code	EDI	Size-mm	Radius	Lip	Material
MT136SSD	14190	152 x 76	10	13	Stainless
MT121SSD	14192	152 x 76	13	16	Stainless
MT155SSD	14180	152 x 102	6	10	Stainless
MT156SSD	14182	152 x 102	10	13	Stainless
MT138SSD	14184	152 x 102	13	16	Stainless

Stainless 2-Way Walking Edger

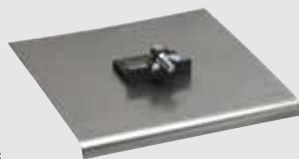

- Heavy 16 gauge Stainless Steel
- Abrasion tests show these edgers will wear twice as long as other stainless steel edgers
- Slightly convex blade prevents gouging
- Use with MT10 handle

Code	EDI	Size-mm	Radius	Lip	Description
MT4121	14121	203 x 102	10	13	Stainless

Marshalltown Chamfer Edger

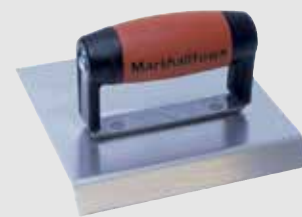

- Heavy gauge stainless steel
- Used to produce bevel at the edge of a concrete slab to help prevent the edge from chipping
- 45° angle

Code	EDI	Size-mm	Lip	Description
MT479CH	14479	152 x 152	13	Stainless
MT483CH	14483	152 x 152	19	Stainless

Hand Edger w/Adjustable Groover



- Heavy 16 gauge Stainless Steel
- Ideal for creating decorative borders in fresh concrete
- Groover is adjustable and tightens with two thumbscrews

Code	EDI	Size-mm	Rad	Bit Depth	Description
MT3488D	13488	356 x 127	10	13	Stainless

Marshalltown Safety Step Groover



- Creates a safety tread effect on steps
- Cuts 6 grooves, 19mm apart and 5mm deep

Code	EDI	Size-mm	Radius	Description
MT4282D	14282	152 x 152	3	Stainless

Marshalltown Zinc Groover



- Made from high quality, long wearing zinc
- Smooth finish allows for easier cleanup

Code	EDI	Size-mm	Deep	Material
MT833D	14105	152 x 111	13	Zinc
MT834D	14106	152 x 111	19	Zinc
MT835D	14107	152 x 111	25	Zinc

Stainless Steel Rocker Groover



- Groover blade has a slight bow which gives this tool a "rocker" effect
- Made of heavy gauge stainless steel then powder coated

Code	EDI	Size-mm	Rad	Deep	Description
MT1790D	11790	152 x 89	6	13	Stainless

QLT Bronze Edger



- Made from high quality, long wearing bronze
- Resilient DuraSoft handle provides a soft feel, reduces fatigue and offers excellent durability

Code	EDI	Size-mm	Rad	Lip	Description
MT7588	17588	152 x 70	6	16	Bronze

QLT Bronze Groover



- Made from high quality, long wearing bronze
- Resilient DuraSoft handle provides a soft feel, reduces fatigue and offers excellent durability

Code	EDI	Size-mm	Bit Depth	Description
MT7374	10439	203 x 152	25	Bronze
MT7315	10433	152 x 114	38	Bronze

Cast Iron Tools

- Made from cast iron
- Will last longer than carbon steel
- Item: 9G is designed to create a 7 line tread surface on steps

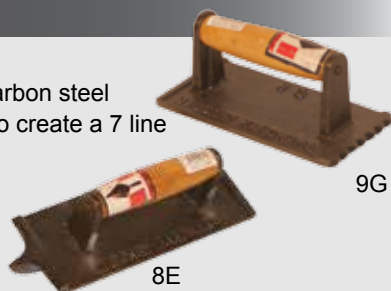

Code	Size-mm	Deep	Pack Qty
8E	200 x 75	25	6
9G	75mm Wide	7 Line	6

Ancora 963 Gauging Trowels



- Durable construction
- SINTESI soft grip handle
- Flexible, hardened steel blade
- Made in Italy



Code	Size mm	Size inch	Handle Type	Pack
PE2803903	152 x 85	6"	Soft Grip	6
PE2803906	178 x 85	7"	Soft Grip	6
PE2803909	203 x 90	8"	Soft Grip	6
PE2803915	228 x 100	9"	Soft Grip	6
PE2803921	254 x 105	10"	Soft Grip	6

Marshalltown Stainless Steel Step Tools



- Heavy gauge stainless steel
- 13mm radius and 102mm lip

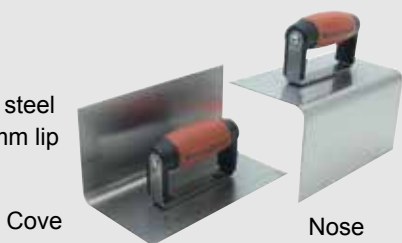

Code	EDI	Size-mm	Angle	Type
MT170SSD	14210	203 x 102	90°	Cove
MT171SSD	14212	203 x 102	90°	Nose

Marshalltown Curb/Sidewalk Tools



- Heavy gauge stainless steel



Code	EDI	Size-mm	Rad	Lip	Description
MT4268D	14268	152 x 102	19	38	Curb
MT4269D	14269	152 x 102	19	38	Sidewalk

Marco Pesaro All Sides Up Trowels



- Made from Long-wearing stainless steel blade
- Ergonomic plastic handle



Code	Size-mm	Handle	Material	Pack
MP209	210 x 160	Plastic	Stainless	6
MP229	290 x 100	Plastic	Stainless	6

Marco Pesaro All Sides Up Trowels



- Made from Long-wearing stainless steel blade
- Ergonomic timber handle



Code	Size-mm	Handle	Material	Pack
202S	230 x 150	Timber	Stainless	6
260S	280 x 127	Timber	Stainless	6

Bronze Bull Float Groover Bits



- Made from high quality, long wearing bronze
- Finely finished to make smooth clean grooves
- Slide easily over any magnesium bull float to give the ability to form grooves
- Perfect for cattle yards



Code	EDI	Radius mm	Width mm	Depth mm
MT7550	17550	6	10	19

Walking Trowels - Stainless Steel



- Made from Long-wearing stainless steel blade



Code	Size-mm	Description	Material	Pack
SSW1	100 x 600	Round both ends	Stainless	2
SSW2	120 x 600	Round both ends	Stainless	2
SSW4	120 x 900	Round both ends	Stainless	2

Walking Trowels - Carbon Steel



- Multi use bracket
- Accepts telescopic or clip together handles with ease



Code	Size-mm	Description	Pack
MP55	120 x 600	Round both ends	6

Marco Pesaro Fresno Trowels



- High quality carbon steel



Code	Size-mm	Description	Pack
MP69	120 x 900	Tilt Mechanism	2

Marco Pesaro Stainless Fresno



- Stainless Steel Blade
- Light Weight
- With tilt mechanism



Code	Size-mm	Description	Pack
SSF1	120 x 600	Tilt Mechanism	2
SSF2	120 x 900	Tilt Mechanism	2
SSF3	120 x 1200	Tilt Mechanism	2

Marco Pesaro Aluminium Bull Float



- Comes Fully Assembled
- Aluminium Tilt Mechanism
- Use with Telescopic handles: MP1076



MPADAPT1 is needed to use with Clip Handles MPCLIP18 & MPCLIP24.

Code	Size-mm	Description	Pack
MP1062	150 x 600	Tilt Mechanism	2
MP1063	150 x 900	Tilt Mechanism	2
MP1064	150 x 1200	Tilt Mechanism	2
MP1065	150 x 1500	Tilt Mechanism	2

Magnesium Bull Floats



- Extruded from magnesium alloy
- Lightweight and long wearing

MTMB48



MTMB48RR

Code	EDI	Size-mm	Type	Bracket
MTMB48	13874	203 x 1219	Square Ends	A3003
MTMB48RR	13866	203 x 1219	Round Ends	BF9

Magnesium Bull Floats - Blade Only



- Extruded from magnesium alloy
- Lightweight and long wearing

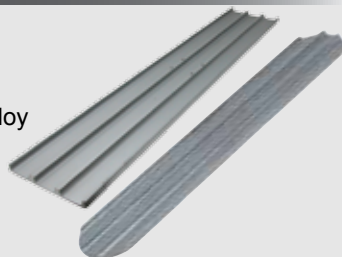

Code	EDI	Size-mm	Type	Pack
MTMB36RB	16886	203 x 914	Round Ends	3
MTMB48B	13873	203 x 1219	Square Ends	3
MTMB48RB	13872	203 x 1219	Round Ends	3
MTMB60B	16898	203 x 1524	Square Ends	3
MTMB72B	16902	203 x 1829	Square Ends	3

Magnesium Bull Float Totes



- Made of double layer durable water resistant nylon with a rigid reinforced base and stiffened side panels
- Specially designed reinforced nylon pole retainers will accept any 35mm or 45mm bull float handles
- Outside cinching straps are perfect for holding 1.2m levels, long trowels and brooms
- Multiple pockets hold a variety of finishing tools
- Kits include:
 - 1.2m magnesium bull float blade
 - MTBF9 - Rock-It mechanism
 - 4 x 35mm clip together handles
 - Tote bag



Code	EDI	Size-mm	Type	Bracket
MTBFKIT10	17399	203 x 1219	Round Ends	BF9
MTBFKIT12	17301	203 x 1219	Square Ends	BF9

Magnesium Channel Bull Float



- Sharp edge used for cutting down high spots, rounded edge used for floating
- Made from finest extruded magnesium

- Stiffer and more resistant to warping than standard bull floats
- Perfect tool to use when high "F" numbers are required

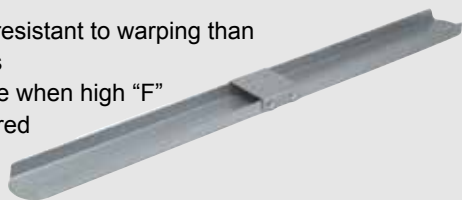

- Use with MPTILT mechanism and MPCLIP18 handles

Code	EDI	Size-mm	Type	Bracket
MTCB72DE	13795	152 x 1829	Round Ends	NIL

Marco Pesaro Telescopic Handles



- Telescopic handles are made from strong extruded aluminium
- Has a twist lock collar to easily adjust handle to desired length
- Will fit standard bull floats, concrete finishing brooms, Fresnos, walking trowels etc..



Code	Size-mm	Description	Pack
MP1076	35 x 2700	Extends to 5m	6

Marco Pesaro Push Button Handles



- Light Weight and Strong Construction
- Snap Button connects handles quickly



Code	Size-mm	Type	Pack
MPCLIP18	35 x 1800	Snap Button	10
MPCLIP24	35 x 2400	Snap Button	10

Wasp Concrete Rake - Open Face



- All Alloy lightweight placer
- Only weighs 1.2kg complete
- 500mm wide head
- The concreters first choice



Code	Blade-mm	Handle-mm	Description
CPR500	500	1500	Open Face

Concrete Roller Tamper



- Ideal for embedding exposed aggregate
- Quickly levels slab and prepares it for final finish
- Dual adaptor allows use with any clip and threaded handles

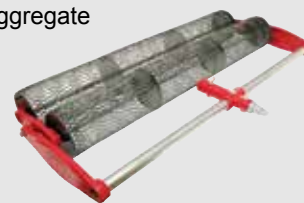

Code	EDI	Size	Pack
MTT459	14459	36"/914mm	1
MTT460	14460	48"/1219mm	1
MT10170	10170	Spare Adaptor	1

Marshalltown Handles



- Constructed of thick-walled aluminium tubing
- Heat-treated, lightweight
- Quick connect snap spring positively locks handles in place



Code	EDI	Size-mm	Type
MTRED790276	25631	44 x 2438	Snap Button
MTB572	14804	44 x 1829	Threaded End

Marshalltown Timber Handles



- Wood handles are fitted with a steel clevis
- Use with tools with a clevis style bracket



Code	EDI	Size-mm	Type
MT10	14842	39 x 1829	Steel Clevis Fitting

Wasp Concrete Placer - Closed Face



- All Alloy lightweight placer
- Powder coated
- 500mm wide head
- Big Red 1.8m long handle

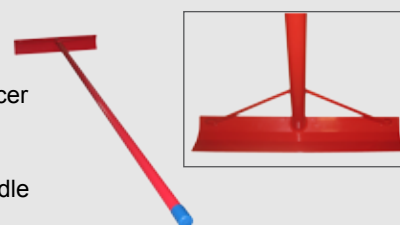

Code	Blade-mm	Handle-mm	Description
CPRMEDRED	500	1500	Closed Face
CPRBIGRED	500	1800	Closed Face

Marshalltown Alum Concrete Placer

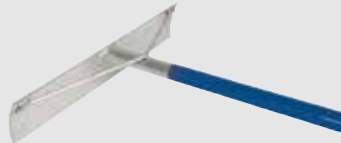

- Aluminium construction, powder coated
- Braced for additional strength
- 1524mm long
- Soft grip end-cap

Code	EDI	Size-mm	Description	Pack
MTAP753F	14753	500 x 1524	Closed Face	5

Marco Pesaro Aluminium Screed



- Screed Comes Fitted with Handle
- Powder Coated Blue



Code	Size-mm	Description	Pack
MPSC12	1200	Standard Handle	2
MPSC12L	1200	Level Handle	2
MPSC15	1500	Standard Handle	2
MPSC15L	1500	Level Handle	2
MPSC18	1800	Standard Handle	2
MPSC18L	1800	Level Handle	2
MPSC21	2100	Standard Handle	2
MPSC21L	2100	Level Handle	2
MPSC24	2400	Standard Handle	2
MPSC24L	2400	Level Handle	2
MPSC27	2700	Standard Handle	2
MPSC27L	2700	Level Handle	2
MPSC30	3000	Standard Handle	2
MPSC30L	3000	Level Handle	2
MPSC36	3600	Standard Handle	2
MPSC36L	3600	Level Handle	2

Marshalltown Rubbing Bricks



- Ideal for dressing down and removing form marks from concrete or cleaning brick

Code	EDI	Size-mm	Type	Pack
MT16533	16533	152 x 25	Round	5
MT841	16441	203 x 89 x 38	Square	5

Concrete Tool Accessories

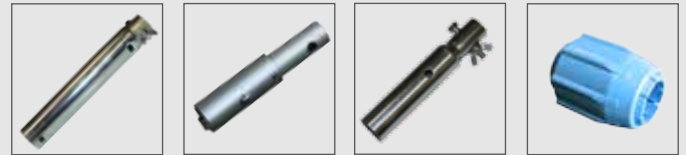

Code	Description
MP1076E	Swaged End tube for #MP1076 - Telescopic Handle
MPADAPT2	Adaptor Used So Clip Handles Can Be Used With #MPTILT Mechanisms
MPADAPT1	Adaptor so clip handles can be used with standard bull floats
MPADPAT3	Adaptor so clip handles can be used with standard bull floats
MP1076FIT	Telescopic Handle Spare Collar Fitting
MT16-MR	Mini Rock-It - 35mm
MPTILT	Bull Float Mechanism - USA Pro Easy Tilt
MP1063M	Bull Float Mechanism Assembly
MTA3003	Threaded Complete Assembly
MPLVH	Spare Screed Handle With Level Vial in Handle
MT12197	Double Button Snap Clip
MT16D	Mag Float Spare Handle

Marco Pesaro Rubbing Bricks



- Made from carbide
- Codes ending in 'H' have a soft grip handle



Code	Size-mm	Description	Grit	Pack
MHRB30H	200 x 90 x 38	Soft Grip	30	12
MHRB60H	150 x 75 x 25	Soft Grip	60	12
MHRB30C	150 x 75 x 38	Block Only	30	12

Marco Pesaro Kneeling Boards



- Made from Virgin Nylon
- 40mm cushion memory foam
- Display Box of 10pcs



Code	Size-mm	Description	Pack
MHKB	306 x 600	40mm Memory Foam Insert	10

Texture Hopper Sprayers



SEE Page 85 for further details



Code	Description
MP001	Marco Pesaro Texture Hopper Gun
MT693	Marshalltown Hopper Gun

Tie Wire Reel Dispenser



- All alloy die cast construction
- Accommodates all types of tie wire



Code	Description	Pack
RD	All Alloy Die Cast Construction	6

Tie Wire Reel Work Belt



- Leather work belt to suit Tie Wire reel #RD



Code	Size-mm	Description	Pack
WB	50mm Wide	Leather	12

Tie Wire - Black Annealed



Code	Description	Length (m)	Pack/Pallet
TW	1.57mm x 1.42kg	94	10/640
TW25-25	2.50mm x 25kg	648	1/20
TW315-25	3.15mm x 25kg	408	1/20

Black Annealed Wire Loop Ties



- Rolls of 2000pcs
- Wire diameter: 1.5mm



Code	Size-mm	Qty per roll	Pack/Pallet
LT110-2K	110 X 1.5	2000	5/45
LT125-2K	125 X 1.5	2000	5/45
LT150-2K	150 X 1.5	2000	4/36
LT200-2K	200 X 1.5	2000	3/27

Wire Twisters



- Compact size allows tool to be used in tight spaces
- Very durable

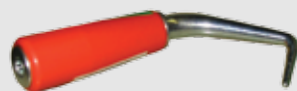

Code	Description	Material	Pack
WTT	Hand Twister	ABS	12

Wire Twisters

- Rubber grip handles
- Twists most ties with a single pull

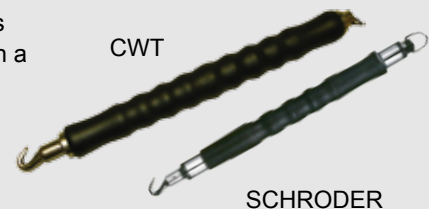

Code	Description	Origin	Pack
CWT	Spiral Drive	China	6
SCHRODER	Spiral Drive	German	6

End Cutting Nippers

Item: 112803

- Extra large head
- Made in Austria
- For soft and hard wire



112803

Code	Size-mm	Description	Pack
112803	270	Very Large Head	5
728C	200	Crescent Brand	6
729C	230	Crescent Brand	6

End Cutting Nippers - Knipex

- Professional Quality
- These pliers are of hardened and tempered chrome molybdenum
- Special tool steel, oil hardened and tempered
- Uses unique high frequency process for cutting edges. Over 60 HRC



Code	Size mm	Soft Wire mm	Medium Wire mm	Hard Wire mm
68-01-180	180	4.0	3.2	2.5
68-01-200	200	4.0	3.5	2.8
68-01-280	280	4.5	4.0	3.2

Primax - Nip Holder

Primax
Nip Holder

The Primax Nipper Holder is tough, strong and compact. It holds most popular types of end cutting nipper, so you can holster your nipper quickly and easily.

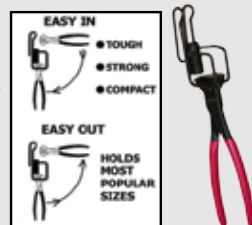

The Best Nip Holder Ever Made!

Code	Size-mm	Description	Pack
PRIMAX	105 x 45	Metal	10

Pocket Cutter

- Lightweight, general purpose
- Special alloy hardened and tempered cutting blade
- Comfortable grip with spring action permitting one hand operation
- Lockable handles



Code	Size mm	Brand	Mild Steel Brinell 140	Hard Steel Brinell 370
HIT200	200	HIT	4mm	2mm

End Cutting Nipper - Ransom Brand

RANSOM
TOOLWORKS

- Professional Quality
- These pliers are of hardened and tempered chrome molybdenum
- Special tool steel, oil hardened and tempered
- Uses unique high frequency process for cutting edges. Over 60 HRC



Code	Size mm	Soft Wire mm	Medium Wire mm	Hard Wire mm
EN200	200	4.0	3.5	2.8
EN280	280	N/A	2.8	1.8

End Cutting Nippers - Knipex

- To twist and cut wire in one operation: fast, reliable and economical
- Precision and long service life make these the most widely purchased concreters' nippers in the World
- Cutting edges additionally hardened; cutting edge hardness approx. 61 HRC
- High-grade special tool steel, forged, oil-hardened



Code	Size mm	Medium Wire mm	Hard Wire mm	Pack
99-01-280	280	2.8	1.8	6
99-01-300	300	3.1	1.8	6

High Leverage Nipper - Knipex

- 25% less effort required compared to conventional concreters' nippers of the same size
- Extra-slim form for tying deep mounted steel rods
- High-leverage joint, minimising strain, even when thick binding wires are used



Code	Size mm	Medium Wire mm	Hard Wire mm	Pack
99-11-300	280	3.8	2.0	6

Knipex Cobolt - Compact Bolt Cutter

- Exceptional cutting performance with minimum effort because of new lever action design
- Cuts material like bolts, nails, rivets, etc.. up to 5.2mm dia.
- Made with precision blades for soft, hard and piano wire
- Chrome vanadium electric steel, oil-hardened and tempered



Code	Size mm	Soft Wire mm	Medium Wire mm	Hard Wire mm	Piano Wire mm
71-12-200	200	6.0	5.2	4.0	3.6

Bolt Cutter - Marco Pesaro



- Recommended for general purpose use
- Suitable for concrete reinforcing rods, medium tensile soft nuts and bolts
- Comfort rubber handles for gripping firmly and safely



Code	Size mm	Size in	Soft Metals 49.6kg/mm ²	Hard Metals 133kg/mm ²	Pack
BC18	450	18"	8mm	6mm	6
BC24	600	24"	10mm	8mm	6
BC30	750	30"	13mm	8mm	5
BC36	900	36"	16mm	10mm	4
BC42	1050	42"	19mm	11mm	3

Rod Cutter and Bender- Marco Pesaro



- Cut capacity of 16mm
- Two in one combination tool
- Can be mounted on board for simple one handed operation
- Cuts and bends concrete reinforcing rods up to 180 deg
- Drop forged heat treated jaws
- Weight 16kg



Code	Length-mm	Max Capacity	Pack
RCB	1320	16mm	1
RCBJAWS	Spare Jaws	16mm	1

Rebar Lifter

- Use to position rebar or mesh while pouring concrete
- Comfortable rubber dipped handle



Code	Size-mm	Description
MT15349	813	Rebar Hook//Lifter

Rebar Bender

- Bends rebar up to 16mm



Code	Size-mm	Description	Pack
MT14739	864	3 Prong	12

Bolt Cutter - HIT



- Recommended for general purpose use
- Maximum hardness of material to be cut: Brinell 370/ Rockwell C40, 133kg/mm²
- Suitable for concrete reinforcing rods, medium tensile soft nuts and bolts
- Features include heat treated manganese vanadium steel jaws, adjusting bolts located at the jaw strap to keep cutting edges parallel during use and to provide better cutting performance
- Comfort rubber handles for gripping firmly and safely



Code	Size mm	Size in	Soft Metals 49.6kg/mm ²	Hard Metals 133kg/mm ²
HIT18	450	18"	8	6
HIT24	600	24"	10	8
HIT30	750	30"	13	9
HIT36	900	36"	16	10
HIT42	1050	42"	19	11

Bolt Cutter - High Tensile Red Jaw



- Recommended for heavy duty use
- Maximum hardness of material to be cut: Brinell 450/ Rockwell C48, 162kg/mm²
- Durable jaws are forged from high tensile alloy steel that is specially heat treated and suitable for cutting hard materials
- Short cutting edge to cut through chain links, high tensile bolts, rods and high tensile wire for pre-stressed concrete, etc
- Comfort rubber handles for gripping firmly and safely



Code	Size mm	Size in	Soft Metals 49.6kg/mm ²	Hard Metals 133kg/mm ²	High Tensile 162kg/mm ²
HIT18H	450	18"	8	6	5.5
HIT24H	600	24"	10	8	7
HIT30H	750	30"	13	9	8
HIT36H	900	36"	16	10	9
HIT42H	1050	42"	19	11	10

Concrete Brooms

SEE Page 29-31 for further details

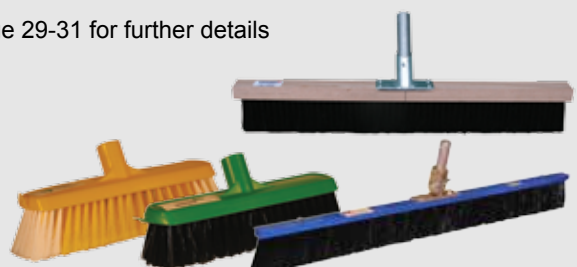

Rebate Clips - Formwork



- Used to form a 150mm brickwork rebate in concrete house slabs
- Two different models to suit 50mm and 40mm timber formwork



Code	Description	To Suit	Pack
RBCLIP40	150mm Rebate	40mm	20
RBCLIP	150mm Rebate	50mm	20

Duct Tape - Silver

- Heavy duty duct tape
- Ideal for concrete underlay and general bundling needs



Code	Description	Pack
TAPE	48mm x 30m x 0.13 micron	60

Monster Pry Bars



- Used for levering and moving objects into place with a lift and swivel motion

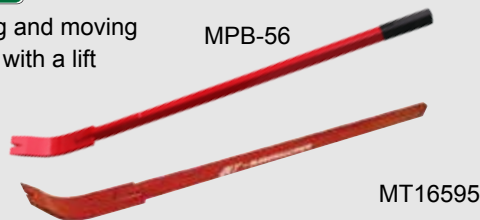

Code	Size-mm	Description	Pack
MPB-56	1400	Monster/Burke Bar	2
MT16595	1422	Monster/Burke Bar	2

Spike Shoes/Gunite Shoes



- Used for installing overlays
- 25mm plated steel spikes are pre-installed and recessed into a flexible black plastic sole
- Cinching buckle clips



Code	Length-mm	Spike Length	Pack
MT6186	305	25mm	6

Tamper

- Cast iron base
- 1219mm steel handle with rubber grip
- Used to flatten and smooth dirt, stone, asphalt and other materials
- Ideal tool for stamping decorative mats



Code	Size-mm	Description
MTHT10	254 x 254	Steel Handle with 254mm Rubber Grip

Mitre Shear - Fillet Cutter



- Neat and effortless cut!
- Opening allows easy cutting of decorative moulding, wood skirting boards, rubber seals, PVC sections

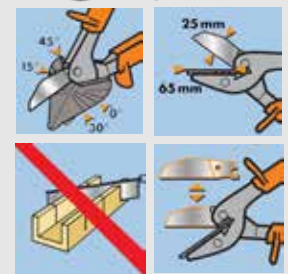

Code	Description	Pack
RT071055	65mm Long Blade	6

Spike Rollers



- Used to de aerate floor coatings
- The use of a spike roller is essential to release any trapped air within screeded toppings and levellers/epoxy coatings
- Use with: Cementitious coatings, fillers, floor levelers and epoxy coatings



Code	Length-mm	Spike Length	Pack
SPIKE250	250	11mm	6
SPIKE500	500	11mm	6

Gauge Rake

- Used to form uniform coating of surface with self-leveling and other materials
- Lightweight and sturdy aluminum
- Comes with 2 adjustable T-Skates to apply materials at a predetermined uniformed depth
- T-Skates can be adjusted up to 51mm



Code	Length-mm	Gauge Depth	Pack
KTCC975-01	600	51mm	1
KTCC976-01	900	51mm	1

Foam Joint - Expansion Joint



- Closed-cell cross linked polyethylene joint filler
- Economical and easy to install
- Precut on both sides so 10mm tear-off strip is easily removed
- Lightweight
- Avoid wastage – Easily cut to required length in the field.
- Suitable for interior and exterior application
- Available in plain and adhesive (Sticky) back



Code	Size	Description	Pack
FF50	50mm x 25m	Standard	20
FF50STICKY	50mm x 25m	Adhesive	20
FF75	75mm x 25m	Standard	14
FF75STICKY	75mm x 25m	Adhesive	14
FF100	100mm x 25m	Standard	10
FF100STICKY	100mm x 25m	Adhesive	10
FF125	125mm x 25m	Standard	8
FF125STICKY	125mm x 25m	Adhesive	8
FF150	150mm x 25m	Standard	7
FF150STICKY	150mm x 25m	Adhesive	7
FF200	200mm x 25m	Standard	5
FF200STICKY	200mm x 25m	Adhesive	5
FF250	250mm x 25m	Standard	4
FF250STICKY	250mm x 25m	Adhesive	4
FF300	300mm x 25m	Standard	3
FF300STICKY	300mm x 25m	Adhesive	3

- White/Cream colour for light coloured surfaces



Code	Size	Description	Pack
FF75STK-CRM	75mm x 25m	Adhesive	14
FF100STK-CRM	100mm x 25m	Adhesive	10

Expansion Cork Joint - Type III

Self expanding cork is manufactured to expand according to the ASTM D1752 Type III specification and is manufactured from the bark of the cork oak tree and granulated to be compressed into blocks then cut into sizes to suit your requirements on site.



Cork vs other materials

Selecting the right material to apply to expansion joints is critical to ensure safety and durability in construction. Cork-based solutions, given the natural properties and benefits of this material, guarantee a sustainable, low maintenance and high technical performance response for buildings and large public works.

Its high compressibility and resilience - make it the ideal material to withstand the swelling and shrinking movements of concrete and other rigid construction elements induced by thermal variations or other factors. Very flexible, cork agglomerates have a resilience of almost 90% after compression at 50% of their initial thickness. These values are much higher than those shown by other fill types.

Cork also meets all other technical requirements of expansion or movement joints. It has high durability without loss of features and without maintenance.

It is a resilient material and resistant to water, oils and acids. In addition, cork solutions do not expand out of the joint, even under heavy traffic or high compression.

Advantages

- Expands to fill joint
- Will not extrude under pressure
- Light weight and easy to handle
- Resilient and waterproof
- Supports sealants subject to hydrostatic pressure

Uses

- Water retaining structures
- Water excluding structures
- Roads, bridges and car parks
- Internal or external traffic areas



Code	Size-mm	Thickness	Pack
CORK-3-100X1500	100mm x 1500	10mm	20
CORK-3-125x1500	125mm x 1500	10mm	20
CORK-3-150x1500	150mm x 1500	10mm	20
CORK-3-200x1500	200mm x 1500	10mm	20
CORK-3-SH10	915 x 610	10mm	30
CORK-3-SH20	915 x 610	20mm	16

Expansion Stiff Joint



- Economical and easy to install
- Lightweight
- Closed Cell polyethylene foam



Code	Size	Description	Pack
SJ75-1500	75mm x 1500	10mm thick	20
SJ75-2400	75mm x 2400	10mm thick	20
SJ100-1500	100mm x 1500	10mm thick	20
SJ100-2400	100mm x 2400	10mm thick	20
SJ125-1500	125mm x 1500	10mm thick	20
SJ125-2400	125mm x 2400	10mm thick	20
SJ150-1500	150mm x 1500	10mm thick	20
SJ150-2400	150mm x 2400	10mm thick	20

Backer Rod - Closed Cell



Code	Size	Colour	Box
BRODCC6	6mm x 250m	White	1
BRODCC10	10mm x 250m	White	1
BRODCC13	13mm x 50m	White	1
BRODCC15	15mm x 50m	White	1
BRODCC20	20mm x 50m	White	1
BRODCC25	25mm x 50m	White	1
BRODCC30	30mm x 50m	White	1

Square Foam Strip

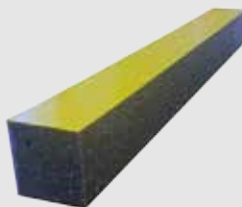

Code	Size-mm	Description	Pack
BR3020	30 x 20 x 2000	Black	200
BR4040AD	40 x 40 x 2000	Adhesive Backed	75

Bitumen Impregnated Expansion Joint

BIF Mastic is Bitumen Impregnated Fibre Board.

It is considered the best available worldwide. BIF Mastic is tough, light weight and does not bleed.

BIF Mastic is simple to install and is available in a variety of pre-cut sizes or is effortlessly cut with a blade or saw. BIF Mastic remains the standard of the industry. With over 70 years of proven performance, it is the highest quality, most cost effective solution for your concrete expansion joint requirements.



Code	Size-mm	Thickness	Pack
BIF75	75 x 2400	9.5mm	20
BIF100	100 x 2400	9.5mm	20
BIF125	120 x 2400	9.5mm	20
BIF150	150 x 2400	9.5mm	20
BIF200	200 x 2400	9.5mm	20
BIF300	300 x 2400	9.5mm	20
BIF900	900 x 2400	9.5mm	20
BIF1200	1200 x 2400	9.5mm	20

Caulking Compound



Code	Description	Box
TC-240124	Dymonic 100 - Polyurethane Sealant - 600ml Sausage - Grey	15
SIKA-519842	Sikaflex Pro 600ml Sausage - Grey	20
1A106240	Supaseal PU - Hybrid Polyurethane Flexible Sealant and Adhesive - Sausage - Grey	12

ProBond Hi-Tack

PROBOND HI-TACK is a single component, MS Polymer adhesive designed for high / instant grab. PROBOND HI-TACK has high initial green strength making it a universal product for bonding materials in horizontal and vertical applications where mechanical fixings are not desirable. PROBOND HI-TACK contains no solvents, phthalates, isocyanates/carcinogens or oils. PROBOND HI-TACK has excellent adhesion to a variety of substrates without the need for priming and minimal surface preparation.



Code	Description	Box
1A103874	Probond Hi-Tack - 290mm - White	12

Expansion Joint System



Full depth & straight steel backed expansion joint with 10mm P.E. cross linked closed cell foam for thermal expansion needs. Continuous pour product ensures cost savings can be achieved. Formed from high quality galvanised steel for maximum strength and minimal distortion. Patented peg & wedge setup system is quickest on market. Superior load transfer capabilities are achieved through full Connolly range of UDS dowel sleeves (round & square). Systems with friction cut dowels & hot dipped galvanised dowels as per Australian standards.

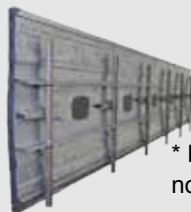

* Pegs and wedges not included in joint only

Code	Size	Description	Pack
CKJ-EXJ10030	100mm x 3m	Joint Only	10
CKJ-EXJ12530	125mm x 3m	Joint Only	10
CKJ-EXJ15030	150mm x 3m	Joint Only	10
CKJ-EXJ20030	200mm x 3m	Joint Only	6
CKJ-PW100X4	4 Pack of Pegs 350mm and Wedges	To suit EXJ10030 EXJ12530 EXJ15030	1
CKJ-PW150X4	4 Pack of Pegs 390mm and Wedges	To suit EXJ20030	1

Keyjoint



Formed from high quality galvanised steel for maximum strength and minimal distortion. Patented peg & wedge setup system is quickest on market. Unique design & profile ensures maximum strength in load transfer and minimal stepping/displacement. Continuous pour product ensures cost savings can be achieved. Knockouts' to accommodate large range of dowel sizes and shapes - works with all Connolly UDS dowel sleeves.



Code	Size	Includes	Pack
CKJ-KJ10030	100mm x 3m	4 Pack of wedges & 350mm long pegs	50
CKJ-KJ15030	150mm x 3m	4 Pack of wedges & 390mm long pegs	50
CKJ-KJ20030	200mm x 3m	4 Pack of wedges & 500mm long pegs	50
CKJ-KJ30030	300mm x 3m	4 Pack of wedges & 750mm long pegs	50

Expansion Joint Systems - Complete



Code	System Includes	Pack
CKJ-EXJ10030SYS	<ul style="list-style-type: none"> EXJ10030 x 1pcs HD Gal Dowels 12 x 300mm Round x 9pcs Dowel Sleeve - 12mm x 9pcs Pegs and wedges x 4pcs 	10
CKJ-EXJ12530SYS	<ul style="list-style-type: none"> EXJ12530 x 1pcs HD Gal Dowels - 16 x 450mm Round x 7pcs Dowel Sleeve - 16mm x 7pcs Pegs and wedges x 4pcs 	10
CKJ-EXJ15030SYS	<ul style="list-style-type: none"> EXJ15030 x 1pcs HD Gal Dowels - 16 x 450mm Round x 7pcs Dowel Sleeve - 16mm x 7pcs Pegs and wedges x 4pcs 	10
CKJ-EXJ20030SYS	<ul style="list-style-type: none"> EXJ20030 x 1pcs HD Gal Dowels - 24 x 450mm Round x 7pcs Dowel Sleeve - 24mm x 7pcs Pegs and wedges x 4pcs 	6

Rebate Moulds



- No need for expensive saw cutting
- Quick and easy to install
- Job is kept cleaner
- Forms a true square or rectangular rebate
- Parallel sides ensure sealant achieves maximum bond to the concrete
- Horizontal joint bottom gives maximum support to hard fillers
- Application of bond breaker tape ensures elastic sealants flex properly
- Two sizes to suit most sealant types and varying joint specifications
- Rigid PVC material ensures joints are straight
- Accurate calculation of sealant quantity

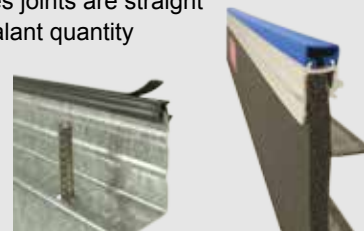

Code	Size-mm	Use With
CKJ-KJRM12X12	12Wx12Dx3000L	Key Joint Yellow
CKJ-KJRM20X10	20Wx10Dx3000L	Key Joint Grey
CKJ-EXJRBM16X10	16Wx10Dx3000L	Exp Joint Blue

Dowels - Friction Cut

Per Australian & New Zealand standard - AS/NZS 3679.1 300
Hot Dip Galvanised as per AS/NZS 4680:2006
Friction Saw Cut carbon steel dowels.
Available in black steel or hot dipped galvanised.
All square and round section sizes available



Code	Shape	Size mm	Length mm	Finish
DB16R-400	Round	16	400	Black
DB16R-450	Round	16	450	Black
DB20R-400	Round	20	400	Black
DB20R-450	Round	20	450	Black
DB16SQ-400	Square	16	400	Black
DB20SQ-400	Square	20	400	Black
DBHDG16R-400	Round	16	400	Galv
DBHDG16R-450	Round	16	450	Galv
DBHDG20R-400	Round	20	400	Galv
DBHDG20R-450	Round	20	450	Galv
DBHDG24R-450	Round	24	450	Galv
DBHDG16SQ-400	Square	16	400	Galv
DBHDG20SQ-400	Square	20	400	Galv
DBHDG20SQ-450	Square	20	450	Galv

Biscuit Plate Dowel System



- Available in 6mm and 10mm black, galvanised
- 6mm - Lateral movement capabilities
- 10mm - Both lateral and end expansion capabilities
- High load and minimal deflection tested qualities
- Ability to fix to timber and steel formwork with ease, using supplied fixing nails and screws
- Ideally suited for construction joints
- Large section sizes (150mm x 110mm) creates increased coverage meaning less dowels required per metre

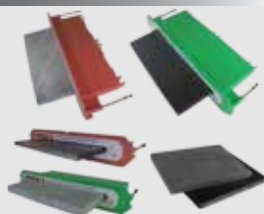

Code	Dowel Plate Size	Sleeve Colour	Dowel Finish	Pack
CKJ-CBPS6BLK	6	Red	Black	10pcs
CKJ-CBPS6BLK500	6	Red	Black	Bulk 500pcs
CKJ-CBPS6GAL	6	White	Gal	10pcs
CKJ-CBPS6GAL500	6	White	Gal	Bulk 500pcs
CKJ-CBPS10BLK	10	Green	Black	10pcs
CKJ-CBPS10BLK500	10	Green	Black	Bulk 500pcs
CKJ-CBPS10GAL	10	Purple	Gal	10pcs
CKJ-CBPS10GAL500	10	Purple	Gal	Bulk 500pcs

Dowel Sleeves "UDS"



- Simply twists in and locks into Connolly key joint and Connolly expansion joint
- Can also be used as a face fixing sleeve on conventional timber or steel formwork
- End support foot allows extra support to ensure correct alignment is maintained during concrete placement
- Rectangular sleeves for square dowels allow for lateral movement
- Provision for longitudinal expansion in the ends of all sleeves



Code	Size mm	Dowel Length Max	Dowel Shape	Bag
CKJ-UDS16R-230	16 x 230	450	Round	25
CKJ-UDS16R-300	16 x 300	600	Round	25
CKJ-UDS20R-230	20 x 230	450	Round	25
CKJ-UDS20R-300	20 x 300	600	Round	25
CKJ-UDS24R-230	24 x 230	450	Round	25
CKJ-UDS33R-230	33 x 230	450	Round	25
CKJ-UDS33R-300	33 x 300	600	Round	25
CKJ-UDS36R-230	36 x 230	450	Round	25
CKJ-UDS36R-300	36 x 300	600	Round	25
CKJ-UDS16SQ-230	16 x 230	450	Square	25
CKJ-UDS16SQ-300	16 x 300	600	Square	25
CKJ-UDS20SQ-230	20 x 230	450	Square	25
CKJ-UDS20SQ-300	20 x 300	600	Square	25

Speed Sleeves



Code	Size mm	Dowel Length Max	Dowel Shape	Pack
DSS-16RX230	16 x 230	450	Round	100
DSS-16RX310	16 x 310	600	Round	100

Connolly Crack Inducer



Formed from high quality galvanised steel for maximum strength and minimal distortion. Available as plain crack inducer or with capping attached.

Capping is tear off top - in black, grey, sandstone, terracotta

- Economical for small pours such as footpaths, entertaining areas and small driveways
- Ideal for joints in stenciled finishes
- Tear off strip to the capping produces a clean true colour to the joint
- Joints can be positioned as the pour proceeds
- Placement in the wet concrete induces a crack to relieve contraction stresses

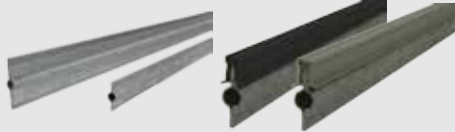

Code	Size	Colour	Pack
CKJ-CI25-PLAIN	25mm x 3m	Plain	10
CKJ-CI25-BLACK	25mm x 3m	Black	10
CKJ-CI25-GREY	25mm x 3m	Grey	10
CKJ-CI25-SAND	25mm x 3m	Sandstone	10
CKJ-CI25-TERRA	25mm x 3m	Terracotta	10
CKJ-CI45-PLAIN	45mm x 3m	Plain	10
CKJ-CI45-BLACK	45mm x 3m	Black	10
CKJ-CI45-GREY	45mm x 3m	Grey	10
CKJ-CI45-SAND	45mm x 3m	Sandstone	10
CKJ-CI45-TERRA	45mm x 3m	Terracotta	10

Connolly Capping



- Provides an architectural finish to the joint
- Available in a range of colours to match most finishes
- One size fits all Connolly key joint profiles
- Quickly and easily installed
- Narrow width to minimise edge damage
- Provides a slightly beveled edge to the joint to reduce spalling
- Prevents foreign particles entering the joint
- Provides a compression area at the top of the joint where it is most needed
- Resistant to oils and petroleum based products
- UV treated PVC material ensures long life

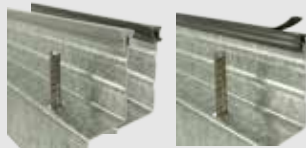

Code	Description	Colour
CKJ-KJCAPR-BLACK	Retained Permanent Cap for Keyjoint - 24m Roll	Black
CKJ-KJCAPR-GREY	Retained Permanent Cap for Keyjoint - 24m Roll	Grey
CKJ-KJCAPT-BLACK	Tear-Off Retained Permanent Cap for Keyjoint - 24m Roll	Black
CKJ-KJCAPT-GREY	Tear-Off Retained Permanent Cap for Keyjoint - 24m Roll	Grey

Connolly Dowel Cradles



- Less on site labour required means more accurate estimating & cost control
- Robust design ensures cradles are stable and can withstand the harsh treatment frequently encountered on site
- Ensures accurate horizontal and vertical alignment of dowels during concrete placement
- Dowels supplied welded in place with bond breaker to half of dowel length
- Available for round, square or plate dowels
- Eliminates the need to tie dowels
- Formed from high quality steel for maximum strength and minimal distortion.
- Made in standard 3.0m lengths for easy handling and transport
- Standard Connolly dowel cradles are made to suit most common dowel configurations or custom built to suit specific slab designs



Code	Dowel Shape	Dowel Size-mm	Dowel Finish	Dowel Spacing
CKJ-6150BLK	Plate	50x6x300	Black	450
CKJ-6150GAL	Plate	50x6x300	Gal	450
CKJ-10180BLK	Plate	50x10x300	Black	450
CKJ-10180GAL	Plate	50x10x300	Gal	450

Connolly Ground Crack Inducer



- Induces a controlled crack from the ground up
- Easy installation
- Secures easily to the ground using PC pins to prevent movement during pours
- Lightweight and durable
- Ideally suited for use with Connolly dowel cradles
- Can save money by helping reduce slab cutting depth



Code	Size	Pack
CKJ-CGI25	25mm x 3m	10
CKJ-CGI50	50mm x 3m	10

PVC Keyjoint Former



Reusable PVC keyjoint former for timber formwork
Uses

Ideal for establishing key joints in concrete pavements, particularly in checker-board layouts

Advantages

- Reusable
- Made from PVC – will not rot or corrode away
- Light weight – easy to handle
- Nailed to timber formwork with regular clouts
- Easy removal from concrete

PVC Keyjoint Formers are available in 2 sizes; the 80 mm size provide a 50 mm key in the concrete and is suitable for concrete pavements up to 150 mm thick; the 112 mm size provide a 72 mm key in the concrete and is suitable for concrete pavements above 150 mm thick

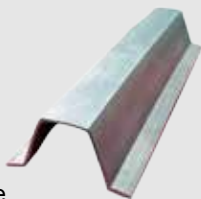

Code	Size mm	Key mm	Pavement Thickness	Pack
KF80PVC	80 x 3000	50	Up to 150mm	20
KF112PVC	112 x 3000	72	Above 150mm	20

PVC Waterstops

Full range of PVC waterstops available. Extruded from specially compounded PVC they are designed for use in water retaining and water excluding structures where a positive seal is required for poured in-situ concrete expansion, construction and contraction joints



Code	Size	Description
HYS150CB	150mm x 20m	Internal Profile Central Bulb for Expansion Joints CJ951
HYS200CB	200mm x 20m	Internal Profile Central Bulb for Expansion Joints CJ952
HYS250CB	250mm x 15m	Internal Profile Central Bulb for Expansion Joints CJ953
HYS150RGX	150mm x 20m	External Profile for Expansion Joints CJ923
HYS200RGX	200mm x 20m	External Profile for Expansion Joints CJ924
HYS250RGX	250mm x 15m	External Profile for Expansion Joints CJ925

EPH Void Former

- Environmentally friendly
- High load capacity when dry
- Light weight and easy to install
- Fully glued units are easy to cut into odd shapes
- Can be stacked to achieve greater void depths
- No assembly required

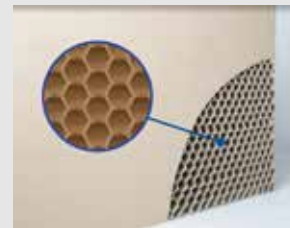

Uses

To separate concrete slabs, ground beams and pile caps etc from unstable expansive soils that can exert significant swelling pressures on structural foundations. EPH Void Formers provide a temporary support for the concrete during curing but collapse over time as the cardboard product biodegrades naturally

Description

EPH Void Former is a honeycomb bonded partition panel selected for its uniformity of manufacture and exhibiting excellent dry strength properties. It will support the weight of construction traffic, reinforcement and wet concrete until the cured concrete gains sufficient strength to be self-supporting. Be aware that the ground and atmospheric ambient moisture conditions are critical to the successful utilisation of this product and hence it must be used only in dry conditions.

EPH Void Formers are used to separate slabs and ground beams from unstable expansive soils.

EPH Void Formers will break down by the absorption of moisture and / or from soil bacterial attack to create a void beneath the slab or beam.

Code	Size-mm	Pallet
EPHVOID50	2400 x 800 x 50	42
EPHVOID75	2400 x 800 x 75	28
EPHVOID100	2400 x 800 x 100	21
EPHVOID125	2400 x 800 x 125	17
EPHVOID150	2400 x 800 x 150	14
EPHVOID200	2400 x 800 x 200	11
EPHVOID250	2400 x 800 x 250	8

PVC Column Formwork

- Lightweight, rigid and durable
- 100% Waterproof
- Exact sizing system means no Wastage
- Fast order turn around
- Easy to Install
- Able to remain in situ



Code	Description
PTUBE	Sizing as per request

Builders Film - Black Poly



Code	Size m	Thickness um	Colour	Pallet
BP450200	4 x 50	200	Black	36

Plastic Shims

Designed for levelling and packing objects with a high load mass. Suited for pre-cast concrete panels across construction industries.

This product is available in several colours and thickness.

This design is crafted with premium quality materials and features ribs to prevent slippage. All panel shims are certified and meet current Australian standards



Code	Size mm	Bag Qty	Colour
TP01SHM	150 x 100 x 1	200	Brown
TP02SHM	150 x 100 x 2	200	Blue
TP03SHM	150 x 100 x 3	100	Green
TP05SHM	150 x 100 x 5	100	Yellow
TP10SHM	150 x 100 x 10	40	Black
TP15SHM	150 x 100 x 15	40	Grey
TP20SHM	150 x 100 x 20	30	White
TP01SHM-HALF	75 x 100 x 1	200	Brown
TP02SHM-HALF	75 x 100 x 2	200	Blue
TP03SHM-HALF	75 x 100 x 3	100	Green
TP05SHM-HALF	75 x 100 x 5	100	Yellow
TP10SHM-HALF	75 x 100 x 10	40	Black
TP15SHM-HALF	75 x 100 x 15	40	Grey
TP20SHM-HALF	75 x 100 x 20	30	White

Hessian



Code	Size	Weight	Pack
H14	50m x 1.8m	14oz	1/21
H18	50m x 1.8m	18oz	1/21

Starter Bar - Screw In Bars

Threaded Starter Bars, threaded both ends with a nut for installation with a rattle gun



Code	Shape	Size mm	Length mm	Finish
SBTN12600	Round	12	600	Black
SBTN16600	Round	16	600	Black
SBTN20600	Round	20	600	Black

Slab On Ground Combination Chairs

Full range of the slab on ground chairs, which are manufactured from selected plastics for superior performance; tested to exceed loads of 200kg, and available in: 25 & 40, 50 & 65, 75 & 90, 85 & 100mm heights



Code	Description	Bag	Pallet
SOG2540	25mm & 40mm	100	5000
SOG5065	50mm & 65mm	100	6000
SOG5065C	50 x 65mm - With Clip	100	6000
SOG7590	75mm & 90mm	100	4000
SOG85100	85mm & 100mm	100	4000

Scaffold Podger Wrench



Code	Description
SRB2124	Scaffold Podger Wrench - 21 x 23.5mm
SRF-3	Ratchet Podger 4 Size - 17 x 21mm, 19 x 24mm
SRARK-10K	Safety Rope for Ratchet Podger Wrenches
SRRHD7	Ratchet Podger Holster for Scaffolders/Riggers

Hot Wire Cutting Bow for Styrofoam



Hot wire cutting bow for a clean cut without polystyrene beads projection - For E.P.S. and X.P.S.
Max. depth : 330 mm. Max. width : 1370 mm
Temperature of the hot wire : 350°C
Transformer : 40 V / 200 W / 230 V
CE certified

Code	Description
267901	EDMA Cordless Hot Wire Ark for EPS Waffle Pods

Steel Fence Posts/Star Pickets



Jack Jaw
Picket Removers
can be found on
Page 25



Code	Size-mm	Description	Sling
SP450	450	Black Steel Post	400
SP600	600	Black Steel Post	400
SP900	900	Black Steel Post	400
SP1350	1350	Black Steel Post	400
SP1500	1500	Black Steel Post	400
SP1650	1650	Black Steel Post	400
SP1800	1800	Black Steel Post	400

Flagging Tape Glo

UV stabilised. Suitable for mining,
construction, surveying, civil works
and other applications



Code	Description	Pack
FT25GBL	Flagging Tape - 25mm x 75m - Blue	10
FT25GG	Flagging Tape - 25mm x 75m - Green	10
FT25GL	Flagging Tape - 25mm x 75m - Lime	10
FT25GO	Flagging Tape - 25mm x 75m - Orange	10
FT25GP	Flagging Tape - 25mm x 75m - Pink	10
FT25GR	Flagging Tape - 25mm x 75m - Red	10
FT25GY	Flagging Tape - 25mm x 75m - Yellow	10

Cementitious Grouts



Code	Description
AF-TECHGC	An economical Class A general purpose non-shrink grout, for dry pack or fluid application
AF-TCHGFINE	A non-shrink general purpose Class C type cement based grout
AF-TECHGPP	An economical Class A non-shrink grout, specifically for fluid application or pumping
AF-TECHGHS	A high strength Class C grout for critical applications.

Safety Cushion Caps



- World recognised accreditation via NATA
- Impact Absorption Technology
- Concave top design aids in displacement of impact
- Reflective Material Technology for excellent night time visibility in all traffic areas
- Inexpensive and reusable
- Colour and strength of caps NOT degraded by UV exposure
- Our technology helps to minimise risk and injury



Code	Description	Bag
CKJ-CSCC12-20	Suits 12mm to 20mm bar	50
CKJ-CSCC20-33	Suits 20mm to 36mm bar & star pickets with reflective technology	50

Safety Picket Caps

A rounded plastic cap used to cover the sharp ends of the star picket posts to minimise injury risk in construction fields, whilst protecting the safety of people working on-site



Code	Size-mm	Box Qty	Colour
SPCAPS	Round	100	Yellow

Cementitious Repair Mortars



Code	Description
AF-FC	Fast drying cementitious surfacing compound for vertical surfaces. Available in standard Grey or Off White
AF-HB	A polymer modified lightweight mortar for the repair of vertical and overhead defects 10 – 80mm in concrete structures
AF-HB50	A polymer modified lightweight repair mortar for the repair of vertical and overhead defects where a strength of 50MPa is required
AF-PAVEPD	Fast setting premixed concrete for pavement repairs from 20 – 200mm thick
AF-RENPRIME-1LT	Acrylic Render Priming Agent - 1lt
AF-RENPRIME-5LT	Acrylic Render Priming Agent - 5lt

PBI Anchor

Powers



Heavy Duty Bracing Expansion Anchors

The PBI anchor is a high performance load controlled, thick sleeve expansion anchor. It is designed for use in bracing shoes (foot plates) for temporary bracing of prefabricated tilt-up concrete panels during construction



Code	Size/Length	Drilled Hole mm	Box
PBI20-20/115LH-PWR	M14/115mm	20	25

Sleeve Anchor - Hex Head

Powers



Medium Duty Expansion Anchors

The Sleeve Anchor is a pre-assembled single unit general purpose anchor available in various finishes and head styles for a broad range of applications. The Sleeve Anchor size is the same as that for the hole which eliminates layout or hole spotting.

Code	Size x Length	Finsh	Box Qty
HS1075-PWR	10 x 75	Zinc Yellow	50
HS10100-PWR	10 x 100	Zinc Yellow	50
HS10120-PWR	10 x 120	Zinc Yellow	50
HS1275-PWR	12 x 75	Zinc Yellow	25
HS12100-PWR	12 x 100	Zinc Yellow	25
HS12130-PWR	12 x 130	Zinc Yellow	25

PTB-PRO Through Bolt

Powers



HEAVY DUTY EXPANSION ANCHORS

The PTB-ETA1-PRO through bolt is a fully threaded, torque controlled, wedge expansion anchor designed for consistent performance in cracked and uncracked concrete. The anchor is easy to install and suitable for a variety of base materials with a nominal drill bit size the same as the anchor diameter. The wide range of available PTB-ETA1-PRO anchor sizes also cover all common capacity demands with a superior load-displacement response that qualifies the PTB-ETA1-PRO through bolt for both standard and adverse loading conditions.

Code	Size x Length	Finsh	Box Qty
69340-PWR	M10 x 120	Zinc Clear	50
69366-PWR	M12 x 135	Zinc Clear	25
69392-PWR	M16 x 150	Zinc Clear	20

Blue-Tip - Screw-Bolts

Powers



Hex Head Blue -Tip SCREW-BOLT™ anchors are one-piece units featuring a finished hex head formed with an integral washer. Suitable for any trade, Carpenter, Formworker, Tie down applications, Racking Installers, Construction, Can be used in Concrete, lightweight concrete, Hollow core concrete, Block, Brick, Stone.

- Hex Head Zinc Yellow finish
- Ratchet teeth on the underside of the hex washer head lock against the fixture
- Removable and vibration resistant
- Patented dual lead thread and a chamfered tip.
- Fast installation with Immediate high strength loading
- Specially matched to the clearance hole, the need for layout or hole spotting is eliminated.
- No expansion forces
- Can be installed closer to the edge than traditional mechanical anchors
- Can be installed at a shallower embedment reducing the chance of striking reinforcing bars or embedded cables

Code	Size	Min Embed	Drilled Hole	Socket Size	Box Qty
BT10060	10 x 60	40	10	17	50
BT10075	10 x 75	40	10	17	50
BT10100	10 x 100	40	10	17	50
BT12075	12 x 75	50	12	19	50
BT12100	12 x 100	50	12	19	50
BT12150	12 x 150	50	12	19	25
BT16100	16 x 100	65	16	19	20
BT16150	16 x 100	65	16	19	20

Adhesive Anchors

Powers



The Pure150-PRO is a two-component 3:1 ratio structural epoxy adhesive injection system. High strength adhesive designed for bonding threaded rod, internal threaded sleeve or reinforcement bars into cracked and uncracked concrete and other solid base materials. Consistent performance in uncracked and cracked concrete of variable strength

The PV45-PRO is a two-component 10:1 ratio styrene-free polyester adhesive anchoring system designed for use in the installation of threaded rod in solid concrete and masonry materials. This medium duty, fast curing formulation is recommended for use in concrete, solid brick and hollow brick materials. PV45-PRO is not recommended for safety-critical long term sustained load applications.

Code	Description	Box
PURE150PRO-585-PWR	3:1 Ratio Structural Epoxy Adhesivew Injection Anchoring System - 585ml	10
PV45PRO-PWR	10:1 Ratio Polyester Adhesivew Injection Anchoring System - 410ml	10

Epoxy Repair



Code	Description
	Resiloc PM 1.5lt KIT
AF-RESILOC	A smooth 2 part epoxy paste for general repairs in pavements, slabs, panels, etc.
	Resiloc PM 6lt KIT
AF-RESILOC-6LT	A smooth 2 part epoxy paste for general repairs in pavements, slabs, panels, etc.
	Resiloc HB 2lt KIT
AF-RESILOCHB2	A high build epoxy mortar for use as a repair mortar for cracked or damaged concrete

Timber Hex Head Screws



Type 17 Timber Self Drilling Hex Head Screws
Type 17 Self drilling point for fixing timber without the need to pre-drill. Slot at end forms a cutting edge which reduces splitting of timber.

- Type 17 Self drilling point for fixing timber without the need to pre-drill
- Slot at end reduces splitting of timber

Code	TPI	Length	Drive	Box Qty
T17HZY1225-PWR	11	12 x 25	5/16	500
T17HZY1240-PWR	11	12 x 40	5/16	1000
T17HZY1250-PWR	11	12 x 50	5/16	1000
T17HZY1265-PWR	11	12 x 65	5/16	1000

SDS Button Head Screws



Button head screws have a large low profile head that gives more bearing over the surface. Used in fixings where there are two flat surfaces, the flat underside is ideal for metal to metal connections

Code	TPI	Length	Drive	Box Qty
SDBHZY816-PWR	18	8 x 16	PH2	1000
SDBHZY820-PWR	18	8 x 20	PH2	1000
SDBHZY825-PWR	18	8 x 25	PH2	1000
SDBHZY832-PWR	18	8 x 32	PH2	1000

Crack Repair - ResigROUT LV

- Excellent adhesion
- High strength
- Moisture tolerant - cures under damp conditions
- Ease of application and convenient mix ratio
- Economical cost of material



Code	Description
	ResigROUT LV - 300ml KIT
AF-RESGLV	ResigROUT LV is a low viscosity epoxy grout for the repair of cracks in concrete pavement.
	ResigROUT LV - 1.5LT KIT
AF-RESGLV-1.5	ResigROUT LV is a low viscosity epoxy grout for the repair of cracks in concrete pavement.

Bullet Head Nails



Code	Description	Size-mm	Pack
BHN50	Bullet Head Nail	2.8 x 50	15kg
BHN75	Bullet Head Nail	3.75 x 75	15kg
BHN100	Bullet Head Nail	4.5 x 100	15kg

Chipboard - Self Embedding Head



Chipboard screws are a fine gauge screw with coarse thread for maximum holding power in chipboard, MDF and soft wood. Countersunk head with six nibbs to self-embed below the material surface.

Code	TPI	Length	Drive	Class	Box Qty
CBSZY0825-PWR	9	8 x 25	PH2	Zinc	1000
CBSZY0835-PWR	9	8 x 35	PH2	Zinc	1000
CBSZY0845-PWR	9	8 x 45	PH2	Zinc	1000

Mickey Pins - 2.5mm Washered



Hammer Drive pins are designed for permanent fastening fixtures to concrete and masonry. This fastener is recommended for light duty applications. It should not be used overhead

Code	Description	Length mm	Pack
MPW320-PWR	2.5mm Washered Mickey Pin	20	500
MPW325-PWR	2.5mm Washered Mickey Pin	25	500

Construction Sprayers - Swissmex

SWISSMEX

THE CHOICE FOR CONSTRUCTION

The Industrial construction line has been expressly built to handle the aggressive chemicals and rugged field conditions of the construction industry. All units feature specially formulated high-grade Viton seals throughout.

Our Acid sprayers effectively apply acid-based etching and cleaning materials.

The Construction line is recommended for building and industrial applications.



SP35C Construction Sprayer	189335 Backpack Sprayer	SP20A Acid Sprayer
----------------------------------	-------------------------------	--------------------------

Specifications	SP35C	189335	SP20A
Working Capacity	13 litres	15 litres	8 litres
Working Pressure	22-36 psi	15-87 psi	10-35 psi
Seals / O Rings	Viton	Viton	Nytril
Weight	3.1kg	4.9kg	3.1kg

Use For	SP35C	189335	SP20A
Curing Compounds	◆	◆	
Form Release	◆	◆	
Form Oil	◆	◆	
Diesel	◆	◆	
Oil and water-based Sealers	◆	◆	
Acid Stain			◆
Acid Etching			◆
Acids: Muriatic			◆
Phosphoric			◆

Royal Condor Classica Backpack Sprayer



RoyalCondor®



- Large screw down lid and strainer for quick filling
- On/Off trigger, extension lance with brass adjustable nozzle
- High pressure pump (1400kPa/203psi)
- Pump handle can be fitted either side of tank
- UV stabilised polytuff tank
- Perfect for spraying Prime Exposure concrete retarder
- Not suitable for solvents

Code	Size-mm	Description	Pack
CONDOR	20lt	Backpack Sprayer	1
RC-202X-01		Lid with Diaphragm	1
RC350A151X		Brass Nozzle	1
RC-920ENX		Trigger Vlve	1
RC-K8X		Piston Kit	1
RC-346EX-INX		Plastic Wand	1

Chapin Industrial Sprayers

- Viton® seals and Gaskets
- TriPoxy Steel Tank with Large Tri-Lock opening
- Brass Spray handle, wand and Nozzle
- Brass Pump



Code	Size	Description	Seals
1949	13 Litre	Red Tank	Viton
1979	13 Litre	Grey Tank with Filter	Viton

Code	Description
C-12521	O-Ring
C-15797	Brass Nozzle - 0.5GPM
C-15934	Brass Nozzle - 0.2GPM
C-15943	Brass Nozzle - 1.0GPM
C-6062	Brass Trigger Handle
C-64627	Repair Kit
C-66091	Spare Hose - 48 inch With Fitting
C-7703	24"/600mm Brass Lance - Male/Male
C-7704	24"/600mm Brass Lance - Male/Female

Pecafil® - Max Frank



From ground beams to separation panels, from box-outs to pile caps and bases, Pecafil® formwork saves you time and takes the hard work out of construction.

With its 20-year track record, Pecafil® is the tried and tested solution for today's construction professionals.

The specially manufactured material is constructed from a steel mesh in a wide range of sheet and strip sizes with various wire diameters, shaped to meet your needs. Its distinctive yellow outer layer is heat-shrunk polyethylene, made from non-toxic, naturally occurring hydrocarbons.

Manufactured in FRANK's 50,000m² dedicated factory, Pecafil® universal formwork is then cut and bent locally for easy distribution. The formwork is environmentally friendly, has no impact on groundwater and is both recyclable and biodegradable.

The benefits of Pecafil®:

- Saves time and costs on blinding, labour and spoil removal
- Curved or complicated foundation forms can easily be produced on-site
- No stripping, cleaning or return of the formwork
- Light enough for just one person to handle – no need for hoists, ready for rapid assembly
- Fast and easy to install – can be cut with basic tools
- Re-use your Pecafil® forms, depending on the specific site conditions and construction method - no waste
- Reduced working space requirement



Code	Width-mm	Length-mm	Sqm Per Sheet
PV1000060225	600	2250	1.350
PV1000090225	900	2250	2.030
PV1000120225	1200	2250	2.700
PV1000150225	1500	2250	3.375
PV1000180225	1800	2250	4.050

*** Cutting and bending services available to suit job specific designs

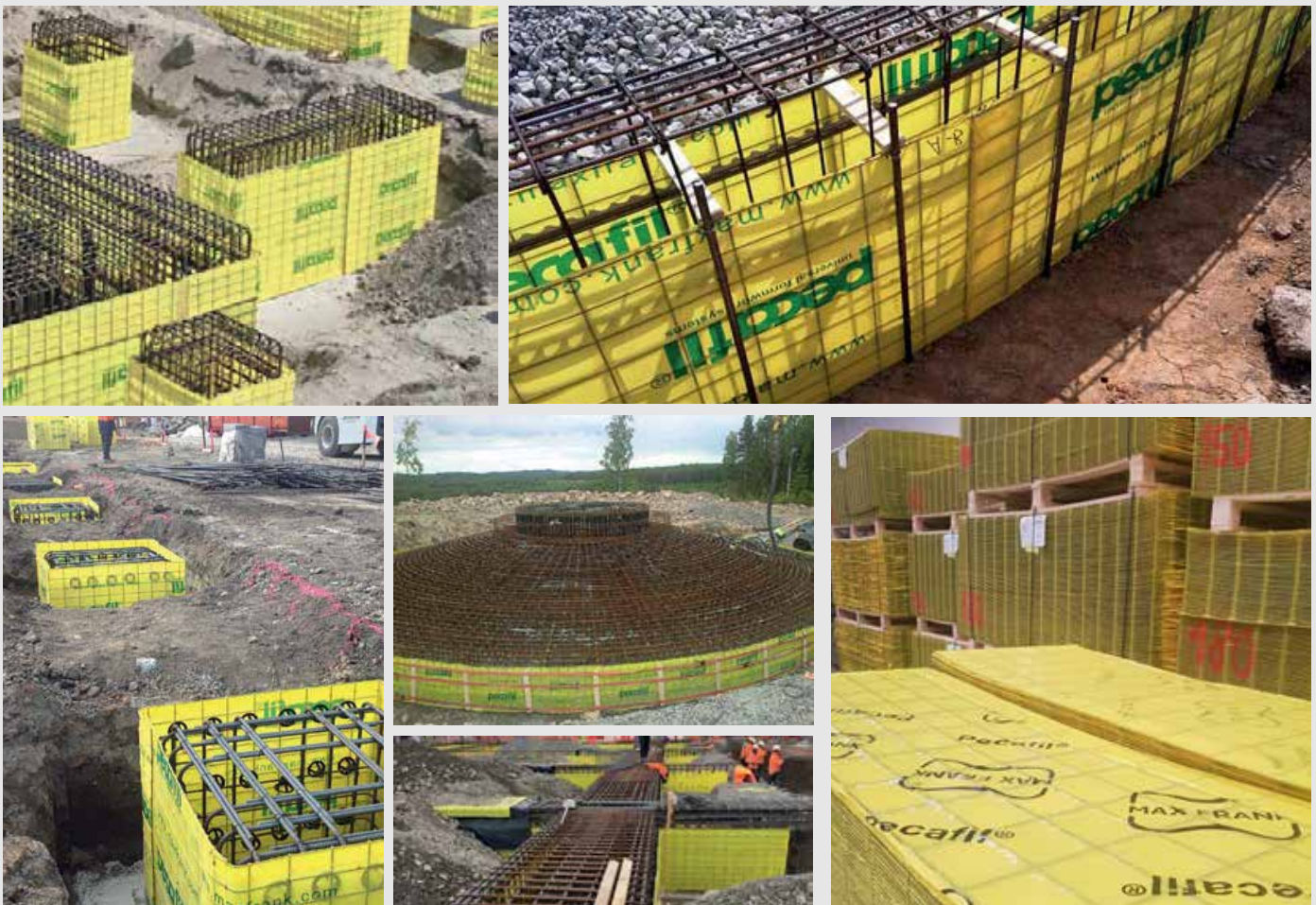



Stremaform®

Stremaform® formwork elements are used as lost formwork in floor slabs, ceilings and walls. The expanded metal that is welded between the bars of a specially designed reinforcing steel mesh gives rise to a rough surface. The reinforcement can be continued without a break into the second concrete pour.

- Other sizes and shapes are available upon request
- Stremaform with Integrated metal water stops or PVC cages available upon request
- Stremaform with key joints available upon request



Stremaform® Standard

Code	Width-mm	Length-mm
PV300000100	100	2400
PV300000200	200	2400
PV300000250	250	2400
PV300000300	300	2400
PV300000350	350	2400
PV300000400	400	2400
PV300000450	450	2400
PV300000500	500	2400
PV300000600	600	2400
PV300001000	1000	2400

Stremaform® Girders

- Can be used to accommodate any slab depth
- Ideal for large structural components
- Rear anchoring in the first concrete pour, hence no additional formwork elements are required for the second concrete pour
- Available in 2400mm length

Code	Length-mm
PV81024	2400

Expanded Mesh Flat Sheet

Code	Size-mm
PV31200	1200 x 2400

Stremaform® Strong (with additional 12mm stiffening)

Code	Width-mm	Length-mm
PV4000600AU	600	2400
PV4001000AU	1000	2400

Stremaform® Fine (for high flow spread/wet mixes)

Code	Width-mm	Length-mm
PV300FM02AU	200	2400
PV300FM06AU	600	2400
PV300FM10AU	1000	2400



Stremaform® Fine vs Stremaform® Standard

Stremaform® Flat material

Stremaform® flat material is used as lost formwork for working joints in floor slabs, ceilings and walls. The expanded metal that is welded between the specially designed steel reinforcement mesh produces a rough surface that avoids the need for subsequent scabbling of the concrete surface prior to a second pour. This surface forms an indented structure with the second concrete pour so that shear forces are transmitted across the working joint just as though it were a monolithic construction (proven by tests carried out at the IBMB Brunswick).

- Optimal static bonding of the joint
- Maximizing off-site prefabrication minimizes work on the construction site and guarantees fast progress of the project
- No need for formwork removal or any other finishing work

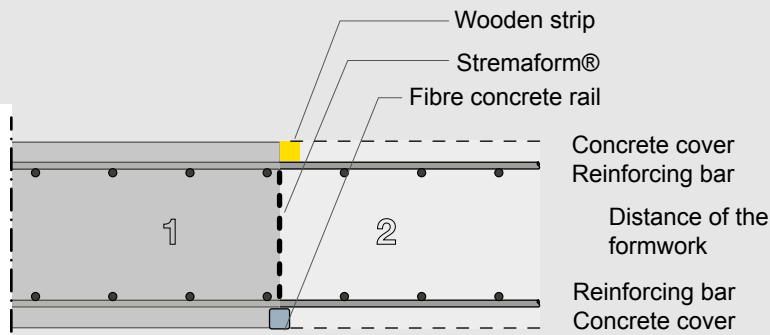

Stremaform® Spacer – The combined spacer

Stremaform® Spacers are used to maintain the concrete cover and to seal the gap beneath the bottom layer of continuous reinforcement. The Spacers thus prevent leakage of cement paste and avoid the need for laborious cleaning and reworking. During production at our factory, the correct spacer for the cover is used and the spacing and widths of the Stremaform combs are chosen to suit the reinforcement layout. The height of Stremaform combs can also be altered to suit multiple layers of reinforcement.

- A large range of concrete covers are available
- Suitable for slabs with very heavy reinforcement





Intec® injection hose system

Intec® injection hose systems consist of an injection hose, assorted accessories and a full range of injection resins. Intec® can be used as a stand-alone seal or as secondary sealing, in combination with metal, swellable waterstops or Max FRANK waterbars to seal all construction joints.

The Intec® injection hose system has been in use for over 20 years and has proved its value on many projects:

- No additional sealing method is required with reduced construction costs and shortened construction times
- Does not clog with water or cement laitance during concreting hose
- Absolutely secure and simple installation
- Injection lengths 30 m up to segment
- Quick sealing of all horizontal and vertical concrete construction joints
- Can be used to seal small cavities
- Approved for potable water applications



Intec® Premium is the proven injection hose system for joint sealing. Its unique and patented design features allow for multiple injections with polyurethane (PUR) resins. The injection chamber can be emptied by effortless pressure flushing; no additional equipment and vacuuming are required. The hose can be installed in individual sections of up to 30 m.

Code	Description
IVINTECP	Premium Hose - 100m Roll
INPACKB	Shutter Connector - Blue - Inlet
INPACKG	Shutter Connector - Yellow - Outlet
ISCHNC	Schnappi Ties for Green Concrete 100pcs per bag
IMSHILT	Metal Clip with Pre-Fitted Nail 100pcs per carton
INPPUR1LT	Injection Resin - 1 Litre



Cresco® GR expanding waterstop

The hydrophilic SEBS expanding waterstop Cresco® GR is a uniquely formulated synthetic rubber based swellable waterstop. It unites the most desirable characteristics of strip applied waterstops in one product. The initial onset of expansion is delayed for up to three days of exposure to water, after which the swelling begins. Overall expansion is restricted in order to prevent concrete spalling. The Cresco® GR waterstop will maintain its shape and will not be flushed out over time.

The proprietary grooved profile improves concrete bond and enhances waterproofing performance.

It can be used for waterproofing any static concrete to concrete joint.

- Acts as a non-swellable waterstop for up to three days
- Swell-rate and overall expansion will not lead to spalls
- Swelling is reversible with retention of initial geometry
- Good resistance to acids, alkalis and most aqueous solutions

Code	Description
QUBCRESGR	Cresco GR - 22 x 6mm - 15m Roll
QUBMKL	Cresco Fixing Glue - 300ml

- QUBMKL 310ml cartridge is sufficient for 8 - 10m
- Resistant to weathering and UV radiation

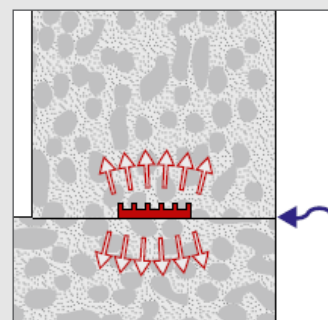

Fradiflex® metal waterstop

Fradiflex® metal water stops are supplied with a special adhesive coating on one or both surfaces with a two-part protective film which is removed individually prior to each pour. The coating forms an excellent bond with fresh concrete to reliably seal construction joints. A range of purpose made accessories including mounting clips and an expansion joint connector are available for easy and rapid installation.

Fradiflex® is a proven accepted alternative to traditional plain metal water stops for sealing construction joints. WU guideline of the DAf-Stb (guideline for watertight concrete structures) states that the standard dimensions of uncoated metal water stops should be a minimum thickness of 1.5 mm and a minimum height of 250 mm. Fradiflex® metal water stops will perform above and beyond DAfStb guideline for watertight concrete structures requirements.

- Unmatched adhesion to fresh concrete
- Tested to resist up to 50 metres hydraulic head
- Supplied in 25 metre long rolls, which reduces the number of laps and thus saving installation time while providing additional safety
- Integrated fixing angles reduce overall installation time. Joints are formed by simply overlapping sections by 100 mm and pressing against each other, no welding required
- Safe, simple and quick joint sealing of all types of construction joints
- Also available in 2.1 m long straight pieces with mounting angels



Zemseal® Premium

Zemseal® Premium is a highly durable, flexible waterproofing membrane. The material consists of three thermally fused lamination layers. The functional side (concrete) consists of a three-dimensional, diamond shaped polypropylene grid, a sandwich layer of a adhesive laced non-woven geotextile fabric and a chemically resistant polypropylene membrane on the waterbearing side. Zemseal® is ideally suited for under slab application due to its excellent mechanical properties.

Zemseal® Standard

Zemseal® Premium is a durable, flexible waterproofing membrane. The material consists of two thermally fused lamination layers. The functional side (concrete) consists of a layer of a adhesive laced non-woven geotextile fabric with a dimpled surface top increase bonding properties and a chemically resistant polypropylene membrane on the waterbearing side.

Major characteristics:

- Enhanced dual bond technology (adhesion and mechanical bond in one)
- Lasting, reliable thermo-welded product (lamination layers are thermally fused)
- Robust and malleable material (triple lamination)
- Durable polypropylene membrane (withstands chemical attack)
- Expedient installation (2 meter wide rolls, pre-formed details)
- Highly efficient (minimal lapping required)
- Engineering Services (waterproofing concepts, training, competent support)
- Climate independent installation (application range 0 °C – 50 °C)
- Part of MAX FRANK structural waterproofing system (one stop shop)

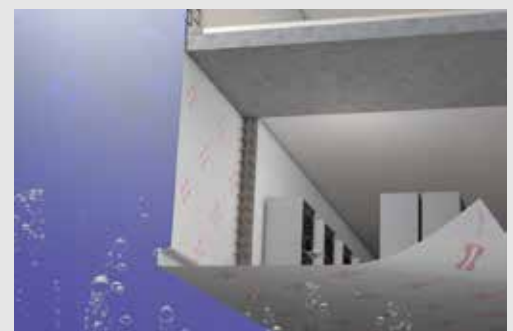

Zemdrain® Controlled Permeability Formliner

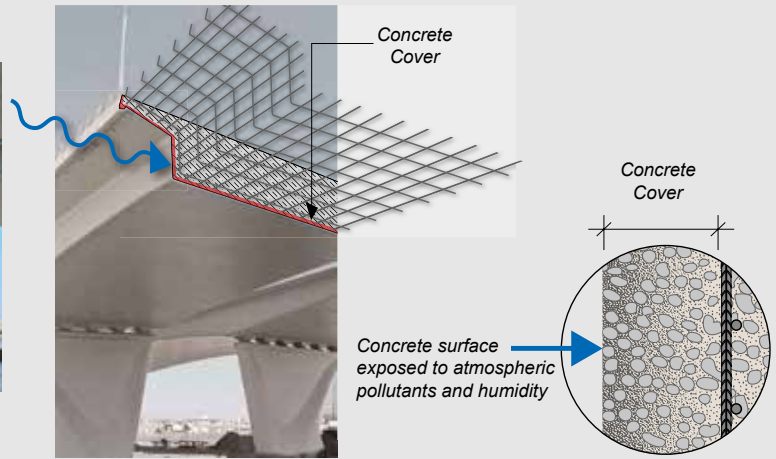

High-quality concrete surfaces

Concrete cover (the zone between reinforcement and concrete surface) protects reinforcement against aggressive environmental elements.

Cover concrete must be as dense and as hard as possible to prevent surface degradation and the ingress of aggressive elements to the reinforcement. Bridges, for example, are exposed to these aggressive elements: oxygen, carbon dioxide, humidity, wind, sand and mineral salts.

Due to the poor quality of concrete surfaces, visible damage to the concrete can occur after only a few years. The use of Zemdrain® modifies the surface characteristics of the concrete which considerably improves all concrete properties increasing quality and durability.



Without Zemdrain®

With Zemdrain®



Smooth to slightly textured, white surface (concrete side)

- Rear side (formwork side) with special draining grid
- Roll dimensions: Width 2.5 m and length 35 m
- Very economic because of the possibility of repeated use (2 – 3 times), simple and quick assembly
- High water storage capacity, therefore also suited for inclined or horizontal surfaces

More than 20 years of experience with Zemdrain®

Zemdrain® controlled permeability formliners have been used for many years in thousands of projects worldwide. In the Gulf region, for example, maximum durability and low maintenance costs under extreme environmental influences are of paramount importance. Very high levels of airborne salts, excessive air humidity and regular sandstorms are extreme challenges for any concrete structure. To ensure the highest quality concrete surfaces and maximum durability resistance, the use of Zemdrain® is highly recommended. Concrete structures must fulfill extremely high quality requirements not only in the Gulf region, but also in other hazardous environments like wastewater treatment plants. Zemdrain® is widely used for improving surfaces of these structures. Concrete must be resistant against hydro abrasion and sufficiently protected against the attacks of chemicals, acid and water. Only a high-quality surface concrete zone prevents premature degradation by abrasion or frost and thus increases the maintenance free life of these structures.

As surfaces are uncontaminated by release agent residues, microbiological growth is also minimised and surfaces are easy to clean.

Applications of Zemdrain®

Zemdrain® of all types consists of a filter layer consisting of polypropylene fibres with a highly controlled pore structure that ensures retention of cement and fine aggregate but is permeable to water and air. Adhesion of the filter to the concrete is minimal. The rear of the liner is a drainage layer consisting of either polypropylene fibres or a special grid.

Zemdrain® is widely used for various applications:

- Drinking Water Structures
- Wastewater & Sewage Treatment Plants
- Marine & Waterways Structures
- Dams & Power Stations
- Transport Infrastructure
- Exposed concrete

Code	Description
ZEMFRASA	Zemdrain® MD - 2.5 x 35m

A low water/cement ratio, reduced to match the hydration requirements in the concrete surface next to the formwork and a compact concrete structure make the surface concrete dense and hard. Additionally Zemdrain® retains part of the water, which is transported back to the concrete surface during the early age hardening phase (curing of green concrete).

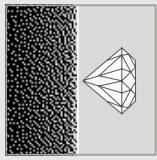

Significantly increased surface hardness and abrasion resistance.

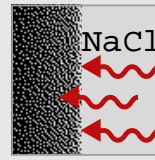

Reduced surface porosity minimises chloride ingress.

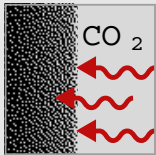

The dense surface with a reduced water/cement ratio significantly reduces the rate of carbonation.

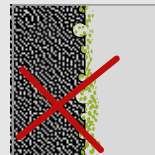

The uncontaminated, virtually blowhole and blemish free surfaces reduce the potential for the growth of micro organisms. Drinking water reservoirs made from concrete without the use of release agents guarantees hygienic drinking water.

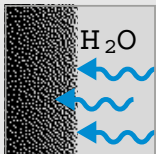

The increased cement content at the surface, together with early-age curing help reduce surface permeability and reduce water absorption.



The percentage of blowholes and pores is not only reduced on the concrete surface, but also immediately below. This provides additional safety for applications in drinking water reservoirs or for the use of coatings.



The dense surface concrete gives increased freeze/thaw resistance.

Principles of use

1. Zemdrain® is fixed to the formwork before erection (see separate Installation Guideline).
2. Once the formwork is erected, concrete is placed and compacted in accordance with normal practice.
3. Zemdrain® retains the concrete fines whilst allowing the controlled drainage of excess air and water that is normally trapped at the concrete/formwork interface. Additionally, water retained within the formwork side of the formliner is given back to the concrete during the curing phase (early age curing of green concrete).
4. After removal of the formwork, the very dense, hard, virtually blowhole free surface uncontaminated by release agents produced with Zemdrain® is immediately visible.
5. Use of Zemdrain® optimises the surface water/cement ratio, minimises blowholes and improves early age curing to give a high quality durable concrete surface with optimum resistance to all forms of environmental attack.

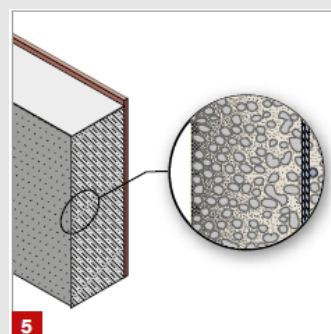
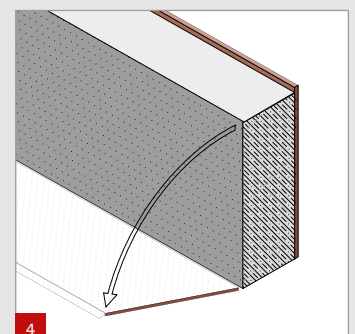
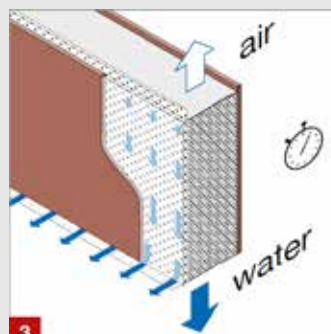
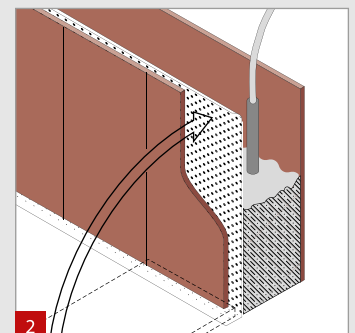
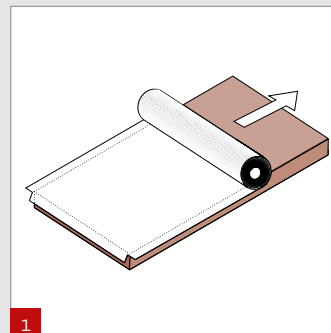



Continuity strip Stabox®

Stabox® reinforcement connections enable the force-locked connection of reinforced concrete components which are produced and concreted in a series of construction phases thanks to rational formwork systems.

Based on the coordinated geometry according to Eurocode and National Annex, Stabox® standard and special connections meet the maximum requirement of an indented joint design.

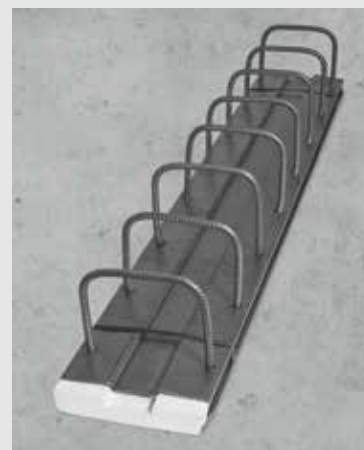

Stabox® S Continuity Strip

	ARTICLE NO.	DESCRIPTION	SLAB SIZE (MM)	L ₀ (MM)	BOX WIDTH (MM)
	STA12B1215	12 mm bar - 150 centers	160 - 180	390	120
	STA12B1220	12 mm bar - 200 centers	160 - 180	390	120
	STA15B1210	12 mm bar - 100 centers	180 - 200	390	140
	STA15B1215	12 mm bar - 150 centers	180 - 200	390	140
	STA15B1220	12 mm bar - 200 centers	180 - 200	390	140
	STA19B1210	12 mm bar - 100 centers	230 - 260	390	190
	STA19B1215	12 mm bar - 150 centers	230 - 260	390	190
	STA19B1220	12 mm bar - 200 centers	230 - 260	390	190
	STA22B1210	12 mm bar - 100 centers	260 - 290	390	220
	STA22B1215	12 mm bar - 150 centers	260 - 290	390	220
	STA22B1220	12 mm bar - 200 centers	260 - 290	390	220
	STA25B1210	12 mm bar - 100 centers	290	390	250
	STA25B1215	12 mm bar - 150 centers	290	390	250
	STA25B1220	12 mm bar - 200 centers	290	390	250

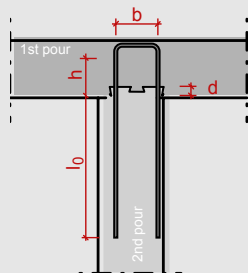
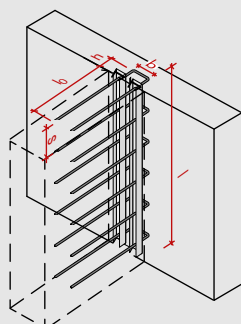



Egcodorn® transverse force dowel

By using the Egcodorn transverse force dowel, complex formwork and reinforcing operations in the area of expansion joints can be avoided. In addition, visually appealing slab undersides are achieved. The structure of the Egcodorn transverse force dowel allows for the transmission of high transverse forces even with minimum component dimensions. The unique corrosion protection system and the use of high-quality materials guarantee high durability.

Egcodorn® DQ

Egcodorn® DQ allows for longitudinal and lateral movement for high loads. The Egcodorn® DQ is suitable for use in environments subject to high corrosion, with a stainless steel sleeve and a dowel core made of high-grade steel

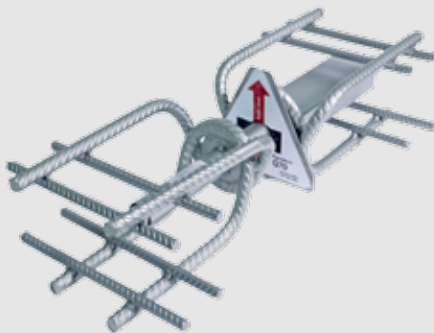

Code	Dowel diameter D [mm]	Anchor body diameter d_s [mm]	Anchor body height h_b [mm]	Minimum wall thickness [mm]
CHDDQ040	22	10	80	180
CHDDQ050	24	12	100	210
CHDDQ070	27	14	120	240
CHDDQ095	30	16	140	270
CHDDQ100	32	16	140	270
CHDDQ120	34	20	170	340
CHDDQ150	37	20	170	340
CHDDQ210	42	25	200	410
CHDDQ300	44	25	240	410
CHDDQ350	52	25	240	410

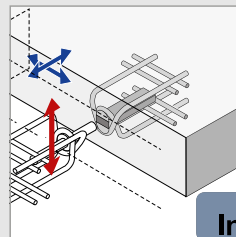

Egcodubel® HQI

Shear force dowels for expansion joints

Egcodubel HQI allows for longitudinal and lateral movement for low to middle loads. The Egcodubel HQI is suitable for use in environments subject to high corrosion, with a stainless steel sleeve and a dowel core made of high-grade steel

Code	Dowel diameter mm	Dowel length mm	Description
EDM20HFHQI	20	340	Stainless Steel Dowel and Sleeve
EDM22HFHQI	22	350	Stainless Steel Dowel and Sleeve
EDM27HFHQI	27	360	Stainless Steel Dowel and Sleeve

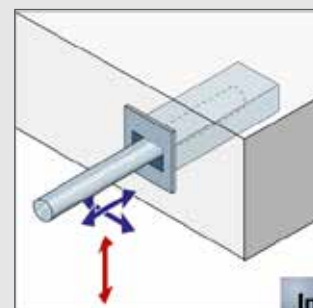



Cast Concrete Spacers with Embedded Wire

For vertical and horizontal reinforcement

Large contact surface and stable fixing for use on the building site and in the precast plant.

- Available in covers from 20 mm to 100 mm
- Available in Round, Square, and Triple Cover Blocks
- Available with galvanised (stock) or stainless (non-stock) steel tying wire
- Other sizes available upon request
- Compressive strength 60+ MPa
- Conforms to AS/NZS 2425
- Test reports available upon request



Round



Square

Code	Cover mm	Top Width mm	Bottom Width mm	Pieces/Bag
AB20HFOEDA	20	43	38	250
AB25HFOEDA	25	43	38	250
AB30HFOEDA	30	43	38	200
AB35HFOEDA	35	43	38	200
AB40HFOEDA	40	43	37	275
AB45HFOEDA	45	44	37	175
AB50HFOEDA	50	44	37	125
AB55HFOEDA	55	45	37	115
AB60HFOEDA	60	48	37	95
AB65HFOEDA	65	48	37	90
AB70HFOEDA	70	50	37	70
AB75HFOEDA	75	50	37	65
AB80HFOEDA	80	55	40	60
AB85HFOEDA	85	55	40	50
AB90HFOEDA	90	60	50	40
AB95HFOEDA	95	65	50	35
AB100HFOEDA	100	65	55	30

Code	Cover mm	Top Width mm	Bottom Width mm	Pieces/Bag
AB20QFOED	20	35	30	400
AB25QFOED	25	35	30	350
AB30QFOED	30	35	30	250
AB35QFOED	35	35	30	250
AB40QFOED	40	40	35	150
AB45QFOED	45	45	35	125
AB50QFOED	50	50	40	85
AB55QFOED	55	55	45	60
AB60QFOED	60	60	45	50
AB65QFOED	65	65	50	40
AB70QFOED	70	70	55	30
AB75QFOED	75	75	60	25
AB80QFOED	80	80	65	20
AB85QFOED	85	85	65	20
AB90QFOED	90	90	70	15
AB95QFOED	95	95	70	15
AB100QFOED	100	100	75	10



Fibre Extruded Spacers

- Available for Horizontal and vertical elements
- Available in various cut widths and covers
- Other sizes available upon request
- Suitable for high load distribution
- Tying wire options available at additional cost
- Compressive strength 60+ MPa
- Conforms to AS/NZS 2425
- Test reports available upon request



Triangular Bar

Code	Cover mm	Length mm	Pieces/Pallet
NFAHD050033	50	330	400
NFAHD055033	55	330	400
NFAHD060033	60	330	500
NFAHD065033	65	330	500
NFAHD070033	70	330	400
NFAHD075033	75	330	400
NFAHD025100	25	1000	100
NFAHD035100	35	1000	750
NFAHD040100	40	1000	500
NFAHD050100	50	1000	350
NFAHD055100	55	1000	350
NFAHD060100	60	1000	300
NFAHD065100	65	1000	200
NFAHD070100	70	1000	250
NFAHD075100	75	1000	150
NFAHD080100	80	1000	100
NFAHD090100	90	1000	100
NFAHD100100	100	1000	100

Square Bar

Code	Cover mm	Length mm	Pieces/Pallet
NFAHV050050033	50	330	600
NFAHV050050100	50	1000	200
NFAHV050070100	70	1000	100

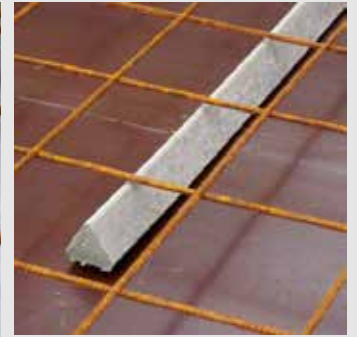
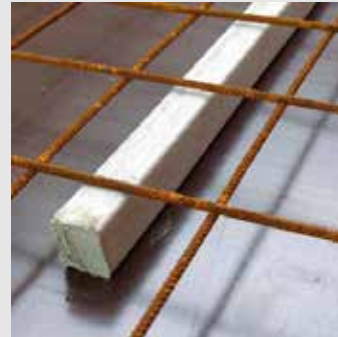

Snake Notched Bar

Code	Cover mm	Length mm	Pieces/Pallet
NFAHKB3533	35	330	2060
NFAHKB5033	50	330	1080
NFAHKB7533	75	330	700
NFAHKS25100	25	1000	1000
NFAHKS30100	30	1000	1000
NFAHKS35100	35	1000	750
NFAHKS40100	40	1000	600

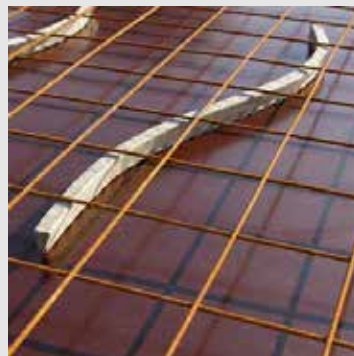

Prime Exposure - Exposed Aggregate



Prime Exposure is used to expose the aggregate in concrete surfaces. Prime Exposure works by delaying the set of the slurry (fat) on the concrete surface to expose the surface aggregate. Because Prime Exposure is coloured a bright fluorescent green you will be able to easily see and gauge the consistency of surface coverage. Use Prime Exposure for patios, driveways, landscaping and pool surrounds.



It's applications are only limited by your imagination...

Code	Litres	Coverage	Pack
PRIME20	20	80-100m ² per 20 Litres	1/32

Prime FormGel



Prime FormGel is a water soluble thick retardant gel that is applied to vertical and horizontal surfaces to expose the aggregate in concrete.



BENEFITS

Applied prior to pouring concrete, Prime FormGel allows you to leave formwork in place to expose the concrete surface 12 to 48 hours after pouring the concrete. This time frame is weather dependant.

Prime FormGel retards the surface ensuring an even exposure effortlessly with a brush/broom and hose or a high pressure washer. The fluoro green colour ensures easy application and reduces the chances of areas being missed or not coated. Prime FormGel is water soluble and Eco-friendly.

Code	Litres	Description	Pack
FORMGEL	20	FormGel Retarder	1/32

Prime Standard Sealer



Prime Exposure Acrylic Standard Sealer is made using the finest German acrylic polymers and is blended in Australia for Australian conditions.

Prime Exposure Acrylic Sealers will enhance the colour in your decorative concrete and keep it looking like new for years. Our sealers are UV resistant and will protect your concrete from mould, staining, algae, moss and repels dirt, grime and oils.



Code	Litres	Description	Pack
PRIMESTD	20	Clear Sealer	1/32

Prime Exposure - Evaploc



Tired of getting grief over hairline cracks? Prime Evaploc is a water soluble liquid when sprayed on curing concrete creates a plastic film that retards water evaporation in setting concrete. This greatly reduces the chances of plastic shrinking (known as hairlines) while making the concrete more workable for an extended period.



BENEFITS

Prime Evaploc reduces the chances of plastic shrinkage by up to 80% if the ground surface has been thoroughly watered prior to concrete placement. Using Prime Evaploc will allow the concrete to be workable for a longer period by delaying the surface to crust over in windy and hot conditions.

Once applied the concrete surface will have a creamy feel under the trowel making finishing easier without altering the concrete strength or durability.

Prime Evaploc retards concrete water evaporation by up to 80% in windy conditions and up to 60% in sunlight. The distinctive fluoro green colour ensures easy and even product application. The bright colour that makes application so easy leaves no staining or residue once cured

Code	Litres	Description	Pack
EVAPLOC	20	Evaporative Retarder	1/32

Prime Xylene/Solvent



Code	Litres	Description
PRIMESOLVENT5	5	Solvent/Xylene
PRIMESOLVENT10	10	Solvent/Xylene
PRIMESOLVENT20	20	Solvent/Xylene

Prime One Coat Sealer



Prime Exposure Acrylic Standard Sealer is made using the finest German acrylic polymers and is blended in Australia for Australian conditions.



Prime Exposure One Coat has been specifically designed utilizing various polymers to save time and money whilst delivering the same results as the two coat process. Prime Exposure Acrylic Sealers will enhance the colour in your decorative concrete and keep it looking like new for years. Our sealers are UV resistance and will protect your concrete from Mould, Staining, Algae, Moss and repels Dirt, Grime and Oils.

Code	Litres	Description
PRIMESEAL1	20	One Coat Sealer - Clear

Prime Colour Sealer



Prime Exposure Acrylic Standard Sealer is made using the finest German acrylic polymers and is blended in Australia for Australian conditions.



Prime Exposure Acrylic Sealers will enhance the colour in your decorative concrete and keep it looking like new for years.

Our sealers are UV resistant and will protect your concrete from mould, staining, algae, moss and repels dirt, grime and oils.

Prime Aqua - Water Based Sealer



Prime Aqua - Water Based Acrylic Sealer Range

- Saves time and money with being able to seal the same day
 - Superior coverage per square meter and will last 30% longer than traditional xylene based sealer
 - Priming system that will set in 30 minutes and extract surface moisture
 - Easy to apply and is non-hazardous with very low odour, ideal for indoor and outdoor application
 - Improves early surface strength and moisture retention
 - Protects against foreign contaminants while assisting in the curing process
 - Can be applied over xylene based sealers
- Available in 8 colours: Black, Charcoal, Basalt, Grey, Woodlands, Light Grey, Wallaby and Bluestone



Code	Colour	Code	Colour
PRIME-1	Black	PRIME-13	Bluestone
PRIME-2	Woodlands	PRIME-14	Grey
PRIME-3	Peppercorn	PRIME-15	Flint
PRIME-4	Dune	PRIME-16	Sandstone
PRIME-5	Evening Haze	PRIME-17	Green
PRIME-6	Brick Red	PRIME-18	Dark Terracotta
PRIME-7	Charcoal	PRIME-19	Basalt
PRIME-8	Wallaby	PRIME-20	Light Grey
PRIME-9	Jasper	PRIME-21	Papyrus
PRIME-10	Paper Bark	PRIME-22	Classic Cream
PRIME-11	Cove	PRIME-23	Terracotta
PRIME-12	Burgundy	PRIME-24	Limestone

Code	Colour	Size
PAQUA-19S	Basalt	10lt
PAQUA-19L	Basalt	20lt
PAQUA-1S	Black	10lt
PAQUA-1L	Black	20lt
PAQUA-13S	Bluestone	10lt
PAQUA-13L	Bluestone	20lt
PAQUA-7S	Charcoal	10lt
PAQUA-7L	Charcoal	20lt
PAQUA-14S	Grey	10lt
PAQUA-14L	Grey	20lt
PAQUA-20S	Light Grey	10lt
PAQUA-20L	Light Grey	20lt
PAQUA-2S	Woodlands	10lt
PAQUA-2L	Woodlands	20lt
PAQUA-PRIMER10	Prime Aqua Primer	10lt
PAQUA-PRIMER20	Prime Aqua Primer	20lt



W.R. Meadows - 1100 Clear Concrete Curing Compound



DESCRIPTION

The 1100-CLEAR series of water-based concrete curing compounds is formulated from hydrocarbon resins and may be used on interior, exterior, vertical, and horizontal concrete surfaces. Once applied, 1100-CLEAR forms a premium-grade membrane that retains an optimum amount of water in freshly placed concrete for complete hydration of the cement. NOTE: After approximately four weeks, the membrane begins to chemically break down when exposed to UV rays. The membrane will eventually dissipate from the surface. This process is sped up by exposure to traffic and UV light, as well as weathering conditions.

USES

The 1100-CLEAR series has been used on both interior and exterior applications where paint, resilient tile, or resilient flooring may be applied later. Because of the wide variety of coatings, paints, adhesives, and toppings available, contact the manufacturer of the flooring system or subsequent coating or topping for application approval over resin-based curing compounds. A small test application is always recommended.

FEATURES / BENEFITS

- When properly applied, 1100-CLEAR produces a premium-grade film, which optimizes water retention.
- Furnished as a ready-to-use, true water-based compound.
- Produces hard, dense concrete ... minimizes hair checking, thermal cracking, dusting, and other defects.
- Offers a compressive strength significantly greater than improperly cured or uncured concrete.
- Increases tensile strength for greater resistance to cracking and surface crazing.
- Improves resistance to abrasion and the corrosive actions of salts and chemicals.
- Minimizes excessive shrinkage.
- Can be applied quickly and easily with conventional commercial spray equipment.
- VOC-compliant.

Code	Litres	Description
WRM1100-5	18.93	Resin Based, Water Emulsion Curing Compound Pail
WRM1100-55	208.20	Resin Based, Water Emulsion Curing Compound Drum

Hydrochloric Acid 32%

Used in Construction (brick cleaning)
For use in electroplating, construction (brick cleaning), aquatic centres and private swimming pools, boiler scale removal and for effluent treatment.



* Victorian Customers Only.

Code	Description	Pack
H5	5lt - Hydrochloric Acid 32%	3
H20	20lt - Hydrochloric Acid 32%	1/32

W.R. Meadows - 1300 Clear Concrete Curing Compound



DESCRIPTION

1300-CLEAR water-emulsion, wax-based concrete curing compound is an excellent cure for interior, exterior, horizontal, and vertical concrete surfaces. When properly applied, the product provides a premium-grade which optimizes water retention. 1300-CLEAR appears white in color when wet, but dries clear. It is also available with a red fugitive dye to visually aid application coverage.

USES

1300-CLEAR can be used on interior, exterior, horizontal, or vertical concrete applications, where subsequent surface treatments will not be applied.

FEATURES / BENEFITS

- When properly applied, provides a nearly impermeable film which optimizes water retention.
- Furnished as a ready-to-use, true water-based compound.
- Produces hard, dense concrete ... minimizes hair-checking, thermal cracking, dusting, and other defects.
- Enhances the functional capabilities of concrete by "sealing in" the performance assets of strength and long life.
- Offers a compressive strength significantly greater than improperly cured or uncured concrete.
- Increases tensile strength for greater resistance to cracking and surface crazing
- Improves resistance to abrasion and corrosive action of salts and chemicals ... minimizes shrinkage.
- Applies quickly and easily with conventional, commercial spray equipment.
- VOC-compliant.

Code	Litres	Description
WRM1300-5	18.93	Resin Based, Water Emulsion Curing Compound Pail

Crete Wash - Concrete Remover



PERFECT FOR REMOVING ACCIDENTAL SPLASHES OF CONCRETE FROM

- Painted surfaces
- Aluminium
- Vehicles
- Rubber

- ✓ Zero Harsh Acids
- ✓ Aluminium & Paint Safe
- ✓ Environmentally Safe
- ✓ Great For Cleaning Paths & Driveways
- ✓ Prevents And Removes Rust
- ✓ Biodegradable
- ✓ User Friendly



SAFE EASY TO USE
CONCRETE REMOVER



Code	Litres	Description	Pack
CW750ML	750ml	750ml Trigger Bottle	12
CW5L	5L	5L Bottle	4
CW20L	20L	20L Drum	1

W.R. Meadows - Duogard Citrus Form Release Agent



DESCRIPTION

DUOGARD CITRUS is a citrus-scented, multi-reactive form release agent. It is composed of an organic chemical that reacts with the alkali content of the concrete to form a release film that effectively prevents the bonding of concrete to the form. In addition, DUOGARD CITRUS also contains a high molecular weight and a nonreactive, chemically inert ingredient to assist in clean and quick form release and removal. These exclusive ingredients combine the effectiveness of a chemically reactive type and an inert barrier type to provide a doubly effective separation ... DUO... and the ultimate in form release.

USES

DUOGARD CITRUS can be used on various types of forms: wood, steel, fiberglass, aluminum, as well as fiber tubes. DO NOT USE on expanded polystyrene (foam), rubber, latex, or latex forms made from SBR or natural rubber. Wood forms should be saturated prior to first use. DUOGARD CITRUS increases the life of wood forms by penetrating into the wood to waterproof and prevent deterioration. It also reduces maintenance requirements on metal forms by forming a rustproof film that makes the metal form essentially self-cleaning and rust-free.

DUOGARD CITRUS should be applied to fiber tube forms even though they may be pre-coated. Tubes will strip much easier, even 60 to 90 days later. If tubes are stripped in 5 - 10 days, hand rubbing is greatly facilitated when tubes are coated with DUOGARD CITRUS.

DUOGARD CITRUS also cuts machine cleanup time because it minimizes concrete buildup. Pavers, trucks, mixers, spreader-finishers, buggies, chutes, and other types of equipment should be sprayed daily with DUOGARD CITRUS for easy cleanup and rust prevention.

DUOGARD CITRUS can be applied on forms for pre-stressed and precast concrete to produce a better and cleaner cast. The product will not stain or discolor concrete.

FEATURES / BENEFITS

- Pleasant citrus scent.
- Contains no diesel fuel.
- Provides a better and cleaner cast when applied on pre-stressed and precast concrete forms.
- Cuts stripping time to an absolute minimum.
- Reduces form cleaning and repairing.
- Increases wood form life, prevents rust, and rustproofs metal forms.
- Effectively minimizes concrete buildup on pavers, R/M trucks, mixers, spreader finishers, buggies, chutes, and other equipment.
- Prevents bonding between poured concrete and form.
- Breaks concrete bond between surface and form cleanly and effectively ... leaves smooth surface.
- Will not stain or discolor concrete and can be painted over.
- Ready to use ... requires no additional mixing.

Code	Litres	Description
WRMCITRUS-5	18.93	Citrus Form Release Agent Pail
WRMCITRUS-55	208.20	Citrus Form Release Agent Drum

W.R. Meadows - Duogard II Form Release Agent



DESCRIPTION

DUOGARD II form release agent is composed of organic chemicals emulsified in water that react with the alkali content of concrete to form a release film that effectively prevents the bonding of the concrete to the form. In addition, the product also contains a high molecular weight, non-reactive, chemically inert ingredient to assist in clean, quick form release and removal. This exclusive combination of physical and chemical reactive components provides a doubly effective separation ... DUO ... and the ultimate in form release efficiency.

USES

DUOGARD II form release agent can be used on various types of forms (wood and steel, as well as fiberglass, aluminum, and fiber tubes). DUOGARD II increases the life of wood forms by penetrating into the wood to waterproof and prevent deterioration. It reduces maintenance requirements on metal forms because it forms a rustproof film that makes the metal form essentially self-cleaning and rust-free.

For fiber tube forms, DUOGARD II should be applied, even though the forms may be pre-coated. The application of DUOGARD II will allow the fiber tubes to strip much easier, even 60 to 90 days later. If tubes are stripped in 5 to 10 days, hand rubbing is greatly facilitated when the tubes are coated with DUOGARD II.

DUOGARD II cuts machine cleanup time and minimizes concrete buildup. Pavers, trucks, mixers, spreader-finishers, buggies, chutes, and other types of equipment should be sprayed daily.

DUOGARD II can be applied on forms for prestressed and precast concrete to produce a better and cleaner cast.

FEATURES / BENEFITS

- Can be safely used inside or outside.
- Produces a better and cleaner cast when applied on pre-stressed and precast concrete forms.
- Cuts stripping time to an absolute minimum.
- Reduces form cleaning and repairing.
- Increases wood form life, prevents rust, rustproofs metal forms.
- Effectively minimizes concrete buildup on pavers, R/M trucks, mixers, spreader-finishers, buggies, chutes, and other equipment.
- Breaks concrete bond between surface and form cleanly and effectively ... leaves smooth surface.
- Will not stain or discolor concrete and can be painted over.
- Ready to use ... requires no additional mixing.
- Minimizes surface voids.
- VOC compliant.

Code	Litres	Description
WRMDUOGARD2-5	18.93	Water-Based Form Release Agent Pail
WRMDUOGARD2-55	208.20	Water-Based Form Release Agent Drum

SiteVibe - Concrete Vibrator - Hoppt

Hoppt SiteVibe portable concrete vibrators are available in 38 and 45mm sizes with the smaller size being suited to concrete blockwork and EPS forms. The Hoppt SiteVibe comes complete with shoulder harness and padded hip protector. Being powered by a genuine Honda GX35 for reliability and serviceability these units are suitable for the small contractor to the large civil contractor.

Features and Benefits

- Genuine Honda GX35
- Shoulder harness & Padded Hip Protector
- High vibrating power
- Long working life
- Wear resistance and reliability
- Easy operation
- Easy maintenance
- Flexshaft length - 545mm
- Weight - 12kg
- Vibrating Frequency – Hz (vpm) - 150 (9,000)



Code	Head Dims mm	Engine
HA-SITEVIBE38	38 x 360	Honda GX35 @ 1.2kW 4 Stroke Petrol
HA-SITEVIBE45	45 x 360	Honda GX35 @ 1.2kW 4 Stroke Petrol

Super Screed - Hoppt

Hoppt offers a concrete screed that would enable professionals to, literally and figuratively, go anywhere they want. It is light yet robust and easy to handle; therefore, maneuvering is simple. The equipment guarantee maximum reliability and high productivity. The result will be a perfectly leveled, flat floors regardless of how small or big the surfaces are.

- Weight - 18kg
- Vibrating frequency - 7,00 vpm
- Fuel Capacity - 0.6 litre
- Fuel consumption - 0.6 litre/h
- Length x Width - 0 892mm x 268mm



Code	Description	Engine
HA-HCS50	Super Screed Drive Unit	Honda GX35 @ 1.2kW 4 Stroke Petrol
HA-HCSB18	1.8m Beam	-
HA-HCSB25	2.5m Beam	-
HA-HCSB35	3.5m Beam	-

Concrete Grinder - CUB - Hoppt

The Hoppt Electric floor grinder features an internal safety cut out system to enable engine overload protection and has a removable shroud system to allow grinding as close as possible to a wall or other floor protrusion. It also features a dust extraction port and water connection. Wheels can be extended and the handle can be folded for easy transportation. Level adjustment on rear wheels allow the user to maintain a flat surface.

Features and Benefits

- Australian tested
- Internal overload protection
- Folding handle to reduce space during transportation
- Level adjustment
- Handle height adjustment
- Water connection
- Dust extraction port
- Operating Weight - 47kg
- Dimensions - 1260 x 320 x 890mm



Code	Motor	Disc Size	Disc Type
HA-FSG-SEA	3HP / 2.2Kw	250mm	10" Plate or Alpha Shoe

Walk Behind Power Trowel - Hoppt

Hoppt full range of Power Trowels is designed with various options to help concrete professionals for their applications. Honda 4-stroke petrol engines power Hoppt Power Trowels. The Gearboxes are precision-engineered to transfer maximum torque to the trowel rotor, for a long, trouble-free life. The cast iron with spheroidal graphite spider, pressure plates and lift levers provide for longer-lasting life. The bushings, trowel arms and spiders are precision-machined to close tolerance. The high strength steel handle provides maximum comfort and control.

Hoppt Range of Edging Trowels is the perfect choice for troweling along the edges of walls or around protruding pipes and conduits. With the availability of various dimensions and sizes, they are versatile even for working in the narrowest places

Features and Benefits

- Certified lifting point for easy loading and unloading
- Hoppt's anti-vibration handle design
- Heavy duty gearbox increases durability and allows for prolonged usage
- Heavy duty safety cut out switch
- Wide range of accessories from pan, finish blades, combi blades



Code	Description	Engine
HA-TOL60G	Edger 24"	Honda GX160
HA-TOL34A	Trade 34"	Honda GX200
HA-TOL90GB	Pro 36"	Honda GX160

Portable Drive Units - Hoppt

Hoppt Portable Drive Units are suited to our range of heavy duty vibration shafts and submersible pumps. Available with either genuine Honda GX160 or Hatz diesel engines all fitted with a three claw coupling.

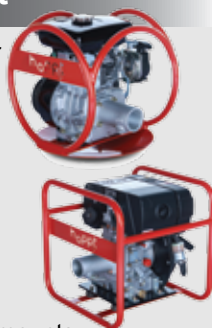

Features and Benefits

- Three Claw Coupling
- 'Easy carry' Tumbler frame with dish base
- Premium square frame with anti-vibration mounts
- Premium frame available with Genuine Honda GX160 petrol engine or HATZ diesel
- Long Working Life
- 2 years warranty
- Easy maintenance

Code	Frame Type	Engine Type
HA-PDU-2	Tumbler	Honda GX160 @ 3.6kW 4-Stroke Gasoline
HA-PDU-P	Premium Square	Honda GX160 @ 3.6kW 4-Stroke Gasoline
HA-DDU	Premium Square	HATZ Diesel 1B20 @ 3.6kW 4-Stroke Diesel

Concrete Vibrator Shaft - Hoppt

Hoppt concrete vibrators with flexible shaft are built with the improved pendulum designed. This series of vibrators consist of 4 diameters, which are the VIB28, VIB38, VIB45 and the VIB60, and 2 lengths of 6 or 9 m. The concrete vibrators are suitable for use in all types of concrete and a wide variety of construction sites from small foundations to very large projects. Vibration parameters have been optimized leading to a maximum output.

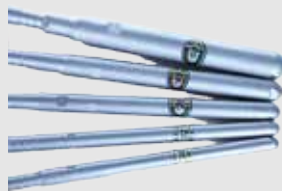

Features and Benefits

- Three-claw Coupling
- Long working life
- Wear resistance and reliability
- Easy operation and compatibility
- Induction hardened magnesium steel alloy
- Reinforced steel hose reinforced by 6 layers of special spun steel

Code	Shaft Size	Resilient Nose
HA-VIB28	28mm x 6m	No
HA-VIB28X9	28mm x 9m	No
HA-VIB38	38mm x 6m	No
HA-VIB38R	38mm x 6m	Yes
HA-VIB38X9	38mm x 9m	No
HA-VIB38RX9	38mm x 9m	Yes
HA-VIB45	45mm x 6m	No
HA-VIB45R	45mm x 6m	Yes
HA-VIB45X9	45mm x 9m	No
HA-VIB45RX9	45mm x 9m	Yes
HA-VIB57	57mm x 6m	No
HA-VIB60	60mm x 6m	No
HA-VIB60R	60mm x 6m	Yes
HA-VIB60RX9	60mm x 9m	Yes

Submersible Pump - Hoppt

The Super Site Pump HFP85 is able to force out aggregates as large as 28mm. All Hoppt Submersible Pumps are made compact with an aluminum casting body for durability to provide an economical and energy-efficient pump. They deliver high performance and offer trouble-free operations.

Features and Benefits

- Aluminium Cast body
- Stainless Steel Impeller
- Self-priming
- 6m Flexible shafts
- Three dog coupling
- Optional lay flat hose available



Code	Weight	Discharge Diameter	Max Lift	Max Capacity Litres/h
HA-HFP85	26kg	50mm	20m	63,000

Simer - Submersible Utility Pump

For Drainage of Cellars, swimming pools, flat roofs and wastewater from building works. Drainage pump for the disposal of faecal free waste water, including rainwater and lightly polluted water.

- Removes water down to a level of 2 mm
- Robust cast aluminium housing
- Suitable for continuous operation
- Max. head - 6 m
- Max. flow - 62 lpm



Code	Description
SIMER	Submersible Utility Pump - Water Level 2mm

Husqvarna Demolition Saws

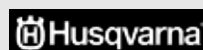

The Husqvarna K 770 is a powerful all-round power cutter with features that make it one of the best power cutters on the market. Equipped with semi-automatic SmartTension™ system allows for optimal power transmission, minimum wear and maximum belt life. The light weight, outstanding power-to-weight ratio, the reliable start and exceptionally low vibrations mean less strain and maximized productivity. Suitable for road work and easy to cut in a straight or curved track or close to sidewalk when used with KV7 trolley.

Code	Size	Power/Size	Cut Depth mm	Weight Kg
K770	14"/350mm	3.7kW 74cc	125	9.9
K970	16"/400mm	4.8kW 94cc	155	11.8

Marco Pro - Premium Line Finishing Trowels



Very durable and flexible
Chromium-molybdenum
Stainless steel

Perfectly formed,
ergonomic handle

Handle screwed on
from rear

Sturdy, high-quality
lightweight aluminum
alloy bracket

Chamfered edges and
polished traverse
lower leaf surface

- Made in Germany
- Perfectly formed ergonomic handles made out of cork, leather, soft grip and timber
- Golden stainless steel blades

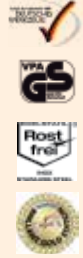

Marco Pro - Cork Grip



- Ergonomic bi-component grip with 96% cork
- Blister-free work due to the cork handle, very comfortable in the hand
- No swelling due to moisture
- Made in Germany

Code	Size-mm	Pack
MP5711	280 x 120	8
MP5728	330 x 120	8
MP5735	356 x 120	8
MP5759	405 x 120	8
MP5216	460 x 120	8
MP5223	508 x 120	8



Marco Pro - Leather Grip



- Ergonomic bi-component grip with 96% leather
- Blister-free work due to the soft leather handle, very comfortable in the hand
- No swelling due to moisture
- Made in Germany

Code	Size-mm	Pack
MP5926	280 x 120	8
MP5742	356 x 120	8



Marco Pro - Timber Handle



- Ergonomically formed traditional timber handle
- Bolted at the back
- No swelling due to moisture
- Made in Germany

Code	Size-mm	Pack
MP5773	356 x 120	8



- A combination of hard thermoplastic core and soft elastomer casing
- Optimal bonding between hand and grip
- Reduced expenditure of energy - easy on muscles and tendons
- Resilient up to 80 kg
- Made in Germany

Code	Size-mm	Pack
MP5780	280 x 120	8
MP5797	330 x 120	8
MP5766	356 x 120	8



Marco Pro - Superflex Stainless Trowels



- Choice of perfectly formed ergonomic handles made out of cork, leather, and soft grip
- Flexible stainless steel blades
- Made in Germany

Two overlapping ultra
flexible and durable
stainless steel blades

Perfectly formed,
ergonomic handle

Handle screwed on
from rear

Sturdy, high-quality
lightweight aluminum
alloy bracket



Code	Size-mm	Handle Type	Pack
MP5704	360 x 125	Cork	8
MP5919	360 x 125	Leather	8
MP5902	360 x 125	Soft Grip	8
MP5889	405 x 125	Soft Grip	8
MP5896	450 x 125	Soft Grip	8





PAVAN
Uternùl per fedeltà di qualità

Manufacturers Since 1858

With its range of more than 1500 professional tools, Pavan "Ancora" brand stands out for quality, experience and innovation to satisfy the most demanding professionals.

The excellence of Pavan "Ancora" brand is the result of a scrupulous choice of materials, innovative production technology and constant manufacturing process control. This is why Pavan is known all over the World as the perfect combination of respect for traditions, modern production processes and total consumer satisfaction.

The whole range of "Ancora" brand products is entirely designed, produced and tested in the company factory in Arcade, near Treviso, in northern Italy, so as to certify the excellent quality level of the total made in Italy Pavan products.

Ancora 845/i Finishing Trowel



PAVAN

- Special stainless steel blade
- SINTESI soft grip handle
- Aluminium shank
- Made in Italy



Code	Size-mm	Description	Pack
PE1814795	280 x 120	Stainless Steel	6
PE1814798	360 x 120	Stainless Steel	6

Ancora 845 Finishing Trowel



PAVAN

- SINTESI soft grip handle
- Aluminium shank
- Special quality steel blade
- Made in Italy

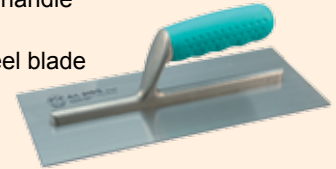

Code	Size-mm	Description	Pack
PE1814372	280 x 120	Carbon Steel	6
PE1814786	360 x 100	Carbon Steel	6
PE1814378	360 x 120	Carbon Steel	6

Ancora 848 Finishing Trowel



PAVAN

- Eccelsa soft grip handle
- Aluminium shank
- Special quality steel blade
- Made in Italy



Code	Size-mm	Description	Pack
PE1815308	200 x 120	Carbon Steel	6
PE1815315	280 x 120	Carbon Steel	6
PE1815324	360 x 120	Carbon Steel	6

Ancora 840/i SS Midget Trowel



PAVAN

- Special stainless steel blade
- SINTESI soft grip handle
- Aluminium shank
- Made in Italy



Code	Size-mm	Description	Pack
PE1813503	200 x 80	Stainless Steel	6

Ancora 841 Midget Trowel



PAVAN

- SINTESI soft grip handle
- Aluminium shank
- Special quality carbon steel blade
- Made in Italy



Code	Size-mm	Description	Pack
PE1813603	200 x 80	Carbon Steel	6
PE1813606	240 x 100	Carbon Steel	6

Marshalltown Midget Trowels



- Aluminium alloy Xtralite mounting is lightweight but very strong
- Carbon and Stainless Steel



Code	EDI	Size-mm	Description	Pack
MT11D	13014	203 x 76	Carbon Steel	6
MT11SSD	13106	203 x 76	Stainless Steel	6

Ancora 816/PIT Flexible Rounded Corner



PAVAN

- Very flexible 0.3mm thick blade
- Rounded corners to prevent the trowel blade digging in
- Trapezoidal in shape
- Sturdy plastic handle
- Made in Italy



Code	Size-mm	Description	Pack
PE1806930	200 x 80 x 0.3mm	Stainless	6
PE1806933	240 x 100 x 0.3mm	Stainless	6
PE1806936	280 x 120 x 0.3mm	Stainless	6



- Finest grade stainless steel
- Fully riveted through the shank
- Soft grip handles for user comfort



Code	Size	Description	Pack
MP280S	280 x 100mm	Stainless Steel	6
MP355S	360 x 120mm	Stainless Steel	6
MP405S	405 x 115mm	Stainless Steel	6

Marshalltown SS Finishing Trowels



- Aluminium alloy Xtralite mounting is lightweight but very strong
- DuraSoft handle



Code	EDI	Size-mm	Description
MTMXS3SDH	11439/13465	279 x 121	Stainless
MTMXS73SDH	11503/13444	356 x 121	Stainless
MTMXS66SDH	15310	406 x 102	Stainless
MTMXS25SSD	13409	508 X 127	Stainless

Marshalltown Carbon Finishing Trowels



- Aluminium alloy Xtralite mounting is lightweight but very strong
- DuraSoft handle



Code	EDI	Size-mm	Description
MTMXS3D	13459	279 x 121	Carbon
MTMXS73D	11500/13233	356 x 121	Carbon
MTMXS66D	13249	406 x 102	Carbon
MTMXS77DH	13263/11452	457 x 114	Carbon
MTMXS205D	13277	508 X 127	Carbon
MTMXS245D	13199	610 X 127	Carbon

Permashape Flat SS Trowels



- Guaranteed to stay flat use after use
- Made from the highest grade Golden stainless steel
- Withstands pressure of hard troweling
- Flat blade makes applications easier with more consistent finish

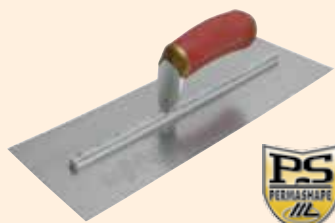

Code	EDI	Size-mm	Description
MT3SSFPD	12185	279 x 121	Stainless
MT13SSFPD	12184	330 x 127	Stainless
MT73SSFPD	12186	356 x 121	Stainless

Permashape Flat Golden SS Trowels



- Guaranteed to stay flat use after use
- Made from the highest grade Golden stainless steel
- Withstands pressure of hard troweling
- Flat blade makes applications easier with more consistent finish

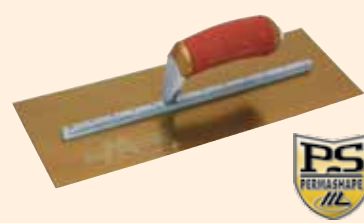

Code	EDI	Size-mm	Description
MT13GSFPD	12166	330 x 127	Golden Stainless
MT145GSFPD	12170	356 x 127	Golden Stainless
MT165GSFPD	12176	406 x 127	Golden Stainless

Permashape 'Broken In' Golden SS



- Inexperienced finishers can do a better job and be more productive sooner
- Broken In shape eliminates line and ripple marks right from the start
- Made from the highest grade Golden stainless steel
- Properly shaped and tempered to a golden finish

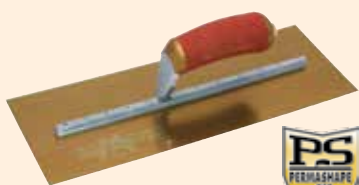

Code	EDI	Size-mm	Description
MTPB13GSD	13438	330 x 127	Golden Stainless
MTPB145GSD	13413	356 x 127	Golden Stainless

Marshalltown Golden SS Trowels



- Highest grade hardened and tempered Golden stainless steel blade
- Aluminium alloy Xtralite mounting is lightweight but very strong
- DuraSoft handle



Code	EDI	Size-mm	Description
MTMXS13GSD	13447	330 x 127	Golden Stainless
MTMXS73GSD	13449	356 x 121	Golden Stainless
MTMXS66GSD	13450	406 x 102	Golden Stainless
MTMXS815GD	13451	457 X 127	Golden Stainless
MTMXS205GD	13452	508 X 127	Golden Stainless

Marshalltown Finishing Trowels



- Aluminium alloy Xtralite mounting is lightweight but very strong
- Timber Handle



Code	EDI	Size-mm	Description
MTMXS3	12128	279 x 121	Carbon
MTMXS73H	11499/13232	356 x 121	Carbon
MTMXS73SSH	13405/11502	356 x 121	Stainless
MTMXS66SS	15309	406 x 102	Stainless

Ancora 824/i Marble Finishing Trowel



PAVAN

- Made in Italy
- Special quality stainless steel, highly polished blade
- Specially made for marble finishing "Stucco", "Veneziano", and "Marmorino" decorative finishes
- SINTESI soft grip handle
- Aluminium shank

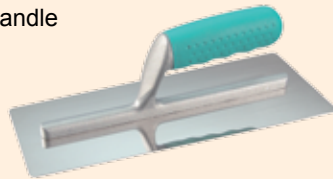

Code	Size	Description
PE1811960	200 x 80mm	Mirror Polish Stainless
PE1811963	240 x 100mm	Mirror Polish Stainless
PE1811966	280 X 120mm	Mirror Polish Stainless

Ancora 501/is SS Putty Knife



PAVAN

- Stainless steel putty knife for polishing Venetian stucco and lime putty
- Rounded angles
- SINTESI soft grip handle
- Made in Italy



Code	Size	Description	Pack
PE0000403	40mm	Mirror Polish Stainless	12
PE0000406	60mm	Mirror Polish Stainless	12
PE0000409	80mm	Mirror Polish Stainless	12
PE0000412	100mm	Mirror Polish Stainless	12

Ancora 817/PV White 1mm Trowel



PAVAN

- 1mm thickness for decorative finishes



Code	Size	Description	Pack
PE1807501	240 x 100 x 1mm	1mm White	10

Permashape 'Duraflex' Golden SS



- Flat, yet flexible thinner blade makes applications easier with more consistent finish; Great for EIFS applications
- Highest grade, hardened and tempered, golden stainless steel
- Withstands pressure of hard troweling



Code	EDI	Size-mm	Description
MT4681DFDL	14681	330 x 127	Golden Stainless

Ancora 844/i Marble Finishing Trowel



PAVAN

- Made in Italy
- Special quality stainless steel, highly polished blade
- Specially made for marble finishing "Stucco", "Veneziano", and "Marmorino" decorative finishes
- ECCELSA soft grip handle
- Aluminium shank



Code	Size	Description
PE1814761	200 x 80mm	Mirror Polish Stainless
PE1814766	240 x 100mm	Mirror Polish Stainless
PE1814772	280 X 120mm	Mirror Polish Stainless

Ancora 504/is SS Putty Knife



PAVAN

- Stainless steel putty knife for polishing Venetian stucco and lime putty
- Rounded angles
- Plastic handle
- Made in Italy



Code	Size	Description	Pack
PE0001321	80mm	Mirror Polish Stainless	12
PE0001327	100mm	Mirror Polish Stainless	12
PE0001333	120mm	Mirror Polish Stainless	12

Ancora 817/TE Linear Effect Tool



PAVAN

- This special trowel is used to create Travertine, vertical and horizontal effects. To be used with decorative coatings with high density
- This trowel is utilized to create many contemporary and modern finishes desired by architects and designers.

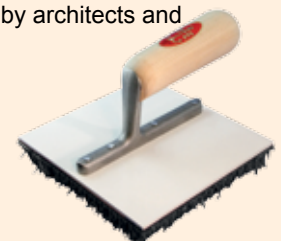

Code	Art. No.	Size-mm	Description
PE1807940	817/TE	150 x 150	Special Linear Trowel
PE1807941	817/TR	150 x 150	Replacement Pad

Ancora 537/I Stainless Hand Spatula



- Stainless Steel
- Thin and flexible
- Made in Italy



Code	Size-mm	Description	Pack
PE0300406	100	Stainless Steel	12

Ancora 817/RS1 Trowel - 1mm



- Thin 1mm plastic base trowel
- Clear non-marking blade
- Aluminium shank
- SINTESI soft grip handle
- Made in Italy

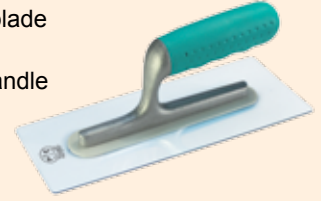

Code	Size	Description	Pack
PE1807929	280 x 120mm x 1mm	Clear Plastic	6
PE1807906	280 x 120mm x 1mm	White Plastic	6

Ancora 817/P Red Texture Trowel



- Traditional red blade
- No. 1 selling texture trowel
- The original and the best
- Made in Italy



Code	Size	Material	Pack
PE1807503	280 x 130mm	Special Red Plastic	10
PE1807630	350 x 130mm	Special Red Plastic	10
PE1807633	480 X 140mm	Special Red Plastic	10

Ancora 817/RSR Red Texture Trowel



- Traditional red blade
- The original and the best
- Soft grip SENTSI handle
- Made in Italy



Code	Size	Material	Pack
PE1807938	280 x 130mm	Special Red Plastic	10

Ancora 817/RS White Texture Trowel



- White non-marking blade
- Aluminium shank
- SINTESI soft grip handle

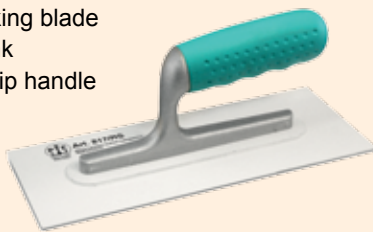

Code	Size	Description	Pack
PE1807930	240 x 100mm	White Plastic	10
PE1807933	280 x 130mm	White Plastic	10

Ancora 817/PT Clear Texture Trowel



- Transparent non-marking blade
- Made in Italy



Code	Size	Description	Pack
PE1807603	280 x 130mm	Clear Plastic	10

Ancora 817/BR White Texture Trowel



- Thin tapered blade
- White non-marking blade
- Aluminium shank
- SINTESI soft grip handle
- Made in Italy



Code	Size	Description	Pack
PE1807207	360 x 120mm	White Plastic	6

Ancora 817/PB White Texture Trowel



- White non-marking blade
- Made in Italy
- Roughened blade surface



Code	Size	Description	Pack
PE1807506	280 x 130mm	White Plastic	10

Plastic Diamond Base Floats - Pointed



- Diamond Base Floats
- High Strength ABS plastic
- Made in Italy

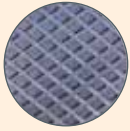

Code	Size	Description	Pack
927P	270 x 140mm	Black Diamond Base	12
926P	270 x 180mm	Black Diamond Base	12

Ancora 1901 Hard Polyurethane Float



PAVAN

- Harder longer wearing one piece polyurethane
- Hard style
- Made in Italy



Code	Size-mm	Description	Pack
PE3600011	280 x 140	Hard Polyurethane	6
PE3600014	400 x 140	Hard Polyurethane	6
PE3600012	450 x 140	Hard Polyurethane	6
PE3600005	400 x 250	Hard Polyurethane	6

Hard Polyurethane Float

- Harder longer wearing one piece polyurethane
- Hard style



Code	Size-mm	Description	Pack
POLY1	18 x 120 x 260	Hard Polyurethane	6
POLY2	18 x 150 x 310	Hard Polyurethane	6
POLY25	27 x 160 x 360	Hard Polyurethane	6
POLY3	18 x 160 x 360	Hard Polyurethane	6

Styrene Foam Floats - White

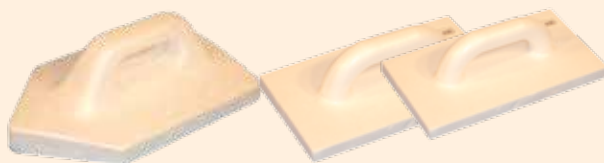

Code	Size-mm	Description	Pack
SFF	350 X 205 Pointed	White Styrene	6
250130	270 X 130	White Styrene	6
320180	320 X 160	White Styrene	6

Plastic Diamond Base Floats



- Diamond Base Floats
- High Strength ABS plastic
- Made in Italy

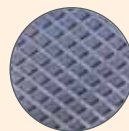

Code	Size	Description	Pack
926	270 x 180mm	Black Diamond Base	12
927	440 x 140mm	Black Diamond Base	12
947	350 x 270mm	Black Diamond Base	12
948	420 x 260mm	Black Diamond Base	12
949	420 x 300mm	Black Diamond Base	12

Plastic Diamond Base Float



- Diamond Base Floats
- High Strength ABS plastic
- Red handle



Code	Size	Description	Pack
926R	245 x 185mm	Black Diamond Base	12

Polyurethane Floats



- Made in Germany
- One piece lightweight polyurethane
- #925 is a trapezium shape



Code	Size-mm	Description	Pack
925	80 x 260	Medium Polyurethane	12
928	140 x 280	Medium Polyurethane	12
929	180 x 320	Medium Polyurethane	12
931	200 x 360	Medium Polyurethane	12
932	220 x 420	Medium Polyurethane	12
933	240 x 480	Medium Polyurethane	12

Styrene Foam Floats



Code	Size-mm	Description	Pack
RF2	400 x 100 x 25	Green Styrene	6
RF3	360 x 145 x 25	Green Styrene	6
RF4	400 x 195 x 25	Green Styrene	6
RF5	350 x 145 Pointed	Green Styrene	6

Marshalltown Redwood Floats



- Made from clear, seasoned redwood
- 19mm thick
- Item # MT144D has a beveled front edge



Code	EDI	Size-mm	Description
MT44D	14503	305 x 127	Soft Grip
MT144D	14505	406 x 89	Soft Grip

German Abachi Wood Floats



- Made from laminated Abachi wood
- Made in Germany



Code	Size-mm	Description	Pack
436048	280 x 140	Poly Handle	6
436049	320 x 180	Poly Handle	6

Marco Pesaro Sponge Float



- Large open cell structure



Code	Size-mm	Description	Pack
MP382	280 x 140 x 20mm	Coarse Open Cell	6

Ancora 819/2 Sponge Rubber Float



PAVAN

- Dark blue rubber float
- 15mm medium-fine texture sponge rubber
- Smooth wooden handle
- Made in Italy



Code	Size-mm	Art No.	Description
PE1808506	240 x 100	819/2	Medium/Fine Grained

Ancora 876 Sponge Float



PAVAN

- One piece lightweight polyurethane
- Medium grained sponge rubber
- 20mm thick
- Made in Italy



Code	Size-mm	Art No.	Description
PE1817606	280 x 140	876	Medium-grained

Ancora 872 Sponge Float



PAVAN

- Brown 40mm Sponge
- Made in Italy



Code	Size-mm	Art No.	Description
PE1817203	290 x 150 x 40	872	Brown Sponge
PE1817221	290 x 150 x 40	872/R	Brown Sponge

Ancora 820/1 Rubber Float



PAVAN

- For standard plaster work
- 20mm medium texture sponge rubber
- Wood handle securely fixed to aluminium backing
- Made in Italy



Code	Size-mm	Art No.	Description
PE1808603	215 x 135	820/1	Medium-grained

Ancora 872/G Sponge Float



PAVAN

- Yellow 30mm Sponge
- Made in Italy



Code	Size-mm	Art No.	Description
PE1817209	290 x 150 x 30	872/G	Yellow Sponge
PE1817227	290 x 150 x 30	872/GR	Yellow Sponge

Marco Pesaro Slotted Back Float



- Zinc plated perforated backing
- Fine cell sponge foam

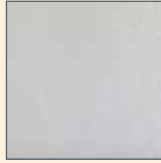
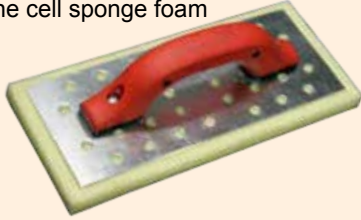

Code	Size-mm	Description	Pack
MP621	300 x 130 x 20	Fine Sponge	6

Marco Hydrosponge Float - Standard



- Made in Germany
- 30mm un-cut sponge float

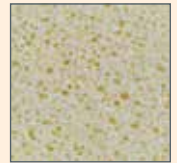

Code	Size-mm	Sponge	Description
MP584	280 x 140 x 30	Un-Cut	Strong Poly Base

Marco Pesaro Sponge Float - Green



- Wears well and does an excellent job on any sandy surface



Code	Size-mm	Description	Pack
MP603	305 x 127 x 25	Green Open Cell	6

Marco Hydrosponge Float - Slotted



- Made in Germany
- 30mm slotted cut sponge float



Code	Size-mm	Sponge	Description
MP585	280 x 140 x 30	Slotted Cut	Strong Poly Base

Marshalltown Foam Float



- Plastic foam pad specially bonded to an aluminium backing plate
- Wears well and does an excellent job on any sand surface
- 19mm thick pad

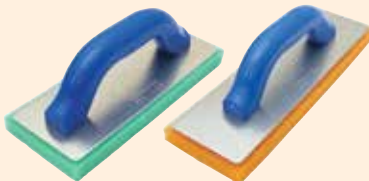

Code	EDI	Size-mm	Colour
MT46BG	14432	305 x 127	Green/Fine
MT46LB	14420	305 x 102	Orange/Coarse

Marco Hydrosponge Float - Profile



- Made in Germany
- 30mm profile cut sponge float



Code	Size-mm	Sponge	Description
MP586	280 x 140 x 30	Profile Cut	Strong Poly Base

Marshalltown Sponge Float



- 28mm thick pad
- Fine cell yellow foam pad specially bonded to an aluminium backing plate
- Wears well and does an excellent job on any sand surface



Code	EDI	Size-mm	Pack
MT4412	14419	305 x 127 x 28	12
MT4419	14412	Replacement 6 Pack	6

Ancora 879 Corner Sponge Float



- One piece lightweight polyurethane
- Long lasting coarse texture sponge rubber
- Made in Italy



Code	Size-mm	Description
PE1817903	350 x 70 x 50	Fine Orange Sponge

Marco Pesaro Hawks



- Strong 6 rivets construction
- Sponge rubber hand guard
- Comfort grip handle



Code	Size-mm	Size-in	Material	Pack
MP211S	305 x 305	12" x 12"	Aluminium	6
MP212S	330 x 330	13" x 13"	Aluminium	6

Marshalltown Hawks



- Edges have been smoothed and the corners rounded
- Callus preventer and handle included



Code	EDI	Material	Size-mm	Size-in
MT5D	15218	Aluminium	305 x 305	12" x 12"
MT1D	15215	Aluminium	330 x 330	13" x 13"
MT5206D	15219	Magnesium	330 x 330	13" x 13"
MT6D	14400	Aluminium	356 x 356	14" x 14"
MT5208D	15221	Magnesium	356 x 356	14" x 14"

Ancora 622 Abrasive Wall Rasp



- Used for shaping raw polystyrene, and eliminating imperfections in the EPS system
- Used for cleaning up unpainted brick and concrete surfaces to remove high spots and loose sand
- Made in Italy



Code	Size-mm	Description	Grit
PE0906133	400 x 160	Complete	16 Grit
PE0906136	400 x 160	Complete	24 Grit
PE0906233	400 x 160	Replacement Pad	16 Grit
PE0906236	400 x 160	Replacement Pad	24 Grit

Marco Pesaro Mesh EIFS Rasp



- Used for shaping raw polystyrene, and eliminating imperfections in the EPS system
- Made from perforated steel pad with rubber handle
- Made in Europe

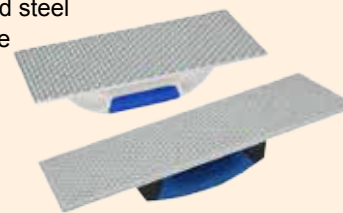

Code	Size-mm	Description	Pack
MPR378	130 x 270	Punched Perforated Steel	6
MPR379	160 x 380	Punched Perforated Steel	6

Ancora 608 Plaster Plane



- Lightweight
- 8 blade alternate angle cutting system
- Made in Italy

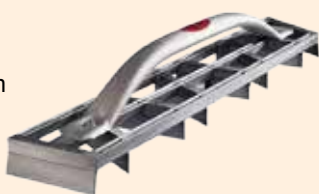

Code	Size-mm	Description	Pack
PE0901603	455 x 85	Angled Cutting Blades	6

Marco Pesaro Plaster Plane/Rabot



- Used to smooth and scrape rendered surfaces as well as cleaning and preparing walls



Code	Size-mm	Description	Pack
955	140 x 280	Strong Steel Construction	6

Ancora 620/P Plastering Scraper



- Plastic Handle
- Metal wall scraper used to roughen up polystyrene where required



Code	Size-mm	Description	Pack
PE0906021	250 x 144	Metal Wall Scraper	6

QLT Scarifiers - Blue Steel



- Made of lightweight yet flexible blue steel
- 6mm wide and 76mm long tines will easily scratch the plaster/render undercoat to promote a good bond with the finish coat



Code	EDI	Size-mm	Description
MT722	15740	203	Blue Steel Scarifier
MT723	15741	305	Blue Steel Scarifier

Masonry Brushes

See range of brushware on page 29



Tape Range

See range of tapes on page 9-10



Marshalltown Stainless Putty Knives



- Heat treated, hardened and tempered; annealed for an even hardness throughout the blade
- Full tang through the handle
- Oversized EMPACT hammering head for quick, effective hammering



Code	EDI	Size-mm	Pack
MTPK764SSD	10764	51	12
MTSK880SSD	10766	76	12
MTSK882SSD	10768	102	12
MTJK884SSD	10769	127	12
MTJK886SSD	10782	152	12

Ancora Small Tools - Fully Forged



- Drop forged and precision ground
- Stainless Steel
- Made in Italy



Code	Size-mm	Description	Pack
212-5/8	16mm	Fully Forged	12
212-3/4	19mm	Fully Forged	12
212-1	25mm	Fully Forged	12

Round IT - Corner Trowel



- Rubber blade is easily adjustable to desired angle
- Used for smooth round corners and outside angles
- Can also be used flat as a wipe down knife



Code	EDI	Description	Size-mm
MTRI355	14335	External	127 x 254

Marshalltown Stainless Taping Knife



- Tempered premium stainless steel blade with aluminium backing plate
- Tapered blade flexes just right for feathering but won't take a set



Code	EDI	Size-mm	Description
MT3508SD	14321	203 x 76	Stainless Steel
MT3510SD	14323	254 x 76	Stainless Steel
MT3512SD	14235	305 x 76	Stainless Steel
MT3514SD	14327	356 x 76	Stainless Steel

Ancora 501/S Paint Scraper



- Heat treated, hardened and tempered; annealed for an even hardness throughout the blade
- Sintesi soft grip
- Carbon steel for perfect balance and feel



Code	Art. No.	Size-mm	Description	Pack
PE0000206	501/S	30	Carbon Steel	12
PE0000212	501/S	50	Carbon Steel	12
PE0000221	501/S	80	Carbon Steel	12
PE0000227	501/S	100	Carbon Steel	12

PU Foam Gun



- Professional foam glue gun
- Teflon coated for extended gun life
- Adjustable flow control

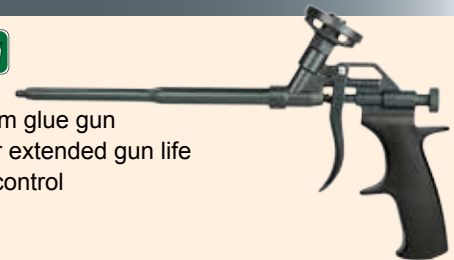

Code	Description	Pack
MP2177	Teflon Coated - Soft Grip Handle	20

Exact Angle Inside Corner Trowel



- Easy to clean nylon blade will not mark walls
- Angle adjusts from 90° - 154°
- Resilient Durasoft handle provides a soft feel, reduces fatigue and offers excellent durability



Code	EDI	Description	Size-mm
MTEA917	14917	Internal	102 x 102

Marshalltown Drywall Corner Trowel



- Lightweight tool made from one piece of flexible stainless steel with aluminum mounting

- Blade set at a 103° angle that flexes to form a perfect 90° corner during use



Code	EDI	Description	Size-mm
MT23D	15323	Internal	102 x 127

Ancora 853/IS External Corner Tools



- Highest grade mirror polished stainless steel
- 5mm radius
- Made in Italy



Code	Size-mm	Description	Radius
PE1814640	40 x 65	Mirror Stainless	5mm
PE1814642	55 x 65	Mirror Stainless	5mm

Internal Corner Trowels



- Lightweight tool made from one piece of 108mm long stainless steel
- Has a 90° angle between the blades



Code	EDI	Description	Size-mm	Material
MT5786D	15786	Internal	108 x 25	Stainless
MT5788D	15788	Internal	108 x 51	Stainless

External Corner Trowels



- Lightweight tool made from one piece of 108mm long stainless steel
- Has a 90° angle between the blades



Code	EDI	Description	Size-mm	Material
MT5767D	15767	External	114 x 25	Stainless
MT5769D	15769	External	108 x 51	Stainless

Ancora 986 Olive Leaf Trowel



- SINTESI soft grip handle
- Flexible, hardened steel blade
- Made in Italy



Code	Size-mm	Description	Pack
PE2901803	120 x 35	Soft Grip	6
PE2901815	160 x 36	Soft Grip	6

Ancora 985 Cats Tongue Trowel



- SINTESI soft grip handle
- Flexible, hardened steel blade
- Made in Italy



Code	Size-mm	Description	Pack
PE2901503	120 x 43	Soft Grip	6
PE2901509	160 x 50	Soft Grip	6

Ancora 986/i Stainless Olive Leaf



- SINTESI soft grip handle
- Flexible stainless steel blade
- Made in Italy



Code	Size-mm	Description	Pack
PE2904803	120	Stainless Steel	6

Ancora 985/i Stainless Cats Tongue



- SINTESI soft grip handle
- Flexible stainless steel blade
- Made in Italy



Code	Size-mm	Description	Pack
PE2904509	120	Stainless Steel	6

Ancora 980/i Stainless Square Tip



- SINTESI soft grip handle
- Flexible stainless steel blade
- Made in Italy



Code	Size-mm	Description	Pack
PE2903009	120 x 80	Stainless Steel	6

Ancora 983/i Stainless Sharp Tip



- SINTESI soft grip handle
- Flexible stainless steel blade
- Made in Italy

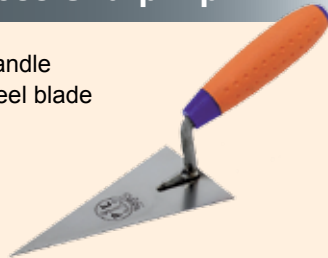

Code	Size-mm	Description	Pack
PE2903609	160	Stainless Steel	6

Ancora 982/i Stainless Square Tip



- SINTESI soft grip handle
- Flexible stainless steel blade
- Made in Italy



Code	Size-mm	Description	Pack
PE2903609	160	Stainless Steel	6

Ancora 984/i Stainless Round Tip



- SINTESI soft grip handle
- Flexible stainless steel blade
- Made in Italy



Code	Size-mm	Description	Pack
PE2904215	160	Stainless Steel	6

Marco Pesaro - Margin Trowel



- Soft grip finger guard handle



Code	Size-mm	Description	Pack
MP98	125 x 50	Soft Grip	12
MP99	200 x 50	Soft Grip	12

Ancora 946 Square Front Trowels



- SINTESI soft grip handle
- Flexible, hardened steel blade
- Made in Italy



Code	Size-mm	Description	Pack
PE2802702	140 x 80	Soft Grip	6
PE2802703	160 x 80	Soft Grip	6
PE2802706	180 x 80	Soft Grip	6
PE2802712	200 x 80	Soft Grip	6
PE2802718	220 x 85	Soft Grip	6

Marco Pesaro Splash Trowel



Code	Size-mm	Description	Pack
MP160	160 x 85 heel x 66 nose	Carbon Steel	12
MP180	180 x 115 heel x 88 nose	Carbon Steel	12
MP220	220 x 120 heel x 88 nose	Carbon Steel	12

Ancora 982 Small Square Front Trowels



- SINTESI soft grip handle
- Flexible, hardened steel blade
- Made in Italy



Code	Size-mm	Description	Pack
PE2900606	140 x 80 heel x 55 nose	Soft Grip	6
PE2900609	160 x 85 heel x 60 nose	Soft Grip	6

Ancora 990 Margin Trowels



- SINTESI soft grip handle
- Flexible, hardened steel blade
- Made in Italy



Code	Size-mm	Description	Pack
PE2906006	150 x 51	Soft Grip	6
PE2906015	200 x 51	Soft Grip	6

Plaster Pan - Plastic Scoop



- Strong design and cost effective
- Made in Europe



Code	Size-mm	Description	Pack
MPP381	180	One Piece Plastic	30

Plaster Pan - Soft Grip Handle



- Zinc Plated
- Soft Grip Handle



Code	Size-mm	Description	Pack
PAN	180	Soft Grip Handle	12

Plastering Splatter/Tyrolene Gun

- Brass plated

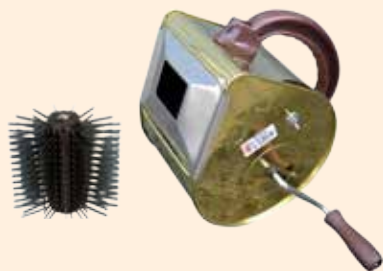

Code	Description	Pack
DTM	Brass Plated Splatter Gun	6
COMBS	Spare Impellor	6

Texture Hopper Sprayers



- Heavy duty and light weight hopper gun
- Comes with rubber 45° & 90° fitting,
- 3 nozzles: 4mm, 6mm, 8mm
- Perfect for spray on texture
- Spare parts available



Code	Description	Pack
MP001	2ft Capacity*	6

Ancora Sponge - Medium



PAVAN

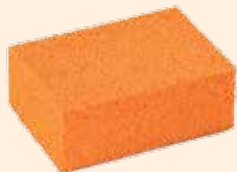

Code	Size-mm	Description	Pack
PE1817160	160 x 110 x 60	Medium Grained	12

Marshalltown Sharpshooter



- Seven orifice sizes with tubular design for reduced over spray and greater texture variety
- Tight sealing flow shut off prevents leakage
- Angled hopper adapter allows hopper to remain level while spraying floors and ceilings
- Gun features a handy air control valve which allows flow control at the gun instead of the pump
- Easy pull swing trigger for greater control and less fatigue
- Hopper with seamless corner design eliminates material build up and reduces clogging
- Plastic hopper capacity is approx 7.57 litres

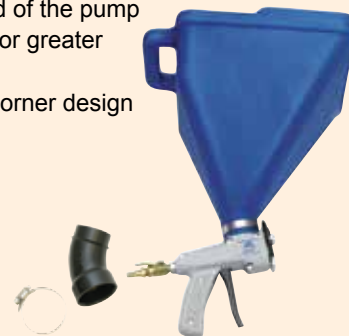

Code	EDI	Description	Pack
MT693	16356	Hopper Gun 1.0	1
MTRK696	16374	Repair Kit	1
MTSS21	28295	Sharpshooter 2.1	1

Sponges

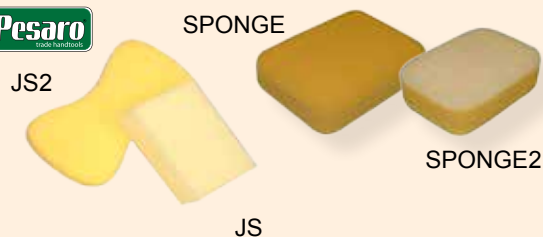

Code	Size-mm	Description	Pack
SPONGE	185 x 135 x 50	Rounded Corners	12
SPONGE2	160 x 115 x 50	With Scrub Side	12
JS	200 x 125 x 75	Rectangle	12
JS2	290 x 170 x 60	Kidney Shape	12
JS3	300 x 200 x 100	Rectangle	12

Ransom 1600W Electric Mixing Drill



- 1600W, 240V/50Hz for extra torque
- 2 speed gear box
- Variable speed control
- M14 female thread
- Lightweight
- Soft grip handles
- Ideal for mixing render and plaster compound
- Comes with free mixing paddle



Code	Description	Pack
RAN160	1600W	2

Ransom Mixing Paddle

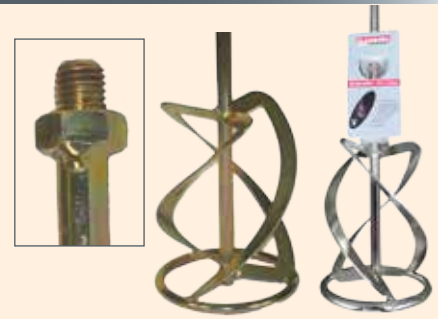

Code	Size-mm	Helix	Thread	Coating
MDR51	135 x 750	Negative Draws Down	12mm Hex	Chrome
MDR53	140 x 650	Negative Draws Down	M14	Chrome
MDR58	120 x 600	Positive Draws Up	M14	Gold Anodised
MDR59	140 x 600	Positive Draws Up	M14	Gold Anodised

Ransom Mixing Paddle Extension



- Mixing paddle extension - M14



Code	Description	Pack
MDR-EXT	150mm Long	12

Ransom Mixing Paddle Adaptor



- Convert M14 thread mixing paddle to a 12mm chuck



Code	Description	Pack
MDR70	M14 to 12mm Hex	12

Ransom Mixing Paddle



- Zinc Plated
- 8mm Hex Shaft



Code	Size-mm	Coating	Pack
MDR56	85 x 500	Chrome Plated	6

Ransom Mixing Paddle - Render



- Powder coated
- 10mm Hex Shaft
- Suitable for render mixing



Code	Size-mm	Coating	Pack
MDR57	130 x 600	Red Painted	6

Marshalltown Gum Tile Grouter



- Pure gum rubber face is bonded to the dense rubber pad; cemented to an aluminium backing plate
- Edges beveled and the two front corners are rounded
- Dense rubber pad is designed specifically for tile grouting
- Item: MT43BC has an offset handle for base/cove work



Code	EDI	Size-mm	Pack
MT43	14422	230 x 121 x 19mm	6
MT43BC	14425	305 x 76 x 13mm	6

Rubber Pointed Grouter



Code	Size-mm	Description	Pack
121	240 x 85	Blue/Yellow Foam	12

841/D "V" Serrated Notch Trowel



- SINTESI soft grip handle
- Aluminium shank
- Serrated quality steel blade
- Made in Italy

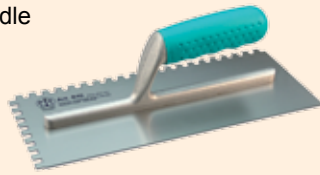

Code	Size-mm	Notch-mm	Description
PE1813737	280 x 120	Vee 3 x 2	Carbon Steel
PE1813735	280 x 120	Vee 4 x 3	Carbon Steel
PE1813736	280 x 120	Vee 6 x 4	Carbon Steel

Aluminium H Profile



- Aluminium H Section
- Fine Ribbed Section for Excellent Grip



Code	Size-mm	Material	Profile	Pack
FE18	1800	Aluminium	'h' Profile	6
FE21	2100	Aluminium	'h' Profile	6
FE24	2400	Aluminium	'h' Profile	6

Aluminium Trapezium Profile



- Aluminium Trapezium section
- Fitted with End Caps



Code	Size-mm	Material	Profile	Pack
FETRAP-15M	1500	Aluminium	Trap Profile	6
FETRAP-18M	1800	Aluminium	Trap Profile	6
FETRAP-2M	2000	Aluminium	Trap Profile	6
FETRAP-25M	2500	Aluminium	Trap Profile	6

Notched Trowel

- Economical notch trowel
- Carbon steel
- Soft grip handle

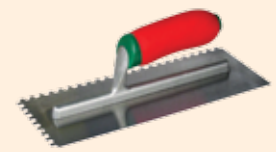

Code	Size-mm	Notch-mm	Description
MPN6	280 x 120	6mm	Carbon Steel
MPN8	280 x 120	8mm	Carbon Steel
MPN10	280 x 120	10mm	Carbon Steel

Aluminium Straight Edge



- 90 x 17mm section with fine rib for excellent grip
- Fitted with end caps
- Powder coated white



Code	Size-mm	Material	Profile-mm	Pack
EDGE12	1200	Aluminium	70 x 20	6
EDGE15	1500	Aluminium	70 x 20	6
EDGE18	1800	Aluminium	70 x 20	6
EDGE21	2100	Aluminium	70 x 20	6
EDGE24	2400	Aluminium	70 x 20	6
EDGE27	2700	Aluminium	70 x 20	6
EDGE30	3000	Aluminium	70 x 20	6
EDGE36	3600	Aluminium	70 x 20	6

NOTES

The notes section is a large rectangular area with a decorative border. It contains 25 horizontal lines for writing. The lines are evenly spaced and extend across the width of the page. The corners of the notes area are rounded.

Marshalltown Brick Trowels



- Forged from a single piece of high carbon steel then heat treated for strength and durability
- Blade is taper ground and polished
- Choices of leather, plastic handle or DuraSoft handle.



Code	EDI	Size mm	Style	Handle Type
MT3411FG	10152 11527	279x146	Wide London	Soft
MT1911FG	10109	279x140	Philadelphia	Soft
MT3412FG	11529	305x146	Wide London	Soft
MT1912FG	11510 10116	305x152	Philadelphia	Soft
MT34L12XH	11532	305x146	Wide London	Leather
MT19L12XH	11516	305x152	Philadelphia	Leather
MT34P12	10254 11534	305x146	Wide London	Plastic
MT19P12	11520 10214	305x152	Philadelphia	Plastic
MT3313FG	10138 11446	330x137	London	Soft

Ancora Pavan - Brick Trowel



- Durable construction
- Perfect for projects of any size
- SINTESI soft grip handle
- Flexible, hardened steel blade
- Made in Italy



Code	Size-mm	Style	Handle Type
PE2804633	305 x 130	Art.966 London	Soft Grip
PE2804718	305 x 150	Art.967 Philadelphia	Soft Grip

Ancora 963 Gauging Trowels



- Durable construction
- Perfect for projects of any size
- SINTESI soft grip handle
- Flexible, hardened steel blade
- Roof pointers favourite trowel
- Made in Italy



Code	Size mm	Size inch	Handle Type	Pack
PE2803903	152 x 85	6"	Soft Grip	6
PE2803906	178 x 85	7"	Soft Grip	6
PE2803909	203 x 90	8"	Soft Grip	6
PE2803915	228 x 100	9"	Soft Grip	6
PE2803921	254 x 105	10"	Soft Grip	6

Ancora 985 Cats Tongue Trowel



- SINTESI soft grip handle
- Flexible, hardened steel blade
- Made in Italy



Code	Size mm	Type	Material	Pack
PE2901503	120 x 43	Cats Tongue	Carbon	6
PE2901509	160 x 50	Cats Tongue	Carbon	6
PE2904503	120 x 43	Cats Tongue	Stainless	6

Marshalltown Gauging Trowel

- Forged from a single piece of high carbon steel
- Carefully taper ground and polished from toe to heel



Code	EDI	Size-mm	Handle Type
MT48D	11443/10749	178 x 86	Soft

Marco Pesaro Gauging Trowel



- Carbon steel stamped blade
- Strong welds and soft grip handle for user comfort



Code	Size-mm	Size-inch	Handle Type	Pack
MP144	178	7"	Soft Grip	12
MP244	203	8"	Soft Grip	12

Ancora 960 Pointing Trowel



PAVAN

- SINTESI soft grip handle
- Flexible, hardened steel blade
- Made in Italy



Code	Size mm	Size inch	Material	Pack
PE2803715	160 x 75	6"	Carbon	6
PE2903906	120 Sharp	5"	Stainless	6

Marco Pesaro Pointing Trowel



- Carbon steel stamped blade
- Strong welds and soft grip handle for user comfort



Code	Size-mm	Size-inch	Handle Type	Pack
MP130	150	6"	Soft Grip	12

Marshalltown Pointing Trowel

- Forged from a single piece of high carbon steel
- Carefully taper ground and polished from toe to heel

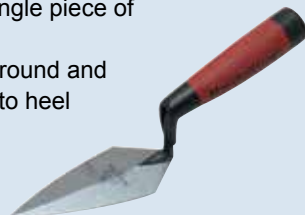

Code	EDI	Size-mm	Handle Type
MT456D	11127/11539	152 x 70	Soft

Ancora 851/S Tuck Pointer



PAVAN

- SINTESI soft grip handle
- Flexible, hardened steel blade
- Made in Italy



Code	Length mm	Type	Handle Type	Pack
PE1814424	170	8mm	Soft Grip	6
PE1814427	170	10mm	Soft Grip	6

Ancora 986 Olive Leaf Trowel



PAVAN

- SINTESI soft grip handle
- Flexible, hardened steel blade
- Made in Italy



Code	Size mm	Type	Material	Pack
PE2901803	120 x 35	Olive Leaf	Carbon	6
PE2901815	160 x 36	Olive Leaf	Carbon	6
PE2904803	120 x 35	Olive Leaf	Stainless	6

Mortar Smoother/Tuck Pointer



- Forged from one piece of high carbon steel
- Soft grip handle

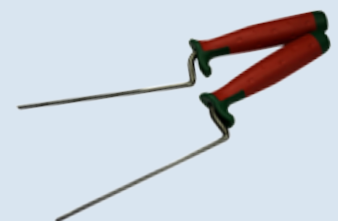

Code	Length mm	Type	Handle Type	Pack
MP125	170	6mm	Soft Grip	6
MP133	170	8mm	Soft Grip	6

Double Ended Brick Jointer



- Made from high carbon steel
- Each end is a different size
- 267mm in length



Code	EDI	Length-mm	Size-mm	Pack
MT80	15522	267	13 x 16	6
MT81	15524	267	19 x 22	6
MT82	15526	267	16 x 19	6
MT83	15528	267	10 x 13	6

Acrylic Brick Jointer



- Shaped from hardened acrylic material
- Will not mark or discolour white mortar
- Durable and lightweight
- 292mm in length

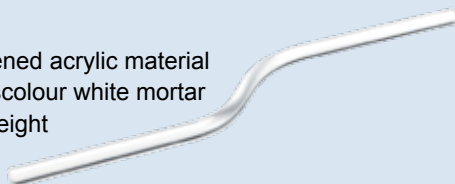

Code	EDI	Length-mm	Size-mm	Pack
MT75	15550	292	10	6
MT76	15552	292	13	6
MT77	15554	292	16	6
MT78	15556	292	19	6

Brick Rakers



600

500

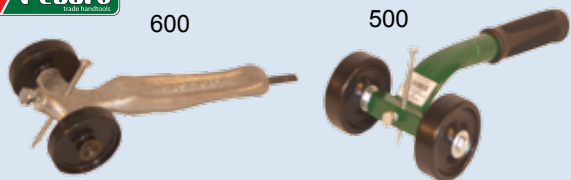

Code	Length-mm	Description	Pack
600	210 x 85	Cast Aluminium	6
500	270 x 110	Steel	6

Marshalltown Masonry Joint Raker



- Large 44mm skate wheels
- Strong aluminium handle is contoured to fit the hand and squared off at the end
- Hardened nail, adjusts to proper depth



Code	EDI	Size-mm	Pack
MT89	15502	216 x 76	6

Marshalltown Barrel Jointer



- Barrel Jointer set includes four popular sizes of changeable hardened steel barrels
13mm, 16mm, 19mm and 22mm
- Threaded barrels are easy to change



Code	EDI	Size-mm	Description
MTBJ850	10850	216 x 64	Complete Barrel Jointer 4 Barrels Included
MTRB851	10851	13mm	Replacement Barrel
MTRB852	10852	16mm	Replacement Barrel
MTRB853	10853	19mm	Replacement Barrel
MTRB854	10854	22mm	Replacement Barrel

Marshalltown Ball Jointer



- Ball head allows for consistent joints from every angle
- Compact design fits into pockets quickly and easily
- Two joint sizes - 13mm & 16mm



Code	EDI	Size- mm	Ball Ends
MTBBJ1258	10799	190	13mm & 16mm

Round Brick Jointer

- Solid construction
- Both ends turned up for use in either direction

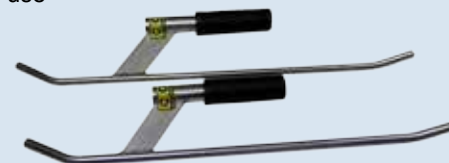

Code	Length-mm	Description	Pack
126	560	10mm Round	6
128	560	12mm Round	6
129	560	16mm Round	6

Line Pins



- Drop forged and hardened



Code	Size-mm	Description	Pack
216		Chrome Plated	12

Pointing & Grouting Applicator



Features

- 10mm nozzle
- Leakage protection for vertical applications
- Quick, precise and accurate
- Great for mortar pointing works around window and door frames, sash frames, horizontally and vertically
- Comes with 2 spare plungers
- Ideal for plaster mortars

Code	Length-mm	Nozzle	Pack
MPMGUN	500	10mm	12

Svenic Pointing & Grouting Applicator

- Multi Function Grout Applicator
- Great for Pointing Mortars and Grouts



Code	Description	Size-mm	Pack
SV685SAE	Mortar Gun	320	6

Grout Bags - Blu-Tip



- Made from seamless white plastic
- Blue molded-in tip can be cut to the desired opening
- Easy clean up



Code	EDI	Size-mm	Description	Pack
MTGB690	17816	305 x 610	Blu-Tip	6

Disposable Grout Bags



- Great for hard to clean materials
- Trim tip to desired opening
- 50 bags per box
- Thermally sealed edge and tip to prevent leaks



Code	EDI	Size-mm	Pcs	Pack
MTDGB661	16661	279 x 533	50	1

Large Line Blocks



- Made form virgin PP



Code	Colour	Description	Pack
460L	Yellow	Hard	20
SLB	Pink	Soft	20

Line Blocks - Rubber



- Display Box of 40pcs
- Assorted colours purple, green, orange and yellow
- Min order of 1 Box



Code	Colours	Description	Pack
FLB	Purple/Green/Orange/Yellow	Rubber	40

Multi Hooks - Dutch Pins - Pack 4 Pcs



- Made in Europe
- Solid forged and hardened
- Square shank



Code	Finish	Shank	Arm	Pack
236CARD	Black	Square	Fixed	20

Multi Hooks - Dutch Pins



- Made in Europe
- Solid forged and hardened



Code	Finish	Shank	Arm	Pack
236BLK	Black	Half Round	Half Swivel	20/100
236GALV	Galv	Half Round	Half Swivel	20/100

Brickies Profile Unit Clamps



- All Items CAD Plated
- Comes complete with arm, profile holder and 2 nail on brackets

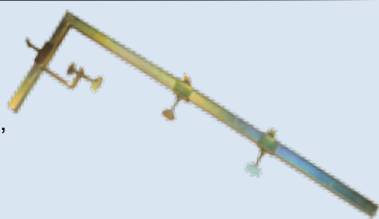

Code	Size-mm	Description	Pack
PUC	300 x 800	Complete Unit	6

Brickies Dummy Clamps



- All Items CAD Plated
- Threaded insert



Code	Size-mm	Description	Pack
BC180	180	Profile Clamp	20
BC300	300	Profile Clamp	20

Internal Profile Clamp



- THROW: 0 - 300mm
- EYE: 40mm x 40mm



Code	Eye Size-mm	Description	Pack
BC125	40 x 40	Internal Profile Clamp	20

Brickies Profile Unit Clamps - Spare

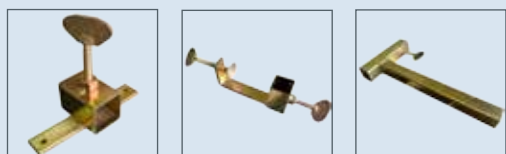

PUCPS

PUCPL

PUCPSA

Code	Description	Pack
PUCPS	Small Vertical Clamp	12
PUCPL	Large Horizontal Clamp	12
PUCPSA	Spare Sliding Arm	12

Brickies Profile Sliding Clamp



- All Items CAD Plated
- Comes complete with sliding arm, profile holder and 2 nail on brackets



Code	Size-mm	Description	Pack
PUCSLIDE	300 x 800	Complete Unit	6

Brickies Dummy Clamps



- All Items CAD Plated



Code	Size-mm	Description	Pack
BC550	560	Sliding Bar Clamp	12

Brick Carrier



- Adjustable Brick Carrier
- CAD Plated for Long Life



Code	Size-mm	Description	Pack
258	400 - 500	For Carrying 8-12 Bricks	6

EDMA Slab Lifter



- Quick adjustment system
- Ideal for carrying pavers, blocks and bricks
- Adjustable up to 625mm



Code	Description	Size-mm Min	Size-mm Max	Pack
RT269055	Soft Grip Handle	380	625	6

F Clamps



- Soft grip handle



Code	Size-mm	Description	Pack
F20080	200 x 80	F Clamp	12
F30060	300 x 50	F Clamp	12

Brickies Gauge Rod

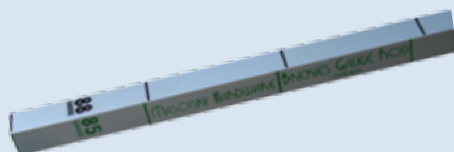

Code	Size-mm	Gauges	Pack
BGR84	20 x 20 x 1200	84, 85, 86, 87	12
BGR	20 x 20 x 1200	85, 86, 87, 88	12

Apron



- Ideal protection for brickies when cutting bricks



Code	Size-mm	Description	Pack
APRON2	905 x 1220	Black	6

Kwikgauge Tape

- Estimate brick quantities prior to & during building construction
- Chase bonds on concrete on footings & concrete slabs for setting door jambs & opening to suit brickwork
- Get correct placement of windows, sliding doors and door jambs in frames prior to commencement of brickwork
- Avoid unsightly 3/4 cuts
- The Original - Made in Australia



Code	Size	Description	Pack
KG	8m x 25mm	Double Nylon Coated Blade	12

Nylon Builders Line - G-String



- #8 and #12 quality braided line
- Excellent durability
- Counter display boxes of 10 spools
- Strong plastic spools



Code	No.	Length-m	Colour	Pack
8-50MFY	8	50	Fluro Yellow	10
8-50MFP	8	50	Fluro Pink	10
8-100MFY	8	100	Fluro Yellow	10
8-100MFP	8	100	Fluro Pink	10
12-100MFY	12	100	Fluro Yellow	10
12-100MFP	12	100	Fluro Pink	10
12-500MFY	12	500	Fluro Yellow	12

Donaghys Nylon Builders Line

Manufactured from shock absorbing multi filament nylon with 8 and 12 plait construction.

This line is strong enough for taut line tensioning and will recover when re-wound for long lasting use.

Available in 885 and 1345 tex sizes, 50m and 100m spools and in 3 colours, White, Fluro Lime and Pink.

- High strength and recovery from stretch
- High visibility colours
- Strong and flexible re-wind friendly spools



Code	Tex	No.	Length m	Colour	Pack
DPRP9002	855T	8	50	White	10
DPRP9000	855T	8	50	Fluro Lime	10
DPRP9014	855T	8	50	Fluro Pink	10
DPRP9021	855T	8	100	White	10
DPRP9001	855T	8	100	Fluro Lime	10
DPRP9015	855T	8	100	Fluro Pink	10
DPRP9017	1345T	12	50	Fluro Lime	10
DPRP9024	1345T	12	100	White	10
DPRP9020	1345T	12	100	Fluro Lime	10

Rite in the Rain



SURVIVES REAL LIFE!

- Rain, Sweat, & Grime
- Kids, Pets, & Spills
- Vacations & Laundry

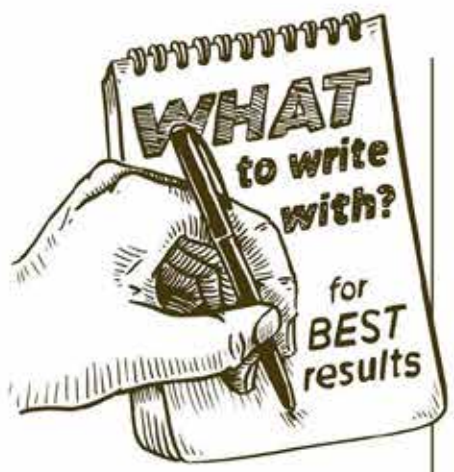

Yes, Rite in the Rain is a wood-based & recyclable paper, but unlike plain paper; it won't turn to mush when exposed to:



ALL-WEATHER TOUGH!

USE WET OR DRY
most pens stop writing when wet

- ALL PENCILS
- RITE IN THE RAIN PENS
- WAX MARKERS
- CRAYONS

WHEN DRY ONLY
what you write won't wash off

- PERMANENT MARKERS
- STANDARD BALLPOINTS

WON'T WORK
water-based inks bead off sheet

- GEL PENS
- MOST HIGHLIGHTERS
- FOUNTAIN PENS
- WATER COLORS



The Rite in the Rain story began a century ago in the forests of the Great Pacific Northwest. Entrepreneur Jerry Darling recognized the logging industry's need for a durable material that could be written on and survive in poor weather conditions. Jerry developed a special coating that created a unique moisture shield on the hand-dipped sheets of paper that he and his wife, Mary, processed at their home. From these humble beginnings, our first all-weather paper was born. Over the many years we've perfected and patented our environmentally responsible coating process. Still located in Tacoma, our continued mission is to provide innovative products for professionals and enthusiasts who brave the outdoors.



INDUSTRY GROUP KEY



level pattern

UNIVERSAL 6mm Rules with faint 6mm Grid



level pattern

FIELD 4 x 4 / 25mm



level pattern

TRANSIT 8 Vertical Lines to the 25mm



level pattern

METRIC FIELD 2 x 2 mm with 10 mm Accents



level pattern

LEVEL 6mm Rules with Vertical Columns



level pattern

JOURNAL 6mm Rules



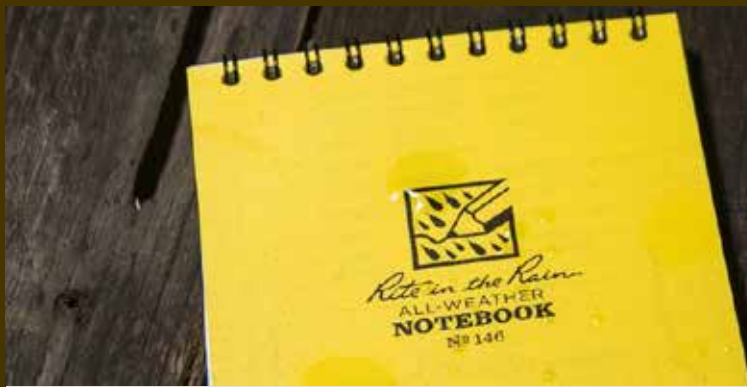

TOP-SPIRAL NOTEBOOKS

YOU CAN'T BEAT THE CONVENIENCE
Tough as any well made multi-tool and just as handy, these Top-Spiral Notebooks feature pages that turn 180 degrees so you can easily flip right to where you are working.
Available in a wide range of sizes.

76 x 127mm TOP-SPIRAL NOTEBOOKS

	DESCRIPTION	ITEM N ^o	PATTERN	PACK
<p>N^o 135</p> <p>Sheet Size: 76 x127mm Overall Size: 76 x 133 x 10mm Cover Material: Polydura, 19 gauge Pages: 100 pages/50 sheets Binding: Wire-o Paper Weight: 20# Rite in the Rain Rulers: Imperial & Metric Reference Materials: Conversion table and map scale</p> <p>★ SPECIAL ORDER</p>	RITR-135	Universal	12	
	RITR-935	Universal	12	
<p>N^o 935</p>	<p>N^o 935T</p>	RITR-935T	Universal	12
<p>N^o 735</p>		★RITR-735	Universal	12



76 x 127mm TOP-SPIRAL KITS

	DESCRIPTION	ITEM N ^o	COVER
<p>N^o 135B-KIT</p> <p>KITS INCLUDE Notebook: • Sheet Size: 76 x127mm • Overall Size: 76 x 133 x 10mm • Cover Material: Polydura, 19 gauge • Pages: 100 pages/50 sheets • Page Pattern: Universal • Binding: Wire-o • Paper Weight: 20# Rite in the Rain • Rulers: Imperial & Metric All-Weather Pen: No. 97 Black Metal Clicker Pen Book Cover: CORDURA® fabric, holds 4 Writing Instruments, Zippered Closure</p> <p>★ SPECIAL ORDER</p>	RITR-135B-KIT	Black	
	RITR-935-KIT	Tan	
	RITR-935T-KIT	Tan	
	★RITR-935M-KIT	MultiCam®	



102 x 152mm TOP-SPIRAL NOTEBOOKS

	DESCRIPTION	ITEM N ^o	PATTERN	PACK	N ^o 946	N ^o 946T
<p>N^o 146</p>	Sheet Size: 102 x 152mm Overall Size: 102 x 159 x 10mm Cover Material: Polydura, 19 gauge Pages: 100 pages/50 sheets Binding: Wire-o Paper Weight: 20# <i>Rite in the Rain</i> Rulers: Imperial & Metric Reference Materials: Conversion table and map scale	RITR-146	Universal	12		
		RITR-946	Universal	12		
		RITR-946T	Universal	12		

102 x 152mm TOP-SPIRAL KITS

	DESCRIPTION	ITEM N ^o	COVER	PACK	N ^o 946-KIT	N ^o 946T-KIT
<p>N^o 146B-KIT</p>	KITS INCLUDE Notebook: <ul style="list-style-type: none"> • Sheet Size: 102 x 152mm • Overall Size: 102 x 159 x 10mm • Cover Material: Polydura, 19 gauge • Pages: 100 pages/50 sheets • Page Pattern: Universal • Binding: Wire-o • Paper Weight: 20# <i>Rite in the Rain</i> • Rulers: Imperial & Metric All-Weather Pen: No. 97 Black Metal Clicker Pen Book Cover: CORDURA® Fabric, holds 4 Writing Instruments, Zippered Closure	RITR-146B-KIT	Black	5		
		RITR-946-KIT	Tan	5		
		RITR-946T-KIT	Tan	5		

121 x 178mm SIDE-SPIRAL NOTEBOOKS

	DESCRIPTION	ITEM N ^o	PATTERN	PACK	
<p>N^o 373</p>	Sheet Size: 121 x 178mm Overall Size: 124 x 178 x 10mm Cover Material: Polydura, 19 gauge Pages: 64 pages/32 sheets Binding: Wire-o Paper Weight: 32# <i>Rite in the Rain</i> Rulers: Imperial & Metric	RITR-373	Universal	12	
		RITR-303	Transit	12	
		RITR-313	Level	12	
		RITR-353	Field	12	
		RITR-363	Metric Field	12	
		RITR-393	Journal	12	

121 x 178mm SIDE-SPIRAL NOTEBOOK KITS

	DESCRIPTION	PACK	COVER	PACK
<p>N^o 373B-KIT</p>	KIT INCLUDES Notebook: <ul style="list-style-type: none"> • Sheet Size: 121 x 178mm • Overall Size: 124 x 178 x 10mm • Cover Material: Polydura, 19 gauge • Pages: 64 pages/32 sheets • Page Pattern: Universal • Binding: Wire-o • Paper Weight: 32# <i>Rite in the Rain</i> • Rulers: Imperial & Metric All-Weather Pen: No. 97 Black Metal Clicker Pen Book Cover: CORDURA® Fabric, holds 4 Writing Instruments and a Refill, Zippered Closure	RITR-373B-KIT	Black	5

216 x 280mm SIDE-SPIRAL NOTEBOOKS

	DESCRIPTION	ITEM N ^o	COVER	PACK
<p>N^o 373-MX</p>	Sheet Size: 216 x 280mm Overall Size: 216 x 286 x 13mm Cover Material: Polydura, 19 gauge (front), 55 gauge (back) Pages: 84 pages/42 sheets Binding: Wire-o Paper Weight: 32# Rite in the Rain Rulers: Imperial	RITR-373-MX	Universal	6
		RITR-313-MX	Level	6
		RITR-353-MX	Field	6

STAPLED NOTEBOOKS

SOLD IN 3-PACKS
THE ULTIMATE DAILY CARRY

Tough and low-profile, these scrappy books won't get in your way and they'll never let you down.

82 X 121mm MINI-STAPLED NOTEBOOKS (3 PACK)

	DESCRIPTION	ITEM N ^o	PATTERN	#'D PG	PACK
<p>N^o 371FX-M</p>	Sheet Size: 82 x 121mm Overall Size: 82 x 121 x 3mm Cover Material: Field-Flex Pages: 24 pages/12 sheets Binding: Saddle-stitched Paper Weight: 32# Rite in the Rain Rulers: Imperial & Metric	RITR-371FX-M	Universal	✓	12 (3 packs)

121 X 178mm STAPLED NOTEBOOKS (3 PACK)

	DESCRIPTION	ITEM N ^o	PATTERN	#'D PG	PACK
<p>N^o 371FX</p>	Sheet Size: 121 x 178mm Overall Size: 121 x 178 x 6mm Cover Material: Field-Flex Pages: 48 pages/24 sheets Binding: Saddle-stitched Paper Weight: 32# Rite in the Rain Rulers: Imperial & Metric	RITR-371FX	Universal	✓	6 (3 Packs)
		RITR-301FX	Transit	✓	6 (3 Packs)
		RITR-311FX	Level	✓	6 (3 Packs)
		RITR-351FX	Field	✓	6 (3 Packs)
		RITR-391FX	Journal	✓	6 (3 Packs)



HARDCOVER NOTEBOOKS

THE TOUGH GUYS ON THE BLOCK

A serious book for serious professionals, these books are made to highest standards of quality. Everything from the cover, the paper, the sewn-in pages, even the glue is designed to survive Mother Nature's wrath.

120 X 190mm HARD COVER BOUND BOOKS

	DESCRIPTION	ITEM N ^o	PATTERN	PACK	PERF. PG	
<p>N^o 370F</p>	<p>Perforated Sheet Size: 112 x 184mm</p> <p>Overall Size: 120 x 190 x 16mm</p> <p>Cover Material: Fabrikoid</p> <p>Pages: 160 pages/80 sheets</p> <p>Binding: Case sewn bound</p> <p>Paper Weight: 32# <i>Rite in the Rain</i></p> <p>Rulers: Imperial & Metric</p> <p>Admissible: For legal defensibility it is recommended that books are numbered and sewn-bound</p>	RITR-370F	Universal	✓	✓	
		RITR-300F	Transit	✓	✓	
		RITR-310F	Level	✓	✓	
		RITR-330F	Blank	✓	✓	
		RITR-350F	Field	✓	✓	
		RITR-360F	Metric Field	✓	✓	
		RITR-390F	Journal	✓	✓	

120 X 190mm GEOLOGICAL HARD COVER BOUND BOOK

	DESCRIPTION	ITEM N ^o	PATTERN	#D PG	PACK
<p>N^o 540F</p>	<p>Sheet Size: 118 x 184mm</p> <p>Overall Size: 120 x 190 x 16mm</p> <p>Cover Material: Fabrikoid</p> <p>Pages: 160 pages/80 sheets</p> <p>Binding: Case sewn-bound</p> <p>Paper Weight: 32# <i>Rite in the Rain</i></p> <p>Rulers: Polydura Photo Scale included inside back cover pocket, Imperial & Metric rules printed on reference pages.</p> <p>Reference Materials: 20 geological reference pages including conversion tables</p>	RITR-540F	Geological with Reference Material	✓	6

GEOLOGICAL POUCH KIT

	DESCRIPTION	ITEM N ^o	PATTERN	#D PG	PACK
<p>N^o 540F-KIT</p>	<p>KIT INCLUDES</p> <p>Bound Book:</p> <ul style="list-style-type: none"> • Sheet Size: 118 x 184mm • Overall Size: 120 x 190 x 16mm • Cover Material: Fabrikoid • Pages: 160 pages/80 sheets • Binding: Case sewn-bound • Paper Weight: 32# <i>Rite in the Rain</i> • Rulers: Polydura Photo Scale, Imperial & Metric rules printed on reference pages. <p>All-Weather Pen: No. 97 Black Metal Clicker Pen</p> <p>Pouch: CORDURA® fabric with waist clips and buckle closure</p>	RITR-540F-KIT	Geological with Reference Material	✓	6

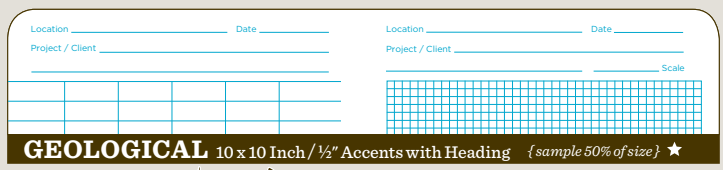

GEOLOGICAL 10 x 10 Inch / 1/2" Accents with Heading {sample 50% of size} ★



FIELD-FLEX BOUND BOOKS

SOMETIMES CONFORMITY IS GOOD

If you need a tough book that loves to travel, then Field-Flex is your road warrior. The covers are soft and flexible; great for shoving into tight places or carrying in your side pants pocket. Field-Flex books are always ready for an adventure!

82 x 133mm SOFT COVER TOP-BOUND BOOKS

	DESCRIPTION	ITEM Nº	PATTERN	PERF. PG	PACK
 <p>Nº 378</p>	<p>Perforated Sheet Size: 82 x 127mm Overall Size: 82 x 133 x 6mm Cover Material: Field-Flex Pages: 100 pages/ 50 perforated sheets Binding: Perfect-bound Paper Weight: 20# Rite in the Rain</p>	RITR-378	Universal	✓	12

89 x 127mm SOFT COVER POCKET BOOKS

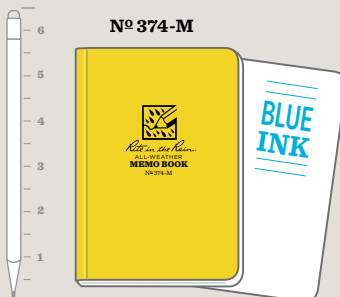
	DESCRIPTION	ITEM Nº	PATTERN	PERF. PG	PACK
 <p>Nº 374-M</p>	<p>Sheet Size: 73 x 127mm Overall Size: 89 x 127 x 6mm Cover Material: Field-Flex Pages: 112 pages/56 sheets Binding: Perfect-bound Paper Weight: 20# Rite in the Rain Rulers: Imperial & Metric Reference Materials: Conversion table & map scale</p>	RITR-374-M	Universal		6

118 x 184mm SOFT COVER BOOKS

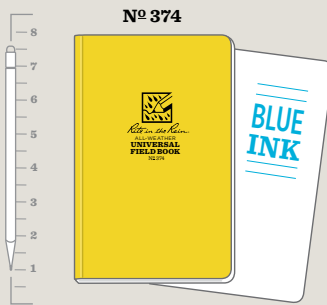
	DESCRIPTION	ITEM Nº	PATTERN	PERF. PG	PACK
 <p>Nº 374</p>	<p>Perforated Sheet Size: 108 x 184mm Overall Size: 118 x 184 x 10mm Cover Material: Field-Flex Pages: 128 pages/64 sheets Binding: Perfect-bound Paper Weight: 32# Rite in the Rain Rulers: Imperial & Metric Reference Materials: Conversion table, map scale, and contents</p>	RITR-374	Universal	✓	6



LASER / COPIER PAPER

Copy or print your own all-weather forms, maps, and worksheets on patented *Rite in the Rain* All-Weather Copier / Laser Paper. Stock is 20# bond weight and completely recyclable. Copy or laser print both sides.

NOT FOR INK-JETS.

COPIER & LASER PAPER

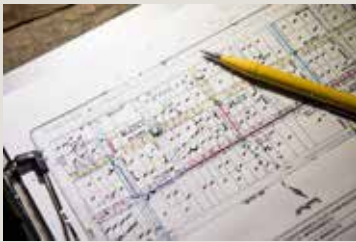

ITEM Nº	SIZE	SHEETS	PACK
RITR-8512	A4 - 21 x 29.7cm	200 Sheets	12
RITR-8518	A3 - 29.7 x 42cm	200 Sheets	6

Printer Paper Applications - Based in customer feedback
No more expensive laminating required

CONSTRUCTION

- Structural and architectural plans
- Reinforcing schedules & Reo marking plans

OUTDOOR SCIENCES

- Note and data taking
- Pre-printed forms
- Maps
- Sketching

MANUFACTURING

- Note and data taking

PUBLIC SAFETY

- Incident reports

MARINE

- Diving records
- Pre-printed forms
- Fishing licenses

OUTDOOR RECREATION

- Maps
- Journaling
- Sketching
- Survival tip sheets

AT HOME

- Emergency lists
- Journaling
- Sketching
- Gardening

TRAVEL

- Travel journals
- Maps

PROFESSIONALS

- Real estate flyers
- Promotional signs

TOP-SPIRAL WATERPROOF (DURARITE)

DESCRIPTION	ITEM Nº	PATTERN	SHEET SIZE	PACK
Nº 635  Cover Material: Polydura, 19 gauge Pages: 100 pages/50 sheets Binding: Top-Spiral, Wire-o Sheet Thickness: 4 mil. Rulers: Imperial & Metric	RITR-635	Universal	76 x 127mm	12
	RITR-646	Universal	102 x 152mm	12

SYNTHETIC COPIER/LASER PAPER (DURACOPY)

DESCRIPTION	ITEM Nº	SIZE	SHEETS	PACK
 Pages: 100 Sheets Waterproof: White Duracopy (synthetic), Tear resistant, Recyclable Paper Weight: 4.7 mil. <i>Not for Ink Jet Printers.</i>	RITR-6512	A4 - 21 x 29.7cm	100 Sheets	20
	RITR-6518	A3 - 29.7 x 42cm	100 Sheets	10

Rite in the Rain





ALL-WEATHER PENS

RECORD WITH CONFIDENCE

All-Weather Pens guarantee that what you write will survive the abuse that Mother Nature dishes out. Not only will the data survive, but these instruments will too. Specially designed for field work, you can count on these trusty instruments to get you through your work day.

ALL-WEATHER PENS

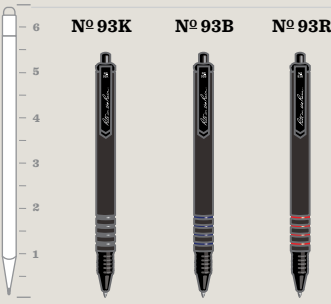
DESCRIPTION	ITEM Nº	INK COLOR	PACK
 <p>Nº 97 METAL CLICKER PEN Size: Length 130mm, Barrel Diameter 10mm Barrel: Metal Colors: Flat Black Description: Writes on wet paper and upside down, the pressurized ink cartridge performs in temperatures from -34°C to 121°C Weight: 0.05 lbs { Refills available }</p>	 <p>RITR-97</p>	Black	12
 <p>Nº 93K Nº 93B Nº 93R</p> <p>DURABLE CLICKER PENS Size: Length 130mm, Barrel Diameter 10mm Barrel: Rubberized Plastic Color: Flat black with ink color identification rings Description: Writes on wet paper and upside down, the pressurized ink cartridge performs in temperatures from -34°C to 121°C Weight: 0.03 lbs { Refills available }</p>	<p>RITR-93K</p> <p>RITR-93B</p> <p>RITR-93R</p>	<p>Black</p> <p>Blue</p> <p>Red</p>	<p>6</p> <p>6</p> <p>6</p>

ALL-WEATHER PEN REFILLS

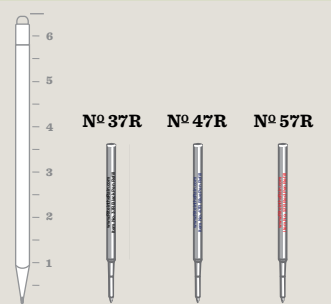
DESCRIPTION	ITEM Nº	INK COLOR	PACK
 <p>Nº 37R Nº 47R Nº 57R</p> <p>ALL-WEATHER PEN REFILLS Size: Length 89mm, Diameter 5mm Fits: All <i>Rite in the Rain</i> Pens Description: Pressurized ink cartridge performs in temperatures from -34°C to 121°C Includes plastic adapter for Parker® style pen retrofits.</p>	<p>RITR-37R</p> <p>RITR-47R</p> <p>RITR-57R</p>	<p>Black</p> <p>Blue</p> <p>Red</p>	<p>12</p> <p>12</p> <p>12</p>

MECHANICAL PENCILS

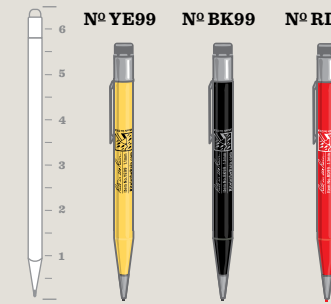
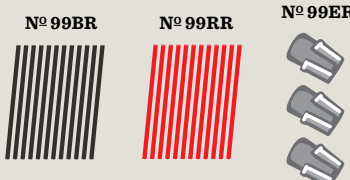
DESCRIPTION	ITEM Nº	DESCRIPTION	PACK
 <p>Nº YE99 Nº BK99 Nº RD99</p> <p>Size: Length 145m Diameter 10mm Barrel: Strong Resin Lead: 1.1 mm Includes: • 7 Leads, 1.1 mm • 3 Erasers</p>	<p>RITR-YE99</p> <p>RITR-BK99</p> <p>RITR-RD99</p>	<p>Black / HB (No. 2)</p> <p>Black / HB (No. 2)</p> <p>Red / B (No. 1)</p>	<p>6</p> <p>6</p> <p>6</p>
 <p>Nº 99ER</p>	<p>RITR-99BR</p> <p>RITR-99RR</p> <p>RITR-99ER</p>	<p>12 Lead Refill Black / HB (No. 2)</p> <p>12 Lead Refill Red / B (No.1)</p> <p>3 Erasers per pack</p>	<p>6</p> <p>6</p> <p>6</p>



Masonry Construction Products

A		Cloth Rags	12	Float - Concrete	34,35
Acid Sprayer	55	Concrete - Edger	35,36	Float - Diamond Base	78
Admixture - Best-Bond	20	Concrete - Finish Broom	29	Float - Lemon	78
Admixture - Plasticizer 504	20	Concrete - Floats	34,35	Float - Plastic	77
Admixture - Rapid Set 704	20	Concrete - Mesh Roller	39	Float - Poly	78
Admixture - Waterproofer 104	20	Concrete - Nippers	42	Float - Render	77-79
Admixture - Waterproofer 404	20	Concrete - Remover	69	Float - Sponge	79,80
Aluminium Straight Edge	87	Concrete - Rubbing Bricks	40	Float - Styrene	78
Anchoring and Fastening	53,54	Concrete - Screed	40	Floats - Bull	38
Apron	94	Concrete - Sealer Broom	31	Floats - Magnesium	34
Aspros	65	Concrete - Sealer Sprayer	55	Floats - Wood	35
B		Concrete - Spacers/Rails	65,66	Floor Scrapers	8
Backer Rod	46	Concrete - Super Screed	71	Floor Sweeper	31
Bar Chairs - Plastic	51	Concrete - Trowel Machine	71	Foam Gun	82
Barricade - Mesh	16	Concrete - Vibrator	71,72	Foam Joint	45
Barricade - Tape	16	Concrete Canvas	19	Folding Rule	14
Bars - Construction	23	Concrete Rake	39,40	Form Oil Sprayer	55
Bars - Crow	25	Concrete Sealer	67,68	Form Release	70
Bars - Monster Pry	44	Copier Paper	102	G	
Bars - Spud	25	Corflute	19	Gauge Rake	44
Bars - Wrecking	25	Cork Expansion Joint	45	Geotextile	19
Best-Bond	20	Crack Chasing Blade	3	Gloves	15,16
Biscuit Dowels	48	Crack Inducer	49	Grinder - CUB	71
Bitumen Paint	19	Crayons - Industrial	6	Groovers	36,37
Bitumen Stiff Joint	46	Cresco® Expanding Waterstop	59	Grooves	92
Bitumen Tape	19	Crow Bars	25	Grout Bags	8,92
Bollards	16	Cup Grinding Wheels	2	Grouting Gun	52
Bolt Cutters	43	Curing Compound	69	Grouts	17
Bolts - Fasteners	53	Cut Off Wheels	3,4	Gumboots	44
Boot Cleaner Brush	31	Cutter - Fillet	44	Gunite Shoes	44
Boots - Safety	17	Cutters - Bolt	43	H	
Brick - Carrier	93	Cutters - Rod/Bar	43	Hammer - Brick	22
Brick - Clamps	93	D		Hammer - Claw	21
Brick - Dutch Pins	92	Dampcourse	19	Hammer - Club	22
Brick - Gauge Rods	94	Demo Saws	72	Hammer - Deadblow	24
Brick - Jointer	90,91	Diamond Blades	1-3	Hammer - Demolition	22
Brick - Line Blocks	92	Diamond Grinding Wheels	2-3	Hammer - Geological	21,22
Brick - Multi Hooks	92	Dowel Cradles	49	Hammer - Mallet	23
Bucket Opener	12	Dowel Sleeves	48	Hammer - Mash	22
Brick - Rakers	91	Dowels	48	Hammer - Sledge	23
Brick - Smoother	91	Drive Units	72	Hammer Tacker	7
Brick - String Line	94	Drop Sheets	9	Hand Tally Counter	13
Brooms and Brushware	29-31	Drywall Square	13	Handles - Broom	30
Brushware	10,29-31	Duct Tape	44	Handles - Bull Float	39
Bucket - Builders	7	Dust Masks	18	Handles - Pick/Mattock	27
Builders Film - Poly	51	E		Handles - Shovel	27
Bull Float Handles	39	Ear Muffs	18	Hawk - Plaster	81
Bull Floats	38	Ear Plugs	17	Hessian	51
Bullet Head Nails	54	Edger - Concrete	35	Hog Ring Pliers	28
Bunting	16	Egcodorn®	64	Hoop Iron	27
Bushmans Repellent	18	Electric Mixer	86	Hopper Gun - Texture	85
C		Electrical Lead Stand	16	Hydrochloric Acid	20,69
Cable Ties	4	Electrical Leads/RCD	4	I,J,K	
Cardboard Void	50	End Cutting Nippers	42	Injection Hose System	57
Carpenters Pencils	6	Expansion Cork Joint	45	Intec®	57
Caulking Compound	46	Expansion Joint	45,46	Jack Jaws	25
Caulking Gun	8	Expansion Joint Systems	47	Jugs - Measuring	7
Caulking Gun - Sausage	8	F		Key Joint	47
Cementitious Products	52	Fencing Tension Claws	28	Keyboxes	63
Chalk	13	Fillet Cutter	44	Keyjoint Former	50
Chalk - Line Reels	13	Flagging Tape	52	Knee Pads	16
Clamps - F Clamps	94	Flap Discs	3	Kneeling Board	41
				Knives - Cutting	8



MASONRY

CONSTRUCTION PRODUCTS

Masonry Construction Products Pty. Ltd
 Head Office
 11/505 Maroondah Hwy
 Ringwood, 3134
 Victoria, Australia
 Postal Address:
 PO BOX 791
 Ringwood, 3134
 Victoria, Australia
 P: +61 3 9870 4242
 F: +61 3 9870 3040
 sales@masonrycp.com
 www.masonrycp.com

Concreting • Plastering • Rendering • Brick Laying • Construction Tools
 Mining • Formwork • Civil • Waterproofing • Concrete Jointing Systems