

U.S.S.-10  
wmm

GPO PRICE \$ \_\_\_\_\_

CFSTI PRICE(S) \$ \_\_\_\_\_

Hard copy (HC) 3.00

Microfiche (MF) .65

ff 653 July 65

**N 68-19142**

FACILITY FORM 602

(ACCESSION NUMBER)

(THRU)

192  
(PAGES)

1  
(CODE)

CR-66559  
(NASA CR OR TMX OR AD NUMBER)

31  
(CATEGORY)

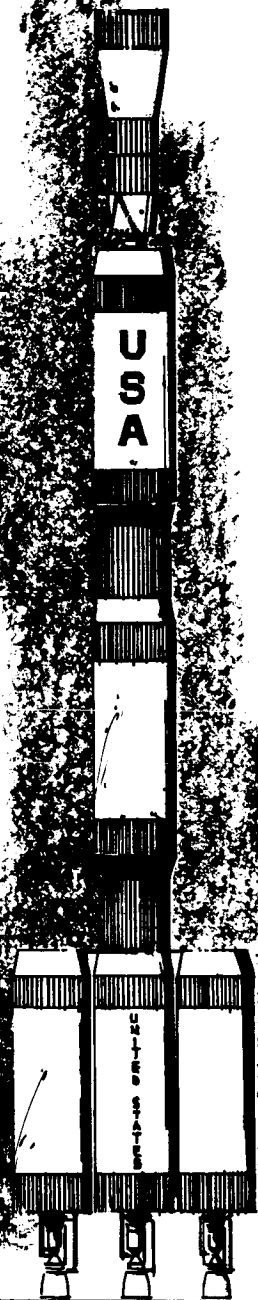

# INTEGRATED MANNED INTERPLANETARY SPACECRAFT CONCEPT DEFINITION

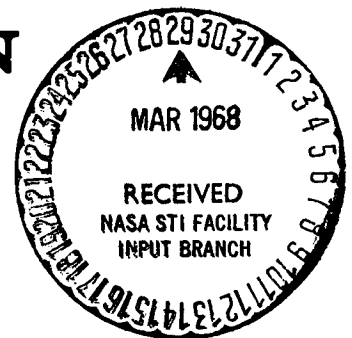

*Volume II*  
**D2-113544-2**

*System Assessment*  
*and Sensitivities*

INTEGRATED MANNED INTERPLANETARY  
SPACECRAFT CONCEPT DEFINITION

FINAL REPORT

**VOLUME II**

**SYSTEM ASSESSMENT  
AND SENSITIVITIES**

**D2-113544-2**

Prepared for

NATIONAL AERONAUTICS AND SPACE ADMINISTRATION

LANGLEY RESEARCH CENTER

Hampton, Virginia

NASA CONTRACT NAS1-6774

January 1968

Distribution of this report is provided in the interest of  
information exchange. Responsibility for the contents  
resides in the author or organization that prepared it.

## RECOMMENDED INTERPLANETARY MISSION SYSTEM

The recommended interplanetary mission system:

- Is flexible and versatile
- Can accomplish most of the available Mars and Venus missions
- Is highly tolerant to changes in environment, go-ahead dates, and funding.

It provides:

- Scientific and engineering data acquisition during all mission phases
- Analysis, evaluation, and transmission of data to Earth
- Return to Earth of Martian atmosphere and surface samples

The mission system is centered around the *space vehicle* which consists of the *space acceleration system* and the *spacecraft*.

The *space acceleration system* consists of five identical nuclear propulsion modules:

- Three in the Earth departure stage
- A single module in the planet deceleration stage
- A single module in the planet departure stage

Propellant is transferred between the stages, as necessary, to accommodate the variation in  $\Delta V$  requirements for the different missions. This arrangement provides considerable discretionary payload capacity which may be used to increase the payload transported into the target planet orbit, the payload returning to the Earth, or both.

The *spacecraft* consists of:

- A biconic Earth entry module capable of entry for the most severe missions
- An Apollo-shaped Mars excursion module capable of transporting three men to the Mars surface for a 30-day exploration and returning
- A mission module which provides the living accommodations, system control, and experiment laboratories for the six-man crew
- Experiment sensors and a planet probe module

The spacecraft and its systems have been designed to accomplish the most severe mission requirements. The meteoroid shielding, expendables, system spares, and mission-peculiar experiment hardware are off-loaded for missions with less stringent requirements.

The space vehicle is placed in Earth orbit by six launches of an uprated Saturn V launch vehicle which has four 156-inch solid rocket motors attached to the first stage. Orbital assembly crew, supplies and mission crew transportation are accomplished with a six-man vehicle launched by a Saturn IB.

A new launch pad and associated facility modifications are necessary at Launch Complex 39 at Kennedy Space Center to accommodate:

- The weight and length of the uprated Saturn V
- The launch rate necessary for a reasonable Earth orbit assembly schedule
- The solid rocket motors used with the uprated Saturn V
- The requirement for hurricane protection at the launch pad.

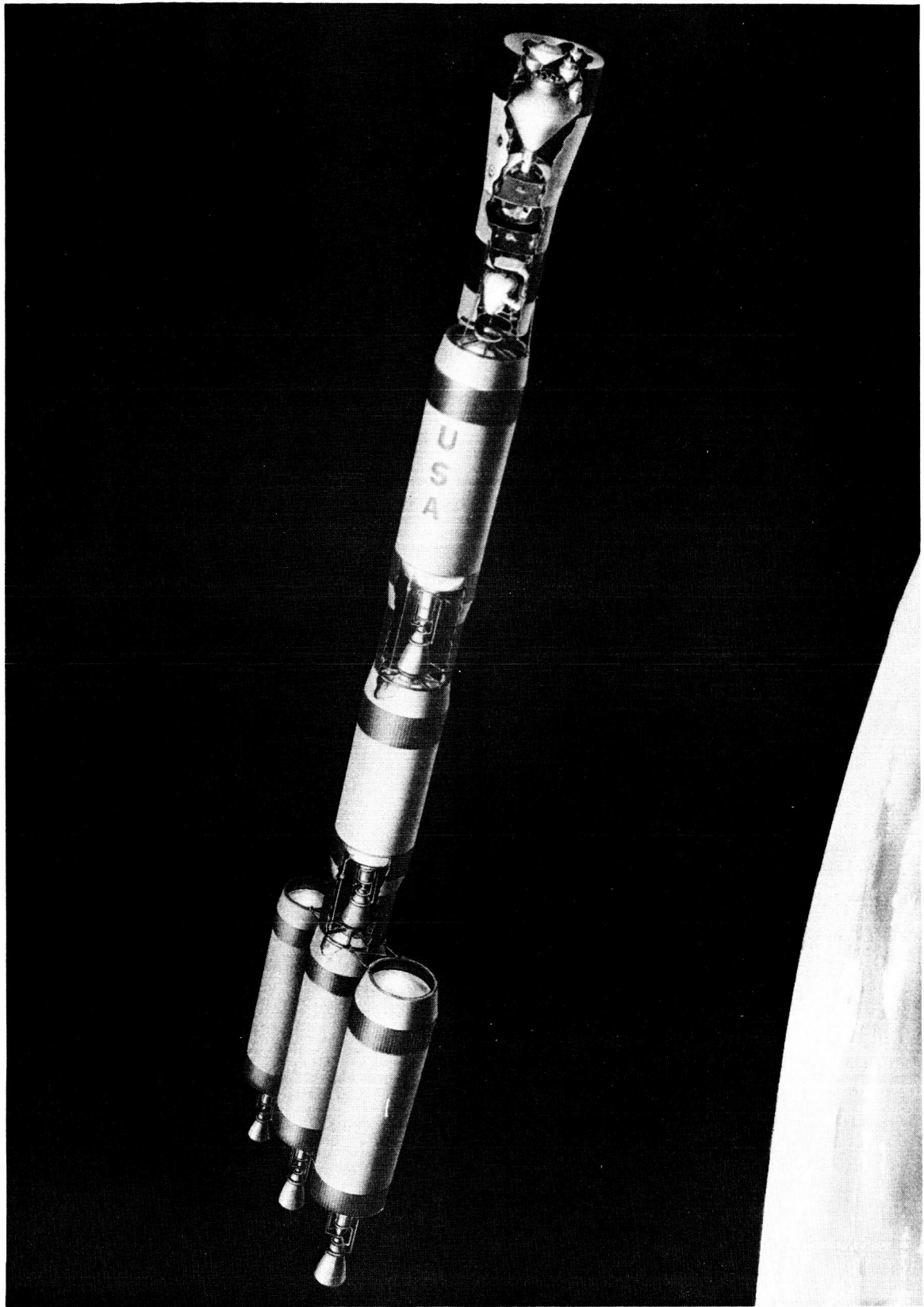



## ABSTRACT

This volume is a handbook for planners of specific manned interplanetary missions. It summarizes the scientific objectives, mission requirements, and the recommended system for accomplishing such missions. It assesses the recommended system in terms of general performance and growth capabilities; sensitivities to variations from the design conditions; performance margins for alternatives to offset these sensitivities; applicability of the system to other space programs and its impact on them; and technology advances required by the system. Finally, it provides specific guides for mission and program planning.

## FOREWORD

This study was performed by The Boeing Company for the National Aeronautics and Space Administration, Langley Research Center, under Contract NAS1-6774. The Integrated Manned Interplanetary Spacecraft Concept Definition Study was a 14-month effort to determine whether a variety of manned space missions to Mars and Venus could be accomplished with common flight hardware and to define that hardware and its mission requirements and capabilities. The investigation included analyses and trade studies associated with the entire mission system: the spacecraft; launch vehicle; ground, orbital, and flight systems; operations; utility; experiments; possible development schedules; and estimated costs.

The results discussed in this volume are based on extensive total system trades which can be found in the remaining volumes of this report. Attention is drawn to Volume II which has been especially prepared to serve as a handbook for planners of future manned planetary missions.

The final report is comprised of the following documents, in which the individual elements of the study are discussed as shown:

<u>Volume</u>	<u>Title</u>	<u>Part</u>	<u>Report No.</u>
I	Summary		D2-113544-1
II	System Assessment and Sensitivities		D2-113544-2
III	System Analysis	Part 1--Missions and Operations	D2-113544-3-1
IV	System Definition	Part 2--Experiment Program	D2-113544-3-2
V	Program Plans and Costs		D2-113544-4
VI	Cost-Effective Subsystem Selection and Evolutionary Development		D2-113544-5 D2-113544-6

The accompanying matrix is a cross-reference of subjects in the various volumes.

STUDY AREAS	DOCUMENTATION					
	Volume I / D2-113544-1 Summary Report	Volume II / D2-113544-2 System Assessment and Sensitivities	Volume III / D2-113544-3 System Analysis Part 1 - Missions and Operations Part 2 - Experiment Program	Volume IV / D2-113544-4 System Definition	Volume V / D2-113544-5 Program Plans and Cost	Volume VI / D2-113544-6 Cost Effective Subsystem Selection and Evolutionary Development
<ul style="list-style-type: none"> <li>● Primary Discussion</li> <li>X Summary or Supplemental Discussion</li> </ul>						
MISSION ANALYSIS	X					
Trajectories and Orbits	X	X	●	X		
Mission and Crew Operations	X	X	●	X		
Mission Success and Crew Safety Analysis	X	X	●	X		
Environment	X	X	●			
Scientific Objectives	X	X	●			
Manned Experiment Program	X	X	●			
Experiment Payloads and Requirements	X	X	●			
DESIGN ANALYSIS	X					
Space Vehicle	X			●		
Spacecraft Systems	X			●		
Configurations	X	X		●		
Subsystems	X	X		●		
Redundancy and Maintenance	X			●		
Radiation Protection	X			●		
Meteoroid Protection	X			●		
Trades	X			●		
Experiment Accommodations	X			●		
Space Acceleration Systems	X			●		
Primary Propulsion--Nuclear	X	X		●		
Secondary Propulsion--Chemical	X	X		●		
System and Element Weights	X	X		●		
IMIEO Computer Program				●		
Earth Orbit Operations and Assembly Equip.	X	X		●		
Earth Launch Vehicles	X	X		●		
Facilities	X	X		●		
System Trades	X			●		
Space Acceleration--Earth Launch Vehicle	X			●		
Space Acceleration Commonality	X			●		
Space Vehicle--Artificial Gravity	X			●		
SYSTEM AND PROGRAM ASSESSMENT	X	●				
System Capability	X	●	●		X	
Design Sensitivities	X	●				
Program Sensitivities	X	●				
Adaptability to Other Space Programs	X	●				
Impact on Other Space Programs	X	●				
Technology Implications	X	●				
Future Sensitivity Studies	X	●				
Program Schedules and Plans	X	X			●	
Test Program	X	X			●	
Facilities Plan	X	X			●	
Program Cost	X	X			●	
Cost Effective Subsystems						●

## ABBREVIATIONS

A.U.	Astronomical unit
bps	Bits per second
C/O	Checkout
CM	Command module (Apollo program)
CMG	Control moment gyro
CONJ	Conjunction
CSM	Command service module (Apollo program)
$\Delta V$	Incremental velocity
DSIF	Deep Space Instrumentation Facility
DSN	Deep Space Network
$\oplus$	Earth
ECLS	Environmental control life support system
ECS	Environmental control system
EEM	Earth entry module
ELV	Earth launch vehicle
EMOS	Earth mean orbital speed
EVA	Extravehicular activity
FY	Fiscal year
fps	feet/sec
GSE	Ground support equipment
IBMC	Inbound midcourse correction
IMIEO	Initial mass in Earth orbit
IMISCD	Integrated Manned Interplanetary Spacecraft Concept Definition
$I_{sp}$	Specific impulse
IU	Instrument unit
KSC	Kennedy Space Center
$\lambda'$	Ratio of propellant weight to overall propulsion module weight
LC	Launch complex
LC-34 & -37	Launch complexes for Saturn IB
LC-39	Launch complex for Saturn V
LH <sub>2</sub>	Liquid hydrogen
LO	Long
LO <sub>2</sub> or LOX	Liquid oxygen
LRC	Langley Research Center

## ABBREVIATIONS (Continued)

LSS	Life support system
LUT	Launch umbilical tower
♂	Mars
MEM	Mars excursion module
MIMIEO	Minimum initial mass in Earth orbit
MM	Mission module
MODAP	Modified Apollo
MSC	Manned Spacecraft Center (Houston)
MSFC	Marshall Space Flight Center (Huntsville)
MTF	Mississippi Test Facility
NAC	Letters designate the type of acceleration systems First letter--Earth orbit depart Second--planetary deceleration Third--planet escape Example: NAC = Nuclear Earth depart/aerobraker deceleration at planet/chemical planet escape
OBMC	Outbound midcourse correction
OPP	Opposition
OT	Orbit trim
P/L	Payload
PM-1	Propulsion module, Earth orbit escape
PM-2	Propulsion module, planet braking
PM-3	Propulsion module, planet escape
RCS	Reaction control system
SA	Space acceleration
S/C	Spacecraft
S-IC	First stage of Saturn V
S-II	Second stage of Saturn V
SH	Short
SOA	State of art
SRM	Solid rocket motor
S/V	Space vehicle
SWBY	Swingby

## ABBREVIATIONS (Continued)

T/M	Telemetry
TVC	Thrust vector control
VAB	Vehicle assembly building
♀	Venus
V <sub>HP</sub>	Hyperbolic excess velocity

CONVERSION FACTORS  
English to International Units

<u>Physical Quantity</u>	<u>English Units</u>	<u>International Units</u>	<u>Multiply by</u>
Acceleration	ft/sec <sup>2</sup>	m/sec <sup>2</sup>	3.048x10 <sup>-1</sup>
Area	ft <sup>2</sup>	m <sup>2</sup>	9.29x10 <sup>-2</sup>
	in <sup>2</sup>	m <sup>2</sup>	6.45x10 <sup>-4</sup>
Density	lb/ft <sup>3</sup>	Kg/m <sup>2</sup>	16.02
	lb/in <sup>3</sup>	Kg/m <sup>2</sup>	2.77x10 <sup>4</sup>
Energy	Btu	Joule	1.055x10 <sup>3</sup>
Force	lbf	Newton	4.448
Length	ft	m	3.048x10 <sup>-1</sup>
	n.mi.	m	1.852x10 <sup>3</sup>
Power	Btu/sec	watt	1.054x10 <sup>3</sup>
	Btu/min	watt	17.57
	Btu/hr	watt	2.93x10 <sup>-1</sup>
Pressure	Atmosphere	Newton/m <sup>2</sup>	1.01x10 <sup>3</sup>
	lbf/in <sup>2</sup>	Newton/m <sup>2</sup>	6.89x10 <sup>3</sup>
	lbf/ft <sup>2</sup>	Newton/m <sup>2</sup>	47.88
Speed	ft/sec (fps)	m/sec	3.048x10 <sup>-1</sup>
Volume	in <sup>3</sup>	m <sup>3</sup>	1.64x10 <sup>-5</sup>
	ft <sup>3</sup>	m <sup>3</sup>	2.83x10 <sup>-2</sup>

# CONTENTS

<u>Section</u>	<u>Page</u>
1.0 INTRODUCTION	1
1.1 System Requirements Summary	2
1.1.1 Scientific Objectives and Payload Requirements	2
1.1.2 Mission Requirements	12
1.2 Recommended System	17
1.2.1 Space Vehicle (S/V)	17
1.2.2 Earth Launch Vehicle (ELV)	35
1.2.3 Orbital Logistics Vehicle (OLV)	35
1.2.4 Mission Support System (MSS)	36
1.2.5 Experiments Equipment	36
1.2.6 Facilities Summary	36
1.2.7 Mission Operations Program	38
1.2.8 Scientific Program	41
1.3 Program Plan Summary	42
1.3.1 Schedule Summary	42
1.3.2 Cost Summary	44
1.3.3 Test Program Summary	45
2.0 PRIMARY VALUES OF THE RECOMMENDED SYSTEM	55
2.1 General System Capabilities	57
2.1.1 Representative Mission Capability	57
2.1.2 General Performance Capability	59
2.1.3 Mission Success Capability	65
3.0 SYSTEM SENSITIVITIES ASSESSMENT	69
3.1 Environmental Constraints Sensitivities	70
3.1.1 Artificial Gravity Effects	71
3.1.2 Meteoroid Environment Changes	72
3.1.3 Mars Atmosphere Effect on MEM	75
3.2 Mission Design Sensitivities	76
3.2.1 Earth Orbit Stay-Time Effects	76
3.2.2 Launch Window Sensitivity	77
3.2.3 Elliptical Orbits at the Target Planets	79
3.2.4 Redundant MEM Effects	81
3.2.5 Planet Stay-Time Effects	82



## CONTENTS (Continued)

<u>Section</u>	<u>Page</u>
3.3 Hardware Design Sensitivities	83
3.3.1 Space Acceleration Sensitivities	84
3.3.2 Space Vehicle Structure Sensitivities	90
3.3.3 Spacecraft Subsystem Sensitivities	93
3.3.4 Mission Payload Sensitivities	97
3.3.5 Reliability and Mission Success Sensitivities	104
3.4 Programming Sensitivities	108
3.4.1 Schedule Sensitivities	108
3.4.2 Funding Level Sensitivities	113
3.4.3 Effects from First Mission Alternates	114
3.4.4 Logistics Program Sensitivities	115
3.4.5 Test Program Sensitivities	117
3.4.6 Development Risk	122
3.5 Adaptability of Hardware to Other Space Programs	126
3.5.1 Mission Module Subsystems Adaptability to Other Missions	127
3.5.2 Propulsion Module Performance Capability for Unmanned Missions	129
3.6 Impact on Other Space Programs	130
3.6.1 Impact on Space Station and Other Earth-Orbit Programs	130
3.6.2 Impact on Earth-Orbit Space Science	134
3.7 Technology Implications	137
3.7.1 Mission Module Subsystems	138
3.7.2 MEM--Technology Implications	144
3.7.3 EEM--Technology Implications	146
3.7.4 Space Propulsion Propellant	147
3.7.5 Space Propulsion Engines	148
3.7.6 Experiment Hardware Development	149
3.7.7 SAT-V-25(S)U Earth Launch Vehicle Technical Implications	153
3.8 Sensitivities for Future Studies	156
3.9 Program Planner's Guide	157
3.9.1 Mission Performance Evaluation	163

## 1.0 INTRODUCTION

This study considered the entire interplanetary mission system--scientific program, Earth-based support, launch vehicles and facilities, orbital support, spacecraft, and space acceleration system--in order to develop the foundations for a balanced program of unmanned and manned planetary missions.

One of the primary goals was to conceive a manned planetary system with a high degree of flexibility for accomplishing missions to both Mars and Venus in the majority of launch opportunities. Another important goal was to provide the system with reserve capabilities to tolerate such uncertainties as annual funding rates, program go-ahead, political pressures, and availability of engineering and scientific data from precursor activities. Still another goal was to make fullest use of Earth-orbital and lunar space programs in developing and testing the required interplanetary capabilities. The recommended system is a concept that has evolved from these goals.

Before the United States can commit resources to a program of this magnitude, the NASA will conduct many planning exercises to resolve or offset these unknowns. Because of this, the capabilities and sensitivities of the recommended system are compiled in one volume.

This volume is designed for use as a handbook by the planners of future manned planetary missions. It is divided into three parts: the first part gives a brief description of the overall requirements and the recommended system; the second part assesses how well the system satisfies the requirements; the third part assesses sensitivities of the recommended system to changes. This assessment of sensitivities answers "what if" questions in three major categories: (1) what will happen if the mission requirements and parameters change? (2) what will happen if design requirements change or if good alternates are selected? and (3) what will happen if schedules, costs, or program plans change? Part 3 also predicts the system's growth capability and applicability to other space programs, identifies its technology implications, assesses its impact on precursor probes and Earth-orbital space stations, and contains "what if" thoughts that appear answerable but are outside the scope of the study.

## 1.1 SYSTEM REQUIREMENTS SUMMARY

## 1.1.1 SCIENTIFIC OBJECTIVES AND PAYLOAD REQUIREMENTS

The primary scientific objectives of manned interplanetary missions were broadly examined by the scientific community at the 1965 Woods Hole (Mass.) Conference, and are being subjected to continuing reviews and refinement by individual scientists according to their fields of interest. There is now general agreement, however, that missions to Mars and Venus should obtain scientific data that will increase our understandings of the forces at work on Earth and help to define our solar system and the life in it. There is a further requirement to obtain data that will give some clues about the origin and evolution of the universe, and the galaxies that compose it.

These broad scientific objectives provided the base from which scientific program concepts for manned interplanetary missions were developed. The scientific program aspects of this study accomplished the following results:

- A logical program of planetary experiments was developed to meet the broad scientific objectives for Mars and Venus explorations. The experiments to be conducted in-transit are distinguished from those to be conducted either in planet orbit or on the planet surface.
- Man's role and the role of precursor unmanned missions were examined, in order to recommend a balanced program of unmanned and manned missions to other planets. The ground training and Earth-orbit training requirements were then identified for space flight personnel.
- Presently authorized or proposed space flight programs were reviewed to consider their possible contributions to the broad objectives associated with manned interplanetary missions.
- Sensor and instrument requirements were determined in each measurement area of the recommended experiments program.
- Scientific payloads required for the exploration of Mars and Venus were then determined. These payloads are listed in Tables 1.1-1 through 1.1-6. The lists include experiment instruments, analytical and support hardware, return samples and data, and the various hardware for unmanned probes.
- Technology advances and testing, which can have critical effects on the success of the scientific program, are identified and recommended for special attention.

Table 1.1-1: MARS-VENUS EXPERIMENT INSTRUMENTS

Instrument	Weight (lb)	Power (watts)	Volume (ft <sup>3</sup> )	Rate or Pointing Accuracy	Data Management (kb/sec)	Mounting <sup>2</sup>
1. UV Spectrometer	135	60	3.0	0.02-0.05 deg/sec	10-20	
2. IR Spectrometer	100	40	7.0	0.02-0.05 deg/sec	10-20	
3. IR Interferometer	50	25	0.2	0.01 deg/sec	2.0	
4. Photographic System	2000	30	230.0	0.03 deg/sec $\pm$ 0.50 deg	(1)	
5. UV Scanner	55	25	7.0	0.02-0.05 deg/sec		
6. IR Scanner	185	25	1.8	0.02-0.05 deg/sec	10-20	
7. Polarimeter	50	20	0.5	0.01 deg/sec	0.01	
8. Photometer	10	20	0.25	$\pm$ 1 deg	0.1	
9. RF Radiometer	100	20	8.0	0.02 deg/sec	19	Boom
10. Bistatic Radar	36	6	0.5			Boom
11. Magnetometer	6	7	0.2		0.2	Boom
12. Charged Particle Detector	50	15	1.0		0.1	Boom
13. Micrometeoroid Detector	115	1.5	1.4		0.01	Body-mounted
14. Mapping Radar	420	1000	2.5	$\pm$ 0.05 yaw $\pm$ 1.0 P&R	180	
15. Ion Probes <sup>3</sup>	300	10	10			
Totals	3610	1265 (av)	400			

1. 80,000 photos (1 photo is equivalent to  $6 \times 10^9$  bits).
2. Scan platform unless otherwise noted.
3. This probe category has been included as it is common to both Mars and Venus missions.

Table 1.1-2: ANALYTICAL HARDWARE

	Equipment	Requirements		
		Weight (pounds)	Power (watts)	Volume (cu ft)
1.	Microscope and Cameras	15	20	1.2
2.	Centrifuge	40	25	0.5
3.	Polarimeters	14	5	0.2
4.	Spectrophotometers (Vis., UV, X-Ray)	135	60	0.5
5.	Nuclear Instrumentation	150	30	0.2
6.	PH Meter Plus Reagents	41	3	0.2
7.	Mass Spectrometer	10	3	0.5
8.	Chromatographs	14	10	0.2
9.	Osmometer	12	--	0.2
10.	Refractometer	8	2	0.2
11.	X-Ray Diffractometer	36	20	1.1
12.	Thermometers	1	1	0.1
13.	Scales	15	1	1.0
14.	IR Spectroscopes	100	40	1.0
15.	Weather Station <sup>1</sup>	100	5	2.5
16.	Magnetometer	6	7	0.5
17.	Seismographs (active and passive)	52	25	3.5
18.	Gravimeter	30	5	1.0
19.	Heat Flow (with small drill)	15	2	1.0
	Total Analytical Hardware	794	264	15.6

<sup>1</sup>Automated with recorder and data transmission (10<sup>4</sup> bps peak)

Table 1.1-3: SUPPORT HARDWARE

Suggested Equipment	Requirements		
	Weight (pounds)	Power (watts)	Volume (cu ft)
Microtome + Slides and Stains	25	15	0.3
Refrigerators	10	40	1.0
Incubators	20	100	2.0
Oven - Sterilizer	40	500	1.0
Work Bench + Glassware (Teflon)	55	--	30.0
Micromanipulators (in above bench)	22	5	--
Ultrasonic Cleaner including Solvent	140	200	2.0
Agitators, Blenders	9	10	0.5
Emulsifier	10	8	0.5
Drilling and Coring	110	500	1.0
Rock Cutters	20	150	1.0
Polishing and Etching	20	50	0.5
Biosampler	11	--	0.2
"Pristine State" Mars Material Box	6	--	2.0
Geological Hand Tools and Containers	25	--	1.0
Data System <sup>1</sup>	50	25	0.5
Total Support Hardware	573	1603	43.5

<sup>1</sup> Includes recorders and telemetry system with capability of transmitting video bandwidth information. Separate from command link between MEM and spacecraft.

Table 1.1-4: SAMPLE AND DATA RETURN

Samples and Data <sup>1</sup>	Weight (pounds)	Power (watts)	Volume (cu ft)
Sedimentary Samples	180	--	1.2
Stratigraphic Records	12	--	0.2
"Long" Core Samples	450	--	4.2
Photographic Records <sup>2,3</sup>	6	--	0.1
Surface Soil Samples	150	--	1.0
Water Samples	8	--	0.1
Environment Data	6	--	0.1
Tape Recordings <sup>3</sup>	12	--	0.2
Ice Samples (includes refrig.)	28	150	1.1
Specimens (lichens, algae, etc.)	60	--	1.0
Total Samples and Data Return	912	150	9.2

<sup>1</sup>Includes packaging where applicable.

<sup>2</sup>Transmission data bandwidth limitations may increase this figure.

<sup>3</sup>Data collected just prior to launch from Mars surface.

Table 1.1-5: MARS ORBIT LAUNCH PROBES

Probe Mode	Qty	Science Payload Wt (lb)	Probe <sup>1</sup> Wt (lb)	Size (ft)	Data to be Acquired
<u>Engineering</u>					
Hard Lander	5	20	330	~7-ft D x 7-ft L (Apollo Shape)	MEM Trajectory Data
Soft Lander	2	100	3335	~14-ft D x 7-ft L (Apollo Shape)	Surface Bearing Strength and Radiation Background
<u>Science</u>					
Orbiter	2	6	100	3-ft D x 3-ft L (Cylindrical)	Occultation
Orbiter	2	22	155	3-ft D x 4-ft L (Cylindrical)	Ionosphere
Orbiter	2	6	100	3-ft D x 3-ft L (Cylindrical)	Magnetic Field
To Mars' Moons Hard Lander	4	25	2600 3305	5-ft D x 10-ft L (Cylindrical) 5-ft D x 11-ft L (Cylindrical)	Martian Moon Imaging
Orbiter	2	420	1415	Cylindrical	Radiometric Maps (Polar)

<sup>1</sup>Total Probe Weight = 22,255 pounds; 23,135 pounds for Venus swingby.



Table 1.1.1-6: VENUS UNMANNED PROBES

Probe Mode	Qty	Science Payload Wt (lb)	Probe <sup>2</sup> Wt (lb)	Size	Data to be Acquired
<sup>1</sup> Atmospheric drifter to surface. Drift-down rate of 20 miles per 20 days which may be inversely proportional to atmospheric density from 1 to 20 atmospheres horizontal velocity. Not critical.	2	50	775	5-ft D x 7-ft L (Cylindrical)	Atmospheric Life
Orbiter	2	150	1,550	5-ft D x 8-ft L (Cylindrical)	Cloud Data
Orbiter	2	420	11,575	5-ft D x 14-ft L (Cylindrical)	Surface Temperature Mapping Data
<sup>1</sup> Atmospheric drifter similar to above with a constant drop rate rather than a proportional rate.	2	80	825	5-ft D x 7-ft L (Cylindrical)	Atmospheric RF Transmission
Same as above, but with soft lander capability.	2	320	2,370	10-ft D x 7-ft L Apollo Shape	Surface Spectral Data

<sup>1</sup>Swingby Mission Complement<sup>2</sup>Total Probe Weight = 34,190 pounds

1.1.1.1 Predicted State-of-Knowledge Contributions by the System

The successful completion of the experiment program permits further projections of the states of knowledge about Mars and Venus. These projections, depicted in Figures 1.1-1 and 1.1-2, are compared with those for 1975 and for the present. The detailed contributions within each major category are presented in Volume III, Part 2.

Three manned missions to Mars permit the complete development or verification of theories in four of the five basic categories. Life's origin on the planet will remain a matter of conjecture. The two missions to Venus advance the same four major categories, but to a lesser degree. The difference between the two projections emphasizes the contributions derived from surface explorations by man--missing from the Venus program. Landing missions are considered essential to the acquisition of sufficient data to verify Venus similarities or dissimilarities to Earth. Further, a comprehensive system of coordinates and surface location charts is considered essential to explorations of both Mars and Venus. Additional questions will be posed by the unpredictable discoveries that surely will be made, not only by these proposed manned missions, but by the precursor and unmanned programs as well.

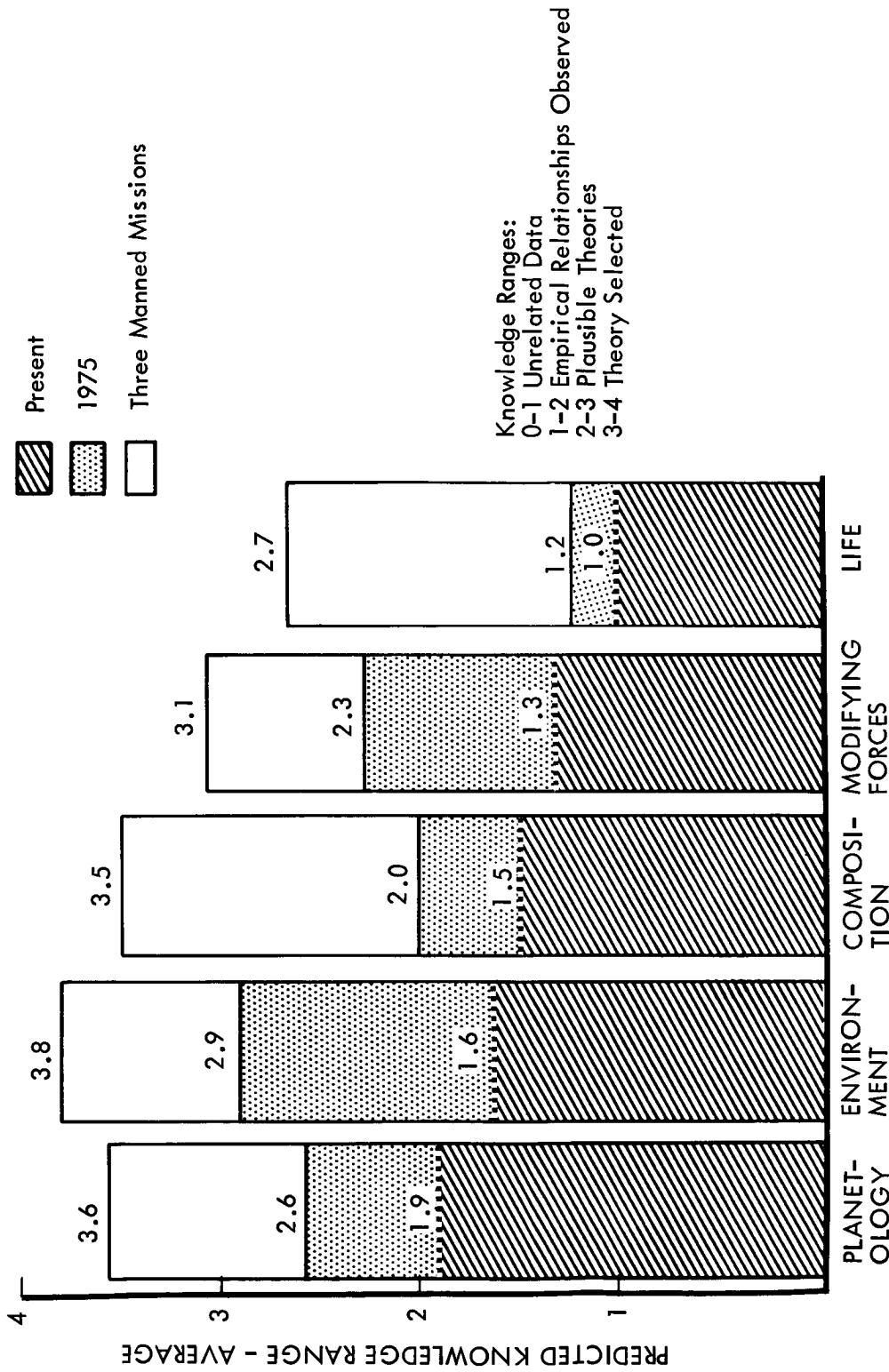

Figure 1.1-1: IMISCD KNOWLEDGE BASE COMPARISONS — MARS

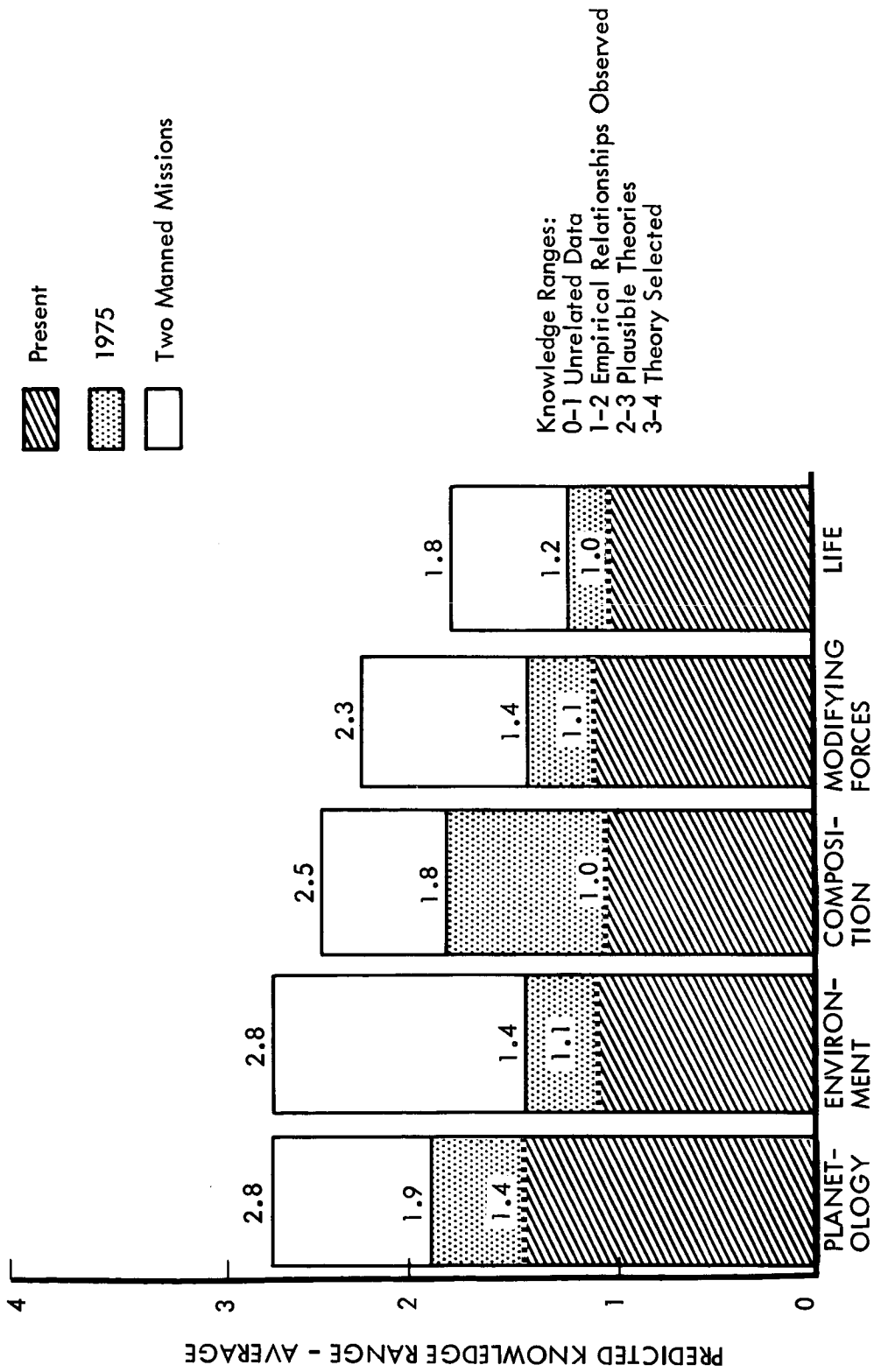

Figure 1.1-2: IMISCD KNOWLEDGE BASE COMPARISONS — VENUS

### 1.1.2 MISSION REQUIREMENTS

Thirty-two Mars and Venus opportunities that will exist during the 1975-1990 Mars synodic cycle are shown in Figure 1.1-3 by the solid lines. Twenty of those opportunities were selected to establish the range of mission requirements for the study, and they are indicated on the chart by the symbolic representation of the planets involved. Placement of the symbols grossly indicate Earth departure, target planet arrival, stay and departure, and Earth arrival.

The Mars missions are divided into three classes:

- 1) Opposition class missions result in round-trip times of approximately 450 days but require the most energy. Selected planet stay time is 40 days. For the unfavorable time between 1975 and 1980, the energy requirement is prohibitive for this class mission.
- 2) Venus swingby missions provide trajectories that are shaped such that very little additional energy is required during these unfavorable periods, and the mission times are increased to approximately 500 days. Again the selected planet stay time is 40 days.
- 3) The Mars conjunction missions require relatively low energy but have durations up to 1000 days, with 500 days planet stay time.

The Venus orbit missions are divided into short- and long-stay classes. Short-stay-time missions assume 40 days at Venus and round-trip times of 460 to 550 days. The long-stay-time mission has the lowest energy requirement but requires stay times up to 450 days and round-trip times of 770 to 800 days. The selected missions cover a Venus synodic cycle which repeats approximately every 7 years.

The  $\Delta V$  requirements are shown in Figure 1.1-4 for each propulsion module and the total, illustrating the diverse requirements that must be accommodated. Earth entry velocities are all within the capability of the biconic entry vehicle shown in Figure 1.1-5, so there is no requirement for a deceleration stage. Also shown for reference is the present capability of an Apollo shape, together with the  $\Delta V$  retropropulsive requirements that would be required to make the Apollo entry vehicle adequate for all missions.

Velocities and trip times for the 20 representative missions are shown in Table 1.1-7.

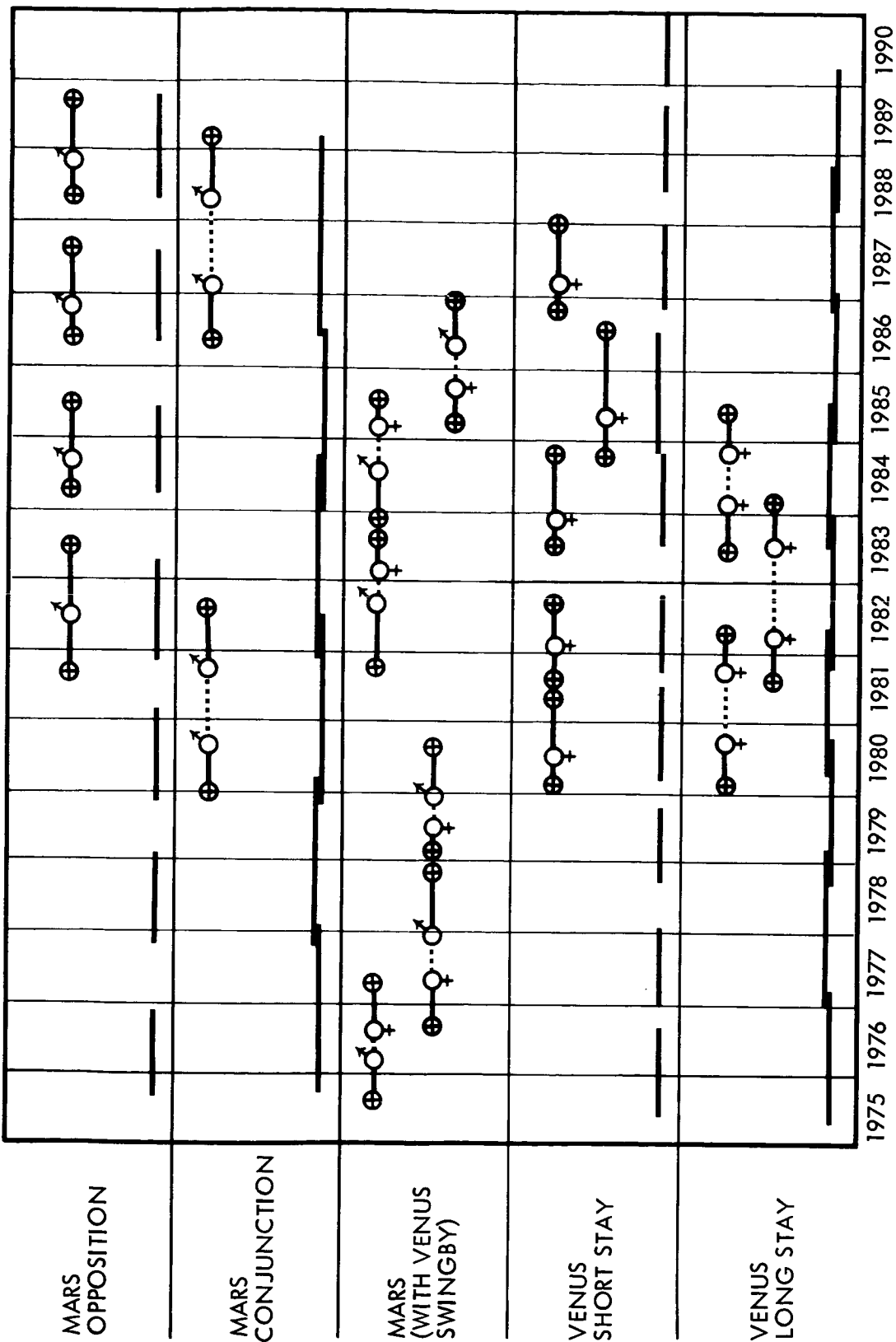

Figure 1.1-3: MISSION TRAJECTORIES

— Mission Opportunities  
 ⊕ Chosen Representative Missions

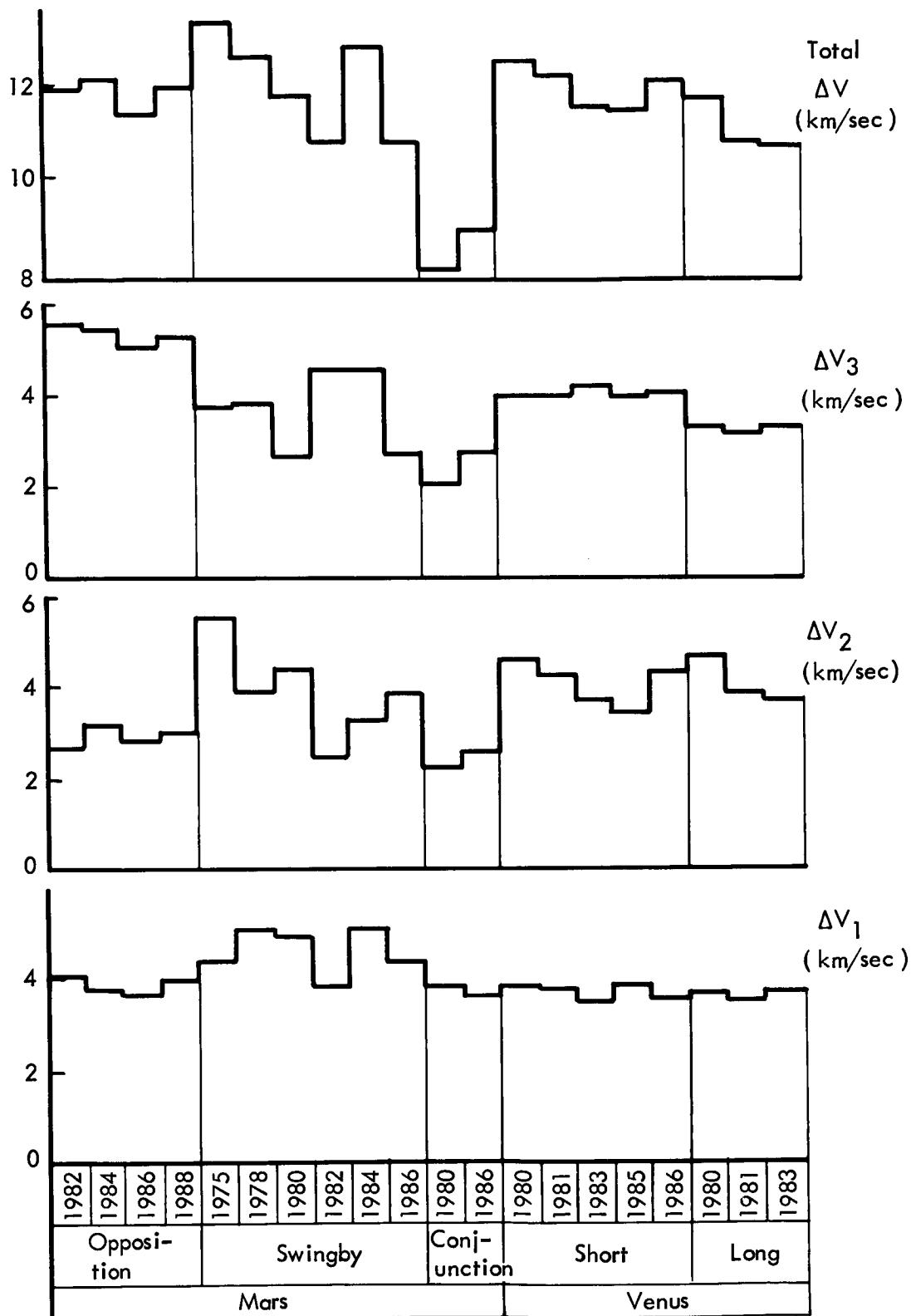

Figure 1.1-4: VELOCITY REQUIREMENTS

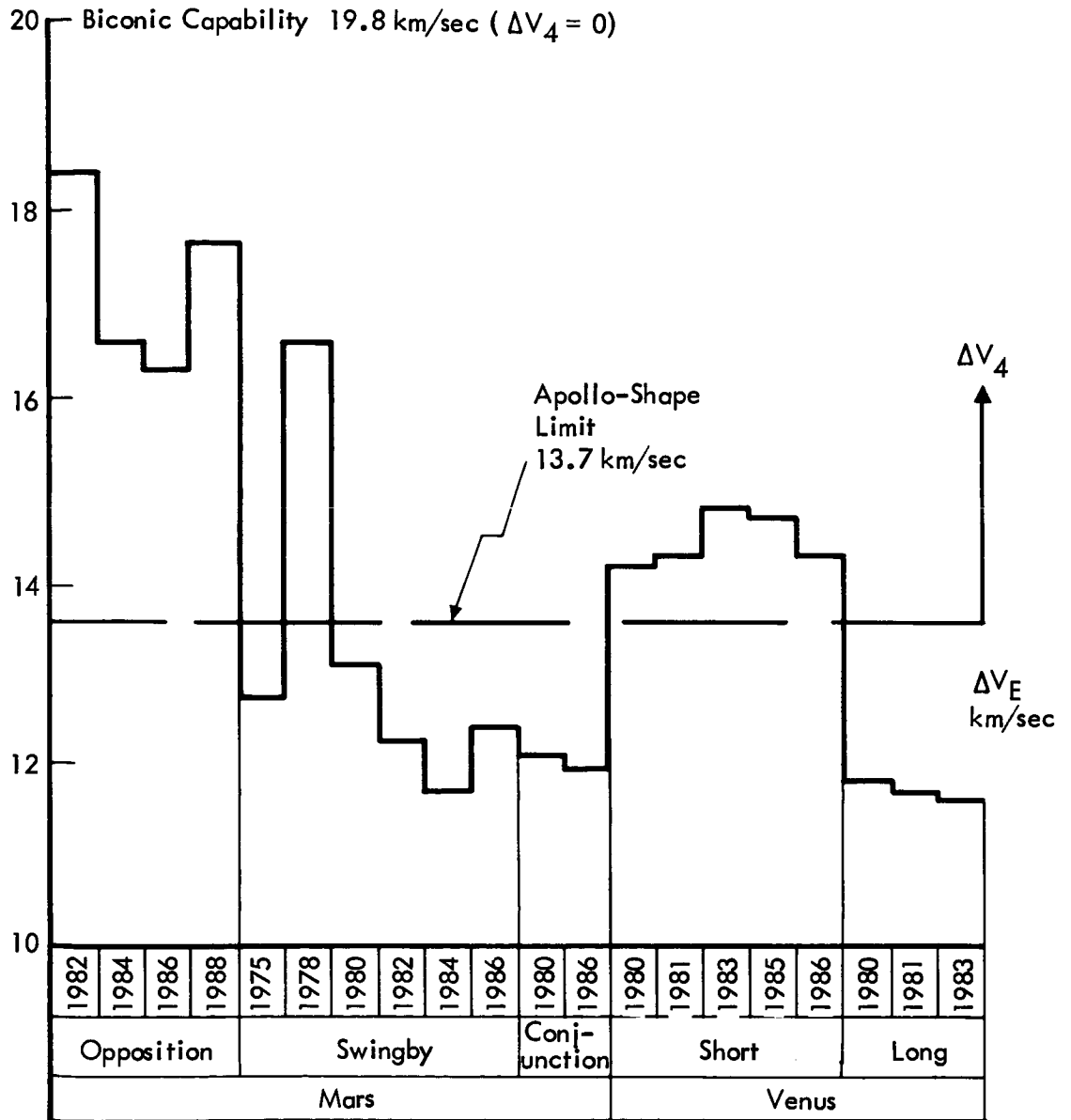

Figure 1.1-5: EARTH ENTRY VELOCITY



Table 1.1-7: MISSION REQUIREMENTS

Mission	$\Delta V_1^{**}$ (m/sec)	$\Delta V_2$ (m/sec)	$\Delta V_3$ (m/sec)	VE (m/sec)	Total $\Delta V$	Outbound Time (days)	Stay Time (days)	Inbound Time (days)	Total Trip (days)
Mars 1982 Opposition	3989	2568	5811	18,350	12,368	290	40	210	540
Mars 1984 Opposition	3685	3086	5352	16,580	12,123	190	40	230	460
Mars 1986 Opposition	3645	2832	4969	16,260	11,446	190	40	250	480
Mars 1988 Opposition	3947	2945	5142	17,620	12,034	170	40	250	460
Mars 1975 Swingby	4379	5312	3701	12,660	13,392	150	40	<del>190*</del> 180	560
Mars 1978 Swingby	5093	3800	3750	16,220	12,643	<del>235</del> 165	40	270	710
Mars 1980 Swingby	4900	4275	2504	13,020	11,679	<del>140*</del> 140	40	300	620
Mars 1982 Swingby	3798	2337	4550	12,160	10,685	260	40	<del>140</del> 160	600
Mars 1984 Swingby	5053	3232	4418	11,650	12,703	280	40	<del>160</del> 160	640
Mars 1986 Swingby	4316	3779	2633	12,380	10,728	<del>150</del> 200	40	200	590
Mars 1980 Conjunction	3869	2124	1926	12,020	7,919	290	370	340	1000
Mars 1986 Conjunction	3684	2470	2713	11,850	8,867	210	580	250	1040
Venus 1980 Short	3858	4538	4070	14,190	12,466	130	40	290	460
Venus 1981 Short	3849	4190	4072	14,280	12,111	120	40	300	460
Venus 1983 Short	3543	3606	4310	14,790	11,459	180	40	330	540
Venus 1985 Short	3900	3337	4089	14,700	11,326	190	40	320	550
Venus 1986 Short	3599	4214	4104	14,270	11,917	130	40	300	470
Venus 1980 Long	3661	4539	3400	11,750	11,600	190	430	180	800
Venus 1981 Long	3539	3788	3306	11,620	10,633	170	430	170	770
Venus 1983 Long	3622	3627	3317	11,610	10,560	190	470	120	780

\*Time to Swingby / Time to Mars or Earth

\*\*  $\Delta V_1$  includes an allowance for launch window

## 1.2 RECOMMENDED SYSTEM

In response to the study objectives, consideration was given to the entire interplanetary mission system and not just to the development of a conceptual design for the space vehicle. Figure 1.2-1 identifies the major elements of the overall interplanetary mission system. Each major element was analyzed to build up a total set of mission requirements. Design selections and procedure recommendations were then developed to satisfy these requirements with high probability of crew safety and mission success. Program plans, schedules, and cost estimates were prepared to show the development effort and resources needed to make the recommended system ready for actual missions.

The recommended manned interplanetary mission system achieves the high degree of flexibility desired for accomplishing missions to both Mars and Venus. The system is capable of performing 15 missions of the 20 opportunities evaluated in the study. The other five missions can also be performed by adding one or two propulsion modules to the recommended space vehicle. These missions cover the time span of both the Mars and Venus synodic cycles and include opposition, conjunction, and swingby missions to Mars, as well as short- and long-stay-time missions to Venus. Capabilities for such a wide range of performance provide the mission system with reasonable tolerance for those uncertainties which could otherwise become hazards to crew safety and mission success.

The following paragraphs provide a brief explanation of how the recommended system applies the integrated concept for manned interplanetary missions. The explanation first describes the integrated hardware concept, and then indicates how this hardware is used for an integrated approach to performing the missions and the experiments for which the missions are designed.

- 1) Mission systems include the space vehicle, Earth launch vehicle, orbital logistics vehicle, mission support system, experiments equipment, and launch and industrial facilities. These hardware systems are described in general terms here, with detailed descriptions in Volume IV of this report.
- 2) Mission operations include the mission operations program and the scientific program. These operations are described in general terms here, to show how the astronauts use the hardware systems to accomplish mission objectives. Detailed descriptions of mission operations are provided in Volume III of this report.

### 1.2.1 SPACE VEHICLE (S/V)

The recommended space vehicle consists of the spacecraft and the space acceleration system. The spacecraft includes a mission module (MM), a Mars excursion module (MEM), an Earth entry module (EEM), and a probe bay. The space acceleration system consists of propulsion modules (PM's): three PM-1 modules for injecting the space vehicle from Earth orbit into the interplanetary trajectory; a single PM-2 module for braking the vehicle into planet orbit; a single PM-3 module for injecting the vehicle into a trans-Earth trajectory; and smaller propulsion modules for mid-course correction and planet orbit trim. The recommended space vehicle, with and without its Earth launch vehicle (ELV), is illustrated in Figure 1.2-2.

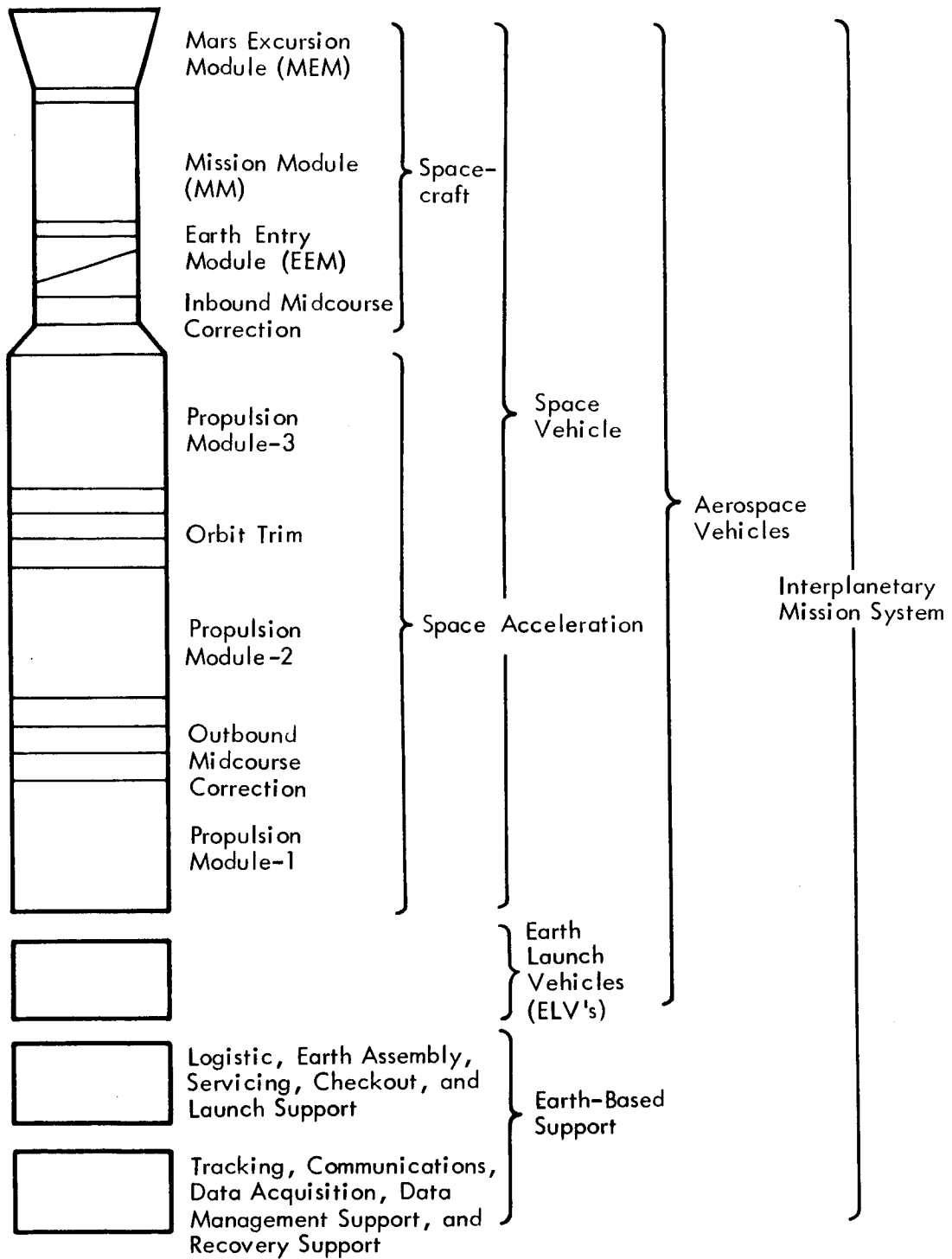

Figure 1.2-1: MISSION SYSTEM

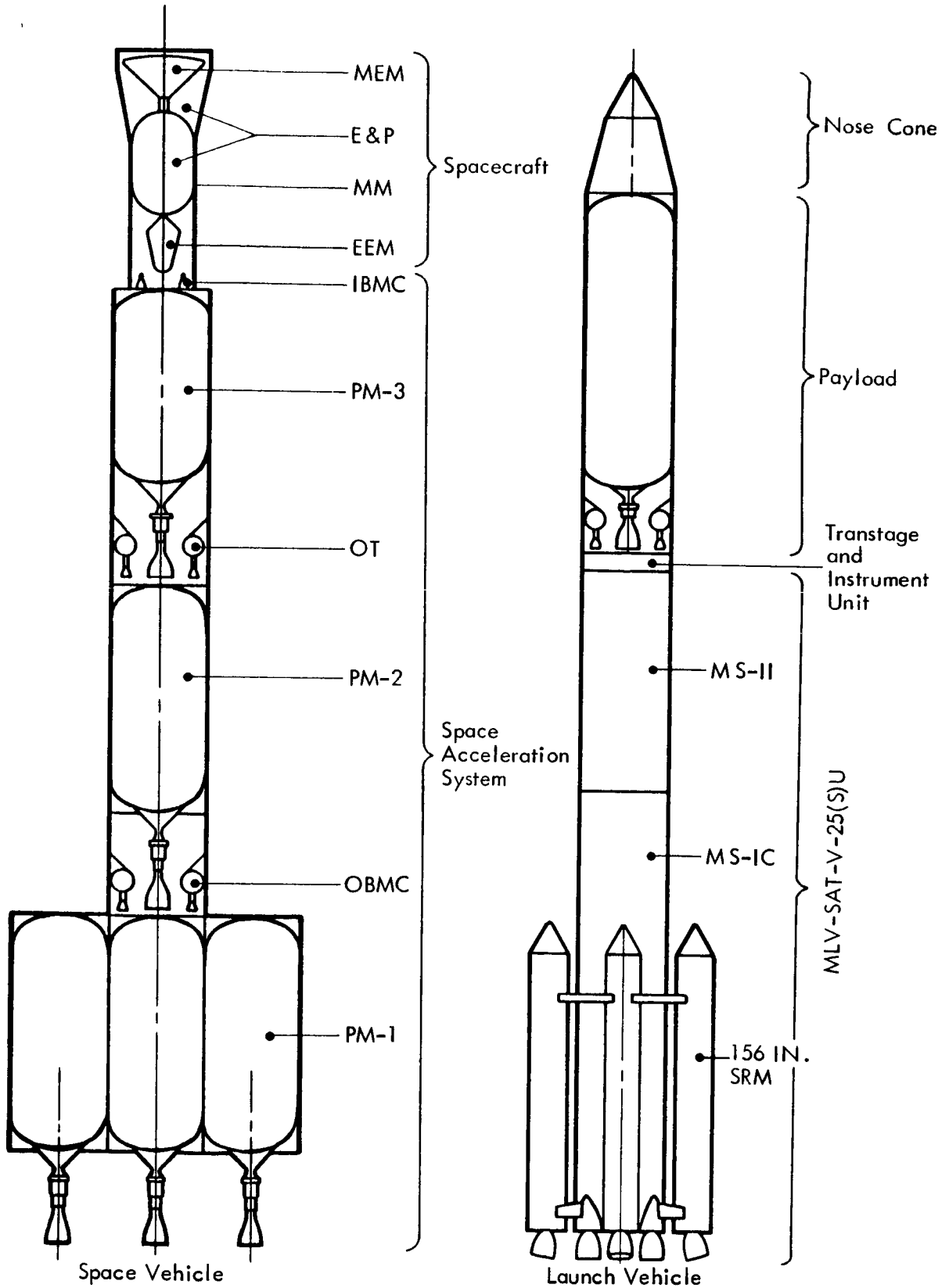

Figure 1.2-2: AEROSPACE VEHICLE

The design objective for the recommended space vehicle was to obtain a low-cost system which would provide maximum commonality within a particular space vehicle, as well as between space vehicles configured for other missions. This objective was attained. The propulsion modules are essentially identical, and permit a sufficient variety of configurations to satisfy the propulsion requirements for any of the desired missions. Table 1.2-1 summarizes the missions that can be performed with the recommended space acceleration train, which uses a 3-1-1 configuration of common propulsion modules (1 for the PM-1, 1 for the PM-2, 1 for the PM-3). This recommended 3-1-1 configuration can perform a majority of the missions, with considerable discretionary payload available for the missions requiring lower energy. The missions requiring higher energy can be accomplished by adding one or two of the common propulsion modules to the recommended configuration.

#### 1.2.1.1 Spacecraft (S/C)

The spacecraft is assembled on the ground, using a very similar configuration for all missions. The completed spacecraft is then launched as a unit, for orbital assembly with the rest of the space vehicle. Figure 1.2-3 is an inboard profile drawing of the spacecraft and illustrates the general arrangement of the spacecraft elements. The forward compartment is a probe bay in which the scientific and engineering probes are stored. These probes are all launched and the bay itself is jettisoned prior to the time the MEM makes its descent to Mars surface. The MEM is stored immediately aft of the probe compartment and is supported by the MEM interstage structure. The MEM interstage structure is jettisoned after the MEM is launched. The ascent module of the MEM is supported by the docking mechanism upon its return to the spacecraft. The MEM docking cone connects to a crew transfer airlock leading to the crew compartment of the mission module. The mission module is just aft of the MEM and consists of an aft interstage compartment, a crew compartment, and a forward interstage compartment. The forward and aft interstages contain most of the mission module and science equipment that does not require location within the pressurized crew compartment. In addition, the forward interstage (forward during launch configuration) compartment contains the EEM, the inbound midcourse correction propulsion system, and the docking mechanism that connects the spacecraft to the space acceleration system.

Mission Module (MM)--By examining mission modules tailored to the individual missions, it was determined that mass variations due to different requirements were reasonably small, except for expendables and spares. Consequently, the mission module is designed for the most stringent mission requirements, thus providing a common mission module for all missions. Provisions for accommodating incremental changes in expendables and spares are included in this design. The mission module contains all the subsystems necessary for life, command functions, experiments analysis, and information transfer during the course of the mission. The mission module serves as the living and operations center for the astronauts during the mission, as well as for assembly crew

Table 1.2-1: MISSION CAPABILITY

3-1-1 Common Propulsion Modules (3 for PM-1; 1 for PM-2; 1 for PM-3)

Launch Date	Destination	Mission Type	Duration (days)
Nov. 1978	Mars	Venus Swingby	680
Nov. 1979	Mars	Conjunction	900
March 1980	Venus	Short	460
Oct. 1981	Mars	Opposition	540
Oct. 1981	Venus	Short	460
Nov. 1981	Mars	Venus Swingby	600
May 1983	Venus	Short	540
Nov. 1983	Mars	Venus Swingby	540
Jan. 1984	Mars	Opposition	460
Nov. 1984	Venus	Short	550
Apr. 1985	Mars	Venus Swingby	590
March 1986	Mars	Opposition	480
Aug. 1986	Venus	Short	470
May 1988	Venus	Short	350
Jun. 1988	Mars	Opposition	460
July 1988	Mars	Venus Swingby	560
Oct. 1989	Mars	Venus Swingby	640
Dec. 1989	Venus	Short	350
Sept. 1991	Mars	Venus Swingby	600
Nov. 1994	Mars	Venus Swingby	560
Dec. 1996	Mars	Opposition	480
Jan. 1998	Mars	Venus Swingby	680

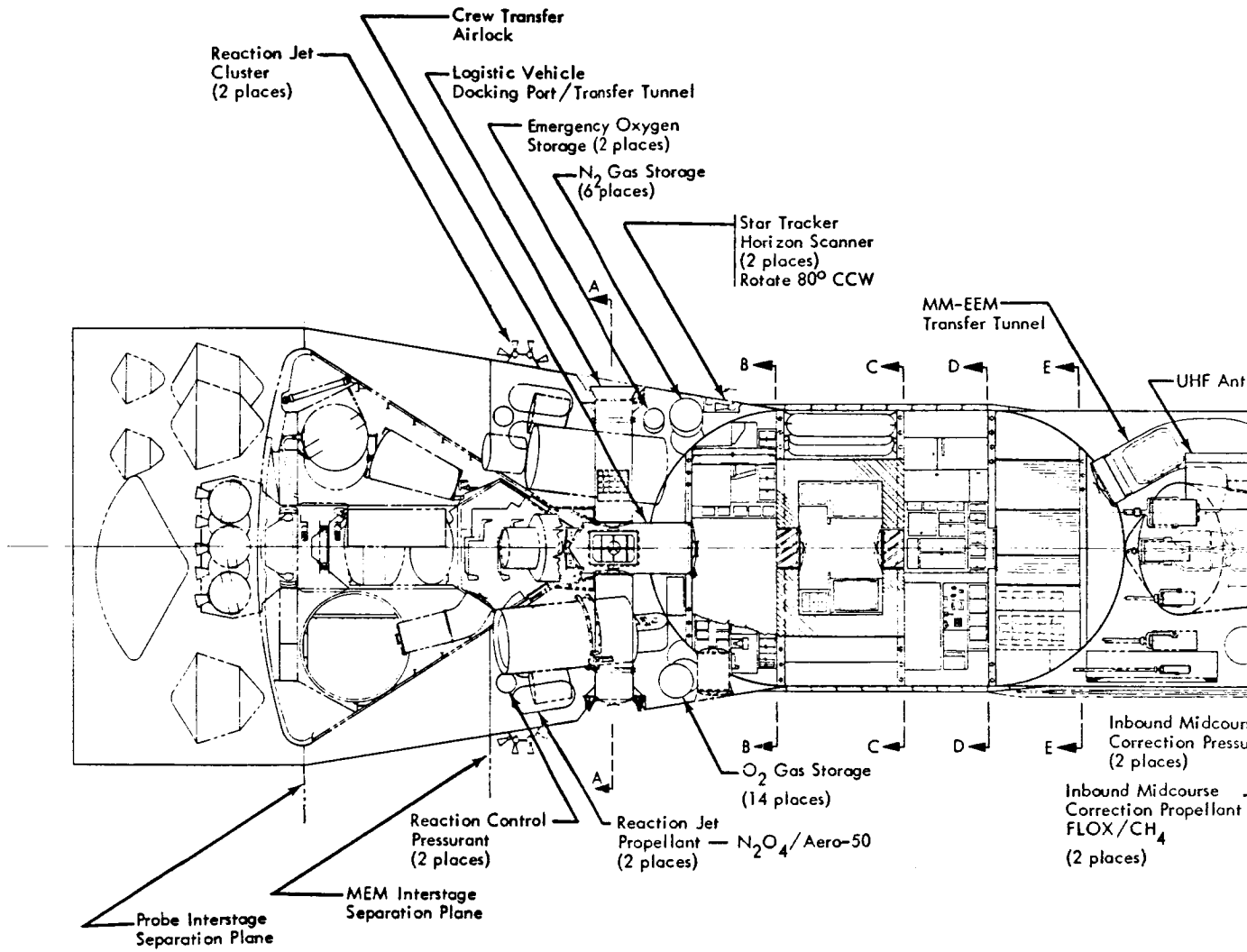

Fig. 1.2-3-A

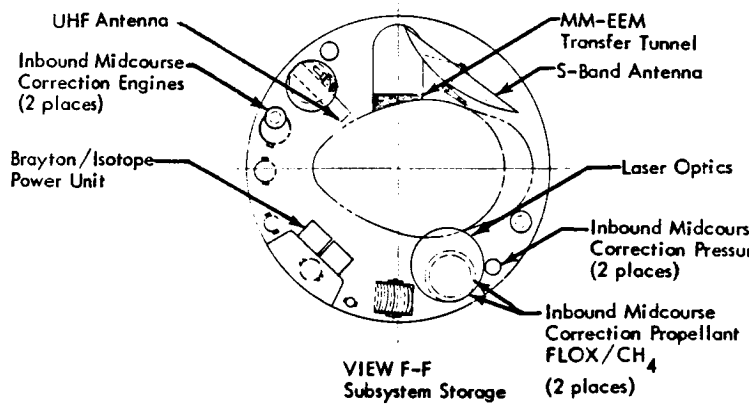
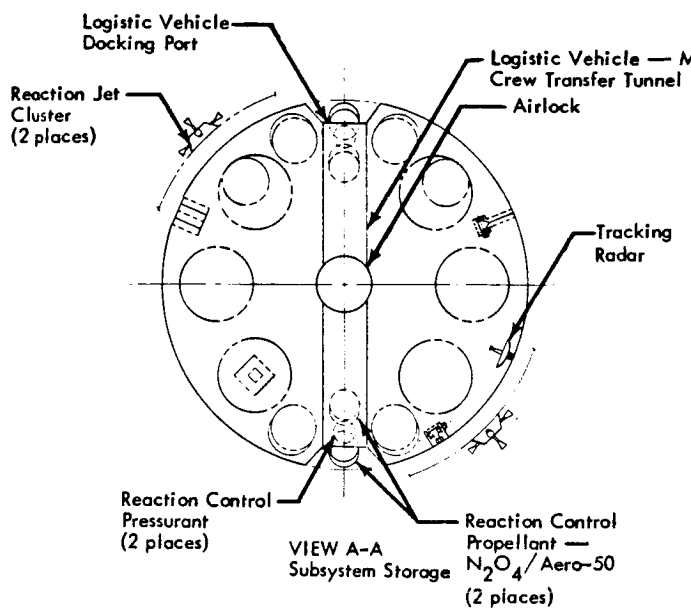
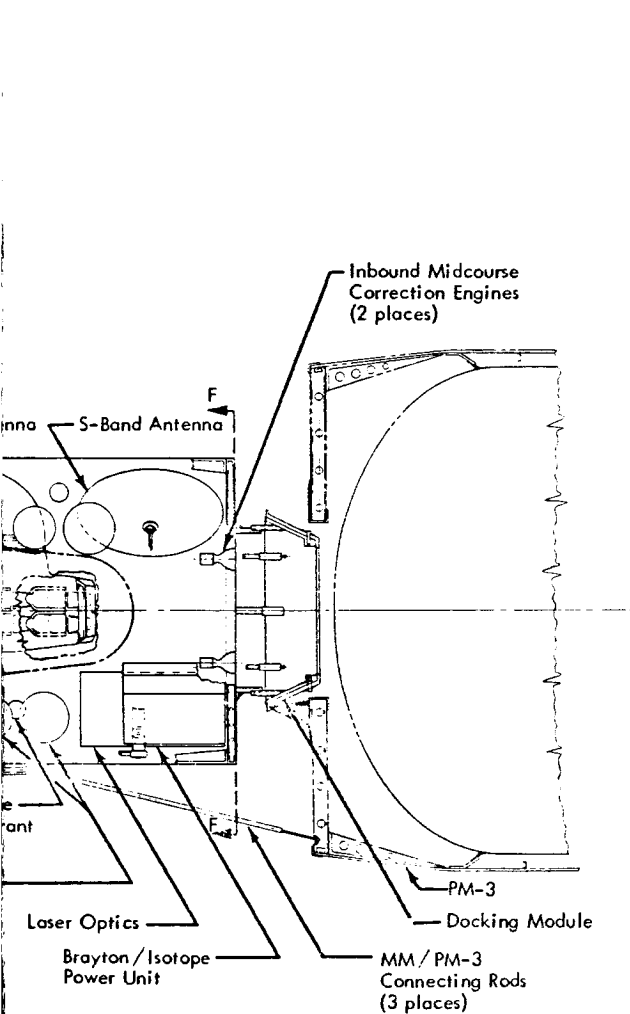
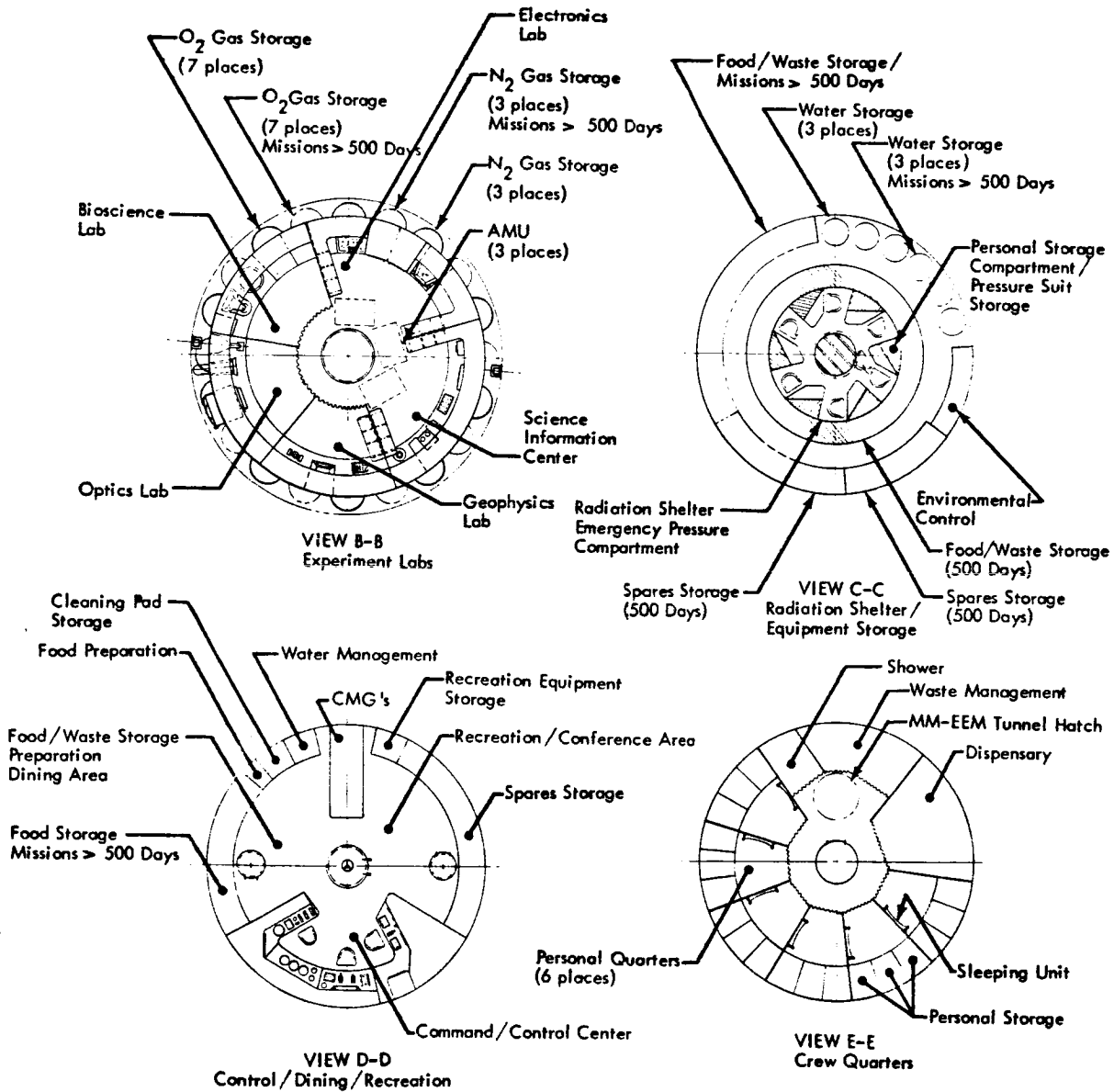

Fig. 1.2-3-B





Note: Reference line items are called out in Figure 4.2-32 of Volume IV Experiment Accommodations Inboard Profile

Figure 1.2-3: SPACECRAFT INBOARD PROFILE

while the space vehicle is being assembled, tested, and checked in Earth orbit. The separate mission module compartments are described below:

Crew Compartment--The crew compartment consists of a cylindrical pressure vessel with hemispherical heads and is divided into four decks. It provides a pressurized shirtsleeve environment for the six-man crew and contains equipment that is used either directly by the crew, or requires a pressurized environment, or is expected to require maintenance. Access from the crew compartment to the EEM is provided by airlocks and a transfer tunnel.

The first deck, located nearest the EEM and shown in plan view as View E-E of Figure 1.2-3, contains the crew's personal quarters, dispensary, zero-g shower, and waste management system. A pressure hatch located in the ceiling provides access to the EEM transfer tunnel.

The second deck, illustrated in View D-D of Figure 1.2-3, includes the control, dining, and recreational areas. The command and control center includes the displays and controls for all subsystems, environment parameters, and vehicle operations. The control center is occupied at all times. The dining area includes the food storage and preparation areas. The wash water/condensate water recovery unit of the waste management system is also located in this area. The recreation area is used for recreation and conferences, and contains a storage area for spares. Miscellaneous electronic equipment is located in a bay between the dining and recreation areas. The control moment gyros of the attitude control subsystem are also installed in this bay. A pressure hatch located in the floor leads to the radiation shelter in the third deck. Removable floor panels provide access to the equipment bays located in the third deck.

The third deck, illustrated in View C-C of Figure 1.2-3, contains the radiation shelter and mission module equipment. The radiation shelter consists of an inner compartment that is 10 feet in diameter and 7 feet high. In addition to providing quarters for the crew during periods of high radiation, the shelter serves as an emergency pressure compartment while repairs are made, should the remainder of the crew compartment become uninhabitable for short time periods. The radiation compartment would be occupied during nuclear propulsion system operation, while passing through the Van Allen belts, and during major solar flares. The bulk of the radiation shielding is provided by a 20-inch-thick combination food and waste storage compartment. Sufficient displays and controls are included in the radiation compartment for space vehicle operation. Also included is a 4-day emergency supply of food, water, and personal hygiene items. The shelter has a separate atmosphere supply with atmosphere control loops. The equipment bay consists of a peripheral compartment 2 feet thick. A concentric passageway between the equipment bay and the food storage compartment surrounding the radiation shelter provides access to both the equipment and food supplies. The majority of the environmental control equipment, including a Bosch CO<sub>2</sub> reduction system, is installed in this deck.

The fourth deck, illustrated in View B-B of Figure 1.2-3, contains the laboratory areas. These laboratories contain the equipment to perform some of the experiments, control the operation of all the experiments, and process and store all experimental data. The laboratory deck is divided into five specialized laboratories: optics, geophysics, electronics, bioscience, and the science information center. The optics laboratory includes a small airlock used to retrieve the mapping camera for servicing and maintenance. The laboratory area is connected to the radiation shelter by a pressure hatch in the ceiling. Another pressure hatch in the floor leads to the airlock used for crew transfer to the MEM or to logistics spacecraft, or for EVA operations. The automatic maneuvering units used for EVA operations are stored beneath the floor adjacent to the exit.

**Forward Interstage Compartment**--The forward interstage compartment, illustrated in View F-F of Figure 1.2-3, is an unpressurized area that contains the EEM, the inbound midcourse correction propulsion system, some of the experiment sensors, and mission module equipment. A hatch is installed in the MM-to-EEM transfer tunnel to provide access to equipment installed in the forward interstage compartment. Some of the major equipment included are a 10-foot-diameter S-band antenna, a 5 x 5 x 12 foot (deployed) end fire UHF antenna, a 40-to-60-inch-diameter x 10-foot telescope for the laser communication subsystem, a radioisotope-Brayton cycle electrical power unit (15 kw maximum power), two 3,000-pound-thrust inbound midcourse correction engines and propellant tanks, and part of the experiment sensors.

**Aft Interstage Compartment**--The aft interstage compartment, illustrated in View A-A of Figure 1.2-3, is an unpressurized area containing a portion of the MEM, an airlock system, and a portion of the mission module and experiment equipment. The crew compartment-to-MEM transfer tunnel contains a hatch to provide access to equipment installed in the aft interstage compartment. Also, there are two tunnels extending from the MEM transfer tunnel to allow pressurized transfer from logistic vehicles. These tunnels are also used as EVA exits. The oxygen and nitrogen tanks for the environmental control system, which supplies a 7-psia atmosphere to the crew compartment, are stored in this compartment. Two clusters of reaction jets for spacecraft attitude and translation control are located in the aft portion of the interstage compartment. Each cluster is provided with separate N<sub>2</sub>O<sub>4</sub>/Aero-50 propellant tanks. Mission module equipment installed in this compartment includes on-board navigation equipment such as star trackers, horizon scanners, and a radar altimeter/tracker. Installed experiment equipment includes the photographic system and other sensors.

**Mars Excursion Module (MEM)**--The MEM is the space vehicle element that transports the surface exploration crew and equipment from the space vehicle in Mars orbit to the Mars surface, provides living quarters and a laboratory while on the surface, and transports the crew, scientific data, and samples back to the orbiting space vehicle. The MEM is not returned to Earth and is left in Mars orbit. An Apollo-type MEM with a lift-to-drag ratio of 0.5 was selected as the recommended Mars excursion module. The MEM design was adapted from work performed by North Ameri-

can Aviation, Inc., under NASA Contract NAS9-6464.\* The selected Apollo-type MEM consists of an ascent and a descent module. The MEM inboard profile is illustrated in Figure 1.2-3, while Figure 1.2-4 shows the MEM configuration during the various mission phases.

The ascent module houses the three-man crew during entry, descent, landing, and ascent. The ascent module consists of the control center, ascent engine, and propellant tanks. A portion of the ascent propellant tankage can be jettisoned to increase ascent performance. The crew couches are arranged in two tiers as shown. During deorbit and entry, all three crewmen are seated, with front-view instrument and control panels provided for the top crewman, and side-view panels available for the men below. After peak descent-velocity reduction, the two lower crewmen take standing positions and pilot the MEM to a landing, using instrument consoles located below the two windows. A docking drogue and hatch, which also gives access to the MEM in the spacecraft during the trans-Mars phase, is at the top of the MEM. The first-stage ascent propellant is stored in eight conical tanks (five for oxidizer and three for fuel) outside the thrust structure. The second-stage ascent propellant is stored in two tanks between the engines and the ascent capsule control center. The crew has access to the unpressurized space between the outside structure of the descent capsule and the cylindrical thrust structure for inspection and maintenance.

The descent stage contains the crew living quarters and laboratory for use while on Mars, the descent engine and propellant tanks, ballutes, landing gear, supporting structure, an outer heat shield/structure, and the various subsystems. The crew quarters and laboratory are formed from a segment of the toroidal lower part of the vehicle and are connected to the control center of the ascent module by airlocks and tunnel. Seven deorbit motors are arranged in a circle outside the heat shield. The descent propellants are housed in three spherical tanks. The descent and ascent engines are both pump-fed, gimbaled, plug-nozzle engines and operate at a chamber pressure of 1000 psi. FLOX-methane propellants are used.

Mars surface operations include experiments and investigations directed toward increasing knowledge of Mars planetology, its composition, environment, and possible life forms, as well as effects of modifying forces on Mars. The return payload, consisting mainly of samples and data, will weigh approximately 900 pounds. After a stay of about 30 days on the planet, an ascent and rendezvous is made with the orbiting space vehicle. The requirements placed on the MEM are primarily functions of the experiments program and, therefore, the one design has been utilized for all missions involving manned landings on a planet.

---

\*NAA Document SD-67-755, *Definition of Experimental Tests for a Manned Mars Excursion Module*, NASA Contract NAS9-6464, North American Aviation, Inc., August 1967

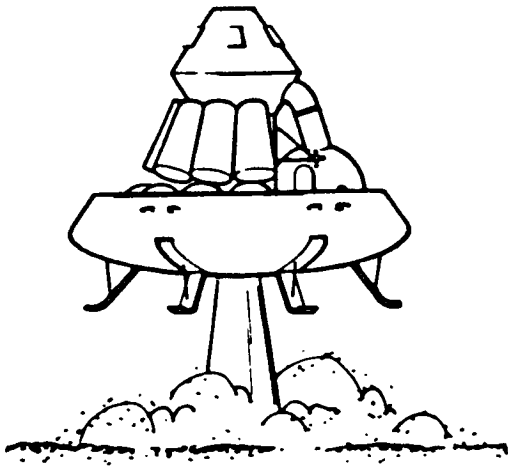

Descent

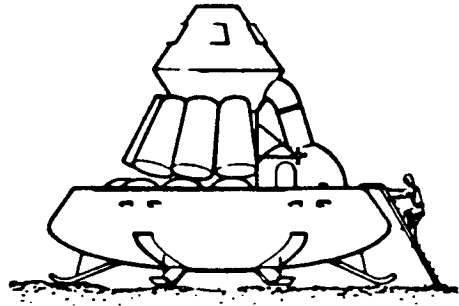

Landed

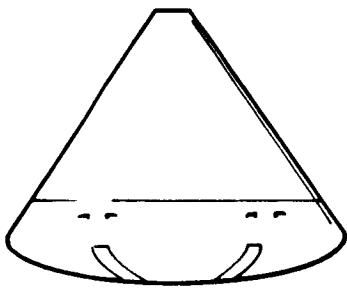

Entry

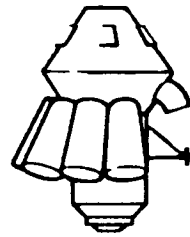

Stage I Ascent

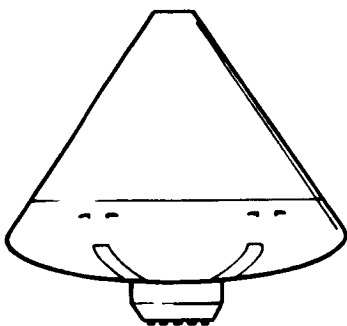

Deorbit

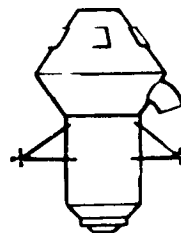

Stage II Ascent

Figure 1.2-4: MEM - MISSION PHASE CONFIGURATIONS

Earth Entry Module (EEM)--A blunted biconic EEM was selected as the recommended Earth entry module. The biconic EEM design was adapted from the work performed by Lockheed Missile and Space Company under NASA Contract NAS2-2526\*. The EEM is designed for a crew of six and for a 1-day occupancy time. The EEM requires no retropropulsion over the entry speed range (up to 65,000 fps) of the 20 missions evaluated.

The EEM is the only part of the interplanetary space vehicle that completes the entire round trip. It performs the vital function of transporting the mission crew and the science data and samples from the mission module on the return hyperbolic trajectory to a safe landing on the Earth's surface.

The biconic EEM configuration is illustrated in Figure 1.2-5, which also shows the general arrangement of the subsystems. The crew is arranged in three rows with two crewmen in each row. The crew volume allowance is 40 cu ft/man. The elliptical cross section of the EEM afterbody, in which practically all the internal subsystems are packaged, dictates the arrangement of most of the large components. These are placed above the heads and below the feet of the crewmen to allow the seats to fill the center portion of the vehicle.

The main access hatch is located on the side of the EEM, with ready access to the seats. This leaves the entire region above the crew's heads available for heavy items. The center-of-mass location and static stability margin constraints on this vehicle dictate that the heavy items such as propellants, life support, etc., all be located above the crew's heads and as far forward as possible. The only exceptions to this requirement are the fuel cells which are too large to be located in the forward portion, the flotation bags which must be placed near their point of deployment, the descent parachutes which must be deployed from the aft end of the vehicle, the display panels which must be placed near the pilot, and part of the science payload in the front part of the vehicle. The EEM is designed for the maximum entry velocity encountered in any of the 20 missions evaluated, and is a completely common vehicle for all missions.

---

\*LMSC Document 4-05-65-12, *Study of Manned Vehicles for Entering the Earth's Atmosphere at Hyperbolic Speed*, NASA Contract NAS2-2526, Lockheed Missile and Space Co., November 1965.

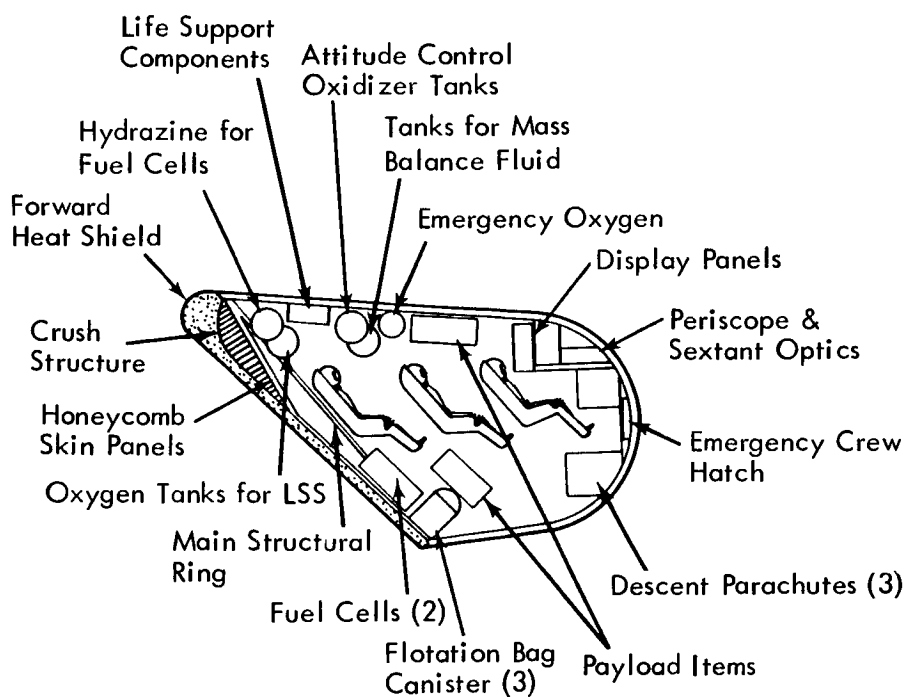

Estimated Weights

Crew and Seats	1,362 pounds
Controls	270
Guidance and Navigation	300
Communications	185
Science	912
Life Support	732
Electrical Power	659
Attitude Control	1,120
Recovery	870
Heat Shield	4,340
Structure	4,160
Growth & Contingency (15%)	2,240
<b>Total</b>	<b>17,150 pounds</b> <b>(7,779 kg)</b>

Figure 1.2-5: BICONIC EEM CONFIGURATION  
SIX-MAN CREW

### 1.2.1.2 Propulsion Modules (PM's)

The recommended space vehicle utilizes all-nuclear propulsion for the major velocity changes. Commonality between the PM-1, PM-2, and PM-3 stages in each configuration and for all missions was obtained by adopting only one size of engine and tank. A common propulsion module concept by itself results in an inefficient space vehicle if the same number of modules are used for a broad range of missions (common space vehicle concept). The inefficiency results because of the wide range of energy requirements. Also, unless a large number of relatively small tanks are used, the PM-2 and PM-3 tanks are likely to be wastefully oversized. However, large numbers of relatively small tanks result in both structural and thermal protection weight penalties because of added tank, meteoroid, and cluster structure weight, and added thermal protection weight due to increased surface area and lower heat sink capability of smaller volumes of LH<sub>2</sub>.

The fuel transfer capability between the primary (nuclear) propulsion modules of the recommended space vehicle is the key concept that permits efficient use of common size modules. The fuel transfer concept permits universal use of a common propulsion module, while permitting efficient use of the individual propulsion modules to meet their unique mission energy requirements. Because of the different payloads, as well as velocity change ( $\Delta V$ ) requirements for each propulsion phase (Earth departure, planet capture, and planet departure), the PM-2 propellant requirements are considerably less than PM-1, and the PM-3 requirements are much less than PM-2. By transferring propellant from PM-2 to PM-1 and from PM-3 to PM-2, efficient use is made of the total tankage, which in turn allows the design of an efficient space vehicle that is common for a wide variety of missions. The propellant transfer concept is shown diagrammatically on Figure 1.2-6.

The Nerva engine produces 195,000 pounds (88,700 kg) of thrust. The tank is 33 feet in diameter and 115 feet long, with a propellant capacity of 385,000 pounds (175,000 kg). The forward and aft interstages and the mechanical and electrical equipment are the same for all nuclear propulsion modules. The meteoroid shield (designed by Earth launch loads) is also the same except for the PM-3 for Mars conjunction missions. (If the "common" meteoroid shield was used on PM-3 for the Mars conjunction mission, the probability of no meteoroid penetration would drop to 0.9962, which is slightly below the design requirement of 0.9970.) The insulation covering PM-1 and PM-2 modules is, for all practical purposes, the same. The PM-3 insulation is nearly the same except for the Venus long and Mars conjunction missions. Accordingly, near identity has been achieved efficiently for a single common nuclear propulsion module, applicable to all mission propulsion phases and to all missions.

Secondary propulsion for the outbound midcourse correction module, the orbit trim module, and the inbound midcourse correction module is provided by three chemical systems based on a single concept, but tailored to individual mission and space vehicle requirements.



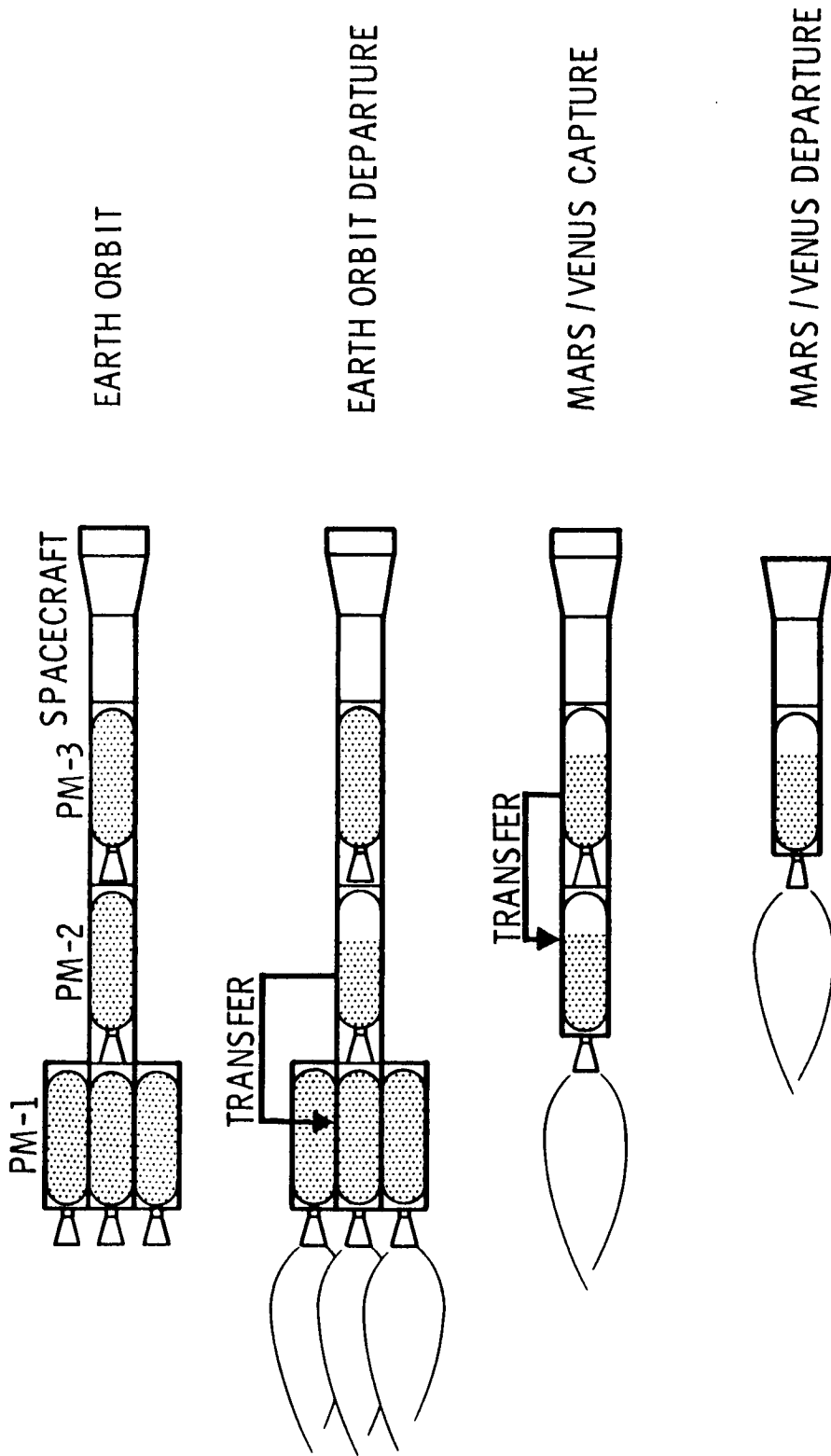

Figure 1.2-6: COMMON MODULE PROPELLANT TRANSFER OPERATIONS

## 1.2.1.3 Space Vehicle Weight Statement Summary

A summary weight statement for the recommended space vehicle, as loaded to accomplish a 1984 Mars opposition mission, is shown in Table 1.2-2. Since the propulsion modules will be launched fully loaded at no increase in the required number of Earth launches, an additional discretionary payload of approximately 84,000 pounds can be injected into Mars orbit for this mission.

Table 1.2-2: WEIGHT STATEMENT FOR 1984 MARS OPPOSITION SPACE VEHICLE  
(in pounds)

Earth Entry Module		17,400
Crew and Seats	1,360	
Controls	270	
Guidance and Navigation	300	
Communications	190	
Science	910	
Life Support	730	
Electrical Power	660	
Attitude Control	1,140	
Recovery	880	
Heat Shield	4,530	
Structure	4,160	
Growth and Contingency (15%)	2,270	
Mission Module		82,900
Structure	15,420	
ECS/Life Support	5,520	
Crew Support	1,920	
Communications and Data Handling	1,370	
Attitude Control	1,400	
Guidance and Navigation	140	
Displays and Controls	490	
Electrical Power	10,170	
Experiment Equipment	10,860	
Expendables	18,060	
Redundancy	4,580	
Growth and Contingency (25%)	12,970	
Mission Module Interstages		10,700
Outer Shell	7,930	
End Closures and Doors	520	
EEM Support and Separation	1,740	
Growth and Contingency (30%)	510	
Mars Excursion Module		95,290
Ascent Capsule	5,590	
Ascent Stage II Propulsion	6,860	
Ascent Stage I Propulsion	13,450	
Descent Stage	43,200	
Deorbit Motor	4,200	
Growth and Contingency (30%)	21,990	

Table 1.2-2: WEIGHT STATEMENT FOR 1984 MARS OPPOSITION SPACE VEHICLE  
(in pounds) (Continued)

Probes		24,480
Hard Lander	1,220	
Occultation Detector-Orbiter	150	
Topside Sounder Orbiter	230	
Magnetometer Orbiter	150	
Mars Moon Hard Landers	8,750	
Soft Lander	4,940	
Mapping Radar Orbiter	1,050	
Probes Support and Separation	1,650	
Growth and Contingency (35%)	6,340	
MEM and Probes Interstages		10,300
Outer Shell	6,950	
MEM Support and Separation	2,860	
Growth and Contingency (5%)	490	
Inbound Midcourse Propulsion		4,020
Inerts	530	
Propellant	3,430	
Growth and Contingency (11%)	60	
Propulsion Module 3		383,770
Inerts	142,950	
Propellant	225,100	
Growth and Contingency (11%)	15,720	
Orbit Trim Propulsion		17,020
Inerts	1,120	
Propellant	15,780	
Growth and Contingency (11%)	120	
Propulsion Module 2		535,900
Inerts	141,650	
Propellant	378,670	
Growth and Contingency (11%)	15,580	
Outbound Midcourse Propulsion		31,640
Inerts	1,790	
Propellant	29,660	
Growth and Contingency (11%)	190	
Propulsion Module 1		1,511,090
Inerts	425,460	
Propellant	1,038,830	
Growth and Contingency (11%)	46,800	
Initial Mass in Earth Orbit (lb)		2,724,510
(kg)		(1,235,840)

### 1.2.2 EARTH LAUNCH VEHICLE (ELV)

The recommended Earth launch vehicle is an improved and uprated Saturn V (MLV-SAT-V-25(S)U), growing out of the findings from NAS8-20266\*. It consists of two stages. The first stage is a Saturn MS-IC, 40 feet longer than a standard S-IC, that uses five uprated F-1 engines (1.8 million pounds thrust per engine) and four solid rocket motors (four-segment 156-inch diameter). The second stage is a standard-length Saturn MS-II with five uprated J25 engines. This configuration can place a payload of 548,400 pounds (248,000 kg) into an elliptical Earth orbit of 100 x 262 nautical miles. A chemical transtage (LO<sub>2</sub>/LH<sub>2</sub>) then provides the final thrust (475 fps) to convert the elliptical orbit into a 262-nautical-mile circular orbit, and to accomplish rendezvous and docking maneuvers with the payload.

The recommended Saturn V-25(S)U satisfies the Earth launch requirements for all 20 missions evaluated in this study. In addition, of all the Earth launch vehicles evaluated, development of the Saturn V-25(S)U--and its readiness for launching in the quantities needed--will have the least disruptive impact on current and planned production, logistics, testing, and KSC launch facilities.

### 1.2.3 ORBITAL LOGISTICS VEHICLE (OLV)

Orbital logistics vehicles are spacecraft that have been manrated for safe transport of assembly crews and astronauts to and from Earth orbit. (The size and weight of the total space vehicle is beyond present Earth launch capacities, and therefore it is subdivided into six or seven primary modules, which are launched separately and assembled into the total space vehicle while in Earth orbit.)

The IMISCD study assumed the availability of a six-man modified Apollo logistics spacecraft that would be boosted into the assembly orbit by a Saturn IB launch vehicle. The logistics vehicle is used to transport the assembly and test crew to the assembly orbit. This crew will live in the spacecraft's mission module during the orbital assembly of the space vehicle. Every 45 days another logistics vehicle will bring up supplies, components, and equipment for special assembly needs, and will also rotate the assembly crew. At the completion of the space vehicle assembly and checkout, the mission astronauts will be transported to the space vehicle and the assembly crew will be returned to Earth in the orbital logistics vehicle.

---

\* Boeing Document D5-13183-1, *Vehicle Description of MLV-SAT-V-INT 20, 21*, The Boeing Company, October 1966.

Boeing Document D5-13183-3, *Vehicle Description of MLV-SAT-V-25(S)*, The Boeing Company, October 1966.

Boeing Document D5-13183-4, *Vehicle Description of MLV-SAT-V-4(S)B*, The Boeing Company, October 1966.

Boeing Document D5-13183-5, *Vehicle Description of MLV-SAT-V-23(L)*, The Boeing Company, October 1966.

#### 1.2.4 MISSION SUPPORT SYSTEM (MSS)

The mission support system is composed primarily of Earth-based communication, tracking, and navigation equipment. Included are near-Earth equipment to facilitate rendezvous, docking, assembly, orbital launch, and recovery at mission completion; the deep space network for interplanetary navigation support and communications; and a laser communication ground receiving network. This study assumed that a suitable mission support system would be available, but did include the proportionate share of mission support system costs chargeable to the manned interplanetary missions.

#### 1.2.5 EXPERIMENTS EQUIPMENT

Experiments hardware includes the experiment laboratories, spacecraft scientific instruments, surface exploration instruments, and the probes (including propulsion for the probes). The weight of this hardware, and its placement for most effective use in support of the recommended scientific program, strongly affected the internal configuration of the spacecraft modules. Items of experiment hardware are identified in detail in Volume III, Part 2 of this report.

#### 1.2.6 FACILITIES SUMMARY

##### 1.2.6.1 Launch Facilities

Existing, modified, and new facilities at Launch Complex 39 and the industrial area at the Kennedy Space Center will be used for the assembly, checkout, and launch of the Saturn V-25(S)U Earth launch vehicle (ELV) and the various payloads required for qualification testing and planetary missions for the manned planetary program. These requirements are summarized in Figure 1.2-7. Expansion and modification of the existing facilities will be required:

- 1) To accommodate the increased length of the first stage of the ELV core,
- 2) To install the strapon solid rocket motors (SRM's),
- 3) To achieve the high launch rate required to support the mission.

Recommended program requirements create the need for the following major launch facilities:

- 1) Four high-bay assembly positions in the vehicle assembly building (VAB);
- 2) Six firing rooms in the launch control center;
- 3) Three modified and four new mobile launchers;
- 4) Two modified and one new launch pads, including increased propellant storage;
- 5) Two modified and one new mobile service structures;

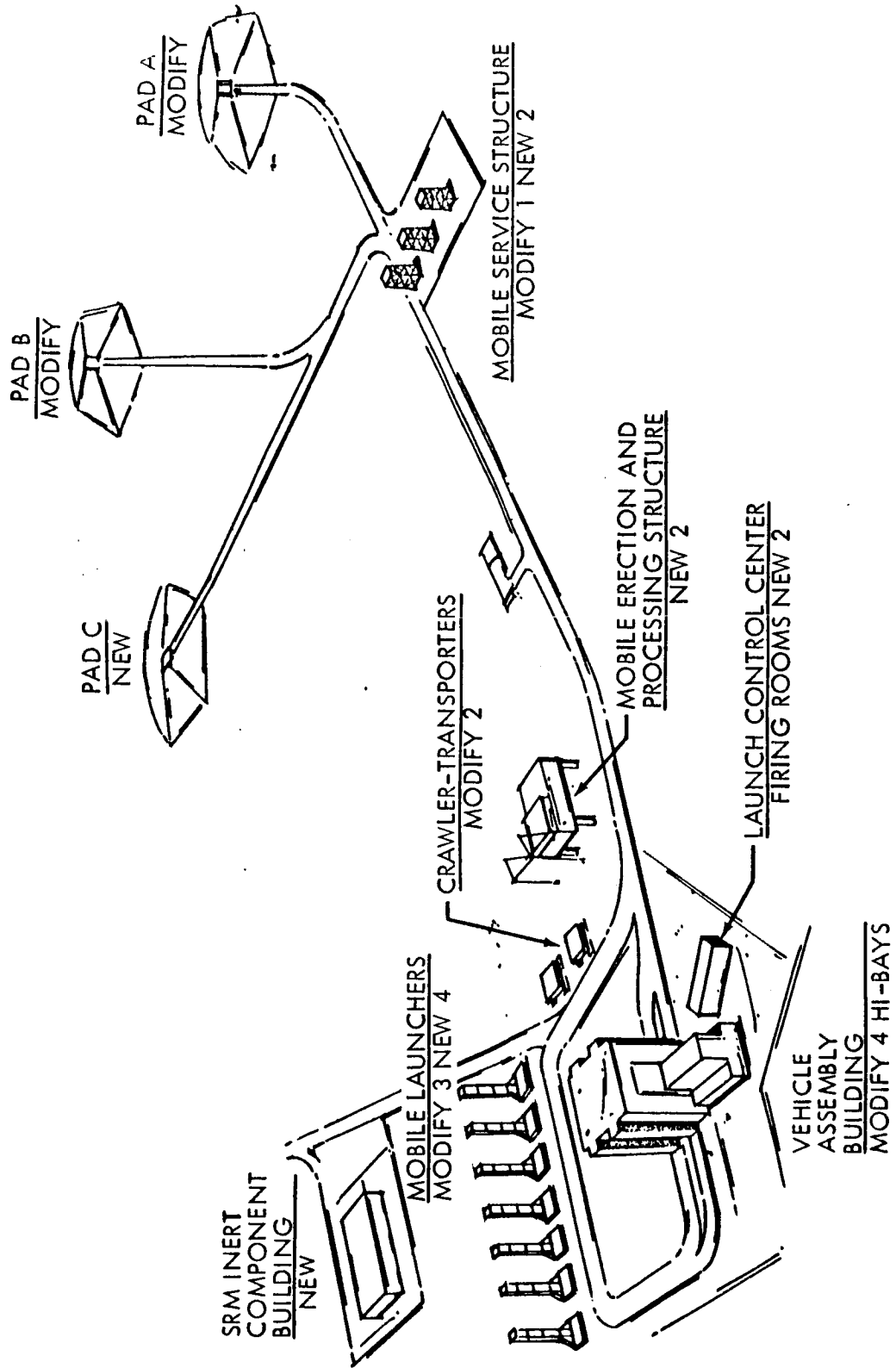

Figure 1.2-7: KSC AND INDUSTRIAL FACILITIES

- 6) Facilities for handling the solid rocket motors, including two new mobile erection and processing structures (MEPS);
- 7) Two modified crawler-transporters to carry the increased weight of the Earth launch vehicle/payload and the mobile launcher;
- 8) A new facility for prelaunch assembly and checkout of the spacecraft.

#### 1.2.6.2 Industrial Facilities

The increased length of the first stage and the structures required to accommodate the completed solid rocket motors will require new and modified facilities to support the manufacture, assembly, and test of the ELV core. These facilities will be provided by:

- 1) Expansion and modification of the manufacturing and test facilities at Michoud,
- 2) Construction of a new dynamic test stand at MSFC,
- 3) Modification of the S-IC static firing stand at MTF.

Facilities for the development and production of the nuclear engines and the solid rockets are assumed to be provided separate from the manned planetary program and therefore have not been treated in this study.

#### 1.2.6.3 Facilities Costs

A cost estimate summary for the major facilities is tabulated in Volume V.

#### 1.2.6.4 Additional Study Considerations

Facility requirements not yet completely defined, but which have a significant effect on the manned planetary program, are identified below for future study:

- 1) Hurricane protection at the launch pad,
- 2) Blast effects from catastrophic failure of the vehicle at the launch pad,
- 3) Manufacture, storage, and handling of subcooled and slush LH<sub>2</sub>.

#### 1.2.7 MISSION OPERATIONS PROGRAM

The major elements of the space vehicle are assembled in space, while in a circular orbit 262 nautical miles away from the Earth's surface.

The complete spacecraft, which includes the mission module and interstage structure (MM), the Mars excursion module (MEM), the Earth entry module (EEM), and the scientific probes, is the first major element to be launched. The spacecraft becomes the control center and living quarters for personnel during the 150-day orbital assembly and checkout of the space vehicle.

The assembly test and checkout (ATC) crew is then launched from Earth in a logistic aerospace vehicle that has been qualified as safe for manned flight (manrated). The logistic vehicle completes rendezvous and docking maneuvers and the crew transfers to the spacecraft, activates it, and prepares to receive the remaining elements of the space vehicle.

The propulsion modules (PM-3, PM-2, PM-1) are launched in series for rendezvous and docking with the space vehicle elements that have already been assembled. Test and checkout of each module is accomplished as the assembly proceeds.

The orbital assembly operation is completed with Earth launch of the interplanetary mission crew in a manrated logistic vehicle, resupply of the mission module, final checkout of the space vehicle, and return to Earth of all orbital support equipment and the ATC crew.

A variety of Earth launch vehicles (ELV's) are used to achieve orbital assembly, test, and checkout: the spacecraft is launched by an uprated core of the Saturn V-25(S)U; each logistic vehicle is launched by a Saturn IB; the PM-3, PM-2, and the propulsion modules making up the PM-1 each require separate launch by a Saturn V-25(S)U. A representative Mars landing mission requires a total of 10 Earth launches--six for the space vehicle and four for logistic vehicles.

Typical events which occur during the course of a Mars landing mission, after completion of orbital assembly test and checkout, are shown in Figure 1.2-8. A swingby mission would also include the events required for deploying unmanned probes at Venus and using its gravitational field for accelerating the Mars trajectory. Operations during a Venus orbiting mission would be similar to Figure 1.2-8, excluding the Mars landing events.

Final mission countdown, accomplished by the mission crew, includes separation and disposition of the PM-1 meteoroid shield and aft interstages, low power operation of the PM-1 Nerva engines, and final system check. Full power firing of the nuclear PM-1 engines injects the space vehicle into the transfer trajectory, out of Earth orbit and into the interplanetary coast. The spent PM-1 modules are propulsively separated from the space vehicle so that (1) their trajectory does not impact the planets; and (2) their separation distance is great enough to ensure safety of the crew from shutdown radiation.

Three midcourse corrections are scheduled for the outbound trip, using the chemical propulsion system (OBMC) provided for such corrections. The first correction is made 5 days after launch from assembly orbit, the second about 20 days later, and the third about 20 days prior to arrival at the selected planet. During coast periods, space vehicle operations are monitored, scheduled and unscheduled maintenance is performed, and interplanetary experiments are conducted.





For those missions in which a Venus swingby occurs on the outbound trip, probes are launched prior to the planet encounter. Data from the probes are recorded and monitored during the swingby and as long thereafter as communications can be maintained. Additional midcourse corrections and/or powered swingby maneuvers may be required for such missions.

Approach to the selected planet is accompanied by separation and disposal of the PM-2 meteoroid shield, aft interstage, and outbound midcourse correction system. The nuclear PM-2 is then fired, retro-propulsively reducing the velocity of the space vehicle to permit injection into a high orbit capture of the planet. The spent PM-2 stage is separated and abandoned in this higher initial orbit, and the space vehicle transfers to a 540-nautical-mile operational orbit, using the chemical orbit trim propulsion system.

For Mars landing missions, 2 to 5 days are spent surveying the Mars surface for landing sites, performing orbital experiments (including deployment of probes), and preparing the Mars excursion module (MEM) for operation. Three of the six-man crew then descend to the Mars surface in the MEM. Small retrorockets insert the MEM into a trajectory that will permit a landing at the selected site. Aeroballistic entry into the Mars atmosphere is followed by braking and retropropulsive descent to the surface. Explorations and observations are conducted throughout the 30-day stay on Mars surface. During this time, the men in the space vehicle monitor and give orbital support to the MEM crew, continue orbital experimentation, and maintain space vehicle operations. The small ascent stage of the MEM is then used to bring the three men and their scientific payload back from Mars surface to a rendezvous with the orbiting space vehicle. The larger descent stage of the MEM is abandoned on Mars surface, while the smaller ascent stage is abandoned in Mars orbit, after the crew and scientific payload have been transferred to the space vehicle.

Preparations for planet departure include separation and disposal of the orbit trim propulsion system, the PM-3 aft interstage, and meteoroid shield. Departure from planet orbit is accomplished by firing the nuclear PM-3 and disposing of its spent stage. The space vehicle has now been reduced to the mission module and the Earth entry module. Interplanetary operations on the return trip are similar to the outbound leg of the mission. About 1 day prior to entering Earth atmosphere, the six-man mission crew and the scientific payload are transferred to the EEM and separation from the mission module is accomplished. The EEM trajectory is adjusted for atmosphere entry, descent, and landing at the desired location on Earth. The crew and scientific payload are recovered, completing the mission operations.

#### 1.2.8 SCIENTIFIC PROGRAM

The scientific program portion of this study concentrates primarily on those measurements and observations necessary to establish the presence of life on the selected planets, and to obtain data concerning the origin and evolution of the solar system. This scientific program is fully described in Volume III, Part 2.

## 1.3 PROGRAM PLAN SUMMARY

## 1.3.1 SCHEDULE SUMMARY

The development and qualification programs for the example Venus 1983 capture mission and follow-on Mars 1986 landing mission are scheduled in summary form in Figure 1.3-1. The Venus mission is shown with a contract go-ahead of January 1972, and 11-1/2 years of flow time before mission launch. Mission hardware developed during the 11-1/2 years includes the mission module (MM), Earth entry module (EEM), primary propulsion modules (PM-1, PM-2, PM-3), midcourse propulsion modules, and orbit trim propulsion module. The Mars mission is shown with a contract go-ahead of mid-1976, and approximately 9-1/2 years of flow time before mission launch. The Mars excursion module (MEM) is the major mission hardware developed during this period, and it uses engineering and test aids transferred from the Venus mission program. The probes program is shown with a contract go-ahead of 1979, and 6 years and 2 months of flow time before delivery of probes mission hardware. The soft lander was selected to represent the probes hardware and experiments since it is the most complex and has the longest lead times.

Program progression is from hardware development to ground qualification, to module orbital qualification, to system qualification and demonstration, and finally to mission operations. Ground qualification will be at both the subsystems level and the module system level.

Launching of the mission module is the most significant milestone in the series of orbital qualifications. Since the mission module is the center of interfaces among the modules, its orbital qualification at the outset will strongly support the orbital testing of the other modules. Also, it will eliminate uncertainties and costs of simulation equipment in space. Furthermore, the mission module, in conjunction with logistics space vehicles, can house the orbiting crew for module testing during the approximately 3 years prior to orbital demonstration. The IMISCD study assumes that appropriate logistics vehicles will be operational when needed, and that launching of men will always be accomplished in a manrated logistics vehicle.

Orbital testing of the Earth entry module will begin with a boilerplate EEM, instrumented to transmit design verification data back to Earth. Following this test, unmanned and manned flights will qualify the reentry capability of the EEM. Propulsion modules will be subjected to orbital assembly and separation operations, storage and transfer of propellants, and qualification by actual firing after appropriate space soak.

The orbital demonstration of the space vehicle will require a total of six launches: one launch for the spacecraft (MM and EEM), one launch each for PM-3 and PM-2, and three launches for PM-1. Standby requirements are planned to include one spacecraft, two nuclear PM's, and one ELV. If these spares units are not used for the demonstration, they will be transferred to mission operations as either standby or operational units. The orbital demonstration will be for 10 months



instead of the full 18 months required for a typical mission. The first 8 months will be used for orbital assembly, installations, checkout, and final qualification of all hardware capabilities. Any final engineering improvements will be incorporated in the operational hardware.

The Venus mission launch and Earth orbital operations require approximately 5 months. The space vehicle modules will be launched in rapid succession, using the "salvo" technique for this and all operational missions. The launching cycle, followed by orbital assembly and installations, will take about 4 months. The remaining month will be used for checkout, final preparations, and countdown when the launch window permits injection into the transplanetary mission trajectory. Similar launch and Earth orbital operations will apply to the Mars mission.

This overall schedule for the recommended program is considered realistic in flow times, and incurs the risks normally associated with space programs. An alternate schedule has been developed to show how earlier mission dates could be met. The earlier mission dates are Venus 1981 capture and Mars 1983 landing, with the same contract go-ahead (1972) as that of the recommended schedule. The alternate schedule would create a high-risk program, however, by requiring more concurrent operations and minimum flow time for discovering and correcting design or performance problems. Further discussion of the alternate program and schedule is provided in Volume V of this report.

### 1.3.2 COST SUMMARY

Program costs and fiscal year funding requirements have been developed for the recommended mission system. Technical data were mated with historical parametric cost data to develop cost estimates for the major program elements. A program planner's guide was then designed to provide the basic reference data required for planning any desired mission program. Costing conditions, rationale, and methodology as well as detailed cost estimates are presented in the guide, which is included in Part 3 of this volume.

A complete set of mission programs has not been committed, so the recommended early missions were used to show example funding level requirements. A 1983 Venus short-stay capture mission, followed by a 1986 Mars opposition landing mission, were used in combination to provide a representative basis for funding. Estimated total costs are as follows:

<u>Phase</u>	<u>\$ Millions</u>
Research and Development	23,765.8
Venus Mission	2,616.8
Mars Mission	<u>2,681.9</u>
Program Total	29,064.5

The following tables and charts display the program costs associated with the above missions:

- Figure 1.3-2 compares the major elements of the total program. The largest cost item, the spacecraft, includes the mission module, the Earth entry module, and the Mars excursion module.
- Figure 1.3-3 shows the funding required by fiscal year, distributing the costs over a 19-year period. Fiscal year funding peaks occur during the development part of the program; by comparison, one operational mission (any selection) could be accomplished every 2 years with funding below these peaks.
- Figure 1.3-4 gives a pictorial representation of the major hardware elements and breaks down the costs for this hardware in terms of basic R&D, flight tests, and combined total.
- Figure 1.3-5 gives a pictorial representation of major hardware elements with their unit costs, as well as orbital and mission operations with their associated support costs.

### 1.3.3 TEST PROGRAM SUMMARY

Test requirements were based strictly on mission requirements identified in the operational analysis of a typical planet capture and landing mission (in Part 1, Volume III, of this report). These major mission events were then translated into functions that could be identified with the individual modules, such as the mission module. The test program developed a logical buildup of tests from the module level to the space vehicle level, after component and subsystem testing by the contractors. Tests were selected to ensure crew safety and mission success without excessive redundancy in testing at the different levels, and without the excessive risks associated with flight testing only at the total space vehicle level.

Ground and flight development tests are specified to support the design of spacecraft hardware where specific technological data are presently lacking. Test articles will frequently simulate module mass and profile, but may be engineering models or prototype hardware as appropriate.

A ground integration model will be kept current throughout the program as the primary means for coordinating the compatibility, positioning, and continuity of all space vehicle interfaces. Functional integration tests will verify continuity of functional operations such as command and control, checkout, electrical power, etc., through test cables between modules of the space vehicle and between flight hardware and ground support equipment. Physical integration tests will verify the mating of flight hardware with ground and launch support equipment and ELV's, through test cabling, fluid servicing lines, and umbilicals. Flight interface simulators, complete only at the region of mating, will help to identify zero-g effects on docking and separation. Flight control integration tests will analyze vehicle flight control dynamics, using flight configuration hardware or models, supplemented by computer simulations with astronauts in the control loops.

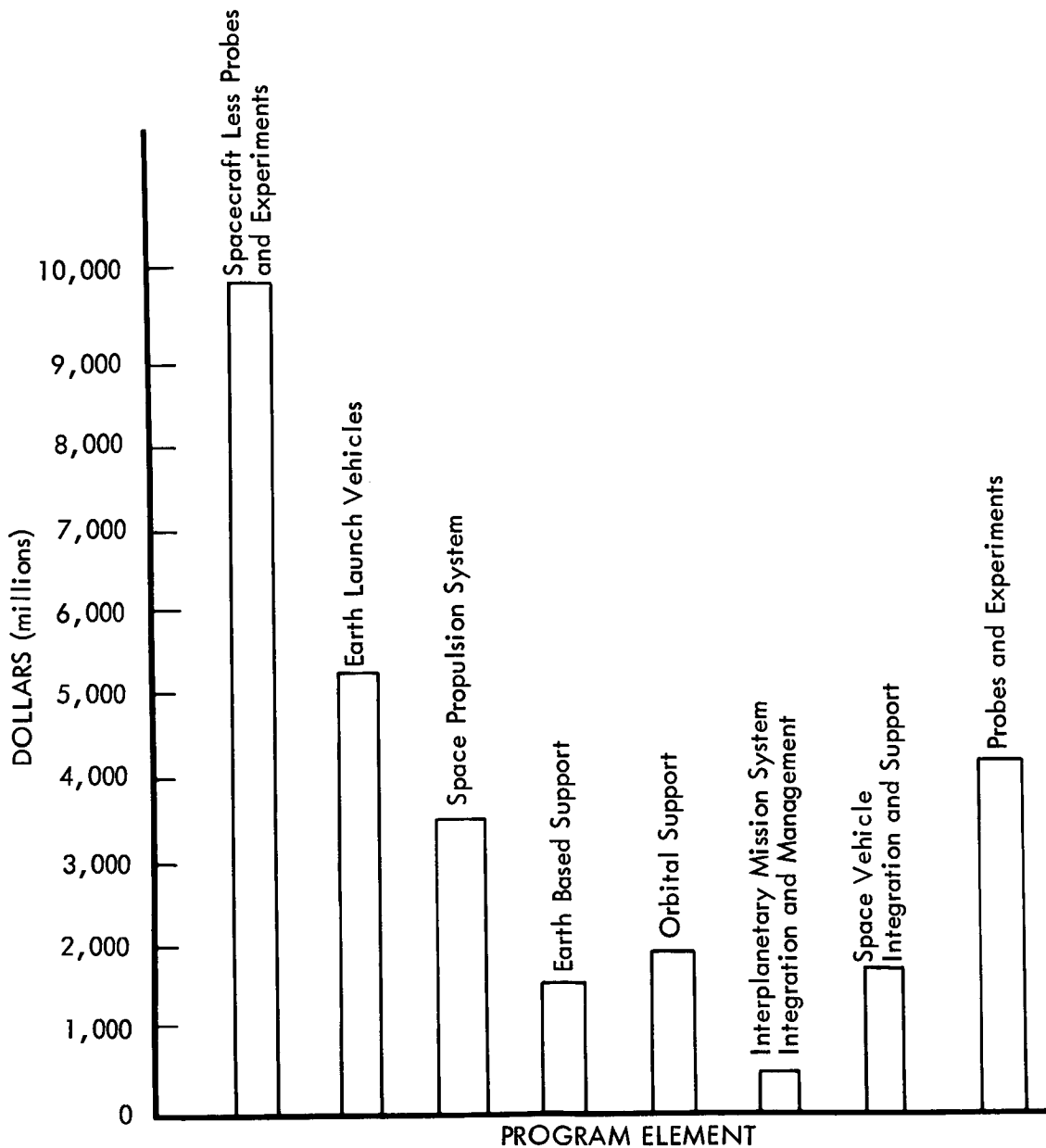

<u>Total Costs</u>	
<u>Phase</u>	<u>Millions</u>
R&D	\$23,765.8
Venus Mission	2,616.8
Mars Mission	2,681.9
<b>Program Total</b>	<b>\$29,064.5</b>

Figure 1.3-2: TOTAL PROGRAM COST — BASIC EXAMPLE

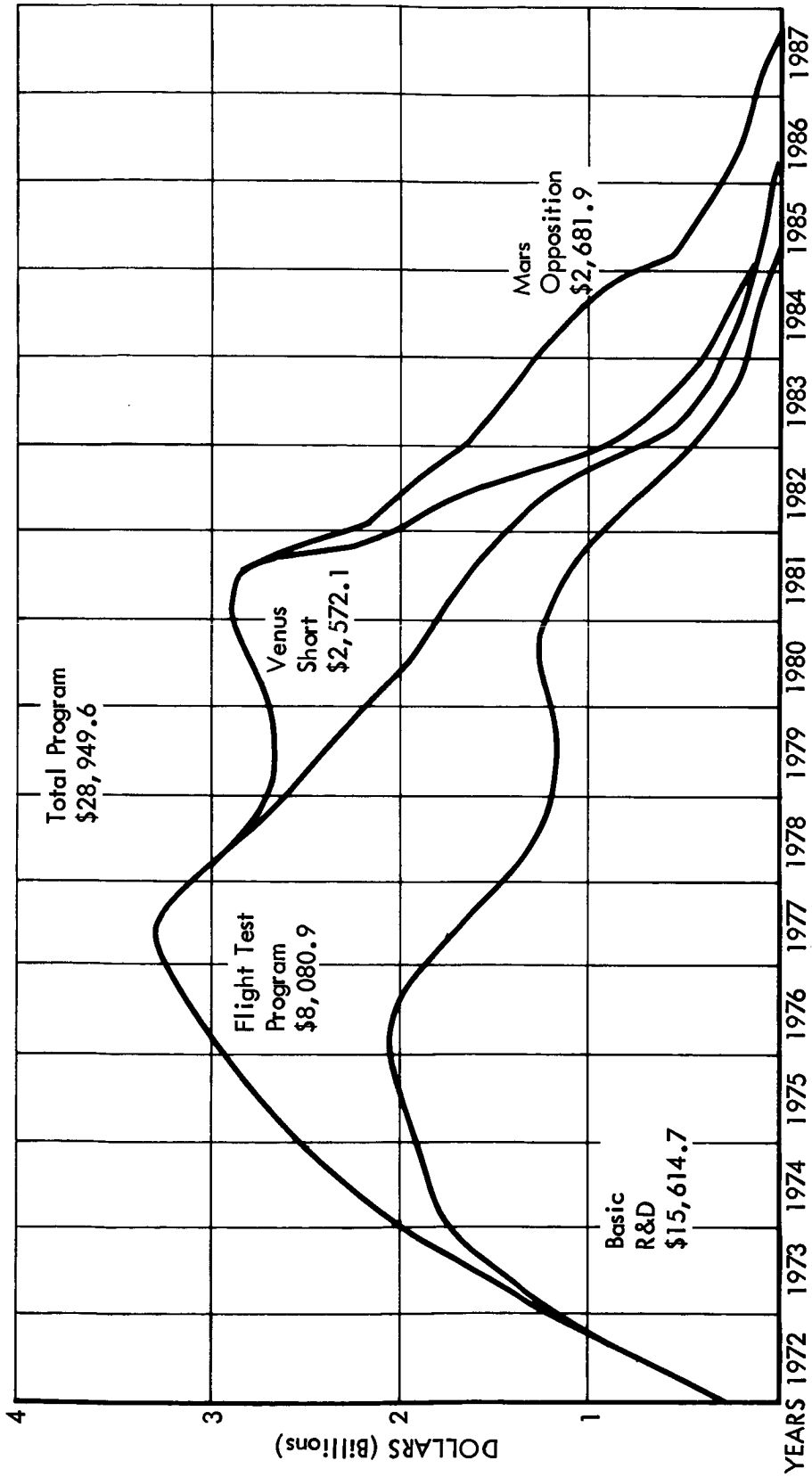
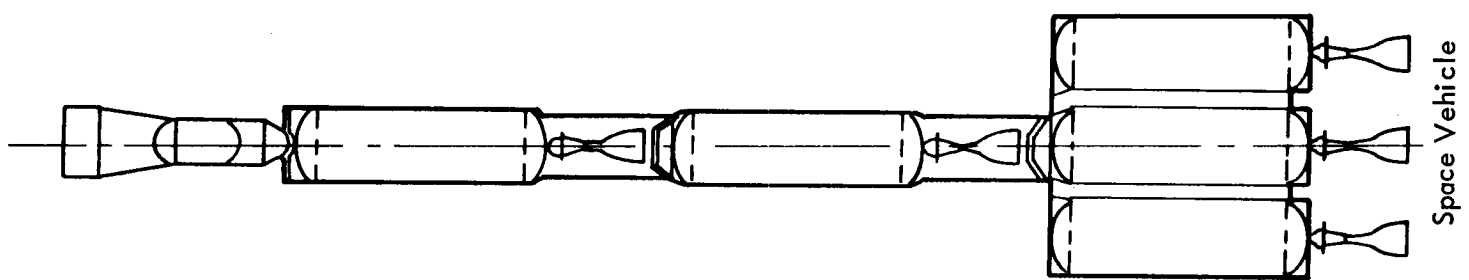

Figure 1.3-3: TOTAL PROGRAM FUNDING — BASIC EXAMPLE



	MEM	Experiment & Probes	MM	EEM	PM-3	PM-2	Assembly and Docking Units	Midcourse Correction and Orbit Trim	PM-1	Space Vehicle Integration & Support	Total
Basic R&D	\$ 2,906.2	3,288.0	3,049.0	1,457.7	0	0	355.9	140.0	2,040.0	1,323.8	\$14,506.6
Flight Test	\$ 826.7	590.8	532.0	263.5	62.0	201.0	137.3	22.5	155.0	279.1	\$3,069.9
Total	\$ 3,732.9	3,878.8	3,581.0	1,721.2	62.0	201.0	493.2	162.5	2,195.0	1,602.9	\$17,630.5



Other Costs  
 Earth Support \$1,035.0  
 Orbital Support 1,022.6  
 Interplanetary Mission System Integration and Management 410.4  
\$2,468.0

	Basic R&D	Flight Test	Total
SAT-25(S)U with Strappons	\$ 248.6	\$ 1,463.0	\$ 1,711.6
SAT-V-25(S)U Core Only	574.8	906.4	1,481.2
SAT-V	0	124.0	124.0
SAT-V INT-21	0	178.6	178.6
Saturn IB	0	164.0	164.0
Atlas Agena	0	7.9	7.9

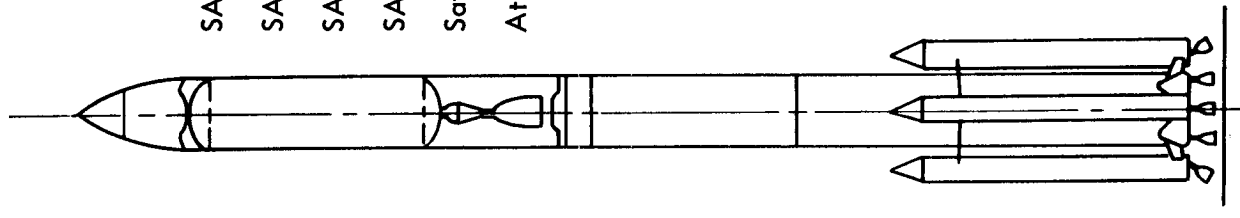

	Total
	\$ 823.4
	\$ 2,843.9
	\$ 3,667.3

\$17,630.5 + \$3,667.3 + \$2,468.0 = \$23,765.8

Fig 1.3-4 A

Figure 1.3-4: B DESIGN DEVELOPMENT AND DEMONSTRATION COSTS (dollars in millions)  
 — BASIC EXAMPLE

Hardware, Assembly, Integration, Checkout, and Orbital Support

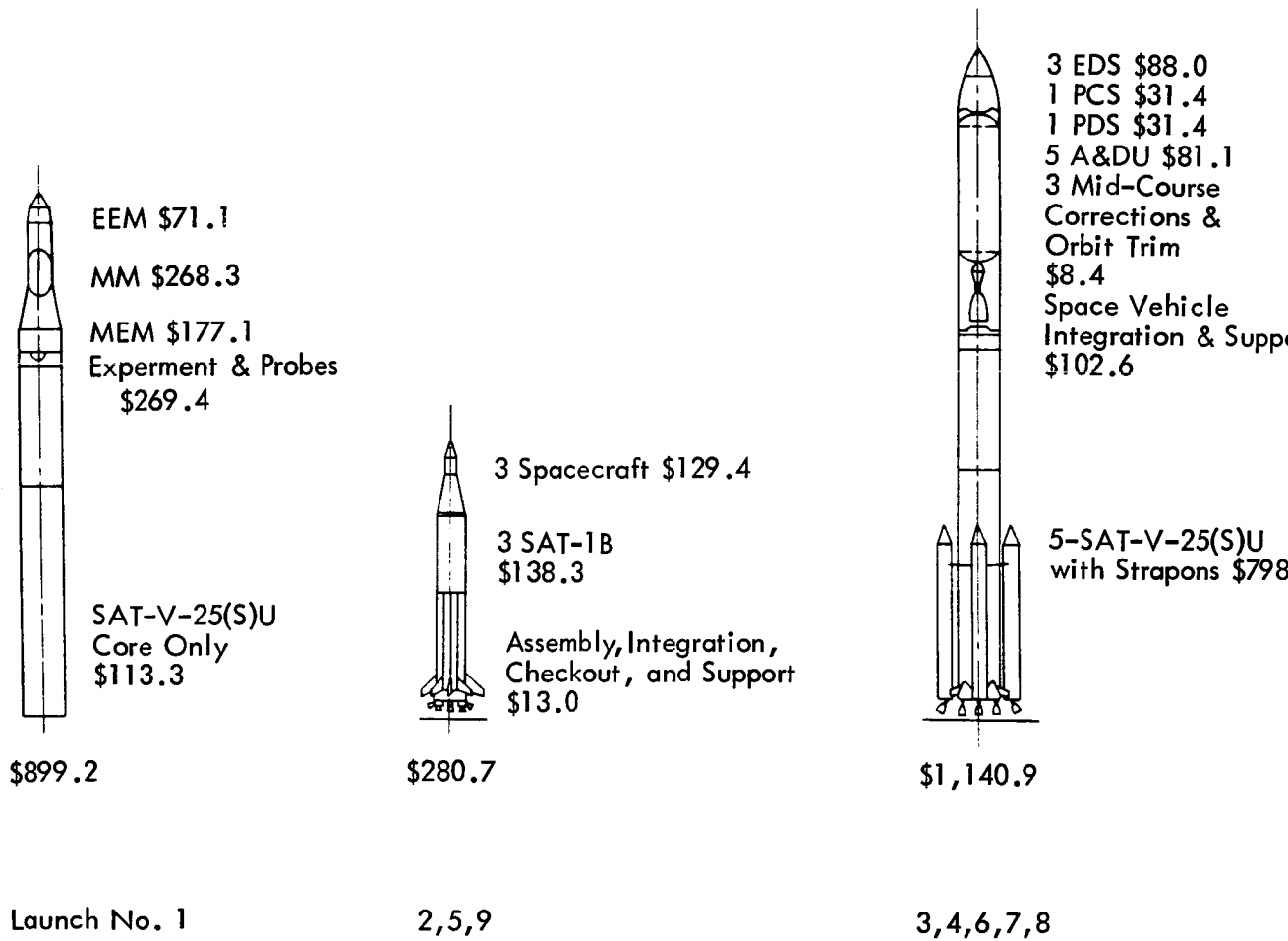
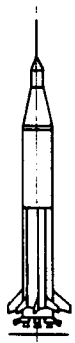

Fig 1.3-5-A

50



Spacecraft  
\$43.1

Assembly, Integration,  
Checkout, and Support  
\$4.3

Saturn - 1B  
\$46.2

\$93.6

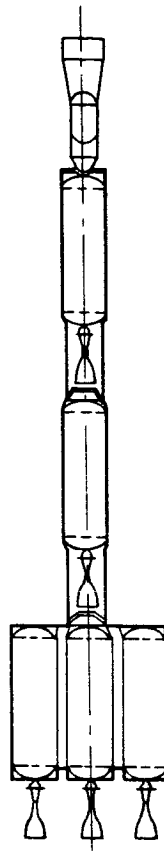

\$2,414.4

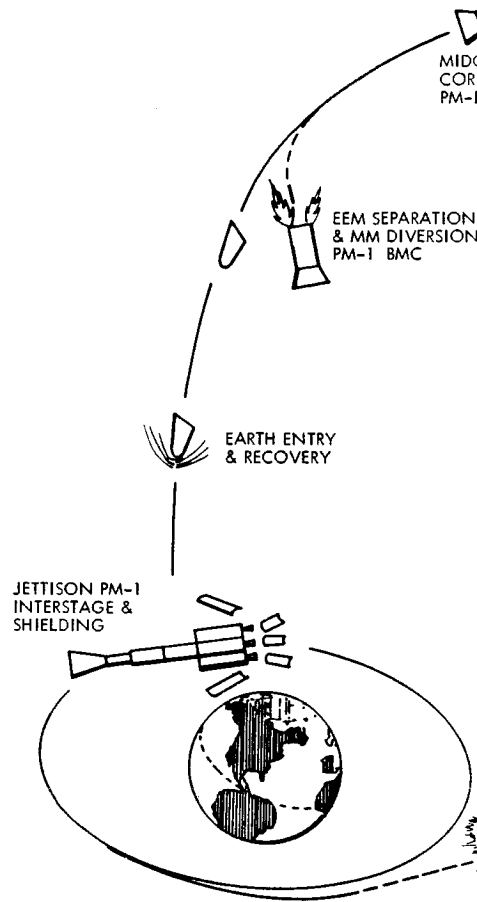

Tracking and Data Management	\$225.9
Recovery	2.0
Interplanetary Mission System Integration and Management	<u>39.6</u>
	\$267.5

Fig 1.3-5-B

51

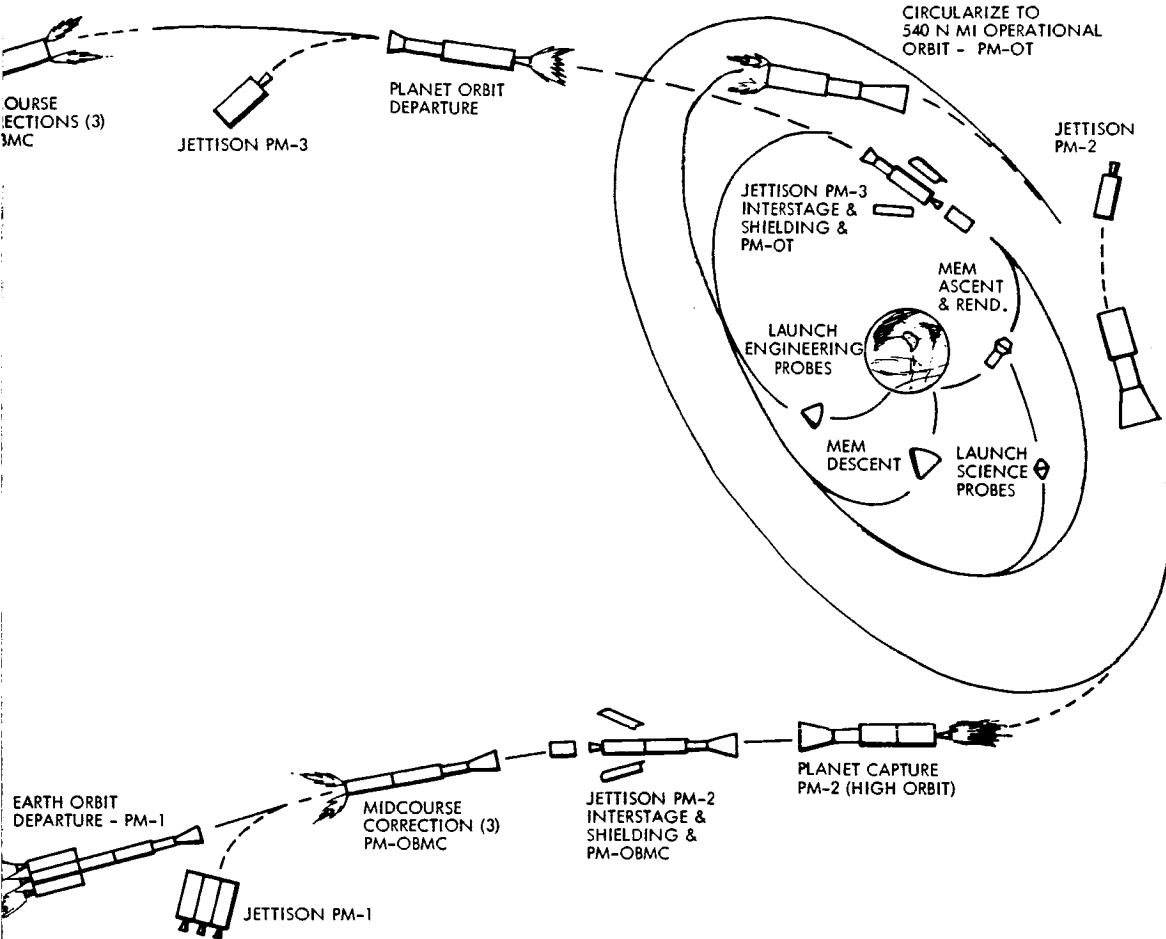

TOTAL MISSION COST

= \$2,681.9

Figure 1.3-5: MARS OPPOSITION MISSION COST (dollars in millions)  
— BASIC EXAMPLE

Ground qualification tests have been preferred, so long as they can verify the hardware capabilities actually required for mission performance. Modules will be subjected to vibration/acoustic tests to verify structural adequacy, as well as acceleration tests and altitude/pressure tests to verify ability to withstand the rapid changes during launch. Interfaces of the spacecraft will be qualified by the ground integration tests already described. PM's will be fired in ground test facilities. Ground environment test chambers will provide appropriate thermal/vacuum and thermal cycling conditions for verifying certain space-dependent capabilities.

Flight qualification tests are required for capabilities that cannot be adequately verified by ground tests. Successful unmanned flights must precede manned flights for testing capabilities that have not been manrated. Flight testing of the mission module will begin early in the program and continue throughout, with astronauts sent up for on-board qualifying of mission module mission control capabilities during the long-duration flight. This will include orbital support for flight testing of the EEM, MEM, and PM's. All space vehicle elements (spacecraft, PM-3, PM-2, PM-1) will be launched into Earth orbit, docked, assembled, and tested by the astronaut crew. The total space vehicle will then be injected into a stimulated mission of abbreviated duration, in the Earth-Moon region, for final qualification. The PM's will be fired and the spent stages separated in mission sequence. All space vehicle capabilities, as well as the performance of integrated systems and astronauts and the effectiveness of ground support, will be verified under flight conditions.

Figure 1.3-6 provides an overall summary of the required tests and test hardware.

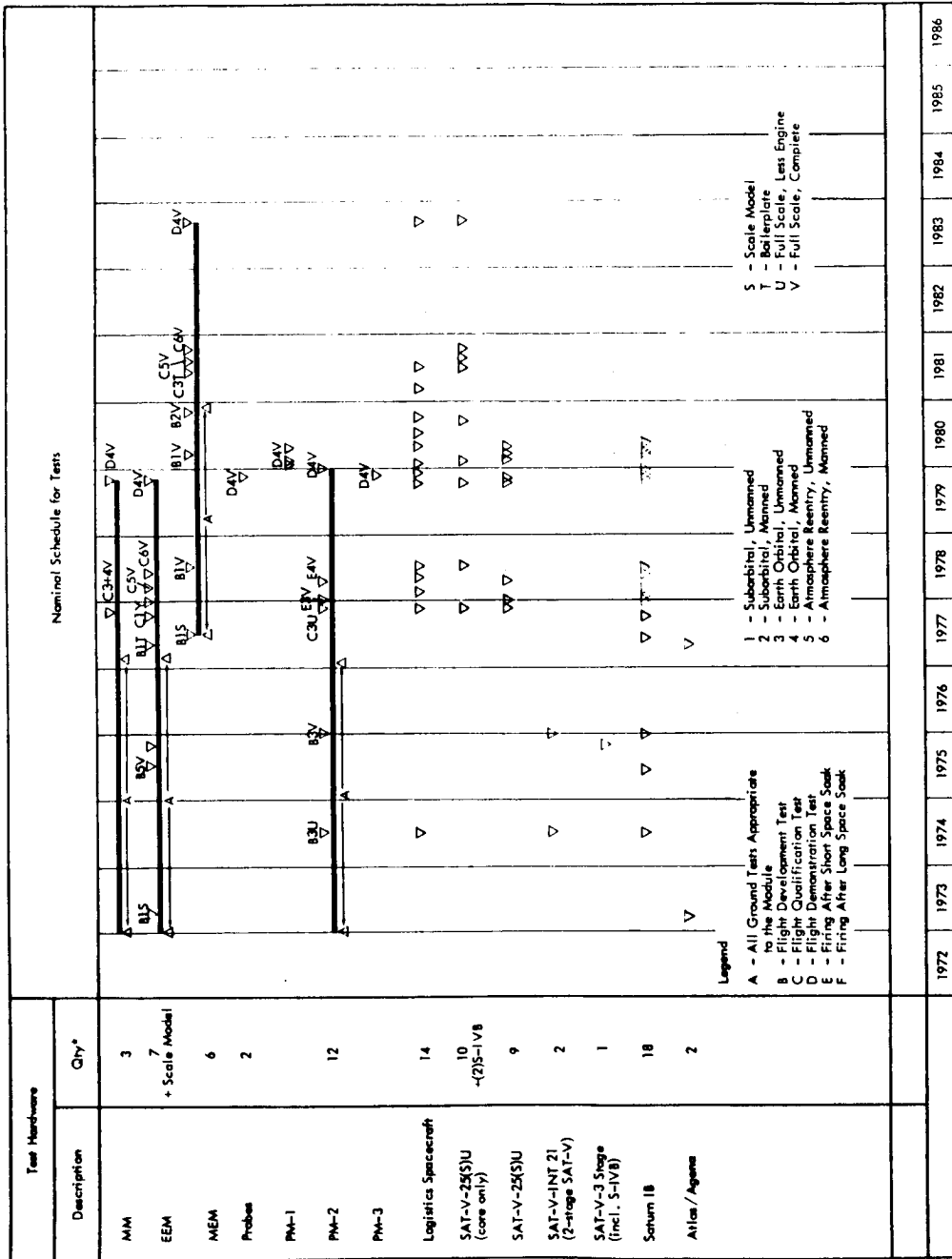

\*Including standbys for demonstration tests

Figure 1.3-6: TEST PROFILE FOR VENUS 1983 CAPTURE AND MARS 1986 LANDING —BASIC EXAMPLE

## 2.0 PRIMARY VALUES OF THE RECOMMENDED SYSTEM

Flexibility is the dominant value of the recommended interplanetary mission system.

The wide range of capabilities provided by the space vehicle is achieved through flexible use of common modules. Propulsion capability for any reasonable mission is developed by configuring universal propulsion modules into a propulsion train with appropriate fuel transfer capacity. Mission operation and control capabilities are provided by spacecraft modules that are appropriate for all missions without substantial change. Sufficient reserve capabilities can thus be combined to tolerate the many uncertainties of interplanetary missions such as meteoroid and radiation flux, planet atmosphere densities, and experiment requirements.

The reduction of the research and technological complexities to relatively few major problem areas provides programming flexibility. Go-ahead on developing and testing is now possible for the total interplanetary mission system, or it can be confined to only the most critical elements at the outset. The state-of-the-art advancements are predictable, and are sufficiently flexible to tolerate the many programming uncertainties relating to scientific objectives, funding rates, mission priorities and dates, multiplicity of contractors, and congestion of launch facilities.

This system concept provides the foundation for a balanced program of unmanned and manned planetary missions that can adjust to changes in national aims and financial commitments without losing continuity of purpose.

The science program identifies the instruments and approaches needed, in view of payload capabilities, to accomplish the highest priority scientific objectives relating to our solar system. Observations and measurements in transit are distinguished from those to be performed in orbit, or on the planet surface. Also, the need for probes and unmanned precursor missions are correlated with manned mission opportunities.

The conceptual design for the aerospace vehicle establishes a baseline reference for future refinement, development, and testing. This aerospace vehicle uses a high percentage of common flight hardware for the variety of opportunities for scientific missions to Mars and Venus, placing payloads of 550,000 to 800,000 pounds into Earth orbit, and maintaining high probability of crew safety and mission success. The Saturn V-25(S)U, with 156-inch strap-ons, can make the required launches with the least impact on KSC facilities, while an all-nuclear propulsion train provides the most flexible space acceleration system for the various missions. A six-man crew is found to be adequate, even for the most critical Mars landing mission. If exposure to zero-g conditions is found to extend beyond reasonable tolerance, relatively simple modifications to the spacecraft can provide the crew with an artificial-gravity environment.

The integrated concept for interplanetary missions can have important impacts on other space programs, and should interact with them. Space station programs and other orbital research should provide continuing opportunities for developing, testing, and utilizing the mission module, the propulsion modules, the subsystem prototypes, the logistics launch vehicles and spacecraft, as well as the mission support systems required for the future interplanetary missions.

The remainder of this volume assesses important aspects of the recommended system, including the primary values just mentioned. General capabilities of the system are presented on the pages which immediately follow. Section 3.0 considers how the recommended system will react to changes from design conditions, and identifies significant technology implications to be resolved.



## 2.1 GENERAL SYSTEM CAPABILITIES

### 2.1.1 REPRESENTATIVE MISSION CAPABILITY

The recommended space vehicle is capable of performing a very broad range of missions, due to the flexibility of its space acceleration train. This flexibility is made possible by propellant transfer between the common propulsion modules to satisfy the energy requirements of any particular mission. The performance advantages are very significant, and do not appear to incur cost penalties. A cost analysis of an acceleration system that uses the common propulsion module versus a less flexible system that uses semitailored modules showed that the slightly greater recurring costs for the common module approach were offset by the additional development and testing costs for the semitailored module concept.

Figure 2.1-1 shows that the recommended space vehicle with a 3-1-1 space acceleration train can accomplish missions to Mars and Venus during each opportunity over a Mars synodic cycle. Missions to Venus can be repeated in the 1990's, but are not tabulated in the Figure. Also, Mars conjunction missions with stay times of about 500 days can be repeated at each Mars opportunity and Venus long stay time missions are available at each Venus opportunity.

The recommended system can accomplish more energetic missions than those shown by addition of one or more propulsion modules. Alternatively, if an elliptical orbit is acceptable at Mars or Venus, additional capability is available with the recommended 3-1-1 system.

Six launches are required when using the recommended 3-1-1 system. Seven or eight launches are required when using the 4-1-1 or 4-2-1 system for extending mission capability to the more energetic missions. Five launches are required for the 2-1-1 system. While this latter system has less performance margin than the recommended system, it has the capability of flying many missions and requires one less launch per mission.

The recommended system is not tailored specifically to each of the missions. Thus, more or less excess or discretionary performance capability is available on all missions. This discretionary performance capability may be used for payload or  $\Delta V$  trade.

---

\*3-1-1 refers to the space-acceleration train only (3-1-1-1 would refer to the space-acceleration train plus the spacecraft, in terms of Earth launches required)

## 3-1-1 Common Propulsion Modules (3 for PM-1; 1 for PM-2; 1 for PM-3)

Launch Date	Destination	Mission Type	Duration (days)
Nov. 1978	Mars	Venus Swingby	680
Nov. 1979	Mars	Conjunction	900
March 1980	Venus	Short	460
Oct. 1981	Mars	Opposition	540
Oct. 1981	Venus	Short	460
Nov. 1981	Mars	Venus Swingby	600
May 1983	Venus	Short	540
Nov. 1983	Mars	Venus Swingby	540
Jan. 1984	Mars	Opposition	460
Nov. 1984	Venus	Short	550
Apr. 1985	Mars	Venus Swingby	590
March 1986	Mars	Opposition	480
Aug. 1986	Venus	Short	470
May 1988	Venus	Short	350
Jun. 1988	Mars	Opposition	460
July 1988	Mars	Venus Swingby	560
Oct. 1989	Mars	Venus Swingby	640
Dec. 1989	Venus	Short	350
Sept. 1991	Mars	Venus Swingby	600
Nov. 1994	Mars	Venus Swingby	560
Dec. 1996	Mars	Opposition	480
Jan. 1998	Mars	Venus Swingby	680

Figure 2.1-1: MISSION CAPABILITY

### 2.1.1.1 Payload Performance Margins

Performance margins for missions using the 3-1-1 space acceleration system may be traded off against increased payload. The payload trade can balance that returned to Earth against that delivered to orbit at the target planet. Figures 2.1-2 through 2.1-5 show lines of payload capability for each of the representative missions. The difference between the design payload point for each mission, and the capability line when measured along the abscissa, yields the additional payload that may be delivered into the planet orbit if payload to Earth remains at the design values. For example, this payload differential may be used for additional probes. Alternatively, the difference when measured along the ordinate yields the additional payload returnable to Earth if payload into the planet orbit is held at the design value. For example, this payload differential may be used for more samples to be brought back. Combinations between these two extremes may also be accommodated as illustrated in Figures 2.1-2, -3, -4, and -5.

For two of the Venus missions (1980 short and 1980 long), the recommended 3-1-1 capability is actually slightly less than the recommended spacecraft weight. For these two missions, a less than 5% improvement in the SAT-V-25(S)U ELV capability is required. Since a 5% ELV allowance was permitted, the Venus 1980 short and long missions are considered within the capability of the recommended 3-1-1 configuration.

### 2.1.1.2 $\Delta V$ Performance Margins

Of the 15 missions that can be done with the recommended 3-1-1 configuration, 13 have substantial performance margins. Table 2.1-1 shows how these margins can be used to produce additional  $\Delta V$  if all of the margin is used in  $\Delta V_1$  or  $\Delta V_2$  or  $\Delta V_3$ . The combinations of the three possible velocities can be derived using the performance maps given in the next section.

## 2.1.2 GENERAL PERFORMANCE CAPABILITY

General performance evaluation nomograms have been developed for the recommended 3-1-1 space acceleration system. These curves, discussed in Section 3.9.1, allow the mission planner to assess any reasonable mission as to its (1) capability, (2) payload optimization, or (3) initial velocity requirements.

For fixed payloads, the performance of the recommended system is shown in Figure 2.1-6 for Mars missions and in Figures 2.1-7 for Venus missions. Given any set of impulsive  $\Delta V$  requirements, these curves can be used to check whether the mission can be flown with the recommended system and how much  $\Delta V$  margin is available. Figure 2.1-8 illustrates their use.

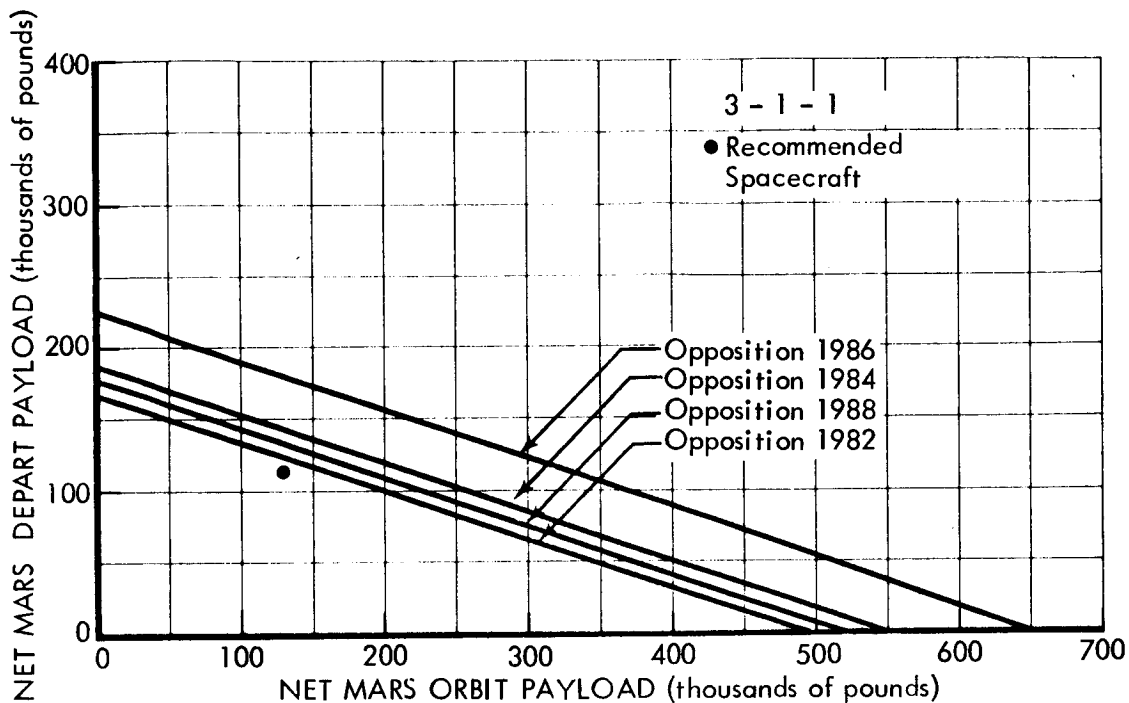

Figure 2.1-2: MARS OPPOSITION PAYLOAD CAPABILITIES

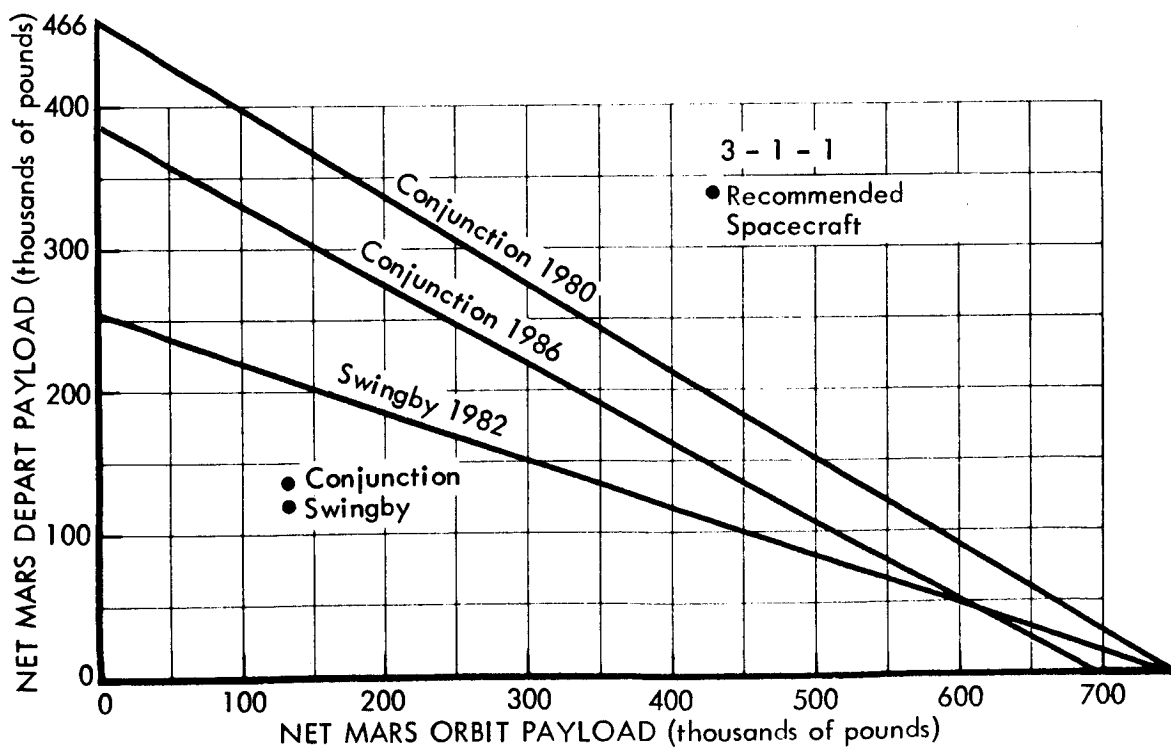

Figure 2.1-3: MARS CONJUNCTION AND SWINGBY PAYLOAD CAPABILITIES

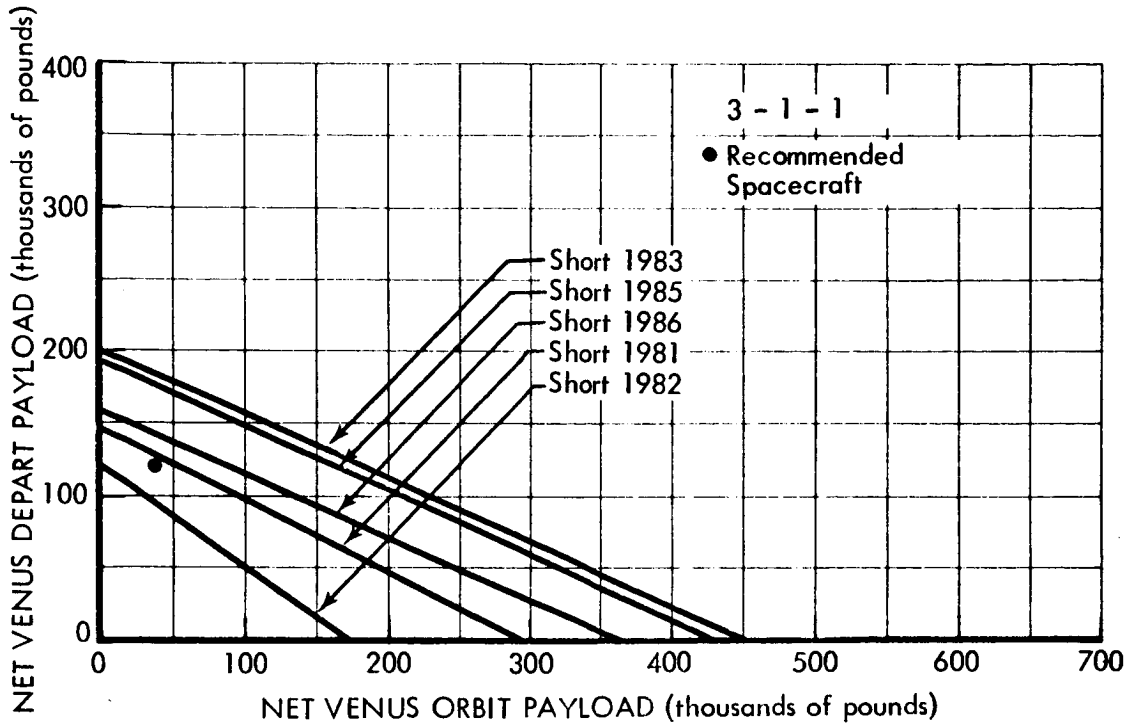

Figure 2.1-4: VENUS SHORT PAYLOAD CAPABILITIES

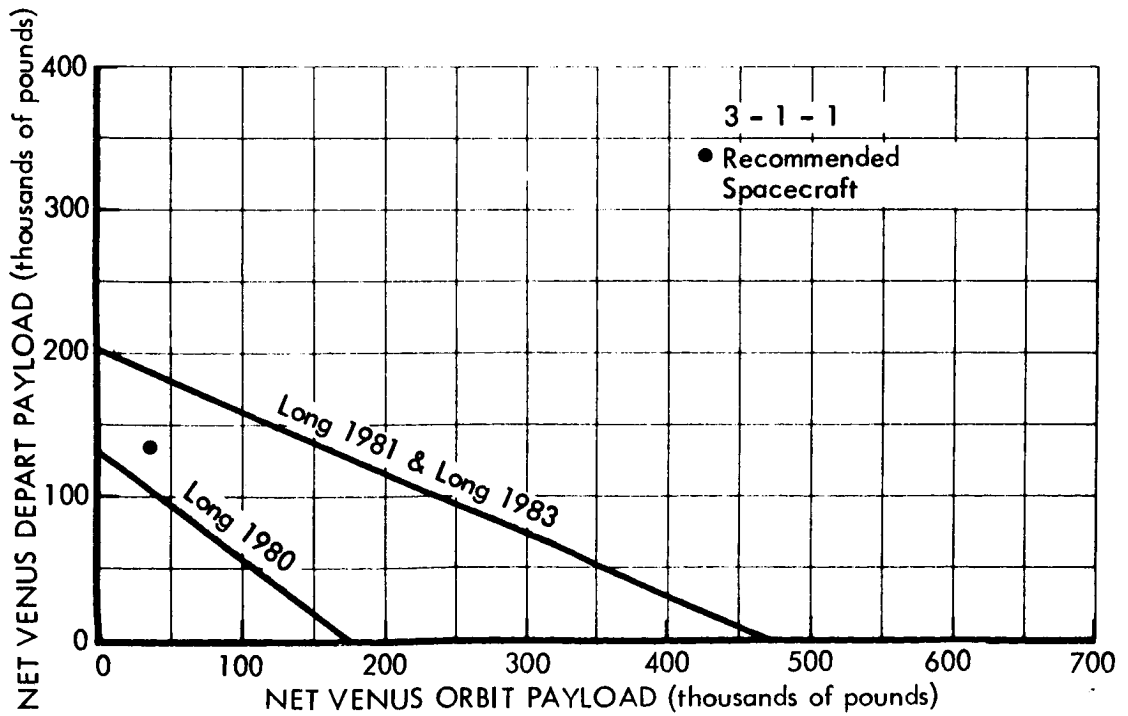

Figure 2.1-5: VENUS LONG PAYLOAD CAPABILITIES

Table 2.1-1: ADDITIONAL VELOCITY MARGINS

(km/sec)

Mission	$\Delta V_1^*$	$\Delta V_2$	$\Delta V_3$
Mars 1982 Opposition	0.09	0.25	0.29
Mars 1984 Opposition	0.29	0.66	1.02
Mars 1986 Opposition	0.53	1.09	1.69
Mars 1988 Opposition	0.13	0.22	0.62
Mars 1982 Swingby	0.76	1.44	2.41
Mars 1980 Conjunction	1.44	3.88	5.17
Mars 1986 Conjunction	1.32	3.33	4.27
Venus 1981 Short	0.14	0.54	1.18
Venus 1983 Short	0.75	1.60	2.35
Venus 1985 Short	0.60	1.26	2.26
Venus 1986 Short	0.47	1.02	2.09
Venus 1981 Long	0.86	1.91	3.38
Venus 1983 Long	0.87	1.35	3.26

\*This  $\Delta V_1$  margin is in addition to that provided for in the PM-1 Earth launch window allowance.

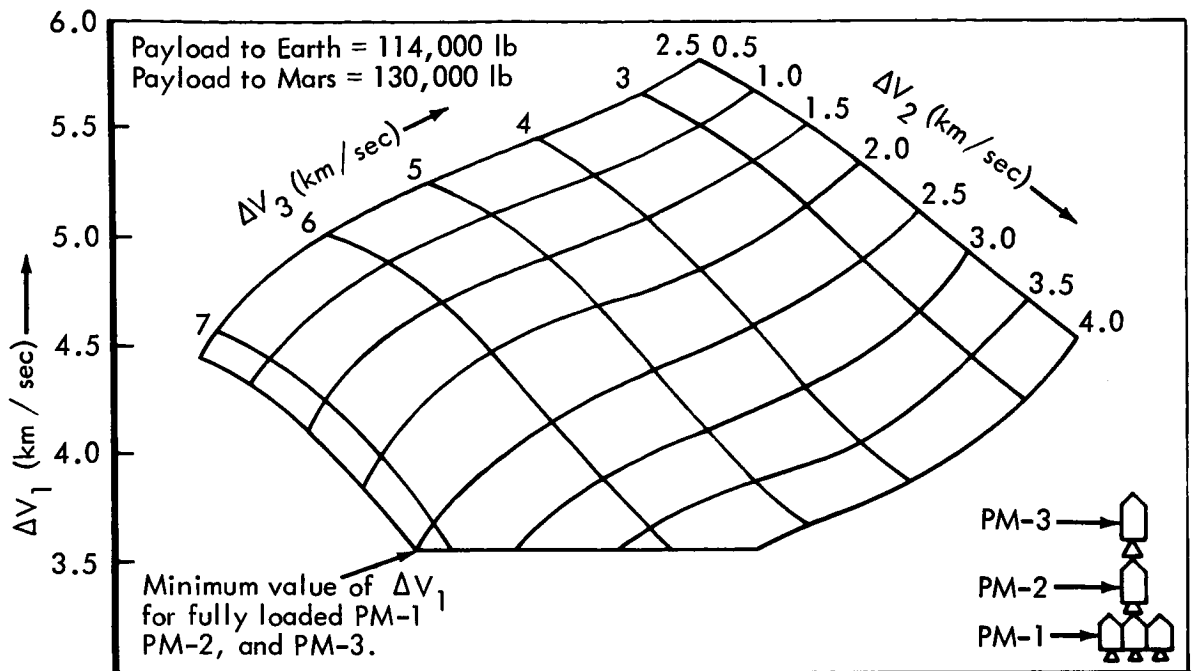

Figure 2.1-6:  $\Delta V$  CAPABILITY FOR MARS MISSIONS

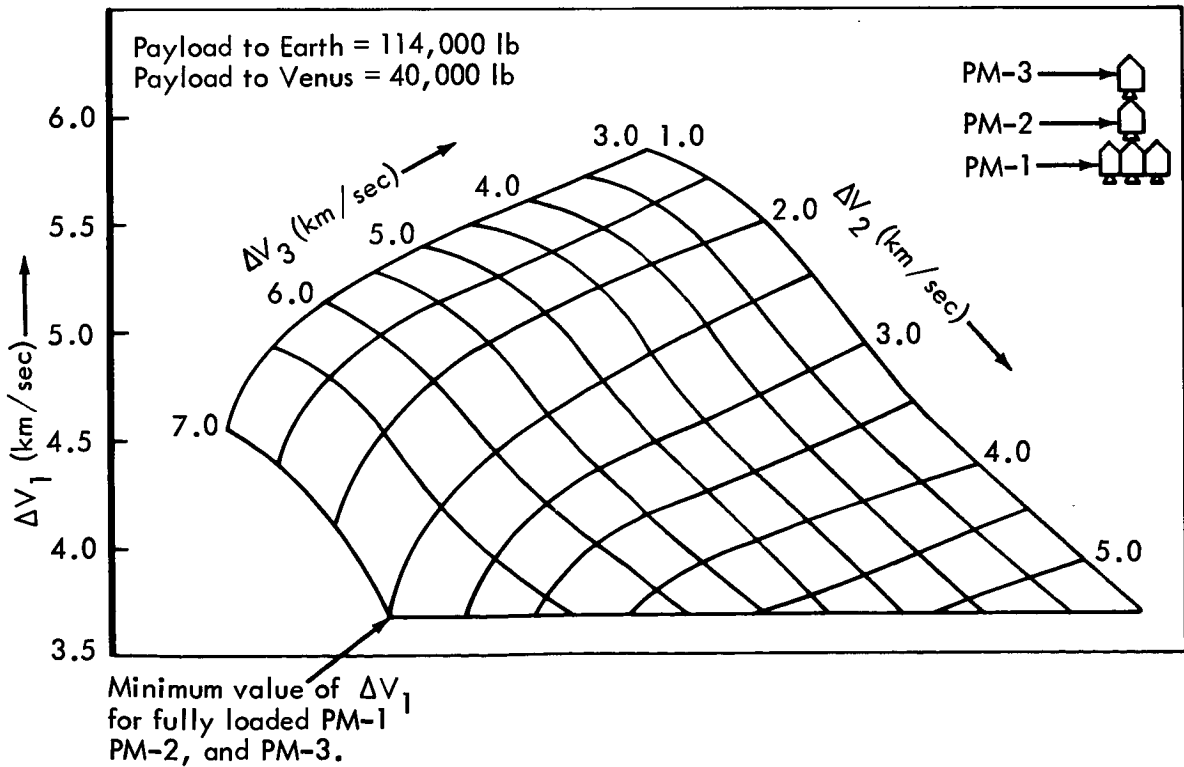

Figure 2.1-7:  $\Delta V$  CAPABILITY FOR VENUS MISSIONS

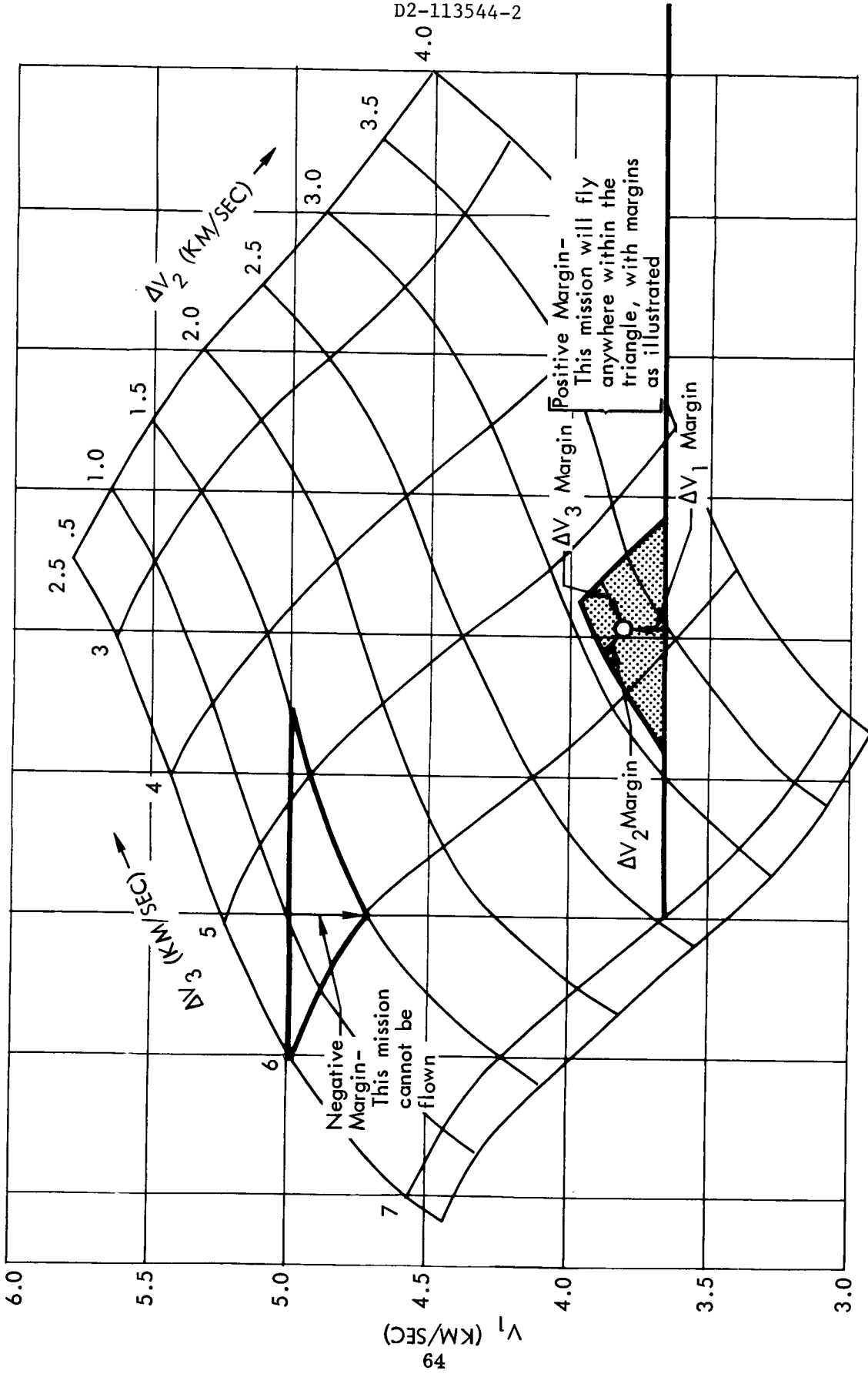

Figure 2.1-8: USE OF  $\Delta V$  PERFORMANCE MAPS



### 2.1.3 MISSION SUCCESS CAPABILITY

The representative missions have been analyzed to assess the probability of their successful completion. This success probability for a representative Mars mission is shown in Figure 3.3-26. Its general shape, decreasing as the mission proceeds, is typical of all missions studied.

An unforeseen occasion may require a command decision to terminate the mission prior to its normal completion. The abort capability has been examined and an abort capability curve for a representative Mars mission is shown in Figure 2.1-9.

The abort capability curves yield minimum return trip times as a function of the time during the mission at which the abort is initiated. For each mission, the abort capabilities have been determined for three cases:

- 1) Both PM-3 and PM-2 propulsion modules are available for the return (labeled  $\Delta V_2$  and  $\Delta V_3$ );
- 2) Only the PM-3 propulsion module is available with the PM-2 module inoperable (labeled  $\Delta V_3$ );
- 3) Only the PM-2 propulsion module is available with the PM-3 module inoperable and its propellant dumped (labeled  $\Delta V_2$ ).

For the missions studied, minimum return trip times are possible for about the first one-third of the outbound leg. A rapid increase in return trip time then ensues due to the sharply increasing  $\Delta V$  requirements.

The probability of successful returns after an abort maneuver has been initiated is shown for a representative Mars mission in Figure 2.1-10. While specific values of success probabilities vary with the mission, the form is the same for all missions.

When the return trip times are short (i.e., during the first third of the outbound leg), relatively high abort success probabilities result. After that, the return trip time increases to values nearly as long as the full mission duration, and the success probabilities drop accordingly. For the 1986 Mars opposition mission, the least success probability occurs on the planet surface ( $P(SA) = 0.893$ ). Figure 2.1-11 illustrates how additional weight for redundancy increases mission module reliability.

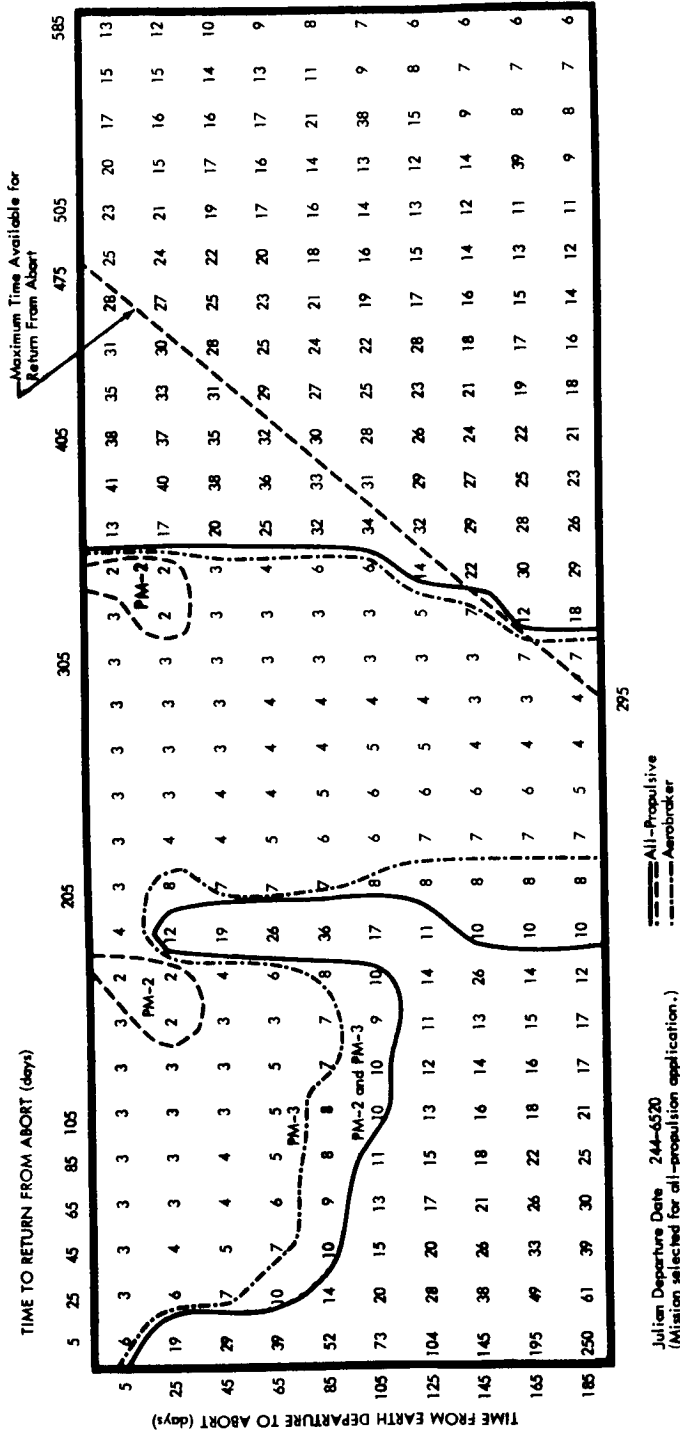

Figure 2.1-9: MISSION ABORT REQUIREMENTS  
 Abort Impulse (kilometers per second)

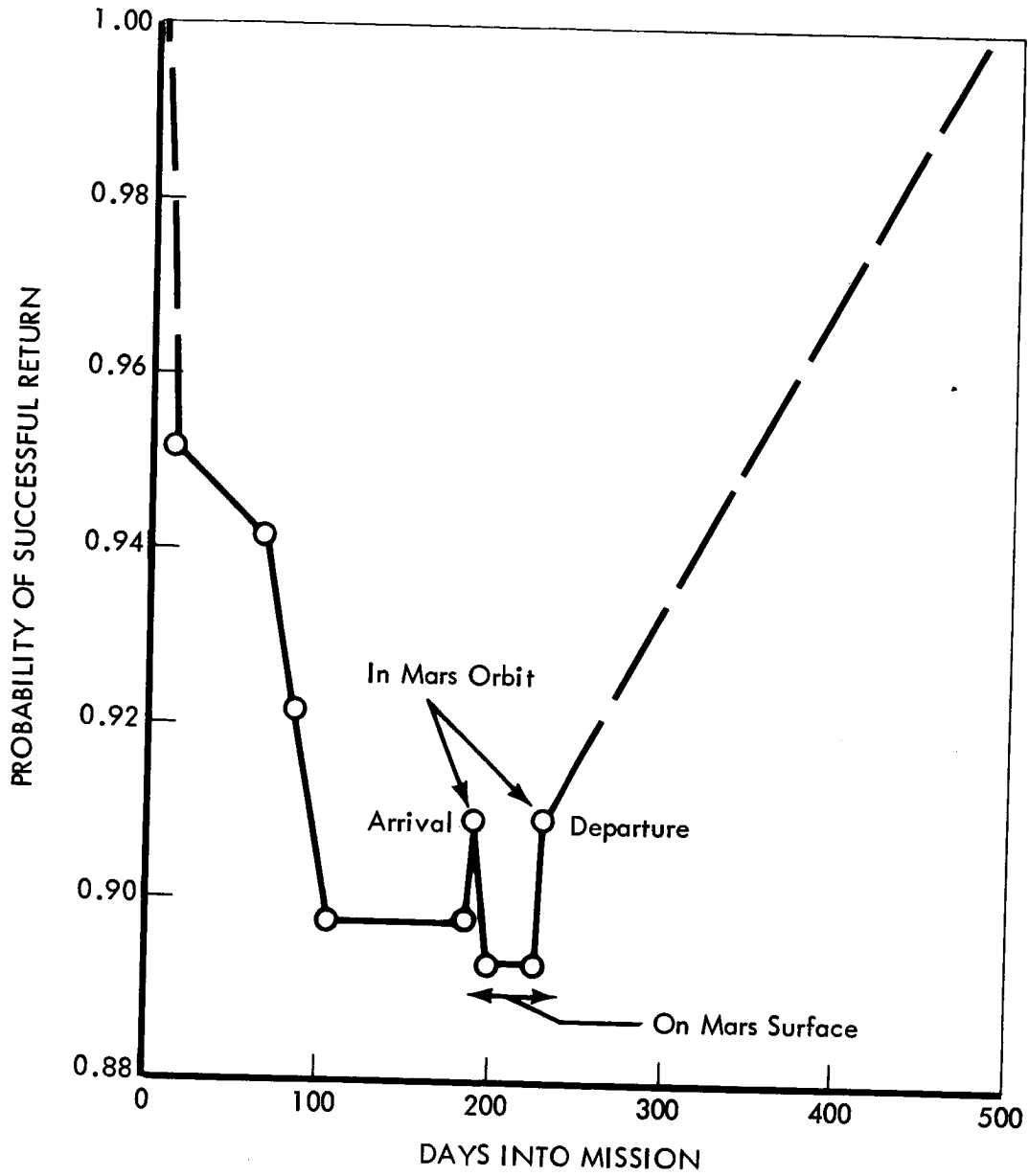

Figure 2.1-10: MARS 1986 OPPOSITION PROBABILITY OF SUCCESSFUL RETURN

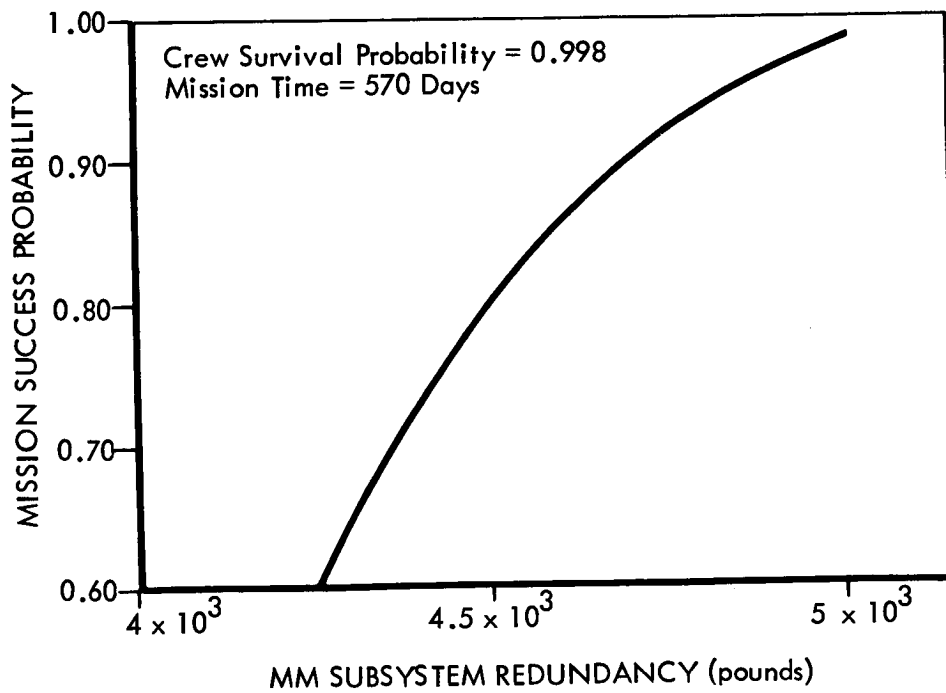

Figure 2.1-11: MM SUBSYSTEMS RELIABILITY

### 3.0 SYSTEM SENSITIVITIES ASSESSMENT

The recommended space vehicle provides the capabilities required to accomplish any reasonable interplanetary mission. The fuel transfer concept permits universal use of a common propulsion module, while permitting unique combinations of these propulsion modules to meet the energy requirements of particular missions. Efficient use is thus made of the total tankage, which in turn allows the design of a space vehicle that has common configuration for a wide variety of missions. The spacecraft itself uses a very similar configuration for all missions. Since emphasis has been placed on broad capability for a variety of missions rather than capability tailored specifically to each mission, a range of excess capability or discretionary performance margin is available for any particular mission.

This discretionary performance margin permits specific options to be considered for improving overall probabilities for crew safety and mission success. The margin can be used to add payload going into the planets, or leaving the planets, or both. Alternatively, some or all of the margin can be allocated to provide propulsion for increased launch windows, or simply for additional safety margins on energy requirements.

A series of technical sensitivities are assessed on the following pages. The curves are plotted to show how design changes in response to these sensitivities would change the recommended spacecraft weight. When an option has been selected for consideration, the effect of its weight value on the curve can be seen directly in Figures 2.1-2 through 2.1-5, earlier in this volume. The new weight increment will modify the present location of the black dot which indicates recommended spacecraft in relation to orbit and orbit departure payloads.

Sensitivities, which are plotted against an ordinate with the caption "LH<sub>2</sub> Capacity Remaining," must first be multiplied by the appropriate factors shown in Table 3.1-1. For example, on the 1984 opposition mission, 1 pound of LH<sub>2</sub> capacity remaining is equivalent to 0.60 lbm of additional Mars orbit payload or 0.21 lbm of additional Mars departure payload. For convenience, these conversion factors have been reproduced on the plots to which they apply.

Table 3.1-1: AVAILABLE PROPELLANT CAPACITY TO PAYLOAD CONVERSION FACTORS

<u>Mission</u>	<u>Planet Orbit Payload</u> / <u>LH<sub>2</sub> Capacity Remaining</u>	<u>Planet Depart Payload</u> / <u>LH<sub>2</sub> Capacity Remaining</u>
Mars 1982 Swingby	0.68	0.26
Mars 1984 Opposition	0.60	0.21
Mars 1986 Conjunction	0.68	0.36
Venus 1981 Short	0.44	0.20

### 3.1 ENVIRONMENTAL CONSTRAINTS SENSITIVITIES

The many environments to be traversed by manned interplanetary missions impose a variety of constraints upon the capabilities that will be required. Some of these constraints are being defined with increasing accuracy, and are significant primarily for the severity of the demands which they impose. The Earth launch environment and the nominal thermal/vacuum space environment might be so regarded. But other constraints contain more uncertainties, both as to the conditions which might be encountered and as to the severity of the demands which they might impose.

Some of the more important environmental uncertainties and constraints deserve major continuing attention. Astronauts may not be able to withstand zero "g" conditions over the long durations required by the missions, thus creating the need for artificial gravity capabilities. Meteoroid flux may be greater and may have more probability of penetration than expected. The Mars atmosphere composition, density and scale height may not correspond to the design models.

Several kinds of options should be considered for reducing the environmental hazards of future manned planetary missions. Need for additional precursor probes should be considered, to obtain valid data that might resolve or reduce the uncertainties about critical environmental constraints. New or modified design approaches may be considered, for increased capability to offset or even avoid some of the constraints. Also, over-design of certain hardware may be considered, to increase its tolerance of external hazards that display wide ranges of variation or persist at a critical level.

Specific environmental constraints are assessed on the pages immediately following. Their trends are shown by curves, which indicate the position of the recommended design and provide a reference base for examining the effects of alternate possibilities.

3.1.1 ARTIFICIAL GRAVITY EFFECTS

The recommended space vehicle is zero gravity. Its length-to-diameter ratio, however, and the placement of the habitable volume in the space vehicle train, make it adaptable to an end-for-end spinning configuration. No cable systems are required--even on the inbound leg. Figure 3.1-1 shows the LH<sub>2</sub> capacity remaining for both the zero and artificial gravity systems. The LH<sub>2</sub> penalty for artificial gravity is about 40,000 to 60,000 lbm.

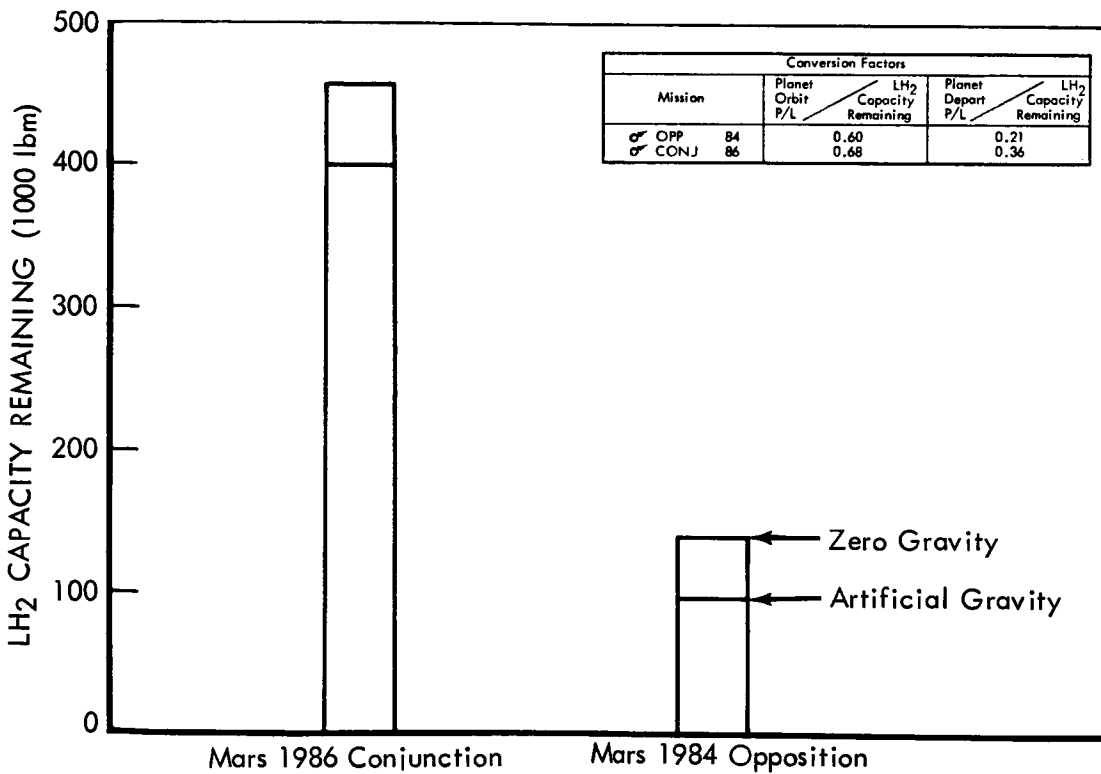

Figure 3.1-1: ARTIFICIAL GRAVITY EFFECTS

### 3.1.2 METEOROID ENVIRONMENT CHANGES

The meteoroid environment is the most uncertain of all environment parameters studied. Observational data obtained at Earth cannot be accurately scaled to the near-Mars vicinity. Also, since both asteroidal and cometary particles must be considered in meteoroid bumper design, the actual flux can be greatly different from the recommended flux model.

Meteoroid bumpers recommended in this study are designed to minimize the effect of such uncertainties in the meteoroid environment. The bumpers are used to carry launch loads and hence have safety margins well beyond the recommended flux model. Also, the bumpers are of multiple- (three) sheet design, which makes meteoroid damage dependent upon particle diameter. An asteroidal particle, therefore, would have to be about 10 times the mass of a cometary particle in order to do the same damage, and equal damage is the criterion for assessing the relative hazards of these different kinds of particles.

The recommended flux can be both increased and decreased by several factors in order to provide a general indication of the effects of changes in the meteoroid environment. Figure 3.1-2 shows the effect of such flux changes upon the meteoroid bumper unit weight. Note that reduction in the expected flux does not permit reduction in the weight of the meteoroid bumper unit, since it is designed to carry launch loads. For the Mars conjunction missions only, PM-3 bumper weight can be reduced by amounts up to  $0.5 \text{ lbm/ft}^2$ , because it is designed according to meteoroid penetration criteria.

The propellant-capacity effect of possible increased fluxes is shown in Figure 3.1-3. Increasing the flux by one or two factors has little effect on all missions because of the bumper design to carry launch loads. A 10-factor flux increase would have an extreme effect upon damage and penetration of bare surfaces. However, the effect upon multiple- (three) sheet design is much less, since particle diameter--not mass--is critical. (Particle diameter only increases as the cube root of the increased particle mass.)

Future changes in the estimated particle density, as well as flux, are probable. Because the multiple-sheet design is diameter dependent, increasing the density from the  $\rho = 0.25 \text{ gm/cm}^3$  would decrease the shield requirements, but would not change the weight of launch-load-designed bumpers. The same argument may hold for future changed estimates of the average particle velocity. Evidence indicates that multiple sheets vaporize faster particles better. However, shock waves are set up that cause other types of damage. In any event, multiple-sheet designs (three or over) are less sensitive to all meteoroid environment changes than are bare surfaces or single-sheet-bumper designs.

The launch-load-designed bumpers provide varying amounts of meteoroid protection. Only the conjunction missions require added bumper thickness to maintain  $P_0 = 0.997$  probability of no meteoroid penetration. The Mars opposition 1984 mission results in  $P_0 \approx 0.998$ . Figure 3.1-4 shows the amount of LH<sub>2</sub> capacity remaining as  $P_0$  is changed. The dotted lines reflect the added capacity attainable if the bumper launch loads are reduced.



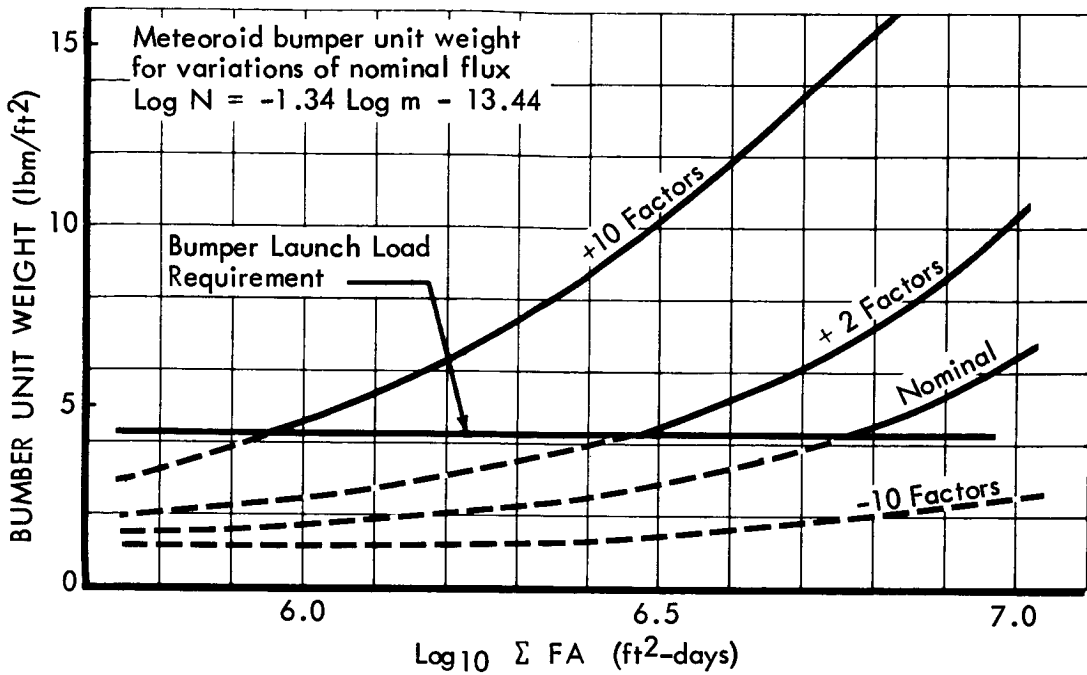

Figure 3.1-2: METEOROID BUMPER UNIT WEIGHT VERSUS FLUX

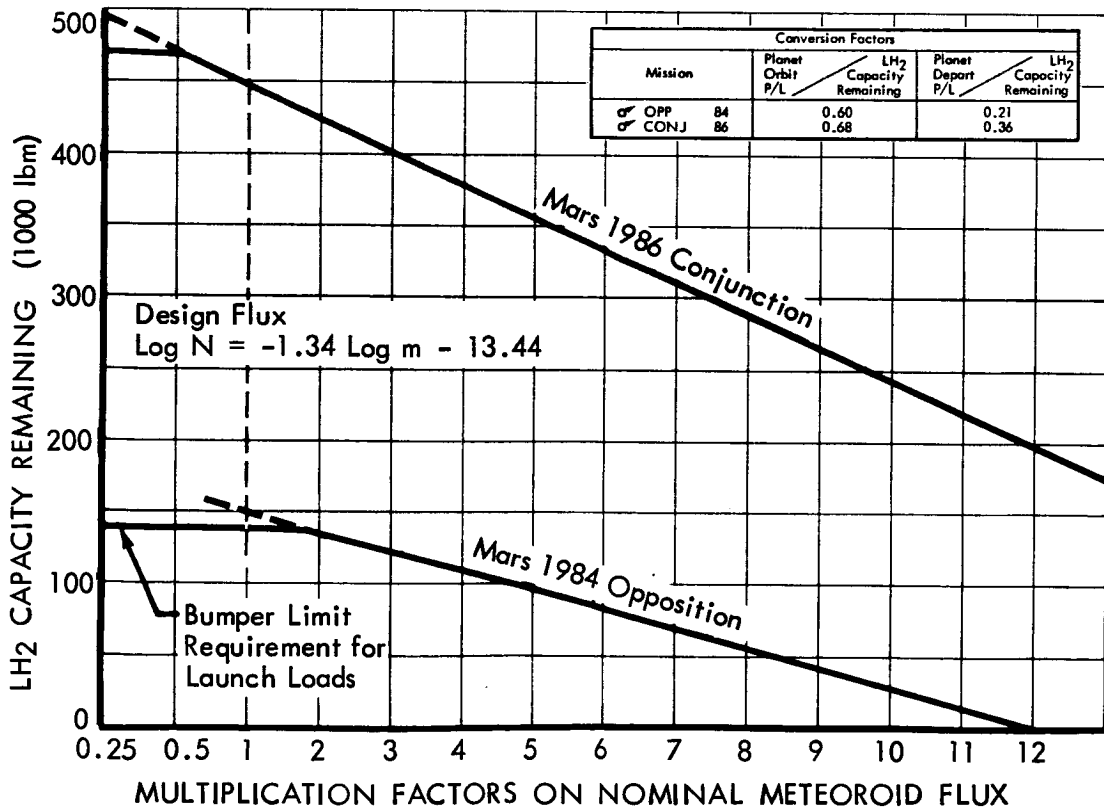

Figure 3.1-3: LH<sub>2</sub> CAPACITY REMAINING VERSUS METEOROID FLUX

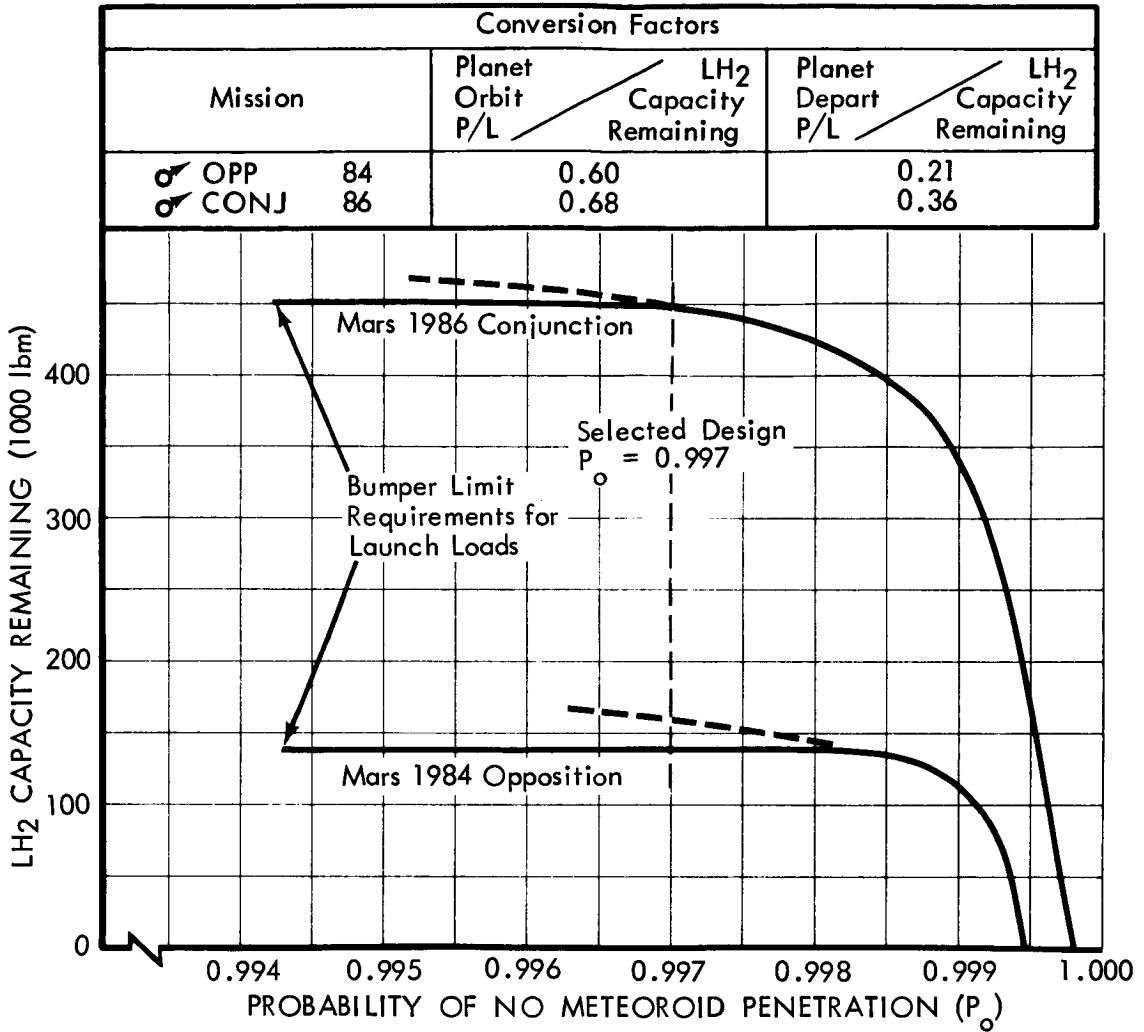

Figure 3.1-4: LH<sub>2</sub> CAPACITY REMAINING VERSUS METEOROID PENETRATION

### 3.1.3 MARS ATMOSPHERE EFFECT ON MEM

The most important Mars atmospheric effect is the near-surface density on the retardation and landing system. The Mars atmosphere composition, density, and scale height determine the type and weight of the MEM thermostructure. However, the thermostructure weight effect for the study entry conditions is much less than the retardation and landing system effect, and the density and atmospheric scale height effects the entry corridor depth.

Although the VM-7 and VM-8 model atmosphere have the same low surface pressure ( $P_0 = 5$  mb), the VM-7 atmosphere represents the worst case for the landing system. This is because the greater scale height would yield lower atmospheric densities at the near-surface altitudes for this system design. For a 10-millibar atmosphere such as VM-3, the retardation and landing requirements are much less than either VM-7 or VM-8. Additional work has been done to include the VM-3 atmosphere effects.

The most noticeable effect of the higher pressure ( $P_0 = 10$  mb) VM-3 atmosphere is that decelerator deployment can take place at lower Mach numbers, which lowers the aerodynamic pressure and heating loads considerably.

Atmospheric scale height changes contribute most to the MEM thermostructure weight effects, at the design entry conditions where  $V_E \approx 11,200$  fps (3415 m/sec). At this velocity, convective heat transfer is predominant and a combination of ablative and radiative heat shields yields the lowest total weight. With this design, the maximum thermostructure weight difference between the various model atmospheres is only about 200 lbm.

Figure 3.1-5 shows the Mars atmosphere effect on the total MEM weight. The all-retropropulsion deceleration and landing is comparable in weight to the ballute or parachute plus retro, especially in the denser VM-8 or VM-3 atmospheres. This is because the ballute or parachute systems include a redundant decelerator in each case. No weight effect has been assigned to the entry corridor difference, which is about 3 degrees less for the VM-8 atmosphere.

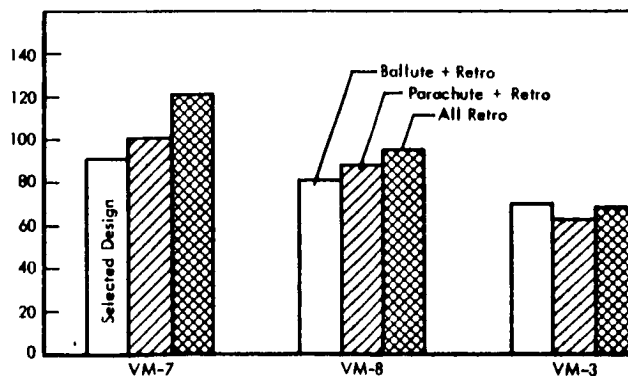

Figure 3.1-5: MARS ATMOSPHERE EFFECT ON MEM WEIGHT

### 3.2 MISSION DESIGN SENSITIVITIES

The nature, timing, and trajectories of a selected mission can often be modified sufficiently to increase the overall probabilities for crew safety and mission success.

Extended stay time in Earth orbit may become necessary, with a resulting loss of propellant capacity. Unfavorable phasing in relation to launch windows may increase acceleration ( $\Delta V$ ) requirements in order to get on the desired interplanetary trajectory. Elliptical orbits may prove acceptable for the scientific observations, and thus provide additional  $\Delta V$  capability. A redundant Mars excursion module or an extended stay time on the planet may be desired, but will incur corresponding weight penalties.

The most fundamental option in mission design is, of course, the selection of a particular class of mission and its phasing in relation to the synodic cycle of the target planet. But within this basic choice, there is a continuing need to refine options relating to scientific objectives, acceleration requirements, and capabilities for the particular mission.

Specific mission design sensitivities are assessed on the following pages. Their trends indicate the position of the recommended design and provide a reference base for examining the effects of alternate possibilities.

#### 3.2.1 EARTH ORBIT STAY-TIME EFFECTS

Figure 3.2-1 shows the effects of a change in the Earth orbit stay time (prior to PM-1 ignition). The mission module contributes no weight change to this curve since it is resupplied 30 days before PM-1 ignition in all cases. The LH<sub>2</sub> capacity remaining is reduced with increased Earth orbit stay time because of the thermal effects (insulation and boiloff) on the propulsion module LH<sub>2</sub> propellant. The slopes of the lines vary from 150 (Mars opposition 1984) to 450 lbm per day (Mars conjunction 1986).

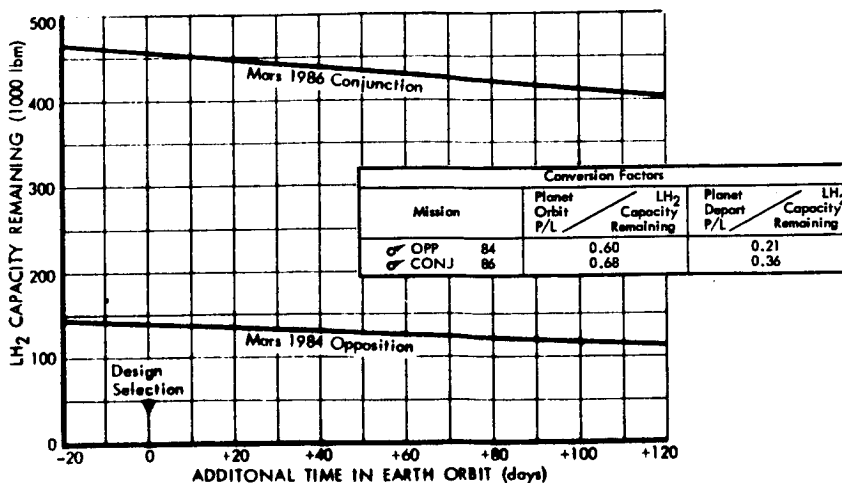

Figure 3.2-1: EARTH ORBIT STAYTIME EFFECTS

## 3.2.2 LAUNCH WINDOW SENSITIVITY

Except during launch window opportunities, additional maneuvers are required to get on the desired trajectory and the resulting total  $\Delta V_1$  requirement is shown in Figure 3.2-2, together with the total available  $\Delta V_1$ . The resulting launch window is split into two opportunities, one lasting about 3 days and the other lasting about 20 days. This pattern would repeat in about 55 days, but with somewhat higher nominal  $\Delta V$  requirements and less  $\Delta V$  capability, as noted in Section 3.2.1. Figure 3.2-3 shows the nominal  $\Delta V$  requirements and the corresponding propulsion module propellant requirements over a 30-day period for the 1982 Mars opposition mission. The given parking orbit at 28.5-degree inclination aligns with the required departure asymptote on two occasions during the 30-day period, allowing the use of the nominal  $\Delta V_1$ .

The recommended 3-1-1 space propulsion system has  $\Delta V_1$  performance margins (see tabulation in Section 2.1.2) for tradeoff against increasing launch windows. For the 1982 Mars opposition design mission (nominal departure date 244-4920), this  $\Delta V_1$  margin of approximately 0.09 km/sec yields an additional approximate 2 days beyond that provided for in the  $\Delta V_1$  capability designed into the space vehicle.

The definition of  $\Delta V$  requirements for launch window provision at both Earth and the planets is mission dependent. Further work for definition of specific launch window  $\Delta V$  requirements and for optimization of energy management should be done.

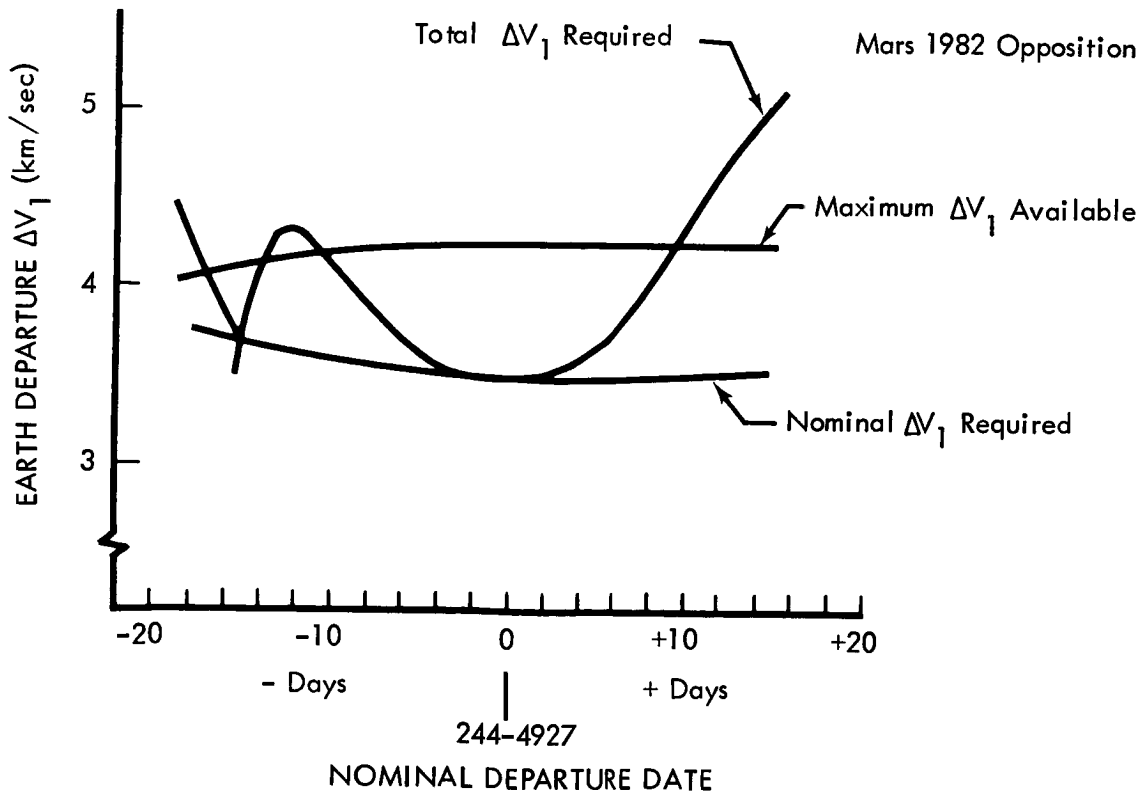
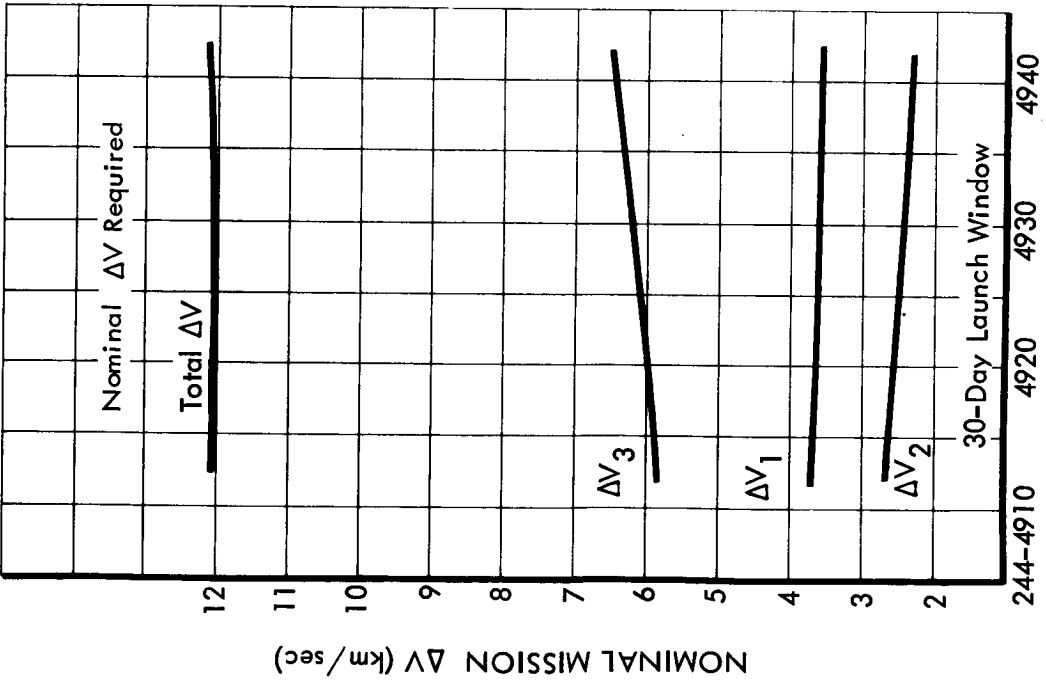
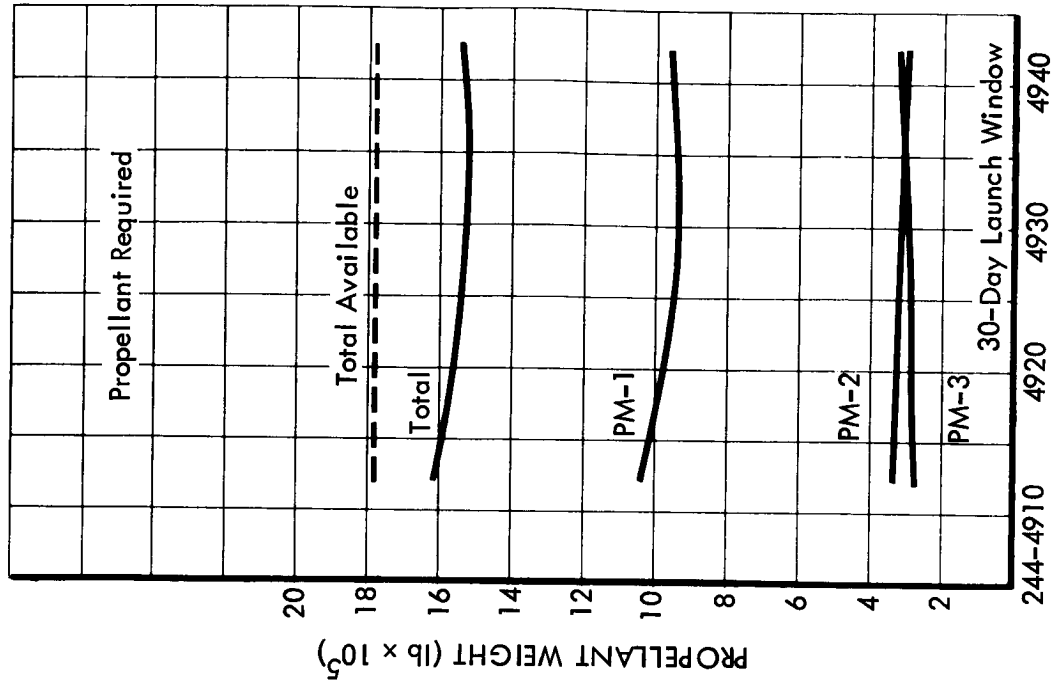

Figure 3.2-2: TOTAL  $\Delta V$  REQUIREMENT — MARS 1982 OPPOSITION MISSION



JULIAN EARTH DEPARTURE DATE

JULIAN EARTH DEPARTURE GATE

Figure 3.2-3: NOMINAL ΔV AND PROPELLANT REQUIREMENTS — MARS 1982 OPPOSITION MISSION

### 3.2.3 ELLIPTICAL ORBITS AT THE TARGET PLANETS

Substantial energy savings are available, particularly at Venus, if elliptical orbits are acceptable from the scientific standpoint, as compared with circular orbits. Figure 3.2-4 demonstrates the effect of such  $\Delta V$  savings on planet orbit and departure payload for a Mars and for a Venus mission. These two cases represent nearly the theoretical maximum  $\Delta V_2$  and  $\Delta V_3$  savings which may be realized.

The potential savings which apply to both  $\Delta V_2$  and  $\Delta V_3$  are shown in Figure 3.2-5 as a function of orbit eccentricity for periapsis of 1000 kilometers. The actual saving that can be realized is dependent on the specific mission and a detailed analysis of arrival and departure geometry is required. Balanced against the  $\Delta V$  savings is the relative penalty limiting scientific observations in orbit due to increasing apoapsis altitude.

The gains due to elliptical orbits are offset to some extent by the increase in energy requirements for the Mars lander, and to a lesser extent, for probes. The increase in Mars lander weight is shown as a function of orbit eccentricity in Figure 3.2-6.

These curves can be used together with the general performance curves in Section 2.1.2 to estimate performance for missions using elliptical orbits.

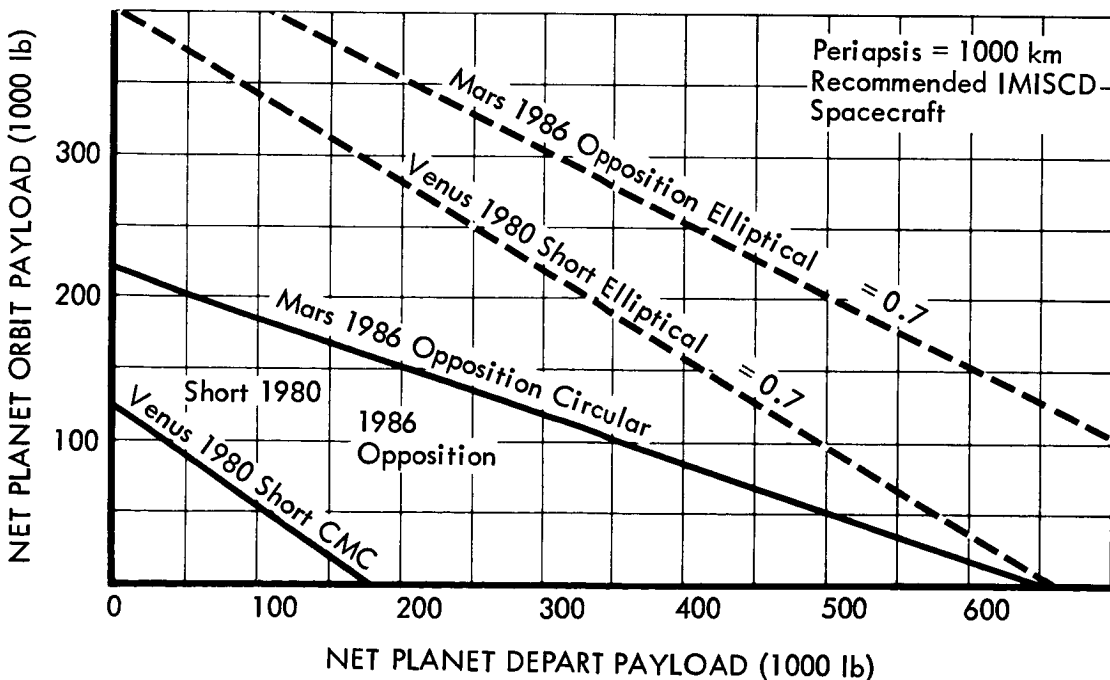

Figure 3.2-4: THE EFFECTS OF ELLIPTICAL ORBITS ON TWO TYPICAL MISSIONS

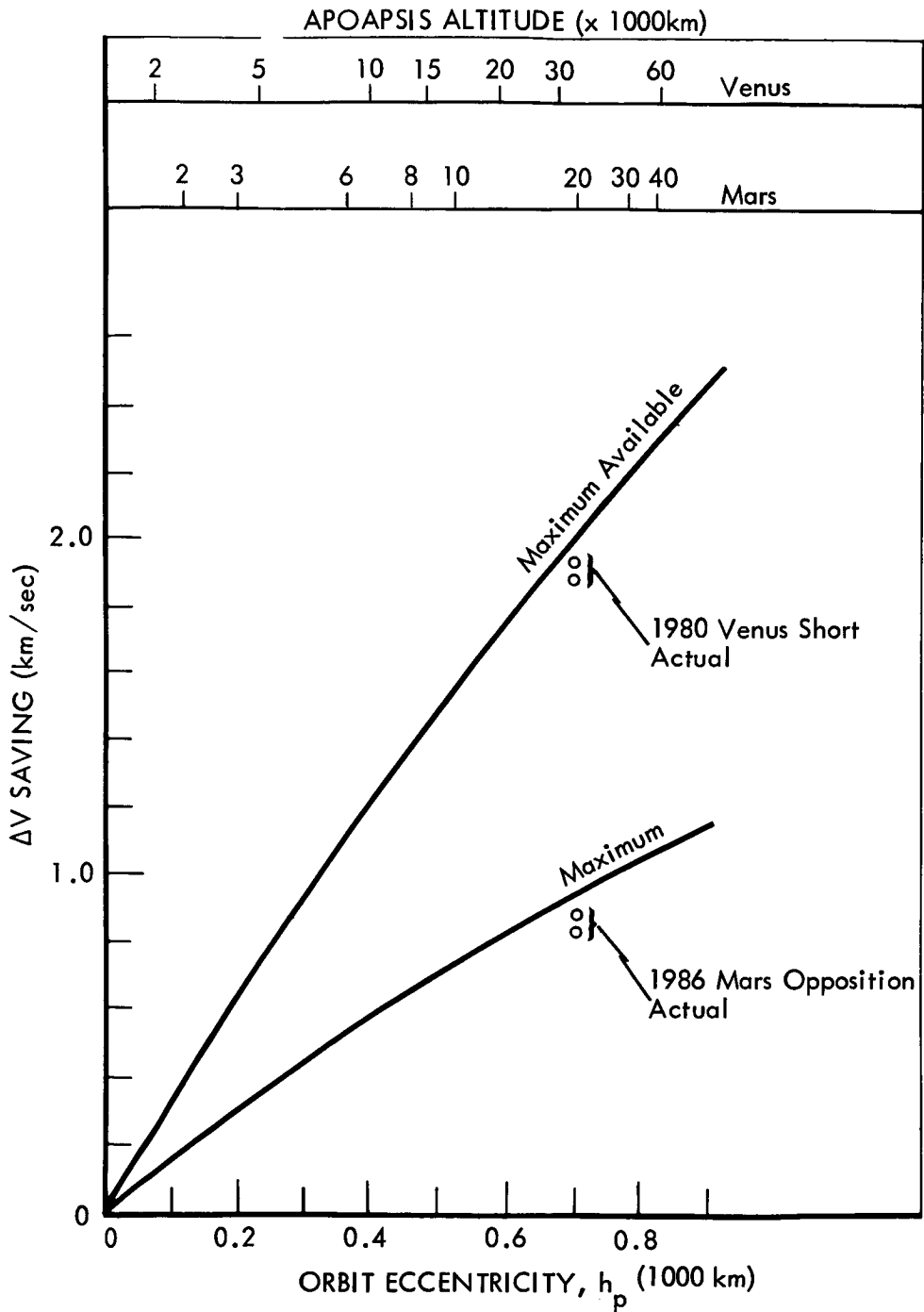

Figure 3.2-5: POTENTIAL SAVING ON  $\Delta V_2$  AND  $\Delta V_3$  RELATIVE TO CIRCULAR ORBIT  
 Periapsis Height ( $h_p$ ) = 1000 km



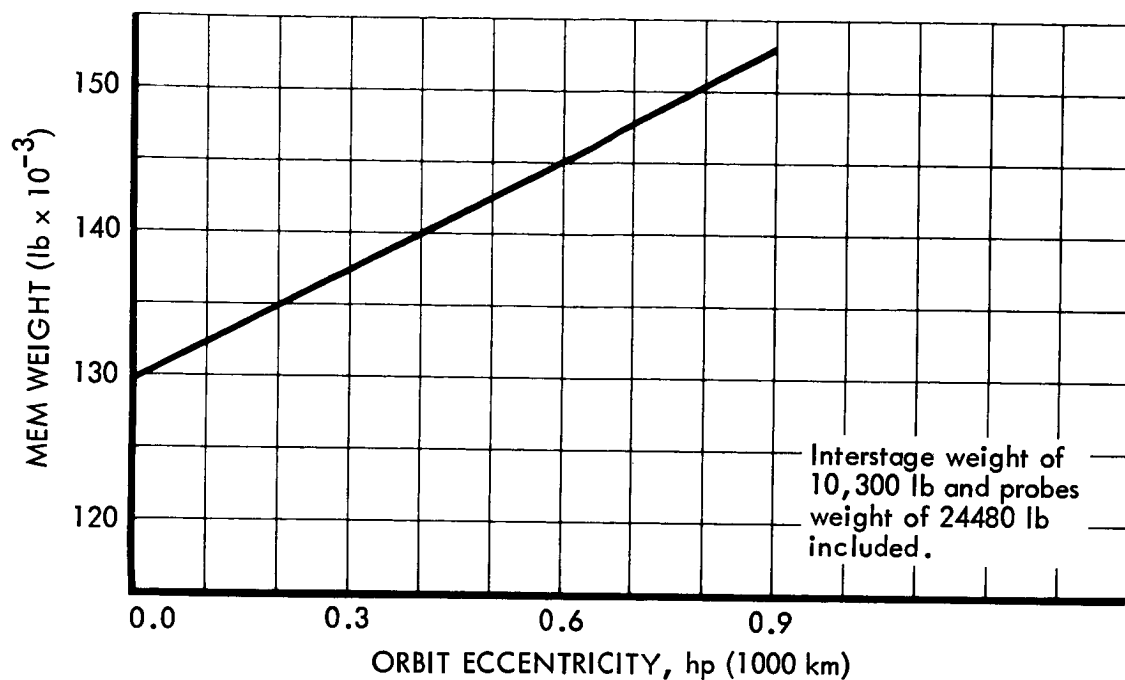

Figure 3.2-6: MEM WEIGHT VERSUS MARS ORBIT ECCENTRICITY

#### 3.2.4 REDUNDANT MEM EFFECTS

The inclusion of a redundant MEM requires the addition of approximately 100,000 lbm (including interstage) to the spacecraft. The MEM is part of the net Mars orbit payload shown in Figures 2.1-2 and 2.1-3. For this reason the redundant MEM effect on the 3-1-1 configuration capability can readily be determined for any Mars mission. Table 3.2-1 shows the missions that are still within the 3-1-1 capability with a redundant MEM.

Table 3.2-1: REDUNDANT MEM EFFECTS

Mars Missions	Missions with 3-1-1 Capability	
	1 MEM	2 MEM
Opposition 1982	X	
Opposition 1984	X	
Opposition 1986	X	X
Opposition 1988	X	
Conjunction 1980	X	X
Conjunction 1986	X	X
Swingby 1982	X	X

### 3.2.5 PLANET STAY-TIME EFFECT

Planet stay time can be affected by mission trajectory constraints or mission objectives. Conjunction missions permit long stay times that are limited only by MEM constraints. In general, the experiments of the baseline missions can be accomplished with a 30-day Mars stay time. The main limitation to the baseline surface operations is lack of mobility. Mobile units will require MEM redesign from the baseline design.

The effect of planet stay time on MEM weight thus depends on the amount of redesign. Minimum weight increase is associated with simple provision of added spares, expendables, and scientific material usage. Crew operations for minimum weight increase would involve intensive geological, biological, and chemical experimentation, essentially at the landing site. Findings would be analyzed and repetitive experiments made for verification.

Figure 3.2-7 shows the effect of Mars surface stay time on MEM weight. The lower curve shows the minimum weight increase with time. The upper curve shows more extensive experimentation which includes addition of a mobile vehicle and remote monitor stations for seismological, meteorological, and other continuous monitor-type experiments. These monitor stations would include independent power supplies and communication equipment. Stay time of about 100 days may include a redundant mobile vehicle and remote living-experiment stations for manned operation far from the landing site. The upper curve of Figure 3.2-7 includes these provisions on the MEM.

It should be noted that there is a limit to the optimal usage of a single MEM and one landing site. For long stay times, more effective planet coverage can be accomplished by placing additional unmanned soft landers on the surface or an additional descent stage for manned landing at another site. The conjunction missions have the greatest discretionary payload to Mars orbit and such capability may be used in this manner. Payload weight to Mars orbit of an additional descent stage would be about 70,000 lbm. Weight of unmanned soft landers can vary from about 2000 to 10,000 lbm depending on maneuvers required.

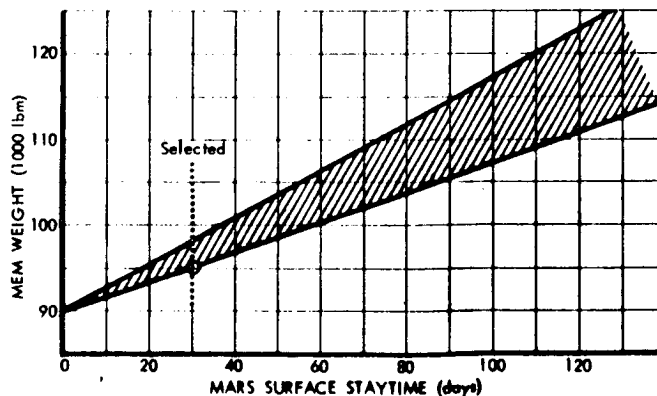

Figure 3.2-7: MEM WEIGHT VERSUS MARS STAYTIME

### 3.3 HARDWARE DESIGN SENSITIVITIES

The recommended space vehicle provides a conceptual baseline design with capability to perform any reasonable mission to Mars or Venus. This broad flexibility eliminates the need to "start from scratch" with a new-point design for each different mission possibility that might be considered. At the same time, the conceptual design provides a practical reference base for developing and evaluating trade studies to refine the hardware design.

Changes in Earth launch and space acceleration capabilities will, of course, directly modify payload capabilities for the mission. But many important options should receive continuing attention within established payload limitations. Scientific payload demands must be balanced against the weight penalties for improvements in structures, subsystem performance, planetary stay time, and other operational needs. All elements of the space vehicle must be subjected to continuing appraisal and refinement for possible improvement of overall probabilities for crew safety and mission success.

Specific hardware design sensitivities are assessed on the following pages. Performance trends indicate the position of the recommended design and provide a reference base for examining the effects of alternate possibilities.

3.3.1 SPACE ACCELERATION SENSITIVITIES

3.3.1.1 Nuclear Engine Thrust Effects

The recommended propulsion modules use one Nerva engine (thrust = 200,000 lbf) per module. Figures 3.3-1 and 3.3-2 show the planet orbit and departure payload capabilities (3-1-1) comparing this 200,000-pound thrust with a 100,000-pound thrust per module. For the two missions shown, the reduction in engine system and interstage weight overbalances the increased gravity losses associated with the lower thrust engine.

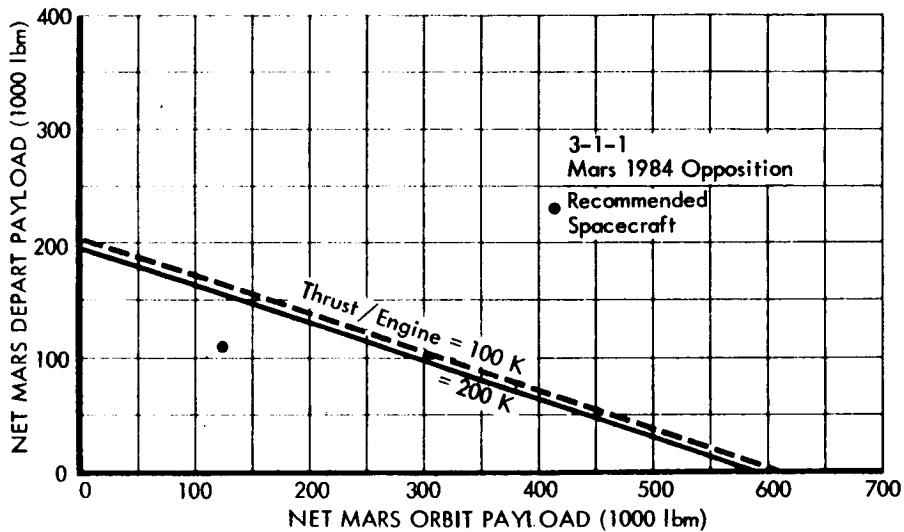

Figure 3.3-1: ENGINE THRUST EFFECTS—MARS 1984 OPPOSITION

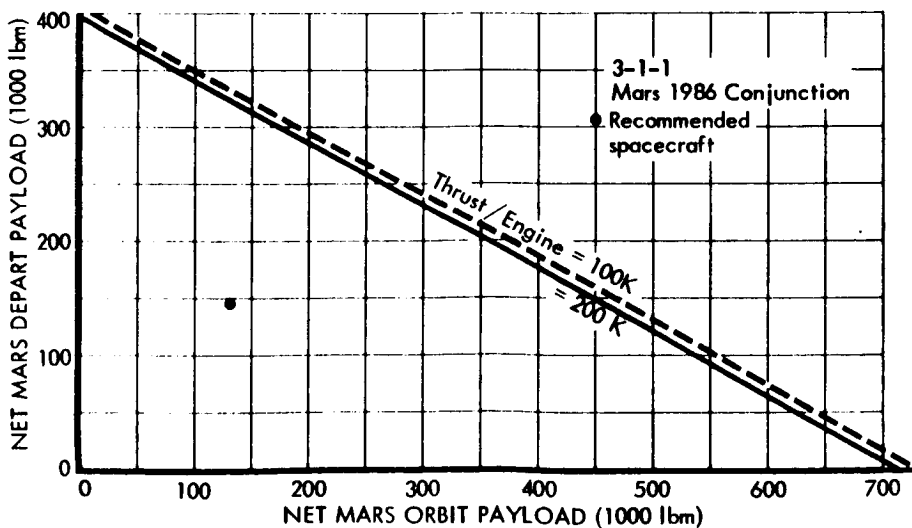

Figure 3.3-2: ENGINE THRUST EFFECTS — MARS 1986 CONJUNCTION

3.3.1.2 Specific Impulse Effects

The early stage of development of the Nerva engine makes it difficult to determine at this time what the delivered specific impulse will eventually be. For this reason Figure 3.3-3 shows the LH<sub>2</sub> capacity remaining for 50 seconds of specific impulse change on either side of the nominal 850 seconds. The 3-1-1 configuration reaches its capacity on the Mars 1984 opposition mission at a specific impulse of approximately 815 seconds.

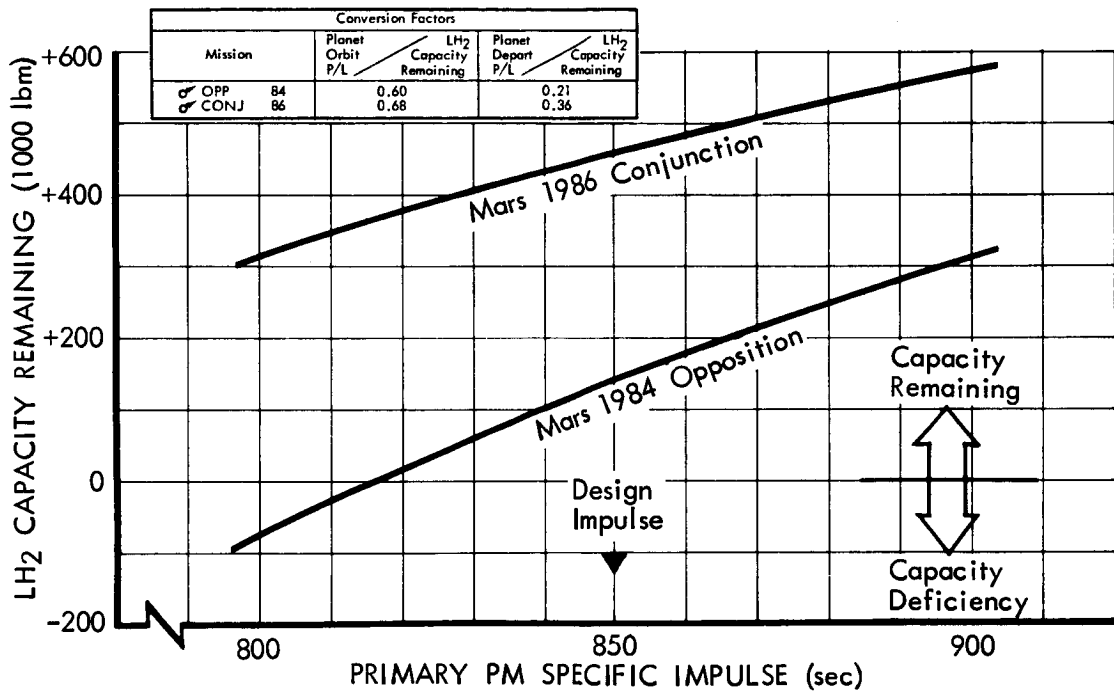

Figure 3.3-3: SPECIFIC IMPULSE EFFECTS

3.3.1.3 Nerva Engine Weight Effects

The Nerva engine is still in the very early stages of development. Along with its shield, it is also a very heavy item (28,530 lbm). Figure 3.3-4 shows the LH<sub>2</sub> capacity remaining with change in the Nerva engine weight. The 3-1-1 configuration will reach its capacity on the Mars 1984 opposition mission if the Nerva engine weight increases by 57%.

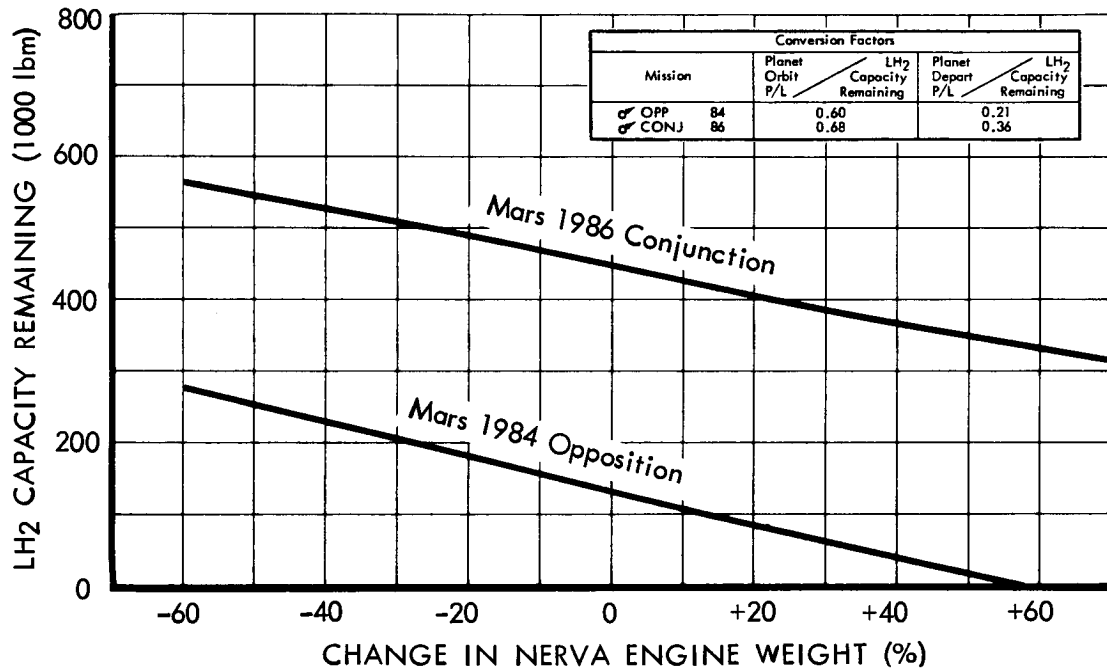

Figure 3.3-4: NERVA ENGINE WEIGHT EFFECTS

## 3.3.1.4 Alternatives If Nuclear Engine is Unavailable

Alternatives to the recommended nuclear space acceleration system were evaluated on the basis of data developed during this study. Competing space acceleration systems were compared on a total-cost basis for five example missions covering a broad range of energy requirements as well as representative classes of missions to both Mars and Venus. If the nuclear engine were unavailable, the number of candidate space acceleration systems would be reduced to two: the all-chemical system (CCC), and the chemical-aerobraker system (CAC).

CCC and CAC Evaluation---The CCC and CAC space propulsion systems have been compared using the recommended SAT-V-25(S)U. Only the tailored-module concept was considered, since the much larger spread of initial mass into Earth orbit (IMIEO) makes the common-module approach appear less attractive for the CCC and CAC systems than for the NNN. Table 3.3-1 summarizes the evaluation of CCC and CAC systems, and includes comparable NNN data for reference purposes. The differences are discussed more fully in the following paragraphs.

Table 3.3-1: CCC AND CAC EVALUATION--SAT-V-25(S)U

Space Acceleration Candidates	SAFETY	UTILIZATION IMIEO Sensitivity (5 Mission Avg)	COST Program (5 Missions)	CRITERIA			
				WEIGHT IMIEO Range (10 <sup>6</sup> lb)	RISK	COMPLEXITY Orbital Assemblies (5 Missions)	Special Problems
NNN	Radiation Hazard	12.8	\$32.2	1.7-2.3	<ul style="list-style-type: none"> <li>• Nuclear Engine Development</li> <li>• Long Term Cryogenic Storage</li> </ul>	23	PM-2 Disposal
CCC		29.9	\$39.1	2.6-5.1	<ul style="list-style-type: none"> <li>• Long Term Cryogenic Storage</li> </ul>	46	Multi- Modules Per Stage
CAC	Abort Difficulty	10.7	\$38.8	1.6-3.2	<ul style="list-style-type: none"> <li>• Atmosphere Uncertainty</li> <li>• Aerodynamic Braking</li> <li>• Long Term Cryogenic Storage</li> </ul>	26	Deploying Aero Shroud  Orbital Assembly of Aero Shroud

Safety--The aerobraker system's abort capability is much less than the all-chemical since the aerobraker does not have an impulsive  $\Delta V$  capability for planet capture that, in the all chemical system, can be used for abort. The dynamics of the aerobraking maneuver itself presents some safety risk. The all-chemical system appears best from the safety standpoint.

Utilization--Since all candidate systems were configured to accommodate all the representative missions considered, the factor considered here was IMIEO sensitivity or the IMIEO required per pound of spacecraft placed on the final Earth return trajectory. The CAC system is superior to the CCC system by a factor of nearly three. The IMIEO sensitivity factors shown are applicable to only small changes in payload (up to 50,000 pounds) for the aerobrakers since no change in size in the aerodynamic shroud was considered.

Cost--The costs of the CCC and CAC systems are comparable and differ slightly in favor of the CAC system. The CAC system's R&D and flight test costs are higher than the CCC system. However, the heavier CCC system requires 22 more ELV's for a five-mission program including spare ELV's.

Weight--The CAC system has a much lower IMIEO than the CCC system. The values shown are those pertaining to Mars 1986 conjunction and Mars 1982 opposition missions for each candidate.

Risk--The problem of developing provisions for long-term cryogenic storage is common to all candidates. Aerobraker systems also have development problems associated with aerobraking provisions and maneuver techniques, as well as dependence on definition of the planetary atmosphere.

Complexity--The CCC requires 20 more orbital assemblies than the CAC. The CCC system with its multimodule configurations has complicated stage and interstage assembly in orbit. For example, the CCC system configuration for the Mars 1982 opposition mission requires seven launches to place the PM-1 modules into orbit. Since seven engines are not required, intramodule connection of fluid lines are included in the orbital assembly operations. On two of the five CAC missions, orbital assembly interfaces that may present difficult orbital assembly problems occur within the aerobraking structure. Also, aerobraker shrouds must be deployed for radiator, communication-antenna, and experiment-sensor operation during the intransit phase and must be jettisoned after the planetary capture maneuver.

Summary--In the event that nuclear systems are unavailable, the manned Mars interplanetary missions can be performed with either CCC or CAC systems. The CCC system is complicated by its very large IMIEO's, which result in a numerous launches and orbital assemblies. The CAC system's major problems appear to be the development of an adequate aerobraker shroud with deploying capability and the testing of entry dynamic techniques. The CAC system also requires some orbital assembly that may present problems.

There are two approaches that would eliminate or reduce the orbital assembly problem. The first is the use of a post-Saturn launch vehicle as evaluated in the space acceleration/ELV trade. The other is the use of an orbital tanking mode. Further detailed study would be required to determine the best approach.



## 3.3.1.5 Effect of Secondary Propulsion Systems

Several candidate propellants and propulsion systems can be considered for the midcourse and orbit trim propulsion maneuvers. The recommended choice of FLOX/CH<sub>4</sub> propellants results in system weights midway between those of undeveloped high-performance combinations, such as H<sub>2</sub>O<sub>2</sub>/BeH<sub>2</sub>, and those of fully developed storables, such as N<sub>2</sub>O<sub>4</sub>/Aerozine -50. Use of the space-storable OF<sub>2</sub> oxidizer combinations would yield weights comparable to the selected combination.

Figure 3.3-5 shows the maximum and minimum weights of each secondary propulsion system, when using FLOX/CH<sub>4</sub>, N<sub>2</sub>O<sub>4</sub>/Aerozine -50, and H<sub>2</sub>O<sub>2</sub>/BeH<sub>2</sub> combinations. The outbound midcourse correction and orbit trim systems do not vary greatly from mission to mission with changes in discretionary payload sum to Mars and to Earth.

The inbound midcourse correction system, however, is greatly affected by the distribution of the discretionary payload. The maximum IBMC system results when the discretionary payload is used for increasing the Earth-return payload, while the minimum IBMC weight occurs when the discretionary payload capability is used for Mars payload.

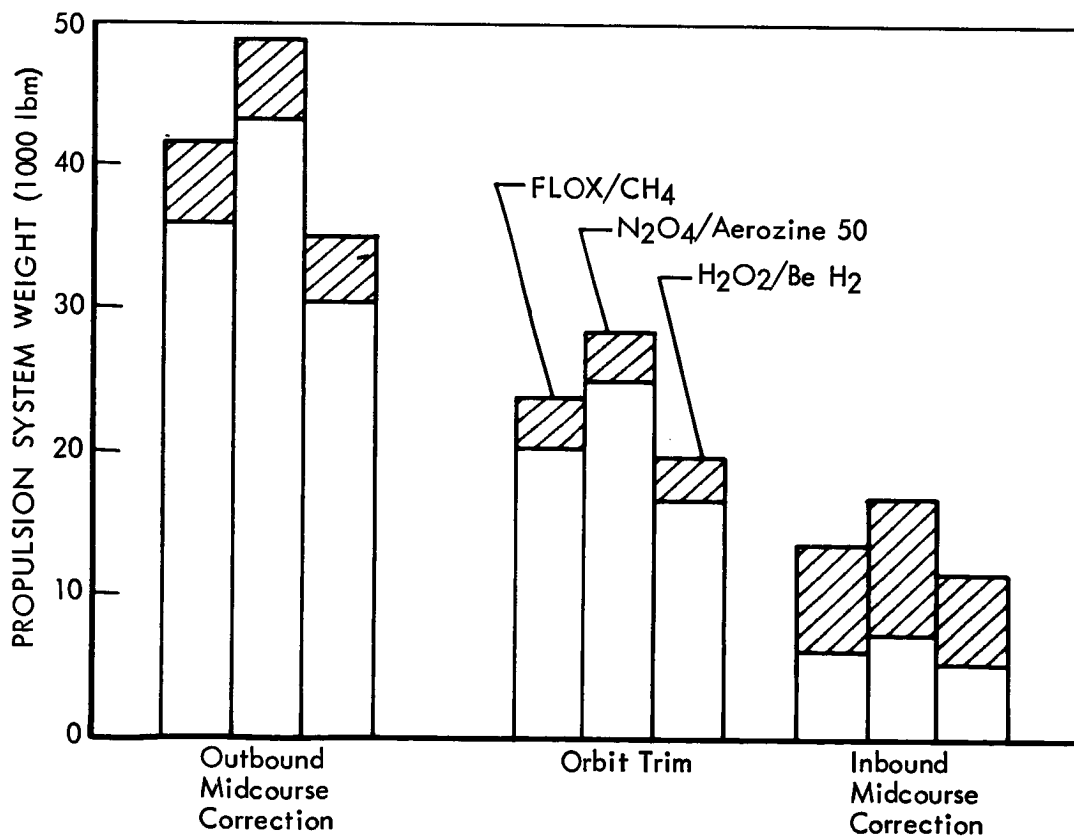

Figure 3.3-5: SECONDARY PROPULSION SYSTEM WEIGHT VERSUS PROPELLANT

3.3.2 SPACE VEHICLE STRUCTURE SENSITIVITIES

3.3.2.1 Meteoroid Shield Weight Effects

For the two missions shown in Figure 3.3-6, the total propellant required to accelerate all the space vehicle meteoroid shields is approximately 100,000 lbm. The use of advanced materials, such as beryllium, for the meteoroid shields has not been investigated. Figure 3.3-8 shows, however, that even if a 50% reduction in the meteoroid shield weight were possible, the LH<sub>2</sub> capacity remaining would only be increased by approximately 50,000 lbm. A considerably greater payload capability effect would result if the PM meteoroid shields were not jettisoned prior to the ignition of each PM.

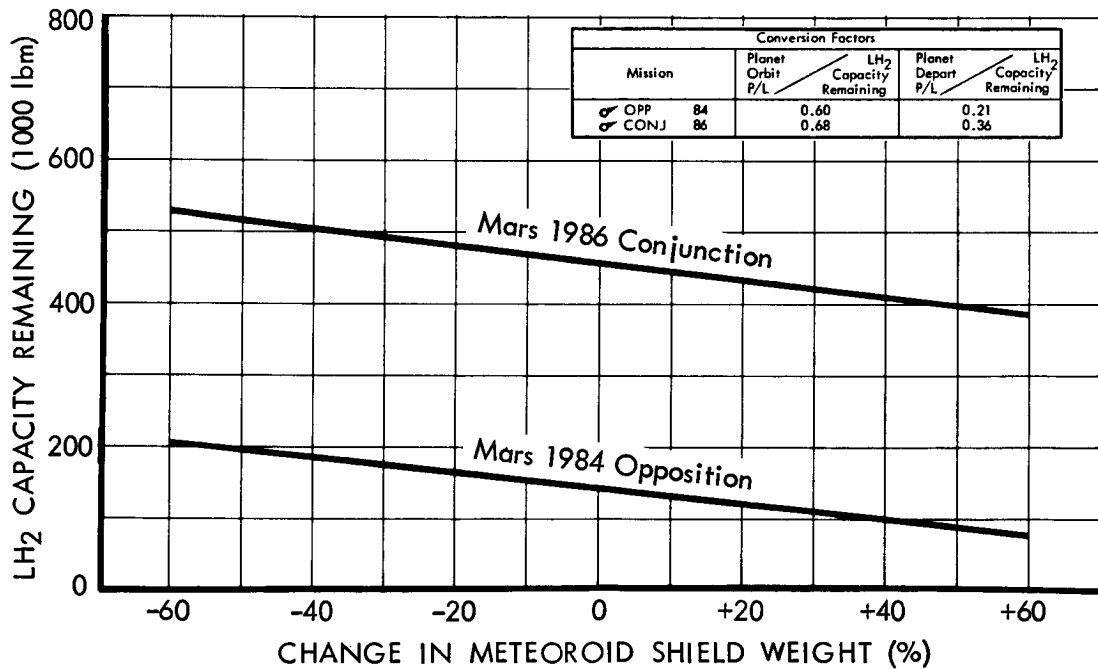

Figure 3.3-6: METEOROID SHIELD WEIGHT EFFECTS

3.3.2.2 Interstage Weight Effects

For the two missions shown in Figure 3.3-7, the total interstage (spacecraft and PM) weight is approximately 76,000 lbm. The total PM propellant required to accelerate these interstages ranges from 70,000 to 90,000 lbm (the PM-1 aft interstage is not accelerated beyond Earth orbit). The use of advanced structural materials to reduce interstage weight has not been considered for this study. Figure 3.3-8, however, shows that even if a 50% reduction in all the interstage weights was possible, the change in LH<sub>2</sub> capacity remaining would be only about 35,000 to 45,000 lbm.

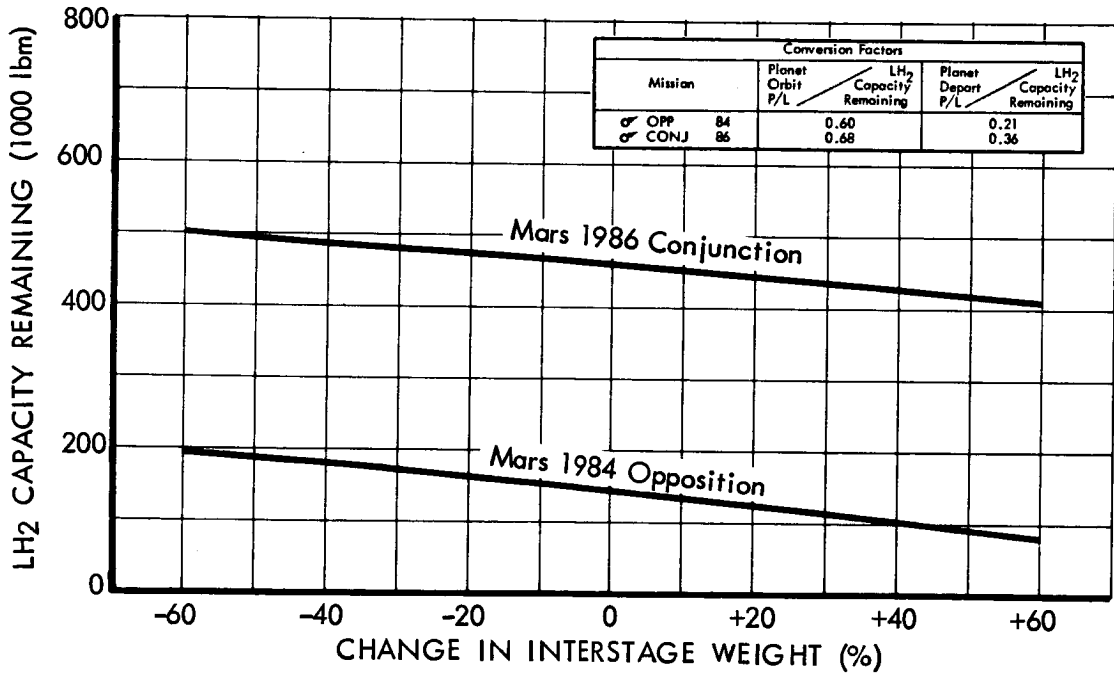

Figure 3.3-7: INTERSTAGE WEIGHT EFFECTS

3.3.2.3 Jettisoned Structure Effect

The recommended space vehicle reflects a design that jettisons the meteoroid shield just before ignition of that PM. The outer interstage, which carries the Earth launch loads, is jettisoned after docking in Earth orbit. Figure 3.3-8 shows that propellant capacity remaining for (1) having a single interstage that is designed by Earth launch loads, (2) not jettisoning the meteoroid shield, and (3) having Earth launch interstages and not jettisoning the meteoroid shield. Note that the 3-1-1 configuration is inadequate for the 1984 opposition mission when the meteoroid shield is not staged.

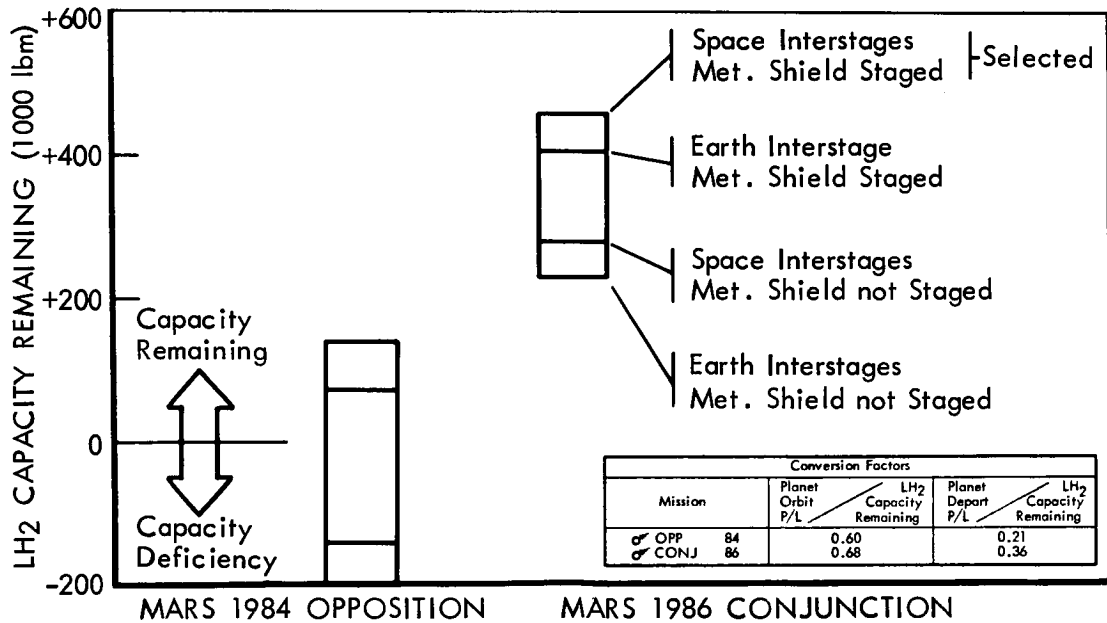

Figure 3.3-8: JETTISONED STRUCTURE EFFECT

3.3.3 SPACECRAFT SUBSYSTEM SENSITIVITIES

3.3.3.1 Effect of Power System Selection

Main candidates for the primary power source are therman reactor-Rankine, isotope-Brayton, and solar cell. The design mission time period could also include development of fast reactor and solar concentrator systems. The effect of the power system selection upon the mission module design is shown in Figure 3.3-9. Included are all penalties associated with integrating the power system into the design. For these purposes, the worst-case mission of Mars 1986 conjunction was chosen.

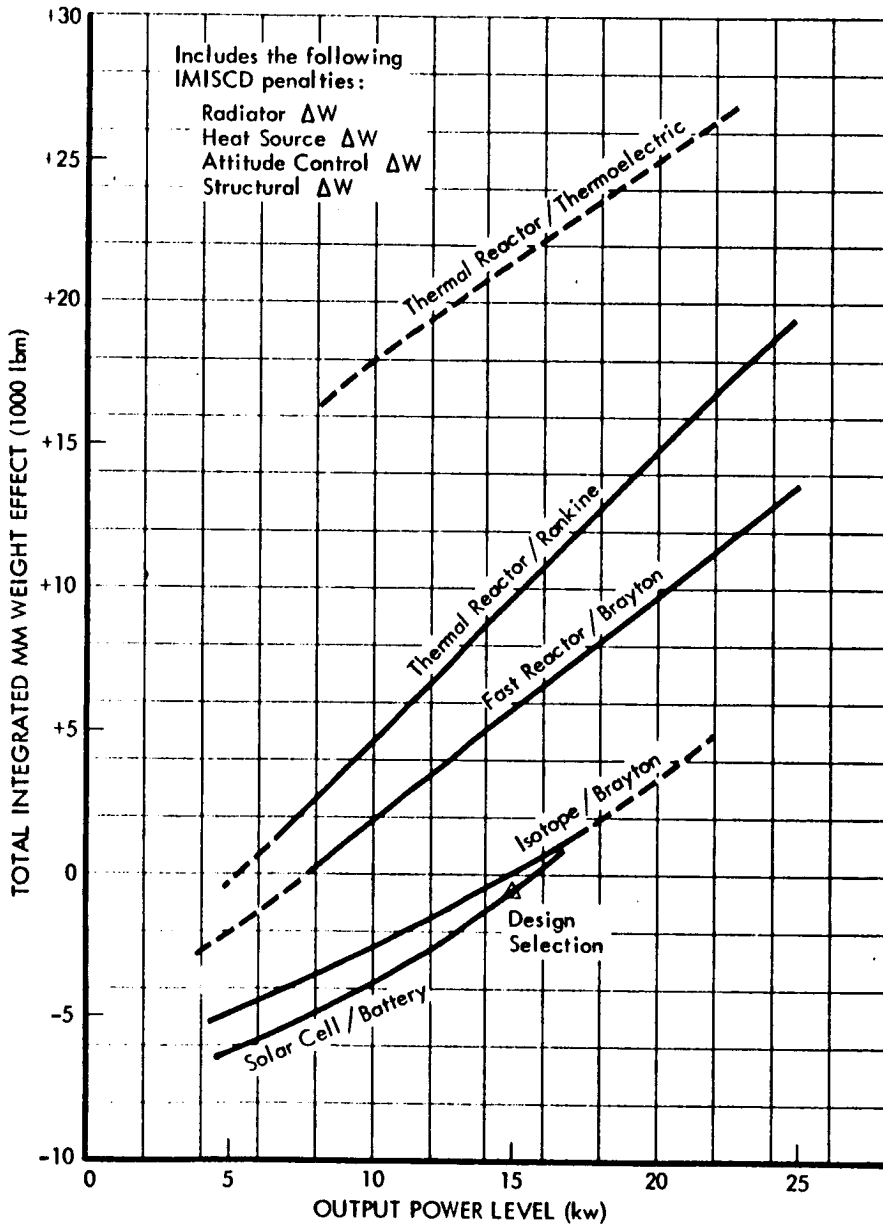

Figure 3.3-9: EFFECT OF POWER SYSTEM SELECTION

### 3.3.3.2 Effect of Atmosphere Supply System Selection

Metabolic requirements and atmosphere leakage yield the greatest mission time-dependent variable weights. The atmosphere supply system selection offers several choices differing greatly in amount and type of expendable usage. The selected system includes gaseous atmosphere supplies, Bosch process oxygen regeneration equipment and water for oxygen makeup. It represents approximately 10% of the mission module weight.

Three other types of basic systems are candidates; these being open cycle oxygen supplies, Sabatier process methods and CO<sub>2</sub> direct reduction processes (no electrolysis). The Sabatier processes require more water makeup than the Bosch, depending on leakage rates, as noted in Section 3.3.3.3. The CO<sub>2</sub> direct reduction processes require oxygen makeup (from O<sub>2</sub> storage or water electrolysis).

Figure 3.3-10 shows a comparison of candidate atmosphere supply system weight versus mission time. Power requirements are also shown, based on an average power penalty of 400 lbm/kw for the isotope-Brayton power supply. The Sabatier process requires about 25% less power than the Bosch. The CO<sub>2</sub> direct reduction process requires about one-half as much power (approximately 1.7 kw), due to the absence of electrolysis units.

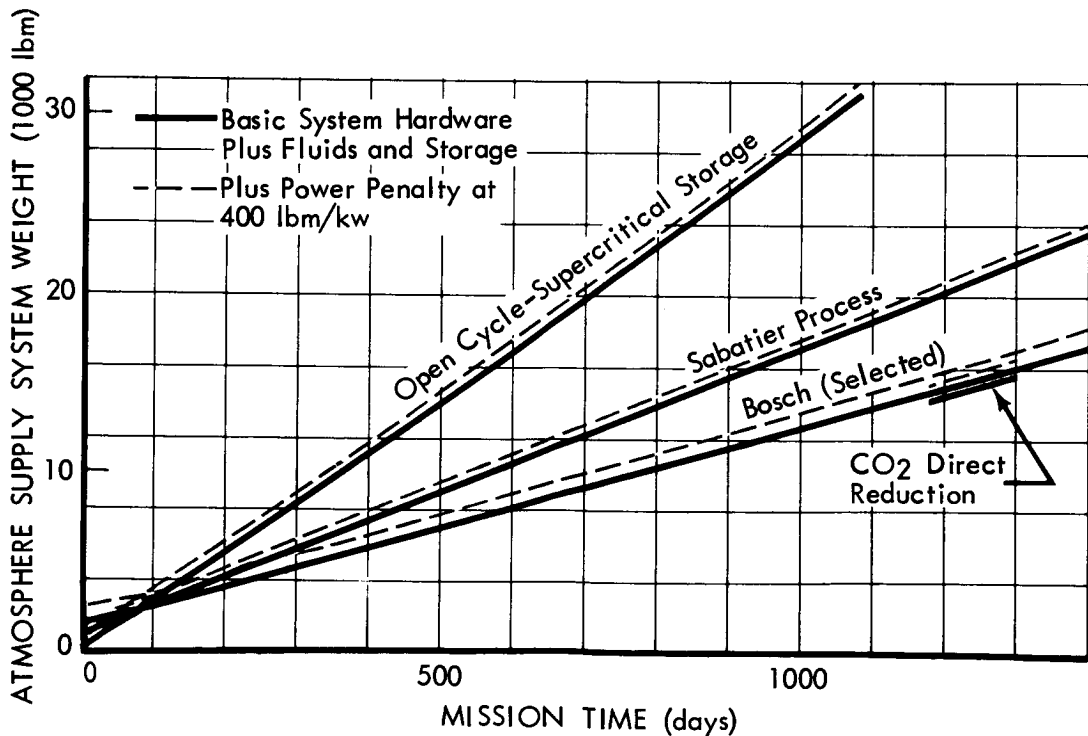

Figure 3.3-10: ATMOSPHERE SUPPLIES VERSUS MISSION TIME

### 3.3.3.3 Effect of Atmosphere Leakage

Atmosphere leakage from the mission module is a variable that can be estimated with only a fair degree of accuracy. The recommended design value of 2 lbm/day (0.9 kg/day) is based on a minimum number of pressure shell penetrations--camera airlock, pointing and tracking scope, two egress hatches, and a single umbilical. Joint leakage to meet this requirement must average about 0.03 lbm/in.-day (0.54 g/cm-day) during the course of the mission. The associated start of mission requirement may be as low as 0.001 lbm/in.-day (0.18 g/cm-day), depending on the amount of joint movement during launch and the inspace activity.

Selection of the CO<sub>2</sub> reduction system for oxygen regeneration depends somewhat on the amount of atmospheric leakage. The Bosch system does not discharge hydrogen overboard, whereas a Sabatier system loses hydrogen in the discharged methane product, thus requiring more metabolic water makeup. However, as atmospheric leakage of O<sub>2</sub> increases, additional water for O<sub>2</sub> production is required. The Sabatier system can use the additional H<sub>2</sub> produced, whereas the Bosch cannot. Figure 3.3-11 shows the effect of atmospheric leakage on the metabolic water makeup requirements for a six-man crew. At a leakage rate of about 13 lbm/day (5.9 kg/day), the two systems require almost equal amounts of water makeup.

Figure 3.3-12 shows the effect of leakage rate on mission module weight. The major portion of the differential weight is water, gaseous nitrogen, tankage, and structural accommodations. Included also are associated increments of electrolysis units, Bosch reactors, and the power penalty.

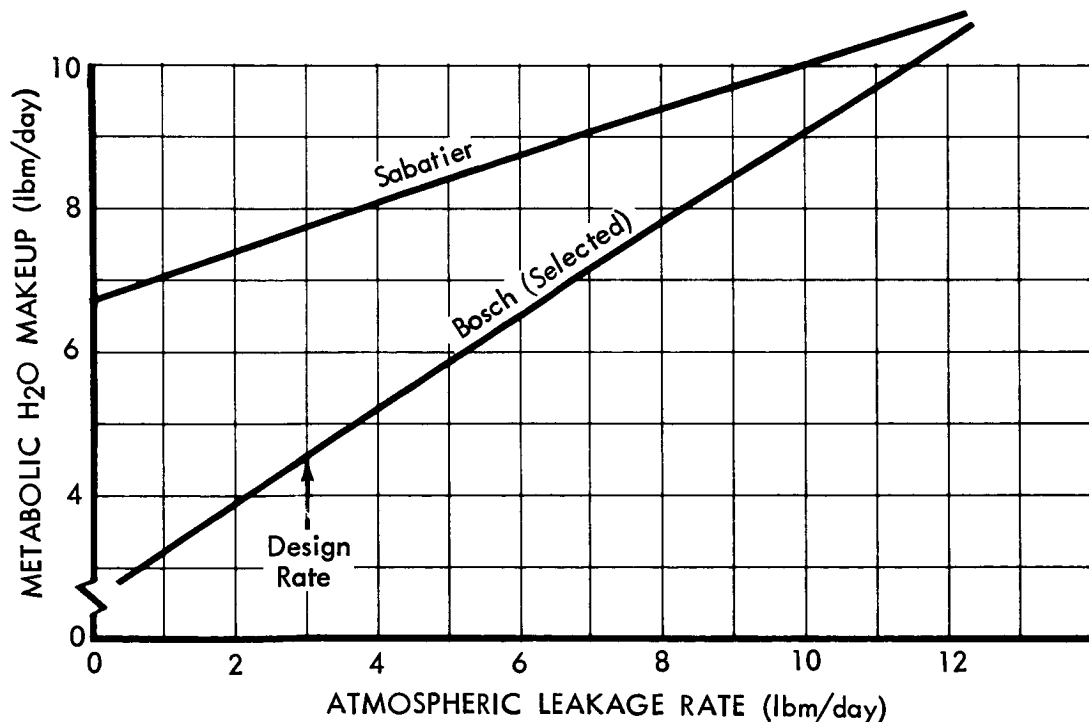

Figure 3.3-11: ATMOSPHERIC LEAKAGE EFFECT ON METABOLIC WATER MAKEUP

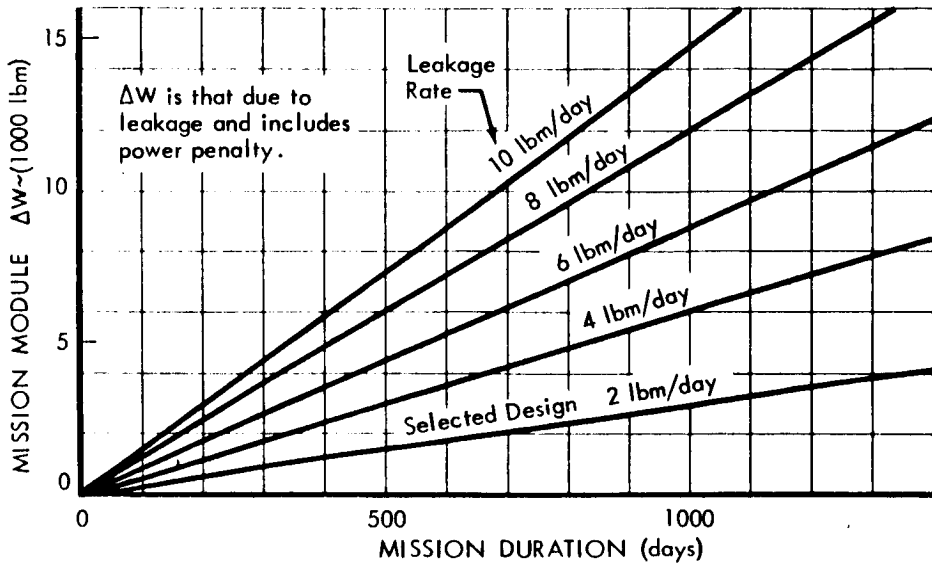

Figure 3.3-12: EFFECT OF LEAKAGE RATE AND MISSION DURATION

3.3.3.4 Effect of Communication Bit Rates

The effect of communication bit-rate changes on the two recommended communication systems is shown in Figure 3.3-13. The laser primary system effects are based on maintaining a signal-to-noise ratio of 20 db with a 1-meter-diameter transmitting aperture. Thus, the mission module weight change is due mainly to modulation power. The S-band system effects are shown for maintaining the same 10-foot-diameter antenna, and also for optimizing antenna diameter and power.

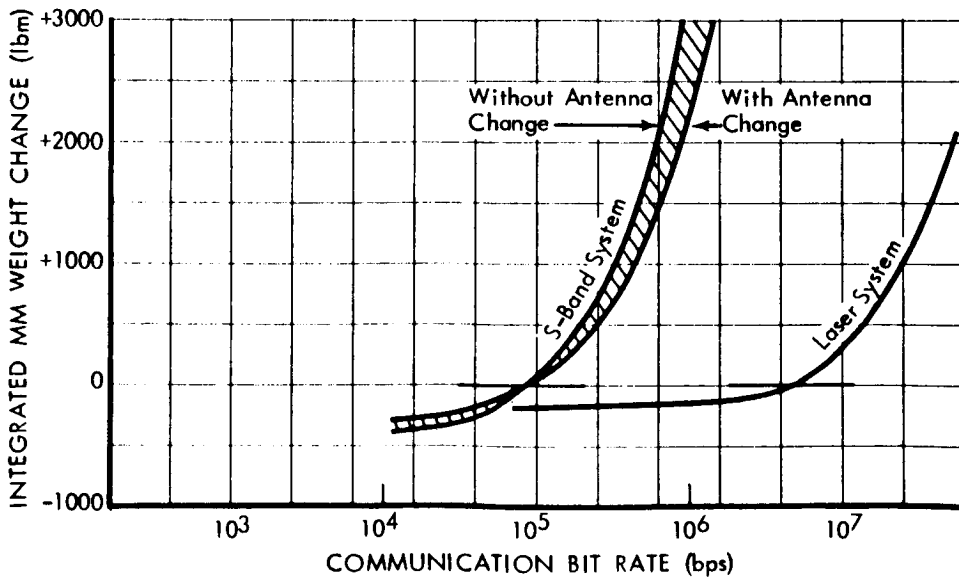

Figure 3.3-13: EFFECT OF COMMUNICATION BIT RATES



3.3.4 MISSION PAYLOAD SENSITIVITIES

3.3.4.1 Crew Size Weight Effect

The overall effect of a change in crew size is shown in Figure 3.3-14. This curve reflects the changes in mission module plus Earth entry module weight. The MEM size is assumed to remain constant at three men.

Figures 3.3-15 and 3.3-16 show the individual element weight effects for the mission module and EEM, respectively. The recommended mission module is one that is designed for the longest mission (Mars 1986 conjunction) and is off-loaded for the other missions.

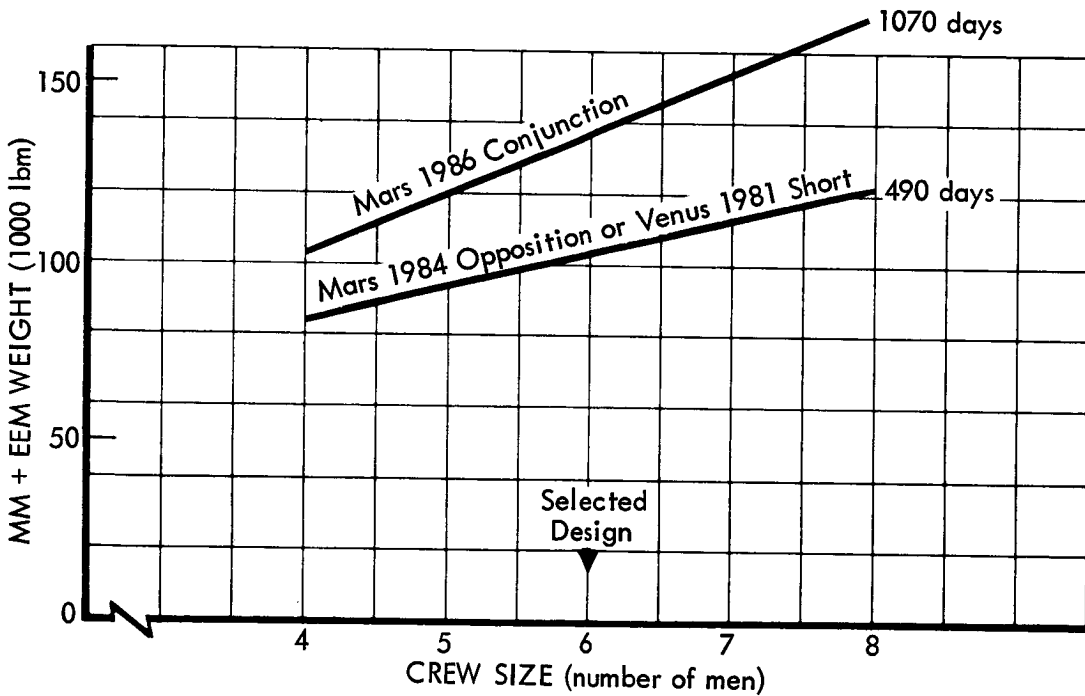

Figure 3.3-14: CREW SIZE WEIGHT EFFECT

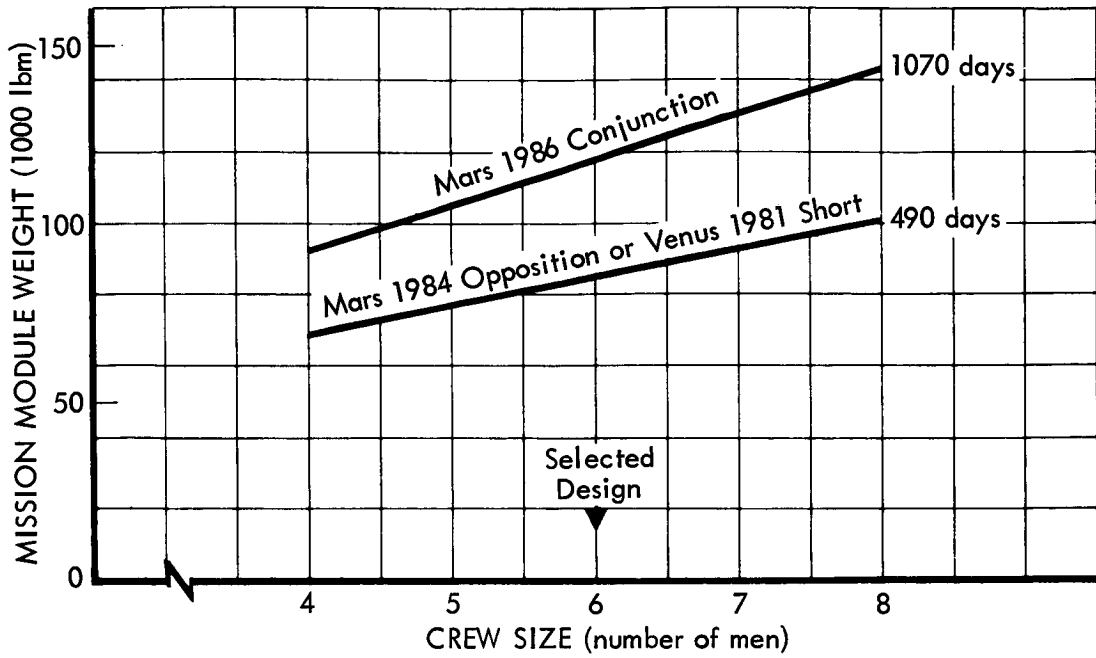

Figure 3.3-15: MM CREW SIZE WEIGHT EFFECT

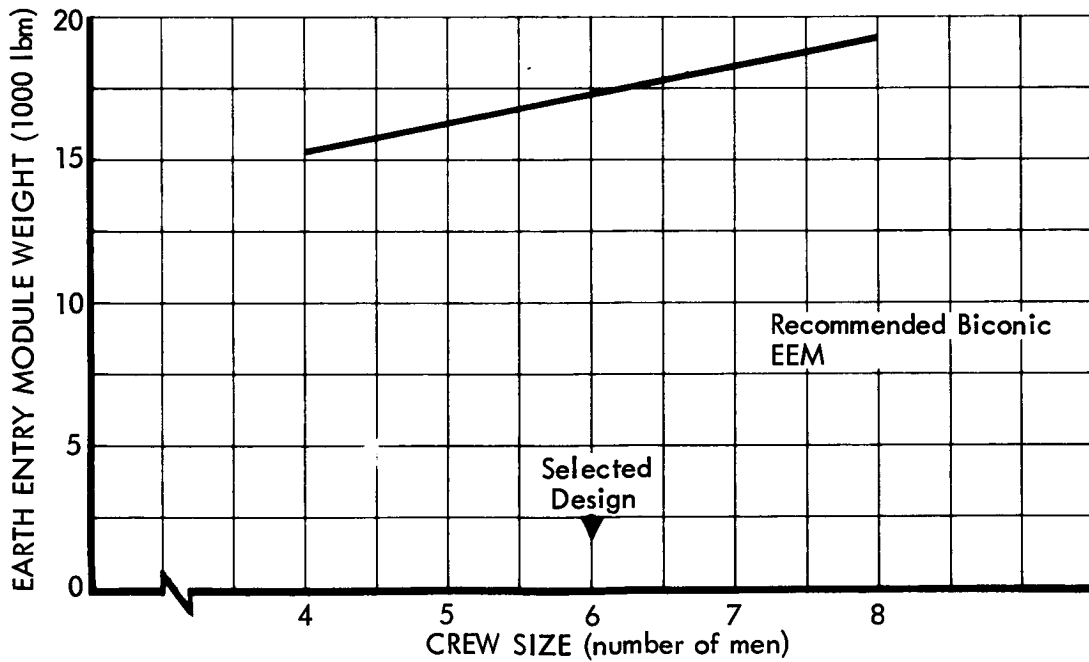

Figure 3.3-16: EEM CREW SIZE WEIGHT EFFECT

3.3.4.2 Effect of Scientific Payload Weight

One of the most probable uses of discretionary payload on a planetary mission would be for addition of scientific payload. Such additions can range in weight from that for several soft lander probes (30,000 to 60,000 lbm) to that for another photographic filter. For those missions with large amounts of discretionary payload, an additional MEM may be desired (70,000 to 120,000 lbm).

Experiment payload added to the mission module requires more H<sub>2</sub> primary propulsion propellant than added probes, providing that the payload added to the mission module is returned to Earth. The payload capability curves of Section 3.9.1 can be used to determine the maximum amount of discretionary scientific payload that can be added to either the probe weights or to mission module experiments, or both. Only gross weight additions to the MEM, not specific scientific payload effects, can be examined with the capability curves. This may be done in the same manner as probe additions since the MEM payload goes to planetary orbit but does not return to Earth.

Changes to the scientific payload of the MEM can be handled separately to determine the gross MEM weight effect at Mars orbit separation. There are four basic mission-dependent stages for MEM scientific payload. These are:

- 1) Items landed on Mars surface and jettisoned there,
- 2) Items ascended only - samples,
- 3) Items landed and returned to Mars orbit,
- 4) Items landed, returned to orbit, and transferred to the mission module for Earth return.

Figure 3.3-17 shows MEM weight factors for scientific (or other) payload changes. Since the question of all-retro descent or parachute/ballute-retro is not fully resolved, factors for both types of MEM are shown. The lower limit for the range shown represents MEM propellant only. The upper limit includes changed tankage and structure.

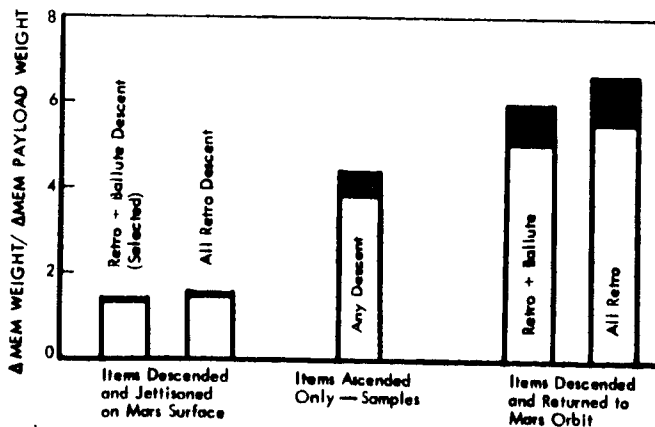

Figure 3.3-17: MEM SCIENTIFIC PAYLOAD FACTORS

Figures 3.3-18 and 3.3-19 show the effect of the various scientific payload options on the hydrogen capacity remaining for two example Mars missions.

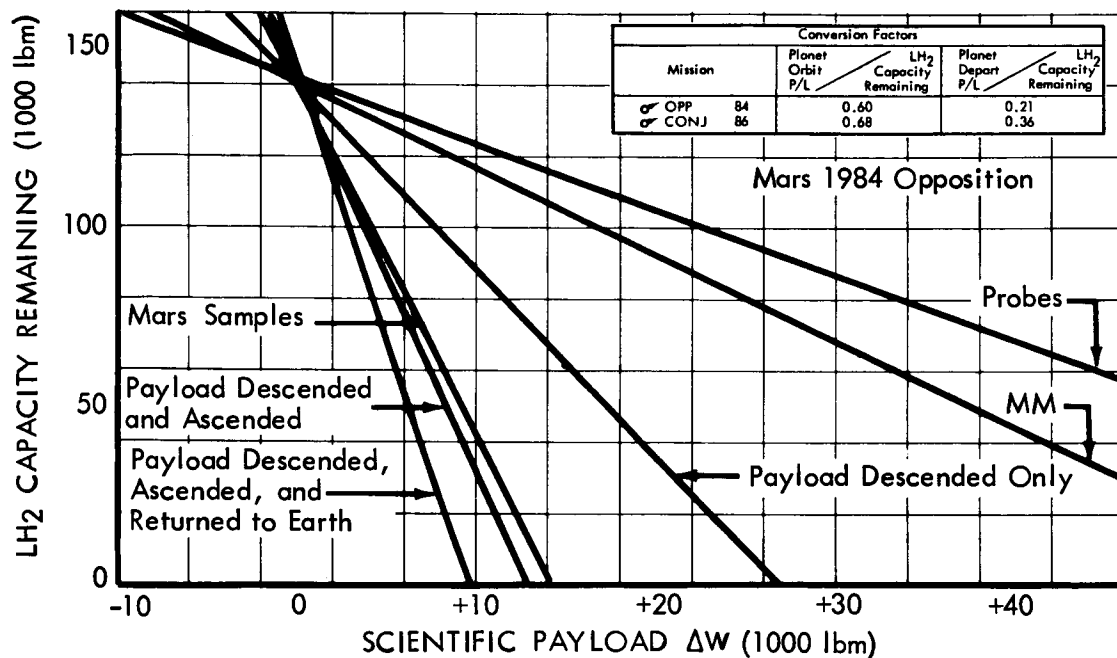

Figure 3.3-18: SCIENTIFIC PAYLOAD VERSUS LH<sub>2</sub> CAPACITY — 1984 OPPOSITION

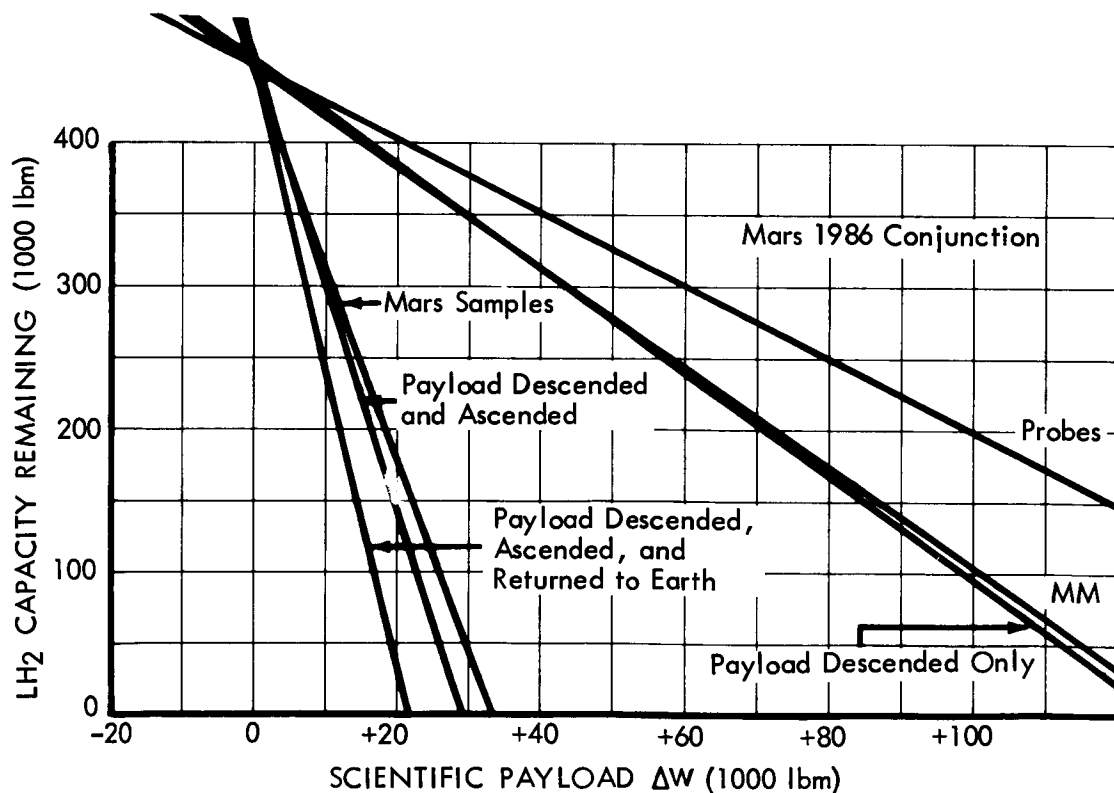

Figure 3.3-19: SCIENTIFIC PAYLOAD VERSUS LH<sub>2</sub> CAPACITY — 1986 CONJUNCTION

3.3.4.3 EEM Weight Effect

The recommended EEM is a biconic shape designed for an Earth entry velocity high enough to encompass all the manned planetary missions studied. If the biconic is never developed, the EEM will most likely be the same shape as the Apollo command module. The entry corridor limits the Apollo shape to an entry velocity of 55,000 fps. Beyond this entry velocity, a PM-4 module brakes the EEM back to the required 55,000 fps. Figure 3.3-20 shows the EEM weights for both the biconic and the Apollo shape. Differences in EEM weight can be related to planet depart payload capacities for the various missions in Figures 2.1-2 through 2.1-5.

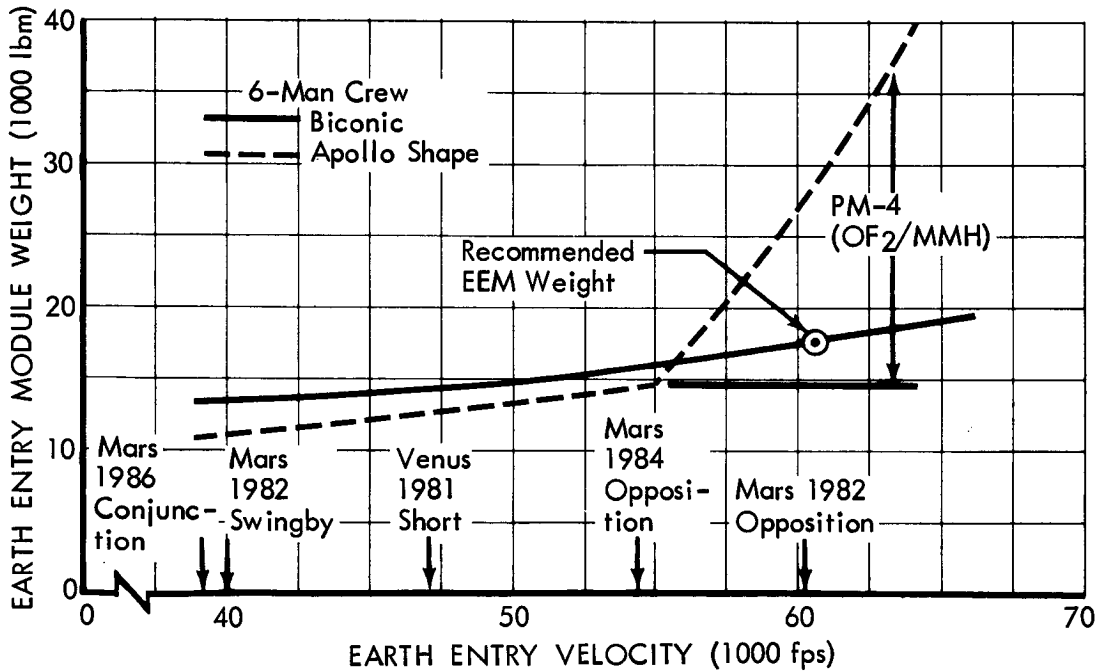

Figure 3.3-20: EEM WEIGHT EFFECT

3.3.4.4 EEM Cost Sensitivities

Differences in costs between a biconic and an Apollo-shape EEM are shown in Figure 3.3-21. Development costs are for the reentry velocity (shown in Figure 3.3-20) for the 1982 Mars opposition mission. Recurring costs are based on the five missions shown in Figure 3.3-20. Costs for the Apollo shape are for the EEM and PM-4 only. It is possible in an actual mission program that an additional propulsion module (PM) might be required because of additional weight associated with the PM-4 in some high reentry envelope. Such additional costs are not included.

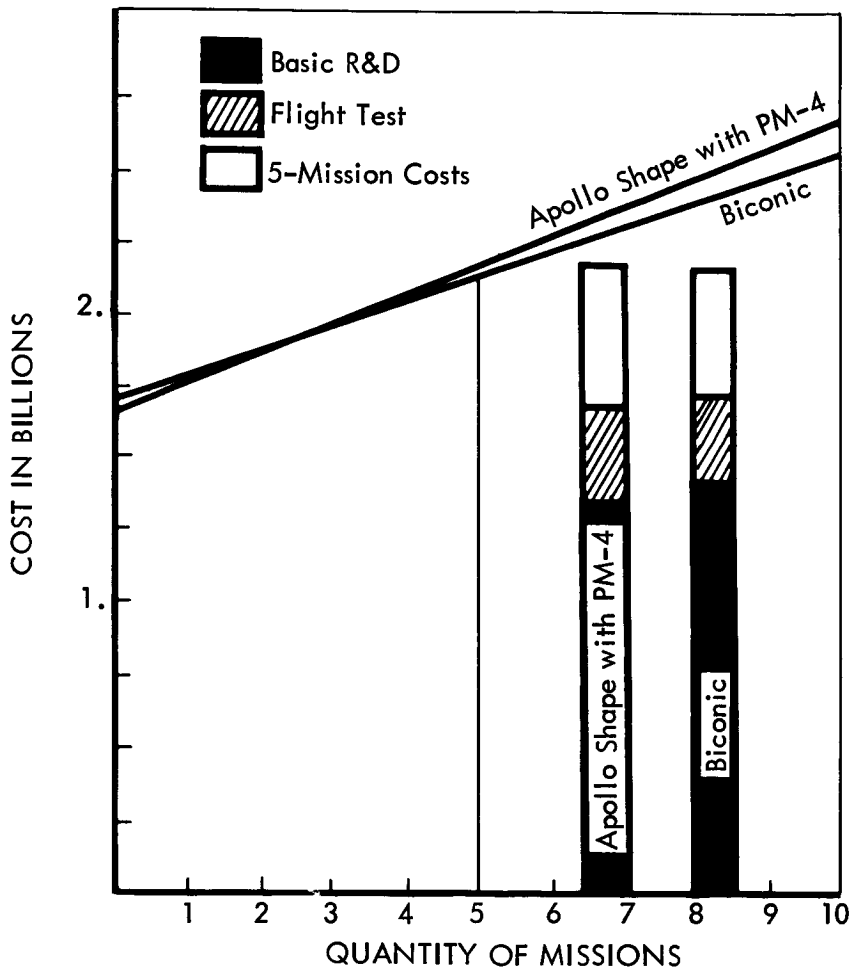

Figure 3.3-21: EEM COST SENSITIVITIES

3.3.4.5 Weight Growth and Contingency Effects

The weight growth and contingency factors are shown below

EEM	15%
MM	25% Inerts
MEM	30%
Probes	35%
Interstages	5%
Propulsion Modules	11% Inerts

Figure 3.3-22 shows the result of changing all these factors to 25% and to 50%. Note that the 3-1-1 configuration cannot perform the 1984 opposition mission with 25% nor the 1986 conjunction mission with 50%.

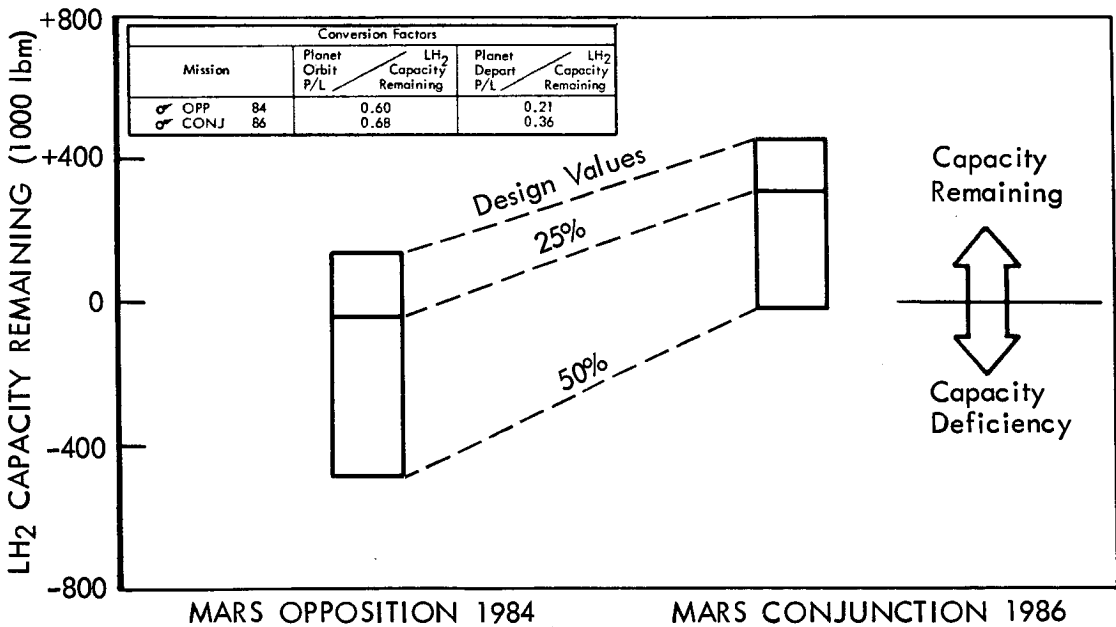

Figure 3.3-22: WEIGHT GROWTH AND CONTINGENCY EFFECTS

### 3.3.5 RELIABILITY AND MISSION SUCCESS SENSITIVITIES

This section presents parametric reliability data based on the recommended 3-1-1 configuration of NNN common modules and a SAT-V-25(S)U launch vehicle. The reliability analysis of the MLV-SAT-V-25(S), prepared as part of the Saturn V uprating studies performed under NASA Contract NAS8-20266 and reported in Boeing Document D5-13183-3\*, resulted in a reliability estimate of 0.986. This same reliability was assumed for the uprated MLV-SAT-V-25(S)U since the uprating consisted of adding a fourth segment to the solid rocket motors and uprating the F-1 engines, both of which can be thoroughly tested on the ground.

The recommended aerospace vehicle consists of six modules: three of the propulsion modules constitute the PM-1, one is the PM-2, and one is the PM-3; The sixth module is the spacecraft. Each of the propulsion modules require one MLV-SAT-V-25(S)U launch vehicle, and the spacecraft requires one MLV-SAT-V-25(S)U core, resulting in six launches and five rendezvous, docking, and orbital assembly operations.

Figure 3.3-23 illustrates the probability of successfully launching and assembling the space vehicle in Earth orbit for a variety of ELV and orbital operations reliabilities, assuming no backup launches.

Figure 3.3-24 illustrates how the number of ELV spares vary on a per-mission basis for different mission success probabilities and with combined reliabilities of the ELV and orbital operations. The curves are slightly conservative since the combined reliabilities include orbital operations on every one of the six launches, when in reality there are only five because there are no orbital operations involved in the first launch. Thus, for a 0.985  $P_g$ , a value within the band should actually be used. The spares per mission are shown as a smooth curve rather than a more realistic step curve so one can find the minimum spares requirements for any number of missions.

---

\*Boeing Document D5-13183-3, *Vehicle Description of MLV-SAT-V-25(S)*, The Boeing Company, October 1966



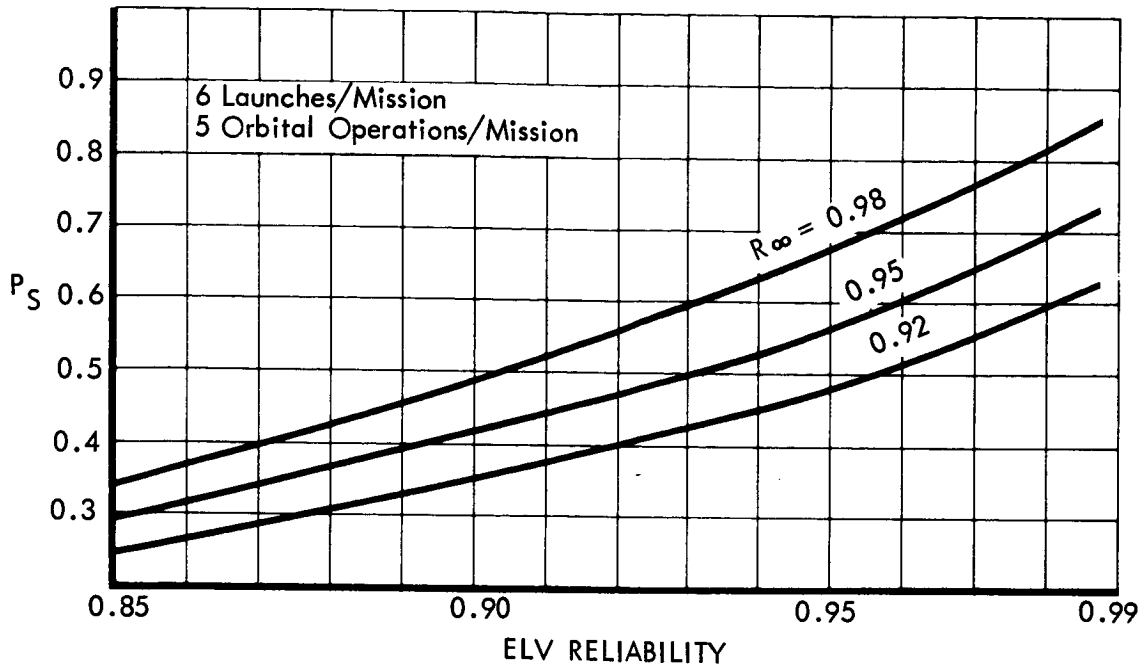

Figure 3.3-23: PROBABILITY OF SUCCESS FOR VARIOUS ELV AND ORBITAL OPERATION RELIABILITIES

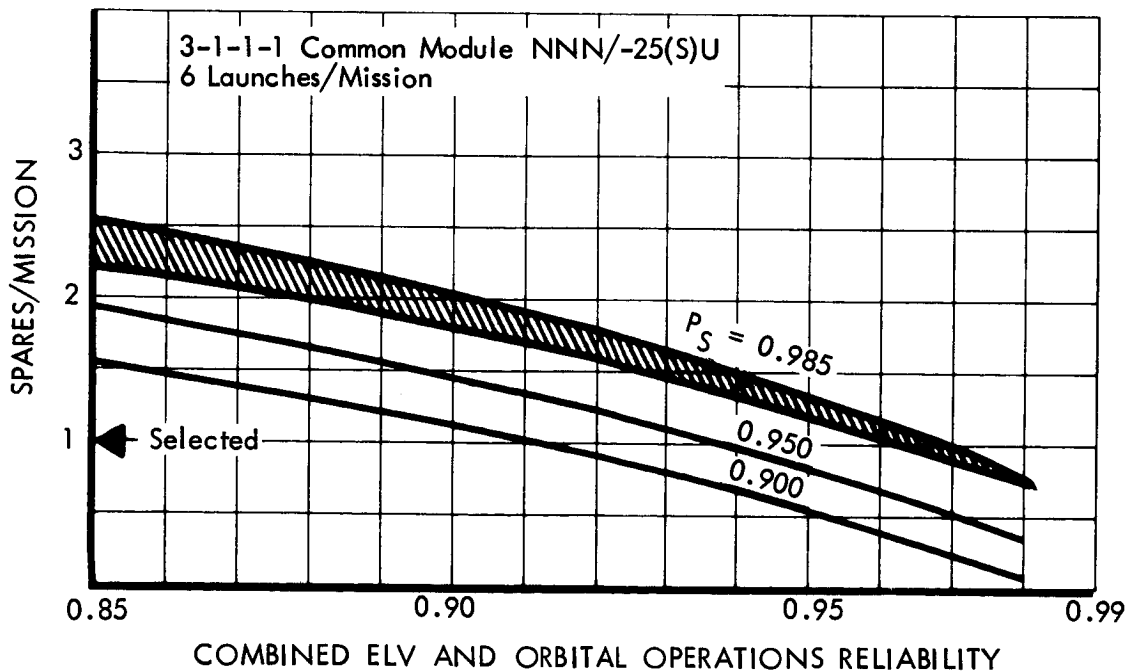

Figure 3.3-24: ELV SPARES REQUIREMENTS

## 3.3.5.1 Mission Module Reliability Effects

Figure 3.3-25 shows the change in mission module weight with a changing probability of mission success. Note that the probability of crew survival is held constant at 0.998. With this relatively high value of crew survival, the mission module weight variation with probability of mission success is small. Figure 3.3-26 and -27 show probability of mission success as modified by different mission module reliability values.

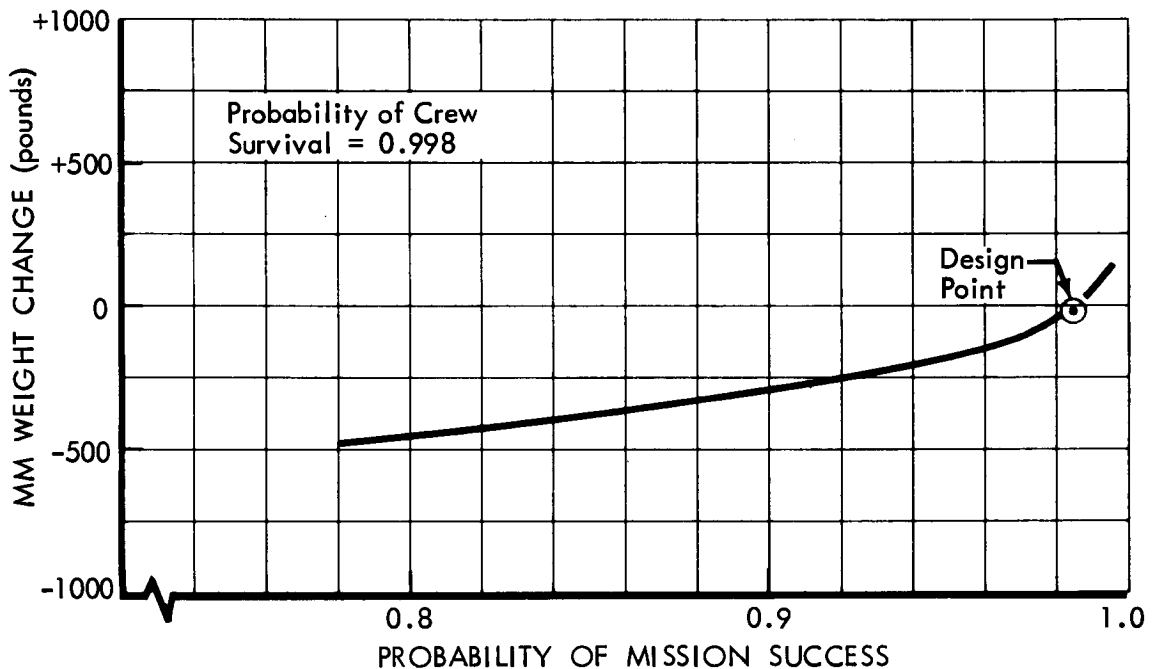

Figure 3.3-25: MISSION MODULE RELIABILITY EFFECTS

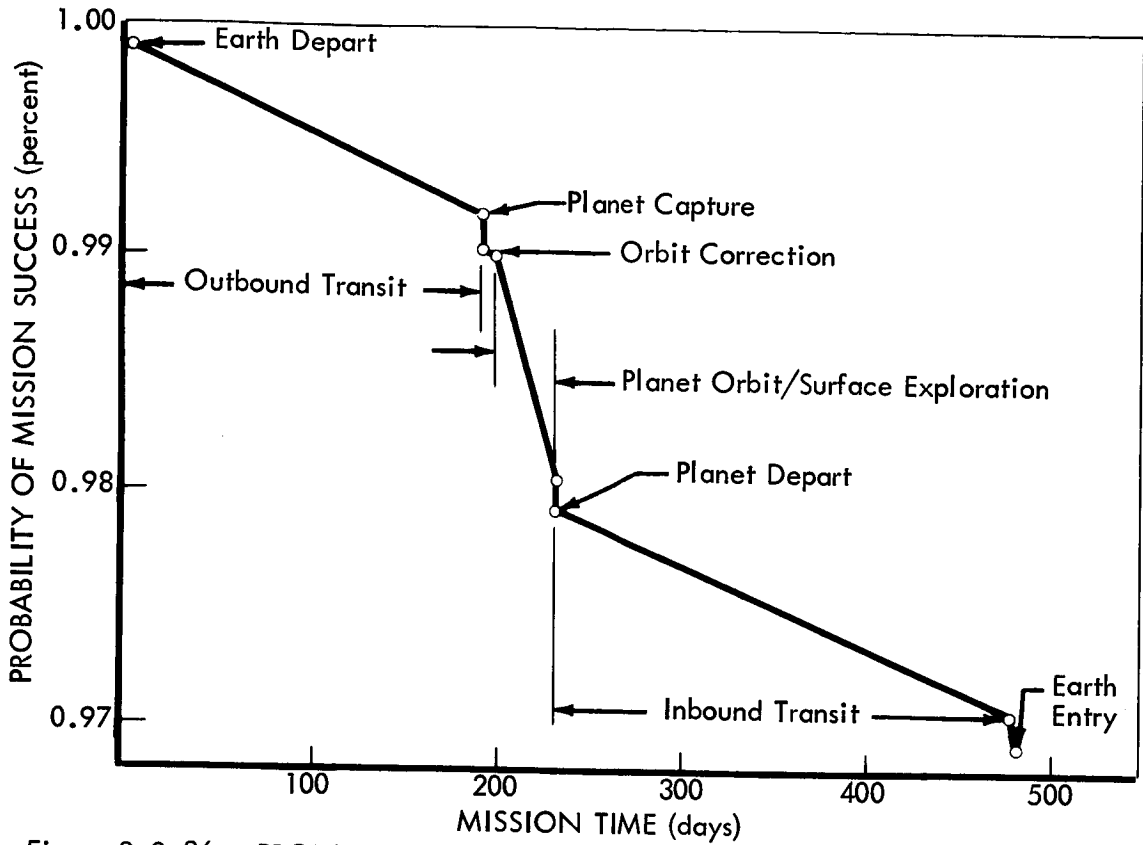

Figure 3.3-26: PROBABILITY OF MISSION SUCCESS — SINGLE-VEHICLE MODE (0.9850 MM Reliability)

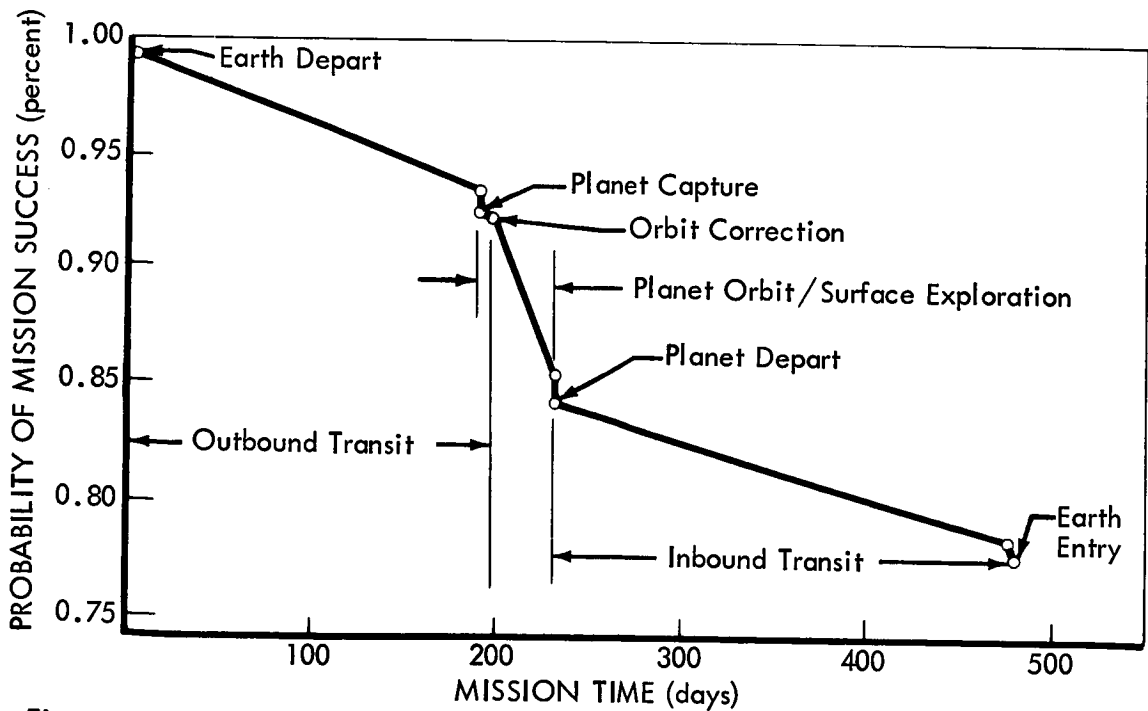

Figure 3.3-27: PROBABILITY OF MISSION SUCCESS — SINGLE-VEHICLE MODE (0.8816 MM Reliability)

### 3.4 PROGRAMMING SENSITIVITIES

Findings from this study indicate a very wide range of choices as to which programs and missions should be selected for early accomplishment, and how hard they should be pushed toward successful completion. Capabilities can be demonstrated and improved in near-Earth programs, and extended by logical step-by-step evolution to the full range of interplanetary missions. On the other hand, preparation for a Venus or Mars mission can be directly committed and developed.

National aims and interest in the manned planetary missions will be revealed periodically in the funding levels that are authorized. Priorities, schedules, and costs will then set the pattern for the direction and extent of progress to be expected from the unmanned and manned planetary programs.

These and other broad programming sensitivities are assessed on the following pages. They include examination of development risks, as well as test and logistics program variables. Examples are presented to indicate the effects from specific types of programming options, and to provide a reference base for examining the effects of alternate possibilities.

#### 3.4.1 SCHEDULE SENSITIVITIES

Sensitivities of the manned planetary program schedule were examined. Schedules are sensitive, of course, to all of the technology developments required throughout the total program. These were not examined in detail. Several areas, however, were examined. These included sensitivities to:

- Unmanned precursor probe programs (Figure 3.4-1)
- Program go-ahead dates
- Limitations in peak fiscal year funding rates
- Development of a space station similar to the manned interplanetary mission module.

#### 3.4.1.1 Schedule Sensitivities to Unmanned Precursor Probes

Unmanned precursor probes should be completed well in advance of the manned missions they are to support. The astrophysics data which they return will permit the formulation of sound mission criteria, which in turn will improve the probabilities for success of the manned flights.

Availability of probe data can strongly affect the timing of contract go-ahead as well as launch data for a manned mission, as indicated in Figure 3.4-1. Delays in launching the probe are shown in terms of missing a manned mission launch opportunity, or meeting it only with the high risks associated with concurrent programming and with no opportunity for review and correction. For example, if unmanned Venus Probe no. 1 returned its design data on schedule, this would allow a manned 1983 Mission B on a normal-risk basis, or a manned 1981 Mission A--but only on a high-risk basis. If the probe data were delayed, the mission dates would slide to a 1984 manned mission C on a normal risk basis, or to a 1983 manned Mission B as the earliest opportunity on a high-risk basis.

#### 3.4.1.2 Schedule Sensitivity to Development of a Space Station Similar to the Recommended Mission Module

Development of a space station similar to the manned planetary mission module would benefit the program. Development risk would be minimized, a test bed would be available for early flight qualification of subsystems, and orbital support could be available for early testing of other space vehicle components. Development of the mission module, the propulsion modules, and the Earth entry module will require approximately the same length of time. Program schedules, therefore, could not be improved a great deal by early development of a space station similar to a mission module. However, reduction of development risks is in itself important, since it increases the probability of crew safety and mission success, and removes some of the hazards from accelerating subsequent schedules.

#### 3.4.1.3 Schedule Sensitivity to Contract Go-Ahead Dates

An example contract go-ahead date of January 1972 has been used throughout this study. Schedule sensitivity to slides in contract go-ahead dates are illustrated in Figure 3.4-2. Slides in completion dates for nonplanetary programs would typically be month-for-month with slides in contract go-ahead dates, but since mission opportunities for any one of the planets occur only once in approximately 2 years, a slide in a planetary contract go-ahead date could result in a 2-year slide of the contract completion date. By the same token, however, contract go-ahead dates for a particular mission can be quite flexible. The range of allowable contract go-ahead dates for various planetary missions are shown. The open milestone,  $\Delta$ , indicates the range for contract go-aheads using the basic manned planetary program schedule. The closed milestone,  $\Delta$ , indicates the range for the high-risk program schedule (with many concurrent operations, accelerated flow times, and restricted opportunities for discovering and correcting problems of design or performance).

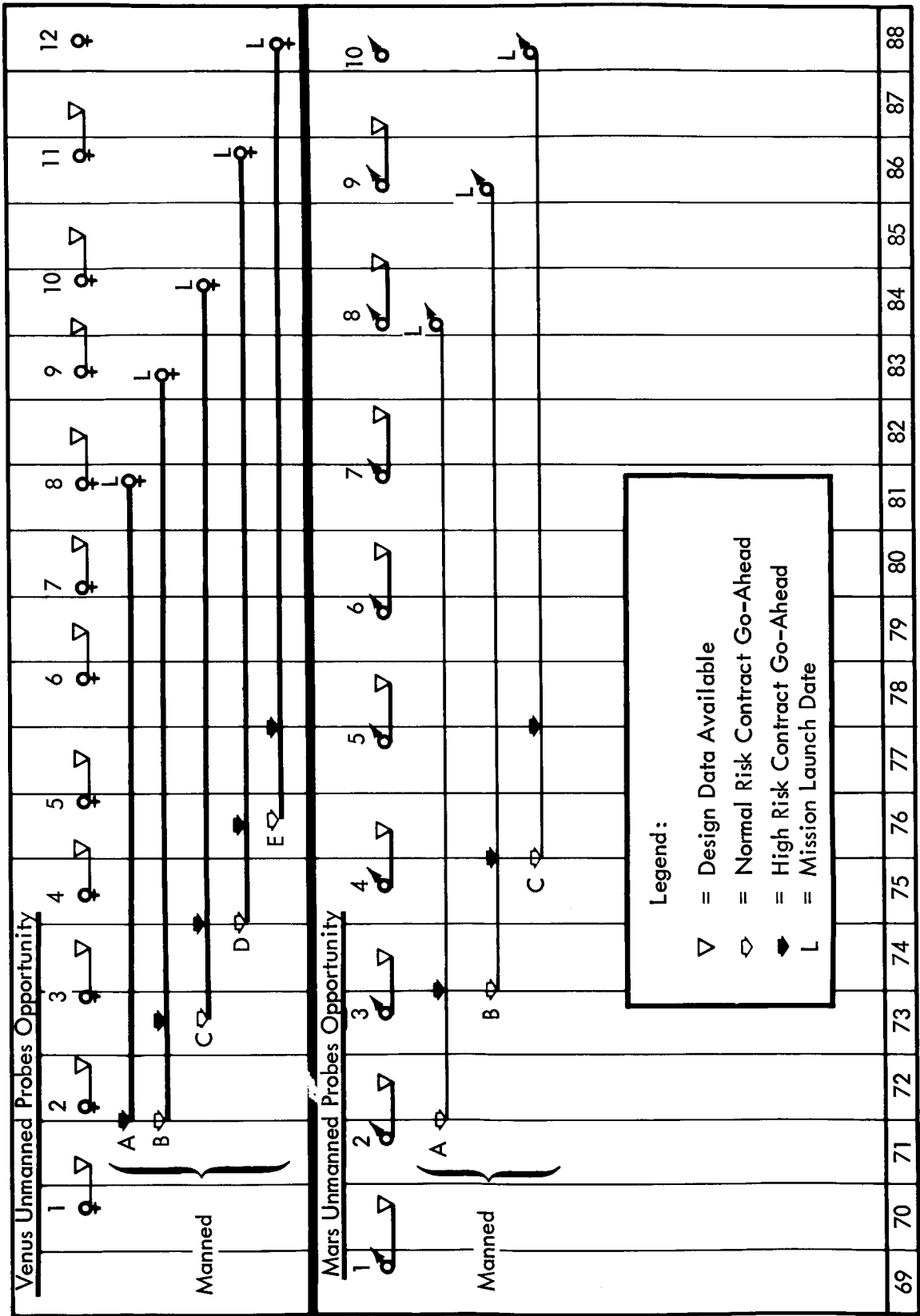

Figure 3.4-1: SCHEDULE SENSITIVITY TO UNMANNED PRECURSOR PROBES

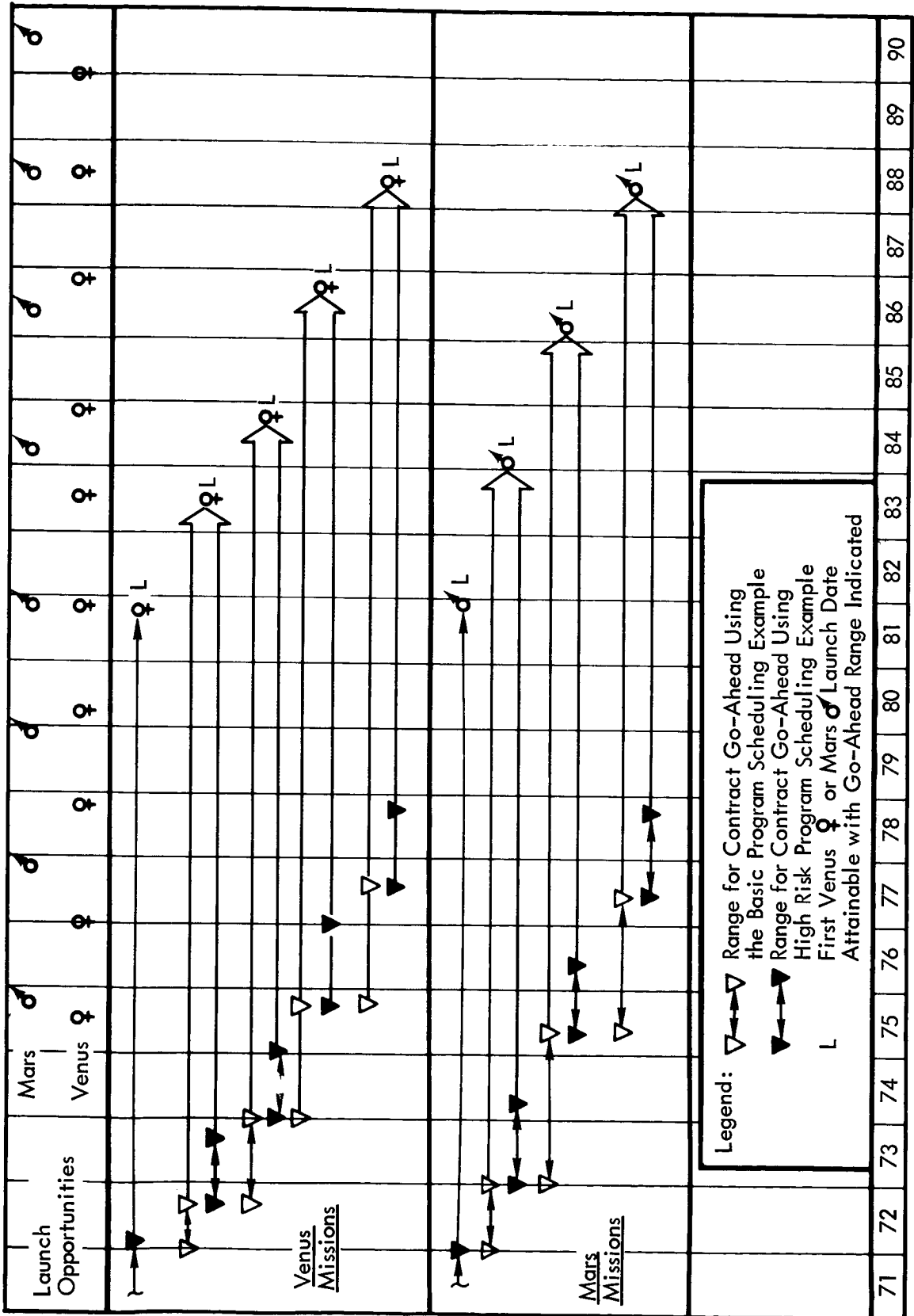

Figure 3.4-2: SCHEDULE SENSITIVITY TO CONTRACT GO-AHEAD DATE

3.4.1.4 Schedule Sensitivities to Limitations in Peak FY Funding Rates

Program schedules may be limited by fiscal year funding rates. Schedule sensitivities to peak limits of fiscal year funding rates were examined and are noted in Figure 3.4-3. The example contract go-ahead is January 1972. First mission dates for Mars or Venus are indicated on the figure for varying funding rates. Only the first mission is shown since funding peaks will always occur during the development program.

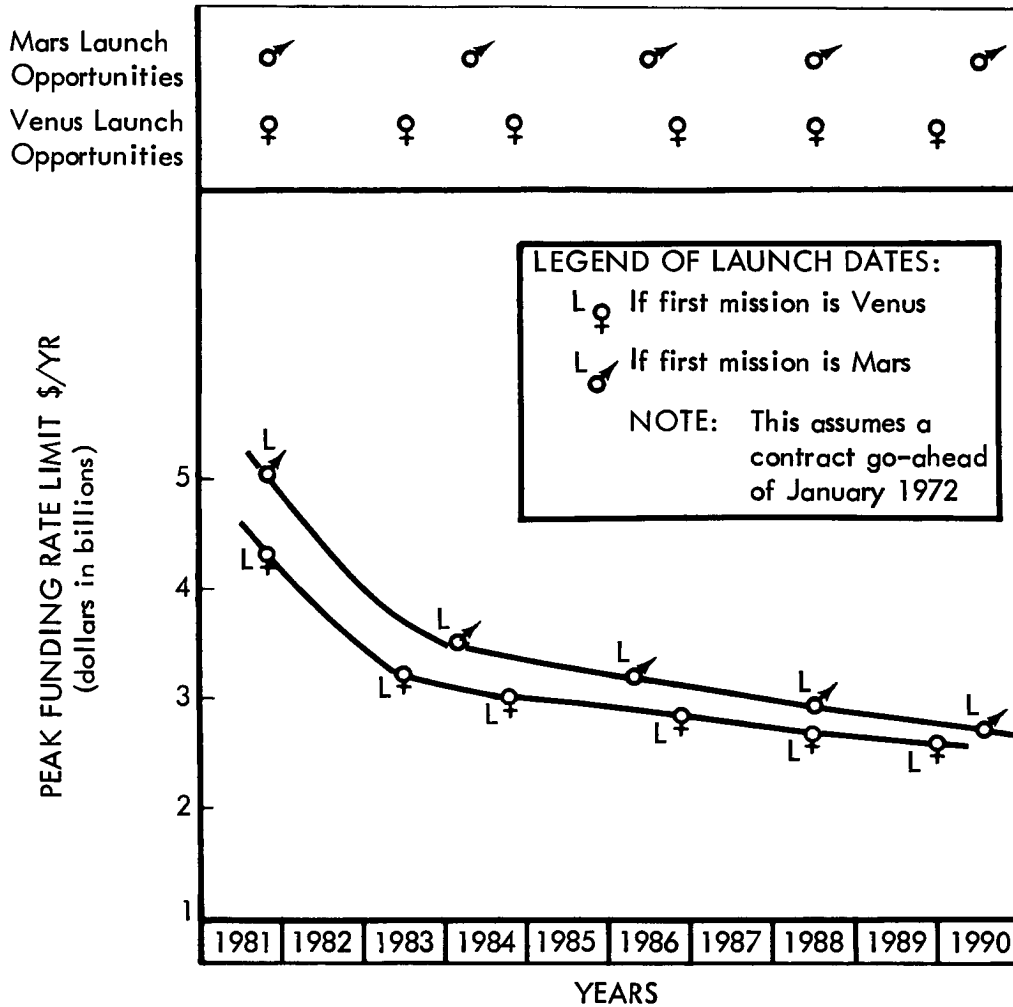
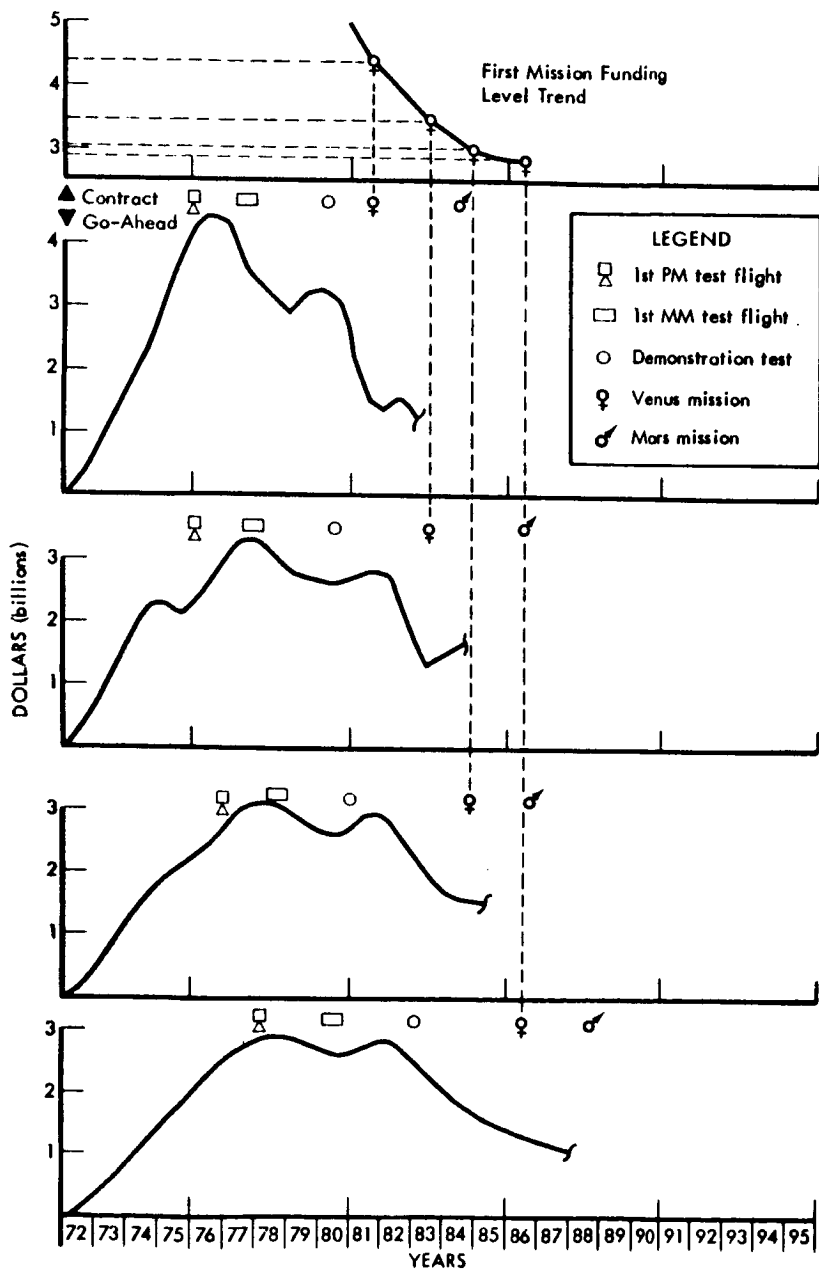

Figure 3.4-3: SCHEDULE SENSITIVITIES TO PEAK FUNDING RATE LIMITS



3.4.2  
FUNDING LEVEL  
SENSITIVITIES



Sensitivities of program schedules to peak funding levels were shown in Figure 3.4-3. Constraints in funding level peaks will cause stretchouts in the total program. This will mean too that technical goals, or milestones, will also be stretched out. Figure 3.4-4 illustrates the effect on accomplishment of technical goals from lowering the peak limits, using three different example funding level rates.

Figure 3.4-4: FUNDING LEVEL SENSITIVITIES

3.4.3 EFFECTS FROM FIRST MISSION ALTERNATES

The effect on funding rates for various combinations of first and second planetary missions was examined. Figure 3.4-5 illustrates these effects. Selection of a first mission to Venus will give the lowest funding rate since the MEM does not have to be developed until the second mission. Selection of the Mars lander-Venus swingby mission gives the highest funding rate because of the additional scientific probes for Venus and because of the longer mission time.

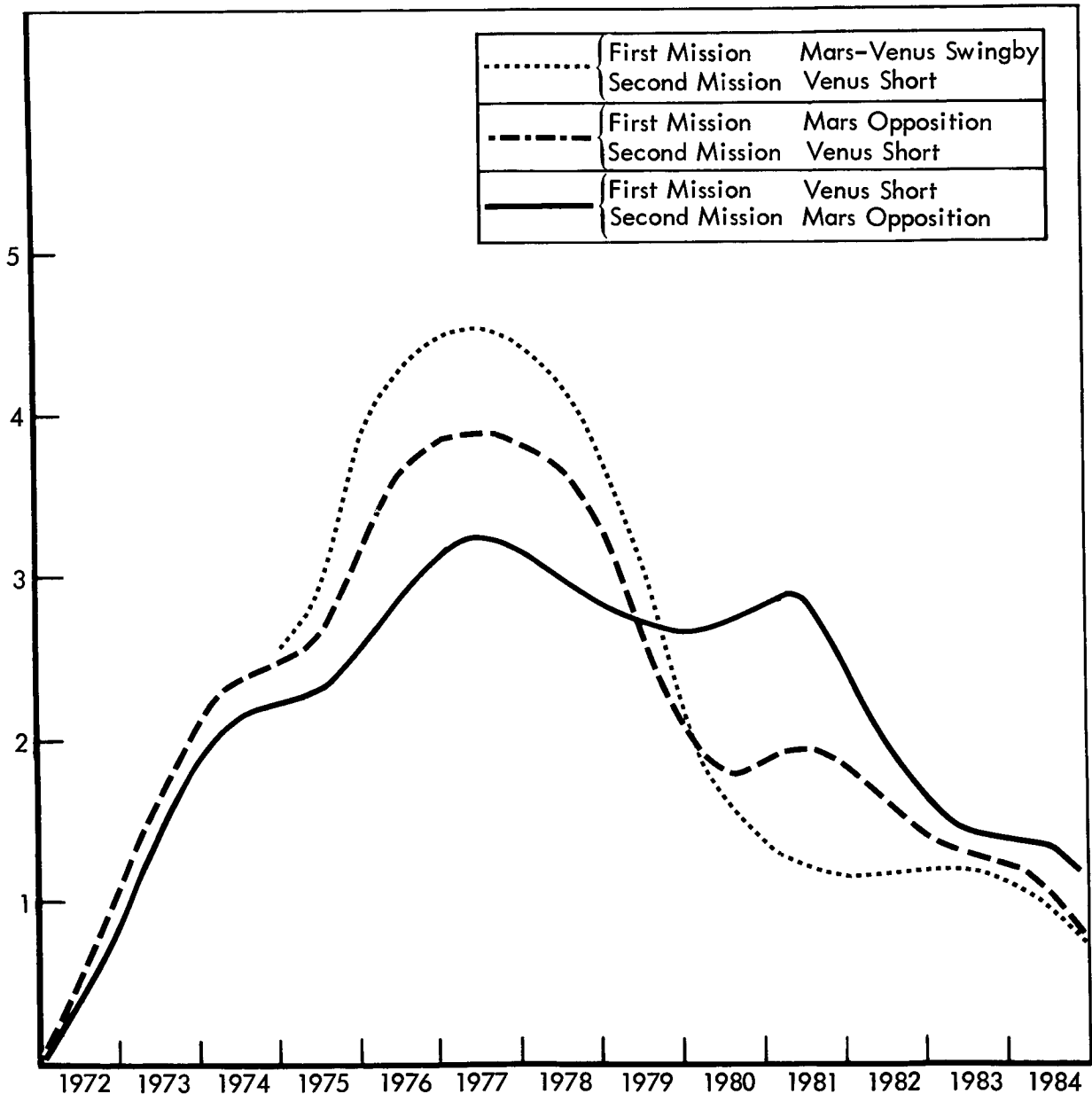

Figure 3.4-5: FUNDING RATE EFFECTS OF FIRST MISSION ALTERNATES

## 3.4.4 LOGISTICS PROGRAM SENSITIVITIES

The logistics spacecraft system was examined to determine the sensitivity of costs to the logistics spacecraft resupply cycle. Four logistics spacecraft launches are required per mission for the recommended program and include:

- One launch for the assembly, test and checkout crew,
- Two launches for resupply, based on a 45-day resupply cycle,
- One launch for the mission crew.

Sensitivities were examined for the following variations to the selected system:

- A 60-day resupply cycle which would give three logistics spacecraft launches per mission.
- No resupply which would give two logistics spacecraft launches per mission.
- No assembly, test, and checkout crew and no resupply which means that the mission crew would also be the assembly, test and checkout crew, and would require only one logistics launch per mission.

The sensitivities to these variations in number of logistics spacecraft launches per mission are shown on Figure 3.4-6 for varying quantities of missions. Total program cost differences for four missions or eight missions are noted in Table 3.4-1.

Table 3.4-1: TOTAL PROGRAM COST DIFFERENCES

	4 Mission Total <u>(\$ billions)</u>	4 Mission $\Delta$ <u>(\$ billions)</u>	8 Mission Total <u>(\$ billions)</u>	8 Mission $\Delta$ <u>(\$ billions)</u>
Selected System	34.2	---	44.8	---
60-day Resupply	33.9	0.3	44.2	0.6
No Resupply	33.7	0.5	43.7	1.1
No Assembly & Checkout Crew and No Resupply	33.4	0.8	43.2	1.6

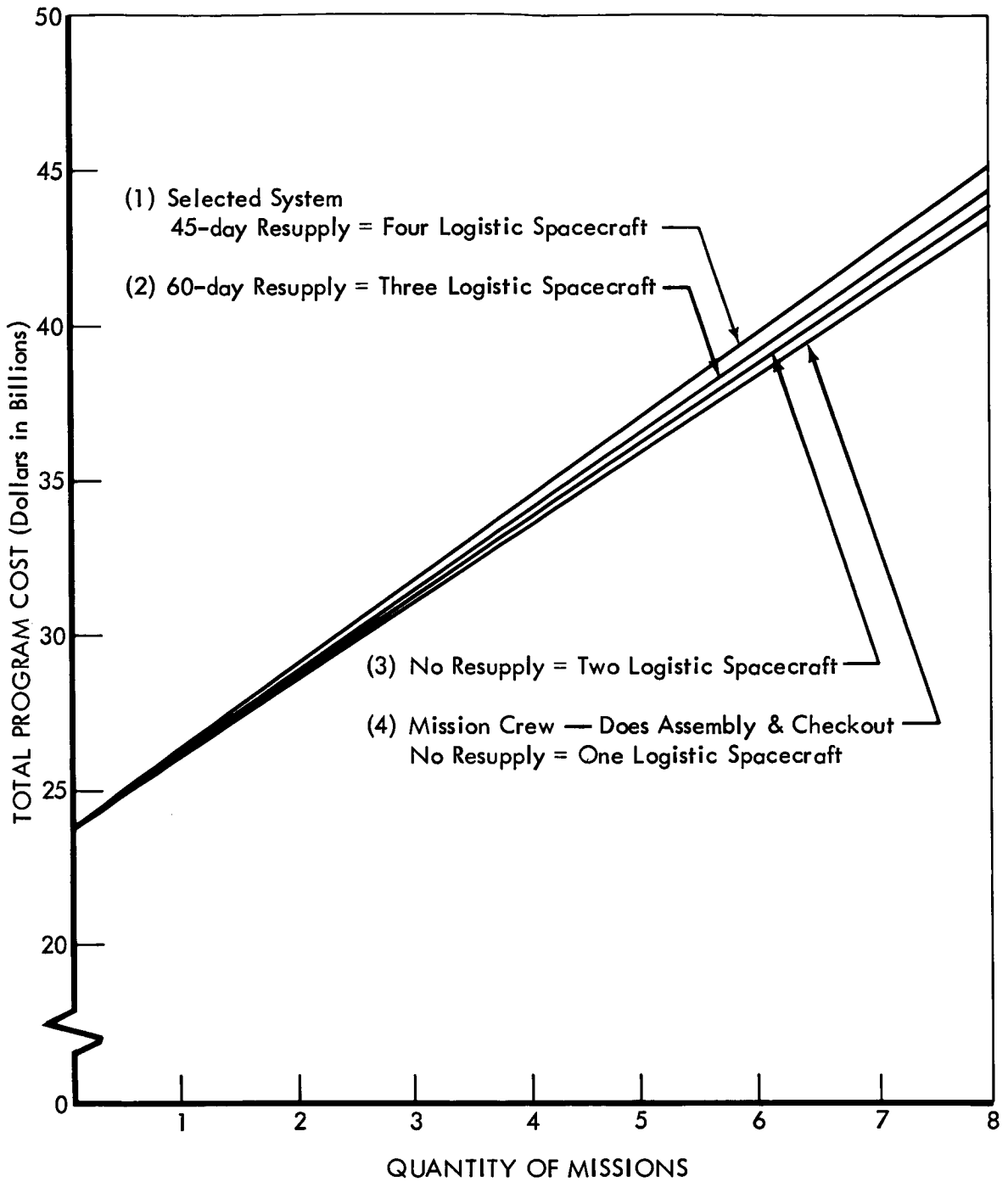

Figure 3.4-6: COST SENSITIVITY TO LOGISTIC SPACECRAFT RESUPPLY CYCLE

3.4.5 TEST PROGRAM SENSITIVITIES

Costs and schedules for the recommended test program are primarily based on the full range of test requirements for a baseline manned interplanetary mission. Therefore, several indexes are provided to assist in evaluating the general effects of specific tests when there is reason to do so.

3.4.5.1 Sensitivity to Repetitive Testing

The need for redundant testing of certain hardware or operational modes may become necessary to establish a proper degree of confidence in the probabilities for crew safety and mission success. This could occur if a scheduled test failed, was only partly successful, or was conducted under conditions that did not adequately represent mission requirements. Conversely, dramatic success of a critical test could eliminate the need for other related tests that had been initially scheduled.

Cost effects of changes in the number of tests required can be determined within broad limits by reference to Figure 3.4-7 for ground tests, and to Figure 3.4-8 for flight tests. Time effects can be determined by reference to the appropriate detail schedules in Volume V of this report.

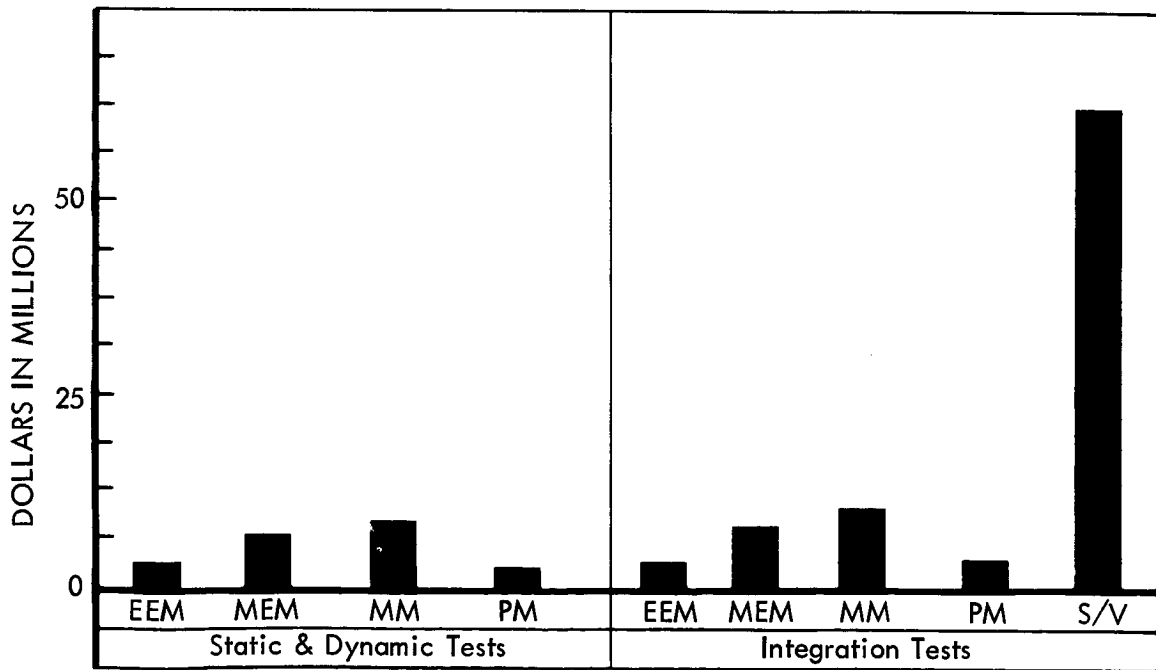

Figure 3.4-7: COST INDEX FOR SINGLE GROUND TESTS  
(GROSS APPROXIMATION WITHIN BROAD LIMITS ONLY)

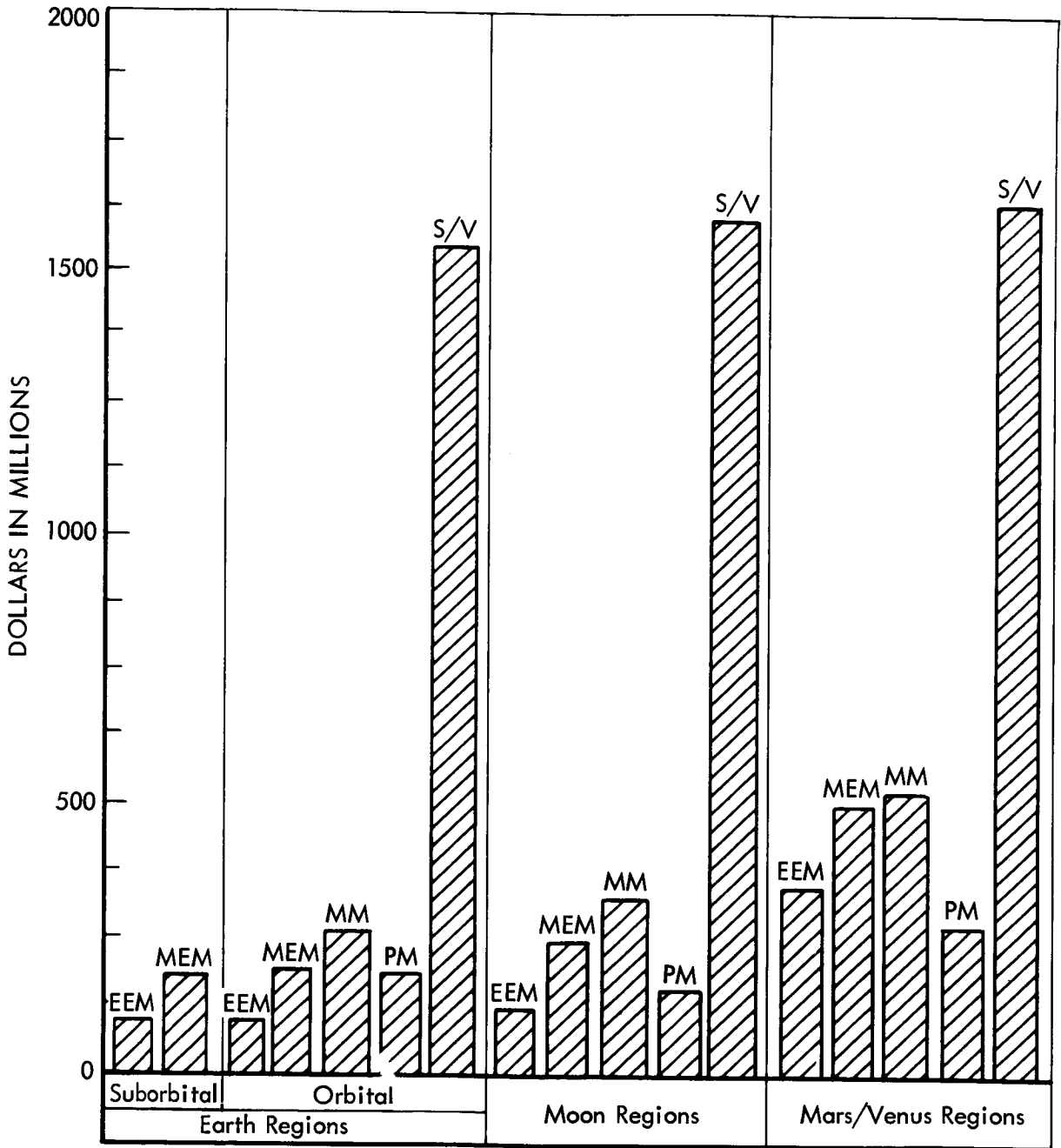

Figure 3.4-8: COST INDEX FOR SINGLE FLIGHT TESTS  
(GROSS APPROXIMATION WITHIN BROAD LIMITS ONLY)

### 3.4.5.2 Effects of "All Up" Flight Testing

Consideration was given to the possibility of flight testing only at the level of the total space vehicle. The time and cost advantages of the "all up" approach would, of course, be most fully exploited by conducting a single, successful manned flight test of the total space vehicle. However, a more reasonable program would require two successful flight tests--one unmanned and one manned--of the total space vehicle. Hardware requirements and costs have been estimated for these two flight tests of the space vehicle, as compared with the recommended program of flight tests. Figure 3.4-9 shows this comparison and the resulting net differences. Although the comparison indicates possible savings of 166.1 million dollars through flight testing at the space vehicle level such a short cut is not recommended for the following reasons:

- Failure of even one launch could wipe out any significant cost advantages from flight testing at the space vehicle level only. More important, a failure could undermine confidence across a very broad range of manned interplanetary capabilities.
- Specific malfunctions would be less accessible for diagnosis and correction if initially encountered in the total space vehicle rather than at a lower hardware level. Also, delays from minor causes could become critical if they occurred during countdown or orbital flight.
- An unmanned flight of the total space vehicle should certainly reduce risks in a subsequent manned flight; from a practical viewpoint, however, the unmanned flight of the total space vehicle would have to wait for completion of all spacecraft and propulsion modules before any could be tested in flight. This would defer the evaluation of technical advances and diagnosis of problems. Also, the test data from maneuvers of an unmanned space vehicle could not be as significant or complete as test data from unmanned plus manned flights of the individual modules.

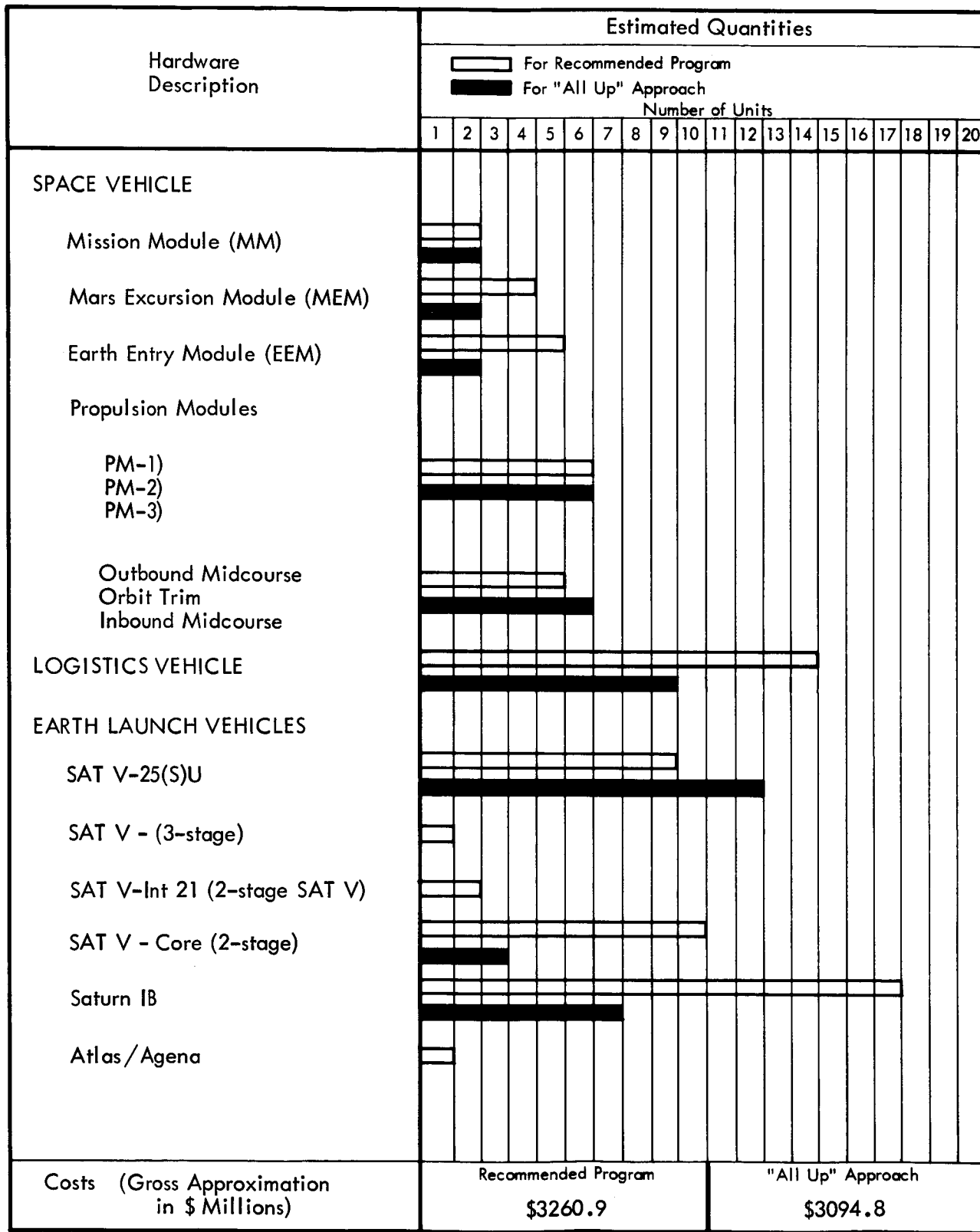

Figure 3.4-9: COMPARISON OF RECOMMENDED IMISCD TEST PROGRAM VERSUS "ALL UP" APPROACH



## 3.4.5.3 Demonstration Test Effects

The program plan defines a demonstration test program which would be a complete simulated mission. All space vehicle modules would be launched from Earth and assembled in orbit. All mission operations would be simulated in the vicinity of the Earth. Planetary travel times, however, would be shortened. The recommended schedule allows a reasonable time period between the demonstration test and the first mission, for incorporation of necessary changes. Changes in the demonstration test philosophy could influence program costs or program schedules. The following conditions were examined.

- No demonstration test,
- First mission following immediately after demonstration test,
- Full mission length demonstration test,
- Demonstration test for Venus plus a demonstration test for Mars.

Table 3.4-2 illustrates the effect of the preceding four alternates on program costs and program schedules.

Table 3.4-2: EFFECTS OF DEMONSTRATION TEST ALTERNATIVES		
Example Program Total = \$28.9 billion		
Example Program Schedule = Venus 1983 Short and Mars 1986 Opportunity		
<u>Alternative</u>	<u>Δ\$ (in billions)</u>	<u>Resulting Earliest Mission Date</u>
No Demonstration Test	- 2.2	Venus 1981 Short
First mission following immediately after demonstration test	Negligible	Venus 1981 Short
Full Mission-Length demonstration test	+ 0.2	Venus 1984 Short
Demonstration test for Venus + demonstration test for Mars	+ 2.4	Venus 1983 Short

## 3.4.6 DEVELOPMENT RISK

Important technology development milestones must be reached in the manned planetary program. These milestones are similar in nature, but different in specific demands from the milestones that have been and will be reached in the manned spaceflight programs already authorized.

The manned spaceflight programs have already passed many significant milestones, and will achieve others, as indicated by the following examples:

- First manned suborbital flight (Shepard in Mercury)
- First manned reentry from orbit (Mercury)
- First manned orbital flight (Glenn in Mercury)
- First launch of a large ELV (Saturn I)
- First successful launch of a large  $\text{LH}_2\text{LO}_2$  stage (Saturn I)
- Demonstration of manned zero-g capability (14-day Gemini flight)
- First manned rendezvous and docking plus EVA (Gemini)
- First very large three-stage ELV launch (Saturn V, SA 501)
- First hyperbolic, 35,000-fps reentry - unmanned (Apollo SA 501)
- First space restart large  $\text{LH}_2\text{LO}_2$  engine (Apollo SA 501)
- First manned lunar landing simulation in Earth orbit (future Apollo)
- First manned lunar landing (future Apollo).

The manned planetary program will also achieve many significant milestones. Examples of these will be:

- First hyperbolic reentry at 65,000 fps - unmanned
- First nuclear engine ground firing
- First nuclear engine and nuclear stage space firing
- First launch of an uprated Saturn V ELV
- First hyperbolic 65,000-fps reentry - manned
- First long-time space soak and firing of a nuclear propulsion module
- First long-time simulated manned planetary mission operation
- First full planetary simulated mission in Earth orbit
- First manned planetary reentry simulation
- First manned planetary capture mission
- First manned planetary landing mission.

The development risks associated with the earlier manned spacecraft programs were perhaps more critical, since this was man's first venture into space, and the necessary technologies were completely new. The risks associated with the manned planetary venture are also great, but to a large extent can be built on the technologies developed for the existing manned spacecraft programs.

Figure 3.4-10 compares the overall program schedules for the existing manned spacecraft programs and for the manned planetary program. It will be noted that approximately 11 years have been required from the first manned spacecraft program go-ahead to the first lunar landing, compared to approximately 11-1/2 years from manned planetary program go-ahead to the first planetary mission. Technology development firsts for each of the programs are also roughly comparable. Example program go-ahead for the planetary mission is shown in 1972, which would leave a gap of several years between the planetary program and the Apollo program. Also, the preliminary study period for the planetary mission extends over a period of approximately 5 years. The manned spacecraft program, however, was under study for only 2 years before the Mercury program go-ahead.

Figure 3.4-11 compares the manned planetary basic program example schedule and the alternate (high risk) schedule with other manned spacecraft program schedules. The manned planetary program is shown to be considerably longer than any one of the particular manned spacecraft programs. It is significant, however, to note that the additional flow time required is primarily in the area of flight qualification and flight demonstration testing, which allows for incorporation of changes required as a result of these tests. We conclude that the program plans and program schedules developed during this study have allowed sufficient time and have provided an adequate test program to minimize development risks.

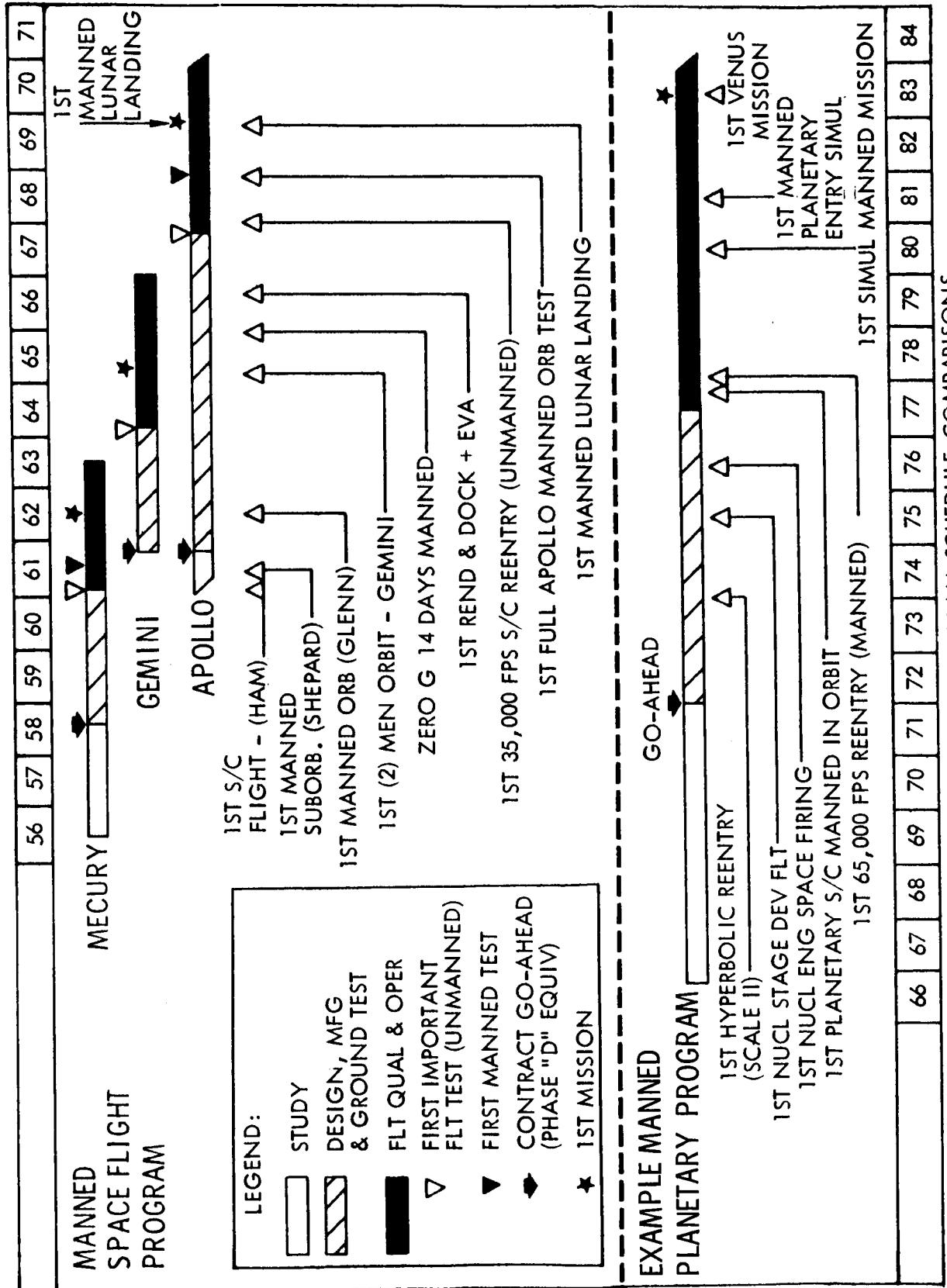

Figure 3.4-10: MANNED PROGRAM SCHEDULE COMPARISONS

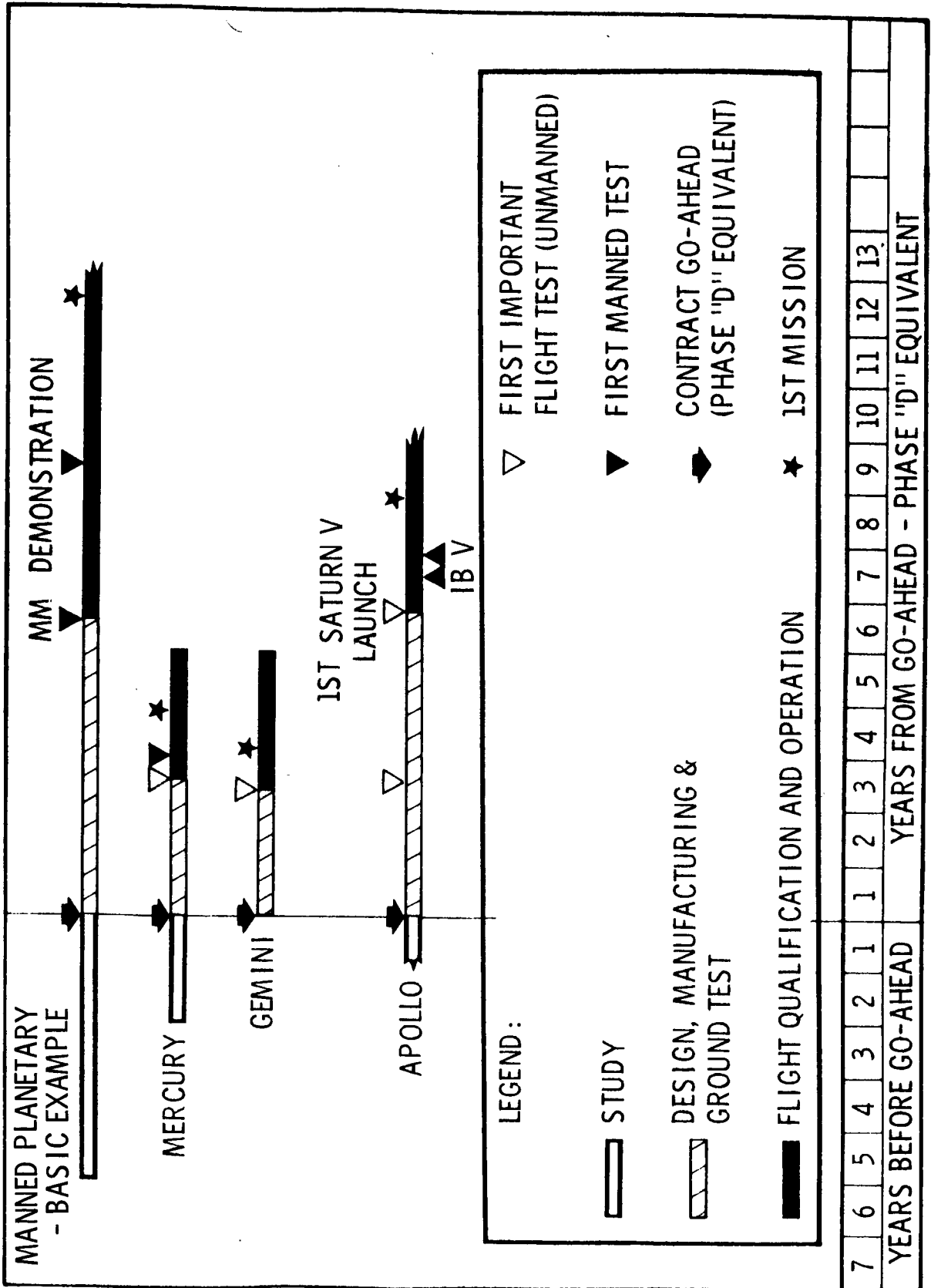

Figure 3.4-11: SCHEDULE FLOW TIME COMPARISONS

### 3.5 ADAPTABILITY OF HARDWARE TO OTHER SPACE PROGRAMS

Interplanetary hardware should be considered for use in other space programs to provide them with much greater capabilities for building a solid foundation of scientific and engineering data about the different space environments.

The mission module can be used directly as the living and working center of an orbiting space station. It contains all the subsystems necessary for life, for command and control of operations, for scientific observations and analysis, and for information processing and transfer to Earth-based support. In addition, all or part of a particular subsystem of the mission module can be used to advantage on the earlier manned spacecraft programs.

The universal nuclear propulsion module has capabilities that can be used to great advantage for unmanned probes and flyby missions. Its high acceleration yield and flexibility offer promise for probes to the near planets as well as to the far planets and deep space.

Use of interplanetary hardware in near-Earth missions can reduce the time and costs required to qualify the hardware for the more ambitious interplanetary flights. However, such considerations are considered more fully in a later section, (3.6) "Impact On Other Space Programs".

Interplanetary hardware is assessed on the following pages as to its adaptability for use on other space programs. Where such uses can be arranged in a practical way, both types of programs will benefit.

### 3.5.1 MISSION MODULE SUBSYSTEMS ADAPTABILITY TO OTHER MISSIONS

Environmental Control--The environmental control subsystem in general is readily adaptable to other missions. The CO<sub>2</sub> removal equipment and the CO<sub>2</sub> reduction/water electrolysis equipment should perform adequately for any mission with the same crew complement. If missions with larger crews are planned, multiple units might be employed rather than develop new hardware scaled specifically to the new crew size.

The only item of questionable adaptability is the space radiator for the environmental control system. In fact, all of the space radiators, including the electrical power subsystem radiator, are subject to question. It seems likely that since the radiators are able to handle the Venus orbital environment, they will be able to function with no problems in Earth orbit. However, if lunar base missions are considered, the radiators will probably have to be redesigned.

Life Support--The life support subsystem is almost directly applicable to all other anticipated missions. This subsystem includes water management, waste management, food preparation and storage, and personal hygiene.

The proposed water management equipment could be used on any mission. Again, if the crew size is increased, additional units may be added. The air evaporation equipment may be adapted to small changes in crew size by increasing the flow rate and changing the wicks more often.

The waste management concept may be used with any number of men but, of course, the sanitary facilities must be sufficient to accommodate the crew size. For lunar missions of long duration, i.e. a lunar base, some other means of waste disposal should be found. If the food storage cabinets are sized for periodic resupply, waste material must be stored in some other part of the station, on the surface of the Moon, or incinerated and dispersed (ferrying the waste back to Earth is possible but not efficient).

Food preparation and storage for any mission could be exactly the same as proposed in this study. However, for the near-Earth missions, the lower cost of payload might make the use of fresh foods possible, which would significantly change the food storage and preparation facilities.

Personal hygiene equipment should be adaptable to any mission. In regard to disposable clothing, disposal of used garments will become a problem on the longer missions. A trade study could be made of the disposable clothing concept versus reusable clothing with a washing machine for long Earth-orbital or lunar-base missions.

Crew Systems--The crew system includes physical conditioning equipment, recreation equipment, medical facilities, pressure suits, and devices. This equipment, with the possible exception of medical and EVA equipment, can be used on any mission.

Medical equipment might be augmented for a lunar-base mission with a surgical facility.

The pressure suits are adaptable to the lunar environment; however, some of the EVA devices do not appear satisfactory for use on the lunar surface without major modification. In particular this applies to the astronaut maneuvering unit (AMU).

Electrical Power--The isotope-Brayton cycle electrical power subsystem is readily adaptable to any manned mission. For the lunar missions, only the radiator might require redesign. The electrical power subsystem, when used in Earth orbit and for lunar missions, is potentially more cost-effective than any other power generation concept with the possible exception of the isotope-Rankine cycle.

Communications--The communications subsystem is adaptable to any interplanetary mission foreseeable in this century. The laser equipment would be particularly advantageous for missions to the outer planets, manned or unmanned. The lunar missions might employ the laser, however this should be determined by further study. For the Earth-Moon libration center missions, the laser might also be employed, again after further study. The near-Earth orbital missions impose more severe pointing and pointing rate problems, which make the use of the laser for communications less desirable than rf techniques. The S-band rf equipment proposed for the interplanetary missions could be used in the Earth-orbital and lunar missions to provide a very high data rate capability, i.e., color TV in real time. The ancillary equipment such as the UHF and HF hardware can be used for local operational communications.

Guidance and Navigation--Lunar base missions excluded, many components in the navigation and guidance subsystem may be used for Earth-orbital missions, although some will perform functions different from their interplanetary mission functions. The inertial measurement unit and the guidance and navigation computer can be used directly. The optical sensors can be used to orient the orbiting space station and to assist in station-keeping. The radio-radar sensors can be used for the same purpose as in the interplanetary missions, as well as for altitude and station-keeping purposes.



Attitude Control--Many elements of the attitude control subsystem can be adapted to Earth orbital missions. Much of the reaction control jet hardware can be used. For example, storage tanks, manifolds, reaction control jet control logic, and possibly the jets themselves. The control moment gyro equipment can be used, but the size of the rotors should be reduced. The control moment gyro concept is also more desirable and cost effective in Earth orbit applications than a pure reaction control jet subsystem.

Data Management--The data management subsystem could be adapted directly to other manned interplanetary missions (outer planets). For Earth-orbital and lunar missions, it is unlikely that it can be taken as a complete subsystem and utilized. It is more probable that individual components of the data management subsystem will be used without modification for these missions.

3.5.2 PROPULSION MODULE PERFORMANCE CAPABILITY FOR UNMANNED MISSIONS

The capability of the nuclear propulsion module for unmanned flyby missions is illustrated in Figure 3.5-1. Both single-stage and two-stage performance lines are shown along with representative mission acceleration ( $\Delta V$ ) requirements. The data are based on launch from a 262-nautical-mile Earth assembly orbit.

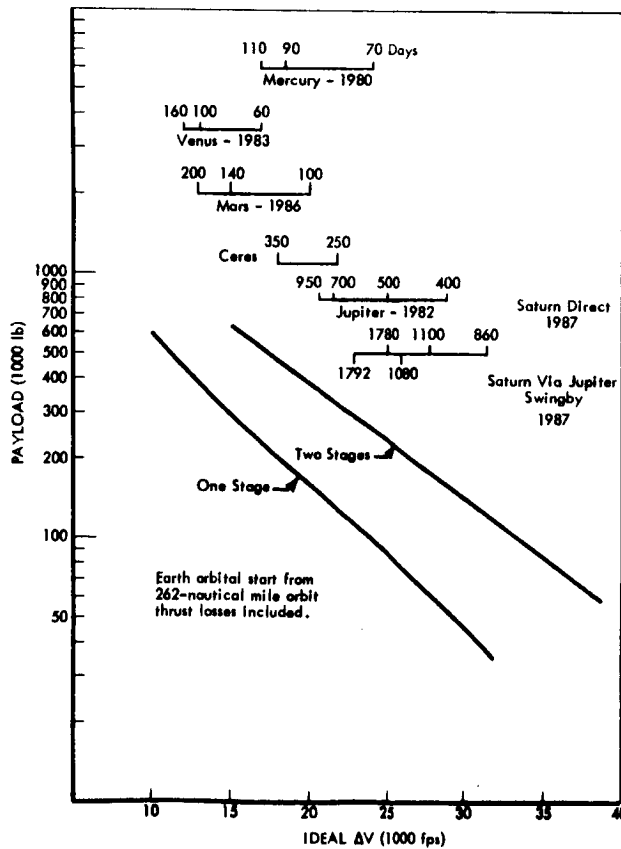

Figure 3.5-1: UNMANNED FLYBY MISSION CAPABILITY

### 3.6 IMPACT ON OTHER SPACE PROGRAMS

#### 3.6.1 IMPACT ON SPACE STATION AND OTHER EARTH-ORBIT PROGRAMS

It is important to consider how the interplanetary mission system will impact on or generate tasks that should be pursued in Earth orbit, prior to the planetary flights.

Few of the elements selected for the interplanetary mission system are directly available today. The requirements are known, but the concepts must be proved. Prototypes must be built and must undergo long-duration tests--2 years or more in some cases. But these tests cannot be in the form of manned interplanetary flights. The costs and durations of such tests would be prohibitive. More important, the demands for crew survival would prohibit the use of "development-type" equipment on a manned interplanetary mission. Flights in Earth orbit, on the other hand, do provide practical opportunities for proving space vehicle hardware. If severe operational problems are encountered in Earth orbit, a quick and safe return is possible. Similarly, Earth-orbit flights provide practical opportunities for proving and refining experiments, hardware, and scientific procedures.

Specific impacts of the interplanetary mission system on space station and other Earth-orbit programs are assessed on the following pages. Recommendations identify some of the more promising opportunities to be emphasized through such integration of the various space programs.

##### 3.6.1.1 Impact on Attitude Control Subsystems

The reaction control jet portion of an attitude control system for interplanetary missions should have only small impact on precursor Earth-orbital programs. Current technology should permit carrying an interplanetary prototype as the prime attitude-control system on an Earth-orbital program. Also, Earth-orbital tests should include long-duration storage tests for the reaction control propellants.

If control moment gyros are required as part of the attitude-control system for interplanetary flights, it will be necessary to carry the specific prototype on an Earth-orbital mission. Use of a control moment gyro is planned for the pointing and control system for the Apollo telescope mount; thus, much of the required technology may be achieved without impetus from interplanetary mission requirements.

### 3.6.1.2 Impact on Electrical Power Subsystems

The electrical power concepts considered for interplanetary missions will have a significant impact on Earth-orbital programs. Generally, the electrical power subsystem is quite heavy. Should the solar array battery subsystem be selected for an interplanetary program, it should be tested on an Earth-orbital mission. The size of the arrays and the configuration of the gimbaling structure, deployment structure, and protective shrouds would be unique. This might cause costly additions to any Earth-orbital mission planned for other purposes; or it might generate the need for a new space station mission. Should the dynamic electrical power subsystem concepts be selected, using either isotopes or nuclear reactors, large weight penalties and configuration concessions might apply to allow for shielding. Penalties would be increased if a full-scale prototype were carried as an experiment on an Earth-orbit mission using solar arrays and batteries as the prime electrical subsystem. However, if an interplanetary prototype dynamic electrical power subsystem were to be carried as the prime electrical subsystem on an Earth-orbital mission, it should not complicate the mission much more than if it had been designed strictly for that mission.

### 3.6.1.3 Impact on Communications Subsystems

Requirements for transmission of operational data during interplanetary missions will not be much greater than for Earth-orbital missions. However, transmission distances are much greater, and, hence, transmitter powers and antenna sizes will be greater.

S-band equipment for interplanetary missions should be carried for qualification testing in Earth orbit. This will constitute additional equipment to be carried and will create additional power requirements. For high rf data rates, various data compression techniques should be operationally tested via Earth orbit.

Laser communication systems should eventually prove to have greater capability and less weight than rf. The data rate capability of the laser would permit transmission of color TV. This would be desirable and some may insist it is a requirement. But to merit inclusion on interplanetary missions, much testing must be done to choose the best laser type, modulation technique, and ground station configuration. Some of these may be determined by laser use in unmanned programs such as Voyager, but testing in manned-orbital vehicles would be desirable. This would impact the Earth-orbital programs either by calling for additional missions or by carrying the laser equipment on presently planned missions on an experimental basis.

Additional impact will result from the fact that the laser transmitter must be pointed more accurately than rf at ground receivers. For Earth-orbital missions, the high relative velocity of the spacecraft and Earth will require more accurate pointing equipment than for interplanetary use or will place stringent attitude control requirements on the Earth-orbiting spacecraft.

3.6.1.4 Impact on ECS-LSS Subsystems

The environmental control and life support subsystems for interplanetary use should be thoroughly flight qualified in Earth-orbital manned missions. They are the subsystems most critical to crew survival. Continuous trouble-free operation of these subsystems in long-duration manned orbital tests will establish the necessary confidence in their reliability.

Environmental Control--A number of CO<sub>2</sub> removal/O<sub>2</sub> recovery concepts can and should be tested on Earth-orbital missions prior to their demand dates for interplanetary missions. More emphasis will be placed on the most feasible candidates.

The molecular sieve CO<sub>2</sub> removal process, baseline for the recommended vehicle, is slated for Apollo Applications Program use already. It is simple and well-developed, but requires quite large thermal power inputs. It should be used in Earth orbit for a number of reasons.

- 1) It will provide simple, reliable CO<sub>2</sub> removal and can serve as either a prime or redundant system.
- 2) It can be coupled with CO<sub>2</sub> reduction processes, or, if not, can easily vent CO<sub>2</sub> overboard.
- 3) It will become flight qualified, and, depending on selections of electrical power system and O<sub>2</sub> rate requirements, may become the optimum CO<sub>2</sub> removal method for interplanetary missions.

The electro dialysis CO<sub>2</sub> removal concept has advantages at certain O<sub>2</sub> rate design points when coupled with CO<sub>2</sub> reduction processes. It does not require large amounts of thermal power, such as molecular sieves do, for desorption of CO<sub>2</sub>. Electro dialysis is apt to require more orbital testing than molecular sieves; however, this method should be pursued because it can be more cost effective for interplanetary missions than molucular sieves.

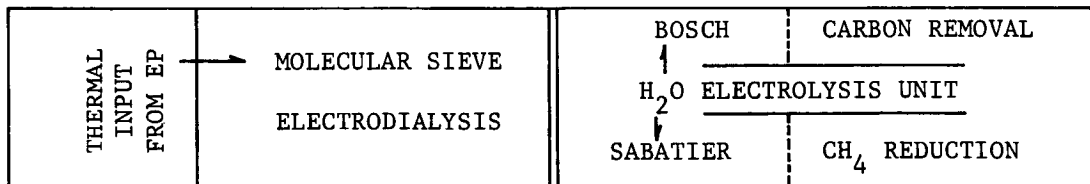

Both Bosch and Sabatier CO<sub>2</sub> reduction concepts should be developed in Earth-orbit tests. The Sabatier is simple and has been proven in ground tests. The Bosch requires development in its mechanical aspects, methods, and efficiency of carbon and catalyst removal and replacement. The environmental control system usually requires a water electrolysis unit and water separators, which must be developed and qualified for zero-g operations. For the Sabatier process, methods are being developed for recovery of hydrogen from the effluent methane, which will make Sabatier more competitive with Bosch.

The necessity to determine daily O<sub>2</sub> requirements is an indirect but important outgrowth of interplanetary environmental control system requirements on precursor Earth-orbital missions. The environmental control system concepts do not compare in the same fashion if there is a large daily O<sub>2</sub> requirement in excess of that for the crew. Cabin leakage rates must be determined. Minimum rates may be achievable, but there are also amounts of atmosphere consumption or usage that depend on the requirements and desires for extra vehicular activity (EVA). Also, for long durations, testing in orbit is required to determine whether control of trace contaminants can be maintained in a well-sealed cabin or a relatively high cabin leakage rate may be necessary to prevent buildup of contaminants. In this event, requirements for O<sub>2</sub> would exceed that available from CO<sub>2</sub> by a wide margin, affecting the ultimate selection of an environmental control system for interplanetary missions.

Life Support Water Management--Condensate urine and wash water can be processed in a number of ways, and several methods should be tried on Earth-orbital missions. Relatively low R&D and units costs make this approach more feasible than it would be for other subsystems. An air-evaporation system was chosen for the baseline design of the recommended vehicle. The "Subsystem Selection Study" (see Volume VI) showed that the most cost-effective approach would be electro dialysis for condensate and wash water recovery and vacuum compression distillation for urine recovery. When considering food and personal hygiene requirements for interplanetary missions, the primary impact on precursor Earth-orbital missions will be the attention devoted to testing many concepts to determine their suitability for long duration with no resupply.

#### 3.6.1.5 Crew Systems

The primary impact of interplanetary crew system requirements on Earth-orbital programs will be on mission duration and quantity of crew equipment carried. The physical environment for the crew on an interplanetary mission is not significantly different from that to be experienced on an Earth-orbital mission. However, the long duration of the interplanetary mission necessitates not only rugged, long-life pressure suits for the crew, but other equipment for physical and mental well-being (i.e., body-conditioning equipment, medical equipment, entertainment equipment). Many different types should be tried; some cannot be fully tested on the ground due to the physical environment or the mental environment on Earth, much in the same manner as a war game is no substitute for war. Earth-orbital tests of durations equal to the interplanetary missions are required to determine, as far as possible, the suitability of crew systems.

### 3.6.2 IMPACT ON EARTH-ORBIT SPACE SCIENCE

#### 3.6.2.1 Back Contamination

The complete safety of all plant and animal life on Earth as well as that on another planet must be assured. This requires that the baseline system for testing all forms of life be selected not only for its mutability in zero-g, but also for its benign effect on the life of a planet--once the test system is again established in a gravitational field. The mouse has been selected as a representative mammal. But if the mouse is going to be used as a biological system for testing the contaminating effects of extraterrestrial samples, then its normal physiological and immunological responses to disease must be established for the space environment.

- 1) Does the new environment select for any genetic change?
- 2) Is the reproductive capacity altered? Is the gestation period changed?
- 3) Is the normal life expectancy altered?
- 4) Is the mouse able to elicit the same immune responses as on Earth?
- 5) Will a change in environment render the mouse immune to normally infectious organisms? Will the change in environment encourage infection in the mouse after exposure to normally benign microorganisms?

These questions could be answered by maintaining a mouse colony in Earth orbit and observing their biological patterns of food processing, general activity, and reproduction. Test groups also would be challenged with microorganisms that are (1) normally nonpathogenic, (2) pathogenic, or (3) pathogenic for animals other than mice. It may also be feasible to attempt to change the immunity of the mouse by administering drugs or chemicals and then challenging it with microorganisms.

If the space environment, alone or coupled with chemical suppressors, can be shown to encourage infection in the mouse from normally benign microorganisms, there will be more confidence in the use of the mouse as a test system for back contamination.

A research program such as the one outlined above would enable better interpretation of data resulting from exposures of animal life to extraterrestrial environments.

A similar program should be initiated to establish similar relationships for the plant kingdom. Cereals and yeasts are recommended as the test systems.

### 3.6.2.2 Experiment Hardware Development

Because equipment developed in a 1-g environment for operation in zero-g may require modification or at least recalibration, final development testing must be performed in Earth orbit. In addition, field testing usually reveals weaknesses in design that are not apparent in the development period. In particular, the following activities must be performed in Earth orbit:

- 1) Preliminary observations in the UV and millimeter portions of the electromagnetic spectrum, using spectrophotometers, photometers, polarizers, and radiometers designed for the mission;
- 2) Assessment of the performance of both hardware and man in making the measurements, observations and related decisions implied by the objectives of the mission;
- 3) Training of the astronaut in the operation of equipment using the established procedures, but permitting modification of the training regime or procedure where necessary;
- 4) Using the spacecraft computer and the data obtained from probes or occultation devices to check out the concept of selecting a landing site within the footprint of the Mars excursion module and the soft landers to be developed for this mission;
- 5) Establishing the figure of the Earth from in-orbit data;
- 6) Verifying the validity of the measurements and observations established as achievable from in-orbit, such as the operation of radar to obtain surface depth data and the operation of other equipment mounted on scan platforms (from an automated program established in orbit);
- 7) Establishing the maintenance and checkout philosophy for the various equipment;
- 8) Verifying the reliability predictions for the various designs;
- 9) Determining the crew skills required.

### 3.6.2.3 Procedure Development

Operation of both man and equipment in the space environment and in the Earth surface environment are sufficiently different to require that all procedures involving the measurements and observations of an interplanetary mission be established in Earth orbit. These procedures can be confirmed only with the final design of the hardware and with men operating the equipment in space to gain experience in its operation. Such an approach is needed to establish the use of the equipment and to determine the step-by-step procedure to be followed during:

- 1) Equipment assembly after leaving Earth orbit;
- 2) Checkout and calibration prior to use in orbit or transfer between the spacecraft modules;
- 3) Datum point selection from display formats established during mockup of the science center;
- 4) Verification of spacecraft attitude and control prior to the use of the photosystem;
- 5) Scan platform operation for all equipment so mounted;
- 6) Data selection for science center storage or for transmission to Earth;
- 7) Equipment stowage or disposal, if not tagged for Earth reentry;
- 8) Computer programming or reprogramming, should the experiment sequence warrant it;
- 9) Display interpretation and control for data acquisition such as atmosphere circulation;
- 10) Crew monitoring to establish techniques and monitoring consistency;
- 11) Test life colony monitoring and experimentation for back-contamination control;
- 12) Data and sample transfer from Mars excursion module to stowage in the spacecraft.



## 3.7 TECHNOLOGY IMPLICATIONS

To simplify the identification of technology requirements and implications, it is necessary to further define "technology" to include research, advance technology, advance development, and supporting development. These subcategories are defined as follows:

- 1) Research--those activities directed toward an advance in basic scientific or engineering knowledge.
- 2) Advance Technology--those activities required to advance the technology of methods and techniques, through the use of science and engineering.
- 3) Advance Development--those activities leading to development of subsystems or components recognized to have long development lead time.
- 4) Supporting Development--those activities leading to development of backup or alternate systems, components and fabrication or test techniques.

Table 3.7-1 shows a matrix of the different technology categories in which advances are required for major elements of the interplanetary mission system.

System Element	Technology Category			
	Research	Advance Technology	Advance Development	Supporting Development
Mission Module (MM) Subsystems				
Attitude Control		X		X
Electrical Power		X	X	X
Communications	X	X		X
Environmental Control And Life Support Crew		X	X	X X
Mars Excursion Module (MEM)	X	X	X	X
Earth Entry Module (EEM)	X	X	X	X
Space Propulsion Propellants Storage and Transfer		X	X	X
Space Propulsion Engines		X	X	X
Experiments Hardware	X	X	X	
Earth Launch Vehicle		X		X

Table 3.7-1: TECHNOLOGY IMPLICATIONS MATRIX

### 3.7.1 MISSION MODULE SUBSYSTEMS

#### 3.7.1.1 Attitude Control

The attitude control subsystem selected for the recommended interplanetary vehicle includes both reaction control elements and control moment gyro elements. The control moment gyros, because of their size, will require certain technological developments, although these developments should not impose any serious problem for the interplanetary missions of the 1980's. The estimated technology developments are summarized below.

##### Research

None required.

##### Advance Technology

- Control moment gyro bearings, drive motors, and torquers of high reliability and long life must be developed for the large units required for the interplanetary vehicles.
- Maintenance on the control moment gyros should be considered and studied. It would be particularly desirable if simple methods of bearing, torquer, and drive motor repair or replacement could be developed.
- The useful life of reaction control thrusters should be extended so that wearout replacement of thrusters need not be considered for the interplanetary flights.
- Long term storage techniques should be developed for bipropellant fuels used in reaction control subsystems. Particular attention should be given to the development of long-life fuel expulsion bladders.

##### Advance Development

None required.

Supporting Development---Pure reaction-control jet attitude control should be considered as an alternative to the combined control moment gyro/reaction control subsystem proposed for development.

### 3.7.1.2 Electrical Power

The electrical power subsystem is one of the more critical subsystems in view of its technology implications. The proposed concept is Brayton cycle conversion of heat energy developed by decay of a radioisotope, Pu-238. While the principle is well founded, there are a number of development problems to be solved.

#### Research

None required.

#### Advance Technology

- A satisfactory method of encapsulating the isotope fuel must be developed. The nuclear material must be contained at the high temperatures to be developed in the matrix of fuel capsules (fuel block) used in the flight hardware. In addition, the capsules must be able to withstand the landing shock after an aerodynamic reentry from Earth orbit; they must also withstand the internal gas pressure developed by isotope decay, and provide some means of relieving gas pressure without allowing escape of radioactive particles.
- Intact recovery of the isotope fuel block is necessary in the event of abort during Earth-launch or Earth-orbital operations. It is undesirable to have any radioactive material dispersed in our atmosphere through disintegration of the fuel package during reentry (planned or unplanned). It is particularly undesirable to have Pu-238 dispersed because, chemically, it is very toxic. A method of ensuring the integrity of the fuel block must be developed. The method developed might also permit economically desirable recovery of the fuel after return from an interplanetary mission.
- The use of Pu-238 for a source of power in space missions, as well as for other uses on Earth which include medical prosthesis, will require that large quantities of the material be available. It is unlikely that present methods of production will be able to meet the demand; therefore, a method for quantity production of the material must be developed.

#### Advance Development

- Procurement of the Pu-238 isotope required as a primary power source is expected to require at least 7 years after a firm quantitative requirement for the material is established.

#### Supporting Development

- Solar arrays should be considered and developed as an alternate method of providing electrical power for the interplanetary missions. It is very likely that arrays will be used for power generation in manned Earth orbital missions between 1975 and 1980. These arrays in a configuration compatible with mission requirements should be considered for the interplanetary missions.

### 3.7.1.3 Communications

The recommended interplanetary vehicle carries both radio frequency and laser communications equipment. Before selection of an interplanetary communications subsystem is finally made, some additional study is required. First, a firm requirement for subsystem performance must be established in terms of information data rate or bandwidth. Next, a performance and economic trade should be made to determine what type of primary communications link should be developed, i.e., laser or rf. Finally, subtrades of antenna size versus transmitter power, modulation techniques, etc., should be made as required for the type of primary link selected.

The technology implications made below assume that the recommended subsystem will be developed, even though it is recognized that additional study is prerequisite to the development program.

#### Research

Some study is required, as noted above.

#### Advance Technology

- For rf communications, large, high-gain antennas must be developed. Particular attention should be given to developing high-accuracy pointing servo-mechanisms and methods of achieving close antenna surface tolerances to minimize antenna losses.
- For laser communications, most items require some degree of advance development. A lightweight laser telescope should be developed. High-accuracy pointing mechanisms are required to make the laser system practical. The laser assembly and the modulator must be developed. Because the laser assembly is expected to be life limited, possibly to 2000 hours for the CO<sub>2</sub> laser, it will be necessary to develop a method of replacing the assembly. Accuracy of alignment of the replacement assembly is expected to be a development problem.

#### Advance Development

None required.

#### Supporting Development

- Because of the problems attendant upon development of the laser as a prime communications link, it is advisable to develop the S-band communications subsystem as an alternate to the laser. This will require the use of high-gain transmitting antennas and high power transmitters that will significantly affect the spacecraft electrical power requirements.

### 3.7.1.4 Environmental Control and Life Support

Assuming that the present rate of technology development continues, the environmental control and life-support systems for interplanetary missions will impact technology primarily with regard to system reliability. This results because: (1) there is more to be gained by having lighter weight, more sophisticated systems (thus usually with a lower experience level and often more complex) for planetary missions as opposed to Earth-orbital missions; (2) the implications of system failure for interplanetary flights are considerably more serious than for Earth-orbital flights; and (3) crew survival and mission success goals can result in large mass penalties for an interplanetary vehicle as opposed to a resuppliable Earth-orbital vehicle. Although it is expected that advanced systems will be developed for prior extended-Earth-orbital missions, it is felt that the reliability and/or equipment life problem with interplanetary vehicles is unique.

Research---None required.

Advanced Technology---Systems that are continuous flow, rather than batch-process flow, and/or provide a satisfactory output for a given input without intermediary subsystems or macroscopic processes (phase changes) tend to be reliable and should be developed. As an example, a molten or solid electrolyte CO<sub>2</sub> reduction-O<sub>2</sub> regeneration system, which directly accepts and processes CO<sub>2</sub> on a continuous basis, is preferable to the Bosch or Sabatier concepts (plus CO<sub>2</sub> adsorbers) because neither CO<sub>2</sub> storage nor separate-batch processing of CO<sub>2</sub> is involved. A further example is the use of electro dialysis rather than adsorbers for CO<sub>2</sub> scrubbing on a continuous basis. This same electro dialysis process can also be used to recover potable water from urine wastes and condensate, without phase change, in a reasonably efficient manner. (A satisfactory urea pretreatment method needs development).

The detrimental effects of contaminants in fluid- and gas-process streams on the equipment they contact will need continuing definition. The performance and equipment life of sensitive ECS/LSS components such as catalysts, adsorbers, absorbers, permeable membranes, electrolysis cells, ionic membranes, wicks, oxidizers, electrodes, and others--when subjected to expected contaminants and contaminant levels--should be investigated and better established. This data will contribute to the design of longer life, higher reliability systems.

Advanced Development --Continuing development is needed of: (1) molten electrolyte oxygen regeneration components that are compatible with zero-gravity operation, as well as solid electrolyte components; (2) water electrolysis cells for zero-gravity operation that do not use an artificial "g" approach, and (3) a urea pretreatment process for use with electro dialysis waste-water recovery. Such development is important because these types of systems can have a significant positive effect on mission success and crew survival probabilities for interplanetary missions.

Supporting Development---

- Electrodialysis should be developed as an alternative to molecular sieves for CO<sub>2</sub> removal. Electrodialysis is potentially superior to molecular sieves in cost and performance.
- Development of the Bosch and Sabatier process for CO<sub>2</sub> removal should be continued. In some respects the Sabatier process is more desirable than the Bosch process; it is less complex and requires less electrical power.
- There are several concepts for clothing the crew and providing personal hygiene facilities that are currently being studied and developed. It seems reasonable to consider development of several competitive concepts, with selection for use on interplanetary missions to be based on the results from competitive use in Earth-orbital missions.

### 3.7.1.5 Crew Subsystems

The crew subsystems will have little impact on technology as defined in Section 3.7. The crew subsystems to be used on the interplanetary missions require selection and routine development. The areas that have technology implications are noted below.

#### Research

None required.

#### Advance Technology

None required.

#### Advance Development

None required.

Supporting Development---Several types of physical conditioning and recreational equipment should be developed and used in Earth-orbital missions before final selection of the interplanetary equipment.

## 3.7.2 MEM--TECHNOLOGY IMPLICATIONS

The Apollo-shaped MEM heat shield is relatively insensitive to entry heat loads. This, combined with the fact that entry technology for Apollo-type configurations will have reached a high level of development in the 1970's, reduces the development requirements for lifting-body-type MEM's. It appears feasible to simulate the MEM entry characteristics in the Martian atmosphere by controlled Earth entry maneuvers. The sensitivity of the MEM design to the descent and ascent engine characteristics, combined with lead time requirement for engine development, make engine development a problem area. Verification of ablator and radiative structure performance in a Martian atmosphere, as well as operation of all subsystems exposed to this atmosphere, is dependent upon a precise determination of the nature of the Mars atmosphere. Long-term passive storage of the MEM in space presents further uncertainties in the design which must be evaluated in the development of the MEM. The use of a ballute retardation system may present a major technology problem area.

Development requirements are as follows:

Research

- The precise determination of the Mars atmosphere structure and constituents is required. Early development of the Apollo shape can proceed on the basis of preliminary data, but final verification of the design must have precise data.

Advance Technology

- The development of large hypersonic ballutes must be initiated early if they are to be used. Subscale testing of 20- to 30-foot (1/3 to 1/2 scale) models is recommended as a logical intermediate development beyond the 6- or 8-foot ballutes that have already been flight tested. Final full-scale testing will include use of upper Earth atmosphere to simulate Mars deployment and stability conditions.
- The performance of ablator and radiative structure in the Mars-type atmosphere must be verified. Based on the definition of the Mars atmosphere, high-performance test facilities should be modified or constructed to simulate the Mars conditions, and tests should be conducted on the selected materials. Verification of the feasibility of Earth-orbit simulation may be established in this phase of the development program.

Advance Development

- Advanced space-storable (FLOX/CH<sub>4</sub>) engines are required. Two major problem areas are the operation at high chamber pressures and the requirement for advanced cooling methods such as transpiration. Associated with the high chamber pressure systems is the development of the hardware elements required. Analysis of new and complex loss mechanisms associated with transpiration cooling is required. Further, the exhaust gas expansion process is complicated by relatively unknown chemical kinetic reaction rates, which causes uncertainties in recombination losses for the new engines. The long-term development of engines warrants an early program start in this development area.



Support Development

- Space storage reliability testing techniques should be studied for all system elements.
- Testing techniques using the Earth atmosphere to simulate the Mars atmosphere should be investigated further by study and experimental validation.
- Scaling factors should be established for use with part scale testing.
- Any unmanned landing program should incorporate the MEM configuration and material concepts in its design to ensure that engineering data is available for comparison with development tests performed in the Earth atmosphere.

### 3.7.3 EEM TECHNOLOGY IMPLICATIONS

The Earth entry module's function is to safely return the crew and science payload samples from the mission module to the Earth's surface. The EEM presents technology problems because of high entry speeds (up to 60,200 fps for selected missions) and long idle-storage times (from 460 to 1040 days) in a space environment before use. A biconic shape EEM was chosen since it has the capability of entering at these high velocities and thereby eliminates the need for a heavy retropropulsion system to reduce entry velocity.

#### Research---

- Continued effort is required to develop realistic mathematical models to predict gas behavior, boundary characteristics and transition phenomena, radiation effects, heat transfer, afterbody heating levels, and interaction of heat-shield material with the atmosphere at entry velocities between 50,000 and 65,000 fps.
- Investigation of basic mechanisms, such as the coupling of radiation and convective heating, is required.

#### Advanced Technology---

- Development is required for test techniques to verify and improve the prediction models, furnish design data and evaluate design concepts for entry in the high-velocity regions. Investigations should be made into Earth-based simulation, in addition to development of testing techniques, using actual flights into the Earth atmosphere.
- Experimental programs should be initiated to verify feasibility of entry into the Earth atmosphere at velocities above 50,000 fps.

#### Advance Development---

- Development is required on atmospheric and approach-guidance procedures, control techniques, and subsystems based on the high-velocity entry requirements.

#### Support Development---

- Investigation should be continued of the feasibility of extending the Apollo-type configuration into the range of 50,000 to 65,000 fps, and evaluation should be made of the potential of this shape in terms of development, testing, manufacture, vehicle weight, and cost, as compared with the biconic configuration.
- Techniques for space storage reliability testing should be investigated.

### 3.7.4 SPACE PROPULSION PROPELLANT STORAGE AND TRANSFER

The propellant used with the nuclear engines is liquid hydrogen (LH<sub>2</sub>). Storing LH<sub>2</sub> for the durations associated with a planet departure stage and the environments encountered with Mars and Venus missions is a problem. Analyses and supporting ground tests indicate that such storage is feasible for nominal mass penalties when subcooled or slush hydrogen is the propellant state at Earth departure.

Propellant transfer between stages, so that  $\Delta V$  capability can be matched to  $\Delta V$  requirements when using the recommended common module approach, is a new concept requiring investigation and hardware development.

The developments required to achieve desired goals should be readily available within the interplanetary program schedule and are summarized below.

Research---None required.

#### Advanced Technology

- Further definition is required of nuclear radiation heating and its effects on the LH<sub>2</sub> thermodynamic state and fluid dynamics.
- Insulative systems and low thermal conductance support systems in conjunction with slush-filled tanks must be evaluated for a simulated ground-plus-launch condition using realistic expected temperatures and ambient pressure conditions.
- Techniques and ground systems must be developed to maintain the at-launch space propulsion tank LH<sub>2</sub> condition within some desired thermodynamic range.
- Techniques need development to determine LH<sub>2</sub> heating in an environment in which free convection is essentially absent.

#### Advance Development

- Engine design and development must include requirement for additional crew shielding.
- Retractable bellmouth or plug nozzle concepts need development if engine interstages are to be shortened.
- Net positive suction head pump development may be required for partially fueled tank startup.

#### Support Development

- Techniques should be investigated for space storage reliability testing.
- Methods and test programs should be developed for crew shield evaluations.
- Methods should be developed for shortening the overall engine length. Consideration should be given to retractable nozzles and plug nozzle concepts.

### 3.7.5 SPACE PROPULSION ENGINES

The Nerva nuclear engines specified for the recommended space vehicle are required to have performance parameters that result in major technology implications. These are:

- A specific impulse of approximately 850 seconds when LH<sub>2</sub> is the propellant
- An engine burn time in excess of 60 minutes when engine thrust is equal to or less than 120,000 pounds and ISP = 850 seconds.
- Engine startup with zero net positive suction head.
- Engine startup after long-time space storage.

In addition, it would be desirable to have the following:

- A shorter engine so that launch vehicle-payload heights and engine interstage weights could be decreased.
- A better definition of the engine radiation environment and crew shielding requirements.

Research---None required.

#### Advanced Technology

- Continued fuel element technology development to produce a reactor core that can provide the temperature associated with an 850-second specific impulse for periods in excess of 60 minutes.
- Accurate calculations of crew shielding requirements for the Mars or Venus departure propulsion stage, which consider a realistic propulsion module and spacecraft structural definition, are needed to establish engine shielding design.
- Performance of retractable or plug nozzle engines needs further definition.

#### Advanced Development---

- Engine design and development must include requirement for additional crew shielding.
- Retractable bell-mouth or plug-nozzle concepts need development if engine interstages are to be shortened.
- Net positive suction head pump development may be required for partially fueled tank startup.

#### Supporting Development---

- Techniques for space storage reliability testing should be investigated.
- Methods and test programs for crew shield evaluations should be developed.
- Methods for shortening the overall engine length should be developed. Consideration should be given to retractable nozzles and plug nozzle concepts.

### 3.7.6 EXPERIMENT HARDWARE DEVELOPMENT

#### 3.7.6.1 Science Information Center Hardware Development

During the study, a requirement became apparent for specific tools to support the acquisition of scientific data. The mass of data required for the complete understanding of a planet and its life imposed three distinct requirements on the data handling system. These three needs are concerned with the display of information connected with selection of data, whether the initial desire was (1) to collect additional data such as that associated with the measurements and the observations, or (2) to store the data for future analysis, or (3) to transmit the data back to Earth. The technology implications are summarized below.

##### Research

None required.

##### Advance Technology

- A library of information on the planets and in the pertinent fields should be collected and formats determined that will permit easy assimilation, storage, or display.
- To integrate equipment capabilities and the procedures for their operation, methodologies should be made available to the astronaut to permit him to organize the collection and storage of data, either for future analysis or for transmission to Earth.

##### Advance Development

- A data transmission system should be developed that will permit the transmission of high-resolution, high-color-contrast-range images. To dispose of information in an expedient manner and to reduce the amount of data recording media required to support a mission to the planets, data must be transmitted to Earth almost as rapidly as it is acquired.
- A mockup should be initiated that will permit storage or retrieval of information after high-resolution display. Figure 3.7-1 indicates the complexity of this step. To select targets or other data or samples, the astronaut must have rapidly assimilated data. This will permit him to make decisions whether to acquire more data from a target or an observable. To evaluate data, he must not only recognize the implication of unique information, but he must also be able to program a computer to make the pattern associations or the spectral associations required for the evaluation and subsequent disposal.

##### Support Development

None required.

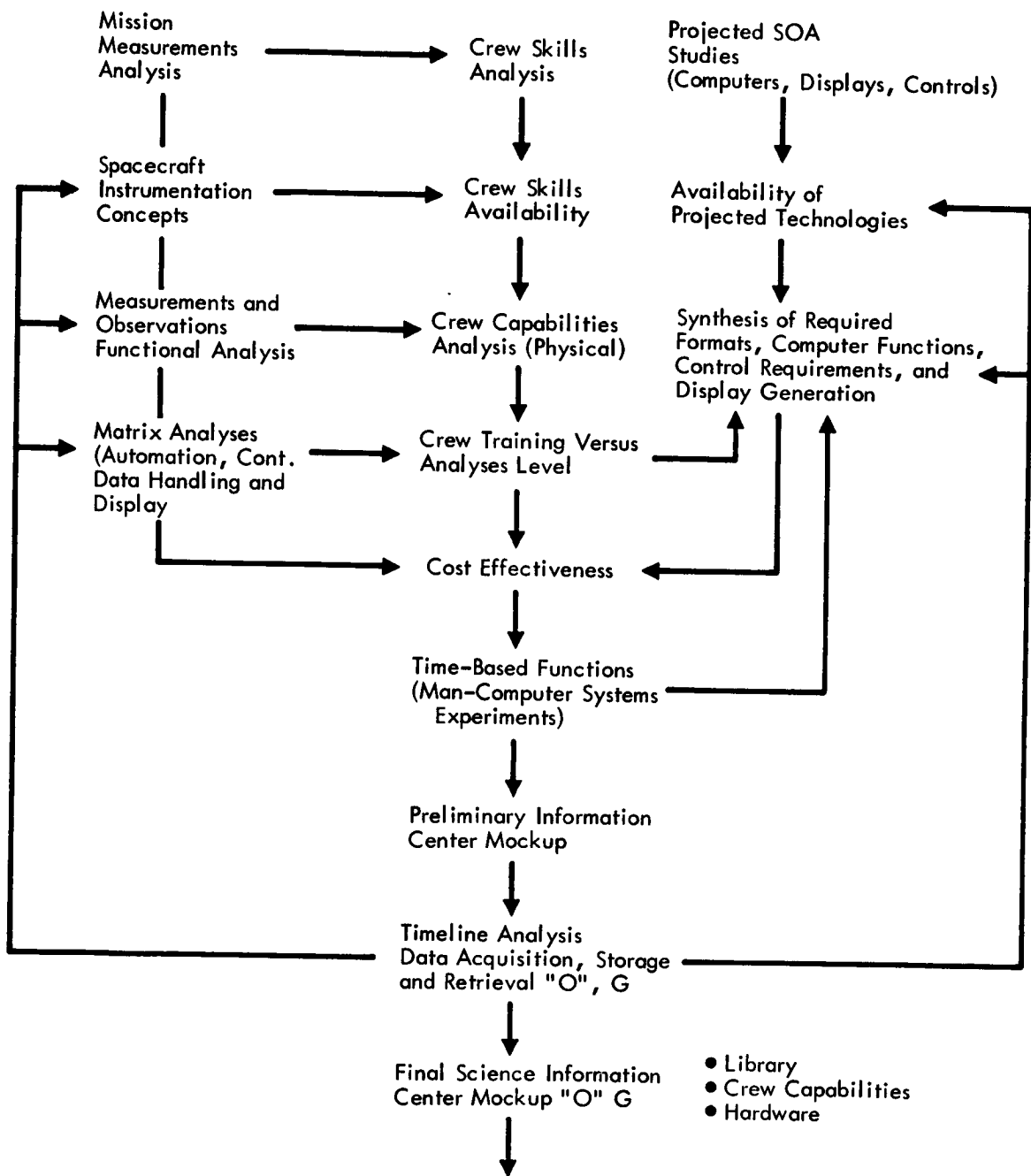

Permits the rapid evaluation, selection and integration and disposal of scientific information at critical points during the mission.

Figure 3.7-1: SCIENCE INFORMATION MOCKUP

### 3.7.6.2 Planet Surface Hardware Development

Time restrictions on surface operations have imposed requirements that, if met, could materially improve the acquisition of meaningful representative samples from the site selected. A transportation system should be developed to permit the rapid transporting of two astronauts over distances amounting to hundreds of miles over the surface of the planet. This requirement is a result of the diversity of surface information required as well as the magnitude of the geological structures to be surveyed. Another need is for data from below the surface to depths of thousands of feet, if not tens of miles. Superficial information from the surface will not permit a determination of the origin and evolution of a planet. A third need is for a spacesuit that will permit surface operations in excess of 4 hours on the surface. This may be met in part by the surface transportation system.

#### Research---

- A subsurface sampling concept should be explored, to satisfy requirements to determine the structure of a planet and the composition of the subsurface material in terms of its mineral content, chemical composition, and isotope ratios. The device can be based on the use of a laser beam to cut by a cylindrical core to depths far exceeding any similar holes presently drilled into the Earth's surface. A laser beam is promising because it may permit the drilling of holes as well as their casing to prevent the escape of liquids or gases from the interior of the planet. Such a device should be considered for the exploration of the Earth's crust as well. A second concept may be the application of ultrasonics to pulverize planet materials and permit their removal and collection in an ordered fashion. This device may be useful as long as the drilled material remains dry. The two concepts should be evaluated on the lunar surface since it approximates that of Mars more closely than that of Earth.

Advance Technology---None required.

#### Advance Development---

- Adaptability of planned or developed lunar surface transportation systems should be evaluated in relation to the needs of the planetary exploration program.
- Requirements should be determined for surface transportation on the planet Mars. The system should permit the transport of equipment and easy access to the surface for sample collection, terrain observation, and automated data station emplacement.
- A spacesuit should be developed that would permit the operation of hardware in a hostile environment for periods up to 10 hours or longer. The adaptability of prosthetic limb advances to the spacesuit, or the development of different experiment hardware control mechanisms to the sensors, are suggested as alternates.

Support Development---None required.

### 3.7.6.3 Experiment Hardware Procedures Development

The efficient collection of scientific data requires that the equipment operator understand the limitations of his hardware and the time required for its operation. This information is also required to establish a timeline for assessing the impact of the synergistic space environment on the astronaut. It is recommended that procedures be developed for a zero-gravity environment in the following areas to ensure the full utilization of the equipment and manpower of both the spacecraft and the Mars excursion module.

#### Research

None required.

#### Advance Technology

- Operation of the orbiting experiment equipment in conjunction with the science information center.
- Launch of hard landers, soft landers, and orbiters into predetermined trajectories to verify that their objectives can be met.
- Performance of biological experiments to establish essential techniques and limitations to ensure the fulfillment of the back contamination objectives, as well as the analysis of such biological data as may be necessary to establish a standard test colony.
- Selection of data from in-orbit with the broad guidelines leading to its disposal, storage, or transmission.
- Training of astronauts in spacesuits in the acquisition with the surface hardware of samples that are representative of the age and geological formation of the landing site as well as of its biota.

#### Advance Development

None required.

#### Support Development

None required.



### 3.7.7 SAT-V-25(S)U EARTH LAUNCH VEHICLE TECHNICAL IMPLICATIONS

The uprated Saturn with its strapon solid rocket motors, greatly increased thrust, payload size and weight capability presents additional technology problems in the areas of aerodynamics, control, communications, structures, and launch facilities.

Research---None required.

#### Advanced Technology---

- It is recommended that wind tunnel tests be conducted on a SAT-V-25(S)U to determine the effect of the strapon motors on the vehicle aerodynamic coefficients. The tests should determine the increment in the aerodynamic coefficients so that the results can be applied to other vehicles with a minimum of effort.
- Generally speaking synthetic wind representations which have been developed from statistical analysis of measured wind data do not produce loads responses with the same probability, i.e., there is no direct correlation between the probabilities of peak wind speed, wind shear, altitude, and direction, and load exceedance probability. In order to obtain loads of known exceedance probability, the following is required:
  - 1) Development of high-speed digital or analog simulations to obtain probability distributions of loads responses to statistical samples of mean winds.
  - 2) Utilization of Jimsphere data to obtain power spectral densities of random turbulence and associated mean wind profiles.
  - 3) Statistical ordering of vehicle responses to mean winds and random turbulence and correlation of these responses using vehicle responses to total wind profiles (Jimsphere).
- Computation of the ground winds loads response for large launch vehicles and their payloads is one of the most problematic areas faced in the course of vehicle design. Limited knowledge of wind forcing functions and the coupled elastic response to random vortex shedding has historically required wind tunnel verification or total reliance on wind tunnel results. Vehicle size has progressed to the point where limited knowledge of scaling relationships seriously hinders application of wind tunnel results. Considerable time and effort is being spent on the current Saturn V program to learn more about this problem area including full-scale ground winds testing using the AS-500 vehicle. An effort should be made to assemble all available knowledge from this and other sources and to extrapolate the results to the larger uprated configurations. In addition, wind tunnel tests of uprated Saturn configurations will be required.

Apply these results to the larger uprated Saturn configurations and obtain revised ground wind loadings for design purposes:

- 1) Plan and conduct wind tunnel tests to establish ground wind load responses of uprated configurations.

- 2) Utilize this information and current Saturn V analysis and test results to extend analyses methods to include the larger uprated vehicles.
- 3) Revise ground wind loads for design purposes based on these results.

Advanced Development---None required.

Support Development---

- The communication data recorded from Titan III flights should be evaluated to determine RF interference through the exhaust plume of combined liquid engines and solid rocket motors. This data should be correlated to data from Saturn I flights and other sources of RF interference data through exhaust plumes. This evaluation should consider the RF interference as a function of antenna look angle.
- The magnitude of the thrust at liftoff (approximately 24,000,000 pounds) of the SAT-V-25(S)U will create a greatly increased acoustical environment. This environment will impact personnel and certain facilities within the Launch Complex 39 area.

The acoustics during launch are extremely directional depending on the orientation of the flame trench and specific Earth and hardware deflectioners, protuberances, etc. Because of this directionality, specific orientation of the launch pad will have a significant effect on the acoustical hazard.

Existing acoustical data must be correlated and analyzed and additional data from actual firings obtained as required. Model tests should be conducted to determine the directionality factors associated with the flame trench. This data must be then combined into an acoustic profile which will define the acoustical environment from ignition through flight ascent to an altitude of approximately 1000 feet. This profile can then be used for specific siting and orientation of the launch pad and for the establishment of safety procedures during launch.

- Current safety criteria rates the solid rocket motor propellant as being 100% equivalent to TNT when the solid rocket motors are adjacent to the fueled core vehicle. This equivalency factor when combined with the 0.4 psi design over-pressure for Launch Complex 39 facilities, creates a major problem (and/or waivers on safety) for siting of the facility items (specifically launch pads). Actual tests to date of similar propellants indicates that this equivalency factor is grossly exaggerated. Existing test data indicates a more reasonable equivalency factor on the order of 10% TNT equivalency.

Similarly, TNT equivalency factors for the propellants in the core vehicle of 60% for LOX/Hydrogen and 10% for LOX/RP-1 stages appear unreasonably large considering the degree of mixing of the propellant constituents which is required to cause detonation on the orders indicated. Present launch vehicle payloads contain only small amounts of propellant and have been ignored in overpressure calculations. However, most of the launch vehicle payload for manned interplanetary flights are propellants and should be included in overpressure

calculations. For the recommended configuration, approximately 385,000 pounds of LH<sub>2</sub> are included in each space vehicle propulsion module launched.

Existing data must be correlated and a test program defined which will more realistically determine the actual TNT equivalencies of the separate propellant components and for combinations of these propellant components.

Joint Air Force and NASA activities to develop the required test programs and to correlate and apply the results should be conducted.

## 3.8 SENSITIVITIES FOR FUTURE STUDIES

A number of questions arose during this study that relate to manned interplanetary missions, but these can more appropriately be answered in future follow-on studies. Answers to some of these questions are dependent on the science aims or the mission program requirements that will evolve. These areas for future consideration are briefly indicated below.

- Effects if electrical propulsion becomes practical for primary propulsion.
- Effects if nuclear liquid or gaseous core becomes practical for primary propulsion.
- Effects if unlimited secondary power becomes available for subsystem operations.
- Effects on logistics program from selection of different ELV's or different spacecraft.
- Effects from availability of greatly increased rate or distance of planet surface mobility.
- Effects of unrestricted communications between a maneuverable probe and Earth-based control.
- Flexibility of recommended system to advances in state-of-the-art.
- Effects if life were discovered (or proved not to exist) on other planets.
- Effects of a scientific breakthrough in any of the disciplines involved in exploration of the solar system.
- Effects if there were free exchange of scientific data among all nations of the world.
- Multiple landings (geographically dispersed) on the planet surface and short-duration stay.
- Effects from unbalanced crew skills (all scientists or all test pilots).
- Effects if all planetary measurements had to be made either from earth orbit or with unmanned probes and orbiters.
- Effects on mission hardware if maximum allowable radiation dosage to man is found to increase or decrease.
- Effects of Earth-based control of planet surface explorations.
- Adaptability of manned interplanetary systems to growth (missions to other planets, Mars base, special missions).
- Assessment of the evolutionary approach to manned planetary explorations.
- Effects on configuration management for all future manned interplanetary activities from extensive use of ground-integration simulators, and of real-time processing from widely scattered data sources.

## 3.9 PROGRAM PLANNER'S GUIDE

The conceptual design for the recommended interplanetary mission system is based on a very few highly specialized modules. The flexibility with which these modules can be combined or separated is the key concept which makes the system practical. It assures a very high proportion of common hardware on all missions, but permits the propulsion capabilities to be built up or scaled down to meet the energy requirements of each individual mission. It provides the means for an extra margin of performance capabilities, which in turn provides a wide range of choices for particular missions and funding rates.

Sensitivities of this interplanetary mission system have been assessed throughout Part 3 of this volume. These sensitivities indicate the position of the recommended system in relation to each of the many variables; they also indicate the range of alternate choices available. These sensitivities, together with the options they make possible, constitute the main portion of the Program Planner's Guide. They will assist planners in devising tailored systems and plans for specific missions.

In addition, a series of examples is provided on the following pages to illustrate ways of using the findings from this study for further planning of specific planetary programs and missions:

- Table 3.9-1 is a "Program Planner's Combination Capability List" and exhibits potential space vehicle combinations that can be used on candidate missions. Potential space vehicle combinations include PM-1 stages (the Earth-depart stage) of two, three, and four common propulsion modules tied together. Potential missions to Mars and Venus with attendant space vehicle possibilities are defined from 1980 through 1988.
- Table 3.9-2, the "Program Planner's Price List," displays the costs involved in securing element combinations that can be used to build tailored programs. Programs can be priced by adding costs assigned to the alternate elements that comprise these programs.
- Table 3.9-3 is an example of the use of the price list. The basic example mission of this study is used to illustrate how total program cost can be generated using the guide.
- Figure 3.9-1, the "Program Planner's Funding Distribution List," allows a reasonable allocation of funds to be planned to meet a program's financial requirements.
- Figure 3.9-2 is an example of the use of the "Program Planner's Funding Distribution List."
- Subsection 3.9.1 provides generalized nomograms together with illustrations and instructions for their use in evaluating mission performance.

Table 3.9-1: PROGRAM PLANNER'S COMBINATION CAPABILITY LIST

Year	Potential Missions					Potential Combinations		
	Venus Short	Venus Long	Mars Opposition	Mars Conjunction	Mars-Venus Swingby	2-1-1	3-1-1	4-1-1
1980	X						X	X
1980		X					X	X
1980				X		X	X	X
1980					X			X
1981	X						X	X
1981		X				X	X	X
1982			X				X	X
1982					X	X	X	X
1983	X					X	X	X
1983		X				X	X	X
1984			X				X	X
1984					X			X
1985	X					X	X	X
1986	X					X	X	X
1986			X			X	X	X
1986				X		X	X	X
1986					X			X
1988			X				X	X

Table 3.9-2: PROGRAM PLANNER'S PRICE LIST

Nonrecurring Costs

(dollars in millions)

Basic System (Venus Mission  
Less Experiments) - 3-1-1  
Combination \$14,517.1

Alternate: Δ\$ Only

A - For 4-1-1	Combination Only	332.0
B - For 4-1-1	& 3-1-1 Mix (A+31.0)	363.0
C - For 2-1-1	Combination Only	-335.0
D - For 2-1-1	& 3-1-1-1 Mix	24.0
E - For 4-1-1	& 3-1-1 & 2-1-1 Mix	387.0
F - For Mars Mission (MEM)		4,857.9
G - For Venus Experiments Only		2,492.2
H - For Mars Experiments Only		1,868.2
I - For Swingby Experiments Only		1,204.0
J - For Venus & Mars Experiments		4,320.6
K - For Venus & Mars & Swingby Experiments		3,955.3

Recurring Costs

(dollars in millions)

<u>Type Mission</u>	<u>Typical Mission Costs for Combinations:</u>		
	<u>2-1-1</u>	<u>3-1-1</u>	<u>4-1-1</u>
Venus - Short	2,413.1	2,572.1	2,731.1
Venus - Long	2,449.7	2,608.7	2,767.7
Mars* - Opposition	2,523.8	2,681.9	2,840.0
Mars* - Conjunction	2,601.3	2,759.4	2,917.5
Mars* - Venus Swingby	2,597.6	2,755.7	2,913.8

\*Mars Missions assume a Venus Mission has been run earlier.

Table 3.9-3: USE OF PROGRAM PLANNER'S PRICE LIST

## Example Problem:

The price list can be used to find the costs of the basic program considered in the IMISCD study.

## Nonrecurring Costs (dollars in millions)

● Basic System	\$14,517.1
● Alternate	
F. for MEM	4,857.9
J. for Venus & Mars Experiments	4,320.6
	<hr/>
Total	\$23,695.6

## Recurring Cost (dollars in millions)

● Venus Short	\$ 2,572.1
● Mars Opposition	2,681.9
	<hr/>
Total Program Cost	\$28,949.6
	<hr/>



Figure 3.9-1: Program and Mission Planner's FY Funding Distribution List

NONRECURRING COSTS - % DISTRIBUTION:

IF VENUS IS FIRST MISSION

3	8	13	14	16	18	14	9	4	1
---	---	----	----	----	----	----	---	---	---

DEMONSTRATION TEST ▼

IF MARS IS FIRST MISSION

2	7	11	12	17	18	17	11	4	1
---	---	----	----	----	----	----	----	---	---

DEMONSTRATION TEST ▼

▲ IF MARS IS SUBSEQUENT MISSION

3	8	14	19	24	19	7	3	2	1
---	---	----	----	----	----	---	---	---	---

MISSION LAUNCH ▼

▲ IF VENUS IS A SUBSEQUENT MISSION

3	24	28	24	18	2	1
---	----	----	----	----	---	---

MISSION LAUNCH ▼

RECURRING COSTS - % DISTRIBUTION  
(PER MISSION COSTS)

VENUS SHORT MISSION

5	21	45	20	5	4
---	----	----	----	---	---

▼ MISSION LAUNCH

VENUS LONG MISSION

9	24	27	20	13	5	2
---	----	----	----	----	---	---

▼ MISSION LAUNCH

MARS OPPOSITION MISSION

10	26	40	14	7	3
----	----	----	----	---	---

▼ MISSION LAUNCH

MARS CONJUNCTION MISSION

9	24	26	20	12	4	4	1
---	----	----	----	----	---	---	---

▼ MISSION LAUNCH

MARS SWINGBY MISSION

9	24	27	21	13	5	1
---	----	----	----	----	---	---

▼ MISSION LAUNCH

▼ DEMONSTRATION TEST FOR FIRST MISSION ONLY

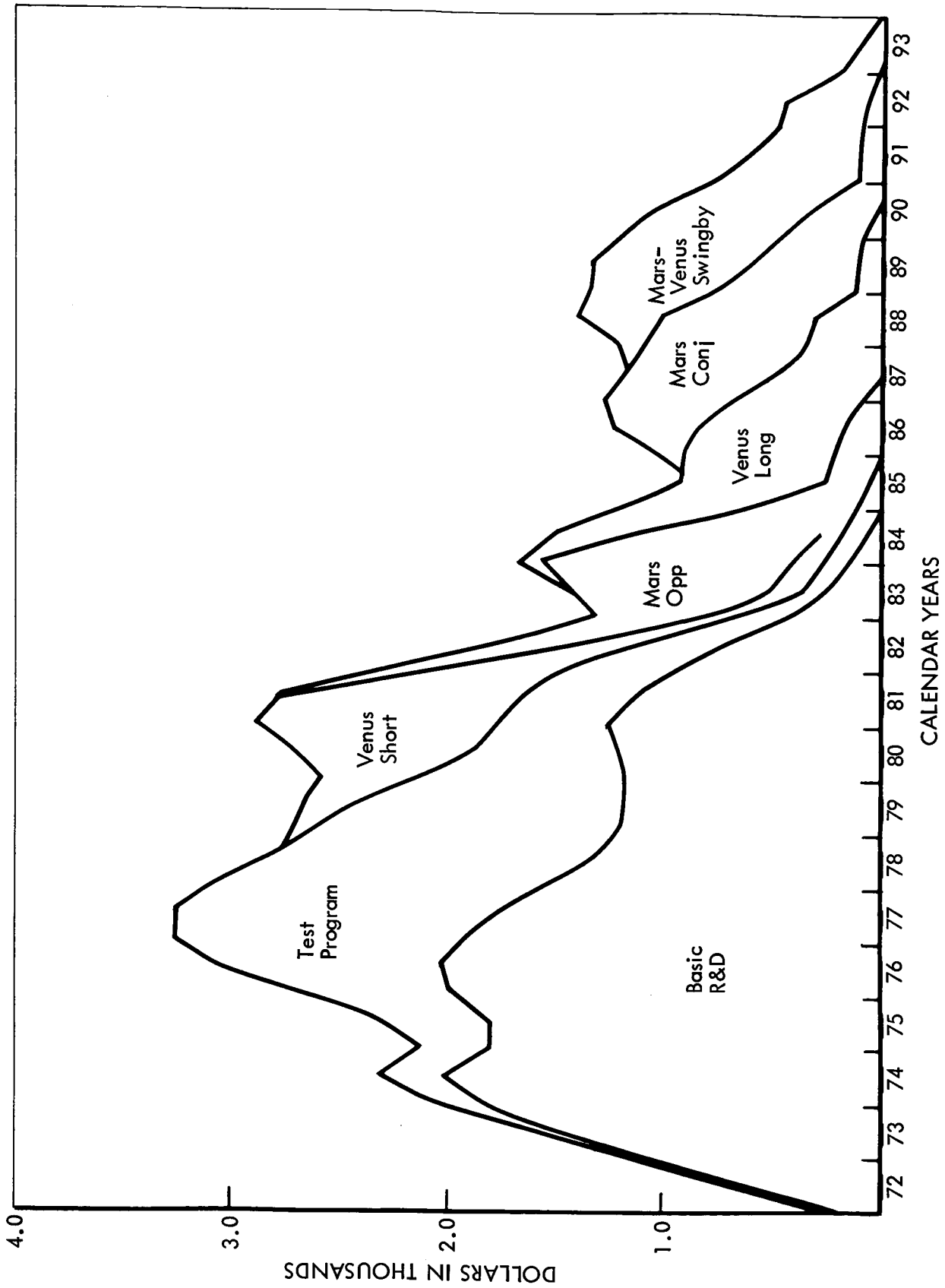

Figure 3.9-2: EXAMPLE PROGRAM FUNDING DISTRIBUTION

### 3.9.1 MISSION PERFORMANCE EVALUATION

Digital computer techniques are used to evaluate mission performances under the constraints of complexly related design variables. Generalized nomograms relating the three primary variables--payload weight, operating propellant weight, and  $\Delta V$  requirements--have been prepared. The nomograms are based upon the 3-1-1 recommended system.

#### 3.9.1.1 Performance Nomograms

Figures 3.9-3 and 3.9-4 present the mission performance evaluation nomograms for the PM-3 and PM-2 and for the PM-1 stages, respectively. Figures 3.9-5 through 3.9-8 summarize the method of moving through the curves to determine IMIEO.

The mission planner may select any reasonable mission and evaluate whether the mission is possible with the  $\Delta V$  capability he has selected. Alternatively, he may use an iterative process to optimize the missions that may be accomplished. Additionally, these curves may be used to estimate velocity or propellant transfer requirements.

By careful interpolation and iteration, IMIEO's may be obtained within 2% of computer calculations.

#### 3.9.1.2 Nomogram Input Data

The variable weights required for input calculation of payloads include the mission module (MM) as a function of mission duration, the Earth entry module (EEM) as a function of entry velocity, and the Mars excursion module (MEM) as a function of Mars orbit eccentricity. These module weights are shown in Figures 3.9-9, 3.9-10, and 3.9-11.

Propellant reserves considered include 2.5% of operating propellant to account for unavailable propellants and 2% of the impulsive  $\Delta V$  for performance reserves. The latter factor is applied to the impulsive  $\Delta V$ 's prior to determining the propellant weights.

Midcourse and orbit trim propulsion modules are represented by a percentage of their payload weights. The values found in selected representative missions are shown in Table 3.9-4:

Table 3.9-4: PAYLOAD WEIGHT PERCENTAGES

Mission Class	Percentage of Payload		
	OBMC	IBMC	OT
Mars Opposition and Outbound Swingby	3	4	3
Mars Inbound Swingby	3	7	3
Mars Conjunction	3	4	3
Venus Short	3	4	3
Venus Long	3	5	3





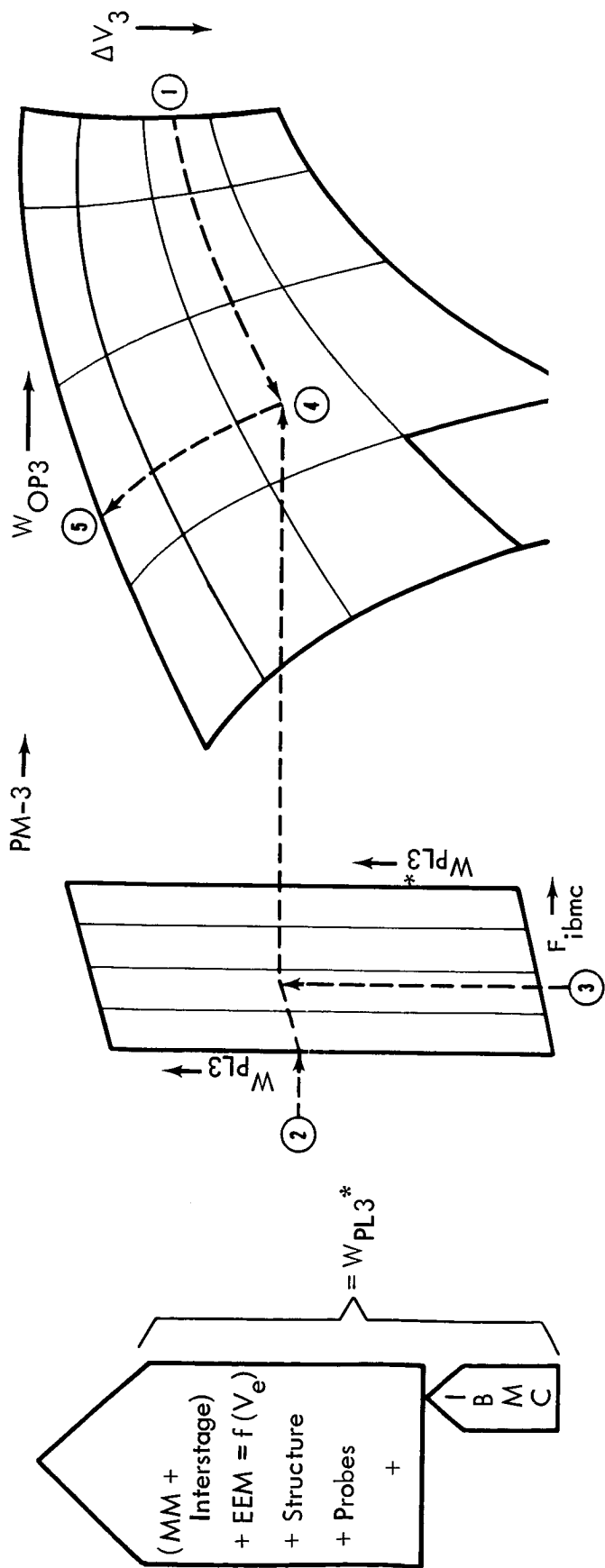

- ① Choose the mission  $\Delta V_3$  required
- ② Calculate payload  
 $W_{PL3} = W_{EEM} + W_{MM} + \text{probes} + W_{\text{Interstage}}$
- ③ Correct  $W_{PL3}$  for selected inbound midcourse correction factor  
 $W_{PL3}^* = W_{PL3} \times F_{IBMC}$
- ④ Enter plot at  $\Delta V_3$  (1) and  $W_{PL3}^*$  (3)
- ⑤ At intersection of (1) and (3), readout required propellant load,  $W_{OP3}$
- ⑥ To include gravity losses, increase  $\Delta V_3$  in (1) by desired percentage, or see Figure 3.9-15.

Figure 3.9-5: CALCULATION OF PROPELLANT WEIGHT FOR PM-3

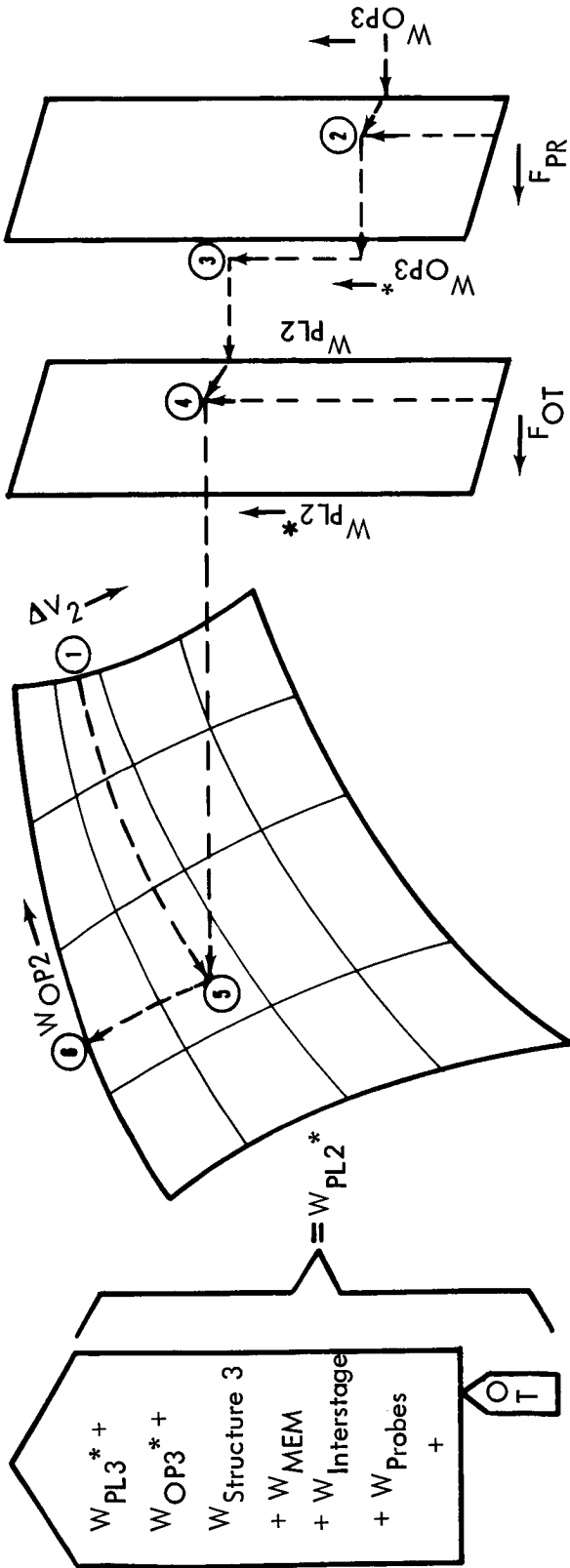

- ① Choose the mission  $\Delta V_2$  required.
- ② Correct  $W_{OP3}$  for desired propellant reserve  

$$W_{OP3}^* = W_{OP3} \times F_{PR}$$
- ③ Calculate payload by  

$$W_{PL2} = W_{OP3}^* + W_{PL3}^* + W_{Structure\ 3} + W_{MEM} + \text{probes} + W_{Interstage}$$
- ④ Correct payload for the outbound leg course trim  

$$W_{PL2}^* = W_{PL2} \times F_{OT}$$
- ⑤ Enter plot at  $\Delta V_2$  ① and  $W_{PL2}^*$  ④
- ⑥ At intersection of ① and ④ read out required propellant load  $W_{OP2}$
- ⑦ To include gravity losses, increase  $\Delta V_2$  in ① by desired percentage, or see Figure 3.9-15.

Figure 3.9-6: CALCULATION OF PROPELLANT WEIGHT FOR PM-2





### IMIEO Calculations

To calculate initial mass in Earth orbit

1. Correct  $W_{OP1}$  for propellant reserve

$$W_{OP1}^* + W_{OP1} \times F_{PR}$$

2. Calculate IMIEO by

$$IMIEO = W_{OP1}^* + W_{PL1}^* + W_{Structure 1}.$$

Note:

The mission cannot be flown with the given thrusts and payload if the sum of propellant weights is greater than propellant capacity. Specifically:

$$W_{OP3}^{Capacity} \geq W_{OP3}^*$$

$$W_{OP3+OP2}^{Capacity} \geq W_{OP3}^* + W_{OP2}^*$$

$$W_{OP3+OP2+OP1}^{Capacity} \geq W_{OP3}^* + W_{OP2}^* + W_{OP1}^*$$

Figure 3.9-8 : CALCULATION OF IMIEO

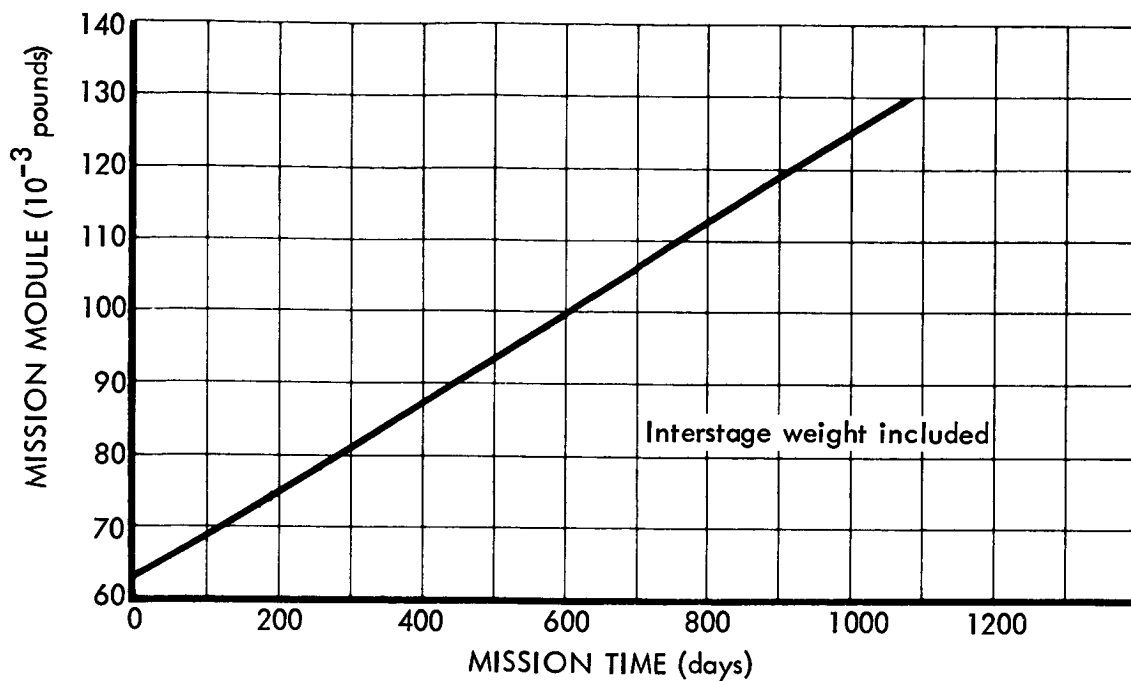

Figure 3.9- 9 : MISSION MODULE WEIGHT

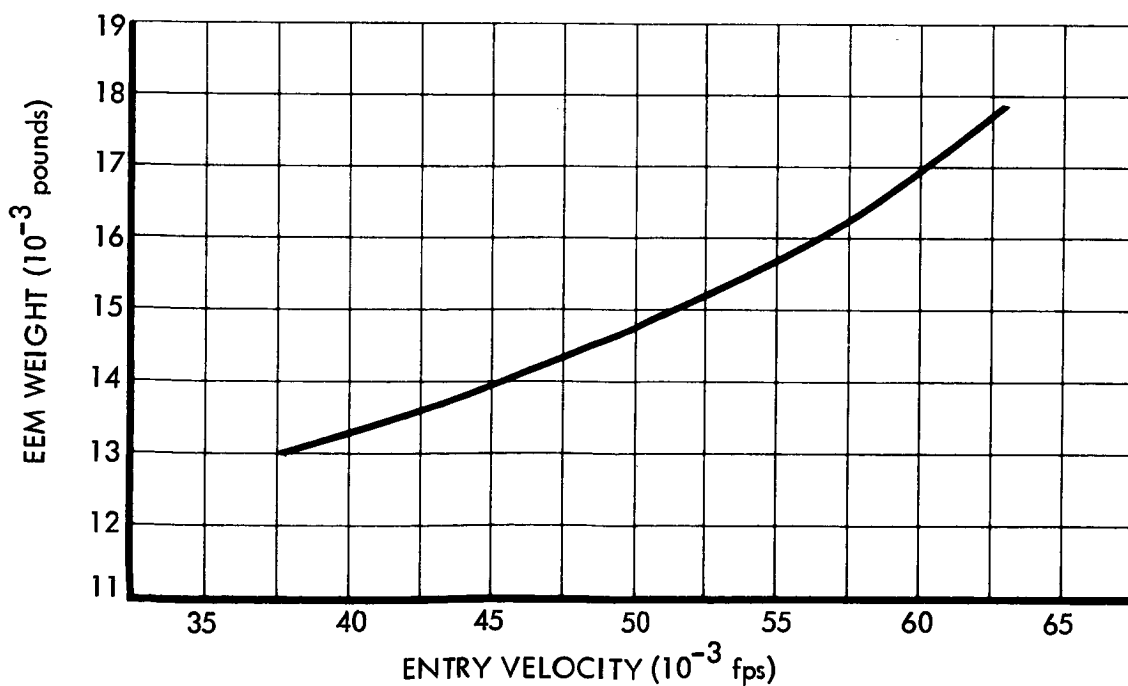

Figure 3.9-10: EEM WEIGHT

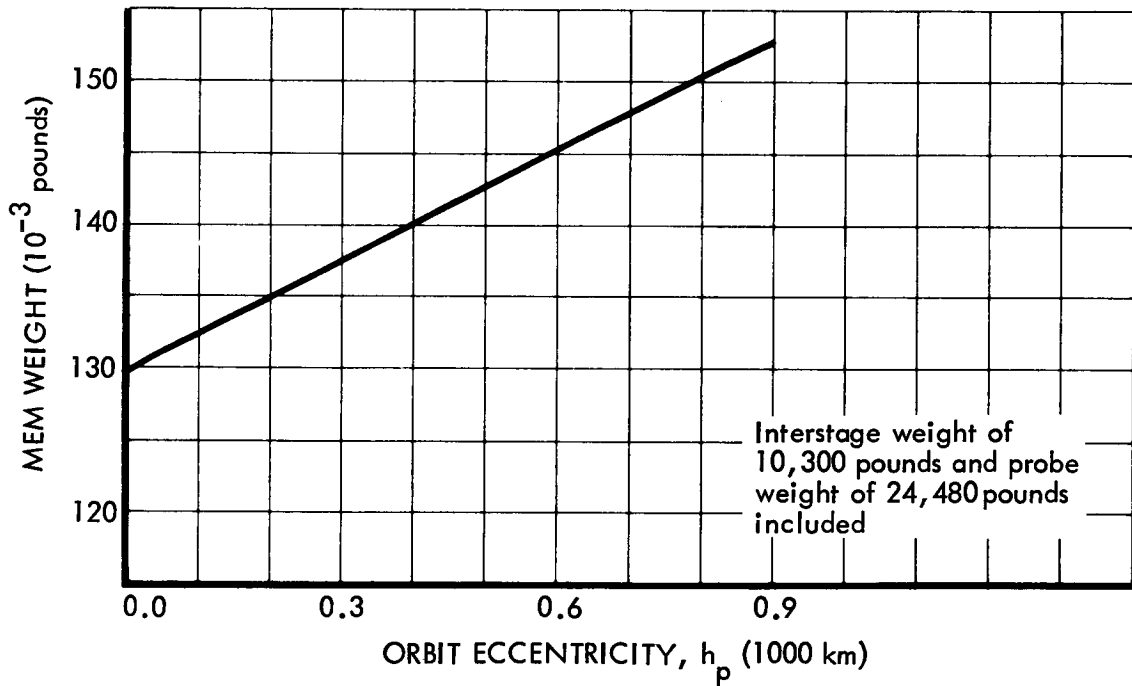

Figure 3.9-11: MEM WEIGHT

Gravity and thrust losses must be accounted for since mission  $\Delta V$ 's are generally determined for ideal impulsive conditions. Figures 3.9-12, 3.9-13, and 3.9-14 are plots of thrust loss corrections for Earth departure, Mars capture and departure, and Venus capture and departure. Figure 3.9-15 demonstrates the method of correcting the mission  $\Delta V$ 's in the performance evaluation.

### 3.9.1.3 Performance Evaluation Example

Heavy lines on the nomograms are shown to illustrate a typical calculation. Mission parameters used are:

$$\begin{aligned}\Delta V_1 &= 12,090 \text{ fps} \\ \Delta V_2 &= 10,125 \text{ fps} \\ \Delta V_3 &= 17,560 \text{ fps} \\ V_{\text{entry}} &= 62,000 \text{ fps} \\ \text{MM operating time} &= 490 \text{ days} \\ \text{Orbit eccentricity} &= 0\end{aligned}$$

Calculation procedures are presented arithmetically to demonstrate calculation sequence.

### 3.9.1.4 Nomogram Model

The recommended 3-1-1 space acceleration train was used as a basis of the nomogram model. Total structural weights were 160,000 pounds for PM-2 and PM-3 and 480,000 pounds for PM-1, which included 51,000 and 153,000 pounds, respectively, for the meteoroid shield and aft interstage. MEM weights as a function of orbit eccentricity assumed a periapsis of 1000 kilometers. On Venus missions, the MEM is replaced with a probe and interstage weight totaling 40,400 pounds. Fully fueled modules assumed a 524,000-pound ELV payload capability and yielded nominal operating propellant fuel weights of 355,600 pounds for PM-3 and PM-2 and 1,066,800 pounds for PM-1.

Neglected in the nomogram generation were small variations in mission parameters due to meteoroid shield, boiloff, and thermal insulation. The meteoroid shield design criteria required that the shield carry the vehicle launch loads combined with the meteoroid flux and penetration probabilities. An essentially constant meteoroid shield for all modules results. Subcooled hydrogen use reduces the propellant boiloff to zero except for very long missions in the PM-3 stage. The magnitude of the thermal insulation weight compared to the total module weight is small and can thus be assumed constant.

The  $\Delta V$  loss curves are based upon an inertially fixed thrust angle. This yields approximately a factor of 2 (for thrust-to-weight ratios of 0.1 to 0.3) conservatism over a calculation using an optimum thrust loss flight path. The forms approach was used because it is the simplest to implement. The other approach requires a continuously changing thrust angle program to obtain an optimum thrust loss flight path determination.

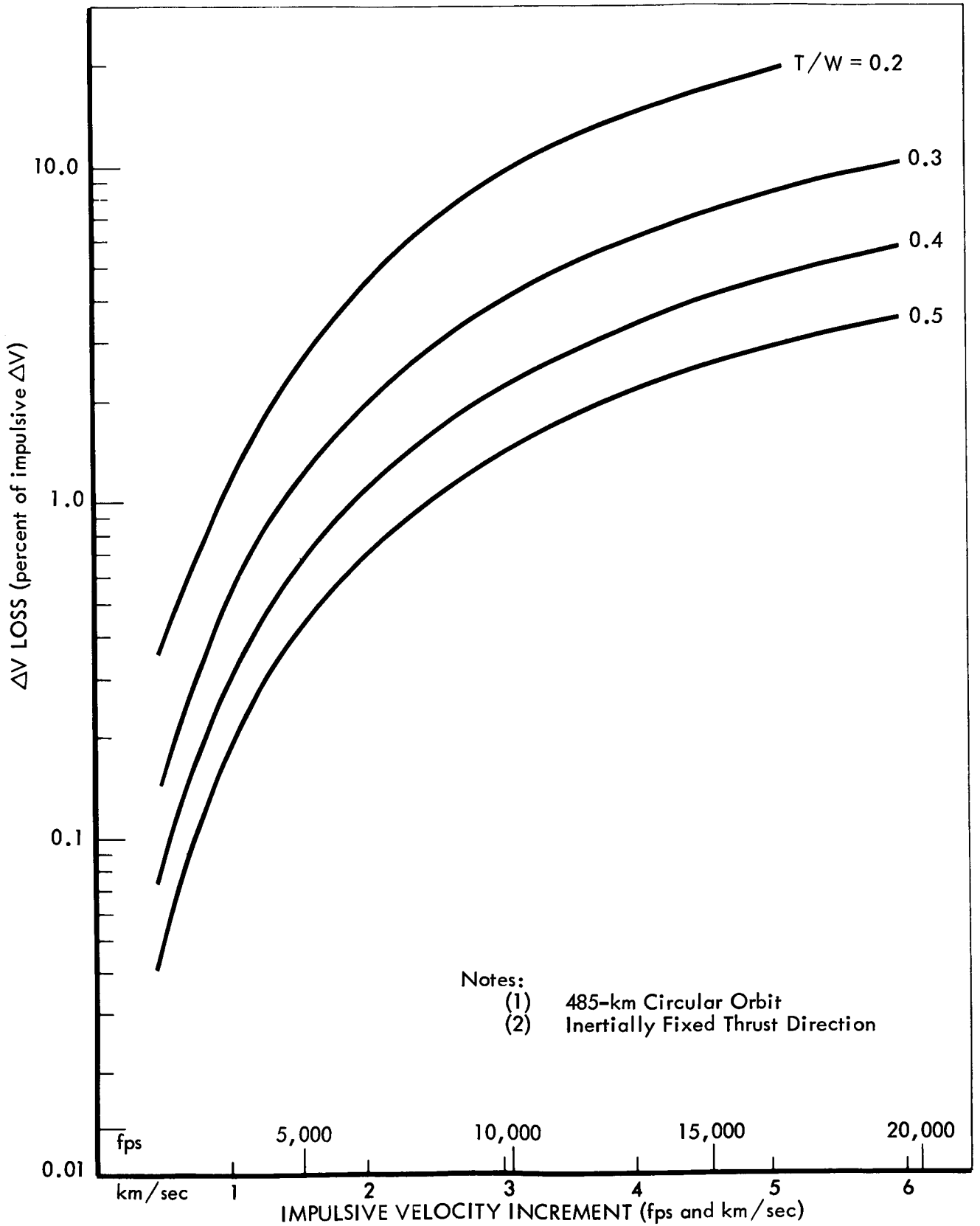

Figure 3.9-12: FINITE THRUST LOSSES FOR EARTH ORBIT DEPARTURE ( $I_S = 850$  sec)

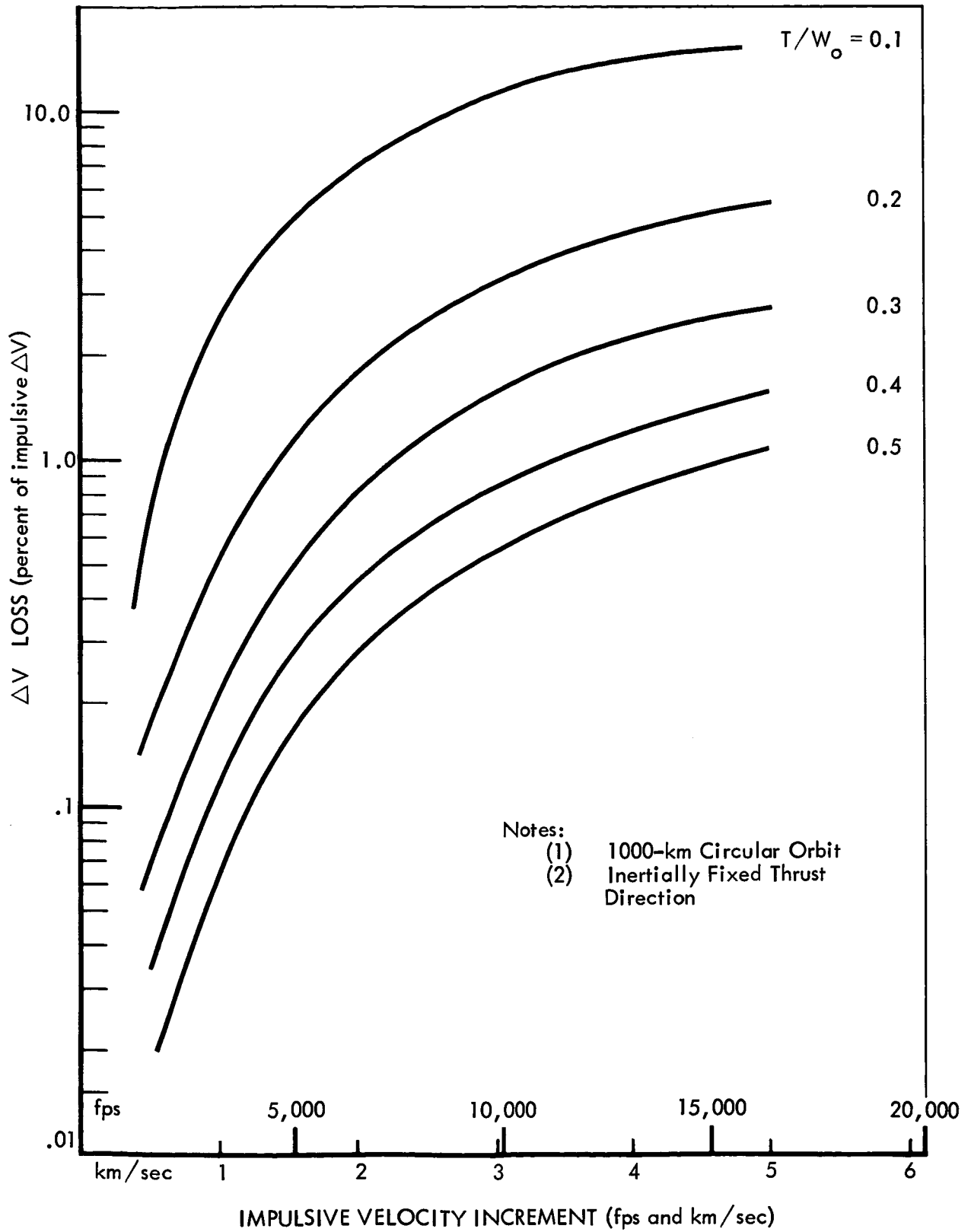

Figure 3.9-13: FINITE THRUST LOSSES FOR MARS ORBIT ( $I_S = 850$  sec)

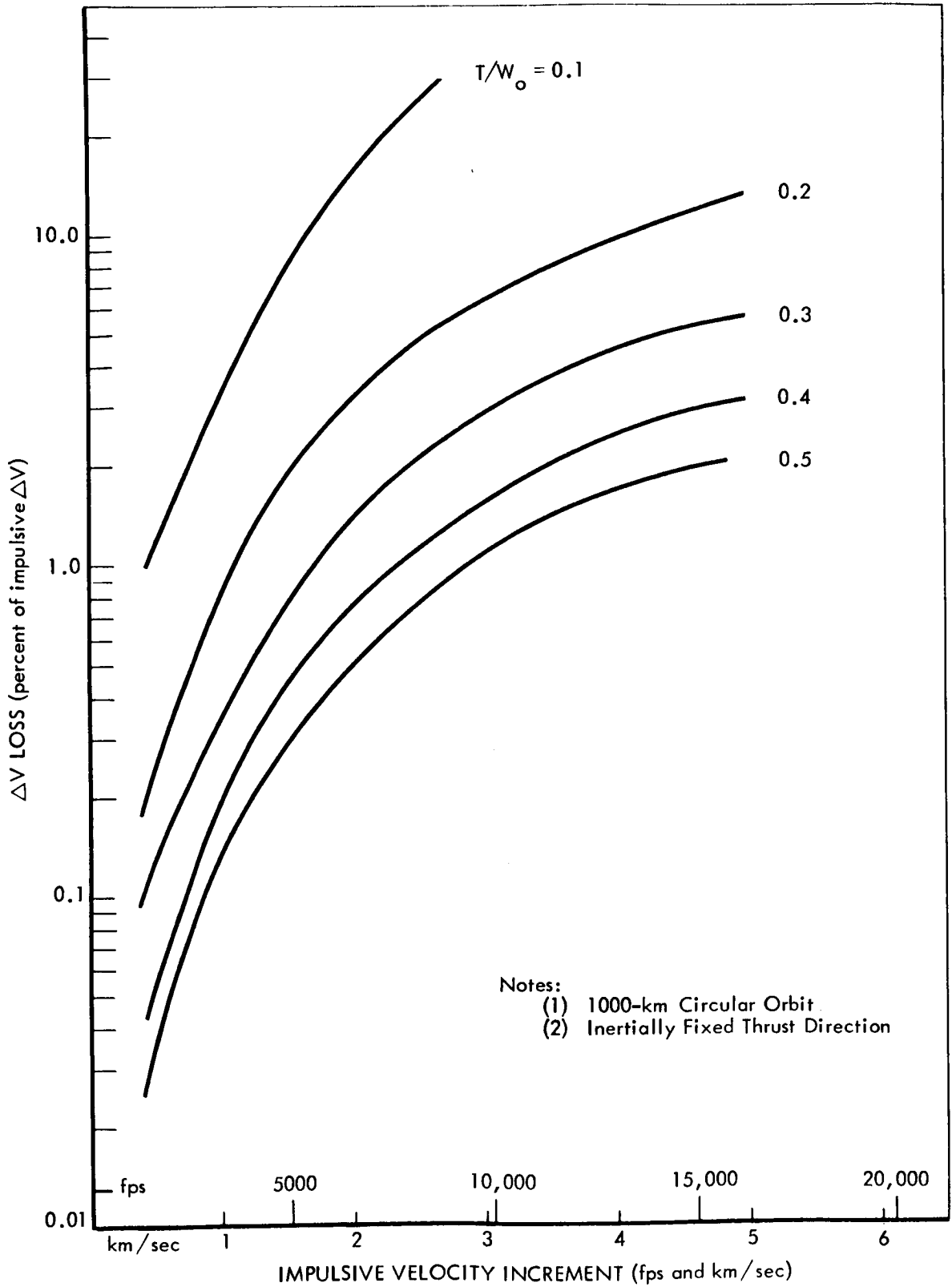
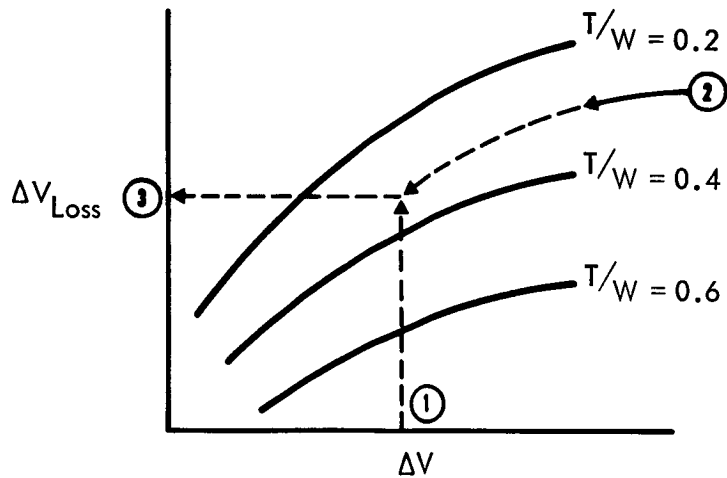

Figure 3.9-14: FINITE THRUST LOSSES FOR VENUS ORBIT ( $I_S = 850$  sec)

1. Use  $\Delta V$  for the stage in question.
2. Calculate thrust / weight ratio for the first  $W_{OP}$  guess.

$$T/W = \text{Thrust} / W_{PL} * + W_{OP} \times F_{\text{Propellant Reserve}} + W_{\text{Structure}}$$

3. Enter curve of velocity loss for planet to obtain  $\Delta V_{Loss}$ .



4. Correct original  $\Delta V$  by
 
$$\Delta V_{Corr} = \Delta V (1 + \Delta V_{Loss}).$$
5. Return to the  $W_{OP}$  calculation and repeat using the corrected  $\Delta V^{Corr}$ .

Figure 3.9-15: INSTRUCTION FOR CALCULATION OF  $\Delta V$  THRUST LOSSES