

Underground Enclosures

Installation Guide



Underground Enclosures

Light Duty • Medium Duty • Heavy Duty • Traffic Rated

Installation Guide

WARNING: All installations must be performed by qualified personnel with proper safety equipment. When installing any surface-level underground enclosures installers must follow all national and local electrical, safety and building codes.

Pedestrian / Greenbelt Installations and Applications

Typical installations are pedestrian and greenbelt spaces and other non-deliberate traffic locations.



Load Rating:

- Light Duty | Pedestrian | Design Load: 300 PSF
- Medium Duty | ANSI/SCTE Tier 8 | Design Load: 8,000 lb

Enclosure Brands:

- Carson®
- Christy®
- Fibrelyte®

Greenbelt, Sidewalk & Right of Way Installations and Applications

Typical installations are greenbelt spaces, sidewalks and right of ways and other incidental non-deliberate traffic locations.



Load Rating:

- Medium Duty | ANSI/SCTE Tier 15 | Design Load: 15,000 lb
- Heavy Duty | ANSI/SCTE Tier 22 | Design Load: 22,500 lb

Enclosure Brands:

- Duralite®
- Oldcastle FRP
- Oldcastle Polymer

Roadways and Deliberate Traffic Areas Installations and Applications

Typical installations are roadways and deliberate traffic areas. Traffic rated products require a steel frame and cover with a concrete collar.



Load Rating:

- Traffic Rated | AASHTO H20 | Design Load: 16,000 lb

Enclosure Brands:

- Christy®

Always ensure the product load rating matches the anticipated load rating of the application.

Underground Enclosures

Light Duty • Medium Duty • Heavy Duty • Traffic Rated

Installation Guide

Installation Notes

- Light Duty
- Medium Duty
- Heavy Duty
- Traffic Rated

Installations on a slope or hillside:

Enclosures installed on a slope or hillside should be installed level and have a retaining wall built to hold the soil to prevent erosion above the enclosure.

Sidewalks:

If the installation is to be within a sidewalk, it is generally more practical to use a masonry saw and remove the entire sidewalk width to facilitate proper soil removal.

Base (crushed stone):

A base of 6"- 8" is recommended in high water table areas. A deeper layer of crushed stone may reduce the chances of settling over time. 2" to 4" of stone may be used in areas with high soil stability.

Lifting:

Enclosures can be safely handled by hand by the proper number of trained workers or with proper lifting equipment. Always follow guidelines for safe lifting.

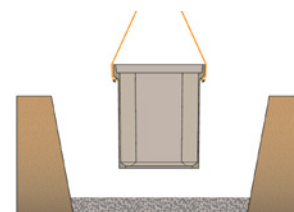

Bracing:

Install bracing within the enclosure to protect the sides from bowing during backfilling. Suitable bracing could be one or multiple wooden 2x4's cut to length and installed snug against the inside walls of the enclosure.

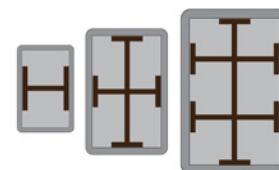

Backfill:

Be sure to remove any stones 3" or larger from the backfill material. An alternate 'dry lean mix' may be prepared for backfill using Portland cement and crushed rock in a ratio of 1:10. This higher strength alternative is useful where known traffic is anticipated within the vicinity of the enclosure that could cause vehicular surcharge loading.

Tamping:

It is recommended not to use mechanical tamping tools such as a tamping ram or plate compactor when tamping the backfill material around the enclosure to prevent bowing to sides of the enclosure. Mechanical compactors can increase the soil density by as much as 200%. DO NOT use heavy equipment, like backhoes, for tamping as damage will occur.

Always ensure the product load rating matches the anticipated load rating of the application.

Underground Enclosures

Light Duty • Medium Duty • Heavy Duty • Traffic Rated

Installation Guide

Pedestrian Rated / Greenbelt Applications

- Light Duty | Pedestrian | Design Load: 300 PSF
- Medium Duty | ANSI/SCTE Tier 8 | Design Load: 8,000 lb

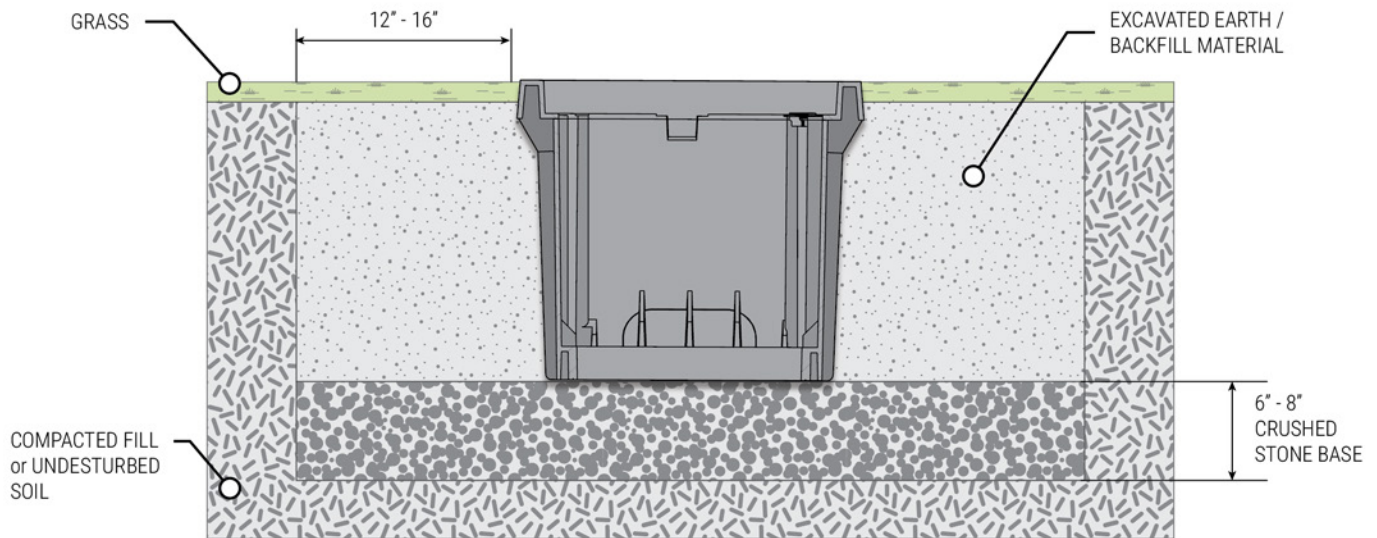

I. Excavation

Excavate an area approximately 12" to 16" longer and wider and 6" to 8" deeper than the actual dimensions of the enclosure to be installed. The excavation floor should be flat and level.

II. Installation

1. Add a 6" to 8" deep base of $\frac{3}{4}$ " and smaller, crushed stone to the excavated hole. The base material shall be crushed, angular stone, not 'river rock or round stone,' and should be free of soil and organic material (see page 2, "Base"). Use a mechanical or hand tamper to tamp down the crushed stone to be flat and level.
2. Set the enclosure box into the excavated hole. Adjust the height to grade. Be sure the enclosure is level, centered in the hole, and is parallel with the sidewalk or curb if applicable.
3. Install bracing (see page 2, "Bracing"), then install the cover and bolts to prevent debris from entering the enclosure and help maintain box rigidity during the backfilling procedure.
4. Utilize the excavated material to backfill along the open, outer sides of the excavated hole (see page 2, "Backfill").
5. Tamp the soil around the enclosure with hand tamping tools*. Soil in the immediate vicinity should be tamped and sloped away from the enclosure. Be sure not to slope the grade towards the enclosure as debris could make the cover difficult to remove.
6. Remove the internal bracing and replace the cover and bolts to complete the installation.

* DO NOT use heavy equipment, like backhoes, for tamping as damage will occur (see page 2, "Tamping").

Always ensure the product load rating matches the anticipated load rating of the application.

Underground Enclosures

Light Duty • Medium Duty • Heavy Duty • Traffic Rated

Installation Guide

Tier 15 & Tier 22 Rated / Greenbelt, Sidewalk & Right of Way Applications

- Medium Duty | ANSI/SCTE Tier 15 | Design Load: 15,000 lb
- Heavy Duty | ANSI/SCTE Tier 22 | Design Load: 22,500 lb

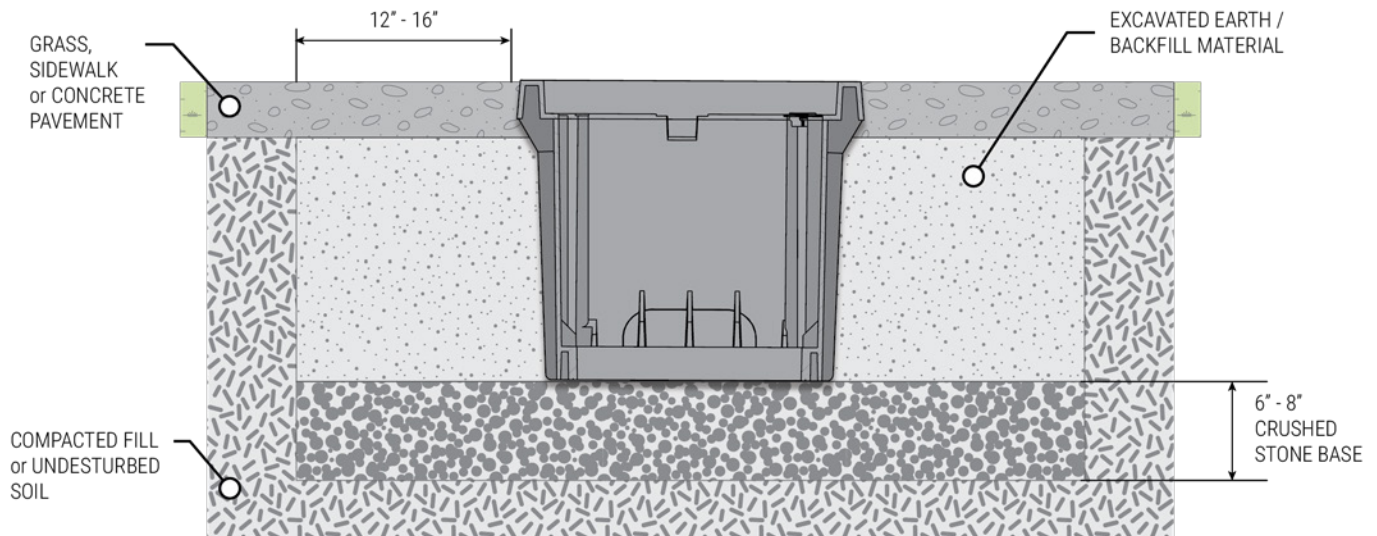

I. Excavation

Excavate an area approximately 12" to 16" longer and wider and 6" to 8" deeper than the actual dimensions of the enclosure to be installed (see page 2, "Sidewalk"). The excavation floor should be flat and level.

II. Installation

1. Add a 6" to 8" deep base of $\frac{3}{4}$ " and smaller, crushed stone to the excavated hole. The base material shall be crushed, angular stone, not 'river rock or round stone,' and should be free of soil and organic material (see page 2, "Base"). Use a mechanical or hand tamper to tamp down the crushed stone to be flat and level.
2. Set the enclosure box into the excavated hole (see page 2, "Lifting"). Adjust the height to grade. Be sure the enclosure is level, centered in the hole, and is parallel with the sidewalk or curb if applicable.
3. Install bracing (see page 2, "Bracing"), then install the cover and bolts to prevent debris from entering the enclosure and help maintain box rigidity during the backfilling procedure.
4. Backfill along the open, outer sides of the excavated hole (see page 2, "Backfill").
5. Tamp the soil around the enclosure with hand tamping tools*. Soil in the immediate vicinity should be tamped and sloped away from the enclosure. Be sure not to slope the grade towards the enclosure as debris could make the cover difficult to remove.
6. Remove the internal bracing and replace the cover and bolts to complete the installation.

* DO NOT use heavy equipment, like backhoes, for tamping as damage will occur (see page 2, "Tamping").

Always ensure the product load rating matches the anticipated load rating of the application.

Underground Enclosures

Light Duty • Medium Duty • Heavy Duty • Traffic Rated

Installation Guide

H20 Rated / Traffic Applications

- Traffic Rated | AASHTO H20 | Design Load: 16,000 lb

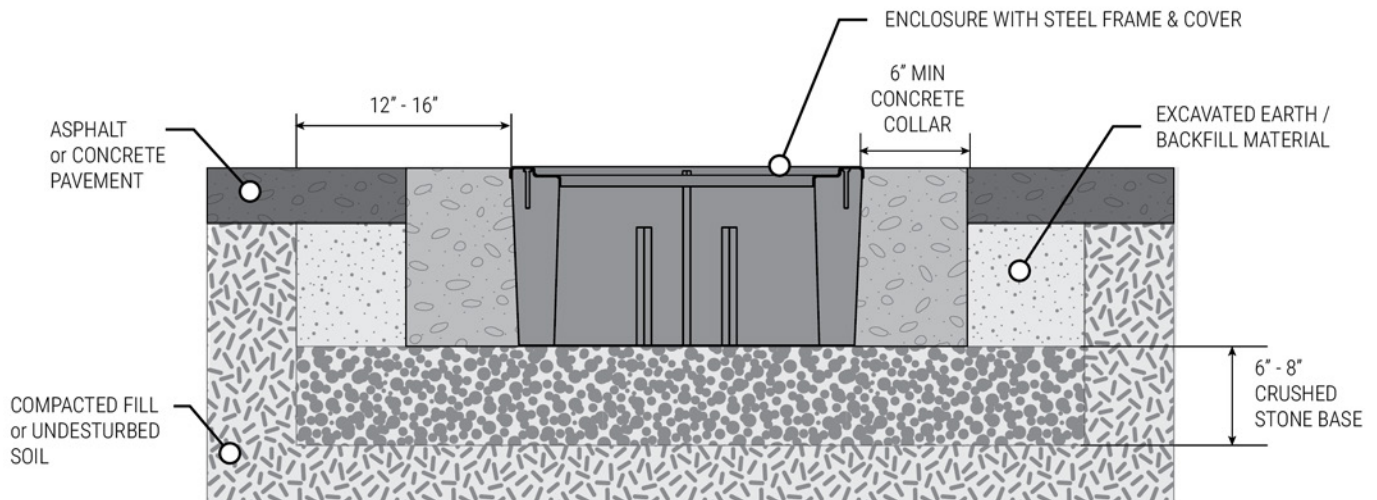

I. Excavation

Excavate an area approximately 12" to 16" longer and wider and 6" to 8" deeper than the actual dimensions of the enclosure to be installed (see page 2, "Sidewalk"). The excavation floor should be flat and level.

II. Installation

1. Add a 6" to 8" deep base of $\frac{3}{4}$ " and smaller, crushed stone to the excavated hole. The base material shall be crushed, angular stone, not 'river rock or round stone,' and should be free of soil and organic material (see page 2, "Base"). Use a mechanical or hand tamper to tamp down the crushed stone to be flat and level.
2. Set the enclosure box into the excavated hole (see page 2, "Lifting"). Adjust the height to grade. Be sure the enclosure is level, centered in the hole, and is parallel with the sidewalk or curb if applicable. Install the cover and bolts to prevent debris from entering the enclosure during the backfilling procedure.
3. Backfill along the open, outer sides of the excavated hole (see page 2, "Backfill").
4. The final 6" to 8" of the excavation should be finished with a concrete collar. This is accomplished by providing a form around the enclosure that would produce a six-inch minimum wide collar. The concrete collar mix used in the installation shall exceed a minimum of 3,000 PSI compressive strength.
5. Secure the cover and bolts to complete the installation.

Always ensure the product load rating matches the anticipated load rating of the application.

Underground Enclosures

Light Duty • Medium Duty • Heavy Duty • Traffic Rated

Installation Guide

- Light Duty
- Medium Duty
- Heavy Duty
- Traffic Rated

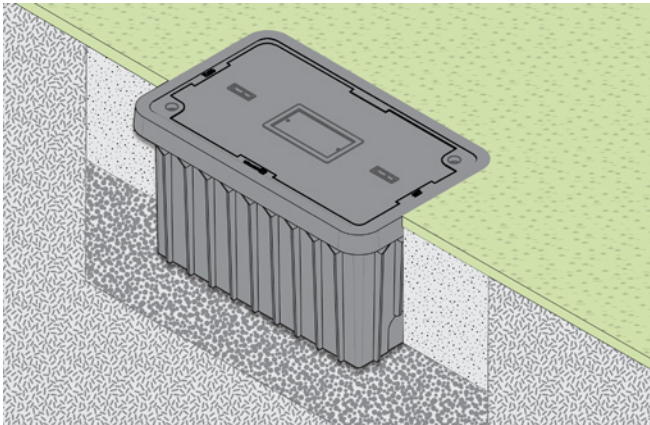

PEDESTRIAN/GREENBELT

- Carson®
- Christy®
- Fibrelite®

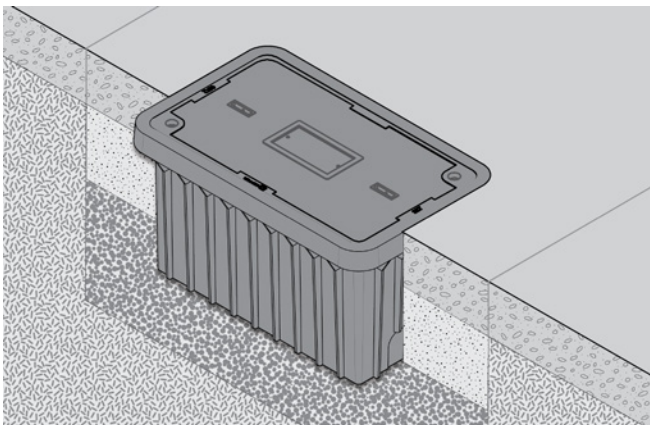
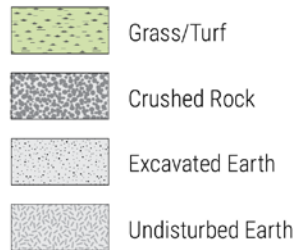

SIDEWALK/CONCRETE

- Duralite®
- Oldcastle FRP
- Oldcastle Polymer

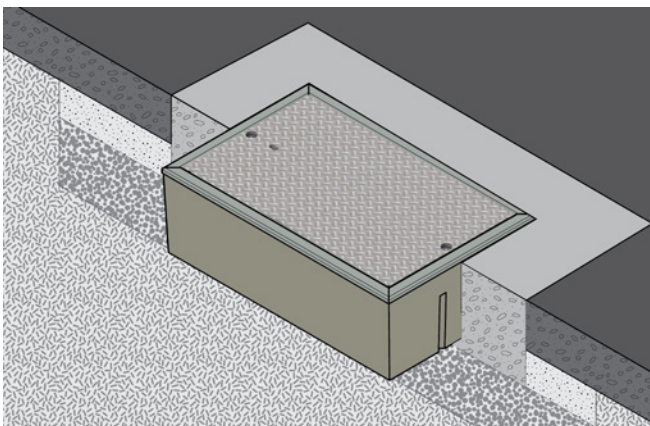
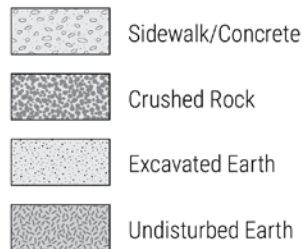

TRAFFIC

- Christy®

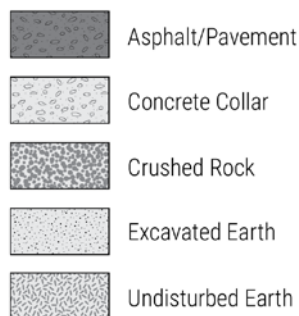

Always ensure the product load rating matches the anticipated load rating of the application.



www.oldcastleinfrastructure.com | (888) 965-3227

Trusted partnerships.
Full scale solutions.