

INSTRUMENT SETS



SECTION BB

CONTENTS

Instrument Sets

1-18



MINIMALLY INVASIVE DISCECTOMY SET

OM#	Qty.	Description
OM 55-0510	1	SCOVILLE CURETTE 20" 9x15mm, straight
OM 55-0523	1	BRUN CURETTE 17" 3x6mm, straight
OM 55-0532	1	BRUN CURETTE 17" 2x4mm, 40 degree angle
OM 55-0533	1	BRUN CURETTE 17" 3x6mm, 40 degree angle
OM 55-0543	1	BRUN CURETTE 20" 3x6mm, 40 degree angle
OM 55-0556	1	BRUN CURETTE 20" 6x9mm, 30 degree angle
OM 55-0566	1	CONE RING CURETTE 20" 6mm diameter, 30 degree angle
OM 55-0573	1	CONE RING CURETTE 17" 3mm diameter, 40 degree angle
OM 55-0586	1	EPSTEIN CURETTE 20" 6x9mm, 30 degree reverse angle
OM 55-0593	1	EPSTEIN CURETTE 17" 3x6mm, 40 degree reverse angle
OM 55-0610	1	COBB ELEVATOR 20" 6mm (1/4")
OM 55-0612	1	COBB ELEVATOR 20" 10mm (3/8")
OM 55-0614	1	COBB ELEVATOR 20" 13mm (.490")
OM 55-0620	1	COBB ELEVATOR 17" 6mm (1/4")
OM 55-0630	1	HIBBS GOUGE 18 1/2" 7mm (.28"), straight
OM 55-0640	1	RIB ELEVATOR 17" 9mm radius tip, 45 degree angle
OM 55-0642	1	HIBBS OSTEOTOME 18 1/2" 10mm (3/8") straight
OM 55-0644	1	RIB ELEVATOR 17" 9mm radius tip, 90 degree angle
OM 55-0654	1	PENFIELD ELEVATOR 15" 4mm (.16")
OM 55-0662	1	NERVE PROBE 15" with ball tip, 45 degree angle
OM 55-0664	1	NERVE PROBE 15" with ball tip, 90 degree angle
OM 55-0676	1	BONE TAMP 17" 3/8" diameter
OM 55-0762	1	FERRIS-SMITH RONGEUR 20" 2.5x10mm bite, straight
OM 55-0763	1	FERRIS-SMITH RONGEUR 20" 4x10mm bite, straight
OM 55-0767	1	FERRIS-SMITH RONGEUR 20" 4x10mm bite, angle up
OM 55-0777	1	FERRIS-SMITH RONGEUR 20" 8x12mm bite, straight, serrated
OM 55-0782	1	KERRISON PUNCH 20" 4mm bite, 90 degree down
OM 55-0788	1	KERRISON PUNCH 20" 2.5mm bite, 40 degree forward
OM 55-0790	1	KERRISON PUNCH 20" 4mm bite, 40 degree forward

LAMINECTOMY SET

OM#	Qty.	Description
OM 29-0059	2	SCALPEL HANDLE #3
OM 29-0060	1	SCALPEL HANDLE #4
OM 29-0061	1	SCALPEL HANDLE #3L
OM 29-0062	1	SCALPEL HANDLE #7
OM 35-0298	1	SUPER-CUT MAYO SCISSORS 6 3/4" Curved
OM 35-0382	1	SUPER-CUT METZENBAUM SCISSORS 6" Curved
OM 35-0394	1	SUPER-CUT METZENBAUM SCISSORS 7" Curved
OM 36-0178	4	CRILE FORCEPS 5 1/2" Curved
OM 36-0318	2	ROCH PEAN FORCEPS 6 1/4" Curved
OM 36-0436	2	ROCH-OCHSNER FORCEPS 8" Straight
OM 36-0744	2	ADSON HEMOSTATIC FORCEPS 7 1/4" Straight
OM 36-0746	2	ADSON HEMOSTATIC FORCEPS 7 1/4" Curved
OM 37-0462	4	BACKHAUS TOWEL FORCEPS 5 1/4"
OM 37-0468	6	LORNA (EDNA) TOWEL FORCEPS 5 1/4"
OM 38-0100	1	DRESSING FORCEPS 10"
OM 38-0184	2	CUSHING BAYONET DRESSING FORCEPS 7 1/4" Serrated
OM 38-0186	2	CUSHING BAYONET TISSUE FORCEPS 7 1/4" 1 x 2 Teeth
OM 38-0272	2	TISSUE FORCEPS 5 1/2" 1 x 2 Teeth
OM 39-0050	2	ADSON FORCEPS 6" 1 x 2 Teeth 1.2mm
OM 39-0692	1	RULER 6" INCH AND MM GRADUATED, Flexible
OM 41-0302	2	MAYO HEGAR NEEDLEHOLDER 6" Serrated, Carbide
OM 41-0314	2	MAYO HEGAR NEEDLEHOLDER 8" Serrated, Carbide
OM 42-0152	2	SAROT NEEDLEHOLDER 7 1/2" Carbide
OM 42-0863	1	FRAZIER SUCTION TUBES 4 1/2" Angled, 7 French
OM 42-0864	1	FRAZIER SUCTION TUBES 4 1/2" Angled, 9 French
OM 42-0866	1	FRAZIER SUCTION TUBES 4 1/2" Angled, 11 French
OM 42-0876	1	FRAZIER SUCTION TUBES 7 1/2" Angled, 11 French
OM 43-0112	2	ALLIS TISSUE FORCEPS 6" 4 x 5 teeth
OM 46-0667	1	ORTHOPEDIC MALLET 10 1/2", 31b./21b.
OM 46-0899	1	BONE TAMP 6", 10mm Diameter, Cross-serrated
OM 48-0217	2	INGE RETRACTOR 6 1/2"
OM 49-0170	2	DEBAKEY ATRAUMA TISSUE FORCEPS 8", 1.5mm
OM 51-0059	2	HIBBS RETRACTOR 9 1/2", 50mm
OM 51-0200	2	RICHARDSON RETRACTOR 9 1/2", 3/4" x 1"
OM 51-0204	2	RICHARDSON RETRACTOR 9 1/2", 1 1/2" x 1 1/2"
OM 51-0372	2	U.S. ARMY RETRACTOR 8 1/2"
OM 51-0530	1	LOVE RETRACTOR 8 1/2" Straight blade
OM 51-0532	1	LOVE RETRACTOR 8 1/2" 45° Angled blade
OM 51-0534	1	LOVE RETRACTOR 8 1/2" 90° Angled blade
OM 52-0266	2	VOLKMAN RETRACTOR 8 1/2", 6 Sharp prongs
OM 52-0444	2	ADSON RETRACTOR 7 1/2", Angled 4 x 4 Sharp prongs
OM 52-0458	1	TAYLOR SPINAL RETRACTOR 7 1/4", 1 1/4" x 3"
OM 52-0460	1	TAYLOR SPINAL RETRACTOR 8", 1 1/4" x 4"
OM 52-0484	2	BECKMAN-ADSON RETRACTOR 12 1/4", 1" x 1" Blunt
OM 52-0498	2	WEITLANER RETRACTOR 5 1/2" Sharp
OM 52-0502	2	WEITLANER RETRACTOR 6 1/2" Sharp
OM 52-0532	2	BECKMAN-WEITLANER RETRACTOR 6 1/2", 3 x 4 Sharp prongs
OM 53-0160	1	STRABISMUS SCISSORS 4" Straight
OM 53-0164	1	STRABISMUS SCISSORS 4" Curved
OM 55-0300	1	WOODSON ELEVATOR and SPATULA 10"
OM 55-0302	1	WOODSON DURAL SEPARATOR and PACKER 7"
OM 55-0440	1	MARKHAM-MEYERDING HEMILAMINECTOMY RETRACTOR 7" Left
OM 55-0441	1	MARKHAM-MEYERDING HEMILAMINECTOMY RETRACTOR 7" Right
OM 57-0614	2	FREER ELEVATOR 7 1/2"
OM 57-0615	2	KLEINERT-KUTZ ELEVATOR/DISSECTOR 7 3/4"
OM 57-0624	1	PENFIELD ELEVATOR 7" Style 1
OM 57-0626	1	PENFIELD ELEVATOR 7 3/4" Style 2
OM 57-0628	1	PENFIELD ELEVATOR 7 3/4" Style 3
OM 57-0630	1	PENFIELD ELEVATOR 8" Style 4



NAIL SET

All the instruments you need - at your fingertips

Each Nail Set contains:

OM#	Qty.	Description
OM 29-0058	1	SCALPEL HANDLE #3
OM 33-0324	1	OPERATING SCISSORS 5 1/2" straight bl/bl
OM 36-0156	2	MOSQUITO FORCEPS 5" straight
OM 36-0158	2	MOSQUITO FORCEPS 5" curved
OM 36-0166	1	KELLY FORCEPS 5 1/2" straight
OM 39-0092	1	ADSON BROWN FORCEPS 4 3/4" 9 x 9
OM 41-0170	1	CRILE-WOOD NEEDLE HOLDER 6" serrated
OM 57-0614	1	FREER PERIOSTEAL ELEVATOR 7 1/2"
OM 69-0294	1	TISSUE NIPPER 5" medium
OM 69-0326	1	NAIL SPLITTER FORCEPS 5" medium jaw
OM 69-0344	1	NAIL SPLITTER FORCEPS 6" heavy, fine point
OM 69-0448	1	NAIL SPLITTER FORCEPS 4 1/2" thin jaw
OM 69-0457	1	CURETTE #4,5" 4mm McGlamry Bullneck
OM 69-0484	1	CURETTE #2,5" 2.5mm with hole
OM 69-0538	1	NAIL RASP 6 3/4" angled double end
OM 69-0579	1	LOCKE ELEVATOR 5" narrow, McGlamry Bullneck
OM 69-0590	1	LOCKE ELEVATOR 5" wide, McGlamry Bullneck (Sorry, no substitutions)

Sterilizing and Storage Containers (optional)

OM 46-0544	1	STERILIZING CONTAINER 9" x 5" x 2" small
OM 46-0545	1	STERILIZING CONTAINER 11" x 9" x 2" large (Instruments will fit into either container. Before ordering, please check size of your autoclave chamber.)
OM 69-0900	1	P.I. NAIL PACK (Instruments only)
OM 69-0901	1	P.I. NAIL PACK AND SMALL CONTAINER
OM 69-0902	1	P.I. NAIL PACK AND LARGE CONTAINER

Instrument Management Made Easy

If you've ever reached for a specific instrument while performing a procedure, only to find it missing from your tray, you know why we created the Nail Set. It includes every instrument you need for nail procedures.

Designed For Flexible Use

The Nail Set was developed, tested, and approved by The Podiatry Institute®. The idea was to make it very flexible, for many different potential nail and digit related conditions. With the addition of another instrument or two, it also works well for arthroplasties, the removal of small extoses, or as a laceration tray.

Efficient and Portable

The optional sterilization/storage container, available in two sizes, allows you to sterilize and store the whole set together. By always sterilizing the complete set, you avoid cross contamination between the used and unused instruments. The removable lid can also be used as a tray.

For Office or Hospital Use

If you need to update a worn or incomplete instrument set, are planning to equip new offices, or are simply tired of finding needed instruments missing from the tray laid out for you, the Nail Set is the perfect solution. Identify your instrument sets with custom engraved, personalized aluminum tags on the container.

INTERNAL FIXATION SET

SMALL FRAGMENT SCREW FIXATION SET

OM 48-0410

includes one each of the following items:

OM#	Qty.	Description
OM 47-0137	1	BONE REDUCTION FORCEPS, POINTED 5 1/4" (133mm)
OM 47-0880	1	SHARP HOOK 6" (152mm)
OM 47-0128	1	BONE REDUCTION FORCEPS 6" (152mm) curved jaw
OM 48-0054	1	DRILL BIT 2.0mm, 4" (102mm)
OM 48-0057	1	DRILL BIT 2.5mm, 4 1/2" (114mm)
OM 48-0058	1	DRILL BIT 2.7mm, 4" (102mm)
OM 48-0063	1	DRILL BIT 3.5mm, 4 1/2" (114mm)
OM 47-0922	1	COUNTERSINK SMALL 2.0mm, 2 3/4" (70mm)
OM 48-0110	1	TAP 2.7mm, 4" (102mm)
OM 48-0112	1	TAP 3.5mm, 5" (127mm) fine thread
OM 48-0114	1	TAP 3.5mm, 4 1/2" (114mm) 1.75mm thread
OM 47-0904	1	QUICK COUPLING HANDLE 4 1/2" (114mm) small
OM 47-0970	1	DRILL GUIDE for 2.0mm drill, 4 1/4" (108mm)
OM 47-0972	1	TAP SLEEVE 2.5mm drill & 3.5mm screw, 5" (127mm)
OM 47-0974	1	INSERT DRILL SLEEVE 3.5/2.7mm, 1 1/2" (38mm)
OM 47-0953	1	SCREWDRIVER BIT 2.5mm, 4" (102mm)
OM 47-0955	1	SLEEVE FOR SCREWDRIVER OM 47-0953, 2" (51 mm)
OM 47-0936	1	DEPTH GAUGE small 6 1/4" (159mm)
OM 48-0412	2	INSTRUMENTTRAYS (with covers) Tray 1: size 9" x 5" x 1 1/4" (229mm x 127mm x 33mm) Tray 2: size 9" x 5" x 1 1/2" (229mm x 127mm x 38mm)

BASIC SCREW SET

OM 73-0001

Two trays with cover

Accommodates 6 each of 1.5mm through 4.0mm screws as long as they are made according to ISO standards (not included with trays).

Includes OM 41-0930 Screw Holding Forceps.

Tray 1: size 9" x 5" x 1 1/2" (229mm x 127mm x 38mm)

Tray 2: size 9" x 5" x 2 1/2" (229mm x 127mm x 64mm)

Combined size of all 4 trays: 9" x 5" x 7" (229mm x 127mm x 178mm)

MINI FIXATION SET

OM 48-0414

For 1.5mm and 2.0mm screws

OM#	Qty.	Description
OM 48-0051	1	DRILL BIT 1.1mm, 2 1/2" (64mm)
OM 48-0052	1	DRILL BIT 1.5mm, 3 1/2" (89mm)
OM 48-0054	1	DRILL BIT 2.0mm, 4 1/2" (114mm)
OM 47-0920	1	MINI COUNTERSINK 1.1 mm, 2 1/4" (57mm)
OM 48-0106	1	TAP 1.5mm, 2" (51mm)
OM 48-0108	1	TAP 2.0mm, 2 1/4" (57mm)
OM 47-0902	1	MINI QUICK COUPLING HANDLE, 4 1/4" (114mm)
OM 47-0968	1	MINI DRILL SLEEVE for 1.1 & 1.5mm drill bits
OM 47-0950	1	SCREWDRIVER BIT 1.5mm, 2 1/4" (57mm)
OM 47-0934	1	MINI DEPTH GAUGE, 4 1/4" (114mm)

| **Note:** To house the OrthoMed Mini Fixation Set, we recommend Container OM 46-0544 and Silicone Mat OM 98-0125.

To order screws and plates please refer to Section T.

INSTRUMENTS FOR MINI FRAGMENT FIXATION

1.5mm, 2mm and 2.7mm screws

OM#	Qty.	Description
OM 45-0208	1	SCREWHOLDING FORCEPS 3 1/2"
OM 46-0206	1	PERIOSTEAL ELEVATOR, 3mm Width
OM 46-0623	1	WIRE CUTTER 7" ANGLED MAX CAP 1.6mm
OM 46-0830	1	MINI HOHMANN RETRACTOR 6 1/2" 6mm
OM 46-0832	1	MINI HOHMANN RETRACTOR 6 1/2" 8mm
OM 47-0119	1	STAGBEEETLE FORCEPS 120mm
OM 47-0133	1	BONE REDUCTION FORCEPS WITH POINTS, 5" Narrow
OM 47-0135	1	BONE REDUCTION FORCEPS WITH POINTS, 5 1/2" Broad
OM 47-0880	1	SHARP HOOK 6" (152mm)
OM 47-0902	1	HANDLE FOR MINI QC INSTRUMENTS 4 1/4"
OM 47-0904	1	QUICK COUPLING HANDLE 4 1/2"
OM 47-0915	1	BENDING IRON FOR 5 1/2" 2.7mm + 3.5mm
OM 47-0916	1	BENDING IRON FOR SMALL PLATES 5 1/2" (140mm)
OM 47-0917	1	PLATE BENDING IRON 4 3/4" 1.8mm
OM 47-0920	1	COUNTERSINK MINI 1.1mm
OM 47-0922	1	COUNTERSINK SMALL 2.0mm 7cm
OM 47-0931	2	BENDING PLIERS FOR 1.5mm and 2.0mm Plates
OM 47-0932	1	PLATE CUTTING FORCEPS
OM 47-0934	1	MINI DEPTH GAUGE 30mm
OM 47-0936	1	SCREW DEPTH GAUGE 50mm
OM 47-0950B	1	MINI HEX SCREWDRIVER BIT
OM 47-0953	1	SCREWDRIVER BIT 2.5mm; 10cm QC
OM 47-0955	1	SLEEVE FOR SCREWDRIVER 47-0952 & 47-0953
OM 47-0959	1	SLEEVE ONLY FOR MINI HEX and CRUCIFORM DRIVER SHAFTS
OM 47-0966	1	2.0MM/1.5MM DOUBLE DRILL SLEEVE
OM 47-0968	1	MINI DRILL SLEEVE 4 1/4"
OM 48-0002	1	2.0MM/2.7MM DOUBLE DRILL SLEEVE
OM 48-0051	2	DRILL BIT QC 1.1 mm, 60/35mm
OM 48-0052	2	DRILL BIT QC 1.5mm, 85/60mm
OM 48-0054	2	DRILL BIT QC 2.0mm, 100/75mm
OM 48-0058	2	DRILL BIT QC 2.7mm, 100/75mm
OM 48-0106	2	TAP 1.5mm, 2"
OM 48-0108	2	TAP 2.0mm, 2 1/4"
OM 48-0110	2	TAP 2.7mm, 10cm QC
OM 48-0242	1	NEEDLE NOSE PLIERS 5 1/2" Delicate with groove
OM 48-0368	1	SCREWDRIVER 2.5mm Hex with notch

Optional

OM 45-0004	1	MINI CRUCIFORM SCREWDRIVER BIT QC
OM 46-0212	1	PERIOSTEAL ELEVATOR 7 1/4" 6mm Curved
OM 46-0827	1	HOHMANN RETRACTOR 6" 15mm Broad tip
OM 47-0137	1	BONE REDUCTION FORCEPS POINTED 5 1/4"
OM 47-0138	1	PLATE HOLDING FORCEPS 5 1/2"
OM 47-0139	1	BONE COMPRESSION FORCEPS 5"
OM 48-0370	1	GRATLOCH™ K-WIRE BENDER 7 1/2"

To order screws and plates please refer to Section T.

SMALL FRAGMENT SET

INSTRUMENTS FOR SMALL FRAGMENT FIXATION

3.5mm and 4.0mm screws

OM#	Qty.	Description
OM 45-0002	1	ADAPTOR (POWER) for QC Instruments
OM 45-0126	1	BENDING TEMPLATE 5 HOLE 3.5mm
OM 45-0127	1	BENDING TEMPLATE 7 HOLE 3.5mm
OM 45-0128	1	BENDING TEMPLATE 9 HOLE 3.5mm
OM 45-0210	1	SCREWHOLDING FORCEPS 3 1/2"
OM 46-0212	1	PERIOSTEAL ELEVATOR 7 1/4" Straight 6mm round curved
OM 46-0827	2	HOHMANN RETRACTOR 6" 15mm broad tip
OM 46-0832	2	MINI HOHMANN RETRACTOR 6 1/2" 8mm
OM 47-0092	1	VERBRUGGE FORCEPS, SELF-CENTERING 7 1/2" (191 mm)
OM 47-0128	1	BONE REDUCTION FORCEPS 6" small curved
OM 47-0133	1	BONE REDUCTION FORCEPS WITH POINTS 5" Narrow
OM 47-0135	1	BONE REDUCTION FORCEPS WITH POINTS 5 1/2" Broad
OM 47-0880	1	SHARP HOOK 6"(152mm)
OM 47-0915	1	PLATE BENDING IRON 5 1/2" 2.7mm & 3.5mm
OM 47-0916	1	BENDING IRON FOR SMALL PLATES 5 1/2" (140mm)
OM 47-0919	2	BENDING IRON FOR 3.5mm & 4.5m Recon plates
OM 47-0922	1	COUNTERSINK SMALL 2.0mm 7cm
OM 47-0936	1	SCREW DEPTH GAUGE 50mm
OM 47-0947	1	BENDING TEMPLATE 22 HOLE for 3.5mm Recon plates
OM 47-0960	1	T-HANDLE QUICK COUPLING
OM 47-0970	1	DRILL GUIDE for 2mm Drill DE; 10.5mm
OM 47-0972	1	TAP SLEEVE 2.5mm Drill & 3.5mm Screw
OM 47-0974	1	INSERT DRILL SLEEVE 3.5/2.7mm Screw
OM 47-0978	1	DRILL GUIDE NEUTRAL & LOAD 2.5/3.5mm
OM 48-0004	1	3.5MM UNIVERSAL DRILL GUIDE
OM 48-0057	2	DRILL BILL QC 2.5mm, 110/85mm Gold
OM 48-0063	2	DRILL BIT QC 3.5mm, 110/85mm
OM 48-0112	2	TAP 3.5mm; 12cm QC, Fine thread gold
OM 48-0114	2	TAP 3.5mm; 11cm QC, 1.75mm Pitch
OM 48-0242	1	NEEDLE NOSE PLIERS 5 1/2" Delicate with groove
OM 48-0348	1	SCREWDRIVER SHAFT QC 2.5mm Hex with notch
OM 48-0365	1	SLEEVE ONLY FOR OM 48-0348/48-0364/48-0368
OM 48-0368	1	SCREWDRIVER 2.5mm Hex with notch
OM 48-0372	1	WIRE AND PIN BENDER 6" 3.2mm (1/8")

Optional

OM 45-0129	1	BENDING TEMPLATE 12 Hole 3.5mm
OM 46-0624	1	WIRE CUTTER
OM 46-0632	1	PIN CUTTER 10" Small
OM 46-0830	1	MINI HOHMANN RETRACTOR 6 1/2" 6mm
OM 47-0090	1	VERBRUGGE FORCEPS SELF CENTERING 6" (152mm)
OM 47-0137	1	BONE REDUCTION FORCEPS POINTED 5 1/4" (133mm)
OM 47-0904	1	QUICK COUPLING HANDLE 4 1/2" (114mm)
OM 47-0925	1	BENDING PLIERS FOR SMALL PLATES
OM 47-0953	1	SCREWDRIVER BIT 2.5mm; 10cm QC
OM 47-0955	1	SLEEVE FOR SCREWDRIVER 47-0952 & 47-0953
OM 48-0370	1	GRATLOCH™ K-WIRE BENDER 7 1/2" (191mm)

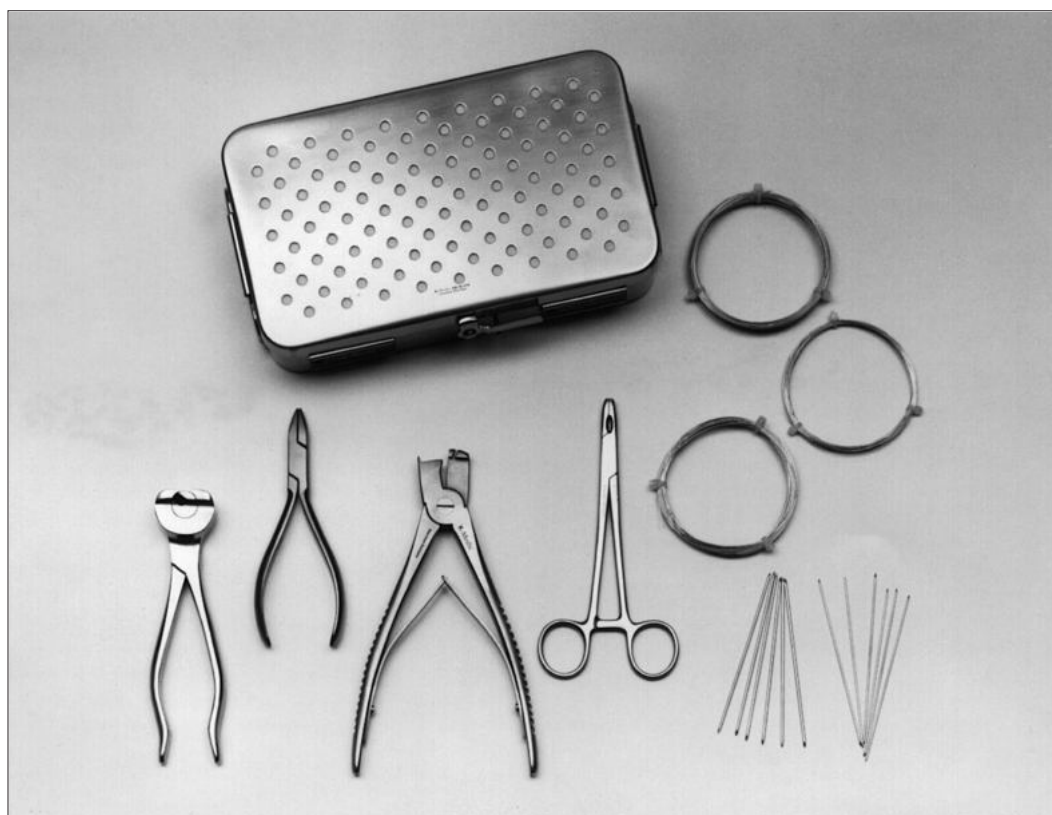

MINI BONE WIRE SET

OM 48-0400

This set is ideal for offices and surgi-centers. The compact sterilization case will fit all sizes of autoclaves.

Each Nail Set contains:

OM#	Qty.	Description
Instruments		
OM 46-0544	1	STERILIZING CONTAINER 9" x 5" x 2"
OM 46-0651	1	DIAMOND PIN CUTTER 6 1/4" (159mm)
OM 48-0245	1	NEEDLE NOSE PLIERS 5 1/2" (140mm)
OM 48-0370	1	GRATLOCH™ WIRE BENDER 7 1/2" (191 mm)
OM 69-0846	1	WIRE TWISTER AND TIGHTENER 6 1/4" (159mm)

K-Wire one package (6 wires) of each

OM 71-0100	1	DOUBLE TROCAR 4" .028" (0.7mm) diameter
OM 71-0101	1	DOUBLE TROCAR 4" .035" (0.9mm) diameter
OM 71-0102	1	DOUBLE TROCAR 4" .045" (1.1 mm) diameter
OM 71-0103	1	DOUBLE TROCAR 4" .062" (1.6mm) diameter

Cerclage Wire 10 meters in length

OM 72-0104	1	0.4mm diameter
OM 72-0106	1	0.6mm diameter
OM 72-0108	1	0.8mm diameter

Optional

OM 46-0540	1	VICKERS EASIDRIVER™
OM 46-0542	1	VICKERS K-WIRE DISPENSER™

SMALL BONE WIRE SET



SMALL BONE WIRE SET

OM 48-0402

This set is useful for foot, ankle and hand surgery, and all other small bone work

Each set contains:

OM#	Qty.	Description
Instruments		
OM 46-0547	1	STERILIZING CASE 20" x 8" x 2"
OM 46-0542	1	VICKERS K-WIRE DISPENSER™ 4" (102mm)
OM 46-0622	1	DELICATE WIRE CUTTER 4 3/4" (121mm)
OM 46-0651	1	DIAMOND PIN CUTTER 6 1/4" (159mm)
OM 48-0245	2	NEEDLE NOSE PLIERS 5 1/2" (140mm)
OM 48-0320	2	WIRE TWISTING FORCEPS 6" (152mm)
OM 48-0370	1	GRATLOCH™ WIRE BENDER 7 1/2" (191mm)
OM 48-0386	1	WIRE PASSER (CANNULATED) 7" (178mm)
OM 48-0602	1	LOCKING PLIERS 8" (203mm)
OM 48-0604	1	PARALLEL PLIERS 7" (178mm)
OM 69-0846	1	WIRE TWISTER AND TIGHTENER 6 1/4" (159mm)

K-Wire one package (6 wires) of each

OM 71-0100	1	DOUBLE TROCAR 4" .028" (0.7mm) diameter
OM 71-0101	1	DOUBLE TROCAR 4" .035" (0.9mm) diameter
OM 71-0102	1	DOUBLE TROCAR 4" .045" (1.1 mm) diameter
OM 71-0103	1	DOUBLE TROCAR 4" .062" (1.6mm) diameter
OM 71-0021	1	DOUBLE TROCAR 6" .028" (0.7mm) diameter
OM 71-0022	1	DOUBLE TROCAR 6" .035" (0.9mm) diameter
OM 71-0023	1	DOUBLE TROCAR 6" .045" (1.1mm) diameter
OM 71-0025	1	DOUBLE TROCAR 6" .062" (1.6mm) diameter

Cerclage Wire 10 meters in length

OM 72-0110	1	1.0mm diameter
OM 72-0112	1	1.2mm diameter

Optional

OM 46-0540	VICKERS EASIDRIVER™	
OM 71-0001, 71-0002, 71-0003, 71-0004, 71-0006 K-WIRE DISPENSERS		

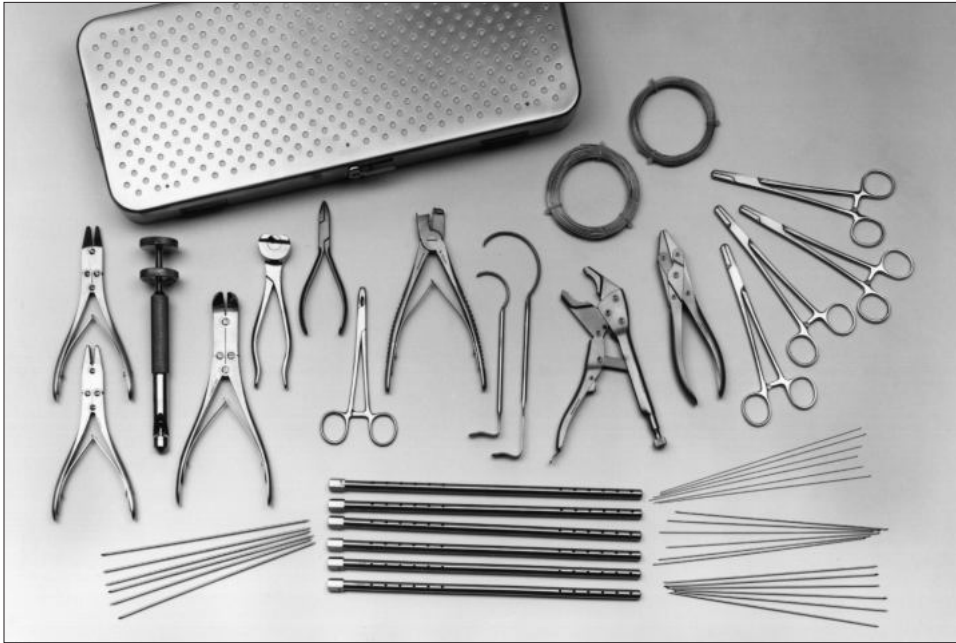

LARGE BONE WIRE SET

OM 48-0404

This set is contains the following.

OM# Qty. Description

Instruments

OM 46-0547	1	STERILIZING CASE 19" x 7 3/4" x 2"
OM 46-0574	2	DOUBLE ACTION EXTRACTING PLIERS
OM 46-0619	1	LOUTE WIRE TIGHTENER 8 1/2" (216mm)
OM 46-0624	1	DOUBLE ACTION WIRE CUTTER 8 1/2" (216mm)
OM 46-0651	1	DIAMOND PIN CUTTER 6 1/4" (159mm)
OM 48-0245	1	NEEDLE NOSE PLIERS 5 1/2" (140mm)
OM 69-0846	1	WIRE TWISTER AND TIGHTENER 6 1/4" (159mm)
OM 48-0370	1	GRATLOCH™ WIRE BENDER 7 1/2" (191 mm)
OM 48-0386	1	WIRE PASSER (CANNULATED) 7" (178mm)
OM 48-0388	1	WIRE PASSER (CANNULATED) 9 1/2" (241mm)
OM 48-0602	1	LOCKING PLIERS 8" (203mm)
OM 48-0604	1	PARALLEL PLIERS 7" (178mm)
OM 48-0324	4	WIRE TWISTING FORCEPS 7 1/4" (184mm)

K-Wire one package (6 wires) of each

OM 71-0111	1	DOUBLE TROCAR 9" .035" (0.9mm) diameter
OM 71-0112	1	DOUBLE TROCAR 9" .045" (1.1mm) diameter
OM 71-0114	1	DOUBLE TROCAR 9" .054" (1.4mm) diameter
OM 71-0113	1	DOUBLE TROCAR 9" .062" (1.6mm) diameter

DISPENSER one each

OM 71-0012
OM 71-0013
OM 71-0014
OM 71-0016

Steinmann Pins one package (6 wires) of each

OM 71-0450	1	DOUBLE TROCAR 9" 5/64" (2.0mm) diameter
OM 71-0453	1	DOUBLE TROCAR 9" 3/32" (2.4mm) diameter

DISPENSER one each

OM 71-0017
OM 71-0019

Cerclage Wire 10 meters in length

OM 72-0112	1	1.2mm diameter
OM 72-0115	1	1.5mm diameter

Optional

OM 46-0540	VICKERS EASIDRIVER™
------------	---------------------

Note: For ordering larger Steinmann Pins and the corresponding cutters, please refer to the appropriate sections elsewhere in the catalog.

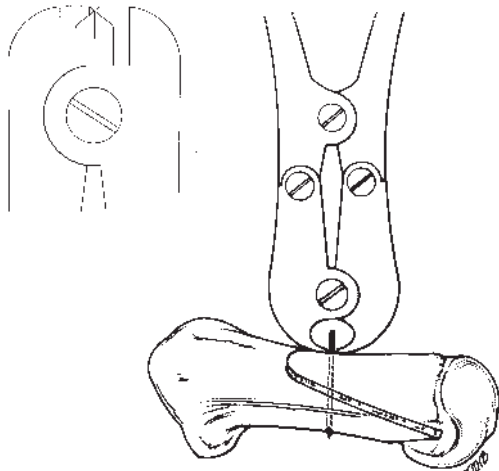
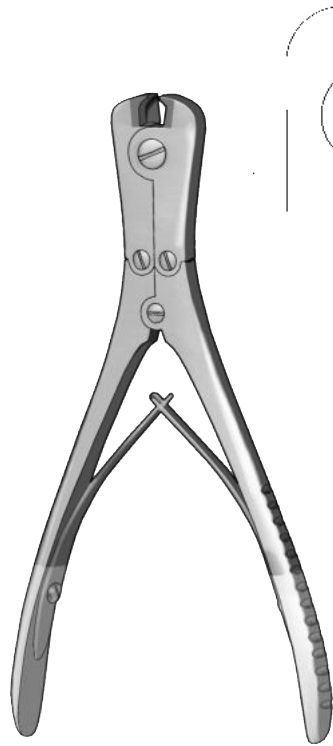

Drawing shows the P.I. Wire Cutter cutting flush to the bone. It is both front and side cutting.

OM 46-0631
7" (178mm) front and side cutting
with carbide inserts
cuts up to .062" (1.6mm)

FLUSH WIRE CUTTER

Our Flush Cutter cuts K-Wire flush to the bone like no other wire cutter. Double action for ease, comfort and power with tungsten carbide jaws for long life and sharpness.

Note:

To achieve the best results when cutting wire, follow these simple steps.

- Choose the appropriate cutter for the wire diameter you want to cut.
- Cut wire in the middle of the jaw not on the edge or in the corner.
- Make a first cut leaving a piece about 1/4" long. Now you can position the cutter for its second and flattest cut.
- When cutting, do not twist and turn the cutter. Just press the handles together.

When removing K-Wire, use the P.I. Plug Cutter to extract a tiny cylinder of bone around the tip of the wire.

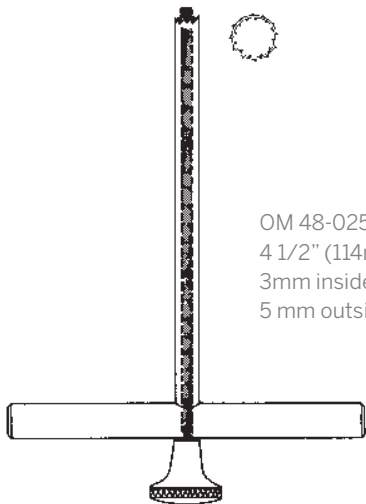

OM 48-0252
4 1/2" (114mm) with obturator
3mm inside diameter
5 mm outside diameter

PLUG CUTTER



The wire can then be easily grasped with our Extraction Pliers. Long lasting tungsten carbide jaws and double action for grasping

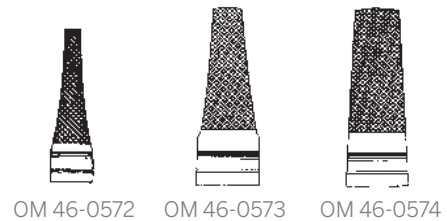

OM 46-0572

OM 46-0573

OM 46-0574

OM 46-0572
7" (178mm) 2mm jaw
carbide

OM 46-0573
7" (178mm) 4mm jaw
carbide

OM 46-0574
7" (178mm) 6mm jaw
carbide

DOUBLE ACTION WIRE EXTRACTION PLIERS



MICRO SURGERY SET (MAJOR SET)

OM 69-0915

Complete set includes one each of the following:

- OM 44-0012 MICRO TYING FORCEPS 4 3/8" (111mm) 0.3mm tip
- OM 44-0032 BARRAQUER NEEDLE HOLDER 5" (127mm) curved, with lock
- OM 44-0018 MICRO SCISSORS 5" (127mm) straight, long blade, round handle
- OM 53-0380 GRAEFE IRIS FORCEPS 4" (162mm) straight 1x2 teeth
- OM 44-0028 MICRO CLAMP APPLICATOR 5 1/2" (140mm)
- OM 44-0030 APPROXIMATION CLAMP without suture holding frame
- OM 44-0022 MICRO SCISSORS (REILL) 5 1/2" (140mm) curved, serrated
- OM 44-0014 PLATFORM TYING FORCEPS 5 1/2" (140mm) 0.7mm tip
- OM 44-0024 HEPP-SCHEIDEL DISSECTING SCISSORS 5 1/2" (140mm) curved
- OM 44-0031 CLAMP BOX for micro clamps OM 44-0030
- OM 98-0135 STERILIZATION AND INSTRUMENT CASE for eight piece micro set
- OM 98-0136 INSTRUMENT RACK for eight piece micro set

MICRO SURGERY SET (MINI SET)

OM 69-0917

Complete set includes one each of the following:

- OM 44-0014 PLATFORM TYING FORCEPS 5 1/2" (140mm) 0.7mm tip
- OM 44-0032 BARRAQUER NEEDLE HOLDER 5" (127mm) curved with lock
- OM 44-0020 MICRO SCISSORS 5" (127mm) curved, long blade, round handle
- OM 98-0137 STERILIZATION AND INSTRUMENT CASE for three piece micro set

MAJOR ORTHOPEDIC SET

OM#	Qty.	Description	OM#	Qty.	Description
OM 29-0059	2	SCALPEL HANDLE #3	OM 46-0453	1	SMITH-PETERSON OSTEOTOME str. 1"
OM 29-0060	1	SCALPEL HANDLE #4	OM 46-0458	1	SMITH-PETERSON OSTEOTOME cvd.3/8"
OM 35-0198	1	WIRE CUTTING SCISSORS 4 3/4"	OM 46-0460	1	SMITH-PETERSON OSTEOTOME cvd.5/8"
OM 35-0212	1	SUPER-CUT LISTER BANDAGE SCISSORS 7 1/4"	OM 46-0462	1	SMITH-PETERSON OSTEOTOME cvd.1"
OM 35-0220	1	SUPER-CUT OPERATING SCISSORS 5 1/2"	OM 46-0466	1	SMITH-PETERSON GOUGE straight 1/4"
OM 35-0292	1	SUPER-CUT MAYO SCISSORS 6 3/4" straight	OM 46-0468	1	SMITH-PETERSON GOUGE straight 1/2"
OM 35-0298	1	SUPER-CUT MAYO SCISSORS 6 3/4" curved	OM 46-0477	1	SMITH-PETERSON GOUGE straight 3/4"
OM 35-0394	1	SUPER-CUT METZENBAUM SCISS. 7" curved	OM 46-0488	1	SMITH-PETERSON GOUGE curved 3/8"
OM 35-0490	1	SUPER-CUT STEVENS SCISSORS 4 1/2" curved	OM 46-0490	1	SMITH-PETERSON GOUGE curved 5/8"
OM 36-0156	12	MOSQUITO FORCEPS 5" straight	OM 46-0493	1	SMITH-PETERSON GOUGE curved 1"
OM 36-0158	12	MOSQUITO FORCEPS 5" curved	OM 46-0565	1	BRUN CURETTE 9" straight #0
OM 36-0166	12	KELLY FORCEPS 5 1/2" straight	OM 46-0566	1	BRUN CURETTE 9" straight #1
OM 36-0168	6	KELLY FORCEPS 5 1/2" curved	OM 46-0567	1	BRUN CURETTE 9" straight #2
OM 36-0186	6	CRILE FORCEPS 6 1/4" straight	OM 46-0568	1	BRUN CURETTE 9" straight #3
OM 36-0188	6	CRILE FORCEPS 6 1/4" curved	OM 46-0569	1	BRUN CURETTE 9" straight #4
OM 36-0318	2	ROCHESTER-PEAN FORCEPS 6 1/4" curved	OM 46-0667	1	ORTHOPEDIC MALLET 10 1/2", 32 oz.
OM 36-0328	2	ROCHESTER-PEAN FORCEPS 7 1/4" curved	OM 47-0526	1	RUSKIN RONGEUR 7 1/4"
OM 36-0426	4	ROCHESTER-OCHSNER FORCEPS 7 1/4" straight	OM 47-0538	1	RUSKIN-LISTON FORCEPS 7 1/2"
OM 36-0746	2	ADSON HEMOSTATIC FORCEPS 7 1/4" curved	OM 48-0343	1	BONE HOOK 9", 11mm x 22mm
OM 37-0386	6	FOERSTER FORCEPS 9 1/2" straight	OM 48-0344	1	BONE HOOK 9", 8mm x 30mm
OM 37-0462	12	BACKHAUS TOWEL FORCEPS 5 1/4"	OM 51-0060	2	HIBBS RETRACTOR 9 1/2"
OM 38-0084	2	DRESSING FORCEPS 5 1/2"	OM 51-0080	2	ISRAEL RETRACTOR 8"
OM 38-0094	2	DRESSING FORCEPS 8"	OM 51-0200	1	RICHARDSON RETRACTOR 9 1/2", 3/4" x 1"
OM 38-0272	2	TISSUE FORCEPS 5 1/2" 1 x 2 teeth	OM 51-0202	1	RICHARDSON RETRACTOR 9 1/2", 1" x 1 1/4"
OM 38-0276	2	TISSUE FORCEPS 6" 1 x 2 teeth	OM 51-0204	1	RICHARDSON RETRACTOR 9 1/2", 1 1/2" x 1 1/2"
OM 38-0280	2	TISSUE FORCEPS 8" 1 x 2 teeth	OM 51-0206	1	RICHARDSON RETRACTOR 9 1/2", 3/4" x 2"
OM 38-0304	2	TISSUE FORCEPS 5 1/2" 3 x 4 teeth	OM 51-0230	1	DEAVER RETRACTOR 1" x 10"
OM 39-0056	2	MICRO ADSON FORCEPS 4 3/4" 1 x 2 teeth	OM 51-0232	1	DEAVER RETRACTOR 1" x 12"
OM 39-0092	2	ADSON BROWN FORCEPS 4 3/4" 9 x 9 teeth	OM 51-0240	1	DEAVER RETRACTOR 2" x 12"
OM 39-0694	1	RULER 8"	OM 51-0372	2	U.S. ARMY RETRACTOR 8"
OM 41-0174	2	CRILE-WOOD NEEDLE HOLDER 6" carbide	OM 51-0521	2	CUSHING VEIN RETRACTOR 9"
OM 41-0175	2	CRILE-WOOD NEEDLE HOLDER 7" carbide	OM 52-0090	2	SENN RETRACTOR 6 1/4", blunt
OM 41-0314	2	MAYO-HEGAR NEEDLE HOLDER 8" carbide	OM 52-0258	2	VOLKMAN RETRACTOR 8 1/2" 2 sharp prongs
OM 42-0824	1	FRAZIER SUCTION TUBE 7 french	OM 52-0264	2	VOLKMAN RETRACTOR 8 1/2" 4 sharp prongs
OM 42-0825	1	FRAZIER SUCTION TUBE 8 french	OM 52-0266	2	VOLKMAN RETRACTOR 8 1/2" 6 sharp prongs
OM 42-0826	1	FRAZIER SUCTION TUBE 10 french	OM 52-0274	2	VOLKMAN RETRACTOR 8 1/2" 4 blunt prongs
OM 43-0124	2	ALLIS TISSUE FORCEPS 7 1/2" 5 x 6 teeth	OM 52-0276	2	VOLKMAN RETRACTOR 8 1/2" 6 blunt prongs
OM 46-0258	1	KEY ELEVATOR 7", 1/4" width	OM 52-0502	2	WEITLANER RETRACTOR 6 1/2" sharp
OM 46-0262	1	KEY ELEVATOR 7 1/2", 1/2" width	OM 52-0768	2	GELPI RETRACTOR 7 1/2"
OM 46-0448	1	SMITH-PETERSON OSTEOTOME str. 1/4"	OM 57-0614	1	FREER ELEVATOR 7 1/2"
OM 46-0450	1	SMITH-PETERSON OSTEOTOME str. 1/2"	OM 58-0088	2	JOSEPH SKIN HOOK 6 1/4" 1 sharp prong
OM 46-0452	1	SMITH-PETERSON OSTEOTOME str. 3/4"	OM 58-0092	2	JOSEPH SKIN HOOK 6 1/4" 2 sharp prongs

MINOR ORTHOPEDIC SET

OM#	Qty.	Description	OM#	Qty.	Description
OM 29-0058	2	SCALPEL HANDLE #3	OM 46-0500	1	HOKE OSTEOTOME 5 1/4" straight 5/16" width
OM 29-0060	1	SCALPEL HANDLE #4	OM 46-0501	1	HOKE OSTEOTOME 5 1/4" curved 3/8" width
OM 35-0198	1	WIRE CUTTING SCISSORS 4 3/4"	OM 46-0502	1	HOKE OSTEOTOME 5 1/4" straight 1/2" width
OM 35-0210	1	SUPER-CUT LISTER BANDAGE SCISSORS 5 1/2"	OM 46-0503	1	HOKE OSTEOTOME 5 1/4" curved 5/8" width
OM 35-0220	1	SUPER-CUT OPERATING SCISSORS 5 1/2"	OM 46-0517	1	BRUN CURETTE 7" #0
OM 35-0298	1	SUPER-CUT MAYO SCISSORS 6 3/4" curved	OM 46-0519	1	BRUN CURETTE 7" #1
OM 35-0394	1	SUPER-CUT METZENBAUM SCISS.7" cvd.	OM 46-0521	1	BRUN CURETTE 7" #2
OM 35-0490	1	SUPER-CUT STEVENS SCISSORS 4 1/2" curved	OM 46-0523	1	BRUN CURETTE 7" #3
OM 36-0156	6	MOSQUITO FORCEPS 5" straight	OM 46-0667	1	ORTHOPEDIC MALLET 11"
OM 36-0158	6	MOSQUITO FORCEPS 5" curved	OM 47-0526	1	RUSKIN RONGEUR 7 1/4" straight
OM 36-0166	6	KELLY FORCEPS 5 1/2" straight	OM 51-0200	1	RICHARDSON RETRACTOR 9 1/2", 3/4" x 1"
OM 36-0168	12	KELLY FORCEPS 5 1/2" curved	OM 51-0202	1	RICHARDSON RETRACTOR 9 1/2", 1" x 1 1/4"
OM 36-0188	2	CRILE FORCEPS 6 1/4" curved	OM 51-0204	1	RICHARDSON RETRACTOR 9 1/2", 1 1/2" x 1 1/2"
OM 36-0318	6	ROCHESTER-PEAN FORCEPS 6 1/4" curved	OM 51-0206	1	RICHARDSON RETRACTOR 9 1/2", 3/4" x 2"
OM 36-0416	2	ROCHESTER-OCHSNER FORCEPS 6 1/4" straight	OM 51-0230	2	DEAVER RETRACTOR 1" x 10"
OM 36-0426	2	ROCHESTER-OCHSNER FORCEPS 7 1/4" straight	OM 51-0372	1	U.S.ARMY RETRACTOR 8" 1 pair
OM 37-0386	6	FOERSTER FORCEPS 9 1/2" straight	OM 51-0521	2	CUSHING VEIN RETRACTOR 9"
OM 37-0458	6	BACKHAUS TOWEL FORCEPS 3 1/2"	OM 52-0088	2	SENN RETRACTOR 6 1/4" sharp
OM 37-0462	6	BACKHAUS TOWEL FORCEPS 5 1/4"	OM 52-0116	1	MEYERDING FINGER RETRACTOR 7" #1
OM 38-0084	2	DRESSING FORCEPS 5 1/2"	OM 52-0118	1	MEYERDING FINGER RETRACTOR 7" #2
OM 38-0094	2	DRESSING FORCEPS 8"	OM 52-0122	1	MEYERDING FINGER RETRACTOR 7" #3
OM 38-0272	2	TISSUE FORCEPS 5 1/2" 1 x 2 teeth	OM 52-0124	1	MEYERDING FINGER RETRACTOR 7" #4
OM 38-0276	2	TISSUE FORCEPS 6" 1 x 2 teeth	OM 52-0128	1	MEYERDING FINGER RETRACTOR 7" #5
OM 38-0280	2	TISSUE FORCEPS 8" 1 x 2 teeth	OM 52-0130	1	MEYERDING FINGER RETRACTOR 7" #6
OM 39-0064	2	ADSON FORCEPS 4 3/4" 1 x 2 teeth delicate	OM 52-0258	1	VOLKMAN RETRACTOR 8 1/2" 2 sharp prongs
OM 39-0092	2	ADSON BROWN FORCEPS 4 3/4" 9 x 9 teeth	OM 52-0262	1	VOLKMAN RETRACTOR 8 1/2" 3 sharp prongs
OM 39-0692	1	RULER 6"	OM 52-0416	1	ALM RETRACTOR 4"
OM 41-0174	2	CRILE-WOOD NEEDLE HOLDER 6" carbide	OM 52-0498	2	WEITLANER RETRACTOR 5 1/2" sharp
OM 41-0302	4	MAYO-HEGAR NEEDLE HOLDER 6" carbide	OM 52-0776	1	GELPI RETRACTOR 3 1/2"
OM 42-0824	1	FRAZIER SUCTION TUBE 7 french	OM 52-0778	1	GELPI RETRACTOR 4 1/2"
OM 42-0825	1	FRAZIER SUCTION TUBE 8 french	OM 57-0614	1	FREER ELEVATOR 7 1/2"
OM 42-0826	1	FRAZIER SUCTION TUBE 10 french	OM 58-0088	2	JOSEPH SKIN HOOK 6 1/4" 1 sharp prong
OM 46-0498	1	HOKE OSTEOTOME 5 1/4" straight 3/16" width	OM 58-0092	2	JOSEPH SKIN HOOK 6 1/4" 2 sharp prongs
OM 46-0499	1	HOKE OSTEOTOME 5 1/4" curved 1/4" width			

LARGE BONE SET

OM#	Qty.	Description	OM#	Qty.	Description
OM 39-0694	1	RULER 8"	OM 47-0098	1	VERBRUGGE BONE FORCEPS 11"
OM 46-0212	1	PERIOSTEAL ELEVATOR 7 1/4" round edge	OM 47-0105	1	BONE HOLDING FORCEPS 6 1/2"
OM 46-0214	1	PERIOSTEAL ELEVATOR 7 1/4" oval edge	OM 47-0107	1	BONE HOLDING FORCEPS 9"
OM 46-0215	1	PERIOSTEAL ELEVATOR 7 1/4" straight edge	OM 47-0366	1	STILLE-LISTON FORCEPS 10 1/2" straight
OM 46-0838	2	HOHMANN RETRACTOR 9" 18mm width	OM 47-0458	1	STILLE-LUER RONGEUR 8 1/2" straight
OM 46-0848	2	HOHMANN RETRACTOR 11" 24mm width	OM 47-0520	1	BEYER RONGEUR 7"
OM 46-0850	2	HOHMANN RETRACTOR 9 1/2" 70mm width	OM 47-0527	1	RUSKIN RONGEUR 7 1/4"
OM 46-0858	2	HOHMANN RETRACTOR 8 1/2" 8mm width	OM 47-0538	1	RUSKIN-LISTON FORCEPS 7 1/2"
OM 46-0880	1	BENNETT RETRACTOR small	OM 48-0204	2	BLOUNT RETRACTOR 10 1/4"
OM 46-0884	1	BENNETT RETRACTOR large	OM 48-0343	1	BONE HOOK 9" 11 x 22mm
OM 46-0892	2	MURPHY-LANE BONE SKID	OM 48-0344	1	BONE HOOK 9" 8 x 30mm
OM 47-0094	1	VERBRUGGE BONE FORCEPS 9 1/2"	OM 49-0630	set	OSTEOTOME, CHISEL AND GOUGE SET
OM 47-0096	1	VERBRUGGE BONE FORCEPS 10 1/4"			

INSTRUMENT SETS

SMALL BONE SET

OM#	Qty.	Description	OM#	Qty.	Description
OM 39-0692	1	RULER 6"	OM 47-0090	1	VERBRUGGE BONE FORCEPS 6"
OM 46-0206	1	PERIOSTEAL ELEVATOR 7 1/4" 3mm width	OM 47-0092	1	VERBRUGGE BONE FORCEPS 7 1/2"
OM 46-0207	1	PERIOSTEAL ELEVATOR 7 1/4" 6mm width	OM 47-0128	1	BONE REDUCTION FORCEPS 6"
OM 46-0830	2	MINI HOHMANN RETRACTOR 6 1/2" 6mm width	OM 47-0410	1	LISTON BONE FORCEPS 5 1/2"
OM 46-0832	2	MINI HOHMANN RETRACTOR 6 1/2" 8mm width	OM 47-0527	1	RUSKIN RONGEUR 7 1/4"
OM 46-0838	2	HOHMANN RETRACTOR 9" 18mm width	OM 47-0534	1	RUSKIN RONGEUR 6"
OM 46-0858	2	HOHMANN RETRACTOR 8 1/2" 8mm width	OM 48-0342	1	BONE HOOK 9"

FOREFOOT SET

OM#	Qty.	Description	OM#	Qty.	Description
OM 29-0058	3	SCALPEL HANDLE #3	OM 46-0631	1	FLUSH WIRE CUTTER 7" carbide
OM 33-0324	1	OPERATING SCISSORS 5 1/2" blunt/blunt	OM 46-0660	1	LUCAE BONE MALLET 8"
OM 34-0258	1	MAYO SCISSORS 5 1/2" curved	OM 46-0832	2	MINI HOHMANN RETRACTOR 6 1/2" 8mm width
OM 34-0462	1	METZENBAUM SCISSORS 6" curved	OM 47-0266	1	BLUMENTHAL RONGEUR 6"
OM 35-0198	1	WIRE CUTTING SCISSORS 4 3/4"	OM 47-0520	1	BEYER RONGEUR 7"
OM 36-0156	4	MOSQUITO FORCEPS 5" straight	OM 47-0555	1	KLEINERT-KUTZ FORCEPS 6"
OM 36-0158	8	MOSQUITO FORCEPS 5" curved	OM 48-0252	1	PLUG CUTTER 4 1/2"
OM 36-0166	1	KELLY FORCEPS 5 1/2" straight	OM 52-0088	2	SENN RETRACTOR 6 1/4" 3 sharp prongs
OM 36-0168	1	KELLY FORCEPS 5 1/2" curved	OM 52-0094	2	RAGNELL RETRACTOR 5 3/4"
OM 36-0176	1	CRILE FORCEPS 5 1/2" straight	OM 52-0417	1	SELF-RETAINING RETRACTOR 4" sharp
OM 36-0178	1	CRILE FORCEPS 5 1/2" curved	OM 52-0492	1	WEITLANER RETRACTOR 4" sharp
OM 36-0406	1	KOCHER FORCEPS 5 1/2" 1 x 2 teeth	OM 57-0614	1	FREER ELEVATOR 7 1/2"
OM 37-0366	1	FOERSTER FORCEPS 7"	OM 58-0068	1	JOSEPH RASP 6 1/4"
OM 37-0462	4	BACKHAUS TOWEL FORCEPS 5 1/4"	OM 58-0076	1	SAYRE ELEVATOR 6 1/2"
OM 39-0060	1	ADSON FORCEPS 4 3/4" serrated	OM 58-0088	2	JOSEPH HOOK 6 1/4" 1 sharp prong
OM 39-0063	1	ADSON FORCEPS 4 3/4" 1 x 2 teeth	OM 58-0092	2	JOSEPH HOOK 6 1/4" 2 sharp prongs
OM 39-0092	2	ADSON BROWN FORCEPS 4 3/4" 9 x 9 teeth	OM 58-0240	2	MALTZ-SEEBURGER RETRACTOR 4 1/2"
OM 39-0682	1	BRUSH FOR INSTRUMENT CLEANING	OM 69-0538	1	NAIL RASP #93
OM 39-0698	1	RULER 12"	OM 69-0544	1	BONE FILE #12A
OM 41-0170	1	CRILE-WOOD NEEDLE HOLDER 6"	OM 69-0547	1	BONE RASP 8 1/2"
OM 41-0278	1	MAYO HEGAR NEEDLE HOLDER 7"	OM 69-0787	1	LOCKE PHALANGEAL FORCEPS 6"
OM 43-0112	2	ALLIS TISSUE FORCEPS 6" 4 x 5 teeth	OM 69-0940	1	BEVELED OSTEOTOME 7" straight 10mm width
OM 46-0258	1	KEY ELEVATOR 7"; 1/4" width	OM 69-0946	1	BEVELED OSTEOTOME 7" straight 20mm width
OM 46-0262	1	KEY ELEVATOR 7 1/2" 1/2" width	OM 69-0950	1	BEVELED OSTEOTOME 7" straight 25mm width
OM 46-0540	1	VICKERS EASIDRIVER 5 1/2"	OM 69-0970	1	BEVELED OSTEOTOME 7" curved 5mm width
OM 46-0542	1	VICKERS K-WIRE DISPENSER	OM 69-0975	1	BEVELED OSTEOTOME 7" curved 10mm width
OM 46-0572	1	WIRE EXTRACTION PLIERS 7" carbide			

KNEE SET

OM#	Qty.	Description	OM#	Qty.	Description
OM 29-0058	2	SCALPEL HANDLE #3	OM 46-0262	1	KEY ELEVATOR 7 1/2"; 1/2" width
OM 29-0060	1	SCALPEL HANDLE #4	OM 46-0650	1	BONE FILE 9 1/2"
OM 29-0062	1	SCALPEL HANDLE #7	OM 46-0741	1	LOWE-BRECK CARTILAGE KNIFE 10"
OM 35-0210	1	SUPER-CUT LISTER BANDAGE SCISSORS 5 1/2"	OM 46-0762	1	SMILLIE KNIFE 6 3/4" straight
OM 35-0292	2	SUPER-CUT MAYO SCISSORS 6 3/4" straight	OM 46-0766	1	SMILLIE KNIFE 6 3/4" left
OM 35-0298	1	SUPER-CUT MAYO SCISSORS 6 3/4" curved	OM 46-0770	1	SMILLIE KNIFE 6 3/4" right
OM 35-0394	1	SUPER-CUT METZENBAUM SCISS. 7" cvd.	OM 46-0772	1	DOWNING CARTILAGE KNIFE 10"
OM 36-0176	4	CRILE FORCEPS 5 1/2" straight	OM 46-0802	1	MARTIN CARTILAGE CLAMP 7 1/4"
OM 36-0186	4	CRILE FORCEPS 6 1/4" straight	OM 46-0818	1	WALTON CARTILAGE CLAMP 8"
OM 36-0408	2	KOCHER FORCEPS 5 1/2" curved	OM 46-0828	1	MARTIN CARTILAGE SCISSORS 8"
OM 36-0416	4	ROCHESTER-OCHSNER FORCEPS 6 1/4"	OM 48-0198	1	SMILLIE KNEE RETRACTOR 5 1/2"
OM 37-0462	6	BACKHAUS TOWEL FORCEPS 5 1/4"	OM 48-0206	2	BLOUNT KNEE RETRACTOR 7"
OM 38-0272	2	TISSUE FORCEPS 5 1/2" 1 x 2 teeth	OM 49-0312	1	ADSON PERIOSTEAL ELEVATOR 6 3/4" curved
OM 38-0304	2	TISSUE FORCEPS 5 1/2" 3 x 4 teeth	OM 51-0372	2	U.S. ARMY RETRACTOR 8" 1 pair
OM 39-0056	2	MICRO ADSON FORCEPS 4 3/4" 1 x 2 teeth	OM 52-0088	2	SENN RETRACTOR 6 1/4"
OM 41-0175	2	CRILE-WOOD NEEDLE HOLDER 7" carbide	OM 52-0258	2	VOLKMAN RETRACTOR 8 1/2" 2 sharp prongs
OM 42-0825	1	FRAZIER SUCTION TUBE 8 french	OM 52-0264	2	VOLKMAN RETRACTOR 8 1/2" 4 sharp prongs
OM 43-0110	4	ALLIS TISSUE FORCEPS 6" 3 x 4 teeth	OM 52-0498	2	WEITLANER RETRACTOR 5 1/2"
OM 46-0258	1	KEY ELEVATOR 7"; 1/4" width	OM 57-0614	1	FREER ELEVATOR 7 1/2"

BASIC TOTAL HIP SET

OM#	Qty.	Description	OM#	Qty.	Description
OM 29-0060	2	SCALPEL HANDLE #4	OM 43-0124	2	ALLIS TISSUE FORCEPS 7 1/2" 5 x 6 teeth
OM 29-0062	1	SCALPEL HANDLE #7	OM 46-0359	1	HIBBS OSTEOTOME 9" straight, 1/4" width
OM 35-0292	2	SUPER-CUT MAYO SCISSORS 6 3/4" straight	OM 46-0360	1	HIBBS OSTEOTOME 9" straight, 3/8" width
OM 35-0298	1	SUPER-CUT MAYO SCISSORS 6 3/4" curved	OM 46-0361	1	HIBBS OSTEOTOME 9" straight, 1/2" width
OM 35-0322	1	SUPER-CUT MAYO SCISSORS 9" curved	OM 46-0652	1	PUTTI BONE RASP 12"
OM 35-0394	1	SUPER-CUT METZENBAUM SCISS.7" cvd.	OM 46-0666	1	MALLET 10 3/4"
OM 35-0406	1	SUPER-CUT METZENBAUM SCISS.8" cvd.	OM 46-0836	1	HOHMANN RETRACTOR 9" 10mm
OM 36-0156	6	MOSQUITO FORCEPS 5" straight	OM 46-0848	1	HOHMANN RETRACTOR 11" 22mm
OM 36-0188	6	CRILE FORCEPS 6 1/4" curved	OM 46-0850	1	HOHMANN RETRACTOR 9 1/2" 70mm
OM 36-0338	2	ROCHESTER-PEAN FORCEPS 8" curved	OM 47-0460	1	STILLE-LUER RONGEUR 8 1/2" curved
OM 36-0436	2	ROCHESTER-OCHSNER FORCEPS 8" straight	OM 47-0472	1	STILLE-LUER RONGEUR 9"
OM 36-0746	4	ADSON HEMOSTATIC FORCEPS 7 1/4" curved	OM 47-0520	1	BEYER RONGEUR 7"
OM 37-0386	2	FOERSTER FORCEPS 9 1/2" straight	OM 48-0343	1	BONE HOOK 9" medium
OM 37-0458	6	BACKHAUS TOWEL FORCEPS 3 1/2"	OM 48-0344	1	BONE HOOK 9" large
OM 37-0462	2	BACKHAUS TOWEL FORCEPS 5 1/4"	OM 51-0060	2	HIBBS RETRACTOR medium
OM 38-0272	2	TISSUE FORCEPS 5 1/2" 1 x 2 teeth	OM 51-0212	1	RICHARDSON-EASTMAN RETRACTOR 9 1/2"
OM 38-0304	2	TISSUE FORCEPS 5 1/2" 3 x 4 teeth	OM 52-0264	2	VOLKMAN RETRACTOR 8 1/2" 4 sharp prongs
OM 39-0056	2	MICRO ADSON FORCEPS 4 3/4" 1 x 2 teeth	OM 52-0266	2	VOLKMAN RETRACTOR 8 1/2" 6 sharp prongs
OM 39-0196	2	RUSSIAN FORCEPS 8" OM 39-0694 1 RULER 8"	OM 52-0502	2	WEITLANER RETRACTOR 6 1/2" sharp
OM 41-0175	2	CRILE-WOOD NEEDLE HOLDER 7" carbide	OM 52-0780	1	GELPI RETRACTOR 5 1/2"
OM 41-0314	2	MAYO-HEGAR NEEDLE HOLDER 8" carbide	OM 58-0228	3	YANKAUER SUCTION TUBE 11 1/2"

AMPUTATION SET

OM#	Qty.	Description	OM#	Qty.	Description
OM 29-0060	2	SCALPEL HANDLE #4	OM 46-0640	1	SATTERLEE SAW 9"
OM 42-0834	1	BARON SUCTION TUBE 5 french	OM 46-0654	1	PUTTI BONE RASP 10 1/2"
OM 46-0266	1	KEY PERIOSTEAL ELEVATOR 8 1/4" 1" width	OM 47-0374	1	STILLE-HORSELY FORCEPS 10 1/2" bayonet
OM 46-0365	1	HIBBS OSTEOTOME 9" straight 1" width	OM 47-0402	1	LISTON BONE CUTTING FORCEPS 7 1/2"
OM 46-0598	1	LISTON AMPUTATION KNIFE 6 3/4"	OM 47-0458	1	STILLE-LUER RONGEUR 8 1/2" straight
OM 46-0610	1	GIGLI SAW HANDLES 1 pair	OM 48-0334	1	BONE HOOK 8"
OM 46-0613	3	GIGLI SAW BLADE 12"	OM 52-0266	2	VOLKMAN RETRACTOR 8 1/2" 6 sharp prongs
OM 46-0614	3	GIGLI SAW BLADE 20"	OM 58-0228	1	YANKAUER SUCTION TUBE 11 1/2"

SHOULDER SET

OM#	Qty.	Description	OM#	Qty.	Description
OM 46-0848	1	HOHMANN RETRACTOR 11" 22mm width	OM 46-0916	1	PENETRATING AWL 9 1/4" curved
OM 46-0892	1	MURPHY BONE SKID 12"	OM 46-0917	1	SUTURE PASSER 9 1/4" curved, crochet hook
OM 46-0902	1	DARRACH ELEVATOR 10 1/4" 1/2" width small	OM 46-0918	1	SUTURE PASSER 9 1/4" curved with hole
OM 46-0903	1	DARRACH ELEVATOR 10 1/4" 3/4" width medium	OM 46-0919	1	PENETRATING GOUGE 8 1/2" 3mm width
OM 46-0904	1	DARRACH ELEVATOR 13 3/4" 1" width large	OM 48-0226	1	LAMINA SPREADER 10 1/2" flat blades
OM 46-0906	1	FUKUDA STYLE SHOULDER RETRACTOR 7" 38mm width	OM 48-0333	1	VOLKMAN BONE HOOK 9" blunt tip
OM 46-0907	1	FUKUDA STYLE SHOULDER RETRACTOR 7" 32mm width	OM 49-0460	1	CONE RING CURETTE 9" angled #3,3mm
OM 46-0908	1	CAPSULE RETRACTOR 10" 3 sharp prongs	OM 51-0202	1	RICHARDSON RETRACTOR 9 1/2", 1" x 1 1/4"
OM 46-0911	1	GLENOID PERFORATING FORCEPS 6 1/2" slight angle	OM 51-0204	1	RICHARDSON RETRACTOR 9 1/2", 1 1/2" x 1 1/2"
OM 46-0912	1	GLENOID PERFORATING FORCEPS 6 1/2" strong angle	OM 51-0206	1	RICHARDSON RETRACTOR 9 1/2", 3/4" x 2"
OM 46-0913	1	PERCUSSION AWL 8 1/2" curved small	OM 52-0474	1	ADSON RETRACTOR 12 1/2" 4 x 5 blunt
OM 46-0914	1	PERCUSSION AWL 8 1/2" curved medium	OM 52-0770	1	GELPI RETRACTOR 7 1/2" blunt tips
OM 46-0915	1	PERCUSSION AWL 8 1/2" curved large			

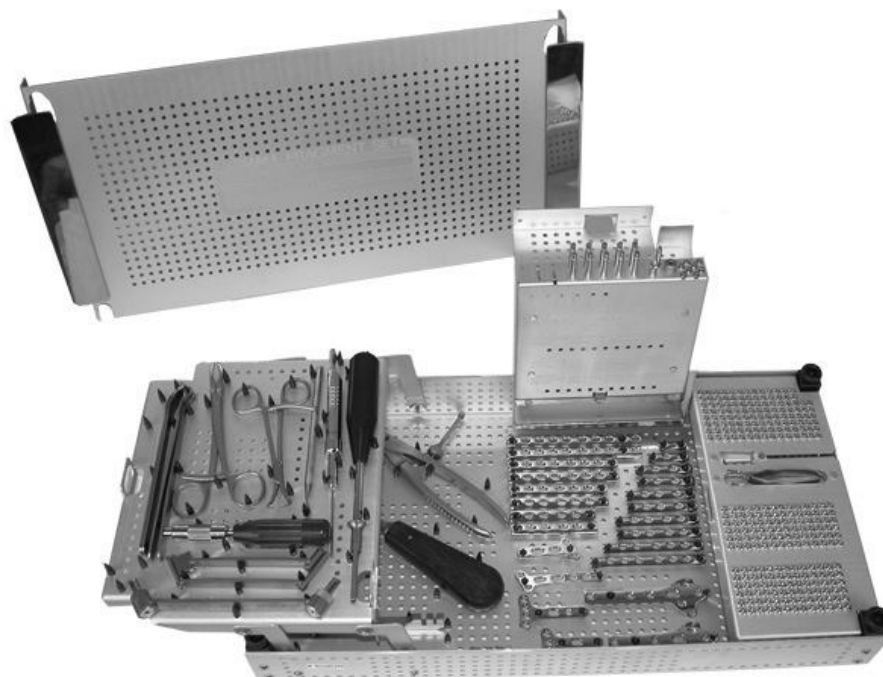

BASIC INSTRUMENTS SET FOR SCREWS AND PLATES

45mm and 6.5mm screws

OM#	Qty.	Description	Optional		
OM 45-0120	1	BENDING TEMPLATE 7 HOLE 4.5mm	OM 45-0118	1	BENDING TEMPLATE 5 HOLE 4.5mm
OM 45-0122	1	BENDING TEMPLATE 9 HOLE 4.5mm	OM 47-0096	1	VERBRUGGE FORCEPS 10 1/2"
OM 45-0124	1	BENDING TEMPLATE 12 HOLE 4.5mm	OM 47-0105	1	BONE HOLDING FORCEPS 7"
OM 45-0210	1	SCREWHOLDING FORCEPS 3 1/2"	OM 47-0137	1	BONE REDUCTION FORCEPS 5 1/4"
OM 47-0094	1	VERBRUGGE FORCEPS 9 1/2"	OM 47-0940	1	LARGE SCREW DEPTH GAUGE 100mm
OM 47-0098	1	VERBRUGGE FORCEPS 11"	OM 47-0954	1	SCREWDRIVER HEXAGONAL 3.5mm 4 1/2" QC
OM 47-0107	2	BONE HOLDING FORCEPS 9 1/2"			
OM 47-0134	1	BONE REDUCTION FORCEPS 8"			
OM 47-0880	1	SHARP HOOK 6"			
OM 47-0911	1	TENSION DEVICE ART. 3 1/2", Span 20mm			
OM 47-0912	1	SOCKET WRENCH 7 1/2", 11mm Chrome			
OM 47-0913	1	COMBINATION WRENCH 6", 11mm, Chrome			
OM 47-0926	1	COUNTERSINK 7", 4.5mm Tip			
OM 47-0935	1	DEPTH GAUGE 120mm			
OM 47-0960	1	T-HANDLE QUICK COUPLING			
OM 47-0961	1	LARGE HEX PELVIC SCREWDRIVER SHAFT QC			
OM 47-0965	1	6.5mm/3.2mm DOUBLE DRILL SLEEVE			
OM 47-0967	1	4.5mm/3.2mm DOUBLE DRILL SLEEVE			
OM 47-0973	1	INSERT DRILL SLEEVE 4.5mm/3.2mm			
OM 47-0980	1	DRILL GUIDE NEUTRAL + LOAD 3.2/4.5mm			
OM 47-0983	1	SLEEVE F. SCREWDRIVER 47-0954			
OM 47-0985	1	4.5mm UNIVERSAL DRILL GUIDE			
OM 48-0054	2	DRILL BIT QC 2.0mm, 100/75mm			
OM 48-0061	3	DRILL BIT QC 3.2mm, 145/120mm			
OM 48-0067	2	DRILL BIT QC 4.5mm, 145/120mm			
OM 48-0118	3	TAP 4.5mm 5" Medium thread			
OM 48-0122	1	TAP 6.5mm 8" Calibrated in cm			
OM 48-0349	1	SCREWDRIVER HEXAGONAL 10" 3.5mm with notch			

PELVIC INSTRUMENT SET

OM#	Qty.	Description
OM 45-0210	1	SCREWHOLDING FORCEPS 3 1/2"
OM 45-0310	1	ASYMMETRIC PELVIC REDUCTION FORCEPS
OM 45-0312	1	PELVIC REDUCTION FORCEPS 200mm with Pointed-Ball tips
OM 45-0314	1	PELVIC REDUCTION FORCEPS 240mm with Pointed-Ball tips
OM 47-0100	1	PELVIC REDUCTION FORCEPS used with screws
OM 47-0101	1	PELVIC REDUCTION FORCEPS 400mm 1 X 2 Pointed-Ball tips
OM 47-0102	1	PELVIC REDUCTION FORCEPS 250mm with angled Pointed-Ball tips
OM 47-0103	1	PELVIC REDUCTION FORCEPS 400mm with Pointed-Ball tips
OM 47-0134	1	REDUCTION FORCEPS with POINTS 205mm Ratchet
OM 47-0190	1	FARABEUPELVIC FORCEPS 190mm
OM 47-0192	1	FARABEUPELVIC FORCEPS 250mm
OM 47-0906	1	STRAIGHT BALL SPIKE
OM 47-0919	2	BENDING IRON FOR 3.5mm & 4.5mm RECON. PLATES
OM 47-0921	4	SPIKED DISK
OM 47-0927	1	BENDING PLIERS F. RECONSTR. PLATES 10"
OM 47-0935	1	DEPTH GAUGE 120mm
OM 47-0946	1	BENDING TEMPLATE 22 F. 3.5mm CVD. RECON. PLATES
OM 47-0947	1	BENDING TEMPLATE 22 F. 3.5mm RECON. PLATES
OM 47-0948	1	BENDING TEMPLATE 16mm F.4.5mm RECON. PLATES
OM 47-0951	1	SMALL HEXAGONAL PELVIC SCREWDRIVER SHAFT QC
OM 47-0960	1	T-HANDLE QUICK COUPLING
OM 47-0961	1	LARGE HEXAGONAL PELVIC SCREWDRIVER SHAFT QC
OM 47-0979	2	3.2mm CALIBRATED THREE-FLUTE DRILL 230/205mm QC
OM 47-0981	2	4.5mm THREE-FLUTE DRILL 195/170mm QC
OM 47-0983	1	SLEEVE F. SCREWDRIVER OM 47-0954
OM 47-0986	2	2.5mm CALIBRATED THREE-FLUTE DRILL 230/205mm QC
OM 48-0050	2	3.5mm DRILL BIT 195mm/170mm QC
OM 48-0068	2	DRILL BIT QC 4.5mm, 195/170mm XLNG
OM 48-0102	2	TAP CALIBRATED FOR 4.5mm CORTEX SCREWS 180/155mm
OM 48-0104	2	TAP CALIBRATED FOR 3.5mm CORTEX SCREWS 175/150mm
OM 48-0201	1	BLUNT PELVIC RETRACTOR
OM 48-0331	1	VOLKMAN BONE HOOK 10 1/4"
OM 48-0332	1	BONE HOOK LARGE 7" Sharp
OM 48-0353	1	LARGE HEX PELVIC SCREWDRIVER 12"
OM 48-0364	1	SMALL HEX PELVIC SCREWDRIVER
OM 48-0365	1	SLEEVE ONLY FOR OM 48-0348/48-0364/48-0368
OM 48-0374	1	UNIVERSAL CHUCK with T-Handle

SMALL SCREW FIXATION SET FOR OFFICE AND SURGERICENTER

2.7mm, 3.5mm and 4.0mm

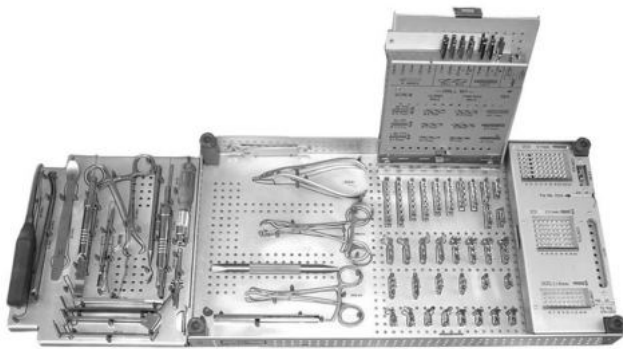

Compact Size

Fits into autoclaves. Autoclaves individually or stacked.

Clear Graphics

Quick reference chart makes set-up, use, and reordering easy.

Lightweight and Portable

Easily transportable between operating sites. Precise placement of contents keeps each item securely in place.

SMALL FRAGMENT SCREW FIXATION SET WITH 2 TRAYS

OM 48-0410

OM#	Qty.	Description
OM 47-0137	1	BONE REDUCTION FORCEPS, Pointed 5 1/4"
OM 47-0880	1	SHARP HOOK 6"
OM 47-0128	1	BONE REDUCTION FORCEPS 6" curved jaw
OM 48-0054	1	DRILL BIT 2.0mm, 100mm
OM 48-0057	1	DRILL BIT 2.5mm, 110mm
OM 48-0058	1	DRILL BIT 2.7mm, 100mm
OM 48-0063	1	DRILL BIT 3.5mm, 110mm
OM 47-0922	1	COUNTERSINK SMALL 2.0mm, 2 3/4"
OM 48-0110	1	TAP 2.7mm, 4"
OM 48-0112	1	TAP 3.5mm, 5" fine thread
OM 48-0114	1	TAP 3.5mm, 4 1/2" 1.75mm fine thread
OM 47-0904	1	QUICK COUPLING HANDLE 4 1/2" small
OM 47-0970	1	DRILL GUIDE FOR 2.0mm DRILL, 4 1/4"
OM 47-0972	1	TAP SLEEVE 2.5mm DRILL & 3.5mm SCREW, 5"
OM 47-0974	1	INSERT DRILL SLEEVE 3.5/2.7mm, 1 1/2"
OM 47-0953	1	SCREWDRIVER BIT 2.5mm, 4"
OM 47-0955	1	SLEEVE FOR SCREWDRIVER OM 47-0953, 2"
OM 47-0936	1	DEPTH GAUGE 50mm
OM 48-0412	1	INSTRUMENT TRAYS

Trays are made of lightweight anodized aluminum.

BASIC SCREW SET

OM 73-0001

Includes: 2 trays with cover.
1 OM 47-0930 Screw Holding Forceps

Trays accommodate 6 each of 1.5mm through 4.0mm screws.

Screws are not included with trays. They can be ordered separately.

For our complete selection of screws refer to section T.

Dimensions: Tray 1: 9" x 5" x 1 1/2"
Tray 2: 9" x 5" x 2 1/2"
All four combined: 9" x 5" x 7"

Metric to Metric Conversions

to convert	to	multiply by
millimeters (mm)	centimeters (cm)	0.1
millimeters (mm)	meters (m)	0.001
centimeters (cm)	millimeters (mm)	10
centimeters (cm)	meters (m)	0.01
meters (m)	millimeters (mm)	1,000
meters (m)	centimeters (cm)	100
grams (g)	kilograms (kg)	0.001
Kilograms (kg)	grams (g)	1,000

English to Metric Conversions

to convert	to	multiply by
inches	millimeters (mm)	25.4
inches	centimeters (cm)	2.54
millimeters (mm)	inches	0.0394
centimeters (cm)	inches	0.394
ounces (oz)	grams (g)	28.3
pounds (lbs)	kilograms (kg)	0.454
grams (g)	ounces (oz)	0.035
kilograms (kg)	pounds (lbs)	2.20

Fractions to Millimeters

inch	millimeters
1/16	1.59
1/8	3.18
3/16	4.74
1/4	6.35
5/16	7.94
3/8	9.53
7/16	11.11
1/2	12.70
9/16	14.29
5/8	15.88
11/16	17.46
3/4	19.05
13/16	20.64
7/8	22.23
15/16	23.81
1	25.40

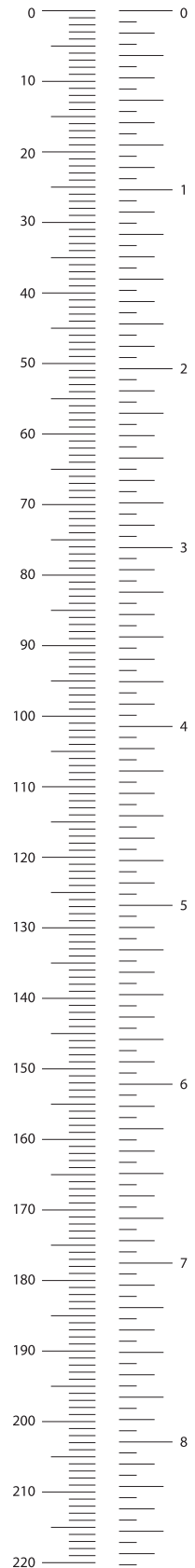

French Scale fr/mm

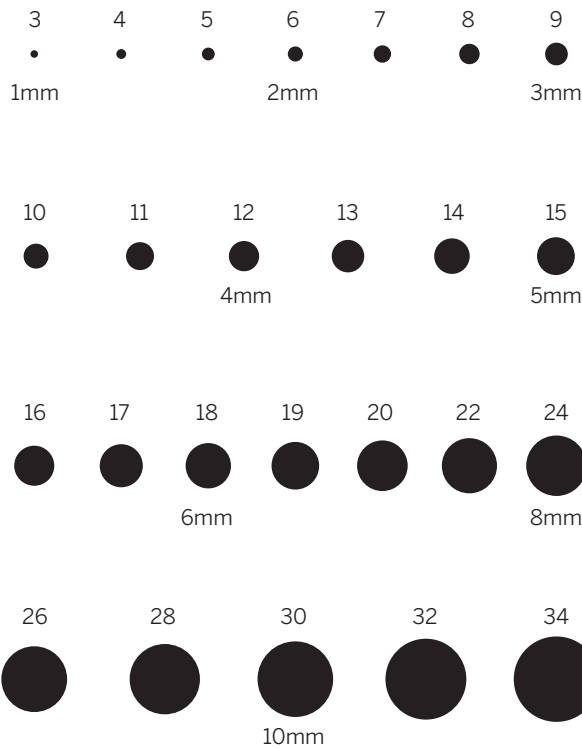

French Scale fr/mm

inch	millimeters
3 fr	1.0mm
4 fr	1.3mm
5 fr	1.7mm
6 fr	2.0mm
7 fr	2.3mm
8 fr	2.7mm
9 fr	3.0mm
10 fr	3.3mm
11 fr	3.7mm
12 fr	4.0mm
13 fr	4.3mm
14 fr	4.7mm
15 fr	5.0mm
16 fr	5.3mm
17 fr	5.7mm
18 fr	6.0mm
19 fr	6.3mm
20 fr	6.7mm
22 fr	7.3mm
24 fr	8.0mm
26 fr	8.7mm
28 fr	9.3mm
30 fr	10.0mm
32 fr	10.7mm
34 fr	11.3mm

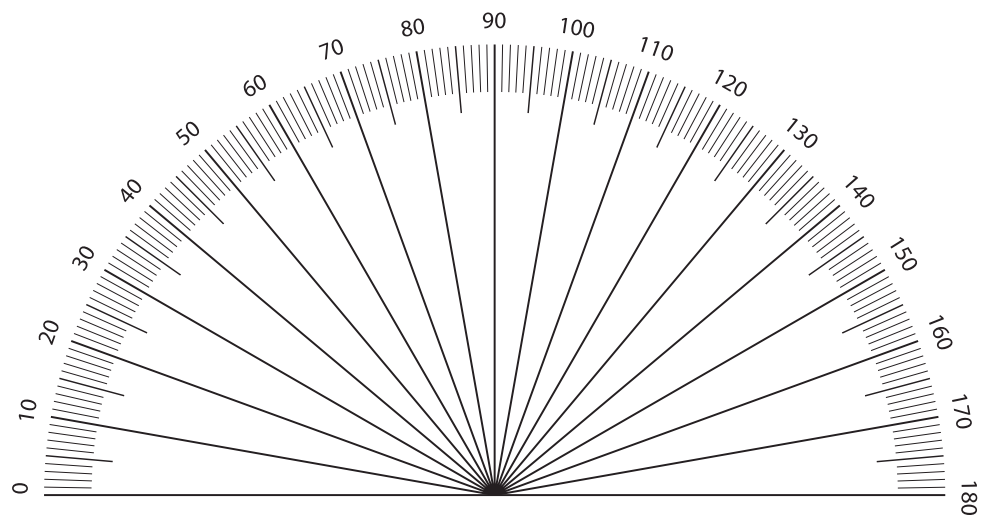
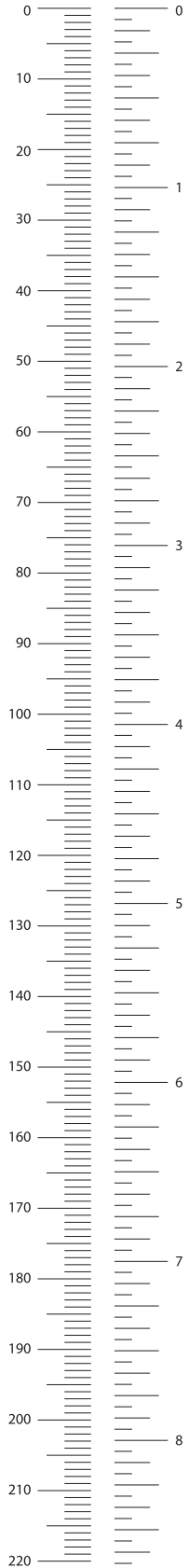

Angle Chart

Jaw curvature and jaw angles are measured in degrees.
Use the angle chart to determine the instrument's degree of curvature.