

Seismic Ceiling Suspension Guide

Chicago Metallic® Suspension Systems



Project – AHL Architects Hawaii Ltd. in Honolulu, HI
Products – Rockfon Artic®, Rockfon® Infinity™, Chicago Metallic Ultraline™

Seismic Codes: Development And Adoption

The code official is the only authority to enforce code compliance

The International Building Code was established to set minimum requirements for life safety and preservation of property. It is important to know that while the building code establishes the requirements, it is the code official that has the power to enforce its provisions.

The code official also has the latitude to allow materials and methods of construction that are not addressed in the code. In this case, officials can perform their own analysis of the evidence presented or they can rely on independent, qualified sources such as International Code Council-Evaluation Services (ICC-ES) to do the analysis and provide their findings.

The resulting report is specific, technical evidence on which the code official can base approval of a particular design without delaying construction.

Purpose of installation requirements for suspended ceilings

- Suspension systems strong enough to resist lateral force imposed upon it without failing.
- Prevent border panels from falling from the ceiling plane.

Seismic Categories

According to the International Building Code, a Seismic Design Category must be established for each construction project based on:

1. Anticipated ground motion
2. Type of soil in a specific geographic area
3. Occupancy category

Note: Seismic Design Categories are established by the building owner and engineer. A SDC is a classification assigned to a structure based on its occupancy or use, and on the level of expected soil modified ground motion.

Seismic Design Category (SDC)	
SDC	Significance
A	Very small seismic vulnerability
B	Low to moderate seismic vulnerability
C	Moderate seismic vulnerability
D	High seismic vulnerability
E & F	Very high seismic vulnerability and near a major fault

Chicago Metallic Suspension Systems are tested to: **ASTM E580 / E580M Standard Practice for Installation of Ceiling Suspension Systems for Acoustical Tile and Lay-in Panels in Areas Subject to Earthquake Ground Motions.**

This practice covers acoustical ceiling suspension systems and their additional requirements in buildings in IBC Seismic Design Categories C, D, E and F. The application of this practice is to be determined by local authorities.

- SDC C Installation Requirements
- SDCs D, E and F Installation Requirements
- Connection Strength SDC C
- Connection Strength SDCs D, E and F
- Referenced standard in ASCE 7-10 (IBC 2021)

Rockfon grid suspension systems comply with 2 codes per ICC ESR-2631 Report:

1. 2020 City of Los Angeles Building Code (LABC)
2. 2019 California Building Code

Industry Standard Construction

	IBC 2021 SEISMIC DESIGN CATEGORY C	IBC 2021 SEISMIC DESIGN CATEGORIES D, E and F
Code Sections	ASCE 7-16. Section 13.5.6.2.1.	ASCE 7-16. Sections 13.5.6, 13.5.6.2 and 13.5.6.2.2.
ASTM C635 Duty Rating	Intermediate or Heavy Duty Load Rating grid as defined by ASTM C635.	Heavy Duty Load Rating as defined in ASTM C635 is required.
Grid Connections	Minimum main runner splices and cross runner intersections strength of 60 lbs. (27.2 kg).	Minimum main runner splices and cross runner intersections strength of 180 lbs. (81.6 kg).
Vertical Suspension Wires	<p>Vertical hanger wires must be a minimum No. 12 gage.</p> <p>Vertical hanger wires maximum 4 ft. (1200 mm) on center unless justified by calculations or test results.</p> <p>For field-tied connections, vertical hanger wires must be sharply bent and wrapped with three turns in 3 in. (75 mm) or less.</p> <p>All vertical hanger wires may not be more than 1/6 out of plumb without having additional wires counter splayed.</p> <p>Wires may not attach to or bend around interfering equipment. Use trapezes to avoid such obstacles.</p>	<p>Vertical hanger wire must be a minimum No. 12 gage.</p> <p>Vertical hanger wires maximum 4 ft. (1200 mm) on center unless other design approvals are listed by the manufacturer.</p> <p>Vertical hanger wires must be straight and shall not use bends or localized kinks for leveling the system.</p> <p>For field-tied connections, vertical hanger wires must be sharply bent and wrapped with three turns in 3 in. (75 mm) or less.</p> <p>All vertical hanger wires may not be more than 1/6 out of plumb without having additional wires countersplayed.</p> <p>A device used to secure the hanger wire to the structure above must sustain a minimum load of 90 lbs. (40 kg).</p> <p>Power-actuated fasteners are now permitted to be used for loads that do not exceed 90 lbs. (40 kg) in concrete and do not exceed 250 lbs. (110 kg) in steel.</p> <p>Wires may not attach to or bend around interfering equipment. Use trapezes to avoid such obstacles.</p>
Lateral Force Bracing	Lateral force bracing is not permitted.	<p>Ceilings less than or equal to 144 ft.² (13.4 m²) and surrounded by walls connected to the structure above are exempt from these requirements of this practice.</p> <p>Lateral force bracing is required for all ceilings greater than 1000 ft.² (90 m²).</p> <p>Where required, lateral force bracing (splay wires or rigid bracing and a compression post) must be located within 2 in. (50 mm) of main runner/cross runner intersection and splayed approximately 90° apart in the plan view, at maximum 45° angle from the horizontal and located 12 ft. (3600 mm) on center in both directions, starting 6 ft. (1800 mm) from two adjacent walls.</p> <p>Lateral force bracing must be spaced a minimum of 6 in. (150 mm) from unbraced horizontal piping or ductwork.</p> <p>Lateral force bracing connection strength must be a minimum of 250 lbs. (110 kg).</p> <p>Rigid bracing must be designed to limit deflection to less than 1/4 in. (6.5 mm).</p> <p>Unless rigid bracing is used or calculations have shown that lateral deflection is less than 1/4 in. (6 mm), sprinkler heads and other penetrations shall have a minimum of 1 in. (25 mm) clear space in all directions.</p>
Perimeter	<p>Perimeter closure (molding) width must be a minimum of 7/8 in. (22 mm).</p> <p>A minimum clearance of 3/8 in. (9.5 mm) must be maintained on all four sides (Refer to Page 8).</p> <p>Grid ends on all four walls must be free to move.</p> <p>When a closure angle with a supporting shelf less than 7/8 in. (22 mm) is used, perimeter runners must be supported by vertical hanger wires not more than 8 in. (20 cm) from the wall.</p> <p>Proprietary solutions may utilize approved attachment devices on some walls and varying closure widths.</p> <p>Perimeter runner ends must be tied together to prevent spreading (Refer to Page 8).</p>	<p>Perimeter closure (molding) width must be a minimum of 2 in. (50 mm) (Refer to Page 10).</p> <p>Proprietary solutions using approved perimeter clips may utilize perimeter closures less than 2 in. (50 mm) (Refer to Page 10).</p> <p>The grid must be connected to the perimeter on two adjacent sides (Refer to Page 10).</p> <p>A minimum clearance of 3/4 in. (20 mm) must be maintained on two, unattached adjacent sides (Refer to Page 10).</p> <p>Perimeter runners must be supported by vertical hanger wires not more than 8 in. (200 mm) from the wall (Refer to Page 11).</p> <p>Unattached perimeter runner ends must be tied together to prevent spreading (Refer to Page 10).</p>

Note: Chart references CISCA Seismic Handbook 2014

Industry Standard Construction

	IBC 2021 SEISMIC DESIGN CATEGORY C	IBC 2021 SEISMIC DESIGN CATEGORIES D, E and F
Light Fixtures	<p>Lighting fixtures must be positively attached to the grid by at least two connections each capable of supporting the weight of the lighting fixture (National Electrical Code).</p> <p>Surface mounted lighting fixtures shall be positively clamped to the grid.</p> <p>Clamping devices for surface mounted lighting fixtures shall have safety wires to the suspension system or the structure above.</p> <p>Lighting fixtures and attachments weighing 10 lbs. (4.5 kg) or less (e.g. canister light fixtures) require one No. 12 gage (minimum) hanger wire connected from the housing to the structure above. This wire may be slack.</p> <p>Lighting fixtures weighing greater than 10 lbs. (4.5 kg), but less than 56 lbs. (25.4 kg) require two No. 12 gage (minimum) hanger wires connected from the fixture housing to the structure above. These wires may be slack.</p> <p>Lighting fixtures weighing 56 lbs. (25 kg) or more require independent support from the structure above by approved hangers.</p> <p>Pendent-hung light fixtures shall be supported by a minimum one No. 9 gage wire or other approved alternate support.</p> <p>Rigid conduit is not permitted for the attachment of fixtures.</p>	<p>Lighting fixtures must be positively attached to the grid by at least two connections each capable of supporting the weight of the lighting fixture.</p> <p>Surface mounted lighting fixtures shall be positively clamped to the grid.</p> <p>Clamping devices for surface mounted lighting fixtures shall have safety wires to the grid or the structure above.</p> <p>When cross runners with a load carrying capacity of less than 16 lbs./ft. (24 kg/m) are used, supplementary hanger wires are required.</p> <p>Lighting fixtures and attachments weighing 10 lbs. (4.5 kg) or less require one No. 12 gage minimum hanger wire connected to the housing (e.g. canister light fixture) and connected to the structure above. This wire may be slack.</p> <p>Lighting fixtures weighing greater than 10 lbs. (4.5 kg), but less than 56 lbs. (25 kg) require two No. 12 gage minimum hanger wires connected to the fixture housing on opposite diagonal corners and connected to the structure above. These wires may be slack.</p> <p>Lighting fixtures weighing 56 lbs. (25 kg) or more require independent support from the structure by approved hangers.</p> <p>Pendent-hung light fixtures shall be supported by a No. 9 gage minimum hanger wire or other approved alternate.</p> <p>Rigid conduit is not permitted for the attachment of fixtures.</p>
Mechanical Services	<p>Flexibly mounted mechanical services weighing less than or equal to 20 lbs. (9 kg) must be positively attached to main runners or cross runners with the same load carrying capacity as the main runners.</p> <p>Flexibly mounted mechanical services weighing more than 20 lbs. (9 kg), but less than 56 lbs. (25 kg) or less require two No. 12 gage (minimum) hanger wires. These wires may be slack.</p> <p>Flexibly mounted mechanical services 56 lbs. or greater require direct support from the structure.</p>	<p>Flexible mechanical services weighing less than 20 lbs. (9 kg) must be positively attached to main runners or to cross runners that have the same load carrying capacity as the main runners.</p> <p>In addition to the previous requirement for positive attachment, flexible mechanical services weighing more than 20 lbs. (9 kg), but less than 56 lbs. (25 kg) require two No. 12 gage minimum hanger wires connected to the fixture housing on opposite diagonal corners and connected to the structure above. These wires may be slack.</p> <p>Flexible mechanical services greater than 56 lbs. (25 kg) require direct support from the structure.</p>
Special Consideration	<p>All ceiling penetrations must have a minimum of 3/8 in. (9.5 mm) clearance on all sides.</p>	<p>Direct concealed systems must have stabilizer bars a maximum of 60 in. (1500 mm) on center with stabilizer bars within 24 in. (600 mm) of the perimeter.</p> <p>Bracing is required for ceiling plane elevation changes.</p> <p>Cable trays and electrical conduits shall be supported and braced independently of the ceiling.</p> <p>As an alternate to providing large clearances around sprinkler system penetrations through ceilings, the sprinkler system and ceiling grid are permitted to be designed by a design professional and tied together as an integral unit. Such a design shall consider the mass and flexibility of all elements involved, including the ceiling, sprinkler system, light fixtures, and mechanical (HVAC).</p> <p>Seismic separation joints, bulkheads braced to the structure, or full height partitions are required that divide the ceiling into areas less than or equal to 2,500 ft.² (230 m²) (Refer to Page 12).</p> <p>Areas divided into 2,500 ft.² (230 m²) sections as above, must have a ratio of the long side to the short side of less than or equal to 4:1.</p> <p>All ceiling penetrations and independently supported fixtures or services must have closures which allow for a 1 in. (25 mm) movement.</p> <p>A licensed design professional must review the interaction effects of non-essential ceiling components on essential ceiling components to prevent their failure.</p>

Note: Chart references CISCA Seismic Handbook 2014

Industry Standard Construction

	IBC 2021 SEISMIC DESIGN CATEGORY C	IBC 2021 SEISMIC DESIGN CATEGORIES D, E and F
Partitions	The ceiling may not provide lateral support to partitions. Partitions attached to the ceiling must use flexible connections to avoid transferring force to the ceiling.	Partition bracing must be independent of ceiling.
Exceptions	The ceiling weight must be 2.5 psf or less. For ceilings over 2.5 psf the prescribed construction for SDCs D, E and F must be used.	
Exemption	Ceilings less than or equal to 144 ft. ² (13.3 m ²) and surrounded by walls connected to the structure above are exempt from the requirements of this practice.	Ceilings less than or equal to 144 ft. ² (13.3 m ²) and surrounded by walls connected to the structure above are exempt from the requirements of this practice.

Note: Chart references CISCA Seismic Handbook 2014



Project – Marian Regional Medical Center in Santa Maria, CA
Product – Chicago Metallic 1200 Seismic

Seismic Ceiling: International Building Code Install

What Chicago Metallic Suspension Systems can I use for my ceiling?

Because ceiling panel performance and non-tee bar suspension systems are not well defined in the IBC requirements, Rockfon is working with an independent, internationally renowned structural engineering firm to test both standard and non-standard ceiling systems for seismic performance. The results of these full-scale seismic tests offer proven safety and performance support for standard and non-standard ceilings, flexible design options, and more efficient installation designs.

Acceptable systems for use in IBC Seismic Design Categories					
Chicago Metallic® System	Intermediate Duty	Seismic Design C	Heavy Duty	Seismic Design DEF	ICC Report 2631
200/250 Snap-grid™	X	X	X		X
640, 650, 660 & 670 Drywall	X	X	X	X	X
660 Wide Face	X	X	X	X	X
730 All Stainless Steel	X	X*			X
830 All Aluminum	X	X*			X
1200/1250 Seismic	X	X	X	X	X
1260/1280 Aluminum Cap	X	X	X	X	X
4500/4550 & 4600 Ultraline™	X	X	X	X	X
4000/4050 Tempra™	X	X	X	X	X
4200 Integrity™		X	X	X	X

* With use of 416 clips - contact technical services for installation instructions

How is the seismic testing conducted and regulated on Chicago Metallic Suspension Systems?

Chicago Metallic Suspension Systems, including the 1496 perimeter clip, 1494 Seismic Separation Clip and 1493 Unopposed Tee Clip, were rigorously tested at the Structural Engineering Earthquake Simulation Laboratory (SEESL) at the State University of New York at Buffalo. The evaluation process, including room size testing on shake tables at the university, was monitored by engineers from Rockfon and the State University of New York at Buffalo, as well as by engineers from an independent structural engineering group, to ensure accurate data was properly collected and summarized.

Third party certification

Rockfon works with industry leaders in technical evaluations for code compliance, providing regulators and construction professionals clear evidence that products comply with the codes and standards for common building hazards such as earthquake, fire and wind load.

Many of Chicago Metallic suspension systems are listed along with the 1496 Perimeter Clip under ICC Evaluation Service (ICC-ES) report ICC-ESR 2631. This listing confirms that the products perform as required by the current IBC. The most current report is available at www.icc-es.org. Along with the full list of products and systems, ICC-ESR 2631 provides additional installation details and requirements.

Rockfon also holds evaluation reports for two metal ceiling products with Intertek under their Code Compliance Research Report (CCRR) program. CCRR-0260 for Rockfon Spanair® Torsion Spring Plus and CCRR-0267 Planar® Linear Metal ceiling system. Both reports are available at www.intertek.com.

Various fire rated assemblies and wind load constructions for both Chicago Metallic suspension systems and Rockfon specialty metal ceilings products are listed with UL. Visit www.ul.com for listings and construction details.

For additional technical installation documents, technical notes with tips and tricks for installers visit rockfon.com

Seismic Ceiling System Details: Alternative Code Installations

Chicago Metallic Seismic Suspension Systems

Chicago Metallic's Suspension Systems offer many solutions for each type of seismic design construction. Most systems are offered in Intermediate Duty and Heavy Duty performance per ASTM C 635 to satisfy the requirements of all seismic code constructions. The exposed tee construction permits direct upward access to mechanical systems and is a cost-effective solution to seismic requirements. Stab-in cross tees cantilever during installation and will not fall out, making for an easier installation and protecting against lateral pull-out. When utilized with the 1494 Seismic Separation Clip, an unbroken ceiling design is maintained in seismic installations.

Contact Rockfon Technical Services for specific installation instructions based on your SDC at cs@rockfon.com

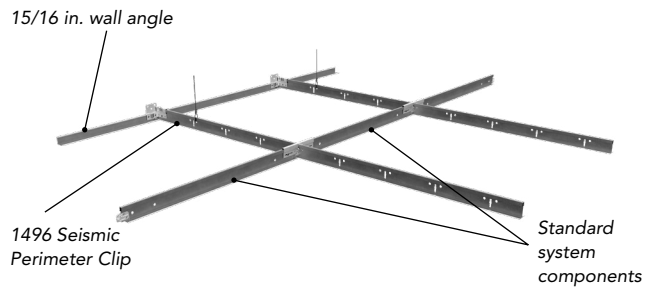

200/250 Snap-grid™,
1200/1250 Seismic
4000 and 4050 Tempra™
4200 Integrity™
4500/4550 and
4600 Ultraline™
260/280 and 1260/1280

Aluminum Cap
660 Wide Face
730 All Stainless Steel,
830 All Aluminum
1830 Environmental
Drywall Suspension Systems

Chicago Metallic 1496 Seismic Perimeter Clip

Each seismic design category has specific requirements regarding perimeter components, and our 1496 Seismic Perimeter Clip has been engineered to meet these stringent codes. Current code requirements include a 2 in. (50 mm) wide perimeter wall molding, and stabilizer bars to prevent the ceiling grid from spreading apart along the molding.

Chicago Metallic 1496 Seismic Perimeter Clip meets seismic criteria set forth by the IBC to stabilize main and cross tees at the ceiling's perimeter, as detailed in ES Report No. 2631. This clip ties together perimeter components and has been tested and recognized as an alternate method of stabilizing tees at the perimeter. Its robust construction allows contractors to use a traditional 15/16 in. (24 mm) angle in lieu of the less desirable 2 in. (50 mm) angle and eliminates costly stabilizer bars.

Features and Benefits of the 1496 Perimeter Clip:

- ICC-ES installation approach (ESR #2631)
- Exceeds IBC requirement of 2 in. (51 mm) ledge support of grid components
- Dimension markers included on clip showing required 3/8 in. (9.5 mm) and 3/4 in. (19 mm) clearance of grid to the wall
- Back plate accommodates additional attachment of clip to wall and/or wall angle
- Screw holes are provided for attaching clip to tee when required

- Bright gold color makes clip easily identifiable on job site inspections
- Installation of the clip is quick due to pre-drilling of screw holes
- Reduced installation time for ceiling panels by eliminating spacer bars

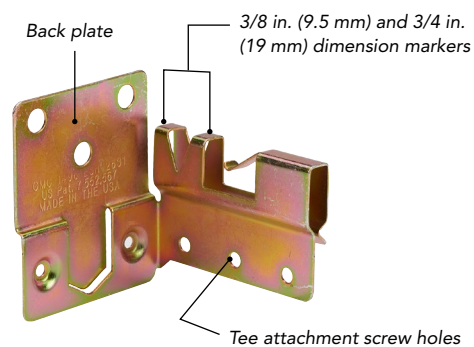

The following Chicago Metallic systems grid are acceptable for use in International Building Code Seismic Design Categories:

Chicago Metallic 1200 Seismic
Chicago Metallic 1260 Aluminum Cap
Chicago Metallic 660 Wide Face
Chicago Metallic 4000 Tempra
Chicago Metallic 4200 Integrity
Chicago Metallic 4500 Ultraline
Chicago Metallic 4600 Ultraline

Note: Check local code for installation requirements.

Seismic Ceiling System Details: IBC Category C

Conventional IBC installation

Chicago Metallic 1496 Clip Installation (ESR-2631) - Option 1

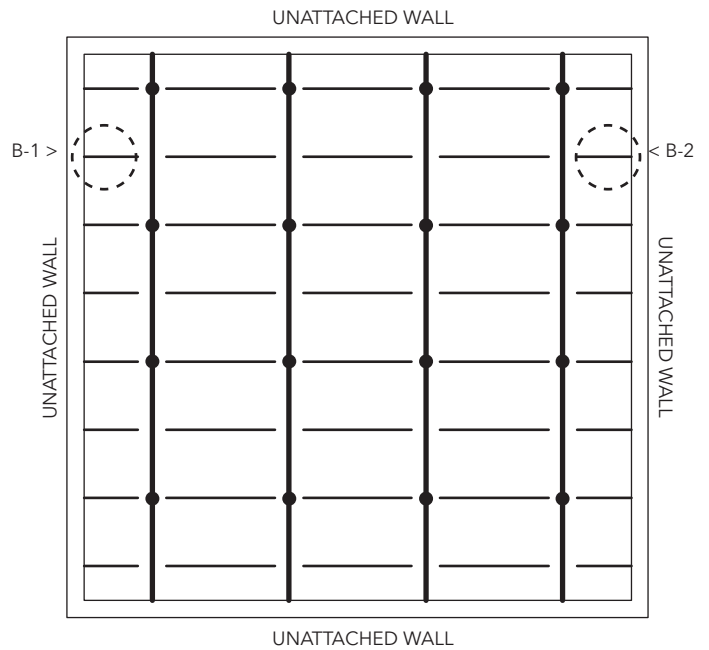
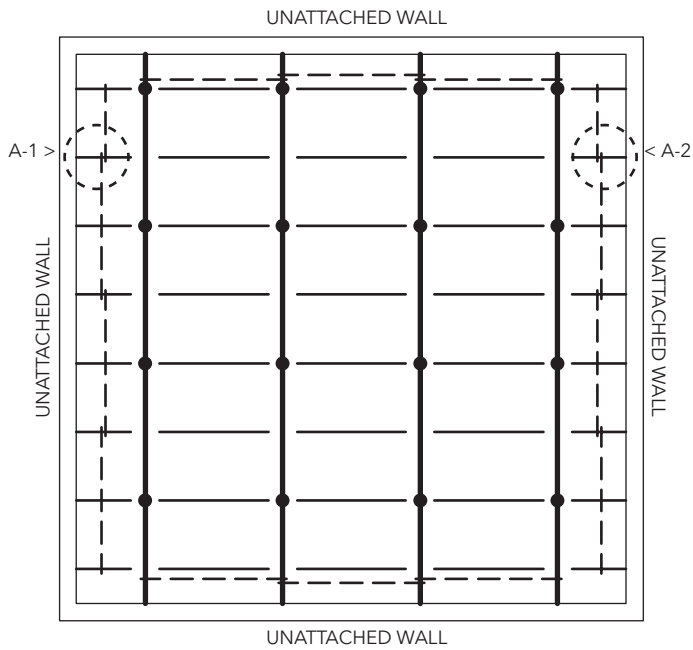

A-1

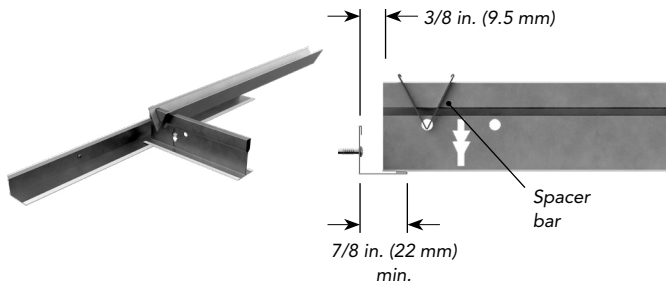

B-1

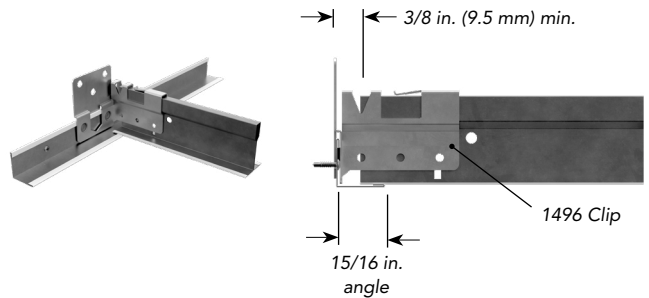

A-2

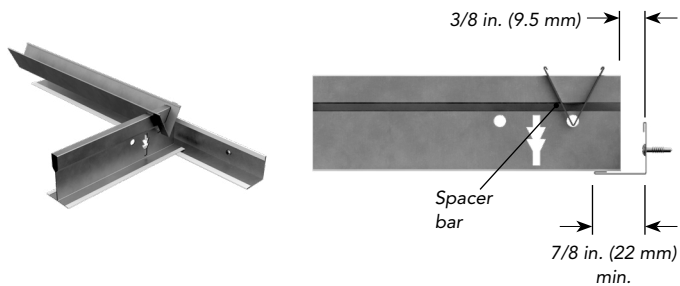

B-2

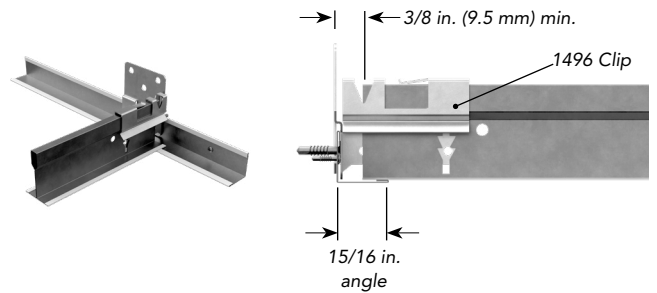

*** Legend**

- 12 ga. Hanger Wire
- Spacer Bar

Seismic Ceiling System Details: IBC Category C

Chicago Metallic 1496 Clip Installation Option 2

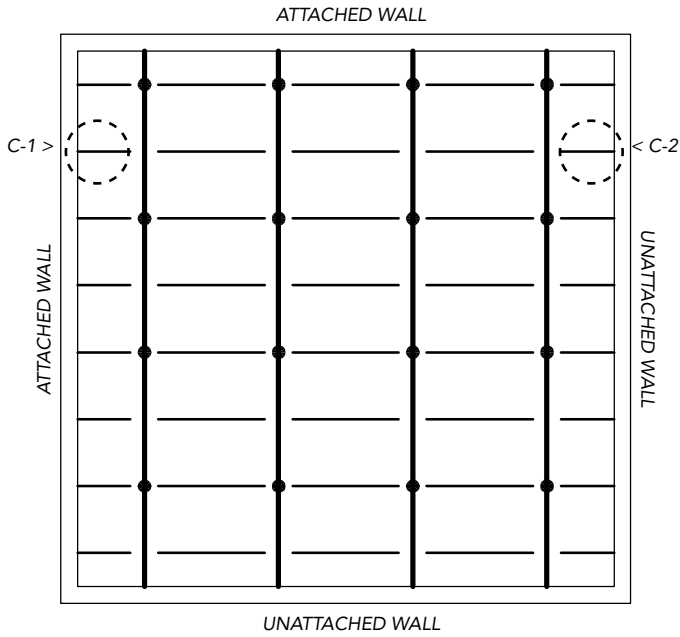

C-1

Option 1

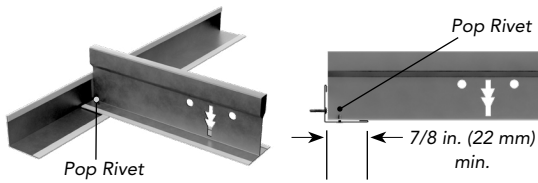

C-2

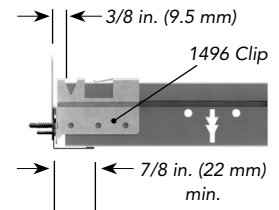

Option 2

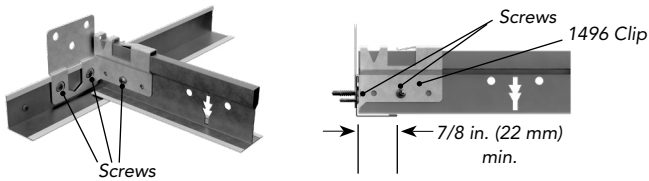

Option 3

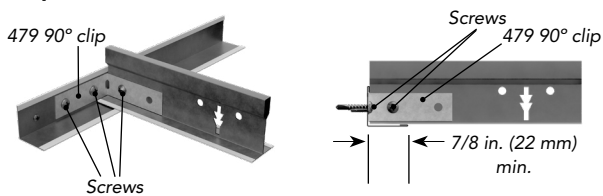

Seismic Ceiling System Details: IBC Category D, E and F

Conventional IBC installation

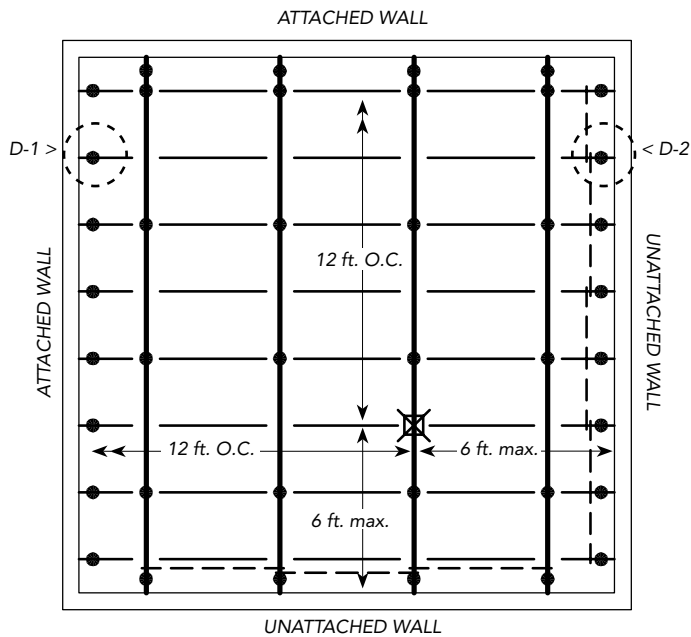

Chicago Metallic 1496 Clip installation (ESR-2631)

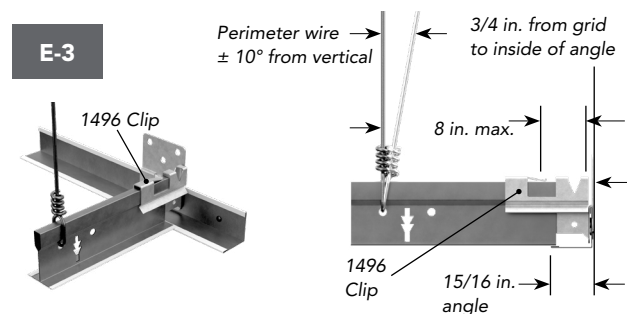
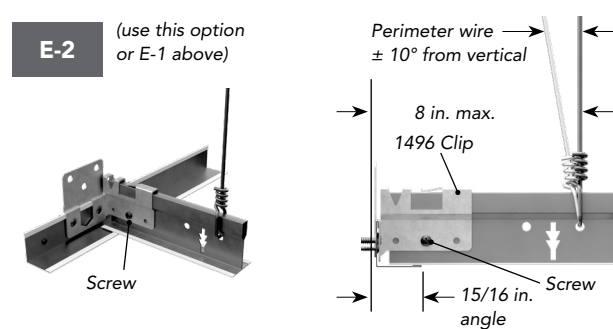
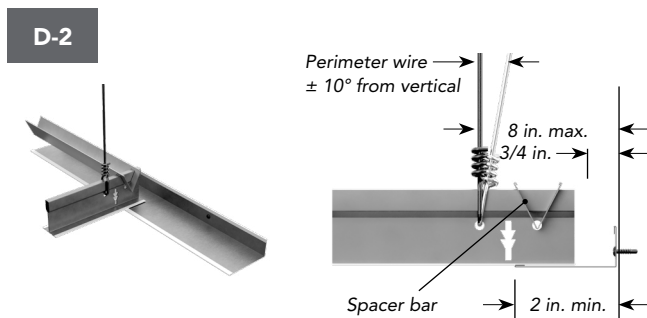
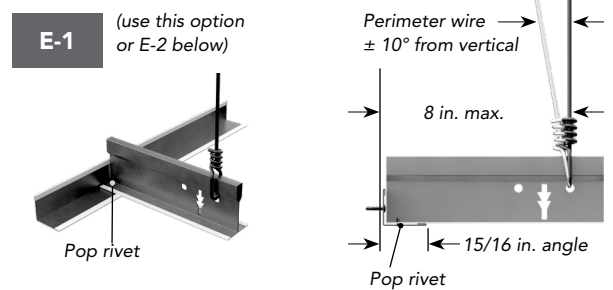
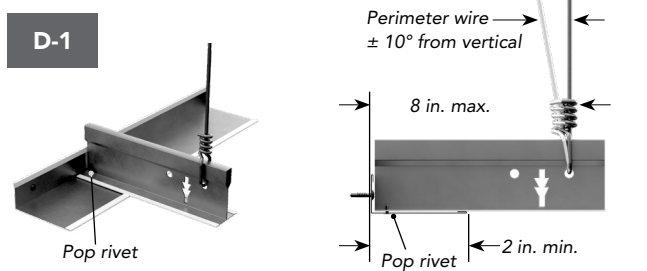
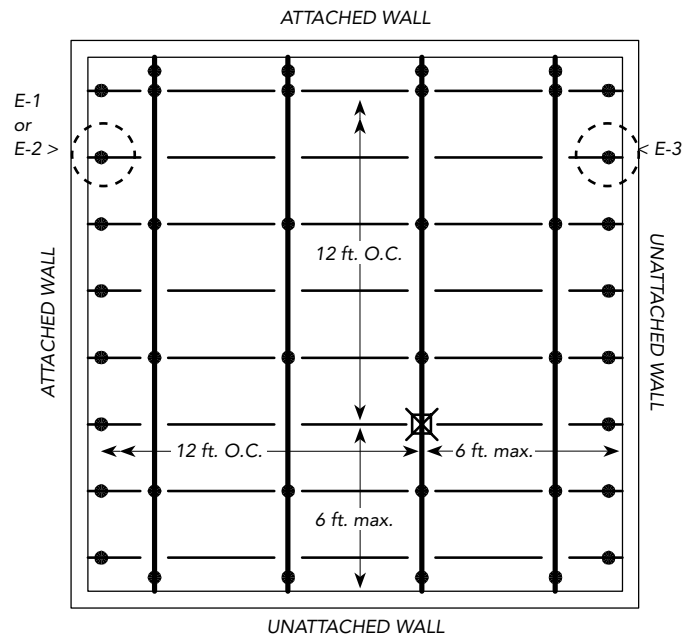

*** Legend**

- 12 ga. Hanger Wire
- ⊗ Horizontal Restraint (Refer to illustration on page 13)
- Spacer Bar

Measurements:

- 3/4 in. = 19 mm
- 2 in. = 50 mm
- 8 in. = 203 mm
- 6 ft. = 1.8 m
- 12 ft. = 3.6 m

Seismic Ceiling System Details: Separation Joints

Seismic separation joints

For large areas, differential movements between the far edges can result in damage to the area. This is recognized in the building codes by limiting size of components such as concrete slabs, and requiring a seismic joint at the edges to allow for the differential movement. Similarly, the building code (ASCE 7-2016) prescribes that for suspended ceilings whose area exceeds 2,500 ft.² (232 m²), seismic separation joints shall be provided. The code states:

For ceiling areas exceeding 2,500 ft.² (232 m²), a seismic separation joint or full height partition that breaks the ceiling up into areas not exceeding 2,500 ft.² (232 m²), each with a ratio of the long to short dimension less than or equal to 4, shall be provided unless structural analyses are performed of the ceiling bracing system for the prescribed seismic forces that demonstrate ceiling penetrations and closure angles or channels provide sufficient clearance to accommodate the anticipated lateral displacement. Each area shall be provided with closure angles or channels in accordance with Section 13.5.6.2.2.a and horizontal restraints or bracing.

Features and Benefits of 1494 Seismic Separation Joint Clip:

- Shaker table tested
- Strong code compliant solution for seismic categories D, E, and F
- Sits on top of the grid members for easy attachment
- Hidden design provides clean look on finished ceiling
- One piece design works on all applications
- 1494 Clip can be used on main runners and cross tees, which minimizes inventory needs
- Maintains ceiling system strength
- Works with most Chicago Metallic Suspension Systems
- Hash mark on clips easily identify screw attachment points in the field

Chicago Metallic solution – 1494 Seismic Separation Clip

The Chicago Metallic 1494 Seismic Separation Clip simplifies the installation of the seismic separation joint, allowing the ceiling to be installed as normal. Joints then can be located where necessary to comply with code requirements.

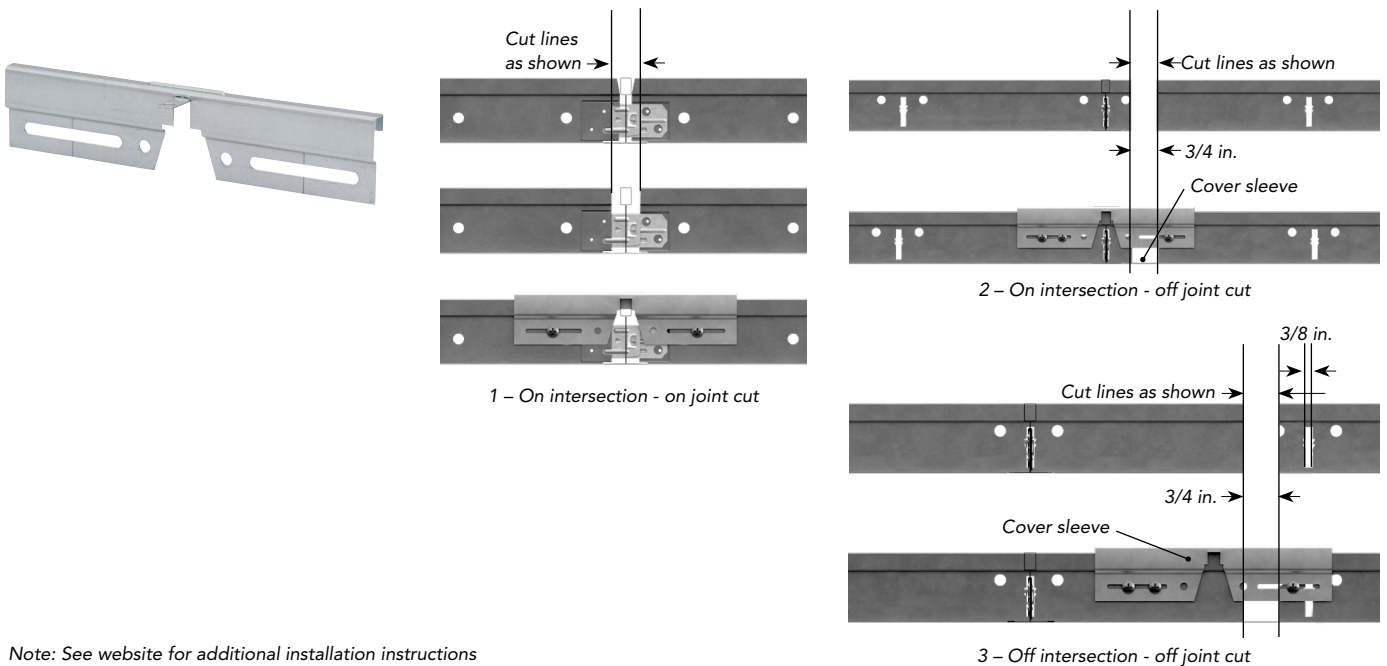

Note: See website for additional installation instructions

Seismic Separation Joint IBC SDCs D, E and F

Conventional IBC installation

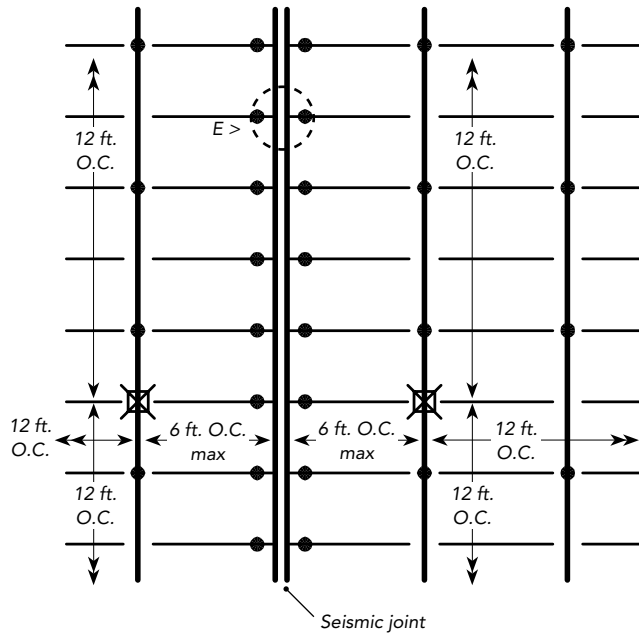

E

Chicago Metallic - 1494 Clip installation

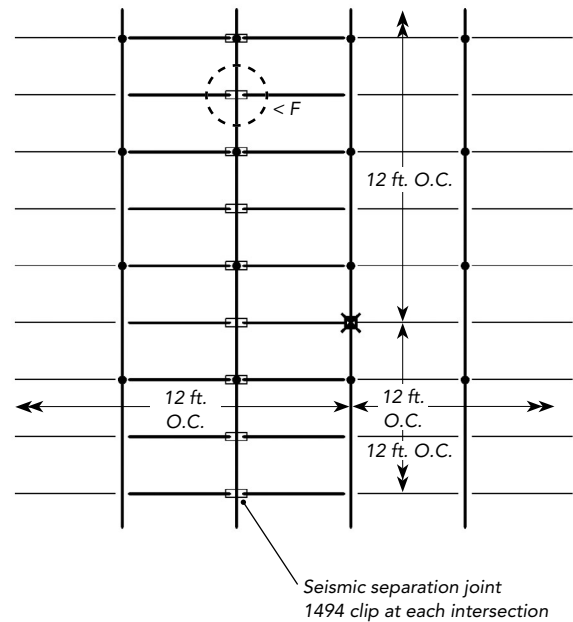

F

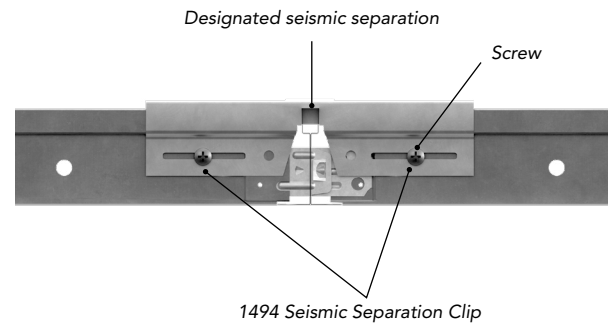
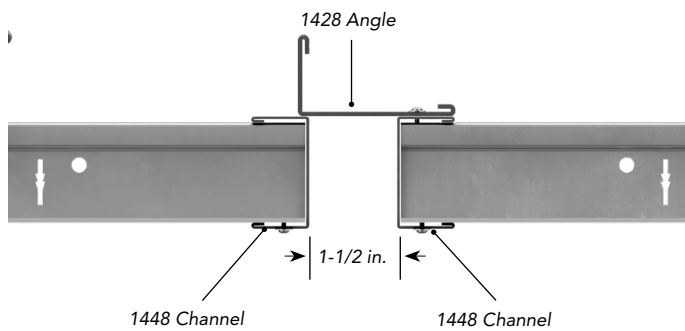

IMPORTANT! Do not place horizontal restraint over separation joint.

*** Legend**

- 12 ga. Hanger Wire
- ⊗ Horizontal Restraint
(Refer to illustration on page 13)
- ⊕ 1494 Clip

Measurements:

- 1.5 in. = 38 mm
- 6 ft. = 1.8 m
- 12 ft. = 3.6 m

Seismic Ceiling System Details: Unopposed Cross Tees

1.3 Unopposed Tee Clip

According to the IBC all system connections in SDCs D, E and F are required to be stronger than 180 lbs. (82 kg) of pull out force. The 1493 Unopposed Tee Clip is utilized when a cross tee does not have another cross tee to engage the ends and meets the above requirement when used with Chicago Metallic Suspension Systems.

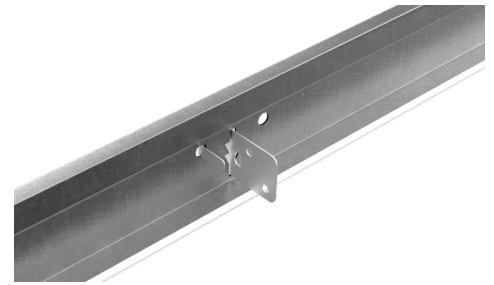
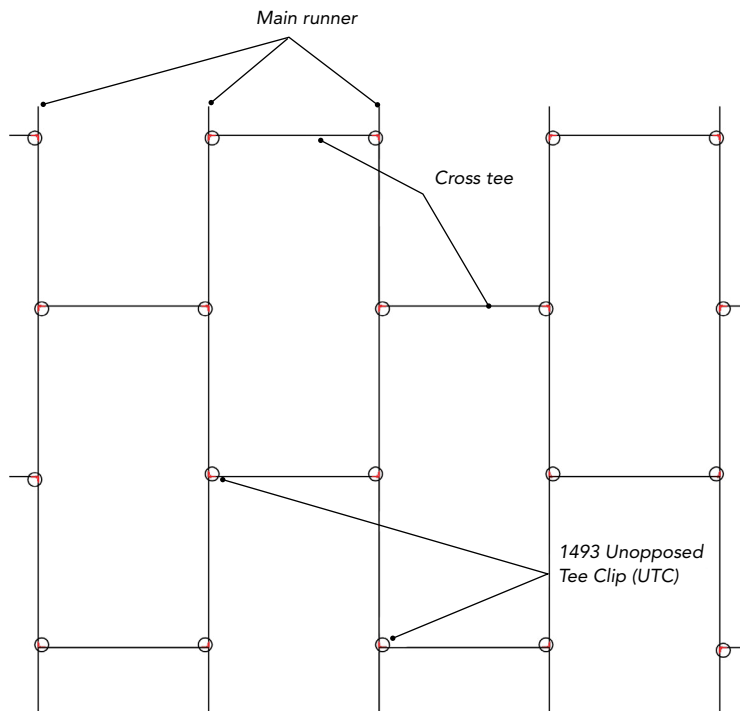
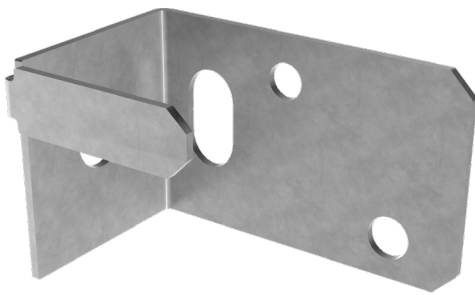

Step 1 - Insert clip into slot

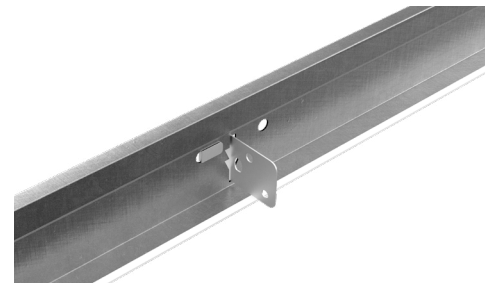

Step 2 - Bend short leg



Step 3 - Insert cross tee



Step 4 - Insert screw

Seismic Horizontal Restraint

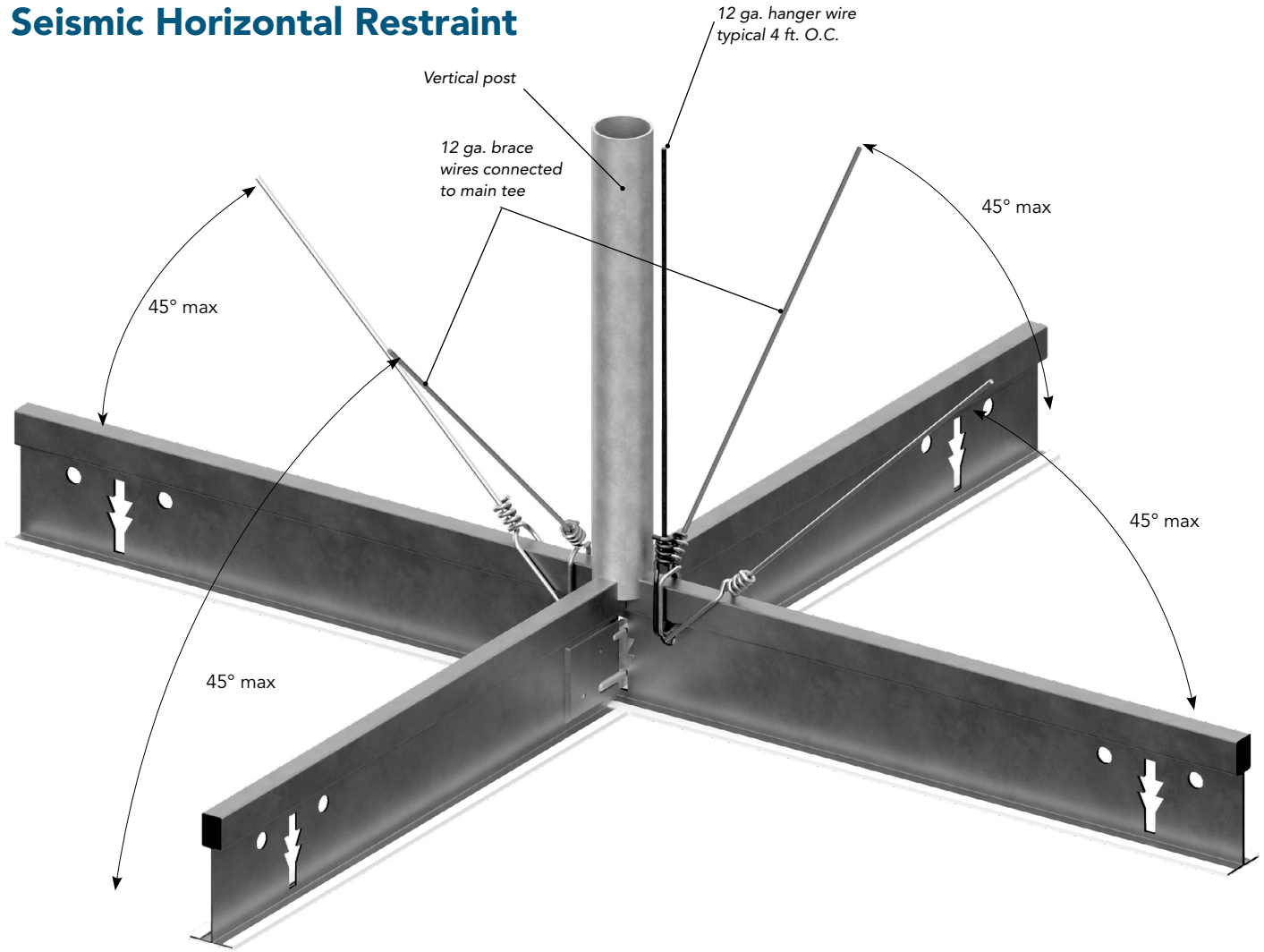

These horizontal restraint points shall be placed 12 ft. (3.6 m) on center in both directions with the first point within 6 ft. (1.8 m) of each wall. Brace wires shall be attached to main tees within 2 in. (50 mm) of cross tee intersection, at a maximum angle of 45° relative to ceiling plane. Wires shall be tied with a minimum of three tight wraps (see ASTM C 636 for examples).

For complete details, please refer to the current version of ASCE 7.

Vertical struts - allowable lengths

Maximum Recommended Length for Vertical Struts¹

EMT Conduit	Metal Studs
1/2 in. (13 mm) EMT up to 5 ft. 10 in. (1.8 m)	Single 1-5/8 in. (41 mm) metal stud (20 ga.) up to 12 ft. (3.6 m)
3/4 in. (19 mm) EMT up to 7 ft. 8 in. (2.3 m)	Single 2-1/2 in. (63 mm) metal stud (20 ga.) up to 13 ft. 6 in. (4.1 m)
1 in. (25 mm) EMT up to 9 ft. 9 in. (2.9 m)	Back-to-back 1-5/8 in. (63 mm) metal stud (20 ga.) up to 15 ft. (4.5 m)
	Back-to-back 2-1/2 in. (63 mm) metal stud (25 ga.) up to 15 ft. (4.5 m)

Note: Plenum areas greater than 15 ft. (4.5 m) will require engineering calculations.

¹Source: Northwest Wall & Ceiling Bureau Rev. 10/09

Clouds and Canopies

3.14 Island Ceilings

Island Ceilings — ASCE 7-16 and ASTM E580 1.8 exempt island ceilings from compliance with seismic requirements with the following language:

EXCEPTION: Components supported by chains or otherwise suspended from the structure are not required to satisfy the seismic force and relative displacement requirements provided they meet all of the following criteria:

1. The design load for such items shall be equal to 1.4 times the operating weight acting down with a simultaneous horizontal load equal to 1.4 times the operating weight. The horizontal load shall be applied in the direction that results in the most critical loading for design.
2. Seismic interaction effects shall be considered in accordance with Section 13.2.3
3. The connection to the structure shall allow a 360° range of motion in the horizontal plane, but ASCE 7 also states in section 13.2.3: The functional and physical interrelationship of components, their supports, and their effect on each other shall be considered so that the failure of an essential or nonessential architectural, mechanical, or electrical component shall not cause the failure of an essential architectural, mechanical, or electrical component. This also must be considered with island ceilings.

Some conditions that will cause island ceilings to need bracing are:

1. Size – Large ceilings can generate significant forces and movement. While there is no definitive size limit, small island ceilings such as less than 144 ft.² (13.4 m²) may not need bracing. Large ceilings such as more than 500 ft.² (46.4 m²) often will need bracing.

2. Plenum Depth – As island ceilings often are used as accents under conventional suspended ceilings, they often have drops of 12 in. (305 mm) or less. As discussed before, a ceiling with a very shallow plenum will not move very far before the hanger wires generate a force opposite to the earthquake force. Ceilings with deeper plenums will experience larger displacements and can generate larger forces.
3. Weight – The larger the mass of a ceiling, the more seismic force it can generate which can cause damage to adjacent structures or components and the island ceiling.
4. Services in the Island Ceiling – Islands containing services such as sprinklers, lights, and mechanical services may not be able to move without damage to these services or having them fall into the occupied space.
5. Damage to Adjacent, Essential Services – Sprinklers, exit signs and other essential services must not be damaged by impact from the island ceiling. When an island ceiling requires bracing, it is generally desirable to minimize the visibility of the bracing.

Several methods to accomplish this are:

1. Use lighter gage, high strength wire
2. Place wire bracing at the perimeter angled towards the interior of the island
3. Rigid bracing placed to minimize visibility





































Note that bracing in the center of an island is ineffective and should not be the sole lateral force bracing.

Please note that any of the suggestions to minimize the visibility of island bracing, such as those suggested above, require the approval of the inspector or local building code official.

Note: Section references CISCA Seismic Handbook 2014

Industry Standard Construction

Rockfon offers a wide range of edge options on our acoustic tiles along with numerous suspension systems. Locate the suspension system on the chart to determine the compatible edge details, and vice versa to ensure the system fits and assembles together properly.

Suspension System Name, Product Number & End Detail		Edge Detail					
		Square (SQ)	Angled Tegular (SLT)	Square Tegular (SL)	Square Tegular Narrow (SLN)	Semi-concealed (SCD)	Concealed-X (CDX)
General Applications							
200 / 250 F/R Hook 1200 / 1250 F/R Stab							
Tempra 4000 / 4050 F/R							
Integrity 4200							
Ultraline 4500 / 4550 F/R (1/4 in.)							
Ultraline 4600 (1/8 in.)							
Special Applications							
Wide Face AL Cap 660							
Barriergrid Standard / Premium							
AL Cap 260 / 280 F/R AL Cap 1260 / 1280 F/R							
All Aluminum 830							
Stainless Steel 730							
Acoustic Stone Wool Tiles*							
Rockfon® Pacific™		✓		✓	✓		
Rockfon Artic®		✓		✓	✓		
Rockfon Tropic®		✓		✓	✓		
Rockfon® Koral™		✓		✓	✓		
Rockfon Alaska		✓	✓		✓	✓	✓
Rockfon Sonar®		✓	✓		✓	✓	✓
Rockfon Sonar® Activity		✓	✓				
Rockfon® Color-all™		✓		✓			✓
Rockfon® Cinema Black™		✓					
Rockfon® Hygienic Plus™		✓					
Rockfon® Medical™ Standard		✓		✓	✓		
Rockfon® Medical™ Plus		✓		✓	✓		✓
Rockfon® Medical™ Air		✓					
Rockfon® Impact™		✓					
Rockfon® Industrial™ Opal / Nature / Black		✓					
Rockfon® Facett™		✓					
Rockfon® Education Standard		✓		✓	✓		
Rockfon® Education Plus		✓		✓	✓		
Rockfon® Education Premium		✓		✓	✓		

* Note: The Acoustic Stone Wool Tiles listed are Rockfon's trademarked brands.

Rockfon® is a registered trademark
of the ROCKWOOL Group.

2022 | Subject to alterations in range and product technology without prior notice. Rockfon accepts no responsibility for printing errors.
® ROCKWOOL IAS 2022. All rights reserved. ® denotes a trademark that is registered in the United States of America.

102422

Rockfon

4849 S. Austin Ave.
Chicago, IL 60638 USA

Tel. +1-800-323-7164
cs@rockfon.com
rockfon.com

