



PARAMOUNT AUTOMOTIVE
PARAMOUNT AUTOMOTIVE
1410 E HOLT BLVD,
ONTARIO, CA 91761
(866)988-8438,

WWW.PARAMOUNT-AUTOMOTIVE.COM

Like Us on Social



2024 CATALOG





Paramount Automotive's mission has always been to design and manufacture innovative vehicle-enhancing products for off-road enthusiasts. To maintain our position at the peak of our industry, we are investing ourselves in new product developments and quality improvements for a wide variety of vehicles and customers. Whether you drive a Truck, Jeep, or SUV, Paramount Automotive is here to enhance your vehicle with products that deliver quality, functionality, and profitability.

To deliver on that highest standard of quality and innovation, Paramount Automotive has enhanced our designs and manufacturing operations in metal and plastics to create superior off-road products. Our metalworking and thermoforming machinery are the finest in the industry, surpassing our competition by all standards of quality and innovation, as we continue to advance from strength to strength.

This positions Paramount Automotive as the pinnacle in off-road design and manufacturing both now and in the future.



JK/JL/JT	04-05	BUMPERS FRONT REAR // CANYON
JK/JL/JT	06-07	BUMPERS FRONT // GUARDIAN
JL/JT	08-09	BUMPERS FRONT // FULL-WIDTH
JK	10-11	BUMPERS FRONT // FULL-WIDTH
JK/JL	12-13	BUMPERS REAR // GEN3
JK/JL/JT	14-15	DOORS // HALF
JK/JL/JT	16-17	DOORS // TRAIL
JK/JL/JT	18-19	FENDER FLARES // HYDRO
JK/JL/JT	20-21	INNER FENDER LINERS // ALUMINUM
JK/JL	22-23	ROCK SLIDERS // CANYON
JK/JL/JT	24-25	ROCK SLIDERS // GEN2
JK/JL/XJ	26-27	ROOF RACKS // FLAT
JK/JL/XJ	28-29	ROOF RACKS // GEN2
JK/JL	30-31	CARGO BASKETS ON TAILGATE & SKID PLATES
JK/JL	32-33	INTERNAL STORAGE RACKS & TAILGATE TABLES
WJ	34-35	BUMPERS
XJ	36-37	BUMPERS
YJ/TJ	38-39	BUMPERS
TJ	40-41	FENDER FLARES // ARMOR
YJ/TJ	42-43	ROCK GUARDS
JEEP	44-45	ACCESSORIES
TACOMA	46-47	BUMPERS
TACOMA	48-49	BED RACKS // ADVENTURE
TACOMA	50-51	ROOF RACKS // ADVENTURE
TOYOTA	52-53	ROCK SLIDERS // CANYON
TRUCK	54-55	BUMPERS
TRUCK	56-57	GRILLES // IMPULSE
TRUCK	57-61	RACKS // CONTRACTOR
	62	POP BUMPER DISPLAY RACKS
	63	TERMS AND CONDITIONS



Paramount Automotive's Canyon Bumpers are designed to take on the toughest trails and beyond. The Canyon series bumpers are engineered for durability, great looks, and extreme clearance on the trail. The recessed winch mount with integrated fairlead plate provides a low center of gravity and accommodates up to a 12,000 lb. winch. Beefy recovery tabs are located above the bumper deck to maintain the highest possible trail clearance. The "stubby" width that allows the tires direct access to the terrain. And when contact with the rocks is inevitable, the Canyon series bumper bites back with beefy 4mm thick plate steel construction. Every Canyon Series product is finished in fine-textured black powder coat and backed by Paramount's Lifetime Structural Warranty.

FEATURES

- High clearance design tucks up tight to provide extreme approach angle and clearance on tight trails
- 4mm thick steel plate construction, CNC laser cut and precision brake-formed
- Multi-stage fine-textured black powder coat finish
- Faceted ends for high clearance at the corners of the Jeep
- Beefy recovery tabs are located on a recessed plane for added clearance
- Intergrated winch plate supports up to 12,000 lb winch
- NOTE: D-Rings are not included.

JK/JL/JT CANYON BUMPERS



JK/JL/JT CANYON BUMPERS



81-20303
JK/JL/JT CANYON FRONT BUMPER



TOP MOUNTED RECOVERY TABS



INTEGRATED WINCH PLATE



FRAME HORN COVERS



81-20401
JL CANYON REAR BUMPER



D-RING MOUNTS WELDED
INSIDE AND OUT



WORKS WITH OE PARKING
SENSOR

81-10400
JK CANYON REAR BUMPER



81-30401
JT CANYON REAR BUMPER



PART	YEAR	MAKE	MODEL	DESCRIPTION
81-20303	07-24	JEEP	WRANGLER JK/JL, GLADIATOR JT	CANYON FRONT BUMPER
81-10400	07-18	JEEP	WRANGLER JK	CANYON REAR BUMPER
81-20401	18-24	JEEP	WRANGLER JL	CANYON REAR BUMPER
81-30401	20-24	JEEP	GLADIATOR JT	CANYON REAR BUMPER



Paramount Automotive presents the new Guardian line of Jeep front bumpers. Featuring a multi-piece design manufactured from a stamped steel process that produces a lightweight product of strength and durability. Featuring interchangeable mid-width and full-width end caps to provide two unique profiles, the Guardian line of front bumpers accommodates larger tires while still providing clearance and protection. The Guardian line is built tough to last you through the road and offroad hazards ahead - no problem!

FEATURES

- Multi-piece design with detachable end caps
- Intergrated winch plate supports up to 12,000 pound winch
- D-Ring mounts with intergrated jack points. NOTE: D-Rings are not included.
- Textured black powder-coat finish for durability and corrosion protection
- Lifetime structural warranty against manufacturers defect
- 5 year finish warranty

81-20301

MID-WIDTH GUARDIAN FRONT BUMPER

PART	YEAR	MAKE	MODEL	DESCRIPTION
81-20301	07-24	JEEP	WRANGLER JK/JL, GLADIATOR JT	MID-WIDTH GUARDIAN FRONT BUMPER

JK/JL/JT GUARDIAN BUMPERS



INTEGRATED SKID PLATE



INTEGRATED WINCH PLATE



REMOVABLE OVERRIDE FOR LOW PROFILE DESIGN



Paramount Automotive's Rear Bumpers for the JK Wrangler incorporate heavy construction and increased clearance with integrated 2" class III receiver hitch. The spare tire carrier can accommodate up to a 37" tire and mounts to the factory tailgate.

FEATURES

- Improves tire clearance while providing superior protection
- 2" Class 3 rated receiver hitch with safety chain loop
- Third light bracket is included
- CNC laser cut and welded for precision and durability
- Manufactured from durable 4mm steel plate
- Textured black powder-coat finish for durability and corrosion resistance
- Easy bolt-on installation
- Lifetime structural warranty against manufacturers defects
- 5 year finish warranty
- NOTE: D-Rings are not included.

JK HEAVY-DUTY REAR BUMPERS



51-0395

BODY WIDTH REAR BUMPER



D-RING MOUNTS WELDED INSIDE AND OUT



TWO WAY ADJUSTABLE TIRE MOUNT



CLASS III RATED 2" RECEIVER HITCH

PART	YEAR	MAKE	MODEL	DESCRIPTION
51-0395	07-18	JEEP	WRANGLER JK	BODY WIDTH REAR BUMPER WITH TAILGATE TIRE CARRIER



Paramount Automotive's JL Wrangler / JT Gladiator Full Width Front Bumpers are the versatile front protection for your Jeep that you need for your next offroad adventure. Heavy duty steel construction and multiple features give you the confidence to tackle any trail.

FB

JL/JT FULL-WIDTH BUMPERS

JL/JT FULL-WIDTH BUMPERS

FEATURES

- Improves tire clearance while providing superior protection
- Built-in winch plate accommodates up to 12,000 pound winch
- CNC laser cut and welded for precision and durability
- Manufactured from 4mm steel plate with a 2-3/8" overrider
- Textured black powder-coat finish for durability and corrosion resistance
- Lifetime structural warranty against manufacturers defects
- 5 year finish warranty
- NOTE: D-Rings are not included.

**51-8061
FULL WIDTH FRONT BUMPER**

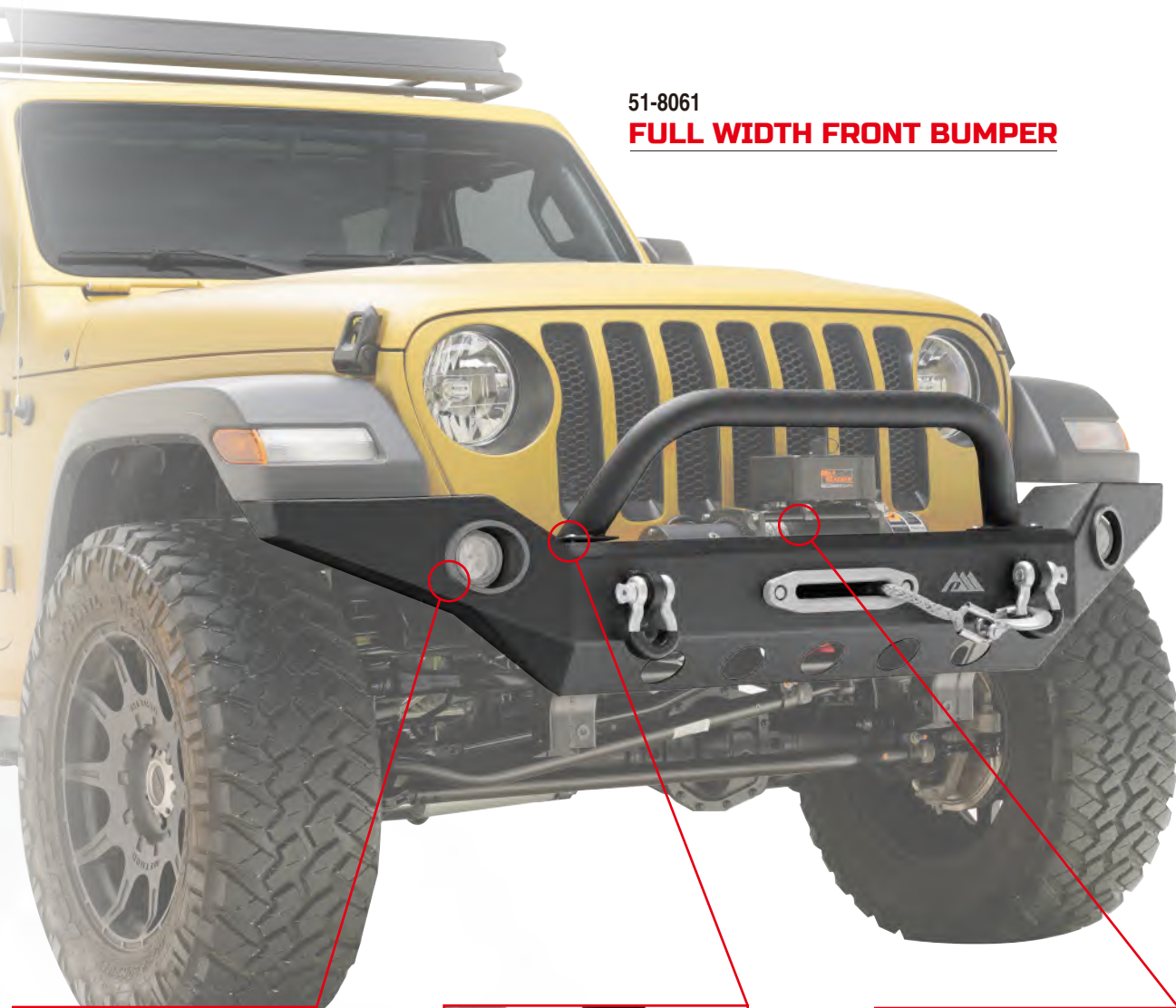

**OE FOG LIGHT PROVISION
PATENTED LIGHT FRAME**



REMOVABLE OVERRIDER



BUILT-IN WINCH PLATE

**51-8062
FULL WIDTH FRONT BUMPER**



**D-RING MOUNTS WELDED
INSIDE AND OUT**



BUILT-IN LIGHT TABS



**FOUR 12W CUBE LED LIGHTS
(1400 LUMENS EACH)**



**120W LED LIGHT BAR
(5400 LUMENS)**



**WIRING HARNESS AND
SWITCH**

PART	YEAR	MAKE	MODEL	DESCRIPTION
51-8061	18-24	JEEP	WRANGLER JL, GLADIATOR JT	FULL WIDTH FRONT BUMPER WITH OE FOG LIGHT PROVISION
51-8062	18-24	JEEP	WRANGLER JL, GLADIATOR JT	FULL WIDTH FRONT BUMPER WITH LED LIGHTS

Paramount Automotive's Full Width JK Front Bumpers are the versatile front protection for your Jeep that you need for your next off road adventure. Heavy duty steel construction and multiple features give you the confidence to tackle any trail.

JK FULL-WIDTH BUMPERS

JK FULL-WIDTH BUMPERS

FEATURES

- Improves tire clearance while providing superior protection
- Built-In winch plate accommodates up to 12,000 pound winch
- Manufactured from 4mm steel plate with a 2"x .120 overrider
- CNC laser cut and welded for precision and durability
- Textured black powder-coat finish for durability and corrosion resistance
- Easy bolt-on installation
- Lifetime structural warranty against manufacturers defects
- 5 year finish warranty
- NOTE: D-Rings are not included.



51-0362
FULL WIDTH FRONT BUMPER



OE FOG LIGHT PROVISION



REMOVABLE OVERRIDER



BUILT-IN WINCH PLATE

51-7016
FULL WIDTH FRONT BUMPER

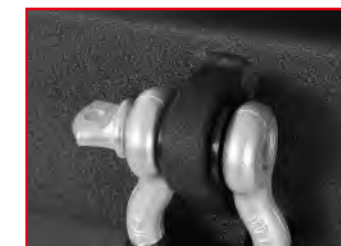

D-RING MOUNTS WELDED
INSIDE AND OUT



BUILT-IN LIGHT TABS



FOUR 12W CUBE LED LIGHTS
(1400 LUMENS EACH)



120W LED LIGHT BAR
(5400 LUMENS)

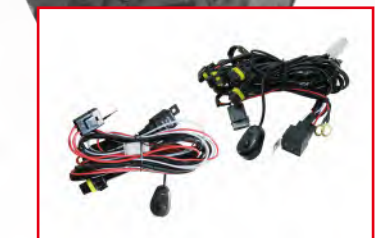

WIRING HARNESS AND
SWITCH

PART	YEAR	MAKE	MODEL	DESCRIPTION
51-0362	07-18	JEEP	WRANGLER JK	FULL WIDTH FRONT BUMPER WITH OE FOG LIGHT PROVISION
51-7016	07-18	JEEP	WRANGLER JK	FULL WIDTH FRONT BUMPER WITH LED LIGHTS



Paramount Automotive's Gen3 bumper for Jeep Wrangler was designed from the ground up to meet the performance needs of everyone from casual to extreme off-roaders. The body-width bumper tucks tightly to the Jeep's corners and has a multi-faceted design to give the best departure angle possible. The high clearance recovery shackle tabs are welded inside and out for strength and the class III hitch receiver is tucked up high and tight. This bumper-mounted carrier removes weight from the Jeep's body while maintaining convenient one-handed operation as it opens and closes in tandem with the tailgate. Mount up to a 40" tire in either vertical or high clearance 45-degree configuration. Rotopax fluid cans may be mounted either high or low according to each Jeeper's needs. Provisions are also included for mounting a high-lift jack, CB antenna, and relocating the license plate, brake light and backup camera to the center of the spare tire.

FEATURES

- Body width, multi-faceted design for high clearance and maximum departure angle in a full-featured bumper
- Integrated high clearance class III tow hitch receiver and mounting provisions for backup sensors
- 1" thick extreme duty recovery shackle tabs are angled for high clearance and welded inside & out
- Heavy duty bumper-mounted tire & accessory carrier removes weight and stress from the Jeep's tailgate & body
- Single-Action operation conveniently opens and closes in tandem with the Jeep's tailgate
- Accommodates up to 40" tire; may be configured in vertical or 45-degree orientation (with fastback top or topless only)
- Configurable mounting positions for Rotopax fuel/fluid jugs; fixed mounts for radio antenna and high-lift Jack
- License plate, backup camera and brake light relocation brackets included
- NOTE: D-Rings are not included



JK/JL GEN 3 REAR BUMPERS

RB

JK/JL GEN 3 REAR BUMPERS

81-20114
JL GEN3 REAR BUMPER WITH TIRE CARRIER



UPPER AND LOWER ROTOPAX MOUNTING LOCATIONS

VERTICAL OR SLANT TIRE MOUNTING

TRAIL JACK AND ANTENNA MOUNTING PROVISIONS

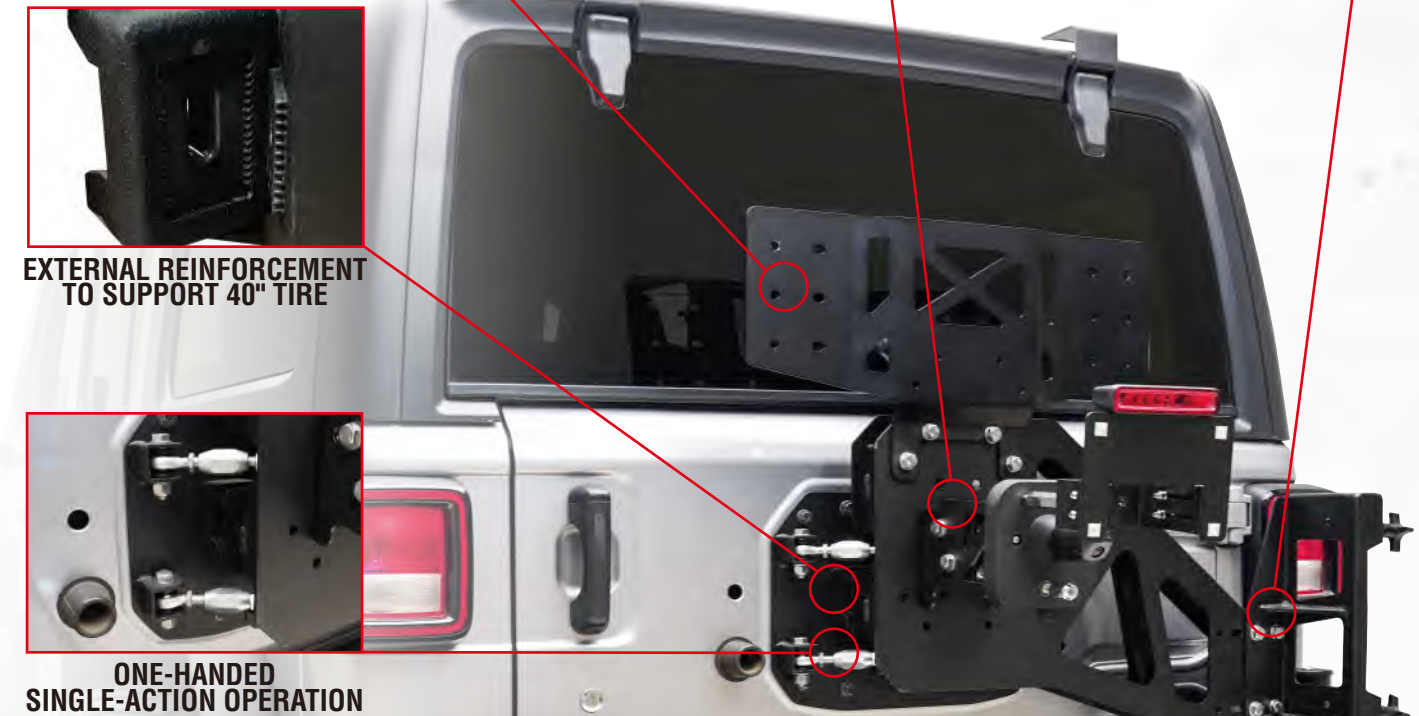

EXTERNAL REINFORCEMENT TO SUPPORT 40" TIRE

ONE-HANDED SINGLE-ACTION OPERATION

PART#	YEAR	MAKE	MODEL	DESCRIPTION
81-10114	07-18	JEEP	WRANGLER JK	GEN 3 REAR BUMPER WITH TIRE CARRIER
81-20114	18-24	JEEP	WRANGLER JL	GEN 3 REAR BUMPER WITH TIRE CARRIER



JK/JL/JT HALF DOORS

JK/JL/JT HALF DOORS

Nothing beats taking the top and doors off your Jeep Wrangler or Gladiator. But going topless and doorless can leave you feeling a bit exposed. While open-air wheeling is amazing, getting smacked by a branch or covered in mud quickly gets old. **Paramount Automotive's** Half Doors give the best of both worlds by offering both protection and tons of airflow. And they do all of this while looking awesome too. A key feature of their design are the aluminum mesh screens. Not only do the mesh screens increase visibility and airflow, but they are also removable and easy to paint or powder coat. The rest of the Half Doors feature stout 3mm-thick steel plate construction that is CNC laser-cut and precision brake-formed. Rattling doors can easily lead to insanity, so ours include bump stops to eliminate any unwanted vibrations. The Paramount Half Doors even come complete with rearview mirrors keeping you legal and making the swap to them simple. Paramount Automotive's Half Doors feature a lifetime structural warranty and a five-year finish warranty.

FEATURES

- Combines open-air wheeling with protection
- Increases visibility on the trail over full doors
- Includes rearview mirrors to keep your Jeep legal and simplify swapping doors
- Bump stops keep the doors rattle-free while limit straps prevent them from over opening
- Constructed from brake-formed and CNC laser-cut 3mm thick steel
- A multi-stage, fine-textured powder coat provides protection and great looks

81-20908+81-20910
JL/JT FRONT & REAR HALF DOORS



SIDE VIEW MIRRORS INCLUDED

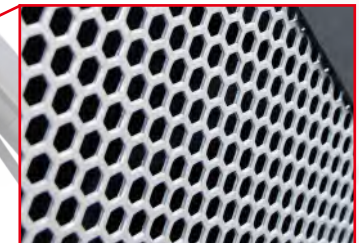

ALUMINUM MESH



REINFORCED DOOR HINGE MOUNTING



OE QUALITY LIMIT STRAP



81-10908
JK FRONT HALF DOORS



81-10910
JK REAR HALF DOORS

PART	YEAR	MAKE	MODEL	DESCRIPTION
81-10908	07-18	JEEP	WRANGLER JK	FRONT HALF DOORS
81-10910	07-18	JEEP	WRANGLER JK	REAR HALF DOORS
81-20908	18-24	JEEP	WRANGLER JL, GLADIATOR JT	FRONT HALF DOORS
81-20910	18-24	JEEP	WRANGLER JL, GLADIATOR JT	REAR HALF DOORS



Paramount Automotive's 3mm steel Trail Doors deliver increased observability and protection on the trail. Removable center bars open the landscape, while Paramount's secure lock handles keep everything secure on the road or offroad. Built tough and to last, our trail doors are the custom enhancement you've always wanted for your Jeep.

TD

JK/JL/JT TRAIL DOORS

JK/JL/JT TRAIL DOORS

FEATURES

- Easy grip door handles
- Mounts to factory hinges
- Side view mirrors included
- Manufactured from 3mm steel plate
- Lifetime structural warranty against manufacturers defects
- 5 year warranty on finish

81-20900+81-20902
JL/JT FRONT & REAR TRAIL DOORS



SIDE VIEW MIRRORS INCLUDED



BLACK TEXTURED FINISH



REINFORCED DOOR HINGE MOUNTING



OE QUALITY LIMIT STRAP

81-10900
JK FRONT TRAIL DOORS

81-10902
JK REAR TRAIL DOORS

PART	YEAR	MAKE	MODEL	DESCRIPTION
81-10900	07-18	JEEP	WRANGLER JK	TRAIL FRONT DOORS
81-10902	07-18	JEEP	WRANGLER JK	TRAIL REAR DOORS
81-20900	18-24	JEEP	WRANGLER JL, GLADIATOR JT	TRAIL FRONT DOORS
81-20902	18-24	JEEP	WRANGLER JL, GLADIATOR JT	TRAIL REAR DOORS



Paramount Automotive outfits your 2007+ Jeep Wrangler for serious off-road duty with great looking, rugged Hydro Series fender flares. The first of their kind on the market, these flares are precision die-formed from a single piece of thick 14-gauge cold rolled steel under extreme hydraulic pressure. This process yields the brutal strength of a fabricated steel flare combined with the refined look of a factory component. Hydro Series flares provide increased tire clearance compared to the stock flares and are engineered to withstand the punishment of hard trail use. Installation is easy with the included stainless steel hardware and simple hand tools. Hydro Series flares are finished in durable fine-textured black powder coat and backed by Paramount's Lifetime Structural Warranty.

FEATURES

- Thick 14-gauge steel one-piece construction for extreme strength
- High pressure die-formed for a precision fit and unmatched "factory" styling
- Integrated DOT approved plug-and-play LED turn signal DRL and side marker lamps
- Easy installation with hand tools and included stainless steel hardware
- Textured black powder-coat finish for protection and durability
- Multi-stage fine-texture black powder coat finish for long lasting great looks and corrosion resistance

JK/JL/JT HYDRO FENDER FLARES

HF

81-21106
JL HYDRO REAR FENDER FLARES



2MM STEEL PLATE

WITH RUBBER GASKETS TO PROTECT CAR PAINT

9"

81-21104
JL/JT HYDRO FRONT FENDER FLARES
PATENT PENDING



DRL SIDE MARKERS



DOT APPROVED LED TURN SIGNAL AND DRL



PLUG-AND-PLAY WITH FACTORY HARNESS

JK/JL/JT HYDRO FENDER FLARES

PART	YEAR	MAKE	MODEL	DESCRIPTION	PATENT
81-21104	18-24	JEEP	WRANGLER JL, GLADIATOR JT	HYDRO FRONT FENDER FLARES	PENDING
81-21106	18-24	JEEP	WRANGLER JL	HYDRO REAR FENDER FLARES	



Paramount Automotive's Gen2 Inner Liners will seriously upgrade the appearance of your Jeep Wrangler and Gladiator. Precision-cut and brake-formed lightweight aluminum plate combines with aluminum mesh to add some much-needed style to your otherwise boring inner fenders. A multi-stage, fine-textured black powder coat adds to the striking good looks of the Gen2 Inner Liners. Not only do the Gen2 Inner Liners look amazing, but they are also functional. The fine mesh helps improve airflow to the engine bay keeping temperatures in check whether you are crawling over rocks or cruising through the desert. While more air flows into your engine bay, the mesh still keeps out rocks, mud, and other debris. The Paramount Gen2 Inner Liners work with the factory fenders as well as most aftermarket ones. A five-year finish and lifetime structural warranty back the liners making them a great addition to your Jeep.

FEATURES

- Adds serious style to the inner fenders of your Jeep
- Crafted from precision-cut, brake-formed aluminum plate with aluminum mesh
- Fits stock and most aftermarket fenders and includes all installation hardware
- Improves airflow to the engine bay at any speed for better cooling
- A multi-stage, fine-textured powder coat offers corrosion resistance and good looks
- Available for both the front and rear fenders and sold as a pair

81-21200

JL FRONT ALUMINUM INNER FENDER LINERS

JK/JL/JT ALUMINUM INNER FENDER LINERS

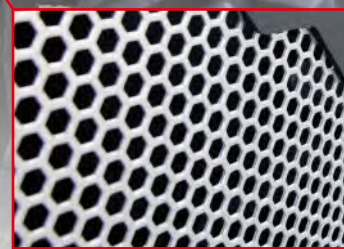
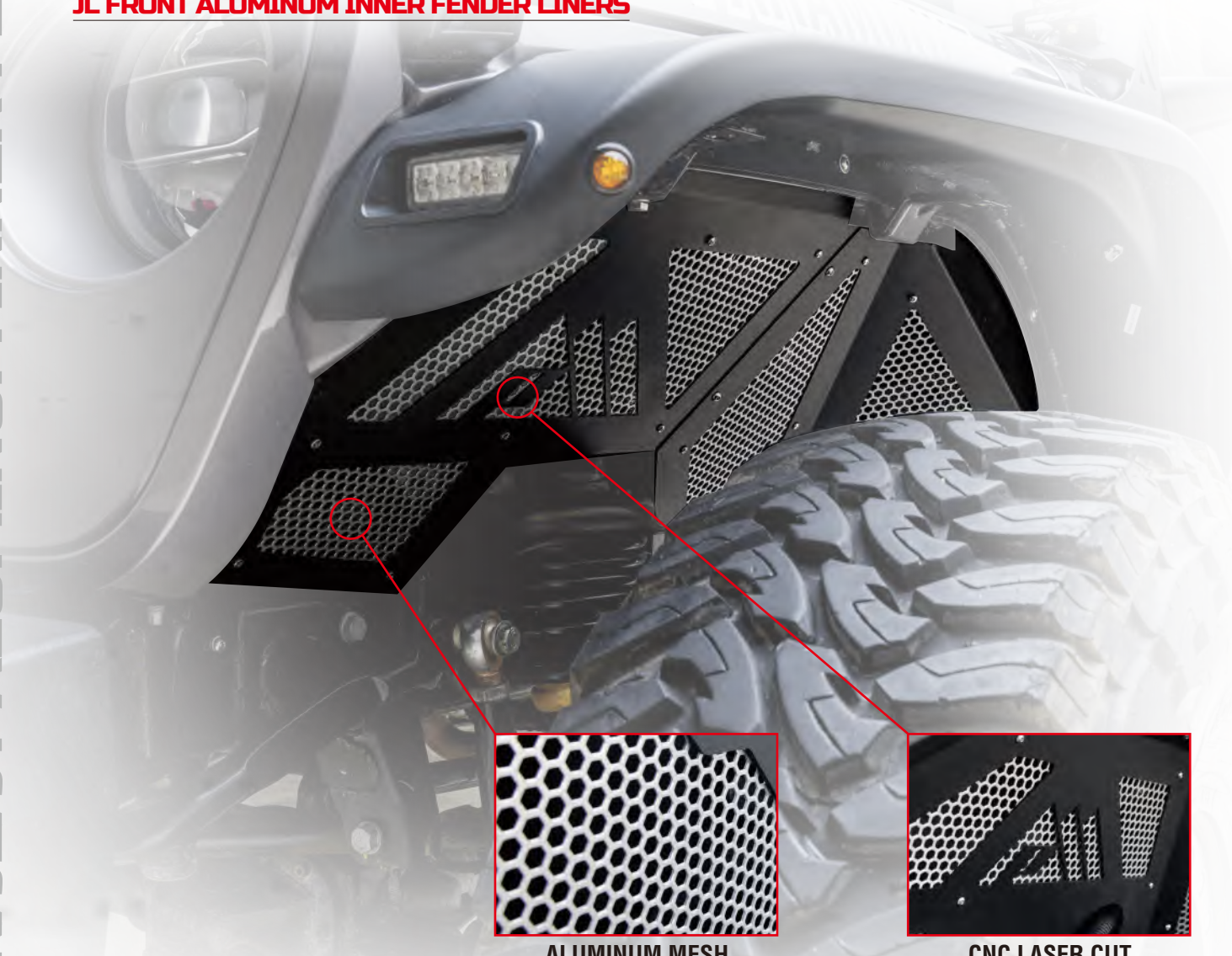

ALUMINUM MESH



CNC LASER CUT



JK/JL/JT ALUMINUM INNER FENDER LINERS



81-21201

JL REAR ALUMINUM INNER FENDER LINERS

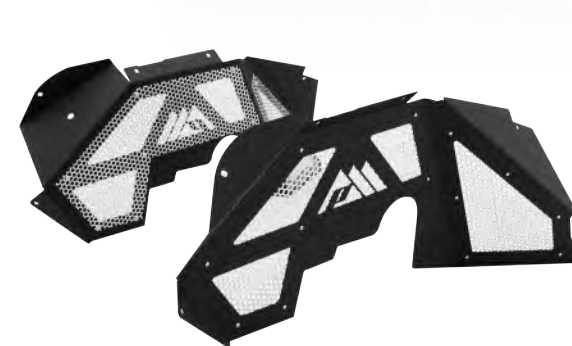

81-11202

JK FRONT ALUMINUM INNER FENDER LINERS



81-11203

JK REAR ALUMINUM INNER FENDER LINERS

PART	YEAR	MAKE	MODEL	DESCRIPTION
81-11202	07-18	JEEP	WRANGLER JK	GEN2 FRONT ALUMINUM INNER FENDER LINERS
81-11203	07-18	JEEP	WRANGLER JK	GEN2 REAR ALUMINUM INNER FENDER LINERS
81-21200	18-24	JEEP	WRANGLER JL, GLADIATOR JT	GEN2 FRONT ALUMINUM INNER FENDER LINERS
81-21201	18-24	JEEP	WRANGLER JL	GEN2 REAR ALUMINUM INNER FENDER LINERS



Designed to take on the toughest trails and beyond, **Paramount Automotive's** Canyon Series Rock Sliders are designed with durability, protection, and clearance for fitting through, over and around the tightest obstacles. Canyon Rock Sliders mount directly to the Jeep at the body mounts rather than placing impact stresses on to the Jeep body itself. The sliders tuck up tight to maintain breakover angle and still provide a beefy rub rail for when the canyon gets tight. And when the trail gets tight, Canyon Series Rock Sliders bite back with beefy 4mm thick plate steel construction, precision brake-formed and professionally welded. Every Canyon Series product is finished in fine-textured black powder coat and backed by Paramount's Lifetime Structural Warranty.

FEATURES

- Sliders mount directly to the Jeep at the body mounts rather than the body itself
- High clearance design tucks up tight to provide great breakover angle on tight trails
- Rock Sliders protrude outward to keep the Jeep's rockers and doors safely away from the rocks
- Integrated entry step features non-slip pads for safe entry and exit in wet and muddy conditions
- 4mm thick steel plate construction, CNC laser cut and precision brake-formed
- Multi-stage fine-texture black powder coat finish for long lasting great looks and corrosion resistance
- Backed by Paramount's lifetime structural warranty and 5-year finish warranty

JK/JL CANYON ROCK SLIDERS

RS

JK/JL CANYON ROCK SLIDERS

81-20602
JL (4 DOOR) CANYON SLIDERS

81-10602
JK (4 DOOR) CANYON ROCK SLIDERS

81-10603
JK (2 DOOR) CANYON ROCK SLIDERS

81-20602
JL (4 DOOR) CANYON ROCK SLIDERS

81-20603
JL (2 DOOR) CANYON ROCK SLIDERS



4MM THICK STEEL PLATE CONSTRUCTION



NON-SLIP STEP PAD



HEAVY DUTY BODY MOUNT BRACKET

4.7"

PART	YEAR	MAKE	MODEL	DESCRIPTION
81-10602	07-18	JEEP	WRANGLER JK	CANYON ROCK SLIDERS (4 DOOR)
81-10603	07-18	JEEP	WRANGLER JK	CANYON ROCK SLIDERS (2 DOOR)
81-20602	18-24	JEEP	WRANGLER JL	CANYON ROCK SLIDERS (4 DOOR)
81-20603	18-24	JEEP	WRANGLER JL	CANYON ROCK SLIDERS (2 DOOR)



Paramount Automotive's Tri-Tube Rock Sliders enhance both your side and undercarriage protection, and your Jeep's offroad look. Featuring a removable steel plate that is ready for personal customization, our Paramount Tri-Tube rock sliders will give you the peace of mind knowing they are built tough, fit your style, and are made to last against any offroad threat.

JK/JL/JT GEN2 ROCK SLIDERS

JK/JL/JT GEN2 ROCK SLIDERS

FEATURES

- Removable steel plate, for personal customization
- Provides side and undercarriage protection
- One piece tubular design
- Manufactured from 42mm diameter steel tube
- Easy bolt-on installation
- Textured black powder-coat finish for durability and corrosion protection
- Lifetime structural warranty against manufacturers defects
- 5 year finish warranty

81-20600
JL (4 DOOR) TRI-TUBE ROCK SLIDERS



HD FRAME MOUNT BRACKET



REMOVABLE ACCENT PLATES



42MM STEEL TUBING



WIDE NON-SLIP STEP PAD

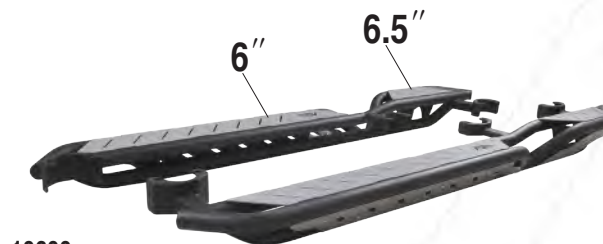

81-10600
JK (4 DOOR) TRI-TUBE ROCK SLIDERS



81-30600
JT (4 DOOR) TRI-TUBE ROCK SLIDERS



81-10601
JK (2 DOOR) TRI-TUBE ROCK SLIDERS



81-20601
JL (2 DOOR) TRI-TUBE ROCK SLIDERS

PART	YEAR	MAKE	MODEL	DESCRIPTION
81-10600	07-18	JEEP	WRANGLER JK	TRI-TUBE ROCK SLIDERS (4 DOOR)
81-20600	18-24	JEEP	WRANGLER JL	TRI-TUBE ROCK SLIDERS (4 DOOR)
81-10601	07-18	JEEP	WRANGLER JK	TRI-TUBE ROCK SLIDERS (2 DOOR)
81-20601	18-24	JEEP	WRANGLER JL	TRI-TUBE ROCK SLIDERS (2 DOOR)
81-30600	20-24	JEEP	GLADIATOR JT	TRI-TUBE ROCK SLIDERS (4 DOOR)



Space is always at a premium when loading up your Jeep for its next off-road adventure. **Paramount Automotive's** Flat Roof Rack creates the perfect place to stow and secure additional gear. Made with heavy-duty 20-gauge steel crossbars, the Flat Roof Rack is plenty stout and capable of holding up to 150 lbs. of whatever you want to throw on it. The flat design allows oversized items like tents to fit flush to the rack for better aerodynamics, increased fuel economy, and clearance for low-hanging trail obstacles or garage doors. Installation is an easy bolt-on process with no drilling and corrosion-resistant stainless-steel hardware. The Flat Roof Rack bolts together for easy shipping and storage when not in use. Like all of Paramount's products, the rack features a five-year finish and a lifetime structural warranty.

RR

JK/JL/XJ FLAT ROOF RACKS

JK/JL/XJ FLAT ROOF RACKS

FEATURES

- Creates a secure and robust spot to haul more gear and cargo
- The flat design can handle larger items like rooftop tents and solar panels
- Maximizes clearance for low-hanging trail obstacles or garage doors
- Heavy-duty 20-gauge steel crossbars and fully welded joints yield an impressive 150-lb. load rating
- A fine-textured, multi-stage powder coat fights corrosion and looks great
- Bolts together for less shipping costs and easy storage options

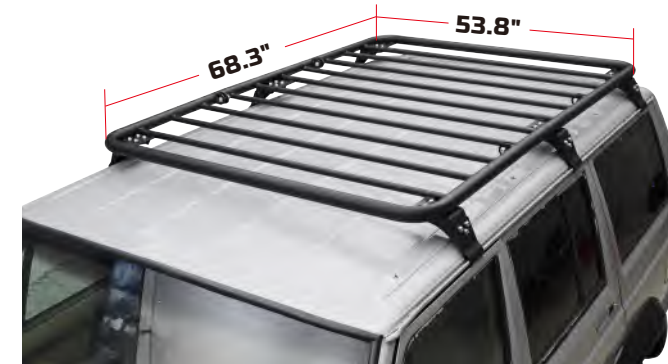

81-40802
XJ FLAT ROOF RACK



81-10802
JK FLAT ROOF RACK

81-20802
JL FLAT ROOF RACK



FULLY WELDED JOINTS



HEAVY DUTY 2" 0.120 WALL TUBING



EASY BOLT-ON INSTALLATION

PART	YEAR	MAKE	MODEL	SIZE	DESCRIPTION
81-10802	07-18	JEEP	WRANGLER JK	65"x59"x7.2"	FLAT ROOF RACK (2 DOOR / 4 DOOR)
81-20802	18-24	JEEP	WRANGLER JL	64.3"x59.5"x7"	FLAT ROOF RACK (2 DOOR / 4 DOOR)
81-40802	84-01	JEEP	CHEROKEE XJ	68.3"x53.8"x6.7"	FLAT ROOF RACK (2 DOOR / 4 DOOR)



Carry more gear for those extended overland adventures, the **Paramount Automotive's** Gen 2 Roof Racks are rated to safely carry up to 150 lbs of gear. The canted front wind deflector reduces wind noise and damage to your cargo. The modular design incorporates fully welded, all steel perimeter sections with raised upper bar for containing and securely tying down loads. The floor of the rack is made of heavy gauge rectangular tubing to provide a flat, secure load surface. Easy, no-drill installation using the included stainless steel hardware. Even empty, the rack will look great on your rig with a multi-stage fine texture black powder coat finish. Backed by Paramount's lifetime structural warranty and 5-year finish warranty.

RR

JK/JL/XJ GEN2 ROOF RACKS

JK/JL/XJ GEN2 ROOF RACKS

FEATURES

- Aerodynamic modular design with canted front wind deflector
- 150 lb. load capacity with heavy gauge rectangular cross bars for a flat, more secure load surface
- Available for both 2-door and 4-door Jeep models
- Fully welded, all-steel perimeter construction with 1" OD top bar and 1.30" OD bottom bar
- Easy assembly with stainless steel hardware. Mounts to the factory hard top without drilling
- Multi-stage fine-texture black powder coat finish for long lasting great looks and corrosion resistance



81-10800
JK FULL LENGTH ROOF RACK



WIND DEFLECTOR



HEAVY-DUTY DESIGN



RUBBER SUPPORT SPACER



EASY BOLT ON INSTALLTION

PART	YEAR	MAKE	MODEL	SIZE	DESCRIPTION
81-10800	07-18	JEEP	WRANGLER JK	91"x54"x4.5"	GEN 2 FULL-LENGTH ROOF RACK (4 DOOR)
81-40800	84-01	JEEP	CHEROKEE XJ	74.5"x49"x4.5"	GEN 2 FULL-LENGTH ROOF RACK
81-20800	18-24	JEEP	WRANGLER JL	91"x54"x4.5"	GEN 2 FULL-LENGTH ROOF RACK (4 DOOR)

81-20800
JL FULL LENGTH ROOF RACK

Note: The 2 door roof racks can be used on a 4 door jeep if you want to use your Freedom tops.



While the smaller dimensions of the Wrangler help add to its off-road capability, they don't exactly produce a cavernous interior. Load up your Jeep Wrangler with gear and you will quickly run out of space. **Paramount Automotive's** Tailgate Cargo Carrier solves this by adding some much-needed cargo capacity to your Jeep Wrangler. The carrier easily bolts into place onto the tailgate without any drilling necessary creating a 39x18x7-inch platform. Rugged construction and 1-inch steel tubing give the Tailgate Cargo Carrier a 35-lb. load rating, making it a perfect spot for coolers, recovery gear, or anything else that won't fit in your Jeep. It is height adjustable allowing the carrier to clear different size spare tires and is a great place to mount a jack or shovel. Comes with a lifetime structural warranty and a five-year finish warranty.

FEATURES

- 100% bolt-on installation with no drilling required
- An easy way to add additional cargo-carrying capacity to your Jeep
- Made from 1-inch tubing for maximum strength with a 35-lb. load rating
- Height adjustable to accommodate various size spare tires and allow proper positioning
- Allows for mounting of accessories like shovels and jacks
- A fine-textured, multi-stage powder coat protects it and gives great looks

JK/JL CARGO BASKETS



ACCEPTS SHOVEL AND JACK MOUNT



UTILIZES THE SPACE ABOVE THE SPARE TIRE



USES OE MOUNTING LOCATION NO DRILLING

81-20111
JL CARGO BASKETS

PART	YEAR	MAKE	MODEL	DESCRIPTION
81-10111	07-18	JEEP	WRANGLER JK	CARGO BASKET ON OE TAILGATE
81-20111	18-24	JEEP	WRANGLER JL	CARGO BASKET ON OE TAILGATE



JL SKID PLATES

Tackle the most extreme terrain with the confidence of knowing your Jeep's vulnerable undercarriage components are protected by beefy 5mm thick plate steel armor. These skid system protects the Jeep's engine oil pan, transfer case fuel tank, and muffler. The components have been 3D CAD designed to tuck up as high as possible for almost no loss of ground clearance. Bolt heads are recessed both to protect the hardware and to reduce snags when sliding over rocks. The plates are finished in fine-texture black powder coat and backed by Paramount's lifetime structural and 5-year finish warranty.

FEATURES

- Undercarriage armor protects the Jeep's vulnerable engine and transmission oil pans when traversing extreme terrain
- High clearance design tucks the skid plates up close to the Jeep's undercarriage for almost no loss of ground clearance
- Recessed bolt heads facilitate sliding over obstacles while protecting hardware from rock damage
- Beefy 5mm thick steel plate construction, CNC laser cut and precision brake-formed
- Multi-stage fine-texture black powder coat finish for long lasting great looks and corrosion resistance
- Backed by Paramount's lifetime structural warranty and 5-year finish warranty

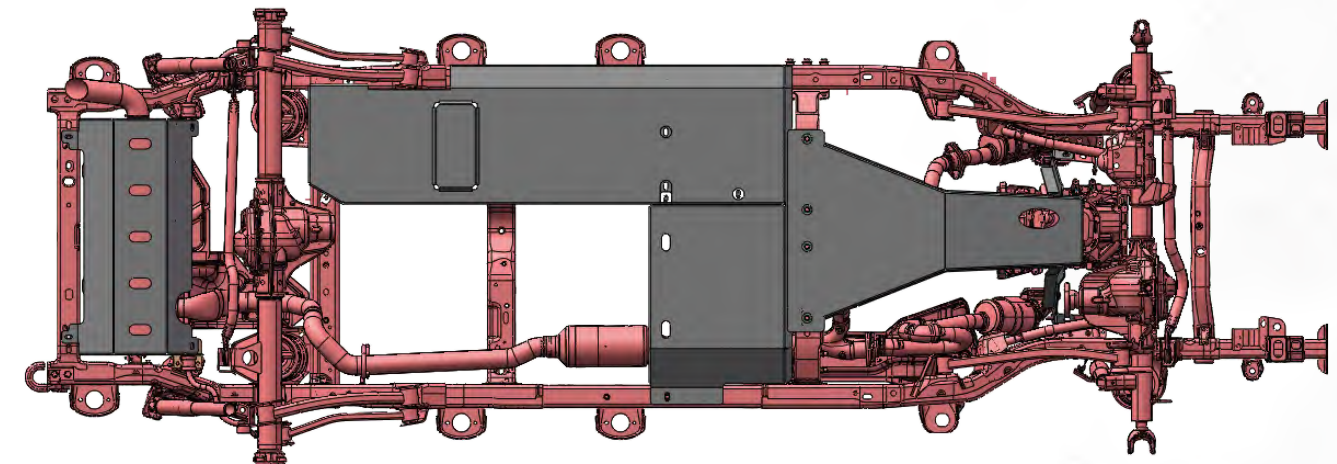

81-25701A
ENGINE SKID PLATE



81-25701B
TRANSFER & GAS TANK SKID PLATE



81-25701C
MUFFLER SKID PLATE

PART	YEAR	MAKE	MODEL	DESCRIPTION
81-25701A	18-24	JEEP	3.6L WRANGLER JL	ENGINE SKID PLATE
81-25701B	18-24	JEEP	3.6L WRANGLER JL	TRANSFER & GAS TAN SKID PLATE
81-25701C	18-24	JEEP	WRANGLER JL	MUFFLER SKID PLATE



While the small size of the Jeep Wrangler makes it perfect for trail use, maximizing its interior space can be a challenge. **Paramount's** new Tailgate Table and Rear Cargo Rack allow you to carry more gear and add versatility to your Jeep. The Rear Cargo Rack mounts in the empty space above the rear cargo area, creating a versatile spot to stow extra gear. A multitude of holes and slots make securing items to the rack a simple process. The Tailgate Table integrates into your Jeep's tailgate creating a perfect spot for trail repairs, cooking, beverages, or other table-related activities. Both the rack and the table use 2mm-thick, precision CNC-machined, and brake-formed steel. And, both feature a fine-textured powder coat for good looks and protection against corrosion. Making adding extra versatility and storage to your Jeep easy.

FEATURES

- The Trail Table is perfect for trail repairs, meal prep, or beverage placement
- The Rear Cargo Rack allows you to take more gear on your next off-road excursion or camping trip
- Installation is easy, drilling required
- Made from 2mm-thick, CNC precision-cut steel for strength without excessive weight
- A fine-textured, multi-stage powder coat prevents corrosion and is good looking
- Both are backed by a five-year finish and lifetime structural warranty

**81-20105
JL TAILGATE TABLE**



BOTTLE OPENER



ANTI-RATTLE PROVISION



STAINLESS STEEL LATCH

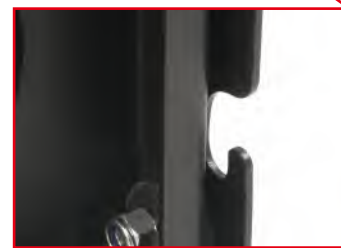

BAG HOOK

**81-20103
JL INTERNAL STORAGE RACK**



USES OF MOUNTING LOCATIONS



CONVENIENT TIE DOWN PROVISIONS



41.3"x23.4" INCH BASKET



**81-10105
JK TAILGATE TABLE**



**81-10103
JK INTERNAL STORAGE RACK**

PART	YEAR	MAKE	MODEL	DESCRIPTION
81-10103	07-18	JEEP	WRANGLER JK	4 DOOR INTERNAL STORAGE RACK
81-20103	18-24	JEEP	WRANGLER JL	4 DOOR INTERNAL STORAGE RACK
81-10105	07-18	JEEP	WRANGLER JK	TAILGATE TABLE
81-20105	18-24	JEEP	WRANGLER JL	TAILGATE TABLE
81-50100	87-06	JEEP	WRANGLER YJ/TJ	TAILGATE TABLE



Paramount Automotive's Bumpers for the Grand Cherokee WJ are the muscular front and rear protection designed for the Jeep Wrangler that tackles rugged terrain. Clean, body wrapping design in various widths and options keep your Jeep safe from hazards in even the tightest off-road conditions.

WJ

WJ BUMPERS

WJ BUMPERS

FEATURES

- Improves tire clearance while providing superior protection
- 2" Class 3 rated receiver hitch with safety chain loop
- Built-In winch plate accommodates up to 12,000 pound winch
- Manufactured from durable 4mm steel plate
- CNC laser cut and welded for precision and durability
- Textured black powder-coat finish for durability and corrosion resistance
- Easy bolt-on installation
- Lifetime structural warranty against manufacturers defects
- 5 year finish warranty
- D-Rings are not included.

51-0805
FULL WIDTH 3PC REAR BUMPER



D-RING MOUNTS WELDED INSIDE AND OUT



CLASS III RATED 2" RECEIVER HITCH

51-0804
FULL WIDTH 3PC FRONT BUMPER WITH LED LIGHTS



BUILT-IN WINCH PLATE



TWO 12W CUBE LED LIGHTS (1400 LUMENS)



WIRING HARNESS AND SWITCH

PART	YEAR	MAKE	MODEL	DESCRIPTION
51-0804	99-04	JEEP	GRAND CHEROKEE WJ	FULL WIDTH 3PC FRONT BUMPER WITH LED LIGHTS
51-0805	99-04	JEEP	GRAND CHEROKEE WJ	FULL WIDTH 3PC REAR BUMPER



Paramount Automotive's Bumpers for the Cherokee XJ offer muscular designs that tackle rugged terrain. Form and function prevail with clean and simple designs that keep your Jeep safe from hazards in even the tightest off-road conditions.

XJ

XJ BUMPERS

XJ BUMPERS

FEATURES

- Improves tire clearance while providing superior protection
- 2" Class 3 rated receiver hitch with safety chain loop
- Built-in winch plate accommodates up to 12,000 pound winch
- Manufactured from durable 4mm steel plate
- CNC laser cut and welded for precision and durability
- Textured black powder-coat finish for durability and corrosion resistance
- Lifetime structural warranty against manufacturers defects
- 5 year finish warranty
- D-Rings are not included.

51-0911

BODY WIDTH REAR BUMPER WITH SUREGRIP TIRE CARRIER

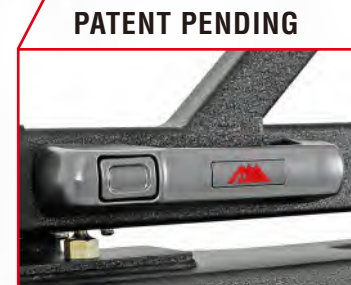
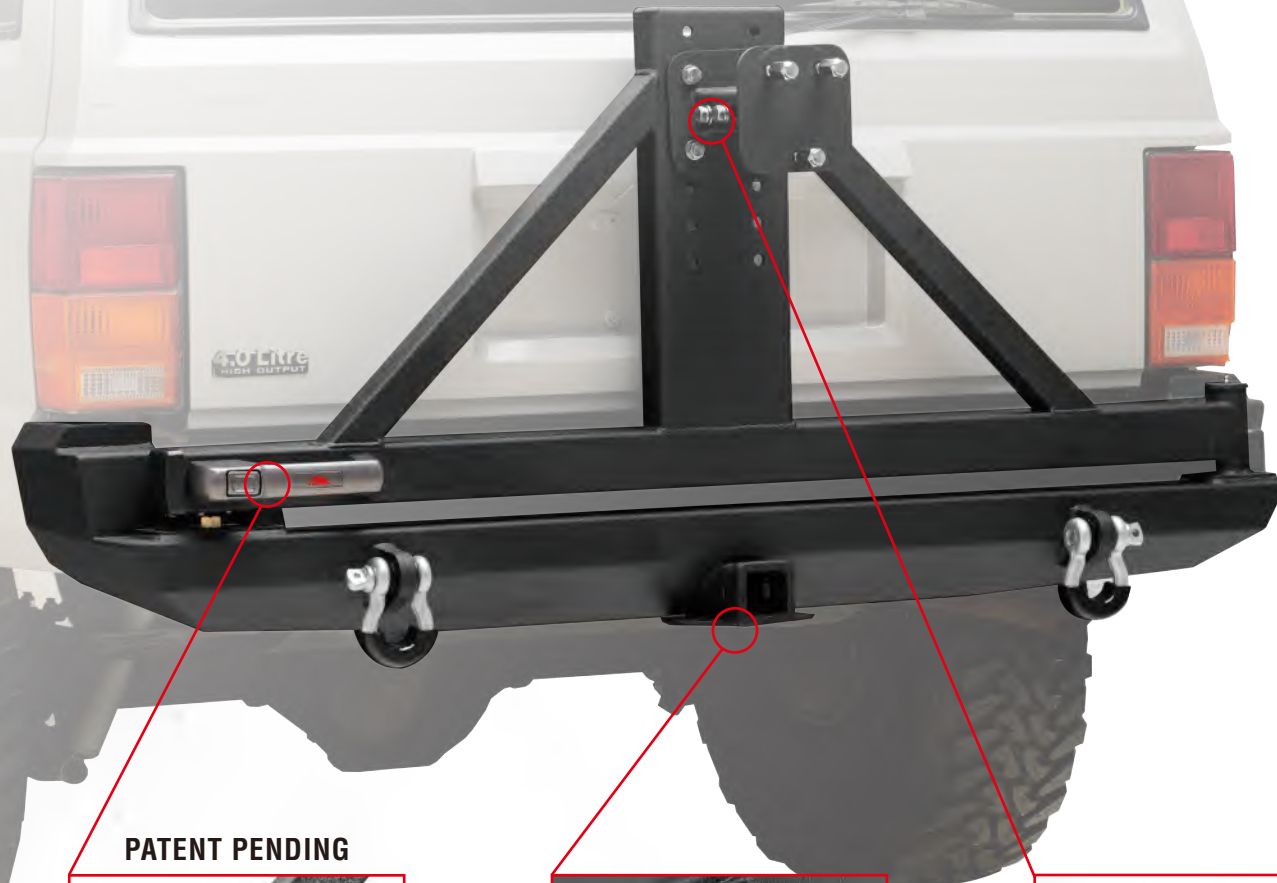

PATENT PENDING

SUREGRIP LATCH



CLASS III RATED 2" RECEIVER HITCH



TWO WAY ADJUSTABLE TIRE MOUNT

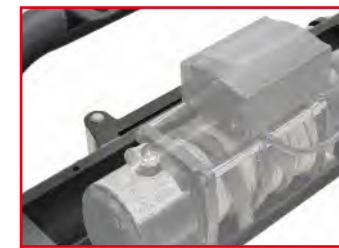

BUILT-IN WINCH PLATE



BUILT-IN LIGHT TABS



REMOVABLE OVERRIDE

BUILT-IN WINCH PLATE

BUILT-IN LIGHT TABS

REMOVABLE OVERRIDE

51-0902

FULL WIDTH FRONT BUMPER



D-RING MOUNTS WELDED INSIDE AND OUT

51-0903

FULL WIDTH REAR BUMPER



PART	YEAR	MAKE	MODEL	DESCRIPTION
51-0902	84-01	JEEP	CHEROKEE XJ	FULL WIDTH FRONT BUMPER
51-0903	84-01	JEEP	CHEROKEE XJ	FULL WIDTH REAR BUMPER
51-0911	84-01	JEEP	CHEROKEE XJ	BODY WIDTH REAR BUMPER WITH SUREGRIP TIRE CARRIER



Paramount Automotive's TJ/YJ Bumpers offer a variety of high quality steel bumper choices for the off-road ready Jeep. All of our bolt on installation bumpers feature heavy duty design and manufacturing innovations, and options to suit your Jeep's need for superior front and rear protection.

YJ/TJ BUMPERS

YJ/TJ BUMPERS

FEATURES

- Improves tire clearance while providing superior protection
- Built-in winch plate accommodates up to 12,000 pound winch
- CNC laser cut and welded for precision and durability
- Manufactured from 4mm steel plate with a 2"x .120 overrider
- Textured black powder-coat finish for durability and corrosion resistance
- Easy bolt-on installation
- Lifetime structural warranty against manufacturers defects
- 5 year finish warranty
- NOTE: D-Rings are not included.

**51-0037
STUBBY FRONT BUMPER**

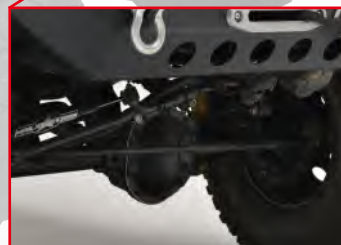
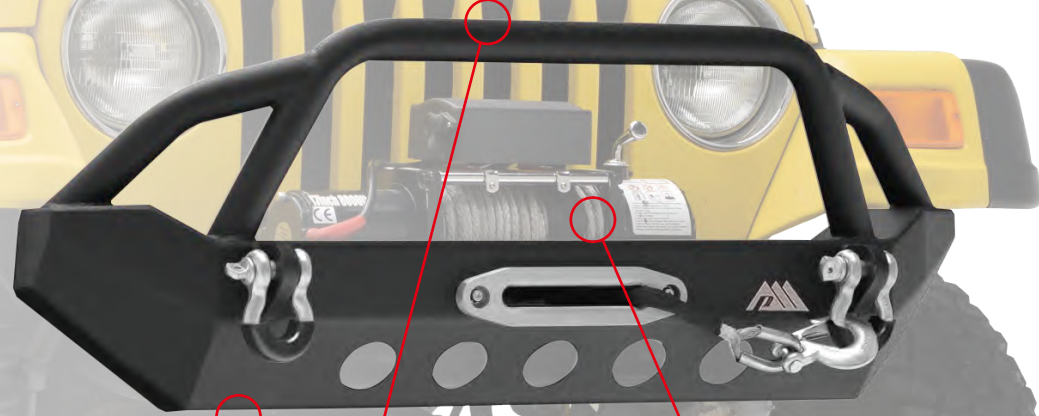

ENGINEERED TO IMPROVE APPROACH ANGLES



BUILT-IN LIGHT TABS

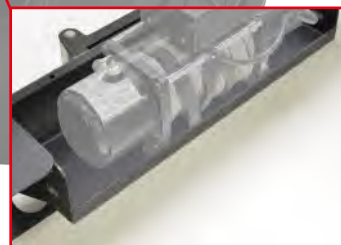

BUILT-IN WINCH PLATE

**51-0007
FULL-WIDTH CLASSIC FRONT BUMPER**



D-RING MOUNTS WELDED INSIDE AND OUT



**51-0008
BODY WIDTH CLASSIC REAR BUMPER**

PART	YEAR	MAKE	MODEL	DESCRIPTION
51-0007	87-06	JEEP	WRANGLER TJ / YJ	FULL-WIDTH CLASSIC FRONT BUMPER
51-0037	87-06	JEEP	WRANGLER TJ / YJ	STUBBY FRONT BUMPER
51-0008	87-06	JEEP	WRANGLER TJ/YJ	BODY WIDTH CLASSIC REAR BUMPER

Built from heavy gauge steel for the highest durability and powder-coated for long life. Every fender flare is engineered to give the maximum clearance allowing the largest tire options. We also incorporated air vents to allow for greater air flow in the engine compartment during extreme conditions. Choose from our armor style front fenders and combine them with our corner guards and rear fender flares makes for ultimate protection off-road.

TJ ARMOR FENDER FLARES

TJ ARMOR FENDER FLARES

FEATURES

- Manufactured from 4mm heavy duty steel plate
- Textured black powder-coat finish for durability and corrosion resistance
- Front fenders include a 3/4" LED turn signals
- Designed for maximum tire clearance
- Some drilling required for proper installation
- Lifetime structural warranty against manufacturers defects
- Cutting required
- 5 year finish warranty

51-0066 + 51-0067

ARMOR FENDER FLARES

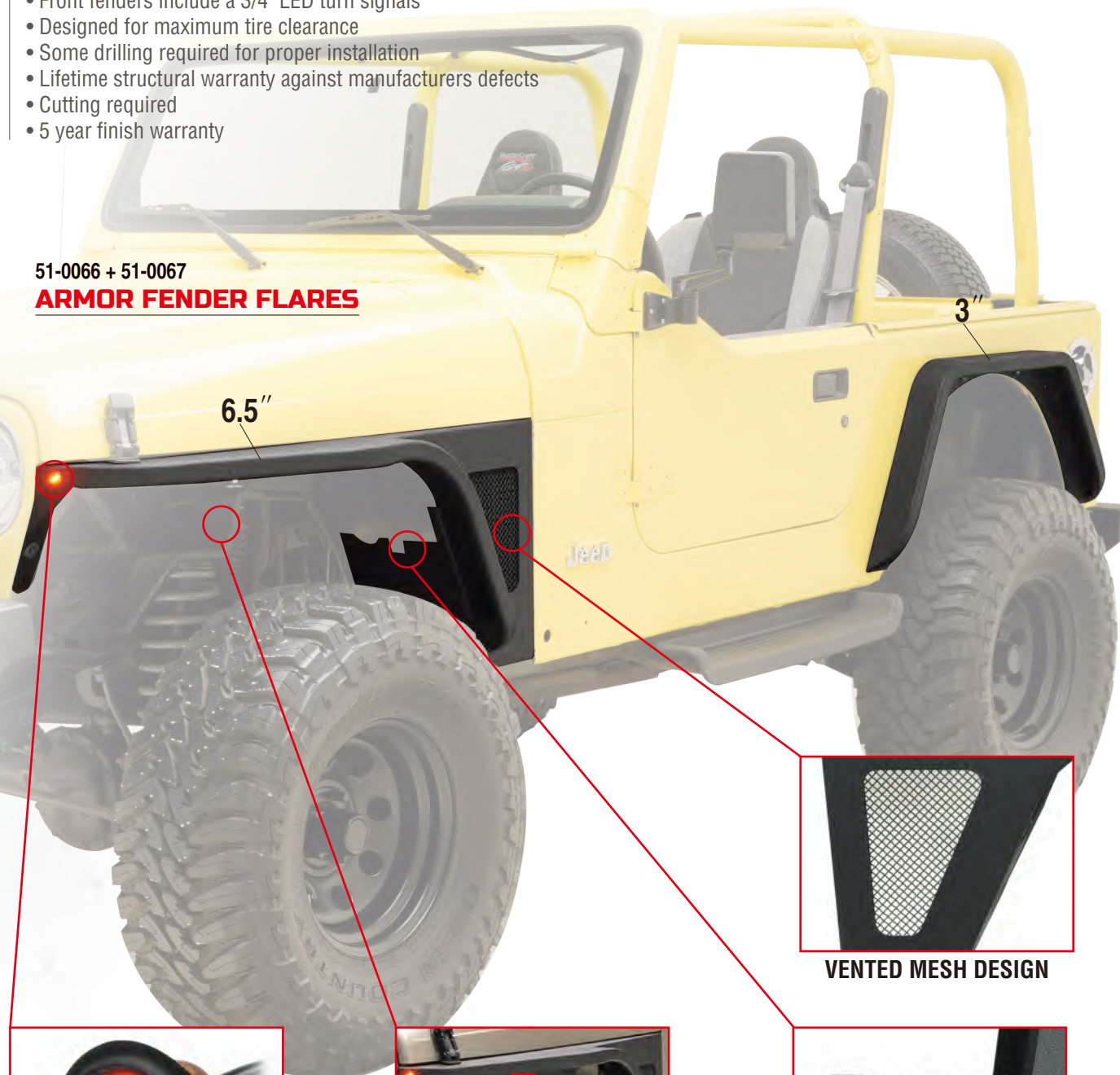

AMBER LED LIGHTS



MAXIMUM TIRE CLEARANCE



VENTED MESH DESIGN

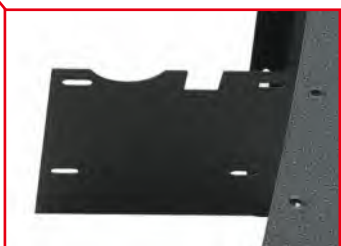

INTERNAL REINFORCEMENT



51-0042 + 51-0043 + 51-0044

ARMOR FENDER FLARES



1 5/8" TUBE STRUCTURE



51-0041

FRONT FENDERS



51-0065

FRONT FENDERS

PART	YEAR	MAKE	MODEL	DESCRIPTION
51-0041	97-06	JEEP	WRANGLER TJ	FRONT FENDER (ALSO FIT 04-06 LJ)
51-0042	97-06	JEEP	WRANGLER TJ	FRONT FENDER WITH FLAIR (ALSO FIT 04-06 LJ)
51-0043	97-06	JEEP	WRANGLER TJ	CORNER GUARD (NOT FIT FOR LJ)
51-0044	97-06	JEEP	WRANGLER TJ	REAR FENDER (ALSO FIT 04-06 LJ)
51-0065	97-06	JEEP	WRANGLER TJ	FRONT FENDER WITH LED LIGHTS
51-0066	97-06	JEEP	WRANGLER TJ	FRONT FENDER WITH FLAIR WITH LED LIGHTS
51-0067	97-06	JEEP	WRANGLER TJ	REAR FENDER



Paramount Automotive's Rock Guards offer the steel hard armored solution your TJ or YJ needs against the punishing off road terrain. The durable steel sheet and tubing construction and textured powder coat protection keep your Jeep looking as good as when you pulled out of the driveway.

RG

YJ/TJ ROCK GUARDS

YJ/TJ ROCK GUARDS

FEATURES

- Manufactured from heavy duty 4mm steel plate
- Integrated side steps double as side armor for additional protection
- CNC laser cut and precision brake formed for an exact fit
- Some drilling required for proper installation
- Textured black powder-coat finish for durability and corrosion resistance
- Lifetime structural warranty against manufacturers defects
- 5 year finish warranty

51-0105

YJ ROCKER GUARD WITH STEP



51-0039

TJ ROCKER GUARD



51-0040

TJ ROCKER GUARD WITH STEP



DURABLE 4MM STEEL SHEET



2" .120" WALL STEEL TUBING

PART	YEAR	MAKE	MODEL	DESCRIPTION
51-0039	97-06	JEEP	WRANGLER TJ	ROCKER GUARD
51-0040	97-06	JEEP	WRANGLER TJ	ROCKER GUARD WITH STEP
51-0105	87-95	JEEP	WRANGLER YJ	ROCKER GUARD WITH STEP

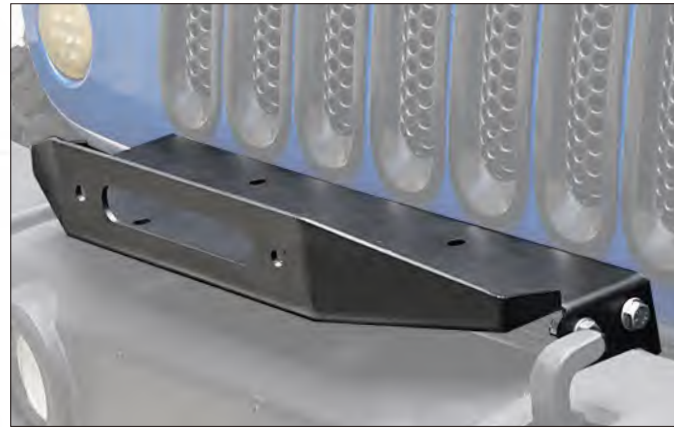

81-10104
JK EXTERNAL WINCH PLATE

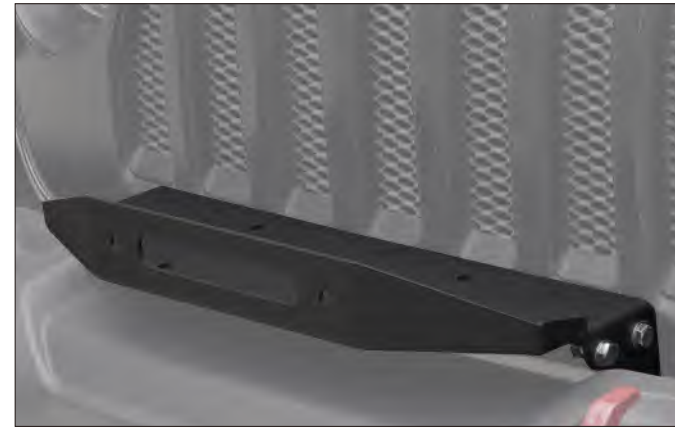

81-20104
JL EXTERNAL WINCH PLATE



51-0459
JK THIRD BRAKE LIGHT MOUNTING BRACKET



51-8419
JL THIRD BRAKE LIGHT MOUNTING BRACKET



81-10100
10" ALUMINUM UNIVERSAL FAIRLEAD FOR WINCH ROPE



81-20107
JL HITCH RECEIVER

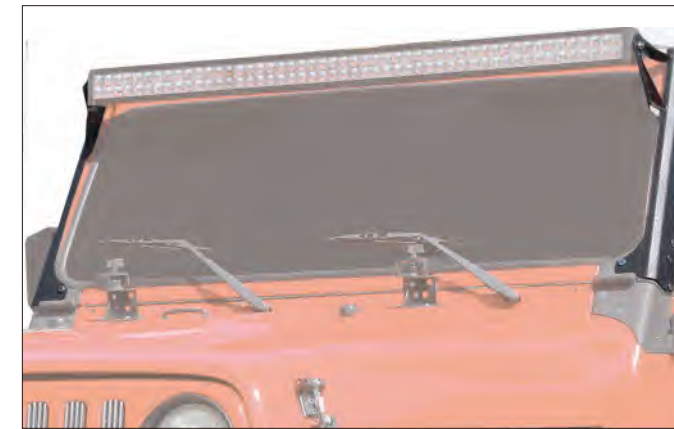

51-0452
TJ 52" LED LIGHT BAR MOUNTING BRACKETS



81-20101
JL/JT LIGHT MOUNTING BRACKETS



81-20113
JL/JT DOOR HINGE STEP



81-20112
JL TAILGATE JACK MOUNTING BRACKET



81-20000
UNIVERSAL GAS TANK BRACKET ON TIRE CARRIER

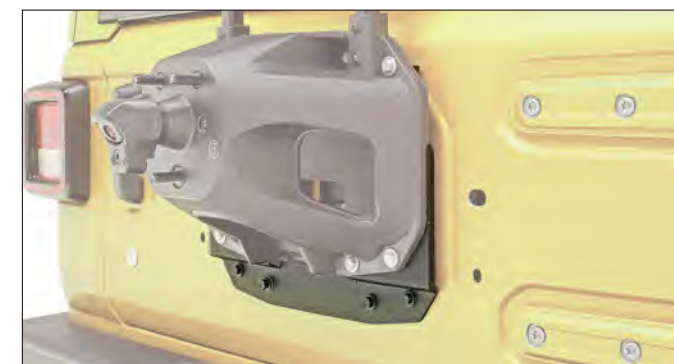

51-8401
JL TIRE RELOCATION BRACKET



81-20102
JL/JT TURN SIGNAL LED LIGHT



Boost your off-road machine's protection to tackle the rugged trails and gnarly terrain with extra piece of mind by setting it with this top-end **Paramount Automotive** Full Width Bumper. Made to be tough as nails, this off-road bumper will keep your steel stallion safe from damage caused by flying rocks, deer, other vehicles, and everything in between while giving it a sharper look. This Tacoma Bumper is the perfect solution for night-time trail runners, as it will accommodate LED light bar and LED cube lights. Every Tacoma Bumper product is finished in fine-textured black powder coat and backed by Paramount's lifetime structural warranty.

TACOMA BUMPERS

TB

TACOMA BUMPERS

FEATURES

- Full-width design for maximum protection against anything the trail can throw at you
- Built-in 30" Single row LED Bar mounting bracket and two square LED light brackets for your future light configurations
- Recessed winch mount with integrated fairlead plate provides a low center of gravity and unrestricted airflow; fits up to 12,000lb winch
- Bumper corners angle upward for departure angle clearance and withstand the harshest off-road conditions
- Two pieces structure with assembled skid plate protecting engine
- Includes openings and mounts for OE license plate lights, and trailer wiring plug
- Direct bolt-on upgrade Tacoma's original stock bumper reusing the factory mounting points
- Bolt-on installation - trimming of factory bumper require
- 4mm thick steel plate construction, CNC laser cut and precision brake-formed
- Multi-stage fine-texture black powder coat finish for long lasting great looks and corrosion resistance
- Backed by Paramount's lifetime structural warranty and 5-year finish warranty

91-65000

FRONT BUMPER



BUILT-IN LIGHT MOUNTING BRACKETS (LIGHTS ARE NOT INCLUDED)



1" THICK EXTREME DUTY SHACKLE TABS (D-RINGS ARE NOT INCLUDED)



RECESSED WINCH MOUNT WITH INTEGRATED FAIRLEAD PLATE

91-65100

REAR BUMPER



OE LICENSE PLATE LIGHT PROVISION



ACCOMMODATES OE TRAILER PLUG



BUILT-IN LIGHT MOUNTING BRACKETS (LIGHTS ARE NOT INCLUDED)

PART	YEAR	MAKE	MODEL	DESCRIPTION
91-65000	16-23	TOYOTA	TACOMA	FRONT BUMPER
91-65100	16-23	TOYOTA	TACOMA	REAR BUMPER



The **Paramount Automotive** Adventure Rack is the perfect solution for securely mounting a rooftop tent to your Toyota Tacoma. A heavy-duty design gives the rack an impressive 600-lb. static load rating making it capable of handling the heaviest rooftop tents and gear. Additional panels between the crossbars make ideal locations to mount anything you need on your next off-road excursion. With 3mm thick precision laser-cut and brake-formed steel, the Adventure Rack is rugged enough for off-road use. Installation is simple with the rack mounting to your Tacoma's factory bed track system and it sits on top of the bed rail for better weight distribution and additional strength. Backed by a five-year finish and lifetime structural warranty and protected with a multi-stage, fine-textured powder coat, the Adventure Rack is available for both short- and long-bed Toyota Tacoma.

FEATURES

- Installs easily by mounting to the factory Toyota Tacoma bed track system
- Can easily handle heavy rooftop tents and cargo with a 600-lb static load rating
- Additional panels allow mounting of recovery boards, Rotopax containers, shovels, and other gear
- Sits on top of the bed rail for better weight distribution and strength
- A heavy-duty design and 3mm thick laser-cut and brake-formed steel make it rugged enough for off-road use
- A fine-textured, multi-stage powder coat provides protection and looks great



91-65203
TACOMA COMPACT ADVENTURE RACK



91-65202
TACOMA ADVENTURE RACK 5FT BED



91-65205
TACOMA ADVENTURE RACK 6FT BED



**INNOVATIVE HOOK
DOUBLE NUTS BRACKETS**



**BALANCED LOAD SHARING
ON C TRACK AND CAB RAIL**

PART	YEAR	MAKE	MODEL	CONTRACTOR RACKS
91-65202	16-23	TOYOTA	TACOMA	ADVENTURE RACK (5FT BED)
91-65203	16-23	TOYOTA	TACOMA	COMPACT ADVENTURE RACK
91-65205	16-23	TOYOTA	TACOMA	ADVENTURE RACK (6FT BED)



RR

Paramount Automotive's Adventure Roof Rack is a solid and secure way to carry additional gear and cargo on your Toyota Tacoma. Made from precision-cut and brake-formed steel, the Adventure Rack is strong enough to yield a 350-lb. static load rating. Multiple crossbars and tie-down points make attaching anything to the rack an easy process. The sleek design of the Adventure Roof Rack and its built-in wind deflector reduce both wind noise and fuel consumption. Other well-thought-out details include grab handles on the side rails to ease access to the top of the rack and cutouts in the front and rear of the rack for LED lights. The Paramount Adventure Toyota Tacoma Roof Rack requires no drilling to install, attaching to factory mounts found on the cab's roof. A multi-stage, fine-textured black powder coat with a five-year warranty protects the rack along with a lifetime structural warranty.

TACOMA ADVENTURE ROOF RACKS

TACOMA ADVENTURE ROOF RACKS

FEATURES

- Easily installs using existing mounts with no drilling required
- An aerodynamic design reduces wind noise and fuel consumption
- Multiple crossbars and tie-down slots make mounting gear easy
- Built-in cutouts in the front and back of the rack for mounting LED lights
- Rugged construction gives the Adventure Roof Rack a 350-lb. load rating for lots of gear-hauling capability
- A multi-stage, fine-textured black powder coat finish protects the rack and looks great

91-65204
TACOMA ROOF RACK



PERIMETER LIGHTING ACCOMMODATIONS



TIE-DOWN PROVISIONS



EASY BOLT-ON INSTALLATION

PART	YEAR	MAKE	MODEL	DESCRIPTION
91-65204	16-23	TOYOTA	TACOMA	ADVENTURE ROOF RACK

Designed to take on the toughest trails and beyond, **Paramount Automotive's** Canyon Series Rock Sliders are designed with durability, protection, and clearance for fitting through, over and around the tightest obstacles. Canyon Rock Sliders mount directly to the truck at the body mounts rather than placing impact stresses on to the truck body itself. The sliders tuck up tight to maintain breakover angle and still provide a beefy rub rail for when the canyon gets tight. And when the trail gets tight, Canyon Series Rock Sliders bite back with beefy 4mm thick plate steel construction that's precision brake-formed and professionally welded. Every Canyon Series product is finished in fine-textured black powder coat and backed by Paramount's lifetime structural warranty.

FEATURES

- Sliders mount directly to the truck at the body mounts rather than the body itself
- High clearance design tucks up tight to provide great breakover angle on tight trails
- Rock Sliders protrude outward to keep the truck's rockers and doors safely away from the rocks
- Integrated entry step features non-slip pads for safe entry and exit in wet and muddy conditions
- 4mm thick steel plate construction, CNC laser cut and precision brake-formed
- Multi-stage fine-texture black powder coat finish for long lasting great looks and corrosion resistance
- Backed by Paramount's lifetime structural warranty and 5-year finish warranty

91-65300
TACOMA DOUBLE CAB CANYON ROCK SLIDERS

4.7"

PART	YEAR	MAKE	MODEL	DESCRIPTION
91-65300	05-23	TOYOTA	TACOMA	DOUBLE CAB CANYON ROCK SLIDERS
91-65301	05-23	TOYOTA	TACOMA	ACCESS CAB CANYON ROCK SLIDERS
91-65302	10-19	TOYOTA	4RUNNER	CANYON ROCK SLIDERS



**4MM THICK STEEL
PLATE CONSTRUCTION**



**ANTISKID
POLYPROPYLENE PEDAL**



**HEAVY DUTY
BODY MOUNT BRACKET**



Improve your truck's appearance, visibility and protection with **Paramount Automotive's** LED Truck Winch Bumper. Designed with built-in brackets for optional 30" LED light bar, heavy duty steel construction to protect and accommodate your 15,000 lb. winch and armored with a textured powder coat to prevent corrosion, this LED Truck winch bumper is the peace of mind you've been wanting for your off road truck.

TB

TRUCK BUMPERS

TRUCK BUMPERS

FEATURES

- Improves tire clearance while providing superior protection
- Built-in winch plate accommodates up to 15,000 pound winch
- Injection molded LED light provision
- Pre-installed LED cube lights and light bar
- Brackets for optional 30" LED light bar (Light bar not included)
- Includes wiring harness and switch for LED light
- Manufactured from durable 4mm steel plate
- Textured black powder-coat finish for durability and corrosion resistance
- Lifetime structural warranty against manufacturers defects
- Vehicle specific application
- D-Rings are not included.



**57-0115
REAR LED TRUCK BUMPER**



WIRING HARNESS AND SWITCH FOR LED LIGHTS

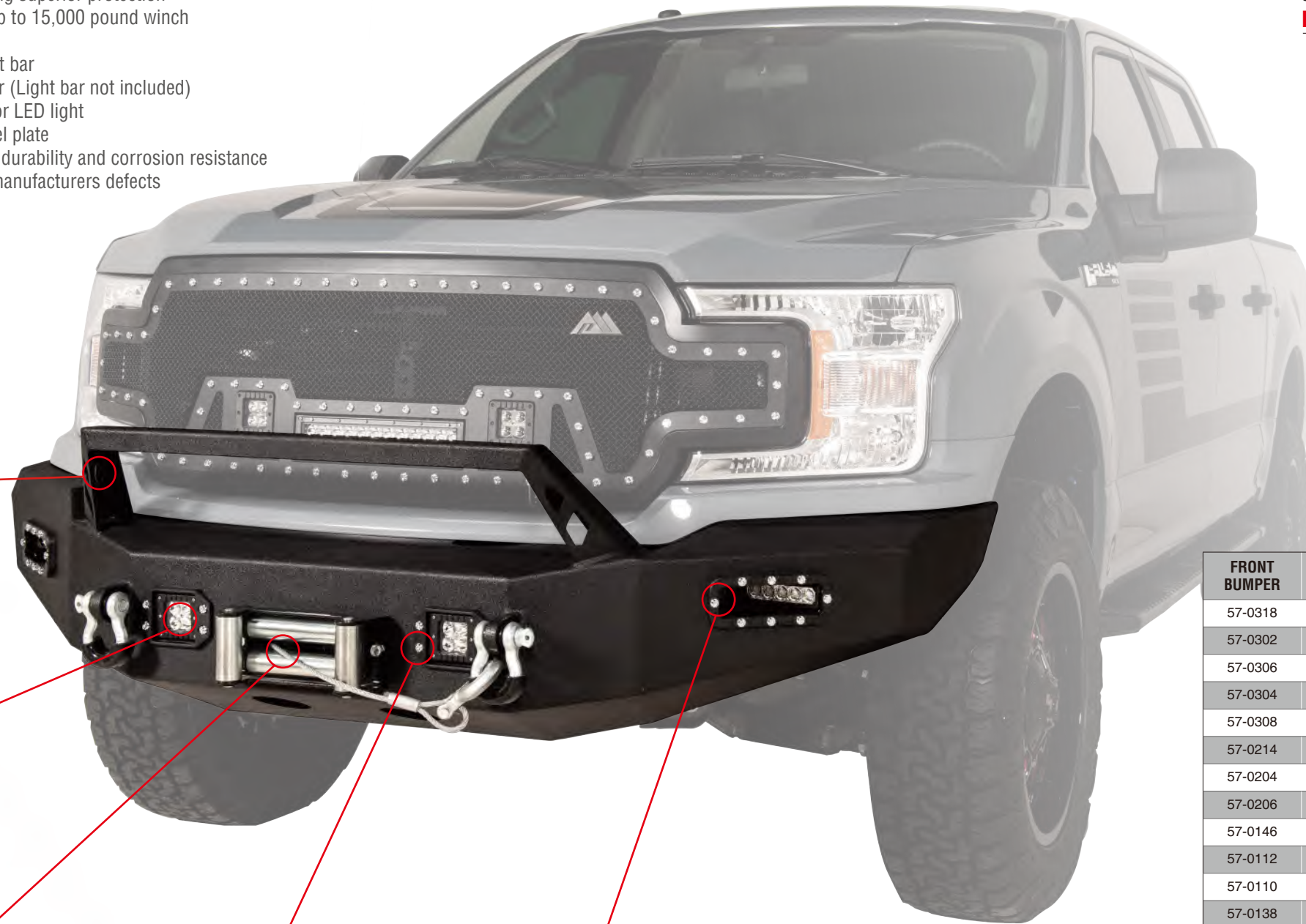

FITS UP TO 30" LED LIGHT



**TWO 12W CUBE LED LIGHTS
(1400 LUMENS)**



BUILT-IN WINCH PLATE



ACCENT RIVET



**15W LED LIGHTS
(1050 LUMENS)**

**57-0146
FRONT LED TRUCK BUMPER**

FRONT BUMPER	REAR BUMPER	YEAR	MAKE	MODEL
57-0318	57-0303	16-18	CHEVROLET	SILVERADO 1500
57-0302	57-0303	14-15	CHEVROLET	SILVERADO 1500
57-0306	57-0307	07-13	CHEVROLET	SILVERADO 1500
57-0304	57-0305	15-19	CHEVROLET	SILVERADO 2500/3500
57-0308	57-0309	11-14	CHEVROLET	SILVERADO 2500/3500
57-0214	57-0215	19-21	RAM	1500
57-0204	57-0205	13-18	DODGE	RAM 1500
57-0206	57-0207	10-18	DODGE	RAM 2500/3500
57-0146	57-0113	18-20	FORD	F-150
57-0112	57-0113	15-17	FORD	F-150
57-0110	57-0111	09-14	FORD	F-150
57-0138	57-0139	17-21	FORD	F250/F350/F450
57-0114	57-0115	11-16	FORD	F250/F350/F450
57-0514	57-0303	16-18	GMC	SIERRA 1500
57-0502	57-0303	14-15	GMC	SIERRA 1500
57-0306	57-0307	07-13	GMC	SIERRA 1500
57-0504	57-0305	15-19	GMC	SIERRA 2500/3500
57-0418	57-0419	16-23	TOYOTA	TACOMA
57-0404	57-0405	14-21	TOYOTA	TUNDRA
57-0406	57-0407	07-13	TOYOTA	TUNDRA



Paramount Automotive's new line of Impulse Grilles for GM, Nissan, RAM and Toyota trucks give you OE quality at an affordable price. Our precision manufacturing and injection molding processes create durable, impact resistant grilles for that rugged look that lasts and lasts.

IG

TRUCK IMPULSE GRILLES

TRUCK IMPULSE GRILLES

FEATURES

- Full grille replacement uses OE mounting locations
- Integrated 3W amber LED running lights
- Includes complete wiring harness
- Impact-resistant light weight ABS plastic
- Premium matte black finish
- Vehicle specific design
- Lifetime structural warranty against manufacturers defect
- 5 year warranty on finish



AMBER LED LIGHTS

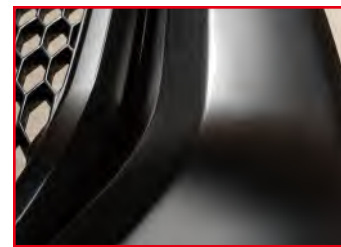

MATTE BLACK ABS

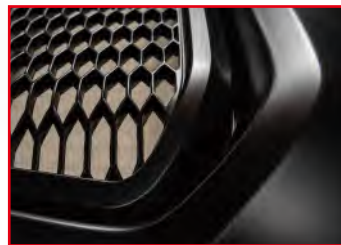

HIGH QUALITY MESH

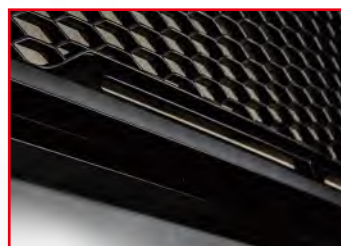

STYLED AIR VENTS



41-0170MB
IMPULSE GRILLE



OE STYLE MOUNTING CLIPS



WATERPROOF WIRING HARNESS

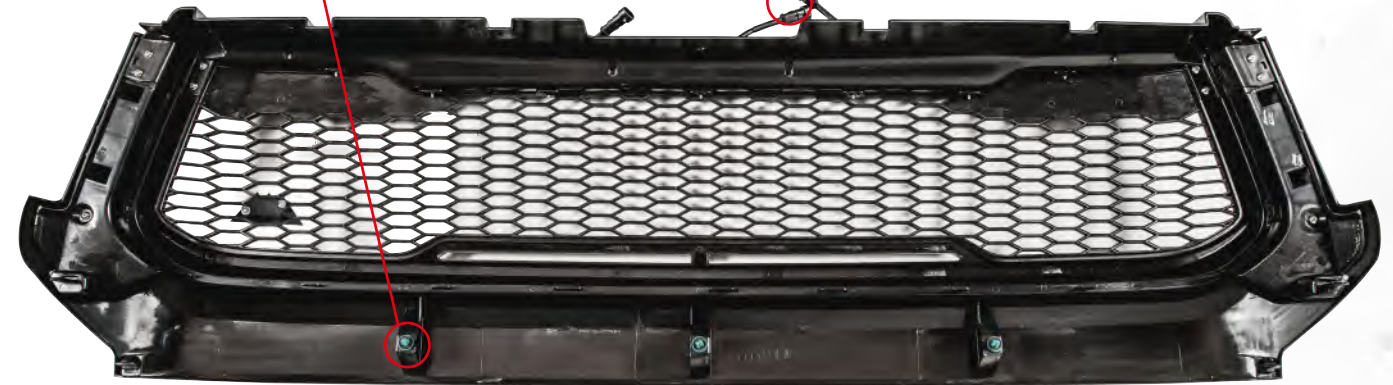

PART	YEAR	MAKE	MODEL
41-0193MB	16-18	CHEVROLET	SILVERADO 1500
41-0196MB	07-13	CHEVROLET	SILVERADO 1500
41-0181MB	11-14	CHEVROLET	SILVERADO 2500/3500
41-0177MB	07-10	CHEVROLET	SILVERADO 2500/3500
41-0183MB	13-18	DODGE	RAM 1500 (NON REBEL)
41-0180MB	09-12	DODGE	RAM 1500
41-0197MB	02-05	DODGE	RAM 1500
41-0176MB	13-18	DODGE	RAM 2500/3500
41-0175MB	10-12	DODGE	RAM 2500/3500
41-0195MB	06-08	DODGE	RAM 2500/3500
41-0197MB	03-05	DODGE	RAM 2500/3500
41-0178MB	07-13	GMC	SIERRA 1500
41-0203MB	04-07	NISSAN	TITAN
41-0171MB	16-23	TOYOTA	TACOMA
41-0201MB	12-15	TOYOTA	TACOMA
41-0202MB	05-11	TOYOTA	TACOMA
41-0170MB	14-21	TOYOTA	TUNDRA
41-0169MB	10-13	TOYOTA	TUNDRA



Paramount Automotive's professional truck racks combine impressive strength, elegant design and ease of installation. Our unique design allows for infinite adjustability in all the right places for a custom fit on all trucks - long bed or short bed. All of our racks include no-drill mounting.

CR

TRUCK CONTRACTOR RACKS

TRUCK CONTRACTOR RACKS



19601
CAMPER SHELL RACK



WIND DEFLECTOR
ELIMINATES CAB NOISE



TWO WAY ADJUSTABLE
FOR UNIVERSAL FIT



NO DRILLING REQUIRED

16601
COMPACT TRUCK RACK



18601
HEAVY DUTY RACK

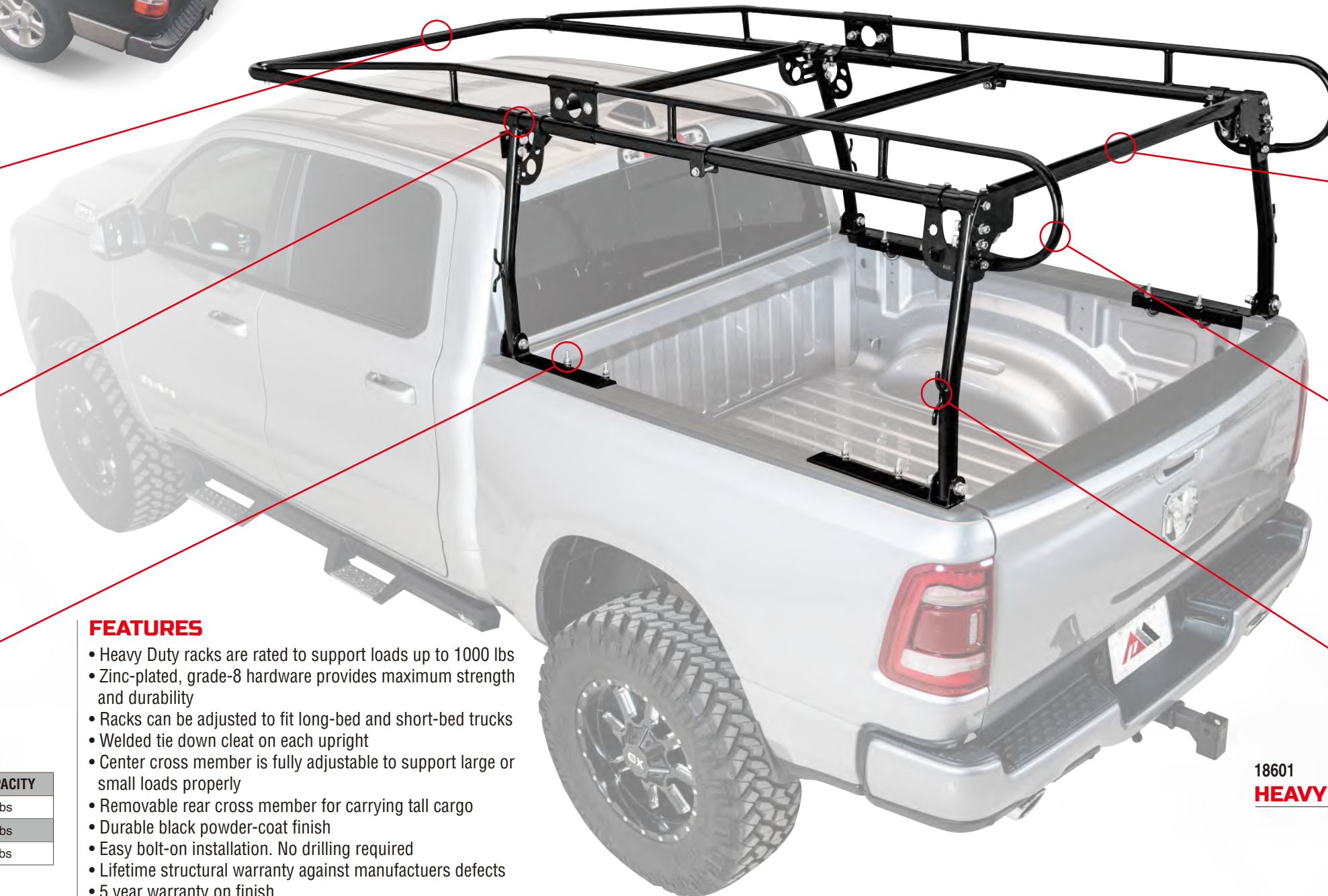

REMOVABLE REAR BAR



EASY GET IN HANDLE



WELDED TIE DOWN CLEAT

18601
HEAVY DUTY RACK

FEATURES

- Heavy Duty racks are rated to support loads up to 1000 lbs
- Zinc-plated, grade-8 hardware provides maximum strength and durability
- Racks can be adjusted to fit long-bed and short-bed trucks
- Welded tie down cleat on each upright
- Center cross member is fully adjustable to support large or small loads properly
- Removable rear cross member for carrying tall cargo
- Durable black powder-coat finish
- Easy bolt-on installation. No drilling required
- Lifetime structural warranty against manufacturers defects
- 5 year warranty on finish

PART	CONTRACTOR RACKS	LOAD CAPACITY
16601	COMPACT TRUCK RACK	1000 lbs
18601	HEAVY DUTY RACK	1000 lbs
19601	CAMPER SHELL RACK	1000 lbs



Paramount Automotive's Premium Contractor Rack combines impressive strength, elegant design and ease of installation. Our unique design allows for infinite adjustability in all the right places for a custom fit on all trucks while increasing load capacity to 1500lbs.

CR

TRUCK CONTRACTOR RACKS

TRUCK CONTRACTOR RACKS

FEATURES

- Premium racks are rated to support loads up to 1500lbs
- Adjustable center cross member
- Welded tie down cleat on each upright
- Front air dam engineered to reduce wind noise
- Easy bolt-on installation. No drilling required
- Removable rear cross member for carrying tall cargo
- Durable black powder-coat finish
- Ships in two boxes
- Vehicle specific design
- Lifetime structural warranty against manufacturers defects
- 5 year warranty on finish



ADJUSTABLE FOR UNIVERSAL FIT



REMOVABLE REAR BAR



CONVENIENT GRAB HANDLE



WIND DEFLECTOR ELIMINATES CAB NOISE



WELDED TIE DOWN CLEAT



NO DRILLING REQUIRED

18602
PREMIUM RACK

PART	CONTRACTOR RACKS	LOAD CAPACITY
18602	PREMIUM RACK	1500 lbs

Now available Paramount Automotive's point-of-purchase displays are made from heavy duty steel and powder-coated for a great look in any showroom. Available in three configurations; Jeep Wrangler JK/JL bumper applications, two front and one rear with tire carrier and Jeep Wrangler JK/JL rock sliders and steel fender flares. Every rack comes pre-packaged; with hardware, brackets, casters, and sign holder.



81-25600+81-25601
POP BUMPER DISPLAY RACK



81-25600+81-25602
POP FENDER FLARE/ROCKER GUARD DISPLAY RACK

PART#	DESCRIPTION
81-25600-1	POP BUMPER/FENDER FLARE/ROCKER GUARD DISPLAY RACK (PACKAGE 1 OF 2)
81-25600-2	POP BUMPER/FENDER FLARE/ROCKER GUARD DISPLAY RACK (PACKAGE 2 OF 2)
81-25601	POP JK/JL BUMPER DISPLAY BRACKETS
81-25602	POP FENDER FLARE/ROCKER GUARD DISPLAY BRACKETS

TERMS AND CONDITIONS:

WARRANTY/DEFECTIVE RETURNS

UNLESS OTHERWISE SPECIFIED:
ALL Paramount Automotive products carry a 5 year warranty on finish and lifetime warranty against manufacturer defect.

Damage due to improper installation, on or off road hazards, product modification, or neglect are not covered.

This warranty is not transferable from the original buyer. For the original buyer to be eligible for the limited warranty coverage, the buyer must provide proof of purchase.

Paramount Automotive's only obligation shall be to replace its product proven to be defective. Paramount Automotive shall not be liable for any injury, loss or damage, direct or consequential, arising out of the use or the inability to use the product.

Before use, the user shall determine the suitability of the product for its intended use, and assumes all risk and liability whatsoever in connection therewith.

Customer's remedy therefore shall be limited to repair or replacement (at Paramount Automotive's option) of any defective part(s) returned to Paramount Automotive at customer's expense. The determination of whether or not a returned part is defective or subject to coverage under the limited warranties stated herein shall be made at Paramount Automotive's sole discretion.

All returned items must have an RGA number assigned and written visibly on the outside of the package. Issuance of an RGA number is not an approval for credit. Paramount Automotive will repair, replace, or issue credit for the defective product only after its receipt and inspection.

Any modifications made to returned product will nullify qualification for credit. Product must be in its original condition. Paramount Automotive is not responsible for shipping, handling, labor or paint costs for items returned or replaced.

THE FORGOING LIMITED WARRANTIES ARE EXCLUSIVE, AND ARE IN LIEU OF ALL OTHER WARRANTIES, WHETHER WRITTEN, ORAL OR IMPLIED, INCLUDING, WITHOUT LIMITATION, ANY WARRANTY OF MERCHANTABILITY OR ANY WARRANTY OF FITNESS FOR A PARTICULAR PURPOSE.

RETURNS/WARRANTY:

Warranty: 5 Year warranty on finish. Lifetime warranty against manufacturer's defect.

All return requests must be sent on a return goods authorization form ("RGA") provided by Paramount Automotive. The RGA number will be issued by the Paramount Automotive and must appear on the bill of lading.

All return authorizations are valid for 90 days from the date of approval.

Any goods returned without an RGA number will be refused and returned to the sender.

All returns could be subject to a minimum of 20% restocking fee. This charge will be dependent upon the condition of the merchandise received.

Goods must be in saleable condition in the original package with all its original content.

A packing slip must go with all shipments. The packing slip must be in the carton marked as such.

The packing slip must show the following:

- Reseller's complete name and address.
- RGA number.
- Reason for return (e.g., warranty, stock adjustment, etc.). Items listed by part number, in numeric order, and boxes numbered and marked with contents.
- All returns must be shipped prepaid. In case of a shipping error or warranty return, freight credit will be issued.
- All return shipments must be packaged appropriately to prevent damage in transit.
- Resellers will be notified in writing if any product is considered not returnable, and will be given ten (10) business days to inform Paramount Automotive whether such product should be returned freight collect. If Paramount Automotive is not notified within this ten (10) business day period, Paramount Automotive will automatically destroy the product.