

Blueprint for a **BRIGHTER FUTURE**

State Policy Innovations for Education, Health,
and Economic Opportunity

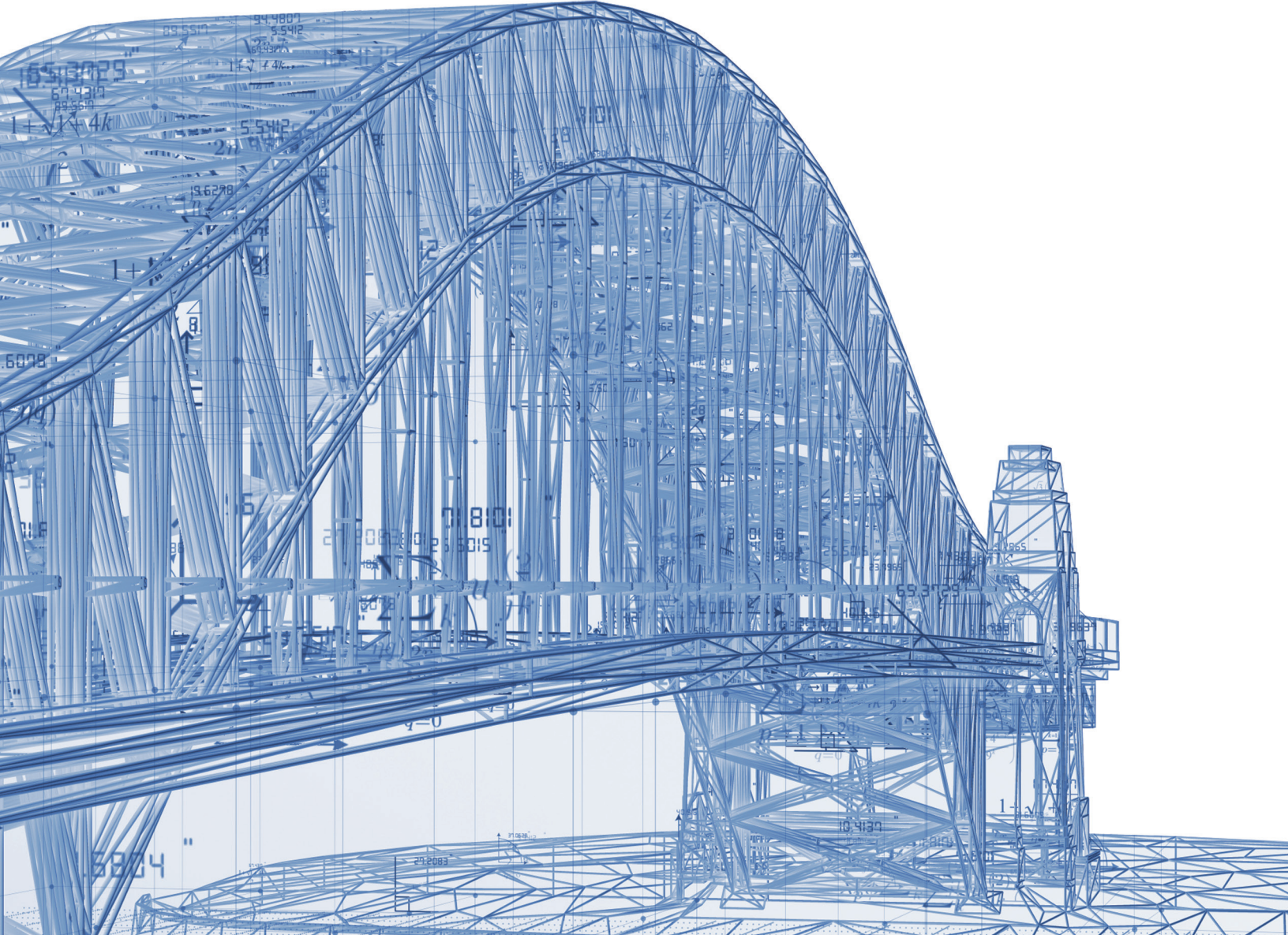

Pioneer Institute's **mission** is to develop and communicate dynamic ideas that advance prosperity and civil discourse in Massachusetts and beyond.

Pioneer's **vision of success** is a state and nation where we prosper and thrive, enjoying world-class options in education, healthcare, and economic opportunity, and where our government is limited, accountable, and transparent.

Pioneer **values** education and a willingness to test our beliefs based on facts and the free exchange of ideas, and a commitment to liberty, personal responsibility, and free enterprise.

Located in Boston and Washington, D.C., and founded in 1988, Pioneer Institute is a nonpartisan, tax-exempt 501(c)(3) organization. To ensure its independence, Pioneer does not accept government grants

Board of Directors

Officers

Adam Portnoy, *Chair*
 Bruce Johnstone, *Vice-Chair*
 James Stergios, *Executive Director*
 James Joslin, *Treasurer*
 Pamela Layton, *Clerk*
 Mary Connaughton, *Asst. Treasurer*

Members

Chris di Bonaventura	Charles Hewitt, III
Brian Broderick	Sara Johnson
Michael Brown	Mary Myers Kauppila
Gary Campbell	Mike Kennealy
Frederic Clifford	M. Holt Massey
Andrew Davis	Mark V. Rickabaugh
Drew Davis	Roger Servison
Brackett Denniston	Brian Shortsleeve
Ed Glaeser	Peter Wilde
Ellen Roy Herzfelder	

Stephen Fantone, *Chairperson Emeritus*
 Diane Schmalensee, *Chairperson Emerita*
 Alfred Houston, *Life Director*
 Gary Kearney, *Life Director*

 [YouTube.com/PioneerInstitute](https://www.youtube.com/PioneerInstitute)

 [Twitter.com/PioneerBoston](https://twitter.com/PioneerBoston)

 [Facebook.com/PioneerInstitute](https://www.facebook.com/PioneerInstitute)

 pioneerinstitute.org/podcasts/

 pioneerinstitute.org

 [pioneer_institute](https://www.instagram.com/pioneer_institute)

Contents 2023

From the Executive	
Director & Chair	2
PioneerEducation	3-5
American Citizenship	6-8
PioneerHealth	9-10
PioneerOpportunity	11-12
Pioneer Public Interest Law Center	13-14
Events	15
Communicating Our Research	16
Donors	17-20
Financials	21
The Pioneer Team	22

By the Numbers

Digital followers:
348K

Video hours:
2,700

Publications:
37

Email subscribers:
65K

Media hits:
1,490

Podcast downloads
323K

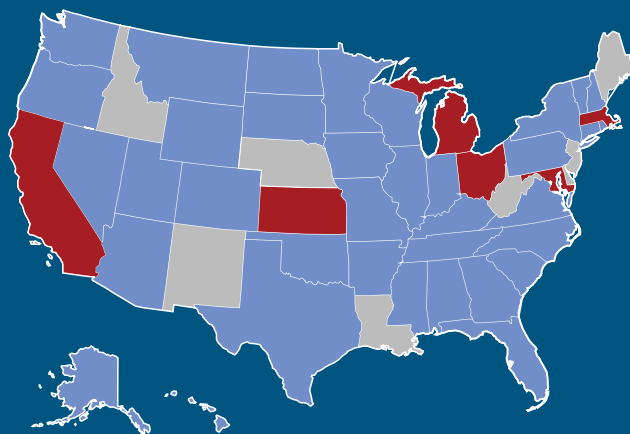

 Media Hits

 Active and Media Hits

Building in 2023

Four years ago, Pioneer faced an inflection point. Our country was divided and unwilling to engage in meaningful, pragmatic discussions. To maximize our impact and achieve our primary mission of improving the lives and opportunities of all Americans, we issued *Pioneer2025*, a new strategic blueprint:

- + Focusing on three **vital domestic issues**: education of the next generation, healthcare innovation, and economic growth.
- + Deploying teams of **national reputation** in our policy priorities.
- + Creating new **tactical capacities** to drive impact in Massachusetts and New England.
- + Prioritizing **innovation and choice** over fixing the government's broken legacy systems.
- + Expanding our engagement efforts in **states across the U.S.**

We are grateful for your support of this vision. This report summarizes our accomplishments in 2023 and offers a sneak peek at 2024.

Our 2023 impact in education starts with Massachusetts, where we helped secure new investments in vocational-technical schools and a new eighth-grade civics test. We expanded our reach to 29 states through webinars, events, and news coverage of our books on vocational-technical schools and civics education.

Recognizing how healthcare innovation is powering miraculous cures, reshaping care, and creating dramatic shifts in the health market, our life sciences policy team tackled big challenges such as rising regulation and price controls, which slow innovation, and costly middlemen, which reduce patient access to life-changing therapies.

Our economic opportunity work aims to reverse the talent outflow from Massachusetts by making the state more cost-competitive and attractive – particularly for young professionals who are the future of our economy. Reversing poor public policy choices on taxes, regulations, and housing will take new tactics.

In one-party Massachusetts, traditional think tank work of research and communications is not sufficient to drive real change. In line with *Pioneer2025*, we have created two new capacities.

Informed by the research of the Institute, Pioneer Public Interest Law Center, drives significant impact across our three policy priorities. In 2024, we will announce a new business partnership. Together, these capacities lay the foundation for dramatically greater policy impact in the Bay State.

Of interest will also be three new initiatives – currently “under construction” – related to Immigrant Entrepreneurship, American Citizenship, and data transparency.

We recognize the challenges ahead. We are grateful for your friendship and generosity. These tactical shifts would not be possible without your trust. With your continued partnership and these new capacities, we will speed meaningful change here in Massachusetts and for our fellow citizens across the country.



Adam Portnoy
Chair



Jim Stergios
Executive Director

Impact highlights:

- + 29 Massachusetts voc-tech schools were awarded \$51 million in grants.
- + Ideas from our joint brief, **Rightsizing Fed Ed**, were included in the U.S. House's Parents Bill of Rights legislation.
- + Our books on vocational education and teaching American civics earned coverage in 29 states.
- + In **Barron v. Southborough**, Pioneer protected free speech in town meetings.
- + The Law Center won key cases related to public access to government information.
- + The U.S. House passed a bill banning federal health programs from using the QALY.
- + The Biden administration repudiated the use of QALY in federal drug cost control efforts.
- + The U.S. House passed a bill forcing PBMs and hospitals to meet price transparency standards.
- + Our 50-state mapping database on abuses of the giant federal 340B Drug Pricing Program gained traction nationwide.
- + Pioneer's studies on out-migration and competitiveness helped advance a modest tax reform in Massachusetts.
- + The Law Center won cases strengthening the stability of tax policy.
- + The Law Center played a significant role in state and federal cases finding municipal takings of home equity unconstitutional.

Blueprint for The Future Of Education

The 1993 Massachusetts Education Reform Act has helped propel Massachusetts to the status of a national leader in K–12 education. Pioneer remains committed to the Act’s vision of high-quality standards, accountability, and school choice options to support rising generations of students who will lead the state and the nation.

Parental Choice

Through webinars, polling, and publications, Pioneer seeks to expand parents’ rights to choose the best learning environment for their children – whether district, charter, vocational-technical, and virtual public schools or, alternatively, private, home, or microschools.

- + A Pioneer Institute/Emerson College poll found that **Massachusetts residents overwhelmingly favor educational choices**, with 62 percent supporting charter schools, 76 percent backing tax credits for private scholarships, and 66 percent favoring a repeal of the state’s nativist amendments prohibiting public funds to private school parents if the money is targeted at lower-income families.
- + In **Room to Grow**, Dr. Cara Candal highlighted the disproportionate need for charter schools in 26 Gateway Cities. The district school alternatives are low performing, and the cities have space under state charter school caps and often substantial charter waitlists.
- + After the release of our book, **Hands-On Achievement: Massachusetts’s National Model Vocational-Technical Schools**, and a series of programs highlighting voc-tech excellence across the Commonwealth, 29 Massachusetts vocational-technical schools were awarded \$51 million in grants. Approximately \$39 million went to nine schools to expand access for students and adults.
- + Pioneer’s paper, **A Tale of Two City Schools**, focused on the successes of vocational-technical schools in Worcester and Springfield. Given the ongoing problems with Boston’s Madison Park Technical Vocational High School, the paper offered Boston educators and policymakers a more hopeful model for providing a vital educational alternative to Boston’s youth.
- + Pioneer launched a campaign to **support existing admissions policies at Massachusetts’ model vocational-technical schools**. Those policies allow administrators to screen applicants for their commitment to the vocational-technical environment, review behavioral records to ensure safety in workshop settings, and represent a good fit with a school’s mission and business partnerships.
- + Pioneer used the national release of our vocational-technical book, **Hands-On Achievement**, as a launch pad for focused outreach with policymakers and activist groups in five target states.

Pioneer Public Interest Law Center is working to force the Commonwealth to fully comply with recent U.S. Supreme Court rulings barring states from discriminating against parents who choose a religious education.



Plaintiffs in the landmark 2020 U.S. Supreme Court decision in *Espinoza v. Montana Department of Revenue*

Across the U.S. from 2000 to 2022, district school market share, measured by student enrollment, has fallen by 10 percent. At the same time, there has been considerable growth in charter public school (+6 percent) enrollments, and homeschool and microschool enrollments (+4.5). Our strategy to continue this progress relies on research, communications, and legal action.

+ **Why Massachusetts Should Be a Leader in Encouraging Innovative K-12 Learning Models** urged state policymakers to encourage the progress of microschools by reducing childhood care licensing requirements for emerging learning models, creating “innovation tracks,” and making it easier to start a private school. These flexible, personalized, and low-cost private education options “don’t fit neatly into a regulatory box.”



Kerry McDonald



Shiren Rattigan



Amar Kumar

Webinar: PioneerEducation Presents Education Innovations: Microschooling (March 15, 2023)

Standards and Accountability

For years, high academic standards and accountability have been under attack in Massachusetts. Pioneer stands at the leading edge, devoted to educational excellence.

- + In **The State of Things: BPS's Road to Improvement**, Dr. Cara Candal found the Boston Public Schools making at best halting, uneven progress in addressing declining enrollment, chronic absenteeism, underutilization of schools, misallocated resources, and failures related to special education, student data management, and transportation – all of which are part of its memorandum of understanding with the state.
- + **Where did the Federal Pandemic Relief Funding Go?** explores how districts spent \$2.9 billion in relief funds. While the funds were meant to address technology, safe school reopening, and learning loss, there is little evidence of impact. With the spending deadline looming, districts are facing funding cliffs and layoffs.
- + Pioneer is educating the public on why the **MCAS graduation requirement** is crucial. Efforts to deemphasize MCAS threaten to degrade the quality of a high school diploma and limit the futures of students.

“Instead of forcing METCO to fight for a line item in the state budget each year, Massachusetts would better serve families by incorporating the program into the Commonwealth's K-12 public education funding formula.”

– Jim Stergios in *The Dorchester News*



Jamie Gass
Director,
PioneerEducation

Advancing State Innovation

In 2023, we worked to push back on federal limitations on state innovation.

- + In collaboration with the Heritage Foundation, Cato Institute, and Catholic University, Pioneer briefed U.S. House staffers on K-12 educational federalism, transparency, and accountability, presenting our joint policy brief, *Rightsizing Fed Ed*. Ideas from our brief were included in the Parents Bill of Rights bill passed by the House.
- + In *Every Student Is Not Succeeding*, Pioneer evaluated the federal Every Student Succeeds Act (ESSA), acknowledging ESSA's progress in providing support for nonpublic schools and highlighting continuing budgetary and execution challenges.

“I was thunderstruck by how much all of Samuel Adams's contemporaries agree that he was the father of the Revolution, the prime mover, the apostle of liberty, as Jefferson says, the earliest, the most active, the most persevering of the patriots.”

– Pulitzer Prize winner, Stacy Schiff on *The Learning Curve*

The Learning Curve Podcast

For more than four years, The Learning Curve podcast has featured the nation's leading experts on American history, the humanities, and every aspect of education – from school choice, standards, and testing to the science of reading, mathematics instruction, and much more. The podcast averages 3,000 downloads per episode, with the audience including education leaders across the country.



“And I remember running the race and just [thinking], you know, the 200 final at the Olympics. And I was like, well, I'm here. This is what I've worked for... [Then] I went to Harvard and I ended up doing neurobiology with a minor in global health and health policy... So, the goal now is to keep improving and go for a gold.”

– Gabby Thomas

In 2023, Pioneer produced 50 episodes, highlighting an all-star cast of Pulitzer Prize-winning historians, educators, and school reformers. Our guests included Dr. Howard Fuller on school choice, former D.C. mayor Adrian Fenty on the need for radical urban school district reform, Sir Jonathan Bate on William Shakespeare's *Julius Caesar*, and biographer Stacy Schiff on Samuel Adams and the American Revolution.

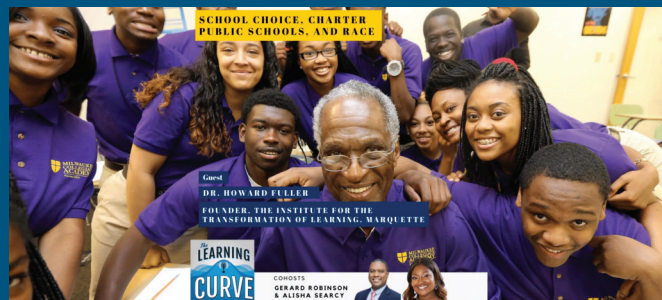
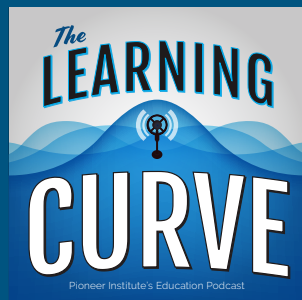
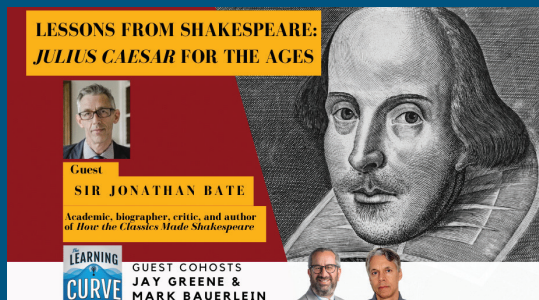

Blueprint for Citizenship

In his 1765 *A Dissertation on the Canon and Feudal Law*, John Adams wrote: "Liberty cannot be preserved without a general knowledge among the people."

Pioneer Institute's educational initiatives are rooted in the same soil that nourished Adams and the Revolutionary generation. Our American Citizenship initiative seeks to safeguard and strengthen the Enlightenment ideals that helped give birth to our nation.

Setting the historical record straight

Pioneer's new book, *Restoring the City on a Hill: U.S. History and Civics in America's Schools*, seeks to reclaim the nation's classrooms as places where students can gain a balanced, nonpartisan, and comprehensive view of the people, ideas, and events that shaped a nation unlike any the world has ever seen.

The book launch was supported by a multi-month social media campaign and featured in *The Washington Times*, *Atlanta Journal-Constitution*, and *Miami Herald*. Jamie Gass and Chris Sinacola appeared on numerous podcasts, including *First Things* and the Heritage Foundation's *Daily Signal*, and on radio talk shows coast to coast.

"The importance of a nonpartisan, fact-based U.S. History and civics education cannot be overstated. Without one, students will not be able to take their place as informed and engaged citizens dedicated to preserving the legacy of America's Founders."

– Jamie Gass in the *Miami Herald*

Restoring the City on a Hill provides parents, local and state leaders, and education policymakers with a blueprint to champion academic excellence. It includes a focus on testing U.S. History and civics in Massachusetts, adopting the U.S. Citizenship Exam as a high school graduation requirement, and rejecting history curricula grounded in political activism, revisionist history, and societal fads. Our goal is to help students become engaged citizens with the ability to make informed decisions about the direction of our country.

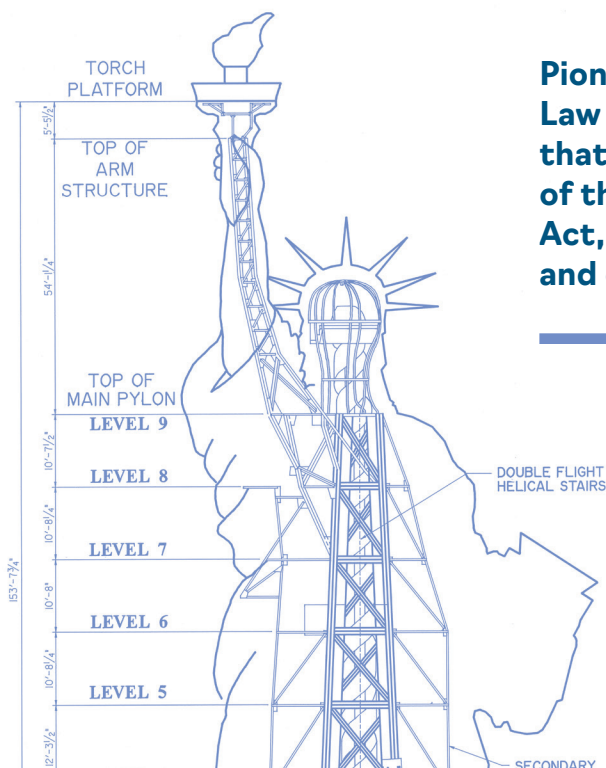
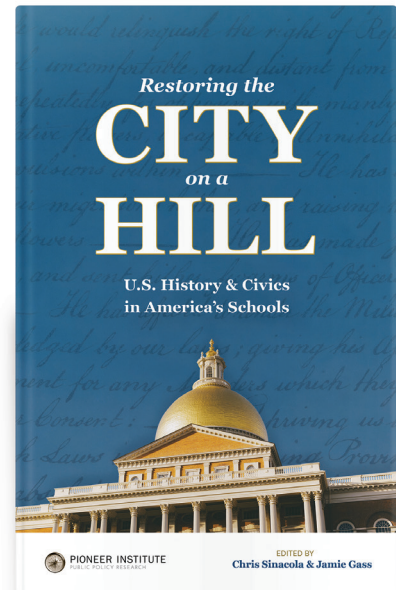

PioneerEducation is working with the Law Center to advance legal strategies that will result in the full implementation of the Massachusetts Education Reform Act, including in the area of U.S. History and civics education.

Pioneer believes that informed participation in government is the surest safeguard against the special interests and cultural trends that would undermine our nation’s priceless legacies of freedom and opportunity.

“**The poor performance of younger people on the exam and the correlation between performance and the number of civics courses taken highlight the near disappearance of civics from Massachusetts public school curricula in recent decades.**”

– Charles Chieppo & Jamie Gass in the *Boston Herald*

- + In 2023, Pioneer promoted our new civics book through 18 radio interviews from coast to coast, with op-eds in papers in Miami, Atlanta, and Washington, D.C., and in podcasts with the Heritage Foundation, American Enterprise Institute, and *First Things*. The Learning Curve podcast included episodes on George Mason and federalism, the legacies of Abraham Lincoln and Frederick Douglass, and how classical and Enlightenment thought shaped the U.S. Constitution.
- + A Pioneer Institute/Emerson College poll found that Bay State residents exhibit disturbing gaps in their understanding and **knowledge of the fundamentals of American government**.
- + Another Emerson College survey showed that 62 percent of Massachusetts residents **support reinstating a U.S. history test** as a high school graduation requirement. Eighty percent of residents believe our public schools should study the nation’s founding and history.

Upcoming in 2024:

- + Our **Civics 2.0 online platform** will offer a comprehensive, nonpartisan, and multimedia history and civics curriculum featuring great books, original documents, and the best that has been written and said about America – all in classroom-ready lesson format.
- + Massachusetts is **introducing a pilot grade 8 civics MCAS test** in the spring of 2024, a partial step toward Pioneer’s recommendation that civics and U.S. history be made a part of the MCAS testing system for all grades – and passage required for graduation from any of the state’s public high schools.

► **Poll Finds Strong Majority of Massachusetts Residents Support Restoring U.S. History MCAS Graduation**

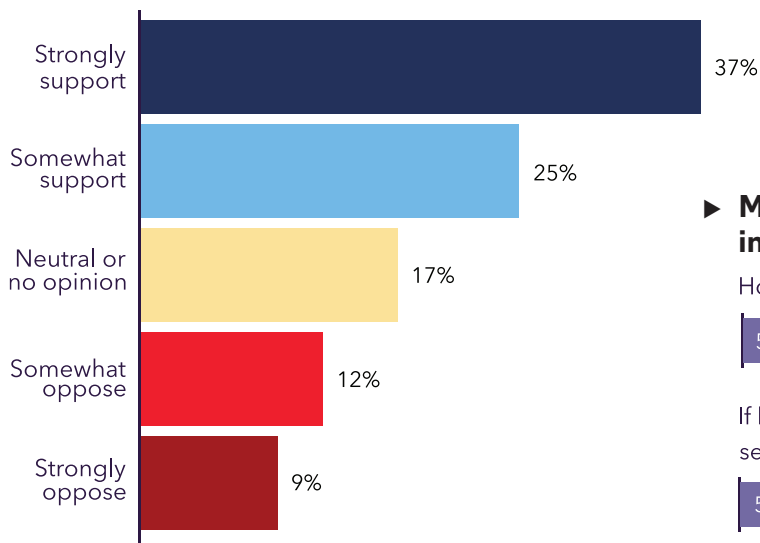

► **Massachusetts Residents Score a ‘D’ in Poll Based on U.S. Citizenship Test**

How many U.S. Senators are there?



If both the President and Vice President can no longer serve, who becomes President of the United States?



■ Correct ■ Incorrect

Blueprint for Government Transparency

The Massachusetts Constitution declares that “the several magistrates and officers of government” shall be “at all times accountable” to the people. Nearly 250 years later, those words too often ring hollow. The Commonwealth’s governor and Legislature remain exempt from the scrutiny and transparency that all other officials abide by. Pioneer is fighting to improve government transparency and accountability on all fronts.

- + **During Sunshine Week 2023**, Pioneer called for eliminating the governor’s office executive order privilege, subjecting the Legislature to the state’s public records and open meeting laws, and supporting an audit of the Legislature.
- + In April, following a **seven-month legal battle**, Pioneer Public Interest Law Center obtained an August 2022 arbitrator’s decision about a dispute between the MBTA and its largest union over the agency’s severely underfunded retirement fund.
- + Pioneer released LaborAnalytics, a web tool that tracks **workforce and unemployment trends** in Massachusetts and the nation. With \$2.5 billion in available funding in Massachusetts, this tool is a must for policy makers.
- + Pioneer enhanced its **340B web tool** to include legislative mapping and levels of hospital charity care, making it easier to analyze which hospitals are using the program as intended.
- + Our Pioneer Life Science Initiative won **access to records** from the Executive Office of Health and Human Services regarding the methodology used to determine drug rebates and discounts.

Government Transparency Interns

To inspire the next generation of government transparency enthusiasts, we engage summer interns to blog using MassWatch, our suite of transparency tools.



Sara Delano used our IRS Data Discovery tool to show that Massachusetts is losing residents to tax-friendly states.



Teddy Wynn used our LaborAnalytics tool to illustrate that healthcare is the biggest employer in Suffolk County.



Peter Mentekidis analyzed the tax revenue through the Massachusetts estate tax by using our MassOpenBooks site.

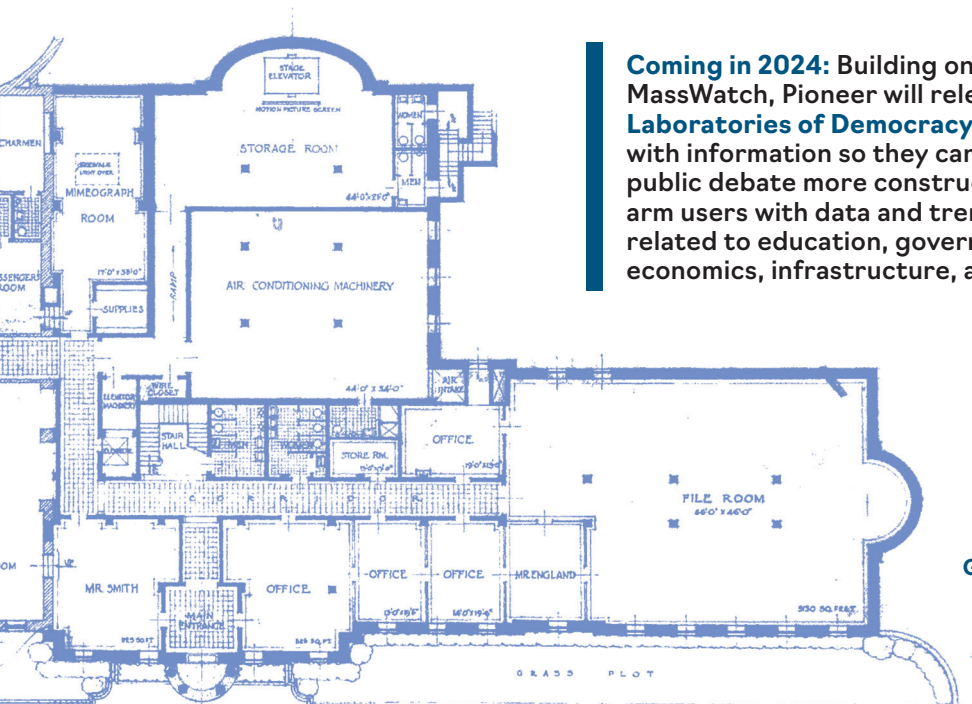

Coming in 2024: Building on the success of MassWatch, Pioneer will release a data-rich **Laboratories of Democracy** site to equip citizens with information so they can engage in the public debate more constructively. The site will arm users with data and trends from each state related to education, government efficiency, economics, infrastructure, and public safety.

Mary Connaughton
COO and Director of Government Transparency



Blueprint for Innovative Care

The Pioneer Life Sciences Initiative (PLSI) had a productive year, publishing numerous op-ed pieces on life sciences topics, and executing two major papers—the first on intellectual property rights and the second on pharmacy benefit manager (PBM) programs and practices that raise out-of-pocket drug and therapy costs for patients.

PLSI also developed and deployed a first-of-its-kind web tool that allows researchers to investigate the federal 340B Drug Pricing Program through searches of contract pharmacies, hospitals, clinics, charity care spending, and 340B resources in legislative districts.

Our staff appeared on numerous national and local podcasts, and regularly participates in task force meetings with state and national policymakers and congressional staff.

PLSI's Impact

QALY

- + Our years-long analysis of the Quality Adjusted Life Year (QALY) methodology helped, in part, spur the House of Representatives to **ban the use of the QALY** in federal programs.
- + PLSI **partnered** with Patients Rising, a patient advocacy group in Washington, DC, to distribute copies of Pioneer's book on the QALY, *Rationing Medicine*, to congressional staff and other D.C. policymakers.



Massachusetts Hospitals Pull Back on Charity Care as Revenue from Federal 340B Drug Discount Program Explodes

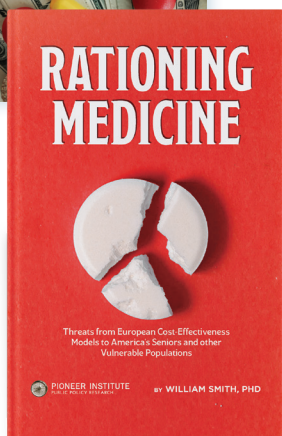

William Smith
Director of Pioneer Life Sciences Initiative

340B Drug Pricing Program

- + We provided **input to six U.S. senators** on the 340B Program and interacted with a bipartisan group of congressional staff.
- + PLSI staff appeared at numerous events to brief patient groups, legislators, and others, joined a 340B work group in **Connecticut**, and attended a patient advocacy summit sponsored by Novartis in Cambridge, **Massachusetts**, and the American Legislative Exchange Council meeting in **Arizona**.
- + Dr. William Smith further educated **Michigan** legislators on 340B, partnered with the **Kansas Policy Institute**, conducted a podcast with the **Rhode Island Center for Freedom**, and continues to collaborate with an **Ohio Pharmacists Association** on PBM practices.
- + PLSI held the first **Pioneer Institute event** in our new **Washington, DC, office**. Policymakers were on hand for the unveiling of our new 340B web tool that can be used to identify how many 340B pharmacies operate in each state and the relative affluence of the communities they serve.

Pharmacy Benefit Managers

- + PLSI's paper on **accumulator and maximizer programs** helped lead numerous states to place a ban on PBM programs that increase out-of-pocket costs for patients.
- + We briefed numerous patient groups about the findings of our study and published multiple op-eds critical of **price control provisions in the Inflation Reduction Act** and the **likely impact** of those controls on the **Massachusetts economy**.

Price Transparency

In addition to our life sciences work, PioneerHealth focuses on consumer health topics within Massachusetts. In November 2022, we issued a white paper summarizing Massachusetts hospitals' compliance with federal price transparency legislation.

- + Our work found that information required by law to be made available to consumers was **unavailable at seven of the 19 hospitals** we surveyed. Compliance with mandatory price information for some 300 shoppable services ranged from 60 percent to 97 percent.
- + Pioneer's work has revealed that **vast pricing disparities continue to exist**, with Massachusetts institutions charging from under \$1,500 to nearly \$5,300 for an MRI brain scan. We found abdominal ultrasound costs ranged from \$374 to \$1,663, while an MRI of a leg joint varied from under \$775 to more than \$3,400 at facilities less than 10 miles apart.

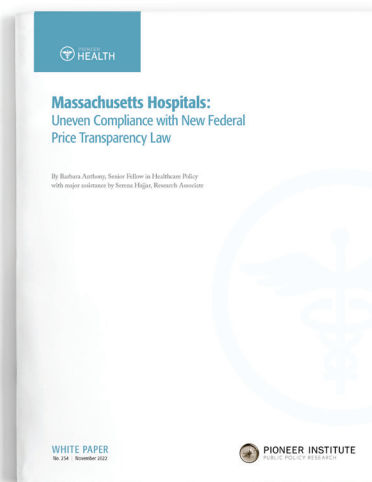

In a market dominated by systems that are able to maintain prices above competitive norms, Pioneer urges that hospitals and medical systems **designate an administrator responsible for compliance** with federal price transparency rules. Moreover, Massachusetts should **create incentives for hospitals to comply** with state and federal price transparency laws, while the federal government should guide hospitals on making **websites consumer friendly** – and **step up compliance actions** when their efforts fall short.

“The government is a very blunt instrument, and sometimes an objectively wrong instrument, when they try to make market-based decisions about prices and things that exist in the commercial marketplace.”

– Dr. William Smith in the Hubwonk podcast

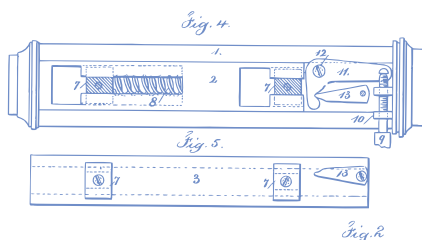
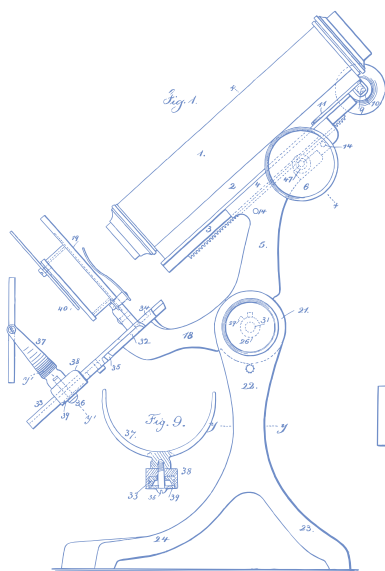

Coming in 2024: PLSI will research the effects of the **Inflation Reduction Act** on the life sciences ecosystem, including its impact on the biopharma marketplace, commercial prices, R&D, employment levels, and clinical trials. We will also explore **international price comparisons, biopharmaceutical competition** and branded drugs, and **gene therapies**.



Barbara Anthony
Senior Fellow in Healthcare

Blueprint for Massachusetts' Competitiveness

The passage of the 2022 tax hike ended Massachusetts' three-decade political consensus that the state would shed its Taxachusetts moniker and leverage its talent advantages to grow businesses and jobs.

In the post-pandemic, post-2017 Tax Cuts and Jobs Act world, state competition for business and talent has intensified. While California, Massachusetts, and New York raised *income* taxes, 25 states lowered them. Add to that the hypermobility of work, and we have a talent problem.

Competitive on Costs

- + **Debunking Tax Migration Myths** found that the top one percent of taxpayers, who are highly mobile, pay a quarter of Massachusetts income taxes and that Massachusetts was losing population.
- + A follow-up study underscored Massachusetts' long-term **trend of net wealth out-migration** to no-income tax states like Florida and New Hampshire. With in-migration not keeping pace, in number or wealth, the loss of high earners, and deterioration in state revenues, is accelerating.
- + **Tax Reality Sets In** explored the new reality of state competition. Massachusetts families and businesses, especially the affluent, were relocating on a net basis at five times the rate of a decade ago. The biggest losses in Adjusted Gross Income (AGI) were among residents aged 55–65, influenced by the Commonwealth's onerous estate tax, and ages 26–35 because of the ubiquity of remote work options and Massachusetts' high housing costs.

Massachusetts net AGI & tax filer out-migration (inflow–outflow), by tax year

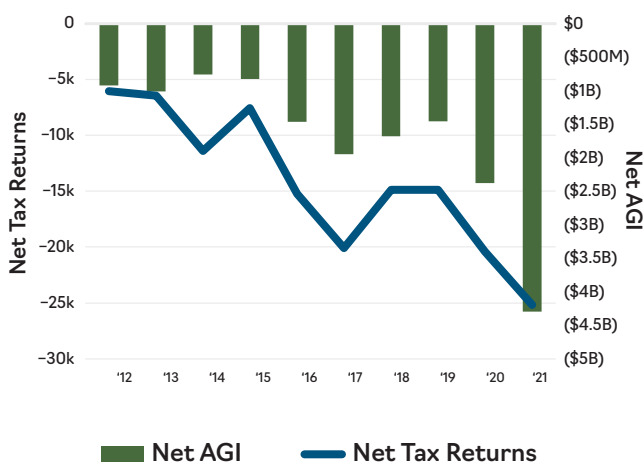

Source: <https://massirsdatabiscovery.com/tax-payer-migration>

- + Pioneer provided analyses on key provisions of tax reform proposals from the Governor, House, and Senate. The resulting **minor tax reform** moved Massachusetts from having the most to the third most onerous **estate tax** in the country, and from the highest to the second highest **short-term capital gains (STCG) tax**. (Most states don't have an estate tax or tax STCG at a higher rate than ordinary income.) Massachusetts joined 39 other states in adopting the **singles sales factor**.

► See **U.S. Auto Parts Network, Inc. v. Commissioner of Revenue**, pg. 14

Talent Pipeline

Massachusetts lives and dies on its ability to develop and recruit talent. In addition to our work on vocational-technical schools, Pioneer focuses on providing data to the business community and advancing reforms in the area of workforce training and unemployment insurance.

- + Aidan Enright's **annual Massachusetts labor market trends highlighted further declines** in labor participation, especially among 25- to 54-year-old men, and policy options to expand our talent pipeline.
- + In *Massachusetts' Workforce Training Infrastructure*, Eileen McAnney demonstrated that Massachusetts spends \$2.5 billion on **workforce training** and indicated how to spend that money effectively, to the benefit of employees, employers and the state.
- + McAnney and Karen Andreas, president of the North Shore Chamber of Commerce, developed a proposal to address the high cost of **unemployment insurance** and encourage those collecting benefits to return to work.

Catalytic Role of Immigrant Entrepreneurs

Immigrant entrepreneurs play a significant role in America's economic growth and innovation, establishing new businesses at double the rate of the rest of the population. In Massachusetts, half of all biotechnology companies have been established by immigrant entrepreneurs.

In 2023, Pioneer launched the Program on Immigrant Entrepreneurship (PIE)—an initiative encompassing research, communications, legal action, partnerships, and events to promote the catalytic role of first-generation entrepreneurship and the power of free markets to improve lives. Our initial goals are to reduce the licensing and regulatory burdens on “neighborhood” (e.g., childcare, beauty, landscaping, construction) businesses and re-establish English immersion as a central policy goal.

+ After launching with *A Comprehensive Review of Immigrant Entrepreneurship*, Aidan Enright and Josh Bedi authored *Immigrant Entrepreneurship in New England*, finding that New England’s immigrant entrepreneurs tend to be self-employed, own businesses in different industries, and have higher or lower levels of formal education than U.S.-born entrepreneurs. They open “neighborhood” businesses and high-growth businesses in fields like technology at higher rates than U.S.-born entrepreneurs. And they struggle with occupational licensing regulations, particularly in low-skilled occupations where safety and consumer protection don’t warrant the restrictions.

► See *Norvella Hill-Junious v. UTP Realty LLC*, pg. 14

“The fact that we have so many restaurants in the neighborhood, if it wasn’t for immigrants, there wouldn’t be those restaurants.”

— Brad Brown, Owner, Blue Frog Bakery, Jamaica Plain

Housing

In Massachusetts, high housing costs discourage talent recruitment, price younger and middle-class families out of the housing market, and contribute to rising homelessness. The competitiveness challenge from lower cost states—which are more welcoming to new housing construction—is clear.

+ The Healey Administration embraced our proposal to support the growth of “in-law” apartments, or **accessory dwelling units**, by 8,000 new units.

► See *Reagan v. Commissioner of Revenue*, pg. 14

► See *Tyler v. Hennepin County*, pg. 14

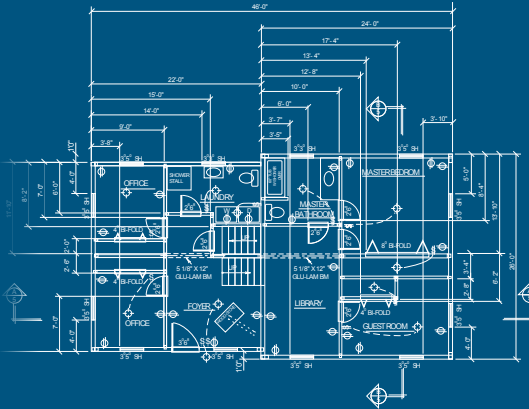

Coming in 2024: Pioneer will continue to raise the alarm on out-migration and Massachusetts’ **competitiveness**, advance proposals on our **talent pipeline**, and commission **housing** research on rent control and the MBTA Communities Act. On **immigrant entrepreneurship**, we will focus on international students, and the Law Center will challenge the legality of Massachusetts’ occupational licensing practices.

Aidan Enright
Research Associate



Eileen McAnneny
Senior Fellow in Economic Opportunity



Blueprint for Justice

In a nation founded upon the rule of law, justice too often remains out of reach for those individuals and families who may lack the resources, knowledge, or connections needed to enlist the help of powerful legal advocates.

Pioneer Public Interest Law Center (PPILC) was founded to help defend educational opportunity, promote transparent and limited government, and defend free markets – for all. We are proud of our success in winning major legal cases.

Equal access to educational opportunities

Access to good schools – and the right school for your child – is not only for the wealthy and well connected, but for all. It is the key to the functioning of a free and merit-based society.

- + **Ensuring opportunity in school sports:** When the Massachusetts Interscholastic Athletic Association barred virtual school students from playing sports with teams in their hometowns, PPILC intervened and forced MIAA to let them play.
- + **Violence in our public schools:** When school is disrupted by fighting among students or with teachers, all hope of a positive learning environment is lost. The Law Center has successfully required the Boston Public Schools to provide records of such behavior to an investigative journalist.

American Citizenship

Free speech is the first freedom. No democracy is workable without it. Nor is democracy workable when the government keeps information from the people, which is why we are committed to keeping government transparent, limited, and accountable.

- + **Landmark free speech victory:** In March 2023, the Massachusetts Supreme Judicial Court ruled in *Barron v. Kolenda et al.*, that municipal civility codes for participation at town meetings violate citizens' constitutional rights. The Law Center filed an *amicus brief* that was cited in the opinion.
- + **Enforcement of Public Records Law:** In several cases, including several litigated in the Superior Court, the Law Center has represented individuals against the Massachusetts Bay Transportation Authority, Massachusetts Department of Revenue, and others to ensure compliance with public records laws and access to such records.



Board of Directors

- | | |
|---------------------------|--------------------|
| Brackett Denniston, Chair | Ernest Haddad |
| Jonathan Albano | R. Scott Henderson |
| Henry Butler | Frank Jimenez |
| Hon. Robert Cordy (ret.) | Mark Matuschak |
| Stephen B. Darr | Bill McQuillan |
| Stephen D. Fantone | Lisa Rickard |
| Lena Goldberg | Stan Twardy |

“Those who have been harmed by unconstitutional or arbitrary actions of government may often feel powerless to fight back. But PPILC’s mission is to show plaintiffs how their courage, tenacity, and adherence to principles can result in legal victories, including in the highest courts in the nation.”

– Hon. Frank J. Bailey (ret.), President, PPILC



KEY SECTION NTS

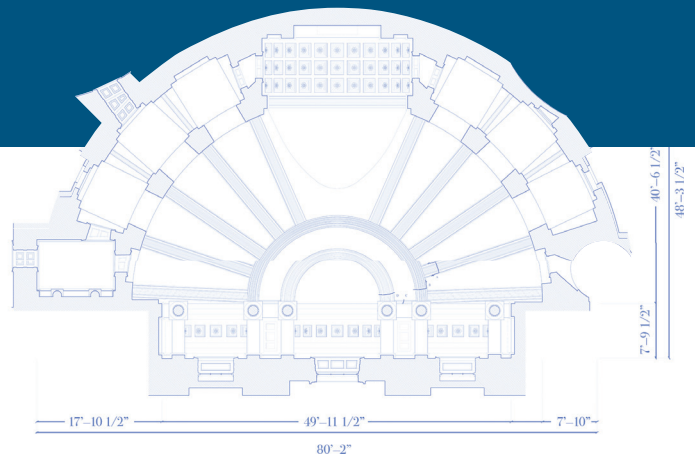



“ This is a situation that I view as government overreach of all things. Government taking family wealth away from people.”

– Hon. Frank J. Bailey (ret.), President, PPILC



Free Markets

Economic freedom provides the greatest opportunity for all. We are committed to making sure they are especially free from unwarranted intrusion for those who are disadvantaged and seeking to rise economically in America.

+ **Stopping retroactive application of tax policy changes:** In *U.S. Auto Parts Network, Inc. v. Commissioner of Revenue* the Law Center’s brief helped ensure a decision that retroactive application of tax policy changes are legally impermissible.

+ **Protecting a developer’s tax concession:** In *Reagan v. Commissioner of Revenue*, the Law Center successfully advanced before the Massachusetts Supreme Judicial Court the view that Department of Revenue decisions eliminating property tax breaks for the creation of affordable housing will lead to less housing development, a critical policy mistake under current market conditions.

+ **Defending immigrant entrepreneurs:** In *Norvella Hill-Junious v. UTP Realty LLC*, the Law Center filed a brief in support of a successful Vietnamese immigrant entrepreneur’s claim that she could not be held responsible for third-party crime near her business property. The Court agreed, citing our argument that to find otherwise would disadvantage immigrant entrepreneurs who frequently invest in higher crime areas. The decision saves small business owners thousands of dollars in insurance premiums and possible catastrophic liability.

+ **Ending home equity theft:** In *Tyler v. Hennepin County*, the Law Center filed an amicus brief with the U.S. Supreme Court in support of homeowners’ rights to their hard-earned equity; the high Court agreed with the Law Center in a unanimous opinion that municipalities taking taxpayers’ entire equity in tax foreclosure cases is an unconstitutional taking. In subsequent actions, the Law Center has sued to protect generational wealth of clients by applying the *Tyler* decision in Massachusetts through both legislation and judicial decisions.

Coming in 2024: PPILC will bring education cases on school choice and civics, continue to press for greater access to public information, and challenge excessive occupation licensing practices in Massachusetts.

+ **Potential challenge to new septic regulations:** With Sidley, Austin and the New England Law Foundation, the Law Center is challenging June 2023 amendments adopted in violation of the state’s own regulations and administrative law which will force homeowners to incur hundreds of thousands of dollars in septic system upgrades and have little, if any, impact on improving coastal waterways.

The Honorable Frank J. Bailey (ret.)
PPILC president



Challenging Conventional Thinking & Promoting Open Dialogue

At a time in our nation's history where reasoned and respectful dialogue is in short supply, Pioneer Institute continues to set the standard for vigorous, fact-based discussion and debate. In 2023, we convened in-person and virtual events that explored leading questions around education, law, economics, and race. Our goal remains as simple and important as ever: Promoting the respectful exchange of ideas that challenge conventional wisdom while pointing to the value of the greatest traditions of American democracy.

The Lovett C. Peters Lecture

Stronger Together: Glenn Loury's Call for Unity and Common Ground

Economic theorist **Dr. Glenn Loury**, Merton P. Stoltz Professor of Economics at Brown University and host of *The Glenn Show*, delivered the keynote address at Pioneer's 2023 Peters Lecture on November 16, 2023.

- + "America could be stronger if we focus more on what we have in common instead of what divides us," Loury declared.
- + "I believe, however," Loury told the Pioneer audience, "there are those who make a living by focusing on our differences, by claiming that there's something fundamentally wrong with America. These people are in error, and that error threatens to tear us apart. They must be opposed forthrightly—and that is my purpose here."



Reasonable Minds Can Differ

A Discussion of Key Cases Before the U.S. Supreme Court in the 2022–2023 Term

On March 1, 2023, Pioneer Public Interest Law Center partnered with the Federal Bar Association and the Social Law Library to present a robust discussion of several major cases before the U.S. Supreme Court in its 2022–2023 term. Professors Jessica Silbey and Gary Lawson of the Boston University School of Law provided insights about cases involving a wide range of issues that are critical to American law and society.

The cases they examined included *Tyler v. Hennepin County*, a Minnesota case testing the constitutionality of a state law that allowed properties to be sold for back taxes, leaving the homeowner without any equity. This past spring, the Supreme Court unanimously struck down that law, casting doubt on a similar law in Massachusetts.

PPILC President Frank Bailey noted that the sophisticated and entertaining program was akin to a "free year of law school" for the nearly 100 attendees. It was also a priceless lesson in the value of reasoned, civil discourse—one that PPILC intends to continue each year. PPILC also sponsored a program on efforts by retired Massachusetts Supreme Judicial Court Justice Robert Cordy and others to promote the rule of law and judicial reform in Ukraine.

Webinars: Promoting Freedom & Choice in Education

In today's multimedia world, spreading the word about educational choice and freedom demands more than traditional approaches. In addition to research papers, op-eds, and *The Learning Curve* podcast, Pioneer Institute in 2023 sponsored education webinars on school choice, vocational-technical education, microschools, and the remarkable work of *The Concord Review*.

- + PioneerEducation Presents Education Innovations: Microschooling
- + *First Things Webinar: Vocational Technical Education*
- + Pioneer's Webinar Series: U.S. History and Civics
- + *Restoring the City on a Hill: U.S. History and Civics in America's Schools Webinar*
- + Education Innovations: Microschooling, Pods, and Homeschooling
- + Pioneer Institute's Virtual Policy Briefing: U.S. History for High Schoolers



Building Audiences Across the New Media Landscape

The digital revolution may have long ago fractured traditional media markets, but consumption of media continues to grow, including on alternative channels, social media, radio, TV, streaming services, podcasts, online platforms, and subscription newsletters. Even in the new media landscape, the challenge for Pioneer Institute remains the same – communicating our message of quality education, free markets, and government that is limited, open, and responsive.



“ People are still being hurt. And it's important for [the state] government to act.”

– Frank Bailey, President, PPILC on Beacon Hill's failure to act after the *Tyler v. Hennepin County* ruling

“ My point with the classification is not that we never have any reason to ever classify anybody... but it has to be logical. It has to be geared towards what you're trying to do.”



– Donald Graham on *The Washington Post* and the role of traditional newspapers in a new media age, on The Learning Curve podcast.

“ And in the pursuit of truth, the newspapers will be prepared to make sacrifice of its material fortunes if such course be necessary for the public good.”



– David Bernstein, author of “Classified: The Untold Story of Racial Classification in America,” on the Hubwonk podcast

By the Numbers

Google Impressions:
5.5M

Website Page Views:
470K

Podcasts:
112 Episodes
323K Downloads

Social Media:
3,057 Posts
4.6M Impressions

“ In the face of desperate need for innovative healthcare solutions, many state leaders are inexplicably dropping the ball on telehealth.”

– Josh Archambault, Senior Fellow at Pioneer Institute



“ At a time when the MBTA faces declining ridership and growing deficits, taxpayers deserve to know about the additional threat the pension fund poses to the T's fiscal stability.”

– Jim Stergios, Pioneer Executive Director



“ The IRA creates a disincentive to invest in the research and development of small molecule drugs – a move that is antithetical to curing cancer.”

– William Smith, Director, Pioneer Life Sciences Initiative



Donors 2023

Pioneer Institute and Pioneer Public Interest Law Center are deeply grateful for the generous Board of Directors, individuals, corporate partners, and foundations who support our work and mission.

The following list recognizes those donors for their support of Pioneer Institute from October 1, 2022 – September 30, 2023.

+ Peters Society

Michael Brown
Christopher & Ellen
di Bonaventura
The Flatley Foundation
Ellen & Bruce Herzfelder
Anonymous
Johnson & Johnson
Holly & Bruce Johnstone
**The Lovett & Ruth Peters
Foundation**
The Ladera Foundation
Pfizer Inc.
Adam Portnoy
Roger & Kristin Servison
Maria & Ray Stata

+ Founders

Jane & Steve Akin
The Lynde & Harry Bradley
Foundation
The Irene E. & George A.
Davis Foundation
The Educational Promise
Foundation
Lucile & William Hicks
The Lynch Foundation
George H. & Jane A. Mifflin
Memorial Fund
Geoffrey Rehnert
Robert L. Reynolds
Mark & Lynne Rickabaugh
The Roe Foundation
Sarepta Therapeutics, Inc.
**Diane & Richard
Schmalensee**
Brian Shortsleeve
The Sidney A. Swensrud
Foundation

+ Chair's Circle

Brian C. Broderick
Gary & Emma Campbell
**Frederic & Barbara[†]
Clifford**
The Adolph Coors
Foundation
**Andrew Davis & Florence
Bourgeois**
Drew Davis
Anonymous
Michael Fish
Charles & Theresa Hewitt
Mike Kennealy
David McGrath
**Mr. & Mrs. John J.
Remondi**
**Cynthia & Grant
Schaumburg**
Peter & Sally Wilde

+ Trustees' Circle

Nancy Anthony
David & Arisa Boit
**Arthur D. Clarke &
Susan P. Sloan**
Cohen Family Fund
Victoria & David Croll
Anonymous
William Edgerly[†]
**Stephen & Elizabeth
Fantone**
**Sandra & M. Dozier
Gardner**
**Peter Goedecke &
Pamela Ireland**
Lena Goldberg
R. Scott Henderson
Alfred & Patricia Houston

William Hunt
Harvey Hurvitz
John E. & Sue M. Jackson
Charitable Trust
Sara L. Johnson
James L. Joslin
Amelia & Joshua Katzen
Brian Kavogian
Pamela & John Layton
Shawni Littlehale
Caleb Loring III
Paul & Anne Marcus
Josie & Jon Marston
Mark Matuschak
William McQuillan
Tish & Steve Mead
**Brigitte & Gerard
Moufflet**
Margaret & William Paine
U.S. Chamber of
Commerce
Richard Spillane
Anonymous
**Mary McFadden &
Lawrence Stifler**
Jeffrey Thomas
Patti & Paul Verderese
Carlo & Hillary von
Schroeter
Landen Williams

Sincerely Grateful

Pioneer wishes to recognize our longtime supporters, listed in **bold**, for their ongoing contributions over five or more consecutive years.

+ Pioneers

Bank of America Corporation
 Kate & Ed Cahill
 Stephen Darr
 Robert A. & Jo Ellen M. Davidson
David & Kathy Dietz
Robert & Happy Doran
 Daniel Flatley
 John Garbarino
 Deborah Hale
 Richard Henken
Bob & Kristine Higgins
William Hoskins
 Anonymous
 Frank Jimenez
 Robert & Jane Lewit
 M. Holt & Sandra Massey
 The Norfolk & Dedham Group
Virginia & George Parker

Paul Russell
Lenoir Charitable Trust
Ross Sherbrooke
Mary & Ted Wendell

+ Benefactors

Pascal Aguirre
Jeff & Larisa Alpaugh
 Kieran Anderson
Judy Bevis & Ron Brooks
 David K. Blakelock
Toby Burr
Robert Carpenter
Doug Chamberlain
Sandy & Doug Dapprich
Stephen Davis
 Sean Deakin
 Anonymous
 Edie & Ted Devnew
Duane R. Downey
Excelsior Foundation

Rick & Lisa Frisbie
Janie & Steven Hoch
 Matt & Jenna Jordan
 Anonymous
Katharine Myers & Robert Kretschmar
 Steve Kuuskvere
 Patsy Lawrence
 Charles Mangum
Walker Martin
 Stephen Neff
 Christopher Oddleifson
Karen & David Parker
 F. Robert Parker
 Roger Scoville
James Stergios
Gregg & Lisa Stone
 Stan Twardy
David Walker
 John Newton & Janice Weber

Pioneer Institute, Inc. is a tax-exempt 501(c)(3) organization. To ensure its independence, Pioneer does not accept government grants. † Indicates donor is deceased.



An Enduring Legacy **William S. Edgerly**

From the very inception of Pioneer, former State Street CEO and chairman, Bill Edgerly, was an unwavering advocate for educational choice and academic quality. As a founding member of Pioneer's Board of Directors, he maintained a close relationship with the Institute for over three decades.

Despite his passing in May 2023, Bill's impact on Pioneer continues. His thoughtful inclusion of the Institute in his estate plan will sustain the mission he helped shape.

In profound gratitude for Bill's enduring dedication, Pioneer remains steadfast in its commitment to providing high-quality educational opportunities for all students, regardless of zip code. As we reflect on his extraordinary contributions, we are proud to carry forward the torch of his tenacious pursuit of educational excellence.

We at Pioneer are grateful for his life and will miss his resolute spirit and friendship.

+ Members**Peter Alcock**

Bryan Austin

Eric & Sally Bacon

Carter & Peggy Bacon

Edward & Elizabeth Baldini

David A. Barrett**Gordon Bennett**

Gary Blank

Katie & Maxwell Bleakie

Richard Bowers

Rob & Nancy Bradley**Catherine Brigham****Paul Buddenhagen**

Julie & Lyman Bullard

Richard Burnes

Beth Campanella

Vera M. Trojan &

Mark P. Carthy

Con Chapman

John & Jean Childs

William H Claflin, IV

Charles Clapp

Dr. & Mrs. Melvin E.

Clouse

Mary Connaughton**Nancy & Lawrence****Coolidge**

Bank of Canton

Howard Cox

Jack Creighton

Bob & Ruth Crocker

Michael F. Cronin

John Cross

Mr. J. Timothy Deakin

Mrs. Edwin J. Delattre

Thomas Demakes**Thomas DeSimone**

Elizabeth Harmer Dionne

Susan & Digger**Donahue**

Michael D'Onofrio

Walter Donovan

Paul Downey

William Ebsworth

Steven Eimert

Alex Fak

Brecht Feigh

T.J. Fitzgerald

Fred K. Foulkes

Thomas Frongillo

Darius Gaskins

Wayne & Marilyn Gass

George Gebelein

Melissa & Jim Gerrity

Scott A. Gieselman

Michael Giunta**Patrick Good**

Preston & Susan Grandin

Liah Greenfield

Gale R. Guild

Michele Hanss

Barbara Hawkins

Randolph Hawthorne

William Hayes

Tim & Mary Hegarty

Paul Henderson**Bill Heuer**

Drs. Fred & Carol

Hochberg

Howard Hodgson

William Hogan**James Hollis**

Jim & Bess Hughes

J.C. Huizenga**Andy Hunter**

Jill & Rob Inches

Kathleen & Robert Ix

Stephen B. Jeffries**Arthur & Abby Kalotkin****Robert S. & Ellen L.****Kaplan**

Gary & Susan Kearney

Tim Kickham

Drew M. Leff**Sandy & Eileen Leith**

Meg Lilly

Longfield Family

Foundation

Elizabeth & Robert**Loring**

Martin W. Lynn

Richard Lyon

Spencer Macalaster

Nicole & Shaun Manseau

John Markowitz

Kevin Martin

Stephen J. McCarthy

F. Warren McFarlan

Colin & Anne McNay

Brian McRoskey

Laura B. Monrad

John Morris

Cecily & Alan Morse**W. Hugh Morton**

Avi Nelson

Dick Nestle

New Jersey Dental Association

Andy Offit**Robert A. O'Neill**

Thomas Palmer

Joseph Pasquale**H. Bradlee Perry†****David & Julie Perry****Ruth "Binky" Peters****Stephenson**

Greg Petrini

Elizabeth P. Powell**Harold I. Pratt**

Daniel Rasmussen

Lawrence Reilly

John M. Reynolds

Lynn & Bill Rice

Cathy & Thomas

Rogerson

Kenneth Rossano**Vicki & Westy****Saltonstall****Lee Sandwen**

Catherine A. Saunders

Kurt Schwartz

David Scudder**Jeremiah & Lorna****Shafir**

Peter Sheridan

Dr. Daniel J. & Suzanne Sigman

Larry & Debbie

Silverstein

Mark Snyderman**Ariel Soiffer**

Vivian & Lionel Spiro

Fredericka &**Howard Stevenson**

Campbell Steward

R. Newcomb Stillwell

Donna & Robert Storer**William S. Strong**

Carlota & Marshall

Taylor

Richard Thompson

Michael & Nancy Tooke**John M. Truelove****Margaret Tyler &****Lee Rubenstein****David Wakefield****Monte Wallace**

Walter & Kathy Weld

Frank Wezniak**Stephen H. & Virginia S. White**

Ruth Anne & Pendleton White

Pamela Steele White Foundation**Alice & Christopher White**

Joseph Wickwire

Dudley H. Willis

Robert & Kathryn

Windsor

Jeffrey Witherell

Richard S. Wood**+ Friends****Elizabeth & Oliver Ames**

Pamela Anderson

Anonymous

Chris & Trish Arnold

Elizabeth & Mark Baker

Jack & Louise Barron

Christopher Barrow

Anonymous

Anonymous**Barbara Baskin-Bowen****Natalie Bassil**

Catherine Batcheller

Peter Nils Baylor**David Begelfer**

David Berkland

Mary Jean & Bill**Blasdale****Roger Blood**

John Blute

Barbara Buell

James Bush

Henry Butler

John Chambliss

Mark Chernin**Walter Ciesluk****Edward Corcoran**

Lauren Corvese

Don Crawford**Philip L. Cunningham**

Herbert P. Dane

Nijan Datar**Thomas Davis**

Mary Dearborn

Dr. Anthony M. &**Paula L. DeMarco**

Pioneer Institute, Inc. is a tax-exempt 501(c)(3) organization. To ensure its independence, Pioneer does not accept government grants. † Indicates donor is deceased.

Robert A Dempsey**Mr. John B. Dirlam****Christine Don**

Charles Donahue

Doran Donovan

David D'Orlando

Maria Dow

Joseph D. Downing

Bob Dumont

Mr. & Mrs. James

F. Dwinell Jr.

Chip & Jane Elfner

Kate Feinstein

Janet & Jim Fitzgibbons

Benjamin Flax

Joseph Flynn

Richard Forte

Frank Gallagher

Arthur Gandt

Dale & Robyn Garth

Debbie Gates

Brian Golden

John Goldrosen

Susan Goldsmith

Bruce Goodman

Bruce W. Graham &

Ann Buchanan

Dr. Robert Guen

Ernest M. Haddad

Matthew Haddad

Robert Hall

Kevin F. Hampe

Richard Hardy

Michael Hart

Daniel Hartman

Eric Haskell

Ryan Hayden

Candy Haydock

Robert Hayes

Penny & Mike Herlihy

Walter Hess &**Janice Cane****Jen & Colby Hewitt**

Phyllis Hollis

Andrew Horgan

Laura Howard Kilfoyle

Richard Hoyer

Nina & Ogden**Hunnewell**

Richard Ivance

Micah Q. Jones

Robert Jones

Michael Kane

Ben Karlin

Sumner Kaufman

Daniel Kelly

Irving Kempner

John Keough

Martha King

Brian Kors

Stanley Kruszewski

Dennis Langwell

Mr. & Mrs. David S. Lee

Mark Leff**Stephen Lindsay****Catherine Lynch**

Emmett Lyne

Marmee Lyon

Eli Manchester

Kathleen Mann

Henry Marcy

Louis Maret**Larry Marks****Peter Mawn**

Craig McGraw

Anonymous

Marc Miles

John R. Milligan

Bruce H. Minevitz

Bri Mirabile

Sandra O. Moose

Timothy Morello

James Morgan

Fred and Liz Morris

Dr. J. Keith Motley

Kenzie Mucci

Samuel Mullin**Carl Narsasian**

Wojciech Numrych

Thomas O'Donnell

Bobbie & Chip O'Hare

Doris O'Rourke

Vincent Osterman

Lawrence O'Toole

Steve & Kit Palenscar

Brainard Patton

Anonymous

James Pelagatti**John Pepper**

Ronna Perlmutter

Mr. & Mrs. Samuel D.

Perry

R. Adams Perry

Harold Petersen

Karen & Matt Pierce

Anonymous

Theodore Pietras

Daniel Polvere

Chris & Sarah Pope

Michael Potaski

Ute & Patrick Prevost**David C. Quade**

Anonymous

Kenneth W. Rendell

Stephen D. Rice

Sarah & Drake Richey

Janet Day Richey**Stephen Richter****Karl Riemer**

Bob Rivers

Gerard Robinson

Mark Robinson

Mary & Dean Rogeness

Matthew Rogers

William E. Russell

Bob & Susan Ruzzo

Maurice Samuels

Brian P. Senier

Nancy Simonds &**Bruce Shaw****William Sherwin**

Harvey Silverglate

John Sivoletta

Peter Skerry

Edwin Smith

Thurman Smith

Steve Snider

Jim Spady

John Spring

Charles Stones

Richard Swasey

Edwin Taff

Anonymous

Andrew &**Christine Taylor****Joan I. Thorndike**

Ann Connolly Tolkoff

Constantine Tsomides

Jim Tuite

Guillermo Vicens

Karen Walker Beecher

Frederick Waterman**Kurt Weisenbeck****Beth & Scott Westvold**

David Winship

Ze'ev Wurman[†]

Charles Zabriskie

“

Education is the key. When I was recently asked why I make Pioneer a philanthropic priority, it all came back to the importance of making a great education possible for kids regardless of where they live. Having grown up in St. Louis, I saw firsthand the transformative impact a strong education can have on someone's life. Pioneer is a proven leader in developing innovative approaches to K–12 education, and I know my support has a direct impact on the future of kids across the country.”

**Andrew Davis**

Board of Directors

Financials 2023

Financial Structure

The 2023 financial results presented here reflect the consolidated financial performance of Pioneer Institute, Inc., and its affiliate, PioneerLegal, LLC, d/b/a/ Pioneer Public Interest Law Center, a not-for-profit public interest law center. Pioneer Institute and PioneerLegal (together the "Organization") are privately funded, accepting no government grants.

In the fiscal year ending September 30, 2023, the Organization received approximately \$4.4 million in contributions, with 71 percent of those without donor restrictions and 29 percent with donor restrictions. The Organization generated \$523,000 in net investment gains and income, increasing its net assets by \$894,000 during the year.

FY2023 Research Expense Distribution (\$2.46 Million)



- Pioneer Education & American Citizenship: 39%
- Pioneer Opportunity: 18%
- Pioneer Health & Life Sciences: 25%
- Pioneer Public Interest Law Center: 17%

FY2023 Expense Distribution (\$4.06 Million)



- Research Areas: 61%
- Communications: 12%
- Signature Events: 2%
- Operations: 8%
- Fundraising: 17%

FY2023 Revenue Distribution (\$4.4 Million)

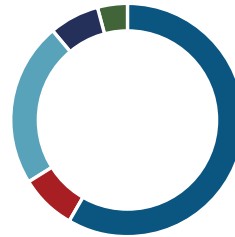

- Individuals: 59%
- Corporations: 8%
- Foundations: 23%
- Event Sponsorship: 7%
- In-kind: 4%

► See audited financial statements available at PioneerInstitute.org



You will be missed.
Linda Brown

Educator and civil rights activist Dr. Howard Fuller said it all:

“The ongoing work to change education in America over the last 30 years has produced relatively few superheroes. Linda Brown is one of them... There are now terrific school leaders all over the country because of Linda.”

Staff 2023

Pioneer Institute

Jim Stergios, *Executive Director*
Mary Z. Connaughton, *Chief Operating Officer*
Andrew Horgan, *Chief Development Officer*
Anneliese Anderson, *Development Associate*
Gauri Binoy, *Research Assistant, Life Sciences Initiative*
Katie Martinez Castellano, *Director of Individual Giving*
Avonlea Cummings, *Communications and Media Associate*
Aidan Enright, *Economic Research Associate*
Jamie Gass, *Director of the Center for School Reform*
Caitlin Marple, *Deputy Director of Development*
Meghan Mulkeen, *Digital Marketing Manager*
William Smith, *Senior Fellow & Director of Pioneer Life Sciences Initiative*

Pioneer Public Interest Law Center

Frank Bailey, *President*
John La Liberte, *Staff Attorney*

Senior Fellows

PioneerEDUCATION

Dr. Cara Candal

PioneerHEALTH

Barbara Anthony
Joshua Archambault
Robert Popovian

PioneerOPPORTUNITY

Eileen McAnney
Josh Bedi

American CITIZENSHIP

Michael Walker

Media

Charles Chieppo

Academic Advisors

John Friar, *Northeastern University*
Keith Hylton, *Boston University*
Jonathan B. Imber, *Wellesley College*
Laurence J. Kotlikoff, *Boston University*
Mark Landy, *Boston College*
Harvey C. Mansfield, Jr., *Harvard University*
R. Shep Melnick, *Boston College*
Peter Skerry, *Boston College*

Advisory Boards

PioneerEDUCATION

Dr. Kenneth Ardon, *Salem State College*
Ken Campbell, *IDEA Public Schools*
Cornelius Chapman, *Esq., Burns & Levinson LLP*
Nancy Myers Coolidge, *Mifflin Memorial Fund*
Dr. Charles Glenn, *Boston University*
Dr. Susan Goldsmith, *Boston University*
Ed Kirby, *Consultant, American Federation for Children*
Dr. Kathleen Madigan, *AccountabilityWorks*
Dr. Paul Peterson, *Harvard University*
Henry Thomas, *Springfield Urban League*

PioneerOPPORTUNITY

Chris Anderson, *Mass. High Tech Council*
David Boit, *Loring, Wolcott & Coolidge*
JD Chesloff, *Mass. Business Roundtable*
Joseph Downing, *John Adams Innovation Institute*
Peter Forman, *South Shore Chamber of Commerce*
John Friar, *Northeastern University*
Ryan Hayden, *PriceWaterhouseCoopers*
Bill Rennie, *Retailers Association of Mass.*

American CITIZENSHIP

Kelley Brown, *Easthampton High School*
Roger Desrosiers, *Massachusetts Center for Civic Education*
Will Fitzhugh, *The Concord Review*
E.D. Hirsch, *Core Knowledge Foundation*
Robert Leming, *"We the People": The Citizen and Constitution*
Anders Lewis, *Advanced Math & Science Academy Charter School*
William Mayer, *Northeastern University*
Mariam Memarsadeghi, *Tavaana: E-Learning Institute for Iranian Civil Society*
Paul Reid, *Author*

PioneerLIFESCIENCES

Dr. Ernst Berndt, *Mass. Institute of Technology*
Timothy Hunt, *Alliance for Regenerative Medicine*
Keith Hylton, *Boston University Law School*
Stephen Knight, *F-Prime Capital*
Pamela Layton, *Bioarray Genetics*
Gary Paul Magnant, *TriBiotica*
Dr. Amir Nashat, *Polaris Partners*
Brian Shortsleeve, *M33 Growth Fund*
William F. Weld, *ML Strategies, LLC*



■ PioneerInstitute.org/
2023 ANNUAL REPORT