



# ISG - Logistic and Ship Loading Solution

2019/2020 Edition

Environment, Productivity & Safety

**CAPEX or OPEX**

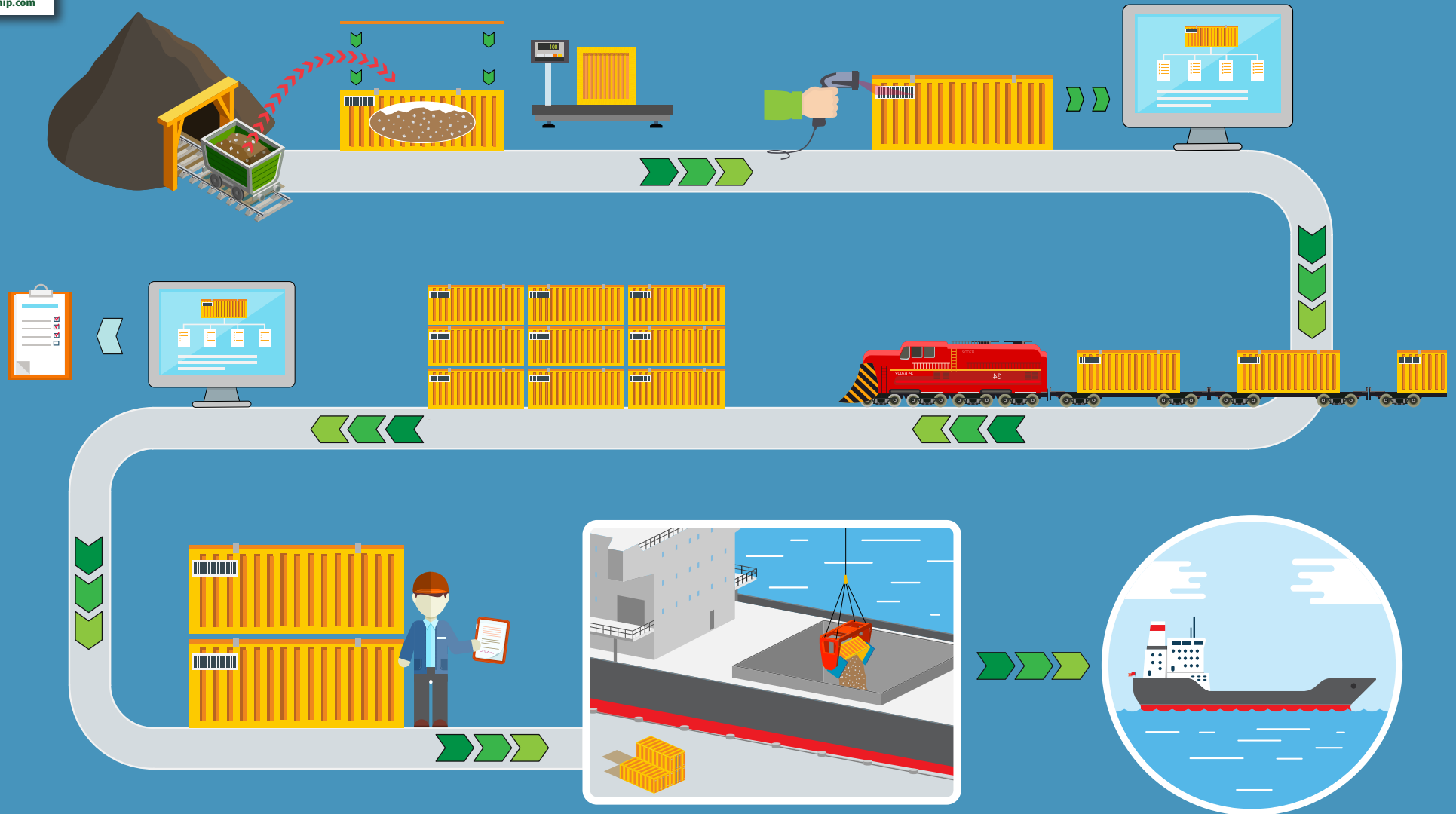

See Page 16 for more  
Information on this Process

Dust Free Logistics & Ship Loading Systems  
for Minerals, Fertilisers and Grain

# ISG - Pit to Ship Solutions™

## Table of Contents

2. Table of Contents
3. Table of Contents
4. Company Background
5. Welcome to Pit to Ship Solutions
6. Our Agents Around the World
7. Global Company, Global Presence
8. Conventional Systems
9. Containers Advantages
10. Case Study
11. Case Study
12. Converting Big Bags to Containerised Bulk Handling
13. Converting Big Bags to Containerised Bulk Handling
14. Ships Crane Operation
15. Ships Crane Operation Cycle
16. Container Blending Flow Chart
17. Introducing the CONTAINERTIPP™
18. 20' CONTAINERTIPP™ for Iron Ore with Added Payload
19. 20' CONTAINERTIPP™ for Copper Concentrates in America
20. 20' CONTAINERTIPP™ for Copper Concentrate A-TYPE
21. 20' CONTAINERTIPP™ for Copper Concentrate B-TYPE
22. 20' CONTAINERTIPP™ for Copper Concentrate
23. 20' CONTAINERTIPP™ for Copper Concentrate
24. 20' CONTAINERTIPP™ for Copper Concentrate with Heavy Duty
25. 20' CONTAINERTIPP™ for Copper Concentrate with Heavy Duty and Hatch
26. 4m CONTAINERTIPP™ for Copper Concentrate
27. Freight Car Americas - ABC Rail Wagons for Copper Concentrate
28. Introducing the ISG Combo™ Truck Trailers and Bulk Containers
29. 20' CONTAINERTIPP™ for Mineral Sands Container
30. 20' CONTAINERTIPP™ for Nickel Concentrate
31. 20' CONTAINERTIPP™ for Salt
32. 40' CONTAINERTIPP™ Multipurpose Containers
33. 20' BK2 Half Height for the European market
34. Pit to Shed Solution
35. Pit to Shed Solution



**Container Designer Matthew Chalmers with the first ISG - Pit to Ship containers delivered into the USA**

# ISG - Pit to Ship Solutions™

## Table of Contents

- 36. Fertilizer Grade Containers
- 37. Fertilizer Grade Containers
- 38. Food Grade Containers
- 39. 20' CONTAINERTIPP™ for Grain
- 40. Tippler Friendly Grain Hatch Container
- 41. Self Aligning System (SAS)
- 42. Introducing the FLEXITOP
- 43. FLEXITOP – Multipurpose – Pallet Wide
- 44. FLEXITOP – Bulk Grain
- 45. FLEXITOP – Sulphur

- 46. FLEXITOP – Salt
- 47. FLEXITOP – Bulk Coal
- 48. FLEXITOP – Ore Container
- 49. 20' Bulk Open Top Containers for End Tipping
- 50. 20' Bulk Open Top Containers for End Tipping
- 51. Standard Bulk Containers
- 52. Bulk - Smooth Wall and Paper Friendly
- 53. Coke and Anode Bulk Containers
- 54. 20' Scrap Steel and Waste Containers
- 55. Introducing Specialised Tanks
- 56. LNG Tanks
- 57. LPG Tanks
- 58. Consultancy
- 59. DCN Environmental or Safety Award
- 60. ALABC Business Excellence Award
- 61. NSW Environment Export Awards
- 62. Sponsorship - Don Orione in Antofagasta, Chile
- 63. Sponsorship - Zirik School, Tanzania, Africa

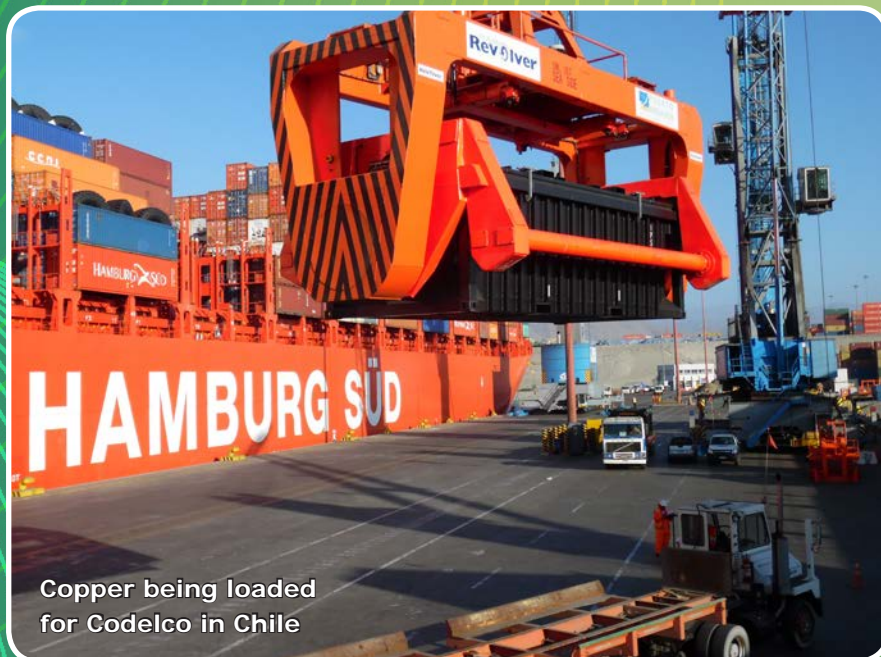

Copper being loaded  
for Codelco in Chile

# ISG - Pit to Ship Solutions™



## Company Background

For the past 10 years our business has been called Intermodal Solutions Group (ISG) . ISG has become the largest supplier of tippler friendly containers in the world. Due to ever changing global demand for our products we are now a true global company with a team of agents around the world.

Having this presence in the global marketplace we have decided to change our logo and our name to suit the global demand in the mining and grain sector. Our old logo of the Kookaburra sitting on a branch is still on thousands of containers we have supplied into the global market. We will eventually be easing this iconic logo out and phasing in the new logo.

Our new logo depicts a tippler turning a container loading the different types of commodities we have designed the containers for. The logo was designed by Tom Cunningham and was chosen from a large group of logo designs.

Our name **Intermodal Solutions Group (ISG)** has been changed to **Pit to Ship Solutions™** for marketing purposes only. ISG will still be the commercial company linked to the new marketing name. So new name , new logo but same friendly service and professional designs. We are now ISG trading as Pit to Ship Solutions.

# ISG - Pit to Ship Solutions™



Garry Pinder - Managing Director  
Pit to Ship Solutions™ - Australia  
Contact: +61 400 035 548



## Welcome to Pit to Ship Solutions

Thank you for taking the time to allow us to introduce the '**DUST FREE PIT TO SHIP SOLUTION**'.

Two international companies have combined their expertise to provide an environmentally sustainable pit to ship mining and grain solution.

**INTERMODAL SOLUTIONS GROUP (ISG) now trading as Pit to Ship Solutions™**, has designed specialised containers for commodities to transport products from the mine site to the ship's hull. These containers are also used as storage sheds providing a dust free environment.

**RAM SPREADERS** have designed four models of revolving spreaders named '**Revolvers**' because of their fast turning action. The four different tippler types allow the containers to be rotated either by ships crane, port crane or reach stacker.

ISG licences their patented lid lifter to RAM spreaders, the patented lid lifter allows the customer to have the lid lifted inside the ship's hull, in conjunction with a water suppressant, providing a dust free environment giving this process the **Green tick of approval**.

The conventional process cost 60-80 million USD using expensive sheds and dust problems.

The '**DUST FREE PIT TO SHIP SOLUTION**' costs around 10 million dollars depending on the amount of containers required.

So, if you have a commodity that needs to be moved from Pit to Ship call the experts and they can arrange a visit to a port where this process is currently being operated.

# ISG - Pit to Ship Solutions™



## Pit to Ship Solutions - Our agents around the world

COUNTRY	NAME	PHONE	EMAIL
AUSTRALIA	GARRY PINDER	+61 400 035 548	gpinder@isgpts.com
NEW ZEALAND	MATTHEW CHALMERS	+61 448 855 650	mchalmers@isgpts.com
MEXICO	ISRAEL ALVARADO	+521 22998 41589	alvarado.israel@grupo-scr.com
BRAZIL	REGIONAL PROJECT AGENTS	+55 11 99212 0330	gpinder@isgpts.com
CHILE	SERGIO OSETE	+34 617 156 714	sergio.osete@ipcholding.com
SOUTH AFRICA	BARRY KEARNEY	+27 31 572 6443	barry@kpmafrica.co.za
ECUADOR	GUSTAVO DELGADO	+593 981 944 957	gdelgado@isgpts.com
EGYPT	MOHAMED FAYED	+202 27 362 537	mohamed.fayed@fedicom.com
GREECE	ANTHONY E. MAZONAKIS	+30 694 5212 028	craneprt@otenet.gr
TURKEY	HAKAN AKTAN	+90 216 680 0242	hakan@marinmakine.com
INDONESIA	HARRY MANDAGI	+62 8119 72483	harry.mandagi@gmail.com
ARGENTINA	CARLOS JANS	+569 5704 7692	cjans@isgpts.com
PERU	ALEJANDRO SARRIA	+51 9 8959 2106	asarria@equiports.com
AMERICA	CHARLES MAGOLSKE	+312 771 2671	cmagolske@isgpts.com
CANADA	MIKE WARREN	+778 833 1171	mikewarrenb2b@gmail.com
NICARAGUA	MIGUEL CUADRADO	+505 2266 0644	info@alke.com.ni

# GLOBAL COMPANY, GLOBAL PRESENCE

Blue Chip Mining, Ports and Grain Customers Using Our System



Dust Free Logistics & Ship Loading Systems for Minerals, Fertilisers and Grain

## CONVENTIONAL



## DISADVANTAGES OF USING THE CONVENTIONAL SYSTEM

HIGH COST

TWO YEAR SETUP

LARGE DUST & POLLUTION PROBLEMS



# ISG - Pit to Ship Solutions™

## versus **CONTAINER**



## **ADVANTAGES OF USING CONTAINERS**

LOW COST

FAST TO MARKET

NO DUST

# ISG - Pit to Ship Solutions™

## Case Study

Junior Iron Ore Miner has a reserve of 20 million tonnes of Direct Shipping Ore (DSO).

The mine is 150 kms from an existing port. Access by road on "B" Double Route

The Port has 15 metres of berth depth which is ideal for shipping 65,000 to 75,000 tonne shipping parcels.

Existing port infrastructure is a grain conveyor system with ship loader from shore storage silos.

The owners will not allow access to the existing system but would be prepared to consider allowing the building of a new system of conveyors and loader to be fitted under the current system and operating at another berth but only on strict terms and conditions.



### OPTION 1

Start up not including mining and the approval process requires capital expenses of

- \$5 million to upgrade roads
- \$25 million for a 100,000 tonnes storage shed, built on land leased from the Port.
- \$20 million for design and construction of conveyor system and ship-loader.

Operating expenses of handling 2 million tonnes per annum

- \$15 per tonne for road haulage with side tipper "B" Double to Storage.
- \$4 per tonne for shed operation.
- \$2 per tonne to existing operator to fit system under their conveyor.
- \$2 per tonne for stevedoring.
- \$0.25 per tonne for \$500,000 a year to Port for lease of land for storage shed.
- \$4 per tonne to Port for Cargo Services Charge.

All these operating charges except the "Cargo Services Charge" are "take or pay contracts" and locked in for 10 years.

### Summary for Port Logistics ( not include mining or shipping)

<b>Capital</b>	<b>\$50 million</b>
<b>Operational Costs</b>	<b>\$27.25 per tonne.</b>

Approvals and construction expect between eighteen months and two years

# ISG - Pit to Ship Solutions™

## Comparing a Bulk Container System

### OPTION 2

Start up not including mining and the approval process requires capital expenses of

- \$5 million to upgrade roads
- \$15 million for 3,000 bulk containers (can be leased )
- \$1.5 million for 3 Revolver tipping Spreaders

Operating expenses of handling 2 million tonnes per annum

- \$15 per tonne for road haulage with “B” double skeletal trailers to storage.
- \$1 per tonne for unloading containers to hard stand at the Port.
- \$5 per tonne for stevedoring.
- \$0.25 per tonne for \$500,000 a year to Port for lease of 15,000 sq metres of Hardstand.
- \$4 per tonne to Port for Cargo Services Charge.

No “take or pay contracts”. Only exception would be the containers if they decided to lease.

### Summary for Port Logistics (not include mining or shipping)

**Capital:** \$21.5 million or \$6.5 million by leasing the containers.

**Operational Costs:** \$25.25 per tonne or \$27.25 per tonne by leasing the containers

Approvals and construction expect nine months to one year.

## Conclusions

By implementing a Bulk Container System the Mine can;

1. Operate one year earlier.
2. Save \$43.5 million in capital.
3. **Not required to be locked into inflexible long term contracts.**

**This case study is showing an overview of the concept but there is much more!**



# CONVERTING BIG BAGS TO CONTAINERISED BULK HANDLING

This company has found the need to move from **Big Bags** to our **Containers** in Canada...

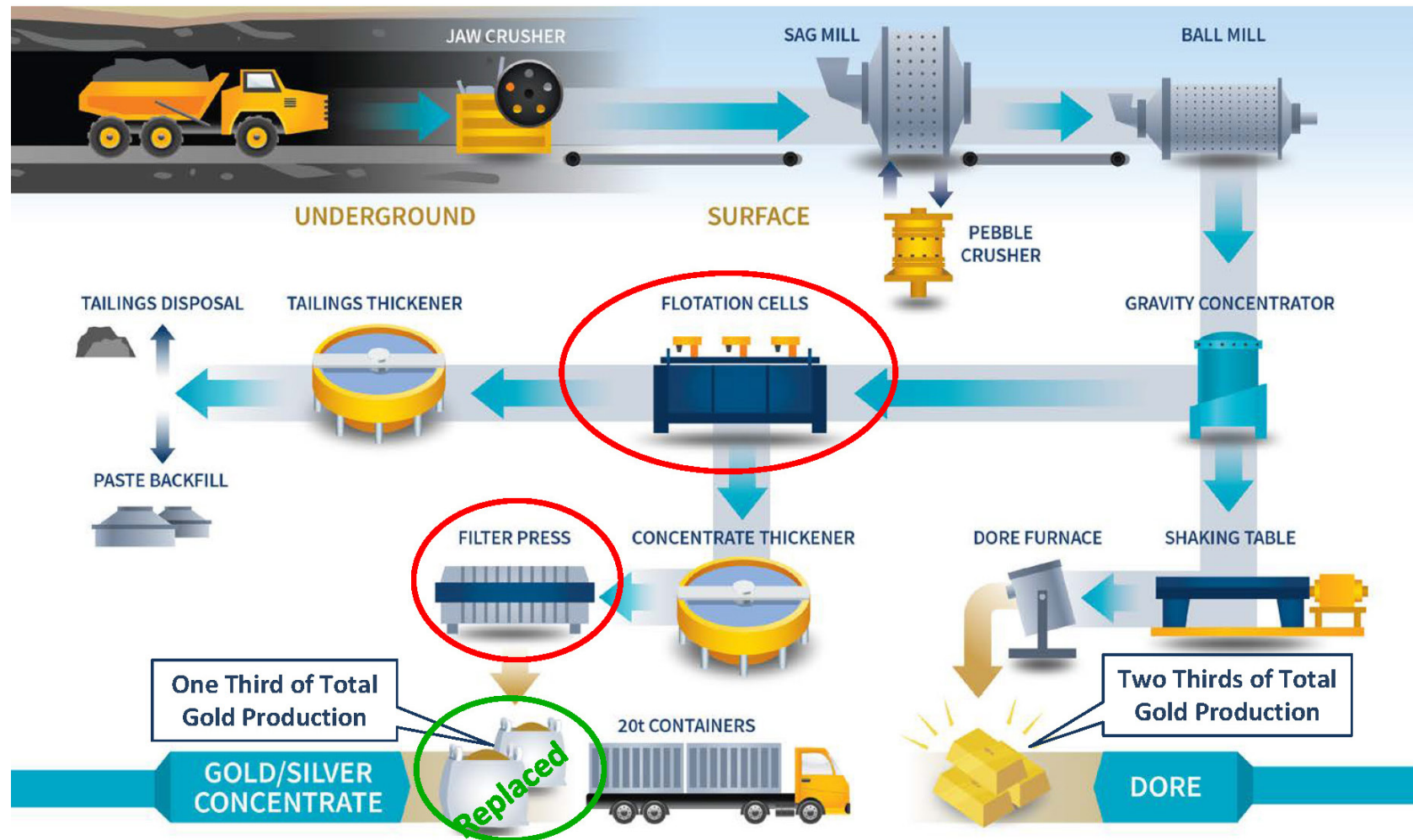

Big bags are a startup solution that is expensive and not environmentally friendly. Bags cost from USD\$7 -25 with RFID tags for two ton of product. In most locations in China, the bags are sliced open at the end customers processing plant, and after the product is released they are place into land fill or even burnt in some locations leaving behind an environmental nightmare with product residual also left in the bags. **Containers have a twenty year life, containers carry 30 ton of product leaving behind no residual product when emptied, fifteen bags equals one container per trip.**

# CONVERTING BIG BAGS TO CONTAINERISED BULK HANDLING

*Bulk Loading System Installed with **Significant Cost Savings***

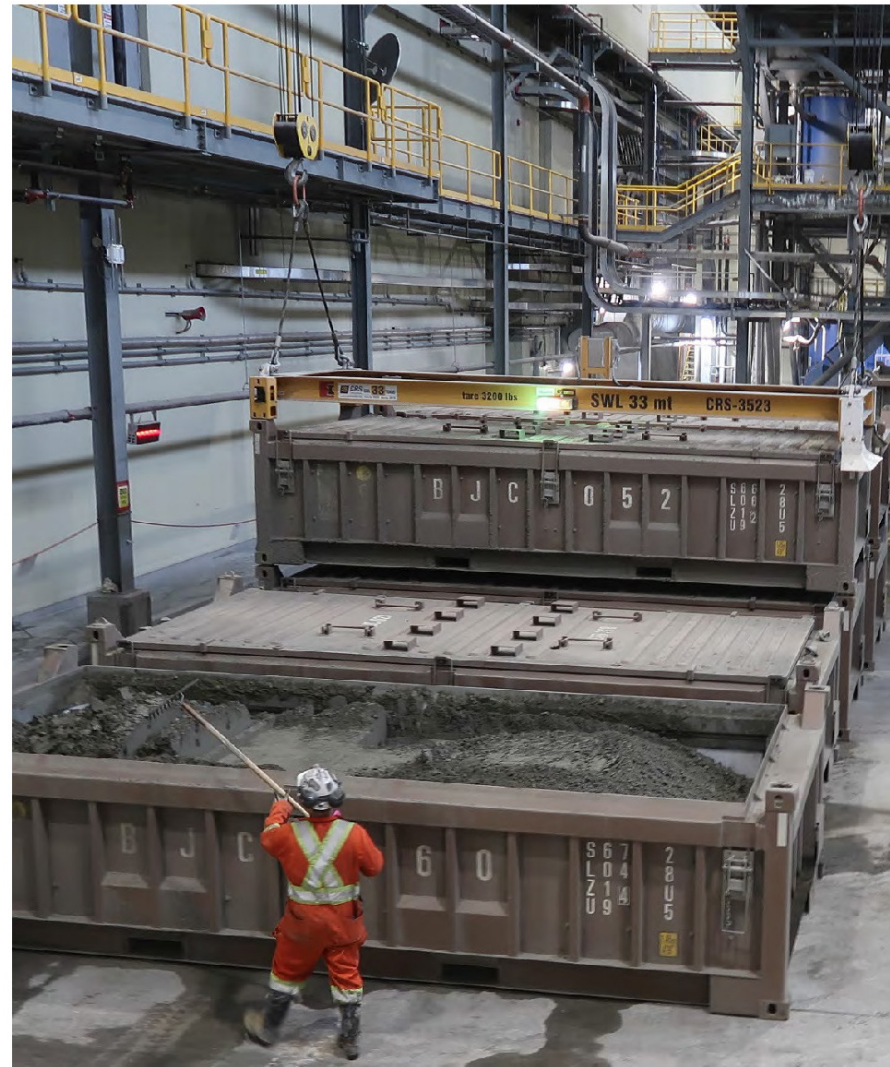

The Containers have Special Coatings inside to assist in the **-30 deg** Temperatures in Winter.

# ISG - Pit to Ship Solutions™



## Ships Crane Operation

Designed for locations where there is no current crane infrastructure . The ISG - Pit To Ship Solutions containers are designed for all crane types so if you have a project where no cranes are available ISG can provide a ships crane tippler and our patented containers.

### Case study

In 2014 the first ship was loaded in Wollongong with copper concentrate using ships cranes and ISG Pit To Ship solutions containers.

At the mine site the ISG containers have their lids removed by the ISG mine site lid lifter. The ISG containers are then loaded with copper at the mine site using a front end loader , the lids are then replaced by the ISG lid lifter.

Each container is placed onto trucks and taken to the railhead where they are loaded onto the train. The copper is then delivered by rail from North Parkes mine. The train arrives into the Patrick terminal in Wollongong where the loaded containers are swapped for the unloaded containers, the train then returns to Parkes.

The loaded containers are taken around to the quay side and using the ships crane and a tippler the containers are placed into the ship's hull. Using the patented ISG lid lifter the containers are rotated 360 degrees and the copper is placed into the ship's hull making this a dust free solution .

The following photos show the loading process using ships crane , tippler and the ISG containers, note the ISG patented lid lifter in operation. This process can be seen on video on our website [www.pittoship.com](http://www.pittoship.com) under the ships crane icon.

# ISG - Pit to Ship Solutions™



Containers being lifted from the quay side.



Patented lid lifter in use.



Containers being tipped into ships hull.



Patented lid lifter replacing the container lids.



Containers being lifted back to the quay side.



The process starting again.

# CONTAINER BLENDING FLOW CHART



**1** The product is loaded at the mine site then sampled in the conventional manner and the containers are sealed. Each container holds around 30 tons of product.

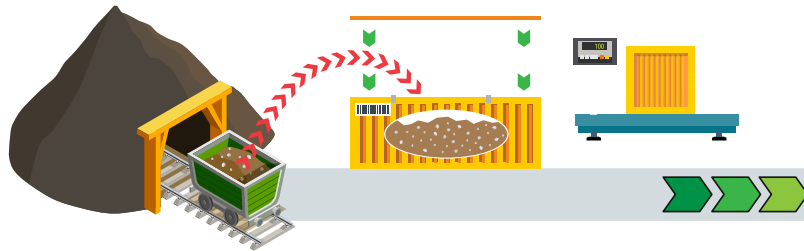

**2** The sample is graded then placed into the computer system. The containers are fitted with RFID tags so they can be tracked and stacked in grade blocks at the port.

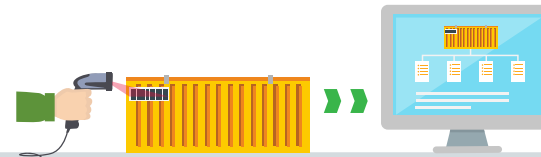

**4** From the database a report is generated using a simple algorithm to determine a precise mix for the ships hold.



**3** The containers are transported via road or rail and then stored at the port.



**6** When the ship arrives the product is tipped into the ships hold in the forecasted sequence to maintain the mix required using a layered system (ie) (200 B grade 300 A grade and 100 C grade ETC).

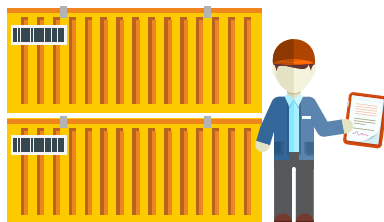

**7** The bulk ship departs with your blended product on board and the containers are returned to the mine site to start the cycle over again.

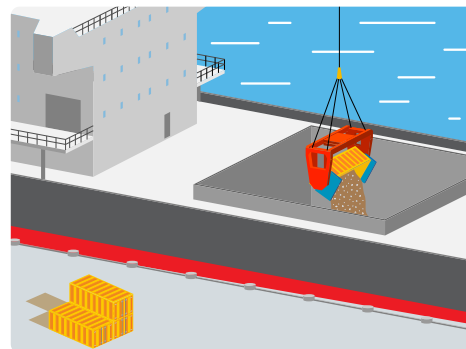

**5** At the port the containers are blocked stacked in their grade ratings awaiting the bulk ship to arrive.



# ISG - Pit to Ship Solutions™

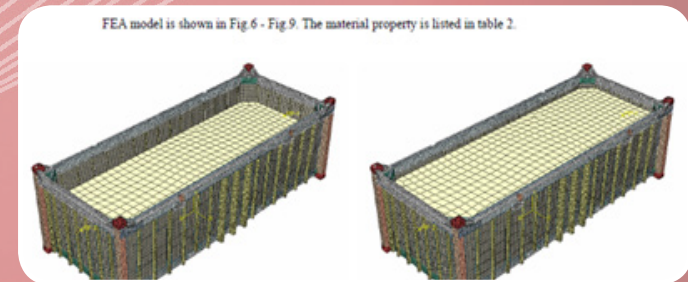
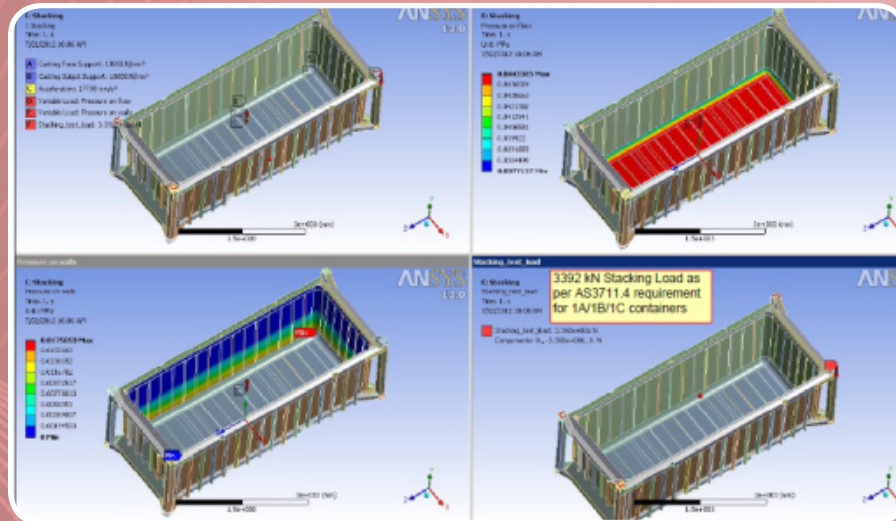

## Introducing the CONTAINERTIPP™

Introducing the CONTAINERTIPP™ range of bulk containers for usage with tipplers. CONTAINERTIPP™ is a trade mark name for bulk containers that can be used with tipplers around the world.

Pit to Ship Solutions containers have had a full structural engineering analysis. We have had our designs fully analysed by independent structural engineering company HAALD. HAALD have done full FEA and have approved the containers for use with revolving spreaders by an independent third party.

Pit to Ship Solutions will provide the full reports to the customer if we are the successful supplier.

Further to the standard container testing and increased loading of 1x payload on the side wall, Pit to Ship Solutions has performed a series of tests which simulate the life cycle of the container. We perform the following additional tests.

- Load the container with 1.2 x Payload on the side walls and lift from only two top corner fittings.
- Load the container with 1 x payload on the side walls and lift from only two top corner castings up to 250 times. This test simulates 10 years of service with 5 cycles per year.

All tests are witnessed by Lloyd's Register, with witness report issued.

# ISG - Pit to Ship Solutions™



## 20' CONTAINERTIPP™ for Iron Ore with Added Payload

- Purpose built for heavy duty mining applications.
- Suitable for products such as Iron Ore and Concentrates.
- Designed and extensively tested for use with a Tippler (180 degree rotation to discharge product).
- Supplied with waterproof removable hard lids which also eliminate dust during transit. These lids can be manufactured to suit any Tippler lid lifting system.
- Heavy duty, empty and loaded lift fork pockets
- Can be custom built to specific requirements, in a range of various heights.
- Can be supplied with or without hard lid.
- Stackable when loaded.
- In 2013 Intermodal Solutions Group (ISG) manufactured 1,350 units for Exxaro. These units can be seen in operation at Pointe Noir in the Congo.
- ***The forces from a tippler with pay loads of 28t -42t would destroy a normal container that is why ISG have designed their CONTAINERTIPP fleet.***

### Specifications

External Dimensions (mm)			Internal Dimensions (mm)			Weight (kg)			Capacity
Length	Width	Height	Length	Width	Height	Max. Gross	Tare	Max. Payload	(M <sup>3</sup> )
6058	2438	1800	2929x2	2276	1515	43500	3500	40000	19.6

# ISG - Pit to Ship Solutions™



## 20' CONTAINERTIPP™ for Copper Concentrates in America **AAR Approved**

ISG Concentrate containers have been reviewed and approved by Association of American Railroads (AAR) for use on US rail networks.

In late 2015 ISG supplied the first copper concentrate containers for Arizona in the United States. The containers were specifically designed to suit the road limit restrictions for the state of Arizona. The container gross weight also maximises payload on the USA rail network, especially when double stacked on the innovative ABC Rail car. The patented ISG container lids allows the unit to be secured for travel from Arizona to the port of Guyamas in Mexico without any product loss from theft or from dust being released into the atmosphere. The lid is placed on at the mine site, using the ISG mine site lid lifter, then secured using customs seals, the lid then remains locked on the container until taken off at the port.

The design team in ISG also added an inspection hatch to the lid to allow US customs a way of inspecting the container interior on the way through the US and Mexican border and on the return leg.

### Specifications

External Dimensions (mm)			Internal Dimensions (mm)			Weight (kg)			Capacity
Length	Width	Height	Length	Width	Height	Max. Gross	Tare	Max. Payload	(M <sup>3</sup> )
6058	2438	1800	5418	2114	1449	27220	2730	24490	16.6

# ISG - Pit to Ship Solutions™



## 20' CONTAINERTIPP™ for Copper Concentrate A-TYPE

Pit to Ship Solutions is the Australian market leader in Open Top half heights for Copper Concentrate. This container has been designed, manufactured and tested in conjunction with some of Australia's leading mining companies. The container is designed for minimum product hang-up which includes curved gussets in all corners, and tapered side and end walls. The container is designed to be suitable with all tippers in the Australian market, and includes a pioneering lid, which is automatically locked and unlocked by the tippers.

The container is also the first open top half height in the Australian market to be certified to BK2 requirements and ADG7. The container also includes our special anti abrasion coating. In 2011 Intermodal Solutions Group (ISG) manufactured 1,400 units for OZ Minerals. These units can be seen in operation at Flinders Ports in Adelaide.

***The forces from a tippler with pay loads of 28t -42t would destroy a normal container that is why ISG have designed their CONTAINERTIPP fleet.***

### Specifications

External Dimensions (mm)			Internal Dimensions (mm)			Weight (kg)			Capacity
Length	Width	Height	Length	Width	Height	Max. Gross	Tare	Max. Payload	(M <sup>3</sup> )
6058	2438	2200	N/A	N/A	N/A	33500	3450	30050	20.5

# ISG - Pit to Ship Solutions™



## 20' CONTAINERTIPP™ for Copper Concentrate B-TYPE

In 2014, Intermodal Solutions Group (ISG) manufactured 600 units supplied to Patricks. These units can be seen in operation at port Kembla NSW. Patrick went to tender and ISG was awarded the contract to supply copper concentrate containers suitable for use with a tippler.

***The forces from a tippler with pay loads of 28t -42t would destroy a normal container that is why ISG have designed their CONTAINERTIPP fleet.***

### Specifications

External Dimensions (mm)			Internal Dimensions (mm)			Weight (kg)			Capacity
Length	Width	Height	Length	Width	Height	Max. Gross	Tare	Max. Payload	(M³)
6058	2438	1850	5872	2126	1566	31600	3050	28550	19

# ISG - Pit to Ship Solutions™



## 20' CONTAINERTIPP™ for Copper Concentrate

In 2014, Intermodal Solutions Group (ISG) manufactured 890 units supplied to CODELCO in Chile. These units can be seen in operation at the Port of Mejillones (Angamos) in Chile. Codelco went to tender for tippers and containers suitable for class 9 dangerous goods transport and tippler use. ISG was awarded the supply contract for their dust free loading solution.

Codelco is the world's largest copper miner and operates in Chile exporting through various port locations.

***The forces from a tippler with pay loads of 28t -42t would destroy a normal container that is why ISG have designed their CONTAINERTIPP fleet.***

### Specifications

External Dimensions (mm)			Internal Dimensions (mm)			Weight (kg)			Capacity
Length	Width	Height	Length	Width	Height	Max. Gross	Tare	Max. Payload	(M <sup>3</sup> )
6058	2438	2000	N/A	N/A	N/A	33350	3350	30000	18.8

# ISG - Pit to Ship Solutions™



## 20' CONTAINERTIPP™ for Copper Concentrate

In 2016 ISG and CSL Leased 450 specialised bulk tippler containers for the Chile rail company FEPASA . The units are loaded at the mine site and railed by FEPASA to the port of PVSA and unloaded for bulk ships. The units are then returned to the mine site by rail and reloaded again. ISG designed the container to be dual purpose so if the need was there they can be de-centered by their rear hatch.

***The forces from a tippler with pay loads of 28t -42t would destroy a normal container that is why ISG have designed their CONTAINERTIPP fleet.***

### Specifications

External Dimensions (mm)			Internal Dimensions (mm)			Weight (kg)			Capacity
Length	Width	Height	Length	Width	Height	Max. Gross	Tare	Max. Payload	(M <sup>3</sup> )
6058	2438	2000	N/A	N/A	N/A	33460	3460	30000	19.5

# ISG - Pit to Ship Solutions™



## 20' CONTAINERTIPP™ for Copper Concentrate with **Heavy Duty**

In late 2016 ISG responded to a tender with HPH for the supply of tippler friendly containers for the Mexican market. ISG was successful and supplied the containers in early 2017. The containers feature a heavy pay load and are built for tippler use in the TIMSA Terminal Manzanillo.

***The forces from a tippler with pay loads of 28t -42t would destroy a normal container that is why ISG have designed their CONTAINERTIPP fleet.***

### Specifications

External Dimensions (mm)			Internal Dimensions (mm)			Weight (kg)			Capacity
Length	Width	Height	Length	Width	Height	Max. Gross	Tare	Max. Payload	(M³)
6058	2438	2000	N/A	N/A	N/A	40000	3560	36440	22



# ISG - Pit to Ship Solutions™



## 20' CONTAINERTIPP™ for Copper Concentrate with **Heavy Duty & Hatch**

In 2017 ISG was successful with yet another tender to supply tippler friendly containers to the Chile marketplace for the moving of Codelco copper. This container type features a heavy payload and the patented ISG lid design and corner castings.

ISG has now supplied in excess of 10,000 tippler friendly containers around the world and are classed as the world leaders in this niche market.

***The forces from a tippler with pay loads of 28t -42t would destroy a normal container that is why ISG have designed their CONTAINERTIPP fleet.***

### Specifications

External Dimensions (mm)			Internal Dimensions (mm)			Weight (kg)			Capacity
Length	Width	Height	Length	Width	Height	Max. Gross	Tare	Max. Payload	(M <sup>3</sup> )
6058	2438	2000	N/A	N/A	N/A	40000	N/A	N/A	22

# ISG - Pit to Ship Solutions™



## 4m CONTAINERTIPP™ for Copper Concentrate, *Thinking Outside the Square!*

In 2015 ISG supplied 1,100 x 4m copper concentrate containers to MMG and Peru rail for the movement of copper in Peru. MMG had a road and rail payload weight problem, if they used 2x20'containers their payload would be over the legal limit in Peru. If they used one 20'container they would fall short of the legal limit and move less copper.

The solution was The 4m container. This provided MMG with an advantage of loading two 4m containers with a pay load of 17,250 KG per container on a road truck and rail wagon providing a better payload then one 20'container. So next time your company has a weight problem, ISG can tailor make a container to suite your project.

***The forces from a tippler with pay loads of 28t -42t would destroy a normal container that is why ISG have designed their CONTAINERTIPP fleet.***

### Specifications

External Dimensions (mm)			Internal Dimensions (mm)			Weight (kg)			Capacity
Length	Width	Height	Length	Width	Height	Max. Gross	Tare	Max. Payload	(M <sup>3</sup> )
4012	2438	1850	N/A	N/A	N/A	19960	2360	17600	11.9

# ISG - Pit to Ship Solutions™

*Mined, Sealed, Delivered!*



## FREIGHT CAR AMERICAS - ABC Rail Wagons for Copper Concentrate

The above pictures are of the ABC rail car delivering bulk copper for Savage Transport from Colorado Springs to Elko Nevada. These wagons were designed for maximising bulk container traffic by allowing the containers to be double stacked over the bogies and single stacked over the two intermediate positions nearest the articulated truck.

The lightweight spine-type design offers maximum payload capacity and low maintenance at a competitive price while the articulation also allows for tighter turning radius. ISG is the agents for the ABC rail wagons combining a full logistic solution with either light weight truck trailers or light weight rail wagons using our patented containerised solution of tipplers and containers.

# ISG - Pit to Ship Solutions™

*Mined, Sealed, Delivered!*

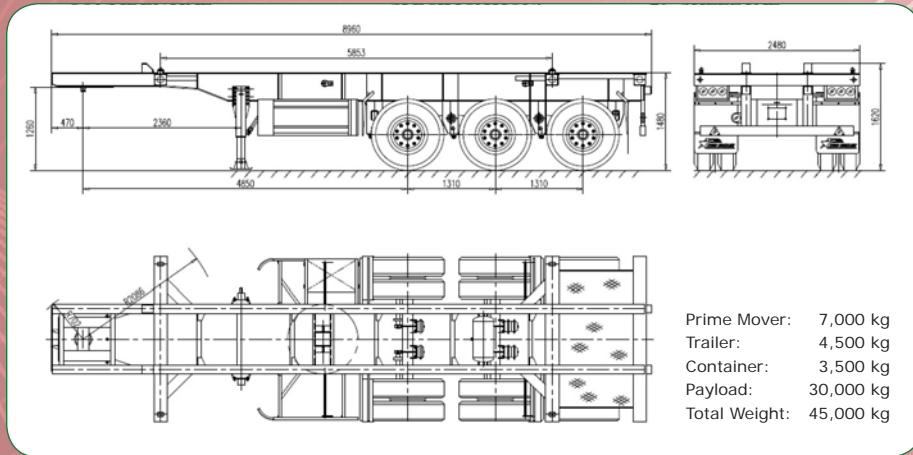

## Introducing the ISG COMBO™ Truck Trailers and Bulk Containers

ISG has designed a trailer to suit our bulk mining containers giving the customer the maximum road capacity available. By allowing the customer to carry an extra three tons of copper from the mine site to the port an estimated 10% saving can be found on logistic costs. ISG has done this by designing both the container and trailer to suit each other allowing a lighter design that allows extra payloads.

**Please Note:** Various countries have different road laws and axle weights apply. You would need to check your local road laws to make sure the above combination works for your location.

# ISG - Pit to Ship Solutions™



## 20' CONTAINERTIPP™ for Mineral Sands Container

- Purpose built for heavy duty mining applications.
- Suitable for products such as Iron Ore and Concentrates.
- Designed and extensively tested for use with a Tippler (180 degree rotation to discharge product).
- Supplied with waterproof removable hard lids which also eliminate dust during transit. These lids can be manufactured to suit any Tippler lid lifting system.
- Heavy duty, empty and loaded lift fork pockets
- Can be custom built to specific requirements, in a range of various heights.
- Can be supplied with or without hard lid.
- Stackable when loaded.
- In 2013 Intermodal Solutions Group (ISG) manufactured 1,750 units for Cristal Mining. These units can be seen in operation at Flinders Ports in Adelaide.
- ***The forces from a tippler with pay loads of 28t -42t would destroy a normal container that is why ISG have designed their CONTAINERTIPP fleet.***

### Specifications

External Dimensions (mm)			Internal Dimensions (mm)			Weight (kg)			Capacity
Length	Width	Height	Length	Width	Height	Max. Gross	Tare	Max. Payload	(M <sup>3</sup> )
6058	2438	2000	N/A	N/A	N/A	38000	3550	34350	22.8

# ISG - Pit to Ship Solutions™



## 20' CONTAINERTIPP™ for Nickel Concentrate

Pit to Ship Solutions has designed, tested and manufactured a high cubic capacity container suitable for use with a Tippler. The container suits products with a lower density such as Nickel Concentrate, which require a high cubic capacity. The container is fitted with a removable hard lid, which can be lifted automatically and can be modified to suit any tippler in the Australian market.

The unit is tested and certified to BK2, IMDG and ADG7 requirements for transporting dangerous cargo, on road, rail or sea. The container includes our special anti abrasion coating. In 2011, Intermodal Solutions Group (ISG) manufactured 1000 containers for Queensland Nickel and Vale. These units can be seen in operation in Townsville QLD.

**The forces from a tippler with pay loads of 28t -42t would destroy a normal container that is why ISG have designed their CONTAINERTIPP fleet.**

### Specifications - 20'x8'6" and 20'x9'6"

External Dimensions (mm)			Internal Dimensions (mm)			Weight (kg)			Capacity
Length	Width	Height	Length	Width	Height	Max. Gross	Tare	Max. Payload	(M <sup>3</sup> )
6058	2438	2591	N/A	N/A	N/A	30480	3900	26580	28.8
6058	2438	2895	N/A	N/A	N/A	30480	4000	26480	32.6

# ISG - Pit to Ship Solutions™



## 20' CONTAINERTIPP™ for Salt

In 2015 ISG delivered Containertipp containers suitable for loading salt in South America. The containers feature specialised anticorrosive paint and the ISG patented lid design and anti -spill corner castings. The ISG patented lid lifter design now allows Salt, copper, mineral sands, grain, iron ore and coal to be loaded using current port facilities. The port does not have to be a bulk port as all equipment is ISO and container ports can now become multiuser ports loading bulk and containers using the same equipment.

***The forces from a tippler with pay loads of 28t -42t would destroy a normal container that is why ISG have designed their CONTAINERTIPP fleet.***

### Specifications

External Dimensions (mm)			Internal Dimensions (mm)			Weight (kg)			Capacity
Length	Width	Height	Length	Width	Height	Max. Gross	Tare	Max. Payload	(M³)
6058	2438	2200	5862	2266	1916	31550	3550	28000	24.8

# ISG - Pit to Ship Solutions™



## 40' CONTAINERTIPP™ Multipurpose Containers

Due to the Revolver construction, centre of gravity is critical when designing our container. Also to ensure the container cannot be overloaded with different products we have developed a patent pending system which divides the container into various compartments. The compartments limit the cubic capacity and also ensure the centre of gravity is maintained to suit the tippler.

We currently manufacture a container suitable for three weight classes using 5 compartments. We can finalise configuration and total weight classes required during detailed design phase.

In **2010**, Intermodal Solutions Group (ISG) manufactured 30 units supplied to DP World. These units can be seen in operation at Maputo port in Mozambique. Units include special anti abrasion and corrosion coating on the interior (around 800 USD). **The forces from a tippler with pay loads of 28t -42t would destroy a normal container that is why ISG have designed their CONTAINERTIPP fleet.** Features include:

- Includes hard lid, suitable for Auto Lifting by the revolver (around 1600 per unit)
- Smooth Internal Walls, 3mm thick
- Floor 4.5 mm thick Steel

### Specifications

External Dimensions (mm)			Internal Dimensions (mm)			Weight (kg) (*excludes lid)			Capacity
Length	Width	Height	Width(mid)	Width(end)	Height	Max. Gross	Tare	Max. Payload	(M <sup>3</sup> )
12192	2438	2050	2213	2276	1888.5	45850	6850*	39000	50.1



# ISG - Pit to Ship Solutions™



## 20' BK2 Half Height Container for the European market

In 2017 Eramat a company based in France went to tender for 150 special half height containers to be used in freezing conditions around Europe. ISG was successful in winning the tender and with the backing of CSL leased the containers to the customer.

### Specifications

External Dimensions (mm)			Internal Dimensions (mm)			Weight (kg)			Capacity
Length	Width	Height	Length	Width	Height	Max. Gross	Tare	Max. Payload	(M <sup>3</sup> )
6058	2438	1433	N/A	N/A	N/A	35000	3080	31920	15.4

# ISG - Pit to Ship Solutions™



## Pit to Shed Solution

Introducing another concept to our dust free logistics and loading solution. The Pit to Shed solution comes into play when there is current port infrastructure available. The customer still uses our dust free patented containers with sealed lids. The containers are loaded at the mine site by either front end loaders or by a conveyor belt system. The lids of the containers are taken off by the ISG mine site lid lifter and after the containers are loaded they are replaced onto the containers. The loaded containers are either railed or transported by road to the port.

At the port the containers are unloaded into the hopper system via a tippler using the ISG patented lid lifting system. The containers are then loaded empty back onto the train or truck and transported back to the mine site to start the cycle again.

The photos above and on the next page shows the system currently working in Peru and another port in Chile is copying the same concept using current port infrastructure. Green field, brown field or just needing a change for safety, environmental or productivity reasons ISG has the solution.

# ISG - Pit to Ship Solutions™



# ISG - Pit to Ship Solutions™



## Fertilizer Grade Containers

In 2017 ISG was successful with another tender this time for UREA containers . The special designed containers will carry urea from Bolivia to Brazil and using the patented ISG lid lifter will be unloaded in Brazil with RAM tippers.

### Logistic task

Bolivia is a very remote country in South America and is land locked . This was a very challenging task to deliver 500 high cube specialised containers from China to Bolivia . The containers were shipped from China to Chile. In Chile two containers per truck were loaded and the trucks delivered the containers 800 klms into a Bolivian rural area where the urea processing plant was being made. Fertilisers are a very corrosive product and ISG applied special interior paint to assist in the protection of the containers. The containers are loaded through a chute arrangement and the lids were designed to suit the chute loading facility in this remote area of the world.

# ISG - Pit to Ship Solutions™

## Fertilizer Grade Containers



# ISG - Pit to Ship Solutions™



## Food Grade Containers

Our containerised solution can also be used for food grade commodities. Take the case in Argentina where the loading and storage of soya beans is taking place. The beans are loaded into the containers and taken to the quay side. At the quay side the containers are lifted up using a tippler with the ISG patented lid lifter and tipped into the ship's hull, the product remains without contamination due to the lid keeping all foreign products out.

Our fleet also has other containers that do not require a tippler to de-center. Our patent pending Flexitop container allows a flexible tarp to be closed or opened in a matter of seconds using hand operated handle. This container is being used for potatoes, wheat and other grains. The container is unloaded via a rear hatch.

# ISG - Pit to Ship Solutions™



## 20' CONTAINERTIPP™ for Grain

Soya bean is being loaded at the port of Rosario in Argentina using the ISG pit to ship solution and the ISG tippler friendly grain containers . The port of Rosario is a brown field site that needs a massive amount of work and money spent on the port to transfer it into a modern facility. The loading of grain is one of the ports major revenue streams. Rather than spending millions of dollars to upgrade the loading process the port looked to ISG Pit To Ship solutions. The patented lid lifter allowed the ISG patented containers to be sealed after loading and become vermin proof until the product is loaded into the ship's hull using a tippler. The lid is removed inside the ship's hull making the process automated and no human interaction is needed making this a safe loading solution.

***The forces from a tippler with pay loads of 28t -42t would destroy a normal container that is why ISG have designed their CONTAINERTIPP fleet.***

### Specifications

External Dimensions (mm)			Internal Dimensions (mm)			Weight (kg)			Capacity
Length	Width	Height	Length	Width	Height	Max. Gross	Tare	Max. Payload	(M <sup>3</sup> )
6058	2438	2896	5862	2266	2612	30480	3900	26580	34.2

# ISG - Pit to Ship Solutions™



## Tippler Friendly Grain Hatch Container

ISG has designed a tippler friendly grain hatch container for loading grain through grain chutes. This allows loaders to use current facilities if they are available. The containers can then be discharged inside the ships hold with the full lid removed using the ISG patented automatic tippler lid lifter for faster loading times. If loading chutes are not available the lid can be taken off and the grain loaded with front end loaders. The container comes with all the patented features and three roof hatches.

***The forces from a tippler with pay loads of 28t -42t would destroy a normal container that is why ISG have designed their CONTAINERTIPP fleet.***



# ISG - Pit to Ship Solutions™



## Self Aligning System (SAS) Patent Pending Technology

Pit to Ship Solutions has exclusive IP rights to an exciting new concept in the Revolving spreader system. to increase cycle time when using a mobile harbour crane or ships crane we can incorporate the "Self Aligning System" (SAS) to our containers.

The SAS improves latching time of revolver onto container, and also assists in applying additional moment to the container body to reduce stress on revolver motors.

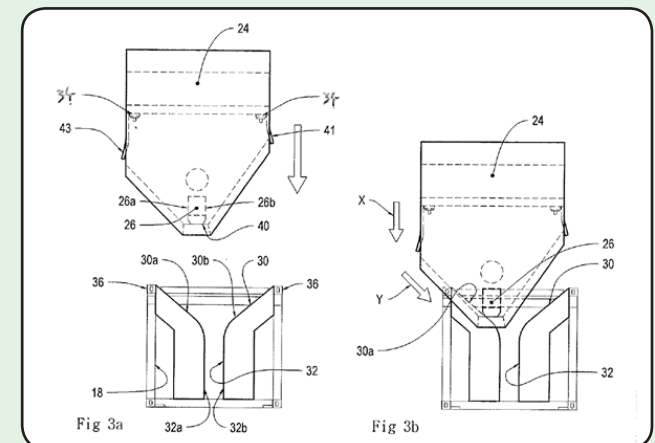

# ISG - Pit to Ship Solutions™



## Introducing the FLEXITOP

Welcome to the Flexitop range of bulk open top containers. Traditional open top containers take two experienced people over 40 minutes to replace the roof tarp. Our patent pending Flexitop container takes one untrained person three–four seconds to win back the handle and seal the roof. This amazing technology has revolutionised the bulk container industry.

Grain loaders and transport companies now have the flexibility of using either road , rail or sea to move their cargo from field to ship by using this technology. Companies like Smiths chips move their potatoes one way and their finished product the other way by using the pallet wide design.

Commodities like salt , sugar , grain , and sulphur are also being carted on road and rail using our Flexitop container. Depending on your product you can de-canter the load using the rear hatches that are fitted with grain locks for extra security.

The following pages will provide you with some interesting designs that we have expanded on with Flexitop technology.

# ISG - Pit to Ship Solutions™



## FLEXITOP – Multipurpose – Pallet Wide

- Manufactured to suit a range of bulk products and Palletised products.
- Load bulk product one way, palletised finished product on the return journey.
- Fitted with FLEXITOP retractable tarpaulin system.
- Smooth Internal Walls
- Large Tipping Hatch
- Rear Doors
- Pallet wide and capable of 10 pallets on the floor.
- Heavy lift fork pockets.
- Sampling ports can be included, to allow product sampling without opening the Flexitop Tarpaulin.
- Within ISO Dimensions for universal handling.
- Units shown in the photos were manufactured to carry potatoes and finished product for SMITHS crisps.



### Specifications

External Dimensions (mm)			Internal Dimensions (mm)			Weight (kg)			Capacity
Length	Width	Height	Length	Width	Height	Max. Gross	Tare	Max. Payload	(M <sup>3</sup> )
6100	2500	2896	5875	2354	2311	31600	3600	28000	32

Stacking Test Load 60,960 kg

# ISG - Pit to Ship Solutions™



## FLEXITOP – Bulk Grain

- Manufactured to suit a range of bulk products such as Wheat and other grain crops.
- Load bulk and discharge bulk product easily and efficiently.
- Fitted with FLEXITOP retractable tarpaulin system.
- Smooth Internal Walls
- Large Tipping Hatch fitted with grain locks.
- Heavy lift fork pockets.
- Sampling ports can be included, to allow product sampling without opening the Flexitop Tarpaulin.
- Stackable empty and loaded.
- Tarp can be operated manually or with power.



### Specifications

External Dimensions (mm)			Internal Dimensions (mm)			Weight (kg)			Capacity
Length	Width	Height	Length	Width	Height	Max. Gross	Tare	Max. Payload	(M <sup>3</sup> )
6058	2500	2896	5829	2354	2431	31560	3560	28000	33.4

Stacking Test Load 27,960 kg

# ISG - Pit to Ship Solutions™



## FLEXITOP – Sulphur

- Manufactured to suit a range of bulk products such as Sulphur and Fertiliser.
- Load bulk and discharge bulk product easily and efficiently.
- Fitted with FLEXITOP retractable tarpaulin system.
- Smooth Internal Walls
- Large Tipping Hatch fitted with grain locks.
- Heavy lift fork pockets.
- Sampling ports can be included, to allow product sampling without opening the Flexitop Tarpaulin.
- Stackable empty and loaded.
- Tarp can be operated manually or with power.



### Specifications

External Dimensions (mm)			Internal Dimensions (mm)			Weight (kg)			Capacity
Length	Width	Height	Length	Width	Height	Max. Gross	Tare	Max. Payload	(M <sup>3</sup> )
6058	2500	2591	5829	2354	2126	31370	3370	28000	29.2

Stacking Test Load 27,430 kg

# ISG - Pit to Ship Solutions™



## FLEXITOP – Salt

- Manufactured to suit a range of bulk products such as Salt and concentrated bulk products.
- Load bulk and discharge bulk product easily and efficiently.
- Fitted with FLEXITOP retractable tarpaulin system.
- Smooth Internal Walls
- Large Tipping Hatch fitted with grain locks.
- Heavy lift fork pockets.
- Sampling ports can be included, to allow product sampling without opening the Flexitop Tarpaulin.
- Stackable empty and loaded.
- Tarp can be operated manually or with power.



### Specifications

External Dimensions (mm)			Internal Dimensions (mm)			Weight (kg)			Capacity
Length	Width	Height	Length	Width	Height	Max. Gross	Tare	Max. Payload	(M <sup>3</sup> )
6058	2500	2591	5829	2354	2126	31370	3370	28000	29.2

Stacking Test Load 27,430 kg

# ISG - Pit to Ship Solutions™



The unit shown in the photo was especially made for KIWI RAIL in New Zealand.



## FLEXITOP – Bulk Coal

- Manufactured to suit a range of lower density products such as Coal, and to suit logistic systems that can only cope with lower payloads.
- Load bulk and discharge bulk product easily and efficiently.
- Fitted with FLEXITOP retractable tarpaulin system.
- Smooth Internal Walls
- Large Tipping Hatch fitted with grain locks.
- Heavy lift fork pockets.
- Sampling ports can be included, to allow product sampling without opening the Flexitop Tarpaulin.
- Stackable empty and loaded.
- Tarp can be operated manually or with power.
- ISO dimensions for universal handling.



### Specifications - 20x2438x2438 Open Top

External Dimensions (mm)			Internal Dimensions (mm)			Weight (kg)		Capacity	
Length	Width	Height	Length	Width	Height	Max. Gross	Tare	Max. Payload	(M <sup>3</sup> )
6058	2438	2438	5829	2292	1855	23000	3000	20000	24.8

# ISG - Pit to Ship Solutions™



## FLEXITOP - Ore Container

- Manufactured to suit a range of higher density products such as Ore and Gravel.
- Smooth Internal Walls
- Large Tipping Hatch fitted with grain locks
- Heavy lift fork pockets.
- Sampling ports, **can be added**, to allow product sampling without opening the Flexitop Tarpaulin.
- Stackable empty and loaded.
- Tarp can be operated manually or with power.
- ISO Dimensions for universal handling.



### Specifications - 20x2438x2438 Open Top (Heavy Duty)

External Dimensions (mm)			Internal Dimensions (mm)			Weight (kg)			Capacity
Length	Width	Height	Length	Width	Height	Max. Gross	Tare	Max. Payload	(M <sup>3</sup> )
6058	2438	2438	5829	2292	1855	30480	3250	27230	24.8



# ISG - Pit to Ship Solutions™



## 20' Bulk Open Top Containers for End Tipping

ISG has designed a range of open top containers with rear tipping hatches. ISG also has a fleet of hard top bulk containers with three round roof hatches for loading commodities into. These containers can also be de-cantered using the rear tipping hatches.

ISG also has heavy duty scrap containers, side door open top containers, Paper friendly bulk containers, coal containers, sugar containers with funnel chutes to name a few. Our engineering team can redesign any of our containers to suit your requirements.

ISG believe in continuous improvement that is why we have such a large range of specialised bulk containers. The ISG fleet is considered to be the largest fleet of specialised designed bulk containers in the world . So whether your moving minerals or grain our fleet can adapt to your task.

# ISG - Pit to Ship Solutions™

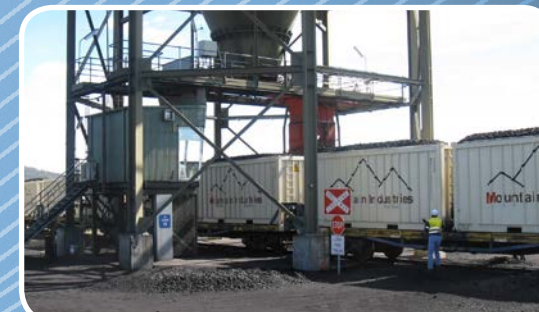

## 20' Bulk Open Top Containers for End Tipping

Pit to Ship Solutions specialised 20' Open Top Containers for Bulk applications are purpose build for the harsh conditions in Australia.

Features include:

- 1200mm High rear tipping hatch
- Hatch locking mechanism is operated from the side of the container
- Hatches fitted with "Grain Locks" for maximum safety on road and rail.
- 5mm thick Steel floor plate
- Deflectors fitted to top rails of container
- Fork pockets for loaded lifting
- Can be fitted with Tarpaulin
- Heavy duty construction for harsh products like Coal.

### Specifications

External Dimensions (mm)			Internal Dimensions (mm)			Weight (kg)			Capacity
Length	Width	Height	Length	Width	Height	Max. Gross	Tare	Max. Payload	(M <sup>3</sup> )
6058	2438	2591	5820	2276	2786	31185	3130	28055	32.1

Stacking Test Load 27,430 kg

# ISG - Pit to Ship Solutions™



20' x 2500 x 9'6  
Pallet Wide Dry Bulk  
Container (Front  
Hatches).

Features three  
hatches in front wall  
Fits 10 Australian  
CHEP pallets on the  
floor.



20' x 2438 x 9'6 ISO  
Dry Bulk Container  
(Letter Box Hatch).

Features letter  
box hatch in front  
wall and rear door  
hatches.



## Standard Bulk Containers

Pit to Ship Solutions manufactures high quality heavy duty Dry Bulk Containers. Dry Bulk Containers can be supplied with various features. Some of these features are: Letter Box Hatches, Door Hatches, Roof Hatches with internal release mechanism, Smooth Walls, Fixings and tie downs for liner bags, Pallet Wide for Australian CHEP pallets.

### Specifications - 20'x2438x9'6" Bulk and 20x2500x9'6" Bulk

External Dimensions (mm)			Internal Dimensions (mm)			Weight (kg)			Capacity
Length	Width	Height	Length	Width	Height	Max. Gross	Tare	Max. Payload	(M <sup>3</sup> )
6058	2438	2895	5847	2324	2704	30480	3080	27400	36.7
6058	2500	2896	N/A	2395	2704	30480	3300	27180	38.1

# ISG - Pit to Ship Solutions™



## Bulk - Smooth Wall and Paper Friendly

Pit to Ship Solutions manufactures high quality smooth wall bulk containers for transporting a wide range of bulk products and general purpose cargo. Smooth wall designs are excellent for food grade products and paper products. High quality paint systems used on these containers ensures long life in harsh conditions. We can offer complete solutions including the design and manufacture of accessories such as hoppers and liner bag systems.

Please contact Pit to Ship Solutions to develop custom bulk containers to suit your particular application.

### Specifications - 20x2500x9'6" Bulk (Smooth Wall)

External Dimensions (mm)			Internal Dimensions (mm)			Weight (kg)			Capacity
Length	Width	Height	Length	Width	Height	Max. Gross	Tare	Max. Payload	(M <sup>3</sup> )
6058	2500	2895	5893	2400	2665	35000	3190	31810	37.7

# ISG - Pit to Ship Solutions™



## Coke and Anode Bulk Containers

In 2009 and 2010 ISG engineering team worked with ARG a Division of QR National to develop a unique container. The Coke and Anode container is designed to transport coke and coal one way, and then Copper anodes on the return leg. These containers are in service for XTRATA mines and refineries in far north Queensland.

Features are:

- Smooth Internal Walls, 3mm Thick
- Steel Floor – 5mm Thick
- Large Tipping Hatch fitted with grain locks.
- Heavy duty racks for carrying packs of Copper anodes
- Side access doors for loading of Anode Racks.
- Heavy lift fork pockets.
- Stackable empty and loaded.
- ISO dimensions for universal handling.

### Specifications - Coke & Anode Bulk Container

External Dimensions (mm)			Internal Dimensions (mm)			Weight (kg)			Capacity
Length	Width	Height	Length	Width	Height	Max. Gross	Tare	Max. Payload	(M <sup>3</sup> )
6058	2438	2896	5829	2247	2577	33290	4390	28900	33.8

# ISG - Pit to Ship Solutions™



## 20' Scrap Steel and Waste Containers

Pit to Ship Solutions specialised 20' Open Top Containers for Scrap steel and Waste are purpose build for the harsh loading and unloading conditions related to these types of products.

Features include:

- Single "Barn Style" Rear Door.
- Door locking mechanism is operated from the side of the container.
- Door locking mechanism is robust, simple to use and easy to maintain.
- Locking mechanism designed for operator safety when unloading the container
- 5mm thick Steel Floor Plate and Side Walls for maximum impact and wear resistance
- Smooth internal walls and door opening to ensure product cannot "Snag" when discharging.
- Heavy Duty Construction
- Suitable for Transport on Road, Rail and Sea

### Specifications

External Dimensions (mm)			Internal Dimensions (mm)			Weight (kg)			Capacity
Length	Width	Height	Length	Width	Height	Max. Gross	Tare	Max. Payload	(M <sup>3</sup> )
6058	2438	2591	5848	2110	2409	30480	4450	26030	39.7

Stacking Test Load 88,430 kg



## Introducing Specialised Tanks

**ISG** has a fleet of standard ISO liquid tanks for either sale or hire. Please ask our expert team for more information on our standard fleet of tanks.

ISG has been working with many customers and tank factories to design and build specialised tanks for the movement of LNG, LNG is an acronym for Liquefied Natural Gas. The following pages will provide you with several tank designs ISG can either hire or sell for your next project.

Another specialised product in the ISG fleet is Liquefied Petroleum Gas (LPG) tanks the following pages will provide you with information on this tank type.

*Disclaimer: ISG can design and supply the aforesaid tanks upon your request, ISG do not recommend what tank type you will need only supply information on what tanks we can supply. It is your responsibility to make sure the tank supplied will suit your product.*

# ISG - Pit to Ship Solutions™

Level 1  
Stainless Inner Jacket  
Stainless Outer Jacket  
Tare: 10,200 kg



Level 2  
Stainless Inner Jacket  
Steel Outer Jacket  
Tare: 12,500 kg



## LNG Tanks

Specifications	LEVEL 1	LEVEL 2
Type of Product	Intermodal ISO container UN T75	Intermodal ISO Container UN T75
Medium	LNG	LNG
MAWP	4.83 Bar ( 70 psi )	8.2 Bar
Water Capacity	45,000 Liters	44,500 Liters
Filling Ratio	95% / 90% / 88%	90%
Tare Weight	10,200 kg (Maximum Tolerance 3%)	12,500 kg (Maximum Tolerance 3%)
Load Weight	20,280 kg	17,980 kg
Maximum Gross Weight	30,480 kg	30,480 kg
Stacking	192,000 kg	192,000 kg
Design Codes	ISO1496, IMDG, ADR, RID, ASME VIII.1	ISO1496, IMDG, ADR, RID, ASME VIII.1
Approvals	CCC & CSC	CCC & CSC
Approval & Inspection	Lloyd's Register or Bureau Veritas	Lloyd's Register



### LPG Tanks

Specifications	
Nominal Capacity	52,500 Litres (Approx.)
Tare Weight (Nominal)	12,000 kg (with Baffles)
Maximum Gross Weight	39,000 kg
Stacking	192,000 kg
Frame	40' x 8' x 8'6"
Tank Material	SA612 N
Products	LPG + Propane + Butane + Class 2 within Specified Pressure and which are Suitable for Tank Inside Surface.
Characteristics	With Sun Shield, Equipped for Bottom Discharge Approved for the Transport of Gases by Road, Rail & Sea.
Design Code	ASME VIII Div. 2 with ASME U2-Stamp
Regulations	RID, ADR, IMDG T 50, SELO ISO 1496/3, UIC 592, CSC and TC TIR/CCC
Design Approval	Lloyds Register or BUREAU VERITAS, Inspection & Certification: Lloyds Register or BUREAU VERITAS

### Tank Data

Nominal Water Capacity	52,500 Liters (+/- 1% Tolerance)
MAWP	18.0 Bar(g)
Test Pressure (Periodic)	25.7 Bar(g)
External Pressure	1.0 Bar(g)
Design Temperature	-40 / +55°C
Material Shell and Heads	SA612N
Flanges	SA 350 LF2
Welding Factor	1.0
Heat Treatment	Post Weld Heat Treatment (Stress Relieved) acc ASME Code
NDE Visual	100% All Welds
RT (X-Ray)	100% All Long. & Circ Butt Welds
MT	100% Studded Pad & Pad-Plate to Shell Welds



# ISG - Pit to Ship Solutions™

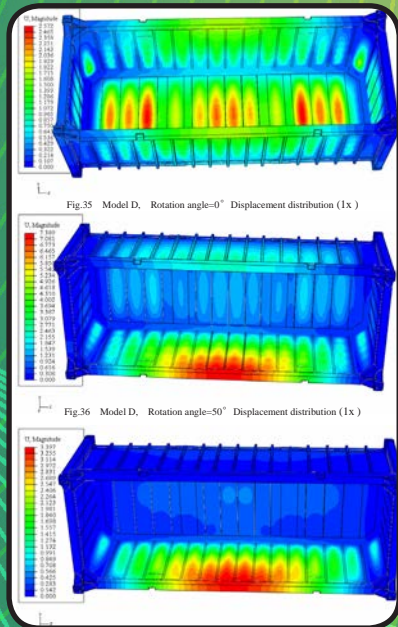

## Consultancy

Above: Matthew Chalmers, Mechanical Engineer & General Manager - Pit to Ship Solutions™  
Contact: +61 448 855 650

Tap into Pit to Ship Solutions wide range of experience.

**Experience:** Australian Road and Rail Transport System, International Shipping, Defence Projects, Mining Projects.

**CAD Design:** 3D Concept Models, Finite Element Analysis, Site Plans and Layouts, 2D Manufacturing Drawings and Specs.

**Technical Documentation:** Marketing Material, Operations Manuals, Spare Parts Support, Training Material, Integrated Logistics Support.

**Strategic Links:** Engineering services to certify products and designs, Assistance in obtaining patents, Membership Institute of engineers Australia, MCIT, Overseas representatives to assist in sourcing parts and products.

Pit to Ship Solutions have qualified engineers that can consult to your company at very reasonable rates. We are willing to be involved in a wide range of projects, not limited to shipping containers.



## DCN Environmental or Safety Award

ISG winners of the Daily Commercial News (DCN) environment award for 2017

This award is given for initiatives or implementation of operating systems or company policies which contribute to an improved environment or improved safety in the movement of freight. This award is also open to entries demonstrating implementation of systems which improve OH&S practices.

In November 2017 ISG was honoured by receiving an award for environment and safety for the implementation of our dust free logistic and loading system in ports around the world.

The award was presented to Matthew Chalmers General Manager of ISG Pit To Ship Solutions.



## ALABC Business Excellence Award

ISG winners at the Australian Latin America Business Councils (ALABC) Business excellence award. The award was presented by the Australian foreign affairs minister, The honourable Julie Bishop. The award focuses on successful Australian companies who have excelled in trading with Latin American countries. ISG now covers the West coast of the Americas with their patented dust free logistic and loading solution in most of the major ports.

Applicants were assessed for their performance against 4 key criteria:

1. Strategy clearly defined for entry/engagement/growth in the Latin American region.
2. Growth in the Latin American region (e.g. indicated by increased revenue, operational activity or markets served.)
3. Innovation underpinning business success (e.g. innovative products, services, processes or business models)
4. Commitment to maintain and grow presence and activity in the Latin American region.

The award was presented to the CFO Julie Boden at a packed ballroom in Sydney on the 30th of November 2017.



## Winners of the 2015 NSW Environment Export Awards

The Export Council of Australia would like to congratulate the finalists announced for the 2015 Premier of NSW's Export Awards. With a wide range of exporters competing from across the state the 85 finalists announced today by the Export Council of Australia (ECA) were selected from the largest pool of applicants in the 53-year history of the awards.

Chief Executive Officer for the Export Council of Australia said "the competition is extremely tough and we wanted to make sure all finalists were recognized for their tremendous efforts."

The above picture of the ISG team celebrating their award winning night, (L-R) General Manager Matthew Chalmers, Director Christopher Edwards, Managing Director Garry Pinder, Marketing Manager Cathie Pinder and Chief Financial Officer Julie Boden.



## Sponsorship - Don Orione in Antofagasta, Chile

In 2018 the ISG team identified a special needs facility in the heart of Antofagasta Chile that needed assistance. Antofagasta is one of the largest areas ISG has been successful in, with their patented logistic and ship loading system. ISG equipment is currently in six ports in the region and supplying to many blue chip mining companies. "Our company appreciates the support that has been given to our team in this region, and we are happy to give some back" commented Garry Pinder Managing Director of ISG. The facility has several needs and has no support other than that of the local people. The facilities roof has several large holes. When it rains the roof leaks which initiates movement of the residents, some bedbound. Often this may occur in the middle of the night.

The ISG team have arranged to completely replace the roof and the roof trusses to alleviate this problem. The roof span is over 300m<sup>2</sup> and is a large project that will take over four weeks to complete. ISG also noted an extra nurse was needed to assist with the residents. ISG has now sponsored two nurses on a one year contract for the facility.

ISG needed some legal assistance on this project and the team at Harris Gomez Chile donated their valuable time and we thank them for their generosity. Harris Gomez Chile office details are; Telephone: [+56 2 2242 1157](tel:+56222421157) | Address: Av.Vitacura 5250, Office 802, Vitacura, Santiago, Chile | Email: [hmg@hgomezgroup.com](mailto:hmg@hgomezgroup.com) | [www.hgomezgroup.com](http://www.hgomezgroup.com)

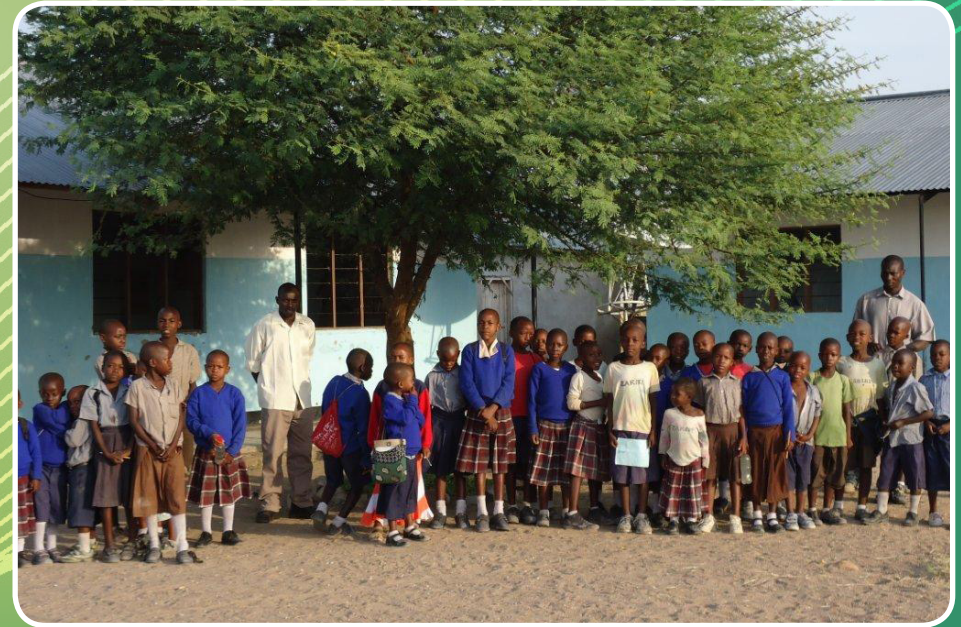

## Sponsorship - Zarik School, Tanzania, Africa

In 2013 the team from Pit to Ship Solutions constructed a classroom for the Zarik School in the fishing village of Magumwanza in Tanzania, Africa.

The Pit to Ship Solutions team has been working in Africa for two years now and decided it was a good idea to build the classroom to assist the children with a good education. The village only had one other classroom and 40 children would go to school from 7am until 12pm. In the afternoon another 40 children would attend the afternoon session from 1pm until 5pm. The room was so overcrowded and only had one teacher for both sessions.

The team have also sponsored a school teacher for two years in the newly constructed Kookaburra classroom. The ISG logo has the iconic Australian bird the Kookaburra as its logo and the team thought it only fitting to have the classroom named after their logo. Now they have two teachers and two classrooms and the children have an eight hour school day (not sure if they are happy about that)!!!

# Intermodal Solutions Group™ - ISG™

## System Benefits

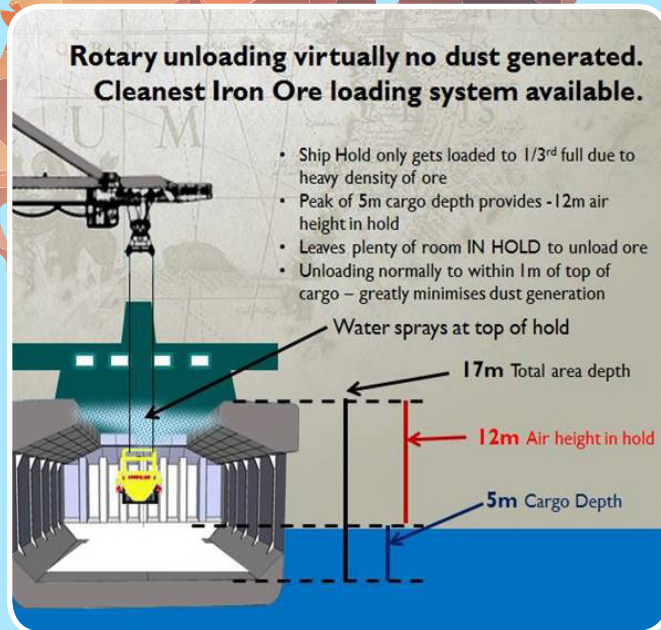

**Cleanest Minerals Loading System Available**



**The ISG new Grain Container in Operation**

### Cost

Lower set up costs (No conveyor, ship loaders, storage sheds).

### Environmental

Zero dust, no clean up. This process is considered best practice by EPA with fast approval.

### Safe & Fast

Virtually man less operation that has loading rates of 1000 TPH per crane

### Proven & Reproducible

All equipment providers have worked to provide a simple proven turnkey solution to exporters.



**Patented Containers and System**



**GARRY PINDER**  
Managing Director  
[www.pittoship.com](http://www.pittoship.com)  
mobile: +61 400 035 548  
email: [gpinder@isgpts.com](mailto:gpinder@isgpts.com)

**Mined, Sealed and Delivered ISG Technology**

**[www.pittoship.com](http://www.pittoship.com)**