



# 6000 Series Commercial Exit Device



**ACCENTRA**

**ASSA ABLOY**

ASSA ABLOY is transitioning the Yale Commercial brand to ACCENTRA. This affects only the brand name; the products and product numbers will remain unchanged. Prior to May 20, 2024, products may be shipped either as Yale Commercial brand or ACCENTRA brand. Products shipping after May 20, 2024, will be branded ACCENTRA.

# Table of Contents







Introduction.....	3-4	Trim Designs.....	17-19
Benefits and Features.....	5	6100ED Series Wide Stile Trims.....	20-24
Finishes.....	6	6200ED Series Narrow Stile Trims.....	25
How To Order.....	7	Electrified Options.....	26-32
6100ED(F) Rim.....	8	Functions.....	33-34
6150ED(F) SquareBolt®.....	9	Applications & Listings.....	35-38
6170ED(F) Surface Vertical Rod.....	10	Cylinders.....	39-42
6160ED(F) Concealed Vertical Rod.....	11	Collars & Tailpieces.....	43
6130ED(F) Mortise.....	12	Strikes.....	44-45
6200ED Rim.....	13	Accessories and Options.....	46-47
6250ED SquareBolt®.....	14	Mullions.....	48-49
6210ED Surface Vertical Rod.....	15	Dimensions.....	50
6220ED Concealed Vertical Rod.....	16	Sample Specifications.....	51

# Introduction

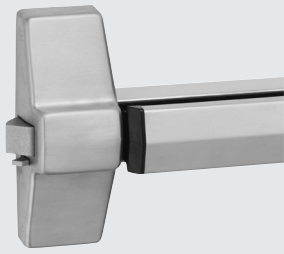
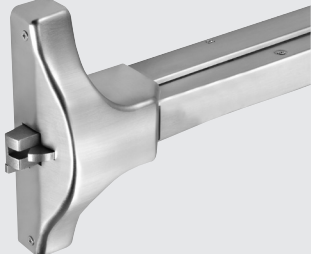
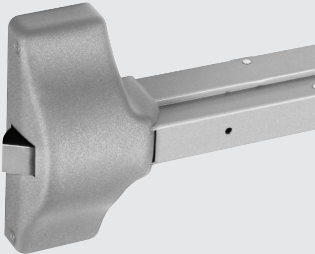

Yale® Commercial Solutions offers innovative and reliable products to solve the challenges of commercial, retail, hospitality, assisted living, mixed-use, and multi-family properties. With over 150 years of door hardware experience, Yale's expertise extends beyond products to people - and provides the service and support you expect.

Featuring durable products to meet all your facilities' requirements - and the quality you expect from a leader in the hardware industry. Yale works for you<sup>SM</sup>.

Yale Exit Devices			
7000 Series	2100 Series	1800 Series	1500 Series
			
			
<ul style="list-style-type: none"> <li>• Ideal for facilities that require durability and innovation to meet their security needs</li> <li>• Wide &amp; Narrow Stile Applications</li> <li>• Rim, SquareBolt, Mortise, SVR &amp; CVR</li> <li>• Mechanical &amp; Electro-Mechanical Functions</li> <li>• Available with Motorized Electric Latch Retraction</li> <li>• Constructed with high quality steel and heavy-duty components</li> <li>• 16 Standard finishes including BSP (Black Suede Powder Coat)</li> <li>• ANSI/BHMA Certified Grade 1</li> <li>• 5 Year Warranty and Two-Year Limited Warranty on Electronic Components</li> <li>• UL Rated for Panic &amp; Fire, Windstorm Rated Options (refer to local codes)</li> </ul>	<ul style="list-style-type: none"> <li>• Ideal for commercial applications and budget conscious end users</li> <li>• Wide Stile Applications</li> <li>• Rim, Squarebolt, CVR &amp; SVR</li> <li>• Mechanical Functions</li> <li>• ANSI/BHMA Grade 1 Certified</li> <li>• UL Rated for Panic &amp; Fire</li> <li>• Architectural &amp; Painted Finishes</li> <li>• 3 Year Warranty</li> </ul>	<ul style="list-style-type: none"> <li>• Ideal for back of the house where function and code compliance are the requirement</li> <li>• Wide Stile Applications</li> <li>• Rim &amp; SVR</li> <li>• Mechanical Functions</li> <li>• ANSI/BHMA Certified Grade 1</li> <li>• UL Rated for Panic &amp; Fire</li> <li>• Powder-coat Painted Finishes</li> <li>• 1 Year Warranty</li> </ul>	<ul style="list-style-type: none"> <li>• Ideal for renovation projects where historical preservation is the desired look</li> <li>• Wide Stile Applications</li> <li>• Rim, CVR, SVR &amp; Mortise</li> <li>• ANSI/BHMA Certified Grade 1</li> <li>• UL Rated for Panic &amp; Fire</li> <li>• Can Meet Buy American Act</li> <li>• Architectural &amp; Painted Finishes</li> <li>• 1 Year Warranty</li> </ul>

# Introduction



With a full range of functions and options and ANSI Grade 1 certification, the Yale® 6000ED Series exit devices provide the right security for your commercial facility.

The stylish, clean lines of the wide and narrow stile 6000ED are visually appealing and blend with any decor. With a multitude of mechanical and electromechanical functions available, the 6000ED can be used in many types of facilities including office buildings, retail environments and mixed-use, and is perfect for both new construction and retrofit applications.

Yale 6000ED Series exit devices come with a full array of electromechanical options and accessories and can be effortlessly integrated into existing security or fire alarm systems.

## 6100ED(F) Series (Wide Stile)

The 6100ED(F) exit device series is available in rim, SquareBolt®, mortise, surface and concealed vertical rod configurations. Perfect for single swing doors or pairs of doors of metal, wood or composite construction. The 6100ED(F) Series is available in both panic and fire rated versions. See pages 8-12 for more information.



## 6200ED Series (Narrow Stile)

The 6200ED exit device series is available in rim, SquareBolt®, surface and concealed vertical rod configurations. Perfect for single swing doors or pairs of doors of metal or aluminum. The 6200ED series is panic rated. See pages 13-16 for more information.



## Warranty

- Mechanical exit devices and 400F, 500F, and 600F trims carry a 10-year limited warranty.
- 690F and 691F trims carry a two-year limited warranty.
- Electrical options and components carry a two-year limited warranty.



# Benefits & Features

## Benefits

- **Smooth, Quiet Operation:** Unique design provides noise reduction and smooth operation of the touch bar
- **Stylish:** Attractive, modern design blends aluminum rail with architectural finishes; available with over 38 levers to match any decor
- **Strong and Reliable:** ANSI/BHMA Grade 1 certified for long life
- **Secure:** Multiple security features provide added resistance against vandalism and authorized entry

## Features

- ANSI/BHMA A156.3 Grade 1 certified **BHMA CERTIFIED**
- Available as rim, mortise, SquareBolt®, surface vertical rod and concealed vertical rod in wide or narrow stile configurations
- Highly durable aluminum rail design with architecturally finished touch bar in 5 finishes
- Heavy duty, angled end cap design protects rail, eliminates catch points and reduces damage
- Available in 13 mechanical functions and 11 electromechanical functions
- Available with standard or Reflections® decorative levers
- Complete offering of mechanical and electro-mechanical solutions
- Available with Microshield® antimicrobial coating
- 10 year warranty

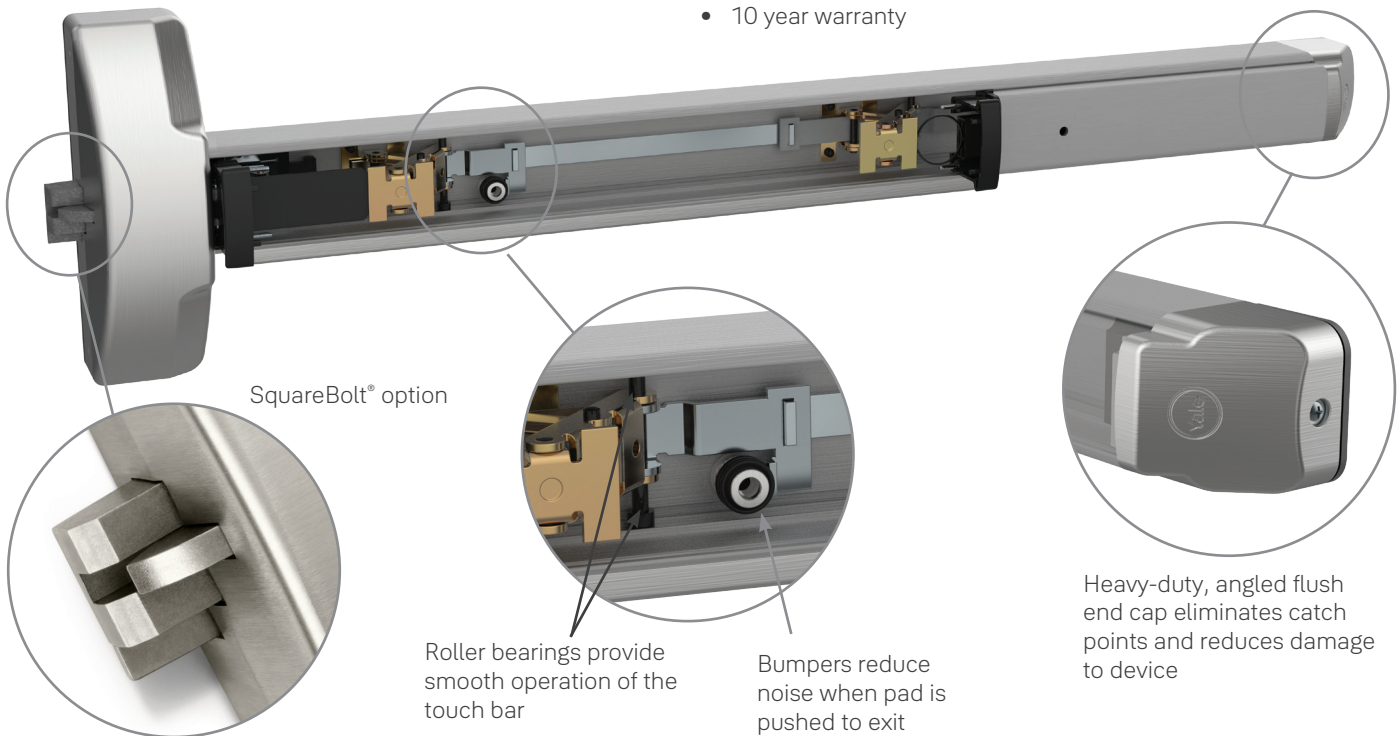

The SquareBolt option offers a latchbolt with greater latch engagement than standard rim devices. Credit cards, crowbars, door rattling and shaking are resisted, significantly reducing the threat of unauthorized entry





## Available with Motorized Electric Latch Retraction!

The Motorized Electric Latch Retraction (MELR) feature provides remote-controlled latch retraction that delivers quiet, smooth operation for convenient, hassle-free egress. Easily installed in new applications and available as retrofit rail kit assemblies for field updates, the MELR features maintenance-free design with few moving parts using 86% less power consumption during retraction than solenoid devices. Plus, MELR is powered by a standard power supply, simplifying installation and increasing system design flexibility. See page 27 for more details.











# Finishes

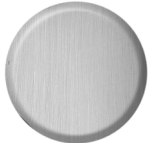

ANSI/BHMA Code Finish Description		
<b>613E</b> Dark Oxidized Satin Bronze - equivalent	<b>629</b> Bright Stainless Steel	<b>630</b> Satin Stainless Steel
		
<b>BSP</b> Black Suede Powder Coat	<b>WSP</b> White Suede Powder Coat	
		

# Trim Finishes

ANSI/BHMA Code Finish Description				
<b>605</b> Bright Brass, Clear Coated	<b>606</b> Satin Brass, Clear Coated	<b>613E</b> Dark Oxidized Satin Bronze - equivalent	<b>625</b> Bright Chrome Plated	<b>626*</b> Satin Chrome Plated
				
<b>629</b> Bright Stainless Steel	<b>630*</b> Satin Stainless Steel	<b>BSP</b> Black Suede Powder Coat	<b>WSP</b> White Suede Powder Coat	
				

Add YMS suffix to order Microshield® antimicrobial coating

\*Finish available with MicroShield® antimicrobial coating, additional finishes by special application. Consult factory for availability.

MicroShield coating may vary finish color from architectural standards. MicroShield is not intended as a substitute for traditional infection control programs such as hand hygiene or use of disinfectants. Coated products must still be cleaned to ensure the surfaces will be free of destructive microbes. Yale makes no representations or warranties, express or implied, as to the efficacy of MicroShield.



# How To Order

Using the chart below, construct the part number based on the options, trim and finish needed.

6	X	X	XED	Mechanical/Electrical	Size <sup>5</sup>	Design	Trim	Finish	Other Info
	<b>Second Digit:</b> "1" - Standard device, 4-1/2" (114mm) or wider door stile.  "2" - Narrow stile door or narrow escutcheon trim (500F, 510F Series)	<b>Third Digit:</b> "0" - Rim Device, Pullman Latch  "1" - SVR Device (narrow stile)  "2" - CVR Device (narrow stile)  "3" - Mortise Device  "5" - SquareBolt®, Rim Security  "6" - CVR Device (wide stile)  "7" - SVR Device (wide stile)	<b>Fourth Digit:</b> "0" - Standard  "5" - Cylinder Dogging (Not with suffix "F")	<b>Mechanical Feature</b> "F" - Fire Exit Device  "LBR" - Less Bottom Rod <sup>2</sup>  "L5" - Mortise Device, Entry by Key with/without Rigid Lever <sup>1</sup>  "L8" - Mortise Device, Entry by Lever  "2" - Double Cylinder Device <sup>3</sup>  <b>Electrical Feature</b> "-A" - Alarm Kit  "A-ALR" - Alarm Kit with red screenprinted touchpad  "-B" - Bar Monitor or Signaling  "MELR" - Motorized Electric Latch Retraction  "-O" - Outside Trim Monitor or Signaling  "-P" - Electric Latch Retraction  "-S" - Latchbolt Status Monitor or Signaling  "-Safe" - Mortise Device Trim Control (Lever only)  "-Secure" - Mortise Device Trim Control (Lever only)	<b>Size:</b> DOW = Door Opening Width)  "24" 24" DOW <sup>4</sup>  "36" - 30" to 36" DOW  42" for 36"-42" DOW  "48" - 42" to 48" DOW  <b>Door Height:</b> -7 = 7' standard  -8 = 8' (2.44m)  -9 = 9' (2.74m)  -10 = 10' (3.05m)	<b>Trim Design</b> See pages 17-18	<b>Trim Model Number</b> See pages 19-25	See Page 6	<b>Other Information:</b> <b>Door Hand</b> - RHR or LHR  <b>Door Thickness</b> - Over 1-3/4" (45mm)  <b>Fastener Options</b> - TORX® Security Screws SNB (wood, composite, or unreinforced metal doors)  <b>Specialty Cylinders &amp; Components</b> (see pages 39-42)

It is recommended that exit devices and trim for the same opening be ordered together. Standard product is for 1-3/4" (44mm) reinforced metal doors. Accessories detached from the device and trim should be specified separately. Materials by others are required to be fit for the purpose as detailed in this catalog and the product installation literature.

**Notes:**

1. Required for electrical feature, Suffix "-SAFE" or "-SECURE".
2. LBR available on 6160(F90) and 6170(F90) devices only.
3. For double cylinder devices, suffix "-2" after fourth digit.
4. If "-24" device is to be used with a DOW greater than 24", the device will ship without UL label. The 12" touchpad will not cover 50% of the device touchbar length.
5. Contact door manufacturer for detailed frame/door requirements and limitations.

## Ordering Examples

**Exit Device Only**

6150EDD-36 x 626 x RHR x SNB

**Exit Device with Trim and Cylinder\***

6170EDF90-9-48 x AU626F x 630 x LHR x 1109 GA 0-bit

**Trim Only**

MO656F x 630 x RHR x LC

**Double Cylinder Exit Device with Trim**

6150F-2-36 x AU626F x 630

\*Yale® exit devices and trims are processed separately. To aid in order processing, the device, trim and cylinder should be detailed as separate line items. These items can be ordered on one line item as shown, but they will be entered to the factory and acknowledged separately.

# 6100ED(F) Rim



The 6100ED(F) is a rim exit device to be used with single doors or pairs of doors constructed of metal, wood or composite materials. Designed for application in high-use areas, the 6100ED(F) comes in a variety of finishes and can be combined with a variety of trims to match any desired style.

## Features

- Designed for wide stile doors
- 3/4" throw deadlocking stainless steel pullman latchbolt
- Available in double cylinder function (must specify handing)
- Non-handed for easy installation



## Applications

- Single swing doors
- Pairs of doors with removable mullions
- Wide stile aluminum, metal, wood or composite door materials

## Specifications

<b>Rail Sizes:</b>	-24 for 24" (60cm) doors -36 for 30" - 36" (76cm - 91cm) doors -42 for 36" - 42" (91cm - 107cm) doors -48 for 42" - 48" (107cm - 122cm) doors Alternate sizes can be special ordered. Consult Technical Product Support.
<b>Door Thickness:</b>	1-3/4" (44mm) standard. Optional thicknesses to 4-1/2"; specify when ordering.
<b>Minimum Stile Width:</b>	4-1/2" (114mm)
<b>Projection:</b>	3-1/4" (83mm) active; 2-1/2" (63.5mm) dogged
<b>Latchbolt:</b>	Stainless steel pullman style, 3/4" (19mm), deadlocking
<b>Strike(s):</b>	757F standard; 793 optional for pairs, panic only
<b>Fasteners:</b>	Machine screws or wood door screws standard for panic; sex nuts and bolts (SNB) supplied standard for fire
<b>Handing:</b>	Non-handed
<b>ANSI/BHMA:</b>	Certified ANSI/BHMA A156.3 Type 1 Grade 1 standards
<b>Dogging:</b>	Hex key dogging standard on panic; optional cylinder dogging (-5)
<b>Shim Kit:</b>	#623SK optional
<b>Finishes:</b>	See page 6 for finish options
<b>Options:</b>	Double cylinder function (-2); specify hand. Anti-pry bracket #625AP.







# 6150ED(F) Rim SquareBolt®

The rim SquareBolt® exit device's unique construction offers innovative protection. Its design provides greater latch engagement for higher security than standard rim devices can offer. Credit cards, crowbars, door rattling and shaking are resisted, significantly reducing the threat of unauthorized entry.

## Features

- Larger bolt engagement
- Designed for maximum holding power
- Delivers higher security
- Non-handed for easy installation
- Can be retrofitted onto existing 7000 Series templated doors
- Fully adjustable surface-mounted 3/8" diameter roller strike complete with positive locking plate and shims
- Available in double cylinder function

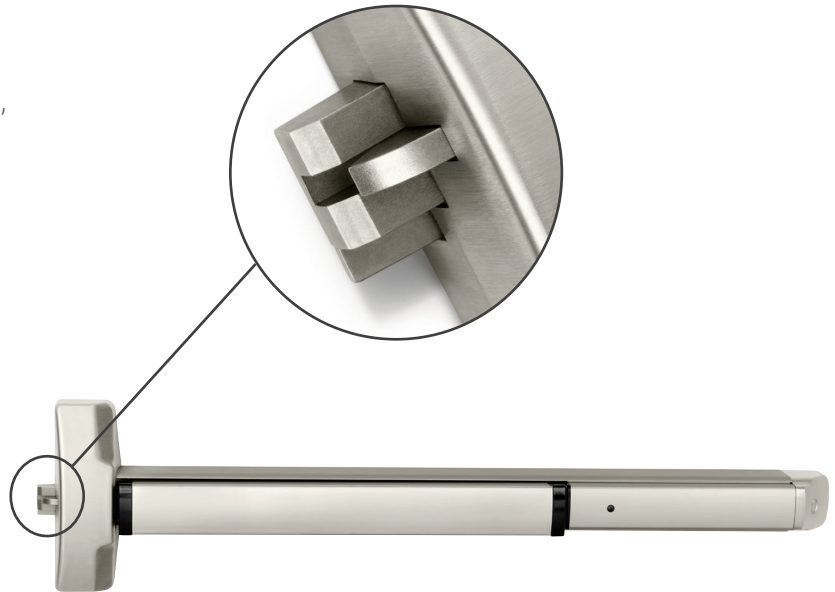

## Applications

- Single swing doors
- Pairs of doors with removable mullions
- Wide stile aluminum, metal, wood or composite door materials

## Specifications

<b>Rail Sizes:</b>	-24 for 24" (60cm) doors -36 for 30" - 36" (76cm - 91cm) doors -42 for 36" - 42" (91cm - 107cm) doors -48 for 42" - 48" (107cm - 122cm) doors Alternate sizes can be special ordered. Consult Technical Product Support.
<b>Door Thickness:</b>	1-3/4" (44mm) standard. Optional thicknesses to 4-1/2"; specify when ordering.
<b>Minimum Stile Width:</b>	4-1/2" (114mm)
<b>Projection:</b>	3-1/4" (83mm) active; 2-1/2" (63.5mm) dogged
<b>Latchbolt:</b>	1" (25mm) slide projection bolt with full 3/4" (19mm) projection
<b>Strike(s):</b>	757F standard; 793 optional for pairs, panic only
<b>Fasteners:</b>	Machine screws or wood door screws standard for panic; sex nuts and bolts (SNB) supplied standard for fire
<b>Handing:</b>	Non-handed
<b>ANSI/BHMA:</b>	Certified ANSI/BHMA A156.3 Type 1 and 28 Grade 1 standards
<b>Dogging:</b>	Hex key dogging standard on panic; optional cylinder dogging (-5)
<b>Shim Kit:</b>	#623SK optional
<b>Finishes:</b>	See page 6 for finish options
<b>Options:</b>	Double cylinder function (-2); specify hand. Anti-pry bracket #625AP.



# 6170ED(F) Surface Vertical Rod



The 6170ED(F) is a surface vertical rod exit device to be used on wide stile and flush doors up to 10' where one- or two-point latching is desired. A Less Bottom Rod (LBR) option is available.

## Features

- Designed for wide stile and flush doors
- Handed. Specify hand (field reversible)
- Interlocking top strike and latch mounting plate
- Available less bottom rod (LBR option)

## Applications

- Single swing doors
- Pairs of doors with removable mullions
- Wide stile aluminum, metal, wood or composite door materials

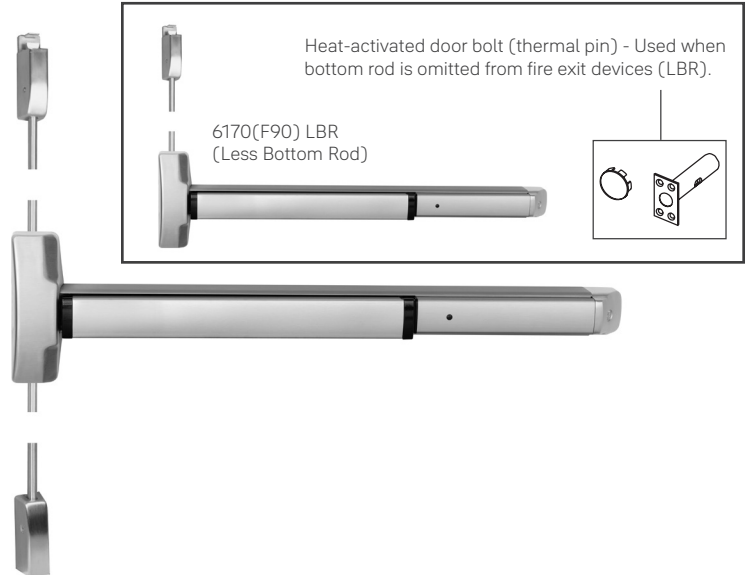

## Specifications

<b>Rail Sizes:</b>	-24 for 24" (60cm) doors -36 for 30" - 36" (76cm - 91cm) doors -42 for 36" - 42" (91cm - 107cm) doors -48 for 42" - 48" (107cm - 122cm) doors Alternate sizes can be special ordered. Consult Technical Product Support.
<b>Door Thickness:</b>	1-3/4" (44mm) standard. Optional thicknesses to 4-1/2"; specify when ordering.
<b>Minimum Stile Width:</b>	4-1/2" (114mm)
<b>Projection:</b>	3-1/4" (83mm) active; 2-1/2" (63.5mm) dogged
<b>Latchbolt:</b>	Top: 3/4" (19mm) pullman style with auto deadlatching; Bottom 5/8" (16mm) deadbolt, held retracted during door swing
<b>Strike(s):</b>	Top: 726; Bottom: flush-mounted 790. 794 floor strike optional (threshold openings)
<b>Fasteners:</b>	Machine screws or wood door screws standard for panic; sex nuts and bolts (SNB) supplied standard for fire
<b>Handing:</b>	Handed, please specify. Field reversible.
<b>ANSI/BHMA:</b>	Certified ANSI/BHMA A156.3 Type 2 Grade 1 standards
<b>Dogging:</b>	Hex key dogging standard on panic; optional cylinder dogging (-5)
<b>Shim Kit:</b>	#624SK optional
<b>Finishes:</b>	See page 6 for finish options
<b>Options:</b>	Rod extensions, Less Bottom Rod (LBR)
<b>Door Height:</b>	7' (213cm) standard. Optional heights 8', 9' and 10'.
<b>Vertical Rods:</b>	1/2" OD brass, bronze or stainless steel with rod guides





# 6160ED(F) Concealed Vertical Rod

The 6160ED(F) is a concealed vertical rod exit device to be used on wood and metal doors up to 10' where one- or two-point latching is desired. A Less Bottom Rod (LBR) option is available.

## Features

- Designed for wide stile and flush doors
- Handed. Specify hand (field reversible)
- Mortised top strike
- Available less bottom rod (LBR option)

## Applications

- Single swing doors
- Pairs of doors with removable mullions
- Wide stile aluminum, metal, wood or composite door materials

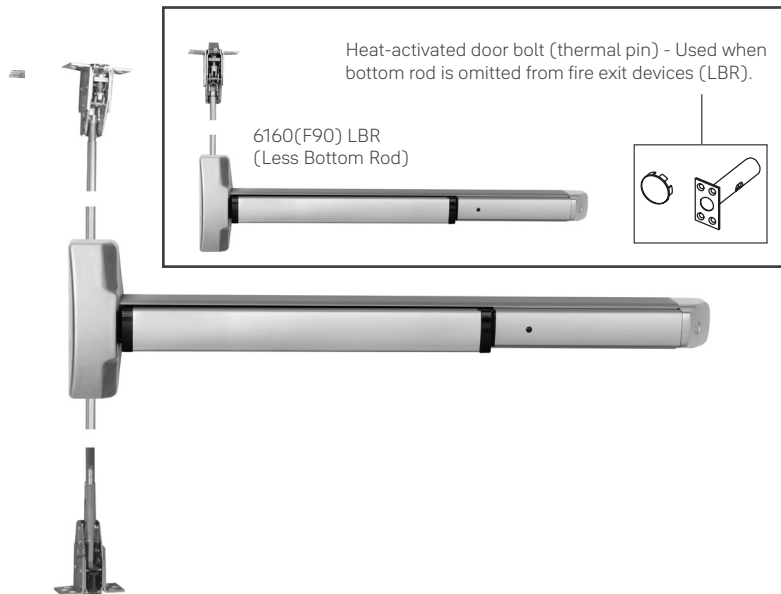

## Specifications

Rail Sizes:	-24 for 24" (60cm) doors -36 for 30" - 36" (76cm - 91cm) doors -42 for 36" - 42" (91cm - 107cm) doors -48 for 42" - 48" (107cm - 122cm) doors Alternate sizes can be special ordered. Consult Technical Product Support.
Door Thickness:	1-3/4" (44mm) standard. 2" and 2-1/4" (51mm and 57mm) optional, specify when ordering.
Minimum Stile Width:	4-1/2" (114mm)
Projection:	3-1/4" (83mm) active; 2-1/2" (63.5mm) dogged
Latchbolt:	Top: 3/4" (19mm) pullman style with auto deadlatching; Bottom 5/8" (16mm) deadbolt, held retracted during door swing
Strike(s):	Top: Mortised 761; Bottom: flush-mounted 790. 794 floor strike optional (threshold openings)
Fasteners:	Machine screws or wood door screws standard for panic; sex nuts and bolts (SNB) supplied standard for fire
Handing:	Handed, please specify. Field reversible.
ANSI/BHMA:	Certified ANSI/BHMA A156.3 Type 7 and 8 Grade 1 standards
Dogging:	Hex key dogging standard on panic; optional cylinder dogging (-5)
Shim Kit:	#623SK optional
Finishes:	See page 6 for finish options
Options:	Rod extensions, Less Bottom Rod (LBR)
Door Height:	Standard door height adjustable to 8'(244cm). Optional heights 9' and 10'.
Vertical Rods:	1/2" (13mm) OD, telescoping tubular rods



# 6130ED(F) Mortise



The 6130ED(F) is an exit device integrated with the Yale® 8700 Series Mortise Lock for use on single doors or active leaf of a pair of doors where life safety and extra security are required. The 8700 Series Mortise Lock is modified for use with exit devices only.



## Features

- Designed for wide stile and flush doors
- Handed. Specify hand (field reversible)
- Two-piece mechanical 3/4" throw deadlocking stainless steel latchbolt
- Available in double cylinder function

## Applications

- Single swing doors
- Pairs of doors with removable mullions
- Wide stile aluminum, metal, wood or composite door materials

## Specifications

Order as follows, according to function.	
<b>6130ED-K5(F)</b>	Exit only, no trim
<b>6130ED-L5(F)</b>	(02) Entry by rigid lever when dogged.
	(03) Key retracts latchbolt.
	Electrical control for 650F Series trim, w/wo key override.
<b>6130ED-T5(F)</b>	(02) Entry by pull when dogged.
	(03) Key retracts latchbolt.
<b>6130ED-L8(F)</b>	(08) Entry by lever lock/unlocked by key or lever only (passage).
<b>6130ED-L8(F)-2</b>	(08) Entry by lever lock/unlocked by key either side or lever only (passage).
<b>6130ED-T8(F)</b>	(05) Entry by thumbpiece lock/unlocked by key or thumbpiece only (passage).

<b>Rail Sizes:</b>	-24 for 24" (60cm) doors -36 for 30" - 36" (76cm - 91cm) doors -42 for 36" - 42" (91cm - 107cm) doors -48 for 42" - 48" (107cm - 122cm) doors Alternate sizes can be special ordered. Consult Technical Product Support.
<b>Door Thickness:</b>	1-3/4" (44mm) standard. 2" and 2-1/4" (51mm and 57mm) optional, specify when ordering.
<b>Minimum Stile Width:</b>	4-1/2" (114mm)
<b>Projection:</b>	3-1/4" (83mm) active; 2-1/2" (63.5mm) dogged
<b>Latchbolt:</b>	Two piece mechanical 3/4" (19mm) deadlocking stainless steel with anti-friction insert and auxilliary deadlocking latch
<b>Strike(s):</b>	798 curved lip; 612 or 712 optional for pairs with astragals, 618 or 718 optional open-back strike. See page 44 for more information.
<b>Fasteners:</b>	Machine screws or wood door screws standard for panic; sex nuts and bolts (SNB) supplied standard for fire
<b>Handing:</b>	Handed, please specify.
<b>ANSI/BHMA:</b>	Certified ANSI/BHMA A156.3 Type 3 Grade 1 standards
<b>Dogging:</b>	Hex key dogging standard on panic; optional cylinder dogging (-5)
<b>Shim Kit:</b>	#623SK optional
<b>Finishes:</b>	See page 6 for finish options
<b>Options:</b>	Double cylinder function (-2); specify hand





# 6200ED Rim

The 6200ED is a narrow stile rim exit device compatible with the aesthetics and functional requirements of contemporary doors. The 6200ED comes in varied finishes and can be combined with a variety of trims to match any desired style.

## Features

- Designed for narrow stile doors
- 3/4" throw deadlocking stainless steel pullman latch
- Non-handed for easy installation
- Used with narrow stile trim



## Applications

- Single swing narrow stile doors
- Pairs of narrow stile doors with removable mullions
- Metal and aluminum doors
- 6200ED for panic-rated doors only

## Specifications

<b>Rail Sizes:</b>	-36 for 30" - 36" (76cm - 91cm) doors -42 for 36" - 42" (91cm - 107cm) doors -48 for 42" - 48" (107cm - 122cm) doors Alternate sizes can be special ordered. Consult Technical Product Support.
<b>Door Thickness:</b>	1-3/4" (44mm) standard. 2" and 2-1/4" (51mm and 57mm) optional, specify when ordering.
<b>Minimum Stile Width:</b>	Pair of doors: 3-1/8" (79mm), does not include glass stop. Single door: 2-5/8" (67mm), does not include glass stop.
<b>Projection:</b>	3-1/4" (83mm) active; 2-1/2" (63.5mm) dogged
<b>Latchbolt:</b>	Stainless steel pullman style, 3/4" (19mm), deadlocking
<b>Strike(s):</b>	759 standard; 793 optional for pairs, panic only
<b>Fasteners:</b>	Machine screws or wood door screws standard for panic
<b>Handing:</b>	Non-handed
<b>ANSI/BHMA:</b>	Certified ANSI/BHMA A156.3 Type 4 Grade 1 standards
<b>Dogging:</b>	Hex key dogging standard on panic; optional cylinder dogging (-5)
<b>Shim Kit:</b>	#623NS optional
<b>Finishes:</b>	See page 6 for finish options
<b>Options:</b>	Anti-pry bracket #625AP.

# 6250ED Rim SquareBolt®



The unique construction of the SquareBolt exit device offers innovative protection. Its design provides greater latch engagement for higher security than standard rim devices can offer. Credit cards, crowbars, door rattling and shaking are resisted, significantly reducing the threat of unauthorized entry. The 6250ED SquareBolt is designed for narrow stile doors.

## Features

- Larger bolt engagement
- Designed for maximum holding power
- Delivers higher security
- Non-handed for easy installation
- Can be retrofitted onto existing 7200 Series templated doors
- Fully adjustable surface mounted 3/8" diameter roller strike complete with positive locking plate and shims
- Used with narrow stile trim

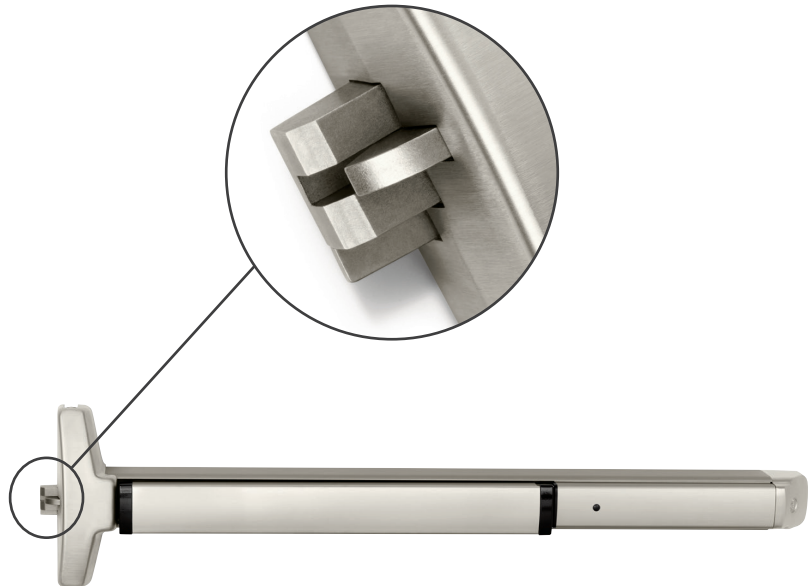

## Applications

- Single swing narrow stile doors
- Pairs of narrow stile doors with removable mullions
- Metal and aluminum doors
- 6250ED for panic-rated doors only

## Specifications

<b>Rail Sizes:</b>	-36 for 30" - 36" (76cm - 91cm) doors -42 for 36" - 42" (91cm - 107cm) doors -48 for 42" - 48" (107cm - 122cm) doors Alternate sizes can be special ordered. Consult Technical Product Support.
<b>Door Thickness:</b>	1-3/4" (44mm) standard. 2" and 2-1/4" (51mm and 57mm) optional, specify when ordering.
<b>Minimum Stile Width:</b>	Pair of doors: 3-1/8" (79mm), does not include glass stop. Single door: 2-5/8" (67mm), does not include glass stop.
<b>Projection:</b>	3-1/4" (83mm) active; 2-1/2" (63.5mm) dogged
<b>Latchbolt:</b>	1" (25mm) slide projection bolt with full 3/4" (19mm) projection
<b>Strike(s):</b>	759 standard; 793 optional for pairs, panic only
<b>Fasteners:</b>	Machine screws or wood door screws standard for panic
<b>Handing:</b>	Non-handed
<b>ANSI/BHMA:</b>	Certified ANSI/BHMA A156.3 Type 4 and 28 Grade 1 standards
<b>Dogging:</b>	Hex key dogging standard; optional cylinder dogging (-5)
<b>Shim Kit:</b>	#623NS optional
<b>Finishes:</b>	See page 6 for finish options
<b>Options:</b>	Anti-pry bracket #625AP.



# 6210ED Surface Vertical Rod

The 6210ED is a narrow stile surface vertical rod exit device to be used on narrow stile, aluminum and metal doors where two-point latching is desired.

## Features

- Designed for narrow stile doors
- Handed. Specify hand (field reversible)
- Bottom deadbolt for secure latching
- Fully adjustable roller strike

## Applications

- Pairs of narrow stile doors
- Metal and aluminum doors
- For panic-rated doors only



## Specifications

<b>Rail Sizes:</b>	-36 for 30" - 36" (76cm - 91cm) doors -42 for 36" - 42" (91cm - 107cm) doors -48 for 42" - 48" (107cm - 122cm) doors Alternate sizes can be special ordered. Consult Technical Product Support.
<b>Door Thickness:</b>	1-3/4" (44mm) standard. 2" and 2-1/4" (51mm and 57mm) optional, specify when ordering.
<b>Minimum Stile Width:</b>	2-3/4" (70mm), does not include glass stop
<b>Projection:</b>	3-1/4" (83mm) active; 2-1/2" (63.5mm) dogged
<b>Latchbolt:</b>	Top: 3/4" (19mm) pullman style with auto deadlatching; Bottom 5/8" (16mm) deadbolt, held retracted during door swing
<b>Strike(s):</b>	Top: 791 roller strike; Bottom: 790 flush mount. 794 floor strike optional (threshold openings)
<b>Fasteners:</b>	Machine screws or wood door screws standard for panic
<b>Handing:</b>	Handed, please specify. Field reversible.
<b>ANSI/BHMA:</b>	Certified ANSI/BHMA A156.3 Type 5 Grade 1 standards
<b>Dogging:</b>	Hex key dogging standard on panic; optional cylinder dogging (-5)
<b>Shim Kit:</b>	#624NS optional
<b>Finishes:</b>	See page 6 for finish options
<b>Options:</b>	Rod extensions, bottom pullman latch
<b>Door Height:</b>	7' (213cm) standard. Optional heights 8', 9' and 10'.
<b>Vertical Rods:</b>	1/2" (13mm) OD tubular brass, bronze or stainless steel with rod guides

# 6220ED Concealed Vertical Rod



The 6220ED is a narrow stile concealed vertical rod exit device to be used on narrow stile, aluminum and metal doors where two-point latching is desired.

## Features

- Designed for narrow stile doors
- Handed. Specify hand (field reversible)
- Bottom deadbolt for secure latching
- Fully adjustable roller strike

## Applications

- Pairs of narrow stile doors
- Metal and aluminum doors
- For panic-rated doors only



## Specifications

<b>Rail Sizes:</b>	-36 for 30" - 36" (76cm - 91cm) doors -42 for 36" - 42" (91cm - 107cm) doors -48 for 42" - 48" (107cm - 122cm) doors Alternate sizes can be special ordered. Consult Technical Product Support.
<b>Door Thickness:</b>	1-3/4" (44mm) standard. 2" and 2-1/4" (51mm and 57mm) optional, specify when ordering.
<b>Minimum Stile Width:</b>	2-3/4" (70mm), does not include glass stop
<b>Projection:</b>	3-1/4" (83mm) active; 2-1/2" (63.5mm) dogged
<b>Latchbolt:</b>	Top: 3/4" (19mm) pullman style with auto deadlatching; Bottom 5/8" (16mm) deadbolt, held retracted during door swing
<b>Strike(s):</b>	Top: 791 roller type; Bottom: flush-mounted 790; 794 floor strike optional (threshold openings)
<b>Fasteners:</b>	Machine screws or wood door screws standard for panic
<b>Handing:</b>	Handed, please specify. Field reversible.
<b>ANSI/BHMA:</b>	Certified ANSI/BHMA A156.3 Type 6 Grade 1 standards
<b>Dogging:</b>	Hex key dogging standard on panic; optional cylinder dogging (-5)
<b>Shim Kit:</b>	#623NS optional
<b>Finishes:</b>	See page 6 for finish options
<b>Options:</b>	Rod extensions, bottom pullman latch (panic only)
<b>Door Height:</b>	Standard door height adjustable to 8' (244cm). Optional heights -9', -10'.
<b>Vertical Rods:</b>	1/2" (13mm) OD, telescoping tubular rods







# Trim Designs



## Escutcheons

420F Series	480F Series	500F Series	620F/650F Series	630F/660F/670F Series
				
Projection: see levers	Projection: 2-13/32" (61mm)	Projection: see levers	Projection: see levers	Projection: 2-1/8" (54mm)

## Roses

440F Series	540F Series
	
Projection: 3-1/2" (89mm)	Projection: 3-1/2" (89mm)

















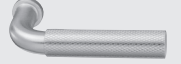











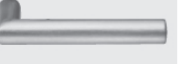



## Standard Levers

<b>Arcadia AR</b>	<b>Augusta AU</b>	<b>Carmel CR</b> 	<b>Jefferson JN</b> 
			
Projection: 3-1/4" (82mm)	Projection: 2-5/8" (61mm)	Projection: 3-1/8" (79mm)	Projection: 2-9/16" (65mm)
<b>Monroe MO</b> 	<b>Pacific Beach PB</b> 	<b>Pinehurst PN</b> 	<b>Virginia VI</b>
			
Projection: 3" (76mm)	Projection: 3-5/16" (84mm)	Projection: 3-1/16" (78mm)	Projection: 3-1/8" (79mm)

Note: Projection dimensions are provided using the 620F Series escutcheon plates.

## Reflections® Levers



<b>Hudson</b>	TB  Projection 3-1/16" (78mm)	UB  Projection 3-1/4" (83mm)	TC  Projection 3" (76mm)	TD  Projection 3-7/16" (87mm)	UC  Projection 3-7/16" (87mm)	
<b>Spree</b>	RS  Projection 3-1/8" (79mm)	RT  Projection 3-1/8" (79mm)	RU  Projection 3-13/32" (87mm)	RV  Projection 3" (76mm)		
<b>Seine</b>	TE  Projection 3" (76mm)	TG  Projection 2-13/16" (61mm)	TI  Projection 3-3/8" (85mm)	TO  Projection 3-1/2" (89mm)	TJ  Projection 3-1/16" (78mm)	TK  Projection 3-1/4" (83mm)
<b>Thames</b>	TM  Projection 3-1/16" (78mm)	TN  Projection 3-1/16" (78mm)	TP  Projection 3-5/16" (84mm)	TR  Projection 3-1/16" (78mm)	TS  Projection 3-1/8" (80mm)	TQ  Projection 3-1/16" (78mm)
<b>Victoria</b>	TT  Projection 2-11/16" (68mm)	TU  Projection 3-1/4" (83mm)	TV  Projection 3-1/2" (89mm)	TW  Projection 3" (76mm)	UW  Projection 3-7/16" (87mm)	TX  Projection 3-5/8" (92mm)
<b>Victoria, continued</b>	UX  Projection 3-7/16" (87mm)	TY  Projection 3-5/16" (84mm)	TZ  Projection 3-7/16" (87mm)			
<b>Niagara</b>	MA  Projection 2-13/16" (71mm)	RA  Projection 3-11/16" (94mm)	RB  Projection 2-13/16" (71mm)	RC  Projection 2-13/16" (71mm)		

Note: Projection dimensions are provided using the 620F Series escutcheon plates.

Note: The following Reflections levers are not available in 629 or 630 finish: Victoria TT, TU, TV, TW, TX, TY, UW, UX, TZ; Seine TG, TJ, TK, TO, TE, TI. Please consider the 618 or 619 finish as an alternative. Reflections levers are not available with knurling option.



# 6100ED Series Wide Stile Trims

## 420F Series Escutcheon Trim



- Certified ANSI/BHMA A156.3, Grade 1
- Thrubolt. 1-3/4" (44mm) door standard. For doors thru 2-1/4" (57mm) or shim-mounted devices, specify on order.
- Dimensions: 2-1/2" x 9-1/2" x 1/4" (64mm x 241mm x 6mm)
- Available only with AU/MO/PB levers
- Cylinders not included. For rim cylinders, see page 39.
- Finishes: 630, 689, 691, 693 and 695
- 1-year warranty
- Ordering Example: PB428F x LHR x 689

								
Applications	Cylinder	Exit Only Blank Plate	Nightlatch	Classroom/ Storeroom	Nightlatch	Dummy Free Wheeling	Passage	Dummy Rigid Lever
6100ED(F), 6150ED(F), 6160ED(F), 6170ED(F)	Rim	420F	421F*	426F	427F*	428F	428F	429F
ANSI		01	03	08/09	03	02	14	02

\*Not recommended for use with 6170ED(F) surface vertical rod exit devices or 6160ED(F) concealed vertical rod devices.  
Note: 09 and Free Wheeling 02 achieved with single trim modification at installation.

# 6100ED Series Wide Stile Trims



## 620F and 650F Series Escutcheon Trim



- Certified ANSI/BHMA A156.3, Grade 1
- Trim through-bolts to exit device for strength
- Beveled sides improve attack resistance
- Solid forged/cast escutcheon and free-wheeling trim for ideal protection
- Flush cylinder in 6-pin applications for additional security
- 1-3/4" (44mm) door standard. For doors through 2-1/4" (57mm) or shim-mounted devices, specify on order.
- Dimensions: 3" x 10-1/4" x 13/16" (76mm x 260mm x 19mm)
- Cylinders not included. See page 40-41 for cylinder options. 1-1/2" mortise cylinder required for mortise trim.
- Available with AR, AU, CR, JN, MO, PB, PN, VI lever designs. See page 17.
  - Finishes: 605, 606, 613E, 629, 630, BSP
- Available with Reflections® lever designs. See page 18.
  - Finishes: 605, 606, 613E, 629, 630, BSP
- Trim ordering example: AU626F x 626 x RHR
- 10-year limited warranty

Application	Cylinder	Exit Only Blank Plate	Classroom Cylinder Controls Lever	Storeroom Cylinder Controls Lever	Nightlatch Cylinder by Lever	Passage	Dummy Trim Free-Wheeling	Dummy Rigid Lever
6100ED(F) 6150ED(F) 6160ED(F) 6170ED(F)	Rim	620F	626F	626F <sup>1</sup>	627F <sup>2</sup>	628F	628F <sup>1</sup>	629F
6130ED(F)	Mortise	620F	656F	—	656F	658F	—	658F
6100ED(F)-2 6150ED(F)-2	Rim x Rim	—	626F	—	—	—	—	—
6130ED(F)-2	Mortise x Rim	—	656F	—	—	—	—	—
ANSI		01	08	09	03	14	02	02

1. 09 function is Free Wheeling; Free Wheeling for 02 function achieved with single trim modification at installation.

2. Not recommended for use with vertical rod devices.

For 626, 629 & 630 finishes the escutcheon is plated to simulate stainless steel.

For 629 & 630 finishes the standard levers are plated to simulate stainless steel.

Free-Wheeling is not available on mortise trim.

For 620F Series trim, optional door thickness available up to 4-1/2", specify on order.

# 6100ED Series Wide Stile Trims



## 630F, 660F and 670F Series Pull/Thumbpiece Trim



- Certified ANSI/BHMA A156.3, Grade 1.
- Trim through-bolts to exit device for added strength.
- Beveled sides improve attack resistance.
- Flush cylinder in 6-pin applications for additional security.
- 1-3/4" (44mm) door standard. For doors through 2-1/4" (57mm) or shim-mounted devices, specify on order.
- Plate Dimensions: 2-3/4" x 15-1/2" x 5/8" (70mm x 394mm x 16mm).
- Pull Dimensions: 6-7/16" (164mm) on centers x 2-1/8" (54mm) projection.
- Cylinders not included. See page 40-41 for cylinder options. 1-1/2" mortise cylinder required for mortise trim.
- Finishes: 605, 606, 613E, 629, 630, BSP
- Trim ordering example: 633F x 630
- 10-year limited warranty.

ANSI No.	03	05	06	02	15	
Applications	Cylinder	Nightlatch Cylinder by Pull	Classroom Cylinder Controls T-Piece	Storeroom Cylinder Controls T-Piece	Dummy Trim Pull Plate	Passage Active T-Piece
6100ED(F) 6150ED(F) 6160ED(F) 6170ED(F)	Rim	632F <sup>2</sup>	633F	633F <sup>1</sup>	634F	635F
6100ED(F)-2 6150ED(F)-2	Rim x Rim	—	633F	—	—	—
6130ED(F)	Mortise	662F K5F	673F <sup>3</sup> T8F	—	634F K5F	675F <sup>3</sup> T8F
6130ED(F)-2	Mortise x Mortise	—	—	—	—	—

1. 06 achieved with single trim modification at installation.  
 2. Not recommended for use with vertical rod exit devices.  
 3. Available for 1-3/4" thick doors only.  
 For 630F Series trim, optional door thickness available up to 4-1/2", specify on order.  
 For 626, 629 & 630 finishes the escutcheon is plated to simulate stainless steel.

# 6100ED Series Wide Stile Trims



## 440F Series Rose Trim



- Certified ANSI/BHMA A156.3, Grade 1.
- 440F rose trim for stock doors (161 Prep).
- 1-3/4" (44mm) door standard. For doors thru 2-1/4" (57mm) or shim-mounted devices, specify on order.
- Cylinders included, accepts component cylinders. See page 42.
- Only available with AU, MO, and PB levers
- Finishes: 613E, 626, 689, 691, 693, 695, BSP.
- "B" trim prefix – Lever trim accepting small format interchangeable cores (SFIC). Specify 6- or 7-pin.  
(Example: B-AU446F)
- Please specify when ordering 1210 LFIC prep.
- 2-year warranty.
- Ordering example: AU446F x RHR x 626.

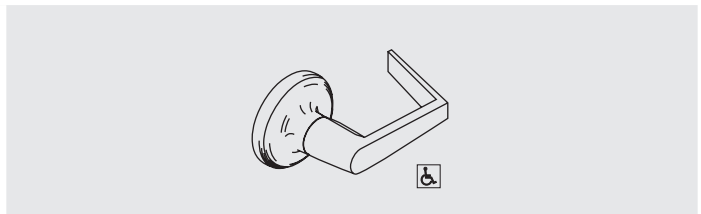
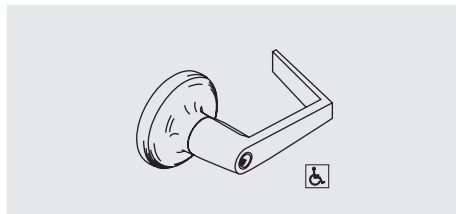

Applications	Nightlatch Access by Key	Classroom	Dummy Trim Free Wheeling Lever	Passage Lever	Dummy Trim Rigid Lever
6100ED(F), 6150ED(F), 6160ED(F), 6170ED(F)	441F*	446F	448F	448F	449F
ANSI	03	08	02	14	02

\*Not recommended for use with vertical rod devices.

# 6100ED Series Wide Stile Trims



## 510F Series Pull/Thumbpiece Trim



- Certified ANSI/BHMA A156.3, Grade 1.
- Trim thrubolts to exit device for strength.
- 1-3/4" (44mm) door standard. For doors through 2-1/4" (57mm) or shim-mounted devices, specify on order.
- Plate Dimensions: 1-5/8" x 15-1/4" x 5/8" (41mm x 387mm x 16mm).
- Pull Dimensions: 6-7/16" (164mm) on centers x 2-1/8" (54mm) projection.
- Accepts rim cylinders. Cylinders not included. See page 42 for cylinder options.
- Finishes: 605, 606, 611, 612, 613E, 619, 626, 629, 630, 693, BSP
- Trim ordering example: 512F x 630
- 1-year limited warranty.

Applications	Nightlatch Access by Key	Classroom/Storeroom Cylinder Controls Thumbturn	Dummy Trim	Passage	Classroom/Storeroom Cylinder Controls T-Piece	Passage
6200ED, 6210ED, 6220ED, 6250ED	512F <sup>^</sup>	513F	514F	517F	518F	519F
ANSI	03	11/12	02	16	05/06	15

<sup>^</sup>Not recommended for use with vertical rod devices.

# 6100ED Series Wide Stile Trims



## 540F Series Rose Trim



- Certified ANSI/BHMA A156.3, Grade 1.
- 540F rose trim for stock doors.
- Trim through-bolts to exit device for strength.
- 1-3/4" (44mm) door standard. For doors through 2-1/4" (57mm) or shim-mounted devices, specify on order.
- AU, PB and MO trim designs.
- Accepts cylindrical type cylinders. Cylinders included, see page 42 for cylinder options.
- Please specify when ordering 1210 LFIC prep.
- Finishes: 605, 606, 613E, 625, 626, BSP.
- 3-year limited warranty.

"B" trim prefix	Lever trim accepting all small format interchangeable cores. 6- or 7-pin (Example: B-AU546F)
"M" trim prefix	Lever trim accepting Medeco® (32 Series) and ASSA® large format interchangeable cores. Available in AU lever only. 6-pin only. (Example: M-AU546F)
"S" trim prefix	Lever trim accepting Schlage® standard cylinders. 6-pin only. (Example: S-AU546F)
"SI" trim prefix	Lever trim accepting Schlage® large format interchangeable cores. 6-pin only. (Example: SI-AU546F)

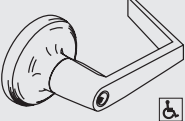
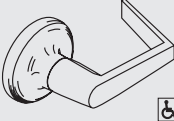
Applications					
	Nightlatch Access by Key	Classroom Cylinder Controls Lever	Passage Lever	Dummy Trim Free-Wheeling Lever	Dummy Trim Rigid Lever
6100ED(F), 6150ED(F), 6160ED(F), 6170ED(F)	541F	546F	548F	548F	549F
ANSI	03	08	14	02	02

## 121NL Nightlatch Access By Key, Cylinder Only

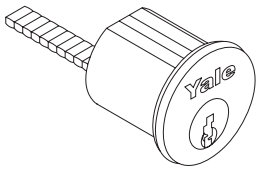

- Application: Available for all wide & narrow stile rim and SquareBolt® devices. Not recommended for surface or concealed vertical rod devices.
- Must specify rim cylinder when ordering. See page 39 for cylinder options.
- Cylinder collar 1765.250 furnished standard for 1-3/4" thick doors.
- For 1109, 5109, K300, K640, A640 and 2109 cylinders:
  - Screw part number 34-2311-8738-048
  - Backplate part number 34-0010-1015-059
- For 1193, 5193 and K840 cylinders:
  - Screw part number 10-1193-1018-048
  - Backplate part number 34-0010-1015-059

Function Description	Nightlatch Access by Key
Model No.	121NL
ANSI	03





# 6200ED Series Narrow Stile Trims

## 480F Series Offset Pull Trim



- 1-3/4" (44mm) door standard. For doors through 2-1/4" (57mm) or shim-mounted devices, specify on order.
- Plate Dimensions: 1-3/4" x L x 3/16" (44mm x L x 5mm) L = Overall plate length is 2-1/4" (57mm) longer than pull dimension.
- Pull Dimensions:
  - 480F and 481F trim have a 7-1/4" (184mm) pull length on centers which through-bolts to exit device for strength.
  - 482F and 483F trim have a 9" (229mm) pull length on centers and are not thrubolt to allow pulls of different lengths to be utilized. Longer lengths of 15" (381mm), 18" (457mm) and up to 30" (762mm) are available.
- 2-13/32" (61mm) projection.
- Cylinders not included. See page 39-41 for cylinder options.
- Finishes: 605, 606, 613E, 629, 630, BSP
- Trim ordering example: 481F x 630 x LHR
- 1-year limited warranty

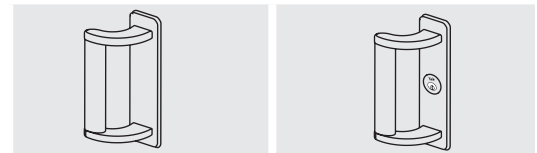

Applications	Cylinder	Dummy Pull	Nightlatch Access by Key
6200ED, 6210ED(F), 6220EDM(F), 6250ED(F)	Rim	480F 482F	481F* 483F*
ANSI	--	02	03

\*Not recommended for use with vertical rod exit devices.  
For 626, 629 & 630 finishes the escutcheon is plated to simulate stainless steel.

## 500F Series Escutcheon Narrow Stile Trim



- Certified ANSI/BHMA A156.3, Grade 1.
- Trim through-bolts to exit device for strength.
- 1-3/4" (44mm) door standard. For doors through 2-1/4" (57mm) or shim-mounted devices, specify on order.
- Dimensions: 1-5/8" x 9-1/2" x 1/4" (41mm x 241mm x 6mm)
- Cylinders not included. See page 39-41 for cylinder options.
- Available with AR, AU, CR, JN, MO, PB, PN, VI, HA lever designs. See page 17-18.
  - Finishes: 605, 606, 613E, 629, 630, BSP
- Available with Reflections® lever designs. See page 18.
  - Finishes: 605, 606, 613E, 629, 630, BSP
- Trim ordering example: AU506F x 626 x RHR.
- 1-year limited warranty.

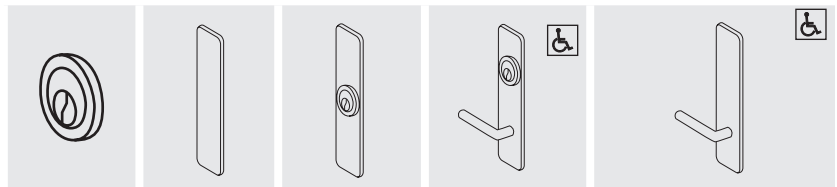

Applications	Nightlatch Access by Key	Exit Only Blank Plate	Nightlatch Access by Key	Classroom/Storeroom Cylinder Controls Lever	Passage or Dummy	Dummy Trim
6200ED, 6210ED, 6220ED, 6250ED	121NL <sup>2</sup>	500F	501F <sup>2</sup>	506F <sup>1</sup>	508F <sup>1</sup>	509F
ANSI	03	01	03	08/09	14/02	02

1. 09 function is Free Wheeling; Free Wheeling for 02 function achieved with single trim modification at installation.  
2. Not recommended for use with vertical rod devices.  
For 629 & 630 finishes the standard levers are plated to simulate stainless steel.

# Electrified Options



The Yale® 6000ED Series exit devices offer a complete range of electrical options. A continuity in appearance, security and functions with the 6000ED Series mechanical exit device is maintained. These electrified exit devices may be integrated into the monitoring security and alarm systems of most buildings.

## Electrified Options

Model #	Exit Device Description	A	A- ALR	B	MELR	O	S	SAFE	SECURE	690F	691F
6100ED(F)	Rim Device (Wide)	x	x	x	x	x	x			x	x
6130ED(F)	Mortise Device (Wide)	x		x	x	x	x	x	x		
6150ED(F)	Rim SquareBolt® Device (Wide)	x		x	x	x	x			x	x
6160ED(F)	Concealed Vertical Rod (Wide)	x		x	x	x	x				
6170ED(F)	Surface Vertical Rod (Wide)	x		x	x	x	x			x	x
6200ED	Rim Device (Narrow)	x		x	x		x				
6210ED	Surface Vertical Rod (Narrow)	x		x	x		x				
6220ED	Concealed Vertical Rod (Narrow)	x		x	x		x				
6250ED	Rim SquareBolt Device (Narrow)	x		x	x		x				

## Electrified Hardware Option Descriptions

A	Alarm Option
A-ALR	Alarm with Red Screenprinted Pushpad*
B	Touchbar Monitor
MELR	Motorized Electric Latch Retraction
O	Trim Monitor Switch
S	Latchbolt Position Monitor
SAFE	Fail Safe Operation (Mortise)
SECURE	Fail Secure Operation (Mortise)
690F	Fail Safe Electrified Trim
691F	Fail Secure Electrified Trim



6100ED-A-ALR

Note: The following options cannot be ordered together:

- 1) MELR or A
- 2) B or A
- 3) 690F or 691F

\*Only available with 6100ED(F) x 36" x BSP

What normally took an hour or more to connect now takes minutes. Yale electrified exit devices and trims are equipped with ElectroLynx® connectors. As a standard feature, these “plug & play” connectors link power from the incoming source to electrified locking products, including hinges, locks, exit devices, magnetic holders and strikes.

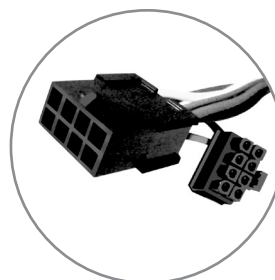

Note: Electrified door hardware with ElectroLynx® connectors require a compatible number of lead wires attached to the door hinge.



## Motorized Electric Latch Retraction "MELR"

### Operation

Allows the latchbolt to be retracted electrically for momentary or maintained periods of time from a remote location. The exit device bolt remains retracted for as long as the device is energized. Removal of power returns the device to the life safety, self-latching mechanical mode. Easy interface with central or local fire alarm systems, automatic door operators, hands-free actuation devices, and access control systems. Allows free egress at all times. Manual hex key dogging standard on non-rated devices. Not available on openings less than 30" wide.

### Electrical Specifications

#### Motor Driven Latch Retraction

- 24VDC (BPS-24-1) regulated/filtered power supply. Requires 1A per device
- .85 amp max during retraction
- .3 amp holding-continuous duty

### Listings

UL/cUL listed for panic and fire exit hardware. Fire-rated devices must be wired into an automatic fire alarm system.

### Applications

Rim: 6100(F), 6200  
SquareBolt®: 6150(F), 6250  
SVR: 6170(F), 6210  
CVR: 6160(F), 6220  
Mortise: 6130(F)

### Ordering

Add Option "MELR" to the Model Number. Ex: 6100 MELR

**Note: Not available on "A" alarm exit device.**

# Electrified Options



## Touchbar Monitor "B"

Provides indication of the pushpad being depressed. Used as a Request to Exit switch to shunt alarm systems, release electromagnetic locks or monitor egress.

**Electrical Specifications:** 4 Amps @ 250VAC contacts

**Listings:** UL/cUL listed for panic and fire exit hardware.

**Applications:** Rim: 6100ED(F), 6200ED  
 SquareBolt®: 6150ED(F), 6250ED  
 SVR: 6170ED(F), 6210ED  
 CVR: 6160ED(F), 6220ED  
 Mortise: 6130ED(F)

**Ordering:** Suffix "B" to the Model Number. Ex: 6170EDB.

**Note:** Not available with the "A" Alarm kit option.

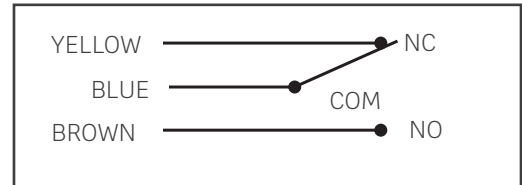

## Trim Monitor Switch "O"

Provides indication of the trim being operated from the outside. Used as a Request to Enter signal switch to shunt alarms, also used to monitor entry.

**Electrical Specifications:** SPDT contacts rated 5 amp @ 28VDC

**Listings:** UL/cUL listed for panic and fire exit hardware.

**Applications:** Rim: 6100ED(F)  
 SquareBolt®: 6150ED(F)  
 SVR: 6170ED(F)  
 CVR: 6160ED(F)  
 Mortise: 6130ED(F)

**Ordering:** Suffix "O" to the Model Number. Ex: 6150EDO.

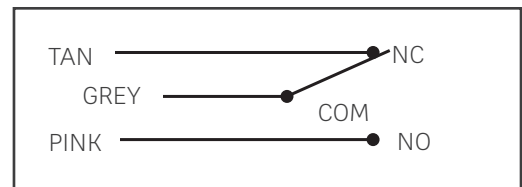

## Latchbolt Position Monitor "S"

Provides indication on the position of the latchbolt. Used with security systems to monitor the latchbolt, also used to activate automatic door operators upon latch retractions.

**Electrical Specifications:** SPDT contacts rated 5 amp @ 28VDC

**Listings:** UL/cUL listed for panic and fire exit hardware.

**Applications:** Rim: 6100ED(F), 6200ED  
 SquareBolt®: 6150ED(F), 6250ED  
 SVR: 6170ED(F), 6210ED  
 CVR: 6160ED(F), 6220ED  
 Mortise: 6130ED(F)

**Ordering:** Suffix "S" to the Model Number. Ex: 6150EDS.

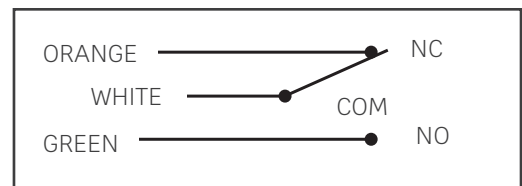

### Electrified System Guide (B, O, S)

#### Components

- 6100EDBOS – PB627F Nightlatch Trim – Yale®
- S Bolt Position Monitor Switch
- B Pushpad Monitor Switch
- O Trim Monitor Switch
- Door Position Switch – Securitron®
- QC12 Power Transfer Hinge by McKinney®
- Surface Door Closer – Yale®

#### Operation

Operation of the 6100ED Exit Device with the B, O, S and ASSW-104A can be used together or individually to sound an alarm, shunt an alarm, monitor the door's security or as a "Request to Exit" in conjunction a magnetic lock.

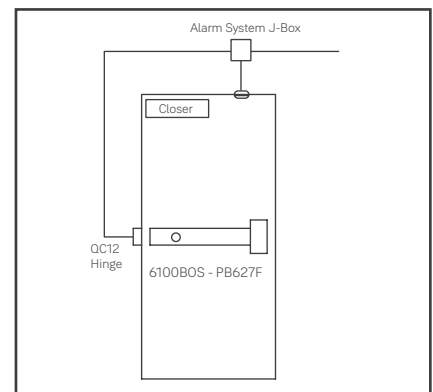



# Electrified Options

## Alarm Kit "A" / "A-ALR"

**Activation:** Alarm is armed by turning key clockwise. Low audible chirp indicates alarm has been activated. Alarm will sound when the exit device pushpad is depressed. Factory preset for standard alarm mode which automatically resets after 5 minutes.

**Continuous Alarm Mode:** Alarm sounds continuous when the exit device pushpad is depressed. Alarm must be manually reset by keyswitch. (This feature is selected by a switch on the circuit board.)

**Low Battery Warning:** Audible chirp.

**Nuisance Alarm:** Factory preset for instant alarm. Selectable feature for alarm to sound when pushpad is depressed for more than 2 seconds. (This feature is selected by a switch on the circuit board.)

**Arming Delay/Authorized Egress:** 10-second delay (after arming) permitting egress (by turning key clockwise).

**Alarm Shunt:** Ingress shunt alarm input for devices with latchbolt position (S) monitor. NOTE: "S" included with SVR devices.

Power Requirements: One 9-Volt Battery (included).

**Loudness:** 90db @ 10 feet.

**Arm/Disarm:** Uses one 1-1/8" straight cam mortise cylinder. Clockwise turn arms the alarm, counter clockwise turn disarms or silences the alarm.

**Device Status:** A Red LED indicator will illuminate every 30 seconds when the alarm is armed.



**Tamper Resistant:** Built-in safety monitor sounds alarm when tampering occurs.

**Warning:** "A" supplied with "EMERGENCY EXIT - ALARM WILL SOUND" decal  
"A-ALR" supplied with red screenprinted pushpad (available in BSP black finish only)



6100ED-A-ALR

**Applications:** Rim: 6100ED(F), 6200ED; SquareBolt®: 6150ED(F), 6250ED; SVR: 6170ED(F), 6210ED; CVR: 6160ED(F), 6220ED; Mortise: 6130ED(F)

**Kit:** Available in kit form for field retrofit.

**Bar Length:** Available for 36"-48" devices only. May not be used on bars less than 36".

- Standard 36" device fits doors 35"-36" Device cannot be cut less than 35".
- Option -48 fits doors 41"-48". Devices cannot be cut less than 41".
- A-ALR option only available in 36" length

**How to Order:** Specify 6116 for alarm kit. Suffix -"A" when ordering with device. Ex: 6100ED-A

Suffix "A-ALR" when ordering with device and decal. Ex: 6100ED- A-ALR x 36 x BSP

**NOTE:** The 6116 alarm kit cannot be retrofitted in the field to the 6170ED(F), 6210ED or 6210ED(F) surface vertical rod exit devices. This option is available as a factory order only for these devices. Any attempt to retrofit the 6116 alarm kit with these surface vertical rod exit devices will void the warranties for these products.

## Mortise Device Trim Control "Safe/ Secure"

### Operation

Allows the outside trim to lock or unlock electrically from a remote location. Exit device allows free egress at all times.

Fail Safe devices are commonly used in stair towers or locations that require the trim to unlock when power is removed or during fire alarm activation.

Fail Secure devices are used to secure openings and are usually integrated into the building security system to allow access control. Fail Secure trims remain locked when power is removed.

### Electrical Specifications

Solenoid

- .35 amps @ 24VDC only (12 volt not available)
- Continuous duty
- Requires a 2-wire pivot or hinge and a standard 24VDC regulated and filtered power source (Recommended BPS power supplies)

### Listings

UL/cUL listed for panic and fire exit hardware.

### Applications

Mortise: 6130ED(F)

### Ordering

"Safe" – Maintains the outside trim in a locked state when energized. Removal of power unlocks outside trim.

"Secure" – Unlocks the outside trim when energized. Remains locked when power is removed.

Suffix "SAFE" or "SECURE" to the Model Number.

Ex: 6130ED x L5 x Safe.

# Electrified Options



## Electric Trim

The electrified 600 Series heavy-duty trim provides electric locking and unlocking of trim. Ideal for door control where increased security is necessary at all times, while meeting life safety codes. Electric trim is ideal for many applications, including stairwell towers, high-security areas, schools, hospitals, and factories.

### Functions

#### 690F Trim - Fail Safe

- Lever is locked when power is on (Free-Wheeling)
- Power off allows entry from trim
- Inside device is always active for egress
- Mechanical key override (09 Function – Key allows lever to retract latchbolt. Key can only be removed in locked position)

#### 691F Trim - Fail Secure

- Lever is locked when power is off (Free-Wheeling)
- Power on allows lever activation for entry
- Inside device is always active for egress
- Mechanical key override (09 Function – Key allows lever to retract latchbolt. Key can only be removed in locked position.)

### Features

- Accepts all standard and Reflections® decorative lever designs
- Plug connector with 4' wire lead (Exit device is used as wire raceway, not door)
- Key Override – Requires rim cylinder (sold separately)



### Applications

- 6100ED(F) Rim Device
- 6150ED(F) SquareBolt®
- 6170ED(F) Surface Vertical Rod

### Electrical Specifications

- 330 mA @ 24 Volts
- SM – Security Monitor Switch
- 4 AMP @ 250VAC
- Voltage: 24 VAC/VDC only
- BPS Series power supplies recommended.

### Options

- SM - Security Monitor. A SPDT switch that monitors the position of the solenoid (lock and unlock status).
- EX - Trim gasket for exterior applications.

## Electrified System Guide

### For use with:

- 691F Electrified Trim – Yale®
- 6100ED Rim Exit Device – Yale®
- Digital Keypad by Securitron®
- QC8 Power Transfer Hinge by McKinney®
- BPS Power Supply

### Operation

Operation of the Digital Keypad will allow keyless entry from the non-protected side of the opening. When a valid code is entered into the keypad, voltage will be applied to the trim, making the lever active and allowing ingress. Free exit is allowed by using the exit device from the protected side of the door.

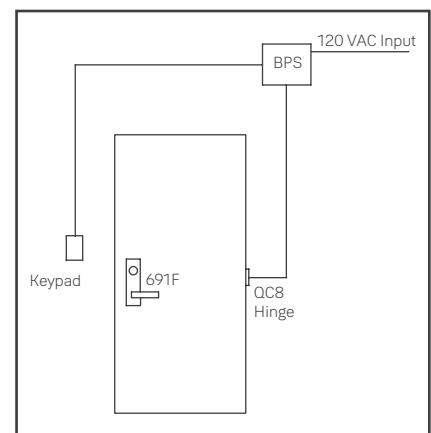

# Electrified Options



## Stand-Alone Door Alarm SDA 16

The stand-alone battery operated door alarm is designed to continually monitor the status of a door. When the door is opened without authorization, an alarm is triggered to alert the security violation. This alarm features a piezo horn which blasts a deafening 105+ decibels to alert the violation.



This unit is ideal for emergency doors as well as stairwell doors and rear exit doors in retail environments. The unit, which can also be hardwired, easily complements existing hardware, making any opening alarmed. The SDA16 door alarm is typically mounted on the interior of the door frame or door and is paired with a magnet mounted on the opposing side of the door gap.

### Features

- Dimensions: 8.3"L x 3.1"W x 2.0"D (210mm L x 79mm W x 52mm D)
- Non-handed unit (field reversible)
- Unit powered by 9V battery
- Unit can be hardwired by using WH-11 wire harness and 784 power supply
- No battery is required in unit with hard-wire option – if power is lost, optional gel-cell battery in power supply will give approximately 10,000 operations
- Reverse battery protection safeguards the unit if the battery is incorrectly installed
- A low-voltage battery is indicated by an audible signal every 30 seconds
- Piezo horn blasts at 105+ decibels if the door is used with out proper authorization
- The LED will flash every 30 seconds, indicating either the unit is armed or, if under auto reset, that the door has been violated
- Various field-adjustable features by dip switch including automatic alarm reset, REX and passage time delay, and LED color preference
- A tamper switch provides instantaneous signal to sound horn in the event the cover is removed. Horn will sound until the unit is reset by the key or remote reset/arm switch
- Conformally coated electronics for weather resistance
- Cover is held in place by cam lock which protects mounting screws, electrical system and internal sensors
- Accepts external cylinder (not included, must be specified)
- Accepts standard mortise cylinders (not included, must be specified)

### Remote Mounting

The SDA16 can be installed remotely from the door by attaching the contacts to the door and frame. The unit can be installed up to 6 feet from the door. This provides the ideal solution for circumstances where exposure to weather may be an issue. To order specify "SDA16XL".

### Cylinders and Accessories

- 784 Power supply (9VDC) – includes plug-in wall transformer
- Plug-in wall transformer with 12' cable assembly (part no. 00-0000-3425)
- Gel-cell battery – optional for use with 784 power supply (part no. 00-0000-3426)
- WH-11 Wire harness for remote power and remote unlock
- Mortise cylinder for unit
- Rim cylinder for outside control
- See pages 39-42 for cylinder information.

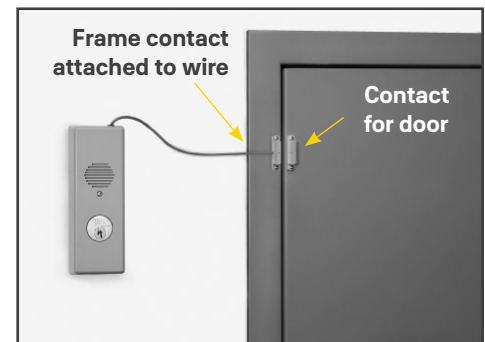

**Note: Actual wire length is 6 feet.**

# Electrified Options



## 782 Power Control

### Operation

Designed to control one or two electric latch retraction "P" exit devices. Equipped with two 20-second timers which can operate the exit devices together or independently. Requires a momentary or timed, dry contact input and can be interfaced with access control systems, automatic door operators, hands-free actuation devices, "blow open" type scenarios and has provisions for N/C fire alarm systems.

**Note:** The 782 is required for use with the "P" latch retraction option. Using any other power supply with the "P" option voids the warranty of the device.

### Features

- Two control inputs. Accepts normally closed dry contacts for device activation from a key switch, push button, access control or fire alarm system.
- Two normally open control outputs for automatic door operators
- Two "P" device outputs
- Fire Alarm Interface input
- 24VDC output for audible or LEDS .25 AMP

**Note:** This part will no longer be listed as a sellable item for use with the 6000 Series exit device as of July 15th, 2024)

## BPS Power Supplies By Securitron®

### Operation

Power supplies are designed to provide reliable filtered and regulated power for long life to a variety of electrified hardware components.

### Product Features

- Individual output circuit breakers
- Regulated and filtered fuse protected outputs
- LEDs monitor zone status (voltage or no voltage)
- Slide switches connect or disconnect load from power (Not available on 1 Amp supplies)
- Internal Back-Up battery charging circuit
- Rugged steel enclosure
- Fire alarm interface

### Listings

- UL CLASS 2

### Applications (use with):

- Safe – Fail Safe mortise device trim control
- Secure – Fail Secure mortise device trim control
- 690/691 – Electric Trim
- MELR - Motorized Electric Latch Retraction

Yale recommends McKinney®, Pemko and Securitron® for power transfer devices and other electronic accessories.



### Electrical Specifications

- 120 VAC 60Hz 750mA (max.)
- 38-42 VDC output
- 10 amp inrush

### Listings

- UL 294
- UL CLASS 2 outputs

### Applications

"P" Electric Latch Retraction Option

### Ordering

782 Controller

### Ordering

Ex: BPS-24-4

Model	Input	Output	Application
BPS-24-1	120 VAC	1 Amp @ 24 VDC	1 "D"
BPS-24-2	120 VAC	2 Amp @ 24 VDC	2 "D" or 1 "D" with Safe or Secure
BPS-24-4	120 VAC	4 Amp @ 24 VDC	4 "D" or 3 "D" with Safe or Secure

Consult factory for additional power supply applications.



# Functions



## Single Cylinder Functions

SquareBolt® 6150ED(F) 6250D		Rim 6100ED(F) 6200ED		Surface Vertical Rod 6170ED(F) 6210ED		Concealed Vertical Rod 6160ED(F) 6220ED		Mortise 6130ED(F)		Function	ANSI Function No.	Function Description
Inside	Outside	Inside	Outside	Inside	Outside	Inside	Outside	Inside	Outside			
										Exit Only	01	Exit only, no trim.
										Dummy	02	Entrance by trim when actuating bar is locked down.
										Nightlatch	03	Entrance by trim when latchbolt is retracted by key. Key removable only when locked.
										Classroom	08	Entrance by lever. Key locks or unlocks lever.
										Storeroom	09	Entrance by lever only when released by key. Key removable only when locked.
										Passage	14	Entrance by trim when latchbolt is released by lever. Lever always active, no cylinder.

Note: 09 and Free-Wheeling 02 achieved with a single modification at installation.

## Double Cylinder Functions

SquareBolt® 6150ED(F)-2		Rim 6100ED(F)-2		Mortise 6130ED(F)-2		Function	ANSI Function No.	Function Description
Inside	Outside	Inside	Outside	Inside	Outside			
						Classroom	08	Entrance by lever. Key either side locks or unlocks lever.



## Thumbpiece, Thumbturn And Pull Trim Functions

SquareBolt® 6150ED(F) 6250ED		Rim 6100ED(F) 6200ED		Surface Vertical Rod 6170ED(F) 6210ED		Concealed Vertical Rod 6160ED(F) 6220ED		Mortise 6130ED(F)		Function	ANSI Function No.	Function Description
Inside	Outside	Inside	Outside	Inside	Outside	Inside	Outside	Inside	Outside			
										Exit Only	01	Exit only, no trim.
										Dummy	02	Entrance by trim when actuating bar is locked down.
										Nightlatch	03	Entrance by trim when latchbolt is retracted by key. Key removable only when locked.
										Classroom	05	Entrance by thumbpiece. Key locks or unlocks thumbpiece.
										Storeroom	06	Entrance by thumbpiece only when released by key. Key removable only when locked.
										Passage	15	Entrance by trim when latch is released by thumbpiece. Thumbpiece is always active, no cylinder.

Note: 06 achieved with a single modification at installation.

# Applications & Listings



## Performance Standards

UL - cUL Panic Exit Listing: Doors up to 4'0" x 10'0"\* (1.22m x 3.05m), single swing or pairs.

UL - cUL Fire Exit Label: Doors up to 4'0" x 10'0" (1.22m x 2.44m), single swing or pairs.

\*UL does not set height limitations on panic devices.

Complies with NFPA80 for fire exit hardware

Complies with NFPA101 for life safety

Meets requirements for ADA



Listing Agency	Listing Number		
	Panic Exit Devices	Fire Exit Devices	Latching Hardware
Underwriters Laboratories, Inc.	(FVSR)	(GXHX)	(ZHEM)
California Fire Marshal	4140-0257: 111	3625-0257: 112	
New York City		MEA: 477-91-E MEA: 333-05-M	
ANSI/BHMA	A156.3 (Directory of Certified Exit Devices)		

Note: Any retrofit or other field modification to a fire rated opening can potentially impact the fire rating of the opening, and Yale Locks & Hardware makes no representations or warranties concerning what such impact may be in any specific situation. When retrofitting any portion of an existing fire rated opening, or specifying and installing a new fire-rated opening, please consult with a code specialist or local code official (Authority Having Jurisdiction) to ensure compliance with all applicable codes and ratings.



## 6100ED Series Wide Stile Applications

Single Door	UL Listing	Maximum Opening	Application	
<b>SquareBolt®</b>				
6150ED/6150ED-2	Panic	4' x *	Surface applied; single-point latching.	
6150ED(F)/6150ED(F)-2	3 Hr.	4' x 8'		
<b>Rim</b>				
6100ED/6100ED-2	Panic	4' x *	Surface applied; single-point latching.	
6100ED(F)/6100ED(F)-2	3 Hr.	4' x 8'		
<b>Mortise</b>				
6130ED/6130ED-2	Panic	4' x *	Mortised in door; single-point latching.	
6130ED(F)/6130ED(F)-2	1-1/2 Hr.	4' x 9'		
6130ED(F)/6130ED(F)-2	3 Hr.	4' x 8'		
<b>Surface Vertical Rod</b>				
6170ED	Panic	4' x 10'	Surface applied; two-point latching.	
6170ED x LBR	Panic	4' x 10'	Surface applied; one-point latching.	
<b>Concealed Vertical Rod</b>				
6160ED	Panic	4' x 10'	Rods concealed in door; two-point latching.	
6160ED x LBR	Panic	4' x 10'	Rods concealed in door; one-point latching.	

\*UL does not set a door height limitation on panic applications.

Pair of Doors with Removable Mullion	UL Listing	Maximum Opening	Application	
<b>SquareBolt® x SquareBolt®</b>				
6150ED x 6150ED x M200 Series	Panic	8' x 10'	Two independent active doors with removable mullion.	
6150ED(F) x 6150ED(F) x M200F Series	3 Hr.	8' x 8'		
<b>Rim x Rim</b>				
6100ED x 6100ED x M200 Series	Panic	8' x 10'	Two independent active doors with removable mullion.	
6100ED(F) x 6100ED(F) x M200F Series	3 Hr.	8' x 8'		



## 6100ED Series Wide Stile Applications

Pair of Doors	UL Listing	Maximum Opening	Application	
<b>Surface Vertical Rod</b>				
6170ED x 6170ED	Panic	8' x 10'	Two independent doors with two-point latching, swinging in the same direction.	
6170ED(F)90 x 6170ED(F)90	1-1/2 Hr.	8' x 10'		
6170ED(F) x 6170ED(F)	3 Hr.	8' x 8'		
6170ED x 6170ED x LBR	Panic	8' x 10'	Two independent doors with one-point latching, swinging in the same direction.	
6170ED(F)90 x 6170ED(F)90 x LBR	1-1/2 Hr.	8' x 10'		
<b>Surface Vertical Rod (Double Egress)</b>				
6170ED x 6170ED	Panic	8' x 10'	Two independent doors with two-point latching, swinging in opposite directions. Overlapping astragal not required.	
6170ED(F)90 x 6170ED(F)90	1-1/2 Hr.	8' x 10'		
6170ED(F) x 6170ED(F)	3 Hr.	8' x 8'		
6170ED x 6170ED x LBR	Panic	8' x 10'	Two independent doors with one-point latching, swinging in opposite directions. Overlapping astragal not required.	
6170ED(F)90 x 6170ED(F)90 x LBR	1-1/2 Hr.	8' x 10'		
<b>Surface Vertical Rod x Mortise</b>				
6170ED x 6130ED	Panic	8' x 10'	Overlapping astragal required for fire-rated openings. Coordinator required with standard ANSI strike.	
6170ED(F)90 x 6130ED(F)	1-1/2 Hr.	8' x 9'		
<b>Concealed Vertical Rod</b>				
6160ED x 6160ED	Panic	8' x 10'	Two independent metal or wood doors with two-point latching, swinging in the same direction.	
6160ED(F)90 x 6160ED(F)90	1-1/2 Hr.	8' x 10'		
6160ED(F) x 6160ED(F)	3 Hr.	8' x 8'		
6160ED x 6160ED x LBR	Panic	8' x 10'	Two independent metal or wood doors with one point latching, swinging in the same direction.	
6160ED(F)90 x 6160ED(F)90 x LBR	1-1/2 Hr.	8' x 10'		
<b>Concealed Vertical Rod (Double Egress)</b>				
6160ED x 6160ED	Panic	8' x 10'	Two independent metal or wood doors with two-point latching, swinging in opposite directions. Overlapping astragal not required.	
6160ED(F)90 x 6160ED(F)90	1-1/2 Hr.	8' x 10'		
6160ED(F) x 6160ED(F)	3 Hr.	8' x 8'		
6160ED x 6160ED x LBR	Panic	8' x 10'	Two independent metal or wood doors with one-point latching, swinging in opposite directions. Overlapping astragal not required.	
6160ED(F)90 x 6160ED(F)90 x LBR	1-1/2 Hr.	8' x 10'		



## 6200ED Series Narrow Stile Applications

Single Door	UL Listing	Maximum Opening	Application
<b>SquareBolt*</b>			
6250ED	Panic	4' x *	Surface applied; single-point latching.
<b>Rim</b>			
6200ED	Panic	4' x *	Surface applied; single-point latching.
<b>Surface Vertical Rod</b>			
6210ED	Panic	4' x 10'	Surface applied; two-point latching.
<b>Concealed Vertical Rod</b>			
6220ED	Panic	4' x 10'	Rods concealed in door; two-point latching.
<b>Pair of Doors</b>			
Pair of Doors	UL Listing	Maximum Opening	Application
<b>Surface Vertical Rod</b>			
6210D x 6210ED	Panic	8' x 10'	Two independent doors with two-point latching, swinging in the same direction.
<b>Surface Vertical Rod (Double Egress)</b>			
6210ED x 6210ED	Panic	8' x 10'	Two independent doors with two-point latching, swinging in opposite directions.
<b>Concealed Vertical Rod</b>			
6220ED x 6220ED	Panic	8' x 10'	Two independent metal doors with two-point latching, swinging in the same direction.
<b>Concealed Vertical Rod (Double Egress)</b>			
6220ED x 6220ED	Panic	8' x 10'	Two independent metal doors with two-point latching, swinging in opposite directions.
<b>Pair of Doors with Removable Mullion</b>			
Pair of Doors with Removable Mullion	UL Listing	Maximum Opening	Application
<b>SquareBolt* x SquareBolt*</b>			
6250ED x 6250ED x M300	Panic	8' x 10'	Two independent active doors with removable mullion.
<b>Rim x Rim</b>			
6200ED x 6200ED x M300	Panic	8' x 10'	Two independent active doors with removable mullion.

\*UL does not set a door height limitation on panic applications.

# Cylinders



## Rim

The following chart details rim cylinders for use with 420F, 480F, 500F, 620F, 630F, 121NL trims and outside of SDA16 door alarm:

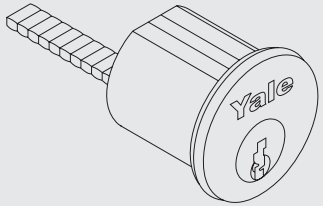
				Collar Requirements*						
				420F	480F/ 500F	620F	630F	121NL	SDA16 Outside	
Model #	Description	Pins	Length							
1109	Standard Fixed Core	6	1-1/4"	599.419	599.419	No Collar	No Collar	1765.250	1765.250	
1109	Standard Fixed Core	7	1-7/16"				1765.438			
1709	CMK	6	1-15/16"	599.544	599.544	1765.250	1765.250			
1709	CMK	7	1-5/8"	599.700	599.700		1765.406			
1193	LFIC Complete	6	1-7/16"	599.544	599.544		1765.250			
1193	LFIC Complete	7	1-5/8"	599.700	599.700	1765.344	1765.406			
5109	Security Fixed Core	6	1-9/16"	599.419	599.419	No Collar	1765.250			
5109	Security Fixed Core	7	1-7/16"				1765.250			
U5109	High Security Fixed Core	6	1"	NA	NA		No Collar			No Collar
U5109	High Security Fixed Core	7	1"			No Collar	No Collar			No Collar
5193	Security LFIC Complete	6	1-7/16"	599.544	599.544	1765.250	1765.250	1765.250	1765.250	
5193	Security LFIC Complete	7	1-5/8"	599.700	599.700	1765.344	1765.406			
K300	Yale® KeyMark® Standard Fixed Core	6	1-1/8"	599.544	599.544	KP4	1765.250			
K300	Yale® KeyMark® Standard Fixed Core	7								
K840/ K880	Yale® KeyMark® LFIC Complete / Housing Only	6	1-7/16"	599.700	599.700	1765.406	1765.500			
K840/ K880	Yale® KeyMark® LFIC Complete / Housing Only	7	1-5/8"	NA	NA	1765.563	1765.619			
K640/ K680	Yale® KeyMark® SFIC Complete / Housing Only	6	1-1/4"	599.544	599.544	KP4	1765.250			
K640/ K680	Yale® KeyMark® SFIC Complete / Housing Only	6 or 7	1-3/8"	599.700	599.700	1765.187	1765.406			
A640/ K680	Best® Keyway SFIC Complete / Housing Only	6	1-1/4"	599.544	599.544	KP4	1765.250			
A640/ K680	Best® Keyway SFIC Complete / Housing Only	6 or 7	1-3/8"	599.700	599.700	1765.187	1765.406			
2109	Schlage® "C" Keyway Fixed Core Available 0-bitted or keyed random.	6	1-1/8"	599.419	599.419	No Collar	No Collar			

\*Based on 1-3/4" door thickness. Collar length required must be specified for cylinders and/or housings ordered separately.

LFIC = Large Format Interchangeable Core

SFIC = Small Format Interchangeable Core

NA = Application Not Available

# Cylinders



## Mortise

The following chart details mortise cylinders for use with 650F, 660F, 670F trims, cylinder dogging, and 6116 alarms:

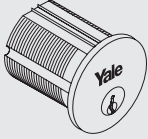
				650F		660F/670F		Cylinder Dogging/ 6116 Alarm				
Model #	Description	Pins	Length	Cam	Collar	Cam	Collar	Cam	Collar			
2153	Standard Fixed Core	6	1-1/4"	2160	NA	2160	NA	2160	1765.156			
2153	Standard Fixed Core	6	1-1/2"		No Collar		KP4		NA			
2153	Standard Fixed Core	7	1-1/4"		NA		NA		1765.156			
2153	Standard Fixed Core	7	1-1/2"		No Collar		KP4		NA			
2196	LFIC Complete	6	1-1/2"		KP4		1765.250		1765.406			
2197	LFIC Complete	7	1-11/16"		KP4		1765.250		1765.594			
5153	Security Fixed Core	6	1-1/8"		NA		NA		No Collar			
5153	Security Fixed Core	6	1-1/2"		No Collar		KP4		NA			
5153	Security Fixed Core	7	1-1/4"		NA		NA		1765.156			
5153	Security Fixed Core	7	1-1/2"		No Collar		KP4					
U5153	High Security Fixed Core	6	1-1/8"		NA		NA		NA			
U5153	High Security Fixed Core	7	1-1/4"		NA		NA					
5196	Security LFIC Complete	6	1-1/2"		No Collar		KP4		1765.406			
5197	Security LFIC Complete	7	1-11/16"		KP4		1765.250		1765.594			
K100	Yale® KeyMark® Standard Fixed Core	6 or 7	1-1/8"		KC1		NA		KC1	NA	KC1	No Collar
K100	Yale® KeyMark® Standard Fixed Core	6 or 7	1-1/2"				No Collar			KP4		NA
K100	Yale® KeyMark® Standard Fixed Core	6 or 7	1-3/4"	Riveted	KP4	Riveted	1765.375	NA				
K820/ K860	Yale® KeyMark® LFIC Complete / Housing Only	6	1-1/2"	KC1	No Collar	KC1	KP4	KC1	1765.406			
K820/ K860	Yale® KeyMark® LFIC Complete / Housing Only	7	1-11/16"		KP4		1765.375		1765.594			
K620/ K660	Yale® KeyMark® SFIC Complete / Housing Only	6	1-1/4"		NA		NA		1765.156			
K620/ K660	Yale® KeyMark® SFIC Complete / Housing Only	6 or 7	1-3/8"		No Collar				1765.281			
K620/ K660	Yale® KeyMark® SFIC Complete / Housing Only	6 or 7	1-3/4"	Riveted	KP4	Riveted	1765.375	NA	NA			
A620/ K660	Best® Keyway SFIC Complete / Housing Only	6	1-1/4"	KC1	NA	KC1	NA	KC1	1765.156			
A620/ K660	Best® Keyway SFIC Complete / Housing Only	6 or 7	1-3/8"		No Collar				1765.281			
A620/ K660	Best® Keyway SFIC Complete / Housing Only	6 or 7	1-3/4"	Riveted	KP4	Riveted	1765.375	NA	NA			
2553	Schlage® "C" Keyway Fixed Core. Available 0-bitted or keyed random.	6	1-1/8"	NA	NA	2160	NA	2160	No Collar			

See legend notes on following page.



# Cylinders



## Mortise

The following chart details mortise cylinders for use with inside of SDA16 door alarm and KRM200SM and KRM200 standard Mullions.

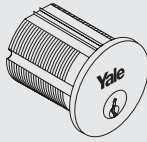
				SDA16 Inside		KRM200 and KRM200SM (Standard)	
				Cam	Collar	Cam	Collar
Model #	Description	Pins	Length				
2153	Standard Fixed Core	6	1-1/8"	2160	No Collar	2160	1765.312
2153	Standard Fixed Core	7	1-1/4"		No Collar		1765.500
2196	LFIC Complete	6	1-1/2"		KP4		1765.750
2197	LFIC Complete	7	1-11/16"		1765.250		1765.844
5153	Security Fixed Core	6	1-1/8"		No Collar		1765.312
5153	Security Fixed Core	7	1-1/4"		No Collar		1765.500
U5153	High Security Fixed Core	6	NA		NA		NA
U5153	High Security Fixed Core	7	NA		NA		NA
5196	Security LFIC Complete	6	1-1/2"		KP4		1765.750
5197	Security LFIC Complete	7	1-11/16"		1765.250		1765.844
K100	Yale® KeyMark® Standard Fixed Core	6 or 7	1-1/8"	KC1	No Collar	KC1	1765.312
K820/K860	Yale® KeyMark® LFIC Complete / Housing Only	6	1-1/2"		KP4		1765.750
K820/K860	Yale® KeyMark® LFIC Complete / Housing Only	7	1-11/16"		1765.250		1765.000
K620/K660	Yale® KeyMark® SFIC Complete / Housing Only	6	1-1/4"		No Collar		1765.500
K620/K660	Yale® KeyMark® SFIC Complete / Housing Only	6 or 7	1-3/8"		No Collar		1765.563
A620/K660	Best® Keyway SFIC Complete / Housing Only	6	1-1/4"		No Collar		1765.500
A620/K660	Best® Keyway SFIC Complete / Housing Only	6 or 7	1-3/8"		No Collar		1765.563
2553	Schlage® "C" Keyway Fixed Core. Available 0-bitted or keyed random.	6	1-1/8"	2160	No Collar	2160	1765.312

Based on 1-3/4" door thickness. Collar length required must be specified for cylinders and/or housings ordered separately.

LFIC = Large Format Interchangeable Core.

SFIC = Small Format Interchangeable Core.

NA = Application Not Available

# Cylinders



## Component

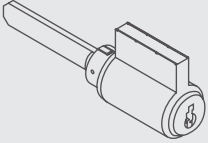

Model #	Description	Pins
1802	Standard Lever Fixed Core	6
1802A	Standard Lever Fixed Core	7
5802	Security Lever Fixed Core	6
5802A	Security Lever Fixed Core	7
1210	LFIC Only	6
1220	LFIC Only	7
5210	Security LFIC Only	6
5220	Security LFIC Only	7
K402	Yale® KeyMark® Lever Fixed Core	6 or 7
K800	Yale® KeyMark® LFIC Only	6 or 7
K600	Yale® KeyMark® SFIC Only	6 or 7
A600	Best® Keyway SFIC Only	6 or 7
2802	Schlage® "C" Keyway Fixed Core. Available 0-bitted or keyed random.	6
3804*	Corbin Russwin "L4", Corbin "60", Russwin "D1", Sargent® "LA" or Schlage® "E" Keyway Fixed Core. Specify keyway. Available keyed random	6
107S	Adaptor kit for Schlage cylinder	—

\*Requires the 107S kit. These cylinders are not ANSI/BHMA certified.



# Collars & Tailpieces

## Cylinder Collars

If required, cylinder collar size must be specified.

<p><b>1765 Recessed Cylinder Collar</b>  <b>"A" Dimension:</b> Thicknesses from 1/16" (2mm) to 1-15/32" (37mm) as required.  <b>Material:</b> Brass, Bronze</p>	<p><b>KP3 Wave Washer</b>          (Furnished standard with 1765 collar for Yale® KeyMark® cylinders and 630F series trim).</p>	<p><b>599 Recessed Cylinder Collar with Radius "A" Dimension:</b>          Thicknesses from 1/16" (2mm) to 1-15/32" (37mm) as required.  <b>Material:</b> Brass, Bronze</p>	<p><b>KP4 Flush Mount Cylinder Collar</b>  <b>Material:</b> Brass, Bronze</p>

## Long Tailpiece Kit

Door Thickness	Trim Type	Part Number
2" - 2-1/2"	620F and 630F Series Trim	81-9500-1665-000
2-1/2" - 3-1/2"	620F and 630F Series Trim	81-9500-1635-000
3-1/2" - 4-1/2"	620F and 630F Series Trim	81-9500-1636-000

Specify part number to order.

## Von Duprin® Tailpiece

This tailpiece is available for the Yale® 1109 rim cylinder to operate the night latch function for Von Duprin exit devices. To order, specify model number: 1145VD.

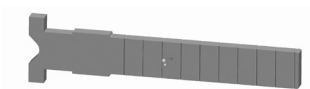

# Strikes



## Rim Devices

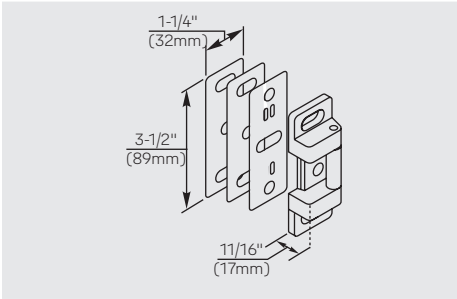

**757F**  
Standard strike for 6100ED(F), 6150ED(F) devices. Supplied with #10-24 x 3/4" machine screws, two shims (each 1/16" thick), and one locking plate.

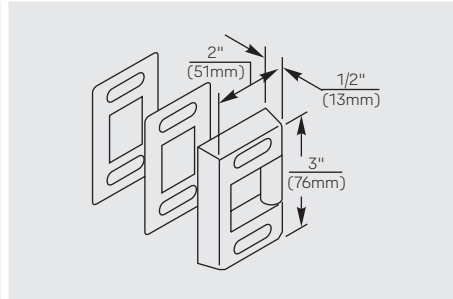

**759**  
Standard strike for 6200ED, 6250ED devices.

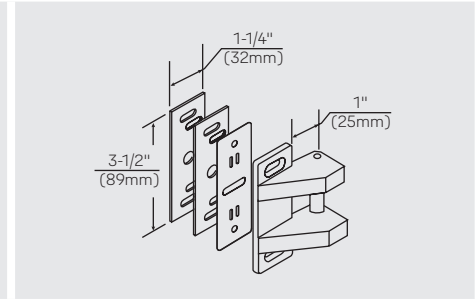

**793**  
Optional strike for 6100ED, 6150ED exit devices on double door applications without a mullion. Supplied with #10-24 x 3/4" machine screws, two shims (each 1/16" thick), and one locking plate. Panic only.

## Mortise Devices

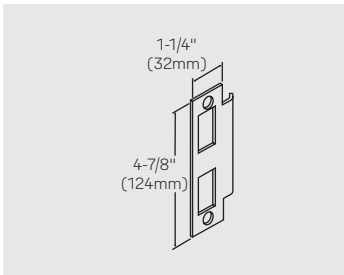

**798**  
Standard curved lip ANSI strike used with 6130(F) devices. (1-1/4" lip)

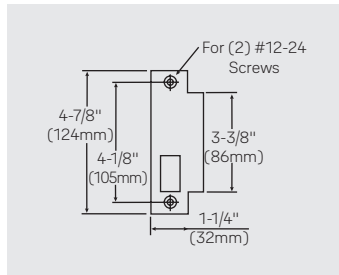

**61/712**  
Optional flat lip ANSI strike used with 6130 devices for pairs of doors with astragals. (7/8" lip)

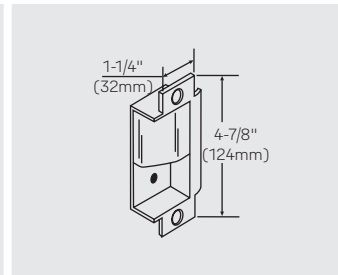

**618/718**  
Optional open back strike. Permits opening of the inactive door for pairs of doors where approved by door manufacturer.

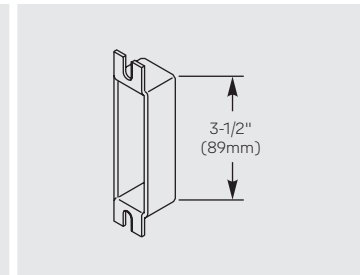

**202**  
Optional strike box for ANSI strikes. 7/8" (22mm) deep.

# Strikes

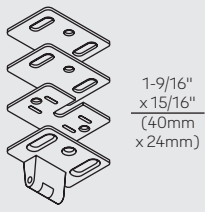
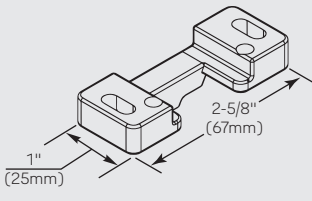
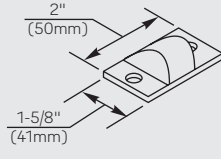
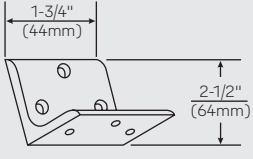

## Vertical Rod Devices - Top Strikes

 <p>1-9/16" x 15/16" (40mm x 24mm)</p>	 <p>1" (25mm)</p> <p>2-5/8" (67mm)</p>	 <p>2" (50mm)</p> <p>1-5/8" (41mm)</p>	 <p>1-3/4" (44mm)</p> <p>2-1/2" (64mm)</p>
<p><b>791</b> Standard top strike for 6110(F), 6120(F), 6210, 6220 series devices. Supplied with #10-24 x 3/4" machine screws, two shims (each 1/16" thick), and one locking plate.</p>	<p><b>726</b> Standard top strike for 6170(F) series devices. Supplied with special #10-24 x 3/4" machine screws.</p>	<p><b>761</b> Standard top strike for 6160(F) series devices. Supplied with #10-32 x 3/8" machine screws and #10 x 1" sheet metal screws.</p>	<p><b>797</b> Optional bracket for mounting 791 top strike in flush transom opening. Supplied with 1/4-20 machine screws; SN-134 sex nuts, optional.</p>

## Vertical Rod Devices - Bottom Strikes

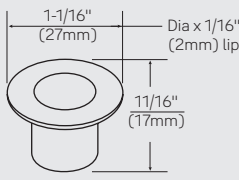
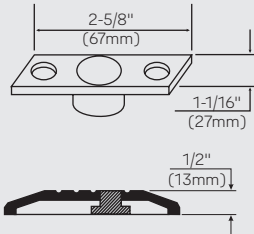
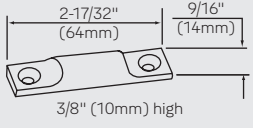
 <p>1-1/16" (27mm)</p> <p>Dia x 1/16" (2mm) lip</p> <p>11/16" (17mm)</p>	 <p>2-5/8" (67mm)</p> <p>1-1/16" (27mm)</p> <p>1/2" (13mm)</p>	 <p>2-17/32" (64mm)</p> <p>9/16" (14mm)</p> <p>3/8" (10mm) high</p>
<p><b>790</b> Standard bottom strike for 6110(F), 6120(F), 6160(F), 6170(F), 6210, 6220 series devices. Press in place.</p>	<p><b>794</b> Optional bottom strike for fire openings using saddle thresholds or for flush floor mount. Must use for fire openings with 1/2" thresholds. Supplied with #10-24 x 1/2" machine screws and floor anchors.</p>	<p><b>702</b> Optional bottom strike for bottom pullman latch option. Supplied with #8 x 8/32" combination screws.</p>

# Accessories/Options



## 620DB Dummy Pushbar

For push-pull vestibule doors leading to doors with 6000ED Series exit devices. Bars fit doors up to 48" (122cm) wide. Same finishes as devices. Specify 620 x finish. Not available with Microshield®.

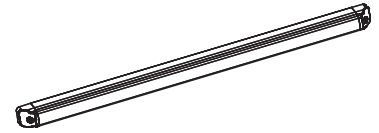

## Anti-Pry Bracket

The anti-pry bracket offers end users increased security by improving resistance against jamb spreading during a pry attack. When the door is in the closed position, the anti-pry bracket interlocks in position between the exit device strike and frame preventing the strike and exit device latch from being separated. For use with all 6100ED(F) rim and 6150ED(F) SquareBolt® devices. Kit includes interlock bracket and end cap shim, the standard exit device mounting screws can be used, therefore, no additional fasteners are required. Black powder coat finish. To order specify option/model number: 625AP

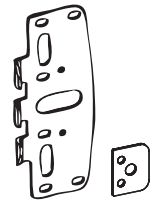

## Bottom Pullman Latch

Optional bottom pullman latch available for panic listed vertical rod exit devices. To order with devices, specify "BPL." 702 bottom strike required, see page 45.



## Cylinder Dogging

All Yale 6000ED exits come standard with hex key wrench for dogging. As an option, cylinder dogging is also available on non-fire rated devices.

Cylinder dogging is available for panic-listed exit devices only. Requires use of 1-1/8" mortise cylinder. When ordered with a device, cylinder must be ordered separately. (See How to Order, "Fourth Digit", page 7.) Cylinder dogging kit available; specify 615 and size (24", 36", 36" NS, 42", 42" NS, 48", 48" NS). Cylinder not included with this kit.

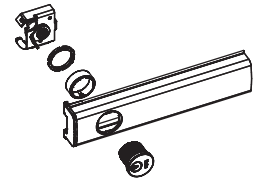

Note: NS = Narrow stile

## Double Cylinder Functions

Available on wide stile rim, SquareBolt and mortise devices, key on either side locks or unlocks lever. Specify using -2 suffix.

## Extension Rods

Model #	Length
7010-2	2" (51mm)
7010-6	6" (152mm)
7010-12	12" (305mm)
7010-24	24" (610mm)

Specify finish.



## Plastic Installation Template

Provided as a standard with all 6000ED Series exit device, the plastic installation template facilitates door markings over traditional paper templates. This provides a more accurate door prep which reduces installation mistakes and overall installation time. Template dimensions: 8-1/4" x 3-1/4" (210mm x 83mm). To order separately, specify part number: 60-6000-9100-999.

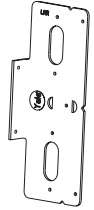

## Schlage® Cam Assembly

This cam and housing assembly includes a cam engineered to accept Schlage rim cylinders. No modifications are required to existing 500 and 600 Series exit device trims thus maintaining the trim's classroom and storeroom functions. To order, specify part number: 60-6000-0815.

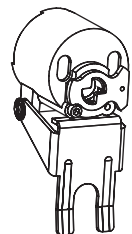

## Shim Kits

Shim kits, for devices on doors with interfering molding, are available. Each standard shim kit contains 2 sets of 1/8" thick shims to shim a device 1/8" (3mm) or 1/4" (6mm). Longer device mounting screws (not included) are required for more than 1/4" (6mm) shimming. 693 (Black) finish.

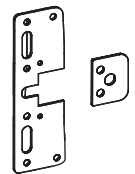

<b>623SK</b>	Shim kit for 6100ED(F) Series rim, 6150ED(F) Series Squarebolt®, 6160ED(F) Series* concealed vertical rod, and 6130ED(F) Series* mortise exit devices.
<b>623NS</b>	Shim kit for 6200ED Series rim, 6250ED series Squarebolt and 6220ED Series* concealed vertical rod exit devices.
<b>624SK</b>	Shim kit for 6170ED(F) Series surface vertical rod exit devices.
<b>624NS</b>	Shim kit for 6210ED Series narrow stile surface vertical rod exit devices

\*Note: Special mortise or concealed vertical rod components needed for openings requiring more than (2) shim kits, or for shimmed mortise devices in doors over 1-3/4" (44mm) thick. Details on application.

## Specialty Fasteners

### Sex Nuts:

Required for wood, composite or unreinforced metal doors.

- SN-104 – Interlock bracket pack of (4) 10-24 sex nuts for all fire rim and Squarebolt® devices.
- SN-134 – pack of (4) 1/4-20 sex nuts for all devices.

### TORX® Security Screws:

Available for factory product orders. Wood screws may only be used in predrilled pilot holes of solid core wood doors.

# Mullions



## M200(F) Removable Mullion

M200(F) steel mullions are for use with 6100(F) Series wide stile exit devices. Mullions may be field cut to fit opening. Gray paint finish.

- M200 panic rated.  
Tubular steel, 2" x 3" (51mm x 76mm). Specify 7'2".
- M200F 3 hour fire rated.  
Tubular steel, 2" x 3" (51mm x 76mm). Specify 7'2" or 10'<sup>11</sup> (Fire rated up to 8').

**Notes:**

**1. For 8' length Mullion must be order as M200F option and cut in the field to 8' size.**

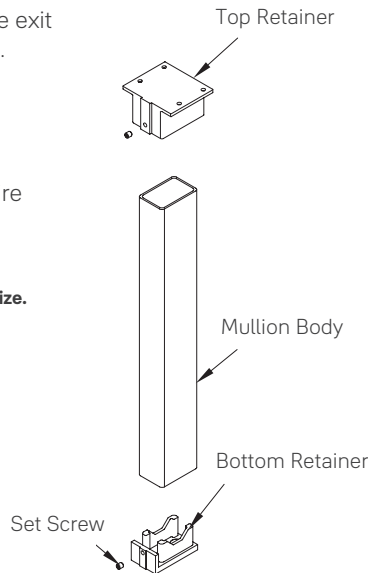

**M200(F)**

## M300 Removable Mullion

M300 mullions are for use with 6200ED Series narrow stile exit devices. They consist of an aluminum extrusion 1-1/4" x 3" (32mm x 76mm), with built-in strikes for device bolts. Supplied with mounting brackets, mechanical fasteners, and mullion stabilizers. Available finishes are 628 (Satin, clear anodized) and 695 (dark amber coat). Specify 8' or 10'. For 9' mullion, specify 10' and cut to size in field.

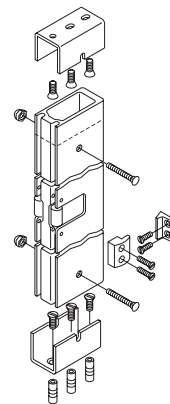

**M300**

## 102S Mullion Stabilizer Kit

Recommended for high openings and whenever door movement must be further restricted. Supplied standard with M300 mullions. To order separately, specify 102S.





# Mullions

## KRM200(F) Keyed Removable Mullion (KRM)

Keyed removable mullions are for use with 6100ED(F) Series wide stile exit devices. They are designed for simple removing when an unobstructed large opening is required and easy replacement and locking to maintain the integrity of the opening.

- Easy cylinder installation.
- Mullion automatically relocks when reinstalled without the use of the cylinder key.
- When ordering, add KR prefix to mullion, example: KRM200 and KRM200F.
- KRM200 panic rated. Specify 7'2".
- KRM200F 1-1/2 hour fire rated. Specify 7'2" or 10'1" (Fire rated up to 8')

**Notes:**

1. For 8' length Mullion must be order as KRM200F option and cut in the field to 8' size.

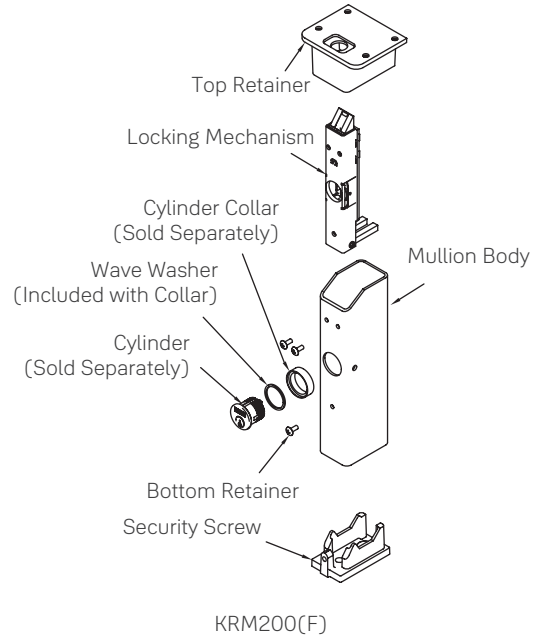

## Split Mullion

- Hassle-free transportation with a 30% smaller packaging size. Mullions may be field cut to fit opening. Gray painted finish. Available only in 8'. When ordering add suffix SM, example M200SM and KRM200SM

**M200SM Standard**

- Panic rated. Specify 8'
- Tubular steel, 2" x 3" (51mm x 76mm).

**KRM200SM Key Removable Split Mullion**

- Easy cylinder installation.
- Panic rated. Specify 8'
- Tubular steel, 2" x 3" (51mm x 76mm).

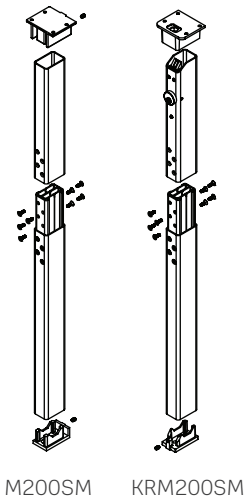

## M200(F), SM and KRM Options

**M203 Spacer Block**

Recommended for double rabbeted frames where the stop face width is less than the mounting hole spacing or for applications with 5-3/4" (146mm) or less door frames.

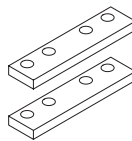

**M204 Angle Bracket**

Recommended for any header configuration with less than 3" (76mm) of mounting surface.

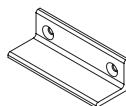

## KRM Cylinders

As with any exit device trim, you must order a cylinder and collar if one is required. The Yale® keyed removable mullion accepts a mortise cylinder. Refer to page 40-41 for details.

# Dimensions



## Device

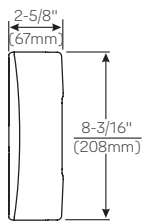

Cover Detail

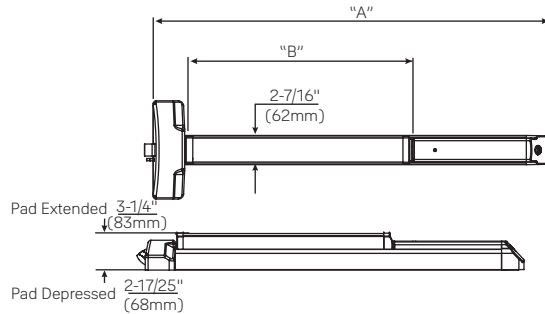

### 6100 Series (all models)

Series	"A"	"B"
6100ED-36	33"	18-5/8"
6100ED(F)-36	(838mm)	(473mm)
6100ED-42	39"	21-5/8"
6100ED(F)-42	(990mm)	(549mm)
6100ED-48	44-5/8"	24-5/8"
6100ED(F)-48	(1133mm)	(625mm)

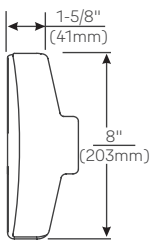

Cover Detail

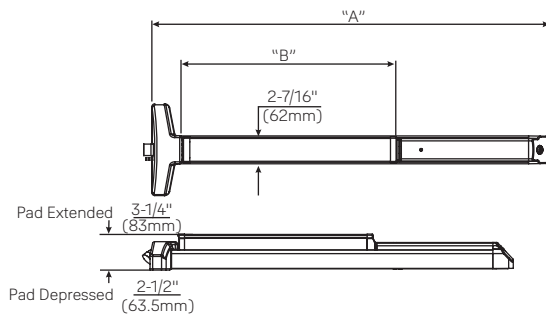

### 6200 Series (all models)

Series	"A"	"B"
6200ED-36	34-3/4"	18-5/8"
	(883mm)	(473mm)
6200ED-42	40-3/4"	21-5/8"
	(1035mm)	(549mm)
6200ED-48	46-3/4"	24-5/8"
	(1187mm)	(625mm)

## Trim

620F/650F Series	630F/660F Series	500F Series	480F Series
Projection: 13/16" (20mm)	Projection: 2-3/4" (70mm)	Projection: 1/4" (6mm)	Projection: 2-7/8" (73mm)

## Lever/Rose

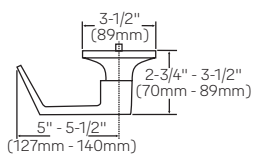

# Sample Specifications



## Specification

Exit devices shall be 6000ED Series Pushpad Exit Devices as manufactured by Yale Locks & Hardware.

The exit device chassis shall be cold forged steel, electroplated for corrosion resistance, and shall be architecturally finished brass, bronze or stainless steel. The pushpad mechanism shall be constructed of extruded aluminum and shall be scalped with architecturally finished brass, bronze or stainless steel. The maximum projection shall be 3-1/4" when the pushpad is active and 2-3/4" when the pushpad is dogged down. Nylon bearings and stainless steel springs shall be used for long life and durability; only torsion springs are acceptable. Rear and active case covers shall be wrought brass or bronze and shall be plated to match the exit bar. Plastic or painted covers are not acceptable. Latchbolts shall be steel and shall incorporate a deadlocking latch for increased security. Devices without deadlocking latches are not acceptable. Mounting screws shall be concealed to deter tampering. Devices shall be closed on all sides with no pinch points. Exit devices shall be easily field sized to accommodate various door widths.

Panic-listed exit devices shall have single point, one quarter turn hex key dogging standard. Optional cylinder dogging shall be available on panic listed devices. Devices with hex key dogging shall be easily field converted to cylinder dogging. Panic listed devices shall be available less dogging.

Trims shall be throughbolted with concealed fasteners. Escutcheon and pull-type trims shall be constructed of brass or bronze. All lever trims shall use cast or forged levers. On rim, SquareBolt® and vertical rod trims with cylinders, the mechanism that locks and unlocks the trim shall be housed in the trim and not in the active case of the exit device. Lever trims (except mortise) shall be Free-Wheeling with clutch mechanism allowing lever to rotate 60° when locked for ideal protection. Lever trims shall match those on Yale® mortise and cylindrical locksets.

Exit devices and trims shall be furnished in ANSI/BHMA standard architectural finishes.

Exit devices shall be listed by Underwriters Laboratories (UL) for safety as panic hardware. Fire-rated devices shall be listed for A label and lesser class doors.

### **Certification:**

ANSI/BHMA A156.3, Grade 1

Devices, trims and cylinders shall be from one manufacturer.

Devices and 400F, 500F, and 600F trims shall carry a ten-year limited warranty.

690F/691F trims shall carry a two-year limited warranty.

Electric options and components shall carry a two-year limited warranty.



**Trusted every day**

**Phone**

1-855-557-5078

**Customer Service Email**

customerservice.yale@assaabloy.com

**Technical Product Support Email**

techsupport.yale@assaabloy.com

**Order Entry Email**

orders.yaleus@assaabloy.com

**Fax**

1-800-338-0965

**Website**

www.yalecommercial.com

## Contact Us

**U.S.A.**

**Yale Locks & Hardware**

Address: 225 Episcopal Road

Berlin, CT 06037-4004

Tel: 1-800-438-1951

Fax: 1-800-338-0965

yalecommercial.com

**Canada:**

**ASSA ABLOY Door Security Solutions Canada**

Address: 160 Four Valley Drive

Vaughan, Ontario L4K 4T9

Tel: 1-800-461-3007

Fax: 1-800-461-8989

assaabloydss.ca

**International:**

**ASSA ABLOY Americas International**

Tel: 1-905-821-7775

Fax: 1-905-821-1429

assaabloyai.com

**MicroShield®**

ASSA ABLOY Group companies offer MicroShield®, an anti-microbial coating for door hardware. MicroShield uses proven silver ion-based technology from Agion®, a leading provider of antimicrobial solutions, to stem the spread of bacteria and other microbes.

MicroShield® is a registered trademark of ASSA ABLOY Access and Egress Hardware Group, Inc.



The Agion antimicrobial is not intended as a substitute for good hygiene. Coated products must still be cleaned to ensure the surfaces will be free of destructive microbes. ASSA ABLOY makes no representations or warranties, express or implied, as to the efficacy of the Agion antimicrobial. A copy of the Agion warranty is available upon request. Agion is a registered trademark of Agion Technologies, Inc., Wakefield, MA, USA.

**THE YALE BRAND**, with its unparalleled global reach and range of products, reassures more people in more countries than any other consumer locking solution.

**THE ASSA ABLOY GROUP** is the world's leading manufacturer and supplier of locking solutions, dedicated to satisfying end-user needs for security, safety and convenience.

Yale Commercial is a business associated with ASSA ABLOY Access and Egress Hardware Group, Inc., an ASSA ABLOY Group company. Copyright © 2015-2024, ASSA ABLOY Access and Egress Hardware Group, Inc. All rights reserved. Reproduction in whole or in part without the express written permission of ASSA ABLOY Access and Egress Hardware Group, Inc. is prohibited. Patent pending and/or patent [www.assaabloydss.com/patents](http://www.assaabloydss.com/patents).