



WE BUILD RIDERS' CONFIDENCE.

PRODUCT CATALOGUE 2024

TEAM SPONSOR & TECHNICAL SUPPORT

MotoGP™ **Moto2™** **Moto3™**

RACING EVENTS



WWW.RCB.COM



WE BUILD RIDERS' CONFIDENCE.

INTRODUCTION

Incorporated in 1998, Meng Kah Auto Parts Trading Sdn Bhd was in the business of importing and distributing motorcycle parts and accessories. As a result of their success, the brand 'Racing Boy' was born. Its purpose was to provide consumers with high precision and quality products. All of Racing Boy's products are meticulously designed, tested and manufactured in-house by our dedicated team of engineers.

In 2013, 'Racing boy' was rebranded to 'RCB' to further venture out into the global market. Today, RCB has expanded its product range to Wheels, Suspensions, Braking systems as well as CNC parts.



A Leading International Brand.

MISSION

From the beginning, our mission has been to provide our stakeholders with quality products and professional services. We aspire to be innovative in all business aspects in providing a platform for financial stability while maximizing returns. We strive to constantly grow our business with the same honesty and integrity we use to craft our products. Our reward, simply the satisfaction we receive from our partners and customers around the world.

VISION

Professional

To provide the best services and solutions.

Brand Perception

To be a visionary leader in the industry.

Excellence

To constantly innovate and improve product quality and range.

Partnership

To uphold integrity with partners and customer in all aspects.

ACHIEVEMENT

Through decades of brand building and constant innovation, in 2011, Racing Boy won its first award in the 2nd Annual Asia Success Award organized by the International Organising Committee, Asia Success Ltd. Racing Boy was awarded the 'Super Golden Product' achievement in the 'Motorcycle Rims' category. In 2012, Racing Boy was presented with an award once again as the 11th Asia Pacific Top Excellence Brand by the Asia Pacific Entrepreneur Alliance, published in the top leading international publication, Global Business Magazine



RCB FACILITIES



RCB MOTORSPORTS





TEAM SPONSOR & TECHNICAL SUPPORT

MotoGP™



Moto2™



Moto3™



Racing Events



Marc Marquez

6x MotoGP™ World Champion
13' 14' 16' 17' 18' 19'

Fabio Quartararo

MotoGP™ World Champion 21'

Kasma Daniel

Moto2™ | AP1000 | CP150
Rider





93

6x MotoGP™ World Champion
13' 14' 16' 17' 18' 19'

MARC MARQUEZ



Marc Márquez
#93



MotoGP™ World Champion 2020

JOAN MIR

36

A white, stylized signature of Joan Mir, followed by the number '36' in a similar style.



RCB



21

MotoGP™ Rider

FRANCO MORBIDELLI

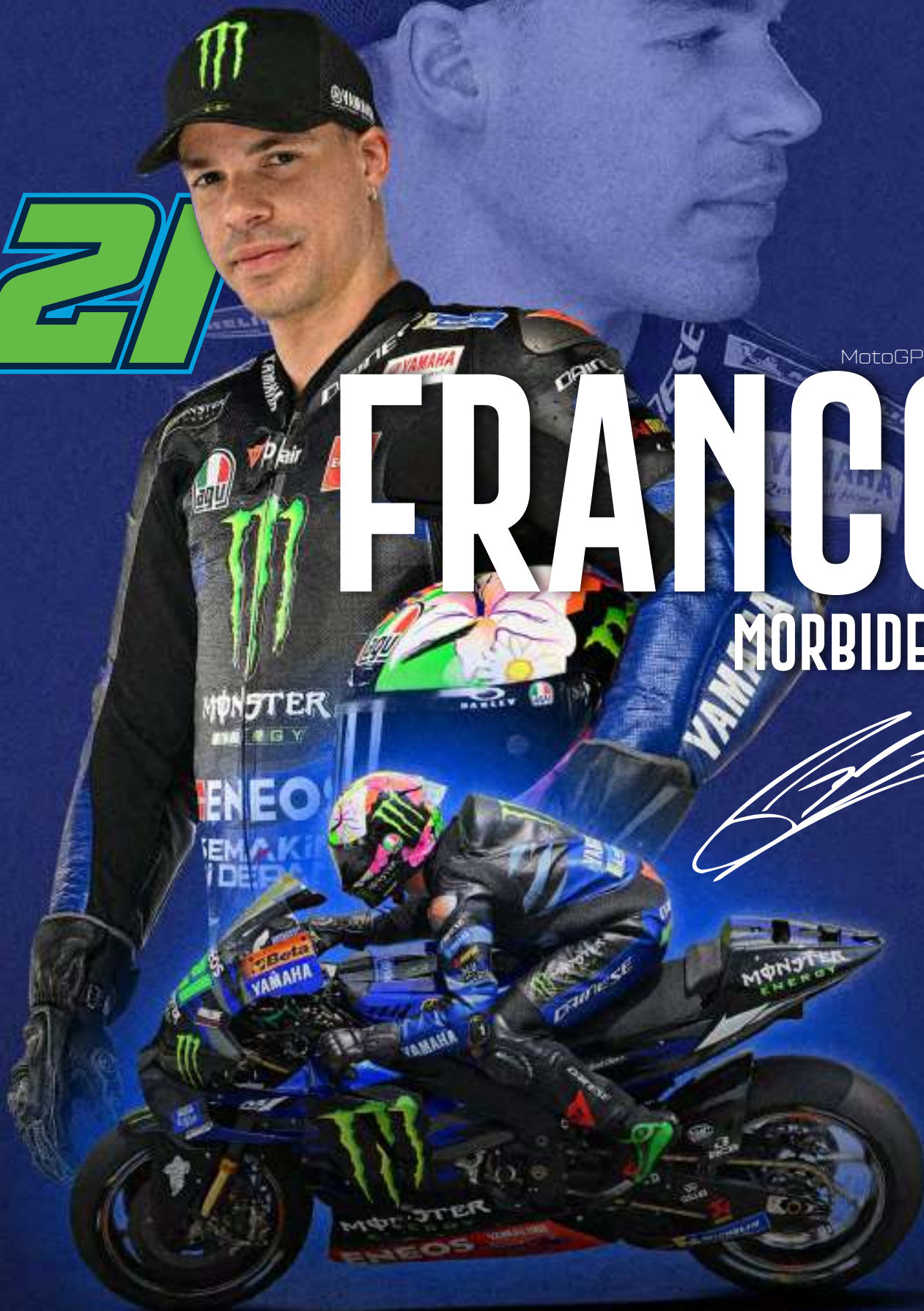

MotoGP™

RCB



MotoGP™ World Champion 2021

FABIO

QUARTARARO

20

Fabio
#20



MotoGP™

RCB



89



MotoGP™ Rider

JORGE MARTIN



MotoGP™

RCB

prima

PRAMAC RACING



MotoGP™ Rider

JOHANN ZARCO



MotoGP™

RCB

Official Sponsor of
aprilia
RACING

RAW
ORGANIC HYDRATION

41

MotoGP™ Rider

ALEIX ESPARGARO



MotoGP™

RCB

Official Sponsor of
aprilia
RACING



MotoGP™ Rider

MAVERICK

VINALES



MotoGP™

RCB

mooney
VR46 RACING TEAM

72

MotoGP™ Rider

MARCO

BEZZECCHI



MotoGP™

RCB

mooney
VR46 RACING TEAM

MotoGP™ Rider

LUCA MARINI

10



MotoGP™

RCB



MotoGP™ Rider

JACK MILLER



MotoGP™

RCB



MotoGP™ Rider

BRAD

BINDER

33



MotoGP™

RCB

GASGAS
FACTORY RACING
TECH3

37

MotoGP™ Rider

AUGUSTO

FERNANDEZ



MotoGP™

RCB

GASGAS
FACTORY RACING
TECH3

MotoGP™ Rider

POL ESPARGARO

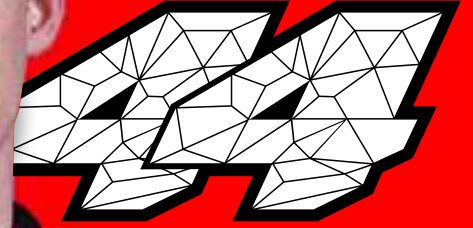

MotoGP™

RCB



MotoGP™ Rider

MIGUEL

OLIVEIRA



MotoGP™

MotoGP™ Rider

RAUL FERNANDEZ

25





Team
GREVINI RACING
MotoGP

73

MotoGP™ Rider

ALEX MARQUEZ

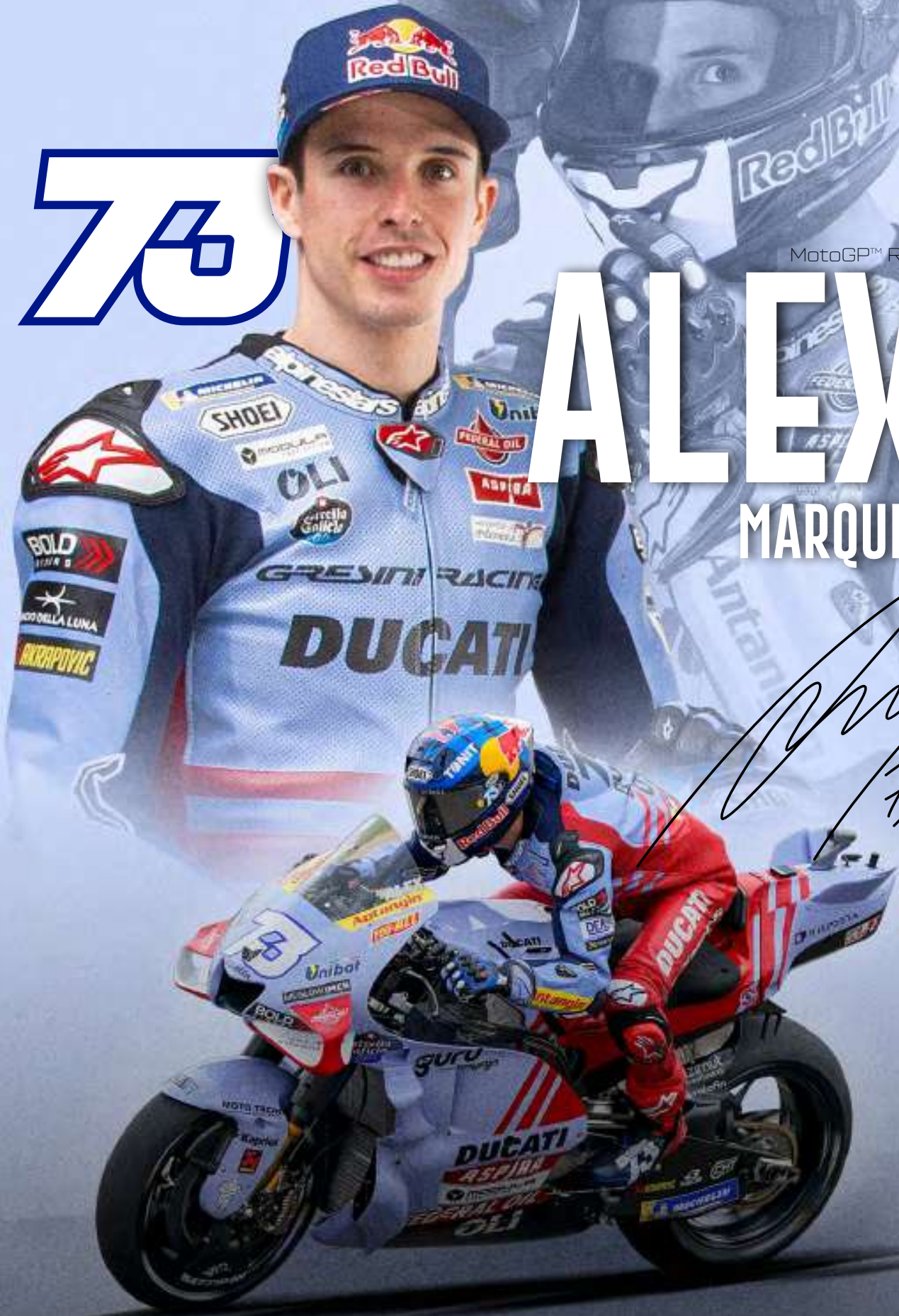

MotoGP™

RCB

Team
GRESINI RACING
MotoGP

49

MotoGP™ Rider

FABIO

DI GIANNANTONIO



MotoGP™

Idemitsu Honda Team Asia



Correos Prepagado Yamaha VR46



QJMOTOR Gresini Moto2™

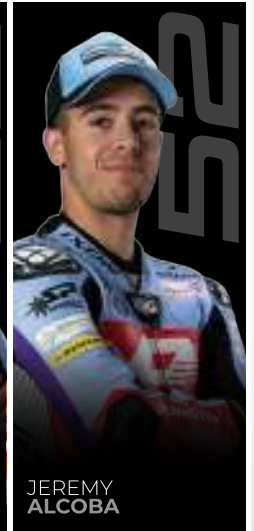

Pertamina Mandalika SAG Team



Liqui Moly Husqvarna Intact GP



Fieten Olie Racing GP

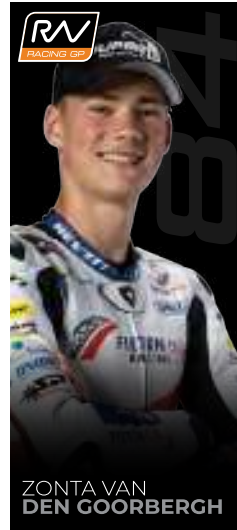

Fantic Racing



Inde GASGAS Aspar M2

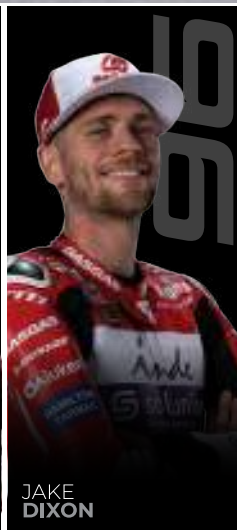
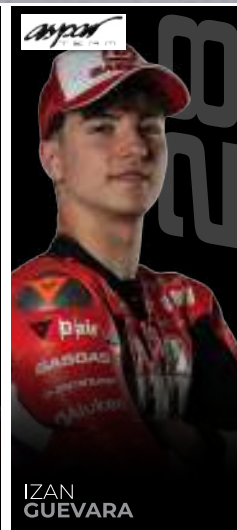

RCB

Red Bull KTM Tech3

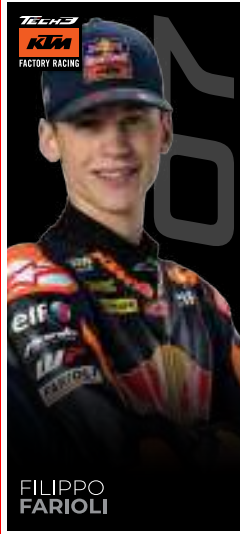

CFMOTO Racing PruestelGP



Honda Team Asia



Rivacold Snipers Team

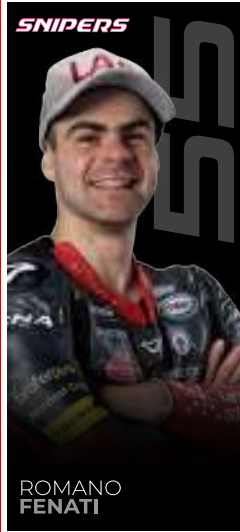

VisionTrack Racing Team



Liqui Moly Husqvarna Intact GP

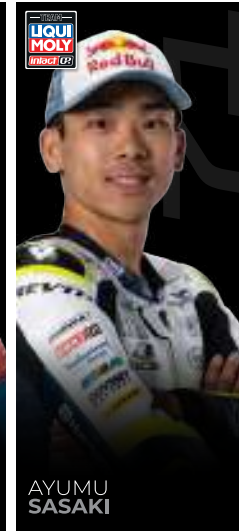

MT Helmets - MSI



Gaviota GASGAS Aspar M3

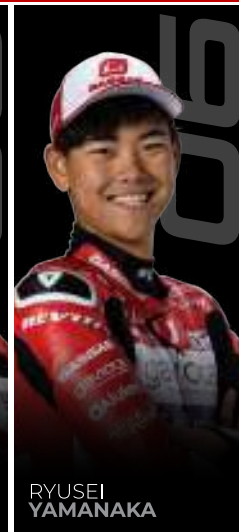
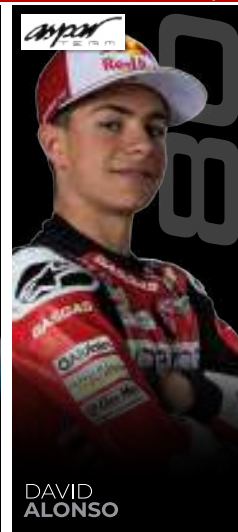



FIM ASIA ROAD RACING
CHAMPIONSHIP

AS 1000

AP 600

AP 250

UB 150

UMA RACING MAJU MOTOR

BOON SIEW HONDA

ASTRA HONDA

YAMAHA THAILAND

HONG LEONG YAMAHA

HONDA RACING VIETNAM

YAMAHA RACING INDONESIA

HAJI PUTRA 969

TVS INDIA

ONE FOR ALL

YUZY RACING

ZK RACING

YY PANG

JRT RACING TEAM





CP150

CP125

WIRA

PETRONAS YAMAHA MAJU MOTOR

IDEMITSU HONDA YUZY RACING

CILIK RCB MOTORSPORT

YY PANG RACING SPORT

HONG LEONG YAMAHA TEAM

BOON SIEW HONDA TEAM

AFB TECH RACING

PETRONAS YAMAHA CKJ

PETRONAS 31 RACING

WIRAMUDA V-FIERTECH ACADEMY

AHM MOTORSPORT

CASTROL POWER 1 RACING

ELF KOYOKO HONDA KC RACING



CONTENTS

WHEELS & ACCESSORIES

| | |
|-----------------------|----|
| CARBON WHEELS | 28 |
| SPORT WHEELS | 30 |
| FORGED WHEELS | 40 |
| TUBELESS ALLOY WHEELS | 44 |
| ALLOY WHEELS | 46 |
| SPOKES | 48 |
| WHEELS ACCESSORIES | 49 |

SUSPENSION

| | |
|-----------------|----|
| DUAL SUSPENSION | 52 |
| MONO SUSPENSION | 64 |
| FRONT FORK | 74 |
| DAMPER | 77 |

BRAKES

| | |
|------------------------|----|
| TEFLON BRAKE HOSE | 79 |
| BRAKE CALIPER | 80 |
| REAR MASTER BRAKE PUMP | 87 |
| CLUTCH PUMP | 87 |
| BRAKE DISC | 88 |
| MASTER BRAKE PUMP | 92 |
| BRAKE DISC BRACKET | 96 |
| BRAKE PAD | 97 |
| BRAKE ACCESSORIES | 99 |

FOOT CONTROLS

| | |
|--------------------------|-----|
| RACING FOOTREST | 101 |
| SINGLE FOOTREST | 107 |
| FULLSET FOOTREST | 108 |
| FOOT CONTROL ACCESSORIES | 111 |

HAND CONTROLS

| | |
|--------------------|-----|
| BRAKE/CLUTCH LEVER | 113 |
| ALLOY HANDLE GRIP | 115 |
| RUBBER HANDLE GRIP | 116 |
| BALANCER | 117 |
| LEVER GRIP | 117 |
| LEVER GUARD | 118 |

DRIVE CHAIN SYSTEM

| | |
|----------|-----|
| CHAIN | 120 |
| SPROCKET | 121 |

BODY PARTS & ACCESSORIES

| | |
|-------------------------------|-----|
| LITHIUM ION BATTERY & CHARGER | 123 |
| SIDE MIRROR | 125 |
| SWING ARM SPOOLS | 126 |
| ULTRA CLUTCH CABLE SET | 126 |

APPAREL

| | |
|---------------------------|-----|
| RIDING JACKET | 128 |
| RIDING SHOES | 128 |
| RIDING GLOVES | 128 |
| RAIN COAT & RIDING GLOVES | 129 |
| MOTORCYCLE COVER | 131 |
| GOGGLES | 132 |

COLOUR GUIDE:

| | | | |
|-------------|---------------|--------|--------|
| Purple | Dark Blue | Blue | Green |
| Titanium | Titanium Thai | Grey | White |
| Red | Dark Orange | Orange | Black |
| Gold | Chrome | Silver | Copper |
| Matte Black | | | |

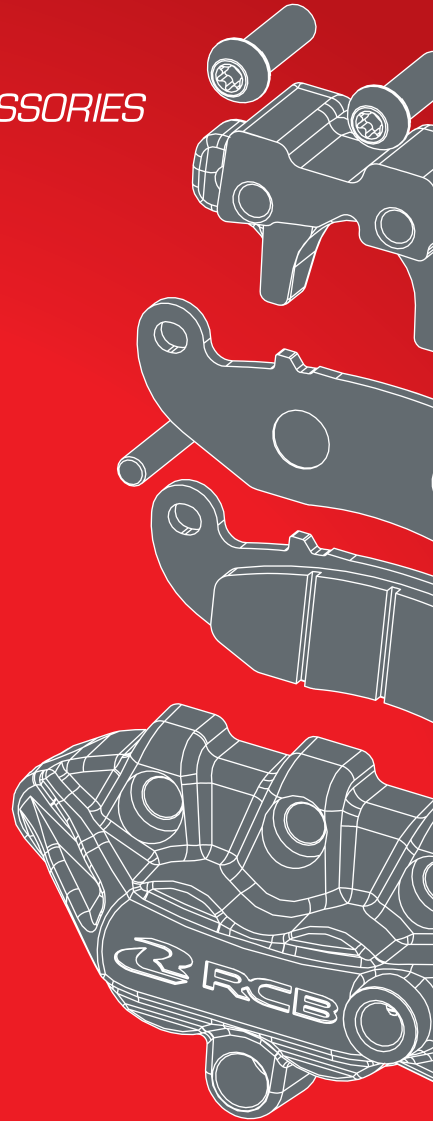

WHEELS & ACCESSORIES



CARBON WHEELS

SPORT WHEELS



FORGED WHEELS

TUBELESS ALLOY WHEELS

ALLOY WHEELS

SPOKES

WHEELS ACCESSORIES

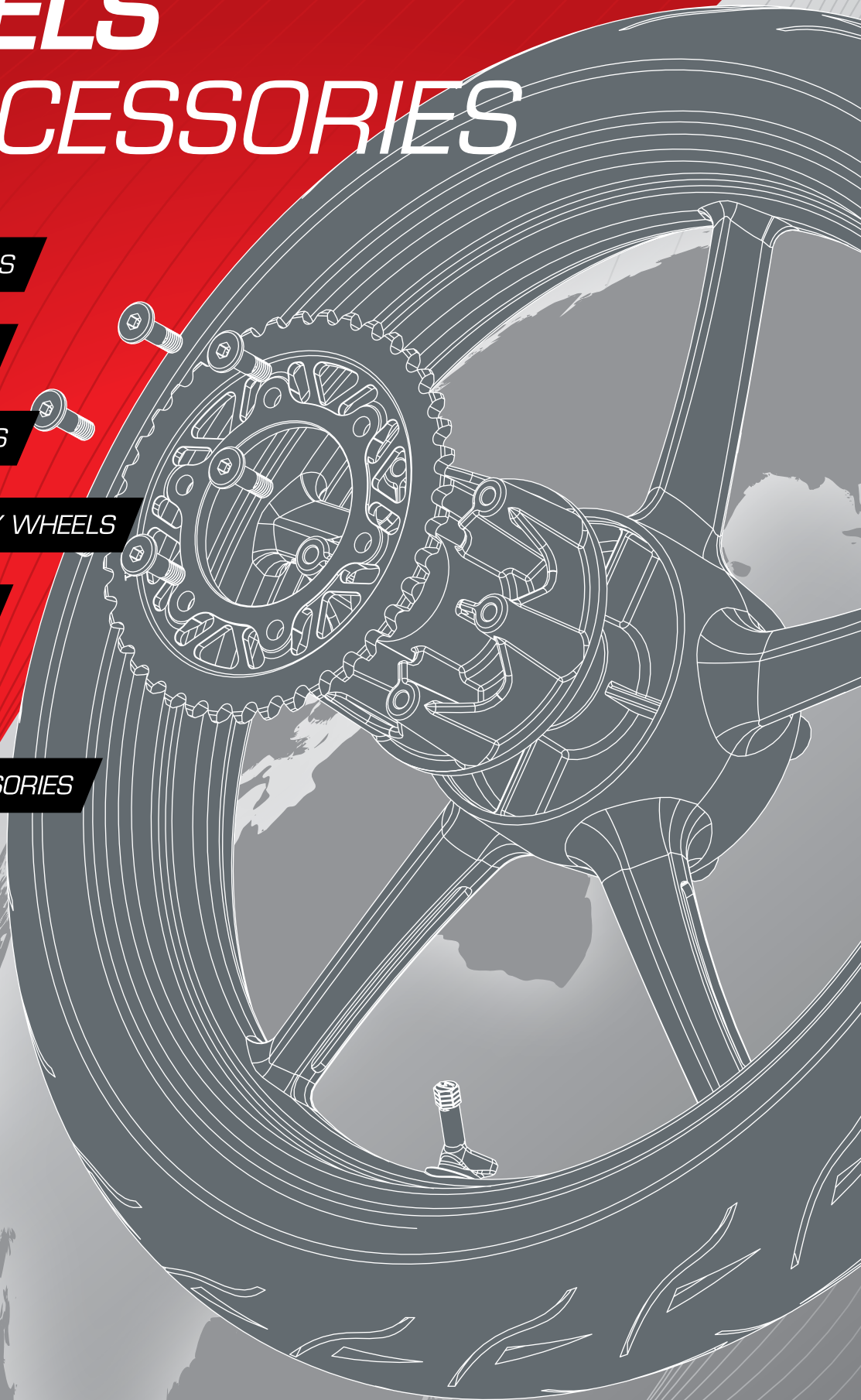

ULTRALIGHT
ENGINEERED
PARTS BY  RCB

CR55

WHEN
TECHNOLOGY
MEETS **SPEED**

SCAN HERE
FOR MORE INFORMATION



Lightweight

Carbon Fibre Composite
Rim (Front & Rear)

WHEELS & ACCESSORIES



**ONE-PIECE CARBON
FIBRE DESIGN**



ANTI-RUST
Resist to corrosion

| CODE | MODEL | BRAND | SIZE | COLOUR |
|---------|-------|--------|---------------|-----------------------|
| 01CR001 | Y15ZR | YAMAHA | 215x17/300x17 | <input type="radio"/> |
| 01CR002 | Y15ZR | YAMAHA | 215x17/300x17 | <input type="radio"/> |

SP500 VR



**DNA EVOLUTION
FROM OUR LEGENDARY
RACE-PROVEN SP522**



FEATURES

- **Revolutionary SP500:** Race-ready inspired by legendary RCB SP522
- Ultra lightweight to improve handling and stability
- Maximize performance by strategic material removal
- **T6 Heat treatment:** 50% stronger and unbeatable performance
- RCB utilizes **RCB Hollow Tech** technology in their design and production to make the wheels lighter, improving handling and stability
- CNC finishing RCB logo
- Hollow hub provide more cooling for bearing
- High durability of paint, stone chip resistant
- The weight 5% lighter than original rim (FR1.85x17, RR3.50x17)



VINTAGE BRONZE

EBONY BLACK

LUXE WHITE

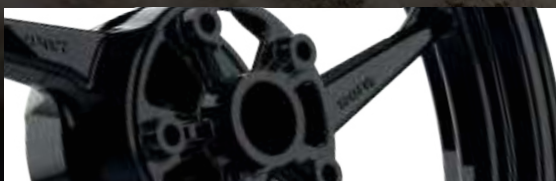

| CODE | MODEL | BRAND | *SIZE | COLOUR |
|------|-------------|--------|---------------|--------|
| - | Y15ZR/Y16ZR | YAMAHA | 185x17/250x17 | ● ○ ● |

*more sizes coming.

SCAN HERE
FOR MORE INFORMATION



SP522

ON THE RACE TRACK AND STREET

Made from Aluminium Alloy, the SP522's 5-spoke design enables riders' to gain speed by reducing the overall weight without comprising structural integrity. Currently the **PREFERRED RIMS** for the *Asia Road Racing Championship*, the SP522 has proven its worth in extreme conditions giving you the confidence you need on the road.

OFFICIAL TECHNICAL PARTNER FOR:



FINISHING

Available in a variety of vibrant colours, the SP522 has a fully powder coated finish that is durable and highly resistant to corrosion, flaking and scratches.

































































































DESIGN

A 5-spoke design that reduces weight while maintaining structural strength.

AVAILABLE COLOURS:



| CODE | MODEL | BRAND | SIZE | COLOUR | |
|---------|------------------|---------------|----------------|---|---|
| 01S0275 | SRL | YAMAHA | 140x17/160x17 |    | |
| 01S0395 | EGO | | 185x14/215x14 |     | |
| 01S0399 | | | 140x17 [1 PCS] |  | |
| 01S0400 | | | 140x14/160x14 |  | |
| 01S0407 | | | 120x17/140x17 |   | |
| 01S0398 | | | EGO/EGO LC | 120x17 [1 PCS] |  |
| 01S0397 | EGOLC | | 185x14/215x14 |     | |
| 01S0401 | | | 140x14/160x14 |  | |
| 01S0409 | | | 120x17/140x17 |   | |
| 01S0161 | Y125Z | | 185x17/250x17 |   | |
| 01S0289 | Y125ZR(LC5S) | | 185x17/250x17 |    | |
| 01S0160 | LC135 | | 185x17/250x17 |    | |
| 01S0396 | | | 160x17/185x17 |     | |
| 01S0367 | FZ150i(N) | | 185x17/250x17 |   | |
| 01S0365 | FZ150-N (RACE) | | 250x17/350x17 |   | |
| 01S0412 | FZ150i | | 215x17/300x17 |   | |
| 01S0350 | Y15ZR (LC150) | | 250x17/350x17 |     | |
| 01S0390 | Y15ZR (S/RACE) | | 185x17/250x17 |   | |
| 01S0366 | Y15ZR | | 185x17/250x17 |     | |
| 01S0387 | | | 160x17/160x17 |    | |
| 01S0408 | | | 160x17/185x17 |   | |
| 01S0410 | | | 215x17/300x17 |   | |
| 01S0430 | | | 160x17/160x17 |  | |
| 01S0441 | | | 185x17/215x17 |   | |
| 01S0442 | | | 185x17/215x17 |   | |
| 01S0368 | | | R15 V2 | 185x17/350x17 |   |
| 01S0349 | | | | 250x17/350x17 |   |
| 01S0465 | | | R15 V3 | 250x17/350x17 |   |
| 01S0394 | R25 | | 300x17/500x17 |   | |
| 01S0413 | NMAX | | 300x17/350x17 |   | |
| 01S0460 | NVX155 | | 140x17/160x17 |    | |
| 01S0414 | LC5S | | 160x17/185x17 |   | |
| 01S0444 | | | 160x17/160x17 |   | |
| 01S0443 | | | 140x17/160x17 |   | |
| 01S0461 | | | VF185I | 160x17/185x17 |   |
| 01S0276 | W110 | | HONDA | 140x17/140x17 |   |
| 01S0277 | W100 | | | 140x17/140x17 |   |
| 01S0381 | RS150R | | | 185x17/250x17 |   |
| 01S0392 | SONIC150 | | | 160x17/160x17 |   |
| 01S0449 | RS150R | | | 160x17/160x17 |   |
| 01S0402 | BEAT/CLICK110 | 140x14/160x14 | |  | |
| 01S0403 | CLICK125/150 | 140x14/160x14 | |  | |
| 01S0474 | VARIO150 | 140x17/160x17 | |    | |
| 01S0389 | GSX150 | 185x17/250x17 | | | |
| 01S0406 | BELANG | 160x17/185x17 | | | |
| 01S0380 | NINJA KRR /KR150 | KAWASAKI | 185x17/250x17 | | |

SP811



OFFICIAL TECHNICAL PARTNER FOR:



FINISHING

Available in a variety of vibrant colours, SP811 HAS a fully powder coated finish that is durable and highly resistant to corrosion, flaking and scratches.



DESIGN

Lighweight with 6 spokes design that able to improve speed and acceleration.

FEATURES

- A 6-spoke design that enhances structural strength for all riding conditions.
- Integrated bearing hole for superior strength and durability.



| CODE | MODEL | BRAND | SIZE FRONT/REAR | COLOUR | | |
|---------|---------------|---------------|-----------------|--------|---|---|
| 01S0207 | Y125Z | YAMAHA | 160x17/185x17 | ○ | ● | ● |
| 01S0212 | Y125Z(R) | | 185x17/250x17 | | ● | |
| 01S0240 | FZ150i | | 185x17/275x17 | ○ | ● | |
| 01S0361 | | | 215x17/350x17 | ○ | ● | |
| 01S0200 | SRLZ | | 160x17/185x17 | ○ | ● | ● |
| 01S0209 | LC135(R) | | 160x17/215x17 | ○ | | |
| 01S0210 | | | 185x17/215x17 | ○ | ● | ● |
| 01S0193 | EGO | | 185x14/215x14 | ○ | ● | ● |
| 01S0431 | | | 160x14/185x14 | ○ | ● | ● |
| 01S0379 | NMAX | | 350x14/400x14 | ○ | ● | ● |
| 01S0429 | | | 300x13/350x13 | ○ | | ● |
| 01S0455 | NMAX(2020) | | 300x13/350x13 | | ● | ● |
| 01S0239 | EGO LC | | 185x14/215x14 | ○ | ● | ● |
| 01S0382 | | | 185x14/215x14 | | ● | ● |
| 01S0432 | | | 160x14/185x14 | ○ | ● | ● |
| 01S0347 | LC5S | | 185x17/250x17 | ○ | | |
| 01S0351 | | | 160x17/185x17 | ○ | ● | ● |
| 01S0415 | Y15ZR | | 185x17/250x17 | ○ | ● | ● |
| 01S0454 | | | 160x17/185x17 | ○ | ● | ● |
| 01S0473 | | | 160x17/185x17 | ○ | ● | |
| 01S0391 | NVX | | 250x14/350x14 | | ● | ● |
| 01S0194 | EX5 | | 140x17/160x17 | ○ | ● | |
| 01S0201 | W100 | | 140x17/160x17 | ○ | ● | ● |
| 01S0203 | W125II | | 160x17/185x17 | ○ | ● | ● |
| 01S0348 | CLICK125 | | 185x14/215x14 | ○ | ● | ● |
| 01S0360 | BEAT/CLICK110 | | 185x14/215x14 | ○ | ● | ● |
| 01S0199 | SMASH PRO | 160x17/185x17 | ○ | ● | | |
| 01S0346 | BELANG | 160x17/185x17 | ○ | ● | ● | |
| 01S0241 | | 160x17/215x17 | ○ | ● | ● | |
| 01S0364 | SKYDRIVE | 185x14/215x14 | ○ | ● | ● | |

SP399

SPORT WHEELS

FEATURES

- Saves weight and improves rigidity
- 3-spoke design with powder coated finishing



AVAILABLE COLOURS:



| CODE | MODEL | BRAND | SIZE FRONT/REAR | COLOUR |
|---------|-----------|--------|-----------------|---------|
| 01S0150 | SRLZ | YAMAHA | 160x17/185x17 | ● ● ● ○ |
| 01S0155 | Y125Z | | 160x17/185x17 | ● ● ● ○ |
| 01S0281 | LC135 5S | | 160x17/185x17 | ● ● ● ○ |
| 01S0157 | LC135 | | 160x17/215x17 | ● ● ● ○ |
| 01S0158 | Y125Z | | 160x17/215x17 | ● ● ● ○ |
| 01S0151 | W100 | HONDA | 160x17/185x17 | ● ● ● ○ |
| 01S0152 | W110 | | 160x17/185x17 | ● ● ● ○ |
| 01S0153 | W125 II | | 160x17/185x17 | ● ● ● ○ |
| 01S0148 | RG SPORT | SUZUKI | 160x17/185x17 | ● ● ● ○ |
| 01S0149 | SMASH PRO | | 160x17/185x17 | ● ● ● ○ |

SP688

- Durable and high-end finish
- High rigidity and lightweight
- Smooth spoke lines and deep concave face

WHEELS & ACCESSORIES



FINISHING

Available in a variety of vibrant colours, SP688 has a fully powder coated finish that is durable and highly resistant to corrosion, flaking and scratches.



DESIGN

Lightweight with 6 spokes design that able to improve speed and acceleration.

SP688

SPORT WHEELS

| CODE | MODEL | BRAND | SIZE FRONT/REAR | COLOUR |
|---------|----------------------------------|---------------|-----------------|-------------|
| 01S0173 | CLICK110 | HONDA | 140x17/140x17 | ● ○ |
| 01S0310 | CLICK125 _(THAI) | | 140x17/140x17 | ● ○ |
| 01S0311 | CLICK125 _(THAI) | | 140x17/140x17 | ● ○ |
| 01S0175 | EX5 | | 140x17/140x17 | ● ○ |
| 01S0417 | EX5 | | R: 140x17 | ● ○ |
| 01S0418 | EX5 | | R: 140x17 | ●/CUT ○/CUT |
| 01S0445 | EX5 | | F: 140x17 | ● ○ |
| 01S0446 | EX5 | | F: 140x17 | ●/CUT ○/CUT |
| 01S0183 | W100 | | 140x17/140x17 | ● ○ ● |
| 01S0354 | NEW DREAM | | R: 140x17 | ● ○ |
| 01S0355 | NEW DREAM | | R: 140x17 | ●/CUT ○/CUT |
| 01S0356 | NEW DREAM | | R: 160x17 | ● ○ |
| 01S0357 | NEW DREAM | | R: 160x17 | ●/CUT ○/CUT |
| 01S0425 | WAVE NCX | | 140x17/140x17 | ●/CUT ○/CUT |
| 01S0426 | WAVE NCX | | 140x17/140x17 | ● ○ ● |
| 01S0184 | W110 | | 140x17/140x17 | ● ○ |
| 01S0294 | DREAM/W110 _(THAI) | | 140x17/140x17 | ●/CUT ○/CUT |
| 01S0295 | DREAM/W110 _(THAI) | | 140x17/140x17 | ● ○ |
| 01S0304 | W110i/CZI | | 140x17/140x17 | ● ○ ● |
| 01S0305 | W110i/CZI | | 140x17/140x17 | ●/CUT ○/CUT |
| 01S0462 | W110i 2021 | | 140x17/140x17 | ● ○ |
| 01S0463 | W110i 2021 | | 140x17/140x17 | ●/CUT ○/CUT |
| 01S0306 | W100 _(THAI) | | 140x17/140x17 | ● ○ ● |
| 01S0307 | W100/W125 | | 140x17/140x17 | ●/CUT ○/CUT |
| 01S0296 | W100/110S _(THAI) | | 140x17/140x17 | ●/CUT ○/CUT |
| 01S0297 | W100/110 | | 140x17/140x17 | ● ○ |
| 01S0300 | W125 _(THAI) | | 140x17/140x17 | ● ○ ● |
| 01S0301 | W125 _(THAI) | | 140x17/140x17 | ● ○ |
| 01S0185 | W125 | | 140x17/140x17 | ● ○ ● |
| 01S0302 | W125 II _(THAI) | | 140x17/140x17 | ● ○ ● |
| 01S0303 | W125 II _(THAI) | | 140x17/140x17 | ●/CUT ○/CUT |
| 01S0186 | W125 II | | 140x17/140x17 | ● ○ ● |
| 01S0248 | W125 | | 140x17/140x17 | ● |
| 01S0192 | W125 II | | 140x17/140x17 | ● ○ |
| 01S0383 | FUTURE FI | | 140x17/140x17 | ● ○ |
| 01S0383 | FUTURE FI | | 140x17/140x17 | ● ○ |
| 01S0298 | NOVA BEAT/DASH _(THAI) | | 140x17/140x17 | ● ○ |
| 01S0299 | SONIC/NOVA | | 140x17/140x17 | ●/CUT ○/CUT |
| 01S0308 | CLICK/SCOPPY _(THAI) | | 140x17/140x17 | ● ○ |
| 01S0309 | CLICK/SCOPPY _(THAI) | | 140x17/140x17 | ●/CUT ○/CUT |
| 01S0337 | CLICK | 140x17/160x17 | ●/CUT ○/CUT | |
| 01S0176 | KRISS I | MODENAS | 140x17/160x17 | ● ○ |
| 01S0177 | KRISS II | | 140x17/160x17 | ● ○ |



| CODE | MODEL | BRAND | SIZE FRONT/REAR | COLOUR |
|---------|-----------------------------------|--------|-----------------|-------------|
| 01S0181 | SPARK135/SRLZ | YAMAHA | 140x17/160x17 | ● ○ |
| 01S0324 | SPARK135/SRLZ | | 140x17/160x17 | ● ○ |
| 01S0325 | SPARK135/SRLZ | | 140x17/160x17 | ● ○ |
| 01S0447 | SPARK110 | | R: 140x17 | ● ○ |
| 01S0448 | SPARK110 | | R: 140x17 | ●/CUT ○/CUT |
| 01S0189 | Y100 | | 140x17/140x17 | ● ○ |
| 01S0322 | Y100 _(THAI) | | 140x17/140x17 | ● ○ |
| 01S0323 | Y100 _(THAI) | | 140x17/140x17 | ●/CUT ○/CUT |
| 01S0326 | Y100 _(THAI) | | 140x17/140x17 | ● ○ |
| 01S0327 | Y100 _(THAI) | | 140x17/140x17 | ● ○ |
| 01S0190 | Y110 | | 140x17/140x17 | ● ○ |
| 01S0191 | Y125Z | | 140x17/160x17 | ● ○ |
| 01S0316 | NOUVO ELEJANCET _(THAI) | | 140x17/140x17 | ● ○ |
| 01S0317 | NOUVO ELEJANCET _(THAI) | | 140x17/140x17 | ● ○ |
| 01S0330 | MIO | | 140x17/140x17 | ● ○ |
| 01S0340 | MIO | | 140x17/160x17 | ● ○ |
| 01S0341 | MIO | | 140x17/160x17 | ●/CUT ○/CUT |
| 01S0334 | MIO115 _(THAI) | | 140x17/140x17 | ● ○ |
| 01S0335 | MIO115 _(THAI) | | 140x17/140x17 | ●/CUT ○/CUT |
| 01S0421 | MIO115 | | 140x17/160x17 | ● ○ |
| 01S0422 | MIO115 | | 140x17/160x17 | ●/CUT ○/CUT |
| 01S0332 | MIO125 _(THAI) | | 140x17/140x17 | ● ○ |
| 01S0333 | MIO125 _(THAI) | | 140x17/140x17 | ●/CUT ○/CUT |
| 01S0342 | MIO125 | | 140x17/160x17 | ● ○ |
| 01S0343 | MIO125 | | 140x17/160x17 | ●/CUT ○/CUT |
| 01S0423 | EGO LC 125 | | 140x17/160x17 | ● ○ |
| 01S0424 | EGO LC 125 | | 140x17/160x17 | ● ○ |
| 01S0331 | EGO/LC135 | | 140x17/140x17 | ● ○ |
| 01S0352 | SPARK/NANO _(THAI) | | 140x17/160x17 | ● ○ |
| 01S0353 | SPARK/NANO | | 140x17/160x17 | ●/CUT ○/CUT |
| 01S0419 | SPARK135 | | R: 160x17 | ● ○ |
| 01S0420 | SPARK135 | | R: 160x17 | ●/CUT ○/CUT |
| 01S0178 | RC | SUZUKI | 140x17/140x17 | ● ○ |
| 01S0312 | RC _(THAI) | | 140x17/140x17 | ● ○ |
| 01S0313 | RC _(THAI) | | 140x17/140x17 | ● ○ |
| 01S0427 | RC/SMASH | | R: 140x17 | ● ○ |
| 01S0428 | RC/SMASH | | R: 140x17 | ●/CUT ○/CUT |
| 01S0179 | RG SPORT | | 140x17/140x17 | ● ○ |
| 01S0180 | SMASH PRO | | 140x17/160x17 | ● ○ |
| 01S0314 | SMASH _(THAI) | | 140x17/140x17 | ● ○ |
| 01S0315 | SMASH _(THAI) | | 140x17/140x17 | ●/CUT ○/CUT |
| 01S0318 | SMASH _(THAI) | | 140x17/140x17 | ● ○ |
| 01S0319 | NEW SMASH | | 140x17/140x17 | ●/CUT ○/CUT |
| 01S0182 | STEP 18T | | 140x17/140x17 | ● ○ |

SCAN HERE
FOR MORE INFORMATION



Precision machining from 6000 series aluminium alloy.

FG525



FULLY INTERGRATED HUB

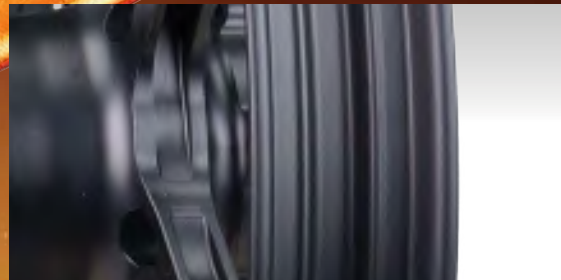

ANODISED ALUMINIUM PARTS

Corrosion and abrasion resistant

FORGED FOR TOUGHNESS

WHEELS & ACCESSORIES

FEATURES

The FG525 is designed for its structural strength with a reduced overall weight. 'Less weight' provides a quicker acceleration response while providing less strain on the suspension components. In extreme riding temperatures, the FG525 is designed to dissipate heat away from the braking system to ensure optimum breaking response.

Forged from 6000 series aluminium alloy, the FG525 is designed to adapt to any road conditions while maximizing your bike's looks and performance.



AVAILABLE COLOURS:

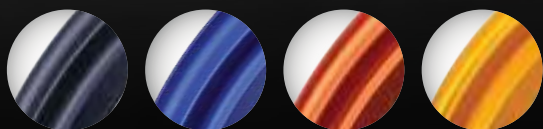

| CODE | MODEL | BRAND | SIZE | COLOUR |
|---------|----------|--------|---------------|---------------|
| 01FG006 | R25/R3 | YAMAHA | 275X17/400x17 | ○ ○ ● ● ● |
| 01FG009 | Y15ZR | | 185x17/250x17 | ○ ● ● ● ● |
| 01FG016 | | | 160X17/160X17 | ○ ● ● ● ● |
| 01FG011 | | | 185X17/250x17 | ○ ● ● ● ● |
| 01FG012 | | | 160X17/160X17 | ● ● ● ● ● |
| 01FG013 | LC5S | | 160X17/160X17 | ● ● ● ● ● |
| 01FG008 | | | 185x17/250x17 | ● ● ● ● ● |
| 01FG007 | NINJA250 | | KAWASAKI | 275X17/400x17 |
| 01FG019 | CBR250RR | HONDA | 275X17/400x17 | ○ ○ ● ● ● |

FG505

FORGED WHEELS

FEATURES

- 5-spoke design
- Fully-intergrated hub
- Forged from 6061-T6 aluminium alloy
- Lightweight to optimize fuel consumption

AVAILABLE COLOURS:



| CODE | MODEL | BRAND | SIZE FRONT/REAR | COLOUR |
|---------|-------|--------|-----------------|--------|
| 01FG001 | LC5S | YAMAHA | 185x17/250x17 | |

FG506

FORGED WHEELS

FEATURES

- Fully-intergrated hub
- Anodised finish to prevent corrosion
- Forged from 6061-T6 aluminium alloy
- Extremely light for its size

AVAILABLE COLOURS:



| CODE | MODEL | BRAND | SIZE FRONT/REAR | COLOUR |
|---------|-----------|----------|-----------------|--------|
| 01FG003 | R25 | YAMAHA | 300x17/500x17 | |
| 01FG005 | CBR 250 | HONDA | 300x17/500x17 | |
| 01FG004 | NINJA 250 | KAWASAKI | 300x17/500x17 | |
| 01FG010 | NMAX | YAMAHA | 325x13/375x13 | |

FG510

FORGED WHEELS

FEATURES

- Unique STAR-design
- Fully-intergrated hub
- Forged from 6061-T6 aluminium alloy
- Advanced CNC machining resulting in weight saving and added rigidness
- Reduced rotational mass, that increases acceleration

AVAILABLE COLOURS:



| CODE | MODEL | BRAND | SIZE FRONT/REAR | COLOUR |
|---------|-------|--------|-----------------|---|
| 01FG002 | LC5S | YAMAHA | 185x17/250x17 |      |

FG511

FORGED WHEELS

FEATURES

- 5-spoke design
- Aluminium Alloy
- Durable & high-end finish
- Extremely light for its size

AVAILABLE COLOURS:



| CODE | MODEL | BRAND | SIZE FRONT/REAR | COLOUR |
|---------|-------|--------|-----------------|---|
| 01FG014 | LC5S | YAMAHA | 160x17/185x17 |     |



X *SERIES* **TUBELESS** **ALLOY RIM**



CROSSHATCH DESIGN

Improve the shock resistant.
Supported by two spokes instead of one.

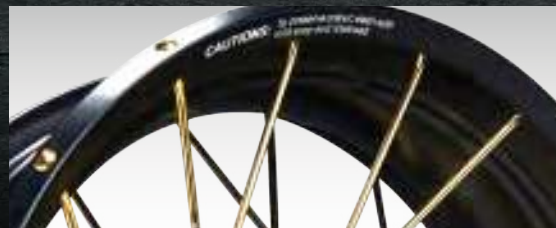

TWIN SPOKE DESIGN

Rim has better alignment, wider and stronger grip.



MADE OF 7000 SERIES ALLUMINIUM ALLOY-T6

Improve strength and durability of the rim



ADJUSTABLE

Adjustable spoke to adapt road conditions

CLASSIC DESIGN WITH A MODERN TWIST

WHEELS & ACCESSORIES



AVAILABLE COLOURS:



| CODE | MODEL | BRAND | SIZE | COLOUR |
|---------|----------------|--------|---------------|--|
| 01RX001 | Y15ZR | YAMAHA | 160x17/160x17 | <input type="radio"/> <input type="radio"/> <input checked="" type="radio"/> |
| 01RX002 | LC5S | | 160x17/160x17 | <input type="radio"/> <input type="radio"/> <input checked="" type="radio"/> |
| 01RX003 | Y15ZR (S/RACE) | | 160x17/160x17 | <input type="radio"/> <input type="radio"/> <input checked="" type="radio"/> |
| 01RX004 | NMAX(2016) | HONDA | 250x13/350x13 | <input type="radio"/> <input checked="" type="radio"/> |
| 01RX005 | ADV150 | | 250x14/350x13 | <input type="radio"/> <input checked="" type="radio"/> |
| 01RX006 | NMAX(2020) | | 250x13/350x13 | <input type="radio"/> <input checked="" type="radio"/> |

ALLOY RIMS

FEATURES

- Greater performance and stability
- High strength and extreme flexibility
- Made from 7000 series aluminium alloy
- Available in various sizes and diameters to fit your needs
- Anodised finish to prevent corrosion and abrasion



AVAILABLE COLOURS:

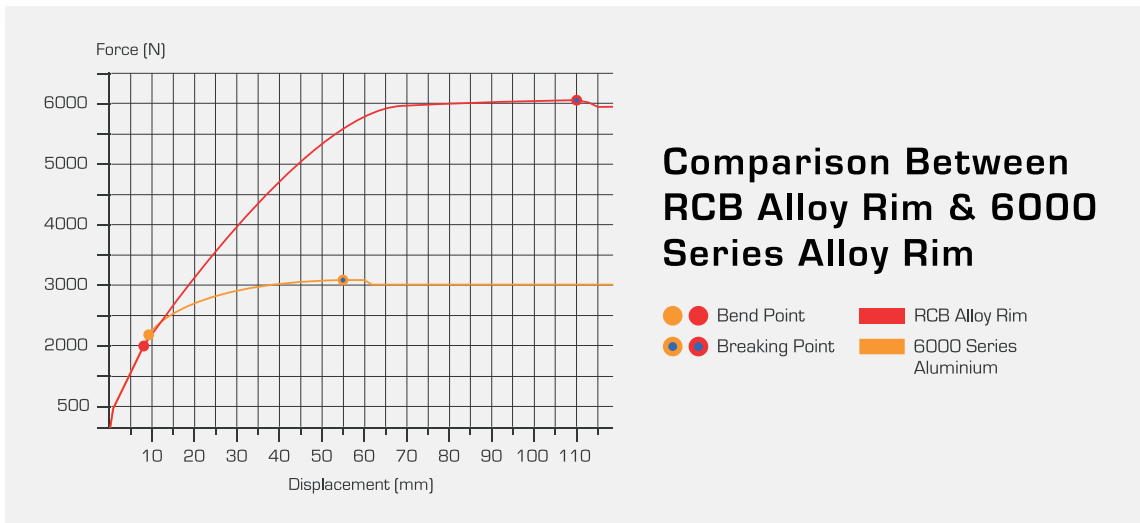
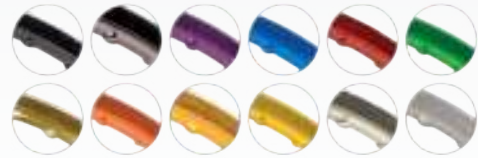

| 28H SERIES | | |
|------------------------------|-----------------|--------|
| CODE | SIZE FRONT/REAR | COLOUR |
| 01R0019 | 185 x 16 | ● ● ● |
| 01R0020 | 300 x 17 | ● ● ● |
| 01R0021 | 350 x 17 | ● ● ● |
| 01R0022 | 160 x 19 | ● ● ● |
| 28H 7075 - RACING USE SERIES | | |
| CODE | SIZE FRONT/REAR | COLOUR |
| 01R0078 | 185 x 16 | ● ● ● |
| 01R0079 | 215 x 18 | ● ● ● |
| 01R0080 | 100 x 19 | ● ● ● |
| 01R0081 | 160 x 21 | ● ● ● |



| 36H | | | | | | | | | | |
|---------|-----------------|--------|---|---|---|---|---|---|---|---|
| CODE | SIZE FRONT/REAR | COLOUR | | | | | | | | |
| 01R0048 | 250x12 | ● | | | | | ● | ● | ● | |
| 01R0037 | 185x14 | ● | | | | | | ● | ● | |
| 01R0038 | 215x14 | ● | | | | | | ● | ● | |
| 01R0023 | 140x16 | ● | ● | | | | | ● | ● | |
| 01R0024 | 160x16 | ● | ● | | | | | ● | ● | |
| 01R0039 | 185x16 | ● | | | | | | ● | ● | |
| 01R0025 | 120x17 | ● | ● | ● | ● | ● | ● | ● | ● | ● |
| 01R0026 | 140x17 | ● | ● | | ● | ● | ● | ● | ● | ● |
| 01R0027 | 160x17 | ● | ● | | ● | ● | ● | ● | ● | ● |
| 01R0028 | 185x17 | ● | ● | | ● | ● | ● | ● | ● | ● |
| 01R0029 | 215x17 | ● | ● | ● | ● | ● | ● | ● | ● | ● |
| 01R0030 | 250x17 | ● | ● | | ● | ● | ● | ● | ● | ● |
| 01R0042 | 300x17 | ● | | | ● | ● | ● | ● | ● | ● |
| 01R0043 | 350x17 | ● | | | ● | ● | ● | ● | ● | ● |
| 01R0045 | 425x17 | ● | | | | ● | ● | ● | ● | ● |
| 01R0047 | 450x17 | ● | | | | ● | ● | ● | ● | ● |
| 01R0046 | 500x17 | ● | | | | ● | ● | ● | ● | ● |
| 01R0031 | 140x18 | ● | ● | ● | ● | ● | ● | ● | ● | ● |
| 01R0032 | 160x18 | ● | ● | ● | ● | ● | ● | ● | ● | ● |
| 01R0033 | 185x18 | ● | ● | ● | ● | ● | ● | ● | ● | ● |
| 01R0034 | 215x18 | ● | ● | ● | ● | ● | ● | ● | ● | ● |
| 01R0035 | 250x18 | ● | | | | | | ● | ● | |
| 01R0044 | 160x19 | ● | | | | | | ● | ● | |
| 01R0040 | 185x19 | ● | | | | | | ● | ● | |
| 01R0036 | 160x21 | ● | | | | ● | | ● | ● | |
| 01R0041 | 185x21 | ● | | | | | | ● | ● | |
| 01R0095 | 250x17 | | | | | | | | | ● |
| 01R0098 | 425x17 | | | | | | | | | ● |
| 01R0112 | 140 x 17 | | | | | | | ● | | |
| 01R0113 | 160 x 17 | | | | | | | ● | | |
| 01R0114 | 185 x 17 | | | | | | | ● | | |
| 01R0114 | 185 x 17 | | | | | | | ● | | |
| 01R0115 | 140 x 18 | | | | | | | ● | | |
| 01R0116 | 160 x 18 | | | | | | | ● | | |
| 01R0117 | 185 x 18 | | | | | | | ● | | |

SPOKES

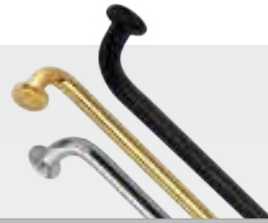

| CHROME SPOKES | | | | |
|-------------------|----------------|---------|------------|-----------------|
| CODE | MODEL | BRAND | TYPE | SIZE FRONT/REAR |
| 01SS125Z | - | - | - | 129x9 |
| 01SS126Z | - | - | - | 130x9 |
| 01SS127Z | - | - | - | 140x9 |
| 01SS128Z | - | - | - | 143x9 |
| 01SS129Z | - | - | - | 149x9 |
| 01SS130Z | - | - | - | 150x9 |
| 01SS131Z | - | - | - | 151x9 |
| 01SS132Z | - | - | - | 153x9 |
| 01SS133Z | - | - | - | 154x9 |
| 01SS134Z | - | - | - | 155x9 |
| 01SS135Z | - | - | - | 157x9 |
| 01SS136Z | - | - | - | 159x9 |
| 01SS137Z | - | - | - | 161x9 |
| 01SS138Z | - | - | - | 163x9 |
| 01SS139Z | - | - | - | 164x9 |
| 01SS140Z | - | - | - | 168x9 |
| 01SS141Z | - | - | - | 172x9 |
| 01SS142Z | - | - | - | 180x9 |
| 01SS143Z | - | - | - | 182x9 |
| 01SS144Z | - | - | - | 184x9 |
| GOLD SPOKES | | | | |
| CODE | MODEL | BRAND | TYPE | SIZE FRONT/REAR |
| 01S029Z | EGO/NOUVO | YAMAHA | REAR | 120x9 |
| 01SS030Z | - | - | - | 140x9 |
| 01SS031Z | - | - | - | 143x9 |
| 01SS032Z | - | - | - | 149x9 |
| 01SS033Z | - | - | - | 150x9 |
| 01SS034Z | SRL/LC | YAMAHA | REAR | 155x9 |
| 01SS035Z | Y100/Y110 | YAMAHA | REAR/FRONT | 157x9 |
| 01SS036Z | KRISS1 | MODENAS | - | 161x9 |
| 01SS037Z | RXZ | YAMAHA | REAR | 163x9 |
| 01SS038Z | - | - | - | 168x9 |
| 01SS039Z | Y125Z | YAMAHA | FRONT | 172x9 |
| 01SS040Z | RXZ | YAMAHA | FRONT | 180x9 |
| 01SS052Z | - | - | - | 181x9 |
| 01SS041Z | - | - | - | 182x9 |
| 01SS042Z | EGO/NOUVO/Y110 | YAMAHA | FRONT | 184x9 |
| 01SS051Z | - | - | - | 193x9 |
| BLACK/GOLD SPOKES | | | | |
| CODE | MODEL | BRAND | TYPE | SIZE FRONT/REAR |
| 01SS001Z | EGO/NOUVO | YAMAHA | REAR | 120x9 |
| 01SS002Z | - | - | - | 140x9 |
| 01SS003Z | - | - | - | 143x9 |
| 01SS004Z | - | - | - | 149x9 |
| 01SS005Z | - | - | - | 150x9 |
| 01SS006Z | SRL/LC | YAMAHA | REAR | 155x9 |
| 01SS007Z | Y100/Y110 | YAMAHA | REAR/FRONT | 157x9 |
| 01SS008Z | KRISS1 | MODENAS | - | 161x9 |
| 01SS009Z | RXZ | YAMAHA | REAR | 163x9 |
| 01SS010Z | - | - | - | 168x9 |
| 01SS011Z | Y125Z | YAMAHA | FRONT | 172x9 |
| 01SS012Z | RXZ | YAMAHA | FRONT | 180x9 |
| 01SS013Z | - | - | - | 182x9 |
| 01SS014Z | EGO/NOUVO/Y110 | YAMAHA | FRONT | 184x9 |

WHEELS ACCESSORIES











AIR VALVE STEMS

FEATURES

- CNC machined aluminium alloy
- Anodised finish to prevent corrosion

AVAILABLE
COLOURS:



| CODE | SIZE | COLOUR | | | | | |
|---------|------|---|---|---|---|---|---|
| 01A0131 | 8MM |  |  |  |  |  |  |
| 01A0130 | 10MM |  |  |  |  |  |  |

WHEELS & ACCESSORIES

WHEELS ACCESSORIES

S SERIES RIM STICKER

FEATURES

- Weatherproof
- Various colours to suit your personality
- Simple installation

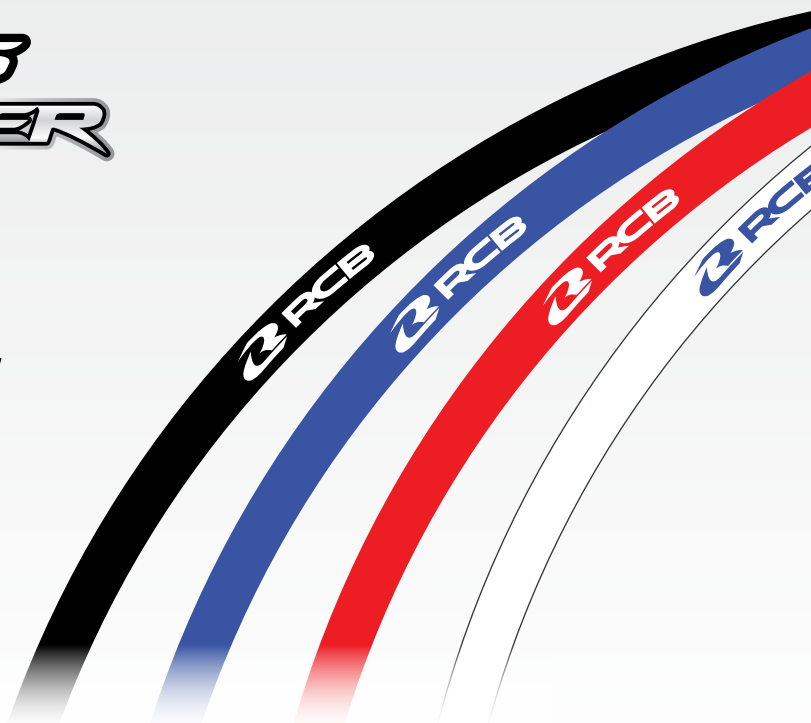

| CODE | SIZE | COLOUR | | | |
|---------|--------|---|---|---|---|
| 01RS001 | 17INCH |  |  |  |  |

FRONT WHEEL BUSH

FEATURES

- CNC machined aluminium alloy
- Increase material fatigue resistance

AVAILABLE COLOURS:



| CODE | MODEL | BRAND | COLOUR | | | | | |
|---------|-------|--------|--------|--|--|--|--|--|
| 01HS002 | Y15ZR | YAMAHA | | | | | | |

HUB SPROCKET

FEATURES

- CNC machined aluminium alloy
- Built for toughness & strength

AVAILABLE COLOURS:



| CODE | MODEL | BRAND | COLOUR | | | | | |
|---------|-------|--------|--------|--|--|--|--|--|
| 01HS001 | Y15ZR | YAMAHA | | | | | | |

SUSPENSION

DUAL SUSPENSION

MONO SUSPENSION

FRONT FORK

DAMPER

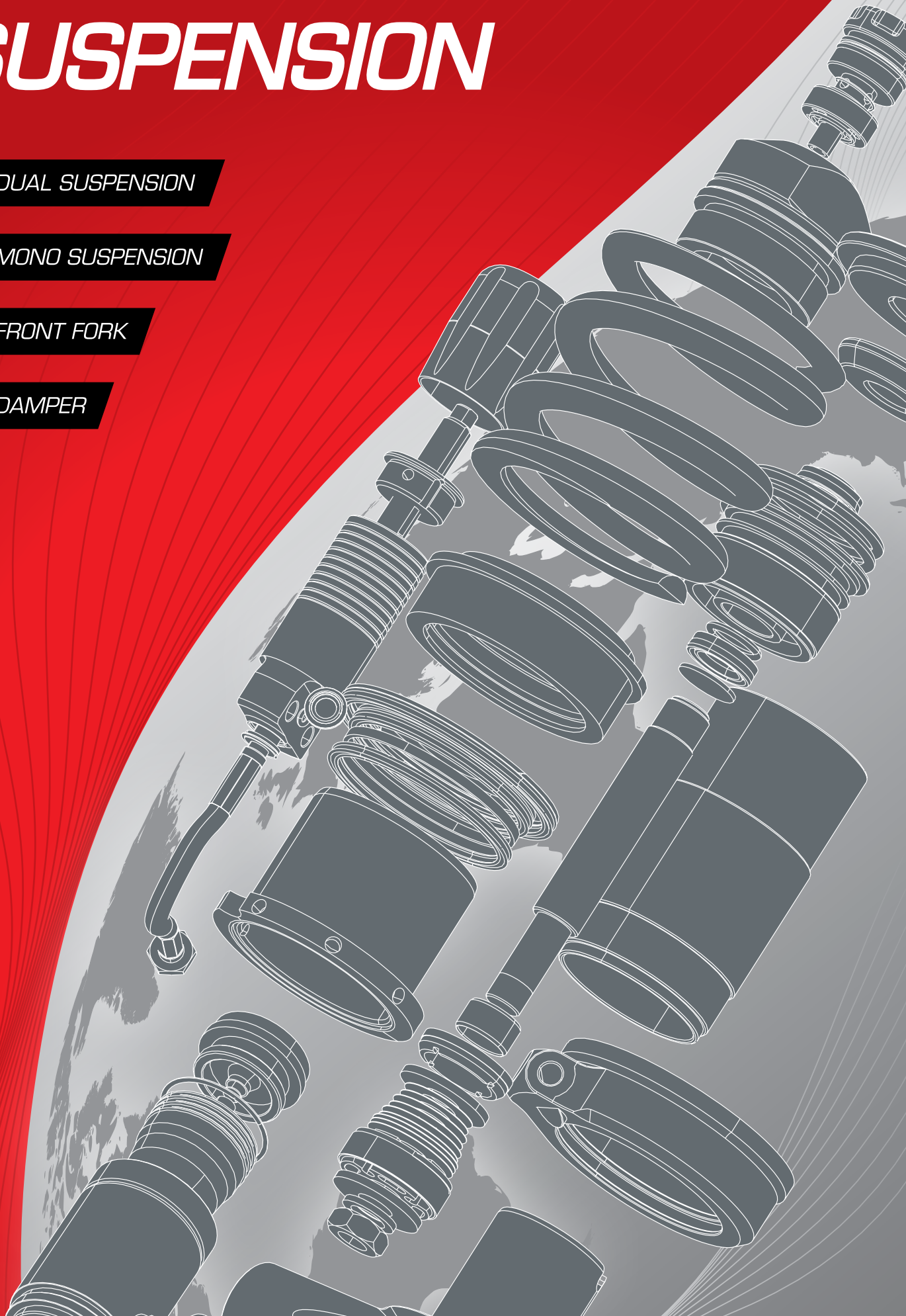

VFR *SERIES* Racing Spec

SCAN HERE
FOR MORE INFORMATION



OFFICIAL TECHNICAL PARTNER FOR:



BUILT FOR RACING

FEATURES



Race Ready



Piston Rod Diameter 14mm



High Pressure Nitrogen Gas Type



Forged Alloy Top Mount



1x Set Extra Springs (Softer)



Big Damper Piston Diameter 35mm



Adjustable Spring Preload



Adjustable Rebound Damping



Adjustable Compression



Forged Alloy Top Mount

Made of forged aluminium alloy to improve strength & provide better resistance to material fatigue from daily use



Compression Adjuster

Compression damping controls the energy absorption when the shock absorber is being compressed



External Reservoir Tank

External gas reservoir (Piggyback type)



Rebound Adjuster

Controls the energy absorption of the shock absorber is being extended

Controls how fast the shock absorbers return to its normal position after being compressed



| CODE | MODEL | BRAND | SIZE | COLOUR |
|---------|-----------|-----------|-------|---|
| 01A0235 | UNIVERSAL | UNIVERSAL | 275MM |  |
| 01A0236 | | | 335MM |  |
| 01A0255 | NVX155 | YAMAHA | 290MM |  |
| 01A0256 | XMAX | | 350MM |  |

V-D SERIES

AVAILABLE
COLOURS:



PREMIUM EDITION



FEATURES



Big Damper Piston Diameter
35mm



Piston Rod Diameter
14mm



N⁷ High Pressure Nitrogen Gas Type



Forged Alloy Top Mount



Adjustable Spring Preload



Adjustable Rebound Damping



1x Set Extra Spring (Softer)



Adjustable Compression



Forged Alloy Top Mount

Made of forged aluminium alloy to improve strength & provide better resistance to material fatigue from daily use



External Reservoir Tank

External gas reservoir (Piggyback type)



Rebound Adjuster

- ▾ Controls the energy absorption of the shock absorber is being extended
- ▾ Controls how fast the shock absorbers return to its normal position after being compressed

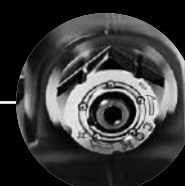

Compression Adjuster

Compression damping controls the energy absorption when the shock absorber is being compress



| CODE | MODEL | BRAND | SIZE | COLOUR |
|---------|-------------------|---------------|-------|--------|
| 01A0159 | UNIVERSAL | YAMAHA | 275MM | |
| 01A0163 | NMAX | | 330MM | |
| 01A0164 | NVX155/NMAX[N] | | 305MM | |
| 01A0165 | XMAX | | 350MM | |
| 01A0160 | UNIVERSAL | HONDA | 335MM | |
| 01A0161 | SH150i | | 380MM | |
| 01A0162 | AIRBLADE | | 320MM | |
| 01A0192 | ADV150 | | 395MM | |
| 01M0176 | CLICK125i | | 330MM | |
| 01A0201 | FORZA | | 430MM | |
| 01M0209 | VARIO160 | | 340MM | |
| 01A0200 | ADIVA | ADIVA | 405MM | |
| 01A0237 | CLASSIC 500(2021) | ROYAL ENFIELD | 315MM | |
| 01A0253 | SR GT200 | APRILIA | 370MM | |

V-S

SERIES

SUSPENSION

FEATURES



Big Damper
Piston
Diameter
35MM



Piston Rod
Diameter
14mm



High Pressure
Nitrogen
Gas Type



Adjustable
Spring
Preload



Adjustable
Rebound
Damping



1x Set Extra
Springs
(Softer)



Forged Alloy
Top Mount

AVAILABLE COLOURS:



| CODE | MODEL | BRAND | SIZE | COLOUR |
|---------|------------|--------|-------|--------|
| 01A0151 | UNIVERSAL | YAMAHA | 275MM | ●●●●● |
| 01A0156 | NMAX | | 330MM | ●●●●● |
| 01A0157 | NVX155 | | 305MM | ●●●●● |
| 01A0254 | | | 275MM | ●●●●● |
| 01A0195 | XMAX | | 350MM | ●●●●● |
| 01M0156 | EGOS | | 295MM | ●●●●● |
| 01M0157 | | | 305MM | ●●●●● |
| 01A0152 | UNIVERSAL | HONDA | 335MM | ●●●●● |
| 01A0153 | SH150i | | 380MM | ●●●●● |
| 01A0154 | AIRBLADE | | 320MM | ●●●●● |
| 01A0193 | ADV150 | | 395MM | ●●●●● |
| 01A0155 | TIGER | | 320MM | ●●●●● |
| 01M0158 | CLICK 125i | | 330MM | ●●●●● |
| 01A0203 | FORZA | | 300MM | ●●●●● |
| 01A0202 | ADIVA | ADIVA | 405MM | ●●●●● |

V-E SERIES

SUSPENSION

FEATURES



Big Damper
Piston
Diameter
35mm



Piston Rod
Diameter
14mm



N⁷ High Pressure
Nitrogen
Gas Type



Adjustable
Spring
Preload



1x Set Extra
Springs
(Softer)



A Forged Alloy
Top Mount

AVAILABLE COLOURS:



| CODE | MODEL | BRAND | SIZE | COLOUR |
|---------|----------------|--------|-------|--------|
| 01A0166 | UNIVERSAL | YAMAHA | 275MM | |
| 01A0170 | NMAX | | 330MM | |
| 01A0171 | NVX155/NMAX(N) | | 305MM | |
| 01A0196 | XMAX | | 350MM | |
| 01A0159 | EGOS | | 295MM | |
| 01M0160 | | | 305MM | |
| 01A0167 | UNIVERSAL | HONDA | 335MM | |
| 01A0168 | SH150i | | 380MM | |
| 01A0169 | AIRBLADE | | 320MM | |
| 01A0194 | ADV150 | | 395MM | |
| 01M0161 | CLICK125 | | 330MM | |
| 01A0205 | FORZA | | 430MM | |
| 01A0204 | ADIVA | ADIVA | 405MM | |

MB-2 PLUS

SUSPENSION SERIES

FEATURES



Adjustable Rebound Damping (Soft & Hard Adjustable)



Big Damper Piston Diameter 30mm



Piston Rod Diameter 12.5mm



Adjustable Spring Preload



External Reservoir Piggyback Tank



16 Steps Rebound Adjustable Level

AVAILABLE COLOURS:



| CODE | MODEL | BRAND | SIZE | COLOUR |
|---------|----------------|--------|-------|--------|
| 01M0200 | EGOS | YAMAHA | 295MM | |
| 01M0201 | EGOS | | 305MM | |
| 01A0241 | SRL | | 275MM | |
| 01A0243 | RX-KING | | 320MM | |
| 01A0246 | NVX155/NMAX(N) | | 305MM | |
| 01A0247 | NMAX | | 330MM | |
| 01M0202 | CLICK125i | HONDA | 330MM | |
| 01M0203 | SCOOPY | | 310MM | |
| 01M0208 | VARIO160 | | 340MM | |
| 01A0242 | WAVE | | 335MM | |
| 01A0244 | SH150i | | 380MM | |
| 01A0245 | AIRBLADE | | 320MM | |
| 01A0248 | TIGER | | 320MM | |

MB-2 SERIES

SUSPENSION

FEATURES



Big Damper
Piston
Diameter
30mm



Piston Rod
Diameter
12.5MM



Adjustable
Spring
Preload

AVAILABLE COLOURS:



SUSPENSION

| CODE | MODEL | BRAND | SIZE | COLOUR |
|---------|----------------|--------|-------|--------|
| 01A0176 | UNIVERSAL | YAMAHA | 275MM | |
| 01A0180 | NVX155/NMAX(N) | | 305MM | |
| 01A0181 | NMAX | | 330MM | |
| 01M0167 | EGOS | | 295MM | |
| 01M0168 | | | 305MM | |
| 01A0177 | UNIVERSAL | HONDA | 335MM | |
| 01A0178 | SH150i | | 380MM | |
| 01A0182 | TIGER | | 320MM | |
| 01A0179 | AIRBLADE | | 320MM | |
| 01A0169 | CLICK125 | | 330MM | |
| 01M0207 | VARIO160 | | 340MM | |
| | | | | |

S SERIES

SUSPENSION

FEATURES



Big Damper
Piston
Diameter
30mm



Piston Rod
Diameter
12.5mm



Adjustable
Spring
Preload



Adjustable
Rebound
Damping



Alloy
Adjusting
Ring Nut

AVAILABLE
COLOURS:



| CODE | MODEL | BRAND | SIZE | COLOUR |
|---------|----------------|--------|-------|-------------|
| 01A0064 | UNIVERSAL | YAMAHA | 275MM | ● ● ● ● ● ○ |
| 01A0122 | NVX155/NMAX(N) | | 305MM | ● ● ● ● ● ○ |
| 01M0076 | EGOS | HONDA | 295MM | ● ● ● ● ● ○ |
| 01A0065 | UNIVERSAL | | 335MM | ● ● ● ● ● ○ |
| 01A0057 | SH150 | | 380MM | ● ● ● ● ● ○ |

SERIES

SUSPENSION

FEATURES



Big Damper
Piston
Diameter
30mm



Piston Rod
Diameter
12.5mm



Adjustable
Spring
Preload



Alloy
Adjusting
Ring Nut

AVAILABLE COLOURS:



| CODE | MODEL | BRAND | SIZE | COLOUR |
|---------|-----------|--------|-------|--|
| 01A0088 | UNIVERSAL | YAMAHA | 275MM | <input checked="" type="radio"/> <input checked="" type="radio"/> <input checked="" type="radio"/> <input checked="" type="radio"/> <input checked="" type="radio"/> <input type="radio"/> |
| 01M0099 | EGOS | | 295MM | <input checked="" type="radio"/> <input type="radio"/> <input checked="" type="radio"/> <input checked="" type="radio"/> <input checked="" type="radio"/> <input type="radio"/> |
| 01A0087 | UNIVERSAL | | 335MM | <input checked="" type="radio"/> <input checked="" type="radio"/> <input checked="" type="radio"/> <input checked="" type="radio"/> <input checked="" type="radio"/> <input type="radio"/> |
| 01A0095 | AIRBLADE | HONDA | 320MM | <input type="radio"/> <input type="radio"/> <input checked="" type="radio"/> <input checked="" type="radio"/> <input checked="" type="radio"/> <input type="radio"/> |
| 01M0100 | CLICK125i | | 330MM | <input type="radio"/> <input type="radio"/> <input checked="" type="radio"/> <input checked="" type="radio"/> <input checked="" type="radio"/> <input type="radio"/> |
| 01A0148 | UNIVERSAL | | 335MM | <input checked="" type="radio"/> <input type="radio"/> <input checked="" type="radio"/> <input type="radio"/> <input checked="" type="radio"/> <input type="radio"/> |

A2 SERIES

SUSPENSION

FEATURES



Big Damper
Piston
Diameter
20mm



Piston Rod
Diameter
10mm



Adjustable
Spring
Preload

AVAILABLE COLOURS:



| CODE | MODEL | BRAND | SIZE | BODY COLOUR | SPRING COLOUR |
|---------|-----------------|---------|-------|-------------|---------------|
| 01M0170 | EGOS | YAMAHA | 295MM | ● | ● ○ ● ● ● |
| 01M0171 | | | 305MM | ● | ● ○ ● ● ● |
| 01M0163 | | | 295MM | ● | ● ○ ● ● ● |
| 01M0164 | | | 305MM | ● | ● ○ ● ● ● |
| 01M0165 | CLICK125I | HONDA | 330MM | ● | ● ○ ● ● ● |
| 01M0162 | VARIO/CLICK125I | | 330MM | ● | ● ○ ● ● ● |
| 01A0185 | UNIVERSAL | YAMAHA | 335MM | ● | ● ○ ● ● ● |
| 01A0184 | | | 275MM | ● | ● ○ ● ● ● |
| 01A0173 | | | 275MM | ● | ● ● ● |
| 01A0174 | | | HONDA | 335MM | ● |
| 01A0175 | KRISS | MODENAS | 310MM | ● | ● ● ● |
| 01A0186 | | | 310MM | ● | ● ○ ● ● ● |
| 01A0198 | NOUVO LC | YAMAHA | 295MM | ● | ● ○ ● ● ● |

A2 SERIES

- Adjustable spring preload
- 20mm damper piston
- 10mm piston rod diameter

SUSPENSION

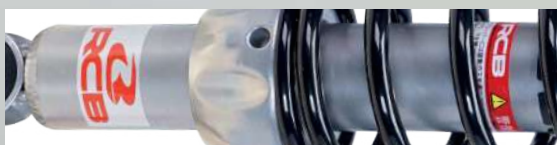

| CODE | MODEL | BRAND | SIZE | BODY COLOUR | SPRING COLOUR |
|---------|--------|--------|-------|-------------|---------------|
| 01M0199 | SCOOPY | HONDA | 310MM | ● | ● |
| 01A0183 | TIGER | HONDA | 320MM | ● | ● ● ● ● ● |
| 01A0238 | NMAX | YAMAHA | 305MM | ● | ● ● ● |

SCAN HERE
FOR MORE INFORMATION



SS Line

ACCESS YOUR BIKE WITH
RCB SS SETUP APPS



FEATURES



Big Damper Piston Diameter 35mm



High Pressure Nitrogen Gas Type



Full Alloy Body



Hardened Piston Rod Gold Finish Diameter 16mm



Adjustable Hydraulic Spring Preload



Adjustable Rebound Damping



Electronic Adjustment



Adjustable Compression



Hydraulics Spring Preload Adjuster

Quick & easy preload spring adjustments for 'on-the-fly' riding conditions/bike loads

Hardened Piston Rod

Heat treated piston rod with gold finish

CNC Machining Process

CNC machining process improves design accuracy and reliability

Electronic Adjustment

Adjust the rebound & compression through, *RCB Electronic Suspension Adjustment App (SS Setup)*. It's that simple!

External Reservoir Tank

| CODE | MODEL | BRAND | SIZE | COLOUR |
|---------|--------|--------|-------|--------|
| 01M0173 | Y15ZR | YAMAHA | 208MM | |
| 01M0197 | RS150R | HONDA | 229MM | |



DD *Line*

FEATURES



Big Damper
Piston
Diameter
35mm



High Pressure
Nitrogen
Gas Type



Full Alloy
Body



Hardened Piston Rod
Gold Finish
Diameter 16mm



Adjustable
Hydraulic
Spring
Preload



Adjustable
Rebound
Damping



Adjustable
Compression

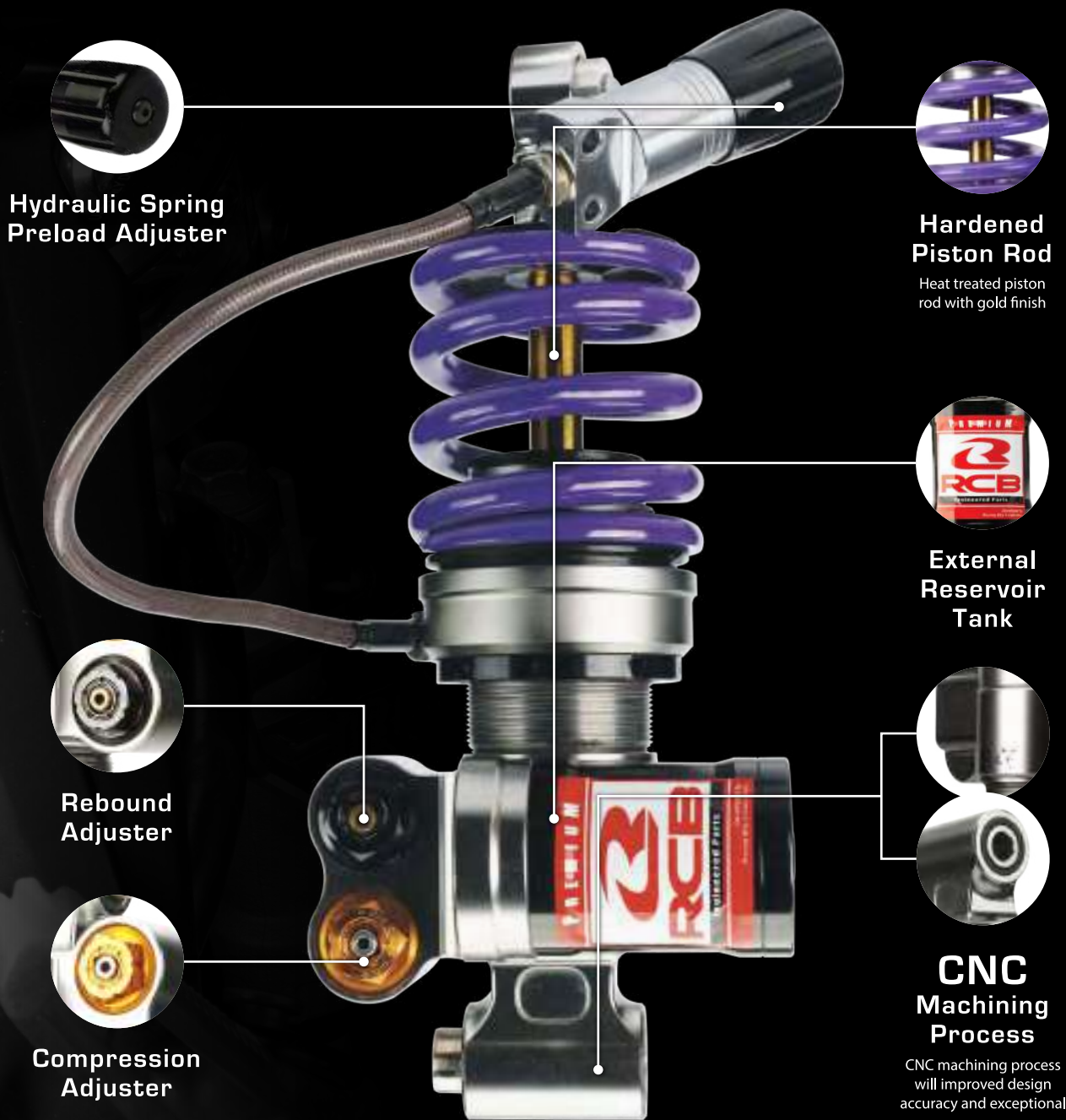

Hydraulic Spring
Preload Adjuster

Hardened
Piston Rod

Heat treated piston
rod with gold finish

External
Reservoir
Tank

Rebound
Adjuster

Compression
Adjuster

CNC
Machining
Process

CNC machining process
will improved design
accuracy and exceptional

| CODE | MODEL | BRAND | SIZE | COLOUR |
|---------|-------|--------|-------|---|
| 01M0166 | R25 | YAMAHA | 280MM |  |

DB-2 PLUS

RACE KIT

SCAN HERE
FOR MORE INFORMATION



PREMIUM EDITION



FEATURES



Big Damper Piston Diameter 35/46mm



High Pressure Nitrogen Gas Type



Forged Alloy Top Mount



Hardened Piston Rod Gold Finish Diameter 16mm



Adjustable Spring Preload



Adjustable Rebound Damping



Adjustable Compression



1x Set Extra Spring (Softer)



Rotatable Hose

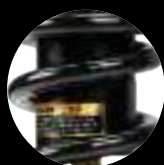

CNC Machining Process

CNC machining process improves design accuracy and reliability



Hardened Piston Rod

Heat treated piston rod with gold finish



Absorber Body

360° Rotatable Hose

Easy installation and arrangement

Forged Aluminium Alloy

Made of forged aluminium alloy to improved strength & provide better resistance to material fatigue from daily use

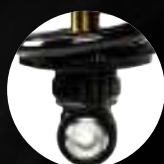

Gas Tank

360° Rotatable Hose

Easy installation and arrangement

| CODE | MODEL | BRAND | SIZE | COLOUR |
|---------|-------------------|----------|-------|--------|
| 01M0123 | FZ150i/R15/M-SLAZ | YAMAHA | 265MM | |
| 01M0135 | LC135 | | 203MM | |
| 01M0136 | Y15ZR | | 208MM | |
| 01M0137 | RS150R/SCNIC150 | HONDA | 229MM | |
| 01M0134 | BELANG | SUZUKI | 285MM | |
| 01M0138 | GSX150 | KAWASAKI | 280MM | |
| 01M0133 | KLX150 | | 405MM | |

DB-2 Line V2

SUSPENSION

FEATURES



Big Damper
Piston
Diameter
35/46MM



High Pressure
Nitrogen
Gas Type



Piston Rod
Diameter
16MM



Adjustable
Spring
Preload



Adjustable
Rebound
Damping



Adjustable
Compression



Full Alloy
Body



| CODE | MODEL | BRAND | SIZE | COLOUR |
|---------|-----------------------|----------|-------|--------|
| 01M0177 | Y15ZR | YAMAHA | 208MM | ● ● |
| 01M0178 | LC135 | | 203MM | ● ● |
| 01M0183 | FZ150i/R15/ M-SLAZ | | 285MM | ● ● |
| 01M0180 | RS150R | HONDA | 220MM | ● ● |
| 01M0179 | | | 229MM | ● ● |
| 01M0182 | BELANG | SUZUKI | 285MM | ● ● |
| 01M0181 | GSX150 | | 280MM | ● ● |
| 01M0184 | KLX150 | KAWASAKI | 405MM | ● ● |
| 01M0185 | KRR | | 260MM | ● ● |
| 01M0196 | VF185 | SYM | 213MM | ● ● |

S-2 Line

SUSPENSION

FEATURES



Big Damper
Piston
Diameter
30/46mm



Piston Rod
Diameter
16mm



Adjustable
Spring
Preload



Adjustable
Rebound
Damping



Full Alloy
Body

AVAILABLE
COLOURS:



| CODE | MODEL | BRAND | SIZE | COLOUR |
|---------|-----------------------|----------|-------|-----------|
| 01M0110 | Y15ZR | YAMAHA | 208MM | ● ○ ● ● ● |
| 01M0111 | LC135 | | 203MM | ● ○ ● ● ● |
| 01M0129 | FZ150i/R15/ M-SLAZ | | 263MM | ● ○ ● ● ● |
| 01M0132 | R25 | | 275MM | ● ● ● ● |
| 01M0114 | RS150R | HONDA | 229MM | ● ○ ● ● ● |
| 01M0186 | RS150 | | 225MM | ● ○ ● ● ● |
| 01M0128 | KLX150 | KAWASAKI | 405MM | ● ○ ● ● ● |
| 01M0130 | BELANG | SUZUKI | 285MM | ● ○ ● ● ● |
| 01M0195 | VF185 | SYM | 213MM | ● ○ ● ● ● |

M-2 PLUS Line

SUSPENSION

FEATURES



Big Damper
Piston
Diameter
35/46mm



Piston Rod
Diameter
12.5mm



Adjustable
Spring
Preload



15 Steps
Rebound
Adjustable
Level



A Alloy
Adjusting
Ring Nut

AVAILABLE COLOURS:



| CODE | MODEL | BRAND | SIZE | COLOUR |
|---------|--------|--------|-------|--------|
| 01M0204 | LC135 | YAMAHA | 203MM | ● ● |
| 01M0205 | Y15ZR | | 208MM | ● ● |
| 01M0206 | RS150R | HONDA | 229MM | ● ● |

M-2 Line

SUSPENSION

FEATURES



Big Damper
Piston
Diameter
35/46mm



Piston Rod
Diameter
12.5mm



Adjustable
Spring
Preload



Alloy
Adjusting
Ring Nut

AVAILABLE
COLOURS:



| CODE | MODEL | BRAND | SIZE | COLOUR |
|---------|--------|--------|-------|---|
| 01M0152 | LC135 | YAMAHA | 203MM |   |
| 01M0153 | Y15ZR | | 208MM |   |
| 01M0155 | RS150R | HONDA | 225MM |   |
| 01M0194 | VF185 | | 213MM |   |

FF *SERIES*

SCAN HERE
FOR MORE INFORMATION



PREMIUM EDITION NEW

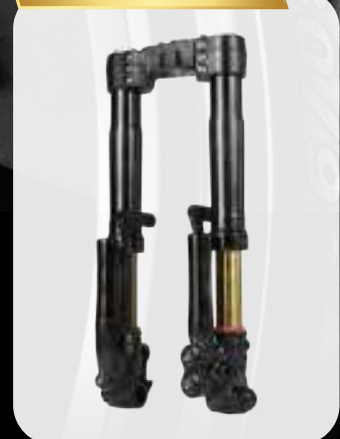

FEATURES



Big Damper
Piston
Diameter
20mm



Piston Rod
Diameter
35mm



High Pressure
Nitrogen
Gas Type



Full Alloy
Body



Adjustable
Spring
Preload



Adjustable
Rebound
Damping



Adjustable
Compression



Spring
Preload
Adjuster

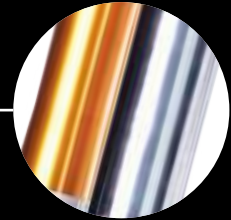

External
Reservoir
Tank



Rebound
Adjuster



Forged Alloy
Fork Bottom

Made of forged aluminium alloy to improved strength & provide better resistance to material fatigue from daily use



Compression
Adjuster

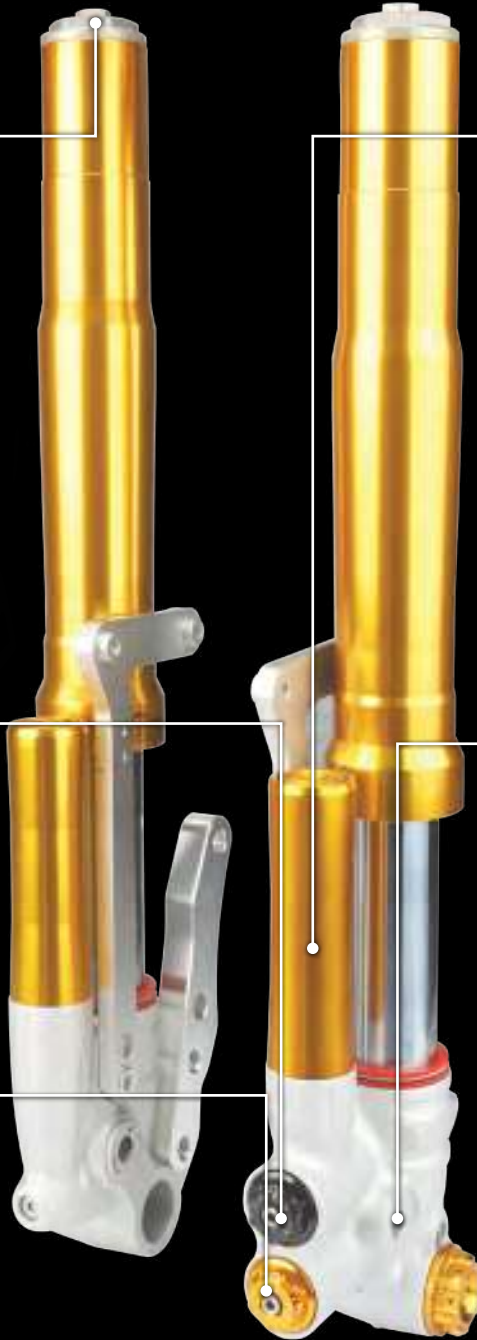

Exclusive For: 

| CODE | MODEL | BRAND | COLOUR |
|---------|-------|--------|---|
| 01A0189 | Y15ZR | YAMAHA |   |

FE SERIES FRONT FORK



FEATURES

- Performance damping force increase 20%
- Higher pressure resists bottom-out & provides firmer compression
- Hardness surface coating
- Plug and play replacement & standard design/position
- Heavy duty synthetic fluid



| CODE | MODEL | BRAND | SIZE | COLOUR |
|---------|------------|--------|------|--------|
| 01A0251 | Y15ZR | YAMAHA | 26MM | ● |
| 01A0252 | LC135 4S | | 26MM | ● |
| 01A0250 | RS150/RS-X | HONDA | 31MM | ● |

APEX PRO DAMPER



FEATURES

- Forged alloy body and mounting eyelet
- Hardened piston rod with gold finish for superior wear resistance
- Up to 14 fine-tuning settings to accommodate different riding styles
- Improve front axle control and stability
- Includes all necessary mounting hardware

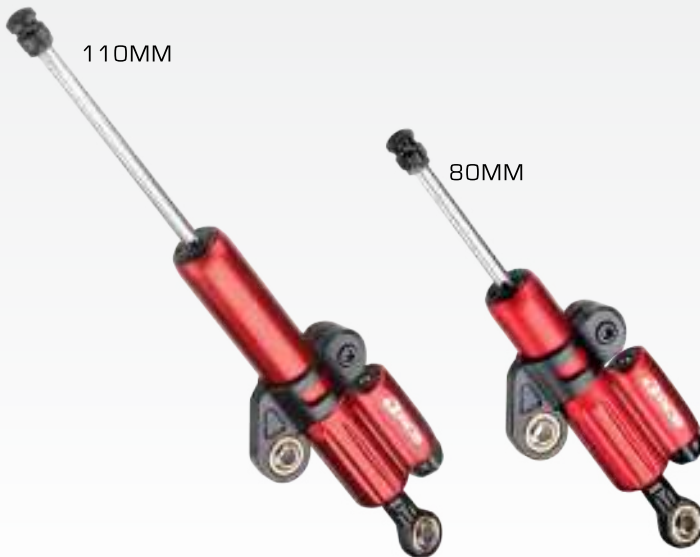

| CODE | MODEL | SIZE | COLOUR |
|---------|-----------|-------|---|
| 01DV004 | UNIVERSAL | 80MM |  |
| 01DV005 | | 110MM |  |

APEX DAMPER



FEATURES

- Forged alloy body and mounting eyelet
- Up to 14 fine-tuning settings to accommodate different riding styles
- Improve front axle control and stability
- Includes all necessary mounting hardware

| CODE | MODEL | SIZE | COLOUR |
|---------|-----------|-------|---|
| 01DV004 | UNIVERSAL | 80MM |  |
| 01DV005 | | 110MM |  |

BRAKES

TEFLON BRAKE HOSE

BRAKE CALIPER

BRAKE DISC

BRAKE DISC BRACKET

REAR MASTER BRAKE PUMP

CLUTCH PUMP

MASTER BRAKE PUMP

CLUTCH PERCH & BRAKE SHOE

BRAKE PAD

BRAKE ACCESSORIES

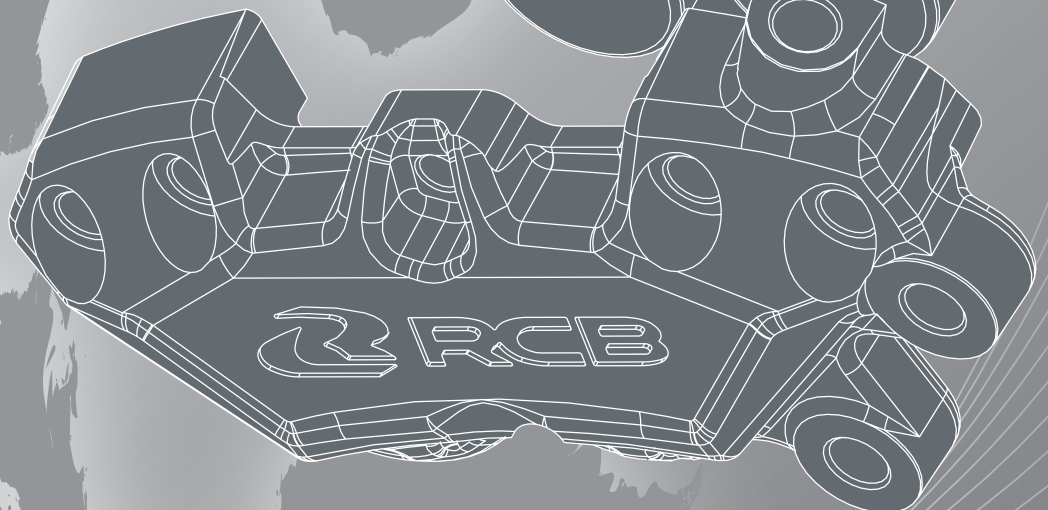

TEFLON BRAKE HOSE

BRAKES



AVAILABLE
COLOURS:



| CODE | MODEL | SIZE | TYPE | COLOUR |
|---------|-----------|--------|-------|---|
| 01BH002 | UNIVERSAL | 480MM | REAR |    |
| 01BH003 | | 850MM | REAR |    |
| 01BH004 | | 950MM | FRONT |    |
| 01BH005 | | 1300MM | FRONT |    |
| 01BH006 | NMAX (R) | 1500MM | REAR |    |
| 01BH007 | | 2000MM | REAR |    |
| 01BH008 | | 2100MM | REAR |    |
| 01BH009 | UNIVERSAL | 550MM | REAR |    |
| 01BH010 | | 1000MM | REAR |    |
| 01BH012 | | 900MM | REAR |    |
| 01BH013 | | 1100MM | REAR |    |
| 01BH014 | | 600MM | REAR |    |

R1 BRAKE CALIPER

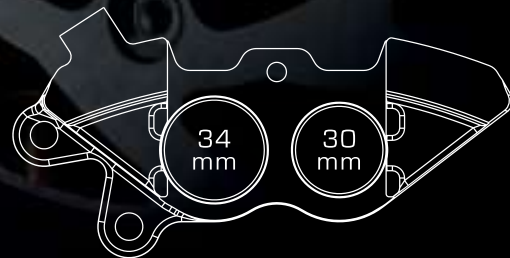

AVAILABLE COLOURS:



4 PISTONS

Dual sized pistons.
34mm x 2(leading), 30mm x 2(trailing).
Can equal distribution of pressure across brake pads and give a longer life span.

2-PIECE DESIGN

4 fastening screws to strengthen the two-piece body assembly.

| CODE | MODEL | TYPE | COLOUR |
|---------|-----------|----------|--|
| 01BC047 | UNIVERSAL | 4 PISTON | <input type="radio"/> <input checked="" type="radio"/> <input type="radio"/> <input type="radio"/> <input type="radio"/> <input type="radio"/> |

R55 BRAKE CALIPER

BRAKES



AVAILABLE COLOURS:



2 PISTONS

Double 34mm piston, offering strong clamping force and braking power



2-PIECE DESIGN

2-piece aluminium forged body, increases rigidity and stability and longer life span for brake pads. Anodized finishing increase surface protection and durability.

| CODE | MODEL | TYPE | COLOUR |
|---------|-----------|----------|--|
| 01BC048 | UNIVERSAL | 2 PISTON | <input type="radio"/> <input checked="" type="radio"/> <input type="radio"/> <input type="radio"/> <input type="radio"/> |

S3 BRAKE CALIPER



SCAN HERE
FOR MORE INFORMATION



25MM DOUBLE PISTON

Improves braking performance by increased surface contact between the brake pad and disc



SINGLE PIECE MONOBLOCK

Single piece monoblock design. Enhanced rigidity and braking stability

DOUBLE PISTON, DOUBLE THE GRIP

BRAKES

▶ PLUG & PLAY

Built-in steel bracket & brake pad included

▶ ANODISED ALUMINIUM PARTS

Corrosion and abrasion resistant



AVAILABLE COLOURS:



| CODE | MODEL | BRAND | COLOUR | | | | | |
|---------|-------------------|--------|-----------------------|-----------------------|-----------------------|-----------------------|-----------------------|-----------------------|
| 01BC029 | LC4S/EGOS | YAMAHA | <input type="radio"/> | <input type="radio"/> | <input type="radio"/> | <input type="radio"/> | <input type="radio"/> | <input type="radio"/> |
| 01BC030 | LC5S/Y125ZR | | <input type="radio"/> | <input type="radio"/> | <input type="radio"/> | <input type="radio"/> | <input type="radio"/> | <input type="radio"/> |
| 01BC031 | Y15ZR | | <input type="radio"/> | <input type="radio"/> | <input type="radio"/> | <input type="radio"/> | <input type="radio"/> | <input type="radio"/> |
| 01BC032 | NMAX/AEROX155/R15 | | <input type="radio"/> | <input type="radio"/> | <input type="radio"/> | <input type="radio"/> | <input type="radio"/> | <input type="radio"/> |
| 01BC033 | NMAX (R) | | <input type="radio"/> | <input type="radio"/> | <input type="radio"/> | <input type="radio"/> | <input type="radio"/> | <input type="radio"/> |
| 01BC037 | CLICK | HONDA | <input type="radio"/> | <input type="radio"/> | <input type="radio"/> | <input type="radio"/> | <input type="radio"/> | <input type="radio"/> |
| 01BC038 | MSX150 | | <input type="radio"/> | <input type="radio"/> | <input type="radio"/> | <input type="radio"/> | <input type="radio"/> | <input type="radio"/> |
| 01BC034 | W110/RS150R/SONIC | | <input type="radio"/> | <input type="radio"/> | <input type="radio"/> | <input type="radio"/> | <input type="radio"/> | <input type="radio"/> |
| 01BC035 | BELANG | SUZUKI | <input type="radio"/> | <input type="radio"/> | <input type="radio"/> | <input type="radio"/> | <input type="radio"/> | <input type="radio"/> |

S-55

BRAKE CALIPER

FEATURES

- Forged monoblock
- Reinforced emboss body
- 32mm Single piston
- Various anodised colours
- Increases rigidity and stability



AVAILABLE COLOURS:



| CODE | MODEL | BRAND | TYPE | COLOUR | | | | | |
|---------|-----------|--------|------|--------|---|---|---|---|---|
| 01BC038 | UNIVERSAL | HONDA | REAR | ● | ● | ● | ● | ● | ● |
| 01BC039 | | YAMAHA | | ● | ● | ● | ● | ● | ● |
| 01BC040 | BELANG | SUZUKI | | ● | ● | ● | ● | ● | ● |
| 01BC041 | BELANG F1 | | | ● | ● | ● | ● | ● | ● |

S SERIES

REAR CALIPER

FEATURES

- Made of hard alloy
- Hard anodised colour finish
- High strength and durability
- Improved piston retraction (for less brake drag)

AVAILABLE COLOURS:



| CODE | MODEL | BRAND | COLOUR | | | | | |
|---------|--------------|--------|--------------------------|--------------------------|--------------------------|--------------------------|--------------------------|--------------------------|
| 01BC001 | EGO/LC135 4S | YAMAHA | <input type="checkbox"/> | <input type="checkbox"/> | <input type="checkbox"/> | <input type="checkbox"/> | <input type="checkbox"/> | <input type="checkbox"/> |
| 01BC007 | Y15ZR/FZ150i | | <input type="checkbox"/> | <input type="checkbox"/> | <input type="checkbox"/> | <input type="checkbox"/> | <input type="checkbox"/> | <input type="checkbox"/> |
| 01BC008 | R15 | | <input type="checkbox"/> | <input type="checkbox"/> | <input type="checkbox"/> | <input type="checkbox"/> | <input type="checkbox"/> | <input type="checkbox"/> |
| 01BC009 | LC5S/Y125ZR | | <input type="checkbox"/> | <input type="checkbox"/> | <input type="checkbox"/> | <input type="checkbox"/> | <input type="checkbox"/> | <input type="checkbox"/> |
| 01BC017 | NMAX | | <input type="checkbox"/> | <input type="checkbox"/> | <input type="checkbox"/> | <input type="checkbox"/> | <input type="checkbox"/> | <input type="checkbox"/> |
| 01BC018 | NMAX (R) | | <input type="checkbox"/> | <input type="checkbox"/> | <input type="checkbox"/> | <input type="checkbox"/> | <input type="checkbox"/> | <input type="checkbox"/> |
| 01BC005 | W125/MSX125i | HONDA | <input type="checkbox"/> | <input type="checkbox"/> | <input type="checkbox"/> | <input type="checkbox"/> | <input type="checkbox"/> | <input type="checkbox"/> |
| 01BC012 | W110/RS150 | | <input type="checkbox"/> | <input type="checkbox"/> | <input type="checkbox"/> | <input type="checkbox"/> | <input type="checkbox"/> | <input type="checkbox"/> |
| 01BC015 | BEAT/CLICK | | <input type="checkbox"/> | <input type="checkbox"/> | <input type="checkbox"/> | <input type="checkbox"/> | <input type="checkbox"/> | <input type="checkbox"/> |
| 01BC002 | BELANG 150 | SUZUKI | <input type="checkbox"/> | <input type="checkbox"/> | <input type="checkbox"/> | <input type="checkbox"/> | <input type="checkbox"/> | <input type="checkbox"/> |

S-45

REAR CALIPER

FEATURES

- Universal
- Made of hard alloy
- Hard anodised colours
- High strength and durability
- Improved piston retraction (for less brake drag)

AVAILABLE COLOURS:



| CODE | MODEL | TYPE | COLOUR | | | | | |
|---------|-----------|------|--------------------------|--------------------------|--------------------------|--------------------------|--------------------------|--------------------------|
| 01BC016 | UNIVERSAL | REAR | <input type="checkbox"/> | <input type="checkbox"/> | <input type="checkbox"/> | <input type="checkbox"/> | <input type="checkbox"/> | <input type="checkbox"/> |

E SERIES

BRAKE CALIPER

FEATURES

- 25mm double pistons
- Monoblock casting caliper body
- Internal dust seal
- Brake pads included
- Built-in steel bracket
- Floating brake caliper

AVAILABLE COLOURS:



| CODE | MODEL | BRAND | TYPE | COLOUR |
|---------|----------------------|--------|------------|--------|
| 01BC074 | EGOS/LC4S/EXCITER135 | YAMAHA | FRONT | ● ● |
| 01BC078 | LC5S | | FRONT | ● ● |
| 01BC077 | Y15ZR/FZ150I/Y16ZR | | FRONT | ● ● |
| 01BC080 | NMAX/NVX/AEROX155 | | FRONT | ● ● |
| 01BC081 | NMAX | | REAR | ● ● |
| 01BC076 | W125/MSX125I | HONDA | FRONT | ● ● |
| 01BC079 | W110/RS150/RSX | | FRONT | ● ● |
| 01BC083 | BEAT/CLICK/VARIO150 | | FRONT (LH) | ● ● |
| 01BC075 | BELANG/BELANG FI | SUZUKI | FRONT | ● ● |

E-45

REAR CALIPER

FEATURES

- 32mm single pistons
- Monoblock casting caliper body
- Internal dust seal
- Universal fit for Honda/Yamaha/Suzuki
- Floating brake caliper

AVAILABLE COLOURS:



| CODE | MODEL | TYPE | COLOUR |
|---------|-----------|------|--------|
| 01BC084 | UNIVERSAL | REAR | ● ● |

S1 REAR GRT MASTER BRAKE PUMP



AVAILABLE COLOURS:



| CODE | TYPE | COLOUR |
|---------|-----------|---|
| 01BP021 | UNIVERSAL |      |

S1 CLUTCH PUMP



FEATURES

- Aluminium alloy
- Precision machining. Improves the clutch switching
- Anti-corrosion & heat resistant
- Sturdy and durable

| CODE | TYPE | COLOUR |
|---------|--------|---|
| 01H0080 | 14MM |  |
| 01H0081 | 12.7MM |  |

S **SERIES** **ALLOY DISC**

SCAN HERE
FOR MORE INFORMATION



Close-Up View 1



Close-Up View 2



▼ **AIRCRAFT GRADE**

Inner disc made from 7075 aluminium alloy.

▼ **FLOATING BRAKE DISC**

Wider ventilation that improves braking response.

▼ **HEAT VENTILATION**

Floating bolt & pin, which improves heat ventilation.

▼ **ANODISED ANTI-RUST ROTOR**

AIRCRAFT GRADE ALLOY FOR YOUR BIKE

BRAKES



Floating-Front 298mm
Yamaha/Y15ZR



Floating-Front 298mm
Honda/RS150R



Floating-Front 245mm
Yamaha/Y15ZR

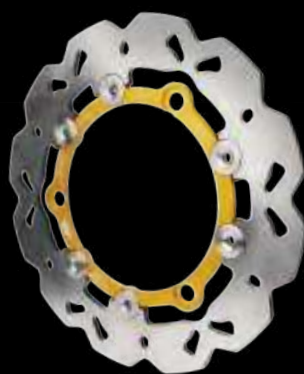

























Floating-Front 230mm
Yamaha/NMAX



Floating-Front 267mm
Yamaha/LC5S



Floating-Rear 203mm
Yamaha/Y15ZR

| CODE | MODEL | BRAND | TYPE | | SIZE | COLOUR |
|---------|--------|--------|-------|------------------|-------|---|
| 01D0484 | Y15ZR | YAMAHA | FRONT | FLOATING DISC | 298MM |    |
| 01D0499 | LC135 | | FRONT | | 298MM |    |
| 01D0483 | Y15ZR | | FRONT | | 245MM |    |
| 01D0486 | NMAX | | FRONT | | 230MM |    |
| 01D0492 | NMAX | | REAR | | 230MM |    |
| 01D0487 | LC5S | | FRONT | | 267MM |    |
| 01D0485 | Y15ZR | | REAR | | 203MM |    |
| 01D0501 | EGOS | | FRONT | | 200MM |    |
| 01D0490 | RS150R | | HONDA | | FRONT | 298MM |

S2 SERIES BRAKE DISC

FEATURES

- Racing grade material rotor
- Designed for high heat dissipation
- Floating disc offering maximum rotor-to-pad contact
- Inner alloy 7 series
- Anodised anti-rust rotor

OFFICIAL TECHNICAL PARTNER FOR:



AVAILABLE COLOURS:



| CODE | TYPE | COLOUR |
|---------|-------|--------|
| 01D0513 | Y15ZR | ● ● ● |

E SERIES BRAKE DISC

FEATURES

- High quality buttons
- Enhances durability
- Heat treated stainless steel
- Improves safety & performance



Fixed Solid - Front
Yamaha Y15ZR OVER/LC5S
267mm













Fixed Solid - Front
Honda RS150R
256mm

Fixed Solid - Front
Honda RS150R
220mm



Fixed Solid - Front/Rear
Yamaha NMAX
230mm

Fixed Solid - Rear
Honda RS150R
220mm

| CODE | MODEL | BRAND | TYPE | SIZE | COLOUR |
|---------|--------|--------|-------|-------|---|
| 01D0476 | Y15ZR | YAMAHA | FRONT | 245MM |  |
| 01D0477 | Y15ZR | | REAR | 203MM |  |
| 01D0488 | LC5S | | | 267MM |  |
| 01D0489 | LC135 | | FRONT | 220MM |  |
| 01D0480 | NMAX | | | 230MM |  |
| 01D0491 | NMAX | | REAR | 230MM |  |
| 01D0514 | LC135 | | FRONT | 245MM |  |
| 01D0517 | Y15ZR | | FRONT | 267MM |  |
| 01D0481 | RS150R | HONDA | FRONT | 256MM |  |
| 01D0482 | RS150R | | REAR | 220MM |  |
| 01D0496 | CLICK | | FRONT | 190MM |  |
| 01D0516 | RS150 | | FRONT | 267MM |  |
| 01D0478 | BELANG | SUZUKI | FRONT | 290MM |  |
| 01D0479 | BELANG | | REAR | 187MM |  |



OFFICIAL TECHNICAL PARTNER FOR:



S1 MASTER BRAKE PUMP



ERGONOMIC DESIGN

Ergonomic, lever adjuster for optimal response between rider & machine.

28° Adjustable Angle



FORGED MASTER CYLINDER BODY

Enhanced structure strength & durability.



With Brake Fluid

BRAKE FLUID RESERVOIR TANK

Transparent brake fluid reservoir tank for convenient monitoring.



COLLAPSABLE LEVER

Designed to deflect crash impact. Reducing damage to the cylinder and lever holder.

SMOOTH AND EFFICIENT



S1 Master Brake Pump Standard - 17mm

S1 Master Brake Pump Standard - 14mm

S1 Master Brake Pump Long Lever - 14mm

SCAN HERE
FOR MORE INFORMATION



AVAILABLE
COLOURS:



S1 Master
Brake Pump
14mm

| CODE | SIZE | TYPE | | BRAND | COLOUR |
|---------|------|------|----|-----------------------|---|
| 01BP012 | 14MM | STD | LH | UNIVERSAL | <input type="radio"/> <input checked="" type="radio"/> <input checked="" type="radio"/> <input checked="" type="radio"/> <input checked="" type="radio"/> |
| 01BP013 | 14MM | | RH | | <input type="radio"/> <input checked="" type="radio"/> <input checked="" type="radio"/> <input checked="" type="radio"/> <input checked="" type="radio"/> |
| 01BP014 | 17MM | | RH | | <input type="radio"/> <input checked="" type="radio"/> <input checked="" type="radio"/> <input checked="" type="radio"/> <input checked="" type="radio"/> |
| 01BP015 | 17MM | LONG | LH | | <input type="radio"/> <input checked="" type="radio"/> <input checked="" type="radio"/> <input checked="" type="radio"/> <input checked="" type="radio"/> |
| 01BP033 | 14MM | | LH | | <input type="radio"/> <input checked="" type="radio"/> <input checked="" type="radio"/> <input checked="" type="radio"/> <input checked="" type="radio"/> |
| 01BP034 | 14MM | | RH | | <input type="radio"/> <input checked="" type="radio"/> <input checked="" type="radio"/> <input checked="" type="radio"/> <input checked="" type="radio"/> |
| 01BP035 | 17MM | | RH | | <input type="radio"/> <input checked="" type="radio"/> <input checked="" type="radio"/> <input checked="" type="radio"/> <input checked="" type="radio"/> |
| 01BP036 | 17MM | | LH | | <input type="radio"/> <input checked="" type="radio"/> <input checked="" type="radio"/> <input checked="" type="radio"/> <input checked="" type="radio"/> |
| | | | | | |
| | | | | <input type="radio"/> | |

RS-1 MASTER BRAKE PUMP

Racing Spec

FEATURES

- Radial master cylinder
- 40ml brake fluid reservoir, brake fluid up to DOT 5
- Carbon fibre lever
- Forged master cylinder body. Enhanced structural strength and durability
- Gold plated internal piston to prevent abrasion and corrosion

OFFICIAL TECHNICAL PARTNER FOR:



Carbon Fibre Reinforced Polymer

| CODE | SIZE | TYPE | COLOUR |
|---------|------|------|--------|
| 01BP029 | 17MM | RH | ● |
| 01BP030 | 17MM | LH | ● |
| 01BP037 | 14MM | RH | ● |
| 01BP038 | 14MM | LH | ● |

E2 MASTER BRAKE PUMP

FEATURES

- Made of high quality aluminium alloy
- Improves stopping power performance
- Hard-anodized surface to increase corrosion resistance and surface hardness
- Transparent reservoir tank



| CODE | SIZE | TYPE | COLOUR |
|---------|------|------|--------|
| 01BP001 | 14MM | RH | ● |
| 01BP004 | 14MM | LH | ● |

E3 MASTER BRAKE PUMP

FEATURES

- Resistant to corrosion
- Transparent reservoir tank
- Improved braking performance
- Fit for all types of motorcycle models



| CODE | SIZE | TYPE | COLOUR |
|---------|--------|------|--------|
| 01BP010 | 12.7MM | RH | ● |
| 01BP017 | | LH | ● |
| 01BP039 | 14MM | LH | ● |
| 01BP040 | | RH | ● |

BRAKE DISC BRACKET

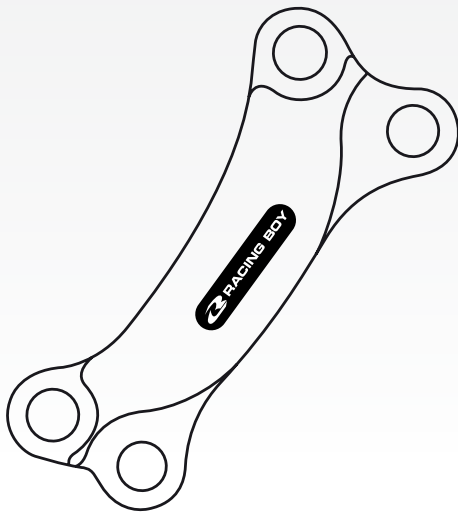

LC135 / SRLZ
260mm

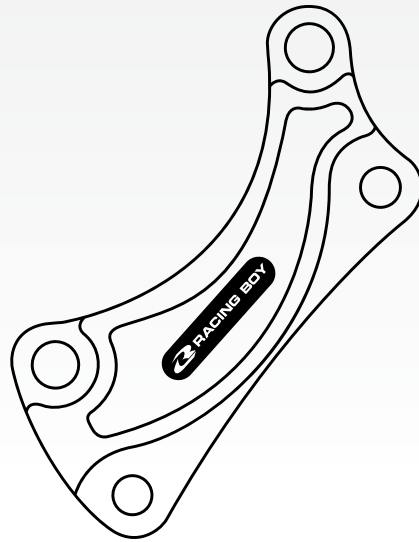

LC135
300mm

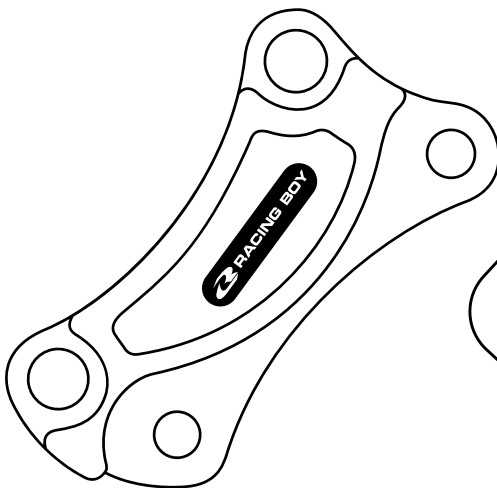

LC135ES
300mm

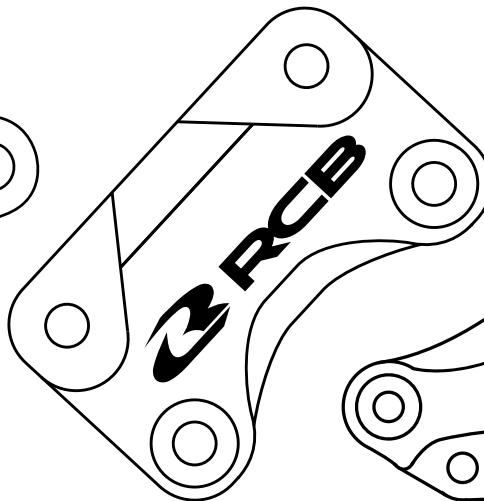

Y15ZR
298mm

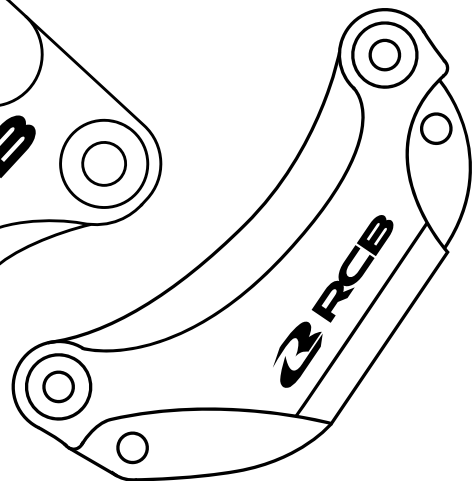

RS150
298mm

| CODE | MODEL | BRAND | TYPE | SIZE |
|----------|--------------|--------|-------|-------|
| 01D0061Z | LC135 / SRLZ | YAMAHA | FRONT | 260MM |
| 01D0074Z | LC135 | | | 300MM |
| 01D0085Z | LC135ES/5S | | | 300MM |
| 01DB002Z | Y15ZR | | | 298MM |
| 01DB005Z | | 267MM | | |
| 01DB006Z | | 298MM | | |
| 01DB003Z | RS150 | HONDA | | 298MM |

S2-D2
- GOLD SERIES -
BRAKE PAD

FEATURES

- World-class materials
- Higher temperature tolerance
- Innovative engineering
- Best in all aspects



Front - Y15ZR/NMAX/NVX
 CODE: 01DP071

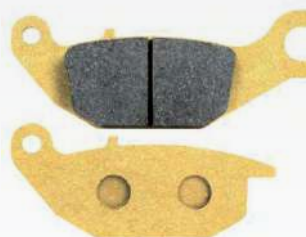

Rear - Y15ZR/LC5S
 CODE: 01DP072



Front - W110/RS150
 CODE: 01DP073



Rear - RS150R/GSX
 CODE: 01DP074



Front - R25
 CODE: 01DP075



Rear - R25
 CODE: 01DP076

| CODE | MODEL | BRAND | TYPE | COLOUR |
|---------|----------------|--------------|-------|--------|
| 01DP071 | Y15ZR/NMAX/NVX | YAMAHA | FRONT | ● |
| 01DP072 | Y15ZR/LC5S | | REAR | ● |
| 01DP075 | R25 | | FRONT | ● |
| 01DP076 | | | REAR | ● |
| 01DP073 | W110/RS150 | HONDA | FRONT | ● |
| 01DP074 | RS150R/GSX | HONDA/SUZUKI | REAR | ● |

E SERIES BRAKE PAD

FEATURES

- Built through hard anodizing process
- Specially designed with better traction
- Function effectively in all riding conditions



Front - RGS/Y125Z
CODE: 01DP010Z



Front - W125
CODE: 01DP011Z



Front - W110
CODE: 01DP012Z



Front - LC135
CODE: 01DP013Z



Rear - LC5S
CODE: 01DP014Z



Front - Y15ZR
CODE: 01DP036Z



Rear - RS150R
CODE: 01DP018Z



Front - CLICK
CODE: 01DP022Z



Front - R15
CODE: 01DP066Z



Rear - R15
CODE: 01DP067Z



Front - FORZA
CODE: 01DP068Z



Rear - FORZA
CODE: 01DP069Z



Rear - SYM VF3I
CODE: 01DP070Z

| CODE | MODEL | BRAND | TYPE |
|----------|----------|--------|-------|
| 01DP010Z | RGS | SUZUKI | FRONT |
| 01DP078R | GSX | | FRONT |
| 01DP079R | RAIDER | | REAR |
| 01DP013Z | LC135 | | FRONT |
| 01DP014Z | LC135 5S | | REAR |
| 01DP036Z | Y15ZR | YAMAHA | FRONT |
| 01DP066Z | R15 | HONDA | FRONT |
| 01DP067Z | R15 | | REAR |
| 01DP011Z | W125 | | FRONT |
| 01DP012Z | W110 | | FRONT |
| 01DP017R | VARIO160 | | FRONT |
| 01DP018Z | RS150R | | REAR |
| 01DP022Z | CLICK | | FRONT |
| 01DP068Z | FORZA | | FRONT |
| 01DP069Z | FORZA | | REAR |
| 01DP077R | VARIO150 | | FRONT |
| 01DP070Z | SYM VF3I | SYM | REAR |

**BRAKE SYSTEM
ACCESSORIES**

**GRT MASTER
BRAKE PUMP**

Charcoal

CODE
01BP002



**BRAKE FLUID
TANK HOLDER**

CODE
01BH001

AVAILABLE
COLOURS:

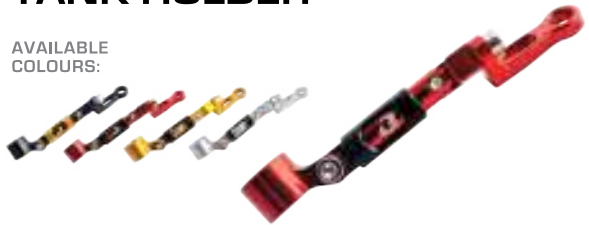

**A1 BRAKE
FLUID TANK**

CODE
01BF001

AVAILABLE
COLOURS:



**A2 BRAKE
FLUID TANK**

CODE
01BF002

AVAILABLE
COLOURS:



**BRAKE HOSE
HOLDER**

CODE
01BH011

AVAILABLE
COLOURS:



**BRAKE FLUID
TANK R102**

| CODE | SIZE |
|----------|------|
| 01B0161Z | 15ML |
| 01B0165Z | 40ML |



**BRAKE
PRESSURE
SWITCH**

CODE
01BS003Z



FOOT CONTROLS

RACING FOOTREST

SINGLE FOOTREST

FULLSET FOOTREST

FOOT CONTROL ACCESSORIES



SGV2 RACING FOOTREST

FOOT CONTROLS



RSX



RACE-READY

Made from hard alloy for enhanced strength and durability.

DESIGN

Ergonomically correct footrest with perfect response precision control and low weight.

| CODE | MODEL | BRAND | COLOUR |
|---------|-------|-------|--|
| 01FR036 | RSX | HONDA | <input type="radio"/> <input checked="" type="radio"/> |

SGV2 RACING FOOTREST



GSX-R 150

| CODE | MODEL | BRAND | COLOUR |
|---------|--------|--------|--------|
| 01FR034 | GSX150 | SUZUKI | ○ ● |

RACING FOOTREST

FEATURES

- Race-ready
- Made from hard alloy for enhanced strength and durability
- Sets can be adjusted to suit individual requirements quickly and easily
- Ergonomically correct footrest, with perfect response precision control and low weight

SE V2 RACING FOOTREST

Y15ZR



| CODE | MODEL | BRAND |
|---|---|---|
| 01FR035 | Y15ZR/Y16ZR | YAMAHA |
| COLOUR | | |
|  |  |  |



SE V2 RACING FOOTREST

RS150R

AVAILABLE COLOURS:

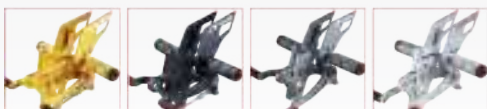

| CODE | MODEL | BRAND |
|---|---|---|
| 01FR029 | RS150R | HONDA |
| COLOUR | | |
|  |  |  |



SC V2 RACING FOOTREST

**R15
VERSION 3.0**

| CODE | MODEL | BRAND |
|---------|--------|--------|
| 01FR030 | R15 V3 | YAMAHA |
| COLOUR | | |
| ● ● | | |



RACING FOOTREST

Y15ZR

| CODE | MODEL | BRAND |
|---------|------------|--------|
| 01FR007 | Y15ZR/LC5S | YAMAHA |
| COLOUR | | |
| ● ● | | |



RACING FOOTREST

**LEGENDA
115**

| CODE | MODEL | BRAND |
|---------|--------|--------|
| 01FR008 | SRL115 | YAMAHA |
| COLOUR | | |
| ● | | |



**RACING
FOOTREST**



| CODE | MODEL | BRAND |
|-----------------------|-------|--------|
| 01FR020 | Y125Z | YAMAHA |
| COLOUR | | |
| <input type="radio"/> | | |



FOOT CONTROLS



**RACING
FOOTREST**



| CODE | MODEL | BRAND |
|--|--------|-------|
| 01FR019 | RS150R | HONDA |
| COLOUR | | |
| <input type="radio"/> <input checked="" type="radio"/> <input type="radio"/> | | |

**RACING
FOOTREST**



| CODE | MODEL | BRAND |
|-----------------------|---------------------|-------|
| 01FR021 | RS150 /SONIC150R | HONDA |
| COLOUR | | |
| <input type="radio"/> | | |



S4 RACING FOOTREST

BELANG R150

FEATURES

- Race-ready
- Made from hard alloy for enhanced strength and durability
- Sets can be adjusted suit individual requirements quickly and easily
- Ergonomically correct footrest with perfect response precision control and low weight
- Made of 6063-T6 aluminium block for a unique fit



| CODE | MODEL | BRAND | COLOUR |
|---------|--------|--------|--------|
| 01FR024 | BELANG | SUZUKI | ● ○ |

SINGLE FOOTREST

FEATURES

- Made of 7075-T6 aluminium
- Sleek and sporty design
- Better control and grip
- Lightweight
- Race ready and daily use

RS-1 SINGLE FOOTREST

Racing Spec

CBR250RR

| CODE | MODEL | BRAND |
|---------|----------|-------|
| 01FR031 | CBR250RR | HONDA |
| COLOUR | | |
| ● | | |



RS-1 SINGLE FOOTREST

Racing Spec

R25-R3

| CODE | MODEL | BRAND |
|---------|--------|--------|
| 01FR032 | R25/R3 | YAMAHA |
| COLOUR | | |
| ● | | |



FULLSET FOOTREST

FEATURES







- Sleek and sporty design
- Better control and grip
- Made from CNC-machined aluminium alloy with anodised finish
- Multiple footrest position options to suit any riding position

S2 FULLSET FOOTREST

Y15ZR

AVAILABLE COLOURS:



| CODE | MODEL | BRAND |
|---|---|---|
| 01FR014 | Y15ZR | YAMAHA |
| COLOUR | | |
|  |  |  |
|  |  |  |









S2 FULLSET FOOTREST

BELANG R150

AVAILABLE COLOURS:



| CODE | MODEL | BRAND |
|---|---|---|
| 01FR016 | BELANG | SUZUKI |
| COLOUR | | |
|  |  |  |
|  |  |  |
|  | | |



FULLSET FOOTREST

BELANG R150

FEATURES

- Sleek and sporty design
- Better control and grip
- Made from CNC-machined aluminium alloy with an anodised finish
- Multiple footrest positions options to suit any riding position



| CODE | MODEL | BRAND |
|---|---|---|
| 01FR023 | BELANG | SUZUKI |
| COLOUR | | |
|  |  |  |



FULLSET FOOTREST

Y15ZR

FEATURES

- Exclusively for Y15ZR
- Better control and grip
- Gives rider a comfortable riding position
- Made of 6063-T6 aluminium block for a unique fit
- Multiple footrest positions options









| CODE | MODEL | BRAND |
|---|---|---|
| 01FR026 | Y15ZR | YAMAHA |
| COLOUR | | |
|  |  |  |



S1 FULLSET FOOTREST LC4S / LC5S

AVAILABLE COLOURS:









| CODE | MODEL | BRAND |
|---|---|---|
| 01FR001 | LC4S & 5S | YAMAHA |
| COLOUR | | |
|  |  |  |
|  |  |  |



S1 FULLSET FOOTREST RS150R

AVAILABLE COLOURS:



| CODE | MODEL | BRAND |
|---|---|---|
| 01FR018 | RS150R | HONDA |
| COLOUR | | |
|  |  |  |
|  |  |  |



**FOOT CONTROL SYSTEM
ACCESSORIES**

FOOT CONTROLS

**FOOTPEG
END**

AVAILABLE COLOURS:



CODE : 01FS008

ALLOY FOOTSTEP

YAMAHA

CODE :
01FS003S FRONT
01FS004S REAR

REAR

FRONT



**ALLOY FOOTSTEP
YAMAHA RACING USE**

YAMAHA



CODE : 01FS009

**ALLOY PEDAL
WITH RUBBER**

*UNFOLD



CODE : 01F0009

**ALLOY FOOTSTEP
100MM - FRONT**



CODE : 01FS006

**R25 YAMAHA
PEDAL**

Gear Pedal
01F0134

Break Pedal
01F0133



**100MM (31MM)
M8 SCREW
FOOTSTEP**

*FZ150I & LC135



CODE : 01F0006

**S2-SERIES
LC4S/5S PEDAL**

Gear Pedal
01F0132

Break Pedal
01F0131



**5S BRAKE SPLINE SHAFT/
RB FOOTREST LC4S**



CODE : 01F0143Z

**S2 SERIES
Y15ZR PEDAL**

Gear Pedal
01F0136



Break Pedal
01F0135



**ALLOY PEDAL
WITH RUBBER**

*UNFOLD

AVAILABLE COLOURS

CODE : 01F0010

**HONDA RS150R
PEDAL**

Gear Pedal
01F0146

Break Pedal
01F0138





WE BUILD RIDERS' CONFIDENCE.

HAND CONTROLS

BRAKE/CLUTCH LEVER

ALLOY HANDLE GRIP

RUBBER HANDLE GRIP

BALANCER

LEVER GRIP

LEVER GUARD



S3 LEVER

FEATURES

- Ø20mm Safety End
- CNC aluminium alloy machining
- Anodised in various colours
- Ergonomic, lever adjuster for optimal response between rider & machine

HAND CONTROLS



OFFICIAL TECHNICAL PARTNER FOR:



AVAILABLE COLOURS:



| CODE | MODEL | BRAND | COLOUR |
|---------|---------------------------|----------|--|
| 01LV139 | LC4S | YAMAHA | <input type="radio"/> <input checked="" type="radio"/> <input type="radio"/> <input type="radio"/> <input type="radio"/> <input type="radio"/> |
| 01LV277 | Y15ZR | | <input type="radio"/> <input checked="" type="radio"/> <input type="radio"/> <input type="radio"/> <input type="radio"/> <input type="radio"/> |
| 01LV278 | EGO | | <input type="radio"/> <input checked="" type="radio"/> <input type="radio"/> <input type="radio"/> <input type="radio"/> <input type="radio"/> |
| 01LV281 | NMAX | | <input type="radio"/> <input checked="" type="radio"/> <input type="radio"/> <input type="radio"/> <input type="radio"/> <input type="radio"/> |
| 01LV284 | R25 | | <input type="radio"/> <input checked="" type="radio"/> <input type="radio"/> <input type="radio"/> <input type="radio"/> <input type="radio"/> |
| 01LV285 | XMAX | | <input type="radio"/> <input checked="" type="radio"/> <input type="radio"/> <input type="radio"/> <input type="radio"/> <input type="radio"/> |
| 01LV287 | R15/FZ150I | | <input type="radio"/> <input checked="" type="radio"/> <input type="radio"/> <input type="radio"/> <input type="radio"/> <input type="radio"/> |
| 01LV292 | NVX155/AEROX WITH STOPPER | | <input type="radio"/> <input checked="" type="radio"/> <input type="radio"/> <input type="radio"/> <input type="radio"/> <input type="radio"/> |
| 01LV293 | EGO AVANTIZ WITH STOPPER | | <input type="radio"/> <input checked="" type="radio"/> <input type="radio"/> <input type="radio"/> <input type="radio"/> <input type="radio"/> |
| 01LV274 | SH150I | HONDA | <input type="radio"/> <input checked="" type="radio"/> <input type="radio"/> <input type="radio"/> <input type="radio"/> <input type="radio"/> |
| 01LV275 | AIRBLADE | | <input type="radio"/> <input checked="" type="radio"/> <input type="radio"/> <input type="radio"/> <input type="radio"/> <input type="radio"/> |
| 01LV276 | ADV150 | | <input type="radio"/> <input checked="" type="radio"/> <input type="radio"/> <input type="radio"/> <input type="radio"/> <input type="radio"/> |
| 01LV280 | RS150R | | <input type="radio"/> <input checked="" type="radio"/> <input type="radio"/> <input type="radio"/> <input type="radio"/> <input type="radio"/> |
| 01LV286 | CBR250 | | <input type="radio"/> <input checked="" type="radio"/> <input type="radio"/> <input type="radio"/> <input type="radio"/> <input type="radio"/> |
| 01LV288 | BEAT FI | | <input type="radio"/> <input checked="" type="radio"/> <input type="radio"/> <input type="radio"/> <input type="radio"/> <input type="radio"/> |
| 01LV291 | BEAT STREET | | <input type="radio"/> <input checked="" type="radio"/> <input type="radio"/> <input type="radio"/> <input type="radio"/> <input type="radio"/> |
| 01LV279 | BELANG | SUZUKI | <input type="radio"/> <input checked="" type="radio"/> <input type="radio"/> <input type="radio"/> <input type="radio"/> <input type="radio"/> |
| 01LV282 | GSX150/BELANG FI | | <input type="radio"/> <input checked="" type="radio"/> <input type="radio"/> <input type="radio"/> <input type="radio"/> <input type="radio"/> |
| 01LV283 | NINJA250 | KAWASAKI | <input type="radio"/> <input checked="" type="radio"/> <input type="radio"/> <input type="radio"/> <input type="radio"/> <input type="radio"/> |

E PLUS LEVER

BRAKE/CLUTCH LEVER

FEATURES

- Matte finish
- Made from high quality CNC machined billet aluminium
- Adjustable lever length for individual ergonomic needs



AVAILABLE COLOURS:



| E-PLUS SERIES SET | | | | | | | | |
|--------------------------------|------------------|--------|--------|---|---|---|---|---|
| CODE | MODEL | BRAND | COLOUR | | | | | |
| 01LE204 | LC4S/LC135 | YAMAHA | ● | | ● | ● | ● | ● |
| 01LE212 | FZ150I | | ● | ● | ● | ● | ● | ● |
| 01LE202 | EGO | | ● | ● | ● | ● | ● | ● |
| 01LE209 | NMAX | | ● | ● | ● | ● | ● | ● |
| 01LE201 | SH150I | | ● | | ● | ● | ● | ● |
| 01LE205 | MSX125I | HONDA | ● | | ● | ● | ● | ● |
| 01LE206 | PCX150 | | ● | | ● | ● | ● | ● |
| 01LE207 | RS150R | | ● | ● | ● | ● | ● | ● |
| 01LE208 | BEAT F1 | | ● | ● | ● | ● | ● | ● |
| 01LE203 | BELANG | SUZUKI | ● | ● | ● | ● | ● | ● |
| 01LE210 | GSX150/BELANG FI | | ● | ● | ● | ● | ● | ● |
| E-PLUS SERIES BRAKE LEVER ONLY | | | | | | | | |
| CODE | MODEL | BRAND | COLOUR | | | | | |
| 01LE102 | SRL115 | YAMAHA | ● | ● | ● | ● | ● | ● |
| 01LE104 | LC4S | | ● | ● | ● | ● | ● | ● |
| 01LE100 | W100 | HONDA | ● | ● | ● | ● | ● | ● |
| 01LE101 | W125 | | ● | ● | ● | ● | ● | ● |
| 01LE103 | EX5 | | ● | ● | ● | ● | ● | ● |
| 01LE105 | W110 | | ● | | ● | ● | ● | ● |

ALLOY HANDLE GRIP

FEATURES

- Available in various anodised colours
- Ergonomic design and maximum grip
- Made from high quality CNC machined billet aluminium

AHG14

CODE : 01HG014



AVAILABLE COLOURS:



AHG16

CODE : 01HG016



AVAILABLE COLOURS:



AHG66

CODE : 01HG011



AVAILABLE COLOURS:

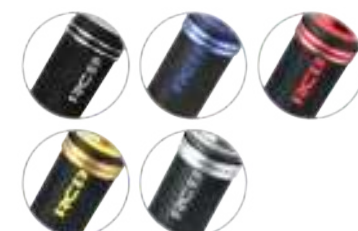

NAGAMAKI

NAGAMAKI ST

NAGAMAKI DT

RACE PROVEN

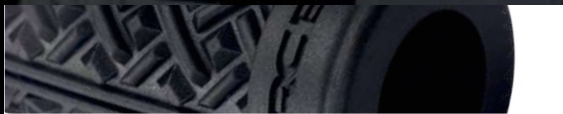

RACE-PROVEN

Race-proven by MotoGP™ championship racing team.



DESIGN

Samurai inspired design for maximum grip vibration absorption.

| CODE | MODEL | TYPE | COLOUR |
|---------|-----------|-------------|--------|
| 01HG020 | UNIVERSAL | DUAL TONE | ○ |
| 01HG021 | UNIVERSAL | SINGLE TONE | ○ |

RUBBER HANDLE GRIP

FEATURES

- Secured grip and comfort
- Available in various colours
- Improves riding safety
- Absorbs vibration

HG77

CODE : 01HG018 (TWO TONE)
01HG019



BALANCER

FEATURES

- Made from hard alloy
- Available in various anodised colours
- High strength and durability

M1 SERIES

CODE : 01BL001

AVAILABLE COLOURS:



M2 SERIES

CODE : 01BL002

AVAILABLE COLOURS:



M3 SERIES

CODE : 01BL003

AVAILABLE COLOURS:



M4 SERIES

CODE : 01BL004

AVAILABLE COLOURS:



LEVER GRIP

FEATURES

- Secured grip and comfort
- Improves riding safety
- High quality rubber grip to reduce hand fatigue

LG55 SERIES

CODE : 01LG001

AVAILABLE COLOURS:



LG66 SERIES

CODE : 01LG003

AVAILABLE COLOURS:



LEVER GUARD

GP2-V1

FEATURES

- Sleek and sporty design
- Resistant to corrosion and abrasion
- Made of aluminum alloy with an anodised finish

MotoGP™ - Inspired Innovation
Used and proven by championship riders



| CODE | MODEL | TYPE | COLOUR |
|---------|-----------|------|--------|
| 01H0083 | UNIVERSAL | SET | ● |

LEVER GUARD

GP2-V2

FEATURES

- Sleek and sporty design
- Resistant to corrosion and abrasion
- Made of aluminum alloy with an anodised finish

MotoGP™ - Inspired Innovation
Used and proven by championship riders



| CODE | MODEL | TYPE | COLOUR |
|---------|-----------|------|--------|
| 01H0082 | UNIVERSAL | SET | ● |
| 01H0085 | UNIVERSAL | RH | ● |

LEVER GUARD

GP3

FEATURES

- Lightweight
- Carbon fibre material
- High durability and strength
- Developed to improve safety
- Race ready



Carbon Fibre Reinforced Polymer

MotoGP™ - Inspired Innovation
Used and proven by championship riders



| CODE | MODEL | TYPE | COLOUR |
|---------|-----------|------|--------|
| 01H0084 | UNIVERSAL | SET | ● |
| 01H0086 | UNIVERSAL | RH | ● |



WE BUILD RIDERS' CONFIDENCE.

DRIVE CHAIN SYSTEM

CHAIN

SPROCKET



RXRING SERIES



FEATURES

- Enhanced by heat treatment
- X-Ring seal designed to reduce friction & increase durability
- Reduces force friction & power loss
- Internal self-lubricating features
- Increases lifespan
- Less maintenance required



Heavy Duty



Longer Lifespan



X-Ring



Self Lubricating



HS SERIES



S SERIES

| S SERIES | | | |
|----------|-------|------|-----|
| CODE | MODEL | SIZE | ● ● |
| 01CH001Z | 428S | 114L | ● ● |
| 01CH002Z | | 122L | ● ● |
| 01CH003Z | | 132L | ● ● |
| 01CH004Z | | 114L | ● ● |
| 01CH005Z | | 122L | ● ● |
| 01CH006Z | | 132L | ● ● |
| 01CH017Z | 415S | 114L | ● ● |
| 01CH018Z | | 122L | ● ● |
| 01CH019Z | | 132L | ● ● |
| 01CH020Z | 420S | 114L | ● ● |
| 01CH021Z | | 122L | ● ● |
| 01CH022Z | | 132L | ● ● |
| 01CH023Z | | 114L | ● ● |
| 01CH024Z | | 122L | ● ● |
| 01CH025Z | | 132L | ● ● |
| 01CH029Z | 415S | 114L | ● ● |
| 01CH030Z | | 122L | ● ● |
| 01CH031Z | | 132L | ● ● |

| HS SERIES | | | |
|------------------|-------|------|-----|
| CODE | MODEL | SIZE | ● ● |
| 01CH007Z | 428S | 114L | ● ● |
| 01CH008Z | | 122L | ● ● |
| 01CH009Z | | 132L | ● ● |
| 01CH010Z | | 114L | ● ● |
| 01CH011Z | | 122L | ● ● |
| 01CH012Z | | 132L | ● ● |
| 01CH013Z | | 106L | ● ● |
| 01CH014Z | | 106L | ● ● |
| 01CH015Z | | 106L | ● ● |
| 01CH016Z | | 106L | ● ● |
| 01CH032Z | | 140L | ● ● |
| RX SERIES | | | |
| CODE | MODEL | SIZE | ● ● |
| 01CH026Z | 428RX | 124L | ● ● |
| 01CH027Z | | 132L | ● ● |
| 01CH028Z | 520RX | 120L | ● ● |

S SERIES CHAIN SPROCKET

FEATURES

- Harden steel material
- High loads and endure heavy usage
- Wear resistance
- Corrosion resistance



| CODE | MODEL | BRAND | TYPE | | |
|----------|---------|--------|-------------|--|---------|
| 01CS044Z | Y100 | YAMAHA | 428-34T | | |
| 01CS045Z | | | 428-35T | | |
| 01CS046Z | | | 428-36T | | |
| 01CS047Z | | | 428-37T | | |
| 01CS048Z | | | 428-38T | | |
| 01CS049Z | | | 428-39T | | |
| 01CS050Z | | | 428-40T | | |
| 01CS051Z | | | 428-41T | | |
| 01CS052Z | | | 428-42T | | |
| 01CS053Z | | | 428-45T | | |
| 01CS054Z | | | 428-46T | | |
| 01CS055Z | | | 428-47T | | |
| 01CS056Z | | | Y15ZR/FZ150 | | 428-38T |
| 01CS057Z | | | | | 428-39T |
| 01CS058Z | | | | | 428-40T |
| 01CS059Z | 428-41T | | | | |
| 01CS060Z | 428-42T | | | | |
| 01CS061Z | 428-43T | | | | |
| 01CS062Z | 428-44T | | | | |
| 01CS063Z | 428-45T | | | | |
| 01CS064Z | 428-46T | | | | |
| 01CS065Z | 428-47T | | | | |
| 01CS066Z | RS150R | HONDA | 428-38T | | |
| 01CS067Z | | | 428-39T | | |
| 01CS068Z | | | 428-40T | | |
| 01CS069Z | | | 428-41T | | |
| 01CS070Z | | | 428-42T | | |
| 01CS071Z | | | 428-43T | | |
| 01CS072Z | | | 428-44T | | |



WE BUILD RIDERS' CONFIDENCE.

BODY PARTS & ACCESSORIES

LITHIUM ION BATTERY & CHARGER

SIDE MIRROR

SWING ARM SPOOLS

ULTRA CLUTCH CABLE SET



SCAN HERE
FOR MORE INFORMATION



BODY PARTS



S LITHIUM ION SERIES BATTERY YTZ5S



01B001
5L
HJT25S-FP



01B002
7L
HJT27S-FP

S LITHIUM ION BATTERY

FEATURES

- Up to 60% lighter than lead acid battery
- 100% maintenance free
- Mounts in any direction
- Includes built-in, Easy-to-Read battery capacity indicator



| CODE | SIZE | MODEL | SPECIFICATION | COLOUR |
|---------|------|-----------|-----------------------|--------|
| 01IB001 | 5L | HJTZ5S-FP | 12V 24WH CCA 120A | ● |
| 01IB002 | 7L | HJTZ7S-FP | 12V 36WH CCA 180A | ● |

AUTOMATIC LITHIUM BATTERY CHARGER

FEATURES

- Safety
- Spark proof
- 100% automatic
- Intelligent maintainer
- Short circuit protected
- Reverse polarity protected
- Maximizes battery power and life
- Recovers deep discharged batteries



| CODE | MODEL | BRAND | SPECIFICATION | COLOUR |
|----------|-----------|-----------|---------------|--------|
| 01IB003Z | UNIVERSAL | UNIVERSAL | 12V-2AMP | ● |

SS SIDE MIRROR



FEATURES

- Tear drop shaped
- Sturdy adjustable ball joint
- High durability and strength
- Resistant to corrosion and abrasion
- Made from aluminum alloy with an anodised finish



AVAILABLE COLOURS:

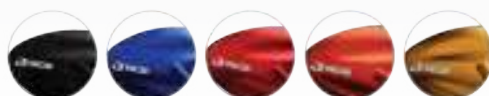

| CODE | BIKE MODEL | MODEL | COLOUR | | | | | |
|---------|------------|-------|--------|--|--|--|--|--|
| 01MR001 | UNIVERSAL | SET | | | | | | |
| 01MR002 | UNIVERSAL | LH | | | | | | |

SS SIDE MIRROR BAREND



FEATURES

- Mounted on handlebar ends
- Tear drop shaped
- Sturdy adjustable joint
- High durability and strength
- Resistant to corrosion and abrasion
- Made of aluminum alloy with an anodised finish



AVAILABLE COLOURS:



| CODE | BIKE MODEL | MODEL | COLOUR | | | | | |
|---------|------------|-------|--------|--|--|--|--|--|
| 01MR003 | UNIVERSAL | SET | | | | | | |

SWING ARM SPOOLS

FEATURES

- Easy to install
- High durability and strength
- Made from aluminum alloy with an anodised finish
- Protects the swingarm and rear axle



AVAILABLE COLOURS:



| CODE | TYPE | SIZE | COLOUR | | | | |
|---------|----------|------|--------|---|---|---|---|
| 01S0384 | YAMAHA | M6 | ● | ● | ● | ● | ● |
| 01S0385 | HONDA | M8 | ● | ● | ● | ● | ● |
| 01S0386 | KAWASAKI | M10 | ● | ● | ● | ● | ● |



FEATURES

- Braided stainless steel cables
- Housings are clear coated for abrasion resistance
- PTFE teflon inner lining for smooth operation and longer lifespan
- High grade wire line increases durability
- Consistent and confident braking feel



| CODE | MODEL | BRAND | COLOUR |
|----------|-------|--------|--------|
| 01P0063R | Y15ZR | YAMAHA | ● |



WE BUILD RIDERS' CONFIDENCE.

APPAREL

RIDING JACKET

RIDING SHOES

RIDING GLOVES

RAIN COAT

MOTORCYCLE COVER

GOGGLES



TTS

SERIES

RIDING GEAR



TTS RIDING JACKET

FEATURES

- 600D Oxford with mesh airflow panels at torso, inner arms and back
- Pre-curved sleeve construction reduces riding fatigue
- Side and back reflective stripes
- Waist adjustment for improved riding fit
- Includes elbow and shoulder armour
- Includes back protector

TTS RIDING SHOES

FEATURES

- Traditional lace closure system with side zipper design
- Reinforced toe cap and heel protector for safety
- Thickened layer for gear shifting
- Reflective strip for night riding
- Rubber outsole. Non-slip & excellent grip



TTS RIDING GLOVE

FEATURES

- Comfortable, durable and breathable
- Strategic perforation and air mesh layers
- Knuckle protector for superior impact and abrasion resistance
- Hook and loop wrist closure
- Touchscreen friendly



TTS RIDING SHOES

| CODE | SIZE | COLOUR |
|----------|------|--------|
| 01SH0010 | 38 | ● |
| 01SH0011 | 39 | ● |
| 01SH0012 | 40 | ● |
| 01SH0013 | 41 | ● |
| 01SH0014 | 42 | ● |
| 01SH0015 | 43 | ● |
| 01SH0016 | 44 | ● |
| 01SH0017 | 45 | ● |
| 01SH0018 | 46 | ● |

TTS RIDING JACKET

| CODE | SIZE | COLOUR |
|---------|------|--------|
| 01J0022 | M | ● |
| 01J0023 | L | ● |
| 01J0024 | XL | ● |
| 01J0025 | 2XL | ● |

TTS RIDING GLOVE

| CODE | SIZE | COLOUR |
|---------|------|--------|
| 01G0076 | M | ● |
| 01G0077 | L | ● |
| 01G0078 | XL | ● |

RAIN COAT 888

FEATURES

- Adjustable cuffs with velcro tabs
- Perfect fit for wet conditions
- Breathable function for added comfort
- Waterproof pockets to keep gadgets safe
- Reflective stripes to increase visibility



Neck, Wrist, Ankle Adjustment



Reflective Tape & Logo



Front Four Pockets



Hood.



Carry Pouch

Waterproof
8000mm
Water Column

AVAILABLE COLOURS:



| CODE | SIZE | COLOUR |
|---------|------|--------|
| 01R0178 | S | ● ● ● |
| 01R0179 | M | ● ● ● |
| 01R0180 | L | ● ● ● |
| 01R0181 | XL | ● ● ● |
| 01R0182 | 2XL | ● ● ● |
| 01R0183 | 3XL | ● ● ● |

APPAREL

RAIN COAT 898

FEATURES

- Perfect fit for wet conditions
- Breathable function for added comfort
- Velcro pockets to keep gadgets safe
- Reflective icons to increase visibility
- Zipper and velcro top for extra protection



Carry Pouch



| CODE | SIZE | COLOUR |
|---------|------|--------|
| 01R0187 | M | ● ● ● |
| 01R0188 | L | ● ● ● |
| 01R0189 | XL | ● ● ● |
| 01R0190 | 2XL | ● ● ● |
| 01R0191 | 3XL | ● ● ● |

RIDING GLOVE

FEATURES

- PU knuckle protection
- Velcro wrist adjustment
- 3D breathable mesh fabric
- Neoprene embossed design for better grip
- Designed for comfort & safety

MC23

RIDING GLOVE - SHORT

AVAILABLE COLOURS:



| CODE | SIZE | COLOUR |
|---------|------|--------|
| 01G0042 | M | ● ● ● |
| 01G0043 | L | ● ● ● |
| 01G0044 | XL | ● ● ● |

MC29

RIDING GLOVE - SHORT

AVAILABLE COLOURS:



| CODE | SIZE | COLOUR |
|---------|------|--------|
| 01G0064 | M | ● ● ● |
| 01G0065 | L | ● ● ● |
| 01G0066 | XL | ● ● ● |

MC29D

RIDING GLOVE - SHORT

AVAILABLE COLOURS:



| CODE | SIZE | COLOUR |
|---------|------|--------|
| 01G0067 | M | ● ● ● |
| 01G0068 | L | ● ● ● |
| 01G0069 | XL | ● ● ● |

MOTORCYCLE COVER PREMIUM

FEATURES

- Durable fabric
- Adjustable belly strap
- UV resistant
- High density waterproof polyester



| CODE | MODEL | TYPE | COLOUR |
|---------|-----------|------|--------|
| 01MC001 | UNIVERSAL | SET | ● |
| 01MC002 | | | ● |
| 01MC003 | | | ● |

E SERIES MOTORCYCLE COVER

FEATURES

- Durable fabric
- Adjustable belly strap
- UV resistant
- High density waterproof polyester
- Lightweight



| CODE | SIZE | COLOUR |
|---------|-----------------------------------|--------|
| 01MC004 | M Size - 2100mm x 750mm x 1180mm | ● |
| 01MC005 | L Size - 2120mm x 840mm x 1180mm | ● |
| 01MC006 | XL Size - 2320mm x 950mm x 1460mm | ● |

X **GOGGLES** SERIES

FEATURES

- Anti-slip
- Anti-fog
- Multi-fit
- Plastic injection moulded frame for high impact resistance
- Interchangeable nose guard
- Variety of visor options
- Available in multiple colours



Multi-Fit



Anti-Slip



Ultra HD
Lens



Anti-Fog

AVAILABLE VISOR COLOURS:



GOGGLES TEAR-OFFS



CODE: 01GL005



AVAILABLE COLOURS:



| CODE | MODEL | GOGGLE COLOUR | VISOR COLOUR |
|---------|----------|---------------|--------------|
| 01GL001 | E-SERIES | ● | ● |
| 01GL002 | X-SERIES | ● | ● ● |
| 01GL003 | X-SERIES | ● | ● ● |
| 01GL004 | X-SERIES | ● | ● ● |

BIKE MODEL BY COUNTIES



| MALAYSIA | THAILAND | PHILIPPINES | VIETNAM | BERMUDA | INDONESIA |
|-----------|--------------|---------------|----------------|--------------|-----------------------|
| Y16ZR | EXCITER 155 | SNIPER 155 | EXCITER 155 | N / A | MX KING 155 |
| EGO | MIO | MIO SPORTY | SPORTY | SPORTY | MIO SPORTY |
| EGO S | MIO MX | MIO ULTIMD | MIO SOUL | MIO SOUL | MIO SOUL |
| EGO LC125 | MIO 125 | MIO 1125 | MIO 125 | MIO 125 | MIO 125 |
| FZ 150i | FZ 150 | FZ 150 | VIXION | VIXION | VIXION |
| LC135 | SPARK 135 | SNIPER 135 | EXCITER 135 | SPARK | JUPITER MX-135 |
| LCES | SPARK 135 | SNIPER 135 | EXCITER 135 | SPARK | JUPITER MX-135 AUTO |
| LC4S | SPARK 135 4S | SNIPER 135 4S | EXCITER 135 4S | SPARK | JUPITER MX-135 CLUTCH |
| LC5S | SPARK 135 5S | SNIPER 135 5S | EXCITER 135 5S | SPARK | JUPITER MX 5 SPEED |
| NMAX | NMAX | NMAX | NM-X | N / A | NMAX |
| NOUVO | NOUVO | NOUVO | NOUVO Z 115 | NOUVO Z 115 | NOUVO Z |
| NOUVO S | NOUVO MX | NOUVO RC | NOUVO Z 115 | NOUVO Z 115 | NOUVO S |
| NOUVO LC | NOUVO 135 | NOUVO RC GP | ELEGANCE | ELEGANCE | N / A |
| NVX | AEROX 155 | AEROX 155 | NVX | N / A | AEROX 155 VVA |
| RXZ | RXZ | N / A | RXZ135 | RXZ135 | N / A |
| SRL 110 | SPARK 110 | JUPITER | JUPITER | SPARK / NAND | JUPITER Z |
| SRL 115 | N / A | JUPITER R | JUPITER F1 | SPARK / NAND | JUPITER Z |
| SRLZ | N / A | JUPITER RC | JUPITER | SPARK / NAND | JUPITER Z1 |
| Y125Z | Y125Z | Y125Z | Y125Z | N / A | Y125Z |
| Y15ZR | EXCITER 150 | SNIPER 150 | EXCITER 150 | N / A | MX KING 150 |
| X-MAX | X-MAX | X-MAX | X-MAX | X-MAX | X-MAX |
| R15 | R15 | R15 | R15 | N / A | R15 |
| R25 | R3 | R3 | R3 | N / A | R25 |
| MT-15 | MT-15 | MT-15 | MT-15 | N / A | MT-15 |
| MT-25 | MT-03 | MT-03 | MT-03 | N / A | MT-25 |



| MALAYSIA | THAILAND | PHILIPPINES | VIETNAM | BERMUDA | INDONESIA |
|-------------|---------------|-------------|-------------|-----------|---------------|
| VARIO | CLICK | CLICK | VARIO | CLICK | VARIO |
| EX5 | DEAM KURUSAPA | DREAM | DREAM | N / A | DREAM |
| EX5 DREAM | DREAM | DREAM | DREAM | N / A | DREAM |
| EX5 110 | DREAM 110i | SUPER DREAM | SUPER DREAM | N / A | N / A |
| BEAT | ICON | BEAT | BEAT | ICON | BEAT |
| RS150R | RS150R | SUPRA GTR | WINNER | N / A | SUPRA GTR |
| WAVE 100 | WAVE 100 | WAVE ALPHA | WAVE ALPHA | WAVE 110 | SUPRA FIT |
| WAVE 110 | WAVE 150 200T | WAVE S 110 | WAVE S 110 | WAVE 125i | RENO ABSOLUTE |
| WAVE 110 DX | WAVE 110 | WAVE X | WAVE X | N / A | N / A |
| WAVE 125 | WAVE 125 | N / A | N / A | WAVE 125 | WAVE 125 |
| PCX | PCX | PCX | PCX | N / A | PCX |
| ADV 150 | ADV 150 | ADV 150 | N / A | ADV 150 | ADV 150 |
| RS-X | N / A | WINNER-X | WINNER-X | N / A | N / A |



| MALAYSIA | THAILAND | PHILIPPINES | VIETNAM | BERMUDA | INDONESIA |
|---------------|------------|-------------|--------------|------------|------------|
| RAIDER 150 | RAIDER 150 | RAIDER 150 | RAIDER F 150 | RAIDER 150 | SATRIA 150 |
| RGS | AKIRA | N / A | RG SPORT | SMASH | N / A |
| SHOGUN 110 | BEST 110 | SHOGUN 110 | SHOGUN | N / A | SHOGUN 110 |
| SMASH PRO 110 | SMASH 115 | SMASH 115 | SMASH 115 | SMASH 115 | SMASH 115 |



| MALAYSIA | THAILAND | PHILIPPINES | VIETNAM | BERMUDA | INDONESIA |
|--------------|--------------|--------------|--------------|--------------|--------------|
| NINJA KRR150 | NINJA KRR150 | NINJA KRR150 | NINJA KRR150 | NINJA KRR150 | NINJA KRR150 |
| NINJA 250 | NINJA 250 | NINJA 250 | NINJA 250 | NINJA 250 | NINJA 250 |
| KLX 150 | KLX 150 | KLX 150 | KLX 150 | KLX 150 | KLX150 |
| KSR 110 | KSR 110 | KSR 110 | KSR 110 | KSR 110 | KSR 110 |



| MALAYSIA | THAILAND | PHILIPPINES | VIETNAM | BERMUDA | INDONESIA |
|----------|----------|-------------|---------|---------|-----------|
| KRISS | N / A | N / A | N / A | N / A | N / A |



| MALAYSIA | THAILAND | PHILIPPINES | VIETNAM | BERMUDA | INDONESIA |
|----------|----------|-------------|---------|---------|-----------|
| RFS150i | N / A | RFS150i | N / A | N / A | N / A |



| MALAYSIA | THAILAND | PHILIPPINES | VIETNAM | BERMUDA | INDONESIA |
|----------|----------|-------------|--------------|---------|-----------|
| VF3i 185 | N / A | VF3i 185 | STAR SR 170i | N / A | N / A |

ASIA

EAST MALAYSIA (SARAWAK) GHEE YONG ENTERPRISE SDN. BHD.

Tel : +082 411 153
Fax : +082 441 557
Email : gheeyong@gheeyong.com.my
Web : www.facebook.com/gheeyong58

No. 56 & 58, Jalan Ellis, 93300 Kuching,
Sarawak, Malaysia.

EAST MALAYSIA (SABAH) EKO KEN MOTOR

Tel : +088 718 735
Fax : -
Email : -
Web : www.facebook.com/Eko-Ken-Motor
Sdn-Bhd-101947436596289/

Lot 3, Tingkat Bawah, Kedai Golden Plaza
Danggangon, 89507 Danggang Penampang,
Sabah.

SINGAPORE MKA Motorparts Asia Pte.Ltd.

Tel : +65 6546 4646
Fax : +65 6547 4658
Email : info@motorparts.asia
Web : -

8 Kaki Bukit Avenue 4, #04-39 Premier
@ Kaki Bukit, Singapore 415875.

INDONESIA PT. ENWAN MULTI PARTINDO

Tel : +62 21 594 05672
Fax : +62 21 596 2647
Email : -
Web : www.facebook.com/racingboy.id

Pergudangan Bizpoint, Sukamulya Kec. Cikupa,
Tangerang, Banten, Indonesia 15710
Bizpoint 5 Blok LV No. 57, 59, & 61

THAILAND RACING BOY CO. LTD

Tel : +66 (0)2 889 6697
Fax : +66 (0)2 889 6697
Email : rbracingboy@gmail.com
Web : www.racingboythailand.com
www.fb.com/racingboy.th

88 MOO5, Saothonghin, Bangyai, Nonthaburi,
Thailand 11140.

CAMBODIA TAKA MOTOR CO., LTD

Tel : +011 818 062 / 097 6 256 789
Fax : -
Email : ls.cheng@taka.com.kh
Web : www.taka.com.kh
www.facebook.com/laopuychhay

62, ST. 310, Sangkat Toul Svay Prey 2,
Khan Chomkar Morn, Phnom Penh.

VIETNAM CÔNG TY TNHH MINH HOH VIỆT NAM

Tel : +03 1749893
Fax : -
Email : ketoan@racingboy.com.vn
Web : -

LÔ 21, ĐƯỜNG TÂN TẠO, KCN TÂN TẠO, P TÂN TẠO,
QUẬN BÌNH TÂN, TP HCM Vietnam.

TAIWAN OOTORI RACING INTERNATIONAL CO., LTD

Tel : +886 04 2359 6300
Fax : -
Email : racingboytw@gmail.com
Web : www.facebook.com/RacingBoyTaiwan

No.203-6, Chaoma Rd., Xitun Dist., Taichung City
40755, Taiwan [R.O.C].

HONG KONG Y.C.LEE MOTORCYCLE SERVICES LTD

Tel : +886 04 2359 6300
Fax : +85223892082
Email : ycl.motorcycle@gmail.com
Web : www.facebook.com/李有昌電單車服務中心 Y.C. Lee Motorcycle Services Center

Rm2 G/f Prosperity Center, 25 Chong Yip Street,
Kwun Tong KL, Hong Kong

INDIA LRL MOTORS PVT LTD

Tel : +91 9539330000
Fax : -
Email : khais@lrlmotors.com
Web : www.lrlmotors.com

Kumbalam, NH Bypass Kochi,
682506

BANGLADESH GEARX BANGLADESH

Tel : +8801789881111
Fax : -
Email : info@gearxbd.com
Web : www.gearxbd.com

GearX Bangladesh, 183/8, Pirenbag, Mirpur
60 feet.

BANGLADESH XETEX INTERNATIONAL

Tel : +880 2 5510 5110
Fax : +880 1796 422263
Email : info@xetexbd.com
Web : www.xetexbd.com
https://www.facebook.com/RCB-
BangladeshOfficial/

142, Bangshal Road, Dhaka 1110,
Bangladesh.

PHILIPPINES BOB'S SCOOTERS TRADING

Tel : +63 922 841 4188 / +63 917 557 0636
Fax : -
Email : racingboyphl@gmail.com
Web : www.racingboy.com.ph
www.facebook.com/rcbphl

Sitio Gipit San Jose Patag, STA Maria,
Bulacan, Philippines 3022.

MYANMAR RACING BOY MYANMAR CO.LTD

Tel : +094 2504 1530 / +094 2526 2458
Fax : -
Email : 5star.eppk@gmail.com
Web : www.fb.com/racingboy.mmm

No 20, Yehtarna Street, Maung Ngan
Kwin Quarter Mawlamyine (Township),
Mon State, Myanmar.

JAPAN KN926 CO., LTD

Tel : +81 78 224 5230
Fax : -
Email : shop@kn926.net
Web : www.facebook.com/racingboyjapan

5-31-2, Kitabefu, Nishiku, Kobes-shi, Hyogo,
651-2117, Japan

KOREA DEAN MOTOR TRADING

Tel : +82 52 251 7008
Fax : +82 52 235 8211
Email : ducati916sps@hotmail.com
Web : www.facebook.com/rcbkorea.co.kr

102 Bongsoo-Ro Dong-Gu Ulsan
South Korea.

NEPAL AUG TRADERS

Tel : +977 9802630115
Fax : -
Email : ducati916sps@hotmail.com
Web : https://augtraders.com/

BUTWAL-9, MILANCHOWK 32900
NEPAL

EUROPE

FRANCE XMAX CONCEPT

Tel : +0692 61 59 71
Fax : -
Email : ludovall@gmail.com
Web : www.xmaxconcept.com
www.facebook.com/XmaxConcept

51 Rue Tesson Appt n°21, Résidence "Les
Ombrelles", Sainte Clotilde (réunion),
97490 France.

GREECE MOTOTRADE MAVRIDIS

Tel : +30 23940 23669
Fax : +30 23940 20846
Email : info@mototrade.gr
Web : www.racingboy.gr
www.facebook.com/racingboy.gr

Katsimidou STR 10 Lagadas Thessaloniki
57200, Greece.

UNITED KINGDOM CHICKEN CHASERS

Tel : +44 (0)7908 221 881
Fax : -
Email : darren@chickenchasers.co.uk
Web : https://www.chickenchasers.co.uk

BOWCOMBE BUSINESS PARK, BOWCOMBE
ISLE OF WIGHT PO30 3HZ

NORTH AMERICA

BERMUDA CARDOSO CUSTOMS & REPAIR., LTD

Tel : +441-405-5389
Fax : +441 295 1386
Email : info@ccrpartshop.com
Web : www.ccrpartshop.com
www.facebook.com/Ccrpartshop441

#10 Bakery Lane, Pembroke,
Bermuda, HMD07

WEST MALAYSIA (RCB HEADQUARTERS) MENG KAH AUTO PARTS TRADING SDN. BHD. RESEARCH & DEVELOPMENT OFFICE

Tel : +603 5033 5833
Fax : +603 2773 9011
Email : enquiry@racingboy.com.my
Web : www.rcb.com

No. 40, Jalan TPP5, Taman Perindustrian Putra,
47130, Puchong, Selangor, MALAYSIA.



RCB



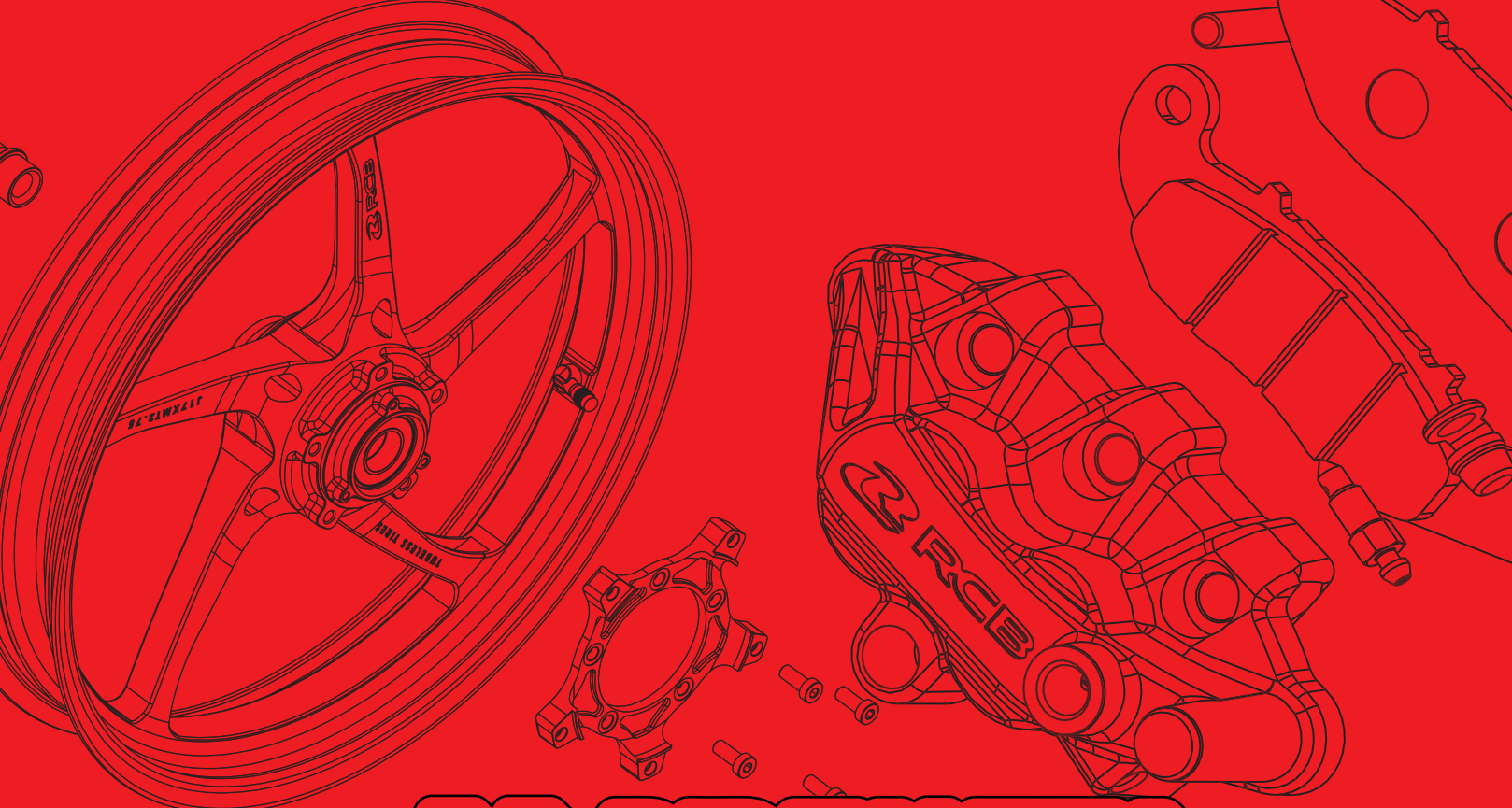

#RIDEWITH RCB

A GLOBAL BRAND OF



@RCB.GLOBAL





AWARDS:



MENG KAH AUTO PARTS TRADING SDN. BHD. (511600-H)

No.40 Jalan TPP5, Taman Perindustrian Putra, 47130 Puchong, Selangor, Malaysia.

Tel: 03-50335833

Fax: 03-27739011

Email: info@mengkah.com

Web: www.rcb.com