

RELLIS Campus Facility Design Guidelines



The Texas A&M University System
Office of Facilities Planning and Construction
Updated August 10th, 2023

TABLE OF CONTENTS

| | Page |
|---|------|
| Introduction | |
| Historically Underutilized Business Program | ii-1 |
| General Information | ii-1 |
| Utility Information | ii-4 |
| Flood Plains | |
| Wet and Dry Utilities | |
| Electrical Utilities | |
| Natural Gas | |
| Design Criteria | |
| Design Philosophy | A-1 |
| Design Quality | |
| Campus Design Standards | |
| Operating & Building Maintenance | |
| Sustainability and Energy Performance | |
| Codes and Standards | A-2 |
| General Requirements | |
| Design Basis | |
| Architectural Design | |
| Civil/Structural Design | |
| Mechanical and Plumbing Design | |
| Electrical Design | |
| Communications Design | |
| Energy and Water Conservation Design | |
| Acoustic Design | |
| Environmental Practices | A-5 |
| Sustainable Design | |
| Energy Performance | |
| Daylighting | |
| Building Materials | |
| Indoor Air Quality | |
| Smart Campus | A-7 |
| Commissioning | A-8 |
| Life Cycle Costing | A-9 |
| Purpose | |
| General Requirements | |
| Energy Systems | |
| Mechanical Systems | |

TABLE OF CONTENTS

| | |
|--|------|
| Electrical Systems | |
| Building Envelope Systems | |
| Building Interior Construction | |
| Building Siting/Massing | |
| Structural Systems | |
| Selecting Cost Effective Alternatives | |
| LCCA Software | |
| The LCCA Process | |
| Initial Costs | |
| Annual Future Costs | |
| Non-Annual Future Costs | |
| Building Elements Lifespan | |
| Space Standards | A-14 |
| Calculation of Building Areas | |
| Building Core Elements | A-15 |
| First Floor Elevation | |
| Building Entrances | |
| Building Circulation | |
| Crawl Space Under Suspended Structural Foundations | |
| Egress Stairs | |
| Equipment Rooms | |
| Electrical Rooms and Closets | |
| Main and Emergency Electrical Room | |
| Communications Closet | |
| Air Handler Rooms | |
| Rest Rooms | |
| Loading Docks | |
| Trash Dumpsters/Trash Compactors | |
| Recycling Rooms | |
| Custodial Closets | |
| Server Room Requirements | |
| Vending Standards | |
| Floor and Space Identification Systems on Drawings | A-21 |
| Assignment of Floor Numbers | |
| Assignment of Room Numbers | |
| Division 0 – Procurement & Contracting Requirements | |
| General Information | 0-1 |

TABLE OF CONTENTS

Division 1 – General Requirements

| | |
|---------------------|-----|
| General Information | 1-1 |
|---------------------|-----|

Division 2 – Existing Conditions

| | |
|--|-----|
| Survey | 2-1 |
| Subsurface Utility Engineering Assessment | 2-3 |
| Phase I | |
| Phase II | |
| RELLIS Environmental, Engineering, and Real Estate Resources | 2-4 |
| Phase I Environmental Site Assessment (ESA) | |
| Phase II Environmental Site Assessment (ESA) | |
| Asbestos and Lead Paint | |
| Natural Resource Constraints | |
| Additional Considerations | |
| Hazardous Materials Assessment | 2-6 |
| Geotechnical Investigations | 2-7 |
| Proposal for Geotechnical Services | |
| Drilling & Sampling Methods | |
| Field & Laboratory Reports | |
| Foundation Evaluation & Recommendations | |
| Pavement Design | |
| Stability of Slopes | |
| Deliverables | |
| Demolition | 2-9 |
| Tree Protection | 2-9 |

Division 3 – Concrete

| | |
|--|-----|
| Concrete | 3-1 |
| Void Space Below Grade Beams | 3-1 |
| General Floor Loading | 3-2 |
| Porches and Steps | 3-2 |
| Cement Finished Floors | 3-2 |
| Crawl Space Under Suspended Structural Foundations | 3-2 |
| Concrete Reinforcing | 3-2 |
| Precast, Tilt-up and/or Special Finished Concrete | 3-3 |
| Roof Decks | 3-3 |
| Mow Strips | 3-3 |

TABLE OF CONTENTS

Division 4 – Masonry

| | |
|---------------------------|-----|
| General | 4-1 |
| Brick | 4-1 |
| Brick Selection Procedure | 4-1 |
| Concrete Masonry Units | 4-2 |
| Cut Stone | 4-2 |
| Cast Stone | 4-2 |
| Overhung Masonry | 4-2 |
| Masonry Accessories | 4-2 |
| Cleaning | 4-3 |

Division 5 – Metals

| | |
|---------------------------|-----|
| Structural Steel | 5-1 |
| Cold-Formed Metal Framing | 5-1 |
| Metal Fabrications | 5-1 |
| Metal Stairs | 5-1 |

Division 6 – Wood, Plastics, and Composites

| | |
|-----------------------------|-----|
| General | 6-1 |
| Wood Treatment | 6-1 |
| Sheathing | 6-1 |
| Plywood | 6-1 |
| Finish Carpentry | 6-1 |
| Millwork | 6-2 |
| Architectural Wood Casework | 6-2 |

Division 7 – Thermal and Moisture Protection

| | |
|---------------------------|-----|
| General Information | |
| Building Insulation | 7-1 |
| Roofing | 7-1 |
| Metal Roof Panels | |
| Single Ply | |
| Guide Specification | |
| Urethane Foam Roof System | 7-4 |

Division 8 – Openings

| | |
|---------|-----|
| General | 8-1 |
|---------|-----|

TABLE OF CONTENTS

| | |
|--|------|
| Doors and Frames | 8-1 |
| Entrances, Storefronts, and Curtainwalls | 8-2 |
| Windows | 8-2 |
| Hardware | 8-3 |
| Hanging Devices Power | |
| Transfer Devices Door | |
| Operating Trim | |
| Cylinders and Keying | |
| Mechanical Locks and Latching Devices | |
| Electromechanical Locking Devices | |
| Auxiliary Locks | |
| Lock and Latch Strikes | |
| Electric Strikes | |
| Conventional Exit Devices | |
| Door Closers | |
| Automatic Door Operators | |
| Architectural Trim | |
| Door Stops and Holders | |
| Architectural Seals | |
| Electronic Accessories | |
| Glazing | 8-15 |

Division 9 - Finishes

General Information

| | |
|-------------------------------|-----|
| Gypsum Wallboard | 9-1 |
| Tile | 9-1 |
| Suspended Acoustical Ceilings | 9-2 |
| Terrazzo | 9-2 |
| Carpet Systems | 9-3 |
| Resilient Tile Flooring | 9-3 |
| Vinyl Wall Covering | 9-3 |
| Fiber Reinforced Panels | 9-3 |
| Painting and Coating | 9-3 |

Guide Specification

| | |
|----------------|-----|
| Carpet Systems | 9-5 |
|----------------|-----|

Division 10 – Specialties

General Information

| | |
|-------------|------|
| Directories | 10-1 |
| Graphics | 10-1 |

TABLE OF CONTENTS

| | |
|---|------|
| Building Dedication Plaque | |
| Building Construction Sign | |
| Toilet Partitions | 10-3 |
| Corner Guards and Rails | 10-3 |
| Toilet Accessories | 10-3 |
| Key Boxes | 10-3 |
| Fire Extinguishers and Cabinets | 10-4 |
| Fire Extinguishers (Portable) | |
| Fire Extinguisher Cabinets | |
| AED Requirements | 10-7 |
| Guide Specification | |
| Case Bronze Dedicatory Building Plaques | 10-8 |

Division 11 – Equipment

| | |
|--|------|
| General | 11-1 |
| Audio-Visual Equipment | 11-1 |
| Audio/Video for Registrar-controlled Classrooms | |
| Audio/Video Requirements | |
| AV Closet Requirements | |
| Room Requirements | |
| Programming Requirements | |
| Mounted Equipment Requirements | |
| Audio Requirements | |
| Video Requirements | |
| Conduit Needs (No AV Closet Present) | |
| Power Receptacles Requirements | |
| Network Connection Using Category 6 Cable Requirements | |
| Audio Visual Surveillance | |
| Camera Operation and Location | |
| Appropriate and Inappropriate AVST Use | |
| Signage for AVST Equipment | |
| Requests for Installation of Equipment | |
| Laboratory Equipment | 11-6 |
| Laboratory Fume Hoods | |
| Special Hoods | |
| Safety Showers | |

Division 12 – Furnishings

| | |
|---------------------|------|
| Window Treatments | 12-1 |
| Laboratory Casework | 12-1 |

TABLE OF CONTENTS

| | |
|---|------|
| Book Shelves | 12-1 |
| Furniture Selection | 12-1 |
| Fixed Seating | 12-2 |
| Division 13 – Special Construction | |
| Controlled Environment Rooms | 13-1 |
| Division 14 – Conveying Equipment | |
| General | 14-1 |
| Elevators | 14-1 |
| Passenger Elevators | 14-2 |
| Combination Passenger/Service Elevator | 14-4 |
| Freight Elevators (Freight Only) | 14-4 |
| Division 21 - Fire Protection | |
| General | 21-1 |
| Fire Protection Systems | 21-1 |
| General | |
| Reference Standards | |
| General Underground Water Supply to Fire Protection Systems | |
| Fire Pumps | |
| Standpipe System Design | |
| Automatic Sprinkler System | 21-4 |
| Design Criteria | |
| Pipe and Fittings | |
| Automatic Air Vents | |
| Special Occupancies | 21-6 |
| Mechanical/HVAC Equipment Rooms | |
| Electrical Rooms/Switchgear Rooms | |
| Data Centers | |
| Emergency Generator Rooms | |
| FDC Signage | |
| Specialty Systems | 21-7 |
| Clean Agent Fire Extinguishing Systems | |
| Water Mist Systems | |
| Fire Department Access and Lock Box | 21-8 |
| Fire Hydrants | |
| Fire Department Connections, PIV, and Standpipes | |

TABLE OF CONTENTS

Division 22 - Plumbing

| | |
|----------------------------|------|
| General | 22-1 |
| General Plumbing Systems | 22.2 |
| Metering | 22-2 |
| Piping | 22-3 |
| Plumbing | 22-3 |
| Mechanical Equipment Rooms | 22-4 |
| Rest Rooms | 22-5 |
| Plumbing Fixtures | 22-5 |

Division 23 - Heating, Ventilating and Air Conditioning

| | |
|---|------|
| General | 23-1 |
| Performance Requirements | 23-1 |
| Energy Code | |
| Mechanical Code | |
| Dry Bulb Temperature | |
| Humidity | |
| Air Movement | |
| Pressurization | |
| Ventilation | |
| Filtration | |
| HVAC Noise Control | |
| Prescriptive Design and Specifications Requirements | 23-2 |
| Design Criteria | |
| Building Ventilation Schedule | |
| Building Pressurization Table | |
| Occupancy Loads | |
| HVAC Load Calculations | |
| Energy Analysis | |
| Schematic Flow Diagrams | |
| Site Plans | |
| Floor Plans | |
| UES Specific Design Standards | 23-4 |
| Hydronic Piping | 23-4 |
| Hydronic Piping Cleaning Guidelines | |
| Duct Systems | 23-6 |
| Mechanical Equipment Rooms | 23-7 |
| Laboratory Exhaust | 23-8 |
| Boilers | 23-8 |
| Chiller Plants | 23-8 |
| Roof Mounted Equipment | 23-9 |

TABLE OF CONTENTS

| | |
|--|-------|
| Testing and Balancing | 23-9 |
| Air Handling Units | |
| Variable Air Volume Terminal Units | |
| Building Controls | 23-11 |
| Metering | 23-11 |
| Division 25 - Integrated Automation | |
| General Information | |
| Automatic Temperature Controls | 25-1 |
| Energy Management System | 25-1 |
| Guide Specification | |
| Automatic Temperature Controls & Energy Management Systems | 25-3 |
| Division 26 - Electrical | |
| General | 26-1 |
| Power System Studies | 26-1 |
| Equipment Ratings | 26-2 |
| Power Quality and System Reliability | 26-2 |
| Standards for Material and Equipment | 26-3 |
| Equipment Location and Layout | 26-3 |
| Component Identification | 26-4 |
| ARC Flash Hazard warning Labels | 26-4 |
| Circuit Identification | 26-4 |
| Working Space Markers | 26-4 |
| Equipment Foundations | 26-5 |
| Electrical Demolition | 26-5 |
| Electrical Acceptance Testing | 26-5 |
| Medium-Voltage Service and Distribution | 26-5 |
| Low-Voltage Service and Distribution | 26-8 |
| Low-Voltage Raceway Systems | 26-12 |
| Interior and Exterior Lighting | 26-14 |
| Backup and Alternative Power | 26-16 |
| Underground Raceways | 26-19 |
| Grounding and Bonding | 26-22 |
| Appendix A | 26-24 |
| RELLIS Lighting Standard | 26-30 |

TABLE OF CONTENTS

Division 27 - Communications

| | |
|--|-------|
| General | 27-1 |
| General Requirements | 27-1 |
| Communications Grounding and Bonding | 27-2 |
| Telecommunication Cable Entrance Into the Facility | 27-3 |
| Manholes and Handholes | 27-5 |
| Cable Distribution Facilities | 27-5 |
| Communication Room Standards | 27-6 |
| Communications Backbone Cabling | 27-10 |
| Workstation Telecommunications Outlets | 27-11 |
| Cable Testing | 27-13 |
| Labeling | 27-13 |
| Intercom and Audio Video Systems | 27-14 |
| Two-Way Communication Devices at Elevator Lobbies | 27-14 |
| Distributed Antenna System (DAS) | 27-15 |
| Metering & Building Automation Communications | 27-15 |
| Audio Visual | 27-16 |
| Sample Pictures - Telecom Room Buildout | 27-25 |

Division 28 - Electronic Safety and Security

General Information

| | |
|--|------|
| General Requirements | 28-1 |
| Building Access Control System (BACS) | 28-2 |
| Video Surveillance Management System (VMS) | 28-3 |
| Fire Detection and Alarm Systems | 28-3 |

Guide Specification

| | |
|--|-------|
| Fire Alarm Specifications | 28-4 |
| Annex A - Design Submittal Requirements | 28-13 |
| Annex B - Fire Alarm Reporting System Interface | 28-15 |
| Annex C - Fire Alarm System Acceptance Checklist | 28-16 |

Division 31 - Earthwork

| | |
|---|------|
| General | 31-1 |
| Site Clearing | 31-1 |
| Topsoil | 31-1 |
| Soil Specifications for Non-Native PlantMaterial | |
| Soil Specifications for Native Plant Material | |
| Soil Specifications for General Lawn Areas | |
| Soil Specifications for Very High Use Landscape Areas | |

TABLE OF CONTENTS

| | |
|---|-------|
| Grading and Compaction | 31-7 |
| Excavation, Trenching, and Backfilling of Utilities | 31-8 |
| Stabilization | 31-9 |
| Termite Treatment | 31-9 |
| Void Space Below Grade Beams | 31-9 |
| Division 32 - Exterior Improvements | |
| General Information | |
| Site Paving | 32-1 |
| HMAC Paving | |
| Concrete Paving | |
| Parking | |
| Concrete Walks | 32-4 |
| Bicycle Racks | 32-5 |
| Trash Removal | 32-5 |
| Porches and Steps | 32-5 |
| Landscaping | 32-5 |
| Sod | |
| Irrigation | 32-7 |
| Irrigation Materials | |
| Plant Selections | 32-10 |
| Guide Specification | |
| Trees | 32-11 |
| Division 33 - Utilities | |
| General | 33-1 |
| Sanitary Sewerage Utilities | 33-1 |
| Storm Drainage Utilities | 33-2 |
| Channels | |
| Earthen | |
| Concrete | |
| Backfill | |
| Concrete Riprap | |
| Concrete Pilot Channels | |
| Storm Sewer Pipe | |
| Manholes and Junction Boxes | |
| Inlets | |
| Headwalls | |
| Frames, Grates, Rings, and Covers | |
| Reinforced Concrete Box Culverts | |
| Backfilling | |
| Regional Stormwater Management Program (RSWMP) | 33-11 |

TABLE OF CONTENTS

| | |
|--|-------|
| RSWMP Overview | |
| RSWMP Participation | |
| Atlas 14 Hydrology | |
| Water Utilities | 33-13 |
| Concrete Utility Boxes | 33-14 |
| Chilled and Heating Water Distribution | 33-14 |
| Electrical Distribution | 33-15 |
| Underground Ductbanks | |
| Power Manholes | |
| Medium Voltage Electrical Distribution | |
| Data/Telecom Distribution | 33-17 |
| High Density Polyethylene (HDPE) Piping Installations | 33-17 |
| Natural Gas | 33-17 |
| Manholes | 33-17 |
| Manhole Cabling | |
| Grounding | |
| Sump Pump | |
| General Installation Procedures | |
| Manhole Covers | |
| Telecommunications Manhole | |
| Site Lighting | 33-19 |
| Typical Design Lighting Levels | |
| Overhead Distribution | 33-21 |
| Materials | |
| Grounding | |
| Riser Poles | |
| Dead End Poles | |
| Overhead Poles with Transformers | |
| Sample Utilities Details | 33-22 |
| Electrical Ductbank Entrance Detail | |
| Medium-Voltage Manhole Details | |
| Section - Power Manhole Detail | |
| Sump Pit Detail | |
| Sump Pump and Pit Installation Detail | |
| Medium-Voltage Manhole Ladder Detail | |
| Ladder Up Safety Post Detail | |
| Separately Derived System Grounding and Bonding Detail | |
| Telecommunications Pull Box Detail | |
| Light Pole Mounting Detail | |
| Light Fixture Fusing Detail | |

TABLE OF CONTENTS

Design Process

| | |
|---|------|
| General | B-1 |
| Integrated Design | B-1 |
| Planning & Design Review Board | B-1 |
| Overall Design Process | B-2 |
| Programming and Space Verification | B-4 |
| Schematic Design | B-5 |
| Minimum Requirements for final Schematic Design Submittal | |
| Completion of Schematic Design | |
| Design Development | B-9 |
| Minimum Requirements for Design Development Submittal | |
| Completion of Design Development | |
| Guaranteed Maximum Price | B-15 |
| Formatting of GMP Documents | |
| Construction Documents | B-16 |
| Progress Meetings | |
| 100% Construction Documents Review | |
| Bidding and Contract Award Stage (CSP Only) | B-19 |
| Contract Award (CSP Only) | B-20 |
| A/E Bid Analysis (Competitive Bids Only) | B-21 |
| Construction | B-21 |
| Pre-Construction Conference | |
| BIM Transition | |
| Monthly Construction Meetings | |
| Color Boards | |
| Subcontractor Best Value Recommendations | |
| Shop Drawings and Submittals | |
| Coordination Drawings | |
| Substitution Requests | |
| Inspection | |
| Record Drawings | |
| COBie Data | |

General Requirements

Terms and Definitions

| | |
|--|-----|
| Office of Facilities Planning and Construction | C-1 |
| System Offices | C-2 |
| Office of HUB and Procurement Services | |
| Office of Safety | |
| System Members | C-2 |

TABLE OF CONTENTS

| | |
|---|------|
| Other Definitions | C-3 |
| Administrative Procedures and Requirements | |
| General | C-4 |
| Payment Schedule for A/E, CMAR & D-B Services Agreement | C-4 |
| Authorization for Reimbursable Services | C-4 |
| Authorization for Additional Services | C-5 |
| Approvals/Notifications | C-5 |
| Distribution of Documents | C-6 |
| Correspondence and Reports | C-6 |
| Pending Issues Report | C-7 |
| Data Furnished to A/E | C-7 |
| Changes in Design | C-7 |
| Schedule of Planning | C-7 |
| Reviews | C-8 |
| Drawing Requirements | C-8 |
| Specification Requirements | C-12 |
| Federal General Requirements | C-15 |
| Alternates (CSP Only) | C-15 |
| Unit Prices (CSP Only) | C-15 |
| Addenda | C-15 |
| Printing and Binding Requirements | C-16 |
| Electronic Drawing Files | C-16 |
| Electronic File Names | C-17 |
| Electronic Folder Names | C-17 |
| Record Drawings | C-17 |
| COBie Data Sets | C-18 |
| Cost Control | C-18 |
| Coded Estimate System | C-19 |
| Cost Estimate Format | C-19 |

INTRODUCTION

HISTORICALLY UNDERUTILIZED BUSINESS PROGRAM

The Texas A&M University System (A&M System) Office of Facilities Planning & Construction is committed to promoting the participation of minority, women-owned, and small businesses through the Historically Underutilized Business (HUB) Program for the procurement of goods and/or services. The procurement process utilized by the A&M System seeks to provide equal opportunity and equal access in the design and construction opportunities on projects managed by Facilities Planning & Construction (FPC).

GENERAL INFORMATION

The “RELLIS Facility Design Guidelines” is intended as guidance for the project architect/engineer team and the contractor team during the design and construction process for The Texas A&M University System Capital Projects. It also serves as a guideline for construction projects with 3rd Party Developers on the RELLIS Campus.

The RELLIS Campus is defined by State Highway 21 to the north, State Highway 47 to the east, Kuder Road and Pitts Road to the west, and Goodson Bend Road and the Brazos River to the south.

The content covers specific design criteria, the design process and administrative procedures for permanent buildings and renovations on RELLIS Campus. Subsets of this document will pertain to renovation, civil, etc. type projects. The Project A/E, CMAR or D-B shall also refer to items covered in their Services Agreement and in the project’s Program of Requirements (POR).

The “RELLIS Facility Design Guidelines” shall be used along with the project specific Program of Requirements and the Services Agreement.

In the event of conflict between this document and specific project requirements the A/E, CMAR or D-B shall contact the Project Manager with Facilities Planning & Construction for clarification.

The guidelines in this document are not intended to prohibit the use of alternative methods, systems, products or devices not covered in this document. All alternatives shall be documented by the A/E, CMAR and D-B and submitted to the Project Manager for approval by Facilities Planning & Construction prior to implementation.

Required review and approval processes are outlined in the master plan, including those administered by the Planning & Design Review Board (PDRB) and the RELLIS Technical Review Sub-Council for compliance of Minor and Major projects within the Facility Design Guidelines and Campus Master plan.

INTRODUCTION

ADDITIONAL LINKS AND REFERENCES:

Utilities and Energy Services (UES)

<https://utilities.tamu.edu/>

979.845.6054

Environmental Health and Safety (EHS)

<https://ehs.tamu.edu/>

979.845.2132

RELLIS Administration

<https://rellis.tamus.edu/>

979.317.3410

SSC Services for Education

<https://facilities.tamu.edu/>

979.458.5500

- Maintenance
- Custodial
- Graphics Shop
- Landscape / Grounds

Mapping and Space Information (MSI)

<https://msi.tamu.edu/>

979.845.8661

- Addressing
- Room Numbering

Texas Higher Education Coordinating Board (THECB)

<https://www.highered.texas.gov/>

Locks / Building Access

<https://buildingaccess.tamu.edu/>

979.845.1207

Campus Police

<https://upd.tamu.edu/>

979.845.2345

City of Bryan Fire Department

<https://www.bryantx.gov/fire/>

979.209.5960

INTRODUCTION

Natural Gas Provider

<https://www.atmosenergy.com/>

888.286.6700

Additional information can be found in the RELLIS Campus Master Plan:

https://rellis.tamus.edu/pdf/RELLIS-CampusMasterPlan_FINAL-Compressed.pdf

INTRODUCTION

UTILITY INFORMATION

Flood Plains

Almost all of the site is located outside of the 100-year flood plain of the Brazos River and its local tributaries, including the Little Brazos River and Thompsons Creek. Regional Detention provided near the source of new runoff from building roofs and pavements has been master planned. Including bio-retention cells, bioswales, or permeable pavements will reduce the size of the detention ponds located near the campus stormwater outlets. New construction and impervious cover will be required to provide stormwater conveyance system (pipes and channels) between the new development and the outlet detention ponds as part of the base project scope of work.

Wet And Dry Utilities

The campus is currently expanding infrastructure to assist with the future campus peak utility loads. Available thermal, sanitary and water exist, see RELLIS Master Plan and RELLIS Facilities Department for infrastructure plan and guidance based on location. New construction will be required to provide wet and dry utilities conveyance systems in accordance with the infrastructure master plan between the new development and future planned developments as part of the base scope of work.

Electrical Utilities

The site is currently being fed from a City of Bryan (CoB) overhead distribution system at 12.47kV, located on the northeast side of the campus. For available overhead and underground electrical feeds, see RELLIS Master Plan and RELLIS Facilities Department for infrastructure plan and guidance. New construction will be required to provide underground electrical feeds in accordance with the infrastructure master plan between the new development and future planned developments as part of the base project scope of work. For new construction adjacent to overhead feeds, the project shall be required to provide underground electrical feeds to the appropriate overhead distribution.

Natural Gas

Currently, natural gas is distributed to the campus buildings by the local utility with meters installed at individual buildings. The route for natural gas distribution follows the utility corridor installed as part of the Campus Infrastructure project. Natural gas service required for any new buildings shall be coordinated with the local utility and aligned with future utility corridors outlined in the infrastructure master plan.

DESIGN PHILOSOPHY

Design Quality

The Texas A&M University System (A&M System) Office of Facilities Planning & Construction is committed to excellence in the design and construction of buildings for the RELLIS Campus. To accomplish this the Office of Facilities Planning & Construction (FP&C) is committed to the highest quality of aesthetics while at the same time delivering a project that is cost effective to operate and maintain throughout its useful life.

All buildings shall be designed with flexibility in mind. Over the life of all major campus buildings the functions will change and the spaces will be reconfigured.

Campus Design Standards

The building design shall follow the guidelines established in the RELLIS Campus Master Plan as well as the guidelines in this document. In the event of a conflict between standards established in the RELLIS Master Plan and this document, the Master Plan shall govern. The master plan document does not outline specific architectural design guidelines, instead the Facility Design Guidelines are intended to serve as these instruments. All design shall blend with campus standards and neighboring buildings. The design shall also conform to neighboring building setbacks, roof lines, etc.

Operating & Building Maintenance

Systems and materials incorporated into buildings should be selected on the basis of long term operations and maintenance costs. The design should incorporate ease and efficiency of operation and allow for easy and cost effective maintenance and repair. Standardization of equipment and parts is also the key to reducing maintenance costs. The Project A/E should obtain constant feedback from the RELLIS Facilities Department during design. Detailed instructions from the Project A/E stating the design intent for all building systems and the operating/maintenance procedures are required during the design process.

Sustainability & Energy Performance

The design of all buildings shall incorporate established principles of sustainable design and energy efficiency. Design following these principles improves the building's performance while enhancing the occupant's health, satisfaction and performance. Sustainable design is an integrated approach in which all phases of the building life cycle are considered. The energy performance of the building should exceed any requirements per code.

DESIGN CRITERIA

CODES AND STANDARDS

Comply with all state and federal laws applicable to construction. The Project A/E and the FPC Project Manager shall also cooperate with municipalities when tying into local utilities. Codes shall be those adopted by other state agencies, the Authority Having Jurisdiction (AHJ) or latest edition.

General Requirements

The Project A/E shall design A&M System projects to comply with the current editions of the following codes and standards and advise the Owner of code revisions having impact on the project design.

The State Fire Marshal is the code Authority Having Jurisdiction (AHJ) for all issues pertaining to NFPA 1, Fire Code and 101 Life Safety Codes. Texas A&M University Environmental Health and Safety Department has been delegated the "Local AHJ" for projects on the RELLIS campus. FPC is responsible for facilitating resolution of conflicts and interpretations after a thorough and joint discussion.

The Project A/E shall prepare a written codes and standards analysis, "Building Code Analysis," for each project for review by the AHJ and FPC. This analysis shall provide a side-by-side comparison of the requirements of the listed codes and standards. The comparison shall include all code items and an indication of which code requirement is being applied to the project. In the absence of a careful and thorough discussion by the design team of a specific conflict between the codes, the default is to design to the more stringent or robust code. These code discussions are project-specific and on an item by item basis within the codes. The final approved Building Code Analysis shall be included in the construction documents for future reference.

In the event of the need for interpretation among the codes and standards, the Project A/E shall inform FPC of the need for an interpretation and FPC will establish the requirements for compliance.

Local municipal building codes are not applicable to construction on State of Texas properties, which includes all properties owned by The Texas A&M University System. However, if it is necessary for a local authority to review any aspect of the project, such review shall be arranged.

FPC may also require the Project A/E to comply with certain provisions from the local fire department that provides fire protection services. These provisions may include locations and dimensions for firefighting access, including fire lanes; locations and specifications for standpipes, fire hose cabinets, fire control room, and fire hose connections; elevator requirements; and other similar matters.

The following statement shall be included on the general information page adjacent to the

DESIGN CRITERIA

project building code summary:

“Life Safety Code Compliance: The Architect/Engineer of Record acknowledges that construction projects for the Texas A&M University System must, at a minimum, be designed in accordance with the requirements of National Fire Protection Association (NFPA) 101, Life Safety Code, as currently adopted by the State Fire Marshal, Texas Government Code sec. 417.008(e). Therefore, the Architect/Engineer of Record affirms that, to the best of his/her professional judgment, knowledge, and belief, the design of this project satisfies the requirements of NFPA 101, Life Safety Code, as well as any other codes or standards made applicable to the project by the professional services agreement.”

Design Basis

- National Fire Protection Association National Fire Codes, with emphasis on NFPA 1 and NFPA 101 - latest edition as identified by “Local AHJ”, Life Safety Code (LSC) and including all referenced standards.
- International Building Code - latest edition

Architectural Design

- NFPA 45 Standard on Fire Protection for Laboratories Using Chemicals as applicable
- Texas Department of Licensing and Regulation (TDLR)
 - Elimination of Architectural Barriers Act, Article 9102, Texas Civil Statutes and Texas Accessibility Standards (TAS)
 - Elevators and Escalators, Health & Safety Code chapter 754 and 16TAC § 74 c. ASME 17.1, 17.2, 17.3 and 18.1
- Boilers, Health & Safety Code chapter 755 and 16TAC § 65
- ASME Boiler and Pressure Vessel Code
- Americans with Disabilities Act, 28 CFR Part 35 Nondiscrimination on the Basis of Disability in State and Local Government Services, Final Rule, as published in the Federal Register Friday, July 26, 1991
- Fair Housing Act accessibility requirements for housing units.

Civil/Structural Design

- ACI – 318, building code requirements for reinforced concrete
- AISC, specification for the Design, Fabrication and Erection of Structural Steel
- Texas Department of Insurance wind load criteria
- FEMA 100 year flood plain designation
- TCEQ SWPPP Requirements
- TCEQ Water (290) and Sewer (217) Requirements

Mechanical and Plumbing Design

- International Mechanical Code latest edition
- International Plumbing Code latest edition
- NFPA 54 latest edition
- ASHRAE 62.1 Indoor Air Quality Standard
- Reference the POR for user designated Disposal Requirements and policies of Environmental Health and Safety.

Electrical Design

- National Electric Code latest edition
- National Electrical Contractors Association Standards latest edition
- Institute of Electrical and Electronic Engineers Standards latest edition

Communications Design

1. TIA/EIA Standards

Energy and Water Conservation Design

- Energy Conservation Design Standard for New State Buildings (including major renovation projects), State Comptroller's Office, Government Code sec. 447.004 and 34 TAC § 19.32
 - ASHRAE / IESNA 90.1 latest adopted Edition
- International Energy Conservation Code (IECC) latest adopted edition (Residential/Apartments)
- SECO Alternative Energy Evaluation Requirements
- SECO Water Efficiency Standards for State Buildings and Institutions of Higher Education Facilities

Acoustic Design

Design in accordance with good practice to achieve conventional ambient noise levels qualified in Noise Criteria (NC) defined in current ASHRAE Applications Volume, Chapter 48 and ANSI S1.8 Reference Quantities for Acoustical Levels.

The ambient sound level of an occupied space is not to exceed the following NC listed for its respective typical occupancy unless specifically directed otherwise by the System Member representative or the project Program of Requirements (POR). Spatial forms, materials, assemblies, systems, and equipment selections are to be designed as required to achieve a standard quality of level of maximum background noise. Key adjacencies are to be studied to provide levels of sound isolation for floor to floor and room to room. Continuous background noise from building systems will need to be evaluated for effects on speech, privacy, and occupant comfort. Transient noise events from occupant activities, corridor traffic, and

DESIGN CRITERIA

impacts need to be considered with regard to disturbance, distraction, and annoyance.

| Occupied Space | Criteria |
|---|-----------------|
| Large Lecture Room(s), Video/Teleconferencing | NC/RC 25 |
| Med. & Sm. Lecture Class Rms, Faculty Conference, Director Office | NC/RC 30 |
| Laboratories Teaching | NC/RC 30 |
| Laboratories research/General | NC/RC 35 |
| Dorm Rooms/Apartment Suites | NC/RC 35 |
| Private Offices: Tenure-Track & Staff, Small Conf, Debrief | NC/RC 35 |
| Instructional & Simulation Labs, Lab Control & Coord, Group Study | NC/RC 35 |
| Lobby, Reception/Waiting, Circulation, Dining/Seating, Break | NC/RC 40 |
| Vending, Work/Copy/File Rooms, Toilets, Laundry, IDF, EER, | NC/RC 45 |
| Elec. Switchgear, MDF, Pump Rm., Elev. Eq. Rm., Dock | NC/RC 50 |

These conventional standards of the level of ambient noise in a space are independent of and prior to the installation of any Owner-furnished equipment, furniture and furnishings unless specified otherwise.

The Project A/E is required to submit sealed documents for an accessibility review. The required review should be accomplished by a Registered Accessibility Specialist located near the project site. The same Registered Accessibility Specialist (RAS) will be utilized for the plan review and the post construction inspection.

The A/E will be required to secure permits from state and federal government agencies when necessary, such as Texas Department of Highways and Public Transportation, Health Department, etc. The cost of any permits will be borne by the Owner.

The Project A/E will complete and submit the Energy Conservation Design Standard Certification form for Nonresidential Buildings and compliance forms required by SECO as part of the required Energy Report to the FPC Project Manager.

ENVIRONMENTAL PRACTICES

Sustainable Design

The design shall employ sustainable design principles based on LEED (latest edition) as established by the U.S. Green Building Council. Specifically employ those principles pertaining to energy and water conservation and indoor environmental quality. Refer to the project POR to determine if the building shall be certified through the U.S. Green Building Council. The A/E shall prepare a checklist to determine the theoretical level of certification. The A/E is responsible for updating this checklist and providing updates at project milestones to the project team. These updates shall include explanations of the point changes. All buildings shall be designed to maximize daylighting, maximize human comfort and minimize energy use.

DESIGN CRITERIA

Energy Performance

All new buildings should be designed to exceed the requirements of ASHRAE 90.1-latest adopted edition. All existing building renovation projects should be designed to exceed the requirements of ASHRAE 90.1-latest adopted edition. Active design features that are incorporated to achieve the additional energy savings shall have a life cycle payback calculated.

Residential projects, as defined by the State Energy Conservation Office (SECO), shall be designed to comply with International Code Council's International Energy Conservation Code, IECC latest adopted edition.

Daylighting

In order to maintain a relationship between the building occupants and the outdoors, direct views of the outside should be provided for most of the regularly occupied areas unless the needs of the spaces dictate otherwise. The building design should strive to provide outside views for 100% of all offices in the building.

If daylighting systems, beyond windows, are included in the design for daylight harvesting the project team must take special concern to ensure adequate daylight illumination, avoid common glare issues and fully integrate the lighting and mechanical systems with the interior architecture and daylighting systems.

Building Materials

Wherever possible, products, and materials with recycled-content and no volatile organic compounds (VOC) should be specified in the building design.

Indoor Air Quality

The design shall follow ASHRAE 62.1-latest edition

SMART CAMPUS

In an effort to allow future research into the built environment and “smart campus” or “smart building” technologies, a team of researchers, faculty, and administrators from departments and disciplines all across the Texas A&M University System and several of its institutes have identified elements for to be included in all RELLIS Campus building projects. These elements are intended to facilitate future research while minimizing future construction and disruption.

AE Teams will include the following items in the design:

Item/ Feature

- Structural capacity and conduit for future rooftop solar photovoltaic array
 - Add column extensions and structural capacity for future PV array at appropriate roof areas
 - Add 4x 4” capped conduits through roof for future connectivity
 - PV array and design not included
 - Array electrical connections, electrical room, inverters, gear not included
- Parking lot conduit loop for future connectivity (if parking spaces and lot is part of scope & POR).
 - Include loop of 1 1/4” conduit from MDF throughout parking lot medians
 - Connect conduit to hand-hole at every fourth pole-mounted parking lot light fixture
 - Cabling not included
- Conduit from crawlspace to landscape for future connectivity
 - For each exterior side of building, include pair of 4” conduits running from interior side of crawlspace at least 20’ out to sealed pull-box in adjacent landscape
- Enhanced wireless access point density
 - Design WAP density to handle multiple connected devices per each building inhabitant
 - Include pair of data drops at each WAP connection so that number of WAP’s can double in future
- Increased IDF room capacity
 - For each IDF, assure that at least one rack more than required will fit in room in future
 - Additional rack not included
- Building automation system “backbone” links
 - Include BAS that’s capable of multiple links to future sensors
 - Future sensors, BAS software integration, and data and power cabling to future sensors not included
- Alternate potable water meter link
 - Meter bypass (valves and tees) at building’s main water service for a future alternate building water meter
 - Alternate meter not included

DESIGN CRITERIA

- Interior potable water metering links
 - Ceiling-accessible metering bypasses (valves and tees) for future metering of potable cold water at each type of fixture (separate metering bypasses for water closets, lavatories, janitor's sinks, water fountains, break rooms, et al.
 - Alternate meter not included
- Stormwater sampling boxes
 - Galvanized shelf and conduit connection in stormwater collection box(es) for future water quality or flow metering
 - Alternate meter not included
- Electric vehicle charger connections
 - Breakers in panel for future electric vehicle chargers
 - Power and data underground conduit from electrical room to planned future charger locations
 - Chargers and power and data connections not included
- Conduit to future battery bank
 - Add two 4" underground conduits from main electrical room to sealed pull box at least 20' from exterior of building to allow connection to a future battery bank
 - Battery bank not included
- Innovative glazing & shading
 - Electrochromic exterior glazing and control system
 - smart controlled exterior shading system
- Condensate water metering
 - Metering bypass (valves and tees) for future metering of all collected condensate at condensate tank
 - Alternate meter not included

With help from the AE team and the General Contractor, the stakeholders and FP&C will consider each of the links and their relative costs. The owner will select certain links to include in the project. The owner may also instruct AE team to include other links as additive alternates to the project to be included later.

COMMISSIONING

All building projects shall employ commissioning practices to assure delivery of program goals and related performance requirements. The Project A/E shall coordinate commissioning practices with the FPC Project Manager, Utility & Energy Services, the Commissioning Authority (if contracted separately) and the Contractor (if the delivery method is construction manager at risk or design-build) during design.

Implement the TAMUS owned Continuous Commissioning® Process in all buildings.

LIFE CYCLE COST ANALYSIS (LCCA)

Purpose

The Texas A&M University System has a long tradition of designing and constructing high quality buildings. Continuing this tradition, Facilities Planning & Construction seeks to ensure that all buildings meet student, faculty, and staff needs as efficiently and cost effectively as possible. Cost effectiveness of a design is therefore a key component and Life Cycle Cost Analysis (LCCA) is a design process for evaluating and controlling the initial and future cost of building ownership. Life Cycle Cost Analysis (LCCA) is defined by the National Institute of Standards and Technology (NIST) Handbook 135 as the total discounted dollar cost of owning, operating, maintaining, and disposing of a building or building system over a period of time.

<http://www.doe2.com/download/lcc/NIST%20Handbook%20135%201995%20Edition.pdf>

LCCA is based on the premise that multiple building design options can meet programmatic needs and achieve acceptable performance, and that these options have differing initial costs, operating costs, maintenance costs, as well as different life cycle costs. By comparing the life cycle costs, LCCA can show the trade-offs between low initial first cost and long-term cost savings. Thus, the most cost-effective system for a given use can be identified, and the length of time it will take to “pay back” the incremental cost for this system can also be determined. In keeping with the A&M System’s sustainability practices, LCCA can identify environmentally desirable solutions. Careful design choices that result in efficient use of energy, water and other resources often yield long-term cost savings. In addition, should environmentally friendly choices not save money over time, LCCA may reveal that their additional cost over time is minimal. These guidelines define the LCCA process, and establish the standards and metrics to ensure accurate and consistent life cycle data collection and evaluation across projects.

The Project A/E shall refer to Utilities & Energy Services – Design Standards & Guidelines for additional information. This can be found at <https://utilities.tamu.edu/design-standards/>.

General Requirements

The master plan requires projects to evaluate and include efficiency measures that minimize the life cycle cost with a 4% discount rate. During the Schematic Design (SD) and Design Development (DD) phases of a project, the A/E is required to perform a minimum of three (3) LCCA comparative analyses from several building system categories. Two of the three analyses shall relate to energy conservation. Each LCCA comparative analysis can have up to four alternatives (one base case plus three alternate cases). Building system categories are as follows, but are not limited to:

DESIGN CRITERIA

Energy Systems

- Central plant vs. stand alone system chillers and boilers
- Equipment options for stand-alone systems (air cooled chillers vs. refrigerant-based direct expansion [DX] units)
- Additional pipe or duct insulation
- Alternative energy systems
- Use of heat recovery systems and other energy saving systems and equipment
- Others as determined with FPC

Mechanical Systems

- Air distribution systems (variable volume vs. constant volume, overhead vs. underfloor).
- Water distribution systems (various piping systems and pumping options)
- Others as determined with FPC

Electrical Systems

- Indoor lighting sources and controls
- Use of natural lighting and daylighting controls
- Outdoor lighting sources and controls
- Power distribution (transformers, buss ducts, power-factor correction systems)
- Alternate/redundant power systems (Central UPS, Emergency generator)

Building Envelope Systems

- Building skin options (masonry, precast, metal panels)
- Additional building insulation
- Roofing systems (types, materials, insulation methods)
- Glazing, daylight, and shading options
- Electrochromic Glass
- Others as determined.

Building Interior Construction

- Floor covering (carpet, terrazzo, tile, vinyl tile)
- Interior partitions (movable vs. fixed)

Building Siting/Massing

- Orientation, floor to floor height, and overall building height
- Landscape, irrigation, and hardscape options

Structural Systems

- Systems/materials selection (wood vs. steel vs. concrete, cast-in-place vs. pre-cast)
- Foundation system (slab on grade, structural, crawl space, drilled piers, auger cast, pilings, spread footings)

Selecting Cost Effective Alternatives

Alternatives that result in a payback of 5 years or less should be incorporated into the project. Alternatives that result in a payback of 6 to 10 years are strongly encouraged to be incorporated into the project. Alternatives with a payback greater than 10 years are optional. The RELLIS Facilities Department has final decision on alternatives selection.

LCCA Software

Project A/E shall use either of the following software programs for LCCA analysis:

BLCC – <https://www.energy.gov/eere/femp/building-life-cycle-cost-programs>

The LCCA Process

The LCCA process involves the Project A/E and FPC and Users (Project Team) and requires that they establish clear objectives, determine the criteria for evaluating alternatives, identify and develop design alternatives, gather cost information, and develop a life cycle cost for each alternative.

The Project Team should establish clear objectives in evaluating alternatives. LCCA can capture dollar cost variations between alternatives and show which option has the overall lowest cost.

The two metrics to be used and calculated in the LCCA are the Life Cycle Cost of each alternative and its Payback over an agreed upon study life. Consideration is given to total costs and the time it takes to recover an incremental initial investment incorporating the time value of money. As mentioned above, Life Cycle Cost is defined as the total discounted dollar cost of owning, operating, maintaining, and disposing of a building or building system over a period of time.

The Project Team should develop up to four alternative designs. The first alternative design is the “base case” and is the standard design or minimum requirement for a project. The base case is typically identified as having the lowest initial cost of all the alternatives. The remaining three alternative designs are developed to evaluate against the “base case.” The Project Team should use their experiences and judgment in selecting relevant building and system component alternative designs.

DESIGN CRITERIA

For each alternative design, the Project A/E should gather cost information. Cost information should include, but not be limited to, the following:

Initial Costs

- Construction costs (labor, materials, equipment, etc.)
- Soft costs (design fees, permit fees, etc.).

Annual Future Costs

- Operating Costs (utility costs such as electricity, gas, water, steam, chilled water, etc. and service costs such as custodial, etc.)
- Maintenance Costs (preventative and reactive)

Non-Annual Future Costs

- Replacement Costs (planned maintenance, renovation at a future date, etc.)
- Demolition Costs (if required)

Note: Residual Value default is set at zero (\$0) for all studies and not included in LCCA unless otherwise directed.

For each alternative, including the base case, the Project A/E should calculate the LCC and Payback metrics. Each alternative should be evaluated using these two metrics, and recommendations should be made as to which alternative design should be incorporated into the project.

All LCCA efforts should be completed in the Design Development phase of the project. If the design changes during Construction Documents the LCCA shall be modified to reflect the change.

Building Elements Lifespan

| | Institutional | Commercial | Apartments |
|---------------------------------|---------------|------------|------------|
| Structural Foundation | 80 yrs | | |
| Slab on Grade Foundation | | 50 yrs | 30 yrs |
| Subgrade Waterproofing/Drainage | 40 yrs | | |
| Building Structure | 80 yrs | 50 yrs | 30 yrs |

DESIGN CRITERIA

| | | | |
|-------------------------------------|--------|--------|--------|
| Exterior Walls | 80 yrs | 50 yrs | 30 yrs |
| Exterior Windows | 40 yrs | 40 yrs | 30 yrs |
| Exterior Doors | 40 yrs | 40 yrs | 30 yrs |
| Roofing | 20 yrs | 20 yrs | 20 yrs |
| Interior Partitions | 20 yrs | 15 yrs | 15 yrs |
| Interior Doors | 20 yrs | 20 yrs | 15 yrs |
| Interior Finishes | 15 yrs | 10 yrs | 5 yrs |
| Elevators | 25 yrs | 20 yrs | 20 yrs |
| Equipment | 25 yrs | 20 yrs | 15 yrs |
| Furnishings | 20 yrs | 15 yrs | 10 yrs |
| Plumbing Rough-in | 80 yrs | 50 yrs | 30 yrs |
| Plumbing Fixtures | 30 yrs | 30 yrs | 30 yrs |
| HVAC Boilers/Chillers | 30 yrs | 30 yrs | 15 yrs |
| HVAC Equipment | 20 yrs | 20 yrs | 15 yrs |
| HVAC Distribution | 40 yrs | 40 yrs | 30 yrs |
| Fire Protection System | 40 yrs | 40 yrs | 30 yrs |
| Fire Detection System | 20 yrs | 20 yrs | 20 yrs |
| Electrical Medium Voltage Equipment | 30 yrs | 30 yrs | 30 yrs |
| Electrical Duct Bank | 80 yrs | 80 yrs | 80 yrs |
| Low Voltage Electrical Rough-in | 80 yrs | 50 yrs | 30 yrs |
| Low Voltage Electrical Equipment | 30 yrs | 30 yrs | 30 yrs |
| Lighting | 30 yrs | 30 yrs | 20 yrs |
| Communications | 20 yrs | 20 yrs | 15 yrs |

Institutional - Permanent campus buildings

Commercial - Non-educational support buildings or developer building

Apartments - Wood frame student housing

SPACE STANDARDS

Calculation of Building Areas

The method used to calculate the assignable square feet and gross square feet in a building is based on guidelines from The Texas Higher Education Coordinating Board (THECB) as established in the Texas Administrative Code, Title 19, Part 1, Chapter 17. These guidelines are intended to establish common standards for building inventory for all state institutions of higher education.

Gross area should be computed by measuring from the outside face of exterior walls, disregarding cornices, pilasters, buttresses, etc., which extend beyond the wall face. The gross area includes all floored spaces from ground level through top floor. It includes basements (except unexcavated portions), attics, garages, enclosed porches, penthouses, mechanical equipment floors, lobbies, mezzanines, balconies (inside and outside) utilized for operational functions, and corridors (provided they are within the outside face lines of the building). The sum of floor areas of a building included within the exterior walls for all stories or areas that house floor surfaces including attics, basements, sub-basements, penthouses, mechanical rooms, etc. These are areas with six foot six inch clear headroom or areas with lower ceilings that are usable for storage or other purposes.

Gross area does not include open courts and light wells, or portions of upper floors eliminated by rooms or lobbies which rise above single floor ceiling height.

Net Assignable Area is defined as the sum of all areas within the interior walls of rooms on all floors of a building assigned to or available for assignment to an occupant or use, excluding unassignable space.

Unassigned Space – This is the sum of building custodial service and mechanical areas, all of which are not assigned directly to support programs. Public restrooms, shell space, or space mothballed/ permanently incapable of use is also unassigned space. Unassigned space is determined by room type and room use data fields.

Building Service Area – Space used for the protection, care, and maintenance of a building.

DESIGN CRITERIA

Circulation Area – Non-assignable hallway or stairwell space.

Inactive Area – Space in a building that once was assignable but is permanently no longer in use.

Mechanical Area – A portion of the facility's space that is designed to house mechanical equipment, utility services, and shaft areas.

Public Restrooms – Restrooms that are accessible to the public. Private restrooms are service areas.

Shell Space – Unfinished space designed to be converted into usable space at a later date.

Area shall be derived from the BIMs. The A/E is responsible for maintaining the areas in the BIM Model throughout the design cycle and final conditions.

Additional information can be found in the THECB webpage:

<http://www.thecb.state.tx.us/DocID/PDF/11538.PDF>

<http://www.txhighereddata.org/index.cfm?objectId=96F8EE70-D880-11E8-BB650050560100A9>

BUILDING CORE ELEMENTS

First Floor Elevation

The first floor elevation of all new buildings where possible shall be equivalent to the 500-yr predicted flood elevations, plus 2ft. (FEMA flood level predictions are based on a statistical average, with standard deviation of +/-2ft).

Where new buildings cannot be located above the 500-yr or 500-yr +2ft flood levels, the first floor elevation shall at least 1 to 2 feet above the 100-yr flood elevation, and high-value equipment, ornate interior finishes and critical operations or research laboratories should be located on a level above the 500-yr +2ft flood elevations.

The storm-water management system shall use grading and drainage sufficient to route predicted rain-water for the 100-yr, 24-hr rainfall event. The system should primarily rely on grading to direct water away from the building, with limited reliance on storm-water drainage systems directly adjacent to building openings or outside equipment. Building designs with below-grade spaces such as basements, service tunnels, etc. are discouraged in areas subject to flooding. Should below-grade service areas or basements be required, they should not have openings located below the 500-yr +2ft in areas subject to flooding, or below grade of the surrounding terrain in areas not subject to flooding.

Building Entrances

At main entry points to a building it is recommended to provide a vestibule that performs as an air lock and; have walk-off mats acceptable to the RELLIS Facilities Department. Weather protection must also be provided for the exterior doors at a minimum this shall consist of door sweeps, weather seals at the door head and jambs, drips at the bottom of the door, and overhead rain drips above the door that extend at least 8” beyond the jambs of the door.

Building Circulation

The building circulation system (corridors) should be clearly designed to lead building occupants from entrances to their destination. It is desirable to introduce as much natural light as possible into corridors, through windows, transoms or borrowed light. Utility systems should be routed in circulation pathways to provide access to utilities without disrupting occupied spaces.

Doors on opposite sides of corridors shall be offset to prevent direct viewing from one room to another. Classroom and laboratory room doors opening into corridors shall be recessed the width of the door to eliminate corridor obstructions.

Building corridors are to have sufficient above ceiling space to accommodate all of the required equipment and provide maintenance access and code required clearances to that equipment. The A/E shall establish and distribute for review the above ceiling stratification. The A/E shall also establish routing strategies for equipment that may run at the same elevation in the ceiling plenum on opposite sides of the corridor.

The A/E shall model clearances required for all above ceiling equipment for coordination purposes and perform clash detection as part of the BIM Execution plan.

Crawl Space Under Suspended Structural Foundations

Where plumbing access or future flexibility is required provide an accessible crawl space with 2 inch thick, 2500 psi unreinforced mud slab, properly sloped and drained. Crawl space must be provided with lighting, weather proof electrical outlets, and code minimum ventilation along with adequately sized access hatches and access ladders. Access to the crawl can be through floor hatched in the mechanical room or an area way on the perimeter of the building. Access shall not be through electrical rooms, telecommunications rooms, or custodial rooms. Switches for crawl space lighting shall be located near access hatches so that the lighting can be turned on prior to entry. The minimum clearance in crawl space shall be determined by the RELLIS Facilities Department and the crawl space shall maintain negative pressure relative to the first floor. Provide staged drainage pump systems with audible alarm and visual strobe. The alarm equipment will be located outside of the crawl space and into the ground floor area where it can be monitored. The alarm system is to be tied into the Campus emergency notification system.

DESIGN CRITERIA

Egress Stairs

The location and design of egress stairs within buildings should encourage their use for everyday vertical circulation. Magnetic door hold open devices, interconnected to the building fire alarm system, are allowed to keep interior doors to egress stairs in an open position to encourage their use.

Equipment Rooms

All mechanical and electrical equipment rooms must be designed with adequate aisle space and clearances around equipment to accommodate maintenance from the floor and replacement of items. There must be a defined pathway from all equipment rooms to the building exterior of adequate size to permit the replacement of equipment. Means of removal of equipment shall be by the most cost efficient path approved by The System Member Facilities Department. Include emergency lighting and adequate infrastructure for onsite maintenance. Plans and elevations for all equipment rooms, at a scale not less than $\frac{1}{4}'' = 1'-0''$, shall be prepared for each room to indicate that adequate circulation and maintenance areas are provided. The A/E shall model all required clearances and pulls required for maintenance and repair of equipment for coordination purposes. All equipment rooms must be designed to control noise transmission to adjacent spaces including corridors. Depress the floor of all mechanical rooms 1-1/2 inches and uniformly slope the entire floor to minimum 4 inch floor drains connected to the building sanitary sewer system.

Electrical Rooms and Closets

Electrical closets must be designed so that three walls stack vertically and NO wall is centered on a structural beam that would interfere with vertical risers. Do not route building utilities capable of conveying liquids through or above electrical rooms. The only exception allowed is the branch sprinkler line serving only the sprinkler head in an electrical closet, do not route above electrical equipment. Provide at least one room per floor.

Main and Emergency Electrical Room

The main and emergency electrical rooms for a building should be located on the ground floor. It shall never be located below restrooms, custodial closets or at an elevation that requires sump pumps for drainage. The layout of the room shall comply with the National Electric Code requirements for minimum clearances. The rooms shall have a 2 hour firewall rating. The Texas State Fire Marshal's Office has interpreted the non-sprinkled allowance of NFPA 13 to be applicable **ONLY** to the main electrical room and the emergency electrical room. Access to electrical closets must be from within the building from the corridor system and not through any other space. Door should open out from space to provide unhindered egress.

DESIGN CRITERIA

Communication Closets

Communication closets must be designed so that all four walls stack vertically and NO wall is centered on a structural beam that would interfere with vertical risers. Communication closets must be provided on each floor and located such that no wiring run exceeds 270 feet. Access to communication closets must be from within the building from the corridor system and not through any other space. Door should open out from space to maximize usable interior floor and wall area.

Air Handler Rooms

Air Handler rooms should be designed so that they stack vertically and NO wall is centered on a structural beam that would interfere with vertical risers. The spaces must be arranged and sized to provide maintenance staff with safe access to all pieces of equipment for routine maintenance. Access to air handler rooms must be from within the building from the corridor system and not through any other space. Door should open out from space to maximize usable interior floor and wall area. Provide a minimum of 2 feet clearance on two sides and one end of the air handlers. Provide clearance for removing coils and filters completely. These clearances shall be modeled for coordination purposes. Air handler rooms shall be reviewed for locations for adjacencies to sensitive sound areas.

Rest Rooms

Rest rooms must be located on each floor and should be located within 200 feet of every occupied space. Rest rooms should be grouped with custodial closets for ease of maintenance and to reduce plumbing runs. Rest rooms should be sized to accommodate a minimum fixture count determined by the International Plumbing Code (IPC) and accessibility based on the Texas Accessibility Standards. Rest rooms serving assembly areas must accommodate short term, high volume traffic and will require higher fixture counts. Either the built in trash receptacle shall be located adjacent to the restroom door or there shall be floor space available next to the door for the placement of a large trash can. Direct or reflected lines of sight into restrooms and dressing rooms from the corridor are prohibited.

Provide at least one accessible family friendly restroom containing one water closet, one lavatory and a diaper changing station. Location should be adjacent to the building entrance or elevator lobby on the first floor.

Loading Dock

The loading dock and service yard is desired to be screened from major streets and views. Refer to the POR and RELLIS Facilities Department for specific requirements for loading dock and whether it shall be raised. Provide at a minimum One 120volt GFCI outlet with weathertight box and cover. Provide at a minimum 1-3/4" Hose Bib. Locate these items on the Loading Dock exterior wall. Verify location with the RELLIS Facilities Department. The

DESIGN CRITERIA

A/E design team should confirm adequate delivery and truck turning access required to support the building.

Trash Dumpsters/Trash Compactors

Provide a concrete pad either in the loading dock service yard or a separate screened enclosure for trash dumpsters. Refer to the POR for any specific requirements for dumpsters or the need for a compactor. Refer to UES for the type of dumpsters used, access requirements, and any other equipment or area requirements that may be needed for the equipment.

Recycling Rooms

A recycling area should be provided for each building located adjacent to the loading dock or service entrance. This space will allow for sorting of recyclables such as paper, glass and metals. Refer to the UES for details on campus recycling programs.

Buildings having laboratories or spaces that could produce chemical, biological or radiological wastes should evaluate the need for room(s) for safe accumulation and storage of these wastes.

Custodial Closets

Should consist of 80 sq. ft. minimum floor space, include shelf, mop sink and hand operated eye wash. The minimum clear width of a custodial closet is six feet. A closet of this size can serve a floor area up to 50,000 gross square feet (gsf). Building designs with floor areas larger than 50,000 gsf shall require more than one custodial closet per floor. Door should open out from the closet to maximize usable interior floor and wall area. Custodial closets shall not have telephone, cable television, data, mechanical or electrical cables or equipment in it nor roof or under floor access through it. The custodial closet should be located near the restrooms on each floor.

Custodial closet shall contain the following (or as determined) :

- Standard 2'x2'x8" floor corner mounted mop sink located close to door.
- Wall surface materials around the mop sink must be moisture resistant, FRP is recommended.
- Provide six mop hangers, above the mop sink and twelve mop and broom hangers along the wall near the mop sink. If the mop hanger has an integrated shelf it should be mounted 72 inches minimum above finish floor.
- Provide shelving on one side wall, at least four 12" shelves 16" to 18" apart with the bottom one being mounted approximately two feet above the floor. Adjustable heavy duty shelving systems are acceptable.
- Overhead fluorescent lighting controlled from the switch just inside the door.

DESIGN CRITERIA

- One electrical duplex outlet on each side wall. Use GFI outlets where required by code when placed near a water source.
- Wall hung lavatory near the door with hand held eye wash.

Server Room Requirements

Server Rooms are governed under TAMU System policy 29.01.03, see link for more information. <https://policies.tamus.edu/29-01-03.pdf>

Almost every building has a requirement for one or more server rooms. Some buildings house mission critical servers and as such have more stringent environmental requirements. The size and intensity of a server room is not usually known during the concept or design phase of a building. Due to rapid advances in technology, the equipment that served as a basis for design is not the equipment that will be installed at owner occupancy. The trend has been for servers to get smaller in physical size yet increase the quantity of power supplies and heat rejection into the space. Thus more equipment with a greater heat and power load is being placed into spaces that were not designed to handle either the power or thermal loads.

Server Rooms shall contain the following (or as determined) :

- Each server room shall be furnished with an electrical service that equals at least 200 watts per square foot. This works out to approximately 7 kW per rack. Some spare capacity must be included. Present design criteria require about 3 kW per rack. A computer grade panel board should be furnished in each server room.
- Each server room should be served from a standby generator. As the servers become more mission critical this requirement becomes essential.
- The thermal requirements for all server rooms should be supplied first from the building thermal utilities with humidity control and secondary back up in the form of an independent DX system. The power for the secondary system should be from a standby generator. Special consideration should be given to consolidating server rooms into one centralized server room. Server rooms should be designed with sufficient capacity to operate at 48 degree chilled water supply to meet planned and future loads.
- Each server room must have some form of entry access control.
- If the server rooms are unmanned and remote some form of environmental monitoring and alarm should be provided.
- The server room minimum width shall be 11' based on a single row of racks in the center of the room. The length shall be determined by the number of racks plus the required circulation space on each end.
- Racks of back-up batteries supporting UPS and other back-up systems should be located in a separate Battery Room, with no normal opening between the two areas. Lead/Acid batteries that overheat release corrosive by-products that can deposit chemical residues on computer equipment circuitry that requires extensive decontamination or replacement. Overcurrent protection should be provided.

DESIGN CRITERIA

While the power and thermal requirements are considerably less, the telecom closets should be likewise provisioned. There are other applications that require increased consideration for reliability and environmental controls that must be evaluated on a case by case basis.

Vending Standards

- Provisions for vending machines should be considered in new buildings with occupancies greater than 25 people.
- At a minimum, space should be allocated for 3 vending machines. Allow 4ft. wide x 4ft. deep for each vending machine. For recessed or alcove applications with ceiling drops, allow minimum 7ft. clear height for vending machines.
- Vending areas should be located in spaces that are readily visible to the public, both occupants and visitors. Vending should be located along the most frequently and highly traveled traffic areas in the building. Vending signage is helpful, but location of machines is more critical.
- Provide a dedicated GFCI duplex receptacle (on separate 20 amp breaker) for each vending machine. Receptacles should be located directly behind each machine. Refrigerated soft drink machines will average 10 to 13 amps when compressor is running. Compressors can pull up to 30 amps for a few seconds during start-up.
- Provide a data drop for debit card (Aggie bucks) readers on vending machines. Run conduit to the communications room in the building.
- Accessible routes should be considered for installation and servicing of vending machines. Ground floor locations are preferred on two story buildings. Elevator access is required on the second floor and above locations. Access and docking or parking for vending product (truck) deliveries to the building should be provided. Ramps should be provided for dolly traffic on approaches to service entrances.
- Provide space for trash containers and recycling containers (aluminum cans) in or near vending areas.
- If provided as a part of the project, vending machines shall be compliant with Energy Star Program Requirements for Vending machines to ensure minimum energy consumption.
- For cellular connection, provide one ceiling or wall mounted WIFI port in close proximity to the vending machines.

FLOOR AND SPACE IDENTIFICATION SYSTEMS ON DRAWINGS

Each space shall be identified by name as identified in the POR or as agreed to by the FPC Project Manager and the User Coordinator and room number.

Coordinate room number with MSI during design utilizing their latest available guidelines. Obtain approval at the Design Development stage.

DESIGN CRITERIA

Room numbers used in the Construction Documents will become the actual and permanent space numbers.

All equipment placed in or above a space shall use the space and floor number as identifying parametric data.

Assignment of Floor Numbers

The floor level containing the primary entrance shall be considered the First Floor and shall be numbered in the 100 series; the floor above being the Second Floor shall be numbered in the 200 series. Third and subsequent floors shall be numbered in a similar manner. Basement level shall be numbered 001 series.

Assignment of Room Numbers

The rooms on each floor opening off of either side of a corridor shall be numbered consecutively in a clockwise direction from the primary entrance which shall be 100. If there is more than one main entrance to the building use the one mutually agreed to by the FPC Project Manager and the User Coordinator.

Rooms and spaces not opening off a corridor shall carry the room number of the connecting room with an additional suffix letter (108A, B, C, etc.). Letter clockwise, if more than one room is involved.

Interior corridors not numbered with room sequence - Instead use Hall 1, Hall 2. This also applies for Stairs (such as 1S1 and 2nd level 2S1) and Elevators, Mechanical, Electrical, Data (Ex: 1M1). Rooms that have no internal access, are not numbered from the interior corridor.

Exterior stairs shall use (open) XS1, XS2, etc.

Restrooms designator includes gender or gender neutral. "R" - (Ex: M101 for Mens Level 1)
Lactation Room - (Ex: L101)

DESIGN CRITERIA

Example Floor plan:

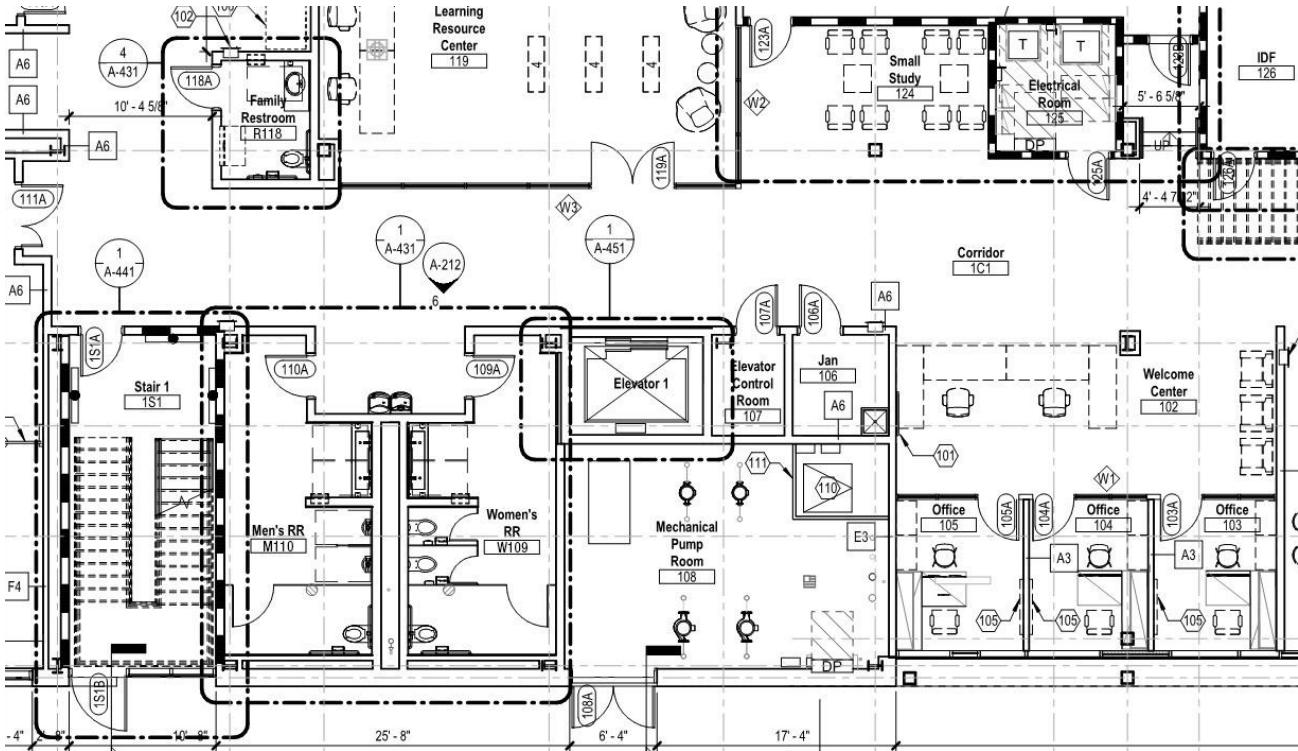

DESIGN CRITERIA

Division 0 – Procurement and Contracting Requirements

GENERAL INFORMATION

The following Division 0 Sections have been developed by Facilities Planning & Construction(FP&C) and are to be utilized on all RELLIS Campus projects.

The FPC Project Manager will provide the Project A/E with a final copy of all Division 0 Sections for insertion into the project specifications.

If the Project A/E has additional sections or changes to these sections these items shall be brought to the attention of the FPC Project Manager. If the additions or changes are agreed upon then the final copy supplied by the FPC Project Manager will reflect the agreed upon items. In no event will the Project A/E modify the final sections supplied by the FPC Project Manager.

The following is a listing of the standard Division 0 Sections for Construction Manager at Risk and Design-Build delivery methods:

- Guaranteed Maximum Price Proposal
- Performance Bond, Form C-6A
- Payment Bond, Form C-6B
- Uniform General and Supplemental Conditions, Form C-8
- Special Conditions and Wage Rates
- Soil Investigation Data

The following is a listing of the standard Division 0 Sections for Competitive Sealed Proposal delivery method:

- Request for Competitive Sealed Proposal
- Instructions for Competitive Sealed Proposal, Form C-3 CSP
- Supplemental Instructions for Competitive Sealed Proposal
- Bid/Proposal Bond, Form C-2
- Part 1, Competitive Sealed Proposal
- Part 2, Proposer's Qualifications
- Part 3, HUB Subcontracting Plan
- Post Proposal Amendment
- Addenda
- Contract, Form C-5a
- Performance Bond, Form C-6A
- Payment Bond, Form C-6B
- Uniform General and Supplemental Conditions, Form C-8
- Special Conditions and Wage Rates
- Soil Investigation Data

DESIGN CRITERIA

Division 1 – General Requirements

GENERAL INFORMATION

The following Division 1 Sections have been developed to work with the Uniform General and Supplemental Conditions and the Special Conditions and are to be utilized on all A&M System projects. The FPC Project Manager will work with the Project A/E to complete Section 01 11 00 – Summary of Work and Section 01 23 00 – Alternates.

The FPC Project Manager will provide the Project A.E with a final copy of all Division 1 Sections for insertion into the project specifications.

If the Project A/E has additional sections or changes to these sections these items shall be brought to the attention of the FPC Project Manager. If the additions or changes are agreed upon then the final copy supplied by the FPC Project Manager will reflect the agreed upon items. In no event will the Project A/E modify the final sections supplied by the FPC Project Manager.

The following is a listing of the standard Division 1 Sections:

- 01 11 00 - Summary of Work
- 01 23 00 - Alternates (Modifications in coordination with A/E Team)
- 01 25 00 - Substitution Procedures
- 01 25 00 - Contract Modification Procedures
- 01 29 00 - Payment Procedures
- 01 31 00 - Project Management and Coordination
- 01 31 26 - Electronic Communications
- 01 31 50 - Project Meetings
- 01 32 00 - Construction Progress Documentation
- 01 33 00 - Submittal Procedures
- 01 42 00 - References
- 01 43 00 - Quality Assurance
- 01 43 39 - Mockups (Required to be provided by A/E Team)
- 01 45 00 - Quality Control
- 01 50 00 - Temporary Facilities and Controls
- 01 60 00 - Product Requirements
- 01 72 50 - Field Engineering
- 01 73 50 - Cutting and Patching
- 01 74 00 - Cleaning
- 01 77 00 - Closeout Procedures
- 01 78 00 - Closeout Submittals
- 01 78 20 - COBie (If directed by RELLIS Facilities Department)

DESIGN CRITERIA

Division 2 – Existing Conditions

SURVEY

A topographic survey will be performed for each project involving new construction and for renovation projects by a surveyor licensed in the State of Texas. Standards of survey should conform to the rules and regulations of the Texas Board of Professional Land Surveying (TBPLS). The land surveyor must provide the professional expertise, trained personnel and equipment necessary to achieve the results disseminated by these standards.

The survey shall include as built and natural information for, but not limited to, topography, existing construction (buildings, roads, sidewalks, etc.), existing utilities on site including closest point of connection if not on site, significant vegetation, easements, etc.

SPECIFICALLY THE SURVEY SHALL:

1. Include a legend of symbols and abbreviations used on the drawing, a north arrow and a graphic scale.
2. Provide contours at a minimum of 1 foot intervals unless directed otherwise by the System Civil Engineer with an error not to exceed 1/2 contour interval.
3. Provide at least two horizontal and one vertical control points with description and elevation to nearest .01'. Datum shall be NAD 83 for horizontal and NGVD 88 for vertical (Grid Values).
4. Provide spot elevations at street intersections and curb, crown of roads, sidewalks, edge of paving including far side of paving, drainage flow line, manhole rims/covers/flowlines, top and bottom of retaining walls, etc. Spot elevation on paving or other hard surface shall be to the nearest .05' and spot elevations on other surfaces to the nearest .1'
5. Include the location of above and below ground structures, man-made and natural features; all floor elevations and finish floor elevations at each entrance of buildings on the property, if applicable.
6. Include the location, size and depth of water, gas and thermal utilities. For depths, coordinate with the Facilities Department. For all Campus Overhead and Underground Utilities Coordinate with: Utilities and Energy Services (UES). Coordinate as needed with ATMOS gas utility.
7. Include the location of fire hydrants available to the property and the size of the main

DESIGN CRITERIA

Division 2 – Existing Conditions

serving each.

8. Include the location and characteristics of power and communications systems above and below grade.
9. Include the locations, size, depth and direction of flow of sanitary sewers, storm drains and culverts serving or on the property; location of catch basins, manholes, and inverts of pipe at each.
10. Provide the name of the operating authority of each utility clearly on survey. Utility Information can be provided by TAMU Utilities and Energy Services, the Facilities Department and TAMUS Facilities Planning Division.
11. Provide the mean elevation of water riparian or littoral body of water.
12. Provide the location of 1% annualized potential and 0.2% annualized potential (100yr & 500-yr) floodplains.
13. Provide the extent of the watershed onto the property.
14. Provide the location of trees along with the species name in English, the caliper in inches (at breast height) and the canopy width.
15. Provide the perimeter outline only of any thickly wooded areas unless otherwise directed.
16. Show boundary lines, giving length and bearing (including reference or basis) on each straight line; interior angles; radius, point of tangency and length of curved lines. Where no monument exists, set a permanent iron pin (monument) or other suitable permanent monument at property corners; drive pin into ground to prevent movement, mark with wooden stake; state on the drawing(s) whether corners were found or set and describe each.
17. Survey shall be reviewed by the FPC Project Manager before being finalized.

SURVEYOR SHALL DELIVER:

The survey shall be drawn using a Computer-Aided design and drafting program and final copy shall be plotted. The survey shall be modeled at 1:1 scale. All dimensions and elevations shall be in English units. The plotted scale shall be 1.0" = 20.00' (or an accepted

DESIGN CRITERIA

Division 2 – Existing Conditions

standard engineering scale 30, 40, 50, 60, 80, 100) and the title block shall include the project name and project number. The final drawing shall be sealed by a Texas RPLS. Upon completion of the survey provide a digital version of the plotted survey containing the native CAD file (along with necessary reference files), a PDF copy of the file, as well as an ASCII file of the processed point data.

SUBSURFACE UTILITY ENGINEERING ASSESSMENT

Provide Subsurface Utility Engineering (SUE) for the area of interest as defined by the project (approximate footprint of the proposed building plus 10' outside of the footprint). SUE should also be conducted where underground utilities will be installed. The width surveyed on either side of the utility alignment should be determined based on the depth and if trench protection is required. The SUE consultant shall follow ASCE 38-02, "Standard Guideline for the Collection and Depiction of Existing Subsurface Utility Data" and coordinate data with A/E design team and owner for the project. CADD files and survey data provided shall be tied into the existing control provided by the A/E team surveyor. All work shall be under the supervision of a Professional Engineer Registered in the State of Texas.

Phase I

Scope: Provide up to Utility Quality Level B during the SD phase of the project. Levels C and B shall be survey level horizontal location of the designation of the utilities.

Deliverables: Field sketches and CADD file with utility information in plan view with appropriate line code, formatting, and labeling to differentiate between levels D, C, and B.

Phase II

Scope: Provide Quality Level A during the DD Phase of the project. Level A shall be survey level horizontal and vertical locating of the utility.

Test Holes: Provide cost for test holes on a per hole basis.

Deliverables: Field sketches, CADD file with amended information from Phase I and Phase II with appropriate line code, formatting, labeling, and symbol embedding to differentiate between levels D, C, B, and A, and Engineering plan(s), sealed by a professional Engineer, to be included in the Construction Drawings. Drawing(s) shall be provided on A/E border.

DESIGN CRITERIA

Division 2 – Existing Conditions

RELLIS ENVIRONMENTAL, ENGINEERING, AND REAL ESTATE RESOURCES

The following study has been completed for the campus and is available upon request:

Phase I Environmental Site Assessment (ESA)

A Phase I Environmental Site Assessment (ESA) has been completed for the entire RELLIS Campus. For A&M System or Member projects, additional Phase I Environmental Site Assessments (ESA) are generally not needed for properties already owned by the A&M System, unless there is reason to believe that a site could have contamination issues (e.g., former service station, dry cleaners, pesticide application site, former wastewater or landfill site). However, for P3 projects, an environmental site screen or a formal Phase I ESA is required to (1) establish a baseline condition prior to development and (2) provide the developer or their financiers assurance that there are no potential liabilities from preexisting conditions. P3 developers shall be responsible for an additional Phase I ESA if needed.

The following studies/assessments along with associated costs shall be the responsibility of the project and/or P3 developer unless noted otherwise:

Phase II Environmental Site Assessment (ESA)

Required for development if Phase I ESA indicates potential pollution liabilities that must be documented through field investigation and sampling. Each project, whether A&M System, Member or P3, shall be responsible for Phase II ESA if needed.

Asbestos and Lead Paint

Any existing structures that are to be renovated or razed on a proposed site must have pre-demolition asbestos surveys and, eventually, abatement. Each project, whether A&M System, Member or P3, shall be responsible for a pre-demolition survey on existing structures and abating the asbestos. It is recommended to complete the survey prior to signing of the development contract so that all parties can have an opportunity to estimate abatement costs impact on project development and understand the effect on schedule. The A&M System shall monitor compliance efforts.

Asbestos abatement or building demolition (even if no asbestos is present) requires 10-day advance notice prior to abatement / demolition to the Texas Department of State Health Services.

For structures built before 1980, a lead paint survey should be included with the asbestos survey, particularly if the structure is to be retained and used as a child-occupied facility.

DESIGN CRITERIA

Division 2 – Existing Conditions

Natural Resource Constraints

Floodplains: Review Federal Emergency Management Agency (FEMA) flood insurance rate maps and site drainage for possible flood impacts to estimate usable area and possible mitigation costs to a planned project.

Wetlands and Waters of the U.S.: If there is any indication that there are possible wetlands or jurisdictional waters of the U.S. that would be impacted by the project development, then a waters and wetlands survey must be conducted by a registered professional engineer or scientist prior to development. It is recommended this work be complete prior to closing so that the P3 developer can know the site constraints and usable acreage. If wetlands would be impacted by development, mitigation or off-setting measures may be required to compensate for the loss of wetlands. Filling or altering waters of the U.S. may require permitting and concurrence from the U.S. Army Corps of Engineers. Either of these can impact project design, cost and schedule.

Threatened and Endangered Species and Migratory Birds: Development of large tracts of rural or raw land may also require prior surveys of threatened and endangered species and nesting surveys of migratory birds. If migratory birds are found to be nesting on the tract, this can restrict the timing of land clearing to outside of the nesting season and may require habitat mitigation measures.

Cultural Resources Constraints: For tracts of raw, undeveloped land, generalized (“desk-top”) antiquities constraints assessments must be conducted prior to Texas Historical Commission (THC) notice (see next section). For properties deemed likely to include antiquities, it may be necessary to conduct archaeology field surveys (site walks and shovel tests) prior to THC notice to ensure that there are no likely antiquities on-site that could limit or slow project development. Also, any structures on site that are 50 years of age or older must also be evaluated for historic significance prior to renovation or demolition.

Under an anticipated MOU with the THC, small projects (5 acres or less) within contiguous, developed campus boundaries would be conducted without prior notice to THC (i.e., the MOU would constitute notice). Any larger or non-contiguous projects require a minimum of 30-days prior notice to THC (see next section). Under the MOU, the THC would review construction or maintenance projects larger than 5 acres in areas where similar activities have not occurred before, but THC would not review projects that are 5 acres or less.

Finally, if federal funds will be directly involved in the project, antiquities reviews must also consider federal listing criteria when evaluating old structures.

Texas Historical Commission (THC) Notice: State antiquities law requires 30-day

DESIGN CRITERIA

Division 2 – Existing Conditions

advance notice to the Texas Historical Commission prior to breaking ground on state-owned land. Aside from an anticipated MOU with the THC (summarized above), there is no lower limit of project size that requires notice. (Texas Natural Resources Code, Chapter 191 Antiquities Code, Sec. 191.0525)

Additional Considerations

Property Condition Assessment (PCA): If the site has existing structures or infrastructure that will be retained and/or renovated, a property condition assessment (PCA) is required for all projects estimated to exceed \$4 million total project budget and recommended for projects less than \$4 million in order to assess the status of:

- **Structural integrity** with estimated engineering cost estimates for structural maintenance or upgrade;
- **Mechanical, electrical and plumbing (MEP)** engineering assessment with estimated engineering cost estimates;
- **Fire & life safety** assessment with estimated engineering cost estimates;
- **Americans with Disabilities Act (ADA)** assessment of building, parking and access with estimated engineering cost estimates.

Each project, whether A&M System, Member or P3, shall be responsible for its own PCA if needed.

Real Estate

- **Survey**. A survey is required to attach to the ground lease as an exhibit to show exactly what area is being leased. The A&M System or Member has the option to obtain the survey. The P3 has the option to obtain the survey with an A&M System authorized surveyor. An access permit is required to enter upon the property in order to survey it.
- **Title**. Leasehold title insurance is not required by the A&M System/Member. The P3 developer shall be responsible for determining whether they want/need title insurance and obtaining accordingly.

HAZARDOUS MATERIALS ASSESSMENT

Hazardous Materials Assessments will be considered on a project by project basis. FPC, UES, SSC or Managing Entity will procure services and manage the cost for hazardous materials assessments for asbestos, lead, mold or any other materials. The hazardous materials assessment firm is to possess all of the licenses, registrations and qualifications to perform services in the State of Texas.

DESIGN CRITERIA

Division 2 – Existing Conditions

GEOTECHNICAL INVESTIGATIONS

If included as a reimbursable service in the A/E Services Agreement the A/E shall include the services of a qualified Geotechnical firm.

Proposal for Geotechnical Services

Borings proposed by the geotechnical engineer are to be indicated on a map with depths.

Where drilled piers are involved, provide a separate hourly rate and a not to exceed cost (based upon 1 trip and 8 hours of time) to be onsite during the first day of pier drilling to verify bearing stratum and other field conditions.

Schedule of rates are to be attached to the proposal.

Drilling & Sampling Methods

Drilling and sampling in accordance with current applicable ASTM standards.

Samples taken at ground surface, at two feet below existing grade and at each change in soil stratification or soil consistency, but not further apart than five feet in each of the borings unless specified.

Rock cores, if applicable are not to be less than 1 3/8" in diameter.

Samples shall be preserved and field logs prepared by an experienced soil technician.

Make any necessary pavement repairs of like material, all spoils to be hauled off or disposed properly.

Field & Laboratory Reports

All parts of the report are to be made in digital format, suitable for distribution and printing. Written reports and analysis shall be on the geotechnical firm's letterhead. Additional information required but not limited to:

- Include with the report a chart illustrating the soils classification criteria and the terminology and symbols used on the boring logs.
- Identify the ASTM or other recognized standard sampling and test methods utilized.

DESIGN CRITERIA

Division 2 – Existing Conditions

- Provide a plot plan with horizontal location and ground elevation of test borings using the same datum as survey.
- Provide vertical sections for each boring plotted and graphically presented showing the number of borings, sampling method used and date of start and finish.
- Soil classified in the field logs in accordance with current applicable ASTM and other standards.
- Description of soil and thickness of each layer
- Where standard penetration testing is utilized, number of blows per foot (N value)
- Depth to cave-in or boring collapse
- Depth to artesian head
- Groundwater elevation and time when water reading was made (repeat observation after 24 hours)
- Presence of gases if odor is noted during drilling.
- Location of strata containing organic materials, wet materials or other inconsistencies that might affect engineering conclusions.
- Description of the existing surface conditions and summarize the subsurface conditions
- Description of sulfates affecting uplift or heave. Test shall be performed in areas lime stabilization is required and in areas known for potential sulfates.

As a minimum, the following tests are to be performed: Moisture Contents, Atterberg Limits, Percent Passing #200 Sieve, Pocket Penetrometer, Unconfined Compression and Unit Dry Weight.

Foundation Evaluation & Recommendations

Foundation support of the structure and slab, including soil bearing pressures, bearing elevations foundation design recommendations, including drilled piers/auger cast piles, potential vertical rise and anticipated settlement.

Anticipation and management of groundwater, including temporary dewatering systems

Lateral earth pressures for design of walls below grade, including backfill, compaction, sub drainage and associated requirements. This shall include design criteria for temporary excavations, temporary protection such as sheet piling, and underpinning.

Soil material and compaction requirements for foundation fill, construction backfill and for the support of structures.

DESIGN CRITERIA

Division 2 – Existing Conditions

Pavement Design

Design parameters for rigid and/or flexible pavement systems, including subgrade treatment, stabilization recommendations and base material as required for pavement type. Include pavement thickness for anticipated uses and design sections.

Stability of Slopes

Where significant slopes are being constructed, modified, loaded with adjacent surcharge, or construction is performed adjacent, provide recommendations for slope stabilization, modification, or reinforcement.

Deliverables

A final report sealed by a Texas Registered Professional Engineer with the project name and project number on the cover page with the report in Acrobat “PDF” format. The PDF shall contain a Table of Contents linked to the corresponding pages.

DEMOLITION

All site demolition shall be indicated on a separate demolition plan indicating all items to be turned over to the FPC and RELLIS Facilities Department. The plan shall indicate all trees and vegetation that shall remain and be protected during construction.

Perform all demolition of existing surface and underground facilities/improvements as required to construct the project. Demolition plans/details shall be included in the design drawings. Underground facilities shall be removed as required to clear construction and in accordance with good prudent practice and considering potential future construction. At a minimum all structures shall be removed to a point 4' below natural ground. All cavities left below ground shall be filled with compacted native material or a flowable fill material and noted on the as-built drawings. The portions of piping systems remaining in place shall be neatly cut and capped/plugged and noted on the as-built drawings. Where partial demolition occurs the remaining portions shall be left in a finished functional condition.

Fill all voids left by clearing and demolition operations with native material compacted in maximum 8" lifts to a density equal to that of the surrounding undisturbed soil.

TREE PROTECTION

Provide adequate tree protection around all trees in the project site that are to remain. Also, refer to Division 1 for additional information

DESIGN CRITERIA

Division 3 – Concrete

CONCRETE

All concrete shall be designed, transported, placed, finished and cured in accordance with American Concrete Institute (ACI) requirements. Components of the concrete mix shall meet applicable ANSI/ASTM requirements. Mix requirements and strength shall be specified by the Design Team for each item of construction. Limit the number of mix strengths specified as much as practical. Hot-weather placement shall comply with current ACI 301 requirements and cold-weather placement shall comply with current ACI 306 requirements.

Concrete form work shall meet applicable ACI requirements.

Concrete reinforcement material, design and placement shall meet the applicable requirements of ACI and the Concrete Reinforcing Steel Institute (CRSI) along with associated ASTM requirements. Reinforcing bars shall be Grade 60. No welded wire fabric reinforcing is allowed except in topping slabs, concrete supported on metal form deck, or unique situations as approved by the FPC Project Manager or The System Member Facilities Department. Main reinforcing bars to be minimum No. 4 in size. Limit No. 3 bars (Grade 40) to ties and dowels.

Admixtures to the concrete mix meeting applicable ANSI/ASTM specifications may be used as recommended by the structural engineer to improve concrete workability, wear/weather resistance characteristics, etc., to better meet project conditions. Pozzolan Admixtures should be used only within the limits recommended by the structural engineer and approved by the Owner.

The project specifications shall clearly establish finish measurement tolerances/standards suitable to the intended use of the surface and its exposure along with other quality control requirements needed to verify the concrete meets the specifications.

Curing compound manufacturer is to provide certification that their product is compatible with the finish flooring scheduled for the space.

The CM/GC is responsible for creating a BIM of the cast-in-place concrete building structure from which shop, fabrication, and as-built drawings shall be derived.

VOID SPACE BELOW GRADE BEAMS

Provide soil retainers at face of grade beams below grade to form a void of sufficient depth to prevent expansion of earth to cause pressure on bottom of beams. Acceptable products are BackFill or SureRetainer by VoidForm Products, or SuperVoid Rib Retainers by SuperVoid Systems.

GENERAL FLOOR LOADING

Design floor live loads on all buildings shall be determined by the International Building Code, with a minimum live loading of 100 pounds per square foot.

Design team shall work with the RELLIS Facilities Department to determine concentrated loads and ensure vibration requirements are met.

PORCHES AND STEPS

All stoops, porches, ramps, docks and steps, exterior and interior should have non-slip surfaces and nosing's where applicable. Slope exterior porches and treads where allowed by Texas Accessibility Standards to drain water. Ponding of water in these areas is unacceptable. It is recommended that exposed concrete work be accomplished in two pours: the first structural and the second a finish topping pour. The other option is protecting the work during construction by the Contractor.

Primary entry floors may not be constructed using brick or pavers since these surfaces are excessively noisy when carts are rolled across them.

Stoops shall be placed at all out swinging doors and shall be isolated from soil movements by void forms or crawl space.

CEMENT FINISHED FLOORS

Cement finished floors should only be for "back-of-house" areas. Generally cement finished floors are to receive hardener with colorant. Positive protection is to be provided to prevent staining and chipping during construction work. Slick finishes shall be avoided.

CRAWL SPACE UNDER SUSPENDED STRUCTURAL FOUNDATIONS

A crawl space is preferred under all buildings. Where a crawl space is included in the design provide a 2 inch thick, 2500 psi unreinforced mud slab, properly sloped and drained. (For further information see *General Information "Crawl Space Under Suspended Structural Foundations"*).

CONCRETE REINFORCING

No welded wire fabric shall be used for reinforcing concrete except in topping slabs or in concrete supported on metal deck forms. All other reinforcing shall be by bars.

DESIGN CRITERIA

Division 3 – Concrete

PRECAST, TILT-UP AND/OR SPECIAL FINISHED CONCRETE

On projects designed for precast, tilt-up and/or special finished concrete, the Specification shall require a sample panel, constructed all as specified, or at least 42 square feet to be erected at the jobsite for approval consideration by The System Member. The approved panel shall remain on the jobsite as a visual criterion which the final construction must match.

ROOF DECKS

The main slope for the roof shall be accomplished by the structural system. Only secondary slopes can be accomplished by insulation.

MOW STRIPS

Include a 2' wide x 4" thick continuous reinforced concrete mow strips around the building in grassed areas which will require mowing. The mow strip shall not be doweled to the building foundation.

Include mow strips along and doweled to the back of the curb in grassed areas adjoining head in parking areas which are subject to car bumper overhang. Mow strip to be sloped in the direction of drainage. Jointing shall be provided to match that in the adjoining curb.

GENERAL

The RELLIS Campus utilizes a limited palette of character-defining materials to draw a consistent built fabric that is identifiable at the campus scale. Materials for the campus are selected to create a unifying aesthetic theme. The predominant facade material for solid areas is brick. Building materials for sites in the secure district may vary somewhat from the overall campus palette. While buildings should still contain feature elements that highlight the campus aesthetic, the RELLIS Red Brick may not be the predominant material for many of these facilities when cost is a significant factor. Complementary materials such as concrete, glass, or metal may be used as the predominant material.

BRICK

Brick masonry to be designed and constructed per the standards of the Brick Industry Association (BIA).

BRICK SELECTION PROCEDURE

Face Brick generally shall be ASTM C216; Type FBS grade SW unless indicated otherwise in POR.

In the drawings the A/E will provide a detail that indicates the size of mock-up panel that will contain all exterior materials such as brick, stone, cast stone, curtain wall, glazing, frames, waterproofing, flashings, sealants, etc. for final approval of all exterior colors for the project as well as assembly means and methods. The material colors will be selected to match the RELLIS standard color. The approved panel shall remain on the jobsite as a visual criterion which the final construction must match.

Product Basis of Design: Acme Brick: www.brick.com

Color and Texture: BLEND 129 University RELLIS Red Modular Velour or equal.

Nominal Size: As indicated on drawings

Mortar shall be Type N with concave tooled joints.

Mortar is Spec Mix white - SM 200 White PCLN or approved equal.

Expansion joints and control joints in masonry veneer walls shall be appropriately detailed and shown on building elevations.

CONCRETE MASONRY UNITS (CMU)

Concrete masonry units shall be used as back up for exterior face brick for service yard enclosures. Concrete masonry units shall comply with ASTM C90.

CUT STONE

Stone shall be no closer than 4 inches to grade when adjacent to lawns and planting areas. Interior limestone masonry shall be sealed. Clean using only Soap and Water, avoid staining from cleaning solutions of adjacent masonry surfaces.

Limestone: Texas Lueders Limestone
Pattern and Location: As indicated on Drawings
Color: Buff
Nominal Size: As indicated on drawings

Marble and granite should be domestic.

CAST STONE

Cast Stone shall be manufactured to match natural Lueders Limestone. Reference RELLIS entrance columns for example.

OVERHEAD MASONRY

Construction where the masonry units are supported overhead using concealed mechanical devices in tension, or where the units extend beyond lower courses using concealed mechanical support devices in tension shall not be used.

MASONRY ACCESSORIES

Mortar net or a comparable mortar collection product shall be added to the base of brick veneer and single wythe concrete masonry walls to prevent clogging of weep holes.

Masonry veneer anchors, dowels, termination bars and other accessories used in setting stone and brick veneer shall be stainless steel.

Base wall flashings and other thru wall flashings shall be stainless steel.

DESIGN CRITERIA

Division 4 – Masonry

CLEANING

RELLIS domestic water source has trace minerals that remain after initial masonry cleaning. Assume four additional clean and rinses required on surfaces.

Remove excess mortar and mortar smears as work progresses. Clean soiled surfaces with cleaning solution. Comply with recommendation of manufacturers of chemical cleaners for protecting building surfaces against damage from exposure to their products.

For stone masonry clean using only Soap and Water, avoid staining from cleaning solutions of adjacent masonry surfaces.

STRUCTURAL STEEL

The contractor shall be required to provide an affidavit, at the completion of the project, that the structural steel framing is plumb and level within the normal tolerances specified in the AISC Code of Standard Practice.

The main slope for the roof shall be accomplished by the structural system. Only secondary slopes can be accomplished by the roof system.

The CM/GC is responsible for creating a BIM of the structural steel from which shop, fabrication, and as-built drawings shall be derived.

All exterior structural steel is to be hot dipped galvanized, as are smaller members mentioned in this section.

The A/E is responsible for ensuring all miscellaneous steel is properly identified in the construction documents, including coordinating elevator hoistway rails and divider beam where required.

COLD-FORMED METAL FRAMING

Cold-formed metal floor and wall framing shall be spaced per code.

METAL FABRICATIONS

All exterior ferrous metals shall be hot dip galvanized including but not limited to ladders, bollards, ledge angles, shelf angles, lintels.

Paint exposed galvanized metal fabrications where desired.

Wherever dissimilar metals come in contact with each other, they must be separated with an approved layer of bituminous coating. Galvanized metal or zinc plated fasteners shall not be used to anchor aluminum or copper. Use aluminum or copper fasteners.

METAL STAIRS

Metal stairs with concrete, terrazzo or other similar treads are acceptable for use as egress stairs. All exterior metal stairs shall be galvanized. All stairs shall have cast in or applied safety nosings.

DESIGN CRITERIA

Division 6 – Wood, Plastics, and Composites

GENERAL

Consider specifying products from sustainable sources such as FSC Certified Wood or regionally available from abundant sources. Avoid use of imported or exotic species of woods.

WOOD TREATMENT

Wood used in conjunction with roofing installations and wood which is installed in contact with concrete or masonry shall be pressure treated with an approved preservative to meet AWPA U1 Standards. Other installations shall receive prime coats suitable for finishes specified as soon as installation is complete. Back prime where dampness or warping is anticipated.

Interior Fire Retardant where required, shall be AWPA U1, Use Category UCFA, Commodity Specification H, low temperature (low hygroscopic) type, chemically treated and pressure impregnated; capable of providing a maximum flame spread index of 25 when tested in accordance with ASTM E84, with no evidence of significant combustion when test is extended for an additional 20 minutes.

SHEATHING

Exterior wall construction with metal stud back-up sheathing material shall be Glass Mat Faced Sheathing: Glass mat faced gypsum substrate as defined in ASTM C1177/C1177M.
Board Thickness: 5/8 inch.
Edges: Square.

PLYWOOD

Communications and Electrical Room shall include mounting Boards: PS 1 A-D plywood, or medium density fiberboard; 3/4 inch thick; flame spread index of 25 or less, smoke developed index of 450 or less, when tested in accordance with ASTM E84. Ensure that the manufacturer UL rated label is not painted over.

FINISH CARPENTRY

Materials and fabrication shall conform to Architectural Woodwork Institute specification for Custom quality work.

DESIGN CRITERIA

Division 6 – Wood, Plastics, and Composites

MILLWORK

Materials and fabrication shall conform to and provide products of quality specified by AWI Architectural Woodwork Quality Standards Illustrated for “Custom Grade”
Provide “Premium Grade” for unique and special features.

ARCHITECTURAL WOOD CASEWORK

Provide Materials and fabrication shall conform to Architectural Woodwork Institute specification for Premium quality work.

DESIGN CRITERIA

Division 7 – Thermal and Moisture Protection

GENERAL INFORMATION

Building Envelope shall comply with State Energy Code, ASHRAE 90.1-latest adopted edition.

A method to clean all exterior glazing must be incorporated into the project. This includes cleaning from ground mounted equipment and lifts up to 3 stories and providing means such as davits and roof anchors for exterior staging. Verify method with RELLIS Facilities Department.

BUILDING INSULATION

Maximize insulation value of the building envelope to conserve energy and incorporate an air barrier. Avoid insulation material containing formaldehyde and consider insulations with recycled content. Exterior insulation shall be continuous (CI).

Non-combustible is recommended in place of foam-based products (polyurethane, polystyrene, etc.), and is especially important in unprotected, concealed spaces, such as attics and crawl spaces, or in hollow-core walls that will be penetrated by electrically-rated equipment. Follow applicable codes for foam-based plastics where used.

Where spray foam based products are exposed, thermal and ignition barriers shall be incorporated.

ROOFING

Renovations of existing roofs shall confirm with RELLIS Facilities Department for system type to be used.

All new roofing systems shall be determined with RELLIS Facilities Department or as indicated in this Division. The use of sloped roofs provides a connective element to unify the campus from a broader vantage point. These roofs shall be standing seam metal roofs and may also incorporate deep overhangs

Specify service walkways (minimum 2'0" in width) appropriately located to service all roof top equipment from the roof access.

Carefully detail roof expansion joints and flashing.

Completely detail all parapet walls, caps, coping and scuppers. Top of coping should slope toward roofs.

Detail roof edges sufficiently high to prevent water from spilling over and spotting walls and

DESIGN CRITERIA

Division 7 – Thermal and Moisture Protection

fascias where roof drains are used.

Provide drips on overhangs, ledges, window stools and coping to prevent discolorations of fascias, soffits and walls.

Ensure that sealants specified are to be used within their limitations.

Flashing materials for permanent type buildings to be aluminum, stainless or copper (not galvanized metal).

Slope roof adequately to drain (minimum 1/4"/ft. slope). Design primary roof slopes for new buildings into structural frame and not by roof insulation. Crickets to roof drains may be sloped with insulation. Metal building roofs (minimum 1/4"/ft. slope).

Lightweight concrete insulating fill roof decks will not be used in conjunction with urethane roof system. Lightweight structural concrete is allowed.

Roof systems for new and existing facilities shall meet International Building Code and NRCA requirements and be selected to meet the specific design requirements of each building considering the following criteria:

- Life Cycle Cost
- Sustainability
- Roof Penetrations
- Roof Traffic to access and repair/maintain roof mounted equipment
- Maintainability of Roof System
- Differential movement
- Historical Requirements
- Visibility from Adjacent Facilities/Aesthetics

Specified roof systems shall carry a manufacturer's 20-year warranty.

Design shall minimize roof mounted equipment where possible otherwise the design shall include "passive" fall protection such as parapets and/or guardrails. Enclosed penthouses are encouraged.

Manufacturer shall visit the site at the appropriate intervals and review installation to verify warranty is enforceable.

A/E team and any 3rd party envelope consultant shall observe the roof installation at progress intervals similar to pre-construction, 30%, 60% and 90% complete.

Quality Control checklist from the contractor is required to include a plan for roof installation. Contractor shall protect the roof system during all construction activities and repair as needed prior to substantial completion.

DESIGN CRITERIA

Division 7 – Thermal and Moisture Protection

Metal Roof Panels

Metal Panels: Factory-formed panels with factory-applied finish.

Steel Panels: Zinc-coated steel conforming to ASTM A653/A653M; minimum G60 galvanizing.

Steel Thickness: Minimum 24 gage (0.024 inch).

Profile: Zee-Lock Double Lock, with separate snap-on battens of same metal as panels; concealed fastener system. Place standing seam clips at 18" O.C. max in the field and perimeter, 9" O.C. max in the corner roof areas.

Texture: Smooth, with intermediate ribs for added stiffness.

Length: Full length of roof slope, without lapped horizontal joints.

Width: Maximum panel coverage of 16 inches.

Finish: Fluoropolymer Coating System: Manufacturer's standard multi-coat thermocured coating system, including minimum 70 percent fluoropolymer color topcoat with minimum total dry film thickness of 0.9 mil; color and gloss to match sample.

Basis of Design: Berridge "Antique Copper-Cote"

Single Ply

Membrane: Flexible, heat weldable sheet composed of thermoplastic polyolefin polymer and ethylene propylene rubber; complying with ASTM D6878/D6878M, with polyester weft inserted reinforcement and the following additional characteristics:

Thickness: 0.080 inch plus/minus 10 percent

Puncture Resistance: 415 lbf, minimum, when tested in accordance with FTM 101C Method 2031.

Solar Reflectance: 0.79, minimum, when tested in accordance with ASTM C1549.

SRI: 92 minimum.

Color: White.

DESIGN CRITERIA

Division 7 – Thermal and Moisture Protection

GUIDE SPECIFICATION

URETHANE FOAM ROOF SYSTEM (FOR REPAIRS ONLY)

- GENERAL
- SUBMITTALS: The following shall be submitted for review by the project architect prior to the start of any contract roof work.
- SCOPE
 - This section specifies polyurethane foam roof systems.
 - Packaging: Materials are to be received in sealed containers of the approved manufacturer; shipped from the factory with legible manufacturer's labels and underwriters labels thereon where applicable.
 - Batch Date: Age of packaged materials shall be evidenced by the date of batch clearly stamped on the container.
 - All material shall be new and to be applied within six (6) months from time manufactured as evidenced by the batch date.
- WARRANTY
 - Roofing System: The Contractor shall provide a manufacturer's written warranty, as specified in paragraph 3.5, covering failure of the Foam Roof System against defects in manufacturing, materials, and/or workmanship. Failure is defined to include, but is not necessarily limited to, defects or deterioration of the system resulting in material discoloration, delamination, peeling, or cracking. Warranty period is ten (10) years after the date of substantial completion.
 - Guarantee Inspections: On expiration of the first year and at least every other year thereafter of the guarantee period, the Coating Manufacturer Accompanied by the Owner shall inspect the urethane foam and coating system to determine the condition of the roof.
 - Any repairs that are necessary shall be accomplished as stated in the guarantee.
 - The Coating Manufacturer shall submit to the Owner a report stating the results of each inspection as it affects the remaining period of the guarantee.

DESIGN CRITERIA

Division 7 – Thermal and Moisture Protection

- PRODUCTS

- GENERAL REQUIREMENTS

- Urethane Foam Roof System shall be UL-790 (ASTM E-108) Class A and UL-723 (ASTM E-84) approved, and comply with International Building Code requirements. Roofing System shall also comply as an assembly with UL 1256, Fire Test of Roof Deck Constructions. Roofing System shall comply with UL-1897 Standard for Wind Uplift and UL-2218 Standard for Impact Resistance.

- SPRAY APPLIED MEMBRANE MATERIALS

- Primers: As required by Materials Manufacturer for the following items or conditions:

Non-ferrous metals.

Ferrous metals.

- All applications shall be applied with the appropriate mil thicknesses as recommended by the approved manufacturer.
- Polyurethane Foam: Provide 3 PCF Density, two Component System, 1:1 ratio formulated for use on roofs where smooth surface characteristics are desired.
- Approved manufacturers: If it meets the criteria of this specification, the following manufacturers will be acceptable;

PSI - S245-30 (SS, RS, WS) Bay Systems North America, Spring, Texas

Elastospray HPS-81302, BASF, Carrollton, Texas

RT-2031, Resin Technology, Ontario, California

- Foam manufacturer shall provide manufacturing date of foam components. Foam shall be applied within six months of date of manufacture.

- SILICONE COATING SYSTEM

- Silicone coating shall consist of a two-coat system, fluid applied elastomeric membrane with granules for protection of polyurethane foam.
- Approved manufacturers: If it meets the criteria of this specification, the following manufacturers will be acceptable:

BASF Elastocoat Silicone 3-5000

Everest Silicone Coating - Eversil 580

- Silicone Coating - SCM 3308 Base Coat and SCM 3304 Top Coat

DESIGN CRITERIA

Division 7 – Thermal and Moisture Protection

Neogard RTV Silicone #7850

- Coating manufacturer shall provide manufacturing date of coating components. Coating shall be applied within six months of date of manufacture.
- Granules: Shall be #1 grit blasting sand. Color to be selected from manufacturer's standard colors.

○ ACCESSORIES

- Roof Jacks: As recommended by the roof system manufacturer, high temperature vents shall have insulation sleeve and storm collar. Roof jack construction and installation shall meet requirements of the International Building Code, International Plumbing Code, International Mechanical Code and NFPA 54, National Fuel Gas Code.

○ EXECUTION

○ SURFACE PREPARATION

- Inspect existing roof system and parapet prior to starting any work. Make note and notify Owner of conditions unfavorable to beginning work.
- All ferrous metal flashing, trim, vent stacks, cants, etc. will be cleaned dust and grease free prior to priming with specified primer.
- All non-ferrous metals will be cleaned and chromate etched prior to applying specified primer.
- No primer will be installed over metals, ferrous or non-ferrous, without a visual inspection by the Owner's representative of all preparation. Failure of inspection may constitute removal of work and work re-attempted until accomplished correctly without any additional cost to the Owner.

○ APPLICATION OF SPRAY FOAM

- Prior to spraying foam the following criteria must be met: Contractor shall give the Owner 48 hours' notice prior to spraying any material, including primer, foam or coating.
- The Contractor shall provide all necessary barricades, signs, warning of spray area as determined in the preconstruction conference. The Contractor shall set these signs out the night before spraying begins.

DESIGN CRITERIA

Division 7 – Thermal and Moisture Protection

- The Contractor shall be responsible for the removal of signs and barricades at the completion of the job.
- The Contractor shall protect any automobile, bicycle, vehicle or other property which is located in a warning area where contact with the Owner has not been made. The Contractor shall secure the property with a polyethylene cover and maintain as necessary during spray operations.
- The Contractor shall employ approved wind screens for all foam applications. The Contractor is responsible for all overspray and shall have sole liability where damage occurs as a result of this work. Suspend foam spraying when wind speeds exceed 15 miles per hour.
- Spray foam applicator shall be approved by the materials manufacturer. Spray foam operations shall be performed only during adequate period of calm, open weather, roof surface and ambient temperature above 50 degrees F., winds not exceeding 15 miles per hour. Protect all property from overspray or other damage.
- Roof surfaces to receive spray foam shall be dry and free of dew or frost. Primer shall be dried free of solvent. One gallon per 100 square feet of surface minimum coverage. Any areas where the primer is ponding shall be removed down to the existing surface and re-primed with one thin coat of primer.
- In areas where total tear off of existing built-up roofing is indicated, apply two inches of new urethane foam roof system as needed to ensure positive drainage.
- In areas where partial removal of existing foam roofing is indicated, remove one-half inch to one inch of existing foam and apply one of new urethane foam to ensure positive drainage. Spray foam shall be applied in smooth uniform thickness over the entire area except those areas where greater thickness is required for proper drainage, and where other thicknesses are called for on the drawings. Foam shall be covered onto the walls, projections and feathered smoothly into drains, as indicated by the drawings. Grind foam smooth and trough around drains for proper drainage.
- Low areas, which form puddles, shall be no longer than 18 inches in longest dimension and no deeper than ½ inch. Contractor shall perform a water test 48 hours prior to final inspection, to identify low areas and ensure all roof drains are functioning properly.
- The quantity of spray foam installed per day shall be regulated by the applicator's capacity to apply protective coating during the same day. Any

DESIGN CRITERIA

Division 7 – Thermal and Moisture Protection

foam left exposed overnight, to include tie-ins, shall be dried and thoroughly primed prior to continuing with the application of new foam or coating.

DESIGN CRITERIA

Division 7 – Thermal and Moisture Protection

- Finished Surfaces: The finished surface texture of the applied spray foam shall be free of excessive ridges, bumps and pinholes, etc. "Popcorn" or "Tree Bark" surfaces as defined by the UFCA coating committee are not acceptable. The finished surface shall be in acceptable condition, without water, dew or excessive moisture prior to application of the specified coating system.
- PROTECTIVE COATING
 - The coating applicator shall be approved by the material manufacturer. Protect all property from overspray or other damage.
 - Protective Coating: Silicone coat shall be applied the same day the foam is applied. **NO EXCEPTIONS ALLOWED!**
 - Equipment: Shall be as required by the approved coating manufacturer.
 - Silicone Coating, Base Coat: Apply to all horizontal surfaces to yield an average of 8 dry mils thickness on horizontal surfaces and 8 dry mils on vertical surfaces. The base coat shall be applied in a single coat using airless spray equipment. Coating to be sprayed using crosshatch method making sure the entire surface is coated evenly without pinholes, sags or curtains.

NOTE TO APPLICATOR: Backroll basecoat to ensure adequate seal of existing surface.

- Intermediate Coat: Apply to all horizontal surfaces to yield an average of 8 dry mils thickness on horizontal surfaces and 8 dry mils on vertical surfaces. Coating to be sprayed using crosshatch method making sure the entire surface is coated evenly without areas of pinholes or sags.

NOTE TO APPLICATOR: The above quantities should yield a minimum of 16 dry mils must be achieved prior to top coat and granule application. Upon the satisfaction of proper foam texture requirements, these minimum requirements can be achieved. A wet mil gauge should be used to check thickness. Verify application thicknesses by taking sample slits to ensure minimums. Granules cannot be applied until Owner can verify that the manufacturer's required minimum thicknesses have been achieved.

- Silicone Coating, Top Coat: Apply to all horizontal surfaces to yield an average of 8 dry mils thickness and 8 dry mils of vertical surfaces. Coating to be sprayed using crosshatch method making sure the entire surface is coated evenly without areas of pinholes or sage.

DESIGN CRITERIA

Division 7 – Thermal and Moisture Protection

- Granules: Immediately upon completion of topcoat application, granules shall be

DESIGN CRITERIA

Division 7 – Thermal and Moisture Protection

uniformly broadcast over the wet silicone, at the rate of 50# per 100 square feet, totally covering the entire silicone roof surface.

- Details: Apply an extra heavy coating in each application around all projections, parapet wall, junctions and drains. Coating shall be applied beyond the foam in a double lap coat 4 inches or as far as possible.
- Batch Mixing: Shall be as recommended by the approved coating manufacturer. Contractor shall submit for approval all documentation regarding the proper mixing and batching of elastomeric coating material. Identify procedure, process of mixing, equipment required, components and sequencing solvents required.

○ INSPECTION

- The Contractor shall maintain a daily project log containing the following information:
 - Temperature and relative humidity at start time, midday and end of day (sling psychrometer permitted)
 - Wind velocity (speed and direction)
 - Sky conditions (overcast, partly cloudy, etc.)
 - Amount of coated foam or coating installed
 - General remarks

- The coating manufacturer shall make an on-site inspection, accompanied by the Owner upon completion of the project. The manufacturer shall submit a report to the Owner stating the final results of the on-site inspection and approval of the application of the materials.
- The inspection shall include, but not be limited to the following: A slit sample, each 2,000 sf., 2 inches long x 1/2 inch wide x 3/4 inch deep. Slits shall be closed by the Contractor using an approved silicone caulk. Depth of foam shall be measured adjacent to slit area.
 - Film thickness shall be measured. Overall thickness shall average 24 mils, with top coat of 8 mils. Thickness shall not vary over .5 mils.

○ CLEANUP

- Limited equipment cleanup, such as nozzles, on the roof will be allowed, and only with a suitable nonflammable solvent such as methylene chloride. Major cleaning of equipment shall be confined to the ground.

DESIGN CRITERIA
Division 7 – Thermal and Moisture Protection

- GUARANTEE
 - The Contractor shall certify that the foam and coatings were applied in accordance

DESIGN CRITERIA

Division 7 – Thermal and Moisture Protection

with the manufacturer's recommended procedures. The Contractor shall submit an executed copy of the Guarantee before final payment.

- The Contractor shall furnish to the Owner a manufacturer's written guarantee, guaranteeing all materials and workmanship for a period not less than ten (10) years from date of final acceptance.
- The urethane foam and silicone coating system shall be guaranteed against failures of workmanship and materials. Repair of the system, including materials and labor, shall be at no cost to the Owner.
- On expiration of the first year of the guarantee, the **COATING MANUFACTURER, FOAM MANUFACTURER AND CONTRACTOR** accompanied by the Owner, shall inspect the urethane foam and coating system to determine the condition of the roof.
- Any repairs that are necessary shall be accomplished as stated in the guarantee.
- The coating manufacturer shall submit to the Owner a report stating the results of each inspection for the remaining period of the guarantee.

DESIGN CRITERIA

Division 8 – Openings

GENERAL

Building fenestration shall comply with State Energy Code, ASHRAE 90.1-latest adopted, including assembly U values, assembly SHGC and percentage of glass.

Ensure that windows, doors, and louvers are designed for adequate wind loading and velocity pressures per International Building Code and Texas Windstorm requirements as applicable.

All general use building entrances shall have a vestibule. At least one door at primary entrances shall be power operated.

Doors may be sliding or swinging, as appropriate to the building use and design, with safeguards and handicapped accessibility as necessary. One-way or two-way types may be used, depending upon traffic. Door types, materials, hardware, and sensors shall be established designs with proven field experience under similar usage. Consideration shall be given to availability of trained service technicians and spare parts.

One or more entrance doors may require card key access. The door frames shall be prepped as a part of the design and construction of the building. The card key devices shall be acquired by the Campus and delivered to the Contractor for installation.

The use of daylighting in the building design is strongly encouraged. Use of skylights is not allowed unless approved in writing by the RELLIS Facilities Department. Use of protected clerestory glazing is allowed.

Warning bars or cross mullions shall extend across all full height glazed areas. Meet requirements of "Model Safety Glazing Code" and "Consumer Product Safety Commission."

DOORS AND FRAMES

Exterior and interior personnel doors shall not be taller than 7 feet high unless approved by the RELLIS Facilities Department and TAMU EH&S for smoke and fire barrier compliance. Coordinate with equipment needs for size and width

All entrance doors and frames shall be hinge and strike reinforced for "High Frequency" use.

Hollow Metal Exterior Doors shall be not less than 16 gauge with 14 gauge or heavier one piece welded frame. Door and frame shall be A60 galvanized.

Interior Hollow Metal Doors shall be not less than 18 gauge with 16 gauge one piece welded frame.

Interior wood doors shall be at least 1-3/4" thick to accommodate mortise locks.

DESIGN CRITERIA

Division 8 – Openings

Interior wood doors are generally flush type, solid core, hardwood. Wood doors can be either wood veneer or plastic laminate faced. Exotic wood veneers are prohibited.

Coordinate access with large equipment in Mechanical and Electrical rooms for moving or replacement equipment for adequate clearance.

ENTRANCES, STOREFRONTS, AND CURTAINWALLS

Metal framed glazed entrance assemblies shall have stiles of sufficient width to receive mortise locksets and/or panic hardware. Custom styled doors with vision panels may be used. Locksets shall be at conventional height and shall not be permitted in bottom rails. Bottom rail shall be a minimum of 12 inches and top rail shall be a minimum of 6 inches.

Wherever possible utilize storefront systems instead of curtainwall systems.

Include in specifications, steel reinforcing inserts in the hinge jamb section of doors in aluminum storefront systems.

Color of storefront, curtainwall and window frames shall match the campus standard - Medium Bronze, Class 1 anodized.

Curtainwalls are expected to be placed on a formed concrete curb at the building perimeter.

Automatic Operator Supplier Qualifications: Power operator products and accessories are required to be supplied and installed through current members of the manufacturer's "Power Operator Preferred Installer" program. Suppliers are to be factory trained, certified, and a direct purchaser of the specified power operators and be responsible for the installation and maintenance of the units and accessories indicated for the Project.

WINDOWS

Heads, jambs, and sills of windows in walls shall be flashed and shall be caulked or sealed during the window installation, prior to the placement of snap-on moldings or covers, to ensure that concealed surfaces are properly sealed against the penetration of wind and water. Flashing shall include pre-molded end dams. All windows should have drips at heads and sills.

Projected and casement type windows, and flush mounted windows are difficult to maintain watertight and their use is discouraged.

Design windows with maintenance in mind and include provisions for cleaning windows including elevated systems. Verify accessibility for cleaning during Design development.

DESIGN CRITERIA

Division 8 – Openings

Provide a typical sample window with weather resistive barrier and flashing in the exterior mock-up. The completed install should be reviewed with all exterior wall components.

HARDWARE

The hardware schedule shall be included in the project specifications.

A minimum of one pair of exterior double doors shall have a keyed, removable mullion for equipment access.

Coordinate access with users for moving mobile equipment out of buildings or spaces for adequate clearance.

All doors leading into hazardous spaces, mechanical, electrical and telecommunication rooms shall have a textured surface on the door lever.

All doors at wet and high humidity areas such as kitchens, shower rooms, mechanical rooms, etc. shall have a brass or bronze (non-ferrous) base metal hinge or stainless steel hinge.

All doors having closers should be protected from wear of wheelchairs by a minimum of 10" high kickplates.

Do not specify pivot hinges or concealed closers.

The A/E shall investigate the security requirements for the project and develop an appropriate keying system. Final keying functions shall be established during a key conference conducted by FPC, with the A/E, User, RELLIS Facilities Department, TAMU Building Access (The Key Shop), Contractor, and successful hardware supplier during construction.

Verify other requirements such as extra key blanks, key box, etc. with the User and RELLIS Facilities Department.

Verify Knox Box type and location with TAMU EH&S, One Blue for Police Department and One Red for Fire Department is required.

HANGING DEVICES

Hinges: ANSI/BHMA A156.1 certified butt hinges with number of hinge knuckles as specified in the Door Hardware Sets.

- Quantity: Provide the following hinge quantity, unless otherwise indicated:
 - Two Hinges: For doors with heights up to 60 inches.
 - Three Hinges: For doors with heights 61 to 90 inches.
 - Four Hinges: For doors with heights 91 to 120 inches.
 - For doors with heights more than 120 inches, provide 4 hinges, plus 1 hinge for every 30 inches of door height greater than 120 inches.
- Hinge Size: Provide the following, unless otherwise indicated, with hinge widths sized for door thickness and clearances required:
 - Widths up to 3'0": 4-1/2" standard or heavy weight as specified.
 - Sizes from 3'1" to 4'0": 5" standard or heavy weight as specified.
- Hinge Weight and Base Material: Unless otherwise indicated, provide the following:
 - Exterior Doors: Heavy weight, non-ferrous, ball bearing or oil impregnated bearing hinges unless Hardware Sets indicate standard weight.
 - Interior Doors: Standard weight, steel, ball bearing or oil impregnated bearing hinges unless Hardware Sets indicate heavy weight.
- Hinge Options: Comply with the following where indicated in the Hardware Sets or on Drawings:
 - Non-removable Pins: Provide set screw in hinge barrel that, when tightened into a groove in hinge pin, prevents removal of pin while door is closed; for the all out-swinging lockable doors.

Acceptable Manufacturers:

- Hager Companies (HA).
- McKinney Products (MK).

Continuous Geared Hinges: ANSI/BHMA A156.26 Grade 1-600 certified continuous geared hinge. with minimum 0.120-inch thick extruded 6060 T6 aluminum alloy hinge leaves and a minimum overall width of 4 inches. Hinges are non-handed, reversible and fabricated to template screw locations. Factory trim hinges to suit door height and prepare for electrical cut-outs.

- Acceptable Manufacturers:
 - Bommer Industries (BO).

DESIGN CRITERIA

Division 8 – Openings

- McKinney Products (MK).
 - Pemko Manufacturing (PE).

DESIGN CRITERIA

Division 8 – Openings

Floor Closers: ANSI/BHMA A156.4 certified floor closers. Provide independent and adjustable valves for closing speed, latch speed, and backcheck with built-in dead stop and hold open features as specified. Provide finished cover plates or thresholds as indicated in door Hardware Sets.

- Acceptable Manufacturers:
 - Dorma Products (DO).
 - Rixson Door Controls (RF).

Sliding and Folding Door Hardware: Hardware is to be of type and design as specified and should comply with ANSI/BHMA A156.14.

- Acceptable Manufacturers:
 - Hager Companies (HA).
 - Pemko Manufacturing (PE).

POWER TRANSFER DEVICES

Electrified Quick Connect Transfer Hinges: Provide electrified transfer hinges with Molex™ standardized plug connectors and sufficient number of concealed wires (up to 12) to accommodate the electrified functions specified in the Door Hardware Sets. Connectors plug directly to through-door wiring harnesses for connection to electric locking devices and power supplies. Wire nut connections are not acceptable.

- Acceptable Manufacturers:
 - Hager Companies (HA) - ETW-QC (# wires) Option.
 - McKinney Products (MK) - QC (# wires) Option.

Electrified Quick Connect Continuous Geared Transfer Hinges: Provide electrified transfer continuous geared hinges with a 12" removable service panel cutout accessible without de-mounting door from the frame. Furnish with Molex™ standardized plug connectors with sufficient number of concealed wires (up to 12) to accommodate the electrified functions specified in the Door Hardware Sets. Connectors plug directly to through-door wiring harnesses for connection to electric locking devices and power supplies. Wire nut connections are not acceptable.

- Acceptable Manufacturers:
 - McKinney Products (MK) - SER-QC (# wires) Option.
 - Pemko Manufacturing (PE) - SER-QC (# wires) Option.

Electric Door Wire Harnesses: Provide electric/data transfer wiring harnesses with standardized plug connectors to accommodate up to twelve (12) wires. Connectors plug directly to through-door wiring harnesses for connection to electric locking devices and power supplies. Provide sufficient number and type of concealed wires to accommodate electric function of specified hardware. Provide a connector for through-door electronic locking devices and from hinge to junction box above the opening. Wire nut connections are not acceptable. Determine the length required for each electrified hardware component for the door type, size and construction, minimum of two per electrified opening.

- Provide one each of the following tools as part of the base bid contract:

DESIGN CRITERIA

Division 8 – Openings

- McKinney Products (MK) - Electrical Connecting Kit: QC-R001.
 - McKinney Products (MK) - Connector Hand Tool: QC-R003.
- Acceptable Manufacturers:
 - McKinney Products (MK) – QC-C Series.

DOOR OPERATING TRIM

Flush Bolts and Surface Bolts: ANSI/BHMA A156.3 and A156.16, Grade 1, certified.

- Flush bolts to be furnished with top rod of sufficient length to allow bolt retraction device location approximately six feet from the floor.
 - Furnish dust proof strikes for bottom bolts.
 - Surface bolts to be minimum 8” in length and U.L. listed for labeled fire doors and U.L. listed for windstorm components where applicable.
- Provide related accessories (mounting brackets, strikes, coordinators, etc.) as required for appropriate installation and operation.
 - Acceptable Manufacturers:
 - Ives (IV).
 - Rockwood Manufacturing (RO).
 - Trimco (TC).

Coordinators: ANSI/BHMA A156.3 certified door coordinators consisting of active-leaf, hold-open lever and inactive-leaf release trigger. Model as indicated in hardware sets.

- Acceptable Manufacturers:
 - Ives (IV).
 - Rockwood Manufacturing (RO).
 - Trimco (TC).

Door Push Plates and Pulls: ANSI/BHMA A156.6 certified door pushes and pulls of type and design specified in the Hardware Sets. Coordinate and provide proper width and height as required where conflicting hardware dictates.

- Push/Pull Plates: Minimum .050 inch thick, size as indicated in hardware sets, with beveled edges, secured with exposed screws unless otherwise indicated.
- Door Pull and Push Bar Design: Size, shape, and material as indicated in the hardware sets. Minimum clearance of 2 1/2-inches from face of door unless otherwise indicated.
- Offset Pull Design: Size, shape, and material as indicated in the hardware sets. Minimum clearance of 2 1/2-inches from face of door and offset of 90 degrees unless otherwise indicated.
- Fasteners: Provide manufacturer's designated fastener type as indicated in Hardware Sets.
- Acceptable Manufacturers:
 - Ives (IV).
 - Rockwood Manufacturing (RO).
 - Trimco (TC).

CYLINDERS AND KEYING

Cylinders: Original manufacturer cylinders complying with the following:

- Mortise Type: Threaded cylinders with rings and cams to suit hardware application.
- Rim Type: Cylinders with back plate, flat-type vertical or horizontal tailpiece, and raised trim ring.
- Bored-Lock Type: Cylinders with tailpieces to suit locks.
- Mortise and rim cylinder collars to be solid and recessed to allow the cylinder face to be flush and be free spinning with matching finishes.
- Keyway: Match Facility Restricted Keyway.

Patented Cylinders: ANSI/BHMA A156.5, Grade 1, certified patented cylinders employing a utility patented and restricted keyway requiring the use of a patented key. Cylinders are to be protected from unauthorized manufacture and distribution by manufacturer's United States patents. Cylinders are to be factory keyed with owner having the ability for on-site original key cutting.

- Acceptable Manufacturers New Construction:
 - Medeco (MC) – No substitution.
 - All Keys Stamped to Texas A&M College Station Standard
 - '0ey Meeting Mandatory on all projects
 - Contacts are Texas A&M Ronnie Schultz 979-458-1335.
 - Medeco Representative Stephen Fox 281-433-0302
 - Key meeting attendees required to attend key meeting: A. General Contractor B. Hardware Distributor Supplying Medeco Keys and Cores and hardware C. Assa Abloy Representative. D. Texas A&M College Station/Rellis Representative
 - All Medeco Products to be shipped to Building Access Ronnie Schultz 600 Agronomy Road. Suite 130 1371 TAMU College Station, TX 77843

Keying System: Each type of lock and cylinders to be factory keyed.

- Conduct specified "Keying Conference" to define and document keying system instructions and requirements.
- Furnish factory cut, nickel-silver large bow permanently inscribed with a visual key control number as directed by Owner.
- New System: Key locks to a new key system as directed by the Owner.

Key Quantity: Provide the following minimum number of keys:

- Change Keys per Cylinder: Two (2)
- Master Keys (per Master Key Level/Group): Five (5).
- Construction Keys (where required): Ten (10).
- Construction Control Keys (where required): Two (2).
- Permanent Control Keys (where required): Two (2).

Construction Keying: Provide temporary keyed construction cores.

Key Registration List (Bitting List):

1. Provide transcript list in writing or electronic file as directed by the Owner.

Key Control Cabinet: Provide a key control system including envelopes, labels, and tags with self-locking key clips, receipt forms, 3-way visible card index, temporary markers, permanent markers, and standard metal cabinet. Key control cabinet shall have expansion capacity of 150% of the number of locks required for the project.

- Acceptable Manufacturers:
 - Lund Equipment (LU).
 - MMF Industries (MM).
 - Telkee (TK).

MECHANICAL LOCKS AND LATCHING DEVICES

Mortise Locksets, Grade 1 (Heavy Duty): ANSI/BHMA A156.13, Series 1000, Operational Grade 1 certified. Locksets are to be manufactured with a corrosion resistant steel case and be field-reversible for handing without disassembly of the lock body.

1. Acceptable Manufacturers:
 - Sargent 8200 – LW1L/LL-26D b. Best 45H - 15H - 626

ELECTROMECHANICAL LOCKING DEVICES

Electromechanical Mortise Locksets, Grade 1 (Heavy Duty): Subject to same compliance standards and requirements as mechanical mortise locksets, electrified locksets to be of type and design as specified below.

1. Electrified Lock Options: Where indicated in the Hardware Sets, provide electrified options including: outside door lock/unlock trim control, latchbolt and lock/unlock status monitoring, deadbolt monitoring, and request-to-exit signaling. Support end-of-line resistors contained within the lock case. Unless otherwise indicated, provide electrified locksets standard as fail secure.
2. Energy Efficient Design: Provide lock bodies which have a holding current draw of 15mA maximum, and can operate on either 12 or 24 volts. Locks are to be field configurable for fail safe or fail secure operation.
3. High Security Monitoring: Provide lock bodies which have built-in request to exit monitoring and are provided with accompanying door position switches. Provide a resistor configuration which is compatible with the access control system.
4. Acceptable Manufacturers:
 - a. Sargent Manufacturing (SA) - 8200 Series.
 - b. Stanley Best (BE) - 40HW EL/EU Series.

AUXILIARY LOCKS

Mortise Deadlocks, Small Case: ANSI/BHMA A156.36, Grade 1, small case mortise type deadlocks constructed of heavy gauge wrought corrosion resistant steel. Steel or stainless steel bolts with a 1" throw and hardened steel roller pins. Deadlocks to be products of the same source manufacturer and keyway as other specified locksets.

d. Acceptable Manufacturers:

- Sargent Manufacturing (SA) - 4870 Series.
- Stanley Best (BE) - 48H Series.

LOCK AND LATCH STRIKES

Strikes: Provide manufacturer's standard strike with strike box for each latch or lock bolt, with curved lip extended to protect frame, finished to match door hardware set, unless otherwise indicated, and as follows:

1. Flat-Lip Strikes: For locks with three-piece antifriction latchbolts, as recommended by manufacturer.
2. Aluminum-Frame Strike Box: Provide manufacturer's special strike box fabricated for aluminum framing.

Standards: Comply with the following:

1. Strikes for Mortise Locks and Latches: BHMA A156.13.
2. Strikes for Auxiliary Deadlocks: BHMA A156.36.
3. Dustproof Strikes: BHMA A156.16.

ELECTRIC STRIKES

Standard Electric Strikes: Heavy duty, cylindrical and mortise lock electric strikes conforming to ANSI/BHMA A156.31, Grade 1, UL listed for both Burglary Resistance and for use on fire rated door assemblies. Stainless steel construction with dual interlocking plunger design tested to exceed 3000 lbs. of static strength and 350 ft-lbs. of dynamic strength. Strikes tested for a minimum 1 million operating cycles. Provide strikes with 12 or 24 VDC capability and supplied standard as fail-secure unless otherwise specified. Option available for latchbolt and latchbolt strike monitoring indicating both the position of the latchbolt and locked condition of the strike.

1. Acceptable Manufacturers:

- Folger Adam EDC (FO).
- HES (HS).

CONVENTIONAL EXIT DEVICES

General Requirements: All exit devices specified herein shall meet or exceed the following criteria:

1. At doors not requiring a fire rating, provide devices complying with NFPA 101 and listed and labeled for "Panic Hardware" according to UL305. Provide proper fasteners as required by manufacturer including sex nuts and bolts at openings specified in the

DESIGN CRITERIA

Division 8 – Openings

Hardware Sets.

2. Where exit devices are required on fire rated doors, provide devices complying with NFPA 80 and with UL labeling indicating "Fire Exit Hardware". Provide devices with the proper fasteners for installation as tested and listed by UL. Consult manufacturer's catalog and template book for specific requirements.
3. Except on fire rated doors, provide exit devices with hex key dogging device to hold the pushbar and latch in a retracted position. Provide optional keyed cylinder dogging on devices where specified in Hardware Sets.
4. Devices must fit flat against the door face with no gap that permits unauthorized dogging of the push bar. The addition of filler strips is required in any case where the door light extends behind the device as in a full glass configuration.
5. Electromechanical Options: Subject to same compliance standards and requirements as mechanical exit devices, electrified devices to be of type and design as specified in hardware sets. Include any specific controllers when conventional power supplies are not sufficient to provide the proper inrush current.
6. Lever Operating Trim: Where exit devices require lever trim, furnish manufacturer's heavy duty escutcheon trim with threaded studs for thru-bolts.
 - a. Lock Trim Design: As indicated in Hardware Sets, provide finishes and designs to match that of the specified locksets.
 - b. Where function of exit device requires a cylinder, provide a cylinder (Rim or Mortise) as specified in Hardware Sets.
7. Vertical Rod Exit Devices: Where surface or concealed vertical rod exit devices are used at interior openings, provide as less bottom rod (LBR) unless otherwise indicated. Provide dust proof strikes where thermal pins are required to project into the floor.
8. Narrow Stile Applications: At doors constructed with narrow stiles, or as specified in Hardware Sets, provide devices designed for maximum 2" wide stiles.
9. Rail Sizing: Provide exit device rails factory sized for proper door width application.
10. Through Bolt Installation: For exit devices and trim as indicated in Door Hardware Sets.

Conventional Push Rail Exit Devices (Heavy Duty): ANSI/BHMA A156.3, Grade 1 certified panic and fire exit hardware devices furnished in the functions specified in the Hardware Sets. Exit device latch to be stainless steel, pullman type, with deadlock feature.

Acceptable Manufacturers: Sargent Manufacturing

1. Rim Mounted 88 series – ETL Trim
2. Rim Mounted Fire rated 12-88 series – ETL Trim
3. Surface Vertical 87 series – ETL Trim
4. Surface Vertical – Fire-rated 12-87 series – ETL Trim
5. Mortise 89 series – ETL Trim
6. Mortise Fire-rated 12-89 series – ETL Trim
7. Removable Mullion 980
8. Removable Mullion Fire 12-980

DESIGN CRITERIA

Division 8 – Openings

Tube Steel Removable Mullions: ANSI/BHMA A156.3 removable steel mullions with malleable-iron top and bottom retainers and a primed paint finish.

- a. Provide keyed removable feature where specified in the Hardware Sets.
- b. Provide stabilizers and mounting brackets as required.
- c. Provide electrical quick connection wiring options as specified in the hardware sets.
- d. Acceptable Manufacturers:
 - Sargent Manufacturing (SA) - 980S Series.

DOOR CLOSERS

1. General: Door closers to be from one manufacturer, matching in design and style, with the same type door preparations and templates regardless of application or spring size. Closers to be non-handed with full sized covers including installation and adjusting information on inside of cover.
2. Standards: Closers to comply with UL-10C for Positive Pressure Fire Test and be U.L. listed for use of fire rated doors.
3. Cycle Testing: Provide closers which have surpassed 15 million cycles in a test witnessed and verified by UL.
4. Size of Units: Comply with manufacturer's written recommendations for sizing of door closers depending on size of door, exposure to weather, and anticipated frequency of use. Where closers are indicated for doors required to be accessible to the physically handicapped, provide units complying with ANSI ICC/A117.1.
5. Closer Arms: Provide heavy duty, forged steel closer arms unless otherwise indicated in Hardware Sets.
6. Closers shall not be installed on exterior or corridor side of doors; where possible install closers on door for optimum aesthetics.
7. Closer Accessories: Provide door closer accessories including custom templates, special mounting brackets, spacers and drop plates as required for proper installation. Provide through-bolt and security type fasteners as specified in the hardware sets.

Door Closers, Surface Mounted (Heavy Duty): ANSI/BHMA A156.4, Grade 1 surface mounted, heavy duty door closers with complete spring power adjustment, sizes 1 thru 6; and fully operational adjustable according to door size, frequency of use, and opening force. Closers to be rack and pinion type, one piece cast iron or aluminum alloy body construction, with adjustable backcheck and separate non-critical valves for closing sweep and latch speed control. STANDARD PRESSURE RELIEF VALVES FOR BOTH OPENING AND CLOSING CYCLES

Provide non-handed units standard.

1. Acceptable Manufacturers:
 - LCN Closers (LC) - 4040 Series.
 - Sargent Manufacturing (SA) - Sargent 1430, Sargent 1431

AUTOMATIC DOOR OPERATORS

1. General: Provide operators of size recommended by manufacturer for door size, weight, and movement; for condition of exposure; and for compliance with UL 325. Coordinate operator mechanisms with door operation, hinges, and activation devices.
2. Fire-Rated Doors: Provide door operators for fire-rated door assemblies that comply with NFPA 80 for fire-rated door components and are listed and labeled by a qualified testing agency.
3. Brackets and Reinforcements: Manufacturer's standard, fabricated from aluminum with nonferrous shims for aligning system components.
4. Standard: Certified ANSI/BHMA A156.19.
 - Performance Requirements:
 - Opening Force if Power Fails: Not more than 15 lbf required to release a latch if provided, not more than 30 lbf required to manually set door in motion, and not more than 15 lbf required to fully open door.
 - Entrapment Protection: Not more than 15 lbf required to prevent stopped door from closing or opening.
5. Configuration: Surface mounted. Door operators to control single swinging and pair of swinging doors.
6. Operation: Power opening and spring closing operation capable of meeting ANSI A117.1 accessibility guideline. Provide time delay for door to remain open before initiating closing cycle as required by ANSI/BHMA A156.19. When not in automatic mode, door operator to function as manual door closer with fully adjustable opening and closing forces, with or without electrical power.
 - On-off switch to control power to be key switch operated.
7. Features: Operator units to have full feature adjustments for door opening and closing force and speed, backcheck, motor assist acceleration from 0 to 30 seconds, time delay, vestibule interface delay, obstruction recycle, and hold open time from 0 up to 30 seconds.
8. Provide outputs and relays on board the operator to allow for coordination of exit device latch retraction, electric strikes, magnetic locks, card readers, safety and motion sensors and specified auxiliary contacts.
9. Activation Devices: Provide activation devices in accordance with ANSI/BHMA A156.19 standard, for condition of exposure indicated and for long term, maintenance free operation under normal traffic load operation. Coordinate activation control with electrified hardware and access control interfaces. Activation switches are standard SPST, with optional DPDT availability.
10. Signage: As required by cited ANSI/BHMA A156.19 standard for the type of operator.
 - Acceptable Manufacturers:
 - LCN Closers (LC) - 4640 Series.
 - Norton Door Controls (NO) - 6000 Series.
 - Record (RE) – 6100 Series

ARCHITECTURAL TRIM

Door Protective Trim

1. General: Door protective trim units to be of type and design as specified below or in the Hardware Sets.
2. Size: Fabricate protection plates (kick, armor, or mop) not more than 2" less than door width (LDW) on stop side of single doors and 1" LDW on stop side of pairs of doors, and not more than 1" less than door width on pull side. Coordinate and provide proper width and height as required where conflicting hardware dictates. Height to be as specified in the Hardware Sets.
3. Protection Plates: ANSI/BHMA A156.6 certified protection plates (kick, armor, or mop), fabricated from the following:
 - Stainless Steel: 300 grade, 050-inch thick.
4. Options and fasteners: Provide manufacturer's designated fastener type as specified in the Hardware Sets. Provide countersunk screw holes.
5. Acceptable Manufacturers:
 - Ives (IV).
 - Rockwood Manufacturing (RO).
 - Trimco (TC).

DOOR STOPS AND HOLDERS

1. General: Door stops and holders to be of type and design as specified below or in the Hardware Sets.
2. Door Stops and Bumpers: ANSI/BHMA A156.16, Grade 1 certified door stops and wall bumpers. Provide wall bumpers, either convex or concave types with anchorage as indicated, unless floor or other types of door stops are specified in Hardware Sets. Do not mount floor stops where they will impede traffic. Where floor or wall bumpers are not appropriate, provide overhead type stops and holders.

Acceptable Manufacturers:

 - Ives (IV).
 - Rockwood Manufacturing (RO).
 - Trimco (TC).
3. Overhead Door Stops and Holders: ANSI/BHMA A156.6, Grade 1 certified overhead stops and holders to be surface or concealed types as indicated in Hardware Sets. Track, slide, arm and jamb bracket to be constructed of extruded bronze and shock absorber spring of heavy tempered steel. Provide non-handed design with mounting brackets as required for proper operation and function.

Acceptable Manufacturers:

 - Rixson Door Controls (RF).
 - Rockwood Manufacturing (RO).
 - Sargent Manufacturing (SA).

ARCHITECTURAL SEALS

1. General: Thresholds, weatherstripping, and gasket seals to be of type and design as specified below or in the Hardware Sets. Provide continuous weatherstrip gasketing on exterior doors and provide smoke, light, or sound gasketing on interior doors where indicated. At exterior applications provide non-corrosive fasteners and elsewhere where indicated.
2. Smoke Labeled Gasketing: Assemblies complying with NFPA 105 that are listed and labeled by a testing and inspecting agency acceptable to authorities having jurisdiction, for smoke control ratings indicated, based on testing according to UL 1784.
 - Provide smoke labeled perimeter gasketing at all smoke labeled openings.
3. Fire Labeled Gasketing: Assemblies complying with NFPA 80 that are listed and labeled by a testing and inspecting agency acceptable to authorities having jurisdiction, for fire ratings indicated, based on testing according to UL-10C.
 - Provide intumescent seals as indicated to meet UL10C Standard for Positive Pressure Fire Tests of Door Assemblies, and NFPA 252, Standard Methods of Fire Tests of Door Assemblies.
4. Replaceable Seal Strips: Provide only those units where resilient or flexible seal strips are easily replaceable and readily available from stocks maintained by manufacturer.
Acceptable Manufacturers:
 - National Guard Products (NG).
 - b.Pemko Manufacturing (PE).
 - c.Reese Enterprises, Inc. (RE).

ELECTRONIC ACCESSORIES

1. Door Position Switches: Door position magnetic reed contact switches specifically designed for use in commercial door applications. On recessed models the contact and magnetic housing snap-lock into a 1" diameter hole. Surface mounted models include wide gap distance design complete with armored flex cabling. Provide SPDT, N/O switches with optional Rare Earth Magnet installation on steel doors with flush top channels.
Acceptable Manufacturers:
 - Sargent Manufacturing (SA) – 3280 Series.
 - Securitron (SU) - DPS Series.
2. Power Supplies: Provide Nationally Recognized Testing Laboratory Listed 12VDC or 24VDC (field selectable) filtered and regulated power supplies. Include battery backup option with integral battery charging capability in addition to operating the DC load in event of line voltage failure. Provide the least number of units, at the appropriate amperage level, sufficient to exceed the required total draw for the specified electrified hardware and access control equipment.

DESIGN CRITERIA

Division 8 – Openings

Acceptable Manufacturers:

- Sargent Manufacturing (SA) – 3500 Series.

3. Switching Power Supplies: Provide UL listed or recognized filtered and regulated power supplies. Provide single, dual, or multi-voltage units as shown in the hardware sets. Units must be expandable up to eight Class 2 power limited outputs. Units must include the capability to incorporate a battery backup option with integral battery charging capability in addition to operating the DC load in event of line voltage failure. Provide the least number of units, at the appropriate amperage level, sufficient to exceed the required total draw for the specified electrified hardware and access control equipment.

Acceptable Manufacturers:

- Securitron (SU) - AQ Series 16 amp with back up battery power. (maximum of 8 doors per power supply) to be supplied by division 8 Contract Hardware Distributor

Finish

Exterior shall match the RELLIS medium bronze doors and frames

Any substitution or alternates will need to be approved by the RELLIS Facilities Department. Approval process will begin with the FPC Project Manager.

GLAZING

High performance glazing is strongly encouraged with a tint to match surrounding buildings. Highly reflective (mirror) glass is not allowed.

RELLIS campus buildings use tint on outboard lite: "PPG Solar Bronze" or equal.

Partial shading of insulating glass can cause stress breakage. Manufacturers consider this to be a design error and will not replace glass broken by temperature differential stresses. Avoid partial shading of large panes.

Provide manufacturer's written guarantee that for ten years from date of Substantial Completion a replacement will be provided for any insulated glass unit which develops edge separation or other defects which materially obstruct vision through the glass or safety or affects the insulating qualities. Guarantee shall not cover glass breakage from physical abuse, storm or similar causes.

Building fenestration shall comply with ASHRAE 90.1-latest adopted including assembly U values, assembly SHGC and percentage of glass.

GENERAL INFORMATION

The preliminary selection of interior finish materials shall take place during the schematic design phase. During the design development phase the A/E's Interior Designer shall present a minimum of two distinct color schemes to the User Coordinator and FPC Project Manager. A final color scheme will be selected and incorporated into the specifications.

Interior finish materials shall be high quality, durable materials that are easily maintained and manufactured regionally. Particular attention shall be given to finishes in public spaces. The use of materials with recycled content is encouraged.

Avoid the use of imported, costly or high maintenance materials. Finishes or detailing that have minimal tolerances and place unrealistic expectations on the installing contractor(s) shall be avoided.

Verify attic stock quantities of interior finish material with Member Facilities Department.

GYPSUM WALLBOARD

All interior gypsum wallboard should be at least a DensArmor or DensArmor Plus or equal impact and mold resistant wallboard.

Impact resistant gypsum board shall be used in public hallways and corridors. Type X very high impact-resistant (VHI), paper-faced panels with moisture and mold resistance. Meets ASTM C1629 level 3 for soft- and hard-body impact

All gypsum wallboard, regardless of location, shall be not less than 5/8". A/E team shall specify finish levels type 5 for large open and common areas. Type 4 only in enclosed areas.

TILE

The use of ceramic tile is encouraged for high profile/high use public areas, restrooms, storage rooms, furniture storage rooms, shower and locker rooms or other spaces where a durable material is appropriate. Avoid dark colors and extremely light colors for tiles. Avoid white or light colored grout for floor applications.

Large format tile shall be coordinated with lighting design. Wall Wash lighting with large format tile is discouraged

Consider the use of tile or other durable material as wainscot on high traffic corridor walls especially near classrooms.

DESIGN CRITERIA

Division 9 – Finishes

All floor tiles shall be non-slip and rated for heavy duty use.

Designs where floor and wall tile indicate a pattern of colors or a “mosaic” shall be detailed in the drawings using specific tile sizes dimensions and notes to clearly indicate the extent and complexity of the pattern or “mosaic”.

All floor tile grout shall be epoxy.. In frequently wet areas such as showers, epoxy wall grout shall be used. Epoxy grout shall match intended application.

Large format tile shall be coordinated with lighting design. Wall wash lighting is discouraged.

Where floor drains are required, such as janitor, lab, restroom or mechanical rooms, the floor shall be sloped to drain with depressed slab as required. Provide waterproofing and crack control membrane as needed.

SUSPENDED ACOUSTICAL CEILINGS

All ceilings shall be designed to be easily accessible for maintenance and other access needs. A single type of ceiling tile such as 2 ft x 2 ft or 2 ft x 4 ft, minimum 5/8” thick, non-directional pattern tiles with a recycled content shall be used throughout a building to minimize maintenance and repair costs. Exceptions to this are special areas that are identified in the POR. Avoid large format ceiling tiles in areas that need regular maintenance.

Ceiling suspension assemblies shall be supported directly from the building structure and shall be supported at all four corners of light fixtures. Location of hangers shall not interfere with access to VAV filters, valves, dampers and other items requiring maintenance.

All ceilings shall be modeled at the assigned height in the BIMs.

Ceiling assembly systems, such as finished gypsum, suspended ceilings, or acoustic ceiling clouds, can require fire protection be provided both above and below, under the following circumstances:

TERRAZZO

Use of epoxy terrazzo or terrazzo flooring where high traffic occurs is encouraged.

CARPET SYSTEMS

Refer to Guide Specification at the end of this division. Use of carpet tiles is encouraged.

RESILIENT TILE FLOORING

Vinyl composition tile shall be 1/8 inch thick with thru pattern or thru-chip construction and meets the requirements of ADA for static coefficient of friction when installed in accordance with manufacturer's guidelines. Recycled content (post-consumer and post-industrial waste) shall be minimum 10%. Material must meet or exceed a 5 year warranty.

Rubber flooring is also acceptable. Material must meet or exceed a 5 year warranty.

Luxury vinyl tile is acceptable. Material must meet or exceed a 5 year warranty.

Contractor is responsible for initial seal and polish of Resilient Flooring. Floor polish material shall be coordinated with the RELLIS Maintenance Department (SSCServ).

VINYL WALL COVERING

The use of vinyl wall covering is discouraged and is not allowed on the interior surface of exterior walls.

FIBER REINFORCED PANELS

The use of FRP is required at janitor rooms and environmental areas as requested by RELLIS Facilities Department.

PAINTING AND COATING

Satin or semi gloss enamel paint shall be used on all surfaces and items normally painted. Flat finish paint is not acceptable. Gloss paint is discouraged. Minimum of two finish coats over a prime coat of a different tint than finish coat.

Manufacturers standard color selection shall be utilized. Avoid the use of deeply saturated colors for walls. The use of lighter colors is recommended since these colors enhance reflectivity and reduce the need for lighting. The selection of zero or low VOC products is required to eliminate problems with off-gassing.

DESIGN CRITERIA

Division 9 – Finishes

Exterior Utility Paint Color to be used under direction from RELLIS Facilities Department - 9110 MALABAR

Inside surface of wood cabinet drawers two receive two coats of clear sealer.

Top and bottom edges of wood doors to receive two coats of tinted sealer to aid visual inspection.

Except for prime coats on equipment and piping insulation, specify all field painting under the painting section of the specifications.

Refer to the UES guidelines for painting of all piping and conduits. Refer to the UES guidelines for marking and/or stencil guidelines for piping and conduits. Stick-on type or plastic wrap-on markers are not acceptable.

GUIDE SPECIFICATION

CARPET SYSTEMS

- GENERAL
- SUMMARY

A. The following shall be used as a guide for a minimum carpet specification. Other products with equal or better characteristics or qualities shall be considered.

- PRODUCTS
- CARPET SYSTEMS
 - Modular vinyl backed carpet tile or six foot roll carpet with vinyl back.
 - Manufacturers: Interface, Shaw, Lees, Mannington, or acceptable substitute shall meet the following requirements:
 - Construction: Textured or level loop tufted.
 - Face Fiber: 100% Invista Antron Lumena® or Antron® Legacy, Antron Blend. Type 6,6 nylon - continuous filament with anti-

soil, anti-stain protection.

- 3. Pile Height: ≥ 0.117 and < 0.187 .
- 1. Yarn Weight: (minimum 22 oz/yd).
- 2. Dye Method: 100% solution dyed or a solution dyed yarn dye blend.
- 3. Stitches per inch: 10.2/in minimum.
- 8. Primary Backing: 100% sealant vinyl or non-woven synthetic
- 10. Density: 5000 minimum.
- 12. Warranty: Lifetime – 20 years, non-prorated warranty against delaminating, edge ravel, zippering, moisture penetration, wear.

DESIGN CRITERIA

Division 9 – Finishes

- Performance Characteristics:
 - Flammability:
 - Radiant Panel Test (Direct Glue): ASTM E-648, Class 1.
 - Pill Test: pass CPSC-FF1-70.
 - Flaming Mode: <450 per ASTM E-662 NBS Smoke Density.
 - Non-flaming Mode: <450 per ASTM E-662 NBS Smoke Density.
 - Static: < 3.5 KV Permanent Conductive Fiber per AATCC-134.
 - Electric Resistance: pass NFPA 99.
 - Burroughs Method: pass NFPA 99.
 - Recycled content: minimum 35%.
 - Recyclable: 100% of all content.
- ACCESSORIES
 - Carpet Adhesive: Releasable, pressure sensitive type adhesive shall be water based and allow for removal without damage to carpet or substrate and leave no residue.
 - Adhesive Seam Sealer: (For 6 foot roll goods) As required, provide adhesive seam sealer certified in writing by the manufacturer as compatible with carpet backing. Seam sealer shall have minimum five year manufacturer's guarantee. Sealer shall create a 100% chemical weld at the seam site to provide a monolithic installation with a moisture barrier.
 - Carpet Edge Guard: Shall be either aluminum or vinyl edge guard or transition in color suitable for a particular installation. Edge guard attachment shall be by mechanical fasteners or glued down.
 - Tread Edge Strip: Shall be rubber or transition in color suitable for a particular installation.
- EXECUTION
- INSTALLATION REQUIREMENTS
 - All existing carpet and existing carpet waste shall be reused or recycled in an "environmentally friendly" manner. "Environmentally friendly" carpet recycling methods shall be performed subsequent to job completion. As used herein, "environmentally friendly" methods consist of the following:
 - Repurposing – reusing the product in another

DESIGN CRITERIA

Division 9 – Finishes

application such as facilitating the donation of used carpeting to a charity or other nonprofit organization.

- Recycling – turning waste materials into new materials.

DESIGN CRITERIA

Division 9 – Finishes

- **INSTALLATION CONDITIONS**
 - All sub floors shall be level, clean, dry, and free of dust, dirt, wax, paint, grease, cut back adhesive or any material that might interfere with the overall bond strength of the adhesive. Concrete floors shall be fully cured and free of excessive moisture and alkalinity. No condensation within 48 hours on underside of a four foot by four foot polyethylene sheet, fully taped at perimeter to substrate. Conduct moisture test maximum allowable amount of moisture emitted from floor shall be 3.0 pounds per 1,000 square feet in a 24 hour period.
 - Store carpet and adhesive at a temperature of 70 degrees Fahrenheit for 48 hours prior to installation and maintain for 48 hours during and after completion.
 - Do not expose adhesive to ultraviolet light. Adhesive may be photosensitive and lose its tack.
 - For 6 foot roll carpet cut edges tight to form seams, without gaps, using carpet manufacturer's recommended seam sealer.
 - When carpet is scheduled for installation on risers and treads, as in auditoriums, and the carpet project as specified with a vinyl cushion back will not install properly over risers and treads, the installer of the carpet project shall be required to provide and install rubber tread edge strips along the front edge of all treads including treads located within the seating areas.
 - Installer shall have at least five years of experience and be certified by the manufacturer of the carpet submitted.

DESIGN CRITERIA
Division 9 – Finishes

RELLIS Campus Facility Design Guidelines
Section-9 Page 7 of 7

GENERAL INFORMATION

DIRECTORIES

Each building shall have at least one primary directory located in the main entrance of the building. Secondary directories on each floor may be required depending on the complexity of the building. Secondary directories are generally located at elevator lobbies. Verify with the User and Facilities Department.

GRAPHICS

Interior base building and wayfinding campus standard signage shall be shown and specified by the A/E and their placement in accordance with Texas Accessibility Standards, International Building Code, International Fire Code, and any other applicable codes and ordinances. Use industry standard method to anchor graphics (double face VHB type tape or silicone construction adhesive adhesive). Interior letters shall be Frutiger Roman in upper and lower case. Identification signage for offices shall have area for changeable names.

Examples of interior base building signs are:

1. Stairway Identification
2. Area of Refuge Identification
3. Elevator Emergency Sign
4. Fire or Emergency Elevator Operation notice
5. Fire Door Signage
6. Electrical Room identification
7. Exit Door Identification
8. Permanent Room Identification
9. Restroom Identification
10. Office Identification
11. Assembly Space Maximum Occupancy
12. Severe Weather or Emergency Shelter Identification

Examples of interior wayfinding signs are:

13. Overhead Directional
14. Wall-mounted Directional
15. Room and Space Identification Blade or Flag signs

All building utility spaces, stairs and rooms shall include the name of the space as well as room number on identification signage.

Room numbering shall be approved by Mapping and Space Information (MSI) and the RELLIS Facilities Department at Design Development.

Exterior graphics such as signs (except "Handicapped Parking" and traffic signs) and

DESIGN CRITERIA

Division 10 – Specialties

building letters will normally be furnished and installed by the Owner. During design the Project A/E will suggest locations on the building elevations for building name. Exterior letters are generally illuminated, dimensional metal letters, Frutiger Lt Std 55 Roman font with both upper and lower case letters.

Traffic control signs shall be heat/vacuum baked process using 0.080 gauge aluminum blank sign face of Engineer grade reflectorized sheeting conforming to specification requirements of the Federal and State Manuals on Uniform Traffic Control Devices.

Building Dedication Plaque

Bronze building dedication plaque shall be provided to the contractor and installed by the contractor using approved wording.

Building Construction Sign

4ft x 8ft construction sign shall be provided to the contractor and installed by the contractor using approved wording.

See below for representative example:



RELLIS Academic Complex Phase 1

The Texas A&M University System

Project Manager

Page

Architect

Hensel Phelps

Design Builder

DESIGN CRITERIA

Division 10 – Specialties

TOILET PARTITIONS

Partitions or stalls should be floor mounted and constructed of solid plastic or stainless steel in all permanent buildings unless other materials are approved by the Owner. Painted metal or Plastic laminate are not acceptable. Provide a coat hook and bumper guard on back of each toilet partition door. Coordinate the location of toilet partitions and floor drains.

CORNER GUARDS AND RAILS

Provide corner guards on corners of corridor walls with heavy pedestrian traffic. Provide wall guard rails along corridor walls in laboratory areas to protect walls from lab carts.

TOILET ACCESSORIES

Verify all accessories with the SSC Custodial Services during Design Development.

Toilet Paper Dispenser: Georgia-Pacific Professional; GP Compact Side by Side Double Roll Bathroom Tissue - #56784: www.blue-connect.com.

Combination Towel Dispenser/Waste Receptacle: Semi Recessed , stainless steel; seamless wall flanges. Product: American Specialties Mfg# 04692-6 or equal.

Waste Receptacle: Recessed, stainless steel, seamless front continuously welded bottom pan and seamless exposed flanges. Product: B-43644 manufactured by Bobrick or equal

Waste Receptacle: Wall-mounted, stainless steel, seamless front continuously welded bottom pan and seamless exposed flanges. Product: B-277 manufactured by Bobrick or equal.

Soap Dispenser:: GOJO Mfg#2730-12 Black Touch Free

KEY BOXES

All new construction or major renovation to a facility shall include the installation of two key boxes. One box shall be keyed to the Texas A&M University Police system and one box keyed to the Bryan Fire Department system.

Location of the key boxes shall be determined by the AHJ during the design phase, but generally installed near the main or service entrance and in near proximity to the location of the fire command center/fire alarm panel. Mounting height should be between 4' and 6' above the finished floor.

The key boxes shall be a Knox Box® brand key box. The standard key box is a Model 4400 series recessed box with a hinged door. Large or more complex facilities may require a different/larger box or additional boxes if the design/access warrants. In general, a location

DESIGN CRITERIA

Division 10 – Specialties

near the main or service entrance and in near proximity to the location of the fire command center/fire alarm panel is preferred at a maximum mounting height of 6' above finished floor.

Other requirements for Knox products such as padlocks, gate key switches, etc. shall be determined by the AHJ during the design phase of the project. Knox Boxes may be ordered directly from the Knox Company – www.knoxbox.com.

It is important to ensure that the appropriate order form/city is identified to ensure that the correct locking system is ordered. Any rekeying will be at the contractor's expense.

FIRE EXTINGUISHERS AND CABINETS

Fire extinguishers and recessed or semi-recessed cabinets shall be incorporated into the design as required by code. Fire extinguisher cabinets shall be uniformly sized in building or campus.

Fire Extinguishers (Portable)

New portable fire extinguishers shall be installed in every new or renovated facility unless approved by the AHJ. Extinguishers shall be clean and free of any dust and construction debris. All extinguishers shall be selected and installed in accordance with the most recent edition of NFPA 10, *Standard for the Installation of Portable Fire Extinguishers*. If a conflict exists, contact TAMU EHS for clarification or direction.

All fire extinguishers shall bear the current years manufacture date at the time of substantial completion of the facility or renovation if substantial completion falls on or after March 1st of the year. If substantial completion of a project occurs between January 1st and the last day of February, then the previous year's manufacture date is acceptable. In no case shall an extinguisher be more than one year past its manufacture date.

Extinguishers should be installed in corridors in accessible and conspicuous locations. Wall/ceiling signage shall be installed if the location of extinguishers is not readily visible. Unless travel distance or specific equipment requirements dictate, extinguishers for mechanical, electrical, telecommunication rooms, etc. should be installed in corridors.

Preference should be given to installing extinguishers in corridors and not behind locked doors.

Strap type brackets are not acceptable and shall not be used.

Where type BC fire extinguishers are called for (around electronics, servers, etc.) provide a 5# CO₂ fire extinguisher. In high hazard areas provide a 10#CO₂. Dry powder BC extinguishers shall not be used unless the hazard dictates their use.

DESIGN CRITERIA

Division 10 – Specialties

The standard fire extinguisher is a 10-pound 4A: 80BC rated ABC fire extinguisher with brass valves (acceptable manufacturers and models are provided in Table 1). Where a hazard requires a higher rated classification of extinguisher, the design team shall submit the proposed extinguisher to the AHJ for approval.

The following manufacturers and model numbers are acceptable for the identified extinguisher types. Other models and manufacturers may be accepted. Request to utilize alternate extinguishers shall be submitted and approved prior to purchasing or installation of extinguishers.

| | | |
|-------------------------------------|---------|----------|
| 10# ABC – Multipurpose Extinguisher | Amerex | B441 |
| | Badger | B10M |
| | Buckeye | 10 HI-SB |
| 20# ABC – Multipurpose Extinguisher | Amerex | A411 |
| | Badger | B20M |
| | Buckeye | 20HI- SB |
| 5# Carbon Dioxide Extinguisher | Amerex | 322 |
| | Badger | B5V |
| | Buckeye | 5CD |
| 10# Carbon Dioxide Extinguisher | Amerex | 330 |
| | Badger | B10V |

DESIGN CRITERIA
Division 10 – Specialties

| | | |
|--|---------|--------|
| | Buckeye | 10CD |
| 15# Carbon Dioxide Extinguisher | Amerex | 331 |
| | Badger | B15V |
| | Buckeye | 15CD |
| 20# Carbon Dioxide Extinguisher | Amerex | 332 |
| | Badger | B20V |
| | Buckeye | 20CD |
| 2.5 Gallon Water (H ₂ O) Extinguisher | Amerex | 240 |
| | Badger | WP-61 |
| | Buckeye | 500 |
| 6L Class K Extinguisher | Amerex | 260 |
| | Badger | WC-100 |
| | Buckeye | WC-6 |
| Non-Metallic | Badger | B5V-MR |

Table 1- Approved Portable Fire Extinguisher Manufacturers and Model Numbers

Fire Extinguisher Cabinets

Cabinets shall be readily identifiable as a fire extinguisher cabinet or identification must be provided. Wall/ceiling signage shall be installed if the location of extinguishers is not readily visible. Cabinets shall be provided with a pull handle with

DESIGN CRITERIA

Division 10 – Specialties

cam-action latch and non-locking hardware. The hinge and door hardware should be of a type which allows full opening of the door and easy removal of the fire extinguisher.

It is the responsibility of the design firm to ensure that fire extinguisher cabinets that are to be installed will accommodate the selected fire extinguishers.

When installed in a fire rated partition, the cabinet construction rating shall be equivalent to the required partition rating.

AED REQUIREMENTS

AED minimum (1) per building coordinated with TAMU EHS, Cardiac Science G3 or G5 Item # 9390A-1001 (plus specified accessories) or Item# G5A-80-P (plus specified accessories) A/E team to Recess mount, Semi recessed mount or Surface mount with accessory cabinet as needed to meet ADA requirements.

GUIDE SPECIFICATION

CAST BRONZE DEDICATORY BUILDING PLAQUES

PART 1 - GENERAL

- SECTION INCLUDES:
 - Description.
 - Submittals
 - Delivery, Storage and Handling
 - Job Conditions
- 2.1 Products
 - DESCRIPTION:
 - Work included: Furnish and install one (1) cast bronze plaque.
 - SUBMITTALS:
 - General Contractor will provide a request to the FPC project manager to initiate the plaque wording approval process.
 - FPC will provide a final detailed layout drawing of the plaque to be used for procurement.
 - DELIVERY, STORAGE AND HANDLING
 - Deliver plaque crated to provide protection during transit and job storage.
 - Inspect plaque upon delivery for damage and correctness.
 - Store plaque where it is not exposed to the elements.
 - JOB CONDITIONS
 - Coordinate installation with work of other trades.

PART 2 - PRODUCTS

- CAST BRONZE PLAQUES
 - Plaques shall be manufactured by Time Works Unlimited, Inc., P.O. Box 9052, College Station, Texas 77842-9052, (<http://timeworksunl.com/>), or approved equal. Tablet is to be cast

DESIGN CRITERIA
Division 10 – Specialties

of virgin ingots (85-5-5-5 standard U.S. Bronze

DESIGN CRITERIA

Division 10 – Specialties

Alloy). Casting shall be free of pits, porosity, imperfections and gas holes and all letters shall be sharp and hand tooled. The backs shall be flat and true. Border and faces of raised letters are to be a satin finish. Background shall be leatherette. Coat compound to ensure plaques will not bleed and discolor the mounting surface. Tap backs of plaques and provide bronze or stainless steel studs for blind fastening.

- Estimates may be obtained using the template provided.

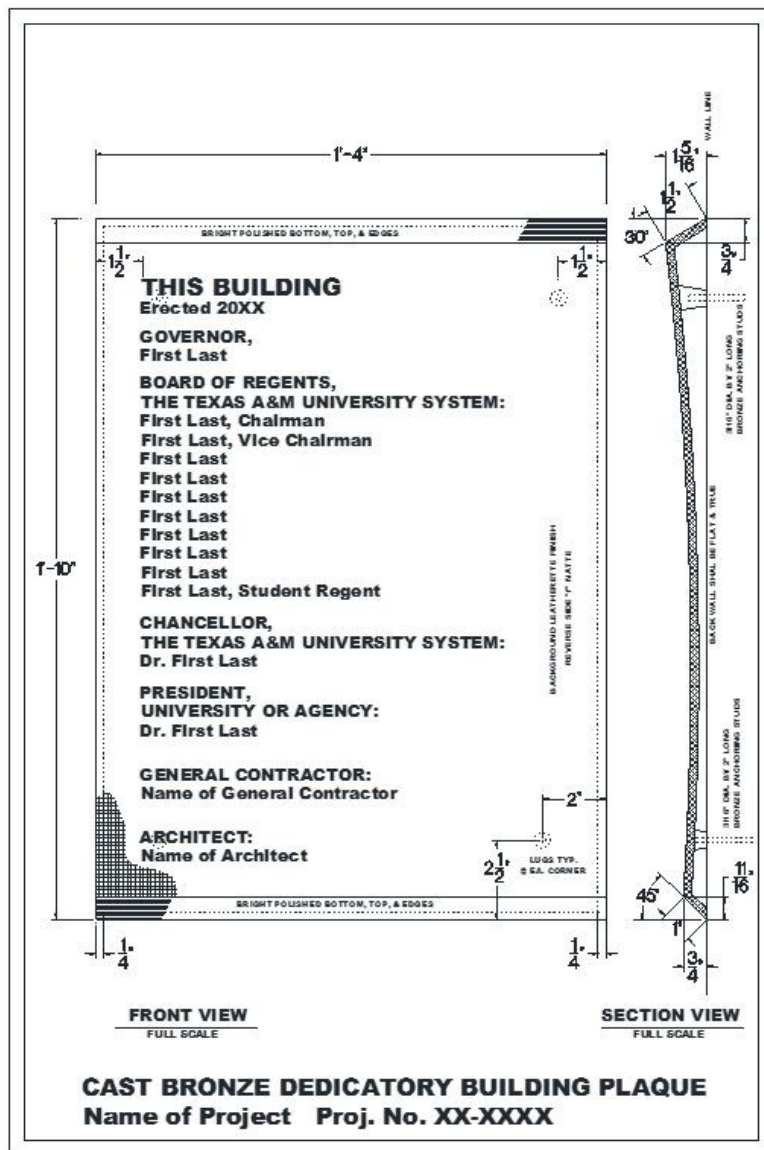

GENERAL

Projection screens, where required by the Program of Requirements, shall be motorized and controlled by a **non-keyed** switch. LED monitors is encouraged instead where applicable

Audio visual equipment may be purchased and installed under a separate contract/integrator managed by FPC.

In areas where an assisted listening device is required or where sound reinforcement is required by the POR then a complete sound system shall be provided in the project. A&M System consultant shall serve as the AV integrator and coordinate with the RELLIS Campus CIO.

AUDIO-VISUAL EQUIPMENT

Audio/Video for Registrar-controlled Classrooms

Include infrastructure as needed for Room Scheduler Devices, coordinate with Users during design.

Audio/Video Requirements

All modifications and systems shall be approved by the RELLIS CIO to comply with standard requirements.

AV Closet Requirements

Buildings with an Audio/Video closet should have a 45 space rack unit such as the Middle Atlantic BGR-45SA-27 or equivalent per room. For example, if one closet corresponds to three (3) rooms, then the closet should contain three (3) rack units.

- 1 Must include a 24"x36" laminated drawing of a line diagram with rack elevations that is mounted to the wall.
- 2 Four (4) 120V 20A outlets should be located at the base of each rack unit.
- 3 Two (2) data lines shall be dropped to each rack unit.
- 4 Two (1.5 ") conduits should run from the lectern floor box (if present) or wall to the AV closet per room. Two additional (1.5 ") conduits should run from the lectern floor box (if present) or wall to the projector's location or main display's. Note: The use of displays or video wall is preferred over projectors.

DESIGN CRITERIA Division 11 – Equipment

Please see the graphic below for one (1) room example :

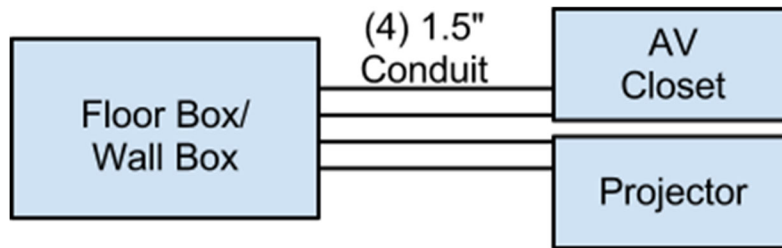

Room Requirements

- 5 Room shall be controlled via AMX controller, video switcher, digital video transmitter/receiver pairs, and a touch panel interface.
- 6 Controller and switcher will be an all-in-one unit or equivalent.
- 7 Video switcher should have capabilities for scaling, digital inputs/outputs, analog inputs/ outputs, and should be HDCP compliant. Switcher should have additional audio/video ports for expandability.
- 8 A Smart Podium/LCD is required.
- 9 Listen Assistive Listening FM ADA standard system is required for all rooms.
- 10 Lecterns will be the Instructional Media Services Eurodesign standard. Lectern model #s are as follows: MPD2644EA-TX11-R, MPD2644EA-TX11-L, MPD3048EA-TX11-R, MPD3048EA-TX11-L.
- 11 Ensure room cooling requirements are coordinated with the mechanical Engineer of Record (EOR).

Programming Requirements

Programming shall resemble IMS standard and include AMX Resource Management Suite software links/hooks.

Mounted Equipment Requirements

Note: If a projector is required then the following equipment is required:

- 12 Chief CMA 440 Lightweight Above Tile Suspended Ceiling Kit.
- 13 Electric non-tab tensioned Projection Screen with built- in Low Voltage Controller of adequate size for the room in a 16:10 AspectRatio.

Audio Requirements

In smaller rooms, where small speakers will suffice, four (4) ceiling mount JBL 16Ω speakers need to be installed, for larger applications, a more specific speaker JBL AC 18/26 speakers or equivalent will need to be specified. Large auditoriums will be wired

DESIGN CRITERIA

Division 11 – Equipment

with front mounted speakers in stereo format with ceiling speakers to fill audio voids in the room.

Audio Wire Runs

- 14 Small/ceiling speakers will require a 14 gauge plenum-rated cable from Liberty cable (14-2C-P-WHT) or equivalent.
- 15 Larger/front mounted speakers will require a 12 gauge plenum-rated cable (12-2C-P-WHT) from Liberty cable or equivalent.

Audio Mixer

- 16 An audio presentation mixer should be present. Preferably a Nexia PM.

Video Requirements

- 16.0 Video signals in the room should be in digital format.
- 16.1 Video to projector will be transmitted via four (4) Category 6 cables from Liberty cable (24-4P-L6SH-WHT) or equivalent. Wires will not be terminated or hooked up to a network switch. These cable runs go from lectern floor box/wall to projector.

Conduit Needs (No AV Closet Present)

- 17 If a floor box is present, two (2) 1.5" inch conduit runs shall connect to the floorbox.
 - 2 One conduit run will terminate in the ceiling to an empty double-gang electrical junction box.
 - 3 One conduit run will terminate at the projector ceiling plate to allow Video cabling to be run inside.
- 18 If a floor box is not present, two (2) 1.5" inch conduit runs shall connect to the wall closest to the podium location and terminate into a a double-gang electrical wall junction box.
 - 2 One conduit run will terminate in the ceiling to an empty double-gang electrical junction box.
 - 3 One conduit run will terminate at the projector ceiling plate to allow Video cabling to be run inside.

Power Receptacles Requirements

- 19 All receptacles specified should be 120V 20A.
- 20 Display or Video Wall Preferred Method (As required)

DESIGN CRITERIA

Division 11 – Equipment

- 21 Projector: If a projector is required then the following equipment is required: _____
- G 2 total outlets/projector attached to projector ceiling plate flush visible below ceiling tile.
- 22 Lectern
- 3 A total of four (4) receptacles are needed in floor box. If floor box is not present, receptacles should be located as close as possible to the podium location to reduce the need for floor tracking.
 - 4 Floor boxes should be ADA specified distance from the wall where the projection screen is located.
- 23 Camera
- 3 2 Power receptacles installed flush with ceiling located at back of room located within 6 inches of camera network ports.

Network Connection Using Category 6A Cable Requirements

- 24 Three network connections ran to Lectern Location.
- C. If located in the floor box, network cable shall be terminated at floor box.
 - D. One (1) of the connections will have a network switch installed on it to split the connection for the Lectern Equipment
 - E. The remaining two (2) connections will be used for other specified equipment.
- 25 One (1) network connection/drop located at the back of the room for security camera.
- 26 The camera location will vary depending on the entrance to the classroom, equipment location, as well as structural limitations such as support posts, etc. Ideal location should have a clear view of projector, lectern, projection screen and entry door. If a room has two entrances, the location of the camera should be centered in the back of the room.

Audio Visual Surveillance

Audio video surveillance technology (AVST) includes all types of cameras and/or receiving audio devices placed internally or externally throughout campus and the related equipment to operate the cameras/audio or view, listen, and record images and/or audio.

All uses/placement of AVST equipment must be reviewed and approved RELLIS Campus CIO

AVST equipment used for surveillance may be monitored or non-monitored.

Camera Operation and Location

Surveillance cameras may be installed in such areas as the following:

1. Those containing such security systems as the following:
 - A. Access control systems, which monitor and record restricted-access transactions at entrances to buildings and other areas
 - B. Security alarms, including intrusion alarms, exit-door controls, hold-up alarms, cashier locations, etc.
2. Those containing sensitive institutional data or technology operations
3. Sections of the Campus and buildings that are high-traffic, such as shopping areas, perimeters, unrestricted entrances, exits, lobbies, corridors, and receiving docks
4. Those housing sensitive operations, such as storage areas for special materials, laboratories, select agents, etc.
5. Those containing rare, high-value, or merchandise property.

Cameras intended for monitoring or displaying general access to public events must be approved in advance and privacy concerns must be specifically addressed by the department requesting approval.

Surveillance cameras must not be located in or monitor a campus housing resident's room or restroom/shower area, or any other restroom/shower area where there is a reasonable expectation of privacy. These types of facilities are used by individuals with a reasonable expectation of privacy and should not be monitored or recorded by a surveillance camera.

Appropriate and Inappropriate AVST Use

Surveillance camera use is considered **appropriate** when it enhances:

1. The protection of equipment, facilities, and individuals
2. The protection of sensitive institutional data or technology operations
3. Instruction or research in the classroom or lab
4. The monitoring of building entrances and exits

Surveillance camera use is considered **inappropriate** when it entails:

5. Infringement on a person's reasonable expectations of privacy
6. Monitoring of personnel related issues or performance not involving safety
7. Monitoring of student performance for academic dishonesty
8. Installation of a "dummy" camera for appearance sake

Signage For AVST Equipment

Conspicuous, public signage must be displayed at all main entrances of buildings and facilities with AVST equipment or in the immediate area of the equipment. Surveillance cameras in some locations may be actively monitored in real time by authorized personnel,

DESIGN CRITERIA Division 11 – Equipment

whether sporadic or continuously, while other camera locations may not be monitored at all. Departments must clearly indicate in their posted signage if their AVST equipment is not monitored.

Signage language is as follows:

- A. “This area is subject to surveillance for security purposes and may or may not be monitored.”

Requests for Installation of Equipment

Approval of installation and relocation requests will be guided by the need for security of state property, facilities and people, with attention given to the privacy of members of the Campus community.

All modifications and systems shall be approved by the RELLIS Campus CIO to comply with standard requirements.

The approval process may take several weeks to complete depending upon the details of the request and supporting materials.

LABORATORY EQUIPMENT

Laboratory Fume Hoods

The following are minimum design specifications for laboratory fume hoods and associated exhaust systems for A&M System projects except as modified with the approval of the Environmental Health and Safety.

All laboratory hoods shall meet the requirements of the National Fire Codes, NFPA 45, “Fire Protection for Laboratories Using Chemicals.” Hoods handling radioactive material shall also meet the requirements of NFPA 801, “Recommended Fire Protection Practice for Facilities Handling Radioactive Materials.” Fume hood systems shall also meet the requirements of the current ANSI Z9.5 Standard/ASHRAE 110 TEST. If the requirements below conflict with those of the most recent versions of these national standards, the national standards shall prevail.

Fume hood testing and certification shall be done by the fume hood manufacturer by an independent certifying firm and be done after the installation of the fume hood.

Hood design will incorporate airfoil jamb and airfoil sill to reduce airflow turbulence.

A variable volume or constant volume hood system design is preferred, depending upon the HVAC system design. For constant air volume hoods, bypass or balanced air feature should

DESIGN CRITERIA

Division 11 – Equipment

be considered to provide an inlet for air to be drawn into the top of the hood as the sash is lowered, still maintaining the velocity through the face opening at 100 FPM. Hoods will be an integral part of the HVAC system.

Auxiliary Air Make-up Hoods with make-up air externally supplied above and on the outside of the hood face are not permitted.

Utility valves and switches shall be external, and shall be in conformance with applicable codes and standards. All service valves shall be easily accessible for maintenance personnel and clearly marked. Fixture outlets inside the hood shall be corrosion resistant or have a corrosion resistant finish.

Hood lighting shall be vapor or explosion proof, depending upon the intended purpose of the hood. Hood design should be such that light bulbs are changeable from the outside of the hood.

The hood sash shall be transparent, easily removable, horizontal sliding or vertical rising panel that will close off the hood face. All parts and counterbalance mechanisms shall be of corrosion-resistant material and finish. The sash panel shall be safety glass or plastic that has a flammability rating of 25 or less.

Fume hoods with vertical sashes shall have stops at 18 inches. Whenever the sash is beyond 18 inches a visual alarm shall be activated. The sash must be auto closing.

Hood construction materials should be selected with regard to the requirements of hood use. Examples of material used include stainless steel and epoxy coated material.

Face Velocity Requirements:

Hood selection is greatly influenced by the type of experiments to be conducted within the hood. It is important to establish the maximum degree of hazard anticipated for present and future use before the choice of a hood is made. National standards recognize that the acceptable face velocity requirement for toxic materials used in research laboratories is an **average face velocity of 100 fpm** with the **hood sash fully open (100%)** and a **minimum at any point of 80 fpm**. These performance parameters are to be met. Fume hood testing shall be in accordance with ANSI/ASHRAE 110. Consideration during the design process for auto sash features for energy management.

Airflow Measuring Device:

An airflow measuring device shall be permanently installed on each fume hood. The device shall continuously monitor airflow face velocity, shall give a digital readout of face velocity, and shall sound an alarm for low-flow conditions or whenever the face velocity drops below 80fpm.

DESIGN CRITERIA

Division 11 – Equipment

Exhaust Duct:

Fume hoods may be designed with either an independent exhaust duct system or a manifold system.

A high transport velocity of at least 2000 fpm is needed so that dust and aerosol-size materials are not deposited in the joints, cracks, or corners in the duct system. Normally all exhaust ducts will be constructed of Type 316L Stainless Steel, except where hydrofluoric acid or fluorides in general are used, with all TIG welded or mechanically fastened joints sealed with mineral impregnated woven fiber taper which is further impregnated with an activator/adhesive of the polyvinyl acetate type as manufactured by Hardcast, Inc. or equal. Ducts should be routed vertically with a minimum number of turns. Alternate duct materials will be considered in some applications.

Perchloric acid hoods shall have a completely welded exhaust duct system. Duct shall be routed by the shortest and straightest path to the roof. Horizontal runs are not permitted in Perchloric acid hoods. When required for construction, and approved by the Owner, flange joints and acid resistant gaskets may be used. Do not manifold perchloric hoods.

Perchloric acid hood exhaust outlets shall be flanged and furnished with a companion flange for welding to the exhaust duct.

Hood exhaust system design should provide for 10% minimum flow through the exhaust duct when hood is not in service. The hood exhaust may be used as part or all of the required exhaust from the laboratory room.

Exhaust fans are to be located to the exterior of the building envelope and the pressure in the duct shall always be negative relative to the building.

Fume Hood Location:

No fume hood should be installed closer than 10 feet to the primary room entrance/exit door. Fume hoods should also not be installed near expected high traffic areas within the laboratory or where supply air grills can cause turbulence at the hood face.

The following codes and standards should be reviewed when planning to purchase and install a chemical fume hood:

ANSI/ASHRAE 110-1995 – Method of Testing Performance of Laboratory Fume Hoods

ANSI/AIHA Z9.5 – The American National Standard for Laboratory Ventilation

NFPA 45 – Standard on Fire Protection for Laboratories Using Chemicals

DESIGN CRITERIA Division 11 – Equipment

SEFA 1.2-1996 – “Laboratory Fume Hoods Recommended Practices”

Suggested Fume Hood Manufacturers:

Kewaunee Scientific Equipment Corporation
Statesville, North Carolina 28677
704/873-7202

Hamilton Laboratory Solutions LLC
Manitowoc, WI 54220
920/657-1970

Advanced Lab Concepts
Houston, Texas 77284
281/859-5496

Special Hoods

Perchloric:

Perchloric acid hoods require a “wash down” feature in which water spray is used to remove acid crystals from the exhaust fan, ductwork, and hood plenum after each use. The water must not splash or fall on the work surface. Only one manual valve will control the wash down water. The valve handle shall be outside of the hood enclosure.

Each perchloric hood shall have an automatic five minute wash down cycle activated when the fume hood fan is de-energized.

Radioisotope:

Requires special construction to permit easy cleaning. Filtration requirements of the exhaust air and fume hood construction shall be determined on a case by case basis in consultation with Environmental Health and Safety.

Biological:

Biological Hoods shall meet NIH 03-112C Performance Specifications and shall be in accordance with National Sanitation Foundation Standard, NSF 49, and be listed by NSF. For application guidelines and filtration requirements use HHS Publication No. (CDC) 93-8395, “Biosafety in Microbiological and Biomedical Laboratories.”

Units shall be of steel or stainless steel construction; interior shall be stainless steel with coved corners. All seams and welds to be ground smooth and polished. Sliding view window shall be ¼" safety or tempered glass. Supply and exhaust HEPA filters shall be front loading and shall be 99.99% efficient for 0.3 micron sized particles. Unit shall be listed by UL and CSA for electrical safety. Unit shall include at least one petcock and one duplex outlet; additional services to be provided by user request. Unit shall include a fluorescent light and an ultraviolet (germicidal) light. Certification of unit after installation is required and

DESIGN CRITERIA

Division 11 – Equipment

must be performed by an approved certification company.

Suggested Biological Safety Cabinet Manufacturers:

NuAire Inc.
BioMedical Solutions, Inc.
281/240-5893

The Baker Company
Scientific Resources Southwest, Inc.
888/980-2845

Thermo Forma
800/848-3080

A list of approved certification companies is available from the Environmental Health and Safety.

Safety Showers

Floor drains are required beneath all safety showers connected to sanitary. Trap guard is acceptable.

Eyewash stations are required, confirm with TAMU EH&S for locations and approval. Refer to user specific requirements in the POR.

For more information:

<https://ehs.tamu.edu/manuals/>

DESIGN CRITERIA

Division 12 – Furnishings

WINDOW TREATMENTS

Window blinds and roller shades are considered to have a significant impact on the HVAC, and day lighting systems in a building. Automatic and/or manual window blinds and shades shall be provided wherever practicable to support and enhance energy efficiency of building systems.

Horizontal 1” mini-blinds shall be included in the design for office areas, in public spaces use mecho shade or equal.

Transparent roller shades (single run) shall be included in the design for classroom areas, mecho shade or equal.

Transparent roller shades and blackout shade (double run) shall be included in the design for conference, Seminar and Auditorium areas, mecho shade or equal.

LABORATORY CASEWORK

Laboratory casework shall be high quality wood or steel construction unless other materials are appropriate due to specific laboratory requirements.

Materials for laboratory tops shall be based on intended use.

Verify casework requirements and layouts for accessibility.

Verify any data networking requirements, including specific routing, labeling and quantity with Users and where indicated in the POR.

BOOK SHELVES

In order to maintain maximum room use and furniture placement flexibility typical faculty and staff offices shall not have built-in book shelving.

Movable bookcases will be provided as Movable Furnishings where indicated in the POR.

FURNITURE SELECTION

During the preparation of the POR, the FPC Interior Designer will consult with the User Coordinator to determine only the types and quantity of furniture needed to satisfy functional requirements.

The A/E in their Schematic and Design Development submittals will include furniture layouts

DESIGN CRITERIA

Division 12 – Furnishings

to POR requirements to ensure accommodation in the space proposed for doors, columns, etc.

FIXED SEATING

All classrooms are to be designed to accommodate left-handed students. Ten percent of the total number of desks shall be for left handed people or as directed by the User.

DESIGN CRITERIA

Division 13 – Special Construction

CONTROLLED ENVIRONMENT ROOMS

Rooms defined as cold rooms, environmental rooms, plant growth chambers, etc. including controls shall be specified as complete units from a single manufacturer.

The design of refrigeration systems for environmental rooms and growth chambers shall be reviewed by the Mechanical Engineer only for coordination with the building mechanical systems.

Project A/E shall specify that the manufacturer of this equipment shall submit a detailed test procedure for factory testing the first unit of each type and that the Owner will witness the test.

DESIGN CRITERIA

Division 14 – Conveying Equipment

GENERAL

Conveying Equipment Must be reviewed by the TAMU Elevator Maintenance Department (SSCServ) for compliance.

ELEVATORS

Elevators shall be selected and designed to comply with American Society of Mechanical Engineers/American National Standards Institute safety code for elevators, dumbwaiters and escalators, and moving walks, A17.1, latest revision as well as all requirements from with Texas Department of Licensing and Regulation and Texas Accessibility Standards.

Elevators manufactured by Otis, ThyssenKrupp, and Kone may be acceptable subject to meeting all applicable requirements of this section. Equal quality elevators of other manufacturers will be acceptable subject to approval of the Project A/E, the FPC Project Manager, SSCServ Maintenance Department Elevator Inspector and the RELLIS Facilities Department.

Elevators shall be specified to receive an electronic door safety device that extends the full height of the cab. Mechanical safety edge or traditional two beam photo-electric eyes are not acceptable.

Installation shall be by mechanic directly employed by the manufacturer or by installers franchised by and responsible to the manufacturer.

Electric operated elevators are preferred; however, oil hydraulic operation may be considered where use is intermittent or where the elevator serves two floors.

General Contractor's use of elevators will only be allowed with written permission of the FPC Project Manager, RELLIS Facilities Department and Elevator Vendor. Contractor shall be responsible for protecting interior finishes of all elevators. At Substantial Completion condition of all elevators shall be as new. Contractor's use of the elevator even with written permission of the Owner and vendor shall not relieve Elevator Vendor of any warranties expressed or implied. Provide complete inspection and maintenance service of each elevator for a period of 12 months at no cost to Owner. Elevator Vendor shall be able to show that they have had successful experience in the erection and maintenance of the type elevator equipment proposed for this project and that they maintain within 50 miles of the elevator installation an adequate stock of parts for emergency and replacement purposes; and that they have qualified men in their own employ available to insure the fulfillment of any maintenance and/or repair services without delay within one hour notification, 7 days a week on a 24 hour basis. Elevator Vendor must be established in operation for the past five years and have a proven selection of parts and service facilities to meet the qualifications stated above for 2 years. The elevator contractor must also be the manufacturer of the elevator being installed.

DESIGN CRITERIA

Division 14 – Conveying Equipment

Provide BIM(s) of elevators to be used. Ensure that the following minimum data is associated with the model: manufacturer, model, number, speed, and capacity.

Provide an Analog Telephone Adapter (ATA) compatible with a Cisco Call Manager system.

PASSENGER ELEVATORS

Speed: 2 through 3 floors travel of 150 ft./min.;
 4 and above floors travel of 350 ft./min.;

Capacity: Generally, stretcher number 3500 to 4500 pounds is specified depending on floor area and person density.

Control: Selective/collective automatic for single cars. For multiple units of two or more, group automatic control. Solid state controls preferred.

Diagnostic Tools: The elevator contractor shall provide to the Owner, integral with and built into the elevator controller, as part of this specification, any and all diagnostic tools and/or instruments and all written operating and instruction manuals needed to use the diagnostic tools required by the specification to allow for adjustment of any and all computer parameters and/or troubleshooting the equipment provided. These diagnostic tools shall be provided at no additional cost to the Owner. The Owner shall not be required to execute any type of written agreement in order to obtain said tools. The use of any handheld or removable diagnostic devices shall be specifically prohibited. The integral diagnostic tools and/or instruments shall permit the Owner and/or his authorized representative to access, diagnose and/or adjust any and all computer and/or software based variable features and/or parameters for the entire lifespan of the new equipment provided as required by the specification.

Operation: Leveling with resistance operation through 150 ft./min.; generator or solid state control for 200 ft./min. and above.

Cab: Stainless steel front and car door, stainless steel base, plastic laminated sides and rear, luminous ceiling with UL approved, manufacturer's Standard concealed fluorescent lighting, exhaust fan, stainless steel handrails on three sides and contain a device for voice communication to meet Texas Accessibility Standards.

The cab should have the following as standard features:

DESIGN CRITERIA

Division 14 – Conveying Equipment

- A. Emergency Phone
 - 1. Hands free, auto dial, flush mount, vandal resistant
 - B. Door Operators
 - 1. Heavy duty
 - C. Door Protection/Reopening Device
 - 1. Infrared electronic scanning
 - D. Fireman service key switches phases I and II
 - 1. “Adams” cylinders with WD01 key
 - E. Cab Lights
 - 1. Fluorescent or screw-in base with easy access for replacement
 - F. Vandal-resistant car enclosures
 - 1. Swing return (hinged) car stations
 - 2. Hall and car button and fixtures
- Hoistway Entrances: 3'-6" min. width, 7'-0" high, baked enamel finish, power operation.
- Electric elevators: Overhead preferred, but location at lower level optional on installations of four floors and less.
- Oil hydraulic elevators: Not above the first floor, adjacent to hoistway preferred.
- Platform: Size according to code for capacity; however, standard sizes should be selected.
- Signals: Provide Braille markings on car operating faceplate and call signals and other features. One emergency alarm bell button in each car connected to emergency alarm station on the main floor. Position indicators, direction arrows, and hall, and car buttons should be L.E.D. standard 100,000 hour lamps
- Flooring: Same as adjacent area by flooring subcontractor.
- Floor Lockout Provisions: Provisions shall be included if directed by the FPC Project Manager.
- Emergency Generator: Interlock with emergency generator if Emergency Power System is approved for building. Otherwise, make no

DESIGN CRITERIA

Division 14 – Conveying Equipment

provision for an emergency generator for the elevator unless specifically directed to do so by the FPC Project Manager and RELLIS Facilities Department.

Hooks & Pads: Hooks shall be installed in all passenger elevators. In addition, one complete set of pads shall be furnished for the Contractors' and Owners' use during construction. Prior to final acceptance, the pads are to be furnished in good condition and clean to the Owner.

COMBINATION PASSENGER/SERVICE ELEVATORS

Will be designed to meet requirements of passenger elevators; cab size, hoistway entrances and capacity to meet freight requirements.

FREIGHT ELEVATORS (FREIGHT ONLY)

Speed: Up to and including 2 floors travel of 50 ft./min.; above 2 floors travel 100 ft./min.

Capacity: Minimum of 2500 pounds; however, product and product weight should be considered.

Control: Same as for passenger elevator operation except for 2 floor installation single automatic push button.

Operation: Same as passenger service.

Cab: Standard freight (steel wainscoting).

Hoistway entrances: Bi-parting type. Generally, door operation is manual; however, consideration should be given to power operation where use of equipment is extensive.

Signals: Door open bell, in use light and illuminating buttons.

Machine Locations: Same as passenger elevators.

Platform: Size and classification according to code, building requirements, and capacity.

DESIGN CRITERIA

Division 21 – Fire Protection

GENERAL

The A/E shall identify on the drawings all areas that may be classified as hazardous in accordance with the latest edition of the NFPA Codes or that may pose a health hazard due to noise levels, radiation, chemical fumes, etc. The A/E shall describe how each such area will be treated in the building design in terms of fire protection.

All CM/GC is responsible for modeling all of the fire suppression system using BIM authoring software.

Fire Protection must be reviewed by the TAMU EH&S Department for TAMU Standards and Code Compliance.

FIRE PROTECTION SYSTEMS

General

All buildings shall have automatic sprinkler system protection throughout. This applies to new construction as well as major renovations and/or modifications. Clean Agent or Water Mist Systems are permitted as a first line of defense. However, it is the interpretation of the Texas State Fire Marshal's Office that sprinkler protection still be provided for all areas in accordance with NFPA 101 Section 9.8.1.

Design and installation of fire protection systems shall meet the latest edition of, NFPA 13 "Standard for the Installation of Sprinkler Systems", NFPA 13R "Standard for the Installation of Sprinkler Systems In Low-Rise Residential Occupancies ", NFPA 14 "Standards for the Installation of Standpipe and Hose Systems", NFPA 20 "Standard for the Installation of Stationary Pumps for Fire Protection", NFPA 24 "Installation of Private Fire Service Mains and Their Appurtenances" and their referenced standards unless fire hazards are specifically addressed by other NFPA Codes and Standards. Fire protection drawings, calculations and listing of all equipment to be installed should be submitted to the A/E team and the "Local Authority Having Jurisdiction" for review and acceptance prior to installation. Submittals shall be in accordance with the respective NFPA Codes and Standards and incorporate any special comments and notes applicable as identified within this Design Guidelines and the respective project specifications.

The A/E shall be responsible for modeling, using BIM authoring software, and included in the Construction Documents the Fire Protection Sprinkler System—Sprinkler and main locations, plans, riser locations and diagrams. Risers shall include sprinkler piping with devices for monitoring by building Fire Detection and Alarm system identified. Drawing shall be laid out to allow for the addition at completion of construction as Record Documents (as built) piping to each sprinkler. Record Documents shall comply with the requirements of the respective NFPA standards.

DESIGN CRITERIA

Division 21 – Fire Protection

The Fire Protection Sprinkler and Standpipe System shall be designed by a Registered Professional Engineer or an organization which possesses a valid Certificate of Registration as issued by the Texas State Fire Marshal's Office and has at least one (1) person engaged in or working on the actual plans, who is licensed to perform the work authorized by the company certificate and the individual's license issued by the Texas State Fire Marshal's Office.

Reference Standards

The reference standards shall include the latest edition of the following as applicable:

1. ANSI-NEMA Standards: National Electrical Manufacturers Association
2. ANSI/ASME B16.1 Cast Iron Pipe Flanges and Flanged Fittings, Class 24, 125, 250, and 800.
3. ANSI/ASME B16.3 Malleable Iron Threaded Fittings, Class 150 and 300.
4. ANSI/ASME B16.5 Pipe Flanges and Flanged Fittings.
5. ANSI/ASME B16.9 Factory made Wrought Steel Butt welding Fittings.
6. ANSI/ASME B16.11 Forged Steel Fittings, Socket welding and Threaded
7. ANSI/ASME B16.25 Butt welding Ends
8. ANSI/ASME B36.10 Welded and Seamless Wrought Steel Pipe
9. ANSI/ASME Sec 9 Welding and Brazing Qualifications
10. ANSI/ASTM A135 Electric Resistance Welded Steel Pipe
11. ANSI/ASTM A47 Malleable Iron Castings.
12. ANSI/ASTM B32 Solder Metal
13. ANSI/AWS A5.8 Brazing Filler Metal
14. ANSI/AWWA C110 Ductile Iron and Gray Iron Fittings
15. ANSI/AWWA C151 Ductile Iron Pipe, Centrifugally Cast
16. ASTM A53 Pipe, Steel, Black and Hot Dipped, Zinc coated Welded and Seamless
17. ASTM A795 Black and Hot Dipped Zinc Coated Welded and Seamless Steel Pipe for Fire Protection Use.
18. AWS D10.9 Specifications for Qualification of Welding Procedures and Welders for Piping and Tubing.
19. NFPA 1 – “Fire Code”
20. NFPA 13 – “Installation of Sprinkler Systems”
21. NFPA 13R – “Installation of Sprinkler Systems In Low-Rise Residential Occupancies”
22. NFPA 14 – “Standpipe and Hose Systems”
23. NFPA 20 – “Standard for the Installation of Stationary Pumps for Fire Protection”
24. NFPA 24 – “Installation of Private Fire Service Mains and Their Appurtenances”
25. NFPA 25 – “Standard for the Inspection, Testing, and Maintenance of Water Based Fire Protection Systems”
26. NFPA 45 – “Standard of Fire Protection for Laboratories Using Chemicals”
27. NFPA 70 – “National Electric Code”
28. NFPA 72 – “National Fire Alarm and Signaling Code”
29. NFPA 101 – “Life Safety Code”
30. UL Fire Protection Equipment Directory

DESIGN CRITERIA

Division 21 – Fire Protection

31. Fire Code and any Standards, Guidelines, or Criteria adopted by the responding fire department. This is applicable to the extent of fire department access, water supply, fire department connections, standpipe systems and hose connections, etc.
32. State of Texas, State Fire Marshal Rules

General Underground Water Supply to Fire Protection Systems

Design and installation of water supply for fire protection systems shall meet NFPA 20 “*Standard for the Installation of Stationary Pumps for Fire Protection*”, NFPA 22 “*Standard for Water Tanks for Private Fire Protection*”, NFPA 24 “*Standard for the Installation of Private Fire Service Mains and Their Appurtenances*”, NFPA 25 “*Standard for the Inspection, Testing, and Maintenance of Water-Based Fire Protection Systems*” and their referenced standards.

New Fire Hydrants shall comply with NFPA 24. Fire Department Connection shall be within 100 feet of the nearest fire hydrant. The A/E shall verify with the Local AHJ if 5-inch quick connect devices (i.e. Storz type) are required on fire hydrants and size/type of fire department connections. Quick connect devices shall be UL Listed.

The underground fire protection supply should have a PIV.

Underground piping for fire protection use shall have the acceptance requirements of NFPA 24 met. This includes flushing of piping based on the minimum flow rate identified by size of pipe within NFPA 24. If the piping will serve a fire pump, the minimum flow rate shall be in accordance with NFPA 20. Hydrostatic testing is also required. The Contractor shall provide a “Contractor’s Material and Test Certificate for Underground Piping” in accordance with NFPA 24. The “Contractor’s Material and Test Certificate for Underground Piping” shall be submitted by a licensed RME-U with the Texas State Fire Marshal’s Office or provide documentation of equal qualifications. The “Local Authority Having Jurisdiction” shall be invited to witness flushing and hydrostatic testing.

Fire Pumps

Fire pumps shall be UL Listed and FM Approved.

Provide concrete pads for the fire pump, fire pump controller, and pressure maintenance pump (jockey).

All elastomeric couplings are prohibited. Alignment of the fire pump shall be done by digital means. A report including the digital readings from alignment shall be included with the pre-test checklist.

Drain lines from the fire pump cup drain to the floor drain shall be CPVC piping. (This is ONLY for the drain line from the cup drain to the floor drain.)

DESIGN CRITERIA

Division 21 – Fire Protection

Fire Pump start-up shall be performed, documented, and transmitted to all parties prior to the Acceptance test. Acceptance testing of fire pump to be witnessed by a combination of representatives from Texas A&M University System, the “Local Authority Having Jurisdiction”, and/or their designated representatives (Third Party Inspectors).

Standpipe System Design

Design of the Standpipe System shall be in accordance with NFPA 14 “*Standard for the Installation of Standpipe and Hose Systems*”:

1. 500 gpm at the most hydraulically remote hose connection
2. 250 gpm at the top of the other standpipes
3. Total flow permitted to be 1,000 gpm IF building protected throughout with automatic sprinkler system (NFPA 13).
4. Design with a minimum 100 psi residual pressure at the most hydraulically remote hose connection

System acceptance testing to include flow test of the standpipe system in accordance with the design criteria:

5. 500 gpm flow at the most hydraulically remote hose connection
6. 250 gpm flow at top of each of the remaining standpipes up to 1,000 gpm IF the building is protected by automatic sprinkler system throughout (NFPA 13)
7. Measure minimum 100 psi residual pressure at the most hydraulically remote hose connection

Hoses need not be installed unless specifically required by other NFPA Codes and Standards.

Standpipe piping shall be Schedule 40 black steel pipe conforming to ASTM A-53 or ASTM A-795. Minimum size of standpipe piping shall be 6-inches in accordance with NFPA 14.

Air ejectors/air vents are required at the top of each standpipe as required by NFPA 14. Air ejectors shall be piped into main and express drains when required by the manufacturer’s installation instructions.

AUTOMATIC SPRINKLER SYSTEM

Design Criteria

Provide water supply flow test data identifying the location, flow characteristics, and the source of the data. Specify that it is the Contractor’s responsibility to verify the flow test information prior to completing the shop submittal hydraulic calculations. The flow test data shall not be more than one (1) year old.

Automatic sprinkler system design criteria shall meet the requirements of NFPA 13. During project design, the A/E shall consult with the Local AHJ and the insurance carrier to verify no

DESIGN CRITERIA

Division 21 – Fire Protection

additional criteria is required.

All materials shall be UL Listed and FM Approved products. The UL Certifications Directory is available at <http://database.ul.com>. The FM Approval Guide is available at https://approvalguide.com/CC_host/pages/public/custom/FM/login.cfm. Registration for access to the Approval Guide is free.

Fire Department Connection shall be within 100 feet of the nearest fire hydrant.

Pipe and Fittings

Compliance with Article 5.43.3 of the Texas Insurance Code and NFPA Codes and Standards is required. Test drains need to be located at the end of each run with a two inch drain located at the main and piped to a drain. Drains can be piped directly to the outside only when approved in writing by the Owner representative and Local AHJ.

All piping to be Schedule 40 black steel pipe in accordance with ASTM A-53 or ASTM A-795. All Schedule 40 pipe shall be fully reamed. All grooved pipe shall be roll grooved. Cut grooved pipe is not permitted.

Internally galvanized piping is not permitted other than for drain piping only. All piping exposed to the open atmosphere shall be treated. If internally galvanized pipe is the only option in the situation of being exposed to an open atmosphere, galvanized pipe may be utilized. However, no welding shall be performed after the hot dipped galvanized process.

Grooved pipe is acceptable for fire protection systems for piping greater than 2 inches in diameter. Piping 2 inches in diameter and less shall be threaded.

Provide insulation and heat tracing for fire protection piping in crawl spaces and other areas in which the temperature could drop below 40 degrees Fahrenheit such as loading docks, drive thrus, exterior stairs or canopies.

Provide a cleaning specification for sprinkler piping. Add to specification clear requirements for maintaining caps on pipe stored on the jobsite.

All piping for armovers shall tie into the top of the branchline instead of the side or bottom. Specify galvanized or cad plated rods and hangers for sprinkler piping. Do not allow black iron rods or shot anchors for hanging sprinkler piping.

If flexible piping (i.e. FlexHead etc.) is proposed; it shall be UL Listed and FM Approved. Provide with product data, a copy of the UL Listing and FM Approval identifying the allowable bend radius and number of bends. Flexible piping shall be limited to a maximum of 48 inches in length. Provide additional specification inspection criteria for flexible piping. Bend radius and number of bends shall not exceed that identified by UL Listing and FM Approval, whichever is most restrictive. Inspection shall be coordinated such that the ceiling grid is in

DESIGN CRITERIA

Division 21 – Fire Protection

as well as the ceiling tiles for the flexible piping sprinkler drop ONLY. All other tiles shall not be installed at the time of the flexible piping inspection. Inspection shall include support screws into the ceiling grid, deflector location below ceiling grid elevation, and support of sprinkler drop to support grid.

All fittings shall be UL Listed and FM Approved. Size on size (weld-o-let type) fittings are not acceptable.

Piping greater than 2-inches may be rolled grooved with grooved fittings. Piping 2-inches and smaller shall be threaded malleable iron.

All couplings shall be UL Listed and FM Approved. Snap joint couplings, mechanical-T style couplings, pressfit couplings, outlet couplings, reducing couplings, cut-in style couplings, and plain end type couplings are not permitted.

Bushings are prohibited.

Automatic Air Vents

Air ejectors are required on every floor with an automatic sprinkler system in accordance with NFPA 13. These air ejectors shall be located at the remote test drain assembly or at the highest elevation of the respective sprinkler system. These air vents are to be piped to the remote express drain or nearest suitable drain termination point in accordance with the manufacturer's instructions.

SPECIAL OCCUPANCIES

Mechanical/HVAC Equipment Rooms

If the equipment room does not contain oil-filled electrical equipment or other flammable liquids, Fire protection should be designed to Ordinary Hazard Group 1.

Electrical Rooms/Switchgear Rooms

ALL Electrical/switchgear rooms SHALL have automatic sprinkler protection except the Main Electrical Room and the Emergency Electrical Room. Note that the recommended preference of the Texas State Fire Marshal's Office is to provide automatic sprinkler protection in all electrical/switchgear rooms including the Main Electrical Room and the Emergency Electrical Room. When the exception is used, these two rooms shall comply with NFPA 13 and have the following features:

- a. The electrical/switchgear rooms are provided with a 2-hr fire rated enclosure. The enclosure shall include the floor/ceiling assembly separating the electrical/switchgear room from adjacent building areas above and below the respective electrical/switchgear room.
- b. UL Listed Monitored Smoke Detection is provided
- c. All wall penetrations are properly sealed with fire-rated material

DESIGN CRITERIA

Division 21 – Fire Protection

- d. The area is kept free of combustibles, and housekeeping policies must be in effect
- e. No oil-filled transformers or switchgear are present

If oil-filled/oil-insulated switchgear or transformer equipment is present, fire protection shall be designed for Ordinary Hazard Group 2

Data Centers

Wet sprinkler systems or UL Listed pre-action systems are recommended, and should include UL Listed smoke actuated fire detection or air-sampling type detectors, automatic emergency shutdown (*manual EPO can be installed for small or non-critical data centers*), and meet the design criteria outlined in NFPA 75 “Standard for the Fire Protection of Information Technology Equipment”, NFPA 76 “Standard for the Fire Protection of Telecommunications Facilities” where applicable, and NFPA 13 “Standard for the Installation of Sprinkler Systems”. A sprinkler density of Ordinary Hazard Group 1 shall be provided.

Clean Agent or Water Mist Systems are permitted as a first line of defense, however, it is the interpretation of the Texas State Fire Marshal’s Office that sprinkler protection still be provided for all areas in accordance with NFPA 101 Section 9.8.1.

Emergency Generator Rooms

Provide automatic sprinkler protection in the generator room designed to Ordinary Hazard Group 2.

FDC Signage

FDC signage shall comply with the requirements of the Texas State Fire Marshal’s Office Notice dated May 2016. Fire Department Connection Signage shall include:

- 8. Building Identification
- 9. Building Location
- 10. Fire Protection Systems served (Sprinkler and/or Standpipe system)
- 11. Identify if there is a Fire Pump
- 12. Identify main building riser location or fire pump room location
- 13. Inlet pressure required by fire department equipment to meet system demand

SPECIALTY SYSTEMS

Clean Agent Fire Extinguishing Systems

All special protection systems should be installed in accordance with NFPA 2001 “*Standard on Clean Agent Fire Extinguishing Systems*”. These systems should not be installed in any

DESIGN CRITERIA

Division 21 – Fire Protection

area where moderate to heavy loading of ordinary combustibles will be present (i.e. special collections in libraries, storage areas for Data Centers, etc.)

If special protection systems are to be used in Data Centers, they must be designed in accordance with NFPA 2001 "*Standard on Clean Agent Fire Extinguishing Systems*". Clean Agent Systems are permitted as a first line of defense, however, it is the interpretation of the Texas State Fire Marshal's Office that sprinkler protection still be provided for all areas in accordance with NFPA 101 Section 9.8.1.

The system shall be UL Listed and FM Approved.

The system shall be designed and installed by an experienced firm regularly engaged with automatic total flooding fire extinguishing systems. The firm shall have a minimum of five (5) years' experience in design, installation, and testing of these systems and shall be certified and licensed by the Texas State Fire Marshal's Office in accordance with Article 5.43.1 of the Texas Insurance Code.

The contractor must perform two (2) tests for total flooding fire suppression systems.

Water Mist Systems

A UL Listed and FM Approved Water Mist System is acceptable if all criteria outlined in NFPA 750 "*Standard on Water Mist Fire Protection Systems*" are satisfied. Water Mist Systems are permitted as a first line of defense, however, it is the interpretation of the Texas State Fire Marshal's Office that sprinkler protection still be provided for all areas in accordance with NFPA 101 Section 9.8.1. The Water Mist System must be UL Listed and FM Approved for that specific application. If not in accordance with a specific application, an Alternate Method of Compliance is required.

FIRE DEPARTMENT ACCESS AND LOCK BOX

Fire Department Access Roads shall follow NFPA 1, Chapter 18. All parts of the structure shall be within 300 feet of a fire hydrant. All access roads shall be 20 foot wide. For buildings exceeding 30 feet in height, an aerial apparatus access road shall be required parallel to one entire side of the buildings to provide access to the roof or structure. Aerial fire apparatus access roads shall be a minimum of 26 feet in width and be located a minimum of 15 feet and a maximum of 30 feet from the building.

Fire Hydrants

Fire Hydrants shall be AWWA C502 Dry Barrel type. Specific model shall be Mueller Super Centurian 250, American Darling B84B, or approved equal. Hydrant shall be free standing with one NSH 4-1/2" and two NSH 2-1/2" outlets, 5-1/4" main valve, and NPS 6" mechanical joint inlet. All hydrants shall have a 5 inch Storz steamer connection.

DESIGN CRITERIA

Division 21 – Fire Protection

Fire Department Connections, PIV, and Standpipes

Fire Department Connections shall be a minimum of two NSH 2-1/2" inlets 5 inch quick connect. Fire Department connections shall be locked with Knox Swivel-Guard Caps Model 3111.

Each underground gate valve on the fire suppression water service piping shall comply with NFPA 24 and include a vertical cast-iron indicator post, UL-Listed or FM Global-Approved.

Fire Department Hose Valves shall have Knox caps (Knox Standpipe Lock).

DESIGN CRITERIA

Division 22 – Plumbing

GENERAL

Plumbing must be reviewed by Utilities and Energy Services (UES) and SSCServ for Compliance with Installation and Maintenance Standards.

Provide necessary services, piping, connections, fittings, and fixtures for floor drains, drinking fountains, custodial floor sinks, work room sinks, laboratories, and toilets as required in the POR. Provide a single hose bib with lock shield under the lavatories in each restroom. Provide the capability for a fume hood and shower and dressing capabilities in the Wet Lab area. Use the latest International Plumbing Code for requirements.

Submit plumbing calculations with the Design Development submittal. Any changes to the plumbing design and calculations shall be submitted a minimum of one week prior to the first interim Construction Documents review meeting.

Room numbers must appear on plumbing plans and room names where space is available. Column lines or designations shall appear on all plumbing sheets as they appear on architectural and structural sheets.

Plumbing and HVAC systems shall be drawn as separate sheets. These systems may be combined only by written permission of the FP&C Project Manager.

CM/GC shall provide as-built BIM(s) of all plumbing piping and valves 2" and larger as well as any plumbing equipment.

Where piping systems are to be installed underfloor, these shall be shown on an underfloor plan and not on the plan prepared for the space above. Floor plans for mechanical systems shall be drawn to show pipes, ducts, etc. on the floor in which they are installed. In general, underfloor plans shall be drawn to show all piping underfloor and, from there up, the systems between each floor slab shall be shown only on the appropriate floor plan.

All construction details shall be shown on the drawings and shall not be bound in the specifications.

All equipment and material specifications shall be bound in the specifications and shall not be shown on the drawings.

Performance data for all plumbing equipment shall be shown in schedules on the drawings. This data may also be included in the specifications but shall be carefully edited for conflicts.

The A/E shall identify on the drawings all areas that may be classified as hazardous in accordance with the latest edition of the NFPA Codes or that may pose a health hazard due to noise levels, radiation, chemical fumes, etc. The A/E shall describe how each such area will be treated in the building design.

GENERAL PLUMBING SYSTEMS

- a. All domestic water to be protected by a reduced pressure backflow preventer.
- b. All domestic water interior to the building shall be type L copper with soft solder joining. All underground shall be type K. No joints in inaccessible areas under slabs unless silver soldered.
- c. Underground sanitary to be hub and spigot and cast iron. Interior of the building shall be no hub C.I.
- d. All ball valves shall be two piece full port with threaded ends stainless steel ball and stem.
- e. All butterfly valves shall be drilled and tapped lugged body or full flanged.
- f. All systems shall be sterilized to meet health department requirements.
- g. All underground domestic water shall be ductile iron, P.V.C. or copper.
- h. All underground gas piping shall be polyethylene with fusion welded anodeless riser turn up,
- i. All lab gases shall be installed with type L copper and fuel gas to be installed with schedule 40 black steel pipe interior to the building.
- j. Provide frost proof hose bibs and weatherproof duplex electrical outlets on exterior of buildings. Major buildings should have a minimum of one hose bib and one electric outlet on each face of the building.
- k. Coordinate with the structural for block outs at floor drains.

METERING

All buildings shall be designed for metering reference [UES Design Standards](#) for requirements.

Projects needing to meet SMART Campus initiatives shall be sub-metered, see section A RELLIS Facility Design Guidelines.

All natural gas lines shall follow ATMOS standards for metering. The Project A/E shall also provide a Commercial Customer Load Requirements sheet (provided by Atmos) and properly locate the meter based on current Atmos guidelines for meter location and meter clearances with respect to building features.

DESIGN CRITERIA

Division 22 – Plumbing

PIPING

Gas lines shall be of all welded black steel construction inside of the building to emergency shut-off valves. Gas lines from valve to lab table or appliances may be screwed black steel with M.I. fittings for 3/4" and smaller. All building gas piping shall be designed and installed in accordance with National Fuel Gas Code, NFPA 54, latest edition.

All control valves shall be listed in a schedule on the drawing showing identification number, body size, port size, if applicable, whether normally open or closed, spring range, and CV.

Provide insulation on all roof drain lines and overflow lines and pipes that accept condensate.

All interior water piping shall be type L copper with soft solder joints. For exterior applications where copper tube is specified, it shall be Type K.

Underground sanitary sewer to be cast iron, hub and spigot. No hub cast iron may be used in the interior of the building

Riser diagrams to show all waste, vent, supply piping, and cleanouts.

Provide threaded wall stops at all lavatory and sink water supply piping.

Deionized water piping shall be completely drainable. All low points and traps in the system shall have the capability to drain the system completely prior to starting the system.

Victaulic type couplings may be used for piping in equipment rooms only. Victaulic piping systems may be used on fire protection systems for piping 2-1/2 inches and larger only.

Underground condensate reclamation pipe shall be PVC. Piping shall be marked appropriately as "NON-POTABLE". Piping shall be purple in color.

Interior condensate reclamation pipe shall be CPVC. Piping shall be marked appropriately as "NON-POTABLE". Piping shall be purple in color.

PLUMBING

Buildings shall be designed to permit gravity flow of sanitary and storm drainage (12 inch maximum storm drain size). Where sewage ejectors or sump pumps are required, they shall be located to have sufficient headroom to pull the pump shaft straight up through the floor plate. Lifting eyes or trolley beams shall be provided to facilitate the removal of the equipment. Emergency power shall be provided if failure of pump would damage or flood electrical or mechanical equipment. A high level alarm shall also be provided.

DESIGN CRITERIA

Division 22 – Plumbing

Pipes penetrating exterior walls below grade must be installed properly to prevent breakage due to building settlement or expansive soil.

All connections to campus distribution systems or public utilities shall be precisely located by dimension or coordinates. Depth of piping shall be shown and inverts will be shown at manholes and other critical points.

Access shall be provided to all working parts of plumbing devices. Do not permanently seal in wall any plumbing items requiring periodic operation or maintenance.

Cleanouts shall be located at each bend and every 50 feet in straight runs.

Roof drains shall be run separately from all other storm water sources to outside of the building. All overflow drains shall be piped independently of the roof drain system

Roof overflow drains shall be designed in compliance with the International Plumbing Code. Scuppers can be used instead of overflow drains.

Caulk all toilets, urinals, and lavatories at the wall interface.

All toilet bowls and urinals to be set within 1/16" of the finished wall.

Provide 1-1/2" P-trap for all lavatories and provide ADA protection where required.

Provide Shock stops on all water piping in toilet battery chases with valve upstream of stop for maintenance. Install either above the ceiling or behind an access door for maintenance at the end of the header.

All no-hub cast iron to be provided with hangers within 18" of the hub on each side.

Provide drum sediment traps for all fume hoods and lab sink drains.

For domestic water supplied to a building, a reduced pressure double check valve assembly is required. For fire protection water supply, a simple double check valve assembly is required. Outside not allowed.

Condensate shall be recovered from HVAC/mechanical equipment. Condensate recovery from HVAC/mechanical equipment shall have a minimum of 20 minutes of storage.

MECHANICAL EQUIPMENT ROOM

Provide at least one (1) 4" floor drain with trap seal protection in each equipment room. Locate out of the walking area, but not under equipment. Connect to sanitary sewer system. Locate one (1) domestic water line hose bib with vacuum breaker in each equipment room

DESIGN CRITERIA

Division 22 – Plumbing

for coil washing. Contain spills inside mechanical room, trench drain or other means.

Mechanical rooms shall have an appropriate epoxy floor covering.

REST ROOMS

Each rest room should have at least one 4" floor drain when serving 80 or more square ft. and 3" min. for less area. (Locate under stall partition or where one is not likely to walk). Floor drains shall be provided with automatic trap seal protection. Each rest room shall have supply of conditioned air and a positive exhaust air system.

Coordinate the location of toilet partitions and floor drains. The drain shall be under the partition but not adjacent to the support.

For sanitary cleanouts in or near restrooms, place the cleanout(s) at a higher elevation than the flood rim of the surrounding fixtures.

Each restroom shall have at least one hose bib with a vacuum breaker provided.

Provide stainless steel access doors for restrooms.

PLUMBING FIXTURES

All water closets shall be on Carriers

All fixtures to be selected by the A/E Design team and submitted for review and approval at Design Development.

Drinking Fountain shall include bottle fillers

DESIGN CRITERIA

Division 23 – Heating, Ventilating and Air Conditioning

GENERAL

Heating, Ventilation and Air Conditioning must be reviewed by Utilities and Energy Services (UES) and SSCServ for Compliance with Installation and Maintenance Standards.

PERFORMANCE REQUIREMENTS

The following are baseline minimum performance requirements for mechanical systems. It is possible for the project Program of Requirements to have requirements that deviate from or exceed these minimums:

Energy Code

See section A, Design Criteria, for energy code requirements.

Mechanical Code

The design is to comply with the latest edition of the International Mechanical Code.

Dry Bulb Temperature

For offices, conference Rooms, and classrooms the indoor design conditions shall be a maximum 72 degrees F for heating and a minimum 75 degrees F for cooling. The controls shall provide for seasonal and unoccupied temperature reset.

For laboratories that are driven by minimum ventilation requirements the minimum cooling design condition shall be 72 degrees F in order to minimize the amount of reheat required

For Mechanical Rooms, Electrical Rooms, Janitors Rooms, and Storage Rooms the minimum cooling design temperature shall be 80 degrees F.

For stairwells, the design conditions shall be specified by the engineer of record

Humidity

Provide a maximum 55 degrees F dew point.

Air Movement

Provide less than 40 feet per minute air speed at the occupied level.

DESIGN CRITERIA

Division 23 – Heating, Ventilating and Air Conditioning

Pressurization

Provide building positive pressure when occupied and when outside dew point is greater than 47 degrees F.

Laboratories generally are maintained under negative pressure in relation to the corridor of other less hazardous spaces. Specific laboratory pressurization requirements are to be confirmed with the Environmental, Safety, and Health officer for the campus.

Ventilation

Provide ventilation rates per the International Mechanical Code (or ASHRAE 62.2-2013 if the ASHRAE 90.1-2010 energy code is being used). Provide demand controlled ventilation when required by IECC2015 or ASHRAE 90.1-2013.

Laboratory ventilation rates are established by the Environmental Safety and Health Officer for each campus. If the EHS officer has no specific requirements then the baseline design shall be a maximum of 8 and a minimum of 4 air changes per hour. Lighting occupancy sensors shall detect occupancy and operate the lights and adjust ACH based on occupancy.

Laboratory fume hoods shall maintain a minimum face velocity of 100 fpm with no measure point less than 80 fpm when the sash is open 18 inches. When the sash is fully open the minimum face velocity shall be 100 fpm with the building lab air supply sized with a 60 % diversity factor.

Filtration

Filtration performance requirements are to be specified by the engineer of record. Currently, the need to get LEED points is driving the specified filtration performance levels above what is required by ASHRAE 62.1-2013

PRESCRIPTIVE DESIGN AND SPECIFICATIONS REQUIREMENTS

Design Criteria

The outdoor design condition criteria are to be established by the engineer of record using the latest edition of the ASHRAE Handbook of Fundamentals. The design criteria shall be shown on the General Information sheet of the mechanical drawings and be included in the Basis of Design narrative.

DESIGN CRITERIA

Division 23 – Heating, Ventilating and Air Conditioning

Building Ventilation Schedule

The Building Ventilation Schedule for all spaces shall be included in the Basis of Design narrative at the Design Development and the Construction Document phase.

Building Pressurization Table

The Building Pressurization Table shall be included in the Basis of Design narrative at the Design Development and the Construction Document phase.

Occupancy Loads

The occupancy loads shall be included in the Basis of Design narrative at the Design Development and the Construction Document phase.

HVAC Load Calculations

The HVAC load calculations shall be included in the Basis of Design narrative at the Design Development and the Construction Document phase.

Energy Analysis

An analysis for compliance with the energy goals shall be included in the Basis of Design narrative at the Design Development and the Construction Document phase.

Schematic Flow Diagrams

Schematic flow diagrams for air, cooling water, and heating water systems shall be included in the drawings.

Site Plans

Site plans showing new and existing thermal lines and the limits of construction shall be included in the drawings at all phases

Floor Plans

The Design Development drawings shall include floor plans showing a single line layout for supply air, return air, and exhaust air. The drawings shall also include enlarged mechanical room plans showing all equipment and access

DESIGN CRITERIA

Division 23 – Heating, Ventilating and Air Conditioning

UES SPECIFIC DESIGN STANDARDS

The Utilities and Energy Services (UES) department maintains prescriptive design standards for many mechanical systems. These standards are found at <https://utilities.tamu.edu/design-standards/ues-design-standards-and-guidelines-booklet/>.

The systems covered by these standards are:

- Building Automation Systems
- Electric Motors
- High Density Polyethylene (HDPE) piping Systems
- Hydronic Piping in Buildings
- Interconnection of Building Hydronic Systems to Campus Utility Infrastructure
- Laboratory Control Systems
- Piping Equipment and Structure Color and Identification
- Procedures for Receiving and Disconnecting temporary and Permanent Utility Services
- Thermal Systems (Chilled & Hot Water)
- Utility Metering
- Underground Piping Systems

HYDRONIC PIPING

In addition to the campus specific design standards:

Pipes in crawl spaces and other spaces subject to condensation must be insulated with non-permeable insulation such as cellular glass.

All pressure piping shall be tested at 150 psi or greater for 4 hour minimum.

All hangers shall be hot dipped galvanized in the crawl space and wet areas and cad plated otherwise.

All ball valves shall be two piece threaded 600 with stainless steel ball and stem.

All gate valves to be rising stem.

For steel piping the basis of design shall be threaded iron malleable iron fittings for 2 inch and under and welded schedule 40 fittings for 2.5 inch and larger.

For copper piping the basis of design shall be brazed or soldered fittings. The engineer of record may recommend specific press seal fitting for alternate pricing

All condensate drain lines shall be insulated to the vertical main. In exposed areas insulation

DESIGN CRITERIA

Division 23 – Heating, Ventilating and Air Conditioning

shall be premolded. In unexposed areas the insulation can be foil wrapped.

All hangers on domestic water and hydronic lines shall be installed on the exterior of the insulation.

3/4" is the smallest size for a hydronic pipe to a coil.

All ball valves on insulated piping to have extension handles.

Provide metal jacket on all crawl space piping, exterior insulate piping and mechanical room piping (up to 8'-0" AFF) insulation.

Density of fitting for insulated piping shall be the same as the specified pipe insulation. Use pre-molded fitting insulation, and loose fill are not acceptable

All auto air vents shall be constructed with a cast iron body and stainless steel ball and seat.

All manual air vents shall be plugged.

All valves preceding pressure gauges shall be needle type with snubbers installed on the discharge side of the pump.

Do not use red rubber gaskets on hot water lines and heat exchangers. Instead use EPDM or hard Garlock gaskets. Use EPDM gaskets in "push on" joints.

Anchor all condensate lines to the floor. Do not gang condensate lines together.

Do not use gate valves in hydronic piping, use ball valves 2" and smaller (e.g. stainless steel ball and stem) and butterfly valves for 2-1/2" and larger.

Butterfly valves shall have ductile iron disc and stainless steel nosing and stem.

Hydronic Piping Cleaning Guidelines:

The Utilities and Energy Services (UES) department maintains prescriptive design standards for these systems and procedures. These standards are found at

<https://utilities.tamu.edu/wp-content/uploads/2014/05/Hydronic-Piping.pdf>

14. Cleaning and Flushing of piping systems must be done by an independent, third party company that specializes in this type of work
15. Submit detailed plan for Engineer's and Owner's review and approval prior to any piping being installed. Plan shall describe in full detail the individual steps associated with this process before any piping is installed. Plan must include a drawing indicating phasing of systems to be cleaned, locations of drains or other temporary connections required for cleaning system, recommended time for cleaning agent circulation and clean water flushing, and cut sheet of proposed temporary pump(s).

DESIGN CRITERIA

Division 23 – Heating, Ventilating and Air Conditioning

16. Clean and flush thoroughly to remove construction debris (e.g., rust, dirt, piping compound/dope, mill scale, oil, grease) and contamination before placing pipe in service. Provide necessary temporary connections, bypass piping or hoses and valves that are required for cleaning, purging and circulating. Provide temporary bypasses around AHUs, fan coil units, and cooling and hot water coils. Bypasses are to be the same size as the supply and return pipe size. Also, do not flush through chillers, cooling towers, pumps, or other equipment. Remove flow meters from building piping prior to cleaning/flushing operation.
17. Cleaning & Flushing fluid velocities are to achieve a minimum velocity of 10 ft/sec to achieve a thoroughly clean system, free of construction debris and contamination before placing piping systems in service
18. Cleaning chemicals/agents must be environmentally friendly. Submit chemical cut sheets to Owner for approval prior to cleaning.
19. Third party is to provide their own temporary pumps and connections as required to achieve minimum velocities for cleaning, purging and circulating. Likewise, third party is to provide temporary strainers necessary to protect sensitive equipment and components during the cleaning/flushing process.
20. Install temporary strainers in front of pumps, tanks, solenoid valves, control valves, and other equipment where permanent strainers are not indicated. Keep these strainers in service until the cleaning and flushing process has ended and the system has been deemed clean and ready for use. Then remove the entire strainer or strainer element only. Replace the strainer basket and gasket. Contractor shall notify Owner so that the reinstallation of clean strainer screens may be witnessed.
21. Do not flush thru our coils (AHUs or air boxes) – normally only up to the isolation valves.
22. Discharge the “dirty” water to the sanitary waste stream – NOT the storm drains.
23. After systems have been cleaned and flushed, third party to provide a written certification that the systems are clean and ready for use.

DUCT SYSTEMS

All spin-ins shall be of the conical type with damper shaft mounted horizontally.

All grilles shall be regulated by a volume damper, when possible, in lieu of an OBD.

All metal components on galvanized sheet metal ducts shall be galvanized materials such as angle stiffeners. Trapeze hangers, rods, straps, etc.

All exposed ductwork to have internal insulation and metal liner and be fabricated from paint grip metal. The use of fiberglass internal duct liner is prohibited

Provide hangers for all slot diffusers and insulate. Provide detail on drawings.

Provide hinged access doors for duct access.

DESIGN CRITERIA

Division 23 – Heating, Ventilating and Air Conditioning

Provide airfoil turning vanes.

All large round ducts to be hung with half-round saddles and rods. Cable hangers are NOT acceptable.

Provide cover plates with appropriate finish for all recessed damper operators.

Provide a duct leakage test procedure.

All ducts to be fabricated from G-90 galvanized materials.

Foil backed tape on ducts is not permitted. Use fiberglass and Benjamin Foster sealant with fiberglass mat embedded in sealant.

All exterior duct insulation shall have a vapor seal and metal jacket applied with fiberglass mesh installed and resealed with vapor barrier sealer.

Acoustic duct lining used in air systems shall be non-fiberglass material impregnated with an antimicrobial agent.

All transfer air openings shall be sized with no more than 300 feet per minute air velocity

MECHANICAL EQUIPMENT ROOMS

Provide a curb around all penetrations through the mechanical room floor and all penetrations shall be sealed with appropriate fire stopping material.

Depress the floor of all mechanical rooms 1-1/2" and uniformly slope entire floor to minimum 4 inch floor drain(s). All floor drains to have trap primers and be connected to building sanitary sewer system

Provide positive ventilation in all equipment rooms that are not return air plenums.

Equipment rooms with other equipment than those items directly related to air handling equipment will not be used for return air plenums. The use of rooms as plenums is permissible provided outside air and return air are directed to the plenum and volume control dampers are provided to control the quantity of each entering the plenum. Each component of an air handling system shall be spaced so there is ample room on all sides for inspection and maintenance (filter removal, bearing replacement, coil replacement, cleaning, etc.) and man sized hinged access doors shall be provided for ready access to the spaces in the air handling equipment.

Air handlers suspended must be provided with permanent platforms for maintenance. The

DESIGN CRITERIA

Division 23 – Heating, Ventilating and Air Conditioning

Maintenance platform must be a minimum of 7'-0" clear from the floor below.

Provide dedicated 120 VAC duplex electrical outlets for maintenance equipment, and separate mechanical keying with University master keying system.

Provide conditioned, supply air into each mechanical room and electrical room for tempering the air in the space.

Housekeeping pads for the floor mounted equipment shall be minimum 6 inches high and shall extend minimum 4 inches beyond on all sides of the equipment that they support.

Refer the Architectural Design section of the Facility Design Guidelines for additional mechanical room requirements.

LABORATORY EXHAUST

Type 316 stainless steel should be used for all parts of the fume hood exhaust system. The exhaust duct should have as few bends as possible and minimal horizontal runs

Refer to Division 11 in the RELLIS Campus Facility Design Guidelines for additional fume hood requirements.

BOILERS

Specifications for boilers to include the following:

- Chemically treat and flush the boiler system prior to initial startup.
- Provide and install an automatic blowdown system.
- Provide and install a conductivity meter.
- Provide and install means for future chemical treatment.

Utilities and Energy Services (UES) maintains prescriptive design standards for these systems and cleaning procedures. These standards are found at <https://utilities.tamu.edu/wp-content/uploads/2014/05/Hydronic-Piping.pdf>

For buildings with dedicated heating water boiler plants: Modular boilers are to be used and with a minimum of two equally sized boilers sized at 67 percent of peak demand.

CHILLER PLANTS

Where needed and for buildings that have dedicated chiller plants: If the total cooling load is 1000 tons or more a minimum of three chillers must be provided. If less than 1000 tons, a

DESIGN CRITERIA

Division 23 – Heating, Ventilating and Air Conditioning

minimum of two equally sized chillers at 67 percent of the peak capacity must be provided.

ROOF MOUNTED EQUIPMENT

Mechanical equipment, except for cooling towers, air cooled chillers, and exhaust fans is not permitted on the roof of the building unless a conditioned mechanical penthouse is provided. Access to roof mounted equipment must be by stairs or freight elevator; ships ladders are not permitted.

TESTING AND BALANCING

Testing, adjusting and balancing of the air conditioning system, related to ancillary equipment and the domestic water system will be performed by an impartial technical TAB firm selected and employed by the TAMUS.

Air Handling Units

Casings

AHU housing must consist of formed and reinforced insulated panels, fabricated to allow removal for access to internal parts and components

Units shall have access doors, minimum 15½" width, to access both sides of the coils, filters, fan section and mixing box sections.

G90 Galvanize all parts of the unit, inside and out, including supports.

AHU units shall be built on a minimum of six inch high rails.

Drain pans shall be of stainless steel double wall construction, sloped both ways to a single outlet with a minimum of 2" of uncompressed insulation, with a minimum condensate connection of 1" NPT stainless steel. Drain pans shall extend downstream of the coil far enough to contain moisture carry-over. Drain pans must be accessible for inspection and cleaning

The Engineer of Record shall specify AHU casing leakage and deflection limits that satisfy the equipment service life specified in the program of requirements. The contractor's scope of supply shall include field leakage testing of one unit of each type that is used in the project.

Air handling units shall be constructed to facilitate easy removal of the coil without disassembly of the cabinet. At the manufacturer's option, the coils may be installed on tracks to facilitate removal.

DESIGN CRITERIA

Division 23 – Heating, Ventilating and Air Conditioning

AHU shall be constructed for a maximum 1% allowable leakage of the rated air flow at +/- 8 inch w.g.

Minimum space between the coils in the air handling units shall be 15½” for cleaning coils.

Safety latches shall be required on the fan section

Fans

The fans are to be specified by the engineer of record.

Coils

Cooling coils must be selected at or below 500 feet per minute face velocity. Heating coils must be selected at or below 750 feet per minute face velocity.

HVAC coils subject to outside air in hot, humid, and marine climates shall be provided with copper tubes and copper fins or electro coated copper tubes with electro coated aluminum fins with a coating thickness to be maintained between 0.6 mil and 1.2 mil and with a minimum salt spray resistance of 6,000 hours.

Individual finned-tube cooling coils, five or fewer rows may have a maximum 12 fins per inch. Individual finned-tube cooling coils of six rows or more shall not exceed 10 fins per inch.

Coil casing shall be stainless steel for chilled water coils. Any penetrations shall have rubber grommets and fully sealed for pressurization and insulated from the casing insulation.

Filters

The filters are to be specified by the engineer of record.

Controls

The A/E shall require controls contractor to supply one, or more, temperature-sensing element(s) in each Air Handling Unit. The sensor shall be required to be installed in a serpentine manner so that at least 75% of the coil's surface is covered and a representative average temperature can be transmitted to the Energy Management System (EMS). The length of sensor should be one (1) foot of length per square foot of coil area.

Electrical

All units with a motor rated at 10 horsepower and larger, shall be furnished with an internal 120 VAC light.

All units shall have a single point of connection for the electrical service to the unit. The manufacturer shall seal the conduit to the motor with “Sealtite” to prevent condensation in

DESIGN CRITERIA

Division 23 – Heating, Ventilating and Air Conditioning

the motor connection housing.

Variable Air Volume Terminal Units

Single duct terminal boxes are to be selected with the maximum scheduled CFM to be lower than 80 percent of the box listed capacity.

Boxes are to be delivered to the jobsite fully assembled with air dampers, heating coil, self-contained volume regulator, flow sensor, and disconnect switch. All controls shall be supplied by the ATC contractor to the box manufacturer for factory installation.

The damper actuator must be factory installed by the box manufacturer. All required linkages must be furnished and factory installed and performance tested by the box manufacturer

Samples of each type terminal units will be selected by the Owner for testing of case and damper leakage. The test will be done at the Testing and Balancing firm's facility. The engineer of record is to provide leakage requirements in the specifications.

BUILDING CONTROLS

The Utilities and Energy Services maintains prescriptive design standards for Building Automation Systems and Laboratory Controls. These standards are found at: <https://utilities.tamu.edu/design-standards/ues-design-standards-and-guidelines-booklet/>

In addition to these standards, UES has undocumented requirements for sequences of operation, design details, and control network architecture. These requirements are fluid and the engineer shall initiate a meeting with UES at the beginning of the project to discover and document these requirements.

METERING

All buildings shall be designed for metering reference [UES Design Standards](#) for requirements.

Projects needing to meet SMART Campus initiatives shall be sub-metered, see section A RELLIS Facility Design Guidelines.

GENERAL INFORMATION

AUTOMATIC TEMPERATURE CONTROLS

Provide a temperature control/energy management system and control function for the entire building. The system shall include a standalone Direct Digital Control (DDC) System. This system shall communicate with the Central EMS at the Facilities Services Department through an Ethernet card and the campus instrumentation control distribution wiring system.

The EMS/Automatic Temperature Control (ATC) system must be compatible with the existing campus system. Systems or building components to be monitored and/or controlled by the central campus systems include, but are not limited to, the following: temperature control, temperature and humidity control of the greenhouse areas, fire alarm, security, outside building lighting, and the start and stop of major equipment. Monitoring of specific mechanical equipment and systems will be dependent on the recommendations of RELLIS Facilities Department.

Provide metering of utilities with indication and totalization capabilities.

ENERGY MANAGEMENT SYSTEM

Provide a stand-alone direct digital control (DDC) system for space conditioning in campus buildings connected to the central campus EMS system. During the design development and construction documents phase, consult with the respective controls firm in order to determine the number of DDC Panels required and the location for each panel. The panel locations shall be shown on the detailed design drawings.

Refer to Utilities and Energy Services Standard for additional information.

<https://utilities.tamu.edu/design-standards/ues-design-standards-and-guidelines-booklet/>

GUIDE SPECIFICATION

AUTOMATIC TEMPERATURE CONTROLS & ENERGY MANAGEMENT SYSTEM

Refer to Utilities and Energy Services Standard for *Building and Automation Systems*.
This can be found at the following link:

<https://utilities.tamu.edu/design-standards/ues-design-standards-and-guidelines-booklet/>

DESIGN CRITERIA

Division 26 – Electrical

GENERAL

The A/E shall not leave engineering calculations to contractor. Calculations such as load flow, short circuit, arc-flash, K-factor, THD, duct bank heat analysis, and pull calculations shall be the responsibility of the A/E. All studies shall be performed by or under direct supervision of a Licensed P.E. (Electrical)

Where the NEC uses terms similar to “by special permission,” obtain written permission from TAMUS.

Power System Studies

The scope of all power system studies shall begin at the project connection to the medium-voltage utility system (including the primary fuse or circuit breaker) and extend to the low-voltage distribution system branch-circuit overcurrent protective devices. The results of all studies should be displayed as paired to equipment on One-line diagrams at 100% CD.

Perform power system studies and analyses according to the methods of IEEE 399. For power system networks having parallel paths, perform a load flow analysis in accordance with IEEE 399, Chapter 6 using a static (positive-sequence) model.

Load Analysis: Include in each load summary a load growth factor of 20% or higher for future load growth.

Fault Current: Use IEEE 242 and IEEE 551. Extend calculations to address all areas spelled out NFPA 70E under Arc Flash study. A preliminary study should be performed at 100% CD design review

Overcurrent Protective Device Coordination: Use IEEE 241 and IEEE 242. Study will need to be performed in conjunction with Arch Flash study to achieve desire worker safety levels. Following approval of switchgear construction submittals, perform a final coordination study for the actual equipment to determine the final overcurrent protective device settings.

Arc-Flash Hazard Analysis: Use procedures and deliverable outlined in NFPA 70E and IEEE 1584. Further guidance and expected safety levels are listed below.

1. Provide the final model back to Owner upon completion of project.
2. Specify overcurrent protective device settings to achieve the required arc-flash results. Included a time over current coordination curve for each relay.
3. Where possible, design the electrical system to limit arc-flash incident energy to a level that does not exceed Category 2 personal protective equipment (PPE).
 1. Arc-flash hazard PPE categories are defined in NFPA 70E-2015, Table 130.7(C)(15)(A)(b).
4. An areas where Category 2 cannot be achieved, use one of the following methods to reduce risk to personnel
 1. Upstream breaker
 2. Upstream current limiting fuse

DESIGN CRITERIA

Division 26 – Electrical

3. Differential relay (where proximity allows)
4. Maintenance switch, include alarm when in maintenance mode.
5. Arc resistant gear.
6. Note: While On-board breaker controls, “Smart Gear”, a control umbilical, and a remote break control are excellent ways to reduce worker risk for breaker operations, it will not eliminate the arc hazard risk while.
5. Provide the final model back to Owner upon completion of project with record drawings.

Equipment Ratings

Main Service should be designed on an infinite bus for Fault ratings. Minimum fault ratings should be 10,000A RMS symmetrical for 100V-250V and 14,000A RMS symmetrical; minimum 251V-1000V.

Do not use series rated equipment.

Unless otherwise required by code, use a solidly grounded, 480Y/277V, 3-phase, 4-wire service and distribution system. Specify a 208Y/120V, 3-phase, 4-wire service only if justifiable by a LCCA comparison to a 480V system. Load voltages should generally be as follows:

1. Connect major 3-phase motor and power loads at the service line-to-line voltage.
2. Connect large to moderate lighting loads at the service line-to-neutral voltage.
3. Connect 120V receptacles, small general loads, and 208V single-phase and 3-phase equipment to separately-derived 208/Y120V systems using dry-type transformers if the service is 480Y/277V.
4. Control voltages should match current facility and be below 120V.
5. Provide correct equipment for voltage. Do not correct equipment voltage level using an auto or buck boost transformer.
6. Where equipment is capable, specify equipment to have a voltage range or multiple voltage taps.
7. Where high single phase or high harmonic loads are present, size neutral bus and/or cable accordantly

Provide for future expansion

1. Provide minimum 20% spare capacity (ampacity or VA) on all transformers feeder circuits and bus equipment (i.e. Panelboards, Switch Gear)
2. For LV equipment provide minimum 10% spare breakers across Facility.
3. For Switchgear and Switchboards provide one “equipped space” per bus.
4. For Panelboards provide 10% spare Space.
5. Minimum spare 20% spare raceway capacity. Cannot include remainder of % Fill on conduits less than 2”

Power Quality and System Reliability

Separate loads as a minimum into HVAC, Lighting, Receptacle, Lab/Health/Sensitive Equipment (when applicable).

Using IEEE 519, provide adequate passive or active filtering to keep total harmonic distortion below 5% while on normal power and 10% on high harmonic. Point of common coupling shall be main breaker. Uses a correct K-Rated transformers for all such instances.

DESIGN CRITERIA

Division 26 – Electrical

Provide a power-factor correction system (PFCS) for buildings where the service entrance equipment is rated 1200A or higher and the uncorrected average power factor of the system is expected to be below 0.95. Target the corrected power factor to be 0.95 (except for TAMU College Station, which is 0.97). Specify an automatically-controlled capacitor bank type PFCS where the VAR rating of the capacitors is less than or equal to 15% of the service transformer capacity (VA) rating or as recommended by the PFCS manufacturer.

Standards for Material and Equipment

Use electrical materials and equipment that is constructed and tested in accordance with the standards of NEMA, ANSI, ASTM, or other recognized commercial standard. A complete current listing is published on <http://www.osha.gov/dts/otpca/nrtl/>. Where a piece of equipment is not labeled, listed, or recognized by any NRTL, provide a manufacturer's Certificate of Compliance indicating complete compliance of each item.

Do not install or use electrical equipment for any application other than that for which it was designed, labeled, listed, or identified unless formally approved for such use by TAMUS.

1. Use only Copper for all electrical Bus, grounding, interior wiring, and wires smaller than 1/0, for all other areas perform LCCA to determine materials.
2. Include a main breaker on all switchgear, switchboards, panelboards, motor control centers and other similar equipment. (except for Sub-panelboards being feed from panel in same room)
3. Where allowed by code and interrupt capacity, use circuit breakers.
4. Arch-energy reduction employing zone-selective interlocking for switchgear and switchboards rated 1200A.
5. For all equipment rated above 1200A or 1000V and for motors rated above 300A use electronic multifunction protective relay.
6. Where equipment maintenance requires temperature readings from internal parts, include infrared viewing windows.
7. When available used hinged doors over bolt on panels.

Equipment Location and Layout

Locate electrical equipment:

1. So it will be accessible for inspection, testing, service, repair, and replacement.
2. So it can be removed without requiring disconnection of any other equipment, except that which is specifically connected to the piece of equipment
3. Provide adequate space for ventilation and avoid stack heat producing electrical equipment. Provide a minimum of 6" unobstructed around such equipment.
4. Avoid suspending electrical equipment (except necessary air handling equipment)

Locate generators so exhaust does not enter occupied spaces through outside air intakes. Provide a fire barrier constructed between the normal power supply (utility transformer) and emergency generator if both units are located within 20 feet. Do not use overhead power.

Do not install electrical equipment below piping or other means of liquid conveyance except where equipment is rated or a mechanical connections dictates location. i.e. Motor coupled with pump.

DESIGN CRITERIA

Division 26 – Electrical

All electrical equipment including in line disconnects and controls necessary (ect.) for Fire Pump shall be rated NEMA 2 or above.

Provide means of replacing gear without the need of a crane for all Indoor Electrical equipment. Do not locate electrical distribution or control equipment in Stairways, Custodial closets, or Restrooms. Do not install transformers in open kitchens or cooking areas.

Show the minimum working clearances and dedicated equipment space around each electrical equipment on all drawings.

Component Identification

Place an equipment code on the electrical symbols legend sheet that defines the nomenclature of all major electrical equipment specified for the project. Alternate component identification systems are acceptable but must include the following information:

1. Location by building level, e.g. basement, first floor, penthouse
2. Location by building area (if assigned by architect), e.g. A, B, C
3. Power system class, e.g. normal, emergency, standby
4. System voltage, e.g. 208/120V, 480/277V, 12.47kV
5. Equipment type, e.g. switchgear, switchboard, transformer, panelboard
6. A number at the end of the equipment designator to distinguish a-specific equipment from other equipment of the same type, i.e. 1, 2, 3.

Arc-Flash Hazard Warning Labels

Provide an Arch Flash warning label on all electrical equipment that contains a switching component. Label needs to be a minimum of 4"x6". Where equipment's incident energy level is equal to or less than 40 cal/cm², provide an orange warning label. For equipment with incident energy level greater than 40 cal/cm² provide red danger label and include a label stating Discounting Device upstream. Label in accordance with NFPA 70E

Circuit Identification

Provide a circuit directory for each switchboard, switchgear, and panelboard as described in NEC 408.4 and as follows:

1. Upon final installation, place a neatly typed circuit directory using text no smaller than 1/8 inch high behind clear heat-resistant plastic in a metal frame door to the inside door of the equipment. Adhesive-mounted directory pockets are not acceptable.
2. The directory shall contain all of the information contained in the panel schedule except load calculations, plus any field modifications.

Specify labels containing circuit number for receptacles in plants and laboratory areas and where requested by the user.

Working Space Markers

In electrical rooms and areas where electrical equipment is located, permanently mark the floor

DESIGN CRITERIA

Division 26 – Electrical

with the NEC-required clear space in front of and behind switchgear, switchboards, transformers, panelboards, motor control centers, motor starters, and disconnect switches. Install marking on the floor using color schemes conforming to ANSI Z535.1 for black and white striped border.

Equipment Foundations

Design concrete bases (“housekeeping pads”) for indoor equipment to be not less than 4 inches high, and not less than 6 inches above grade for outdoor equipment. Extend floor pads to not less than 4 inches beyond the supported equipment in both directions. Specify foundations to be within manufacturer’s tolerances.

Provide vibration isolating pads for transformers and other vibrating electrical equipment, if not integral to equipment.

Electrical Demolition

Remove abandoned electrical distribution equipment, utilization equipment, outlets, and the accessible portions of wiring, raceway systems, and cables back to the source panelboard, switchboard, switchgear, telecommunications, or cabinet. Remove conduits, including those above accessible ceilings, to the point that building construction, earth, or paving covers them. Cut conduit beneath or flush with building construction or paving. Plug, cap, or seal the remaining unused conduits. Install blank covers for abandoned boxes and enclosures not removed. Leave abandoned electrical equipment, conductors, and material in place only if one or more of the following conditions exist:

- The removal requires the demolition of other structures, finishes, or equipment that is still in use. An example is abandoned conduit above an existing plaster ceiling.
- Removal of abandoned conductors may damage conductors that must remain operational.

Extend existing equipment connections using materials and methods compatible with the existing electrical installation and this Division. Restore the original fire rating of floors, walls, and ceilings after electrical demolition.

Electrical Acceptance Testing

Perform electrical acceptance testing in accordance with the current edition of the International (National) Electrical Testing Association (NETA) “Acceptance Testing Specification ATS.”

Medium-Voltage Service and Distribution

Permanent overhead distribution for medium-voltage and low-voltage systems is prohibited for new construction.

Unless noted otherwise in the project Program of Requirements (POR), any modifications necessary to extend or upgrade the campus utility distribution system to supply electrical service to a new project or project site must be fully funded by that project.

Contact TAMU Utility Energy Services.

DESIGN CRITERIA

Division 26 – Electrical

All medium-voltage conductors shall be installed in IMC, RMC, PVC, RTRC, or Cable Tray Only. Above grade installations shall be in rigid galvanized steel (RGS) conduit unless in a limited access industrial facility. For all underground installations see “Underground Raceways.”

The A/E shall design reliability and redundancy into medium voltage system on campus. This shall include the addition of extra Conduit, Cable, Manholes, and Switches or Switchgear, so as to complete (or make ready to complete) feed loops and/or secondary feeds.

IEEE 241, Subclause 4.8 for design guidance and information.

When applicable all medium voltage equipment shall include:

1. Dead-front design with separable insulated-type connectors
2. Full overcurrent protection
3. SCADA interface (if required by user)
4. Visual indication of switch, contact, or breaker status
5. A concrete foundation.
 1. With vault where connections are made in close proximity to base. i.e. Padmount switches and Padmount transformers
 2. Equipment Pad must be checked for Level to Manufacture tolerances before equipment is set.
6. Low profile enclosure (if available)
7. Provide bollards, curbs, or other structures to keep vehicles out of the required working space, when in proximity of vehicles’ path.
 1. Spare set of fuses
 2. Torque mark is on all bus connections
 3. Shall comply: [Texas A&M University’s Utility Energy Services’ Standard](#)
1. Outdoor Oil filled transformers shall be located transformer per table 26.1

| Table 26.1 Outdoor Oil filled Transformer Separation from Building Main Wall | | | | |
|--|-------------------|----------------------------|---------------------|----------------------|
| Transformer Fluid Type | Fluid Volume, gal | 2-hour fire-rated wall, ft | Non-Combustible, ft | Combustible Wall, ft |
| High Temperature Esters | ≤10,000 | 5 + Containment | | 25 + Containment |
| | >10,000 | 15 + Containment | | 50 + Containment |
| Mineral Oil or Equivalent Flashpoint | <500 | 5 + Containment | 15 + Containment | 25 + Containment |
| | ≤5,000 | 15 + Containment | 25 + Containment | 50 + Containment |
| | >5,000 | 25 + Containment | 50 + Containment | 100 + Containment |
| Design Containment per IEEE 980 Ch7. Minimum containment shall extend 5 feet from fluid-containing components. | | | | |

Medium-Voltage Cable

Comply with ANSI/NEMA/ICEA S-93-639/NEMA WC-74, the NEC, IEEE 576, IEEE C2, and UL 1072 for medium-voltage power cable components materials, installation, and testing.

Specifications for Medium-Voltage Cable shall comply with Texas A&M University’s Utility Energy Services’ standard [Medium Voltage Power Systems](#)

DESIGN CRITERIA

Division 26 – Electrical

Where cables tie into existing cable, new cable shall match old cable until next termination.

Medium-Voltage Cable Terminations and Splices

1. Do not splice medium-voltage cables without written authorization by TAMUS.
2. Specify terminating materials and ratings that are compatible with the cable supplied.
1. Submit electrician's cable splicing and terminating qualifications and certifications to TAMUS prior to performance of the work. See TAMU UES's standards for qualifications. [Cable Splicing & Termination Qualifications](#)

Medium-Voltage Separable Connectors

1. Connector system components shall comply with IEEE 386.
2. Pre-molded ethylene propylene diene monomer (EPDM)-type, submersible, fully shielded, separable insulated connectors for use with MV-105 power cable as specified above.
3. Specify 200A-rated load-break elbow connectors for outdoor terminations at medium-voltage transformers and switchgear with switch-ways rated at 200A continuous.
4. Specify 600A-rated dead-break Tee body connectors for terminations at medium-voltage switchgear with switch-ways rated at 600A continuous.
5. Do not use separable connectors to splice cables. Except in Junction Boxes above ground.

Medium-Voltage Non-Separable Terminations

Terminate shielded medium-voltage cables using cable terminators that meet Class 1A requirements of IEEE 48.

1. Indoor Terminators: Silicone rubber, cold shrink, tubular or skirted.
2. Outdoor Terminator: Silicone rubber, cold shrink, skirted.
3. Acceptable Manufacturers: Elastimold, RTE, 3M

Medium-Voltage Cable Testing

Factory Tests

The cable manufacturer shall perform non-destructive factory tests on all medium-voltage conductors in accordance with ICEA, NETA ATS, and IEEE standards and shall furnish certified test reports to TAMUS.

Contractor Responsibilities

1. Field-test cables prior to energization, and verify with Factory Test reports.
 1. During construction (typically during the Acceptance Testing phase), notify TAMUS 14 days in advance of the time that the cables will be ready for field testing. This will allow time for TAMUS to contract the services of a certified cable-testing firm to conduct the tests described below.
 2. Complete the TAMUS Medium-Voltage Cable Testing Information Form 26A-2.1 in Appendix A and submit to TAMUS 14 days prior to testing date. TAMUS will provide the completed form to the cable testing firm.
 3. Cooperate with and give all necessary assistance to this firm while the tests are conducted.
 4. Provide means to ensure safety during the tests.
 5. If a cable fails any of the required testing, remove all cables in the conduit between the nearest pulling points on each side of the failure. If, in the opinion of TAMUS, the other cables in the same conduit have not been damaged, they may be reinstalled, but the cable which failed shall

DESIGN CRITERIA

Division 26 – Electrical

be replaced with a new and unused cable. After the faulted cable and any other damaged cables have been replaced and installed, re-test all cables in the faulted section or circuit at the same voltage levels and durations as the original test.

6. During the period of warranty, any failure in medium-voltage cable, terminations, or splices shall require immediate correction. In the event of a cable failure creating interruption in electrical service, furnish and install all labor and materials for temporary services to return the electrical system to service. Work shall begin immediately upon notification of a failure, regardless of time. TAMUS will not pay any costs associated with a cable failure.

Testing Firm Responsibilities

Perform full test report on all cables and terminations (non-destructive). Compare results to factory test reports, reject any cable not within margins set forth by manufacture. When factory does not provide test reports, or when require preform a “proof test” (High-Voltage Withstand Test – Destructive). Use the appropriate voltage and durations in accordance with IEEE 576-2000 and the cable manufacturer’s recommendations.

Low-Voltage Service and Distribution

Convert existing facilities with ungrounded service systems to solidly grounded service systems during major renovations or service equipment replacements.

Note: The service point, as defined in the NEC, is at the secondary terminals for the utility transformer for projects served by TAMU Utilities and Energy Services

Building Service

Electrical service shall be run in a manner so that the “Conductors Considered Outside the Building” (NEC 230.6) up to the Service equipment disconnect. Service equipment disconnect shall be a 100%-rated, single, main circuit breaker integral to the service equipment.

1. Do not splice service conductors between normal and emergency/standby power supplies (e.g. utility transformers and generators) and the service or power transfer equipment.

All facilities require a main electrical meter, refer to the online TAMU UES Design Standards for additional metering requirements.

- Important: Contact TAMU/UES for meter selection specific to each project or installation.
- All meters shall be a digital meter, with a display and communication. Communications shall be compatible across all meters and with any local SCADA system.
- Provide an Ethernet data port at the main-meter location for connection to the UES power metering LAN.
- TAMU UES’ “WAGES” panel shall be furnished and installed by the electrical contractor under Division 26.

Low-Voltage Surge Protection

Provide permanently-installed surge protection for electrical power systems, control circuits, communications systems (including but not limited to CATV, alarm, and data circuits), and antenna systems entering and exiting all buildings and other structures, including buildings and structures that may not have lightning protection on the roof.

Specify UL 1449 4th edition, permanently-connected, hard-wired type surge protective devices

DESIGN CRITERIA

Division 26 – Electrical

(SPDs) for low-voltage service and distribution equipment, IEEE 1100, NFPA 780, NEC 285, and NEC 700.8 Show all SPDs on the one-line diagram down to the branch-circuit panelboards.

1. Provide surge protection for all low-voltage building services; connect a Type 1 or Type 2 SPD to the main bus of the service equipment on the load side of the main breaker.
2. Install SPDs outside the enclosures of panelboards and switchboards; however, SPDs may be installed in separate compartments of a switchgear assembly (UL 1558) if supplied by a dedicated circuit breaker.
3. Specify visual indication that the unit has malfunctioned or requires replacement. Provide Form C dry contacts in the SPD and extend wiring to the building automation system for remote monitoring.
4. Specify not less than a 5-year warranty and include unlimited free replacements of the unit if destroyed by lightning or other transients during the warranty period.

Low-Voltage Switchgear

Design metal-enclosed low-voltage power circuit breaker switchgear per IEEE C37.20.1, NEMA SG-5, and UL 1558.

1. Specify electrically-operated, individually-mounted draw-out type circuit breakers.
2. The switchgear and circuit breakers shall be the product of the same manufacturer.
3. Switchgear shall be fully accessible from the front and rear.

Low-Voltage Switchboards

Design switchboards in accordance with NEMA PB2 and UL 891.

1. Specify switchboard assemblies to be front- and rear-aligned.
2. Devices shall be completely isolated between sections by vertical steel barriers.

Low-Voltage Panelboards

Design panelboards in accordance with NEMA PB1 and UL 67.

1. Panelboard enclosures shall be wall-mount type.
2. Specify Type 304 or 316 stainless steel covers for panelboards located in open kitchens, cooking areas, and wash-down areas.
3. Specify panelboards with bolt-on breakers; load center-style panelboards and plug-in type breakers are not permitted.
4. Do not specify sub-feed breakers.
 1. Do not use panel boards for service entrance equipment unless service is rated for less than 800A
 1. If ground-fault protection is required for the service disconnecting means on 480/277V services, provide an additional step of ground-fault protection in the next level of feeders.
 1. Do not use series-combination-rated circuit breakers, tandem circuit breakers, Stab-on breakers, and/or feed-through (“sub-feed”) breakers.
 2. Breakers 400A and above shall be 100% continuous current rated, with electronic strip (shunt trip) and LSIG. Breakers shall also be identify on the one-line diagram.
 3. Use common-trip type 2- and 3-pole breakers so that an overload or fault on one pole will trip all poles simultaneously; handle ties are not acceptable.

Low-Voltage Motor Controllers & Motor Control Center

Use source transformer or generator performance curve as well as motor starting curve to determine if a reduce voltage starter, soft start or VFD is required.

1. Provide controllers having a UL 508 short-circuit withstand rating that exceeds the fault current available

DESIGN CRITERIA

Division 26 – Electrical

2. Provide color-coded and labeled LED type indicator lights on the front of each magnetic controller.
3. Provide start-stop switch function on the front of each magnetic controller not connected to automatic controls. Arrange control circuit to include emergency stop functions, such as fire alarm interlocks.
4. Specify selector switches on motor controllers for the purposes of testing or manually controlling the equipment.
5. Use solid-state motor starter overloads.
6. Except for packaged equipment with integral controllers, do not locate motor controllers above ceilings.

Low-Voltage Dry-Type Distribution Transformers

Specify low-voltage transformers to comply with the efficiency requirements of [10 CFR 431.196 \(DOE 2016\)](#). For additional sizing and ratings see IEEE C57.96 IEEE 1100, IEEE 519, IEEE C57.110, and UL 1561.

1. Limit the capacity rating of each low-voltage transformer to 112.5 kVA or less.
2. Do not use step-up, auto transformers or field-installed “buck-boost” transformers.
 1. Do not locate 3-phase dry-type transformers supplying building loads outdoors.
 2. Design the installation such that transformer vibrations are not transmitted to the surrounding structure or where sound level is not increased by sound reflection. Use flexible couplings and conduit to minimize transmission through the connection points.
 3. Bond the transformer secondary neutral (X₀) directly to the grounding electrode by means of a listed bonding kit.

Low-Voltage Electric Motors

Motors are typically furnished and installed under the division that specifies the component or system they are associated with, with electrical connections by Division 26.

Use the following guidance in selecting motor-rated voltages:

1. 200/208V, 230V, or 460V, 3-phase, 60 Hz for motors 1/2 HP and larger; match building secondary service voltage.
2. 460V, 3-phase for motors 25 HP and larger.
3. 4,160V, 3-phase for motors 500 HP and larger.
4. 120V, 277V, or 200/208V, single-phase, 60 Hertz for motors smaller than 1/2 HP.

Low-Voltage Variable-Frequency Drives

Variable-frequency drives (VFDs) shall Comply with IEEE 519, IEEE C37.96, and NEMA ICS 7.0 in the selection of VFDs. In addition to this section, refer to [UFC 3-520-01, Appendix B “Adjustable Speed Drives”](#) for additional design guidance on the use of VFDs. For Specific application see the [NIH Design Requirements Manual](#).

1. Contactor bypass option, or Spare VFD per size on project.
2. Overcurrent protection.
3. BACnet communications capability for interface with building automation system.
4. Shaft grounding rings (SGRs) or common-mode filters to eliminate high frequency damage to motor bearings.
5. Minimum 6-pulse width modulation (PWM) design.
6. Provide VFD-rated cable between the VFD and the motor supplied.
7. Where a disconnect switch exists between VFD and Motor, provide an interlock scheme to prevent damage to VFD.

DESIGN CRITERIA

Division 26 – Electrical

Low-Voltage Receptacles

Determine final receptacle types, ratings, NEMA configuration, and quantities as per user and code requirements.

1. Do not connect more than 5 single duplex receptacle (or equivalent) per 20A breaker.
2. For receptacles that are automatically controlled, comply with ANSI/ASHRAE 90.1 8.4.2
3. Specify emergency-powered receptacles with red colored faceplates engraved with 0.25-inch white letters to read “EMERGENCY.”
1. Specify metallic weatherproof covers for receptacles located outdoors.
2. Insure duty rating and housing of receptacle match permanently installed equipment.
3. If required, provide 120V, 20A isolated-ground grounding-type receptacle outlets for electronic equipment.
4. Quantity and locations (120V):
 1. All rooms shall have a minimum of one outlet, and entire facility shall have an outlet with in at least 20 feet from any one location.
 2. All general offices, labs, small –medium classrooms rooms, and areas designated for study, should have a receptacle with in 6ft from any point and at least one per wall.
 3. Rooms with computer or small equipment should include at least one outlet per expected computer/small equipment. Single person offices should have at least two walls with two (duplex) receptacles each.
 5. Provide receptacle (480V 3-wire) outlets for electric welders in mechanical equipment rooms, and other areas where future repairs may warrant. (where applicable design to use no more than one (1) 50ft extension cable,)

Low-Voltage Branch-Circuit Wiring Devices

1. All devices shall be specification-grade and rated at 20A minimum.
2. Specify stainless steel device plates in laboratory spaces; nonmetallic plates, if used, shall be nylon. Coordinate style selections with architect.
3. Group power and communications outlets and light switches in a symmetrical fashion.
4. Show all wiring devices on the design drawings and any changes on the as-built drawings.
5. Do not place outlet boxes back to back; provide at least 12 inches of separation between outlet boxes located on opposite sides on common walls.
6. Avoid Placing receptacle and lights under windows.

Low-Voltage Power Conductors

Calculate the ampacity of low-voltage power conductors installed in parallel underground ducts within the same trench or concrete envelope in accordance with NEC 310.15, IEEE 835 , IEEE 399, or approved software.

Use IEEE 241 and ANSI 90.1 for Voltage drop calculation and standards.

Identify all power wiring system conductors (phase, grounded (neutral), and grounding conductors) at each accessible location using color-coding that is consistent throughout the building. Refer to Table 26.2 for standard color-coding of wiring according to system operating voltage level and number of phases.

DESIGN CRITERIA
Division 26 – Electrical

TABLE 26.2: COLOR CODE FOR LOW-VOLTAGE POWER CONDUCTORS

| CONDUCTOR | 240 / 120V | 208 / 120V | 480 / 277V |
|--|-------------------|-------------------|-------------------|
| PHASE A | BLACK | BLACK | BROWN |
| PHASE B | RED | RED | PURPLE |
| PHASE C | N/A | BLUE | YELLOW |
| NEUTRAL | WHITE | WHITE | GRAY |
| EQUIPMENT GROUND | GREEN | GREEN | GREEN |
| ISOLATED GROUND | N/A | GREEN /YELLOW | N/A |
| SWITCHED LEG | PINK | PINK | PINK |
| HIGH LEG (prohibited for new insulation) | N/A | ORANGE | N/A |

Low-Voltage Building Wire and Cable

All conductors shall be soft-drawn annealed copper class B, C, or D stranded. Specify as follows:

1. General power and lighting: Minimum size #12 AWG; solid conductors for #12 AWG and #10 AWG and stranded conductors for #8 AWG and larger.
2. Stranded conductors for connections to motors, generators, and other vibrating equipment (all sizes).
3. Control (field-installed): Minimum size #14 AWG; stranded conductors all sizes.

Specify 600V Type XHHW-2 insulated copper conductors where installed outdoors above and below grade. Note: The NEC does not require temperature ampacity adjustment for Type XHHW-2 insulated conductors.

Install building wire and cable as follows:

4. Do not install building wiring, equipment, and devices that are listed for dry/indoor locations- only until the building is dried-in.
5. Do not use multiwire branch circuits. Provide a dedicated grounded (neutral) conductor for each branch circuit that requires a neutral.
6. Do not direct bury conductors; install all underground conductors in conduits.
7. Metal-Clad Cable or MC Cable may be used for light switches and receptacles whips of no more than 25 ft and as follows :
 1. Only in general occupancy rooms, such as offices, classrooms and conference rooms. Do not use in Rooms such as Mechanical Rooms, Electrical Rooms, Laboratories, or any other high equipment rooms or laboratories.
 2. MC Cable must be installed to a minimum of NECA standards, additionally must be installed in straight runs with definite bends only and must be well secured. Well secured shall be no more than 1” deflection for straight runs and 3” of deflection for bends at 3 lbs of force.
 3. When routed horizontally through walls MC Cable must maintain one horizontal level. (Do not zig zag cable in walls.)

Low-Voltage Raceway Systems

Specify raceway systems to contain low-voltage service, feeder, and premises branch-circuit wiring systems. Maintain minimum separations between power levels as described in IEEE 518.

DESIGN CRITERIA

Division 26 – Electrical

Raceways, boxes and fittings used under raised floors (e.g., computer rooms, server rooms) must have low flame spread, low smoke, and zero halogen characteristics determined in accordance with ASTM E 162, ASTM E 662, or Bombardier SMP-800C, *Toxic Gas Generation*.

Unless otherwise specified do not apply spray-on or other types of insulating material on the outside of conduits and other raceways installed above ceilings.

Raceways and Fittings

For below grade Raceways see Underground Raceways.

1. Do not specify nonmetallic conduit or tubing above grade in indoor or outdoor locations except for grounding electrode conductors where permitted by NEC.
 1. Do not exceed 270° between pull points.
 2. For electrical Power do not use trade conduit size less than 3/4 inch. For control wiring do not use trade conduit sizes less than 1/2 inch.
 3. Use IMC or RMC where subject to major physical damage, such as that done by a vehicle.
 4. Where floor boxes are used on the first floor, specify corrosion-resistant cast-in-place type.
 1. Seal entries into floor boxes and “poke-through” fittings installed over unconditioned spaces by a means approved by TAMUS.
 1. Install a nylon pull rope with not less than 200 pounds tensile strength in all empty conduit runs.
 2. Connections to luminaires (fixture whips): 1/2-inch flexible metal conduit may be used in 6-foot maximum lengths for tap conductors to luminaires above accessible suspended ceilings.
 3. Only use ARC, RTRC, corrosive resistant RMC, or corrosive resistant IMC in cooling towers, or in other corrosive environments
 1. Where polyvinyl chloride (PVC) coating is used for supplementary protection, it shall consist of a minimum of 20 mils thick, 2-inch wide field-applied PVC tape wrap, or 40 mils thick factory-applied PVC coating.
 4. Do not use PVC above grade unless specified. General exception for crawl spaces.
 5. Do not mix PVC schedule 40 and 80.
 6. Use FMC or LFMC for connections to vibrating or moving equipment such as motors and transformers. Minimum length shall be 18 inches, maximum length 72 inches.
 7. Do not use Set-screw fittings.
 8. All conduits shall be marked by color code at minimum before each box and before and after any poke through.
 1. Mark shall be minimum 3/8 inch band that completely wraps conduit and shall comply with color code in Table 2.

Electrical Boxes

Use all ANSI and NEMA standards for electrical boxes. Also include the provision that follow:

1. Masonry Boxes shall be galvanized
2. Boxes larger than 4”x4” located outdoors and below grade shall be rated NEMA 4 at minimum.
3. All junction and Pull Box Covers shall be labeled.
 1. Label shall include all Circuits contained within box as well as Panel and breaker number.
4. Boxes and Box Covers shall be painted to match color code in Table 26.3, unless excluded for aesthetic purposes.

TABLE 26.3: COLOR CODE FOR BOXES

DESIGN CRITERIA

Division 26 – Electrical

| SYSTEM | CONDUIT BAND | | BOX COVER | |
|--------------------------------|--------------|-----------------------------|-----------|----------------|
| | COLOR | IDENTIFICATION | COLOR | IDENTIFICATION |
| FIRE ALARM | RED | FA | RED | |
| EMERGENCY POWER (ALL VOLTAGES) | WHITE | EM / PANEL ID / CKT. NO. | WHITE | |
| 208/120V NORMAL POWER | BLUE | PANEL ID / CKT. NO. | BLUE | |
| 480/277V NORMAL POWER | YELLOW | PANEL ID / CKT. NO. | YELLOW | |
| DATA, TELECOM, FIBER OPTIC, AV | ORANGE | DATA, TELE, FIBER OPTIC, AV | ORANGE | |
| HVAC CONTROLS | GREEN | HVAC | GREEN | |
| SECURITY | PURPLE | SEC | PURPLE | |

Interior and Exterior Lighting

Specify an LED light source for all interior and exterior lighting. Alternative light sources may be considered for special indoor use only.

Design lighting systems according to the latest editions of:

1. [ANSI/IES Recommended Practice \(RP\) Standards for Lighting](#)
2. ANSI/IESNA The Lighting Handbook, latest edition
3. ANSI/ASHRAE/IESNA Standard 90.1 or IECC

Perform lighting calculations using appropriate procedures as outlined in the IES or IESNA Lighting Handbook.

Refer to [TAMU UES Design Standards](#) for outdoor lighting requirements. The lighting standards used shall be considered a reference only on indoor light for the RELLIS campus. Contact Facility User’s represented to verify indoor lighting requirements.

Controls for Interior Lighting

Adjust time-out settings for occupancy sensors to optimize energy saving, relamping cost, and customer satisfaction. The following optimal settings have been determined:

1. Classrooms, private offices, open offices, laboratories, and restrooms: longest time-out setting, but not more than 30 minutes.
2. Break rooms, storage rooms, copy machine rooms: 5-minute time-out setting
3. Conference rooms: 10-minute time-out setting
4. Corridors, lobbies: 15-minute time-out setting

In corridors design un-switched “night lighting” luminaires at the entrance/exit to the corridor and at major corridor intersections. Night lighting luminaires may also be part of the emergency lighting system described below. In spaces with more than one personnel entrance, design the lighting controls so any required manual control will be available at each entrance.

Emergency Lighting Unit Equipment

Use emergency lighting unit equipment that is UL 924 listed and labeled for the intended use.

1. In finished spaces of office and laboratory spaces, use emergency battery/inverter units with a self-test feature.
2. For typical service and industrial spaces, use wall-mounted, receptacle- connected lighting unit equipment with a self-test feature. Install a dedicated receptacle adjacent to each

DESIGN CRITERIA

Division 26 – Electrical

- emergency lighting unit.
3. Certain locations in special facilities may have environments or other conditions that require special emergency lighting unit equipment suitable for the application.
 4. Where commercially available, use emergency lighting units that automatically perform a self-test of battery and lamps for not less than 30 seconds every 30 days and have a visual status indicator to indicate any failure.
 5. Connect emergency lighting unit equipment to the branch circuit serving normal lighting in the area and ahead of any local switches. In lighting panelboards, clearly identify the branch circuits that serve unit emergency lighting equipment.

Emergency Exit Signs

1. Where practical, use LED emergency exit signs that are UL 924 listed and labeled for the intended use and meet EPA “Energy Star” standards.
2. Specify exit signs with green LED lamps.
3. New and replacement emergency exit signs shall automatically perform a self-test of battery and lamps for not less than 30 seconds every 30 days; a visual status indicator shall indicate any failure. Units shall also perform tests that are manually initiated by a test button.
4. Connect emergency exit signs to the branch circuit serving normal lighting in the area and ahead of any local switches. In lighting panelboards, clearly identify the branch circuits that serve emergency exit signs.

Exterior Building Lighting

Outdoor light shall comply with “dark skies” requirements published by the State of Texas in its [Health and Safety Code, Chapter 425, Regulation of Certain Outdoor Lighting](#). The International Dark Sky Association "Lighting Code Handbook" provides useful design guidance.

Exterior Luminaire Selection

Design building-mounted safety and security lighting for exterior doors, stairways, loading docks, and mechanical equipment yards, plus parking lots and pedestrian walkways located adjacent to the building.

Select exterior lighting systems following guidance in the IESNA Lighting Handbook. Minimize the number of lamp and ballast types.

Controls for Exterior Lighting

Design exterior lighting controls that comply with energy code requirements applicable to the project.

Control exterior lighting to be on at dusk and off at dawn by means of a photocells and time clock combination through a HAND-OFF-AUTO selector switch and lighting contactor; where HAND bypasses photocell.

Roadway and Site Lighting

Refer to [TAMU UES Design Standards](#) for specifications for road way and site lighting. Control lights individually with 7 pin photocell.

DESIGN CRITERIA

Division 26 – Electrical

Exterior Illumination Levels

Design to the illumination levels in Table 26.4 below unless directed otherwise by TAMUS.

TABLE 26.4– ILLUMINATION LEVELS

| Location | Min. Horiz. Footcandles | Avg. Horiz. Footcandles | Min. Vert. Footcandles | Avg. Vert. Footcandles | Uniformity Ratio |
|-----------------|----------------------------|----------------------------|---------------------------|---------------------------|---------------------|
| Pedestrian Ways | 1.0 | - | 0.1 | 2.2 | - |
| Parking Lots | 1.0 | - | 0.1 | 2.2 | - |
| Roadways: | | | | | |
| Major | - | 1.2 | - | - | 3:1 |
| Collector | - | 0.8 | - | - | 4:1 |
| Local | - | 0.6 | - | - | 6:1 |

Backup and Alternative Power

Energy sources that may be used to supply backup power to TAMUS building and facility loads in the event that the primary (utility or normal) power source fails include on-site engine-generator systems (EGSs), central battery systems, and uninterruptible power supply systems.

Identify all loads connected to backup power sources (generators, battery systems, UPSs, etc.) in the load analysis summary including NEC power class associated with each load type (Emergency, legally required standby, optional standby, COPS, etc.). The terms “emergency system,” “legally required standby system,” and “optional standby system” used in this section are the same as the terms defined in NEC 700, 701, and 702, respectively.

Multiple methods exist to supply EPSS to any facility’s use LCCA to most cost effective option, include all maintains cost.

Other than an EGS locate all other EPSS systems in a fire rated Emergency Electrical room.

Engine-Generator System

Size the EGS to supply all of the connected loads simultaneously, starting connected motor loads, and providing not less than 20 percent future load growth.

1. If the EGS will be an alternate supply to variable frequency drives or similar harmonic-generating loads exceeding 25 percent of the EGS nameplate rating, assure that the non-linear loads can operate successfully when powered by the EGS.
2. If the EGS will be an alternate supply to elevator loads exceeding 25 percent of the EGS nameplate rating, ensure that elevator controller has provisions to absorb regenerative power. Coordinate EGS selection and provisions with elevator and EGS manufacturers.

Coordinate the EGS electrical design with the mechanical and architectural design. Diesel EGSs shall be located outdoors and on grade, preferably within the same service yard as the utility (normal supply) transformer, with a fire barrier separating the EGS from the transformer as described under “Outdoor Equipment”. Allow adequate clearances for operations and maintenance.

EGSs may be designed to operate in parallel with the local utility.

DESIGN CRITERIA

Division 26 – Electrical

Refer to [TAMU UES Design Standards](#) for specifications and other requirements for diesel EGSs, load banks, and automatic transfer switches.

Specify that all malfunctions of EGS be transmitted to the building automation system (BAS). Provide a contact for the EGS output breaker to be connected to the BAS, indicating output breaker position, to allow annunciation of the open position on the BAS.

Provide maintenance and operational testing of the EGS, including all EPSS equipment, in accordance with NFPA 110, Chapter 8. Perform all load tests using the load bank furnished with the EGS.

Legally Required Stand by Systems

Specify a minimum Class 24 emergency power supply system (EPSS) to supply building loads, where 24 is the minimum time in hours for which the EPSS is designed to operate at its rated load without being refueled (see NFPA 110, Chapter 4).

Specify a Type 10 EPSS, where 10 is the maximum time in seconds that the EPSS will permit the load terminals of the transfer switch to be less than 90 percent of the rated voltage (see NFPA 110, Chapter 4).

Optional Standby System

For facilities that have an NEC classified Optional Standby System; specify transfer of power from normal to on-site generated power in no less than 60 seconds of normal power failure. Note: Unless disallowed by code, the same transfer scheme may be used to supply both legally required and optional standby loads.

Automatic Transfer Switches

Refer to [TAMU UES Design Standards](#) for specifications Automatic Transfer Switches (ATSs)

Central Battery System

Design, install, and test the Central Battery Systems (CBSs) in accordance with IEEE 446, NFPA 70, NFPA 101, NFPA 111, and UL 924. CBSs shall:

1. Comply with the requirements for a Level 1, Type 10 stored-energy.
2. Be design for a minimum time of 90 minutes
3. Use batteries with a minimum 20-year design life.
4. Be sized with proper de-rating based on ambient temperature, altitude, and design life.
5. Include an external bypass maintenance switch, to connect load directly to Normal power
6. Be designed not to have any exposed live parts.
7. Be designed with a safe means of testing and maintenance, per NFPA 111
8. Shall self-execute all NFPA required maintenance test and issue report both as an email as a downloadable file, with 4 year of internal memory.

Uninterruptible Power Supply Systems - (Non-EPSS)

Evaluate requirements for Uninterruptible Power Supply (UPS) systems on a case-by-case basis. If a UPS is required, it may or may not require generator backup. Provide sufficient battery capacity to accomplish an orderly shutdown of UPS loads when generator backup is unnecessary.

If the nature, magnitude, and locations of critical loads to be supplied by the UPS is not identified

DESIGN CRITERIA

Division 26 – Electrical

in the POR, the A/E shall determine these requirements during the Design Development phase of the project.

Design, install, and test UPS systems in accordance with IEEE 446, IEEE 493, IEEE 944, IEEE 1100, NFPA 70, NFPA 111, NEMA PE 1, and UL 1778.

Addition design requirements:

9. If required for NFPA, equipment shall self-execute all NFPA required maintenance test and issue report both as an email as a downloadable file, with 4 year of internal memory.
1. Determine UPS type by listed requirements as well as a LCCA based on a 20-year life.
1. Include initial cost in both hardware and floor space and maintenance cost for both unit maintenance and condition space requirements.
2. Do not supply AC motors from a static type UPS system; specify a rotary or flywheel type UPS or use DC motors supplied directly from static source.
3. If UPS connects to an EGS as a load, limit UPS recharge while on Emergency power.
4. If UPS is backed up by an EGS, to provide for continuous operation, specify the EGS to supply all necessary auxiliary UPS equipment, i.e., the lighting, ventilation, and air-conditioning.
5. Size the UPS system with spare capacity of at least 25% (amp-hour) in stored energy and 10% in supplied power (kVA).
6. Specify a redundant UPS module depending on the criticality of the supplied loads.
7. IF UPS is of a battery type use nickel–cadmium or lead-calcium batteries
8. Be design not to have any exposed live parts and with a safe means of testing and maintenance.
9. Provide both a local and a remote system status and alarm panel, with both audio and visual status/alarms. Specify that all alarms be transmitted to the building automation system (BAS).

Include status /alarms, as a minimum:

1. System on
2. System bypassed
3. System fault
4. Out-of-phase utility/line fault
5. Closed generator output breaker
6. Audible alarm and alarm silencer button

Locate UPS systems as follows:

1. UPSs used as part of EPSS may be located in the Emergency Electrical Room.
2. For UPS systems over 100 kVA and of a battery type, provide rack-mount batteries in a dedicated battery room with in accordance with applicable codes.
3. For UPS systems rated over 15 kVA and of a battery type, batteries shall be separate from charger and inverter.
4. UPS room shall:
 1. Isolate noise of UPS
 2. Will be an unoccupied space for UPS systems louder than 60dBA
 3. Maintain a temperature of based on Manufacture specification at all times.
 4. Be provided with a minimum 30% efficiency air filtration.
 5. Include necessary fire and personnel safety equipment.
 6. Include an area for all Spare parts and maintenance equipment.

Renewable Energy Sources

Renewable electrical energy source (RES) technologies that may be considered for use at the RELLIS campus presently include photovoltaics (solar), wind turbine generators (wind), and

DESIGN CRITERIA Division 26 – Electrical

hydropower.

Any user request for such systems shall require the A/E to justify implementation by performing a LCCA comparison to that part of the building electrical system that otherwise be used as a source of normal (utility) power. A payback period of more than 10 years for any RES system shall not be considered cost effective.

Refer to Section A, “Sustainability & Energy Performance” for general information.

Refer to [Unified Facilities Criteria UFC 3-540-08, Utility-Scale Renewable Energy Systems](#), Chapter 2, “Planning and Development” for general design criteria and guidance that may be used for the LCCA evaluation.

Underground Raceways

Underground raceways shall be either Concrete Reinforced ductbank or direct buried conduit, difference shall be determined by use.

Concrete Reinforcement shall be required if any of the following is meet:

- Conduit’s intended use either now or in the future is for 1000V or grater.
- Conduit’s intended use either now or in the future is part of a 1000V or greater system. i.e 2” conduits add to campus distribution duct bank for power or communications
- Conduit is greater than 3” trade size, this includes communication conduits. (3” and larger will be concrete encased)
- Conduit is Part of The RELLIS Campus Communications Infrastructure, now or in the future. This is before the point of demarcation. See Division 27
- The Owner request Concrete encasement.

Direct buried conduits are allowed for all conduits not following in to one of these categories.

Coordinate the placement of proposed underground ductbanks and manholes with TAMUS and the utility provider.

General requirements: All underground include:

1. Install warning tape above all underground raceways for low-voltage conductors as described in “Underground Warning Tape”
1. Specify a metallic tape or material containing a metallic strip integral to the tape so that it is detectable from above the ground surface.
2. Tape color shall be bright red and be marked in black letters “CAUTION: BURIED ELECTRIC LINE BELOW.”
3. In grassy areas, place tape approximately 12 inches below finished grade; in areas where ductbank will be below concrete or stabilization material, coordinate tape placement with civil engineer.
4. Extend warning tape continuously for the full length of the run.
2. Maintain minimum separations between power levels as described in IEEE 518.
3. Do not combine MV, LV ductbanks. Electrical and Data may share common duct bank but not pull boxes or manholes.
4. Maintain 36 inches separation between electrical and other services/utilities for parallel routes and 12 inches separation at vertical crossings.

DESIGN CRITERIA

Division 26 – Electrical

5. Maintain minimum of 3 inches between conduits.
6. Specify bending radius equal to or greater than the minimum bending radius of the conductors.
7. Where RGS conduits are used underground specify polyvinyl chloride (PVC) coating is used for supplementary protection, with a minimum of 20 mils thick, 2-inch wide field-applied PVC tape wrap, or 40 mils thick factory-applied PVC coating.
8. Install a nylon pull rope rated for the appropriate tensile strength in all spare conduits and conduits in which percent fill is less than 50%.
9. Include a minimum 33% spare
10. Show cross-section details on the drawings for each conduit configuration including section cuts referenced from plans; indicate spares.
11. Perform initial cable calculations in accordance with IEEE 576.
12. Specify Long couplings.
13. Specify that the contractor give notice to TAMUS before cables are pulled so that the TAMUS inspector may observe the pull.
14. Do not assume free use of spare conduits.

Reinforced Concrete Ductbank (RCDB)

Design RCDB to meet the requirements as follows:

1. For all ductbanks that are Utility in nature or contain conductor rated a 1000V and above. Reference and comply with UES standard for electrical Utility raceways.
2. Do not route MV or Communications lines beneath building foundations expect for conduits that terminate inside building.
3. Minimum conduit size shall be 2" trade size.
4. Specify a minimum cover of 30 inches from grade to the top of the concrete ductbank.
5. Design ductbank and manhole systems to slope away from the building and toward manholes with sumps at a minimum of 4 inches per 100 feet (0.33%).
6. When multiple manholes are uses (on same ductbank system), design system to slop to common manhole.
7. Where cables enter manholes, handholes, or underground pull boxes, fill the lower rows of ducts and leave the upper rows of ducts spare to facilitate future cable pulls.
8. Locate spare conduit stub-ups into equipment to facilitate future cable installation.
1. Minimum Schedule 40 polyvinyl chloride conduit (PVC).
2. Concrete shall have a minimum compressive strength of 2,500 psi at 28 days.
3. Specify steel rebar at each corner and rebar stirrups at sizes and intervals for the entire length of the ductbank. Provide reinforcement at the point where ductbanks enter manhole or building walls. Reinforcement may consist of PVC-coated or tape-wrapped hot-dipped RGS conduits or 1/4 inch thick wall fiberglass-reinforced (RTRC) conduits extending to a minimum of 10 feet from point of entry into ductbank.
4. Specify bell ends manufactured of heavy-wall fiberglass or Schedule 80 PVC at the points of penetration/termination.
5. Specify all bends over 30 degrees to be RTRC / IMC, or RGS.
6. Provide 6 inches concrete around the exterior of duct bank.
7. Specify factory-fabricated, interlocking, cast-in-place spacers designed to arrange, support, and fix conduits in concrete encasements, every 4 ft. Spacers shall interlock vertically and horizontally.
8. Specify bend radius of 48 inch.
9. Arrange spare conduits to facilitate future cable installation where ductbanks enter manholes, handholes, equipment enclosures, or other pulling spaces.

DESIGN CRITERIA

Division 26 – Electrical

10. Install a continuous bare #2/0 AWG copper conductor centered within ductbank that runs the full length. (To serve as Ufer-Ground)
11. Low-Voltage ductbanks may excluded steel reinforcement based on soil reports and Civil engineers approval.
12. Communications ductbank's warning tape shall be bright orange and be marked "CAUTION: BURIED COMMUNICATIONS LINE BELOW."

Duct Blockage Tests

Specify that the contractor perform a test for duct blockage or deformation for all ductbanks after the concrete has cured for 24 hours.

1. Use a flexible mandrel/scrapper no smaller than 1/4 inch less than or 80% of the internal diameter of the duct to be tested, or other TAMUS-approved means.
2. Replace any duct section found blocked.
3. Notify TAMUS inspector not less than 14 working days before duct tests.
4. Submit written reports of tests to TAMUS inspector using Duct Blockage Test Form 26A-6.1 and foldout diagram of each manhole identifying each duct subject to test.

Direct-Buried Conduit

1. Specify Schedule 80 PVC conduits where installed outside the building perimeter.
2. Specify Schedule 40 PVC conduits where installed inside the building perimeter.
3. Do not mix Schedule sizes on the same route.
4. Specify minimum trade size 1-inch.
5. Bury conduits at a minimum depth of 24 inches.
6. Support conduit with spacers as described RCDB Requirements.
7. Encase all sides of the conduits in a minimum 3" sand bedding within the trench; use cement-stabilized sand where routed below pavement. Add backfill material above the sand bedding up to finished grade and compact per structural engineer.
8. Install a concrete cap, minimum thickness of 2 inches, above conduits where not under other concrete (or equal) surface.

Manholes and Vaults

Provide precast concrete manholes and vaults dedicated to the campus medium-voltage utility and distribution system. Include all standard hardware and accessories. Design manholes/vaults in accordance with IEEE C2 Rule 323. Please see Texas A&M's Utility Energy Services Standard [Electric Manholes](#). Note: Drawing may differ from actual requirements.

1. Use 400 feet as standard spacing between manholes.
2. Arrange manholes so conduits enter on same relative height of manhole.
3. Conduits shall enter a minimum of 12 inches above manhole floor.
4. Provide with manhole as a minimum:
 1. Thin-wall knock-outs on every wall
 2. Hot-dip Galvanized ladder anchored to floor and wall.
 3. Ground rods and Ground ring (see TAMU UES standard)
 4. Sump pit with floor grate
 5. Sump pump (required for manholes designed to contain submersible switchgear)
 6. Non-corrosive/corrosion-resistant ladder-up safety post
 7. Heavy-duty fiberglass cable racks and arms

DESIGN CRITERIA

Division 26 – Electrical

8. Non-corrosive/corrosion-resistant pulling irons
5. All Vaults (for switches, transformers, and other gear) shall have
 1. Minimum 8 inch thick walls, and minimum 18 inch depth basin.
 2. One 3/4 inch copper clad ground rod (two on main campus)
 3. Minimum 2/0 ground ring that wraps along the walls of the interior of vault.
 4. Opening should leave a minimum of 6 inches, from walls, around all theoretical conduits. Do not decrease 3 inch spacing of conduits.
6. Requirements for communications manholes and handholes are covered in Division 27 - Communications.

Grounding and Bonding

Show bonding and grounding of medium-voltage and low-voltage equipment on one grounding system diagram prepared for each project.

Install grounding systems for medium-voltage systems and equipment in accordance with NEC 250 Part X, IEEE 142, IEEE C2, IEEE 81 and IEEE 1100.

Soil resistivity should be determined for each site as part of geotechnical report. Use a reliable measurement to determine the soil resistivity such as the four-electrode Wenner Method as described in ASTM G57-06. Perform calculations of grounding electrode resistance using the measured soil resistivity values and the methods outlined in IEEE 142

Grounding and Bonding for Medium-Voltage Systems

Design the facility to have a single-point grounded-neutral systems. The A/E will need to evaluate the soil resistivity and potential fault levels at the campus location and make recommendations as to whether a solidly grounded-neutral or an impedance grounded-neutral system is more suitable. IEEE 142 provides guidelines in the selection of these types of grounding systems.

1. Bond the shields of medium-voltage cables to the equipment grounding means (lug or bus bar) inside each equipment enclosure where terminations, splices, and bonding connections are made.
2. For solidly grounded medium-voltage systems, install a #2 AWG minimum, 600V Type XHHW-2 equipment grounding conductor within the raceway (e.g., duct or conduit) with the circuit conductors and bond to equipment.
3. Provide a dedicated ground rod at each outdoor medium-voltage switchgear and transformer.

Grounding and Bonding for Low-Voltage Systems

The low-voltage portion of the grounding system will typically originate at the secondary side of the service (utility) transformer and extend to the neutral and equipment grounding buses in a branch-circuit panelboard. Grounding system shall have a ground resistance not to exceed 5 ohms for low voltage. Data Centers shall have a ground resistance not to exceed 1 ohm.

Design a main grounding electrode (MGE) as:

1. A “Ground Ring” completely around the perimeter of the building, 3 feet below grade and at a minimum distance of 3 feet outside the structure foundation.
 1. Ground Ring should be sized based on ground study but as a minimum of 4/0
 2. Ground ring should be bare copper.

DESIGN CRITERIA

Division 26 – Electrical

3. Bond each perimeter structural steel column to the MGE ground ring. Specify an IEEE 837-compliant high-compression type connector listed for the purpose.
4. Specify all bonds below grade to be an exothermic weld.
5. Specify ground rods to be a minimum 3/4 inch diameter 10 ft long.
6. As a single point ground, specify a copper “Ground Bar: located in the Main Electrical Room adjacent to the service-entrance equipment.
 1. Minimum dimensions: 1/4 inch by 2 inches, but with a cross-sectional area not less than 25% of the aggregated cross-sectional area of the connected feeders.
 2. Specify pre-drilled and tapped NEMA 2-hole connections with minimum 25% spare.
 3. Label each connection
 4. Mount on insulated supports
 5. Use a dedicated ground electrode to connect to “Ground Ring”.
 6. Include a like Ground bar in all other electrical rooms, connecting back to Main.
 7. Main transformer shall have a minimum of one ground rod, and unless otherwise noted shall be a solidly bonded neutral. Use minimum 4/0 to bond to “Ground Ring”.
 8. Use bonding Jumpers from all electrical switchgear, switchboard, and panelboards to system “Ground Bars”. Do not use factory-furnished bonding screws.
 9. Bond and ground all separately-derived systems to nearest “Ground Bar” or “Ground Ring” do not exceed system ground resistance requirements.

Isolated-Ground Systems (IG)

1. Derive each IG power system using a K-rated, dry-type transformer with electrostatic shielding between primary and secondary windings and supplied by a dedicated feeder.
2. Specify a 200%-rated neutral bus, and a 1005 rated Ground Bus
3. Use bonding jumpers; do not use a factory-furnished bonding strap or bonding screws.
4. In addition to the equipment grounding conductor, install a dedicated full current rated 600V insulated (green/yellow) IG grounding conductor for each IG branch-circuit and feeder.
5. Show all IG conductors on wiring diagrams.

Lightning Protection Systems

Provide a lightning protection system (LPS), including surge protection as described under for every new building and structure. Exemptions will be considered only if the results of a Lightning Risk Assessment performed by the A/E in accordance with NFPA 780, Annex L indicate a low risk of damage or injury that is acceptable to TAMUS.

Design LPSs in accordance with NFPA 780, LPI-175, and UL 96A.

1. For building additions, extend the existing LPS to the addition structure if the addition is not within the zone of protection.
2. Specify UL 96A Class II materials for all LPSs regardless of structure height. Refer to NFPA 780, Table 4.1.1.1.2 for a list of Class II minimum material requirements.
3. Coordinate roof wall penetrations with other disciplines to ensure that the integrity of the facility envelope is not compromised.
4. AE shall provide:
 1. LPS Lightning Risk Assessment in accordance with NFPA 780, Annex L.
 2. Performance specification.
 3. Preliminary lightning protection roof plan including conductors, air terminals, and connections to roof-mounted mechanical equipment.

DESIGN CRITERIA
Division 26 – Electrical

4. Building grounding plan (same plan as described in “Grounding and Bonding for Low-Voltage Systems” [3.12]) showing locations of MGE ground ring, down-conductors, ground rods, and ground test wells.
5. Typical connection details for air terminals, Ground Ring, ground rods, down conductors, parapet wall penetrations, and ground test wells.
6. Specify use of Building ground ring. Do Not install 2 ground rings
 1. Terminate each LPS down-conductor at a dedicated ground rod and bond both the down-conductor and ground rod to the building MGE ground ring.
 2. Bond all metallic objects such as pipes and conduits crossing the ground ring.
 3. Provide ground test wells at accessible locations along the ground ring.
 4. Install LPS conductors in Schedule 80 PVC conduit if routed inside the building or structure.
5. Consult building envelope designer on best means of entry.
6. New buildings or Buildings who’s master envelope is being altered shall be certified with minimum of either a Master C label from UL or Inspection Program label from LPI upon installation of the system.

APPENDIX A

APPENDIX A – LIST OF CONTENTS

| <u>Reference No.</u> | <u>Title</u> |
|-----------------------------|---|
| Figure 26A-1 | Sample Arc-Flash Hazard Warning Label |
| Form 26A-2 | Medium-Voltage Cable Testing Information Form |
| Form 26A-3 | Duct Blockage Test Form |



| | |
|--------------|---------------------------------------|
| Figure 26A-1 | Sample Arc-Flash Hazard Warning Label |
|--------------|---------------------------------------|

DESIGN CRITERIA
Division 26 – Electrical

MEDIUM VOLTAGE CABLE TESTING
INFORMATION FORM 26A-2

CONTRACTOR SHALL SUBMIT COMPLETED TO TAMUS INSPECTOR AT LEAST 14 DAYS PRIOR TO TEST

PROJECT NAME _____

PROJECT NUMBER _____

CONTRACTOR NAME _____

DATE AND TIME OF TEST REQUESTED _____ / _____ / _____ : _____ AM / PM

REQUESTED BY: _____

CABLE MANUFACTURER _____

CABLESIZE _____

CABLE RATED VOLTAGE _____

OF CONDUCTORS _____

ACTUAL VOLTAGE _____

INSULATION TYPE _____

THICKNESS (MILS) _____

AGE OF CONDUCTOR(S) NEW _____ OLD (YRS) _____

LENGTH OF CONDUCTOR(S) _____

TYPE OF TERMINATIONS: _____

ELBOWS (MFR)

STRESS CONE (MFR)

CABLE END LOCATIONS _____

DESIGN CRITERIA
Division 26 – Electrical

Duct Blockage Test Form 26A-3

| | | |
|--|----------|-------|
| Physical and Electrical Inspection Completed? Inspector Name: | Yes / No | Date: |
| Contractor Name: | | |
| Contractor Phone and e-mail: | | |
| Manhole # : | | |
| Conduit (s) ID | | |

Objective:

- 1. To verify that all conduit is in acceptable condition.
- 2. To verify that all conduit have pulling string per specifications

Test Equipment:

Conduit Diameter:

Mandrel Size:

Success Criteria:

- 1. All conduit is installed per contract documents
- 2. All conduit is continuous without obstruction between junction boxes
- 3. All conduit is clean and in good physical condition

DESIGN CRITERIA
Division 26 – Electrical

Test Procedure:

| Procedure Description | Measured | Results Pass/Fail |
|--|----------|----------------------|
| Verify conduit is the correct size and color. | | |
| Verify the conduit is clean and terminated per contract documents in the junction boxes. | | |
| Verify mandrel is at least 80% of the conduit internal diameter, at least twice as long as the conduit diameter, composed of rigid material. | | |
| Verify mandrel moves freely through the entire length of all conduit runs. | | |

Test Completed by:
Representative Witness:

Date:

TAMUS

Signature

Signature

Print Name

Print Name

DESIGN CRITERIA
Division 26 – Electrical

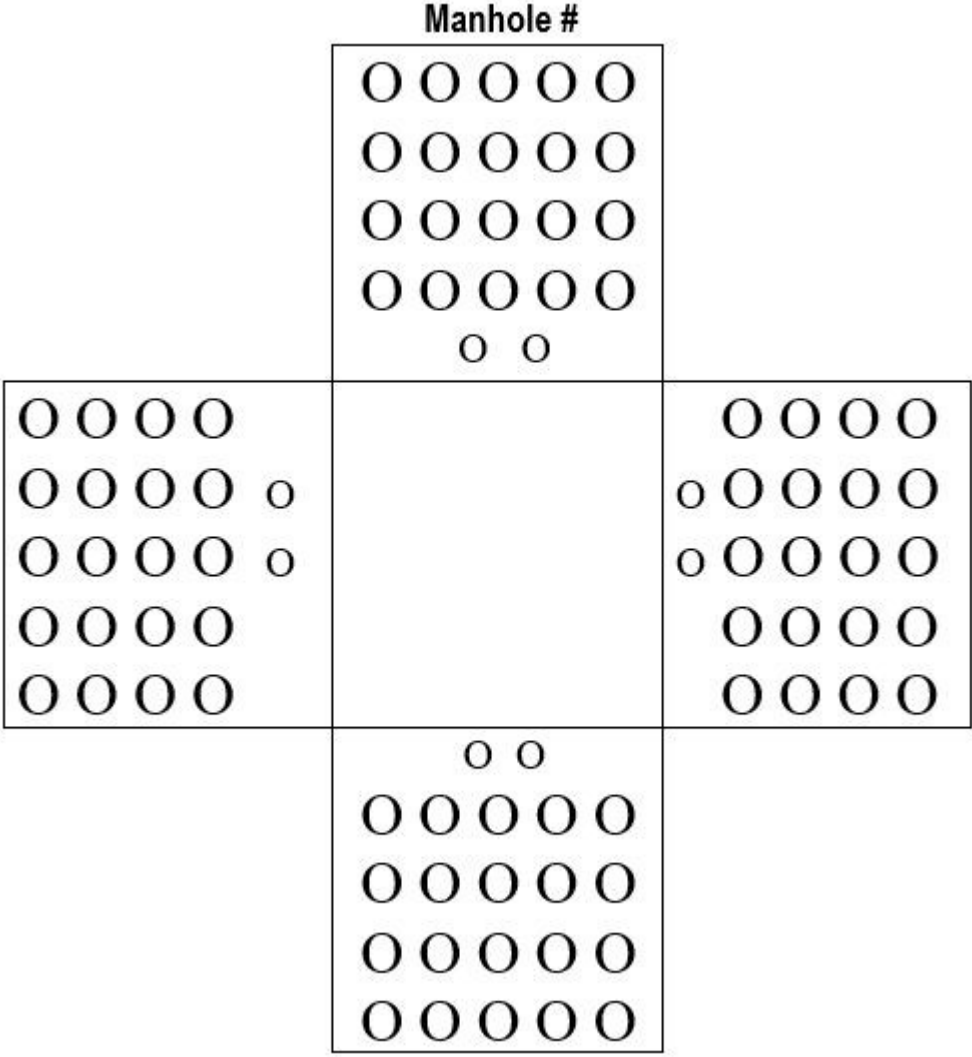









NUMBER DUCTS: NORTH, EAST, SOUTH, WEST WALLS

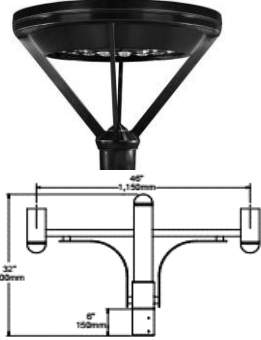

(EXAMPLE: N1-N22, E1-E22, S1-S22, W1-W22)

LIST DUCT NUMBERS ABOVE IN CONDUIT ID SPACE AFTER VERIFICATION OR FAILURE

RELLIS LIGHTING STANDARD

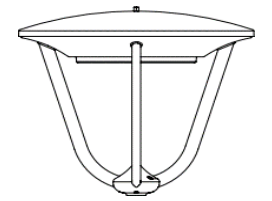
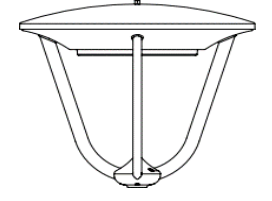
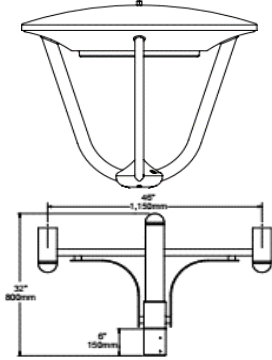
| THUMBNAIL | MANUFACTURER | DESCRIPTION | CATALOG NO. | DIMENSIONS HEIGHT x DIAMETER | LAMP WATTS | DELIVERED LUMENS | Color Temperature | EFFICACY (LM/W) | FINISHES | Lighting Control | Poles |
|---|--------------------------------------|---|--|------------------------------------|---------------|---------------------|----------------------|--------------------|---|---|--|
|  | ARCHITECTURAL AREA LIGHTING (AAL) | 10' PEDESTRIAN SINGLE HEAD MOUNT, PHOTOCELL | SLVT-T2-56LED-4K-450-FINISH- PT3-PCA-C | 20" x 25.5" | 85 | 8236 | 4000K, 70 CRI | 66 | Premium Color - 4 digit Color (RAL 7008) | NEMA 7-pinm Twist Lock Photocell, no timeclocks | Gardco, Sterner or NLS Bronze Anodized Hiawatha 312 |
|  | ARCHITECTURAL AREA LIGHTING (AAL) | 18' PARKING AREA SINGLE HEAD MOUNT, PHOTOCELL | SLVT-T3-56LED-4K-700-FINISH- PCA-C | 20" x 25.5" | 129 | 8285 | 4000K, 70 CRI | 64 | Premium Color - 4 digit Color (RAL 7008) | NEMA 7-pinm Twist Lock Photocell, no timeclocks | Gardco, Sterner or NLS Bronze Anodized Hiawatha 312 |
|  | ARCHITECTURAL AREA LIGHTING (AAL) | 18' PARKING AREA DOUBLE HEAD MOUNT, PHOTOCELL | (QTY 2) SLVT-T5-56LED-4K-700- FINISH-PCA-C / SLA1-2-FINISH | 20" x 25.5" | 129 | 16352 | 4000K, 70 CRI | 63 | Premium Color - 4 digit Color (RAL 7008) | NEMA 7-pinm Twist Lock Photocell, no timeclocks | Gardco, Sterner or NLS Bronze Anodized Hiawatha 312 |
|  | ARCHITECTURAL AREA LIGHTING (AAL) | 18' ROADWAY SINGLE HEAD MOUNT, PHOTOCELL | SLVT-T3-56LED-4K-700-FINISH- PCA-C | 20" x 25.5" | 129 | 8285 | 4000K, 70 CRI | 64 | ALL RAL AND CUSTOM PAINT COLORS ARE AVAILABLE: Street - Lighter Platinum Bronze | NEMA 7-pinm Twist Lock Photocell, no timeclocks | Gardco, Sterner or NLS Bronze Anodized Hiawatha 312 |
|  | CREE LIGHTING (Cree Edge Series) | 10' PEDESTRAIN SINGLE HEAD MOUNT, PHOTOCELL | ARE-EDR-2M-R3-04-E-VOLT- FINISH-350-P | 21.4" x 23" | 46 | 5003 | 4000K | 108 | Parking and sidewalks - Bronze (BZ) | NEMA 7-pinm Twist Lock Photocell, no timeclocks | Gardco, Sterner or NLS Bronze Anodized Hiawatha 312 |
|  | CREE LIGHTING (Cree Edge Series) | 18' PARKING AREA SINGLE HEAD MOUNT, PHOTOCELL | ARE-EDR-3M-R3-06-E-VOLT- FINISH-700-P | 21.4" x 23" | 134 | 11779 | 4000K | 87 | Parking and sidewalks - Medium bronze (BZ) | NEMA 7-pinm Twist Lock Photocell, no timeclocks | Gardco, Sterner or NLS Bronze Anodized Hiawatha 312 |

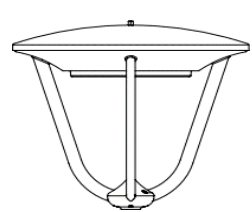
| THUMBNAIL | MANUFACTURER | DESCRIPTION | CATALOG NO. | DIMENSIONS HEIGHT x DIAMETER | LAMP WATTS | DELIVERED LUMENS | Color Temperature | EFFICACY (LM/W) | FINISHES | Lighting Control | Poles |
|---|-------------------------------------|--|--|------------------------------------|---------------|---------------------|----------------------|--------------------|---|---|--|
|  | CREE LIGHTING (Cree Edge Series) | 18' PARKING AREA DOUBLE HEAD MOUNT, PHOTOCELL | (QTY 2) ARE-EDR-5M-R3-06-E- VOLT-FINISH-700-P / SLA1-2- FINISH | 21.4" x 23" | 268 | 26140 | 4000K | 97 | Parking and sidewalks - Medium bronze (BZ) | NEMA 7-pinm Twist Lock Photocell, no timeclocks | Gardco, Sterner or NLS Bronze Anodized Hiawatha 312 |
|  | CREE LIGHTING | 18' ROADWAY SINGLE HEAD MOUNT, PHOTOCELL | ARE-EDR-3M-R3-06-E-VOLT- FINISH-700-P | 21.4" x 23" | 134 | 11779 | 4000K | 87 | Street - Lighter Platinum Bronze | NEMA 7-pinm Twist Lock Photocell, no timeclocks | Gardco, Sterner or NLS Bronze Anodized Hiawatha 312 |
| | | | | | | | | | | | |
|  | NERI LIGHTING | 10' PEDESTRAIN SINGLE HEAD MOUNT, PHOTOCELL | PU106L023P6 | 20.8" x 23.6" | 54 | 3914 | 4000K | 72 | ALL RAL AND CUSTOM PAINT COLORS ARE AVAILABLE: Parking and sidewalks - Medium bronze Street - Lighter Platinum Bronze | NEMA 7-pinm Twist Lock Photocell, no timeclocks | Gardco, Sterner or NLS Bronze Anodized Hiawatha 312 |
|  | NERI LIGHTING | 18' PARKING AREA SINGLE HEAD MOUNT, PHOTOCELL | PU106L023P6 | 20.8" x 23.6" | 54 | 3914 | 4000K | 72 | ALL RAL AND CUSTOM PAINT COLORS ARE AVAILABLE: Parking and sidewalks - Medium bronze Street - Lighter Platinum Bronze | NEMA 7-pinm Twist Lock Photocell, no timeclocks | Gardco, Sterner or NLS Bronze Anodized Hiawatha 312 |
|  | NERI LIGHTING | 18' PARKING AREA DOUBLE HEAD MOUNT, PHOTOCELL | (QTY 2) PU106L063P6 / SLA1-2- FINISH | 20.8" x 23.6" | 108 | 8034 | 4000K | 74 | ALL RAL AND CUSTOM PAINT COLORS ARE AVAILABLE: Parking and sidewalks - Medium bronze Street - Lighter Platinum Bronze | NEMA 7-pinm Twist Lock Photocell, no timeclocks | Gardco, Sterner or NLS Bronze Anodized Hiawatha 312 |

| THUMBNAIL | MANUFACTURER | DESCRIPTION | CATALOG NO. | DIMENSIONS HEIGHT x DIAMETER | LAMP WATTS | DELIVERED LUMENS | Color Temperature | EFFICACY (LM/W) | FINISHES | Lighting Control | Poles |
|--|--|---|-----------------|------------------------------------|---------------|---------------------|----------------------|--------------------|---|---|--|
|  | NERI LIGHTING | 18' ROADWAY SINGLE HEAD MOUNT, PHOTOCELL | PU106L023P6 | 20.8" x 23.6" | 54 | 3914 | 4000K | 72 | ALL RAL AND CUSTOM PAINT COLORS ARE AVAILABLE: Parking and sidewalks - Medium bronze Street - Lighter Platinum Bronze | NEMA 7-pinm Twist Lock Photocell, no timeclocks | Gardco, Sterner or NLS Bronze Anodized Hiawatha 312 |
|  | CREE LIGHTING (OSQ Series) | 30' ROADWAY SINGLE HEAD MOUNT, PHOTOCELL, High Output Area/Flood luminaire | OSQ-HO-A-NM-2ME | 22" x 35.3" | 130 | | 4000K, 70 CRI | up to 125 | RAL 7048 | NEMA 7-pinm Twist Lock Photocell, no timeclocks | Gardco, Sterner or NLS Bronze Anodized Hiawatha 312 |
|  | LANDSCAPE FORMS, INC. (Annapolis Series) | 6" BOLLARD | Annapolis | 6" | 3 | 10 | 3500k | | BLACK | NEMA 7-pinm Twist Lock Photocell, no timeclocks | NA |

DESIGN CRITERIA

Division 27 – Communications

GENERAL

These guidelines shall be referred to during the design and construction of telecommunication systems for RELLIS Campus buildings. These guidelines are minimum standards and shall be referred to during design and implementation, the building Owners may specify additional requirements.

In accordance with the TIA Engineering Manual and the American National Standards Institute (ANSI), two categories of criteria are specified; mandatory and advisory. The mandatory requirements are designated by the word “shall”; advisory requirements are designated with the words “should”, “may”, or “desirable”, which are used.

Communications must be reviewed by TAMUS RELLIS IT for Materials and Equipment Installation.

GENERAL REQUIREMENTS

- A. All data contractor installation personnel must be BICSI Certified Installer Level I or higher. The onsite supervisor of the data contractor must be a BICSI Certified Technician for the term of the construction period of the project.. The data contractor must have on staff a BICSI Certified RCDD who shall affix their stamp to shop drawings, submittals and as-built documentation. All certifications must be current. Proof of certification must be presented for supervisors and all installation personnel at or before the pre-installation meeting.
- B. The A/E design team of consultants shall include a data/voice/audio/video/physical security design consultants, one of which shall be a certified BICSI RCDD with credentials and with extensive previous experience in higher education building design environments. The consultant should also provide support during the construction process to ensure all submittals, test procedures and actual installation meets the requirements as specified for the project.
- C. Warranty - It is the intent that the complete cabling system be installed to satisfy 20-year minimum warranty requirements of the cabling infrastructure manufacturers. Warranty documentation shall be provided at the time of substantial completion. Test results are required prior to turnover of Telecom Rooms (MDF/IDF) And must be submitted in electronic format to the RELLIS Campus CIO.
- D. There shall be a pre-installation meeting with the general contractor, data contractor, FPC Project Inspector, A/E technology consultant and RELLIS Networking representative to review the installation requirements and planned installation.
- E. There shall be a pre-testing meeting with the general contractor, data contractor, FPC

DESIGN CRITERIA

Division 27 – Communications

Project Inspector, and RELLIS Networking representative to review the test requirements and plan for all fiber and copper installed.

- F. Provide BICSI credentials for data crew. Lead Technician shall hold at least BICSI Technician, remainder of crew shall hold at minimum BICSI Installer I certification.

COMMUNICATIONS GROUNDING AND BONDING

- A. All conductor wire, busbars and conduit shall be UL listed.
- B. The communications ground system shall be independent from all power grounding except for the connection to the building's electrical service main grounding electrode system.
- C. Power grounding and/or bonding shall not be allowed to interfere or provide any back feed or be a conductor to the separate communications ground system source or to any communications bonded materials or equipment.
- D. Primary Bonding Busbar (PBB) and Telecommunications Bonding Conductor (TBC)
 - 1. The main ground source feed for the Primary Bonding Busbar (PBB) in the ER (MDF) shall be an independent feed from the building's electrical service main grounding electrode system, known as the Telecommunications Bonding Conductor (TBC).
 - 2. The TBC shall be stranded copper ground wire from the building ground system to the PBB in the ER (MDF) sized at a minimum #4/0 unless otherwise sized by the Electrical Engineer of Record.
 - 3. The TBC connections shall be low emission exothermic welds at the connecting ends.
 - 4. All grounding busbars must be pure copper **not** copper plated.
- E. Telecommunication Bonding Backbone (TBB) and Secondary Bonding Busbar (SBB)
 - 1. The Telecommunication Bonding Backbone (TBB) originates at the PBB and shall be extended from the PBB within the ER (MDF) throughout the building along the same route as the telecommunications backbone pathways, to the Secondary Bonding Busbar(s) (SBBs) in each TR (IDF).
 - 2. The minimum TBB conductor size between busbars shall be stranded copper ground wire one (1) AWG size smaller than the Telecommunications Bonding Conductor (TBC).
- F. Backbone Bonding Conductor (BBC)

DESIGN CRITERIA

Division 27 – Communications

1. Whenever two or more TBBs are used in a multistory building, the TBBs shall be bonded together with a BBC (by low emission exothermic welds) at the top floor and at a minimum of every third floor in between with a copper conductor equal to the gauge of the TBB.

G. TEBC and RBC

1. All cabinets and racks shall be connected by the Telecommunications Equipment Bonding Conductor (TEBC). The TEBC is a stranded copper #4 conductor from the PBB/SBB extending along each row of racks within the room. Bond each rack with a Rack Bonding Conductor (RBC). The RBC is a stranded copper #6 conductor connected to the vertical rack bonding terminal. All connections shall be irreversible crimp connections. Route conductor so as to minimize the quantity of sweeping bends.

CAMPUS TELECOMMUNICATION AND ENTRANCE INTO FACILITIES

Updated 9-30-21

All customer owned cabling shall utilize the underground pathway system identified in this document and referred to in ANSI/TIA. Entrance point diversity is highly desirable.

A. RELLIS Campus Communications Infrastructure (RCCI):

1. The RCCI is the portion of the RELLIS communication system that connects all RELLIS Facilities. The point at which the RCCI ends and the Facilities communication system begins shall be known as the Communications Demarcation Point. This Point will be the MDF except under the following conditions:
 - a. facilities that are classified as “Group U” of the International Building Code
 - b. Pre-manufacture building that are of a temporary nature.
 - c. Special permission by RELLIS Campus
2. Communications Demarcation Points not located inside a building shall be brought into an approved above ground Patch panel dedicated for this purpose. Patch panels Location shall also need RELLIS’s approval.
3. The RCCI duct bank shall be a minimum of four (4) 4-inch Schedule 40 PVC conduits.
4. The RCCI shall be Concrete encased per directions in Div 26
5. The RCCI shall provide precast, concrete manholes and handholes for underground telecommunication outside the building.
 - a. Shall provide manholes with a minimum inside dimensions of 6-feet wide, 12-feet long, and 7-foot high for cable splicing purposes.
 - b. Shall provide handholes with minimum dimensions of 3-feet wide, 5-feet long, and 3-feet high for pulling purposes.

DESIGN CRITERIA

Division 27 – Communications

- c. Shall place handholes not to exceed cable manufacturer's pulling tension by a safety factor of two and shall limit horizontal and vertical bends to no more than 180-degree between pull points.
6. Where RCCI extends into a building, Conduits shall be in 3 inches of concrete or 2 hour fire rated.

B. Building Primary Terminal Room Facilities (MDF):

1. The MDF shall be the first communications room where fiber enters the building and shall be sized in accordance to the standards noted in this document.
 - a. The room shall house fiber and copper service entrance equipment for telecommunications, data, and all required wide area network equipment. Note: This may include Distributed Antenna System (DAS) equipment; consideration for the equipment to have a separate room or located in an electrical space shall be given priority and coordinated with RELLIS IT.
 - b. A minimum of 48-strands of Single Mode fiber optic cable shall be installed from the MDF to the telecommunications manhole, tunnel or other service point designated by the assigned team members.
 - c. In the event a diverse pathway is provided into the building there can be consideration to have a 24-strand Single Mode fiber optic cable installed through each pathway for a total of 48-strands. (Primary path = 24-strands; Secondary/Diverse path = 24-strands).
 - d. Provide (12) 4-pair Category 6A cables from the MDF to each IDF. These cables will provide backup in the event the fiber backbone is damaged or fiber network cards fail. Only install to IDF's within the 270' maximum distance.

C. Additional Building communication connection points.

- a. Install a minimum of four (4) 4-inch conduits stubbed out of the building for Smart Campus. One conduit stubbed out of the building in each direction and into hand holes. Distance from building and location to be coordinated with civil and landscape.
- b. For buildings with loading docks or garage type facilities plan for power and data to support electric autonomous vehicles. Refer to electrical guidelines for supporting information. Provide conduit, back boxes and data connectivity.
- c. Provide conduit pathway from the MDF to a hand hole adjacent to the building and site parking lot. Provide a 2-inch conduit from the hand hole and extend in a path between parking lot light poles.
 - i. Provide a small (18"x18") hand hole at every other light pole and connect to the 2-inch conduit pathway.
 - ii. Extend a 1-inch conduit from the hand hole into the light pole and up to minimum 15-feet.
 - iii. Provide knockout on pole to support wireless or surveillance cameras. Depending on the system deployed it may require

DESIGN CRITERIA

Division 27 – Communications

110-power.

- d. Conduits shall be installed to at minimum six (6) locations for WiFi/Surveillance cameras to support vehicle activity. Location shall be determined and the quantity possibly adjusted during design.

MANHOLES AND HANDHOLES

- A. Manholes: Oldcastle #SBC-612-7 or Owner Approved Equal
- B. Handholes: Oldcastle #264-UEP3660PB or Owner Approved Equal

CABLE DISTRIBUTION FACILITIES

- A. Overhead basket tray shall be provided from each telecom room as the distribution conveyance system for all station outlets being served. Provide a 1 ¼" EMT conduit (not to exceed 100 feet length) from accessible ceiling near the installed tray to each station outlet box. Utility/ power poles, if used, shall be connected to the serving raceway in a similar manner. Cables shall lay loose in the trays installed above the ceiling, dressing of cables in basket tray is not required. Basket tray is for the exclusive use of the structured cabling system. Power cabling should not access the same tray. Consideration for security, audio visual and other low voltage cables shall be made, basket tray section dividers or the use of J-hooks attached to the exterior of the tray can be reviewed as options. Screened or shielded cables from other trades shall be considered case by case.
- B. Trays shall be mounted 6" above accessible ceiling, have a minimum 6" clear above the tray, and have 3' of unencumbered space to the side of the tray for every 10' segment of tray.
- C. J-hooks suspended by threaded rod shall be utilized to span distances between conduits and tray. Space J-hooks on 4-5' centers. J-hooks shall only be utilized where shown on the plans or when identified and approved through project submittals. Contractor shall verify the use of J-hooks as a method for cable support.
- D. Install a pull cord in all empty conduits.
- E. Maintain all clearances from electrical elements (lights, conduits, motors, generators, etc.)
- F. In general, install cable runs in conduit (EMT) back to the cable tray. Leave approximately 18" of cable slack at the cable tray end of the conduit. Coil and secure the slack cable to the end of the conduit. Do not leave cable slack in the cable tray.
- G. Tray shall be sized to accommodate the designed structured cabling system plus 25% growth.

COMMUNICATION ROOM STANDARDS

- A. Communication rooms general information and guidelines:
1. The minimum MDF room size shall be 12-foot by 14-foot. Size may increase based on building size and quantity of data ports being supported.
 - a. Floor mounted racks and weight loads shall be reviewed for floor loading. The typical 7'x19" 2-post Communications Rack has a load capacity of 1000 lb are required unless specified differently by Building Owner and approved by RELLIS Campus CIO.
 - b. All flooring allocated for the installation of racks in the MDF and secondary IDF's shall support a fully loaded 2-post or 4-post Communication Racks.
 2. When required the room shall be divided for security purposes and to establish two service areas in the same room. Mesh fence with a sliding locking gate/door will assist with maintaining usable floor space.
 3. Intermediate Distribution Facility (IDF) minimum room size shall be 12-foot by 9-foot. Size may be increased based on the quantity of data ports being supported.
 4. The quantity of communication rooms shall be based on usable square footage, quantity of floors and horizontal cable length.
 5. MDF/IDF rooms must be keyed separately from the building master similar to a mechanical room and access to the keys will need RELLIS IT or building owner IT signoff.
 6. No means of water conveyance shall pass through IDF / MDF rooms, except for one sprinkler head. No main water lines or ductwork shall pass through the data rooms. Any water conveyance in these rooms must be approved by the RELLIS Campus CIO.
 7. **Important:** For turn over to RELLIS IT, all IDF and MDF rooms must be clean. These rooms must be as clean as any other room in the building to pass Final Completion.
 8. Turnover of MDF/IDFs should be on the critical path of any construction project; these rooms should be turned over before substantial completion in proportion to the number of MDF/IDF rooms within the building. A good estimate for determining the turn over date would be (Number of MDF/IDF rooms * 2 weeks) before substantial completion with a minimum of one month before substantial completion.
 - a. Items needed to be achieved before RELLIS IT/Building Owner IT will populate these rooms for permanent switch installation.

DESIGN CRITERIA

Division 27 – Communications

- i. Room must be clean and environment dust free, Room shall be finished to the degree of any other room in the building upon take over.
- ii. Floors shall be covered in antistatic tile and grounded.
- iii. Rooms must have permanent power and boxes should be mounted at normal outlet height or in basket tray depending on occupant's preference.
- iv. A NEMA L6-30R at the base of each rack positioned so as not to interfere with door operation on the back side of the vertical cable manager mounted at basket tray based on building owner preference. In addition we also need one L5-30R at the base of the rack or on basket tray depending on building owner preference housing the fiber enclosure.
- v. Include two courtesy NEMA 5-20R duplex outlets on opposite sides of the room.
- vi. A NEMA 5-20R receptacle shall be mounted at 4' on the wall designated for access control close to the location of the access controller.
- vii. Room must have sufficient lighting (30 foot candles at floor), light fixtures shall be mounted parallel to the rack row, one on the front side and one on the back side of the row of racks.
Lights must be on permanent power
- viii. All electrical outlets throughout rooms shall be on dedicated circuits and connected to emergency generator power.
- ix. Air conditioning units shall be on permanent power; there must be a working thermostat in the room. Basket trays on the same wall as the split fan coil unit shall be mounted 6 to 8" away from wall so cables will not be directly under the A/C unit.
 1. AC gear shall be sized to support a fully loaded MDF or IDF. Heat loads to be estimated based on previous projects and customer anticipated equipment installation, plus the available space in the room to support future equipment. AC system shall be expandable with increased cooling capacity to support more dense and powerful networking equipment.
- x. Rooms shall have permanent doors with TAMU RELLIS cores, not construction doors and locks.

B. Telecom Equipment rooms shall comply with the following requirements:

1. Comply with Telecommunications Industry Association (TIA) Telecommunications Building Wiring Standards.
2. There shall be a minimum of one communications room per floor and support

DESIGN CRITERIA

Division 27 – Communications

the cable distance of 270-feet.

3. MDF and Intermediate Distribution Frame (IDF) rooms should be designed to accommodate a minimum of 50% increase in rack space beyond the final building requirements.
4. MDF/IDF rooms shall be lined with $\frac{3}{4}$ " AC plywood with the smooth side facing out. Plywood must be marine grade and have 2 coats of fire retardant paint on both sides and all edges. **Do not cover fire-rated stamp with paint.** The plywood shall be 8' tall and start at outlet height of 12"s.
5. Floors shall be covered in anti-static tile and bonded to the communications grounding system.
6. Firestop in high density wiring locations shall utilize a mechanical firestop system equal to Specified Technologies, Inc - EZ Path.
7. All electrical circuits serving communications racks shall be mounted at the basket tray level, typically at 6" above floor mounted racks. All thread support of basket tray shall be spaced no more than 4-feet to 5-feet on center.
8. Provide the ground bus required by TIA/EIA-607.
9. Provide 19" 2-post (PREFERRED) 7, 8, 9-foot as appropriate to serve the building and available space in the Telecom Room.
10. Typical Rack arrangement per Telecom Room:
 - a. Rack #1 - Closest to the wall - Fiber panel
 - b. Rack #2 - Data Patch Panels
 - c. Rack #3 - Network Switches and UPS
 - d. Rack #4 - Spare (if required)
11. Vertical management shall be double sided with doors, (not snap on panels) in appropriate lengths to match cable racks; either 7, 8, or 9' in height. Ten inch managers shall be placed between racks and six inch managers at the ends of the rack row.
12. Horizontal management shall be 2U one sided with doors; there shall be 1 manager provided for every 2 patch panels installed (minimum of 3 managers).
13. All telecom room walls must stack exactly with the telecom room located on the floor above and below it.
14. Telecom rooms shall not serve outlets on other floors except as necessary for in-floor outlets that are not practical to run to the same floor telecom room. No open through hole penetrations are allowed to be made from conditioned

DESIGN CRITERIA

Division 27 – Communications

- space to unconditioned space (Example: outlets in the floor or in the wall where the cable drops down from a conduit stub into a cable tray in a basement crawl space.
15. Cabling Contractor shall provide detailed shop drawings indicating routing, length, and labeling of all elements of the structured cabling system. Shop drawings shall be reviewed both by the Owner and technology consultant prior to the installation of the structured cabling plant.
 16. No ceiling permitted in this room.
 17. Longest path routing in wiring closets should be used to provide additional cable for an equivalent service loop of at least 2 meters.
 18. To allow for future growth inside of wiring closets, racks should be placed to maximize the number of racks that can be fit into the available space.
 19. Finish color for racks and associated patch panels, vertical and horizontal managers should be black.
 20. Basket cable tray shall start from the data room cable entry point and circumference the room and across the row of racks. Basket tray shall be hung with acceptable triangular cable tray wall mounts or trapeze style with 1/2" all thread rods and unistrut. Basket tray runs should be mounted 6" above rack height and connected to racks with a 6" stand up bracket and waterfall rack drops used to transfer from basket tray into Vertical managers.
 21. Acceptable manufacturers:
 - a. B-line/
 - b. GSMetals/Flextray
 - c. Cablofil.
 - d. WBT
 22. All racks and basket tray shall be properly grounded to the grounding busbar in each IDF; all grounding busbars shall also be terminated to the main grounding busbar in the MDF. All grounding busbars must be pure copper **not** copper plated.
 23. Mechanical firestop devices for ingress and egress of cabling for MDF and IDF is preferably Specified Technologies Inc, EZPath as Basis of Design.
 24. In general, cable runs should be in conduit back to the cable tray. Approximately 18" of slack should be left at the cable tray end of the conduit. The slack should be coiled and secured at the end of the conduit. Slack should not be left in the cable tray.
 25. Sprinklers may be installed in telecom rooms as required by NFPA Code but **MAY NOT** pass through the room to access an adjacent room.

DESIGN CRITERIA

Division 27 – Communications

26. Do not locate ductwork or plumbing cleanouts in electrical or telecom rooms
27. No crawl space access from the electrical or telecom rooms
28. MDF/IDF rooms must be keyed separately from the building master similar to a mechanical room and access to the keys will need RELLIS IT or building owner IT signoff.
29. Surveillance cameras shall be installed in the MDF, Server Rooms and each IDF.
30. Provide one (1) 4" conduit from the top floor IDF in a multistory building or the MDF from a single story building to the roof to support connectivity for roof mounted equipment.
 - a. Provide data and convenience power at the roof level. All devices shall be outdoor rated. Quantity of devices and location are determined by the project Owner.

COMMUNICATIONS BACKBONE CABLING

- A. Single mode fiber optic cable is required between the MDF and each IDF of the building. 24-strand is minimum between MDF and each IDF.
- B. All fiber terminations shall be accomplished with fusion splice to fiber optic assemblies with ST UPC connectors. All fiber splices must be fusion spliced, no mechanical splices accepted on campus. Fiber blocks shall be ST – ST connections. All fiber strands must be terminated, no loose strands, and tested with level IV fiber OTDR tester.
- C. All fiber terminations will house in a rack mounted fiber optic enclosure.
- D. Fiber riser cables from the MDF to the IDFs shall be armored plenum or riser rated, cables shall be rated for the environment.
- E. Provide fiber patch cables equal to the number of fiber strands terminated times two. Single mode patch cables should be yellow, UPC polish, factory made, with test results provided, in the following lengths:
 1. 25% in 3 meter ST - ST
 2. 25% in 3 meter ST - LC
 3. 25% in 5 meter ST - ST
 4. 25% in 5 meter ST - LC
 5. Add (1) 3 meter LC/LC duplex fiber optic patch cable for each 48-port patch panel installed.

DESIGN CRITERIA

Division 27 – Communications

- F. Fiber patch cords shall be individually packaged with Test result summary on or in package.
- G. Test all installed fiber cables using a Power/Light Meter and/or OTDR. Submit full test results to the General Contractor and the RELLIS Campus CIO.
- H. Install (12) Category 6A cables from the MDF to each IDF if within the 270-foot distance limit.
- I. All fiber terminations shall be labeled within the enclosure of their termination point including room number, rack number and enclosure id. I.e. A1-A6 to Room 2134 Rack 1 Fiber Panel 1 B1-B6. If the fiber terminates in a building outside of the existing building a building number or common name should be included as well. I.e. A1-A6 to Building 8535 Room 1231 Rack 1 Fiber Panel 1 B1-B6. If the destination building is a single room the Room number can be omitted.

WORKSTATION TELECOMMUNICATIONS OUTLETS

- A. Unless noted otherwise, furnish telecommunications workstations with the following items:
 - 1. Provide two (2) Category 6A cables at each workstation. Grounding of box and conduit shall be in accordance with NEC. Quantity of cables may increase based on the needs of the stakeholders.
 - 2. Data outlets shall be installed near the power outlets that are not associated with timer deactivation.
 - 3. As stated in TIA 568A Section 4.3, the maximum horizontal run for Category 6A cable shall be 295-feet as measured from the patch panel in the telecom room to the most distant outlet in the work area. Utilizing 270-feet will assist in maintaining the maximum distance of 295-feet. Contractor's shop drawings shall show that the horizontal cabling elements (inclusive of service loops and vertical transitions) permanent link complies with the TAMU RELLIS standard of 270'.
 - 4. All outlet jacks, patch panels, racks, cables, shall meet the requirements of TIA 568-A Category 6A. Termination pinout shall be 568B.
 - 5. Each station outlet shall have a deep (3-1/2 inch) dual gang box with a single gang mud ring and single gang faceplate.
 - 6. One 1 1/4" inch conduits shall run from the outlet box to the nearest cable tray.
 - 7. Outlet box should be located a minimum of 12 inches from the nearest power outlet.
- B. Cable: Communications cabling shall be of a fire-retardant "open air plenum" type; meeting all federal and state fire codes. The cable shall be four pair, Category 6A cable. Cable shall have cable length markers minimum every two feet and relevant

DESIGN CRITERIA

Division 27 – Communications

UL markings. Cable type to be above the base level Category 6A cable.

C. Qualified cable manufacturers are:

1. Berk-Tek
2. Mohawk
3. Superior-Essex

D. There shall be no proprietary connectivity parts, each cable manufacturer shall use connectivity parts associated with their respective “partners” (i.e. Superior Essex/Ortronics, Mohawk/Hubbell, Berk-Tek/Leviton).

E. Cable jacket color shall be blue.

F. Provide Blue copper patch cords to match cable type in these lengths and percentages - provide two (2) patch cables for each horizontal cable installed;

1. 50% -- 7ft. in length for MDF and IDFs.
2. 40% -- 10ft in length for users
3. 5% -- 20ft in length for users
4. 5% -- 3ft. in length for WAP's (wireless access points); see drawing for details.

G. Category 6A Wiring Installation:

1. Do not strip cable sheath back more than is necessary to complete the termination.
2. No wire pairs untwisted more than 1/2".
3. Install cabling without kinks.
4. Bend radius should **not** be greater than 4 times the cable diameter.
5. No damage allowed to the sheath. If damaged, cable should be replaced.
6. Install cabling runs at least 6 inches away from fluorescent lights in suspended ceilings and 1 ft from power outlets.
7. Use Velcro cable ties; do not compress wire bundles.
8. Support cable bundles as appropriate using only industry-standard fittings.
9. Separate cable runs from power cabling by a minimum of 12 inches parallel and 3 inches crossing.

H. Install two Category 6A cables to each location designated for a wireless access point. As a general rule, wireless access point locations should be planned for on a 60 ft. grid, modified as necessary to make allowance for the building structure and for the areas intended purposes. For above ceiling locations, install each cable with a 20 ft. service loop at the access point end. Terminate the cables with an RJ45 plug or RJ45 outlet in a two-port surface-mounted plenum-grade mount. Wireless access points should generally not be located in ceilings above 14 ft. In those locations, strong consideration should be given to a wall-mounted outlet. Locate wall-mounted

DESIGN CRITERIA

Division 27 – Communications

outlets for access points no more than 14 ft. above the finished floor.

- I. Category 6A patch panels should be 48-port. Modular patch panels shall be populated with jacks. Horizontal managers should be 5"-6" deep 2U with attached covers.

CABLE TESTING

- A. Horizontal cable: Data contractor must provide test results in linkware, (Fluke's proprietary software) in digital form and 2 copies in CD or flash drive to RELLIS IT and Building Owner IT. Test results shall be 100% PASS; no marginal results accepted. In Linkware each cable must also show room number of the outlet location.
- B. Test all installed Category 6A cable according to the complete Category 6A test standards for permanent link using a Level IV test unit such as a Fluke DSX model. The unit must have been calibrated within the last year.
- C. Required information:
 1. Outlet number and room number on the test result for each station cable.
 2. A list of outlet numbers and the corresponding room numbers and cable lengths in Excel spreadsheet format.
 3. Laminated half-size as-built drawings indicating each outlet location and outlet number. These will be permanently maintained in each MDF/IDF for future reference.
 4. Provide all documentation in soft copy/flash drive. Flash drive to include all close out documents.
- D. Warranty: It is the intent that the complete cabling system be installed to satisfy 20-year minimum warranty requirements of the cabling infrastructure manufacturers.

LABELING

- A. Label all patch panels, cables, and outlets according to the campus labeling standard. Verify labeling scheme with the RELLIS Campus CIO.
- B. Cables shall be marked with machine printed labels at each end of horizontal run, on faceplates in rooms and on front of patch panels in the IDF / MDF rooms. Patch panels shall also depict cable number and room number on front of patch panels. Cable numbers should be in the format of MDF/IDF number plus three digit cable number i.e. 1001-1999 for IDF number 1. If the building has more than 9 IT rooms

DESIGN CRITERIA

Division 27 – Communications

then the format should use a dot notation. For example, 1.001-1.999 for IDF number 1 and 10.001-10.999 for IDF 10. Never should cable numbers in a multiple building complex start over if they are served from a single MDF.

INTERCOM AND AUDIO VIDEO SYSTEMS

- A. Coordinate all requirements for intercom, video, and audio equipment with RELLIS Project Manager and User Coordinator. Provide power outlets, conduit, wire and grounding as required. As a minimum, provide a complete sound system including ADA/TAS hearing assistance system and all reasonable infrastructure for audio-visual equipment and appurtenances for all classrooms, meeting rooms, and auditoriums whose seating capacity exceeds 50 seats.
- B. Consideration shall be given to include professional grade sound systems for all spaces with 50 seats or more. Coordination with the building Owner is required during design.
- C. Documentation:
 - a. Laminated half-size as-built drawings shall be included within all Audio Visual rooms.

TWO-WAY COMMUNICATION DEVICES AT ELEVATOR LOBBIES

- A. Provide wall box, conduit and required cabling from the master unit, remote master units, switches and call stations.
- B. A power supply is required to supply DC power to the master unit and any remote master unit or switches. Power supply shall have battery backup included.
- C. Maintain all distance requirements for power and network connections.
- D. Maintain survivability rating per NFPA 72 for Two-way in-building wired emergency communications.
- E. Conduit should be full, end to end with pull points no further than 150' apart and with no more than 180 degrees of bends between pull points.
- F. Provide an Analog Telephone Adapter (ATA) compatible with a Cisco Call Manager system.
- G. Devices
 - a. Master Unit - located near the fire alarm annunciator panel.
 - b. Remote Master - this device is required when the cable distance is exceeded from the master to the Call Station.

DESIGN CRITERIA

Division 27 – Communications

- c. Remote Call Station - located at elevator landings or designated Areas of Refuge. Connected to the Master Unit with Category cabling, distance requirements to be maintained.
- d. Power Supply - located in Mech, Electrical or Telecom space, wall mounted, 110-power required, battery backup integrated. Power supply and power monitoring cables are typically required.

DISTRIBUTED ANTENNA SYSTEM (DAS)

- A. Coordinate the DAS requirements with the campus DAS communications service carrier prior to installation, requirements may change depending on the carrier's equipment specifications.
- B. RELLIS Campus DAS is managed and operated by a 3rd party operator with a "Hub and Spoke" model.
- C. Provisions shall be made for new buildings constructed on campus to accommodate a distributed antenna system (DAS) to enhance wireless communications (e.g., cell phones, first responder radio) within the building area.
- D. The following equipment, wiring, and raceways at selected location(s) on the roof of the building to support the future equipment:
 - 1. One spare 2" empty conduit with pull string from nearest electrical closet to designated roof location.
 - 2. One 1 ½ inch empty conduit with pull string from the nearest IDF room to the designated roof location
- E. DAS shall support 5G technologies.

METERING & BUILDING AUTOMATION COMMUNICATIONS

- A. All buildings will have meters installed that record consumption. These meters will utilize the campus Ethernet and the Category 6A communication cabling within the building. The PowerLogic electric meters and the WAGES PLC will utilize a Category 6A Ethernet cable to an EGX-400 Ethernet gateway. The DDC systems will communicate with a Category 6A communication cable to a designated DDC panel, a separate additional communications network, specifically for the DDC system, using Category 6A cable will be installed for communications between the DDC panels. This separate DDC communication network will have the Category 6A wiring installed by the ATC. Any switches, terminations, and set-up and integration will be provided by the owner's representative as part of the owner provided DDC system. This separate network will be managed and maintained by the Utilities and Energy

Management.

- B. Provide data connectivity (wireless or wired) to support Internet of Things (IoT) devices deployed for the project. Buildings systems, lighting, security, exit signage, and other systems may be considered.

AUDIO VISUAL

A. A/V SYSTEMS

1. Overview

- a. This document covers general learning, meeting and public spaces and does not intend to cover all types of spaces or scenarios in higher education. What it offers are contemporary, systems-oriented, guidelines that are grounded in industry best practices in AV systems design and installation.
- b. It does not specifically address purpose-designed spaces that require specialized hands-on instructional activities (e.g., lecture halls, medical simulation, academic recording studios, physical science labs, vocational training labs, maker spaces, or kinesthetic learning spaces etc.).

2. Active Equipment

- a. Equipment refers to particular A/V devices which have specific costs and capabilities associated with them. Equipment can be thought of as speakers, projectors, racks, switching gear, amplifiers, flat panel displays, etc. Cable is also considered part of the active equipment package because selection of specific A/V system elements will govern which type of cable will be used (i.e. coaxial, twisted pair, speaker, HDMI etc.)

3. Standards & Guidelines

- a. AVIXA
 - i. ANSI/AVIXA 3M-2011, “Projected Image System Contrast Ratio”
 - ii. ANSI/AVIXA 2M-2010, “Standard Guide for Audiovisual Systems Design and Coordination Processes”
 - iii. ANSI/AVIXA 1M-2009, “Audio Coverage Uniformity in Enclosed Listener Areas”
 - iv. ANSI/AVIXA 4:2012, “Audiovisual Systems Energy Management”
 - v. AVIXA, 2003, “Basics of Audio and Visual Systems Design”
 - vi. AVIXA, 2008, “AV Installation Handbook – The Best Practices for Quality Audiovisual Systems”
 - vii. AVIXA 10:2016 DS1, “Audiovisual Systems Performance

DESIGN CRITERIA

Division 27 – Communications

- Verification”
- viii. AQAV, 2014, “AQAV Standard AV-9000-2014 Quality Management System for the Audiovisual Technology Industry” Revision 7/1/14”
- b. NEC
 - i. The National Electrical Code (NFPA 70), Article 800
 - ii. Commercial Building Standard for Telecommunications Pathways and Spaces (TIA-569-B)

4. Room Descriptions

- a. Digital Signage/Wayfinding:
 - i. Displays
 - 1. A medium/large recessed in-wall back box will be provided, allowing for the termination of power, telecom and audiovisual cabling will be installed at all digital signage display locations.
 - 2. In-wall blocking will be provided at all digital signage display infrastructure locations.
 - 3. A minimum of two(2) category 6A network cables will be provided at all digital signage display infrastructure locations.
 - 4. Displays and mounts overall depth to not exceed 4” in depth from finished surface to comply with ADA & TAS requirements.
 - 5. Dedicated digital signage players or displays with onboard graphics processing (H.264) will be utilized determined by the signage software platform selected by RELLIS.
- b. Huddle Rooms (2-5 persons):
 - i. Displays
 - 1. A medium/large recessed in-wall back box will be provided, allowing for the termination of power, telecom and audiovisual cabling will be installed at all display locations.
 - 2. In-wall blocking will be provided at all display infrastructure locations.
 - 3. Displays and mounts overall depth to not exceed 4” in depth from finished surface to comply with ADA & TAS requirements.
 - ii. Audio Reinforcement
 - 1. Most commonly the displays onboard speakers will suffice

DESIGN CRITERIA

Division 27 – Communications

for audio reinforcement for these smaller square footage spaces. Recessed, flush mounted in-ceiling speakers can be installed within hard lid or drop ceiling if the project determines it to be appropriate.

- iii. System control
 - 1. Most commonly the displays manufacturer supplied remote will suffice for simple control of the display. A table top mounted touch panel, button controller may also be used for a more robust and fixed control interface.
 - iv. Headend equipment
 - 1. Based on the limited amount of inputs and system functionality there is no headend equipment required for these space types.
- c. Small Conference Rooms (6-10 persons):
- i. Displays
 - 1. A medium/large recessed in-wall back box will be provided, allowing for the termination of power, telecom and audiovisual cabling will be installed at all display locations.
 - 2. In-wall blocking will be provided at all display infrastructure locations.
 - ii. Displays and mounts overall depth to not exceed 4" in depth from finished surface to comply with ADA & TAS requirements.
 - iii. Audio Reinforcement
 - 1. Recessed, flush mounted in-ceiling speakers will be installed within hard lid or drop ceiling, in an exposed ceiling environment pendant speakers will be installed. 70v enabled speakers are the preferred solution for simplified cabling needs.
 - 2. Preference for ceiling mounted microphones to be used for speech reinforcement.
 - 3. Determining if the system must integrate with VOIP can change the entire microphone design.
 - iv. System control
 - 1. Touch control panels are preferred to be touch enabled and installed at the table surface. This allows the end-users to easily access the system controls without having to leave the near proximity to the installed PC or source devices being used. These touch panels must be sized appropriately for various features and most often POE

DESIGN CRITERIA

Division 27 – Communications

- powered.
- v. Headend equipment
 1. Due to the undesirable aesthetic impact of a floor rack within the conference room space, it is preferred to locate this rack outside of the room. This can be done by coordinating with RELLIS and the A&E team to house the AV equipment within a telecom IDF or gain a dedicated space for AV equipment (storage room, closet etc.). If a dedicated space for AV equipment is selected, the project must ensure that the space is adequately cooled.
- d. Large Conference Rooms (10-18 persons)
 - i. Displays
 1. Two(2) medium/large recessed in-wall back box will be provided, allowing for the termination of power, telecom and audiovisual cabling will be installed at all display locations.
 2. In-wall blocking will be provided at all display infrastructure locations.
 - ii. Audio Reinforcement
 1. Recessed, flush mounted in-ceiling speakers will be installed within hard lid or drop ceiling, in an exposed ceiling environment pendant speakers will be installed. 70v enabled speakers are the preferred solution for simplified cabling needs.
 2. Preference for ceiling mounted microphones to be used for speech reinforcement.
 3. Determining if the system must integrate with VOIP can change the entire microphone design.
 - iii. System control
 1. Touch control panels are preferred to be touch enabled and installed at the table surface. This allows the end-users to easily access the system controls without having to leave the near proximity to the installed PC or source devices being used. These touch panels must be sized appropriately for various features and most often POE powered.
 - iv. Headend equipment
 1. Due to the undesirable aesthetic impact of a floor rack within the conference room space, it is preferred to locate

DESIGN CRITERIA

Division 27 – Communications

this rack outside of the room. This can be done by coordinating with RELLIS and the A&E team to house the AV equipment within a telecom IDF or gain a dedicated space for AV equipment (storage room, closet etc.). If a dedicated space for AV equipment is selected, the project must ensure that the space is adequately cooled.

- e. Divisible/Combinable Multi-Purpose Room:
 - i. Video Wall (Preferred)
 - 1. Provide recessed in-wall back box(s) will be provided, allowing for the termination of power, telecom and audiovisual cabling will be installed at all video wall locations.
 - 2. In-wall blocking will be provided at all display infrastructure locations. Opening size may need supplemental structural framing.
 - 3. Frame will be coordinated to facilitate final architectural finishes.
 - 4. Adequate ventilation is required
 - 5. Adequate access is needed
 - ii. Projection Screens (*With approval from RELLIS Campus CIO*):
 - 1. Multiple ceiling mounted (appropriately sized) recessed, motorized ceiling mounted projection screen with projector are most often utilized. During the design coordination meetings, the image aspect ratio will be determined with the end users to ensure the source signal is 16x10 or 16x9, regardless of the selected aspect ratio, the design team will utilize twisted pair receivers with scaling functionality to ensure that any signal resolution is displayed properly on the screens.
 - iii. Projectors (*With approval from RELLIS Campus CIO*)
 - 1. (1) The projectors brightness (lumens) must be appropriately calculated for a .7-.9 screenmaterial.
 - iv. Audio Reinforcement
 - 1. (1) Recessed, flush mounted in-ceiling speakers will be installed within hard lid or drop ceiling, in an exposed ceiling environment pendant speakers will be installed. 70v enabled speakers are the preferred solution for simplified cabling needs.
 - 2. (2) Surface mounted speakers are also an acceptable

DESIGN CRITERIA

Division 27 – Communications

audio reinforcement method for retrofit application (plaster lap ceilings etc.) or when a more robust front soundstage stereo image is determined to be appropriate.

3. (3) Wireless lavalier style microphones are preferred for instructors, ensure that the lectern/teaching station has storage drawers housing the bodypack when not in use.
- v. System control
1. (1) Operable partition sensors will be installed at the ceiling to provide a trigger to the AV system processor to automatically configure the AV system into a combined or variety of divisible modes.
 2. (2) Touch control panels are preferred to be touch enabled and installed at the table surface. This allows the end-users to easily access the system controls without having to leave the near proximity to the installed PC or source devices being used. These touch panels must be sized appropriately for various features and most often POE powered.
- vi. Headend equipment
1. (1) Due to the increased quantity of inputs and outputs for divisible spaces, it is often required to provide a larger rack to house the headend equipment (switcher, dsp, PC, control processor etc.). Due to the undesirable aesthetic impact of a floor rack within the CLC, it is preferred to locate this rack outside of the room. This can be done by coordinating with RELLIS and the A&E team to house the AV equipment within a telecom IDF or gain a dedicated space for AV equipment (storage room, closet etc.). If a dedicated space for AV equipment is selected, the project must ensure that the space is adequately cooled.
- f. Classroom (Lecture Style - Didactic):
- i. Video Wall (Preferred)
 1. Provide recessed in-wall back box(s) will be provided, allowing for the termination of power, telecom and audiovisual cabling will be installed at all video wall locations.
 2. In-wall blocking will be provided at all display infrastructure locations. Opening size may need supplemental structural framing.

DESIGN CRITERIA

Division 27 – Communications

3. Frame will be coordinated to facilitate final architectural finishes.
 4. Adequate ventilation is required
 5. Adequate access is needed
- ii. Projection Screen (*With approval from RELLIS Campus CIO*):
1. To support this lecture based teaching method a single ceiling mounted appropriately sized recessed, motorized ceiling mounted projection screen with projector is most often utilized. During the design coordination meetings, the image aspect ratio will be determined with the end users to ensure the source signal is 16x10 or 16x9, regardless of the selected aspect ratio, the design team will utilize twisted pair receivers with scaling functionality to ensure that any signal resolution is displayed properly on the screen.
- iii. Projector (*With approval from RELLIS Campus CIO*):
1. The projector brightness (lumens) must be appropriately calculated for a .7-.9 screen material.
- iv. Audio Reinforcement
1. Recessed, flush mounted in-ceiling speakers will be installed within hard lid or drop ceiling, in an exposed ceiling environment pendant speakers will be installed. 70v enabled speakers are the preferred solution for simplified cabling needs.
 2. Surface mounted speakers are also an acceptable audio reinforcement method for retrofit application (plaster lap ceilings etc.) or when a more robust front soundstage stereo image is determined to be appropriate.
 3. Wireless lavalier style microphones are preferred for instructors, ensure that the lectern/teaching station has storage drawers housing the bodypack when not in use.
- v. System control
1. Touch panels are preferred and will be installed at the lectern/teaching station desk surface. This allows the instructor to easily access the system controls without having to leave the near proximity to the installed PC or source devices being used. These touch enabled control panels must be sized appropriately for the various features to be controlled. These touch panels are most often POE

DESIGN CRITERIA

Division 27 – Communications

- powered.
- vi. Headend equipment
 1. Based on the limited amount of inputs and outputs generally found in these system types, it is common for the headend equipment (switcher, dsp, PC, control processor etc.) to be housed within the lectern or teaching station. These pieces of furniture are recommended to be within the AV scope of work, and at minimum be specifically designed to house AV equipment (rack rails, integrated cooling features, cable management features etc.).
- g. Collaborative Learning Classroom (Active Learning):
 - i. Collaborative Learning Classrooms (CLC) are teaching and learning spaces that allow faculty to move their course design beyond the lecture. The room design, flexible furniture, writing surfaces, and technology all combine to support faculty in engaging with their students through collaborative learning activities and more participatory use of media. CLC's facilitate diverse sizes and groupings of students, creating a flexible and supportive environment for a class to transition seamlessly between a professor's presentation and facilitated student group work. Such rooms enable options for supporting a myriad of teaching and learning arrangements.
 1. Furniture
 - a. For larger CLC's seven (7) foot circular tables are preferred, in smaller classrooms of this type it is preferred to use D-shaped tables, effectively by lining the walls with the tables. Try to arrange the tables so that students anywhere in the room can see anywhere else in the room. You should have at least 5 feet between table edges (12' center to center table separation). If possible, supply power via a floor box, poke-thru, raised floor or other system that keeps the cords hidden.
 2. Displays
 - a. The minimum display configuration would consist of two optimally sized ceiling-mounted motorized, retractable projection screens with ceiling mounted projectors showing the central system sources of content. A video wall

DESIGN CRITERIA

Division 27 – Communications

arrangement is preferred.

- b. Many newer CLC's have a wall-mounted screen for each table that can be used by the students to work together on assignments, or by the instructor to project slides or other content. These student displays signal can be required to be routed back to the central system for presentation on the projection screens.

3. Headend Equipment:

- a. Due to the increased quantity of inputs and outputs for CLC's, it is often required to provide a larger rack to house the headend equipment (switcher, dsp, PC, control processor etc.). Due to the undesirable aesthetic impact of a floor rack within the CLC, it is preferred to locate this rack outside of the room. This can be done by coordinating with RELLIS and the A&E team to house the AV equipment within a telecom IDF or gain a dedicated space for AV equipment (storage room, closet etc.). If a dedicated space for AV equipment is selected, the project must ensure that the space is adequately cooled.

4. Audio Reinforcement:

- a. Recessed, flush mounted in-ceiling speakers will be installed within hard lid or drop ceiling, in an exposed ceiling environment pendant speakers will be installed. Any speakers must be 70v enabled allowing for simplified cabling needs. The speakers will provide program (content) and speech reinforcement for the system.
- b. In the larger CLC's a wireless lavalier microphone will be provided for the instructor. During the programming phase for these space types the AV consultant and RELLIS PM will determine if microphones are required at the student tables.

5. System Control Panels:

- a. Touch panels are preferred and to be installed at the lectern/teaching station desk surface. This

DESIGN CRITERIA

Division 27 – Communications

allows the instructor to easily access the system controls without having to leave the near proximity to the installed PC or source devices being used. Due to CLC's often having a reduced size for the lectern/teaching station it is acceptable for these control panels to be wall mounted near the instructor station.

SAMPLE PICTURES - TELECOM ROOM BUILDOUT



DESIGN CRITERIA
Division 27 – Communications



DESIGN CRITERIA

Division 27 – Communications

Telecommunications Pull Box Detail

Not to Scale

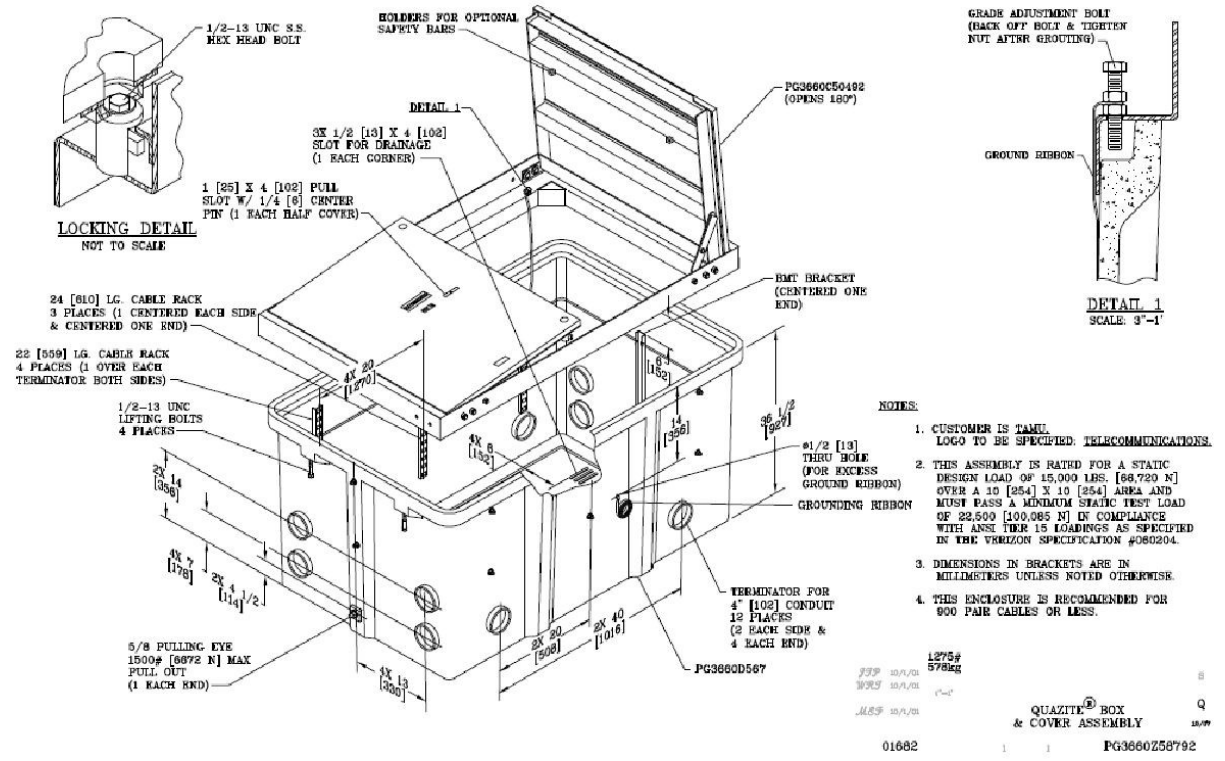

DESIGN CRITERIA

Division 28 – Electronic Safety and Security

GENERAL INFORMATION

These guidelines shall be referred to during the design and construction of the Electronic Security systems and subsystems for the Texas A&M RELLIS Campus buildings.

Division 28 must be reviewed by TAMUS RELLIS IT/ EH&S for continuity as well as Material and Equipment Type.

GENERAL REQUIREMENTS

- A. All security contractor (integrator) personnel must be manufacturer certified and capable of an installation that falls under the manufacturer's guidelines necessary to obtain a manufacturer warranty.
- B. The security contractor (integrator) shall maintain a valid Type B license from the Texas Private Security Bureau and an operating facility in the local area (100 mile radius) of the RELLIS Campus to provide service to the Owner for the warranty period. All certifications must be current. Proof of certification must be presented for supervisors and all installation personnel at or before the pre-installation meeting.
- C. The A/E design team of consultants shall include a security design consultant with extensive previous experience in higher education building design environments. The consultant should also provide support during the construction process to ensure all submittals, test procedures and actual installation meets the requirements as specified for the project.
- D. Warranty- The security contractor (integrator) shall warrant all completed work, including all materials and labor, to be free from defects in design, workmanship, and/or materials for a period of two (2) years from final acceptance date. The acceptance is defined as the completion of all functional performance testing and the resolution of all punch list items.
- E. There should be a pre-installation meeting with the general contractor, security contractor, FPC Project Inspector, and RELLIS Security representative to review the installation requirements and planned installation.
- F. There should be a pre-testing meeting with the general contractor, security contractor, FPC Project Inspector, and RELLIS Security representative to review the test requirements and plan for all systems and subsystems installed.

DESIGN CRITERIA

Division 28 – Electronic Safety and Security

- G. In addition to Electronic Security, the building design shall include Crime Prevention Through Environmental Design (CPTED) strategies that include adequate site and exterior building lighting, landscaping techniques, and proper signage.

BUILDING ACCESS CONTROL SYSTEM (BACS)

- A. All buildings on the RELLIS campus shall be equipped with a building access control system (BACS) that is an extension of an existing Avigilon BACS monitored and maintained by RELLIS IT/Facilities.
- a. This system replaces the typical mechanical key controlled door lock with a door locking system that uses a card reader / biometric reader as the access credential.
- B. The BACS system will consist of card readers, biometric readers, door position switches, and request-to-exit sensors operating in conjunction with associated electric door hardware that grant access and monitor BACS controlled openings.
- a. Typical BACS configuration is card/bio reader or scheduled controlled entry with free exiting that allows for system wide lock down during security events.
- C. Typical BACS controlled openings (doors, hatches, etc.) include:
- a. BACS monitoring at all accessible exterior openings (doors, hatches, etc) with Card Reader control at designated primary points.
 - b. BACS vertical card reader control at elevators and stairwells to allow for system segregation of designated building levels.
 - c. BACS card reader control at designated suite entrances to allow for system segregation of designated building sections.
 - d. BACS biometric dual authentication card reader control at the telecom MDF. Future biometric infrastructure to be supplied for all IDF rooms.
 - i. Bio readers are Viridi AC-2000-SC
- D. All wire and cable for BACS components shall be U.L. approved for its intended application and shall meet or exceed manufacturer's recommendations for the components connected.
- a. Increase conductor sizes on cables as required to be consistent with circuit current ratings, length of wire runs, and manufacturers' recommendations.

DESIGN CRITERIA

Division 28 – Electronic Safety and Security

VIDEO SURVEILLANCE MANAGEMENT SYSTEM (VMS)

- A. All buildings on the RELLIS campus shall be equipped with High megapixel, multiple sensor video surveillance cameras. The video footage of these cameras shall be managed by an existing Avigilon VMS monitored and maintained by RELLIS IT/Facilities.

- B. The VMS system will consist of surveillance cameras, Power over Ethernet PoE switches, and head-end Network Video Recorders (NVR) that record and store surveillance camera footage/images.
 - a. Unshielded Twisted Pair (UTP) cable for surveillance cameras shall be provided by the telecom contractor (Div 27)

- C. All exterior public entrances to the building shall deploy exterior video surveillance cameras in such a manner to provide comprehensive remote situational awareness of the building approach and overall site.

- D. All interior public entrances to the building shall deploy interior video surveillance cameras in such a manner to capture fully identifiable characteristics of each individual entering and exiting.

- E. All elevator lobbies and stairwell entrances shall deploy interior video surveillance cameras in such a manner to capture fully identifiable characteristics of each individual entering and exiting the floor.

FIRE DETECTION AND ALARM SYSTEMS

The Fire Detection and Alarm System shall be designed in accordance with NFPA 72 by a firm registered in the State of Texas and whose employees have a valid fire alarm planning superintendent's license or fire alarm technician license issued by the state fire marshal. All material shall be approved by Factory Mutual Laboratories and Listed by Underwriters Laboratories. Compliance with article 5.43-2, Texas Insurance Code is required.

All fire alarm systems shall be addressable systems.

DESIGN CRITERIA

Division 28 – Electronic Safety and Security

GUIDE SPECIFICATION

FIRE ALARMS SPECIFICATIONS

Purpose: This guide specification shall serve as a design and installation standard for fire alarm systems installed on the RELLIS Campus.

General Information

- A. The contractor shall perform all work necessary to design, install, and test any new fire alarm system installation. This includes, but is not limited to, all labor, materials, and commissioning.
- B. The complete installation shall conform to the applicable sections of the most current edition of the National Fire Protection Association (NFPA) codes and standards, American Disabilities Act (ADA), the National Electrical Code, the International Building Code, the Texas Accessibility Standards Act (TAS), and these specifications.
- C. All fire alarm system retrofit projects shall include a field survey of the facility to determine device locations and system layout. The walkthroughs should include a member from the RELLIS Facilities Department, personnel from the Facilities Department, and Environmental Health and Safety.
- D. All components of the fire alarm system shall be able to interface completely with the fiber network reporting system used by RELLIS while maintaining a UL listing and as approved by Environmental Health and Safety.

Design Guidelines

- A. All new fire alarm systems installations at RELLIS shall utilize the following general guidelines as a basis for the system layout. These general guidelines are for fully sprinklered buildings. These are general guidelines and may vary as determined by the AHJ during walkthrough and plan review sessions.
 - a. Smoke detectors
 - i. Unless specified by the AHJ shall be photoelectric
 - ii. Shall be installed in the following locations:
 - 1. All corridors and common use spaces such as lobbies, reception areas, etc.

DESIGN CRITERIA

Division 28 – Electronic Safety and Security

2. Intermediate or remote areas where smoke would need to penetrate multiple doors to reach a smoke detector in a corridor or common area
 3. Electrical Rooms
 4. Storage rooms with large combustible loads
 - iii. Smoke detectors shall not be installed in the following locations:
 1. Custodial closets
 2. Non-conditioned pump rooms
- b. Heat Detectors shall be installed in break rooms
- c. Manual pull stations shall be installed at the following locations:
 - i. Every level at every enclosed or exterior exit
 - ii. In corridors where travel distance to a pull station exceeds 200 feet
 - iii. Every horizontal exit as defined by NFPA 101, *Life Safety Code*®
- d. Specific design issues
 - i. High-rise building specifications
 1. Provide a fireman's phone system and boxes for phone
 2. Provide an unsupervised printer that shall record all system events and time of the event
 3. All high rise buildings will be programmed for general alarm activation (not high-rise mode)
 - ii. Residence Hall specific requirements
 1. Detectors in resident hall rooms shall be combination heat/smoke detectors. Activation of the heat/smoke detector shall sound a local and general alarm.
 2. Activation of a general alarm shall activate sounder bases in all resident hall rooms.
 - iii. Animal housing areas - Chimes may be installed in animal housing areas (system designer should verify with the user to determine if and when this might be necessary.)

Instructions to Contractors

- a. The contractor shall provide three (3) copies of detailed plans, and specifications as enumerated in Appendix A for review and approval prior to installation.

DESIGN CRITERIA

Division 28 – Electronic Safety and Security

- b. The contractor shall get clarification from the AHJ and approval from the FPC Project Manager when a question or discrepancy arises.
- c. Upon completion of the installation and testing of the system, the contractor shall provide a structured training class to designated university personnel on troubleshooting, maintenance and repair of the installed system as requested. A manufacturer representative shall be present.
- d. Contractor shall contact the Communication Center and the Building Proctor before work is started each day.
- e. The contractor shall provide a price list identifying any special tools and/or equipment required for inspection, testing or maintenance of any installed components. The project manager will determine any equipment needed and provide a list to the contractor. The cost of this equipment shall be included in the contract price.
- f. The contractor shall provide within fourteen (14) calendar days of the acceptance test one (1) electronic copy in the native format of the BIM authoring software as well as the same information in IFC format and copies of all sheets of the Record drawings in DWG format as well as in PDF format on removable media (flash/hard drive) and three (3) hard copies of Record drawings reflecting any and all changes noted during acceptance testing.

Quality Control Assurance

- a. All components of the fire alarm system shall be products of an Underwriters Laboratories Inc. listed fire alarm manufacturer, and shall bear the UL label. Partial listing **shall not** be acceptable.
- b. All components of the fire alarm systems shall use the most current technology available.
- c. Only new parts shall be installed at the time of initial installation and to repair the system during the warranty period. No reconditioned parts shall be used.
- d. All devices shall be tested and certified that they meet or exceed the “Service Life Expectancy Rating” as outlined by UL and NFPA.
- e. The equipment and installation supervision furnished under this specification is to be provided by a manufacturer who has been engaged in production of this type of equipment (software-driven) for at least 5 years and has a

DESIGN CRITERIA

Division 28 – Electronic Safety and Security

fully-equipped service organization within 150 miles of the installation site. Service shall be provided within 24 hours of problem notification.

- f. All conductors shall be uniformly and consistently color-coded and labeled throughout.
- g. All power supplies connected to the system shall have transient protection in accordance with UL 864.
- h. Detectors **shall not** be installed until cleanup of all construction trades is complete as required by NFPA 72. Any detectors found installed prior to this cleanup will be replaced at the contractor's expense.
- i. Conduits shall not be filled to more than 40% capacity. Conduits shall have a J-box no further than 100 feet or at each 90⁰ turn, whichever occurs first. All J-boxes shall be painted red or have the letters FA in red on the cover. Where a J-box at every 90⁰ turn may be considered excessive, the contractor should get direction from the RELLIS Facilities Department before omitting any J-box. All J-boxes shall be easily accessible.
- j. The contractor shall identify and label circuit breakers on main and emergency power supplies and identify these electrical panel location(s) and breaker number(s) inside the Fire Alarm Control Panel (FACP) in accordance with NFPA 72. Any breaker associated with the FAS shall be painted red.

Design Specifications

- k. General Requirements
 - i. Panels shall be easily expandable and upgradeable.
 - ii. Unless otherwise approved by the Authority Having Jurisdiction (AHJ), the FACP shall have software that will enable the system to be intelligent.
 - iii. All Fire Alarm Systems (FAS) shall be equipped with voice notification and have public address capability unless otherwise approved by the AHJ.
 - iv. Provide software that:
 - 1. Is password protected
 - 2. Offers computer driven device calibration test and reporting features, by device, loop, or system.

DESIGN CRITERIA

Division 28 – Electronic Safety and Security

3. Latches all Alarm, Trouble, and Supervisory signals, unless otherwise requested by AHJ.
- v. Power for the FAS (FACP and all components) shall be from one electrical panel unless approved by the AHJ.
- vi. Furnish and install “surge protection devices” on all circuits that extend beyond the main building (i.e. walkways, aerial, or underground methods):
 1. Surge protection devices shall be located as close as practical to the point where circuits leave the building.
 2. Surge protection devices shall have a line to line response time of less than one nanosecond capable of accepting 2000 amps to earth.
 3. Surge protection devices shall comply with UL 497B and NEC 760.
- vii. All addressable loops shall have loop isolation protection devices to maintain partial fire alarm system integrity should a fault occur. A loop isolation device shall not exceed a maximum of 20 devices.
- viii. A maximum of 80% capacity of initiating devices is allowed per loop.
- ix. The fire alarm system shall use closed loop initiating device circuits with individual zone (device) supervision, individual notification appliance supervision, and primary and standby power supervision.
- x. Each device shall be labeled and the label designations shall be accurate and consistent with those on the prints, the annunciators, the points list, and message displays.
- xi. All devices, panels and auxiliary panels shall be mounted in easily accessible locations. The top of all panels shall be mounted no more than six (6) feet above the finished floor.
- xii. The FACP will consist of a control center utilizing state of the art electronics with microprocessor-based technology and a minimum of four zone (loop) capability. The FACP shall be software controlled with the capability of owner programming. The installer will supply all programming data (complete program, data list) software and all updates to the software. Software media shall be Windows compatible using the most current version.

DESIGN CRITERIA

Division 28 – Electronic Safety and Security

- xiii. The FACP shall have software capable of supervising Air Handler Unit (AHU) shutdown.
 - xiv. The FACP will have an audible device and separate LEDs indicating ALARM, TROUBLE and SUPERVISORY conditions with each having a separate and distinguishable sound. The FACP shall have a backlit LCD display of at least three lines of at least 40 characters each. An indication of POWER, TROUBLE, and PARTIAL DISABLE shall be included as an LED output.
 - xv. The FACP equipment cabinet shall be of sufficient size to accommodate the main fire panel, main and standby power supplies (battery), cable and wire harnesses and any auxiliary relays.
 - xvi. Remote annunciators (if installed) shall have the same capabilities as the FACP in all respects unless otherwise directed by the AHJ.
 - xvii. There shall be a separate box located next to the FACP of sufficient size to accommodate spare detectors and paperwork (16" x 16" x 6" min.). This box shall be of matching color with the FACP cabinet and shall be keyed the same as the FACP.
 - xviii. Printer interface modules shall be installed in all systems.
- I. Programming Requirements
- i. Provide a "Drill Function" on the panel that is easily identifiable and only initiates notification appliances on all floors.
 - ii. Provide a Programmable "Bypass" function for:
 - 1. AHU shut down
 - 2. Elevator recall
 - 3. Stairwell pressurization fans
 - 4. Notification appliances
 - 5. Alarm verification
 - iii. Provides for all controlled systems to "auto reset," (i.e., AHUs and elevators)
 - iv. Provides for all system devices to be restorable from the FACP.
- m. Initiating Devices

DESIGN CRITERIA

Division 28 – Electronic Safety and Security

- i. All water flow switches shall be time adjustable complying with NFPA 72.
- ii. Valve tamper switches shall comply with NFPA 72. A supervisory condition shall result from a tamper switch activation.
- iii. Beam detectors shall:
 - 1. Comply with UL268
 - 2. Be 24vdc operation
 - 3. Have automatic contamination compensation
- iv. Detector bases shall:
 - 1. Be low profile, surface, or flush mounted into a standard four inch square electrical box
 - 2. Be able to accept heat, ionization, or photoelectric devices interchangeably
- v. Smoke detectors shall:
 - 1. Have an LED that flashes during normal operation
 - 2. Ionization detectors shall be dual chamber and be scaled against rear airflow
 - 3. Be self-adjusting for airborne contaminants
 - 4. Have clear, distinct visual alarm indication
 - 5. Be mounted in easily accessible locations
 - 6. Be programmed to have alarm verification
- vi. Duct detectors shall:
 - 1. Report to FACP as a Supervisory Alarm
 - 2. Be of the photoelectric type
 - 3. Have clear, distinct visual power and alarm indications
 - 4. Be programmed to have alarm verification
 - 5. Have extended visual indicators if mounted above ceiling located as close to duct detector as possible
- vii. Heat detectors shall:
 - 1. Be of the dual element, self-restoring type
 - 2. Have a flashing LED for normal operation
 - 3. Have clear, distinct visual alarm indication
- viii. Manual pull stations shall:
 - 1. Be cast aluminum or high impact plastic and be red in color
 - 2. Be zoned separately if not addressable
 - 3. Provide a clear visual indication when activated

DESIGN CRITERIA

Division 28 – Electronic Safety and Security

4. Not require consumable parts to reset to normal condition
- n. Notification Appliances
- i. Audible devices:
 1. Shall be tapped to an adequate wattage capable of achieving the minimum required dB reading throughout the facility
 2. Shall be tapped at the highest wattage in all mechanical rooms
 3. May be ceiling mounted speakers or combination devices where permitted to be installed by code
 - ii. Visual devices:
 1. May be ceiling mounted or combination devices where permitted by code

Installation, Testing, and Acceptance

- o. The contractor shall have all devices on the system installed and the system pre-tested prior to the scheduled acceptance test.
- p. The contractor shall provide all tools, labor, and materials required for all installation start-up tests, including a qualified technician to conduct the test.
- q. Installation and testing shall be inspected and certified by a contractor supplied NICET II (minimum) Technician.
- r. System acceptance test shall be conducted in accordance with NFPA 72. See Annex C for Texas A&M acceptance test checklist.
 - i. Any deficiencies noted during acceptance testing shall be corrected within 14 calendar days and a retest shall be scheduled for all deficiencies noted if not corrected during the acceptance test.
 - ii. System acceptance shall be contingent upon approval by Environmental Health and Safety, Facilities Planning and Construction, and a Facilities Department representative.
 - iii. Upon completion of testing, the contractor shall install the proper certification certificates in the FACP and provide a copy of NFPA 72 Record of Completion and the FML-009 Form to Environmental Health and Safety.

DESIGN CRITERIA

Division 28 – Electronic Safety and Security

- iv. The contractor shall provide three (3) copies of drawings to be used during the acceptance test. These drawings shall reflect the installed device locations with device address on a floor plan representing the layout of the fire alarm system at the time of acceptance testing.
- v. The contractor shall supply an electronic copy of site specific software within 14 calendar days to the RELLIS Facilities Department per NFPA 72.

B. Warranty

- a. The system shall be guaranteed to be free from all defects of material and workmanship for a period of one year, effective upon the date of system acceptance.
- b. The contractor shall guarantee parts availability for a minimum of five (5) years after installation.

DESIGN CRITERIA

Division 28 – Electronic Safety and Security

Annex A - Design Submittal Requirements

All preliminary and as-built design drawings and supporting documentation shall include:
Floor plan drawings, riser diagrams, control unit wiring diagrams, point to point wiring diagrams, and typical wiring diagrams as described herein

- I. Name of owner and occupant
- II. Location, including street address
- III. Device legend
- IV. Date
- V. Input/output programming matrix
- VI. Licensed Designer Information – Registered Professional Engineer or Alarm Planning Superintendent (APS)
- VII. Battery calculations
- VIII. Notification appliance circuit voltage drop calculations
- IX. Floor Plan
 - a. Floor identification
 - b. Point of compass
 - c. Correct graphic scale
 - d. All walls and doors
 - e. All partitions extending to within 15 percent of ceiling height
 - f. Room descriptions
 - g. Fire alarm device/component locations
 - i. Signal notification devices
 - ii. Initiation devices
 - iii. Smoke control systems
 - iv. Initiation of automatic extinguishing equipment
 - v. Doors that unlock or close automatically
 - vi. Zone verification for detection devices
 - vii. Fire/Smoke damper control
 - viii. Fire alarm panel location
 - ix. Fire alarm annunciators
 - x. Control valves to Fire Protection System
 - xi. Duct smoke detectors
 - xii. Supervisory devices
 - xiii. Elevator location
 - xiv. Elevator recall system location
 - h. Location of fire alarm primary power connections
 - i. Location of monitor/control interfaces to other systems
 - j. Riser locations
 - k. Methods for compliance with 6.9.10.4 for survivability (emergency voice systems) as shown in section 6.9, where applicable

DESIGN CRITERIA

Division 28 – Electronic Safety and Security

- I. Ceiling height and ceiling construction details
- X. Fire alarm system riser diagram
 - a. General arrangement of the system, in building cross-section
 - b. Number of risers
 - c. Type and number of circuits in each riser
 - d. Type and number of fire alarm components/devices on each circuit, on each floor or level
- XI. Control unit wiring diagrams should be provided for all control equipment, power supplies, battery charges, and annunciators and should include the following:
- XII. Identification of control equipment depicted
- XIII. Location(s)
- XIV. All field wiring terminals and terminal identification
- XV. All indicators and Manual controls, including the full text of all labels
- XVI. All field connections to supervising station signaling equipment, releasing equipment, and fire safety control
- XVII. Typical Wiring diagram should be provided for all initiating devices, notification appliances, remote light emitting diodes (LEDs), remote test stations, and end-of-line and power supervisory devices.

DESIGN CRITERIA

Division 28 – Electronic Safety and Security

Annex B - Fire Alarm Reporting System Interface

All new fire alarm installations on the RELLIS Campus shall be designed to interface directly with the dedicated fiber optics network. The network utilizes Siemens® technology to link all fire alarm systems on the campus and connect to a central monitoring station.

- I. General Requirements
 - A. Each new FAS installation requires a minimum ¾” conduit to be installed between the FACP and a fiber interface cabinet in the fiber network room.
 - B. Wiring requirements
 1. Provide one (1) 18/2 shielded cable between the FACP and the fiber interface cabinet
 2. Provide one (1) 14/2 cable between the FACP and the fiber module in the fiber interface cabinet.
- II. Panel Specific Requirements
 - A. The following components are required for interfacing a Siemens XLS FACP to the campus FAS network
 1. NIC –C Network Interface Card
 2. RPM Remote Printer Interface (Provides the 485 Network)
 3. D2300CP OR D2325CPS (single mode module) Fiber Interface Module
 - B. The following components are required for interfacing a Siemens MXL FACP to the campus FAS network
 1. NIM-1 Network Interface Card
 2. MOM-2 Mother Card for the NIM-1
 3. D2300CP OR D2325CPS (single mode module) Fiber Interface Module
 - C. Specific components for other manufactures or Siemens panels must be verified with Siemens.

DESIGN CRITERIA
Division 28 – Electronic Safety and Security

Annex C - Fire Alarm System Acceptance Checklist

Building #: _____ **Building Name:** _____ **Date:** _____

Attendees: _____

| | | | |
|---|------------------------------|-----------------------------|------------------------------|
| Functional test of all Smoke Detectors | <input type="checkbox"/> Yes | <input type="checkbox"/> No | <input type="checkbox"/> N/A |
| Functional test of all Heat Detectors | <input type="checkbox"/> Yes | <input type="checkbox"/> No | <input type="checkbox"/> N/A |
| Functional test of all Manual Pull Stations | <input type="checkbox"/> Yes | <input type="checkbox"/> No | <input type="checkbox"/> N/A |
| Functional test of all Duct Detectors | <input type="checkbox"/> Yes | <input type="checkbox"/> No | <input type="checkbox"/> N/A |
| Functional test of all Flow Switches | <input type="checkbox"/> Yes | <input type="checkbox"/> No | <input type="checkbox"/> N/A |
| Functional test of all Audio/Visual devices | <input type="checkbox"/> Yes | <input type="checkbox"/> No | <input type="checkbox"/> N/A |
| Functional test of all Magnetic Releases | <input type="checkbox"/> Yes | <input type="checkbox"/> No | <input type="checkbox"/> N/A |
| Functional test of all Remote Annunciators | <input type="checkbox"/> Yes | <input type="checkbox"/> No | <input type="checkbox"/> N/A |
| Functional test of all Fireman Phones | <input type="checkbox"/> Yes | <input type="checkbox"/> No | <input type="checkbox"/> N/A |
| Flow test of all Duct Detectors | <input type="checkbox"/> Yes | <input type="checkbox"/> No | <input type="checkbox"/> N/A |
| dB level check on all Audible Devices | <input type="checkbox"/> Yes | <input type="checkbox"/> No | <input type="checkbox"/> N/A |
| Conduct Battery Discharge Test (30 Minutes) / Full Alarm Test (General - 5 Min./Emergency Voice 15 Min.) | <input type="checkbox"/> Yes | <input type="checkbox"/> No | <input type="checkbox"/> N/A |
| Verify That the Locations of All Power Supplies are Identified at FACP | <input type="checkbox"/> Yes | <input type="checkbox"/> No | <input type="checkbox"/> N/A |
| Functional test of all Relays <input type="checkbox"/> AHU Shutdown <input type="checkbox"/> Elevator Recall <input type="checkbox"/> Suppression Systems <input type="checkbox"/> Exhaust Fans <input type="checkbox"/> Pressurization Fans | <input type="checkbox"/> Yes | <input type="checkbox"/> No | <input type="checkbox"/> N/A |
| Verification of Trouble Alarms <input type="checkbox"/> Smoke Detector Circuit <input type="checkbox"/> A/V Circuit | <input type="checkbox"/> Yes | <input type="checkbox"/> No | <input type="checkbox"/> N/A |
| Verify all Supervisory Alarms <input type="checkbox"/> Sprinkler/Tamper <input type="checkbox"/> Duct Detector | <input type="checkbox"/> Yes | <input type="checkbox"/> No | <input type="checkbox"/> N/A |
| Verify Alarm, Supervisory, & Trouble Signals Received at Communication Center | <input type="checkbox"/> Yes | <input type="checkbox"/> No | <input type="checkbox"/> N/A |
| Verify Installation of Storage Box | <input type="checkbox"/> Yes | <input type="checkbox"/> No | <input type="checkbox"/> N/A |
| Sensitivity Test Printout Sent to Electronic Shop Personnel | <input type="checkbox"/> Yes | <input type="checkbox"/> No | <input type="checkbox"/> N/A |
| O&M Manual transferred to Electronic Shop Personnel | <input type="checkbox"/> Yes | <input type="checkbox"/> No | <input type="checkbox"/> N/A |
| Transfer of any special tools to Electronic Shop | <input type="checkbox"/> Yes | <input type="checkbox"/> No | <input type="checkbox"/> N/A |

DESIGN CRITERIA
Division 28 – Electronic Safety and Security

| | | | |
|--|------------------------------|-----------------------------|------------------------------|
| Personnel | | | |
| FML-009 Form Completed and Transferred to EHSD | <input type="checkbox"/> Yes | <input type="checkbox"/> No | <input type="checkbox"/> N/A |
| Other: | <input type="checkbox"/> Yes | <input type="checkbox"/> No | <input type="checkbox"/> N/A |

Comments: _____

GENERAL

Earthwork must be reviewed by SSCServ Landscape Maintenance for landscape material type and soil preparation.

SITE CLEARING

Clear/grub/strip of trees, roots and vegetation that portion of the site to receive landscaping and improvements. Remove roots to a minimum depth of 24". No onsite burning is allowed unless approved by Owner. Trees/vegetation to remain shall be adequately fenced and otherwise protected from damage by construction operations.

If good friable topsoil exists on site, strip this material to a depth of 6" and stockpile for reuse in areas to receive grass and other landscaping. Top soil to be free of significant vegetation, rocks or other deleterious materials.

All areas disturbed shall have erosion and sediment control, to be maintained by contractor, until landscaped and grassed areas have been established.

TOPSOIL

Topsoil shall be a natural, fertile, friable soil, possessing characteristics of representative productive soils in the vicinity. It shall be obtained from approved naturally well-drained areas. Only the top 12" (inches) of earth shall be removed and used. It shall not be excessively acid or alkaline or contain toxic substances, which may be harmful to the plant growth. Topsoil shall be without admixture of subsoil and shall contain a minimum of lumps, stones, stumps, roots, or similar substances 1" (inch) or more in diameter, quality to be determined by the Physical Plant Department or its representative. Topsoil shall not be collected from sites that are infected with a growth of, or the reproductive parts of, noxious weeds (Nut Sedge, Johnson grass, and Bermuda grass). Topsoil shall not be stripped, collected, or deposited while wet. It is the responsibility of the Contractor to furnish the location where the topsoil is to be obtained to FPC Project Manager or its representative in writing, as well as a one gallon sample of such soil.

All quality assurance and approval is to be done by the FPC Project manager or the designated agent. Prior to installation of plant material, all soils should adhere to the following standards:

Soil Specifications for Non-Native Plant Material

If the plant material is non-native, provide the following samples:

1. Provide 1 test sample and report for each 250 cubic yard, or a minimum of two

DESIGN CRITERIA Division 31 – Earthwork

samples total, if total stockpiled soil to be used is less than 500 cubic yards of on-site stockpiled topsoil to be used on site. Samples to be taken from various areas in the stockpiled material.

2. Organic Mulch: 1-quart volume of mulch; in sealed plastic bags labeled with composition of materials by percentage of weight and source of mulch. Each Sample shall be typical of the lot of material to be furnished; provide an accurate representation of color, texture, and organic makeup.
All mulch used should be shredded pine bark.
3. Compost: 1-quart volume of compost; in sealed plastic bags labeled with composition of materials by percentage of weight and source of mulch. Each Sample shall be typical of the lot of material to be furnished; provide an accurate representation of color, texture. Compost to be comparable to:

| <i>Compost Parameters</i> | <i>Test Results</i> | <i>Reported as (units of measure)</i> | <i>TMECC Test Method</i> |
|---|---------------------|---|--|
| Particle Size | 100.00 99.68 | %, dry weight passing through 5/8th inch screen and 3/8th inch screen | 02.02-B Sample Sieving for Aggregate Size Classification |
| Heavy Metals Content | PASS | PASS/FAIL: Per US EPA Class A 40 CFR 503.13, tables 1 and 3 | 04.06-Heavy Metals standard, and Hazardous Elements |
| Soluble Salts | 0.62 | dS/m (mmhos/cm) | 04.10-A 1:5 Slurry Method Mass Basis |
| pH | 6.6 | Unitless | 04.11-A 1:5 Slurry pH |
| Maturity Indicator (bioassay) Percent Emergence Relative Seedling Vigor | 100 100 | average % of control average % of control | 05.05-A Germination and vigor (meets DOT spec. Item 161 for germ. & root elongation) |
| Organic Matter Content | 54.46 | %, dry weight basis | 05.07-A Loss-on-Ignition Organic Matter Method (LOI) |
| Stability Indicator | 2 | mg CO ₂ -C/g OM/day | 05.08-B Carbon Dioxide Evolution Rate |
| Fecal Coliform | PASS | PASS/FAIL: Per US EPA Class A standard, 40 CFR 503.32(a) | 07.01-B Fecal coliforms |

4. Aggregates: 1-quart volume; in sealed plastic bags labeled with source. Each Sample shall be typical of the lot of material to be furnished; provide an accurate representation of color, texture, and organic makeup.
5. Topsoil: 1-quart volume; in sealed plastic bags labeled with composition of materials by percentage of weight and source. Each Sample shall be typical of the lot of material to be furnished; provide an accurate representation of color, texture, and organic makeup.
6. Planting bed mix should be 40% sandy loam, 35% coarse sand, 25% well decomposed compost.

Supply high quality imported topsoil of loamy character, high in humus and organic content from local agricultural source. Topsoil to be free from clay, lumps, coarse sands, stones, roots, and other foreign matter. There shall be no toxic amounts of acid or alkaline elements. Topsoil to be used for on-site mixing of backfill mix.

DESIGN CRITERIA

Division 31 – Earthwork

Topsoil shall be free of roots, clods, stones larger than 1-inch in the greatest dimension, pockets of coarse sand, noxious weeds, sticks, lumber, brush and other litter. It shall not be infested with nematodes or other undesirable disease-causing organisms such as insects and plant pathogens.

Topsoil shall be friable and have sufficient structure in order to give good tilth and aeration to the soil.

Gradation Limits: Soil shall be a sandy loam or loam. The definition of soil texture shall be the USDA classification scheme cited below. Gravel over 2 millimeters in diameter shall be less than 20% by weight.

Permeability Rate: Hydraulic conductivity rate shall be not less than one inch per hour nor more than 20 inches per hour when tested in accordance with the USDA Handbook Number 60, method 34b or other approved methods.

Fertility: The range of the essential elemental concentration in soil shall be as follows for approval of source soil: Ammonium Bicarbonate/DTPA Extraction parts per million (mg/kilogram dry weight basis phosphorus 10 - 40 potassium 100 - 220 iron 5- 35 manganese 0.6 - 6 zinc 1 - 8 copper 0.3 - 5 boron 0.2 - 1 magnesium 50 - 150 sodium 0 - 100 sulfur 25 - 500 molybdenum 0.1 – 2

Acidity: The soil pH range measured in the saturation extract (Method 21a, USDA Handbook Number 60) shall be 6.0 - 7.9.

Salinity: The salinity range measured in the saturation extract (Method 3a, USDA Handbook Number 60) shall be 0.5 - 2.5 dS/m.

Chloride: The maximum concentration of soluble chloride in the saturation extract (Method 3a, USDA Handbook Number 60) shall be 150 mg/l (parts per million).

Boron: The maximum concentration of soluble boron in the saturation extract (Method 3a, USDA Handbook Number 60) shall be 1 mg/l (parts per million).

Sodium Adsorption Ratio (SAR): The maximum SAR shall be 3 measured per Method 20b, USDA Handbook Number 60.

Aluminum: Available aluminum measured with the Ammonium Bicarbonate/DTPA Extraction shall be less than 3 parts per million.

Soil Organic Matter Content: Sufficient soil organic matter shall be present to impart good physical soil properties but not be excessive to cause toxicity or cause excessive reduction in the volume of soil due to decomposition of organic matter. The desirable range is 3% to 6%. The carbon:nitrogen ratio should be about 10. A high carbon:nitrogen ratio can indicate the presence of hydrocarbons or non-humified organic matter.

DESIGN CRITERIA

Division 31 – Earthwork

Calcium Carbonate Content: Free calcium carbonate (limestone) shall not be present for acid loving plants.

Heavy Metals: The maximum permissible elemental concentration in the soil shall not exceed the following concentrations:

Ammonium Bicarbonate/DTPA Extraction parts per million (mg/kilogram) dry weight basis

- arsenic 1
- cadmium 1
- chromium 10
- cobalt 2
- lead 30
- mercury 1
- nickel 5
- selenium 3
- silver 0.5
- vanadium 3

If the soil pH is between 6 and 7, the maximum permissible elemental concentration shall be reduced 50%. If the soil pH is less than 6.0, the maximum permissible elemental concentration shall be reduced 75%. No more than three metals shall be present at 50% or more of the above values.

Phytotoxic Constituent, Herbicides, Hydrocarbons: Germination and growth of monocots and dicots shall not be restricted more than 10% compared to the reference soil. Growth inhibiting constituents must not be present.

Soil Specifications for Native Plant Material

If the plant material is native, provide the following samples:

1. Provide 1 test sample and report for each 250 cubic yard, or a minimum of two samples total, if total stockpiled soil to be used is less than 500 cubic yards of on-site stockpiled topsoil to be used on site. Samples to be taken from various areas in the stockpiled material.

Planting medium for native plant material will generally be minimally to non-altered soils. Depending on the soil tests of the stockpiled soil to go back, modifications may need to be made.

Soil Specifications for General Lawn Areas

Given the high sodium content of the local irrigation water, it is important that the clay content be kept low and the sand content high. A maximum of 10% clay and a minimum of

DESIGN CRITERIA

Division 31 – Earthwork

80% sand is reasonable to allow the soil to be functional and stable yet still have a reasonable amount of permeability. Placement at a minimum depth of 6 inches is recommended to provide adequate rooting and sufficient water retention.

Since this soil will be more permeable than the underlying subsoil, it will be necessary to grade the subsoil so that it has a slope to allow drainage water to go through the sand and then flow downhill along the top of the subsoil. It will also be necessary to put some subsurface drainage in areas plated with this soil to prevent the formation of a belowground pool. This will be especially important at the bottom of the slope in areas where the soil may abut a nearby non-permeable surface such as a concrete sidewalk or curb.

If areas plated with the soil outlined in this section are to be sodded, the sod needs to be grown on a soil that is compatible with the below specifications. If this is not available, then washed sod should be used. Under no circumstances should sod grown on a clay textured soil be placed above the specified sandy soil. If sprigs are used, they should be essentially free of high clay content soil. Turf species and cultivars should be selected carefully and favor warm season grasses that have high salinity tolerance, drought tolerance, traffic tolerance and high recovery potential.

Management of areas plated with the Lawn and Landscape Soil may be slightly different from areas of native clay soil. The turf will require the same total amount of irrigation water (approximately 1 inch per week in the heat of summer). However, it will have a smaller storage capacity and may require smaller, but more frequent applications that total the same 1 inch per week. Fertilization will have a similar management plan with sand capped areas requiring the same total amount applied in smaller, but more frequent applications. The use of slow release fertilizer products will help reduce nutrient losses due to leaching.

Since this soil will have some clay and also a fairly large amount of fine sand particles, it will tend to compact. Therefore, routine aerification will be needed. In large areas, this can be done using tractor pulled equipment such as a drum or spoon type aerator or an Aerway type aerator that has a slicing mode of action. Ideally, this should be done monthly during the growing season. Caution should be exercised to flag irrigation heads, valve boxes and shallow pipes prior to aerification.

Sand or Loamy Sand texture containing:

≤10% clay

≤20% silt

≤20% total silt plus clay

≥80% sand

pH = 5.5-7.5 or have a plan to amend it to reach this range

EC = <2 mmhos/cm

Sodium absorption ratio (SAR) = <3

Soil shall be free of sticks, stones and debris larger than ¾ inch

Soil shall be free of weeds and other undesirable vegetation

Soil shall be free of oil and other anthropogenic chemicals

DESIGN CRITERIA

Division 31 – Earthwork

Soil shall be free of herbicides and insecticides that may affect subsequent growth of turf or other plantings, or that may be toxic or injurious to humans and/or animals.

If a local source of native sand meeting these specifications cannot be located, a commercially available masonry sand should be sampled and tested to see if it meets the above specifications.

A 1-2 gallon representative soil sample shall be tested by the owner's representative noted below prior to purchase and delivery to the site.

After approval for use, a representative 1-2 gallon soil sample shall be submitted and tested from every 500 tons of delivered soil to ensure consistent quality. Materials not passing the above specifications shall be removed and replaced by the contractor/subcontractor at no additional expense to the owner. One of these initial samples should be tested by the owner's representative for fertility to determine a suitable pre-plant fertility application.

Soil shall be placed at depths specified by owner or contract documents. Depths are to be measured after settling by irrigation and/or light compaction from no more than 2 passes with a smooth drum 1 ton roller.

Soil Specifications for Very High Use Landscape Areas

Coarse Concrete (C-33) Sand containing:

≤2% clay

≤3% silt

75-95% sand

<20 gravel (2-4 mm)

10-20% very coarse sand (1-2 mm)

15-35% coarse sand (0.5-1 mm)

23-35% medium sand (0.25-0.5 mm)

2-12% fine sand (0.15-0.25 mm)

<5% very fine sand (0.05-0.15 mm)

pH = 5.5-7.5 or have a plan to amend it to reach this range

EC = <2 mmhos/cm

Sodium absorption ratio (SAR) = <3

Sand shall be free of sticks, stones and debris larger than ¾ inch

Sand shall be free of weeds and other undesirable vegetation

Sand shall be free of oil and other anthropogenic chemicals

Sand shall be free of herbicides and insecticides that may affect subsequent growth of turf or other plantings, or that may be toxic or injurious to humans and/or animals.

Sources of sand meeting these specifications will include sand plants that manufacture this grade of sand for ready mix type concrete plants and highway use.

A 1-2 gallon representative sand sample shall be tested by the owner's representative noted

DESIGN CRITERIA

Division 31 – Earthwork

below prior to purchase and delivery to the site.

After approval for use, a representative 1-2 gallon sand sample shall be submitted and tested from every 500 tons of delivered sand to insure consistent quality. Materials not passing the above specifications shall be removed and replaced by the contractor/subcontractor at no additional expense to the owner. One of these initial samples should be tested by the owner's representative for fertility to determine a suitable pre-plant fertility application.

Sand shall be placed at depths specified by owner or contract documents. Depths are to be measured after settling by irrigation and/or light compaction from no more than 2 passes with a smooth drum 1 ton roller.

GRADING AND COMPACTION

Slopes of planted areas should allow easy maintenance. Turf areas shall have a slope of no more than 4:1. A 2 percent minimum slope is desirable, however, site specific grading may require swales with shallow slopes that shall be designed by the Engineer for proper capacity. Areas with slopes greater than 4:1 must be planted with ground cover and constructed to control erosion.

Existing trees and other plant material to be preserved shall be indicated on the grading plan. Where trees are to be preserved no grading or paving of the existing grade within the drip line is allowed.

Slopes for walkways shall comply with Texas Accessibility Standards.

Unless otherwise determined by applicable geotechnical report, non-structural areas (outside of paved or improved areas) backfill or embankment shall be compacted in lifts no greater than 8" loose thickness to a minimum of 95% maximum density as per ASTM D-698 with a moisture content of +/- 2% of optimum. Open area embankment may be compacted in lifts no greater than 12" loose thickness to a minimum of 90% maximum density as per ASTM D-698 with a moisture content of +/- 2% of optimum.

Paving area shall be proof rolled with a 20-ton pneumatic tire roller. Unless otherwise determined by applicable geotechnical report, structural area (extending 2 foot beyond edge of pavement or back of curb) backfill or embankment shall be compacted in lifts no greater than 8" loose thickness to a minimum of 98% maximum density as per ASTM D-698 with a moisture content of +/- 2% of optimum. Backfill around structures shall be placed uniformly and only after the elements of the structure have attained the required strength to resist the soil pressure.

Select fill where required shall be a material available in the general area of the project (if possible) having a plasticity index (PI) ranging from 7 to 15, a liquid limit of 35 or less and

DESIGN CRITERIA

Division 31 – Earthwork

being free from organic matter, large rocks or other deleterious materials.

All existing utility appurtenances (valve boxes, fire hydrants, manhole ring and cover, etc...) shall be adjusted to final grades.

EXCAVATION, TRENCHING, AND BACKFILLING FOR UTILITIES

Excavation/trenching and backfilling operation shall be coordinated such that a minimum amount of trench is open at any one time. Backfilling is to be scheduled so there is a minimum amount of open excavation left during hours of no work. All open excavation shall be properly lighted and barricaded during hours that the contractor is not on site. The open ends of all utility lines shall be temporarily sealed at the end of the working day.

Adequate measures shall be taken to prevent runoff water from entering the trench without damage to surrounding facilities/properties.

De-watering systems shall be provided as required for excavation/backfill activities and to allow installation of utility lines and embedment envelope on dry stable trench bottom. Discharge from the de-watering system shall be directed to drainage facilities of adequate capacity in a manner that will not damage or interfere with the use of adjoining facilities/properties. De-watering systems shall be provided at no additional cost to the Owner.

The embedment zone for a utility line extends from 6" below the bottom of a utility line to 12" above its top. Embedment material for water and sanitary sewer HDPE lines shall be clean bank run sand. Embedment material for storm sewer RCP lines may be cement stabilized sand, gravel, or regular sand. Embedment material for pre-insulated thermal utility piping is sharp sand. Electrical duct bank is typically encased in red concrete and installed on the undisturbed trench bottom. High water table elevations may necessitate the use of an alternate embedment material and different embedment zone dimensions.

Backfill above the embedment zone for trenches in non-structural areas, unless otherwise determined by applicable geotechnical report, shall be compacted in lifts no greater than 8" loose thickness to a minimum of 95% maximum density as per ASTM D-698 with a moisture content of +/- 2% of optimum. Backfill above the embedment zone for trenches in structural areas under existing or proposed pavement or ground supported structures shall be cement stabilized sand (2 ½ sacks of cement per cubic yard of sand) compacted in maximum 8" lifts to 95% of ASTM D558 with a moisture content between +/- 2% of optimum. Consolidation of trench backfill by flooding/jetting is not allowed.

An excavation/trench safety program shall be implemented which complies with OSHA trench safety standards, Subpart P. A trench safety plan shall be prepared and sealed by a Texas Professional Engineer and submitted to the Owner prior to the start of construction.

STABILIZATION

Stabilization shall be required, refer to Division 32, Site Paving section.

TERMITE TREATMENT

When soil treatment is required all products used for the treatment of termites shall display labels bearing Environmental Protection Agency approvals and shall be mixed and applied in accordance with directions on the label.

VOID SPACE BELOW GRADE BEAMS

Provide soil retainers at face of grade beams below grade to form a void of sufficient depth to prevent expansion of earth to cause pressure on bottom of beams. Acceptable product is SureRetainer by MotzBlock.

GENERAL INFORMATION

SITE PAVING

Site paving shall be provided to facilitate pedestrian and vehicular access along with emergency and service vehicle access to the site and facility being designed.

Materials, parameters and methods shall be in basic conformance with the TxDOT “Standard Specifications for Construction of Highways, Streets and Bridges,” latest edition, applicable Bryan/College Station Unified Design Standards, and applicable ASTM standards.

Unless otherwise determined by applicable geotechnical report, stabilization shall be required. Subgrade material to receive pavement sections other than pedestrian sidewalks which have a plasticity index (PI) greater than 20 shall be stabilized in place with lime prior to placing the pavement. Lime shall be placed in slurry form.. Lime shall be thoroughly mixed per TxDOT Specification Item 260. Subgrade material to receive pavement sections other than pedestrian sidewalks which have a PI equal to or less than 15 shall be stabilized in place with Type I portland cement. Cement shall be dry mixed into the subgrade using a rotary pulverizing mixer, appropriate water added, and then thoroughly mixed with the cement and soil per TxDOT Specification Item 275. Prior to the application of lime or cement to the subgrade, the optimum percentage of material to be added shall be determined based on TEX-121-E (Lime) and TEX-120-E (Cement) Laboratory tests conducted on mixtures of the subgrade soils with varying percentages. The amount of lime required for stabilization should be the percent required by weight to produce a PI less than 18. The amount of Cement required for stabilization should be the percent required by weight to produce a minimum compressive strength of 50 PSI prior to being open to local or construction traffic.

Compaction shall be required, refer to Division 31, Grading and Compaction section.

Appropriate design vehicles shall be selected and modeled to design paving structure, radius, and required widths. Design vehicles may include 73 foot tractor trailer (53 foot trailer), front loading trash trucks, delivery vehicles, aerial fire apparatus, and TAMU bus. A/E team shall coordinate design vehicle selection with owner and user groups.

Pavement sections subject to vehicular traffic shall be either a rigid section of jointed reinforced concrete pavement (JRCP) or a flexible section consisting of hot mix asphaltic concrete (HMAC) surface over an approved flexible base material or HMAC Base Type A or B (Black Base)(coordinate pavement type selection with Owner). JRCP pavement sections shall be a minimum of 6" thick. Finish shall be broom or burlap drag. The thickness of the pavement section elements shall be recommended by the geotechnical engineer based on soil conditions and anticipated traffic loadings. Pavement at trash dumpsters, loading docks, etc. subject to heavy vehicular maneuvering and turning shall be JRCP.

DESIGN CRITERIA

Division 32 – Exterior Improvements

HMAC Paving

HMAC shall be Type D and the flexible base material shall be Type A, Grade 1 as defined in the TxDOT Specification Item 247, 2004 Edition. A rolling pattern for HMAC shall be established in the field by a testing laboratory using a Troxler Nuclear Density Gauge. The flexible base shall be compacted in maximum 8" lifts to a minimum density of 95% of the maximum density as per ASTM D-1557 with a moisture content between +/-2% of optimum. The base shall be primed with approved asphaltic material at a rate established by the team and shown on the plans prior to HMAC placement. Between successive HMAC courses, an approved asphaltic tack coat at a rate established by the team and shown on the plans shall be placed as needed to properly bind layers.

HMAC Tests:

Mix Verification -

Laboratory Density - The HMAC surface course shall be compacted to contain 3 to 8 percent air voids when tested in accordance with Tex-207-F and Tex-227-F.

Thickness Verification -

Laboratory Stability -

HMAC flexible pavement sections shall typically be edged by reinforced concrete curb and gutter to receive storm drainage from the pavement and to stabilize the pavement edge. Place doweled expansion joints in curb and gutter as a minimum at end of radius returns, at curb inlets and at maximum 40' centers in straight runs. Expansion joints in curbs with adjoining sidewalks shall match the joint location and spacing in the sidewalk. Contraction joints a minimum depth of 1/4 slab depth and shall be placed at 10' intervals. Curb and gutter section shall be placed on 6" stabilized and compacted subgrade.

Concrete Paving

Concrete shall consist of Type I or II Portland Cement conforming to ASTM C150, Type C or F fly ash conforming to ASTM C618 (up to 25% percent by weight of cementitious materials), aggregate meeting ASTM C33, and water conforming to ASTM 1602. Additional admixtures may be used meeting appropriate ASTM standards. Concrete pavement shall have a minimum compressive strength of 3,000 psi at 28 days. A concrete mix design with current (within 365 days of submittal) 28 day break data shall be submitted by the contractor and reviewed by the A/E team.

Concrete Tests:

Test Cylinders at 7 and 28 days per ASTM C39

Air Content

Water shall not be used as a finishing agent. Evaporation retarders may be used to aid in finishing if required.

DESIGN CRITERIA

Division 32 – Exterior Improvements

A jointing plan shall be prepared as part of the design plans showing the type and location of joints in all JRCP pavements including sidewalks and curbs/valley gutters. The expansion joints in sidewalks shall be placed at walk intersections and at maximum 20' centers in straight runs. Expansion joints, contraction joints, construction joints, and isolation joints shall be placed in accordance with good engineering practice as required to control cracking and other distress in the concrete pavement and to facilitate construction with a maximum spacing equal to 2 times the thickness of the pavement in feet (2*t') with a maximum spacing of 15 foot. Concrete sawn joints shall be cut "green" using the "soft saw cut technique" as soon as the concrete hardens to support the weight of an early entry type concrete saw and operator to avoid raveling.

Concrete pavement shall typically be edged with a 6" concrete curb. Preferably the curb shall be poured monolithically with the pavement but doweled curb sections are allowed. If poured separately the curb section shall be recessed 1" into the pavement and attached with dowels of sufficient spacing and length to hold the curb firmly to the pavement.

All pavement/surfaces and gutters shall be crowned and/or sloped sufficiently to positively direct storm runoff to points of discharge or collection as to eliminate "birdbaths". Minimum cross slopes for open pavement areas shall be 1%; minimum crown for streets shall be 6" above the gutter line; minimum slopes for curb and gutter shall be 0.5%.

Concrete for all site paving/curbs/gutters shall have a minimum compressive strength of 3,000 psi at 28 days. Reinforcement shall be new deformed steel bars conforming to ASTM A615, Grade 60 minimum No. 4 bar in size. No welded wire fabric shall be used as reinforcement except in unique situations as approved by Owner. All concrete shall be adequately cured by protecting it against moisture loss for a period of not less than 72 hours beginning immediately upon completion of finishing operations and initial set of concrete. The use of water as a finishing agent is prohibited, the use of evaporation retarders may be used to aid in finishing

Expansion joints shall consist of smooth bar dowel assemblies conforming to ASTM A615, grade 60 with a PVC sheath over the free end, asphalt impregnated fiberboard filler, and cold applied self-leveling polyurethane sealant with closed cell polyethylene backer rod. A PVC cap seal may be specified in lieu of a joint sealant as approved by the owner.

Parking

The basic configuration of parking lots shall be as follows:

| | |
|----------------|---|
| Parking Angle: | 90 degrees |
| Stall Width: | 9' - 0" |
| Module Width: | 64' - 0" (stripe to stripe), 62' - 6" (face of curb to stripe), 61' - 0" (face of curb to face of curb) |
| Drive Aisle: | 24' - 0" |

DESIGN CRITERIA

Division 32 – Exterior Improvements

Stripe Width: 4"
 Stripe Length: 20' - 0"
 Stripe Colors: White for general parking. Yellow for no parking, and loading.

Landscaped Medians: Planted with low profile vegetation, irrigated, and spaced appropriate to the design.

Concrete Mow Strips: 2'-0" wide back of curb for head-in parking when no wheel stops are provided

Lighting:

Refer to UES guidelines:

<https://utilities.tamu.edu/wp-content/uploads/2020/03/TAMU-Design-Standards-No-Interior-Lighting.pdf>

| Lighting Level Specifications | | |
|--|----------------------------------|-------------------------------------|
| Location | Avg. Horizontal Footcandles (fc) | Uniformity Ratio (Avg. fc : Min fc) |
| Pedestrian Ways, Bikeways, and Parking Lots | | |
| High Activity ^a | 1.0 | 4:1 |
| Medium Activity ^b | 0.5 | 4:1 |
| Low Activity ^c | 0.2 | 10:1 |
| Roadways | 0.6 | 6:1 |
| Roadway Intersections & Crosswalks | 1.3 | 6:1 |
| ^a High activity: Commercial areas in urban environments with high nighttime pedestrian activity – high probability for detection of pedestrians is required. ^b Medium activity: Intermediate areas with moderate nighttime pedestrian activities, where pedestrian safety and provision of guidance for primary travel ways are key design elements. ^c Low activity: Allow the pedestrian to visually orient in the environment, detect obstacles, identify other pedestrians, read street signs and recognize landmarks. | | |

CONCRETE WALKS

Pedestrian sidewalks shall be JRCP with a minimum thickness of 4" and a minimum width of 6' or sized to handle pedestrian and bicycle flow. Pedestrian sidewalks that may also be service and/or emergency vehicle pathways shall be a minimum of 6" thick and appropriate width. The finish shall typically be a light broom finish but shall be coordinated with any campus standard finish schemes. Sidewalks shall be designed per Texas Accessibility Standards with a cross-sloped (max. 2%) in the direction of site drainage patterns. Do not dowel sidewalks into adjoining foundations or entrances/exits to structures. A structural stoop outside of entrances/exits shall be designed as part of the foundation and graded by the site civil. Sidewalks adjoining a building structure or a concrete curb and gutter shall not be doweled into the building or curb and gutter section. Avoid surface drainage of stormwater across sidewalks.

DESIGN CRITERIA

Division 32 – Exterior Improvements

BICYCLE RACKS

Show bicycle racks in sufficient quantity near but not in front of entrances. Use standard ribbon hot dipped galvanized pipe type embedded in concrete.

These details shall be incorporated in the drawings. The number of racks required will be determined during the schematic design stage with the RELLIS Facilities Department.

TRASH REMOVAL

Trash receptacle location should be at grade level and should be placed so that they can be loaded from top as well as side and screened from public view. Verify method of disposal at various research centers/stations and Universities.

Receptacle area should be adequately lighted for night use.

At dumpster locations, provide a concrete pad of sufficient size and strength to accommodate the dumpster and truck.

PORCHES AND STEPS

All stoops, porches, docks and steps, exterior and interior should have built-in abrasive surfaces. Slope exterior porches and treads to drain water 1/4" per foot. Exposed concrete finished work shall be accomplished in two pours: the first structural and the second being a two inch minimum finish topping poured near completion of project. Primary entry floors may be constructed using brick, tile, pavers or other permanent floor materials.

LANDSCAPING

All landscaping plantings shall be planned and designed to be compatible with the overall campus landscaping scheme. Emphasis shall be placed on durability and low maintenance characteristics.

At final completion of any landscape project the sod or landscape beds should be weed free.

Planting bed mix should be 40% sandy loam, 35% coarse sand, 25% well decomposed compost.

Depth of the planter should be based on the plant material to be used. All planters should be irrigated. Crown surface for drainage.

DESIGN CRITERIA

Division 32 – Exterior Improvements

Turf Areas: Minimum 3-4” of sand cap mix placed and fine graded before placement of turf; 6” is recommended.

Concrete Mow Strip: Planter areas that are adjacent to turf areas shall have a 12” wide x 4” thick, reinforced concrete mow strip. Reinforcing shall be No. 3 rebar. Medium broom finish. Concrete shall be 5 sack mix, 3000 PSI at 28 days, minimum. Adjacent to building the mow strip shall be minimum 24” wide with an expansion joint and not doweled to the building foundation.

Sod

Bermuda grass cultivar 'Tif-Tuf' for full sun areas.

Sod shall be composed of certified, approved, or nursery grown grass and shall be true to name/variety. Sod shall be substantially free of noxious weeds, disease, insects, thatch and undesirable grasses. Sod shall have a sufficient density so that no surface soil is visible at a mowing height of 1.5 “(inches). Sod shall be neatly mowed and mature enough that when grasped at one end it can be lifted and handled without damage to the sod. Maximum mowing height shall be 2.5 “(inches).

Sod shall be cut to provide a sufficient root zone and stand of live grass. Sod shall be cut with a uniform soil portion of a ½” thickness, plus or minus ¼ inches.

Sod shall be cut, delivered and installed within 24 hours of cutting. Sod shall be cut by mechanical means such as sod cutters. Sod shall be cut when the moisture content (either excessively wet or dry) will affect the lifespan of the sod.

Area to be designated for sod, shall be fine graded, smoothed, with Sand Cap Mix placed before final grading. If soil is dry, lightly moisten before placement of sod. Any sticks, stones larger than 1” or other debris should be removed as part of fine grading.

First row of sod shall be placed in a straight line with additional placement of rows shall be parallel and tightly placed against each row. Staggered lateral joints butted tightly shall be used. Sod shall not be stretched or overlapped.

Sod should not be laid on top of existing grass or weeds. For new construction or for landscape repairs it should be cut in to match the surrounding grade.

Sod on slopes greater than 3:1 shall be placed perpendicular to slope. Sod on slopes shall be temporarily fastened to ground by stakes, staples, pegs or other approved methods. After sod has become established, contractor shall remove fasteners.

Sod shall be lightly rolled after the section is placed. Once sod has been placed, immediately water sod to prevent excessive drying. Thoroughly water sod so that underside of sod and

soil are completely wet.

All disturbed areas shall be graded to properly drain and seeded or sodded with a permanent grass.

IRRIGATION

Texas A & M University/RELLIS Campus Irrigation Design Guidelines & Specifications

Intent:

This document is intended to cover a complete irrigation system from design to installation for the Texas A & M University Central and RELLIS campuses.

Prior to commencement of any involvement such as design, or installation with an irrigation project, identify the person or persons properly authorized to make project decisions. TAMU FP&C, Facilities Dining Administration or SSC Engineering Design Construction Services to identify this individual. All plans for new or renovated irrigation systems are to be reviewed and approved by the TAMU FP&C, Facilities Dining Administration or SSC Engineering Design Construction Services.

Obtain and furnish copies of all permits and licenses applicable to the intended work to be done. Copies of these documents to be a part of the Project Documents.

Ensure that there is compliance with the relevant codes and regulations both in the design and during the conduct of the work involved in the project. The design and installation of the irrigation must meet the requirements of TCEQ (Texas Commission on Environmental Quality). The irrigation system must be installed under the supervision of a Licensed Irrigator.

Supply and install the components required for an automatic irrigation system to provide supplemental water to the intended landscape efficiently and uniformly. All material shall be installed in strict accordance to the manufacture's installation specifications, which shall be considered a supplement to these specifications.

Obtain or prepare a scaled design of the proposed irrigation system which meets Irrigation Association Design Standards and standards set by this document herein. All construction drawings shall have licensing seal affixed to the document by a licensed Irrigator. All plans must be approved by Texas A & M Facilities Planning and Construction and SSC Services Irrigation Department. Provide a digital version for the university at no additional expense. A suitably scaled as built drawing shall be provided upon project completion prior to substantial completion. All components of the irrigation system shall be shown as installed, with clear measurements from an identifiable reference point to the location of the controller and its circuit breaker, master valve, zone control valves, main water connection, blow out connection, pump and its electrical connections, and any other similar features. Furnished As-Built Drawings shall be two hard copies as well as an electronic file such as AutoCAD or other software capable of providing the

DESIGN CRITERIA

Division 32 – Exterior Improvements

electronic files in a readable and scaled printable format.

It is understood that piping layout is diagrammatic only and piping shall be routed to avoid plants and structures when possible. No machine trenching, unless approved by the University Architect, or SSC Arborist, is to be done within drip line of trees. Trenching is done by hand, tunneling, boring, or other methods approved by Architect/Arborist

Obtain properly informed agreement from the owner's representative as to the inclusion or not of desirable features in the design which exceed IA Design Standards and/or are site specific.

All irrigation work shall be done by a suitably experienced and qualified licensed irrigation contractor, having trained and competent personnel adequate for the scope of work. Utilizing Staff certified by the IA in such disciplines as Certified Irrigation Technician (level 1 or 2), Certified Designer. The contractor shall be a member in good standing of the Irrigation Industry Association and or TCEQ Texas Commission on Environmental Quality and have met the qualification standards currently applied to licensed contractors by that organization.

The irrigation system shall have head to head coverage. The irrigation system should also be designed for matched precipitation rates. The contractor shall follow all of the manufactures operating and performance specifications. All irrigation heads need to be flush with the final grade of the soil. Irrigation valve boxes must be to flush with the final grade of the soil and supported by bricks beneath the boxes and plastic sheeting wrapped around the base of boxes to reduce infiltration of soils and sediment around components within. No gravel shall be placed in the valve boxes. Gravel can only be placed in the double check vault.

A written guarantee of the installed system shall be provided to the owner covering workmanship and materials for a minimum of one year from final acceptance.

Provide clear instructions for operating the irrigation system " in season", showing the relative timing differences between zones of different precipitation rates, and a schedule of run times suggested for various weather conditions. Division of the system into "Hydrozones", or areas with different water requirements, whether based on gardens/grass, sun exposure, drainage patterns, or distinct areas is encouraged. Also consider slopes in the design of the system so that runoff water from higher elevations can be beneficial to middle and lower elevations.

1. Owner or Representative

Prior to commencement of any involvement with an irrigation project, identify the person or persons properly authorized to make project decisions. TAMU Facilities Planning and Construction to identify this individual.

2. Pre – construction Irrigation Audit:

A mandatory preconstruction audit will be performed for all projects involving any and all existing irrigation system or systems to be impacted by construction projects in the vicinity. This audit will identify and document any portions of the existing system having deficiencies and determine the extent to which the expected repairs be acceptable by the Owner or Owners representative. Contractor will be responsible for

DESIGN CRITERIA

Division 32 – Exterior Improvements

maintaining fully functioning irrigation system to adjacent properties which are always affected by the construction project. It is the duty of all contractors to provide proper notice to SSC Services to complete the irrigation audit or it is assumed that the system is 100% functional and operational, and any damage found or incurred after this date will be repaired to the Owners satisfaction at contractor's expense.

3. Site Conditions:

Existing Structures: Contractors working on campus shall at their expense preserve and protect turf, trees, plants, monuments, structures, paved areas, and any other site amenities that may not be identified here from damage during the installation. Repair all damages to the original condition immediately and notify Owner's representative of the repair complete with photo documentation of before and after.

Existing Trees: Trenching and excavations within the drip lines of existing trees are to be performed by hand or compressed air excavation. Exercise extreme care to ensure clean cuts through all roots encountered. Close trenches showing exposed roots within 24 hours. All excavations within the critical root zone and drip line shall follow the Operational Overview of Tree Protection Procedures form the office of the University Architect.

Existing Utilities: Coordinate staking and identification of utilities with all agencies prior to excavations. Take the necessary precautions to protect underground utilities during construction. Repair any damage immediately at no additional cost to Owner and provide photo documentation of the repair.

Existing irrigation components: Any irrigation components i.e. Heads, Valves, Controllers, Backflow Devices, removed or demolished are the property of the Owner and shall be returned to Owners Representative or disposed of at their discretion.

Any discrepancies involving the preexisting site conditions and return thereof will refer to the Uniform General Conditions of Texas A & M University.

4. Execution:

Install main lines with a minimum of eighteen "18" inches of earthen/soil cover and lateral lines with a minimum of twelve "12" inches cover. All mainlines 4" inches and larger to be class 200 gasket pipe. Mainlines 3" and smaller shall be schedule 40 PVC pipe, and all lateral lines shall be class 200 PVC pipe. Mainlines 5" inches and above shall be class 200 PVC.

Backfill in trenches to be flooded and compacted to prevent future settling and to match the adjacent finish grade.

Test entire Mainlines for 24 hours in open trenches and at the point of connections for a minimum of one hour to ensure components are sealed and no leaks are present. All testing to be performed under the direction of SSC Irrigation personnel. Any leaks or component failures to be corrected within 72 hours and retested immediately thereafter.

All sprinklers are to be checked for operation and proper arc of spray. Adjust or change nozzles as necessary to obtain the optimum desired spray patterns.

The complete system to be guaranteed against defects in materials and installation for a period of one year from the date of substantial completion and, maintenance of the system for a period of 90 days will begin. Maintenance and guarantee do not include alterations made necessary by re-landscaping or changes in site layout. Maintenance does not include trimming grass around heads, or any service required due to the service of owner's maintenance to lawn or landscape planting.

5. Installation:

General

Stake the locations of sprinklers for approval by the Landscape Architect or Owners Representative before proceeding with installation of irrigation components. Any Turf area designated as a "Fire Lane" shall be

DESIGN CRITERIA

Division 32 – Exterior Improvements

independently zoned and isolated by ball valve from the rest of the system in the event of an emergency and for repairs.

Pipe Installation:

Trenching: Provide firm uniform bearing for entire length of pipe to prevent uneven settlement.

Sprinkler Mains: Provide “6” wide trenches with “18” minimum cover. For all gasketed pipe install concrete thrust blocks in areas where the rubber-gasket irrigation main changes direction such as at ells and tees and where the rubber-gasket main terminates.

Lateral Lines: install in “4” wide trenches with “12” inches minimum cover.

Backfill: Hand tamp and water jet to prevent extreme settling. Hand rake trenches and adjoining areas to leave grading condition equal to before installation.

Sprinkler heads: provide pop-up sprays, rotary, flood bubblers, and drip irrigation heads and components in accordance with approved for construction Architectural drawings manufacturer recommendations.

Adjust revise nozzle degree and trajectory if wind conditions affect coverage.

Provide Hunter or approved equal swing joint assembly at each head consisting of schedule 80 PVC.

Install quick coupler valves along the mainline, valve to be Rainbird 33DRC Quick Coupling Valve with 2-Piece Body, 3/4” double track key lug; rubber cover, brass body construction on double swing joints schedule 80 PVC, one per control valve or every 150 L.F. along the mainline, whichever is practical to be determined by owner’s representative.

Install a line sized manual isolation ball valve at every electronic control valve or at the front and back side of manifold valve clusters. The ball valve to be schedule 80 PVC with manual flow control handle. Install this valve approximately 18” inches away to allow for future repairs.

Any turf grass damaged or destroyed during the installation process should be replaced to the owners satisfaction with solid sod laid flat on a 1” inch cushion of screened bank sand or enriched topsoil and rolled smooth to remove lumps and seams. Sod shall have a seamless transition with existing adjacent turf and hard surfaces as well.

6. PVC Pipe and Assembly:

Solvent: Use solvent and procedures recommended by manufacturer to make solvent - welded joints. Thoroughly clean pipe and fittings before applying PVC pipe primer/ solvent and Christy’s blue glue adhesive and purple primer or approved equal.

PVC To metal connections: Work metal connection first, use a non-hardening pipe dope such as Permatex No2. On threaded PVC to metal joints. Use only light wrench pressure to tighten. Threaded PVC connections; require use on threaded PVC adapters into which pipe may be welded.

7. Controller; WeatherMatic Smart Link “SL 1600 or SL4800”

- Each irrigation controller shall have a weather station to manage microclimates. The controller shall utilize real time ET data to determine plant water requirements. Evapotranspiration deficits shall be calculated daily and transferred to the controller.
- Controller must not require software to be installed locally. Connection to controller through the web shall be through a web-enabled appliance such as a PC, Smart Phone, Tablet, etc. For every 25 controller the manufacturer will provide one Smart Phone or a Tablet.
- Weather station shall be WeatherMatic SLW5 or most current model wireless and suitable for outdoor mounting. Weather station shall be capable of two-way communications with controller(s) and have independent power supply, self-diagnostic circuit and microprocessor. Weather Station shall be installed in the open as much as possible along the eaves of nearby structures identified as the most suitable location by owner’s representative.

DESIGN CRITERIA

Division 32 – Exterior Improvements

- Each point-of-connection (POC) shall utilize a normally closed master valve with pressure regulating capabilities not to exceed more than 60 psi and a real time flow sensor to communicate and respond to both high flow and low flow events. Flow meter must have a flow range of 0.25 to 12 FPS. Flow meter shall be a 4 blade impeller (paddle wheel). The flow meter shall also be an in- line type, compatible with the WeatherMatic SmartLink Controller.
- Controllers must be able to receive data from multiple flow sensors. Multiple controllers must be able to receive data individually from a single flow sensor. This shall be achieved using Isoflow and Combiflow WeatherMatic components.
- Controller shall have self-diagnostic capabilities to detect “short” or “open” zones and the ability to display lists of faults on an LCD display for the user. Diagnostics shall also include LCD display of volt/amp readings by zone and for transformer output as well as backup battery reading. A chatter function shall also be provided to assist in locating buried valves. The controller shall automatically prevent master valve opening when the valve locator diagnostic is used.
- Controller shall be capable of standard timed watering or auto adjust watering times. Auto Adjust watering shall be based on real time, on-site weather data and system audit data entered by the user. Auto adjust timing shall be based on real time ET data. Controller shall provide reviewable watering deficits, scheduled run times by zone and a total run time recap for each zone which is resettable by the user. A timer shall be provided to allow run time adjustment by zone for shade/sunlight, system efficiency and other local factors. Auto adjust mode shall also include automatic calculation of run/soak times based on both soil type and zone elevation.
- Manual operation shall be provided by program, by station, or on a programmable test program with durations from ten (10) seconds to ten (10) minutes. The programmable test program shall also check for short and open conditions on each zone each time it is run.
 - Non-volatile memory shall retain all programming and real-time clock shall be provided to maintain date and time.
 - Controller will accommodate either traditional valve wiring systems or TWO Wire valve systems.
 - Initial and perpetual onsite technical training as part of continuing connectivity fees.
 - A three year warranty on all hardware and one year warranty on labor. The manufacturer is solely responsible for all warranty issues and will be the only point of contact with TAMU.
 - Controller must be EPA Water Sense approved and have Center for Irrigation Technology (CIT) Smart Water Application Technology (SWAT) Protocol.
 - Affix a non-fading copy of irrigation diagram to the inside cabinet door below controller’s name. Irrigation diagram shall be sealed between two (2) plastic sheets, 20 mils. Minimum thickness. Irrigation diagram shall show clearly all valves operated by the controller, showing station number, valve size, and type of planting irrigated.

DESIGN CRITERIA

Division 32 – Exterior Improvements

- Lighting Protection and Grounding: Provide full grounding and lighting protection per system manufacturer's recommendations. Grounding network shall measure 10 OHMS or less when measured with a vibra-ground instrument.
- Power to Controller and Locations: Locations shown on plan for controllers is approximate. Final location shall be determined on site by owner. Contractor shall supply 120 VAC to controller from adjacent existing power sources. Follow local governing codes in electrical work.

8. Backflow Prevention Device: Reduced Pressure Zone Device (RPZ)

Backflow prevention device assemblies (RPZ) shall be in new condition and installed according to the local plumbing code and sized to accommodate the flow requirements present, and successfully tested by a licensed Certified Backflow Prevention Tester.

Before installing a RPZ (Reduced Pressure Zone) Backflow Preventer, flush the lines thoroughly to remove all debris, chips and other foreign matter. If required a strainer should be placed upstream of the Backflow Preventer

The RPZ must be installed in a horizontal only position with flow down to provide proper operation of the relief valve. Provide adequate space around the installed unit so that the test cocks will be accessible for testing and servicing facing straight up. All backflow prevention devices and Controllers to be placed in the same general vicinity of one another. Insulate all above ground piping in accordance with university design guidelines.

After the installation of a RPZ backflow prevention device has been completed, place the unit in service as follows:

1. Start with both shut-off valves closed. Slowly open the inlet shut-off valve until the backflow preventer is completely pressurized.
2. A brief discharge from the relief valve may occur while the assembly is pressurizing. The discharge should cease by the time the shut-off valve is fully open.
3. If the discharge does not stop, refer to "Maintenance Instructions" for Repair Procedures.
4. After the assembly has been pressurized, vent all trapped air from both check valves and the relief valve by slightly opening each of the four test cocks.
5. Slowly open the downstream shut off valve. The Model RPZ Reduced Pressure Principal Backflow Preventer is now in service.
6. If 'spitting' or intermittent discharges from the relief valve are noted, 'spitting' (drainage) from the relief valve could be a result of pressure fluctuations and/or water hammer condition in the system. If such condition exists, install water pressure reducing valves or water hammer shock arrestors in compliance with industry standards as needed.
7. After the backflow preventer has been properly installed, test the assembly (see Test Procedures). If the assembly fails the test, remove the first and second check valves and thoroughly flush the assembly. If the relief valve fails to operate properly, inspect the sensing passage for clogging (also see maintenance instructions). Clean rubber seats of all debris and place unit back in service. If cleaning procedure fails replace the check valves that failed with new ones. If unit continues to fail replace with a new backflow preventer.

9. Master Valves & flow meters:

Install one line sized combination Master valve with flow meter on the mainline near the point of

DESIGN CRITERIA

Division 32 – Exterior Improvements

connection and after the backflow prevention device. For Mainlines below 3" inches in diameter use a WeatherMatic Master Valve and flow sensor, and for lines 3" inches and above utilize Rainbird on Hunter brass body Master valves. Master Valves and Flow Meters to be installed per manufacturer's specifications, including but not limited to straight pipe length requirements. Wire rides are only to be used as a last resort and may only be used with explicit written permission from Owner's Rep.

10. Tree Protection:

Tree protection must adhere to the Texas A & M University; Operational Overview Tree Protection Procedures from the Office of the University Architect.

11. Sleeves / Conduit:

- (a) All sleeves in soil shall be installed and backfilled with the same considerations for protection of the material as if it were water pipe. Compaction shall be to the same standard as the adjoining undisturbed soil and the sleeves shall project at least 12" on either side of the hard surface being crossed.
- (b) Sleeves being installed beneath roads or driveways for later use shall have the necessary pipe installed at the same time with each end elbowing to at least 36" above grade
All new sleeves shall be schedule 80 PVC pipe, unless the circumstances of its installation require a stronger material to ensure its survival during ongoing construction activity by other trades.
- (c) Sleeves shall be sized to be no less than twice the size of the pipe being protected if lateral line and three times the size if main line. Install at every 150' L.F. of paving, driveway, roadway or any hard surface that may be encountered a minimum, of two sleeves at each location.
- (d) Sleeves crossings any hard surface such as roadways, sidewalks, driveways, or other impenetrable surfaces will be identified by a ¼" Brass carriage bolt at each end of the crossing for future locations.

12. Inspection/Testing Notify owners Representative 48 hrs. prior to testing

- a) Upon completion of the irrigation system installation, all pressure regulation, arcs, distances of throw, sprinkler locations and height, controller zones, etc., must be adjusted so as to optimize the operation of the system and make it ready for inspection and testing.
- b) Inspection will be carried out with the owner's representative and installation contractor to ensure that the work has been done in a neat and workmanlike fashion and meets the intent of the installation standards previously agreed upon in the design documents and the pre – construction meeting. Hydrostatic Test: Test irrigation main line, before backfilling trenches, to a hydrostatic pressure of not less than operating pressure for 6 hours. Piping may be tested in sections to expedite work. Remove and repair or replace piping and connections which do not pass hydrostatic testing. Pressure shall be maintained for a 24 hour leak test.
- c) The test will require that the system be operated sequentially with the controller, in the presence of the owner's representative.
- d) The purpose of the test is to ensure that the system adequately covers the landscape to be irrigated and meets the design criteria previously agreed upon.

Coverage requirements are based on operation of one (1) circuit at a time. However in larger systems where University Representatives has specified the need to operate multiple zones concurrently during the design phase multiple zones will be tested at once to determine hydrologic capabilities.

13. Deficiencies/ Punch List:

- a) A punch list will be created during the final inspections identifying any items in need of correction or repairs.
- b) Any deficiencies noted during the inspection and testing will be rectified by the installation contractor promptly and signed off by the owner's representative.
- c) Any disputes arising from the use or implementation of these standards may be referred to the TAMU Facilities and Dining Administration, FP&C, SSC Irrigation Department for arbitration or recommendations.

14. Final Acceptance:

- a) Record Drawings: Provide completed record AS-Built drawings for review by the Landscape Architect or Owner's representative 72 hours prior to requested inspection. Affix irrigator license seal to copies of drawings.
- b) Operations and Maintenance Manuals: Provide three copies of all operations and maintenance manuals upon completion. This manual should include a table of contents, diagram of controller, spec/product sheets on all parts of the system, as-built drawings diagrams of all stations complete with pictures of zones locations written descriptions in the controller, and also perform a zone flow calibration exercise as directed by owner's representative prior to final acceptance. Provide recommendations on irrigation cycles appropriate to the region and season etc. The manual should be in a loose leaf 3 ring binder format for standard three-hole punch sheets and must be clearly organized with tabs and dividers as needed.
- c) Before Certificate of Substantial Completion will be awarded the Irrigation Contractor must provide a demonstration and training session for the Owners, or Owners Representative, and any maintenance personnel. The Operations Manuals which may be a single digital file, and all maintenance responsibilities will be handed off to the Owners representative during this training session. This session may require videotaping for client's future reference.
- d) The Smartlink controller should have each zone identified in written descriptions in the controller along with pictures to further identify the zone locations.

15. Retrofits and repairs to existing systems:

- a) Retrofits and repairs to existing irrigation systems must follow these design guidelines and specifications and be completed to the satisfaction of the Owner's representative.
- b) **NOTE: Any project, new construction, or renovation will adequately provide irrigation coverage to all areas effected by said project previously irrigated at the start of the project.**

16. Alternate Materials

- (a) The formal approval of the owner's representative is required prior to the use of materials that are different from those shown in the design. In general alternates will not be excepted unless the product can be verified to be equal to or better than the specified product and accepted by the Owners representative.
- (b) Alternate materials must match the original materials in performance, flow, pressure loss, and other

DESIGN CRITERIA

Division 32 – Exterior Improvements

important characteristics so as not to compromise the intent of the design.

(c) The materials must all remain compatible. When changing from one product to another the flow from all the sprinklers must be recalculated to confirm flow is still below 5 ft. /sec.

(d) The alternate materials proposed if accepted must be applied according to their manufacturer's recommendations.

If there is an existing system i.e. Piping, valves, heads, and other components that are abandoned during this installation of this new irrigation system, the contractor is to notify SSC Irrigation department of exact locations of abandoned components to ensure no leaks are present.

17. SITE MAINTENANCE:

- a)) The job site shall be kept in a neat, clean, and orderly condition at all times during the installation process. As determined by Owner's Representative, FP&C Project Manager, or SSC Services.
- b) All scrap and excess materials are to be regularly removed from the site and not buried in trenches.
- c) Trenching, laying pipe, and backfilling shall be continuous so that the amount of open trench at the end of each workday is minimized. Any open trench or other excavations shall be barricaded and marked with high visibility flagging tape.
- d) **Contractor shall correctly maintain the irrigation system during the installation process and throughout the landscaping maintenance service period and not more than 90 days from substantial completion.**

18. APPROVED IRRIGATION COMPONENTS AND SUBMITTALS:

Spray Heads:

Hunter Pro spray (PRS -40) with MP rotary nozzles 1000, 2000, 3000 series with check valve.

- i. Turf area should be 6".
- ii. Shrub heads shall be 6" or 12".
- iii. Side inlets shall not use on any heads.
- iv. Nozzle size no less than 8' and no more than 15'.
- v. Van nozzle will be permitted in only area that a fix nozzle will spray on the hardscape.

Rotors Heads:

WeatherMatic T3, PGJ, and I-25

- i. Hunter PGJ will only be accepted in areas less than 20'.
- ii. WeatherMatic T3nozzles shall be low angle for flat surfaces. For berms, the nozzles shall be no smaller than a 7.
- iii. All heads shall have a check valve installed before the head.
- iv. I-25 nozzles smaller than a 15 are not permitted.

Tree Bubblers:

Tree bubblers shall be Irritrol 533 adjustable flood bubblers. Bubbler shall be installed on 12" Hunter swing joints. Tree Bubblers shall be the only acceptable method of irrigating trees. No

DESIGN CRITERIA

Division 32 – Exterior Improvements

other forms of drip will be accepted.

Drip:

Drip tubing should be installed on the uphill side of all plants.

- i. Ground cover areas: Drip shall be Hunter drip tube with 12" spacing. Drip shall also have a 6" pop-up indicator.
- ii. Other plantings of shrubs, ornamental grasses, etc.: Blank drip tubing should be used, and individual drip emitters installed so that only the root zone of the individual plants is irrigated.
- iii. Automatic line flushing valve shall be installed at the end of each independent zone. The valve shall be capable of flushing one (1) gallon of water at the beginning of each irrigation cycle.
- iv. Pressure regulating valve shall be capable of regulating pressure from 111111115-50 psi using interchangeable, color coded regulating springs. The regulator shall have a built in indicator that shows when the proper outlet pressure has been reached.
- v. Drip lines shall consist of nominal sized 1/2" low density, linear polyethylene tubing, housing internal pressure compensating, continuously self-flushing, and integral drip emitters. The tubing shall have an outside diameter (O.D.) of 0.67", and an inside diameter (I.D.) of 0.57". The emitters shall have the ability to independently regulate discharge rates, with an output pressure of 7-70 psi, at a constant flow of 0.62 gph. The dripper line shall have factory install emitters 12" on center.

Flow Meter:

Flow meter will be installed at every point of connection.

- i. Shall be a WeatherMatic SLFSI.
- ii. Wiring shall be CAT5ES or PE39 wiring.

Electric Control Valves:

Valves

- i. 3" valve shall be Hunter ICV-301 or Rainbird 3" brass valve.
- ii. 1 ½ " and 2" valve shall be WeatherMatic Black Max 11000.
- iii. 1" valve shall be WeatherMatic N100S.
- iv. Drip irrigation valve shall be Rainbird xcz-100-prf.
- v. 1 ½ "and 2" and Drip valve boxes shall be 14"x19".
- vi. 1" valve boxes shall be 10". One valve box per valve.
- vii. Remote Control Valve Tags: One (1) remote control valve tag shall be attached to stem of each electric remote control valve. Tags shall be numbered sequentially. Numbers shall correspond to station numbers in electric controller. Provide tags and corresponding numbers for wires pulled for future valves.

Ball Valves:

DESIGN CRITERIA

Division 32 – Exterior Improvements

- i. Ball shall be McDonald or approved equal installed 12” before the RPZ Reduced Pressure Zone
- ii. Isolation ball valve shall be installed 12” before each zone. However, it is acceptable to install 2 to an isolation valve if necessary.
- iii. Gate valves will not be permitted.

Back Flow Preventer:

- i. Reduced Pressure Zone (RPZ) Febco 860
- ii. 2” and less shall be in a 24”x36” metal cage. (RPZ) Reduced Pressure Zone need to be installed on a concrete Slab on grade with metal enclosure to accommodate the size of the RPZ backflow prevention unit.
- iii. All back flow preventers will be installed on the outside of the building.
- iv. Back flow preventers shall be tested and provide certificate to the responsible party.

Fittings

- i. All threaded fittings shall be schedule 80 toe nipples.
- ii. All other fittings shall be schedule 40.

Wire:

- i. The irrigation wiring shall be 14 AWG direct burial WeatherMatic two wire system, or Low-voltage, Branch-circuit Cables: No. 14 AWWG minimum, between controllers and automatic control valves; color-coded different from feeder-circuit-cable jacket color; with jackets of different colors for multiple cable installation in same trench.
- ii. Grounding rods shall be place to manufactures recommendations.
- iii. All wire splices shall be made with Wade, DBY (Direct Bury) Splice by 3M or approved equal. Use one (1) splice per connector sealing pack. All splices must use UL approved connector. DBRY-6. All splices shall be installed in a 10” valve box.
- iv. An expansion curl shall be provided within 3’ of each wire connection. Expansion curl shall be of sufficient length at each splice connection at each electric control, so that in case of repair, the valve bonnet may be brought to the surface without disconnecting the control wires. Control wires shall be laid loosely in trench without stress or stretching of control wire conductors.
- v. Where more than one (1) wire is placed in a trench, the wiring shall be taped together at intervals of 10’.

Controller:

- i. WeatherMatic Smart Link Controller

DESIGN CRITERIA

Division 32 – Exterior Improvements

- ii. Stainless steel wall mounted or pedestal assembly as needs with air card with flow, and weather station.
- iii. Master valve must be installed.
- iv. All controllers will be installed on the outside of the building.
- v. The controller shall have a power source disconnect next to the controller.

Pipe:

- i. All constant pressure lines (Main Lines) 4" and larger shall be class 200 rubber gasket pipe, and 3" and smaller shall be schedule 40 PVC with solvent welded joints.
- ii. All lateral lines 2" inches and below shall be class 200 PVC with solvent welded joints.
- iii. All valves must have at least 18" spacing before any fitting. This will allow for future repairs.
- iv. All fittings must have at least 18" spacing before the next fitting. This will allow for future repairs.
- v. All pipes shall be installed with minimum of 8" and a maximum of 15" earthen cover.
- vi. Sleeves shall be schedule 40. Sleeves shall not be installed deeper than 12" below the roadway, walks, curbs, and etc.
- vii. ½" pipe will not be permitted. ¾" pipe or greater are permitted on lateral and main lines.

Point of Connection:

Point of connection

- i. There should be no more than two points of connection per one controller.
- ii. POC shall be a McDonald or equal ball valve, RPZ, master valve, and flow meter.
- iii. If there are multiple points of connections SLF-Combiflow must be installed.

Swing Joints:

Swing Joints will be installed at every sprinkler heads.

- i. Hunter SJ swing joints will be permitted for sprinkler heads with ½" or ¾" inlet.
- ii. Hunter HSJ swing joints or equal shall be used for heads with 1" inlet.
- iii. No cut off risers will be permitted.
- iv. Funny pipe is not permitted.

DESIGN CRITERIA
Division 32 – Exterior Improvements

Quick Coupling Valves:

Quick Coupling

- i. 3/4" Rainbird "33DRC "Quick Coupling or equal.
- ii. All Quick Couplings shall have a ball valve no less than 12" and no further than 24" from the valve.

WeatherMatic Components:

- i. The controller shall be a Smartline Controller Models SL1600 or SL4800. This will vary on the number of zones.
- ii. The air card shall be SLAIR-GSM/FLOW.
- iii. The weather station shall be SLW5.
- iv. The flow meter shall be SLFSI. The flow meter shall be size as the same size of the mainline.

The pedestal assembly shall be SLPED-ENC.

19. Items to be included on as-built plan are:

- A. Scale of the drawing, complete with legend of equipment. Date of the installation/ As-Built Plan Affix licensee stamp to hard copies of irrigation As- Built drawings.
- B. Minimum system requirements (e.g., 60 USGPM @ 55 PSI)
- C. Location of the main connection referenced to a permanent structure. Information included shall be:
- D. The size and type of the pipe the system is connected to
- E. Size and type of backflow prevention device.
- F. Location and type of winterization point.
- G. Locations of all sprinklers used on the property, including the make and manufacturer of all sprinkler types used. The plan shall indicate what type is used in what location (usually done in the Legend)
- H. Locations of all underground irrigation pipe including type and size of pipe. No PEX or Gray conduit pipe will be accepted.
- I. Location of all valves and valve Boxes, including make, model and size; as well as an indication of the operation (e.g. Manual operation or Automatic.)
- J. Location of all irrigation controllers, including make and model.
- K. Location of all buried wire and connection points.
- L. Location and function of other irrigation equipment used on the project (e.g. Fertilizer injectors, Rain Shut-off Devices, Booster pumps, Weather Stations, Backflow Prevention devices, etc.)
- M. Location of all underground sleeves including the size and type of pipe.
- N. Name and contact phone number and address of the installing contractor.

DESIGN CRITERIA

Division 32 – Exterior Improvements

- O. All final Punch list items to be completed not more than 30 days from final walk thru. If punch list is not completed within said timeframe SSC Services will complete at the contractor's expense with SSC Services standard rates for materials labor and markup.
- P. Include final flow readings from flow calibration via chart listing design flow and actual calibrated flow by zone, listing type and quantity of heads.

PLANT SELECTIONS

Plant selections shall be approved by the RELLIS Campus, Reference Campus Master Plan.

<https://rellis.tamus.edu/rellis-campus-master-plan/>

Spacing shall be determined by the plant species, mature plant height and spread. Use AgriLife resources to determine mature size:

<https://ekps.tamu.edu/>

All plant material shall be container nursery grown. Plants shall meet the American Standards for Nursery Stock.

Spacing shall be either triangular or square as shown on the plan or approved by the Landscape Architect.

GUIDE SPECIFICATION

TREES

PART 1 - GENERAL

1.01 SUMMARY

- A. Purpose - The A&M System recognizes and values the importance of the campus trees as an essential and valuable resource and as a major component of the campus identity. These specifications for the RELLIS Campus give direction to proper procedures regarding tree design, selection, maintenance, preservation, protection, and replacement. Prior to any work that is done on campus, which has any tree impact, a tree training course will be provided and required. Refer to RELLIS Campus Master Plan for additional information: <https://rellis.tamus.edu/rellis-campus-master-plan/>
- B. Related work described elsewhere:
 - i. Section 32 84 00- "Irrigation"
 - ii. Section 32 01 90- "Operation and Maintenance of Planting"

1.02 DEFINITIONS

- A. *Branch Collar*: Wood tissue that forms around the base of a branch between the main stem and the branch. Usually as a branch begins to die, the branch collar begins to increase in size.
- B. *Best Management Practices (BMP)*: Best available, industry recognized course of action, in consideration of the benefits and limitations, based on scientific research and current knowledge.
- C. *Caliper Inch*: is the diameter of a young tree. It is measured 6" above ground for trees up to and including 4" caliper size. If caliper at 6" above ground exceeds 4" caliper, the tree will then be measured at 12" above the ground. Newly planted (nursery stock) trees on the RELLIS Campus are measured in caliper inches.
- D. *Cambium Layer*: Growing point between bark and sapwood.
- E. *Closure*: Refers to the roll of the wound wood growth around the wounded area.
- F. *Critical Root Zone (CRZ)*: an area from the base of the tree that extends beyond the drip line. It is equal to 1 foot radius for every inch of stem

DESIGN CRITERIA

Division 32 – Exterior Improvements

diameter. This minimum area is needed for tree and root health and stability.

- G. *Cut*: The exposed wood area that remains after the branch has been removed.
- H. *Cut Back*: Specific reduction of the overall size of the tree or individual branches, but may include the overall reduction of the sides as well as the top of the tree.
- I. *Damage or damaged*: A tree is considered “damaged” when a physical/mechanical action damages parts of the stem, canopy or roots.
- J. *Diameter at Breast Height (DBH)*: a standard method of measuring stem diameter 4.5 feet above the ground. Established trees on RELLIS campus are measured in DBH inches.
- K. *Dormant*: A condition of non-active growth. Deciduous trees are considered to be dormant from the time the leaves fall until new foliage begins to appear.
- L. *Drip Line*: Considered the outer edge of the tree canopy. An imaginary vertical point that extends from the canopy edge to the ground.
- M. *Elevating*: The removal of lower branches for under clearance.
- N. *Existing Soils*: A naturally occurring soil that has not been relocated or was present before construction.
- O. *Girdling Roots*: Circular root growth around the base of the trunk. These roots can be below or above ground level. These roots choke the tree and restrict the flow of sap.
- P. *Heading Back*: The cutting back of terminals of a temporary limb or branch to a lateral branch or bud to slow its growth, while allowing it to produce food resources for the tree. This is a common nursery practice. Heritage Trees: Trees greater than 24” DBH. Trees greater than 30 years of age that are in good health. Does not include: Tree of Heaven, Mimosa, Mulberry species, Siberian Elm, Calleryana Pear.
- Q. *Lifting*: The removal of lower branches for under-clearance or sight line issues.
- R. *Owner*: TBD by project scope
- S. *Owner’s Representative*: TBD by project scope.
- T. *Parent Stem*: The trunk of the main tree.
- U. *Planting Medium/Mix, Acceptable*: A soil mix developed by amending the

DESIGN CRITERIA

Division 32 – Exterior Improvements

existing soil or removing the existing soil and replacing with new soil mix. Soil mix shall be of uniform composition throughout, with admixture of subsoil. It shall be free of stones, lumps, live plants and their roots, sticks, and other extraneous matter.

- V. *Pre-cut or Pre-cutting*: The removal of the branch at least 6” beyond the finished cut to prevent splitting into parent stem or branch.
- W. *Pruning*: The removal of dead, dying, diseased, or live, interfering objectionable and weak branches in a scientific manner.
- X. *Replacement Tree*: A self-supporting tree on the RELLIS Campus Master Plan Species list that meets caliper inch requirements.
- Y. *Scars or Injuries*: Natural or man-made lesions of the bark in which wood is exposed.
- Z. *Suckers*: Abnormal growth of small branches usually not following the general pattern of the tree.
- AA. *RELLIS representative*: Representative or administered by the Planning & Design Review Board (PDRB) for compliance.
- BB. *Temporary Limb*: A limb left on a small tree to provide for tree growth until permanent scaffold limbs and adequate top limbs are developed. If large, they are headed back to prevent their challenging the desired terminal for dominance.
- CC. *Thinning Out*: The removal of live branches to reduce wind resistance and create more space.
- DD. *Top Soil*: Native soil on site or natural soil harvested from another site than naturally has the texture and composition to meet the specification described and is free of noxious weed seed, shall constitute an Acceptable Planting Media (APM).
- EE. *Topping*: Any pruning practice that results in more than one-third of the foliage and limbs being removed. This includes pruning that leads to the disfigurement of the normal shape of the tree.
- FF. *Tracing*: Careful cutting of the bark along the lines of sap flow to encourage wound closure.
- GG. *Tree Training*: Pruning young trees in a specified manner to shape their growth in keeping with their genetically determined natural form and the urban requirements immediately surrounding them.

DESIGN CRITERIA

Division 32 – Exterior Improvements

- HH. *Trimming*: Same as pruning
- II. *Wounded Wood*: New growth made by the cambium layer around all of a wound.
- JJ. *SSC Sponsored Arborist*: Typ. Arborist appointed under the direction of RELLIS Facilities Department.
- KK. *Tree Value*: The estimated value of the tree as provided by a licensed arborist certified to do tree appraisals.
- LL. *Tree Survey*: Part of the construction plans; contains tree tag number, location of trees (GPS located if possible), DBH, species, and drip line (if possible).
- MM. *Tree Protection Plan*: A written part of the construction plans that describes measures to protect trees during all phases of the project; it should include details, notes, location of tree protection fence, and any other applicable items.

1.03 REFERENCE STANDARDS

- A. National Arborist Association (NAA)
- B. American Association of Nurserymen (AAN)
- C. American National Standards Institute (ANSI)
- D. International Society of Arboriculture (ISA)
- E. Tree Care Industry Association (TCIA)
- F. US Forest Service Urban and Community Forest
- G. Arbor Day Foundation
- H. Texas A&M Forest Service

1.04 PRE CONSTRUCTION

- A. Preconstruction Meeting
 - i. At least 7 days prior to the start of work, a pre-construction meeting with the Owner's Representative shall be set to review any questions the contractor may have regarding the work, administrative procedures during construction, and project work schedule as the questions relate to trees. This meeting should be held on the construction site when applicable and possible. This meeting shall include:
 - 1. RELLIS representative.
 - 2. General Contractor
 - 3. SSC Sponsored Arborist
 - 4. ISA Certified Arborist (If outside arborist is overseeing work)
 - 5. Subcontractor assigned to install Tree and Plant Protection

DESIGN CRITERIA

Division 32 – Exterior Improvements

Measures

6. Earthwork Contractor
7. All Site Utility Contractors that may be required to dig or trench into the soil.
8. Landscape Subcontractor
9. Irrigation Subcontractor

B. Construction Site Tree Assessment

- i. Prior to any construction, the SSC Sponsored Arborist shall provide a tree evaluation of trees on site. This is to be communicated to RELLIS Facilities Department, SSC and other applicable TAMUS representatives prior to any site work begins. The project may provide an assessment from an outside arborist (ISA Certified Arborist, or ASCA Registered Consulting Arborist (RCA). The Assessment shall include all potential root pruning, branch pruning, tree removals, transplanting, and/or the current health of the tree and an ongoing care plan. This assessment must be approved by the SSC Sponsored Arborist and a RELLIS campus representative. Cost appraisal of the tree should be provided when applicable and requested by the Campus.

1.05. CRITICAL ROOT ZONE (CRZ):

- A. The SSC Sponsored Arborist shall coordinate specific requirements regarding tree protection fencing, construction storage, construction parking, construction traffic through site, scaffolding, forms, foundation or any other issues as they relate to CRZ. This shall be the minimum amount of preservation required with any additional requirements determined in coordination between the SSC sponsored arborist and the project manager:
 - ii. 1 foot of radial protection per diameter inch of tree shall determine CRZ (i.e., a 25" tree would have a 50 foot diameter CRZ; see chart below)
 - iii. Areas:
 1. A quarter of CRZ means no impact is allowed in this area.
 2. Half of CRZ means no cut or fill greater than 4" is allowed in this area.(i.e., for a 25" tree it would be 25 ft in diameter)
 3. Total CRZ needs to be preserved by at least 50%

| Tree diameter, DBH (inches) | Critical Root Zone, CRZ (feet) |
|-----------------------------|--------------------------------|
| 8 inches | 16 feet |
| 10 inches | 20 feet |

DESIGN CRITERIA
Division 32 – Exterior Improvements

| | |
|-----------|---------|
| 15 inches | 30 feet |
| 20 inches | 40 feet |
| 25 inches | 50 feet |
| 30 inches | 60 feet |
| 40 inches | 80 feet |

The Critical Root Zone- Development Impact

Example: 20 inch diameter tree

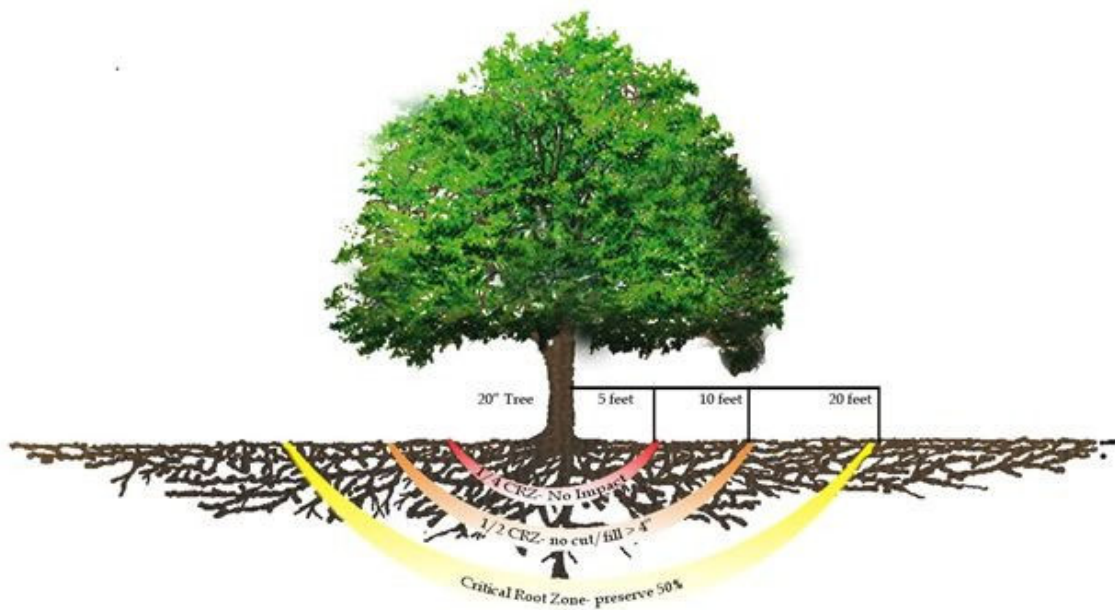

1.06 TREE PROTECTION FENCING

- A. All trees shown on plan to be preserved shall be protected with temporary chain-link fencing. In areas where installation of chain-link fencing would be detrimental to a tree or a tree’s root system, other methods of fencing may be acceptable per approval from SSC designated Arborist (i.e., Chain-link panels, plastic fencing, etc.).

DESIGN CRITERIA

Division 32 – Exterior Improvements

- B. Protection fencing shall be installed prior to the start of any site preparation work (clearing or grading) and shall be maintained throughout all phases of the construction project until substantial completion and the approval to remove the fencing from the SSC sponsored arborist.
- C. Tree protection fencing that is damaged or found to be non-compliant shall be repaired/replaced within 24 hours of notice or a stop work order shall be given. Tree protection found to be moved by anyone other than the project arborist or the SSC sponsored arborist will require that all work stop until the issue is investigated, the fence returned and any needed care, as determined by the arborist, is taken. Depending on all circumstances, a fine might be imposed to the contractor who moved the fencing.
- D. Erosion and sedimentation control barriers shall be installed or maintained in a manner that does not result in damage to the tree or Critical Root Zone (CRZ) and in a manner that does not result in soil buildup.
- E. Protective fences shall surround the trees or groups of trees, and will remain at the location specified in the approved site plan. For natural areas, protective areas shall follow the limit of construction line in order to prevent the following:
 - a. Soil compaction in the root zone area as a result from vehicular traffic, parking or storage of equipment and materials.
 - b. Root zone disturbances due to grade changes (greater than 4 inches of cut or fill). No removal of soil or piling of soil is permitted within the CRZ of protected trees.
 - c. Trenching not approved or authorized by the SSC designated Arborist.
 - d. Compaction from construction activities, including eating or resting under protected trees.
 - e. Welding or any other heat sources under or near trees.
 - f. Other activities detrimental to trees such as chemical storage, concrete clean-outs and other construction spoils. Portable toilets should not be placed within any area of a CRZ of a protected tree.
- F. Exceptions to installing fences at CRZ shall be permitted in the following cases:
 - a. Where there is to be an approved grade change, impermeable paving surface, tree well, or other such site development, erect the fence 2 to 4 feet beyond the area disturbed.
 - b. Where permeable paving is to be installed within a tree's CRZ, erect the fence at the outer limits of the permeable paving area (prior to site grading so that the area is graded separately prior to paving installation to minimize root damage).
 - c. Where construction activities come within 6 feet of any tree, Permission must be obtained from the Campus prior to any work. If

DESIGN CRITERIA

Division 32 – Exterior Improvements

approved, protection of the trunk with strapped on planking to the height of 8 feet (or the limits of lower branching) may be required in addition to the reduced fencing provided.

- d. Where trees are close to proposed buildings, erect the fence so there is 6 to 10 feet of workspace between the fence and the building.
- e. Where there are severe space constraints due to limits of construction (LOC) or other special requirements contact the SSC designated Arborist.

1.07 TREE TRANSPLANT SPECIFICATIONS

- A. Trees suitable for transplanting and their future locations shall be designated on site plan and marked on site at least six months prior to commencing site preparation activities.
- B. Tree transplant contractor should be allowed at least 90 days lead time for root pruning activities prior to moving trees. It is recommended that root pruning occur between the months of October and February, if possible.
- C. It is recommended that trees be moved between the months of October and February, if possible. A good example of pruning and moving a tree would be to prune in the fall and move during spring. Or visa versa.
- D. Final grading and elevation of transplant trees shall be confirmed by the SSC designated arborist and the appropriate Campus representative prior to final issuance of construction documents.
- E. Coordination of logistics for movement of transplant trees shall include RELLIS Facilities Department, general contractor, engineer, and SSC designated Arborist.
- F. Transplanting of trees shall be done in a manner that is industry standard (e.g., time-tested practices etc.). SSC designated Arborist shall approve these means and methods.
- G. The tree transplant contractor or landscape subcontractor shall maintain all transplanted trees during construction and for an additional twelve months following substantial completion and is responsible for the tree health. If the tree dies or declines to a state not suitable to the Campus, the contractor is responsible for replacement. If a tree fails to survive the above timeframe, a new tree(s) will be provided by the project.
- H. The project must either assign a certified arborist to care for trees within fenced areas, or designate the SSC sponsored arborist. Responsibilities of this area include irrigation, mulching, erosion control, weed control, insect and

DESIGN CRITERIA

Division 32 – Exterior Improvements

disease and any other necessary plant care activities.

- I. Construction activities shall not take place within five (5) feet of the edge of any transplant tree root ball

1.08 TREE REMOVAL AND REPURPOSING SPECIFICATIONS

- A. Trees approved for removal shall be removed in a manner that does not impact trees to be preserved.
- B. Contractor performing tree removal shall coordinate with SSC designated Arborist and the appropriate Campus representative to remove selected trees in a manner that will enable them to be processed into usable materials.
- C. Contractor will transport trees removed for repurposing on RELLIS Campus (exact onsite/offsite location TBD).

1.09 TREE PROTECTION DURING CONSTRUCTION

- A. Projects on the RELLIS campus shall adhere to specifications based on the most current editions of the following:
 - a. American National Standards Institute (ANSI) A300– 05 Management of Trees and Shrubs during Site Planning, Site Development, and Construction (latest edition).
 - b. ANSI z133.1 Safety Standards
 - c. Related ISA Best Management Practices (BMP's)
- B. Trees within LOC are ultimately the property of RELLIS Campus. All attempts shall be made to ensure survivability of trees in regards to construction impacts. Including:
 - a. Continuous inspection of tree protection fencing installed per Campus specifications and approved site plan (by SSC designated arborist and general contractor).
 - b. Any encroachments into tree protection fencing and CRZs shall be brought to the attention of the project manager and/or construction inspector, SSC designated Arborist, or SSC Landscape Services representative.
 - c. Deviations from approved tree preservation plans will occur only with written authority from SSC designated Arborist or the proper Campus representative.

1.10 CRITICAL ROOT ZONE MANAGEMENT

- A. Any roots two inches (2") or greater severed by construction activities shall be

DESIGN CRITERIA

Division 32 – Exterior Improvements

pruned flush with the soil. Roots severed shall be backfilled with quality soil or compost as soon as possible. Cuts to oak roots shall be made using disinfected tools and painted when finished. If exposed roots are not backfilled within 48 hours, cover them with organic material in a manner that reduces soil temperature and minimizes water loss due to evaporation.

- B. Excavations within CRZ shall be first assessed by means of air excavation. Utilizing a compressed air tool significantly decreases damage to roots.
- C. Locating roots using this method allows for proper root pruning and preservation techniques that will increase the chance of survival of the tree.

1.11 AIR SPADING SPECIFICATIONS

- A. Air Spading Specifications:
 - a. A compressor-powered air excavation tool shall be used to “pot- hole” (probe soil to certain depth in search of root material) proposed excavation areas.
 - b. Roots 2” and greater will be exposed and cut cleanly back to existing soil (wound paint and disinfected tools required for all oaks).
 - c. A quality topsoil and/or compost shall be used as backfill in areas where roots are present.
 - d. Coordinate with the requirements of the proposed Planting Soil section for modifications to the soil within the root zone of existing trees.
- B. Any trenching required for the installation of landscape irrigation shall be installed as far from existing tree trunks as possible, and must be outside of quarter CRZ. **No trenching underneath the drip line of existing trees.**
- C. No soil greater than 4 inches shall be permitted within the half CRZ of trees. No soil or mulch is permitted on the root flare of any tree. Compost may be used in this area if the mix and the use are approved by the SSC designated arborist and the proper Campus representative.
- D. Pruning to provide clearance for structures, vehicular clearance and equipment shall take place before damage occurs (ripping of branches etc.).
- E. All pruning shall be performed to ANSI A300 - 01 Pruning Standards (latest edition), ANSI Z133.1 Safety Standards, and be completed by tree care professionals with a minimum of an ISA Certified Tree Worker on site. No more than 25% of the tree may be pruned. Anything above 25% must be approved by SSC designated Arborist.
- F. SSC System designated Arborist and the appropriate Campus representative

DESIGN CRITERIA

Division 32 – Exterior Improvements

shall recommend approval of any modifications to the tree protection plan.

- G. Removal of Hardscape Areas from CRZ
- H. Special care shall be taken when removing sidewalks, streets, pavers, etc., from within CRZ. This will include but not be limited to:
 - a. Saw cutting and hand removal of materials within CRZ
 - b. Reduced heavy equipment access within CRZ. Any vehicle activity within these areas shall only be done with the consent of the SSC sponsored arborist.
 - c. Installation of mulch (4-6 inches) within CRZ for root protection
- I. Installation of Ground Protection Mats or Mulch
 - a. In areas where foot traffic or storage of lightweight materials is unavoidable, provide a layer of 4-5 inches of wood chips or mulch. Prior to any activity, near or under trees, communication and approval from the SSC sponsored arborist and the proper Campus representative is required.
 - b. Areas where heavy vehicle traffic is unavoidable provide a layer of 6-8 inches of wood chips or mulch and add ground protection mats on top.
 - c. Concrete Washout areas shall be outside of CRZ.
- J. Irrigation Standards for Trees Preserved on Site
 - a. In order to minimize impacts of construction, trees located within LOC and slated for preservation shall continue to receive the necessary levels of irrigation to ensure survival.
 - b. Trees within preservation zones will continue to be irrigated through the duration of the project.
 - c. Irrigation systems shall be continually monitored to ensure correct coverage.
 - d. If irrigation service is interrupted, water shall be provided by the general contractor. Water barrels, tree gators and water trailers/tankers are suitable substitutes. Maintenance of CRZ Areas within LOC
 - e. Contractors shall be responsible for grass and weed maintenance inside LOC and tree protection fence areas.
 - f. Grass will remain trimmed inside all tree protection fencing, work shall be performed on the same frequency as the surrounding area.
 - g. Routine hand weeding is required for all mulch areas located within the tree protection zone.
 - h. Trash inadvertently deposited within tree preservation zones shall be removed prior to trimming or mowing.

DESIGN CRITERIA

Division 32 – Exterior Improvements

K. Tree Inspections

- a. To ensure compliance of tree preservation, an SSC designated Arborist, Campus representative, and if necessary, a project appointed arborist, shall conduct regular inspections. Frequency based on project needs. Inspections shall include:
 - i. Tree preservation zone encroachment
 - ii. Structural integrity of tree protection fencing
 - iii. Irrigation/soil moisture levels
 - iv. Evidence of plant stress
 - v. Insects and disease activity
 - vi. Dust levels on leaves

1.12 TREE MITIGATION POLICY

A. Heritage Trees

- a. Heritage Trees (24" DBH and above) shall not be removed without a review process. That review will take into account the following:
 - i. Current health of the tree (tree is dead, tree is a risk, or tree is diseased)
 - ii. The tree is a danger to the public.
 - iii. SSC designated Arborist shall determine the current condition of the tree. If a tree is dead, diseased, or poses a risk.
 - iv. Final approval will be determined by the proper Campus representative.
 - v. Trees shall be replaced on a 3" to 1" ratio (i.e., if you have removed a 24" DBH tree, 72 caliper inches must be replaced).

B. 8"- 23" DBH Trees

- a. Trees shall be replaced on a 1" to 1" ratio. For example: a 20" diameter tree will be replaced by 20 caliper inches; this could mean five, 4" trees or ten, 2" caliper trees.

C. Trees less than 8" in diameter require a 1 to 1 replacement.

1.13 TREE REPLACEMENT REQUIREMENTS

- A. Tree mitigation shall be required when the above sizes of trees are removed. Examples shall include one or more of the following mitigation measures:
 - a. Planting replacement trees on the site in accordance with the latest edition of the American Standard for Nursery Stock (ANSI Z60.1).

DESIGN CRITERIA

Division 32 – Exterior Improvements

- b. Transplanting existing trees on site or nearby. Any transplant tree can count 50% toward total mitigation; for example: a 30” diameter oak would count toward 45 inches of required mitigated inches (due to heritage trees being replaced 3:1).
- c. All trees below 8” diameter that are preserved on site will count 50% toward total mitigation; for example: five 6” elm trees are preserved on the perimeter of the site – this would count toward 15 inches of required mitigated inches.

B. Quantities of Replacement Trees

- a. Existing tree inches are calculated in DBH inch but replacement trees are calculated in caliper inch (i.e.: 20” DBH tree removed equals 20 caliper inches replaced).
- b. Size of trees replaced on development sites should range between 1” and 4” in caliper. Trees greater than 4” may be planted if feasible and approved by SSC designated Arborist and the appropriate Campus representative.
- c. Replacement trees shall be planted to the extent of the site without jeopardizing spacing requirements for future growth of the trees, or impacting existing tree canopy.
- d. Newly planted trees on development projects shall be spaced in the following manner:
 - i. **ALL TREES SHOULD BE MIN 10FT FROM CENTERLINE TO EDGE OF ANY UTILITY DUCT BANK OR ASSIGNMENT.**
 - ii. Large trees shall be planted at least 30 feet off center
 - iii. Medium sized trees shall be planted at least 20 feet off center
 - iv. Small sized trees shall be planted with proper spacing per species
- e. Types of replacement trees: refer to the RELLIS Campus Master Plan: <https://rellis.tamus.edu/rellis-campus-master-plan/>
- f. A minimum of 5 different species from the RELLIS Campus Master Plan should be planted if more than 100 caliper inches is required. No more than 30% of one species should be planted.

C. Newly planted trees should have the following available soil volumes:

- a. Large trees (from RELLIS Campus Master Plan) - 1,200 ft³ to 2,000 ft³
- b. Medium trees – 1,000 ft³ to 1,500 ft³

DESIGN CRITERIA

Division 32 – Exterior Improvements

- c. Small trees (ornamental) – 500 ft³ to 1,000 ft³
- D. Planting Season Requirements - Optimal tree planting window in Central Texas is typically from October through March. Projects shall consider this during the site plan process. If possible, landscape installations should be held to that time frame. Signage and education materials can be used to assist in this area. Consider minimal plantings to suffice until planting season.

1.14 TREE CARE FOR EMERGENCY UTILITY WORK

It is recognized that emergency utility work is an ongoing necessity on campus. The following are guidelines to help best safeguard the RELLIS campus trees from this continual work.

DESIGN CRITERIA

Division 32 – Exterior Improvements

Examples of tree protection details for construction documents:

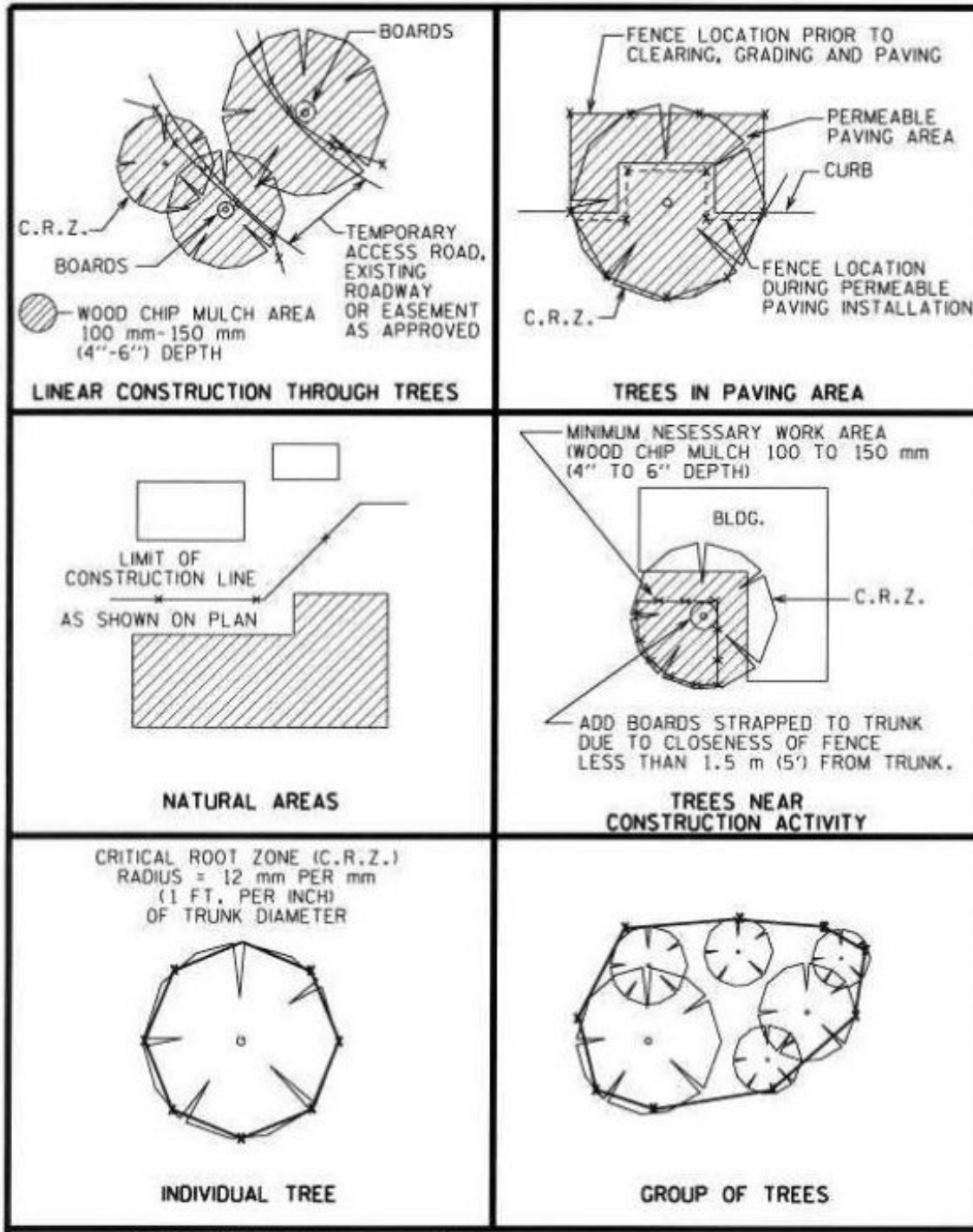

DESIGN CRITERIA

Division 32 – Exterior Improvements

Examples of tree protection details for construction documents:

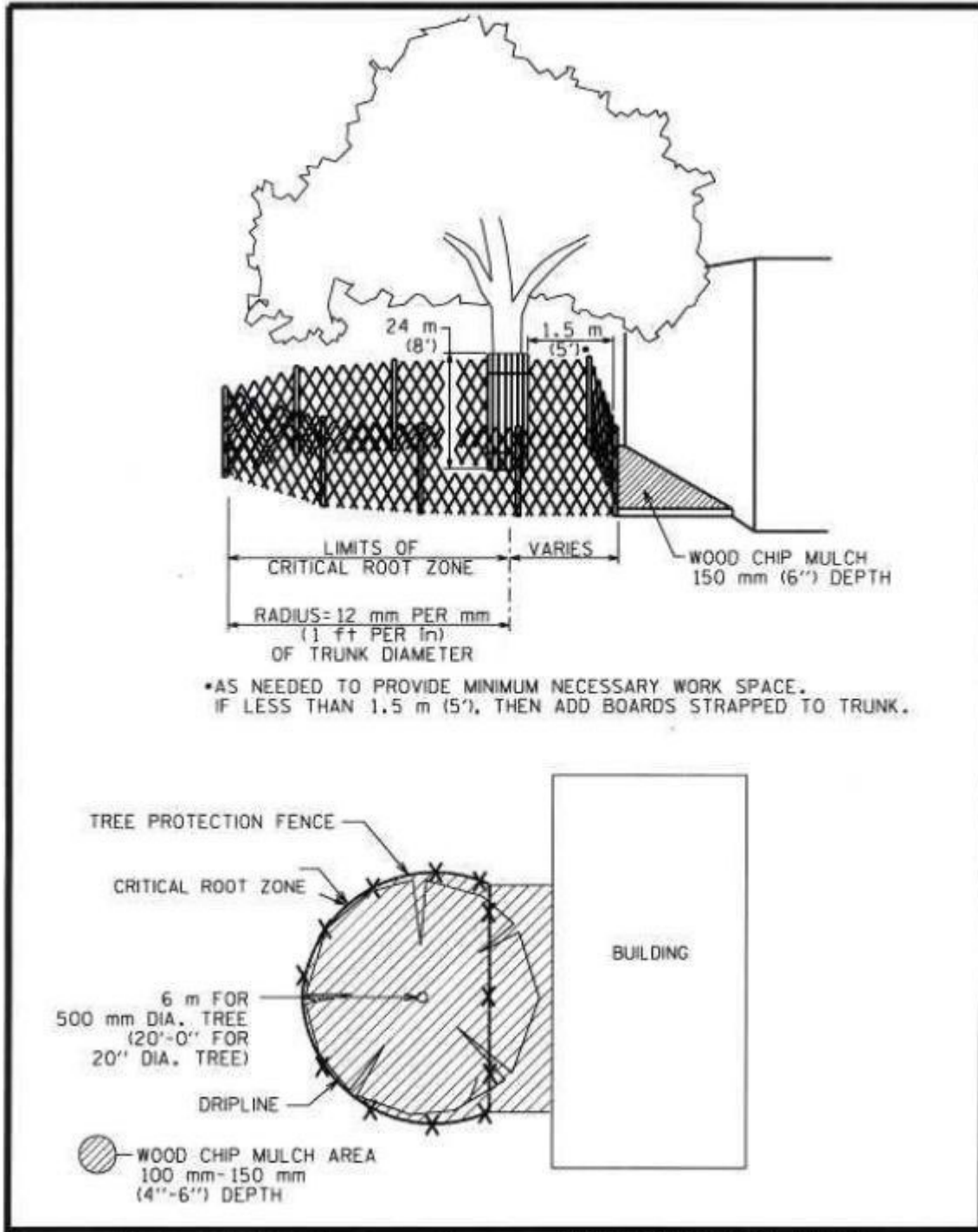

DESIGN CRITERIA

Division 32 – Exterior Improvements

Technical Standards for Tree Planting, Maintenance and Removal

2.01 TREE PLANTING SPECIFICATIONS AND DESIGN

- A. Projects on RELLIS Campus shall adhere to specifications based on the most recent editions of the following for tree planting: (**Any excavation work shall contact Texas 811 prior to digging.*)
- B. American National Standards Institute (ANSI) A300 – 06 Planting and Transplanting Standards (latest edition)
- C. American National Standards Institute (ANSI) Z60.1, standards for nursery stock
- D. ANSI Z133.1 Safety Standards
- E. Related ISA Best Management Practices (BMP's)
- F. Design Guidelines:
 - a. TAMUS will not approve designs proposing additional tree plantings within existing tree canopies and CRZ.
 - b. There shall be no site improvements located within the CRZ. Site improvements include: light fixtures, signage, paving that require excavating, tables/benches/walls that require footings.
 - c. There shall be no plant materials located within CRZ, including turf and groundcovers. Mulch only.
- G. Planting Soil: refer to RELLIS Campus soil specifications and standards.
- H. Irrigation: Refer to RELLIS Campus landscape irrigation specifications. Note: Tree irrigation zones (valves) must be separate from other landscape irrigation zones. Every newly planted tree shall have a minimum of 1 irrigation bubbler installed (drip allowed), with the goal of watering as much of the root ball surface area as possible.
- I. Staking: Place 3 t-posts (or similar) around each tree, and drive into existing soils. Preferred attachment method incorporates Arbortie-green by Deeproot Products or equivalent in lieu of wire or rope. Stakes should be removed after the first growing season. Posts must be marked for safety (PAINTED, SAFETY CAPS, etc.). Six foot t-posts are the typical means of staking. Thirty gallon size and below should have untreated 1" x 1" wooden stakes driven

DESIGN CRITERIA

Division 32 – Exterior Improvements

through the root ball into undisturbed soil.

- J. Tree Grates: Only in instances of pier and beam (floating-deck) walk areas will tree grates be permitted. These are areas where a significant gap exists between top of root ball of newly planted trees and the finished elevation of the hardscape. No tree grates shall be installed on existing mature trees.
- K. Types of Nursery Stock. Containerized grown trees and shrubs are available throughout the growing season and are preferred over use of bare root or root balls wrapped in burlap (B&B). The preference is for all plant material to be from a local seed source. TAMUS shall receive at least 48 hour notice of delivery of plants to job site.

2.02 PLANTING OF CONTAINERIZED TREES

- A. Roots of bare root trees should be moist and protected at all times prior to planting. Prepare planting hole for each plant before removing it from their protected area.
- B. The hole prepared shall be large enough to spread the roots without crowding. The sides of the hole shall be roughed to ensure glazing of hole does not occur.
- C. Inspect roots and prune any that appear broken or damaged.
- D. Place the roots in the hole at a level so that the soil surface will be at the same level where the plant was previously growing, as indicated by the slightly darker area of the trunk. Trees should be planted so that trunk flare is visible above the final soil surface.
 - i. Any tree that does not obviously have the root flare planted above grade will be rejected.
- E. Backfill with existing soil from the excavated hole, and add the soil into the hole a few inches at a time, firming the soil after each addition. While backfilling, be sure the plant remains vertical and be careful not to damage roots. Use water to settle the soil around the roots while backfilling. Do not compact wet soil.
- F. After backfilling is complete, DO NOT FORM A RIDGE (berm) around the edge of the hole to hold water.
 - i. Only Non-irrigated trees should receive a formed Ridge/Berm around

DESIGN CRITERIA

Division 32 – Exterior Improvements

the tree.

- G. Staking as noted in RELLIS Facility Design Guidelines.
- H. The edge of the tree ring should be cleanly cut with a 3" deep beveled shovel cut edge which holds mulch in place and prevents surrounding turf from growing into the tree ring.
- I. There should be no weeds, sod or debris in the tree ring.
- J. Tape, plant tags and bamboo support poles should be removed at planting.
- K. Ground pine bark mulch should be applied at 3" depth and should be pulled away from the trunk of the tree.
- L. Thoroughly water the tree at installation.

Example of bare root tree for construction documents:

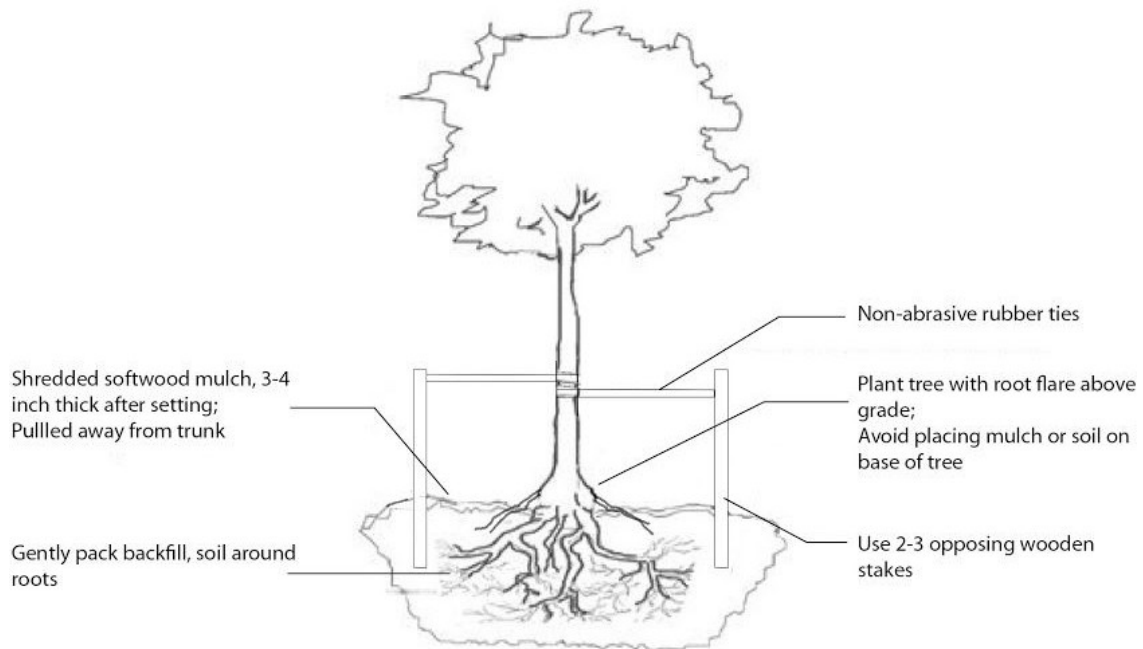

DESIGN CRITERIA

Division 32 – Exterior Improvements

2.03 PLANTING OF CONTAINERIZED TREES

- A. Prepare a planting hole as described in 2.02 above. The depth of the hole should be the same as the soil in the container, and the width of the hole should be at least twice the width of the container.
- B. Once the planting hole is prepared, lay the containerized tree or shrub on its side and gently slide the plant out of the container. It may be necessary to push on the sides of the container to loosen the root ball. If the plant has become root-bound and roots have circled the container, slice the root ball in 4-5 places with a pruning saw or hand pruners that will cleanly cut roots. Loosen exterior of root ball to promote lateral root growth.
- C. Place the intact ball in the hole. Trees should be planted so that trunk flare is visible above the final soil surface. Ideally, this is the same level at which the tree was growing in the container, but many trees are buried several inches deep.
- D. Roots which are girdling the trunk must be removed at planting.
- E. After backfilling is complete, DO NOT FORM A RIDGE (berm) around the edge of the hole to hold water.
 - a. Only Non-irrigated trees should receive a formed Ridge/Berm around the tree.
- F. Staking as noted in RELLIS Facility Design Guidelines.
- G. The edge of the tree ring should be cleanly cut with a 3" deep beveled shovel cut edge which holds mulch in place and prevents surrounding turf from growing into the tree ring.
- H. There should be no weeds, sod or debris in the tree ring.
- I. Tape, plant tags and bamboo support poles should be removed at planting.
- J. Ground pine bark mulch should be applied at 3" depth and should be pulled away from the trunk of the tree.
- K. Thoroughly water the tree at installation.

DESIGN CRITERIA

Division 32 – Exterior Improvements

Example of containerized tree for construction documents:

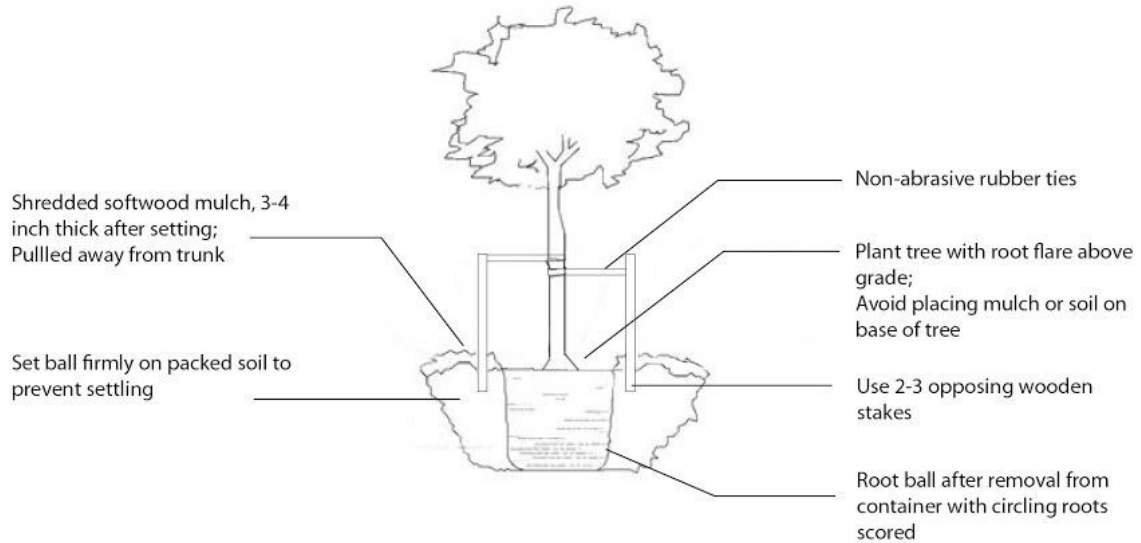

2.04 COMMON PLANTING PROBLEMS

- A. Planting too deep - roots suffocate
- B. Planting too shallow – roots dry out
- C. Hole too narrow – root system struggles to establish
- D. Soft fill added to bottom of hole – plant settles too deeply
- E. Twine left on trunk – girdles trunk
- F. Wire basket left intact – girdles roots
- G. Container tree circling roots left intact – root system struggles to establish/girdles trunk

DESIGN CRITERIA

Division 32 – Exterior Improvements

Example of tree for construction documents:

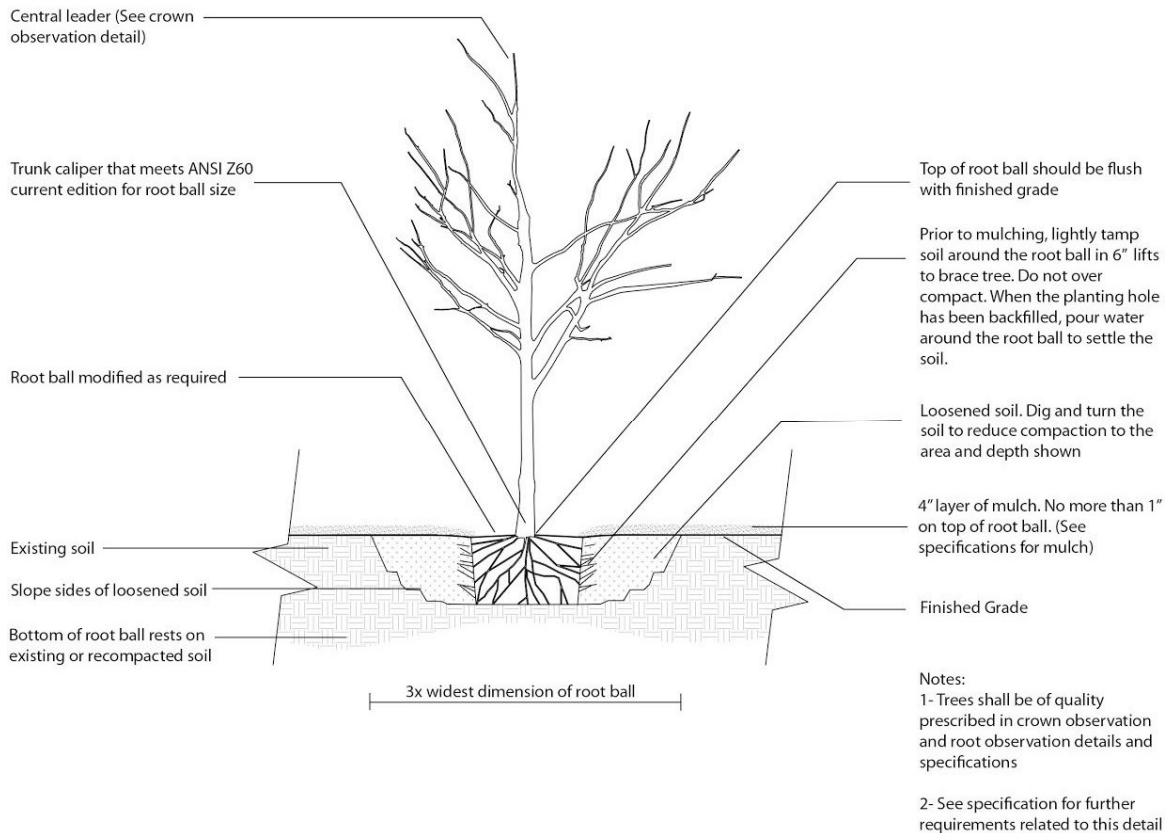

2.05 TREE PRUNING SPECIFICATIONS

- A. Projects on RELLIS campus shall adhere to specifications based on the most current editions of the following for tree pruning:
 - a. American National Standards Institute (ANSI) A300 - 01 Pruning Standards (Latest)
 - b. ANSI Z133.1 Safety Standards
 - c. Related ISA Best Management Practices (BMP's)
- B. Contractors will apply the standards and guidelines when engaged in pruning operations on campus. To ensure that pruning is appropriate for the species and tree/site conditions, it is important to have a clear understanding of the specific needs of the tree and the objectives for pruning.

DESIGN CRITERIA

Division 32 – Exterior Improvements

C. Requirements for Pruning Trees:

- a. No more than 25% of the tree may be pruned. Anything above 25% must be discussed and approved by SSC designated Arborist.
- b. No tree shall be cut back in such a manner that its health will be impaired. An exception to this may occur in tree removal or emergency storm damage situations in which protecting people or property is urgent. Any emergency procedures shall be brought to the attention of the SSC designated Arborist.
- c. When pruning cuts are made to a lateral branch, the remaining branch must possess a basal thickness of at least half the diameter of the wound affected. Such cuts shall be considered correctly done when the branch collar is left intact and the cut is not “flush” with the stem.
- d. Tree branches shall be removed and controlled in such a manner as not to cause damage to other parts of the tree or to other plants and property.
- e. All cutting tools and saws used in pruning shall be kept adequately sharpened so as to retain smooth surfaces and secure bark on all cuts.
- f. Precautions for the inadvertent transmittal of oak wilt will be recognized. This includes the disinfecting of cutting tools between trees and cuts to be treated with tree wound dressing.

D. Pruning Objectives:

- a. Maintenance Pruning: Recommended when the primary objective is to maintain or improve tree health and structure, and includes risk reduction pruning.
- b. Risk Reduction Pruning: Recommended when the primary objective is to reduce overall tree risk and chance of limb or tree failure.

E. Pruning Types:

- a. Crown Cleaning: The selective removal of one or more of the following items: dead, dying or diseased branches, weak branches and water sprouts.
- b. Crown Thinning: The selective removal of branches to increase light penetration, air movement and to reduce weight.

DESIGN CRITERIA

Division 32 – Exterior Improvements

- c. Crown Raising: The removal of lower branches to provide clearance.
- d. Crown Reduction or Shaping: Decrease the height and/or spread of a tree. Consideration should be given to the ability of the species to sustain this type of pruning.
- e. Vista Pruning: The selective thinning of framework limbs or specific areas of the crown to allow a view of an object from a predetermined spot.
- f. Crown Restoration: Should improve the structure, form and appearance of trees that have been severely headed, vandalized or storm damaged

F. Campus Clearance Recommendations:

- a. All trees and/or branches in or around infrastructure shall be shortened or removed when necessary to prevent damage to infrastructure or tree.
- b. Growth on the tree should be directed away from infrastructure such as buildings, light poles, power lines and signs by reducing and/or removing limbs on that area of the tree.
- c. Vertical clearance for roads shall provide a minimum clearance of 14 above street level. An 8' vertical clearance shall be provided for pedestrian walkways.
- d. Building Clearance:
 - i. Clear all branches and foliage in contact with or within 2 foot of roofs, walls, stairways, decks or other building appendages to the extent feasible while maintaining aesthetics and canopy structure. Prune to direct growth parallel to or away from the building.
- e. Exceptions will be made in instances that operations will eventually hinder the structural integrity of the tree or clearly cannot conform to ANSI A300 standards.

G. Prohibited Pruning Acts:

- a. Excessive Pruning: Except for clearance of utility lines, traffic or abating a public nuisance, excessive pruning will not be tolerated.
- b. Topping: Topping is the indiscriminate cutting of tree branches to

DESIGN CRITERIA

Division 32 – Exterior Improvements

stubs or lateral branches that are not large enough to assume the terminal role. Other names for topping include “heading,” “tipping,” “hat-racking,” and “rounding over.”

- c. “Lion Tailing”: Excessive removal of branches from the lower two-thirds of a stem or branch.
- d. No pruning of a tree’s canopy shall take place to compensate for removal or damage to its root system.
- e. No cavities shall be filled with any substance (except in instances of bee hive relocations)

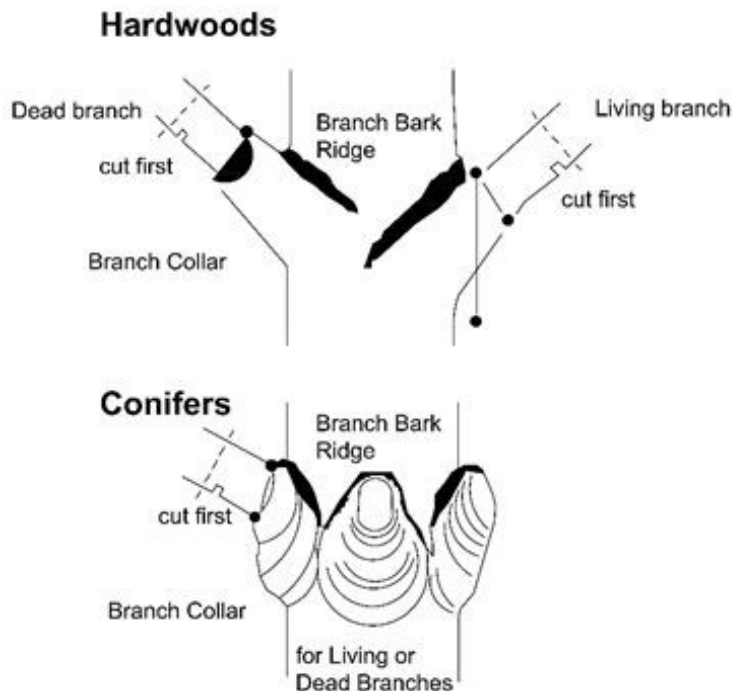

2.06 TREE REMOVAL SPECIFICATIONS

- A. Projects on the RELLIS Campus shall adhere to specifications based on the most recent editions of the following for tree removals:
 - a. American National Standards Institute (ANSI) A300 – 01 Pruning Standards (latest edition)

DESIGN CRITERIA

Division 32 – Exterior Improvements

- b. ANSI Z133.1 Safety Standards
- c. Related ISA Best Management Practices (BMP's)
- B. A campus tree shall not be removed without Campus owner representative review and approval.
- C. Any tree removed for campus operations will likely be dead or a risk to the Campus. These tree locations will be made available for new trees planted by SSC Landscape Services.
- D. Trees may be removed if:
 - a. A tree is infected with an insect or disease and its removal is recommended practice to prevent transmission.
 - b. The tree is creating an extreme nuisance because of its species, size, location, or condition. The nuisance could be caused by fruit or seed drop, harboring insects, root conflicts and excessive twig or limb breakage.
 - c. The tree is posing a severe safety risk that cannot be corrected by pruning, transplanting or other treatments. Tree risk assessments (per the ISA Tree Risk Assessment Qualification ANSI A300-09 Tree Risk Assessment (latest edition) should be performed as needed for significant trees.
 - d. The tree severely interferes with growth and development of a more desirable tree.
 - e. The tree's aesthetic value is so low that the site would be enhanced visually by the removal of the tree.
 - f. Any construction, improvements or maintenance to be made around the tree would substantially interfere with the tree's natural growth and size or would damage or destroy it.
 - g. The tree has been topped or disfigured thus producing an unsound branching structure conducive to severe storm damage, wind throw and accelerated death.

2.07 PLANT HEALTHCARE (PHC) FOR TREES

- A. A Soil Analysis shall be done when prescribing soil amendments and fertilizer for trees.
- B. The application of pesticides shall be done by a Texas Department of

DESIGN CRITERIA

Division 32 – Exterior Improvements

Agriculture (TDA) licensed applicator, and the products must be labeled to target the desired pest. All applications shall be logged and recorded per TDA rules. All pesticide recommendations must come from an ISA certified arborist.

- C. Tree Growth Regulators (TGR) must be applied by a TDA licensed applicator, and be used only as the label states. Special considerations are for trees in overhead utility corridors or smaller grower spaces, and trees growing in reduced soil volumes.

- D. Soil health is critical to the survival of trees at RELLIS. Several tactics are used to improve the soils where trees grow. These include incorporating various types of compost and other forms of organic matter (via soil injection or air-tillage), such as bio-char, mycorrhiza fungi, and humate. Fertilizers and fungicides are used only as a last resort where timing and condition of the tree are of utmost important.

GENERAL

All connections to campus utility distribution systems or public utilities shall be accurately located by dimensions or coordinates. Depth of piping shall be shown and inverts must be shown at manholes and other critical points.

All site utilities shall be included as part of the BIM(s). They shall be shown accurately in terms of size, depth, and location.

SANITARY SEWERAGE UTILITIES

The conventional sanitary sewer collection system shall be designed, installed, and tested in accordance with TCEQ requirements.

Gravity sanitary sewer mainlines shall be no less than 6" and services lines shall be no less than 4". Sanitary sewer piping and fittings shall meet UES design standards (<https://utilities.tamu.edu/design-standards/>) for High Density Polyethylene (HDPE) pipe with a DR 11 or heavier.

Manholes are required for all horizontal and vertical bends as well as changes in pipe size. Manholes on sanitary sewer mainlines shall be spaced per TCEQ rules and regulations 30 TAC 217. Sanitary sewer service lines shall have two-way cleanout spaced as required per accepted plumbing code and at the building. Appropriate wye fittings shall be used at service connections. Sanitary sewer manholes shall be pre-cast sections meeting ASTM C478 with a reinforced concrete base and resilient pipe connections meeting ASTM C923. Minimum 28 day concrete strength shall be 3,000 psi. Manholes shall be placed on 9" of 1-1/2 sack cement stabilized sand. A sealant shall be used between the ring/cover and throat adjustment rings and manhole chimney. The throat adjustment rings shall be 12" (minimum of 2 and a maximum of 4). Manhole construction, sizing (including manhole opening), invert slope, channel shape, and testing shall be in accordance with TCEQ requirements.

Sanitary sewer and storm sewer shall be shown on separate sheets along with profiles. Profiles on sewer lines shall be shown for all pipe sizes. The profiles shall show as a minimum, depth of cover, other utility crossings with verified elevations, slope, inverts, pipe material and class of pipe.

All pipes penetrating exterior walls or foundations of buildings below grade must be installed properly with sleeves to prevent breakage due to building settlement or expansive soil.

Sanitary sewer lift stations shall consist of precast (ASTM C478) or cast-in place reinforced concrete wet well containing a heavy-duty duplex pumping system readily accessible/removable for replacement/maintenance. A lockable hatch system of adequate size for maintenance/access shall be provided. A reliable level control system shall be

DESIGN CRITERIA

Division 33 – Utilities

provided to start/stop the pumps including a high level alarm. The basic control system shall consist of a remote disconnect, combination starter for each motor, H-O-A switches, visual and audible high level alarm, run lights and seal failure sensors. All Conduit connections to the wet well will be adequately sealed to sewer gases/moisture. Pump discharge piping for each pump shall be flanged ductile iron containing a check valve and plug valve located in a valve pit exterior to the wet well. Metal surfaces inside the wet well and the inside surfaces of the wet well shall be protected by appropriate coatings. Valve pit shall have a lockable hatch of adequate size for operation and maintenance of valves.

Sanitary sewer force mains shall be AWWA C906 DR 11 or heavier. Exposed piping shall be ductile iron with appropriate coating protection. PE material shall have a minimum designation number of PE4710 and the resin used in the extrusion of the polyethylene pipe shall conform to ASTM D3350 Cell Classification PE445574C. Fittings shall be butt-fusion or electrofusion type, with DR number, designation number, and cell classification matching pipe. Fittings and stock shall meet ASTM D3261, ASTM F1055, and AWWA C906 as appropriate. All angles, bends, tees, etc. shall be stabilized with concrete thrust blocks, sized by the Project A/E. All non-metallic force mains shall have aluminum detector tape 12" placed below final grade.

The sanitary sewer system shall be designed, installed and tested in accordance with Texas Commission on Environmental Quality (TCEQ) requirements. All interior beads shall be milled from the PE pipe to allow for deflection tests. Deflection tests shall be by a mandrel pulled 30 days following trench backfill. All tests shall be witnessed by the Owner.

STORM DRAINAGE UTILITIES

The storm drainage planning and design shall follow the current adopted Bryan/College Station Unified Stormwater Design Guidelines (B/CS USDG) and any adopted amendments and/or updates thereto. This Facility Design Guidelines manual directs all users to utilize the Atlas 14 rainfall values stated herein in lieu of the values stated within the B/CS USDG. The current adopted version can be found at www.bcsunited.net; however, developer shall insure that the most current adopted version is used regardless of the version located at weblink. In situations that the B/CS USDG and this manual contradict one another, this manual shall take precedence.

The following two items should be considered during the design process.

1. Diversion of stormwater away from the natural watercourse will not be allowed, except within the property boundaries controlled by the developer under the following conditions:
 - a. The storm water is returned to its natural flowing watercourse prior to leaving the developer's property,

DESIGN CRITERIA

Division 33 – Utilities

- b. For watersheds greater than twenty (20) acres, a timing analysis of the existing and diverted hydrograph must be performed to confirm that the peak flow rate has not been increased at the point that it reenters the watercourse, as a result of the diversion.
2. All developments shall provide adequate drainage outfall at the lower end of the site into an existing ditch, channel, drainage easement or right-of-way, or to the centerline of an existing natural drain. Where a proposed street, storm drain, or open channel does not discharge into a natural low or into an existing adequate drainage easement, then facilities and drainage easements of adequate width — to contain the design discharge — shall be constructed and dedicated to the centerline of an existing natural low within the same watershed.

Storm sewer conveyance system (pipes or open channels) sizes shall be determined by a licensed Texas Professional Engineer (PE) and are to be based on existing/future capacities determined by a drainage study following the parameters contained within these guidelines and the B/CS USDG. If the existing infrastructure cannot accommodate the increased capacity, then onsite detention/retention pond(s) shall be required or the development shall bear the cost to construct adequate infrastructure to a regional pond facility, if available and as approved by the RELLIS Campus Facilities and Construction Department. Developer shall be responsible for acquiring easements and/or right-of-ways as needed to construct conveyance system.

Channels

A fifteen (15) foot access road on one side of the extreme limits of the channels is required when channels do not parallel and adjoin an alley or roadway. Where utilities are installed in the access road of the channel, the access road will be widened to seventeen (17) feet. The access road will slope toward the channel with a maximum cross slope of one (1) inch per foot. Additionally, the top of utility manholes or any at-grade appurtenances within the access road shall match the finish ground surface elevation within zero (0) to plus (+) four (4) inches at the time of construction or as set forth in the B/CS USDG, whichever is most stringent.

The channel(s) shall be designed for the ultimate twenty-five (25) year storm with freeboard. If the drainage area to the channel is more than one hundred (100) acres, the channel shall be designed for the ultimate one hundred (100) year storm.

Modifications to existing watercourses or newly created open channels may be designed as earthen channels, concrete lined channels or a combination of both. Liners other than grass or concrete which enhance the aesthetics or habitat value of the watercourse and which reduce future maintenance requirements are encouraged. Preliminary planning for the applicability of other channel liners shall be reviewed with the RELLIS Campus Facilities and

DESIGN CRITERIA
Division 33 – Utilities

Construction Department Manager or his/her representative prior to the submittal of construction plans for approval.

The constructed channel geometry may be triangular, rectangular or trapezoidal in shape. All channel side slopes should be 4H:1V or flatter to provide ease of maintenance and vehicular protection.

Earthen

The design of earthen channels shall not have side slopes steeper than four (4) horizontal to one (1) vertical and shall provide adequate conveyance capacities as set forth in these guidelines.

Concrete

From the top of the concrete lining to the top of the ditch, a side slope not steeper than four (4) horizontal to one (1) vertical shall be required; nor shall the slope be less than twelve to one (12:1). The minimum longitudinal slope shall be 0.4 percent, or 0.1 percent with a minimum "cleaning" velocity of three (3) feet per second (3 fps) during an existing conditions five (5) year storm event. The depth of all tie downs shall be thirty-six (36) inches upstream, twenty-four (24) inches downstream, and eighteen (18) inches for side slopes.

Concrete Reinforced Riprap side slopes shall not be steeper than one and one-half (1½) horizontal to one (1) vertical, unless soil tests made by a geotechnical engineer show that a greater slope, or a special design, will be stable. Where vehicular traffic may travel within a horizontal distance equal to one-half (½) the vertical rise of the slope, a two-foot surcharge load shall be included in the design.

Fencing, guardrails or handrails will be required adjacent to the channel where channel vertical wall heights exceed two (2) feet. Fencing will also be required adjacent to the channel where channel side slopes exceed two to one (2:1) and the channel depth is greater than two (2) feet. The fencing must not cause sight distance problems for motorists.

Vertical walls will not be permissible for depths greater than two (2) feet unless properly fenced or enclosed. Walls will have a minimum thickness of six (6) inches.

Backfill

When the plans indicate fill of a channel side slope, the fill material shall be placed in layers not to exceed 12 inches and shall be benched or notched into existing slopes. Each lift of fill shall be compacted to the required Density and moisture contents shown below, unless otherwise shown on the plans:

Subgrade Material Density Moisture Content

DESIGN CRITERIA

Division 33 – Utilities

| | | |
|---------|--------------------------|------------------------|
| PI ≤ 20 | ≥ 95% of Max Dry Density | -2% of Opt. or greater |
| PI > 20 | ≥ 95% of Max Dry Density | ≥ Opt. Moisture |

The maximum dry density and optimum moisture content shall be determined in accordance with TxDOT Test Method Tex-114-E. Tests for in place density shall be made in accordance with TxDOT Test Method Tex-115-E and within 24 hours after compacting operations are completed. If the material fails to meet the density specified, it shall be re-worked as necessary.

The fill material shall be free from roots, trash, silt and objectionable debris and shall be approved by the Engineer. The channel side slopes, in fill areas, shall be cut to the finished dimensions after completion of the fill process.

Concrete Riprap

Concrete riprap shall be reinforced with No. 3 or No. 4 reinforcing bars spaced at a maximum of 18 in. in each direction unless otherwise shown. Provide a minimum 6-in. lap at all splices. Provide horizontal cover of at least 1 in. and no more than 3 in. at the edge of the riprap. Place the first parallel bar no more than 6 in. from the edge of concrete. Use approved supports to hold the reinforcement approximately equidistant from the top and bottom surface of the slab. Adjust reinforcement during concrete placement to maintain correct position.

Sprinkle or sprinkle and consolidate the subgrade before the concrete is placed as directed. All surfaces must be moist when concrete is placed.

Compact and shape the concrete once it has been placed to conform to the dimensions shown on the plans. Finish the surface with a wood float after it has set sufficiently to avoid slumping to secure a smooth surface or broom finish as approved. Cure the riprap immediately after the finishing operation.

Concrete Pilot Channels

Concrete Pilot Channels must be used within the flowline of all earthen, grass lined drainage channels when the minimum "cleaning" velocities within the channel are not met. The concrete pilot channels shall have a minimum width equal to one-third (1/3) of the channel's bottom width and be constructed of reinforced concrete, minimum 4" thick. The concrete shall be reinforced with No. 3 or No. 4 reinforcing bars spaced at a maximum of 12 in. in each direction. Provide a minimum 6-in. lap at all splices. Provide horizontal cover of at least 1 in. and no more than 3 in. at the edge of the pilot channel. Place the first parallel bar no more than 6 in. from the edge of concrete. Use approved supports to hold the reinforcement approximately equidistant from the top and bottom surface of the slab. Adjust reinforcement during concrete placement to maintain correct position.

Storm Sewer Pipe

The minimum cleaning velocity for a storm sewer line is three (3) fps for a 5 year event is recommended. The maximum velocity for a storm sewer trunk line is 15 fps.

The minimum slope for the storm sewer line is 0.3% or as approved by the RELLIS Campus Facilities and Construction Department Manager. The minimum pipe size for main lines shall be 24-inches in diameter unless the option for multiple smaller sized pipes are approved by the RELLIS Campus Facilities and Construction Department Manager.

Storm sewer lines should not be placed below/underneath buildings or structures unless approved by the RELLIS Campus Facilities and Construction Department Manager. If a proposed building or structure is over an existing storm drain, the storm drain should be relocated around the exterior of the building or structure at the expense of the developer.

Campus storm sewer main lines shall be High Density Corrugated Polyethylene (HDPE) dual walled pipe. Campus storm sewer laterals or “yard lines” may be SDR 26 PVC (ASTM D3034) or heavier for less than 18-inches or as approved by the RELLIS Campus Facilities and Construction Department Manager

- A. HDPE pipe and fittings shall be manufactured in accordance with requirements of ASTM F 2306, latest edition. The pipe shall have a full circular cross section, with an outer corrugated pipe wall and a smooth inner wall.
- B. Virgin material for pipe and fitting production shall be used and be high density polyethylene conforming with the minimum requirements of cell classification, as defined and described in the latest version of ASTM D3350, except that carbon black content should not exceed 4%.
- C. Minimum Pipe Stiffness (PS) at five percent deflection shall be as described in ASTM F 2306, Section 6.3 when tested in accordance with ASTM D 2412.
- D. All HDPE Corrugated and Smooth Lined Pipe shall be certified through the Plastics Pipe Institute (PPI) Third Party Certification program. All HDPE pipe delivered and used shall bear the Third Party Administered PPI seal.

All pipe shall be clearly marked at intervals of not more than 10 ft, and fittings and couplings shall be clearly marked as follows:

- A. Manufacturer’s name, trade name, or trademark
- B. Nominal size

DESIGN CRITERIA

Division 33 – Utilities

- C. Specification designation (e.g. ASTM F 2306)
- D. Plant location
- E. Date of manufacture
- F. Legend polyethylene (PE)

Joints shall be installed such that the connection of pipe sections will form a continuous line free from irregularities in the flow line. Joints shall conform to one of the following:

- A. Integral Bell and Spigot. The bell shall overlap a minimum of two corrugations of the spigot end when fully engaged. The spigot end shall have an O-ring gasket that meets ASTM F 477 “Specification for Elastomeric Seals (Gaskets) for Joining Plastic Pipe.”
- B. Exterior Bell and Spigot. The bell shall be fully welded to the exterior of the pipe and overlap the spigot end so that the flow lines and ends match when fully engaged. The spigot end shall have an O-ring gasket that meets ASTM F 477 “Specification for Elastomeric Seals (Gaskets) for Joining Plastic Pipe.”
- C. Watertight Joints. When required, watertight joints shall be in accordance with the requirements of ASTM 3212.

The pipe shall be bedded in accordance with the requirements of ASTM D 2321, and manufacturer’s recommendations. A minimum of 6 inches of bedding shall be provided prior to placement and shall be loosely compacted. Maximum material size limited to 1½ inches.

The minimum cover for HDPE storm pipe shall be two and-a-half feet (2.5’) for all mains as measured from the outside top of pipe vertically to finished ground or pavement, provided that all HDPE pipe be encased with manufacturer recommended backfill filling the void between trench wall and pipe outer diameter up to a minimum 24-inches above crown of pipe or as approved by the RELLIS Campus Facilities and Construction Department Manager.

Storm roof drains shall be run separately from all other storm water sources to the outside of the building and collected by underground storm drain laterals connected to an associated storm drain collection system.

Manholes and Junction Boxes

Manholes and/or junction boxes with access openings shall be installed on the storm sewer system at all piping intersections, changes in slope and angle points with the exception of small drain leads which may use appropriate wye fittings. Access Manholes or junction boxes shall have a maximum spacing of 300’ for 24” diameter pipe and smaller, and 400’ for

DESIGN CRITERIA

Division 33 – Utilities

larger than 24" diameter. Manholes shall be either pre-cast (ASTM C 478) or cast-in-place with a reinforced concrete foundation. Junction boxes shall be of reinforced precast or cast-in-place construction. In high visibility areas near buildings, at pedestrian drop off points or within driveways/aisles, Manholes and Junction Box tops may be cast-in-place to allow finished lines and grades of the design plans to match evenly with inlet tops. Minimum 28 day concrete strength shall be 3,000 psi. Foundation for manholes and/or junction boxes shall be on 1-1/2 sack cement stabilized sand.

At the spring line of the pipe, the inside wall of the junction box must be a minimum of the outside diameter of the pipe, plus six (6) inches on each side of the pipe. If the pipe is at a skew to the junction box wall, additional distance is required. When an upstream conduit is smaller than the downstream conduit, it is preferable to match conduit soffits, unless the upstream conduit needs to miss a conflict such as a utility or minimum conduit cover.

Inlets

Area inlets for the storm sewer system shall be either pre-cast or cast-in-place reinforced concrete with frame and grate iron castings conforming to ASTM A48 Class 35B and shall be traffic rated. Curb inlets shall also be either precast or cast-in-place with a manhole frame and cover installed in the top to allow access. In high visibility areas near buildings, at pedestrian drop off points or within driveways/aisles, inlet tops may be cast-in-place to allow finished lines and grades of the design plans to match evenly with inlet tops. Minimum concrete 28-day compressive strength for inlets shall be 3,000 psi.

Grate Inlets in Sump Grates should be designed assuming a clogging factor of 50%. When calculating the capacity of a grate inlet the net area of opening should be used, minus 50% for the clogging assumed above when calculating its capacity. The flow of water through grate openings may be treated as the flow of water through a rectangular orifice.

Headwalls

Storm sewer discharge points shall be stabilized with either a pre-cast or cast-in-place headwall structure with adequate surrounding rip-rap (concrete or appropriately sized loose rock) to control erosion. The typical headwalls for circular pipe or box culverts shall follow the Texas Department of Transportation (TxDOT) standards for cast-in-place or precast headwall structures. Minimum concrete 28-day compressive strength for headwalls shall be 3,000 psi or as directed by TxDOT standards. Headwalls that create a vertical drop of 24" or more near pedestrian access areas shall incorporate the appropriate RELLIS Campus standard guardrail or handrail into the structure.

Frames, Grates, Rings, and Covers

Provide 30-inch diameter access openings for all manholes, Junction Boxes and Inlets. Iron

DESIGN CRITERIA

Division 33 – Utilities

castings for manhole rings, grates, frames and covers shall conform to ASTM A 48, Class 35B and be traffic rated. All covers for storm sewer applications shall be marked "Storm Sewer".

Reinforced Concrete Box Culverts

Precast reinforced concrete box culverts shall be manufactured in accordance with the latest revisions published by the American Society for Testing Materials of the following specifications:

- A. ASTM C1577 – Precast Reinforced Concrete Monolithic Box Sections for Culverts, Storm Drains and Sewers, Designed According to AASHTO LRFD.
- B. ASTM C1677 – Joints for Concrete Box Using Rubber Gaskets

Unless otherwise specified, all boxes furnished shall be fabricated with water-tight rubber gasket joints.

Trench shall be fine graded to the established sub-grade and re-compacted to a density of at least 90% of maximum as determined using ASTM D 698. Any over excavation of the subgrade shall be filled with 2 sacks per cubic yard of cement stabilized sand.

All box sections must be laid in a straight line with the tongue end of the box section pointed downstream entering the grooved end of the previously laid box section, to full depth.

No box sewer shall be laid in a trench in the presence of water. All water shall be removed from the trench sufficiently ahead of the sewer placing operation to insure a dry, firm bed on which to place the sewer, and if necessary, the trench will continue to be dewatered until after the sewer is bedded and backfilled as directed by the Engineer. Removal of water may be accomplished by pumping or pumping in connection with the well point installation as the particular situation may warrant. The Contractor shall satisfy himself as to the soil conditions to be encountered.

Where necessary, to comply with OSHA Regulation 1926.650, the side of the trench or other excavation shall be braced and rendered secure to the satisfaction of the Engineer. Board sheeting and/or steel sheeting may be utilized as directed by the Engineer. The bracing shall be in accordance with OSHA requirements.

Following compaction of the trench bottom at the established grade, the Contractor shall place a minimum of a 6 inch thickness gravel bedding in such a manner that once the box sections are laid, the invert elevation in the box section shall conform to the plan elevations. No voids in the bedding material shall be permitted.

DESIGN CRITERIA

Division 33 – Utilities

Should multiple parallel precast box culverts be used for a storm drain line, the spacing between adjacent boxes shall be six (6) inches. An increase in this dimension will require additional consideration of the fill material between the boxes. Should multiple conduits, other than multiple parallel precast box culverts mentioned above, be used, the minimum spacing between conduits should be one (1) foot to allow for the compaction of backfill around the conduits.

Backfilling

Backfilling to the top of the box culvert (initial backfill) shall be completed by one of the four methods 1., 2., 3, or 4. below. Backfill behind cast-in-place culvert walls shall not begin until the concrete has attained a compressive strength of 2,000 psi. Backfill on top of cast-in-place supporting slabs shall not begin until the concrete has attained a compressive strength of 3,000 psi. Avoid wedging action of backfill against structures. If necessary, to prevent such action, step or serrate slopes bounding the excavation. Place backfill along both sides of culverts equally and in uniform layers. Where backfill occurs beneath a road surface the material from two (2) feet below subgrade to the established base material shall be compacted to a density of 98% standard proctor density (ASTM D 698). For materials that require backfilling at an elevation of two (2) feet below subgrade and below, follow project geotechnical recommendations.

1. Suitable On-site Excavated Material

Suitable materials shall be CL/CH materials as determined by the Uniform Soil Classification System that are cohesive in nature, free of debris and organic materials and acceptable to the Engineer. Material for backfill shall be placed in uniform layers not more than 12 inches in depth (loose measurement) and shall be compacted to the density specified herein. Each layer of backfill material, if dry, shall be wetted uniformly to the moisture content required to obtain the specified density and shall be compacted to the required density, by means of a mechanical tamper.

Each lift of fill shall be compacted to the required density and moisture content as shown below, unless otherwise shown on the plans:

| Subgrade Material | Density | Moisture Content |
|-------------------|--------------------------|------------------------|
| PI ≤ 20 | ≥ 95% of Max Dry Density | -2% of Opt. or greater |
| PI > 20 | ≥ 95% of Max Dry Density | ≥ Opt. Moisture |

The maximum dry density and optimum moisture content shall be determined in accordance with TxDOT Standard Laboratory Test Method Tex-114-E. Tests for in place density shall be made in accordance with TxDOT standard laboratory test method Tex115-E and within 24 hours after compacting operations are completed. If the material fails to meet the density specified, it shall be re-worked as necessary to obtain the density required.

2. Select Fill

A clean gravel, or gravel approved by the Engineer, may be used for backfill material from the bottom of the trench to the top of the conduit or as otherwise shown on the plans. The gravel shall be placed in the trench in loose lifts not to exceed 12 inches in depth and lightly tamped to consolidate and seat the mass against conduit and earthen surfaces.

3. Controlled Low Strength Material (CLSM)

CLSM shall be placed by direct discharge from a mixer truck or other approved method. A minimum of 30 psi at 3 days and maximum strength of 800 psi at 28 days is required.

A filter fabric shall be placed on the top and the sides of the gravel backfill (initial backfill) between the trench sides as well as the secondary backfill. The filter fabric shall conform to the requirements of Texas Department of Transportation Material Specification DMS-6200, Type1.

Mark precast boxes with the following:

name or trademark of fabricator and plant location;
ASTM designation;
date of manufacture;
box size;
minimum and maximum fill heights;
designated fabricator's approval stamp.

REGIONAL STORMWATER MANAGEMENT PROGRAM (RSWMP)

RSWMP Overview

The RELLIS Campus determined that regional stormwater management is preferable to site-specific storm water mitigation. The regional stormwater management program provides for the administration, planning, design, construction, and operational management of regional stormwater facilities (RSWF). Regional stormwater management uses a watershed-wide approach to analyze potential flooding problems, identify appropriate mitigation measures and select site locations and design criteria for RSWF. These RSWF include, but are not limited to, regional detention and retention ponds, watershed protection, land purchase, waterway enlargement, channelization, and improved conveyance structures. The regional stormwater management program allows developers to participate in the program rather than constructing the on-site detention controls required by this section, when the RELLIS Campus has determined that the increased runoff from the proposed development will not produce a significant adverse impact to other properties.

RSWMP Participation

- A. All developers shall participate in the RSWMP in one of the following ways:
- B. Construction of on-site or off-site measures (typically storm water detention facilities) to mitigate increases in runoff resulting from the proposed development.
- C. Construction or participation in the construction of an off-site RSWF to mitigate increased stormwater runoff anticipated from ultimate development of the watershed.

Adverse Impact

Three (3) development conditions shall be analyzed with each adverse impact analysis:

- A. Existing Conditions. This refers to current development conditions in the watershed and on site. This shall be used as the baseline for determining the impact of the development of the site, or the watershed, to other properties or drainage systems.
- B. Proposed Conditions. This refers to existing conditions with the proposed development added. This shall be used to determine if the increased runoff from the proposed development results in an adverse impact to other properties or drainage systems.
- C. Ultimate Conditions. This refers to ultimate development conditions within the watershed. In addition to being used to design proposed drainage facilities this condition shall also be used to determine if the increased runoff from the ultimate development of the watershed results in an adverse impact to other properties or drainage systems.

The RELLIS Campus may reject a developer's request to participate in the RSWMP by mitigation and require on-site detention. The Campus' decision will be based on the knowledge of significant adverse impacts that would be created by ultimate development of the watershed regardless of the distance from the development to the area of concern. The Campus may also reject a request for participation when it is not in the best interests of the RSWMP. The developer is recommended to meet with the RELLIS Campus Facilities and Construction Department manager to discuss participation options prior to commencing design of a project. This preliminary meeting in no way relieves the developer of his responsibility to prepare the necessary engineering documentation to support his request for participation.

Atlas 14 Hydrology

All RELLIS Campus hydrologic studies/analysis shall use rainfall data provided by NOAA Atlas 14 publication.

WATER UTILITIES

The domestic water system shall be designed, installed, and tested in accordance with TCEQ requirements.

Domestic water piping and fittings shall meet UES design standards (<https://utilities.tamu.edu/design-standards/>) for High Density Polyethylene (HDPE) pipe with a DR 11 or heavier. Exposed piping shall be ductile iron with appropriate coating protection. Fittings may also be ductile iron (AWWA C153) with flanged ends. Appropriately spliced and terminated tracer wire or aluminum tape shall be laid with all non-metallic sewer piping.

All angles, bends, tees etc. shall be stabilized with concrete thrust blocks sized by the Project A/E. Appropriately spliced and terminated tracer wire or aluminum tape shall be laid with all non metallic water line.

Line valves shall be placed at all points of connection to existing water lines, at branch intersections and any other location necessary for adequate control of the water system. Typically the number of valves at an intersection will equal the number of branches less one. "In line" valves shall be placed in long runs of pipe at approximate 1000 foot spacing. Adequately supported air/vacuum relief valves shall be installed as required along the main in enclosures to facilitate drainage and maintenance/inspection.

Line valves 3" and larger shall be direct bury resilient wedge gate valves meeting the requirements of AWWA C509 with flange joints and non rising stem nut operator. Valves shall be poly wrapped in accordance with AWWA C105. All valve operators shall open when turned counterclockwise and close when turned clockwise.

Line valves smaller than 3" shall be bronze body ball valves with threaded connectors, stainless steel ball and stem, lever operated with a rated working pressure of 200 psi.

Cast iron adjustable valve boxes with surface reinforced concrete collar shall be provided over all buried valves to provide access from ground surface to valve operating nut. A gate valve extension shall be provided and terminate 1' from the top of the box when the operating nut is more than 2' from the top of the box.

Adequate fire hydrants shall be placed around the facility such that no portion of the building is over 300 feet from a hydrant. Fire hydrants shall be 5 1/4" main valve opening with 2 ~ 2 1/2" hose nozzles and a 4 1/2" pumper nozzle. Coordinate nozzle size and thread requirements with entity providing fire protection. Hydrants shall be dry-top compression type hydrants, traffic model, complying with AWWA C502. Auxiliary gate valves shall be placed in all hydrant leads.

Where necessary, connections to existing water mains shall be a "hot" tap using a tapping sleeve and valve appropriate to the type of pipe being tapped. No full size taps shall be made without approval by the Owner.

DESIGN CRITERIA

Division 33 – Utilities

The domestic water supply to a facility shall be metered unless directed otherwise by the Owner.

The complete site domestic water system installed for the project shall be pressure tested for leakage in accordance with TCEQ requirements along with applicable fire protection codes and shall be disinfected in accordance with the requirements of AWWA C651.

All water lines shall have an aluminum detector tape placed 12” below final grade.

CONCRETE UTILITY BOXES

Concrete boxes required by the mechanical, plumbing, civil site work and/or electrical divisions must be properly dimensioned, reinforced and/or detailed.

Chilled water and heating water valves in underground systems shall have as an enclosure a concrete valve box with sufficient space to maintain and operate valves. Direct buried valves may be considered if acceptable to the System Mechanical Engineer.

CHILLED AND HEATING WATER DISTRIBUTION

The RELLIS Campus requires the use of Extra High Molecular Weight Plus (EHMW Plus) High Density Polyethylene (HDPE) pipe due to its additional performance against abrasion, higher pressure and elevated temperatures. Refer to UES design standards (<https://utilities.tamu.edu/design-standards/>).

This pipe is manufactured with the PE4710 resin. For chilled water and domestic cold water a minimum of SDR 17 is required. For heating water and domestic hot water a minimum of SDR 11 is required. For heating water, all pipes shall be “DOW 2499 Water” per the specification in Appendix A (attached).

The following standards and practices shall be adhered to:

Polyethylene fabricated fittings shall be manufactured from polyethylene pipe, sheet stock or molded fittings meeting the material requirements of this specification and all appropriate requirements of AWWA C-901 or AWWA C-906.

Polyethylene fittings, including custom fabrications, shall have the same internal pressure rating as the mating pipe. At the point of fusion, the wall thickness and outside diameter of the fitting shall be in accordance with AWWA C-901 or AWWA C-906 for the same pipe size

For campus buildings served by RELLIS central thermal distribution systems, supply and return lines typically have piping with identical size and material for each system - chilled

DESIGN CRITERIA

Division 33 – Utilities

water (CHW), heating hot water (HHW), and domestic hot water (DHW). Because these thermal distribution lines are identical in size and appearance for each thermal system, there is the potential for cross-connection between supply and return.

To avoid possible cross-connection of supply and return lines, design engineers shall require field verification in construction documents and contractors shall field verify the configuration of supply and return lines, using an appropriate temperature sensing device and adequate system flow, before making building connections.

Any discrepancy between construction documents and field verification should be promptly reported to the project A/E and the Owner's representative before completing piping installation, so proper piping configuration can be verified. An isolation valve shall be installed on any lateral feeding a building so that the building can be isolated without bringing down adjacent buildings. The valve shall be a direct buried gate valve.

HIGH DENSITY POLYETHYLENE (HDPE) PIPING INSTALLATIONS

The Project A/E shall refer to Utilities & Energy Services – Design Standards & Guidelines for additional information. This can be found at <https://utilities.tamu.edu/design-standards/>

NATURAL GAS

Natural Gas service is provided by Atmos Energy. The Project A/E shall contact Atmos Energy for location of connection and coordinate routing of the service. The Project A/E shall also provide a Commercial Customer Load Requirements sheet (provided by Atmos) and properly locate the meter based on current Atmos guidelines for meter location and meter clearances with respect to building features.

All Atmos natural gas mains on campus are protected by an associated easement, typically 10' wide.

- Insulators shall be put on every support arm and zip tied down.
- Fire taping shall be used from duct to the termination.

ELECTRICAL DISTRIBUTION

Updated 9-30-21

All new facilities shall fully provide infrastructure to site. The electrical underground electrical utilities shall be design per the Concrete Encase Ductbank Section per Division 26 and TAMU UES standards. <https://utilities.tamu.edu/design-standards/>

All raceways, manholes, electrical equipment, and other hardware used for electrical utilities shall be dedicated to this purpose.

OVERHEAD DISTRIBUTION

Overhead electrical distribution shall be used only at the discretion of the RELLIS. All over head will be

RELLIS Campus Facility Design Guidelines
Section-33 Page 15 of 19

DESIGN CRITERIA

Division 33 – Utilities

per TAMU UES standards and shall be done as direct by TAMU UES.

DATA/TELECOM DISTRIBUTION

Updated 9-30-21

Shall be per the RELLIS Campus Communications Infrastructure section of Div 27

SITE LIGHTING

All roadways, parking lots and pedestrian ways, shall be illuminated during the hours of darkness. Power for site lighting by building. Bollards and building mounted flood lights shall not be used. Form cast concrete poles shall not be used. All site and exterior lighting shall use campus standard lamps. All site lighting fixtures and poles shall be in accordance with the campus standard fixtures.

Site lighting shall be controlled through a mechanically held contactor using photocell off and on with a hand-off-auto (HOA) switch override. All site lighting fixtures shall be individually fused at each pole. Each pole shall be grounded with a 3/4" x 10' ground rod.

The Project A/E shall refer to Utilities & Energy Services – Design Standards & Guidelines for additional information. This can be found at <https://utilities.tamu.edu/design-standards/>.

DESIGN CRITERIA
Division 33 – Utilities

Typical Design Lighting Level

RELLIS follows the lighting level chart below as a guide, refer to IESNA, TXDOT, and local codes requirements for new installations.

| Lighting Levels | | | | | |
|---|--------------------------------|--------------------------------|-------------------------------|-------------------------------|-------------------------|
| Location | Min. Horiz. Footcandles | Avg. Horiz. Footcandles | Min. Vert. Footcandles | Avg. Vert. Footcandles | Uniformity Ratio |
| General Area | | | | | |
| Non-designated Pedestrian Ways | 0.5 | ... | ... | ... | ... |
| Large Open Areas Requiring Surveillance Only | ... | ... | 0.05 | 0.2 | ... |
| Confined Areas Requiring Surveillance Only | ... | ... | 0.1 | 0.5 | ... |
| Pedestrian Ways | | | | | |
| Type A - Roadside | 1.0 | ... | ... | 2.2 | 5:1 |
| Type B - Distant from Roadway | 0.5 | ... | ... | 0.5 | 5:1 |
| Areas 6.5' to 16' on Each Side of Type B ways | 0.2 | ... | ... | 0.2 | ... |
| Parking Areas Open Facilities | 0.9 | ... | ... | ... | 4:1 |
| Covered Facilities | ... | 5.0 | ... | ... | 4:1 |
| Roadways | | | | | |
| Major | ... | 1.2 | ... | ... | 3:1 |
| Collector | ... | 0.8 | ... | ... | 4:1 |
| Local | ... | 0.6 | ... | ... | 6:1 |

DESIGN CRITERIA
Division 33 – Utilities

Light Pole Mounting Detail
Not to Scale

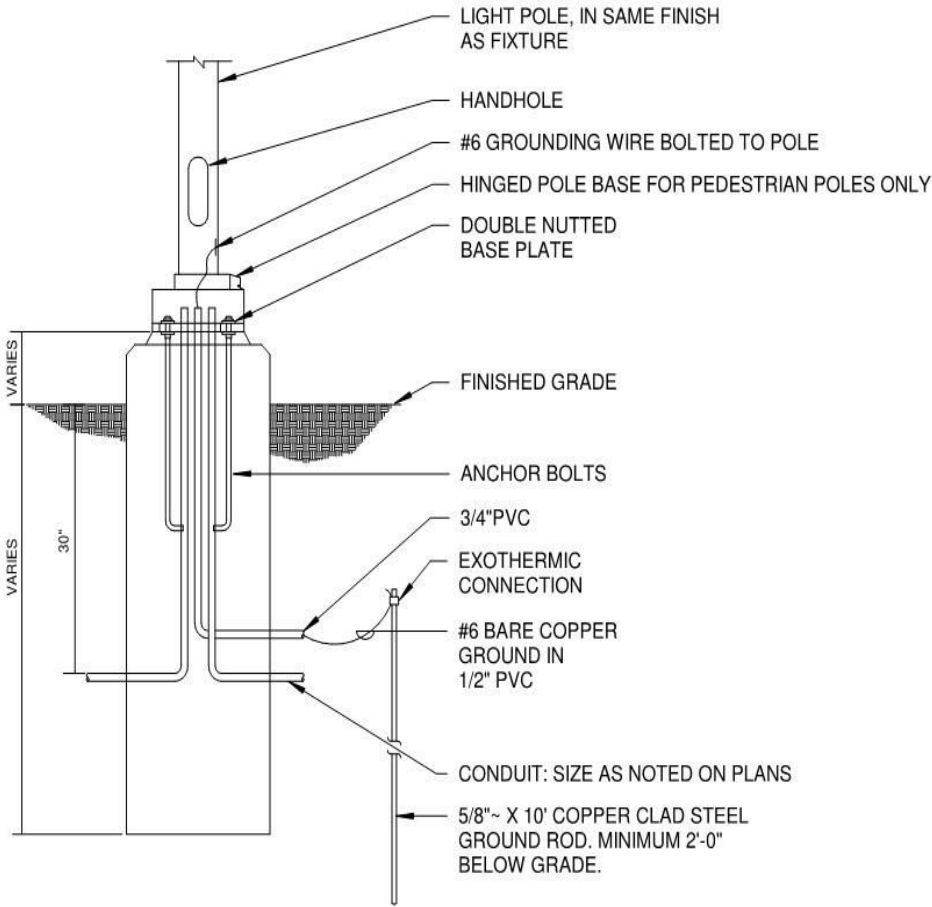

NOTES:

1. VERIFY ANCHOR BOLT LOCATIONS WITH MANUFACTURER'S TEMPLATE PRIOR TO BASE CONSTRUCTION.
2. PROVIDE RE-INFORCING STEEL - (4)#4 VERTICAL, EQUALLY SPACED AND (6)#3 CLOSED TIES HORIZONTAL EQUALLY SPACED, COORDINATE WITH STRUCTURAL.

Light Fixture Fusing Detail

Not to Scale

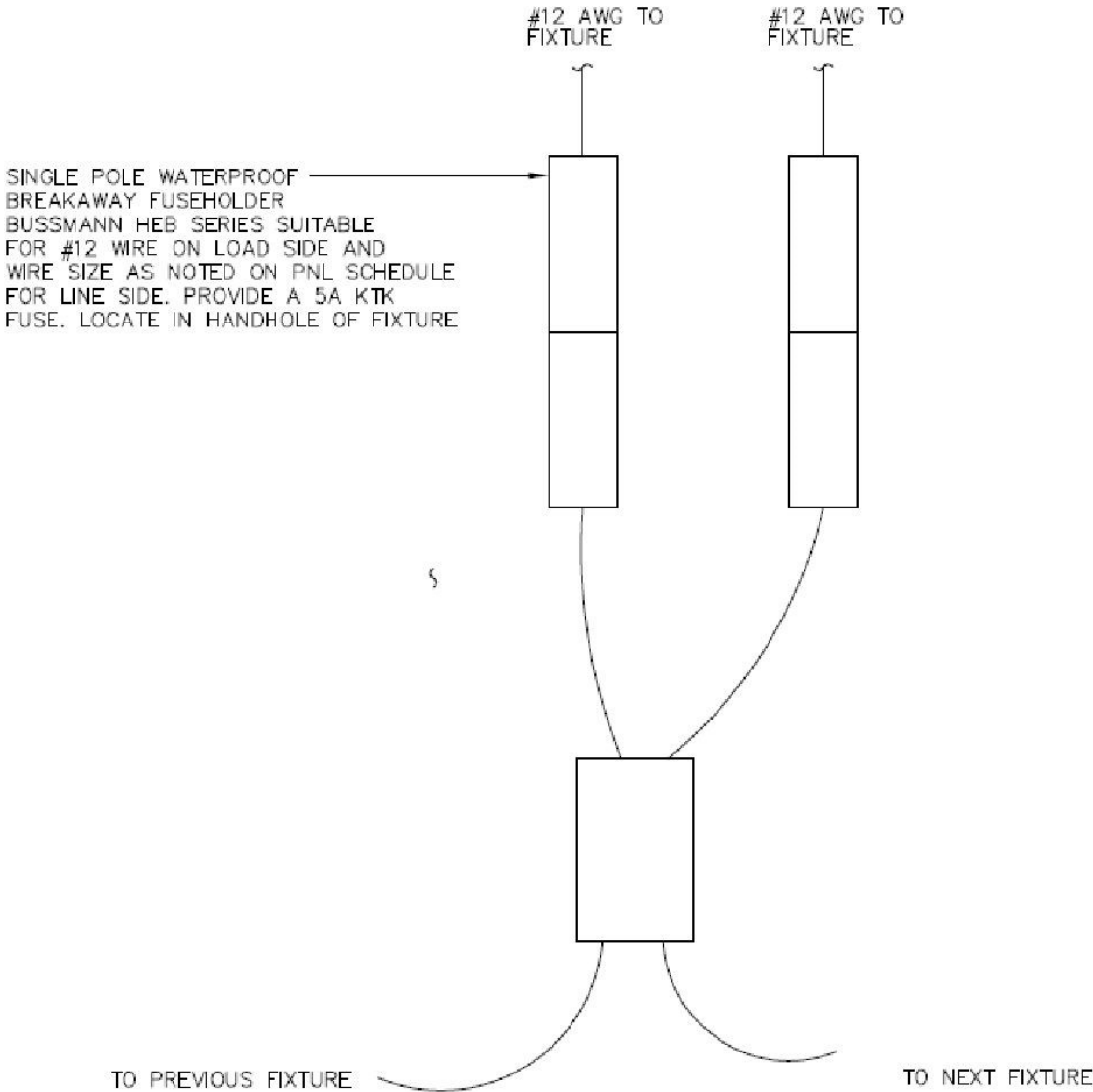

DESIGN PROCESS

GENERAL

The Design Process described in this section is primarily for Construction Manager at Risk and Design-Build delivery process. Items specific to Competitive Sealed Proposal or other delivery methods are so noted.

INTEGRATED DESIGN

Representatives from all parties to the design and construction of the project, the Architect/Engineer team, the Contractor team, the System member, the RELLIS Campus representatives, and the FPC team are expected to work very collaboratively and openly sharing information, including but not limited to BIMs, knowledge and experience from the beginning of Schematic Design through the completion of construction. Representatives from all teams and all disciplines are expected to attend and actively participate in all design meetings.

PLANNING & DESIGN REVIEW BOARD

All projects on the RELLIS Campus (both minor and capital projects) will be reviewed by the Planning & Design Review Board (PDRB) to ensure they are developed in accordance with the RELLIS Campus Master Plan. Projects should be reviewed at the following intervals:

1. Initial review of proposed project, conceptual design, and potential site selection to ensure conformance with the master plan.
2. Technical review for feasibility in terms of function, site selection, availability and sufficiency of utilities, roads and parking, etc.
3. Review of site and exterior design at major milestones (at a minimum of SD and DD).
4. Review of exterior building material, assembly mockup, and signage.

Following review by the PDRB, projects shall be submitted for approval by the RELLIS Campus Director.

Additional details on the PDRB members and responsibilities can be found in the Review and Compliance section of the RELLIS Campus Master Plan.

DESIGN PROCESS

OVERALL DESIGN PROCESS

Using BIM in the design process means that there are several issues that need to be set up day one of the design process and remain in place and consistent throughout the process, into construction, and closeout.

Using BIM with most delivery methods results in a very linear process, as outlined in the following diagram.

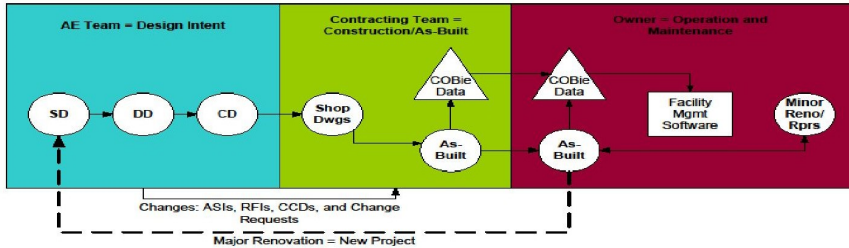

The delivery methods we will focus on here is Construction Manager at Risk (CMAR). This process is more collaborative and gives the Construction Manager more input during the design process. Take some time to review the following diagram.

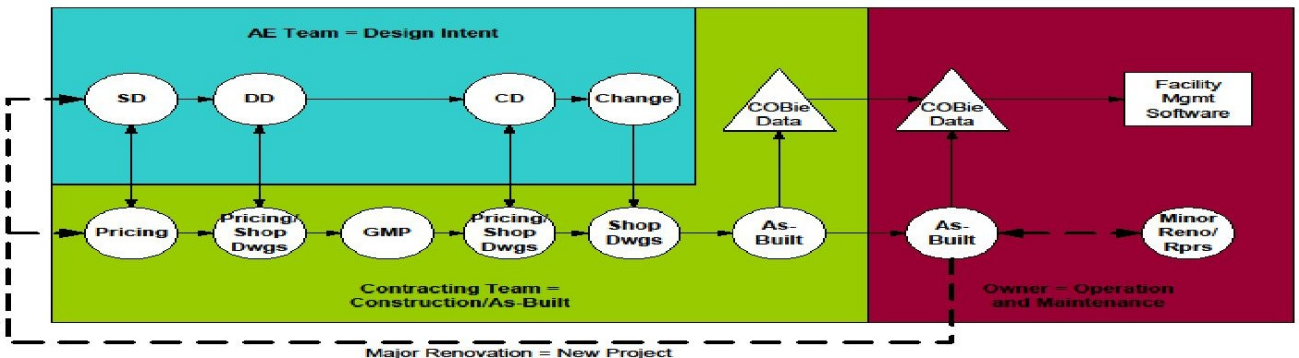

Using BIM means that most decisions on how to set up the project have to be made early on in the process. The following is a summary of many of the issues that need to be implemented or set up early on.

- File/folder naming is important to the organization of the files and sets up the methodology for file archiving.
 - The models being generated are to be used on future projects. The model files should be transmitted in both the native file format of the BIM authoring software as well as optimized IFCs. Free IFC optimizers are available on the internet. See www.solibri.com for an example of one.
 - Each drawing sheet should be delivered in both DWG as well as PDF formats.
 - Copies are to be provided to Mapping and Space Information.
 - Specifications should be delivered in both Word Doc format as well as PDFs.
 - All files shall be delivered in the proper location as set up in the folder layout

DESIGN PROCESS

which is to be distributed via FPC's website. See the following illustration.

- Set the A/E is to set the project origin. This origin shall be the same for all models. The origin shall relate to a real world survey datum.
- The elevation shall be set according to the real world elevation. That is if the 1st floor elevation is at 230.00' above sea level then the first floor elevation in the model should be the same.
- Models should be split vertically and not horizontally.
- All consultants shall produce BIM models. This includes civil.
- The survey of the model shall also be produced using BIM authoring software. The location and elevation of the utilities shall be indicated on the drawing and modeled.
- The A/E shall work with the owner's team to set the stratification of equipment in the ceiling plenum.
- The A/E shall work with FPC's project manager to establish the project's abbreviated name. For instance the Corp Dorm Renovation project may be known as CDR or the Memorial Student Center Renovation project may be known as MSC.
- The A/E shall work with FPC's project manager to establish room numbering standards and methodologies. This shall remain in place throughout the project so it should not be taken lightly.
 - Mapping and Space Information approval is required for the final room numbering in accordance with the room numbering guidelines
- Room area shall be established and updated throughout the project by using standards established by The Higher Education Coordinating Board (THECB).
- All equipment that requires access after construction is complete shall have the required clearance modeled along with the equipment.
- All equipment shall be named using an easily identifiable naming standard such as those set forth in the National CAD Standard V4.0. For instance an air handler unit's family or object name should start out with something like AHU then go into more description.
- Equipment objects shall have the minimum parametric attributes:
 - Location, that is room number in which or above which the piece of equipment is located.
 - Manufacturer, at the beginning of the project this is the basis of design manufacturer established by the A/E. In a CMAR project the CM may help to establish the manufacturer that is most likely to be used. This information shall be updated by the CM and its subs.
 - Model number. Again this is based on design intent set by the A/E at the beginning of the project and finalized by the CM at the end of the project.
 - Any pertinent design criteria such as CFM, voltage, watts, volume, velocity, etc. This again is information that shall be updated by the CM and its subs and later by the commissioning (Cx) team.
- Models should be shared frequently by all members of the team. This includes the CM and their subs. Sharing should occur daily if not more frequently to ensure that real time coordination is occurring.
- All efforts shall be taken to reduce the amount of duplication between disciplines. This is more prevalent amongst the A/E team. For instance the architect may show the location of lights then the electrical engineer will show the location of lights but the architect does

DESIGN PROCESS

not remove them from their model. This causes collisions to occur and also raises questions by the CM and its subs as to which lighting layout is correct. By sharing the various models and using them in addition to the file in which one is working helps to eliminate this sort of problem.

- All trade information shall be contained in a single model not split into multiple models by floor. For instance there should be one model identified as the electrical model. At the beginning of the project this model will belong to the electrical engineer but will then transition to the electrical sub. The model should stay intact as one model and not split into multiple floors. If file size becomes an issue it is preferable to split the building vertically and not horizontally. This split should be consistent through all trades if required.
- All project schedules shall be linked to the model and be generated using parametric data from objects in the model. This link shall remain throughout the project.
- Basic sun shading analysis shall be used to aid in the siting and massing of buildings to help produce efficient buildings that respond to the demands of their geographic location.
- The A/E is required to do clash and collision detection and submit reports addressing the issues found. These reports and models are required at each milestone of the project. Each report shall not be the first run of the report at the milestone. The A/E is required to run the report prior to the due date to address major issues and any false positives that may be found. In the CMAR process the CMAR will be responsible for working with the A/E to run the reports. It is understood that reports run during Schematic Design will generate little data, that is they should generate little data.
- The MEP consultant is required to have a person that is responsible for the coordination and design of the various disciplines at coordination meetings, not just one overall project manager.
- The BIMs should be used to generate quick images for use in explaining the spaces to the clients. Elaborate renderings are not always required.
- The model files shall be transmitted with object/family and IFC libraries.

PROGRAMMING AND SPACE VERIFICATION

The use of BIM allows us to create and verify program and programmatic requirements. This also means that the following parametric information must be associated with spaces/zones to be able to extract and compare it to the program. The data may also be used later for submission to THECB. Use BIM to assign and then extract the following parametric data from the model and compare it to the program:

- Room names
- Room numbers
- Room occupancy type
- Room maximum occupancy number
- Departmental information associated with spaces. All spaces shall be assigned a department. The department may also identify circulation and mechanical spaces as well.

DESIGN PROCESS

- Floor/level of all rooms and spaces
- Three digit room type codes
- Two digit room use code
- Two digit part of system code
- All departmental spaces shall be assigned a color. This color should be the same as that assigned to associated degree type. For instance Architecture is a lavender color and philosophy is blue.
- Square footages of:
 - Rooms (Net)
 - Departmental spaces
 - Overall square footages by floor
 - Circulation area
 - Unassignable area

Square footages and room type codes of spaces should be determined using standards set forth by THECB and the Facilities Inventory and Classification and Procedures Manual distributed by Texas A&M University Office of Mapping and Space Information (MSI).

SCHEMATIC DESIGN

The A/E team and the Contractor team shall make professional evaluations of design problems and issues related to this project, analyze the advantages and disadvantages of each evaluation, and recommend cost effective solutions in the Schematic Design phase. The A/E is responsible for the design and arrangement of building components and spaces to provide aesthetically pleasing and functional spaces. Detailed studies by the A/E and Contractor will be required during this design phase to establish the most economical and efficient use of the site, use of materials and construction methods in order to accomplish the System Member's requirements for the project within the approved budget.

It is anticipated that several meetings involving all participants from the A/E team, the Contractor team, the System Member team and the FPC team will be required to develop a design that satisfies the Program of Requirements within the project budget.

For a typical building project the first Schematic Design meeting will explore possible ways to place the building on the site and begin to explore the building mass. Use software to perform day lighting analysis of the buildings. Be sure to take into account obstructions that will cast shadows on the building(s). Prepare massing studies to compare at least three massing schemes. Other Schematic Design meetings will explore arrangements of the individual spaces, including required support spaces, massing and building elevations. The FPC Project Manager shall receive a copy of all presentation materials a minimum of two (2) days prior to each of these Schematic Design meetings. Each Schematic Design meeting may involve multiple presentations to various groups and committees. Refer to the FPC Project Manager for specifics of each Schematic Design presentation.

DESIGN PROCESS

Drawings for these first Schematic Design meetings can be in rough form, such as butter-paper sketches, since revisions will probably occur. Computer imaging and modeling is encouraged. Hardcopies of all concepts to be presented are required. All members from the A/E team and the Contractor team shall be present and participate at these meetings.

At each of these Schematic Design meetings the Project A/E shall prepare and present a minimum of three (3) different schemes. At the end of each of the meetings the Project A/E will have a direction from the Owner and User as to a design direction for the next Schematic Design meeting.

The final Schematic Design review meeting will determine the arrangements of all building spaces as well as the exterior appearance of the building. The final Schematic Design review meeting will occur a minimum of one (1) week after the submission of all required materials.

The AE and CM shall review construction sequencing. Once the sequencing has been established the AEC shall review and establish any special drawing packages that will be required to begin construction in a timely manner. The drawings required for each package shall be reviewed and documented to ensure that the required drawings are completed and submitted when they are needed.

These early design meetings are a good time for the AEC to review any special project requirements or layout of equipment. For instance the team shall establish a preliminary ceiling plenum stratification strategy by which the AE shall stack building services in the ceiling plenum or leave clearances for ceiling mounted equipment.

A component of Schematic Design will be, in conjunction with the contractor on CMAR and D-B projects, to identify early release drawings and specifications that can be ready for construction after the approval of the GMP.

Some projects may be able to accomplish Schematic Design in fewer meetings; other projects may take more meetings. The A/E will not proceed to Design Development until all requirements for Schematic Design have been satisfied and approval of Schematic Design has been received.

Minimum Requirements for final Schematic Design Submittal

Drawings

General

- All sheets shall have a text scale and graphic scale.
- All applicable sheets shall have a north arrow in a consistent orientation.
- If the site plan(s) and/or floor plan(s) is divided over multiple sheets then a key map near the title block is required.
- Plotted sheet size cannot exceed ANSI E Size Sheet (34" by 44")
- All text shall be minimum 1/8" when plotted to full size. Text will then be legible on half size sets of drawings.

DESIGN PROCESS

Hazardous Materials

- Plan(s) showing location of hazardous materials found during survey.

Civil

- Site plan(s) at the same scale and orientation as the architectural site plan showing existing and new vehicular and pedestrian circulation, existing and new civil utilities, site drainage areas and calculations of runoff, existing and new contours, existing and new site features, limits of construction and construction staging area.

Landscape

- Site plan(s) at the same scale and orientation as other site plan(s) showing existing and new planting, existing and new irrigation zones and other site features.

Structural

- Floor plan of all levels showing column grid, preliminary location of beams with sizes, location of openings and shear walls and floor depressions.
- Preliminary foundation plan
- Preliminary roof framing plan showing major roof slopes.

Architectural

- Architectural site plan showing all existing and new site features as well as limits of construction and construction staging area.
- Floor plan of all levels showing fire walls, hazard level occupancies and travel distances.
- Floor plan of all levels showing room names, capacity information (occupancy), relative wall thicknesses, door swings, fixed casework and equipment, floor elevation, column grid, wall fire ratings, travel distances.
- Floor plan of all areas showing room names, preliminary furnishings and movable equipment, indication of floor and wall finishes.
- All elevations showing materials, floor elevations, fenestration, exposed mechanical and electrical equipment, finish grades and significant site features
- Major building sections showing relative thickness of floors and walls, floor elevations, finish grades, room names, and significant mechanical and electrical equipment.
- Exterior and interior perspectives and/or animations to illustrate design.

Equipment

- Floor plan of typical laboratories showing laboratory casework and laboratory equipment.

Plumbing

- Floor plan of all levels showing all plumbing equipment and preliminary routing of main horizontal and vertical runs.

DESIGN PROCESS

Mechanical

- Site plan(s) at the same scale and orientation as other site plan(s) showing existing and new thermal and gas lines as well as the limits of construction.
- Typical enlarged mechanical room plan showing equipment and required maintenance access.

Electrical

- Site plan(s) at the same scale and orientation as other site plan(s) showing existing and new electrical distribution as well as limits of construction and construction staging area.
- Typical enlarged electrical room plans showing equipment and code required access
- One line diagram of electrical system

Telecommunications

- Site plan(s) at the same scale and orientation as other site plan(s) showing existing and new telecommunications, data and cable television distribution as well as the limits of construction.
- Floor plan showing typical means of cable distribution.
- Typical enlarged data/telecom room plan showing equipment and access.
- Typical enlarged plans showing location of audio-visual equipment.
- One line diagram of data, telecommunications, broadband distribution and audio-visual systems.

Reports

Reports shall be on letter size paper and all bound together in a three-ring binder or spiral bound. All reports shall also be delivered in PDF format as well as Microsoft Word format.

Basis of Design

The Basis of Design is a narrative description of the project containing the basic information, criteria, logic, major decisions, evaluations and considerations developed in the following applicable categories to prepare the Schematic Design submittal.

- Hazardous Materials Survey Narrative
- Civil and Landscape Design Narrative
- Structural Design Narrative
- Architectural Design Narrative
- Mechanical Design Narrative
- Plumbing Design Narrative
- Electrical Design Narrative
- Data/Telecommunications Design Narrative
- Audio Visual Design Narrative
- Sustainable Design Narrative using LEED Checklist
- Listing and size of spaces comparing POR with Schematic Design

Cost Estimate

- Cost estimate in MasterFormat.

Completion of Schematic Design

Completed final Schematic Design documents are a result of a completed product and are not a function of time or duration of work.

Final Schematic Design documents that are “on average” 100% complete are not acceptable.

Upon completion of Schematic Design the following are established

- The project scope, form and spatial relationships are defined.
- The selection and initial design of major building systems such as exterior envelope, structure, mechanical, plumbing and electrical are finalized.
- A preliminary construction schedule is established.
- The project as defined is achievable within the established Amount Available for the Construction Contract based on continuous input from the Construction Manager at Risk.
- An early release package is identified on CMAR and D-B projects.

DESIGN DEVELOPMENT

The approved Schematic Design shall be developed into Design Development documents sufficient to fully reveal all aspects of the project. This will include all items to meet the System Member's needs, and development of all facility components to fully illustrate the proposed aesthetics, construction, systems, utilities, services, and accessories.

Between the Schematic Design approval and the submission of Design Development most projects will require various meetings to identify the full requirements for basic components of the design as well as special or unique components such as data/telecommunications, audio visual systems, security systems, food service requirements, laboratory design, etc. It is anticipated that these meetings will occur, at a minimum, monthly.

Results of these meetings must be documented in a narrative describing systems and identifying the scope that will be in the project.

All submitted documents shall be complete and coordinated between design disciplines.

All documents will address all comments from Schematic Design phase.

Proposed building dimensions, finished floor elevations, surrounding contour elevations plan, number of stories, etc.

DESIGN PROCESS

Roof Construction Design & Assembly Requirements (including geographic area factors (rainfall, wind speed, etc.), proposed safety factors, construction importance factor, etc.)

Fire Protection Design Requirements

Project specifications document, if differ from the “Facilities Design Guidelines” document.

The AEC team shall review the drawings required for multiple packages, if required, to ensure that the required drawing list is still accurate and that it is still valid. This is the time to modify the required list of drawings for the early release drawing sets.

If a contracting team is involved during the design phases of the project the BIMs shall be forwarded to them so that they may begin the process of creating submittal/shop drawings.

Minimum Requirements for Design Development Submittal

(Includes requirements for Schematic Design Submittal)

Drawings

General

- General Information Sheet(s) showing design criteria, net and gross square foot per floor, legend of symbols, abbreviations, drawing conventions, vicinity map & project location map.

Hazardous Materials

- Plan(s) showing location of hazardous materials found during survey.

Civil

- Demolition Site Plan containing all site demolition.
- Overall site plan(s) showing all new civil construction with demolished items removed including spot elevations and dimensions.
- Separate plans showing site grading.
- Separate plans showing new vehicular paving with jointing and dimensions.
- Separate plans showing pedestrian paving with jointing and dimensions.
- Composite utility map including site mechanical, electrical and telecommunications.
- Separate plan and profile sheets for site water, sanitary and storm drainage.
- Drainage plan with calculations.
- SWPPP plan and details.
- Typical detail sheets.

Landscape

- Overall site plan(s) showing all new landscape construction with demolished items removed.
- Separate plans showing landscape features with spot elevations and

DESIGN PROCESS

dimensions.

- Separate plans showing new plantings.
- Separate plans showing new irrigation areas with type of heads and flow rates.
- Typical detail sheets.

Structural

- Foundation plan with pier sizes.
- Crawl Space grading plan showing drainage.
- Floor plan of all levels showing column grid, location of beams and shear walls.
- Column and beam schedules.
- Typical detail sheets.

Architectural

- Floor plan of all levels showing room names, room numbers, capacity information (occupancy), square footage, actual wall thicknesses, floor elevation, structural grid, equipment, casework, vertical transportation and dimensions.
- Floor plan of all levels showing fire protection elements and egress plan with travel distances
- Floor plan of all areas showing room names, room numbers, all furnishings and equipment, indication of finishes
- Reflected ceiling plans
- Roof plan showing major rooftop equipment
- Interior Finish Schedules
- Door Schedules
- Window/Glazing Schedules
- All elevations showing materials, floor elevations, exposed mechanical and electrical equipment, finish grades and significant site features
- Interior elevations of typical spaces like restrooms and casework and major spaces like lobbies and ballrooms.
- Major building sections showing actual thickness of floors and walls, floor elevations, finish grades, room names, and significant mechanical and electrical equipment.
- Typical wall sections and details
- Enlarged stairways plan and section with railing details
- Enlarged plan of restrooms with interior elevations
- Enlarged plan and interior elevations of auditoriums and tiered lecture halls
- Typical detail sheets.

Equipment

- Floor plan of all laboratories showing laboratory casework and laboratory equipment.
- Enlarged plan and elevations of typical laboratory spaces

Plumbing

- Floor plan of all levels showing all plumbing fixtures/equipment and routing of horizontal and vertical runs
- Details of major equipment and special conditions.

DESIGN PROCESS

Mechanical

- Site plan(s) at the same scale as other site plan(s) showing existing and new thermal and gas lines as well as limits of construction and construction staging area.
- Floor plans showing single line duct layout for supply air, return air and exhaust air and location of mixing boxes, coils, dampers, etc
- Enlarged mechanical room plans showing equipment, maintenance access
- Preliminary mechanical equipment schedules
- Typical details

Electrical

- Site plan(s) at the same scale as other site plan(s) showing existing and new electrical distribution as well as limits of construction and construction staging area.
- Floor plans showing typical light fixture layouts.
- Floor plans showing typical power outlet layouts
- Enlarged electrical room plans showing equipment and code required access
- One line diagram of electrical system

Telecommunications

- Site plan(s) at the same scale as other site plan(s) showing existing and new telecommunications, data and cable television distribution as well as limits of construction and construction staging area.
- Floor plans showing means of cable distribution location of all devices and outlets
- Enlarged data/telecom room plan showing equipment and access
- Enlarged plans showing location of audio-visual equipment
- One line diagram of data and telecom systems

Reports

Basis of Design

The Basis of Design report from Schematic Design shall be updated to include the basic information, criteria, logic, major decisions, evaluations and considerations developed in the following applicable categories to prepare the Design Development submittal.

- Hazardous Materials Survey Narrative
- Civil and Landscape Design Narrative
- Structural Design Narrative
- Architectural Design Narrative
- Interior Design Narrative
- Mechanical Design Narrative
- Plumbing Design Narrative
- Electrical Design Narrative
- Data/Telecommunications Design Narrative

DESIGN PROCESS

- Audio Visual Design Narrative
- Sustainable Design Narrative using LEED Checklist
- Listing and size of spaces comparing POR with Schematic Design and Design Development
- Code Analysis
 - Life Safety Code Analysis: Provide a code analysis of the design utilizing the Life Safety Code, latest edition (NFPA 101) and all referenced codes.
 - Building Code Analysis: Provide a code analysis of the design utilizing the International Building Code, latest edition covering only those elements not covered by the Life Safety Code (no duplicate items).
- Energy Conservation
 - Provide a report on energy conservation provisions at Design Development that shall consist of compliance documentation that the building envelope meets the code. The report shall also include the manufacturer's performance data for building envelope components. The report shall address all other code sections including HVAC, service water heating, power, lighting and other equipment.

To summarize the report shall cover the following ASHRAE 90.1 applicable areas and include all Compliance forms:

| | |
|------|--------------------------------------|
| 5.0 | Envelope |
| 6.0 | HVAC |
| 7.0 | Service Water Heating |
| 8.0 | Power (Specification Item) |
| 9.0 | Lighting |
| 10.0 | Other Equipment (Specification Item) |

Note: 8.0 and 10.0 will only be indicated in the project specifications.

OR

| | |
|------|---------------------------|
| 11.0 | Energy Cost Budget Method |
|------|---------------------------|

The SECO Compliance Certification form(s) shall be included in the front of the report. There may be one or more certification forms, depending on how many separate professionals take responsibility for the various disciplines. The Certification form must be preliminary at this point in the design.

- Life Cycle Cost Analysis
- Wind Tunnel Analysis
- Design Calculations
- Schedule of all recommended construction material testing. The schedules shall contain item tested, recommended test, frequency of test, estimated number of test, sampling method, testing method and acceptance criteria.
- Clash and collision detection report. This report shall consist of the report run after a preliminary run of the report which identifies issues that are addressed before running the final DD report for submittal. The A/E is responsible for generating this report in the absence of a contracting team. When a contracting team is part of the design

DESIGN PROCESS

phases they shall be responsible for running and vetting the report.

Specifications

- Specifications for significant architectural materials and engineering systems and equipment indicating quality of materials used in project

Cost Estimate

- Cost estimate in MasterFormat latest edition format.

Completion of Design Development

Completed Design Development documents are a result of a completed product and are not a function of time or duration of work.

Final Design Development documents that are “on average” 100% complete are not acceptable.

Upon completion of Design Development the following are established such that the Construction Manager at Risk can provide a Guaranteed Maximum Price for the project.

- The project scope, form and spatial relationships are finalized.
- The design of all major building systems such as civil, landscape, site utilities, exterior envelope, interior finishes, structure, mechanical, plumbing, electrical and special systems such as telecommunications, data, audio-visual and security are completed.
- A construction schedule is established.
- The project as designed is achievable within the established Amount Available for the Construction Contract based on continuous input from the Construction Manager at Risk.
- Drawings and specifications for an early release package are ready for construction on CMAR and D-B projects.

After approval of the Design Development, the A/E shall furnish the following if required in their agreement:

- Presentation rendering(s) shall consist of an exterior view and/or interior view, drawn in perspective, at a scale of sufficient size (24" x 30" min.) to convey a true representation of the design of the project without distortions that would give misleading impressions. Landscape features together with existing structures should be indicated in a realistic manner. The perspective, professionally prepared, may be rendered in any color media, provided suitable reproductions can be made from the media selected and it shall be glazed with non glare glass and framed. The frame shall be clear maple in a rectangular profile with dimensions approximately $\frac{3}{4}$ " by 1-1/4". The name of the project, location, and the name of the A/E shall appear along the lower edge of the perspective. Photographs of models are not acceptable.

DESIGN PROCESS

- Detailed scale model of the project, in order to give a better understanding of the project as to scale, proportion, mass, or location, indicating fenestration, exterior material, color, trim, walks, drives, parking, and major landscape features. The model shall be mounted on a wood base and protected with a plastic cover. Scale shall be determined by the A/E and the FPC Project Manager; however, the overall dimension should not exceed 48" x 48".
- Presentation animation. The animation shall be fully rendered and be of at least one minute in duration. It shall show the exterior of the building and its site as well as the interior of significant spaces. The resolution shall be 1080P that is a resolution of 1920x1080 at 30 FPS. Light quality shall be ray trace with environmental maps. The textures shall be photorealistic.
- PowerPoint presentation of the project that includes campus plan, site plan, representative floor plan(s), exterior perspective(s) and presentation animation. The PowerPoint will be used by the Facilities Planning and Construction to present the project to the Board of Regents for approval. The slides shall have light colored backgrounds. Black background with white line work is not allowed for PowerPoint presentation.

GUARANTEED MAXIMUM PRICE

In the CMAR Agreement the Construction Manager is required to submit a Guaranteed Maximum Price Proposal (GMP) based on the Design Development documents and review comments. The GMP is required to be submitted to the FPC Project Manager no later than three (3) weeks after the Design Development Review Meeting. The Construction Manager should coordinate with the FPC Project Manager to ensure the GMP process and review is completed in time to confirm inclusion on the agenda for the appropriate Board of Regents meeting. The A/E team is expected to assist the Contractor in developing the GMP.

Formatting of GMP Documents

The contractor shall submit three (3) copies of the GMP documents each in a three ring binder. The three original signed GMP proposal (Exhibit "E" from the Agreement) shall not be bound in any binder. The GMP documents shall contain the following

Cover of GMP document titles "Guaranteed Maximum Price Proposal for (Project Name), System Member name, Project Number,
Transmittal letter to Chief Financial Officer and Treasurer
Table of Contents
Summary of work including phasing plan, anticipated Notice to Proceed date and Substantial Completion Date.
Copy of Exhibit "E" with Detailed Cost Breakdown
Master Project Schedule showing phasing and all major milestones.
Staffing Plan

CONSTRUCTION DOCUMENTS

The approved Design Development documents shall be developed into Construction Documents sufficient to construct the project.

Progress Meetings

The project time schedule and the agreements identify interim progress meetings for review of Construction Documents by System Member and FPC staff generally at 25%, 50% and 75% stages of completion. These meetings do not constitute approval of documents to date, but are for the purpose of answering questions and resolving problems.

During the 25% Construction Documents meeting the Project A/E needs to present to the FPC Project Manager and others at least two interior color schemes for comments. Updates and refinements to the mechanical systems sequence of operation need to be presented for comment. Also, during the review the team must review cut-sheets of all major elements of the design and pieces of equipment with FPC personnel. Examples of these are curtain wall systems, fixed seating, laboratory equipment, audio visual equipment, air handling units, variable air volume boxes, plumbing fixtures and light fixtures. Verify list of items requiring cut-sheets with FPC Project Manager.

During the 50% Construction Documents meeting the Project A/E needs to present to the FPC Project Manager and others the revised interior color scheme for comments. Updates and refinements to the mechanical systems sequence of operation need to be presented for comment. Also, during the review the team must review revised cut-sheets of all major elements of the design and pieces of equipment with FPC personnel.

Reports

Basis of Design

The Basis of Design report from Design Development shall be updated to include the basic information, criteria, logic, major decisions, evaluations and considerations developed in the following applicable categories to prepare the Construction Documents submittal.

- Hazardous Materials Survey Narrative
- Civil and Landscape Design Narrative
- Structural Design Narrative
- Architectural Design Narrative
- Interior Design Narrative
- Mechanical Design Narrative
- Plumbing Design Narrative
- Electrical Design Narrative
- Data/Telecommunications Design Narrative
- Audio Visual Design Narrative
- Sustainable Design Narrative using LEED Checklist

DESIGN PROCESS

- Listing and size of spaces comparing POR with Schematic Design and Design Development
- Code Analysis
 - Life Safety Code Analysis: Provide a code analysis of the design utilizing the Life Safety Code, latest edition (NFPA 101) and all referenced codes.
 - Building Code Analysis: Provide a code analysis of the design utilizing the International Building Code, latest edition covering only those elements not covered by the Life Safety Code (no duplicate items).
- Energy Conservation
 - Provide a report on energy conservation provisions at Design Development that shall consist of compliance documentation that the building envelope meets the code. The report shall also include the manufacturer's performance data for building envelope components. The report shall address all other code sections including HVAC, service water heating, power, lighting and other equipment.

To summarize the report shall cover the following ASHRAE 90.1 applicable areas and include all Compliance forms:

| | |
|------|--------------------------------------|
| 5.0 | Envelope |
| 6.0 | HVAC |
| 7.0 | Service Water Heating |
| 8.0 | Power (Specification Item) |
| 9.0 | Lighting |
| 10.0 | Other Equipment (Specification Item) |

Note: 8.0 and 10.0 will only be indicated in the project specifications.

OR

| | |
|------|---------------------------|
| 11.0 | Energy Cost Budget Method |
|------|---------------------------|

The SECO Compliance Certification form(s) shall be included in the front of the report. There may be one or more certification forms, depending on how many separate professionals take responsibility for the various disciplines. The Certification form must be preliminary at this point in the design.

- Life Cycle Cost Analysis
- Wind Tunnel Analysis
- Design Calculations
- Schedule of all recommended construction material testing. The schedules shall contain item tested, recommended test, frequency of test, estimated number of test, sampling method, testing method and acceptance criteria.
- Clash and collision detection report. This report shall consist of the report run after a preliminary run of the report which identifies issues that are addressed before running the final DD report for submittal. The A/E is responsible for generating this report in the absence of a contracting team. When a contracting team is part of the design phases they shall be responsible for running and vetting the report.

DESIGN PROCESS

Drawings

- Complete and coordinated drawings.

Specifications

- Complete specifications with a minimum of three manufacturers for all items

Cost Estimate

- Cost estimate in MasterFormat latest edition format.

100% Construction Documents Review

Drawings for all divisions of work shall be complete and thorough in all respects, well coordinated, clear, and neatly drawn and in accordance with the Standard of Care for the professions.

Completed Construction Documents are a result of a completed product ready to be used for construction (bidding in the case of CSP delivery) and are not a function of time or duration of work.

Construction Documents shall not be submitted for review until all documents are 100% complete and a complete quality control/coordination check has been made by the Project A/E of all documents.

If the Construction Documents are missing information from team members or drawing sheets are obviously incomplete **do not submit for the 100% Detailed Design review.**

If cursory review by FPC Project Manager indicates that the documents are not 100% complete, the submittal will be returned for completion.

A Construction Documents review meeting will be scheduled by the FPC Project Manager to include representatives from the A/E team, the Contractor team, the System Member team and the FPC team for a detailed discussion of comments.

All comments from the Construction Documents review meeting shall be incorporated into the final documents prior to issuance for construction (bidding in the case of CSP delivery). No lengthy addendum to correct the CSP bid documents is acceptable.

BIDDING AND CONTRACT AWARD STAGE (CSP ONLY)

The FPC Project Manager will establish the dates for advertising, pre-proposal conference, and proposal opening in consultation with the Project A/E for major projects that utilize the Competitive Sealed Proposal process to procure a Contractor

The CSP process calls for a three (3) part proposal submittal. The proposal parts are identified as:

Part 1 - Competitive Sealed Proposal (Price and Time)

Part 2 - Proposer's Qualifications

Part 3 - HUB Subcontracting Plan

The Project A/E is responsible for helping to secure good competitive proposals. The Project A/E shall oversee the distribution of plans and specifications to general contractors, sub-contractors, suppliers and plan rooms. The Project A/E shall also forward to the FPC Project Manager and all plan rooms on a weekly basis a list of all plan holders.

The Request for Proposals (Bid Advertisement) will be prepared and submitted to the media by the Facilities Planning & Construction Department. A copy of the advertisement along with Division 0 and Division 1 documents will be provided by the FPC Project Manager to the Project A/E to be included in the Specifications.

In addition to the bound plans and specifications all general contractors shall be provided two (2) loose copies of the Proposal Parts 1 through 3, two (2) loose copies of the Bid Bond form, and one (1) unmailer envelope.

If addenda are issued by the Project A/E, each Addendum sheet shall be dated with pages numbered consecutively.

The Project A/E is responsible for the distribution of all addenda to all plan holders at no additional cost.

The Project A/E and required consultants will attend the Pre-proposal Conference prepared to receive contractor's questions and conduct a site tour if necessary.

The Code "E" Estimate will be prepared and submitted 10 days before receipt of proposals and should reflect any factors affecting the cost that the Project A/E may be able to determine during the bidding period.

The FPC Project Manager will prepare a "Bid Tabulation Form", with assistance from the Project A/E, which lists all expected general contractors and provides sufficient quantities to satisfy the needs at the Bid opening.

The Project A/E is required to attend and assist with the proposal opening procedure to be

DESIGN PROCESS

conducted by the Area Manager. At the conclusion of the proposal opening the Project A/E will be provided one (1) copy of all Part 2 General Contractor Qualifications submittals. The Project A/E will also receive instructions from the Area Manager as to their responsibilities during the contractor evaluation and negotiation period.

The Project A/E will assist in analyzing bid proposals, and provide reports as required concerning the experience, qualifications and references of the bidders, including the named subcontractors and suppliers.

The Project A/E is required to attend the contractor evaluation meeting. The Project A/E shall bring all Part 2 submittals to this meeting. FPC will retain these copies and return them to the contractor.

The Project A/E will assist the Owner during negotiations with the selected Contractor by evaluating the value engineering offerings from the selected Contractor. The A/E will be required to provide any and all documentation required to adequately describe the nature and extent of all accepted value engineering items.

The Project A/E shall assemble all value engineering items from all general contractors and subcontractors into a computer spreadsheet format. This spreadsheet shall be emailed to the FPC Project Manager prior to the Contractor Evaluation meeting. On the spreadsheet the Project A/E team needs to indicate their opinion (yes, no or maybe) for each value engineering item. Upon receipt of the spreadsheet System Member and FPC staff will do likewise. At the end of the Contractor evaluation meeting all parties will review the list with comments to determine a final list that will be presented to the first ranked contractor at the first negotiation meeting.

The items that are listed as yes or maybe will be presented to the selected contractor for pricing. At the conclusion of the negotiations with the selected contractor the contractor will prepare a Post Proposal Amendment which will include all value engineering items that are accepted by the Owner. This Post Proposal Amendment will be signed by both the Contractor and the Project A/E and will be included in the construction contract award documentation.

CONTRACT AWARD (CSP ONLY)

Immediately following action by the awarding authority, the successful Bidder will be notified of the award by facsimile message from and by the Owner.

The Project A/E will not incorporate any addenda into a “construction set” to be issued to the Contractor. The “Bid Sets” are to be used by all parties to construct the building and it is the responsibility of each party to post all addenda and post proposal amendment information to these “Bid Sets”.

DESIGN PROCESS

The Owner will assemble the Contract Books and secure signatures.

When the contract books are signed and all bonds and insurance is in place the "Notice to Proceed" will be issued to the Contractor by the Chief Financial Officer and Treasurer.

A/E BID ANALYSIS (COMPETITIVE BIDS ONLY)

The A/E will submit to the Owner a bid analysis within 48 hours after the bid opening. This analysis will provide information to the Owner for his consideration in taking action on the bids. The analysis shall be a concise evaluation of the low bidder and his bid amount(s).

Investigate the low bidder's capability, past performance, and experience, particularly in construction similar to subject project. Include this information in the analysis. (The Owner will investigate the financial status of the low bidder.)

Evaluate base Bid and Alternate Bids with respect to the Code "E" Cost Estimate and include in the analysis along with recommendation on acceptance of alternates.

If in the opinion of the Project A/E, the lower bidder is not considered qualified to perform the work, confer with the Area Manager for determination of further action.

As needed, contact the lower bidder and obtain information necessary to prepare cost comparisons of quantity take-offs and price extensions with major elements of the detailed design estimates. Include this comparison and explanations of cost differences in the analysis.

If no bids are received or only one bid is received at the time of opening the Project A/E needs to determine the reasons for lack of bidders.

CONSTRUCTION

Pre-construction Conference

After the construction contract has been awarded the FPC Project Manager will establish a date for the Pre-Construction Conference. The Project A/E is expected to attend. The FPC Project Manager will review Owner procedures to accomplish the terms of the construction contract.

BIM Transition

The A/E will transition the maintenance of the project models to the contracting team once all addenda are issued. From this point forward the contracting team shall be responsible for keeping the model up to date and transitioning the design intent model to a

DESIGN PROCESS

construction/as-built model. The A/E shall still be responsible for issuing model updates for responses to RFIs, and any changes caused due to ASIs, CCD, change requests, or any other change driven by the owner. Installation changes are the responsibility of the contracting team.

Monthly Progress Meetings

On the same day each month a monthly progress meeting will be held. The Project A/E is expected to attend and be able to answer questions that arise.

The Project A/E is required to attend all monthly construction progress meetings. The A/E team consultants may be required to attend specific monthly meetings based on the project's requirements.

Color Boards

The Project A/E is required to develop color boards for all exterior and interior colors based on the contractor's manufacturer and/or supplier. The color boards shall be presented to the system member representative for approval. After approval the Project A/E will develop a second set of interior colors assembled into a 3-ring binder. The Project A/E shall also generate a listing of all finish materials for the FPC Project Manager and the General Contractor. The AE is responsible for updating all binders throughout the construction phase of the project.

The Project A/E shall also provide an updated listing of all finish materials along with the Record Drawings.

Subcontractor Best Value Recommendations

The contractor is required to submit subcontractor best value recommendations to the Owner for approval for all subcontracts on construction manager at risk and design-build projects. The subcontractor best value recommendations shall be bound in a three ring binder and contain the following

A transmittal letter summarizing the contents of the recommendation package and recommended subcontractors

Subcontractor evaluation and methodology

Subcontractor Proposals

Technical Proposals

HUB Plans

Shop Drawings and Submittals

All major subs shall be required to work in BIM authoring software. Typically this includes MEP and fire protection. Other subs that shall be required to produce and update BIMs are

DESIGN PROCESS

structural subs, elevator installation, and subs working on the building skin.

The contracting team is required to update the BIM model to reflect actual products being installed. They are required to update the information required of the AE as well as the addition of serial numbers for equipment. When required by the facility management team RFID and/or Bar Codes shall be affixed to equipment.

The Project A/E team is responsible for the timely review and processing of contractor shop drawings and submittals as indicated in the Uniform General and Supplemental Conditions included in the Design Criteria section of this manual.

Roof Construction & Assembly

Full submittals for roof construction and assembly should include the following:

Plans and calculations for proposed primary & secondary roof drainage are still needed for review

Fire Protection System Design

For Existing Underground Fire Mains & Water Supplies:
Occupancy Description

Recent water tests and available supply calculations at effective point

For New Underground Fire Mains & Water Supplies:
Occupancy Description

Recent water tests and available supply calculations at effective point

For Fire Sprinkler Protection

Properly labeled engineering drawings and Hydraulic calculations for all zones

Full list of all materials and components; trade name and sprinkler identification no.

Coordination Drawings

As required in Division 1, Section 01 31 00 the General Contractor is required to produce coordination drawings that will be submitted to the Project A/E for approval. The Project A/E shall review these like all other shop drawings and submittals. The contracting team shall maintain copies of all coordination drawings on site for use on site. Each major sub is required to produce coordination drawings. The lines for the various disciplines shall be unique. There shall be a master coordination drawing printed in color at 1/4" scale which is a combination of all of the coordination drawings. This drawing shall be used for field coordination purposes only. It is to be issued to the AE for information purposes only. The coordination drawings shall be kept up to date and reflect any changes made in the field.

DESIGN PROCESS

These changes are to be made in the as-built model and reflected in the record drawings.

Substitution Request

The Project A/E team is responsible for the timely review and approval or rejection of contractor substitution requests. Concurrence from FPC Project Manager is required prior to the approval of any substitution request

Inspections

The A/E shall be responsible for transcribing any and all punch lists as prepared by the A/E, its consultants and Owner. The Owner will provide a blank form and sample for A/E to use. The Owner will either convert its punch lists to a WAV, WMS or DSS file and email to the A/E. The Owner's punch list is recorded in Olympus' DSS format compatible with Olympus transcription equipment. The A/E may elect to purchase the Olympus AS 5000 Transcription Kit that comes complete with software.

Record Drawings

The Project contracting team is responsible for recording all items from the contractor's record prints, models, and providing the FPC Project Manager the appropriate Record Drawings as per this manual. The record drawings/model shall be a representation of the as-built condition of the building. They shall reflect changes made due to constructability as well as field coordination issues. Ensure the room numbers on the plans have been verified to match the existing room numbers in the building. The drawings/model shall be accurate reflections of the location of valves, dampers, and any other equipment concealed in the ceiling plenum that may need periodic maintenance.

COBie Data

The contractor is required to extract COBie data from the construction BIM for import into the FM software. The most efficient way to get the COBie data is to ensure that it is input into the BIM as parametric data associated with the various families/objects. The COBie data should be checked for consistency and to ensure that all of the required data fields have been completed. If information is missing it should be updated or added to the model then extracted again. Editing of the COBie data in chart form should be avoided to ensure that the required information is embedded in the model and not just the chart. There are software packages available which can be used to help expedite this process. Note: Costs to use these packages should be included in the project and are not permissible as added cost to the project.

GENERAL REQUIREMENTS

TERMS & DEFINITIONS

OFFICE OF FACILITIES PLANNING AND CONSTRUCTION

The Office of Facilities Planning and Construction (FPC) is a part of the A&M System Offices (SO) and manages all major construction projects for the A&M System and reports to the Chancellor of the A&M System. For the purposes of this document FPC is also the Owner.

Facilities Planning and Construction is located on the second floor of the Moore Connolly Building located at 301 Tarrow in College Station.

Executive Director, Facilities Planning & Construction is responsible for the administration, planning and construction of projects for the A&M System. The staff consists of the following:

Director is responsible for assisting the System Members with pre-planning assistance, preparation of project Program of Requirements and managing assigned campus master plan projects.

Area Manager is responsible for the daily coordination and project management of the projects assigned to their teams and for successfully completing all projects in their region of the State.

Project Managers are responsible for managing the design and construction phase under the leadership of the Area Manager and coordinating the activities of their team in accordance with policies and procedures established by the Department.

Interior Designer is responsible for managing the furnishings programming, selection and installation and working with the Architectural Project Managers to ensure the designs accommodate the required furnishings.

Area Manager for Engineering is responsible for coordinating the activities of discipline specific System Engineers and Engineering Inspectors to assist the Area Managers during design and construction

System Engineer is responsible for providing discipline specific engineering knowledge to assist the Area Managers and their teams during design and construction.

Engineering Inspector is responsible for inspecting their discipline specific aspect of the Work.

GENERAL REQUIREMENTS

SYSTEM OFFICES

Office of HUB and Procurement Services

The Office of HUB and Procurement Programs is a part of the A&M System Offices and is responsible for identifying and promoting the use of Historically Underutilized Businesses on projects managed by Facilities Planning and Construction. The Office of HUB and Procurement Services will assist the design teams and contractors in meeting their HUB Goals.

HUB and Procurement Programs also oversee the procurement of other design and construction related services such as Construction Testing, Commissioning, Air Balancing and Furnishings.

Office of Safety

The areas of health and safety, fire and life safety, environmental stewardship, and security are all governed by the Office of Safety.

The Fire and Life Safety group of the Environmental Health and Safety Department is dedicated to helping the Campus community be a safer place to work, study, live, and play. This group conducts fire safety inspections of campus facilities, assists in the development and implementation of emergency evacuation planning and inspects, maintains, and provides training in the proper use of portable fire extinguishers. In addition, the group also conducts plan reviews of new construction projects as well as renovation projects and assists with testing of all fire detection/suppression systems to ensure compliance with nationally recognized codes and standards.

Environmental & Hazardous Waste Management assists the Campus in ensuring protection for the environment and compliance with federal, state, and university environmental protection policies, rules, and regulations.

SYSTEM MEMBERS

Chief Executive Officer is defined as the Director of the RELLIS Campus or other part of the System.

User or Using Agency is the academic institution or agency that will use the completed facility.

User Coordinator: The individual designated by the User or Using Agency as its

GENERAL REQUIREMENTS

representative during the programming, design and construction of the project. The User Coordinator will serve as the contact and representative of the department, Campus or agency and will be responsible for coordinating the procurement of special equipment, telephone installation and scheduling the relocation of equipment and/or personnel to/from the spaces affected by the construction. The User Coordinator has no contractual or approval authority with regards to the design and construction agreements.

OTHER DEFINITIONS

Project: The term "Project" may include the construction of any building or any structure or any facility or utility appurtenant thereto, including fixed equipment and furnishings thereof, and of any addition to, alteration, rehabilitation or repair of any existing building or any structure, or any facility or utility appurtenant thereto.

Program of Requirements (POR) is prepared for the project by the Campus, User, Using Agency, and/or User coordinator with the assistance of a firm contracted by the A&M System under a Master Services Agreement to develop the POR, with a firm contracted by the Campus via public advertisement, or by the Project A/E as a reimbursable service. The POR shall be based on input from the User or Using Agency and/or the User Coordinator and approved by the CEO of the Using Agency. The POR is the single written source of information concerning the scope of the project and the detailed requirements to be achieved by the project. The POR identifies the project specific elements to be included in the new and/or renovated facility. It establishes basic design criteria and shall be verified by the A/E through meetings with the Users during the Schematic Design phase of the project. The POR is to be used in conjunction with the Facility Design Guidelines and the Services Agreement to establish the overall responsibilities of the design and construction team.

Contractor: The individual, corporation, company, partnership, firm or other organization that has contracted to perform the Work under the Contract with the Owner.

Record Drawings are the contract drawings, modified and/or corrected to incorporate all changes made during construction.

Additional Definitions can be found in Article I of the "Uniform General and Supplemental Conditions", located in the Appendix section of this manual.

GENERAL REQUIREMENTS

ADMINISTRATIVE PROCEDURES & REQUIREMENTS

GENERAL

At any time during the course of the project the Texas A&M System reserves the right to contract on its own any of the services required to complete the project.

PAYMENT SCHEDULE FOR A/E, CMAR AND D-B SERVICES AGREEMENT

Payments to the A/E, CMAR and D-B for work completed will be made in accordance with the Services Agreement. All invoices shall be submitted through e-Builder and shall be accompanied by a completed Progress Assessment Report (PAR).

AUTHORIZATION FOR REIMBURSABLE SERVICES

The Services Agreements contain several items that are reimbursable services. Even though these items are listed in the Services Agreement they still need to be authorized by the Owner prior to execution of the services. The A/E, CMAR and D-B must forward to the FPC Project Manager a proposal for the services with a not to exceed amount from the consultant/vendor. The cover letter should summarize the amount. The FPC Project Manager will review the proposal and if the total amount is within the amount listed in reimbursable services of the Services Agreement the FPC Project Manager will authorize the service in writing. Many of the reimbursable items like site survey, soils investigation and rendering will be authorized with the instruction that there will be one "lump sum" payment made at the successful completion of the task. Other reimbursable items like special consultants, whose work is incorporated into the design documents, will be authorized and the amount will be paid by project milestones as indicated in the A/E Services Agreement or in the proposal acceptance letter.

If the proposed reimbursable services amount exceeds the amount listed in the Services Agreement then the authorization will come from the Director of Project Delivery and the reimbursable amount in the Services Agreement will be modified by a change order to the agreement.

Upon completion of a "lump sum" reimbursable item the A/E, CMAR and D-B must submit an invoice to the FPC Project manager for payment. The invoice must be from the A/E, CMAR and D-B and contain as backup a copy of the consultant/vendor's invoice. The cover letter must indicate that the services have been performed to their satisfaction and are complete.

GENERAL REQUIREMENTS

If due to extenuating circumstances a “lump sum” reimbursable service is not able to be completed the Owner will entertain a partial payment. The A/E, CMAR and D-B must send a letter to the FPC Project Manager explaining the circumstances, indicating the amount of work completed and suggesting a partial payment amount. The FPC Project Manager will review this request with the Area Manager. Upon the concurrence of the Director of Project Delivery a partial payment will be made.

AUTHORIZATION FOR ADDITIONAL SERVICES

The Services Agreements states the conditions for which the A/E, CMAR and D-B may receive compensation for additional services.

If the A/E, CMAR or D-B foresees that additional services should be performed because of instructions received, or unusual circumstances, they shall submit a change order through e-Builder. The additional services shall not be performed or contracted by the A/E, CMAR or D-B until the change order has been approved.

APPROVALS/NOTIFICATIONS

At each step in the design process the A/E, CMAR and D-B must receive approval from the Owner prior to proceeding to the next step. These approvals take different forms and can vary due to project complexity. Generally, the A/E, CMAR and D-B will be authorized to proceed by the following:

1. Begin Design: Letter transmitting fully executed Agreement
1. Schematic Design: Approval Letter for Schematic Design
2. Design Development: Approval Letter for Design Development
3. Construction Documents: Approval Letter for Construction Documents
4. Construction Phase: Issuance of Notice to Proceed with Construction Services

On all projects the Schematic Design approval letter will come from the Area Manager. The larger and more complex projects will have an approval letter that will be first routed through the campus or agency administration for their approval prior to our approval of Schematic Design. This approval routing will also contain letter and/or tabloid size color copies of the project site plan, floor plans and exterior appearance.

The approval process for Design Development begins with an approval letter, along with letter and/or tabloid size color copies of the project site plan, floor plans and exterior appearance, that will be first routed through the campus or agency administration for their approval.

GENERAL REQUIREMENTS

The approval process for Construction Documents begins with an approval letter, along with letter and/or tabloid size color copies of the project site plan, floor plans and exterior appearance, that will be first routed through the campus or agency administration for their approval.

At a point after the completion of Design Development and prior to the acceptance of a GMP or the award of any construction contract the project will be presented by the Chief Financial Officer and Treasurer to the Board of Regents for approval.

If reviews or approvals of documents are required by Federal agencies, the A/E may be expected to make necessary presentations with Facilities Planning Division's assistance.

DISTRIBUTION OF DOCUMENTS

The A/E shall furnish the FPC Project Manager the number of sets of documents as identified in the A/E Agreement at each step of the design process. The documents sent to FPC Project Manager are reviewed by FPC personnel and the documents sent to the User Representative are reviewed by representatives from the using department, Physical Plant personnel, Safety & Health personnel, Campus Police personnel, etc.

CORRESPONDENCE AND REPORTS

Communications between all parties involved in the planning and construction of a project is a requisite. Oral communications, instructions, directives, and minutes of conferences shall be confirmed in writing by the A/E and distributed to those involved in the planning and construction within five (5) working days of the meeting date.

The Project Architect/Engineer is expected to provide leadership of all design meetings and provide minutes of each meeting within five (5) working days. The meeting minutes shall separately indicate all decisions made at the meeting and all items requiring a decision, which party has responsibility for the decision and when the decision is required.

All correspondence and reports shall be dated and show clearly the project number, the name of the project, the Part of the System, the location, and the A/E contract number, if pertinent.

All correspondence and reports shall be addressed to the Project Manager of FPC during the design phase and construction Phase.

GENERAL REQUIREMENTS

PENDING ISSUES REPORT

The Project A/E shall prepare and maintain a Pending Issues Report throughout the Schematic Design, Design Development and Construction Documents phases of the project. The report shall document all items requiring decisions on the part of the design team, FPC and the User. The report shall be updated at least monthly during the course of the project and also provided along with meeting minutes from the milestone reviews.

DATA FURNISHED TO A/E

The A/E will be furnished a copy of the Program of Requirements (POR) unless the POR development is included as a reimbursable service in the A/E Agreement, existing campus master plans and other studies and reports, soil investigation reports from surrounding buildings if available, existing utility information and existing building information if the project involves renovation.

CHANGES IN DESIGN

There shall be no changes made in the Scope of Work, Area Requirements, or Project Cost without approval of the FPC Project Manager. During the design process the A/E shall maintain a listing of all spaces listed in the Program of Requirements and their square footage. The listing will begin with the POR spaces and be updated at each design milestone.

Major changes to the spaces in an approved POR shall be approved by the Using Agency CEO.

SCHEDULE OF PLANNING

The POR for each Project contains a time schedule indicating dates for project milestones. It is very important that these dates be followed as closely as possible since it can be very difficult to reschedule around all parties' existing business schedule. If changes must be made the A/E must notify the FPC Project Manager several weeks in advance. Deviations from the POR time schedule will only be made when mutually agreed to by the User, the A/E and the FPC Project Manager.

Under special conditions, the planning schedule may be dictated by the need for the Owner to place a completed project in service by an established date deadline. This may occur as a result of grant restrictions, land use or deed restrictions, or a critical need for the facility to be placed in operation to meet semester schedules. In this event, a specific construction

GENERAL REQUIREMENTS

completion date will be established by the FPC Project Manager, and the various planning stages shall be scheduled from that date.

Should the A/E find that the dates of the Planning Schedule cannot be met, they shall give prompt notice in writing to the FPC Project Manager.

REVIEWS

The review of any drawings and specifications by the Owner and others does not relieve A/E of any responsibility nor do they constitute approval of drawings and specifications to that date.

DRAWING REQUIREMENTS

The Project A/E shall produce the design for this project using Building Information Model (BIM) authoring software capable of producing IFC compliant files. The Project A/E shall begin using BIM as early in the design process as possible but no later than the drawings required for Design Development submittal. The A/E is encouraged to use BIM to verify compliance with the POR. Maximum drawing sheet size is restricted to ANSI E size - 34" x 44". Lettering is to be of sufficient size so it can be easily read when reproduced full size and half size. Minimum size of letters on any full size printed drawing is 1/8". Use only the standard fonts supplied with the Microsoft Windows OS. On all drawings, provide a graphic scale in addition to the standard inch scale. On all plan sheets provide a north arrow and if a plan is divided over multiple sheets provide a key plan adjacent to the sheet number in the title block. **Do not use the word "PROPOSED" in designating new work.** All work shown on drawings shall be assumed to be new unless designated as existing.

All drawing sheets shall comply with the following sheet numbering format.

| | | | | |
|---|---|---|---|---|
| A | - | N | n | n |
|---|---|---|---|---|

Where "A" is the discipline designator, "N" is the drawing sheet type designator, "nn" is the sheet number.

The following are the discipline designators as well as the order the drawings shall be placed in a set.

| | | |
|---|---|---------------------|
| G | - | General |
| H | - | Hazardous Materials |
| C | - | Civil |

GENERAL REQUIREMENTS

| | | |
|---|---|--------------------------|
| L | - | Landscape |
| S | - | Structural |
| A | - | Architectural |
| I | - | Interiors |
| Q | - | Equipment |
| F | - | Fire Protection |
| P | - | Plumbing |
| M | - | Mechanical |
| E | - | Electrical |
| T | - | Telecommunications |
| R | - | Resource |
| X | - | Other Disciplines |
| Z | - | Contractor/Shop Drawings |

The following are the drawing sheet type designator.

| | | |
|---|---|------------------------|
| 0 | - | General |
| 1 | - | Plans |
| 2 | - | Elevations |
| 3 | - | Sections |
| 4 | - | Large Scale Views |
| 5 | - | Details |
| 6 | - | Schedules and Diagrams |
| 7 | - | User Defined |
| 8 | - | User Defined |
| 9 | - | 3D Representations |

Title block shall be on the right side of the sheet extending the entire height of the sheet. All text in the title block can be orientated horizontally or vertically.

Drawing orientation should be either north to the top or right of the sheet.

The title block shall include at a minimum, beginning from bottom of title block to top:

- Sheet number (minimum 1/2" text height)
- Sheet Title
- TAMUS Project Number (minimum 3/16" text height)
- Building Inventory Number (minimum 3/16" text height)
- Drawn by
- Checked by
- Name of Project
- Campus or Agency
- Location

GENERAL REQUIREMENTS

- Firm name of Architect/Engineer under contract with owner and consultant if applicable
- Seals

All documents must be sealed or have the appropriate designation per respective licensing board rules.

Cover sheet for the drawings shall contain

- Name of the project
- The RELLIS Campus name
- The A&M System project number
- Date
- The design team names and addresses
- Copy of the project rendering or the campus/agency seal.

General Information Sheet shall contain

- Location Map showing contractor's route, construction limits and contractor lay down area
- Index of drawings
- Abbreviations used in the project
- Net and Gross square foot per floor with total and alternates separate
- Code, Structural, Mechanical, Plumbing and Electrical Design criteria
- Symbols and Legend unique to the project. Unused symbols shall not be included. Where symbols imply a specific data and/or telecom outlet provide a detail of the outlet.

Room numbers shall appear by each equipment and shall be part of the parametric data automatically assigned to objects by placement in rooms.

Detailing shall be adequate, with sufficient schedules, keys to materials, symbols and notes to clearly indicate the work required. Abbreviations shall be held to a minimum.

All schedules shall be derived from the BIM(s) by extracting parametric data associated with the objects used in the model.

All required details will be shown on the drawings, not in a separate manual.

All references to other disciplines shall indicate the appropriate sheet and detail.

Room finish, door and window schedules shall be on the drawings.

GENERAL REQUIREMENTS

All items of mechanical and electrical equipment such as air handlers, pumps, fans, panelboards, light fixtures, etc. shall be scheduled on the drawings Include all appropriate design and operating parameters for each unit. Each piece of equipment on the schedule should include the estimated quantity and multiple acceptable manufacturers. All of this data shall be attached to the associated objects as parametric data.

Electrical panelboard schedules shall list all unique characteristics of each panelboard including but not limited to each breaker size, the loading of each circuit, circuit number, wire size, main breaker size, bussing, interrupt rating, load summary, and all panel Nameplate data. Schedules that list quantities of breakers without scheduling each circuit shall not be used. All of this data shall be attached to the associated objects as parametric data.

All panelboards, switchboards, transformers and other major electrical equipment shall have a unique identifier or tag. Panelboards shall use the following numbering scheme:

| | | |
|---|---|---|
| x | p | n |
|---|---|---|

Where “x” is the floor number the panel is located on.

Where “p” is the panel type using “L” for low, “H” for high and “E” for emergency.

Where “n” is the panel sequence number.

Electrical one-line diagram shall show in a one-line format all medium voltage equipment including manholes, switchgear, transformers and cables. The Low Voltage system (600 volt and below) shall be detailed to the branch circuit panelboard level, and to any point required in the NFPA 70E to have an Arc Flash Label. Online shall include all information that results from an electrical study, such as: size of all wire, conduit, breakers, starters, transformers, generators, meters and transfer switches shall be indicated. Tables may be used. The sizing of wire and conduit using only panel schedules will not be accepted.

Ground riser diagram shall show the size and interconnection of all grounding systems. In most cases ground conductors shall be sized larger than required by the National Electrical Code.

Telephone riser diagram shall show all riser cables, conduits, sleeves and line protectors in their relative relationship to the building.

Fire Alarm riser diagram shall show all equipment associated with the fire alarm system

Broadband distribution riser diagram (Cable Television) shall show all cable sizes, riser cables, amplifiers, splitters, outlets and head end equipment as may be required.

Lightning protection system drawing(s) shall show the arrangement of the lightning protection system with details for each unique connection and roof penetration. These

GENERAL REQUIREMENTS

details shall be coordinated and compatible with the roof system.

SPECIFICATION REQUIREMENT

Specifications shall include bidding and contract documents and technical specifications and the bound document will be entitled "SPECIFICATIONS."

The importance of accurate, complete and coordinated specifications is very important. Specifications shall be carefully checked to include all items pertaining to the project and to eliminate inclusion of items not incorporated into the project.

Specifications shall follow CSI Masterformat and be prepared on 8 1/2" x 11" paper with contents arranged in order indicated below.

Project A/E may use descriptive or performance type of specifications, naming **three** products by name, catalogue number and manufacturer which will meet the standards required. Care shall be taken not to adopt wording recommended by a single manufacturer if the wording will require unique or patented features of a product.

Throughout these Guidelines and Specific Information there are references to single products and/or manufacturers. These are NOT sole source items. The project A/E is required to identify and include in the documents other products and/or manufacturers that are equal.

In the various specification sections where the specification is based around the performance of a specific product or model from a manufacturer (for example fixed seating, laboratory casework, laboratory equipment, air handlers, etc.) all other manufacturers listed as approved equals must also indicate comparable model numbers.

Details and schedules shall be shown on the drawings and not in the specifications

Specifications written "Install in accordance with the manufacturers specifications" are not an acceptable specification. Spell out the procedure to be used so that the FPC Project Inspector and the Contractor's Superintendent can ascertain from the Specifications the manner in which a product is to be used or applied without reference to numerous catalogues which may not be handily available.

Scope of work shall be accurately defined in each section; reference all allied work provided under other sections of work.

Clearly define work to be included under each applicable alternate in each section of work.

GENERAL REQUIREMENTS

Omit duplication of specifications included under Uniform General and Supplemental Conditions or Special Conditions; in each instance, reference the applicable paragraph by number and expand or modify the requirement only as necessary to accomplish a specific purpose. (This is particularly applicable to Mechanical and Electrical sections).

Require delivery, acceptance and approval of all "Certificates of Manufacturer's Quality Control" before delivery of applicable equipment or material.

The specification cover shall contain the following information

- Title: "SPECIFICATIONS."
- Project Number
- Name of Project
- RELLIS Campus
- Location of Project
- Owner: "THE TEXAS A&M UNIVERSITY SYSTEM."
- Set number.
- Firm name of A/E.
- Date (same as drawings).

The title page in the specifications shall contain the following information

- Title: "SPECIFICATION."
- Project Number (including Federal project number, if applicable).
- Name of Project.
- Name of Part of System applicable.
- Location of project.
- Members of the Board of Regents, The Texas A&M University System.
- Chancellor, The Texas A&M University System.
- Director of the RELLIS Campus.
- Director.
- Date (same as shown on Specification cover sheet).
- List of Design Professionals with address, phone numbers and fax numbers.

The color coding and duplexing requirement for the specification is as follows:

| Item | Name | Provided By: | Paper Color | Special Instructions |
|------|------------------------|--------------|--------------|---|
| 1 | Cover | A/E | A/E's Choice | One-sided, cover stock. Back cover same material and color. |
| 2 | Board of Regents Title | FPC | White | One-sided. |

GENERAL REQUIREMENTS

| | Page | | | |
|----|--|---------|-------|---|
| 3 | Design Team Professional Seals Page: | A/E | White | One-sided. |
| 4 | Table of Contents | A/E | White | Two-sided. |
| 5 | Schedule of Drawings | A/E | White | Two-sided. |
| 6 | Request for Competitive Sealed Proposal (CSP ONLY) | FPC | White | Two-sided. |
| 7 | Instructions for Competitive Sealed Proposal (CSP ONLY) | FPC | White | Two-sided. |
| 8 | Supplemental Instructions for Competitive Sealed Proposal (CSP ONLY) | FPC | White | Two-sided. |
| 9 | Bid/Proposal Bond (CSP ONLY) | FPC | White | One-sided. Provide two loose copies of this with the proposal package to each General Contractor for bidding purposes. |
| 10 | Part 1, Competitive Sealed Proposal (CSP ONLY) | FPC | White | One-sided. Provide two loose copies of Parts 1 with the proposal package to each General Contractor for bidding purposes. |
| 11 | Parts 2 and 3, Competitive Sealed Proposal (CSP ONLY) | FPC | White | One-sided. Provide one loose copy of Parts 2 and 3 with the proposal package to each General Contractor for bidding purposes. |
| 12 | GMP Proposal (CMAR & DB ONLY) | CMAR/DB | White | One Sided |
| 13 | Contract Form (CSP ONLY) | FPC | White | One-sided. |
| 14 | Performance Bond | FPC | White | One-sided. |
| 15 | Payment Bond | FPC | White | One-sided. |
| 16 | Uniform General & Supplemental Conditions | FPC | White | Two-sided. |
| 17 | Special Conditions: | FPC | White | Two-sided. |
| 18 | Prevailing Wage Rate Schedule | FPC | White | Two-sided. |
| 19 | Geotechnical Investigation Report | A/E | White | As received from Geotechnical Firm |

GENERAL REQUIREMENTS

| | | | | |
|----|---------------------------------|-----------|-------|------------|
| 20 | Division 1 General Requirements | FPC & A/E | White | Two-sided. |
| 21 | Divisions 2 through 14 | A/E | White | Two-sided. |
| 22 | Divisions 21 through 33 | A/E | White | Two-sided. |

FEDERAL GENERAL REQUIREMENTS

One copy of each form required by the Federal Agency concerned (General requirements, wage rates, certificates, etc.) shall be bound into the Specifications on Projects involving Federal funds.

FPC Project Manager will furnish one copy to the Project A/E for his use in reproducing necessary copies.

ALTERNATES (CSP ONLY)

Provide a description of each Alternate.

Additive alternates are required for projects not involving Federal funds. For Federally funded projects deductive alternates are generally required and must be listed in order of acceptance.

UNIT PRICES (CSP ONLY)

Used for added depth of piers and pier casing only

Provide for cost separations of items, units, etc. as directed by the FPC Project Manager.

ADDENDA

Addenda shall be reserved for items inadvertently omitted from bidding documents. Documents shall be prepared in a comprehensive and a complete manner without use of Addenda.

Addenda sheets shall be 8-1/2" x 11", or the same size as those of the bid set drawings, numbered in sequence with the prefix "AD" and the date of issue and other required identification of the project.

GENERAL REQUIREMENTS

PRINTING AND BINDING REQUIREMENTS

All drawing review sets shall be securely bound using staples or screw post. All reports required for reviews shall be bound with spiral binding or in a 3-ring binder.

All bid set drawings shall be securely bound using staples or screw post. All bid set specifications, except for 10 copies, shall be securely bound using long staples, "VELO" plastic strip, or screw posts and securely taped (ring, spiral or GBC bindings are not acceptable).

The 10 unbound sets of Specifications will be used as the actual contract documents and shall be delivered to the FPC Project Manager. **These ten sets shall not be punched or bound in any manner of fashion.**

ELECTRONIC DRAWING FILES

Digital files shall follow a layer/level format that complies with the AIA CAD Layer Guidelines. The A/E shall provide a hard copy listing of all files, levels, reference file, etc. All items in digital files shall be drawn to full scale.

BIM files shall be divided by discipline/trade. Splitting models not allowable except when approved in writing by the FPC project manager. When drawings need to be split that split shall be vertically not horizontally.

Object libraries for all models shall be included with the model files. This is especially important for IFC files.

BIM files shall be provided in their native format as well as IFC. The IFC files shall be optimized prior to submission. Model files shall be named in the following format:

A B - C E F G H I J K L M N O P Q R S . T U V

- A-B - Campus Number
- C-G - Project Number
- H-K - Building Number (if required)
- L-O - Abbreviated Project Name (add more letters if needed)
- P-S - Discipline (Arch, Elec, Mech, etc)
- T-V - File Extension

In cases where there are more than one building involved in the project the building number shall be used after the project number to differentiate between the two.

GENERAL REQUIREMENTS

During the course of the design digital files are required by FPC Interior Designer for furnishings layouts and by Project Controls Division to update campus maps for illustration purposes. These digital files shall be made available to FPC Project Manager (two weeks before each meeting) at the following project milestones:

1. Design Development (architectural floor plans & site plan)
2. 50% Design (architectural floor plans only)
3. 75% Design (architectural floor plans only)
4. 100% Design (architectural floor plans & site plan)

ELECTRONIC FILE NAMES

DWG and PDF files will be required for all sheets in the drawing sets. The file names used for all digital files delivered to Facilities Planning and Construction shall follow the following format.

A B C D E - F G H I J K L M N O P Q . R S T

| | | |
|-----|---|---|
| A-C | - | Sheet Number (This refers to the overall number in the set) |
| D-E | - | Campus Number |
| F-I | - | Project Number |
| J-M | - | Sheet Number |
| N-Q | - | Sheet Name |
| R-T | - | File Extension |

ELECTRONIC FOLDER NAMES

An electronic folder structure has been established by FPC. This structure along with example file names shall be provided by the FPC project manager.

RECORD DRAWINGS

All changes during the course of the design and construction shall be incorporated into the BIM (s). The A/E is responsible for making changes through the issue of all addenda at which point the model(s) will be turned over to FPC and the GC/CM. The A/E shall also be responsible for providing updates to the model(s) that are changed through RFI, ASI, CCD, Approved Proposal Request, The GC/CM shall be responsible for maintaining and updating the model(s) after the issue of the final addendum. The model(s) shall be maintained as the as-built model(s) from which the record drawings will be derived.

GENERAL REQUIREMENTS

Deliver to the OWNER two (2) copies of all drawings in DWG and PDF format, native model files, as well as IFC file format, corrected to be "Record Drawings" on disk type media (DVD or CD). The disk shall be labeled with a pre-printed label that contains the name of the project, the Campus/agency, the project number, GC/CM name, and the A/E firm name. No other digital format will be accepted. Scanning of drawings is not acceptable.

The digital version of the record drawings shall have one digital drawing file for each drawing sheet in the project bid set. All reference files and "xrefs" must be inserted into the final digital file.

COBie/FACILITIES MANAGEMENT ASSET DATA SHEETS

The GC/CM is required to submit data in the most current version of COBie/Facilities Management Asset Data Assembly of the COBie data requires that the A/E, GC/CM, and commissioning agent provide or even input data into either the BIM(s) or MS Excel spreadsheet. The GC/CM is responsible for coordinating and compiling this data. The preferred method for assembling the data is by deriving/extracting the data from the BIM(s).

For more information on COBie/Facilities Management Asset Data Sheets:

See below link for access to the Facilities Management Data Specification Section 01 78 20.

<https://rellis.tamus.edu/wp-content/uploads/2023/08/01-78-20-Facilities-Management-Data-Specification-New-2021.pdf>

COST CONTROL

In the Program of Requirements the project scope matches the "Base Bid Scope" line item on the Estimated Project Budget page. To achieve an awardable project, the base bid represents 90% of the funds available to award a construction contract. The Project A/E is required by contract to work with the Users and the Facilities Planning Division to keep the design within the "Base Bid Scope" and identify additive alternates to utilize all project funds. Deductive alternates will not be considered.

Throughout the design process, the Project A/E and Construction Manager at Risk or Design-Build Contractor will be required to furnish knowledgeable cost estimates for all items of construction. These estimates shall be itemized in sufficient detail so as to allow the Campus to make informed choices when questions of priority are considered to include or exclude an item. The A/E shall share the BIM(s) with the CM. The CM is encouraged to use these models for establishing conceptual pricing.

GENERAL REQUIREMENTS

CODED ESTIMATE SYSTEM

Code A Estimate: Based on completed Program of Requirements.

Code B Estimate: Based on and submitted with completed Schematic Design (A/E, CMAR, D-B responsibility). The estimate detail shall be in Unifomat 98 (Assemblies) format.

Code C Estimate: Based on and submitted with completed Design Development (A/E, CMAR, D-B responsibility). The estimate detail shall be in Unifomat 98 (Assemblies) and Masterformat format.

Code D Estimate: Based on and submitted with completed Construction Documents (A/E, CMAR, D-B responsibility). The estimate detail shall be in Masterformat format.

Code E Estimate: Submitted 10 days prior to Bid Opening (CSP Only); based on changes in Construction Documents and other events that have occurred since Code D estimate was submitted. For the Code E estimate, if there is a major change in the estimate from the Code D estimate the A/E shall also provide the estimate detail in CSI Masterformat, otherwise only the summary is required.

The Project A/E is cautioned not to confuse the design contingency indicated on the team's estimate with the Bid Contingency (CSP Only) indicated in the POR. These numbers are not the same. Based on the level of completeness of the design there will be a design contingency percentage that is included by estimators. This percentage will decrease as the design proceeds towards the Construction Documents review. The Bid Contingency number is only for variations in the bidding market that were not anticipated by the A/E team's estimator and to purchase additive alternates.

COST ESTIMATE FORMAT

(THE ARCHITECT/ENGINEER WILL NOTE THAT THE CONSTRUCTION COST IS ONLY A PART OF THE PROJECT COST. THE A/E SHALL SUBMIT COST ESTIMATE IN THIS FORMAT ONLY. USE ONLY ITEMS APPLICABLE TO THE PARTICULAR PROJECT. DO NOT USE "N/A." CHANGE NUMBER SEQUENCE IF A CERTAIN LINE ITEM IS OMITTED.)

(Project Name)
(System Member)
(City)

Project No.
Date

CODE "_" COST ESTIMATE

GENERAL REQUIREMENTS

Total Gross Building Area: s.f.
Total Site Acreage: ac.
Total On-Site Parking Spaces:

(ITEM NUMBERS 1, 2, AND 3 BELOW INCLUDE GENERAL CONDITIONS, OVERHEAD, PROFIT AND BONDS.)

1. Building Cost
 - a. General Construction--Building excavation, foundation, structure, roofing, exterior and interior walls, doors, windows, finishes, specialties, and conveying equipment except as listed below \$ xx,xxx.00
 - b. Plumbing--All building plumbing to five (5) feet outside of building line xx,xxx.00
 - c. Mechanical--All building HVAC, including heating and chilled water lines, to five (5) feet outside of building line xx,xxx.00
 - d. Electrical--All building electrical work to five (5) feet outside of building line xx,xxx.00
 - e. Total Building Cost \$ xxx,xxx.00
2. Fixed Equipment Cost
 - a. Built-in lockers, food service, fixed seating, casework, fume hoods, etc. xxx,xxx.00
3. Site Development Cost
 - a. Demolition--All demolition; whether site, structures, mechanical, electrical or plumbing, excluding asbestos removal \$ xxx,xxx.00
 - b. Site Development--All walks, drives, parking, grading, walls, steps, and site appurtenances from five (5) feet outside edge of building xxx,xxx.00
 - c. Landscaping--All trees, shrubs, sod, planting and irrigation xxx,xxx.00

GENERAL REQUIREMENTS

| | | | |
|----|--|----|-------------------|
| d. | Site Mechanical--All HVAC and plumbing lines from five (5) feet outside edge of building, including storm and sanitary sewer systems | | xxx,xxx.00 |
| e. | Site Electrical--All electrical work from five (5) feet outside edge of building and cost of transformers regardless of location | | xxx,xxx.00 |
| f. | Total Site Development | \$ | <u>xxx,xxx.00</u> |
| 4. | ESTIMATED CONSTRUCTION CONTRACT AMOUNT (SUM OF 1, 2, AND 3, Not to exceed 90% of Line 6) | | x,xxx,xxx.00 |
| 5. | Bid Contingency (CSP) | | xxx,xxx.00 |
| 6. | AMOUNT AVAILABLE FOR CONSTRUCTION CONTRACT | \$ | x,xxx,xxx.00 |

Building Unit Cost (ITEM 1.e "TOTAL BUILDING COST" DIVIDED BY TOTAL GROSS SQUARE FEET) \$xx.xx Cost/G.S.F.

Alternates (CSP ONLY - LIST BY NUMBER WITH BRIEF DESCRIPTION AND ESTIMATED COST)