

Structural Methods for Controlling Coastal Erosion

Charles R. O'Neill, Jr.

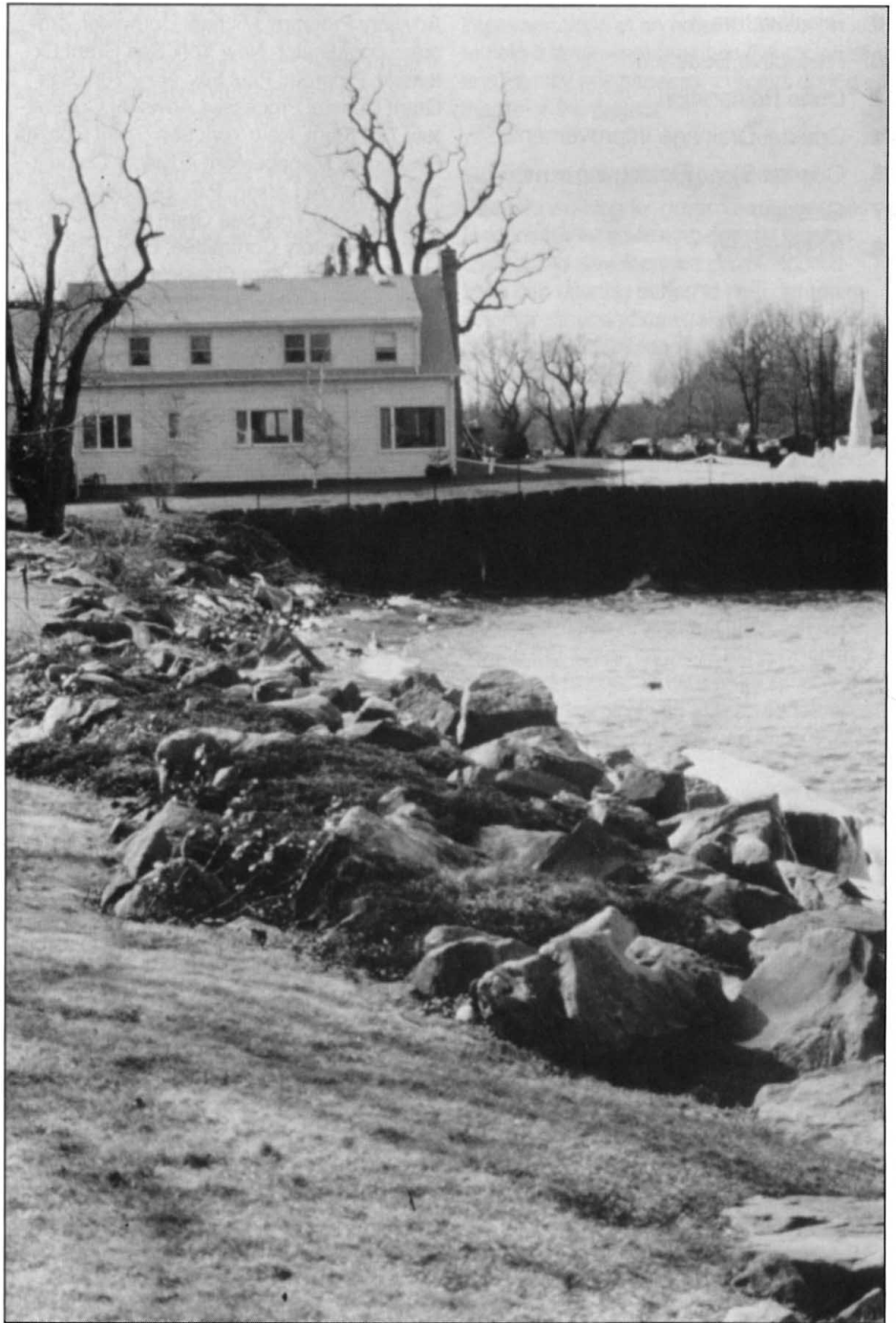

Information Bulletin 200

A Cornell Cooperative Extension
Publication

Contents

- 1 Introduction
- 1 How to Use This Publication
- 2 Selecting an Alternative
- 3 Design Considerations
- 7 Seawalls
- 10 Bulkheads
- 14 Revetments
- 15 Groins
- 18 Breakwaters
- 20 Protective Beaches
- 22 Dune Restoration
- 24 Coastal Drainage Improvements
- 25 Coastal Slope Reshaping
- 27 Glossary
- 28 Bibliography

The author would like to express his deepest appreciation to the following individuals for their review and critique of this manuscript:

Dr. Robert Adams, chairman, Department of Earth Sciences, SUNY College at Brockport; Dale Baker, director, Minnesota Sea Grant Extension Program; Sandra Brennan, New York Sea Grant Extension Coastal Processes Advisory Committee; Bruce DeYoung, program coordinator, New York Sea Grant Extension Program; Brian Doyle, director, New Hampshire Sea Grant Marine Advisory Program; Michael Duttweiler, program coordinator, New York Sea Grant Extension Program; Paul Fox, New York Sea Grant Coastal Processes Advisory Committee; Ted Klem, New York Sea Grant Coastal Resources Management Advisory Committee; Lauren A. Larsen, P.E.; Stephen Murphy, New York Sea Grant Coastal Processes Advisory Committee; David Reville, New York Sea Grant Coastal Resources Management Advisory Committee; Spencer Rogers, coastal engineer, North Carolina Sea Grant Marine Advisory Service; Jay Tanski, regional extension specialist, New York Sea Grant Extension Program.

Charles R. O'Neill, Jr., is a regional specialist in the NYS Sea Grant Extension Program, SUNY College, Brockport, NY 14420.

Introduction

Many areas of New York's coast are naturally subject to shoreline erosion. In many of these areas, particularly where there are homes, businesses, or other structures, the erosion becomes a problem.

Too frequently, good coastal erosion control engineering and design considerations are poorly understood when shoreline development is being planned and implemented in erosion-prone and erosion hazard areas. Many actions undertaken to cope with erosion problems, therefore, either fail to work as intended, do not last long enough to realize a practical or financial benefit to the owners, or may even compound the problem for that site or for neighboring areas of the coast. Many private coastal erosion structures are underdesigned, making them susceptible to damage from storm waves and leading to premature deterioration and failure.

How to Use This Publication

This Information Bulletin is intended to give coastal landowners, developers, and government officials a means to determine what erosion control alternatives might be applicable to specific situations. Information is presented on planning and designing coastal erosion control projects, materials used for such construction, which alternatives are suitable for general types of coastal landforms, and which are compatible with general categories of shoreline land use. It is part of the Shoreline Conservation Series of Information Bulletins and related Fact Sheets. For different situations, one or more of these publications should be used in conjunction with others. The following is an idealized scheme of how these publications might be used by landowners and permit agents.

Shoreline Landowners

Readers who own eroding coastal land and who are thinking of installing some form of erosion control project will be able to use this series to plan and implement projects that are suitable for their particular situation. They could use Information Bulletin 199, *A Guide to Coastal Erosion Processes*, to determine the actual cause of the erosion at their site and to identify natural erosion control features (such as barrier beaches and dunes) that may be present and that may be capitalized upon as part of an overall erosion control project. Information Bulletin 199 will also be useful in determining what effects their own activities may be having upon shoreline erosion.

Next, they can use this bulletin to identify what structural erosion control alternatives might be suitable for their particular erosion situation and to identify general design criteria necessary for a successful project. They can then use the structure-specific sections to narrow the choices down to a proposed project.

More-detailed information on planning and designing coastal erosion control structures can be found in the publications listed in the Bibliography.

A third bulletin in the series, Information Bulletin 198, *Vegetation Use in Coastal Ecosystems*, can help a landowner understand the potentials and constraints for the use of vegetation for reduction of erosion in

situations where a structural alternative may not be desirable.

Finally, professional design assistance should be sought; although the information in these publications is sufficient for making decisions on what types of erosion controls are viable alternatives and for initial planning phases of such projects, it is not intended to take the place of professional marine engineering design or on-site consultation.

New York Sea Grant Extension Fact Sheet 104.00, *Maintaining Coastal Erosion Control Structures*, will be useful after the implementation of an erosion control project to help a landowner maintain the structure and identify any necessary repairs during the life of the project.

Government Permit Agencies

Readers working for government agencies responsible for reviewing coastal erosion control and development permit applications can use this series to help determine whether proposed coastal erosion control projects are suitable for specific locations, as well as to make general determinations as to whether the projects are reasonably well planned and designed. This should enable them to make better decisions on permitting or approving such projects. They should also become familiar with New York State coastal erosion regulations.

As with landowners, permit agencies will find Information Bulletin 199, *A Guide to Coastal Erosion Processes*, useful in determining the actual cause of the erosion at a site under review. Natural erosion control features present will be able to be identified and protected (and made part of an overall erosion control project).

Next, this bulletin can be used to determine in a general way whether the structural erosion control alternative under review is suitable for the particular erosion situation and to determine if general design criteria necessary for a successful project are present. A more-detailed review is given in the structure-specific sections. These agencies can use the publications listed in the Bibliography for more-detailed information on planning and designing coastal erosion control structures.

Finally, such reviewing and permitting agencies should avail themselves of professional engineering assistance to determine whether specific design criteria have been met.

Selecting an Alternative

In selecting the appropriate coastal erosion control alternative for a specific site, several questions must be considered.

- What type of structure is generally suitable for use with the physical shoreline form present at the site?
- What erosion process is affecting the shore?
- How is the site currently (or how will it be in the future) put to use, and which structures will be generally compatible with those uses?
- What resources are available for implementing the proposed alternative (financial, as well as physical)?
- What characteristics and functions are desirable for the proposed erosion control alternative?

Information Bulletin 199, *A Guide to Coastal Erosion Processes*, can aid in the determination of which erosion process is most important at a particular site. Figure 1 can help determine which structures will be generally compatible with current and future uses of the site. When determining what characteristics and functions are desirable for the project, the following list of advantages and disadvantages for each alternative can be of help. Finally, coastal engineers, marine contractors, and Sea Grant extension specialists can all provide information on coastal erosion control that can be of great help to a project proponent in deciding what alternative to select.

Key to suitability and compatibility charts

Figure 1. General suitability of structures for various shore types and compatibility with existing and potential future shoreline uses are important considerations when deciding upon what type of erosion control project to undertake. Use the key

SUITABILITY (landform)

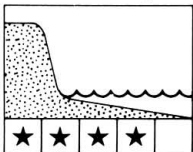

High bluff

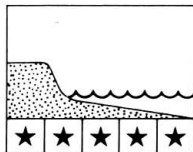

Low bluff

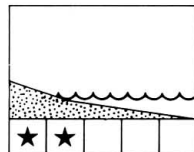

Beach

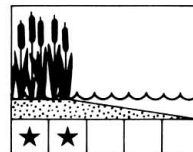

Wetland

COMPATIBILITY (shoreline use)

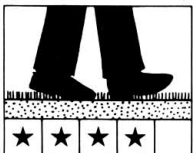

Strolling

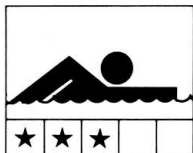

Bathing

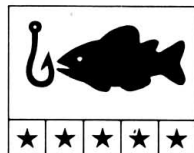

Fishing

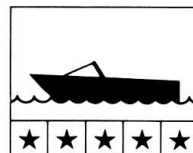

Boating

Advantages

Suitable for most wave climates

Revetments Seawalls

Bulkheads Breakwaters

Do not deplete fronting beach

Slope reshaping Dune restoration

Drainage improvement

May build up beach by trapping littoral drift

Groins

Breakwaters

Benefit downdrift shore & immediate area

Protective beaches

Benefit long section of shoreline

Breakwaters

Protective beaches

Not subject to flanking

Breakwaters

Few negative environmental impacts

Seawalls Dune restoration

Bulkheads Drainage improvement

Revetments

Decrease local turbidity

Seawalls Drainage improvement

Bulkheads Slope reshaping

Revetments

Improve or do not restrict access

Protective beaches Breakwaters

Groins Slope reshaping

May provide angler access to deeper waters

Groins

Breakwaters

Provide direct boat access to the shore

Seawalls Bulkheads

Provide sheltered swimming/mooring area

Breakwaters

Do not affect use of fronting beach

Slope reshaping Dune restoration

Drainage improvement

Provide more beach for shoreline recreation

Protective beaches

Groins

May provide improved/additional fish/wild-life habitat

Groins Dune restoration

Breakwaters Revetments

Create opportunity for nature study

Dune restoration

Relatively low cost

Drainage improvement Dune restoration

Protective beaches

Disadvantages

Not suitable for severe ice climates

Gabions

May increase erosion downdrift

Seawalls Groins

Bulkheads Breakwaters

May increase wave scour at toe

Seawalls Breakwaters

Bulkheads

May decrease size of fronting beach

Seawalls Revetments

Bulkheads

May cause steepening of fronting beach

Seawalls Revetments

Bulkheads

Do not protect against direct wave action

Protective beaches Slope reshaping
 Dune restoration Drainage
 improvement

Limit access to shore

Seawalls Revetments
 Bulkheads Dune restoration

Limit travel along beach

Groins

May limit use of fronting beach

Seawalls Revetments
 Bulkheads

May be hazardous to people walking on them

Revetments

May create bathing hazard from rip currents

Groins

Drop off into deeper water at sill may pose bathing hazard

Protective beaches

Submerged sections may be navigation hazard

Groins Protective beaches
 Breakwaters

Increased turbidity may impair fishing

Protective beaches

May impair water quality in still water between or behind structure

Groins
 Breakwaters

May reduce view from upland areas

Dune restoration

Reduce amount of usable land at top of slope

Slope reshaping

Very susceptible to storm damage

Protective beaches
 Dune restoration

Expensive to construct

Seawalls Breakwaters
 Bulkheads

Very difficult to repair

Breakwaters

Design Considerations

For New York readers, it should be noted that New York Coastal Erosion Management Regulations [Environmental Conservation Law Article 34, 6NYCRR 505] require that all coastal erosion control structures be designed and built using generally accepted engineering and construction practices demonstrated to be effective in controlling coastal erosion. All such structures must, under state law, have a reasonable likelihood of controlling erosion for 30 years, and their plans must incorporate a long-term maintenance program to ensure that the structure will reach its planned 30-year life expectancy.

Design Water Level

After choosing the appropriate structure for a given physical situation, expected use, and function, it is necessary to determine the water level and wave heights that the structure will be expected to withstand. This information will be used to develop a design height for the structure.

Generally speaking, in waters where there are tides, the elevation of the spring or diurnal tide plus between 2 and 3 feet (for storm setup) is a reasonable design water level. To determine a reasonable design water level on the Great Lakes, with their seasonal water level fluctuations, the midpoint between the long-term average annual high water level and the highest recorded monthly average water level should first be determined. Next, the highest monthly average water level of the previous year should be determined. The design water level is the greater of these two figures plus a storm setup figure of between 2 and 4 feet (based upon local observations) for Lake Erie and about 1 foot for Lake Ontario.

Design Wave

As discussed in *A Guide to Coastal Erosion Processes*, waves are generated either by wind or by boat activities. In most situations, the major wave activity will be from wind-generated waves; so most structures, except those in sheltered bays or coves where boat wakes are the primary problem, will be designed based upon wind wave-generation characteristics.

To find the maximum height of a breaking wave for an erosion control project site, for which an erosion control structure could then be designed, the water depth 50 feet offshore from the site is determined. To this

is added the difference between the design water level and the water level on the day of depth measurement (from either the *Tide Tables* or the *Monthly Bulletin of Lake Levels for the Great Lakes*). This figure multiplied by 0.8 will yield the maximum breaking wave height for that site.

Structure Height and Runup

When waves break against an erosion control structure, they will run up or splash up to a level above the still water level. Overtopping of a structure by white spray is acceptable; however, greenwater overtopping should be avoided. Overtopping can lead to failure of erosion control structures by removing the land behind them (fig. 2).

A wave striking a smooth vertical structure will splash up approximately twice the height of the wave. "White water" spray will go even higher. Detailed computations involving such factors as wavelength, wave period, water depth at the structure, and structure slope can be used by marine engineers to determine wave runup. A rough estimate, however, of runup using the following method can be useful in the early planning stages of a structure. Runup on a sloping structure varies from 3/4 to 2 1/4 times the wave height, with the



Figure 2. Storm waves frequently overtop erosion control structures. When they do, the land behind the structure should be protected with a splash apron. Drainage tile behind the structure can remove excess water.

Figure 3. Overtopping can easily lead to structure failure if measures are not taken to prevent the land behind from being washed away.



runup decreasing with an increase in the roughness of the face and an increase in the horizontal versus vertical slope of the face (fig. 4).

For example, given a design wave height (H) of 4 feet and a smooth-faced structure with a slope of 4 horizontal to 1 vertical ($m = 4.0$), the wave runup (R) will be 6 feet above the still water level ($R = 1.5H$). To prevent overtopping, the structure should, therefore, be built to a height of 6 feet above the still water design water level.

If it is not feasible to build a structure as high as this computation would determine, a splash apron should be constructed behind the top of the structure to prevent erosion by overtopping waves (figs. 2 and 3). Drainage for overtopping water should also be provided.

Protection against Flanking

Most erosion control structures (except for groins and some offshore breakwaters) provide protection only to land immediately behind them and are susceptible to erosion progressing around their ends. Such flanking can be prevented by constructing wing-walls or returns at the ends of the structure to tie the structure into the shoreline (figs. 5 and 6). Returns can be built as part of the original structure or can be added at a later time after flanking begins if the structure has not been substantially damaged by the flanking. Ideally, a structure is designed to prevent the start of flanking. Alternatively, as erosion progresses and the structure begins to be flanked, it could be lengthened instead of having returns added. This would be possible, however, only if adjacent property owners gave their permission and if funds and physical locations permitted.

Foundations

In many regards, a structure is only as good as the foundation upon which it is constructed. A sandy bottom is very prone to erosion by direct wave attack. Structures

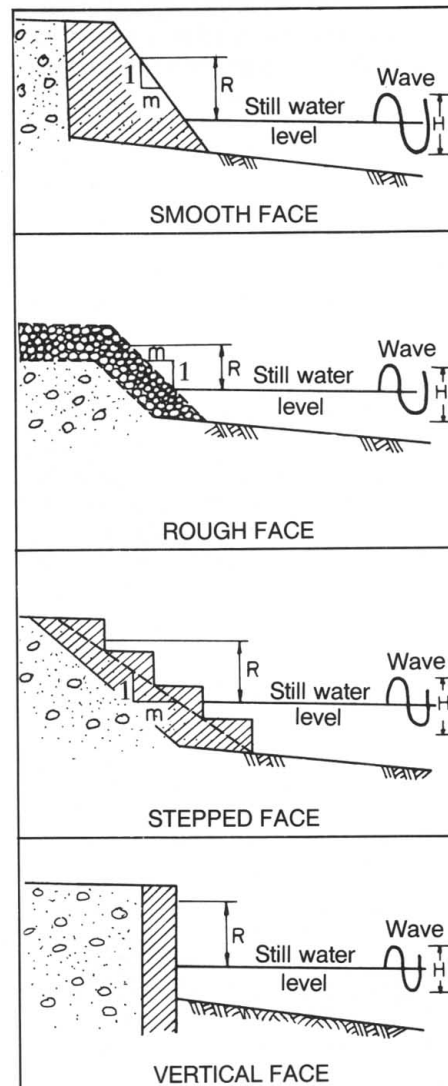

m	R
1.5	2.25 H
2.5	1.75 H
4.0	1.50 H

m	R
1.5	1.25 H
2.5	1.00 H
4.0	0.75 H

m	R
1.5	2.00 H

m	R
—	2.00 H

Figure 4. Wave runup on various types of structure surfaces and slopes can be approximated from this chart. (Adapted from U.S. Army Corps of Engineers 1981.)

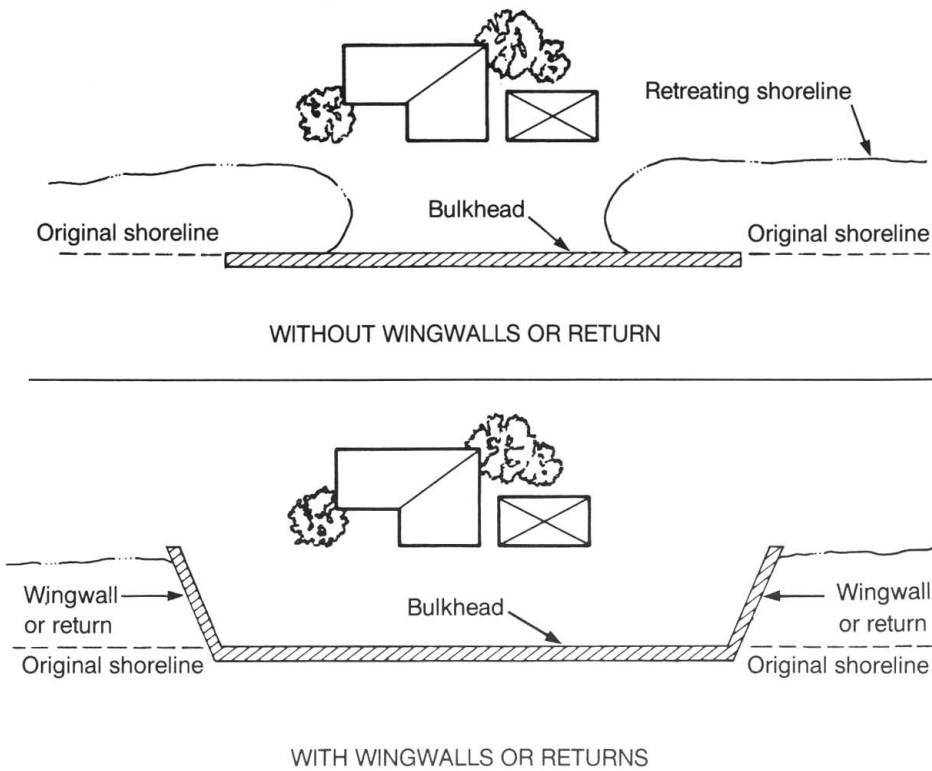

Figure 5. Wingwalls and returns prevent waves from getting behind, or "flanking," a structure. (Adapted from U.S. Army Corps of Engineers 1981.)

built in sandy areas are, therefore, very susceptible to being undercut and require foundations that extend below the depth to which wave scour can be expected to occur. Drainage characteristics of sandy soils are, however, usually very good. Clayey soils are not as prone to wave scouring, but are quite impermeable, possibly resulting in the buildup of water pressure behind a structure, which could push the structure forward in an effort to reduce that pressure. Structures in clayey areas usually require additional drainage to be designed into them. Clay also tends to swell when it is wet and shrink when it dries, a characteristic that could result in some displacement of the structure from its original alignment. Excavation before construction and subsequent backfilling with nonclay materials can help to alleviate this problem.

Silty soils that absorb water without allowing it to drain quickly away may evidence frost heaving during early- and late-winter freeze and thaw periods. Such frost heaving could have the effect of lifting a shallow-founded structure out of its original position. As with clayey soils, excavation and backfilling can help to minimize some of these drawbacks.

The weight of a coastal erosion control structure could result in its settling, no matter what type of material (other than bedrock) is beneath its foundation. If such settling was different along one part of a structure than another, the structure could crack or separate. Gravity structures (that is, those that simply sit on the bottom and rely upon their own mass to remain in place) should always be placed upon a foundation of crushed stone or gravel. In some situations, the bottom may be too soft to support the structure even in this manner, in which case driven piles must be used as a foundation upon which the structure rests.

When the foundation beneath a structure is bedrock (or bedrock is near the surface), those structures that require deep penetration into the bottom (such as cantilevered sheet pile bulkheads) are not appropriate.



Figure 6. Without wingwalls or returns, flanking can lead to a structure's premature failure.

Filtration and Drainage

Filtration and drainage are among the most-neglected design areas of coastal erosion control structures. As waves break against an erosion control structure or as rain falls on the land behind it, water collects behind the structure and flows naturally toward the lowest point around, which is usually the water body in front of the structure. If this water is not allowed to pass through the structure, there will be a buildup of hydrostatic pressure behind the structure. Such pressure could eventually crack the structure or actually push it over in an effort to allow the water to drain and relieve the pressure. Saturated soil is also heavier and harder to hold in position than well-drained soil. In addition, as water moves through any spaces in the structure (or beneath or around it, if the structure is impermeable), soil and fill particles are washed away, creating voids and hollows beneath and behind the structure.

To prevent this from happening, structure design should include some provision for draining the area behind and beneath the structure, while still preventing soil particles from being carried away through the structure. This can be done by installing weep holes to allow the excess water to drain from behind a solid structure and including some form of filtration such as synthetic filter fabrics or graded gravel behind and beneath the structure to retain soil particles (fig. 7). Permeable structures such as rock revetments should still incorporate filter cloth (or, at the least, a bed of gravel) to prevent soil from being washed from behind and beneath the structure.

Such filter fabrics are woven or nonwoven cloths of very high strength nylon or other synthetic materials. Woven cloths provide a uniform series of small openings, which allow water to pass through, but which are too small for soil particles to pass through. Nonwoven fabrics are composed of fibers glued, melted, or pressed together. Although less expensive than woven cloth, nonwoven cloth does not have uniform openings, may not provide as effective filtering under all conditions, and is usually not so strong as woven cloths. Different filter fabrics have different-size openings; the choice of appropriate material for a given soil situation

Figure 7. A "state-of-the-art" erosion control structure incorporates filtration, drainage, toe protection, tie backs, and deadmen. (Adapted from U.S. Army Corps of Engineers 1981.)

should be determined by a qualified engineer.

Materials

The power of the waves that the structures will have to withstand is an important consideration in designing and building coastal erosion control structures. Although some materials may be less costly to obtain or to work with, such materials may also be less durable than more-expensive materials, depending upon the specific situation in which they are used. Always determine what the most appropriate material for the specific structure and site is and then use that material if it is available.

Stone. That selected should be durable and hard; free from cracks, laminations, and undesirable weathering; angular quarry stone, not rounded field boulders. The greatest dimension of individual pieces should not exceed 3 times the least dimension (keep surface area to a minimum). High specific gravity reduces the volume needed and minimizes buoyancy of individual stones.

Concrete requires appropriate air entrainment in a marine setting (especially in a freezing climate). It should be reinforced with steel with at least 3 inches of concrete over it. Durable aggregate materials should be chosen. The correct type of portland cement and the correct cement/water ratio should be used for the situation. Forms should be smooth with rounded corners to minimize effects of weathering on the final structure.

Metal. Corrosion of metals in salt water is a major problem. Instead of plain steel, special corrosion-resistant hot-dipped galvanized steel or wrought iron should be used in the marine setting (in fresh water, this is

not so critical a problem). Care should be taken to isolate dissimilar metals (such as steel and aluminum) from contact with each other, because salt water provides a medium for an electrolytic reaction to take place, increasing the rate of corrosion of the materials.

Wood. When wood is used as a primary construction material, the wood should be pressure treated to resist rotting and damage by marine organisms. Any cut surfaces are potential locations for rot or infestation to occur and should, therefore, be treated by a surface application of wood preservative immediately after construction. Similarly, any places where the wood has been drilled should be plugged with treated dowels or packed with epoxy to prevent problems in the future.

General. Round structural members have a lower surface area and provide better flow characteristics and longer structure life.

Toe Protection

The majority of cases of failure of coastal erosion control structures are caused by undermining of the toe (that part of the front of the structure lowest to the bottom and closest to the water) by wave scour. In designing an erosion control structure, toe protection (that is, some form of armoring of the toe of the structure and the bottom immediately in front of it) should always be included (fig. 7). In general, structures should be built extending far enough into the bottom to not be undercut by wave action. A rule-of-thumb for this depth is to build at least one design wave height plus anticipated future erosion depth down into the bottom.

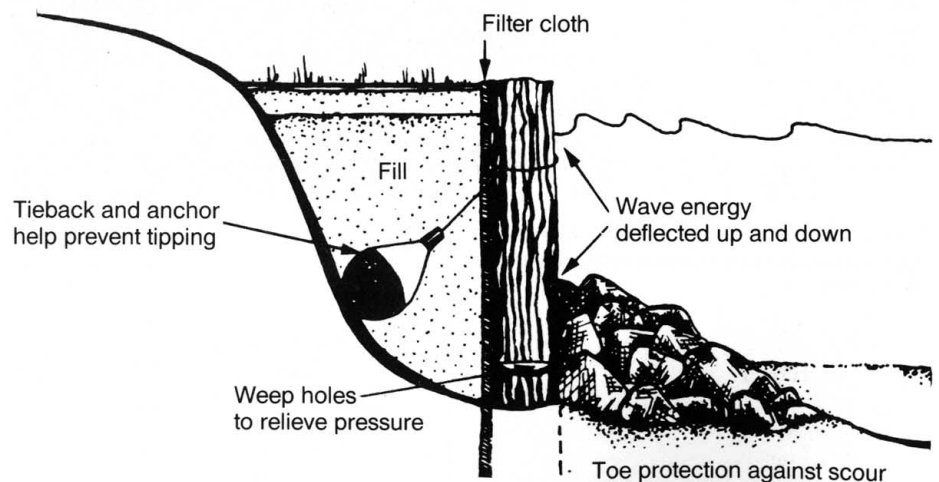

Anchors and Tiebacks

Vertically driven pilings or buried horizontal wooden, concrete, or metal weights (called *deadmen*) can be used to anchor a seawall, bulkhead, or groin (fig. 7). When the distance between the structure and any buildings is very small, wooden or metal piles, driven at an angle in front of the structure, can be used as braces instead of using anchors behind the structure.

When using anchors or deadmen, they should be placed far enough behind the structure (in general, a distance at least equal to the height of the top of the structure above the bottom) to prevent the anchor from being pulled or pushed forward with the structure as the forces of waves and land movement attempt to move the structure. Anchors should be buried deeply enough to resist being pulled through the soil and prevent the structure from rotating seaward.

Galvanized or other corrosion-resistant steel rods or cables are used as *tiebacks* connecting the anchors to the structure. The tiebacks should not be attached directly to any of the vertical components of the structure. Instead, they should connect to horizontal wales located at or near the top of the structure to distribute the lateral loads on the structure.

Figure 8. Lack of tie backs and deadmen led to this bulkhead's failure.



Seawalls

Definition, Functions, Purposes

A *seawall* is a structure built parallel (or nearly parallel) to the shore to separate the land and the water for the purpose of protecting against erosion and other wave damage. A secondary function of a seawall is that it acts as a bulkhead or retaining wall, holding back the land behind it. (*Note:* Small seawalls are often called bulkheads and are sometimes difficult to distinguish functionally from bulkheads. The two terms are also often incorrectly used interchangeably.) A seawall is a freestanding structure, not requiring backfill. Seawalls are very effective at deflecting wave runup. Seawalls, because they are subject to the full force of storm waves, are very massively built structures. They are often used to protect areas that extend out from the adjacent coastline or that are not protected to any great degree by a fronting beach.

Types

Cast-in-place concrete

Smooth face. This type of concrete seawall is built with a smooth surface, the angle of which can vary from vertical to quite flat, and is usually restricted to low to moderate wave climates. This seawall is built with a very wide base, which either extends a short distance below the bottom, resting upon a foundation of vertically driven pilings or a foundation of gravel, or simply sits on the bottom, and is prevented from settling by means of its large bottom surface area.

Wave runup can be a problem with a smooth-faced seawall, for smooth concrete does not present a great deal of friction to slow waves down or to dissipate their energy. The nearer to vertical the face of a seawall is, the greater the height of wave runup.

Also, the steeper the face, the more apt the structure is to be undercut by wave scour at the front toe; for when a wave hits a vertical (or near vertical) surface, the amount of energy directed down (toward the bottom) is nearly the same as the energy directed up (in the form of splashing, uprushing white water). The energy directed downward can result in scour at the toe of the structure. Some protection against undercutting from such wave scour should be provided in the form of either armor stone or a sheet pile cutoff wall, depending upon site-specific characteristics. Generally, toe scour is reduced as the slope of the face of the structure is flattened.

Stepped face. This type of concrete seawall (fig. 9) is similar in design to a smooth-faced wall and rests on the same type of foundation. The difference is that the stepped face is designed to reduce wave runup. This type is used in moderate wave climates. As with a smooth-faced seawall, toe scour can be a problem and must be taken into consideration.

Curved (reentrant) face. Designed for high wave energy situations, these are usually the most massive of all seawalls. The concave-curved face turns waves over on top of themselves and is very effective at preventing runup and overtopping in all but the most severe storms. This configuration is also most effective at preventing toe scour; however, armor stone or a cutoff wall should still be included in the design to prevent any potential undercutting. Foundation considerations are the same as for the preceding types (fig. 10).

Rubble mound. Mounds of heavy stone rubble can be used as seawalls in various wave climates; the more severe the wave energy, the heavier the rock and the more massive the structure (fig. 11). Wave runup on this type of seawall is much less than on the preceding concrete structures because of the rough face, which provides far more friction to dissipate wave energy. Toe scour and undercutting are also less of a problem because individual stones can settle and readjust the structure to fit a changing bottom profile. These seawalls are prone to gradual, rather than catastrophic, failure when design conditions are exceeded.

If such a rubble mound is freestanding, it is functioning as a seawall; if backfill has been placed or if the structure extends up an existing slope, it should more accurately be called a *revetment*.

Limitations

A seawall protects only the land immediately behind the structure. Adjacent land and fronting beaches often experience increased rates of erosion, for the seawall prevents soil that would otherwise have been contributed by erosion of the land behind the seawall from entering the littoral system, thereby changing the littoral drift rates. Many studies now confirm this negative effect of seawalls on fronting beaches, and their use in beach areas is prohibited in some states because of this. In areas where sandy beaches are not common, such as along the Great Lakes coast, this is not as much of a problem. Waves reflected from the structure may also cause an increase in erosion in front of the structure.

Design Considerations

Foundation. Seawalls are frequently gravity structures, that is, they remain in place primarily through their own weight on the shore. They are particularly suitable for areas where subsurface conditions (such as bedrock very close to the surface) preclude pile driving for other types of structures. In areas where there is not bedrock to provide support, gravity seawalls require strong foundation soils to support their mass.

Prevention of scour. Toe scour in front of a seawall can be expected to continue as deep beneath the original elevation of the bottom as the height of the maximum unbroken wave at that location. For example, if the depth of the water in front of the structure is 5 feet and the maximum unbroken wave that can be expected is 5 1/2 feet, scour could progress to a depth of 5 1/2 feet below bottom. A cutoff wall extending at least half again that far below the bottom should be constructed, or armor stone heavy enough to withstand the anticipated wave forces should be placed in front of the structure to prevent such scour. Armor stone will also settle into any localized scour trough that may develop over time.

Drainage and filtration. As waves break against a seawall or as rain falls on the land behind it, water collects behind it and flows

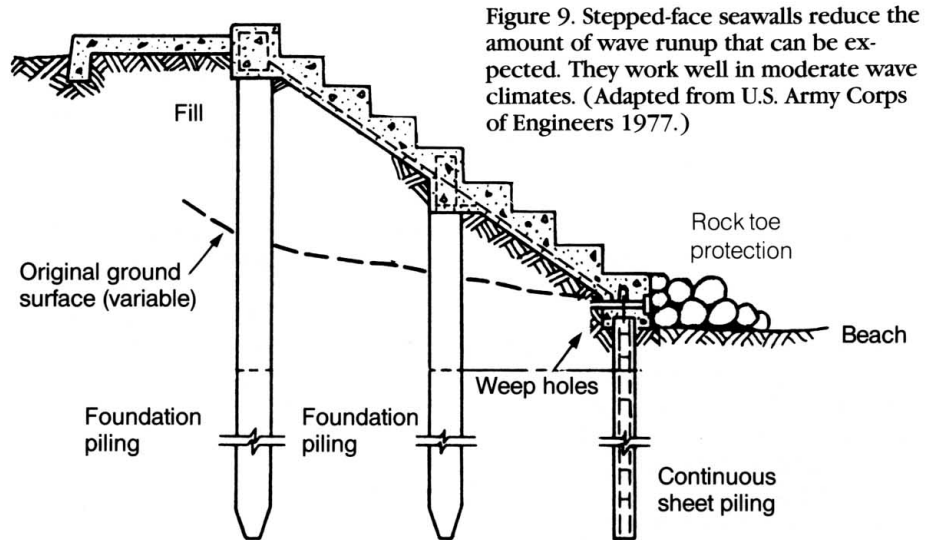

Figure 9. Stepped-face seawalls reduce the amount of wave runup that can be expected. They work well in moderate wave climates. (Adapted from U.S. Army Corps of Engineers 1977.)

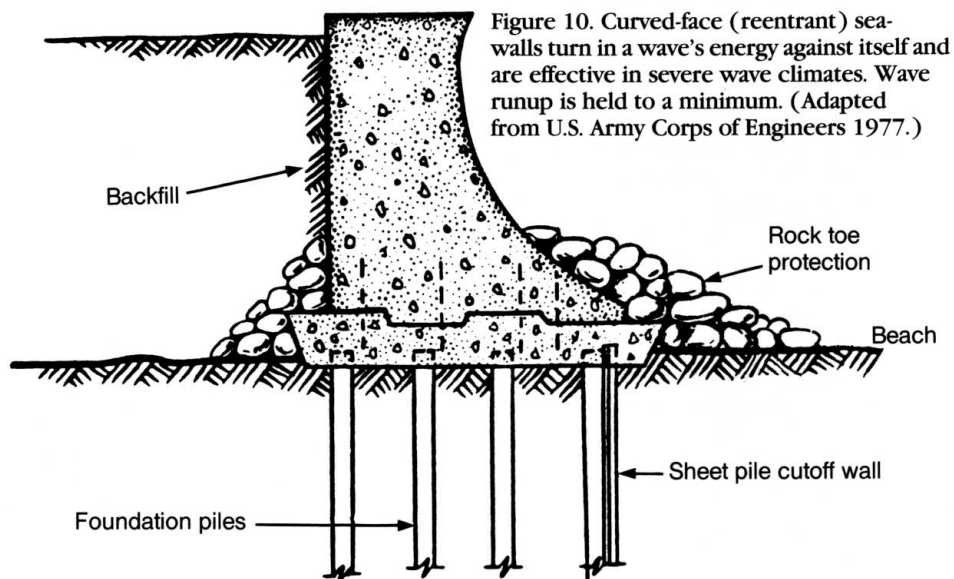

Figure 10. Curved-face (reentrant) seawalls turn in a wave's energy against itself and are effective in severe wave climates. Wave runup is held to a minimum. (Adapted from U.S. Army Corps of Engineers 1977.)

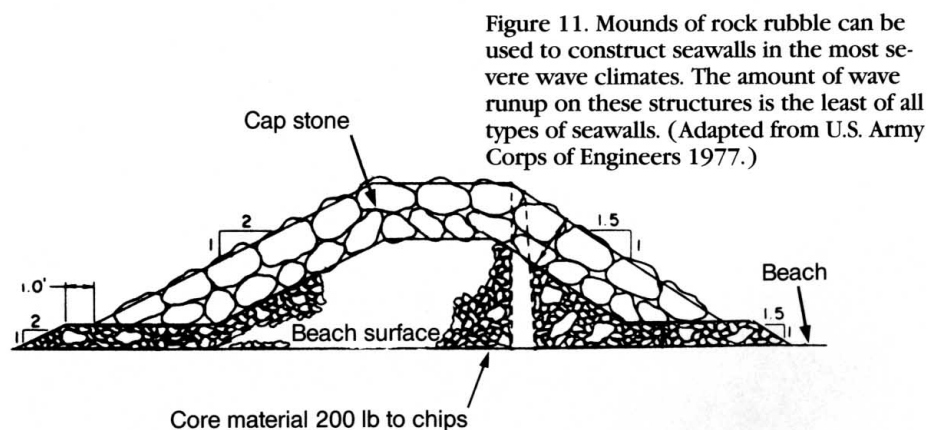

Figure 11. Mounds of rock rubble can be used to construct seawalls in the most severe wave climates. The amount of wave runup on these structures is the least of all types of seawalls. (Adapted from U.S. Army Corps of Engineers 1977.)

downhill, usually toward the water body in front of the structure. If this water is not allowed to pass through the seawall, hydrostatic pressure will build up behind the structure. Such pressure could eventually crack the structure or actually push it over as the water attempts to drain and relieve the pressure. Saturated soil is also heavier and harder to hold in position than well-drained soil. In addition, as water moves through any spaces in the seawall (or beneath or around it, if it is impermeable), soil and fill particles will be washed away, creating voids and hollows beneath and behind the structure.

To prevent this from happening, seawalls should be designed incorporating drainage provisions for the area behind and beneath the wall, while still preventing soil particles from being carried away through the wall. This can be done by installing weep holes to allow excess water to drain from behind a solid seawall and by including filtration in the form of synthetic filter fabrics or graded gravel behind and beneath the structure to retain soil particles (fig. 12). Permeable rubble-mound seawalls should also incorporate filter cloth or gravel to prevent soil from being washed from behind and beneath the structure.

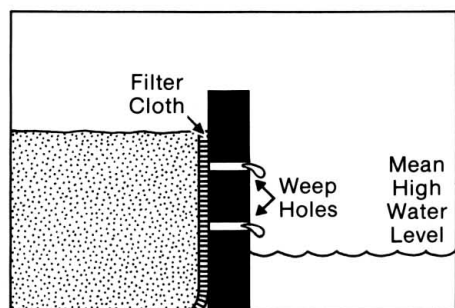

Figure 12. Weep holes provide for draining excess water from behind a seawall. Filter fabrics or gravel retain the soil particles behind and beneath it.

Materials. When seawalls are constructed of concrete, steel reinforcing rods or mesh should be used to prevent cracking and separation of the concrete. The steel should be covered by at least 3 inches of concrete to prevent corrosion.

Effects on Coastal Processes

Seawalls may cause some depletion of the downdrift shore by preventing sediments from behind the wall from entering the littoral drift system and replenishing the downdrift area. Reflected waves may increase toe scour, beach depletion, or beach steepening immediately in front of or adjacent to the structure. Sharp-angle turns in the face of the wall may create flushing or shoaling problems.

Socioeconomic Effects

Seawalls can severely limit recreational uses of the shoreline (swimming, waterskiing, diving, fishing, shellfishing). They stand out visually from their surroundings. Floating trash may accumulate in any sharp angle turns in a seawall.

Biological and Environmental Effects

Wave energy reflected from a seawall may destroy stable marine bottoms. When located in beach situations, seawalls may result in a loss of beach habitat. When located in wetlands areas, they may result in a loss of wetlands habitat, diminishing the wetlands' biological functions. Seawalls eliminate much of the intertidal zone and may affect fish spawning, feeding, and nursery habitat and behavior. They can affect plant and animal communities in the upper foreshore and backshore areas by eliminating or altering habitat. Construction activities may cause local erosion and, temporarily, increased local turbidity and water-quality degradation. If turbidity of water immediately adjacent to the structure is decreased as a result of removing the source of fine sediments from the system, water quality and fish habitat at that location may be improved. Smooth solid structures may eliminate protective habitat for fish fry; rubble-mound structures may provide additional habitat for fish fry in their submerged sections. Bottom habitat may be lost if a channel is dredged to bring boating up to the face of the seawall.

Advantages and Disadvantages

Advantages

Provide good protection to property.
May provide direct boat access to the shore.
Fair ease of repair.

Disadvantages

Structural integrity depends upon toe protection, anchoring, or foundation.
Must be well engineered for wave forces.
Near-vertical face increases wave scour at toe.
May increase erosion immediately downdrift.
Expensive to build.
Often decrease size of fronting beach.
Often cause steepening of fronting beach.
May limit access to shore from upland.
May limit use of fronting beach.

Seawall

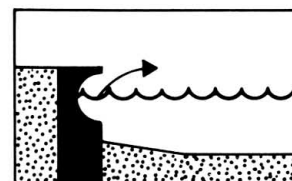

Suitability (landform)

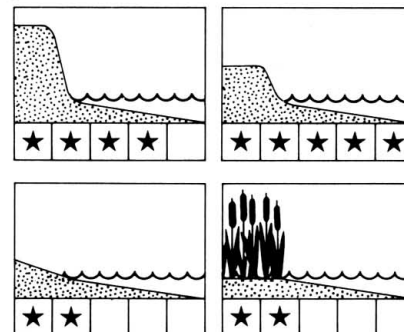

Compatibility (shoreline use)

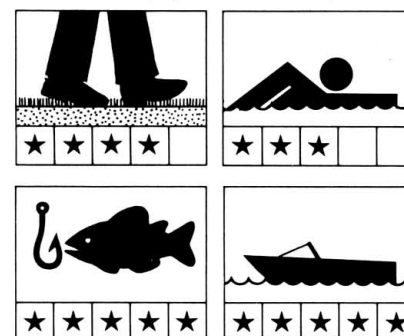

Bulkheads

Definition, Functions, Purposes

A *bulkhead* is a structure built parallel (or nearly parallel) to the shore along a bank, at the toe of a bluff, or along a beach to retain or hold back the land and prevent it from moving waterward. A bulkhead may also be properly called a *retaining wall*. Secondary functions are to protect the land against wave action and to reclaim lost land by backfilling. A bulkhead does not ensure the stability of the land behind it; if a bulkhead were to be constructed at the toe of a high, unstable bluff, the structure itself could be buried or pushed waterward by major sliding of the bluff. A bulkhead is fairly effective at deflecting wave runup. Bulkheads are often used in situations where there is little or no fronting beach to protect the shore.

Often, people will call a bulkhead a seawall and vice versa. This is because it is often difficult to determine whether a structure built at the toe of a bluff is holding back the land (a bulkhead) or the water (a seawall) or a bit of both. A major construction difference between the two is that since a bulkhead's primary function is holding back the land, not taking the full brunt of storm wave attack (except occasionally during major storms), a bulkhead can be constructed of lighter materials and be less massive than a seawall. This also means, however, that unless specifically designed for those major storm events, a bulkhead is susceptible under such extreme situations.

Types

Sheet pile. This type is built from interlocking or closely spaced sheets of steel, concrete, aluminum, or treated wood driven vertically into the ground. Horizontal members, called *wales*, tie the vertical piles together and prevent them from bending or bowing outward from the force of the fill or land behind the structure.

Cantilevered. This type of sheet pile bulkhead relies on its depth of penetration into the bottom for its strength (fig. 13). Because the sheet piles must be driven deeper into the ground than for anchored bulkheads, these are suitable only in areas where bedrock is not near the surface. Depth of penetration should be at least $2\frac{1}{2}$ (ideally greater than 3) times the freestanding height above the predicted erosion scour depth in front of the wall in order to resist both overturning by waves and undercutting by wave scour at the toe.

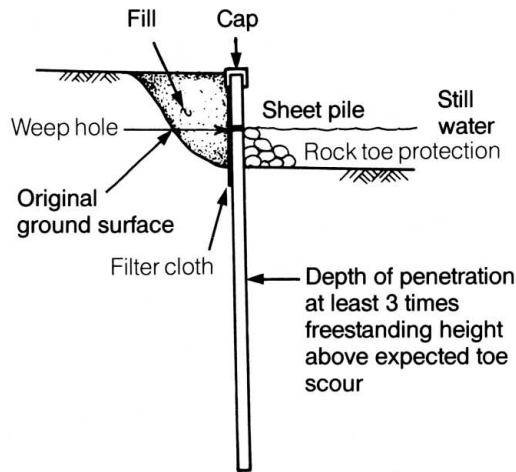

Figure 13. Cantilevered bulkheads rely on deep penetration into the bottom for their support. Drainage should be provided by means of weep holes and filter cloth, or gravel should be used to provide for filtration to prevent soil from being washed from behind the wall. Toe protection in front of the wall helps to prevent undercutting by wave scour. (Adapted from U.S. Army Corps of Engineers 1981.)

A splash apron may be added behind wall to reduce damage from overtopping

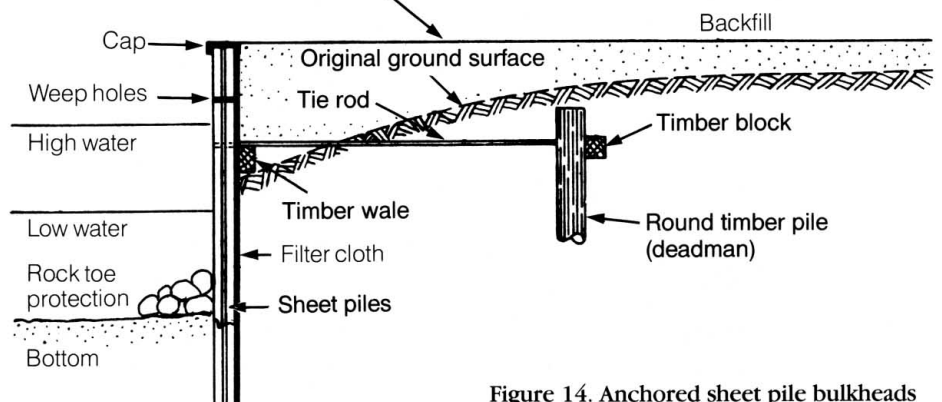

Figure 14. Anchored sheet pile bulkheads have anchors on their landward side. (Adapted from U.S. Army Corps of Engineers 1977.)

Anchored (braced). This type of sheet pile bulkhead is constructed with anchors placed behind it on the landward side (fig. 14) or tilted bracing in front of it on the seaward side (fig. 15). Depth of penetration of the sheet piles should be a minimum of $1\frac{1}{2}$ to $2\frac{1}{2}$ times the structure height above the predicted erosion scour depth in front of the wall. Vertically driven pilings or buried horizontal wooden, concrete, or metal weights (called *deadmen*) can be used as anchors. Anchors should be placed far enough be-

hind the structure and buried deeply enough to prevent them from being pulled out. Galvanized or other corrosion-resistant steel rods or cables are used as *tiebacks* connecting the anchors to the bulkhead. Wooden or metal piles, driven at an angle in front of the structure, can be used as bracing.

Cast-in-place concrete. This type of bulkhead resembles a concrete seawall except that it is not so massive. Like a sheet pile bulkhead, this bulkhead relies either upon a

cantilevered construction or upon anchoring to retain its vertical position and to resist wave action (fig. 16).

Precast concrete. Usually used in low wave energy situations, precast concrete members (usually a variation of hollow backless boxes) are set in place, bolted together, anchored, and backfilled. Additional toe protection is essential, because these structures do not extend below the bottom and can easily be undercut (fig. 17).

Treated timber. This type of bulkhead is constructed by driving vertical wooden piles into the bottom. Treated planks are then

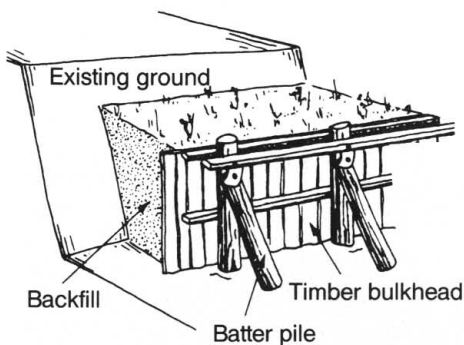

Figure 15. Bracing in front of this bulkhead maintains it in an upright position.

Figure 16. Cast-in-place concrete bulkheads resemble seawalls.



spiked or bolted to the landward side of the piles. The piles should penetrate into the bottom at least 2 to 3 times the structure height above the predicted erosion-scour depth in front of the wall. To protect against undercutting by wave scour, either the horizontal planks should continue at least one wave height below the bottom or the structure should be fronted with some stone toe protection. Treated timber bulkheads can be constructed with anchors or bracing to increase their strength (fig. 18).

Railroad ties and steel H-piles. This variation on the treated timber bulkhead uses steel H-piles driven vertically with their flanges facing each other to hold horizontal lengths of railroad tie slid down in the channels. The H-piles are driven into the bottom at least 1 1/2 times the height of the structure, and the ties extend at least one wave height below bottom. A steel channel is welded across the tops of the steel piles to provide lateral strength and to hold the ties in place. As with other bulkheads, this structure can be strengthened through the use of anchors or bracing (fig. 19). Owing to a relatively shallow penetration into the bottom, this structure is susceptible to undercutting by scour in severe wave climates.

Timber crib. Open-lattice boxes are constructed of heavy horizontal and vertical timbers bolted together (similar to a child's Lincoln log house). These cribs are then filled with fieldstone or large cobbles. Because these do not extend below the bottom, additional toe protection is necessary (fig. 20).

Gabions. Gabion baskets (see Glossary) can be used to construct bulkheads, similar

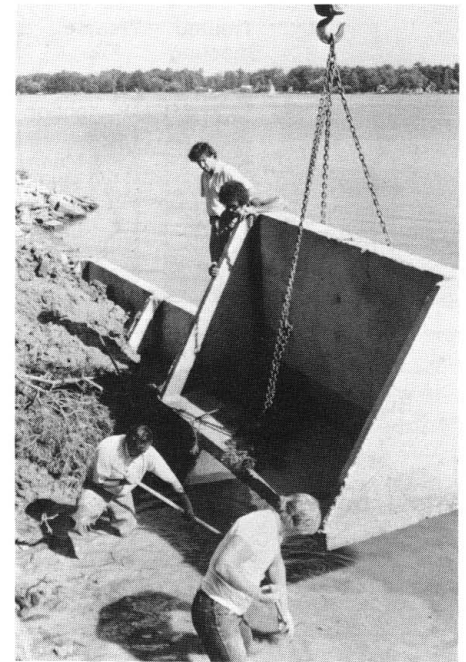

Figure 17. Precast concrete modules can be used in low energy situations to build bulkheads.

to the use of gabions as highway retaining walls. Because these do not extend below the bottom, additional toe protection is required (fig. 21).

Limitations

A bulkhead protects only the land immediately behind the structure. Adjacent land and fronting beaches often experience increased rates of erosion, for the bulkhead prevents soil that would otherwise have been contributed by erosion of the land behind the bulkhead from entering the littoral system, thereby changing the littoral drift rates. Many studies now confirm this negative effect of bulkheads on fronting beaches, and their use in beach areas is prohibited in some states because of this. In areas where sandy beaches are not common, such as much of the Great Lakes coast, this is not a problem. Wave reflection from the bulkhead may result in the depletion of fronting beaches or those adjacent to the bulkhead.

Design Considerations

Prevention of scour. Toe scour in front of a bulkhead can be expected to continue as deep beneath the original elevation of the

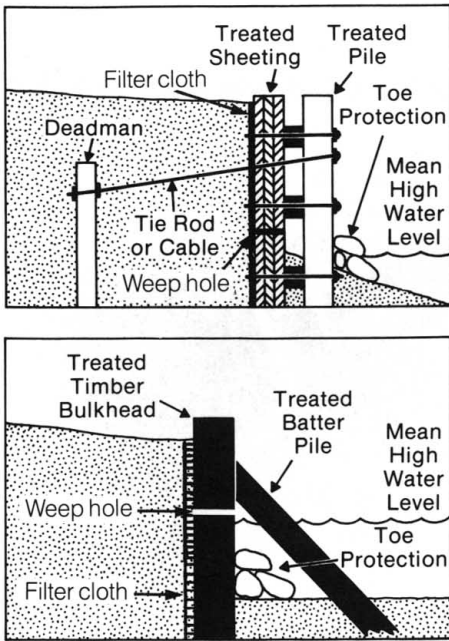

Figure 18. Treated-timber bulkheads rely on either deadmen or bracing for additional structural strength. Untreated wood will deteriorate rapidly in a marine setting.

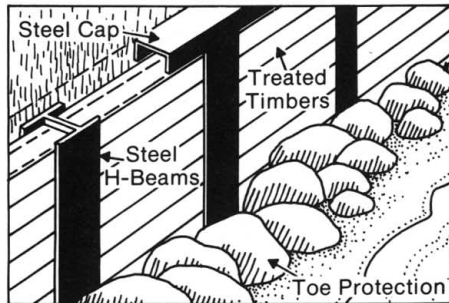

Figure 19. A new approach to an older structure, this variation of a timber bulkhead can withstand heavier wave action than timber alone, through the use of driven steel piles and heavy-duty timbers. The back is lined with filter cloth.

bottom as the height of the maximum unbroken wave at that location. For example, if the depth of the water in front of the structure is 5 feet and the maximum unbroken wave that can be expected is 5 1/2 feet, scour could progress to a depth of 5 1/2 feet below bottom. A cutoff wall extending at least half again that far below the bottom should be constructed, or armor stone heavy enough to withstand the anticipated wave forces should be placed in front of the

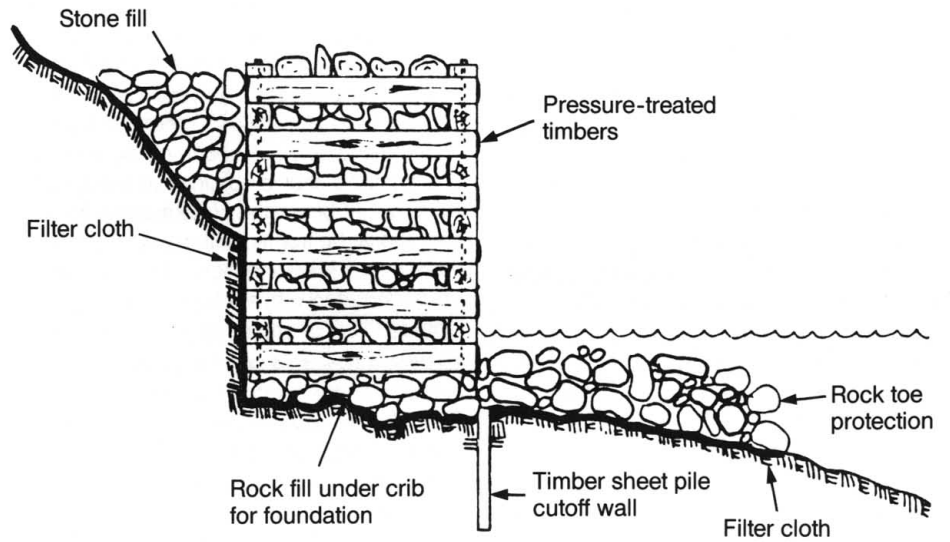

Figure 20. Timber cribs will spill their fill if they are damaged. They are suitable only in areas of light to moderate wave energies.



Figure 21. Gabion bulkheads are suitable in areas with no ice or when used above the ice line.

structure to prevent such scour. Armor stone will settle into any localized scour trough that may develop over time.

Drainage and filtration. As waves break against a bulkhead, or as rain falls on the land behind it, water collects behind it and flows downhill, usually toward the water body in front of the structure. If this water is not allowed to pass through the bulkhead, hydrostatic pressure will build up behind the structure. Such pressure could eventually

crack the structure or actually push it over as the water attempts to drain and relieve the pressure. Saturated soil is also heavier and harder to hold in position than well-drained soil. In addition, as water moves through any spaces in the bulkhead (or beneath or around it, if it is impermeable), soil and fill particles will be washed away, creating voids and hollows beneath and behind the structure.

To prevent this from happening, bulkheads should be designed incorporating drainage provisions for the area behind and beneath the wall, while still preventing soil particles from being carried away through the wall. This can be done by installing weep holes to allow excess water to drain from behind a solid bulkhead and by including filtration in the form of synthetic filter fabrics or graded gravel behind and beneath the structure to retain soil particles.

Materials. When a bulkhead is constructed of concrete, steel reinforcing rods or mesh should be used to prevent cracking and separation of the concrete. The steel should be covered by at least 3 inches of concrete to prevent corrosion. If gabions are used, the wires should be PVC coated or galvanized to prevent corrosion in a marine setting.

Effects on Coastal Processes

Bulkheads may cause some depletion of the downdrift shore by preventing sediments from behind the wall from entering the littoral drift system and replenishing the downdrift area. Waves reflected by the bulkhead may increase toe scour, beach depletion, or beach steepening immediately in front of or adjacent to the structure. Sharp-angle turns in the alignment of the bulkhead may create flushing or shoaling problems.

Socioeconomic Effects

Bulkheads can severely limit recreational uses of the shoreline (swimming, waterskiing, diving, fishing, shellfishing). They stand out visually from their surroundings. Floating trash may accumulate in any sharp angle turns in their face alignment.

Biological and Environmental Effects

Wave energy reflected by a bulkhead may destroy stable marine bottoms. When located in beach situations, they may result in a loss of beach habitat. When located in wetlands areas, they may result in a loss of wetlands habitat, diminishing the wetland's biological functions. Bulkheads eliminate much of the intertidal zone and may affect fish spawning, feeding, and nursery habitat and behavior. They can affect plant and animal communities in the upper foreshore and backshore areas by eliminating or altering habitat. Construction activities may

cause local erosion and, temporarily, increased local turbidity and water quality degradation. If turbidity of water immediately adjacent to the structure is decreased as a result of removing the source of fine sediments from the system, water quality and fish habitat at that location may be improved. Smooth solid structures may eliminate protective habitat for fish fry; rubble-mound structures may provide additional habitat for fish fry in their submerged sections. Bottom habitat may be lost if a channel is dredged to bring boating up to the face of the bulkhead.

Advantages and Disadvantages

Advantages

Provide good protection to property.
May provide direct boat access to the shore.
Fair ease of repair.

Disadvantages

Structural integrity depends upon toe protection, bracing, or anchoring.
Vertical face increases wave scour at toe.
May increase erosion immediately downdrift.
Pile driving requires special equipment/skill.
Relatively expensive to build.
May decrease size of fronting beach.
May cause steepening of fronting beach.
May limit access to shore from upland.
May limit use of fronting beach.

Bulkhead

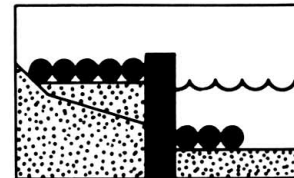

Suitability (landform)

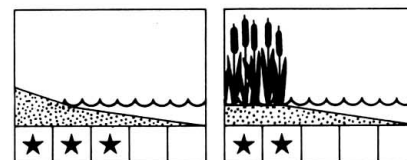
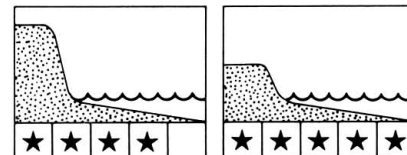

Compatibility (shoreline use)

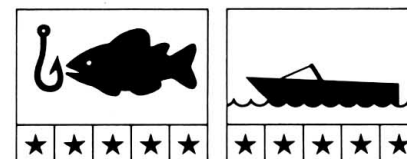
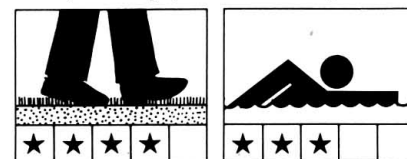

Revetments

Definition, Functions, Purposes

A *revetment* is a structure of stone, concrete, gabions, and the like built at and parallel to the toe of a bluff, embankment, or scarp, or at the front of a beach to protect the slope against wave or current-induced erosion. Revetments are often used in place of bulkheads in areas with moderate to severe wave energy.

Types

Rigid. This type of revetment is made of cast-in-place concrete similar to a seawall, but is a thinner, sloping structure covering the slope of the shore and supported by that slope. Rigid revetments provide excellent protection against erosion, but require extra attention to drainage of water from behind the structure and to uneven settling, which could crack and weaken the concrete. When such revetments fail, they fail catastrophically.

Flexible (articulated). These revetments are also excellent providers of erosion protection. They can settle (to a degree) without major reductions in structural integrity or erosion control effectiveness.

Rock rip rap. This type of revetment (fig. 22) uses large, angular rocks as its armor layer, which is exposed to wave energies. The numerous spaces between the rocks provide excellent release of hydrostatic pressure from behind the structure. This type is suitable for use in the most-extreme wave climates.

Interlocking concrete block. This type uses precast concrete blocks as its structural components (fig. 23). Although more flexible than a cast-in-place structure, these revetments cannot withstand as much settling as a rock rip rap structure. Hydrostatic pressure is relieved as water flows from between the blocks, which fit together in a series of tongues and grooves (the stronger joint type) or ship-lap joints and are not cemented together.

Design Considerations

Revetments consist of three components: a filter layer, an armor layer, and toe protection (fig. 22a). As water moves through the spaces between the stones or blocks in a revetment, soil and fill particles will be washed away, creating voids and hollows beneath and behind the structure. The filter layer, either graded gravel or filter fabric, traps the particles, which would otherwise

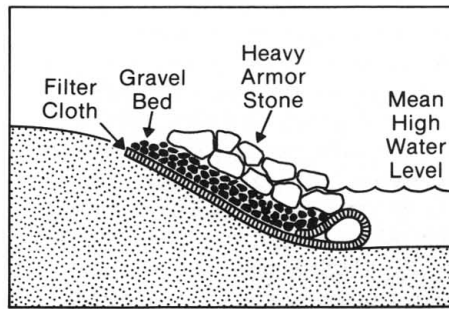

Figure 22a

Figure 22. This rock rip rap revetment contains a filter layer, armor stone, and toe protection to prevent undercutting by scour.

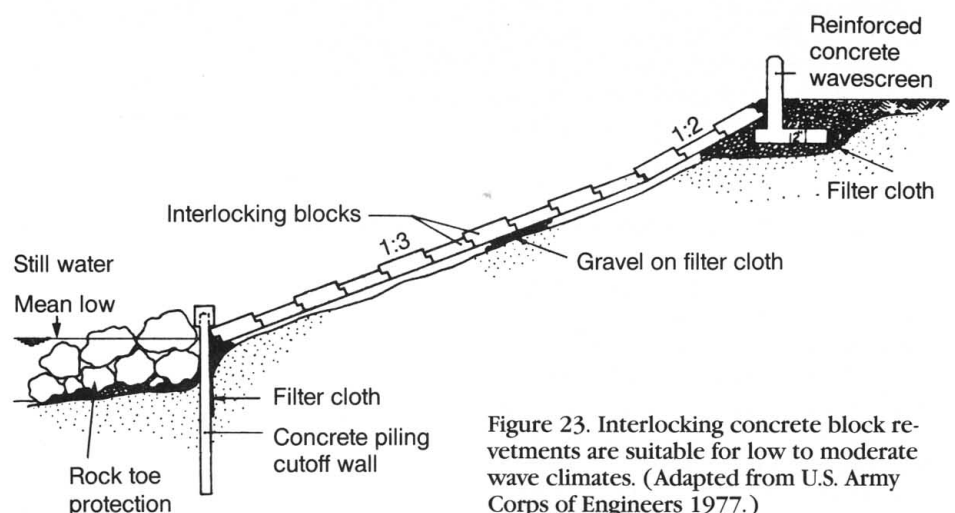

Figure 23. Interlocking concrete block revetments are suitable for low to moderate wave climates. (Adapted from U.S. Army Corps of Engineers 1977.)

be carried away, and prevents the armor layer from settling into the underlying soils. It also allows groundwater and washover from behind the structure to drain away, thus relieving hydrostatic pressure.

The armor layer (either cast-in-place concrete, rock rip rap, or concrete blocks) must resist wave action and should be placed on a slope flat enough to be stable. The toe protection is usually made up of

heavier stones to prevent seaward displacement of the rest of the revetment due to wave scour or undercutting at the toe. A revetment should be built high enough up the slope to prevent frequent overtopping by green water from storm waves.

Limitations

Revetments do not provide protection to adjacent areas. Adjacent areas may experience increased erosion as a result of wave reflection from the structure.

Effects on Coastal Processes

Revetments may increase downdrift erosion or result in depletion of fronting beaches by preventing the addition of sediment to the littoral current and by reflecting incoming waves. However, this effect is less than with seawalls or bulkheads because of the dissipation of wave energy on the irregular face of the structure.

Socioeconomic Effects

Foot access to fronting beaches is limited, requiring construction of walkways over the revetment. Fronting beaches may be depleted because of scour, reducing their utility for recreational uses. Visually, concrete and concrete block revetments stand out significantly from their natural surroundings.

Biological and Environmental Effects

Reflected wave energy may destroy stable marine bottoms. When located in beach situations, they may result in a loss of beach habitat. Construction activities may cause local erosion and temporarily increased local turbidity and water quality degradation. If turbidity of water immediately adjacent to the structure is decreased as a result of removing the source of fine sediments from the system, water quality and fish habitat at that location may be improved. If made of stone and partially submerged, revetments may increase or improve fish and shellfish habitat; the shallower the slope and the more angular the stone, the greater the amount of habitat provided.

Advantages and Disadvantages

Advantages

Result in less toe scour or depletion of fronting beach than do seawalls and bulkheads. Initial cost is usually reasonable (if materials are readily available).

For rock rip rap, repair costs are usually reasonable because the whole structure rarely fails at once.

Disadvantages

Decrease access to beach from upland. May be hazardous to people walking on them.

Revetment

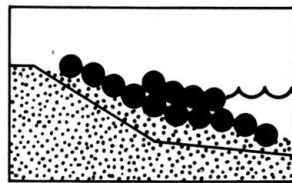

Suitability (landform)

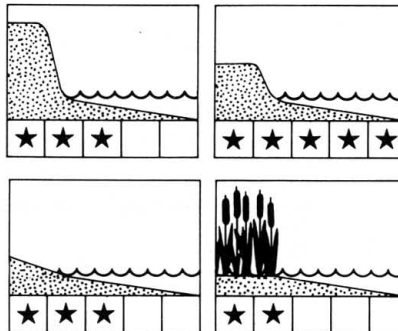

Compatibility (shoreline use)

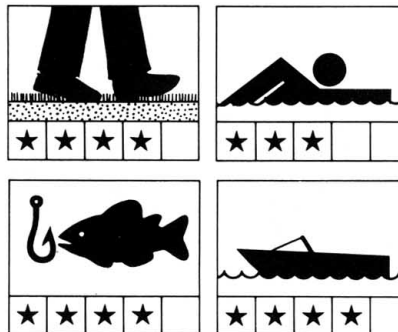

Groins

Definition, Function, Purposes

A *groin* is a structure built generally perpendicular to the shore, extending into the water like a finger pointing to the sea. Groins are used to build up or widen a beach or to protect and stabilize a beach by slowing down the rate of erosion. They do this by trapping and holding sediment (littoral drift) passing through the area in which they are built. A high groin that effectively blocks all (or almost all) littoral drift is called a *terminal groin*; lower structures tend to bypass some littoral material, especially at high tide or during storms. Groins can be used singly or in groups of two or more called *groin fields*. Groins can be permeable or impermeable, depending upon the amount of littoral drift trapping desired. Permeable groins have been found not to be very effective and are, therefore, not recommended.

In operation, a field of groins will typically create a sawtooth effect on the shoreline, with fillets of sediment building up on the updrift side of the groins and erosion taking place downdrift of the structures (fig. 24). It is these fillets of sand that provide the protection for the beach, absorbing storm-wave impacts and being eroded before the beach itself is attacked.

Groins are one of the most widely used coastal erosion control structures in areas that have large amounts of sand in the littoral system. They are often also one of the most poorly planned and designed coastal erosion structures, often showing only minimal benefits and sometimes resulting in severe downdrift erosion problems. The use of a groin or a groin field to control shoreline erosion requires a thorough understanding of both structure design and of the littoral processes taking place at the structure site. Groins must be engineered for each specific site. No generalized design, height, spacing, or length will work for all situations. Groins are not candidates for do-it-yourself planning and design; they should only be used with qualified marine engineering consultation.

Types

Groins can be constructed of many of the same materials as can bulkheads and breakwaters.

Timber. This type of groin is built of wooden sheet pile supported on vertical round wooden piles to provide the primary support and horizontal wales to provide longitudinal integrity (fig. 25).

Steel. This type is built of interlocking steel-sheet piles supported by vertical round-steel or timber piles. Because the sheet piles are interlocking, they may not require horizontal wales for extra strength except in areas of high wave or current energies.

Concrete. This type uses cast-in-place construction or flat precast sheets of concrete held in place with a cast-in-place concrete cap.

Rubble mound. This type of groin is constructed of stone similar to a rubble-mound breakwater, but is usually not so massive. A mound of progressively larger stone is built up on top of a bed of crushed stone. The structure is capped with an outer layer of fairly heavy armor stone. These groins are used either where there is heavy wave or current action or where there is a ready supply of cheap stone.

Gabion. In locations where winter ice is not a factor and where wave energies are fairly low, groins can be constructed from gabions. This type of groin is usually used only in protected or sheltered situations.

Planning and Design Considerations

As mentioned, groins are used in areas rich in sand. They are not effective in areas with littoral drift finer than sand because silts and clays will not settle out behind the groin. Instead, they remain in suspension and are transported away by the slightest current. Unidirectional longshore transport is a basic requirement for the use of groins.

Length. The length must be sufficient to create a beach fillet, while still passing drift at the outer end. Groins typically extend a distance from the top of the berm to the breaker zone or less. In determining the actual length of a groin, it is important to determine how much of the littoral drift could safely be trapped without creating an unacceptable downdrift erosion problem. Generally speaking, groins will be able to trap most of the littoral drift along a section of shore by extending out to the breaker zone or to the 6-foot-depth contour line in the Atlantic and the Great Lakes. If a groin is too long (extends out beyond the breaker zone), any sand bypassing the groin will go into deeper water where it will be lost from the system. Less of the drift will be trapped as the groin is reduced in length from extending to the breaker zone to some intermediate length between the beach and that zone. However, if the groin is too short, it will not trap enough sand to be effective.

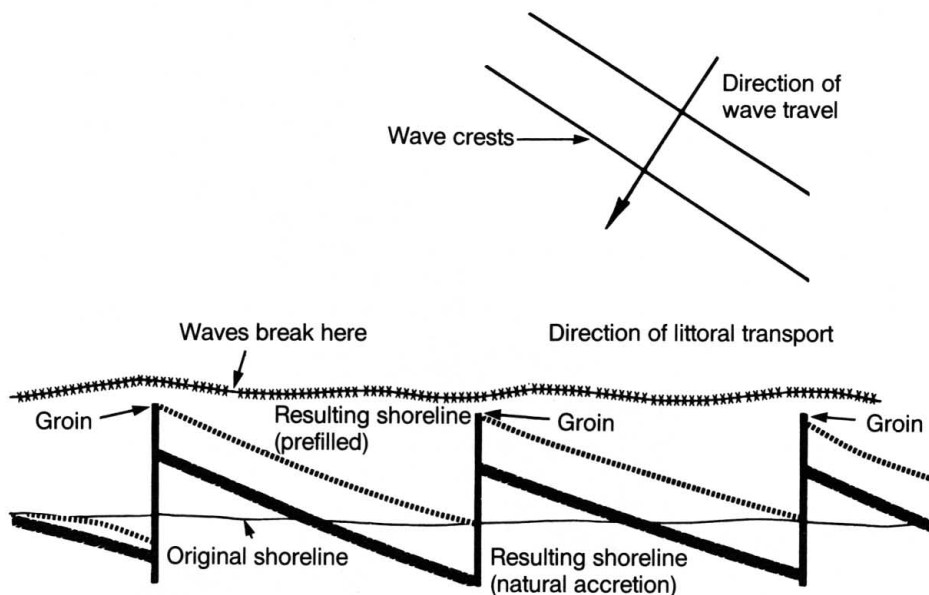

Figure 24. A sawtooth configuration is typical of a beach established by the use of a series of groins (a groin field). Littoral drift is trapped on the upstream side of the groin resulting in the fillets of sand. (Adapted from U.S. Army Corps of Engineers 1981.)

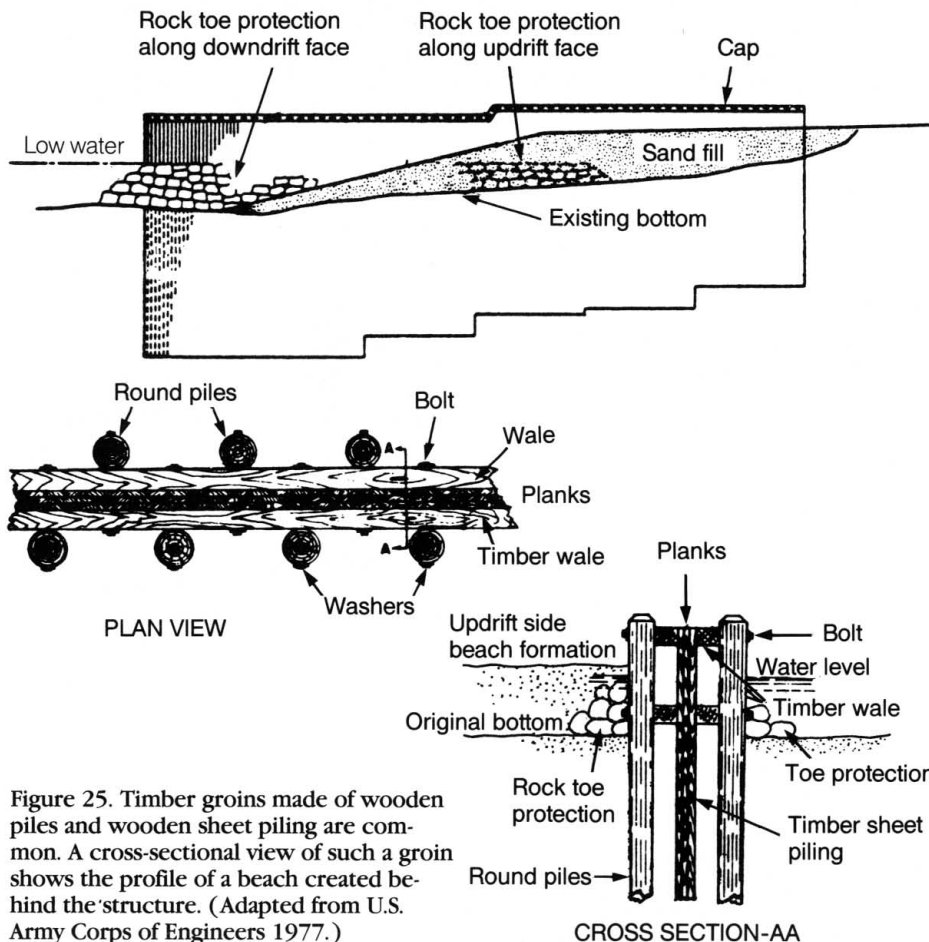

Figure 25. Timber groins made of wooden piles and wooden sheet piling are common. A cross-sectional view of such a groin shows the profile of a beach created behind the structure. (Adapted from U.S. Army Corps of Engineers 1977.)

Height. At the landward end, the minimum height equals the height of the desired berm to be entrapped or protected. This is usually the height of maximum high water plus the additional height of normal wave uprush. The intermediate section height is parallel with the configuration of the foreshore desired. The waterward end is generally built as low as safety (boating, swimming) permits above the bottom grade.

Spacing. This is a very difficult criterion to set for a groin field. When filled to capacity, the updrift fillet should reach to the base of the next updrift groin. If built too far apart, there will be excess erosion between the individual groins. If built too close together, there may not be sufficient time or space for sand to pass around the end of one and come back into the beach to form a fillet before being forced back seaward by the next. A general rule here is that spacing should be 2 to 3 times the length from the berm crest to the waterward end.

When a groin is first built, sand accumulation on the updrift side and erosion on the downdrift side may not be balanced by the amount of sand bypassing around the groin. The fillet on the updrift side should be immediately filled with placed sand so that bypassing of natural drift around the structure can begin. This will help to minimize the amount of increase in downdrift erosion. The particle size of placed sand should match that occurring naturally in the system. Placed sand should come from an inland source or from offshore, but never from the vicinity of the groin field being filled. A groin field should be built one groin at a time, starting with the groin farthest downdrift and always filling behind each completed groin before starting on the next.

Limitations

There must be an adequate sand supply to ensure that groins will work correctly. If the supply is not sufficient, continued artificial filling may be required to prevent downdrift starvation and erosion increases. Littoral drift must come predominantly from one direction. It is very important for groins to extend far enough inland to prevent flanking at the inland end during major storms or in case of downdrift erosion problems. A flanked groin can cause extreme localized erosion problems.

Effects on Coastal Processes

Groins may deplete downdrift beaches by cutting off the source of littoral sediments.

Socioeconomic Effects

Floating debris may accumulate on the updrift side of a groin. Travel along (parallel to) a beach may be interrupted. A relatively straight natural beachline will be changed to a sawtoothed alignment. Groins may stand out visually from a natural beach.

Biological and Environmental Effects

Rough-sided groins, made of materials that leave numerous intercomponent spaces, usually improve and increase habitat for fish and shellfish. Groins tend to attract fish and often provide for additional fishing opportunities. If all littoral drift is trapped, the resulting downdrift erosion could degrade aquatic resources and damage benthic habitat. The area filled by accretion results in a loss of bottom habitat. Groins may impair the water quality between the structure and the shore because of decreased wave action and inhibited water circulation and cycling, but to a lesser degree than do breakwaters. Groins provide a protected area allowing for establishment of beach vegetation.

Advantages and Disadvantages

Advantages

- May build up beach by trapping littoral drift.
- May provide angler access to deeper waters.
- May provide improved/additional fish habitat.
- Do not reduce access to beach from upland.

Disadvantages

- Submerged waterward end may be navigation hazard.
- Limit travel along beach.
- May increase erosion on downdrift side.
- May deplete downdrift beaches.
- May create bathing hazard from rip currents.

Groin

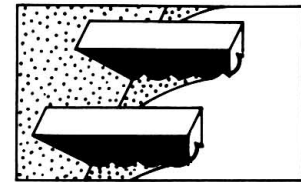

Suitability (landform)

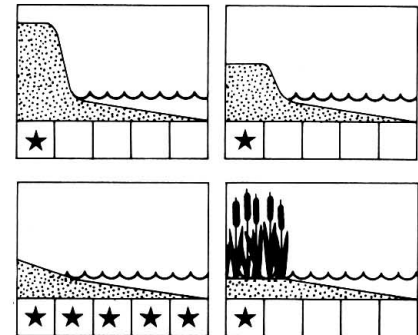

Compatibility (shoreline use)

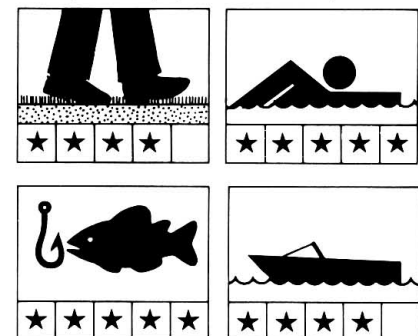

Breakwaters

Definition, Functions, Purposes

A *breakwater* is a structure constructed either offshore from or connected to an eroding shoreline, extending out into the water to protect the shore from wave action and (or) to provide calm water for boat mooring or docking (when used to protect harbors or basins). Breakwaters can be either floating or bottom anchored. Offshore breakwaters are usually built parallel to the shore, but can be aligned at a slight angle to the shore to meet specific wave or bottom conditions.

Breakwaters provide erosion control by dissipating and deflecting wave energy and creating an area of calm water (shadow) in their lee. Since sediment transport is a function of wave height squared, the reduced wave activity on the shore results in reduced erosion (example: if wave height in the shadow is cut to $1/2$ of the original, the resulting waves will have $1/2 \times 1/2 = 1/4$ of the sediment-transporting power of the original waves). Breakwaters may result in accretion (deposition) on the shore in the calm waters in their lee as sediments suspended in the littoral current settle out in the calmer waters.

Types

Cellular steel. In areas of moderate wave energies, boxes are constructed of steel sheet piling driven 6 to 8 feet into the bottom and then filled with sand, stone, or concrete (when filled with sand, these are often capped with concrete to keep the fill from being washed out). These can be built and function effectively in waters up to 40 feet in depth. The major maintenance problem with such structures is rusting and corrosion of the steel piles (fig. 26).

Concrete caisson. Also used in areas of moderate wave energies, these structures are built of reinforced concrete boxes, which are floated or barged into position. They are then lowered onto a bottom foundation of stone and filled with sand, stone, or concrete. As with cellular steel breakwaters, these are usually capped with concrete to keep the fill from being washed out.

Rubble mound. This type of breakwater is constructed of stone or various angular pre-cast concrete units. A foundation of crushed stone is prepared, on top of which a mound is built up of layers of progressively larger and heavier stone (fig. 27). The final structure is capped with an outer layer

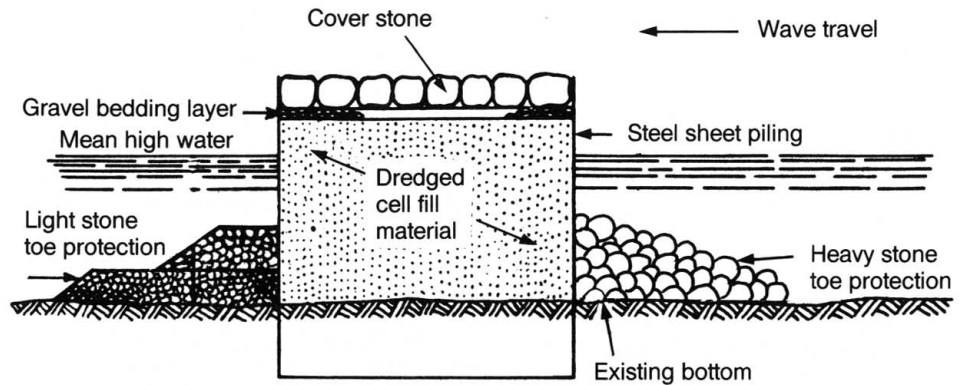

Figure 26. Cellular steel breakwaters can be built and function effectively in waters up to 40 feet deep. (Adapted from U.S. Army Corps of Engineers 1977.)

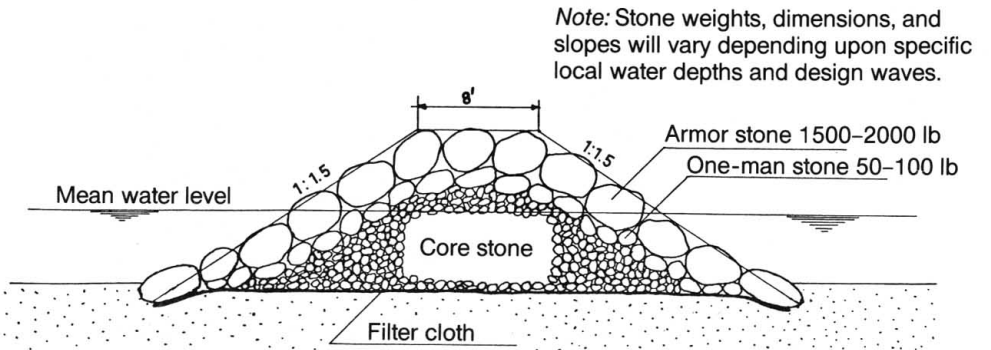

Figure 27. Rubble-mound breakwaters can be used in almost any depth of water and in almost any wave climate.



Figure 28. Gabion breakwaters can be used in protected or sheltered locations where winter ice is not a factor and where wave energies are fairly low.

of very massive armor stone. These breakwaters can be used in almost any depth of water and in almost any wave climate.

Gabion. In locations where winter ice is not a factor and where wave energies are fairly low, gabions can be used to construct breakwaters. This type of breakwater is usually used only in protected or sheltered situations (fig. 28).

Planning and Design Considerations

Height. The height of an offshore breakwater is dependent upon its desired function. A structure high enough to block all but the most-severe storm wave energies approaching the shore will result in a calm, protected harbor behind the structure. Such a high breakwater will also be most effective in reducing erosion and causing accretion in its lee. Because a total barrier to long-shore drift may result in increased erosion downdrift from the structure, it may be desirable to build the breakwater lower than a height that would not be overtopped by incoming waves, thus allowing some littoral current to continue in its lee. Special care must be taken in the orientation and spacing of offshore breakwaters to prevent undesirable effects behind or adjacent to the structures as a result of wave refraction and (or) diffraction effects.

Limitations

Breakwaters provide protection only to the shoreline in their lee. Downdrift areas may experience increased rates of erosion as a result of the disruption of the littoral current.

Effects on Coastal Processes

Decreased wave action behind the structure will result in increased deposition when there is sufficient material in littoral currents. The downdrift shore may experience some depletion if a substantial amount of littoral drift is removed from currents behind the structure. If the accretion behind the breakwater increases to the point that the breakwater becomes connected to the shore, a groin is, in effect, formed; and littoral drift will be totally cut off from the downdrift areas of the beach, possibly resulting in severe downdrift erosion.

Socioeconomic Effects

Offshore breakwaters tend to be more expensive to build and maintain than structures connected to the shore. When they

are built with a low profile, their impact on the visual environment is kept to a minimum. Floating garbage may become trapped in the calm waters behind a breakwater, detracting from recreational uses of that area.

Biological and Environmental Effects

Rough-sided breakwaters, made of materials that leave numerous intercomponent spaces, can improve and increase habitat for fish and shellfish. Rough-surfaced, sloping-faced structures are generally less detrimental to the natural environment than are vertical, smooth-faced ones. They may impair water quality between the structure and the shore because of decreased wave action and inhibited water circulation and cycling, resulting in warmer, less-oxygenated waters, affecting biological activities in that area. Offshore or shore-connected breakwaters may interfere with existing fish-migration patterns.

Advantages and Disadvantages

Advantages

- Maintain access to beach from upland.
- Provide sheltered swimming/mooring area.
- Beneficial effect may extend over a long section of shoreline.
- Not subject to flanking.
- May improve fish habitat.
- May increase deposition, increasing beach size.

Disadvantages

- May cause toe scour on waterward side.
- May increase erosion on downdrift side.
- Subject to foundation failures.
- May negatively affect the environment.
- May be damaged by moving ice.
- May be navigation hazard if submerged.
- May disrupt scenic views from shore.
- Usually very expensive to construct.
- Very difficult to repair.

Breakwater

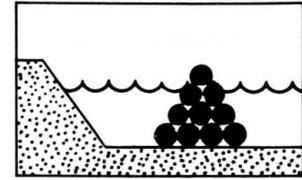

Suitability (landform)

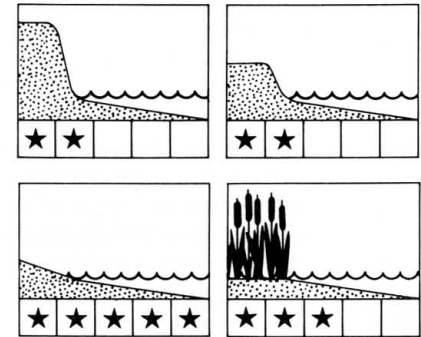

Compatibility (shoreline use)

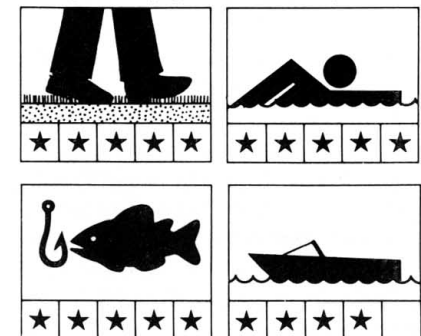

Protective Beaches

Definition, Functions, Purposes

Beaches can be very effective at reducing the amount of wave energy reaching upland areas of the shore. As a beach erodes, sand is moved downdrift, naturally replenishing that section of beach; sand may also be moved offshore and deposited in an underwater bar. The amount of sand moved and its destination depends upon several variables, including the grain size of the sand and the wave climate at any particular location. Waves hitting the shallow water over the bar tend to break farther out from shore than before, dissipating some of their energy before hitting the beach proper. As the beach continues to be eroded and the bar grows, waves break farther offshore and release even more of their energy (fig. 29). Some beaches show seasonal differences in the rate of erosion. The most-common occurrence of this phenomenon is a cycle of winter erosion and summer building up of beaches.

When a beach is either artificially created or nourished or maintained in its natural state for the purpose of providing protection, it is considered to be a *protective beach* and qualifies as an erosion control structure for the purposes of this paper. The continuing, periodic stockpiling of sand on a beach to act as a reservoir replacing sand that is washed away by wave action is termed *beach nourishment* (fig. 30). When a beach is retained above the natural profile by means of a submerged dike or sill surrounding it, it is called a *perched beach* (fig. 31). Beaches can also be enlarged or maintained by using groins.

Planning Considerations

Borrowed sand can be dredged from offshore and pumped onto the beach or can be brought in by truck from upland or other coastal locations and dumped on the beach. It is important that the borrowed fill be placed at the updrift section of the beach in the area of wave uprush. It is not necessary to mechanically grade the sand into a smooth, flat beach; wave action will distribute the fill both seaward and downdrift. Offshore redistribution must be expected and planned for.

How often the beach must be replenished will depend upon the severity of wave action, frequency of storms, and coarseness of fill material. In general, the coarser the fill material, the slower it will be eroded away, and the longer the intervals between replen-

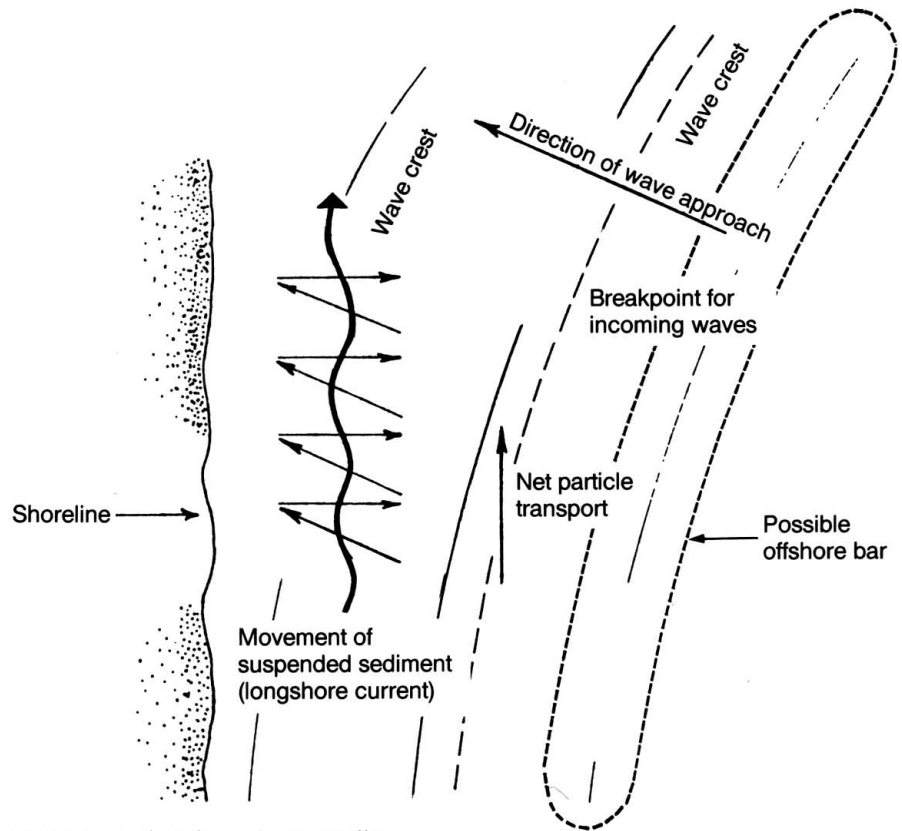

Figure 29. As a beach erodes naturally, sand is carried alongshore and offshore. Sand carried offshore may form an offshore bar.

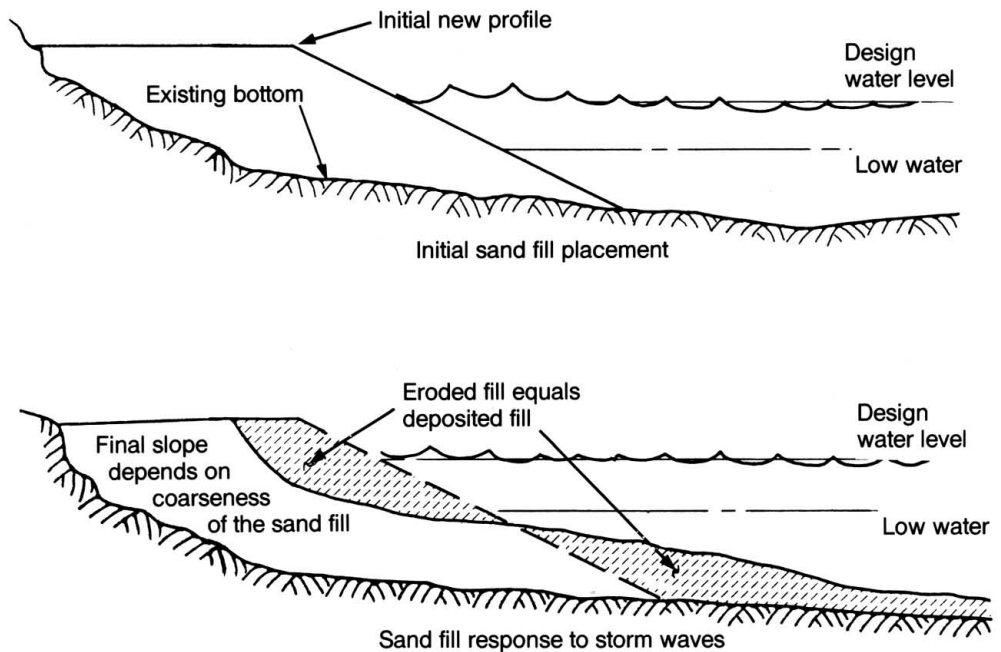

Figure 30. A protective beach formed by artificially nourishing or replenishing an existing eroded beach. The new beach profile is usually higher, initially, than the

original, but erodes to a more natural profile as a result of wave action. (Adapted from U.S. Army Corps of Engineers 1981.)

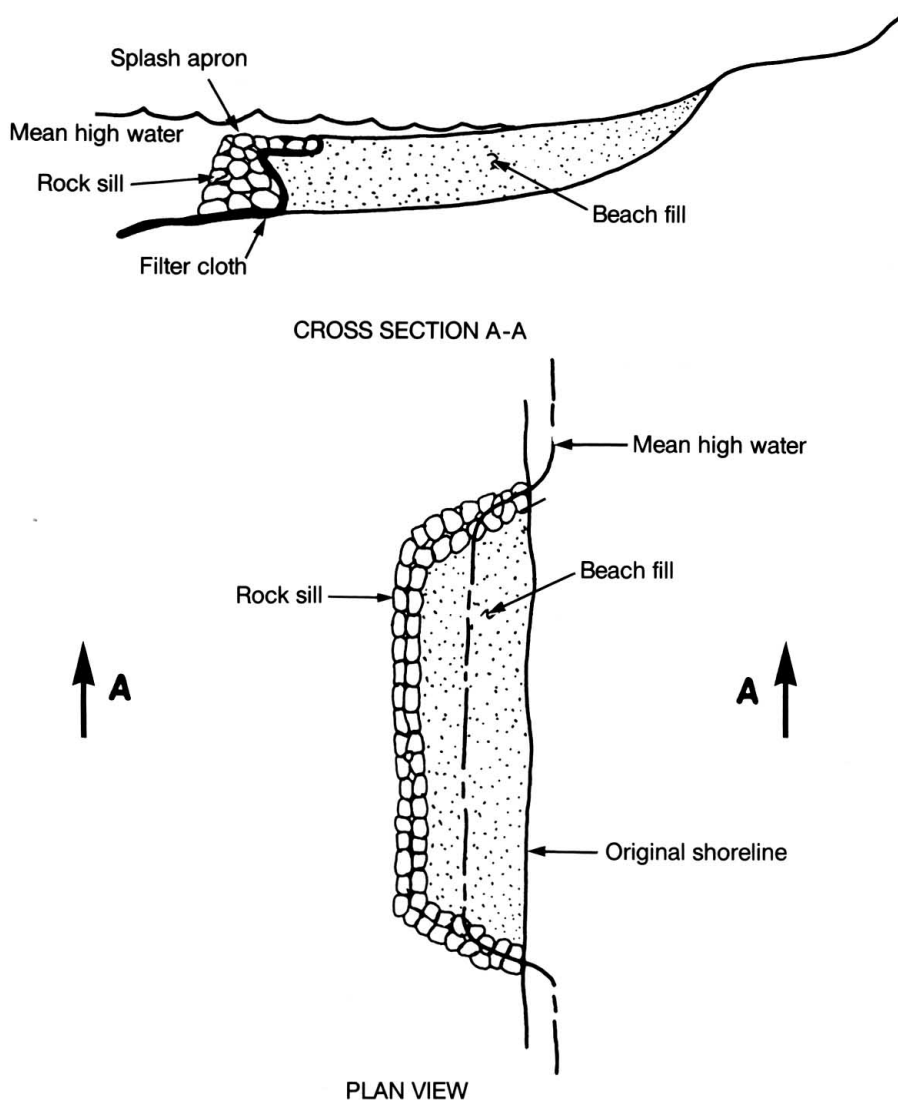

Figure 31. A perched beach is held in place by a submerged dike or sill on its seaward side. This form of protective beach is more expensive than simple renourishment. (Adapted from U.S. Army Corps of Engineers 1981.)

lost (or to be regained) equals 1 cubic yard of beach fill lost (or to be provided). The immediate loss of fine materials should be taken into account by filling with approximately 50 percent more sand than would be absolutely necessary to form a beach with the width and berm height desired. Since artificial nourishment of a beach is not inexpensive, it is important to use fill sand no finer than exists naturally on the beach in order to minimize the amount of fines lost.

Fill material. When selecting fill material, look at the existing beach material and try to duplicate as nearly as possible its coarseness, for this indicates what size material will be easily removed and what size will remain behind for the specific wave energies at that site. If the fill material contains sand finer than what is naturally at that site, the finer sand will be quickly eroded away and deposited offshore in waters still enough to allow for such deposition. High amounts of finer sand in the borrowed sand will result in high losses to the littoral system and will necessitate more frequent refillings. The slope of the face of a beach is also dependent upon the coarseness of the sand; the finer the sand, the flatter the slope. If a beach is nourished with sand significantly coarser than what was originally there, the slope of the face can be expected to steepen or the sand could be lost offshore. Very coarse borrowed sand may also reduce the desirability of the beach for certain recreational activities. It is also very important that the source of borrowed sand be unpolluted.

Limitations

Beach replenishment will not stop or prevent erosion; it is simply a "turning back of the clock" to a time when there was more sand there before erosion carried the sand away. Because offshore bars and beaches can be dramatically eroded during severe storms and are continually subjected to the erosive actions of virtually all waves, unless they are situated in an area with abundant amounts of sand in the littoral system, they will have to be periodically augmented with sand placed by mechanical methods (regular beach maintenance).

ishment activities. To a certain degree, however, too coarse sand will be lost offshore as storm waves carry it away from the beach, and lower-energy swells are unable to transport it back onto the beach.

Berm height and width. In designing a beach nourishment project, the elevation of the berm should be high enough to prevent its being overtopped by any but the most-severe storm wave, thus providing sufficient protection to upland areas. If the fill is placed lower than the natural berm elevation, a secondary ridge may be formed at the crest of the fill. Storm waves overtopping this ridge may be trapped between it and the natural berm, resulting in temporary ponding. To prevent this, the fill should extend at least as high as the natural berm elevation. When placing beach fill, some

sand can be placed in the water and still have a beneficial effect on the overall project. It's important, however, that sand not be placed in water at such depths that it would be moved seaward only, with none being carried along the shore. A general guideline is to place no fill at depths greater than 30 feet below mean low water along the ocean coast and no deeper than 20 feet along the Great Lakes.

Amount of fill. The amount of sand placed should be sufficient to last for several years before replenishment needs to be undertaken again. It's important to determine the deficiency in natural supply of sand along a beach to be artificially nourished. In lieu of detailed supply and demand studies, one can use the general rule-of-thumb that 1 square foot of beach surface

Effects on Coastal Processes

Protective beaches may decrease erosion on downdrift beaches by providing more sand to the system and may accelerate shoaling in downdrift or nearshore areas.

Socioeconomic Effects

A protective beach provides additional beach area for passive and active recreation. It does not (usually) detract from natural surroundings.

Environmental Effects

If the front of the beach is held in place by a submerged rock rubble mound, this will result in increased fish and shellfish habitat. Turbidity may increase as the amount of sand available to the system is increased. Turbidity increase may have a short-term negative impact on aquatic habitat.

Advantages and Disadvantages

Advantages

Provide more beach for shoreline recreation.

Do not restrict access to beach.

Long stretches of beach can be protected at lower costs than by use of humanmade structures.

Can have beneficial effects to downdrift shoreline as well as immediate area.

Disadvantages

Increased turbidity may impair fishing.

Drop off into deeper water at the sill may pose a hazard to bathers.

Submerged sill may be navigation hazard.

Protective beach

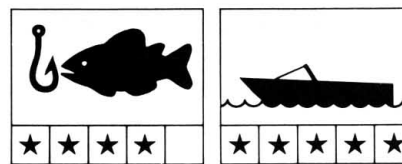
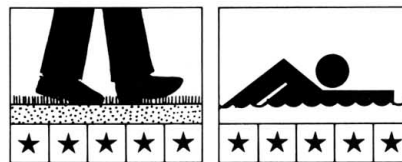
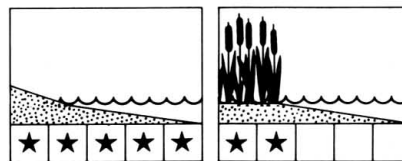
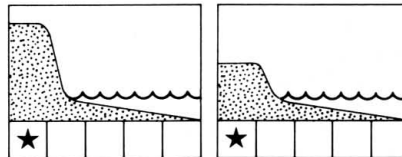
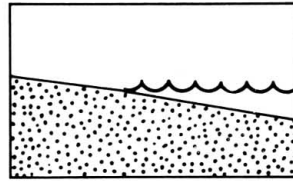

Dune Restoration

Definition, Functions, Purposes

Coastal sand dunes are of vital importance in providing natural protection to beaches and backshore areas from infrequent severe storms. They are less effective against gradual losses from routine erosion. Dunes serve as a sand reservoir to replenish beaches eroded during storms or high water periods. They also form a physical barrier to storm waves, preventing them from reaching farther inland.

Dunes themselves are, however, very susceptible to erosion damage from both wind and water. Although vegetation usually cannot protect the foredune from storm wave damage, it can and does trap and hold windblown sand. Damage to natural vegetation on a dune, whether as a result of drought or human interference, can lead to formation of *blowouts* or localized damage to the dune, reducing the dune's natural erosion control effectiveness. In cases where dunes have been damaged and are not naturally rebuilding themselves or where natural dunes have not formed, but where there is a sufficient supply of sand to form dunes, dune construction or reconstruction techniques can be used. Such activities are usually fairly cost efficient.

Types of Dune Construction

Dunes are built when some form of obstruction blocks the wind, which is moving sand particles, allowing the sand to be deposited and trapped. The higher the dune becomes, the steeper its waterward face will be, further catching and holding additional sand. There are two main methods of artificially "seeding" dunes in sandy areas:

Mechanical. Fences or windbreaks made of brush (such as discarded Christmas trees), wooden slat snow fence, or various plastic sand fence materials are used to provide artificial barriers to the wind and sand. Although the old trees are inexpensive, their aesthetic appearance in the initial phase of such a project (that is, before they are covered with sand) may limit their use in certain areas. Fencing is still fairly inexpensive, not labor intensive, and effective, while minimizing adverse visual effects (fig. 32). Such dune building is a fast, but temporary, remedy until the dune can be stabilized with vegetation.

Vegetative. Although dunes can be created mechanically, the use of various types of tolerant vegetation can be effective. Because established vegetation can grow up

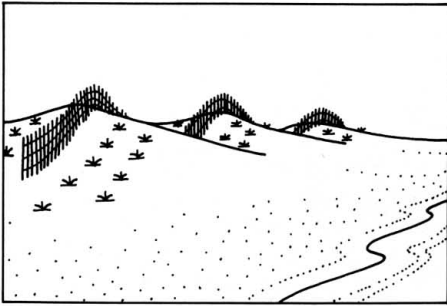

Figure 32. Snow fence can be used to trap windblown sand and “build” a dune to protect inland areas. Such dunes should then be stabilized with vegetative plantings.

through the sand as a dune becomes higher, the maintenance for a vegetative dune stabilization project is minimal. Vegetation also has certain environmental benefits, such as provision of habitat, which make it preferable to fencing in areas where prevailing wind conditions are not so severe that mechanical augmentation is necessitated. Some of the plant types suitable along New York’s marine and Great Lakes coasts for dune stabilization include American beachgrass, bayberry, Virginia creeper, beach plum, dusty miller (beach wormwood), and rugosa rose. Japanese black pine could be used to stabilize a mature dune, but is not recommended for dune building.

Planning Considerations

For constructing or reconstructing dunes with fencing, it is preferred that fencing with at least equal areas of open space to solid material (a porosity of 50%) be used. The ideal ratio of solid to open is 80:20. Slats and the spaces between slats should not be any greater than 2 inches. Under the right conditions, this type of fence will usually be full within about one year. Fence supports should be driven at least 2 to 3 feet into the sand to prevent the fence from being toppled by the force of the sand buildup. Slats should also extend about 2 or 3 inches into the sand to avoid blowouts forming under the fence.

The fence should be placed at a distance back from the berm crest sufficient to prevent it from being undermined by normal wave action. Observe natural dunes in the area and locate the fencing at an equivalent spot to the natural foredune or vegetation line. The most efficient configuration is a

straight alignment of the fence parallel to the shoreline. Zigzags or spurs have not been shown to improve the dune-building process and can increase the project costs by up to 20 percent.

Dunes can be built higher as the fence fills by erecting subsequent lifts of fence above the original. The effective height of each lift of fence is about 3 feet for a 4-foot-high fence. The width of a dune can be expanded by installing additional rows of fencing on the side of the dune (shoreward or landward) to which the dune is desired to grow. The distance between fence rows should be 4 times the height of the fence (for example, a 4-foot-high fence would require a 16-foot interference spacing). Rows of fence at the same elevation will result in a broad, flat dune. New lifts above older filled fencing will result in a steep, high dune (usually too steep to remain stable). New lifts placed parallel to old fence, but partway between toe and crest, will increase both the height and width of the dune without exceeding a stable slope.

The use of vegetation for coastal erosion control projects is covered in the Shoreline Conservation Series Information Bulletin 198, *Vegetation Use in Coastal Ecosystems*, and will not be presented in detail here.

Limitations

Snow and sand fencing deteriorates over time. As the fencing material fails, the dunes formed may migrate or *blow out*. Vegetation is susceptible to human damage and severe weather conditions. Loss of vegetation can result in migration or blowout. Sand dunes cannot be formed in areas where there is little or no sand in the system to be trapped and held.

Effects on Coastal Processes

Dune restoration may deplete downdrift beaches by removing sand from the system.

Environmental Effects

Dune restoration may create additional wildlife habitat in new vegetation.

Advantages and Disadvantages

Advantages

- May create wildlife habitat.
- Creates opportunity for nature study.
- Blends in with natural surroundings.
- Prevents flooding of inland areas.

Disadvantages

- May reduce access to beach from upland.
- May deplete downdrift beaches.
- May reduce view from upland areas.

Dune restoration

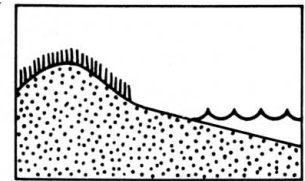

Suitability (landform)

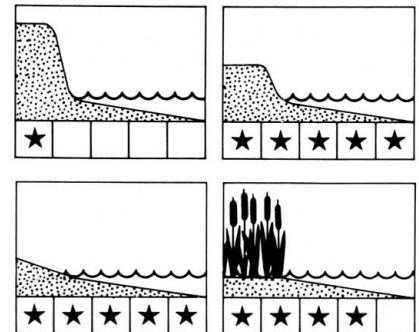

Compatibility (shoreline use)

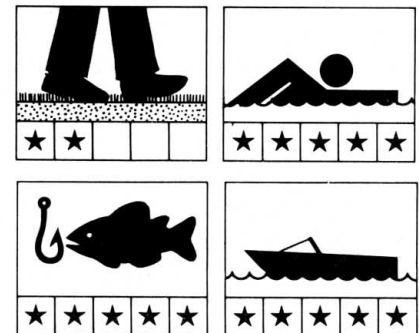

Coastal Drainage Improvement

Definition, Functions, Purposes

The stability of many coastal bluffs, along both the Great Lakes and the marine coast of New York, often depends upon the amount and action of groundwater within the bluff and surface water action over the face of the bluff as much as it does upon the steepness of the slope and the action of waves at the toe of the slope. Erosion of bluffs due to groundwater and surface water is often quite slow and, thus, may tend to be "invisible" to landowners. However, over long periods of time the damages can be equal to or greater than those from other more obvious forms of erosion.

Even when a slope may be stable under "normal" circumstances, excesses of groundwater can render it unstable and result in significant, sometimes startling, amounts of erosion. Groundwater actions carry with them the potential for sudden, major, catastrophic occurrences, such as landslides, slumps, and mudflows, which result in significant amounts of erosion overnight or almost instantaneously.

Natural precipitation is not the only source of groundwater in coastal bluffs. Septic system leach fields can add tremendous amounts of water to the soil. Home roof drains, lawn sprinklers, and runoff from paved driveways, parking lots, and roads also add water to the soil.

Excessive groundwater in coastal bluffs can be controlled to a degree by improving the subsurface drainage of the bluffs and the inland areas draining to and through the bluffs. This is done by removing such excess water and reducing seepage at the face of the slope. Surface erosion can be minimized by collecting and diverting runoff from the face of a slope, by minimizing hard-surfaced areas, which tend to "shed" rainwater more rapidly than natural ground surfaces, and by proper use of vegetation to slow runoff and provide a less-compact soil surface (fig. 33).

Planning Considerations

Methodology. Subsurface (groundwater) drainage improvements involve the use of perforated or permeable conduits buried beneath the surface of the ground (fig. 34). These pipes are laid in a trench excavated parallel to the top lip of the bluff, 5 to 10 feet back from the edge. Groundwater flows into

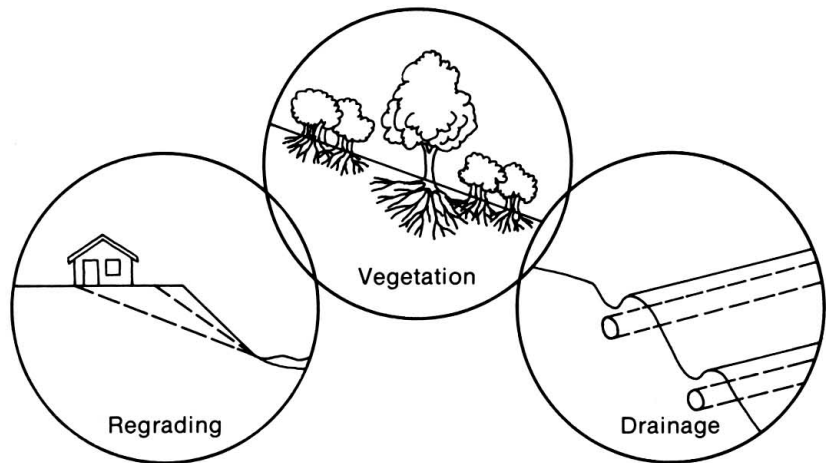

Figure 33. Surface runoff controls include collecting and diverting runoff from the face of a slope; minimizing hard-surfaced areas, which "shed" rainwater more rapidly than natural ground surfaces; regrading the slope to a gentler angle; and using vegetation to slow runoff and provide a less compact soil surface.

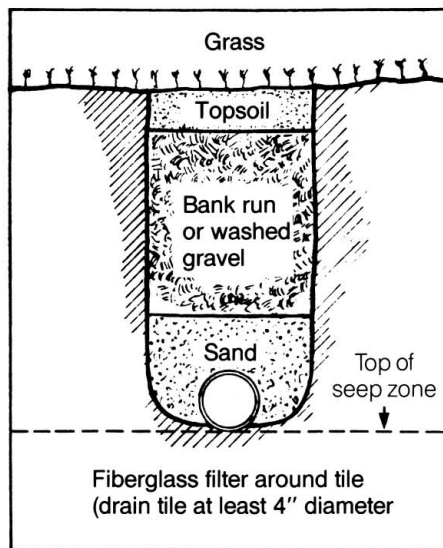

Figure 34. Groundwater drainage can be improved by the use of perforated or permeable conduits buried beneath the surface of the ground. (Adapted from DeYoung and Brown 1979.)

these pipes (which offer less resistance to flow than does the soil around them) and can be directed to a drainage point either away from the bluff or through a solid pipe down the face of the bluff to the water's edge.

The depth of the trench is dictated by the depth from the surface of the ground to the impermeable clay or hardpan layer acting

as a barrier to normal groundwater movement. (Note: If the depth of the barrier layer is too great, drainage conduits may not be feasible.)

The conduit is then laid into the trench, and the trench is backfilled with a uniform porous material such as washed or bankrun gravel. It is important that the pipe be laid at a slope of at least 2 inches of vertical drop for every 100 feet of horizontal run in order for the water to drain properly. Otherwise, silt could build up in the pipe, eventually clogging it.

Materials. Two main types of conduit are available:

Clay or concrete tile. Baked clay has been used for drainage tiling for several hundred years; concrete is a newer form of tile, but performs similarly to clay. Clay or concrete tile comes in sections of 1 or 2 feet in length and diameters of 4 to 24 inches. Individual tile segments butt up to each other with water entering the pipe through the spaces at these joints. Since they are rigid, clay and concrete tile do not require soft bedding material in the trench beneath them and are resistant to deformation due to uneven ground and backfill pressures.

Corrugated plastic tubing. This new, state-of-the-art material, made of polyethylene or

polyurethane tubing, comes in diameters of 4 to 12 inches and in lengths of up to 250 feet. Water enters this pipe through small holes or slits. The corrugations help provide some additional strength to prevent flattening, but the tube may still be crushed if it is not placed on a well-prepared bed and covered with a uniformly sized backfill material. Plastic tubing is much easier to handle than is clay or concrete tile and allows for more feet of tiling to be laid in the same length of time than can be laid with the older materials.

Length of Structure. Subsurface and surface drainage projects should ideally extend for the entire length or the area affected by groundwater seeps or surface erosion.

Filtration. Fine sands can enter a subsurface drainage pipe through the joints between sections or through the holes in the tubing. If water flows are gentle, this material could settle out, clogging the pipe. To prevent this, in sandy soils the joints (or the tube) should be wrapped with special fiberglass filter cloth available specifically for that purpose.

Limitations

Drainage improvements do not provide protection to adjacent areas, nor do they protect against erosion resulting from direct action of waves at the toe of a slope.

Effects on Coastal Processes

Drainage improvements may result in a decrease in fine sediments in the littoral system by reducing the amount of clays or silts being eroded away from a slope.

Environmental Effects

No significant effects result, except if turbidity of water immediately adjacent to the project is decreased as a result of removing clay and silt from the system; water quality and fish habitat at that location may be improved.

Advantages and Disadvantages

Advantages

Does not affect use of fronting beach for other uses.

Relatively low cost.

Disadvantages

None identified.

Coastal Slope Reshaping

Definition, Functions, Purposes

When a coastal slope is steeper than the angle at which the soil particles will remain naturally in place, the potential for erosion is dramatically increased, particularly if the surface of the slope is devoid of vegetation, which would normally hold the soil in place; if moisture is added to the soil in the slope, lubricating it and allowing for slumps and flows; if the toe of the slope is undercut at its base by wave action, causing major slides; or if additional weight is placed at the top of the slope in the form of a house, a swimming pool, or other human-made structure, destabilizing the underlying slope.

Provided there is sufficient room at the top of the slope, a coastal bluff could be regraded to a flatter angle to increase its stability. Regrading by itself is not a solution to surface erosion, but instead must be performed as part of an overall restabilization project, including revegetation of the slope.

Coastal drainage improvement

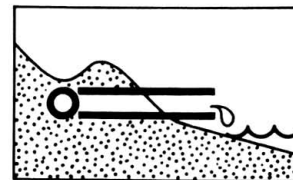

Suitability (landform)

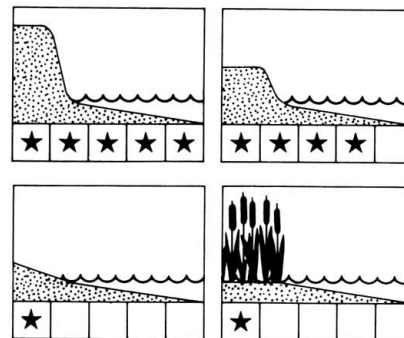

Compatibility (shoreline use)

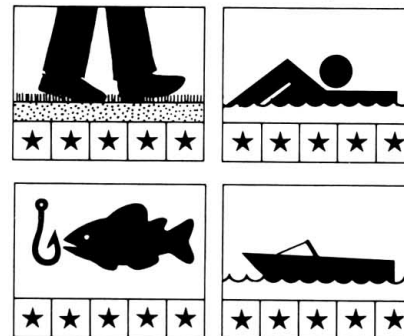

If there is a problem with undercutting at the toe, a structural control measure such as a bulkhead may also be necessary.

Planning and Design Considerations

Vegetation is essential to the surface (and shallow subsurface) stability of a slope. Plants will be difficult or impossible to establish on a slope steeper than a ratio of 1:1 (that is, 1 foot vertical rise per every 1 foot of horizontal run), or about 45 degrees. When regrading a coastal slope, the ideal angle to aim for, provided there is room at the top of the slope to do so, is a 1:3 (18°) slope. Since this gentle a slope "eats up" space at the top, where there are existing structures close to the slope's edge, a slightly steeper 1:1.5 (33°) slope may be a viable alternative (fig. 35). For situations where it is impractical or too expensive to regrade a bluff to even a 1:1.5 ratio, the use of railroad tie, gabion, or stone terracing may be an alternative method of reducing

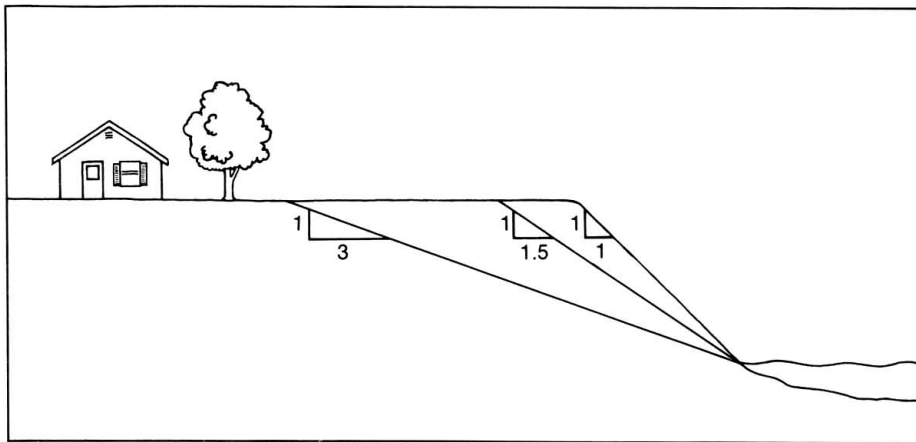

Figure 35. An ideal angle for a regraded coastal slope is a 1:3 (18°) slope. If lack of space at the top of the slope precludes this gentle an angle, a slightly steeper 1:1.5 (33°) slope can be a viable alternative.

Advantages and Disadvantages

Advantages

Access to the shore is generally improved. Does not affect use of fronting beach for other uses.

Disadvantages

Reduces amount of usable land at top of slope.

Coastal slope reshaping

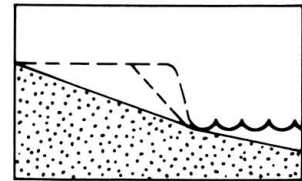

Suitability (landform)

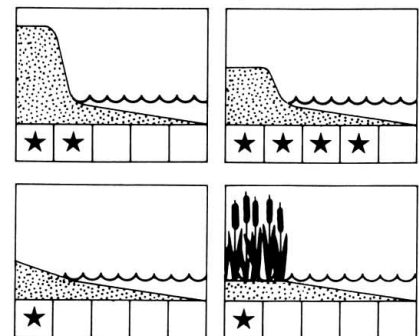

Compatibility (shoreline use)

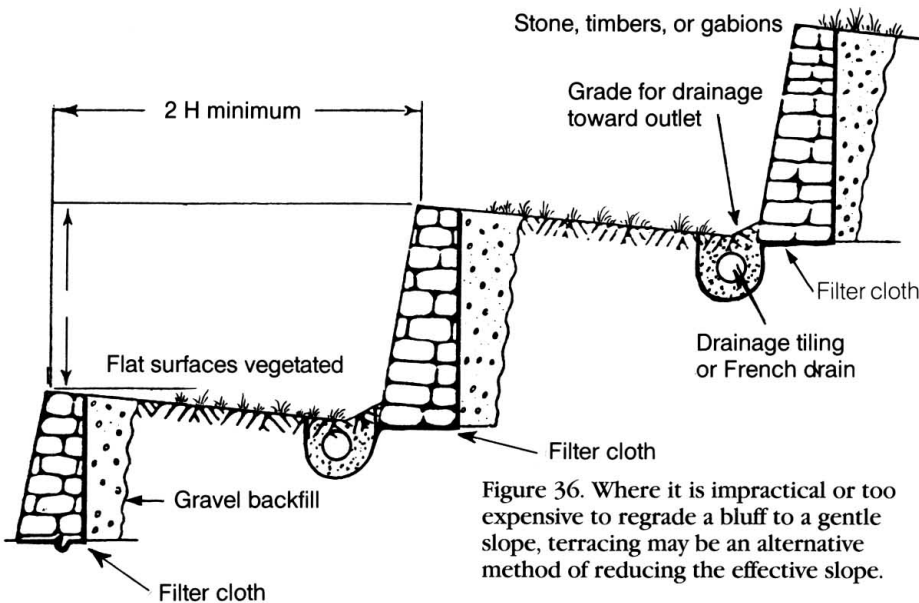
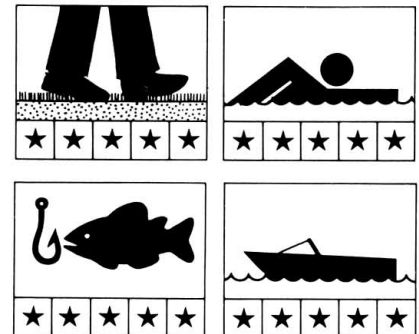

Figure 36. Where it is impractical or too expensive to regrade a bluff to a gentle slope, terracing may be an alternative method of reducing the effective slope.

the effective slope of the bluff, while providing horizontal steps to hold vegetation and stabilizing the vertical sections mechanically (fig. 36). For discussions on use of vegetation as a coastal erosion control, readers are advised to consult the Cornell University Shoreline Conservation Series Information Bulletin 198, *Vegetation Use in Coastal Ecosystems*.

Limitations

Slope reshaping does not provide protection to adjacent areas, nor does it protect against erosion resulting from direct action of waves at the toe of a slope.

Effects on Coastal Processes

Slope reshaping may result in a decrease in fine sediments in the littoral system by reducing the amount of clays or silts being eroded away from a slope.

Environmental Effects

No significant effects result, except if turbidity of water immediately adjacent to the project is decreased as a result of removing clay and silt from the system; water quality and fish habitat at that location may be improved.

Glossary

Note. The terms presented in this glossary come from various sources, but were culled mainly from U.S. Army Corps of Engineers, *Shore Protection Manual*, volume 3, 3d edition, U.S. Army Coastal Engineering Research Center, Fort Belvoir, VA, 1977.

- ACCRETION.** The buildup of a beach, by actions either of nature (such as deposition of sand by wind or water) or of humans (mechanical deposition of beach fill or trapping of sand behind a groin, jetty, etc.).
- ARTIFICIAL NOURISHMENT.** Replenishing a beach (usually with sand) from another location by mechanical means.
- BACKSHORE.** That portion of a beach or the shore lying between the first major inland change in topography and either the crest of the first (seaward or lakeward) berm or the upper limit of wave wash at high tide. The backshore is affected by waves only during severe storms. Also called the **BACKBEACH**.
- BAR.** A submerged or emerged embankment of sand, gravel, or other unconsolidated material deposited on the bottom of a waterbody by waves and currents in shallow water.
- BARRIER BEACH.** A bar, parallel to the shore, that extends at its crest above normal high water levels. Also called an **OFFSHORE BARRIER** and **BARRIER ISLAND**.
- BAY.** A recess in the shoreline or an inlet between two headlands.
- BEACH.** The area of unconsolidated sediments extending landward from the low water line to the place where there is a marked change in either material or landform or to the line of permanently established vegetation. The area between the most inland limit of storm waves and the mean low water line.
- BEACH BERM.** The part of a beach formed by the deposit of material by wave action. Usually horizontal.
- BEACH EROSION.** The carrying away of beach materials by waves, currents, or wind.
- BEACH FACE.** The section of a beach that is normally exposed to the action of up-rushing waves. Also called the **FORESHORE**.
- BEACH PROFILE.** The intersection of the ground surface with a vertical plane; extends from the top of a dune line to the seaward limit of sand movement.
- BLUFF.** A high, steep bank or cliff composed of erodible materials. A bank or cliff with a precipitous or rounded face adjoining a beach or a body of water. The seaward limit is the landward limit of the contiguous beach, or where no beach is present, the seaward limit is the mean low water level.
- BOTTOM.** The ground or bed under a body of water.
- BREAKER.** A wave breaking (plunging, spilling, collapsing) on a shore.
- BREAKWATER.** A structure built either offshore from an eroding shoreline or connected to that shoreline, extending out into the water, to protect the shore from wave action and (or) to provide calm water for boat mooring or docking (when used to protect harbors or basins).
- BULKHEAD.** A structure built to retain land and prevent it from sliding into a body of water. Bulkheads also protect the land behind them from direct attack by waves.
- COAST.** The strip of land, of indefinite width (up to several miles), that extends from the shoreline to the first major change in topography.
- COASTAL EROSION HAZARD AREA.** Under New York State law, an area of the coastline that is (a) subject to erosion and located landward of shorelines having an average annual recession rate of 1 foot or more per year (inland boundary is a horizontal distance 40 times the long-term average annual recession rate landward from the receding edge of a bluff and perpendicular to the shoreline); or (b) a natural [erosion] protective feature.
- CURRENT.** A flow of water.
- DOWNDRIFT.** The direction of predominant movement of littoral materials.
- DRIFT.** A shortened form of the term **LITTORAL DRIFT**.
- DUNE.** A ridge or mound of loose, wind-blown material, usually sand.
- EROSION.** The loss or displacement of land along the coast due to the action of waves, currents, tides, wind-driven water, waterborne ice, or other impacts of storms; or the direct action of wind, runoff of surface water, or groundwater seepage.
- FETCH.** The area of open water over which a wind with constant direction and speed blows, generating waves.
- FORESHORE.** That portion of a beach or the shore lying between the crest of the seaward berm (or upper limit of wave wash at high tide) and the ordinary low water line. The foreshore is the area normally traversed by daily and tidal waves. Also called the **BEACH FACE**.
- GROIN.** A coastal erosion control structure usually built perpendicular to the shore to trap and hold littoral drift and slow the erosion of the shore. Groins can also be used to cause beach accretion.
- GROIN FIELD.** A series of groins acting together to protect a reach of shore.
- GROUNDWATER.** Subsurface water below the water table in the zone of soil saturation. Groundwater supplies wells and comes to the surface as seepage or in springs.
- HARBOR.** A protected water area that affords a safe place for boats and (or) ships.
- JETTY.** A structure extending into a body of water for the purpose of preventing shoaling of a channel by littoral materials.
- LEE.** The sheltered side of a coastal structure, away from wind and waves.
- LITTORAL.** Of or pertaining to the shore.
- LITTORAL CURRENT.** Any current in the zone extending seaward from the shoreline to just beyond the breaker zone, caused primarily by wave action.
- LITTORAL DRIFT.** The material moved along the shore by waves and currents.
- LITTORAL TRANSPORT.** The movement of littoral drift along the shore by waves and currents, both parallel to the shore (longshore transport) and perpendicular to it (offshore transport).
- LITTORAL ZONE.** An indefinite area extending from the shoreline to just beyond the breaker zone.
- LONGSHORE.** Parallel to and near the shoreline.
- LONGSHORE BAR.** A bar that is parallel to the shoreline.
- MEAN HIGH WATER.** The approximate average of the high water level for a given body of water at a given location.
- MEAN LOW WATER.** The approximate average low water level for a given body of water at a given location.
- NATURAL [EROSION] PROTECTIVE FEATURE.** Under New York State law, a nearshore area, beach, bluff, primary dune, secondary dune, or wetland and the vegetation thereon that afford protection to inland areas from coastal erosion.

NEARSHORE. An indefinite area extending seaward from the shore to beyond the breaker zone and identified by the presence of nearshore currents.

NOURISHMENT. See ARTIFICIAL NOURISHMENT.

OFFSHORE. A direction seaward (or lake-ward) from the shore.

OVERTOPPING. Passing of wave water over the top of a coastal erosion control structure as a result of wave runup or surge action.

PERCHED BEACH. A beach retained above the otherwise normal beach profile by a submerged dike or sill.

PILE. A long, heavy timber or piece of metal or concrete driven or jetted into the bottom to serve as a support for or part of an erosion control structure, dock, pier, or wharf.

PRIMARY DUNE. The most seaward major dune where there are two or more parallel dune lines within a coastal area. Where there is only one dune present, it is the primary dune. Smaller dunes formed seaward of the primary dune are considered to be part of the primary dune.

RECESSION RATE. The rate, expressed in feet or meters per year, at which an eroding shoreline moves landward.

REVTMENT. A facing of stone, concrete, and the like, built to protect a bluff, beach, embankment, or structure from erosion by wave action or currents.

RILL. A tiny drainage channel cut in a beach or bluff face by the seaward flow of surface water. With continued erosion, rills become gullies.

RIP RAP. A facing of stone, randomly placed, to prevent erosion or scouring. Also may refer to the stone used for such a layer.

RUBBLE. Rough, irregular fragments of broken rock.

RUBBLE MOUND. An erosion control structure made of random-shaped and randomly placed stones or specially shaped concrete units.

RUNUP. The uprush of water on a beach or structure. Also called UPRUSH.

SEAWALL. A coastal erosion control structure built to separate the land from the water and to prevent damage from wave attack. A secondary purpose is to retain the land behind the structure.

SHEET PILE. A pile with a generally flat cross section to be driven or jetted into the bottom and interlocked with other sheet piles to form a wall or bulkhead.

SHORE. The narrow strip of land in immediate contact with the water, including the area between high and low water lines. This encompasses the backshore and the foreshore.

SHORELINE. The intersection of the plane of water with the shore or beach.

TOE. The lowest point on the slope of a bluff or a dune.

UPDRIFT. The direction opposite that of the predominant movement of littoral materials.

UPRUSH. See RUNUP.

WAVE. An undulation of the surface of a body of water.

Bibliography

Cheung, F. K., and F. H. Kulhawy. 1981. *Pile foundations*. Coastal Structures Handbook Series, New York Sea Grant Institute, Albany. 277 pp.

Clemens, R. H. 1977. *The role of vegetation in shoreline management; A guide for Great Lakes shoreline property owners*. Great Lakes Basin Commission, Ann Arbor, MI. 32 pp.

DeYoung, B., and L. Brown. 1979. *Controlling bluff groundwater along the Great Lakes*. New York Sea Grant Extension Fact Sheet 102.00. Cornell Univ., Ithaca. 6 pp.

Ehrlich, L. A., and F. H. Kulhawy. 1982. *Breakwaters, jetties, & groins*. Coastal Structures Handbook Series. New York Sea Grant Institute, Albany. 355 pp.

Freese, J. H., and F. H. Kulhawy. 1983. *General planning considerations for small-scale coastal structures*. Coastal Structures Handbook Series, New York Sea Grant Institute, Albany. 124 pp.

Great Lakes Basin Commission. 1975. "Shore use and erosion." Appendix 12, in *Great Lakes Basin framework study*. Ann Arbor, MI. 111 pp.

Hubbell, W. D., and F. H. Kulhawy. 1982. *Environmental loads*. Coastal Structures Handbook Series, New York Sea Grant Institute, Albany. 217 pp.

———. 1982. *Materials*. Coastal Structures Handbook Series, New York Sea Grant Institute, Albany. 105 pp.

Mulvihill, E.L., et al. 1980. *Biological impacts of minor shoreline structures on the coastal environment: State of the art review*. Vol. 1. U. S. Fish and Wildlife Service, U. S. Dept. of the Interior, Washington, DC. 156 pp.

N.Y.S. Department of Environmental Conservation. 1983. *Coastal erosion management regulations*. 6NYCRR505. Albany. 41 pp.

O'Neill, C. R., and J. Tanski. 1984. *Maintaining coastal erosion control structures*. New York Sea Grant Extension Fact Sheet 104.00, Cornell Univ., Ithaca. 6 pp.

Saczynski, T. M., and F. H. Kulhawy. 1982. *Bulkheads*. Coastal Structures Handbook Series, New York Sea Grant Institute, Albany. 324 pp.

U.S. Army Corps of Engineers. 1966. *Shore protection, planning and design*. Tech. Rept. no. 4, 3d ed. Coastal Engineering Research Center, Ft. Belvoir, VA.

———. 1973. *Help yourself; A discussion of erosion problems on the Great Lakes and alternative methods of shore protection*. North Central Division, Chicago, IL. 24 pp.

———. 1977. *Shore protection manual*. Coastal Engineering Research Center, Ft. Belvoir, VA. 964 pp.

———. 1981. *Low cost shore protection*. . . a guide for engineers and contractors. Washington, DC. 173 pp.

———. *Monthly bulletin of lake levels for the Great Lakes*. Detroit District, MI.

Wiegel, R. L. 1953. *Waves, tides, currents, and beaches: Glossary of terms and list of standard symbols*. Council on Wave Research, The Engineering Foundation, Univ. of California, Los Angeles.

The New York State College of Agriculture and Life Sciences is a statutory college of the State University, at Cornell University, Ithaca, N.Y. 1986.

Produced by Media Services at Cornell University

This publication is issued to further Cooperative Extension work mandated by acts of Congress of May 8 and June 30, 1914. It was produced with the cooperation of the U.S. Department of Agriculture, Cornell Cooperative Extension, New York State College of Agriculture and Life Sciences, New York State College of Human Ecology, and New York State College of Veterinary Medicine, at Cornell University. Cornell Cooperative Extension offers equal program and employment opportunities. Lucinda A. Noble, Director.

12/86 2M ML 9996