



14+  
age

# SPYDI

Instructions For Use  
Gebrauchsanweisung

V1.0

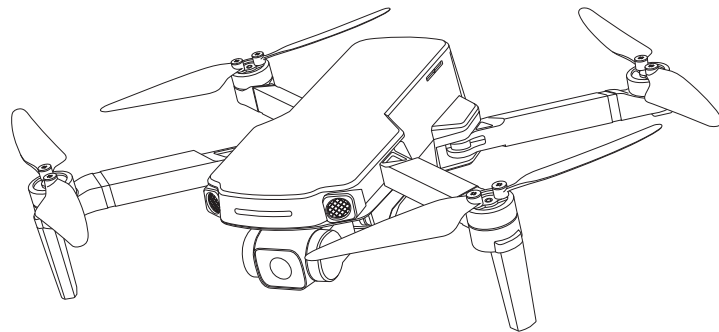

+1(855)888-6699  
www.holystone.com

usa@holystone.com (USA) eu@holystone.com (EU)  
ca@holystone.com (CA)

English 01-61

Deutsch 62-119

# CONTENTS

## 1

### Product Introduction

- 01 Package Contents
- 02 Diagram of the Drone
- 03 Diagram of the Transmitter

## 2

### Operation Guidance

- 09 Charging
- 11 Pre-Flight Preparations
- 15 Flight Environment Requirements
- 16 Pre-Flight Checklist
- 17 Flight

## 3

### Product Functions

- 27 Flight Functions
- 33 APP Functions
- 48 Stabilization Function
- 50 Storage

## 4

### General Information

- 51 Specifications
- 53 Contact Us

## 5

### Safety Instructions

- 54 Disclaimer & Warning
- 54 Safety Guidelines
- 57 Maintenance
- 57 Recycle this Product
- 58 Compliance Information

## 1.1 Package Contents &gt;&gt;

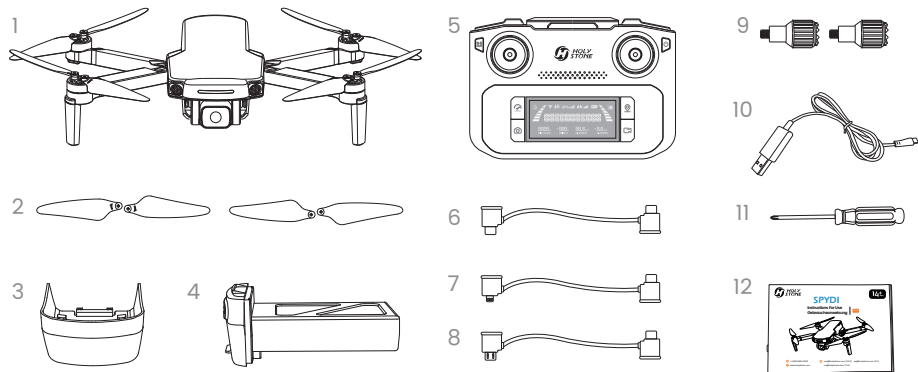

- |                |                             |                                |                         |
|----------------|-----------------------------|--------------------------------|-------------------------|
| 1 Drone        | 4 Drone Battery             | 7 Connection Cable (micro-USB) | 10 USB Charging Cable   |
| 2 Propellers   | 5 Transmitter               | 8 Connection Cable (lightning) | 11 Screwdriver          |
| 3 Camera Cover | 6 Connection Cable (type-C) | 9 Joysticks                    | 12 Instructions For Use |

## 1.2 Diagram of the Drone &gt;&gt;

## Drone

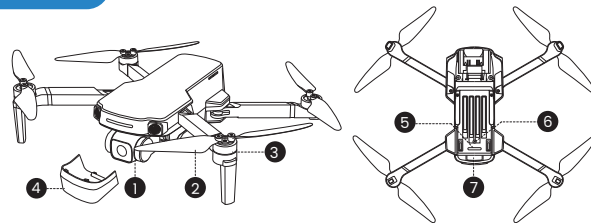

- |                          |
|--------------------------|
| 1 Camera                 |
| 2 Propeller              |
| 3 Motor                  |
| 4 Camera Cover           |
| 5 Drone Status Indicator |
| 6 Optical Flow Module    |
| 7 Drone Battery          |

## Battery of the Drone

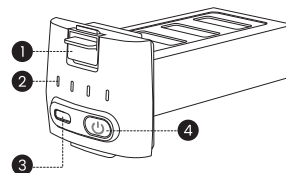

- |                            |                          |
|----------------------------|--------------------------|
| 1 Snap                     | 3 Charging Port (Type-C) |
| 2 Battery Level Indicators | 4 Power Switch           |

- **on/off:**  
Turn the battery on/off by **pressing the power switch for 3 seconds**. When the battery is on, the battery level indicators will display the current battery status. When the battery is powered off, all the indicators are out.

## 1.3 Diagram of the Transmitter &gt;&gt;

## Transmitter Functions

## ● Front:

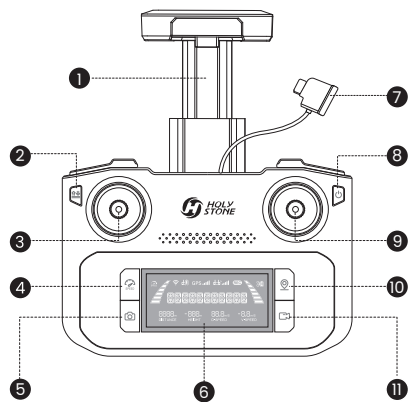

## ● Top:

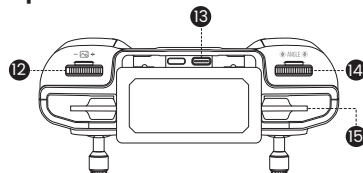

## ● Bottom:

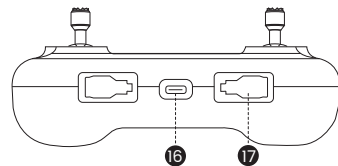

1 Cellphone Holder

2 Takeoff/Landing: Short Press

Emergency Stop: Long Press

3 Left Joystick

4 Speed Switch: Short Press

GPS Switch on/off: Long Press

5 Take Photo

6 LCD Screen

7 Connection Cable

8 Check Battery Level : Short Press

Power Switch: Short press, then hold

9 Right Joystick

10 Return to Home

11 Record Video

12 Zoom Dial

13 Connection Port

14 Camera Adjustment Dial

15 Cellphone Slot

16 Charging Port (Type-C)

17 Storage Slots for Joysticks



## 1.3 Diagram of the Transmitter &gt;&gt;

## LCD Screen

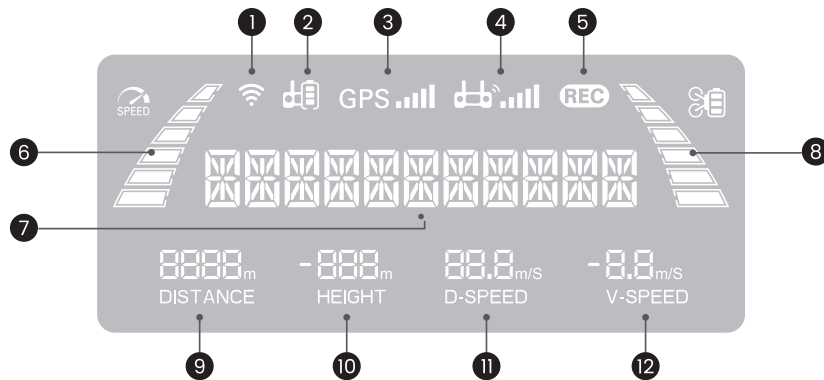

- |                               |                             |                         |
|-------------------------------|-----------------------------|-------------------------|
| 1 Transmitter WiFi Signal     | 2 Transmitter Battery Level | 3 GPS Signal Strength   |
| 4 Transmitter Signal Strength | 5 Photo/Record Indicator    | 6 Flight Speed          |
| 7 Drone Status                | 8 Drone Battery Level       | 9 Flight Distance       |
| 10 Flight Height              | 11 Flight Speed             | 12 Ascend/Descend Speed |

**⚠** When the battery level of the transmitter is low, its icon (  ) will start to flash. When this happens, please bring the drone down to the ground immediately and charge the transmitter.

## 1.3 Diagram of the Transmitter &gt;&gt;

## Joystick Mode

- **Mode 2:** (Left joystick as the throttle joystick)

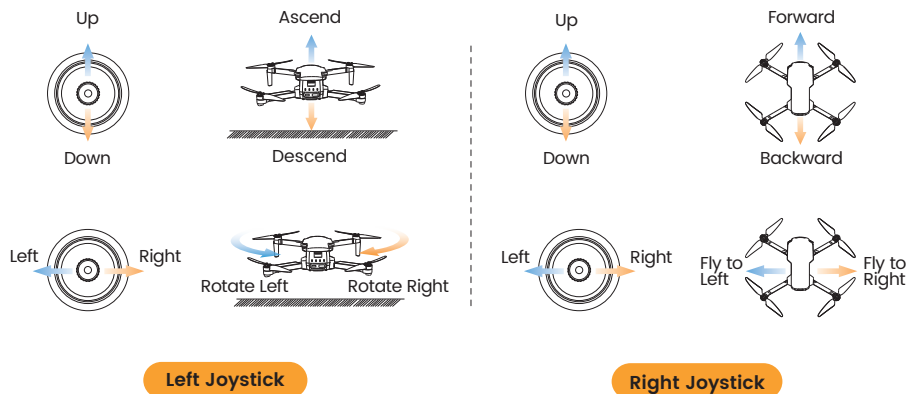

- **Mode 1:** (Right joystick as the throttle joystick)

Hold the ( ) button, short press the ( ) button of the transmitter once, then hold the latter until the transmitter quickly beeps 3 times. You will see "R HAND MODE" displayed on the LCD screen, which means the transmitter is now in Mode 1.

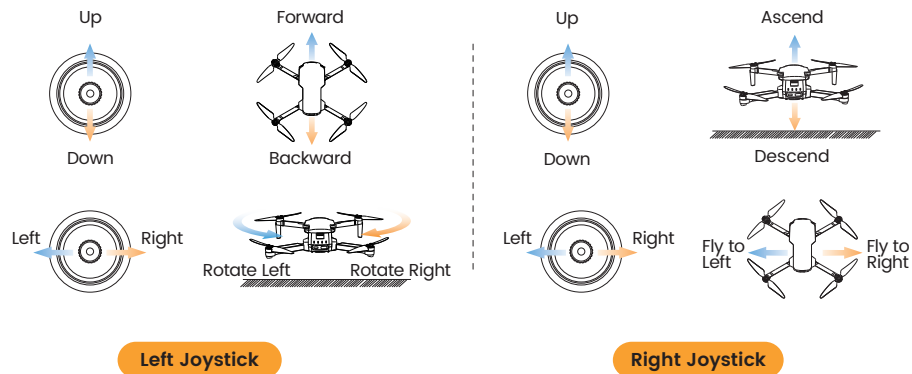

## 2.1 Charging >>

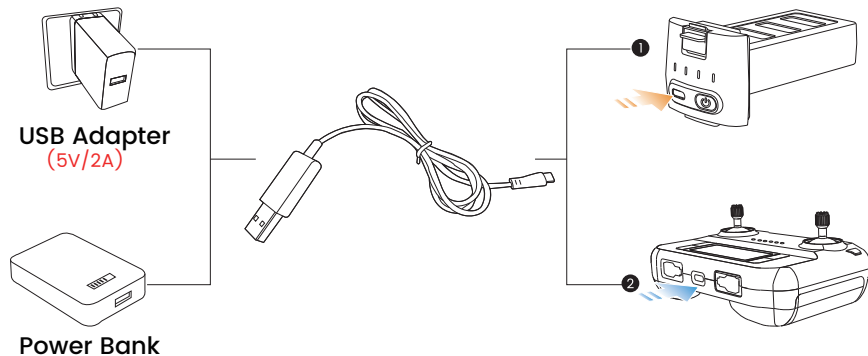

- ⚠** · Before charging, please read the instructions in the "**Safety Guidelines**" carefully.
- Please use the original charging cable to charge the drone battery and transmitter.
- DO NOT charge the drone battery immediately after a flight as the temperature of the battery may be too high. Please wait until it cools down to room temperature before charging again.

### 1 Charging of the Drone Battery :

- 1 Insert the Type-C plug of the charging cable into the drone battery.
- 2 Plug the other end of the cable into a USB adapter (5V/2A) or power bank to start charging.
- 3 When the battery is charging, the battery level indicators **will keep flashing**. When it is fully charged, all the indicators **will be on**.
- 4 It takes about 3 hours to fully charge a drone battery. A fully charged battery offers about 20 minutes of flight time.

### 2 Charging of the Transmitter :

- 1 Insert the Type-C plug of the charging cable into the Type-C port of the transmitter.
- 2 Plug the other end of the cable into a USB adapter (5V/2A) or powerbank to start charging.
- 3 When charging, the cells in the battery level bar will light up in turn. The LCD screen displays "**CHARGING.**" When the charging is done, all 3 cells will light up and the LCD screen displays "**CHARGE DONE.**"
- 4 It takes about 2 hours to fully charge the transmitter. A fully charged transmitter offers about 2 hours of usage time.

## 2.2 Pre-Flight Preparations >>

### ① Download & Installation



iOS

Android APP on  
Google play

The drone is equipped with a Live-Feed function. Please scan the corresponding QR-code above, and download the "HS FLY" app to use the related functions.



Required operating systems:  
**iOS 11.0 or above.**  
**Android 5.1 or above.**

### ② Camera Cover

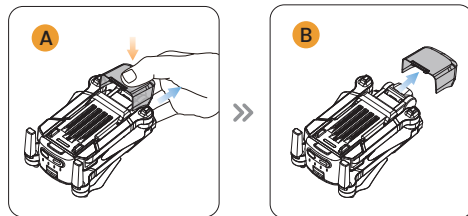

Loosen the buckle on the camera cover.

Gently pull the cover up, then pull it toward the front of the drone.



Please remove the camera cover before you turn on the drone.

## 2.2 Pre-Flight Preparations >>

### ③ Drone Battery

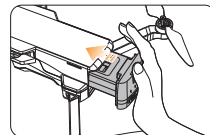

• **Installation:**  
**Push the battery into the fuselage.** Make sure you hear a click when inserting the battery, which indicates that it is installed firmly.

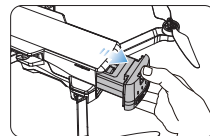

• **Remove:**  
**Press down on the snap and pull the battery out** of the fuselage.



- Please make sure that the battery is firmly installed. Otherwise, the flight safety of your drone may be affected. The drone may crash due to a power-cut during the flight.
- Only install/remove the battery when it is powered off.

### ④ Arms

- Unfold the **front** arms

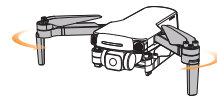

- Unfold the **rear** arms



All arms of the drone are folded when it is packaged at the factory. First, unfold the front arms, then unfold the rear arms.

## 2.2 Pre-Flight Preparations &gt;&gt;

## ⑤ Propeller

## ● Installation:

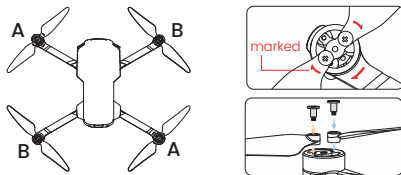

Install the marked propellers to the marked motor shafts. Use the screwdriver to tighten the two screws in place. Install then the unmarked propellers to the unmarked motor shafts.

## ● Remove:

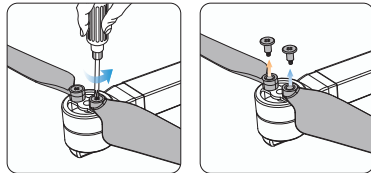

Use the screwdriver to turn the screws anti-clockwise to remove them. Then pull the propellers up.

- ⚠ • The marked propellers have a different spin direction than the unmarked ones. So please ensure that they are installed to the right motor shafts.
- Before each flight, check if the propellers are secure and tight.
- If the propellers become deformed or damaged, please replace them before flying again.

## 2.2 Pre-Flight Preparations &gt;&gt;

## ⑥ TF Card

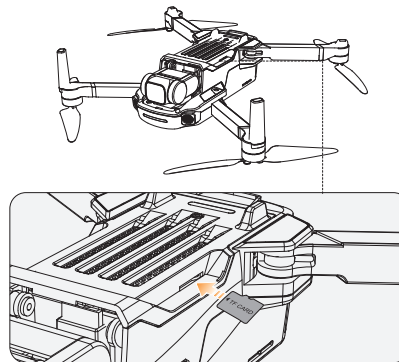

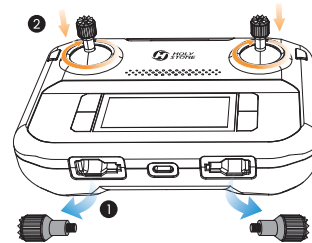

Insert a TF card (**not included**) into the TF card slot before turning on the drone. This drone supports TF card with a max storage of 128GB.

## ⑦ Joysticks



Take the joysticks out of the storage slot and mount them onto the transmitter.

## 2.3 Flight Environment Requirements >>

✓ Fly in Open Areas

---









✓ Maintain Line of Sight

---



✓ Fly Below 394 ft

     

! Avoid flying over or near obstacles, crowds, high voltage power lines, trees, airports or bodies of water. Avoid flying near areas with magnetic or radio interference, including as power lines, mobile base stations, radar stations, and broadcasting towers.

      

⊘ DO NOT use this drone in severe weather conditions including heavy wind, rain, snow, fog, hail, or lighting.

## 2.4 Pre-Flight Checklist >>

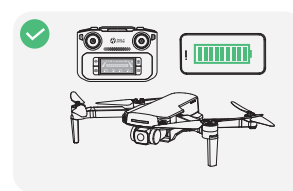

Make sure the transmitter, the cellphone and the drone battery are fully charged.

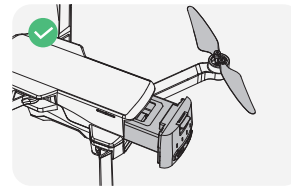

Make sure the drone battery and the propellers are installed securely.

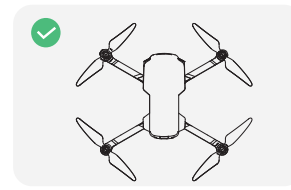

Make sure the drone arms are fully expanded.

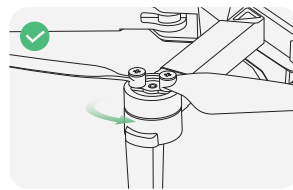

Make sure that there is nothing obstructing the motors.



Make sure the camera cover is removed.



Make sure you use HolyStone accessories.

## 2.5 Flight &gt;&gt;

## Pairing

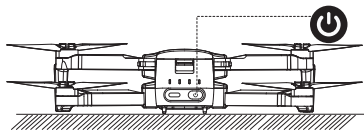

- To avoid unnecessary loss or damage, it is strongly recommended that the pilot flies this drone in an open, outdoor area.
- All of the operations shown in this manual are demonstrated using MODE 2.

**1 Turning on the drone**

Long press the power switch to turn on the drone. **Place it on a level surface with its head pointing forward.** The drone status indicator starts to blink red. The drone is now waiting to be paired.

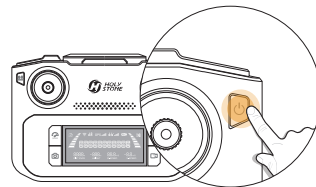
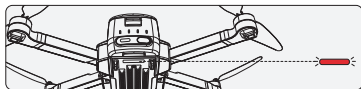
**2 Turning on the transmitter**

Short press the power switch of the transmitter once, then hold it to turn on the transmitter.

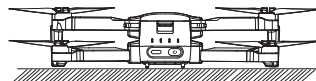
**3 Auto-Pairing**

It takes about **40 seconds** to pair the transmitter with the drone. During the pairing, the transmitter will keep on beeping. Finally, it will long beep once, and the drone status indicator turns solid, indicating that the pairing is complete.



## 2.5 Flight &gt;&gt;

## App Connection

- 1 Cellphone connection:** Pull the cellphone holder out. Draw out the connection cable from the transmitter. (A Type-C connection cable is pre-installed. You will also receive a micro-USB and a Lightning type connection cable.)

After setting the cellphone into the holder, use the connection cable to connect the transmitter with the cellphone. Make sure the latter is secured by the holder.

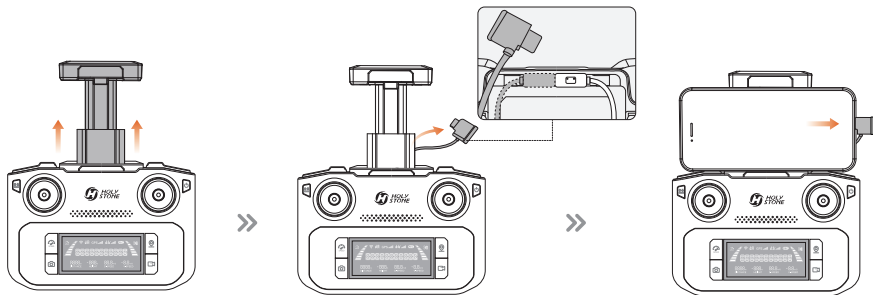

- 2** Run the "HS FLY" app and open up the live-feed interface.



HS FLY App



When using an Android phone, please choose "charge only" when the cellphone asks you to choose a connection mode. Other options may cause the connection to fail.



## 2.5 Flight &gt;&gt;

## Compass Calibration



- **STEP 1**

Push both joysticks **towards the inner, upper corners** simultaneously to start the compass calibration.

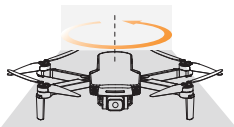

- **STEP 2**

Rotate the drone horizontally (**keeping it parallel to the floor**) until the transmitter beeps once.



- **STEP 3**

Point the head of the drone **upward and rotate it** till the transmitter beeps again, and the drone indicator turns solid blue. The compass calibration is complete.

## 2.5 Flight &gt;&gt;

## Unlocking the Motors

- **Unlocking**

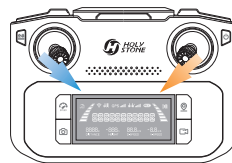



Push both of the joysticks simultaneously toward the inner, lower corners. The motors start to spin, the drone is unlocked.

**Lightbulb Locking:** If no command is given, the motors will lock themselves automatically 20s after the they are unlocked. You can also push both of the joysticks to the inner corners to manually lock them.

## Takeoff/Landing



- **Takeoff** Short press the (  ) button, the drone slowly takes off. You can control the drone with the joysticks now.

- **Landing** When the drone is in the air, short press the (  ) button. The drone slowly descends to the ground.

**Warning:** In places with weak GPS reception, the drone indicator will keep flashing blue slowly. If you want it to take off, you can hold the (  ) on the transmitter for 2 seconds to exit the GPS mode. The drone indicator will flash blue quickly, the LCD screen displays "ATTI MODE," the drone goes into attitude mode, it can take off, but all the GPS-related functions are unavailable now.

## 3.1 Flight Functions &gt;&gt;

## Camera Adjustment

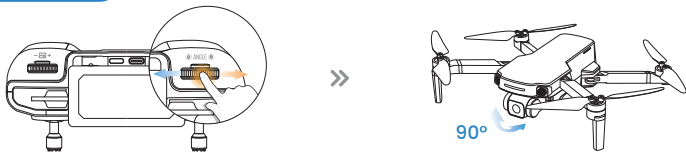

Adjust the camera angle by scrolling the camera adjustment dial (⊕ ANGLE ⊖) (tilt range: -90°~ 0°)

## Zoom

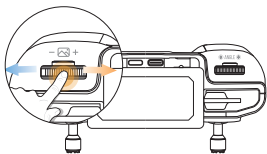

To zoom in, scroll the zoom dial (⊖ ⊞) to the right. The LCD screen displays "ZOOM IN."

To zoom out, scroll the zoom dial (⊖ ⊞) to the left. The LCD screen displays "ZOOM OUT."

## 3.1 Flight Functions &gt;&gt;

## Emergency Stop

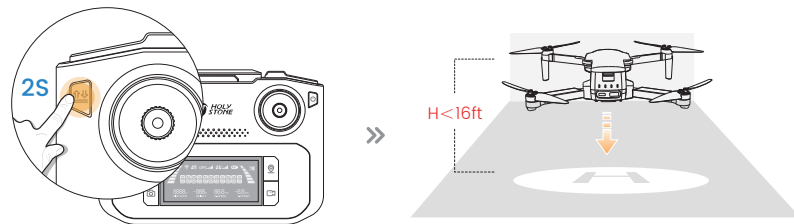

Hold the (⏏) button for 2 seconds to use Emergency Stop. This function only works when the drone's altitude is lower than 16ft.

**⚠** The Emergency Stop function should only be used in case of emergency during the flight to avoid any damage or injury.

## 3.1 Flight Functions &gt;&gt;

## Speed Switch

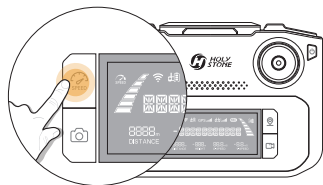

Short press the (  ) button once to switch speed.

 The normal mode is the default setting.

## ● Low:



The transmitter beeps once.  
The LCD screen displays  
**"CAMERA MODE"**(  ).

## ● Middle:



The transmitter beeps twice.  
The LCD screen displays  
**"NORMAL MODE"**(  ).

## ● High:





The transmitter beeps 3 times.  
The LCD screen displays  
**"SPORT MODE"**(  ).

## 3.1 Flight Functions &gt;&gt;

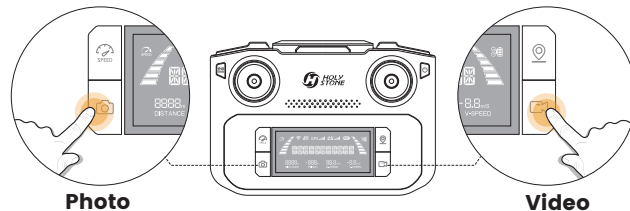
## Photo/Video



- 1 Short press the (  ) button on the transmitter. The ( **REC** ) on the LCD screen flashes once, which means that you have successfully taken a photo.
- 2 Short press the (  ) button on the transmitter. The ( **REC** ) on the LCD screen starts to blink, which means the camera is recording. Short press the button again will stop video recording.

 During the recording, the "Take Photo" function is disabled.

## 3.1 Flight Functions &gt;&gt;

## GPS Return to Home

The GPS Return to Home (RTH) function brings the drone back to the home point. As the name indicated, this function can only be triggered when the drone is in GPS mode.

There are 3 types of RTH: Smart RTH, Failsafe RTH and Low Voltage RTH.

\* **RA:** the Return Altitude set in the app setting.

### 1 Smart RTH:

Short press the (  ) button to activate Smart RTH. The drone will fly back to the last recorded Home Point.

During Smart RTH, the transmitter will keep on beeping. Short press the (  ) button again to exit Smart RTH.

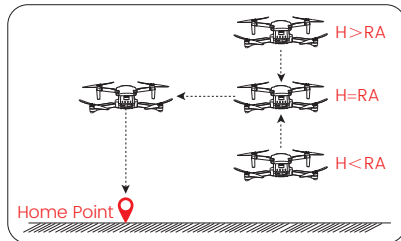
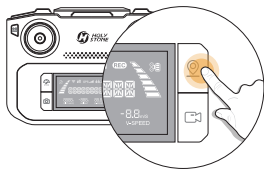

### 2 Failsafe RTH:

If the transmitter loses the connection with the drone, the Failsafe RTH will be automatically triggered. The drone will fly back to the last recorded Home Point.

During Failsafe RTH, the drone will try to re-establish connection with the transmitter. Once the connection is re-established, the pilot can manually end the RTH procedure by pressing the (  ) button again, thus regaining control of the drone.

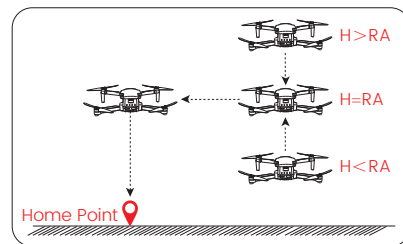

## 3.1 Flight Functions &gt;&gt;

## GPS Return to Home

**3 Low Voltage RTH:** (The first stages)

During the first stage of Low Voltage RTH, the transmitter will keep beeping, and the LCD screen will display "GOING HOME." The drone then generates a "safe zone" (**flight distance  $\leq 98$  ft, flight altitude  $\leq 66$  ft**). The drone can only fly within the safe zone during this stage. There are 3 possible RTH procedures during this stage.

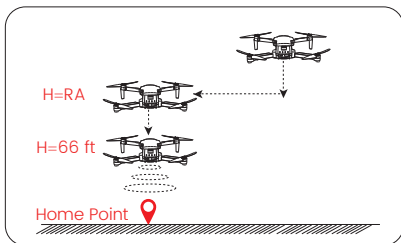
**a Flight altitude > RA**

When the flight altitude of the drone is higher than RA, the drone will descend to RA and fly back over the Home Point. It will then **descend to 66 ft and hover there**. The RTH ends.

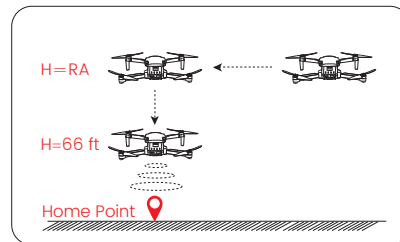
**b Flight altitude = RA**

When the flight altitude is equal to RA, the drone will keep its current altitude and fly back over the Home Point. It will then **descend to 66 ft and hover there**. The RTH ends.

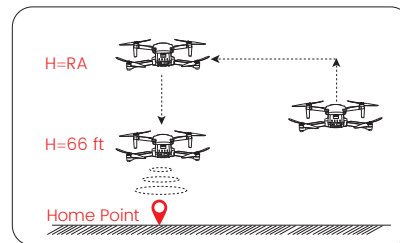
**c Flight altitude < RA**

When the flight altitude is lower than RA, the drone will first ascend to RA and fly back over the Home Point. It will then **descend to 66 ft and hover there**. The RTH ends.

## 3.1 Flight Functions &gt;&gt;

## GPS Return to Home

## 4 Low Voltage RTH: (The second stages)

The transmitter keeps on producing long beeps, the LCD screen displays "GOING HOME," the battery level bar on the screen keeps flashing. The drone will automatically fly back to the Home Point and land. There are 2 possible RTH procedures during this stage.

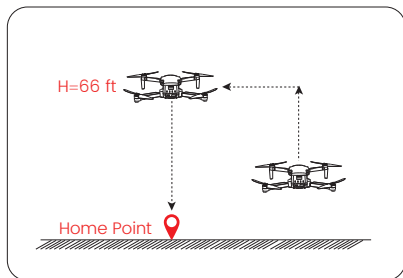

## a Flight altitude &lt; 66ft

When the flight altitude is lower than 66ft, the drone will first ascend to 66ft and fly back over the Home Point. It then **descends and land**.

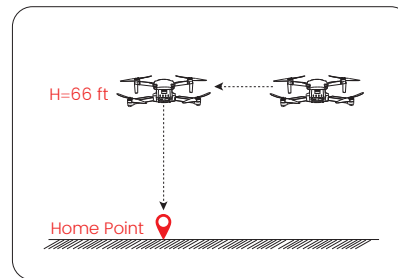

## b Flight altitude = 66ft

When the flight altitude is equal to 66ft, the drone will keep its current altitude and fly back over the Home Point. It then **descends land**.

**!** The drone is NOT equipped with obstacle avoidance. During your flight, DO NOT turn the transmitter off. Otherwise the Failsafe RTH will be automatically triggered due to the connection break.

## 3.2 APP Functions &gt;&gt;



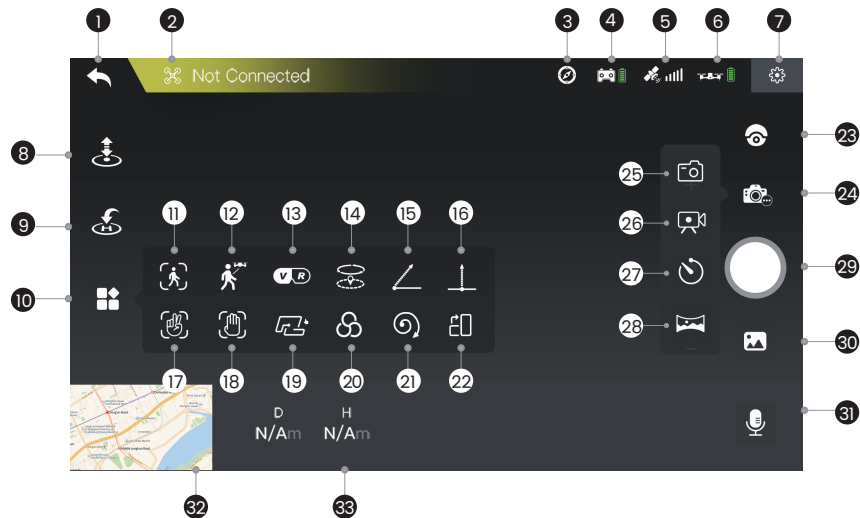





## The Interface















- 1 Homepage ( ) : Tap this icon to return to the main menu.
- 2 System Status ( ) : Displays the flight status and various warning messages.
- 3 Interference Index of Compass ( ) : Displays the current level of electromagnetic interference. "0" means no interference, "1000" means max. interference.
- 4 Transmitter Battery Level ( ) : Real-time display of the current battery level of the transmitter.
- 5 GPS Signal ( ) : Displays current GPS signal strength.
- 6 Drone Battery Level ( ) : Real-time display of the current battery level of the drone.
- 7 Settings ( ) : Tap to enter the setting interface. Alter settings for flight height/distance, return altitude, etc.
- 8 Takeoff/Landing ( ) : Tap the icon, follow the instructions in the prompt box to takeoff/land.
- 9 Return to Home ( ) : The drone returns to the last recorded Home Point.
- 10 Multi-functions ( )
- 11 Image Follow ( ) : After selecting a target, the camera will always point towards it no matter how the target moves. The position of the drone in the air remains unchanged. (The target should not move too fast.)

## 3.2 APP Functions &gt;&gt;

## The Interface

- 12 GPS Follow(  ): The drone stays at a distance from the operator and follows the GPS position of the paired mobile phone (See page 39).
- 13 VR Screen-Split(  ): Pair the mobile phone with a pair of VR glasses (not included) first. Then use this function to watch 3D live feed in real-time.
- 14 Point of Interest(  ): The drone flies around a point (See page 41).
- 15 Catapult(  ): The drone flies backward and ascends, with the camera locked on the subject. A video is made during this (See page 42).
- 16 One-key Ascension(  ): The drone ascends with the camera locked on the subject. A video is made during this (See page 43).
- 17 Gesture Selfie(  ): When in this mode, you can trigger the shutter of the drone camera by holding a "V" -sign near your face. (The drone camera should be pointing to your face.)
- 18 Gesture Selfie video(  ): When in this mode, you can trigger the shutter of the drone camera by holding your palm near your face. (The drone camera should be pointing to your face.)
- 19 TapFly(  ): The drone flies along the flight path you draw on the screen of the mobile phone (See page 44).
- 20 Camera Filter(  )

- 21 Spiral Up(  ): The drone ascends and spiral around the subject. A video is made during this (See page 45).
- 22 Portrait(  ): The shooting mode will turn from landscape to portrait.
- 23 Adjustment(  ): You can zoom in/out and adjust the camera angle here.
- 24 Shooting Mode(  ) 25 Take Photo(  ): Tap to use the photo function.
- 26 Record Video(  ): Tap to use the record function.
- 27 Time-lapse(  ): Tap to use time-lapse shooting (See page 46).
- 28 Panorama (  ): Tap to use the Panorama function (See page 47).
- 29 Shutter (  /  )
- 30 Album (  ): Tap to preview photos and videos taken by the drone camera.
- 31 Voice Recording(  ): Record sounds and voices with your mobile phone while shooting videos.
- 32 Map(  ): Tap the Mini Map to switch between Camera View and Map View.
- 33 Flight Parameters  $\left\{ \begin{array}{l} \text{Flight Distance} \left( \frac{D}{N/Am} \right) : \text{Horizontal distance from the Home Point.} \\ \text{Flight Altitude} \left( \frac{H}{N/Am} \right) : \text{Vertical distance from the Home Point.} \end{array} \right.$



## 3.2 APP Functions &gt;&gt;

## Beginner Mode

The beginner mode is the default operating mode. When in the Beginner mode:

- 1 The flight distance can not exceed 98 ft.
- 2 The flight altitude can not exceed 98 ft.
- 3 The return altitude during RTH is 66ft.

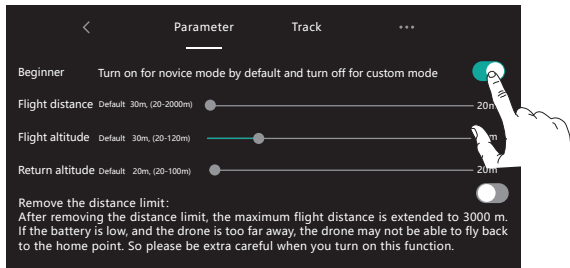

If you want to alter the above-mentioned parameters, please first turn off the beginner mode. You can go to the "Settings" to modify these parameters.



**Flight Settings  
On APP**



Remove the distance limit:

After removing the distance limit, the maximum flight distance is extended to 3000 m. If the battery is low, and the drone is too far away, the drone may not be able to fly back to the home point. So please be extra careful when you turn on this function.



If you want to get a longer flight distance, you can activate the **"Remove Distance Limit"** function in the "Settings" and boost the max flight distance up to 9842 ft.







Please be cautious when removing the distance limit. If the battery of the drone is low, the drone may not be able to fly back to the Home Point!

## 3.2 APP Functions &gt;&gt;

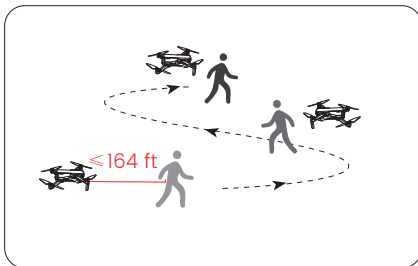
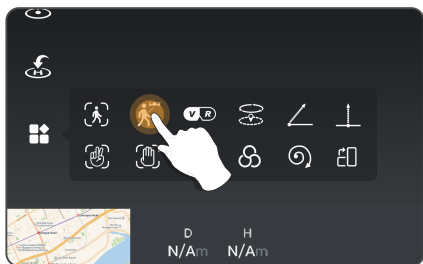
## GPS Follow

When the GPS Follow function is enabled, the drone will track your movement by following the GPS signal on your cellphone. (Please make sure that the connection between the drone and the transmitter is strong and stable.)





- 1 Make sure that the drone's flight distance is within 164 ft. Tap the (  ) icon first, then select the (  ) icon.
- 2 Follow the prompt box to enter the GPS Follow function — the drone will now follow your cellphone's coordinates.
- 3 To exit GPS Follow function, simply tap the (  ) icon on the app interface again.

- ⚠ The GPS Follow function can only be used if the flight distance is within 164 ft.
- Follow Me function may be difficult to activate if the mobile phone's GPS signal is too weak. This could be caused by signal interference from surrounding buildings, trees, mobile network congestion etc.
- Please use this function in an open area and be mindful of your surroundings. The drone is NOT equipped with obstacle avoidance.

## 3.2 APP Functions &gt;&gt;

## Point of Interest





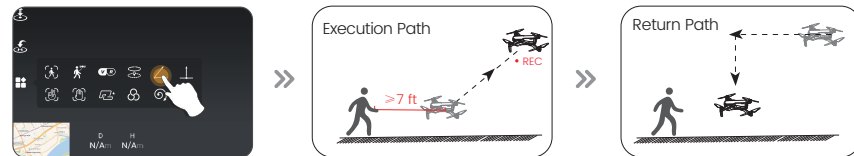

- 1 Tap the (  ) icon first, then select the (  ) icon, and follow the prompt box to activate the Point of Interest function. You can set the circling radius in the prompt box.
- 2 The moment you activate this function, the drone will record its current flight position as the "point of interest". It will then continuously circle around that point clockwise. (default radius: 16 ft)
- 3 To exit Point of Interest mode, simply tap the (  ) icon again.

## 3.2 APP Functions &gt;&gt;

## Catapult



- 1 Make sure that the drone is at least 7 ft away from the target. Adjust the camera angle so it points directly to the target.
- 2 Tap the (  ) icon, then tap (  ). Swipe in the prompt box to confirm.
- 3 The drone will automatically start recording, while flying about 82 ft away from the target.
- 4 After this, it will fly back to the starting point.
- 5 Tap the (  ) icon again, or push the right joystick to exit this function.

 Make sure there are no obstacles or people in the flight path of the drone. In case of emergency, push the right joystick to exit Catapult.

## 3.2 APP Functions &gt;&gt;

## One-key Ascension

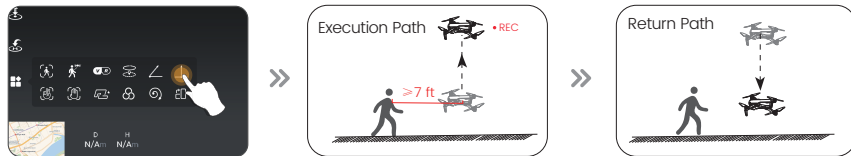

- 1 Please make sure that the drone is a least 7 ft away from the target. Adjust the camera angle so it points directly to the target.
- 2 Tap the ( ) icon, then tap ( ). Swipe in the prompt box to confirm.
- 3 The drone will automatically start recording and ascend to 49 ft.
- 4 After this, the drone will fly back to the starting point.
- 5 Tap the ( ) icon again, or push the right joystick to exit this function.

Make sure there is no obstacles or people in the flight path of the drone. In case of emergency, push the right joystick to exit One-key Ascension.

## 3.2 APP Functions &gt;&gt;

## TapFly

When using the TapFly, it is recommended to enlarge the map before drawing the flight path.

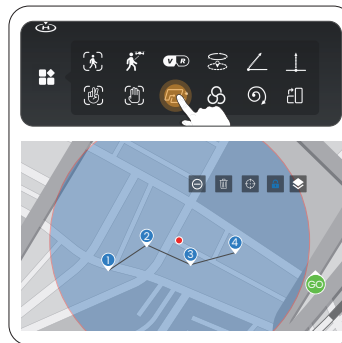





- 1 Tap the ( ) icon, then Tap ( ).
- 2 You can tap a dozen of times (but no more than 16) on the phone screen to create a flight path. Hit "GO" to submit the route. The drone will then fly along the path created by connecting the points you tap in order.
- 3 You can exit TapFly by tapping the ( ) icon again, or pushing the right joystick in any direction.

· DO NOT fly the drone towards people, animals, or small/thin objects (e.g. tree branches and power lines) or transparent objects (e.g. glass or water).  
· The actual flight path and the path you draw may not align perfectly.

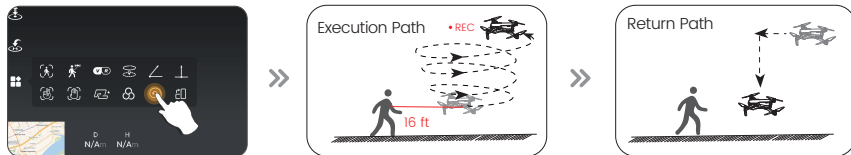
## 3.2 APP Functions &gt;&gt;

## Spiral Up







- 1 Make sure that the drone is about 16 ft away from the target. Adjust the camera angle so it points directly to the target.
- 2 Tap the (  ) icon, then tap (  ). Swipe in the prompt box to confirm.
- 3 The drone will automatically ascend and circle around (max. radius: about 49 ft) and start recording.
- 4 After this, it will fly back to the starting point.
- 5 Tap the (  ) icon again, or push the right joystick to exit this function.

**!** Make sure there is no obstacles or people in the flight path of the drone. In case of emergency, push the right joystick to exit Spiral Up.

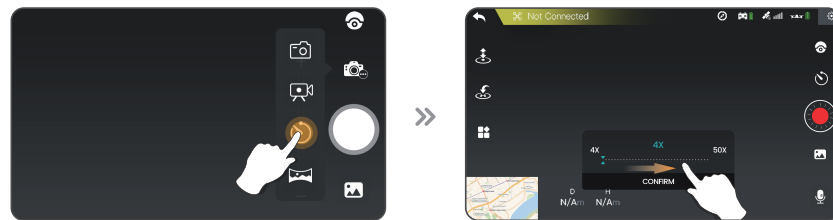
## 3.2 APP Functions &gt;&gt;

## Time-lapse





- 1 Tap the (  ) icon, then tap (  ) to use time-lapse shooting.
- 2 Swipe to choose the video playback speed, tap again to confirm.
- 3 Tap the shutter (  ), the time-lapse shooting begins.
- 4 Tap the shutter (  ) again to stop recording.

## 3.2 APP Functions &gt;&gt;

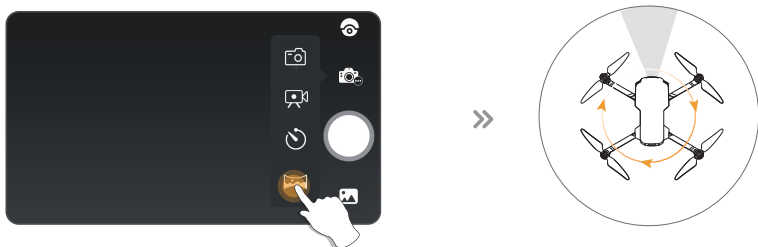
## Panorama



- 1 Tap the (  ) icon, then tap (  ) to use the Panorama function.
- 2 Tap the shutter (  ).
- 3 The drone will maintain its current position and rotate. A panorama picture is then auto-generated and saved to the album. A prompt box will pop up when this is done.

## 3.3 Stabilization Function &gt;&gt;

## Optical Flow Positioning

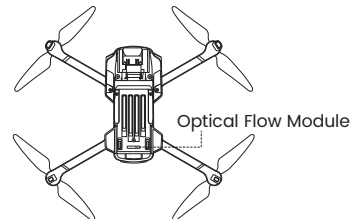

The Optical Flow Positioning System consists of a camera module, which acquires the position information of the drone through visual images to ensure precise positioning of the drone.

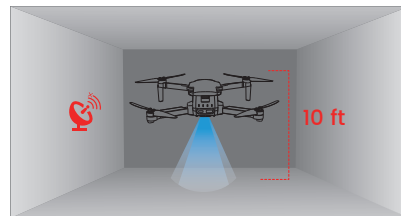

The Optical Flow Positioning System is typically used in an indoor environment when GPS signal is weak or unavailable. It works best when the drone altitude is less than 10 ft.

- ⚠ The optical flow positioning system works best when the drone's altitude is less than 10 ft.
- Flying speed should be controlled not to be too fast. When the drone is 3 ft from the ground, the flying speed should not be over 16 ft/s. When the drone is 7 ft from the ground, the flying speed should not be over 33 ft/s.

### 3.3 Stabilization Function >>

#### Optical Flow Positioning

The precision of the Optical Flow Positioning System is easily affected by the light intensity and features of the surface textures. Once the image sensor is not working properly, your drone will switch to altitude-hold function automatically. Please be cautious to operate the drone in the following situation:

- 1 Fly fast at an altitude below 2 ft.
- 2 Fly over monochrome surfaces (e.g. pure black, pure red and pure green).
- 3 Fly over highly light reflective surfaces.
- 4 Fly over water or transparent surfaces.
- 5 Fly over moving surfaces or objects.
- 6 Fly in an area where the lighting changes dramatically and frequently.
- 7 Fly over extremely dark (<10 lux) or bright (> 10,000 lux) surfaces.
- 8 Fly over surfaces without clear patterns or textures.
- 9 Fly over surfaces with highly repeating textures (small grid brick in the same color).

### 3.3 Stabilization Function >>

#### Altitude-Hold Function

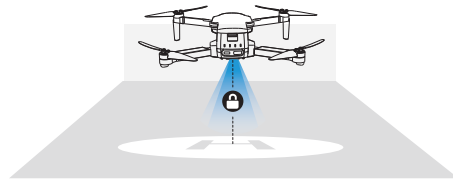

The drone is designed with an altitude-hold function to maintain its altitude after releasing the left joystick. (The left joystick will automatically spring back to the middle)

### 3.4 Storage >>

- 1 If no TF card is inserted, the photos and videos will be saved to the APP album and the gallery of your cellphone.
- 2 If a TF card is inserted, the photos and videos will be saved to the APP album and the TF card.
- 3 If you want to view the photos and videos through the app, please make sure that the drone, the transmitter and the cellphone are properly connected.

## 4.1 Specifications &gt;&gt;

• **DRONE :**

Model : HS360S	Weight : 249 g/8.78 oz
Max Flight Time : 20 minutes (per battery)	Operating Temperature Range :14° to 104°F
Size : 141*94*56 mm (folded)	297*215*56 mm (unfolded)

• **DRONE BATTERY :**

Capacity : 1500mAh	Voltage : 7.4V
Battery Type : Lithium-ion Polymer Battery	Rated Power : 11.1 Wh
Charging Temperature Range : 41° to 104°F	Charging Time : about 3 hours

• **USB CHARGING CABLE :**

Input: 5V/2A	Rated Power: ≤10 W
--------------	--------------------

## 4.1 Specifications &gt;&gt;

• **TRANSMITTER :**

Operating Frequency : 5500-5700 MHz	Charging Time : about 2 hours
Max Flight Distance : 9842 ft <i>(outdoor and unobstructed)</i>	Usage Time : about 2 hours
Battery Type : 3.7V 1500mAh	Operating Temperature Range : 14° to 104°F

• **CAMERA :**

Operating Frequency : 5500-5700MHz	Lens Angle : FOV 85°
Max Photo Resolution : 3840×2160P (in TF card)	3840×2160P (in mobile phone)
Max Video Resolution : 3840×2160P@20fps (in TF card)	1280x720P@20fps (in mobile phone)
Max Transmission Distance : 9842 ft <i>(outdoor and unobstructed)</i>	Photo Formats: JPEG
Video Formats: AVI/MP4	File Systems: FAT32
Supported TF Cards : Class 10 or above TF Card with storage up to 128 GB <i>(not included)</i>	



## 4.2 Contact Us >>

Please do not hesitate to contact us if you need further support.



4:00 PM ~ 7:00 AM (PST)



usa@holystone.com (America)  
ca@holystone.com (Canada)  
eu@holystone.com (Europe)



+1(855) 888-6699



For online support,  
please scan this code with Live  
Chat

## 5.1 Disclaimer & Warning >>

- Please read this Disclaimer & Warning and Safety Guidelines carefully before using our product. This product is not recommended for people under the age of 14. By using this product, you hereby agree to this disclaimer and signify that you have read it fully. You agree that you are responsible for your own conduct and any damage caused while using this product, and any consequence. You agree to only use this product for its designed purposes and in accordance with the local laws, regulations and all applicable policies and guidelines that HolyStone may provide.
- When using this product, please be sure to strictly abide by the specification requirements and safety guidelines stated in this document. Any personal injury, property damage, legal disputes and all other adverse events caused by the violation of any of the safety instructions or due to any other factor, WILL NOT be HolyStone's responsibility.

## 5.2 Safety Guidelines >>

- This product is a high precision drone that integrates various electronic stability and control mechanisms. Please be sure to configure this drone carefully and correctly to ensure safe, accident-free operation.
- Ensure that the batteries of the drone and transmitter are clean, undamaged, and fully charged before every use.
- Ensure that all the propellers are undamaged and are installed in the correct orientation.
- Please perform a thorough check of the product before each use. If there is any problem found after checking the drone, please refrain from using it until the problem is resolved.

- DO NOT use this product to follow any moving vehicles.
- During the flight, turn off the motors only in case of an emergency.
- When the battery runs low, return the drone back to your starting point.
- DO NOT use this product if you feel unwell, tired, or are under the influence of alcohol or drugs.
- Be aware of the volume of noise that the drone produces. Please ensure to keep your distance to avoid ear damage.
- Stay away from the rotating propellers and motors.
- DO NOT fly in any spaces where the drone are prohibited. Please respect people's right to privacy by not flying your drone close to others.
- DO NOT answer incoming calls, text messages, or do anything that may distract you from operating your smart device to control the drone during flight.

### Battery Usage :

- Always check the battery's condition before charging or using it.
- DO NOT crush or squeeze the batteries as this could cause the risk of fire or explosion.
- DO NOT mix new and old batteries, as this can lead to poor product performance.
- If the device is not going to be used for an extended period of time, please remove the batteries to prevent potential damage to the drone from battery leakage.
- DO NOT attempt to disassemble or modify the battery in any way.
- DO NOT use the battery if it gives off an odor, generates heat, becomes discolored, deformed, or appears abnormal in any way. If any of these situations occur while the battery is in use or being charged, remove it immediately from the device or charger and discontinue its use.
- DO NOT immerse the battery in water or get it wet.
- DO NOT solder the battery terminal in any way.

- DO NOT short-circuit the battery by connecting wires or any other metal object to the positive (+) and negative(-) terminals.
- Failure to follow all the instructions may result in severe injury, irreparable damage to the battery, and cause a fire, smoke, or explosion.
- This toy should only be connected to the equipment with symbol Class II. 

### Battery Storage :

- Keep batteries out of reach of children or pets.
- Never expose the LiPo battery to source of moisture or direct sunlight or store it in a place where temperatures could exceed 60°C.
- Please keep the packaging as it contains important information.

### Battery Disposal :

- DO NOT expose dead batteries to heat or fire, or they may explode.
- Please dispose of used batteries carefully. Used batteries should be brought to specialized battery recyclers, participating retailers that provide battery takeback services or local household hazardous waste collection programs.



#### Li-Po Battery Disposal & Recycling

Waste Lithium-polymer batteries must not be placed with household trash. Please contact local environmental or waste agency or the waste agency or the supplier of your model or your nearest Li-Po battery recycling center.



### 5.3 Maintenance >>

- Clean the drone after each use with a clean, soft cloth.
- Avoid prolonged exposure to direct sunlight and avoid buildup of heat on the drone or batteries.
- This device is not waterproof. DO NOT allow it to get wet or submerged in water. Failure to keep the device completely dry will result in the failure and permanent damage to the unit. Be aware that although it might be dry where you are, droplets of rain or mist from a river or waterfall could damage your drone while it is flying.
- Frequently check the charging plug and other accessories for signs of damage. If any part of the device or cables are damaged, avoid use or charging until the damaged part is replaced.

### 5.4 Recycle This Product >>

- This symbol on the product or its documentation indicates that it must not be disposed of with household waste.
- Uncontrolled waste disposal may harm the environment or human health.
- Please separate your device from other types of waste to recycle it responsibly. This will help to foster the sustainable re-use of material resources.
- We invite you to contact your retailer or inquire at your local town hall to find out where and how the drone can be recycled.



### 5.5 Compliance Information >>

#### FCC Notice:

This device complies with part 15 of the FCC Rules. Operation is subject to the following two conditions:

- (1) This device may not cause harmful interference, and
- (2) This device must accept any interference received, including interference that may cause undesired operation.

The Supplier's Declaration of Conformity is available at the following address:

[https://www.holystone.com/Download/US/HS360S\\_FCC\\_sDoC.pdf](https://www.holystone.com/Download/US/HS360S_FCC_sDoC.pdf)

This equipment has been tested and found to comply with the limits for a Class B digital device, pursuant to part 15 of the FCC Rules. These limits are designed to provide reasonable protection against harmful interference in a residential installation. This equipment generates, uses and can radiate radio frequency energy and, if not installed and used in accordance with the instructions, may cause harmful interference to radio communications. However, there is no guarantee that interference will not occur in a particular installation. If this equipment does cause harmful interference to radio or television reception, which can be determined by turning the equipment off and on, the user is encouraged to try to correct the interference by one or more of the following measures:

- Reorient or relocate the receiving antenna.
- Increase the separation between the equipment and receiver.
- Connect the equipment into an outlet on a circuit different from that to which the receiver is connected.
- Consult the dealer or an experienced radio/TV technician for help.

Changes or modifications not expressly approved by the party responsible for compliance could void the user's authority to operate the equipment.

**RF Exposure :**

The equipment complies with FCC radiation exposure limits set forth for an uncontrolled environment. This device should be installed and operated with minimum distance 20cm between the radiator & your body. This part belongs to the drone.

**RF warning for Portable device :**

The device has been evaluated to meet general RF exposure requirement. The device can be used in portable exposure condition without restriction. This part belongs to the transmitter.

**IC Notice :**

This device is restricted to indoor use when operating in the 5150 to 5250 MHz frequency range.

This device complies with Industry Canada license-exempt RSS standard(s). Operation is subject to the following two conditions:

- (1) this device may not cause interference, and
- (2) this device must accept any interference, including interference that may cause undesired operation of the device.

**CAN ICES-003 (B) :**

Avis d' Industrie Canada

Le présent appareil est conforme aux CNR d'industrie Canada applicables aux appareils radio exempts de licence. L'exploitation est autorisée aux deux conditions suivantes :

- (1) l'appareil ne doit pas produire de brouillage, et
- (2) l'utilisateur de l'appareil doit accepter tout brouillage radioélectrique subi, même si le brouillage est susceptible d'en compromettre le fonctionnement.

**CAN NMB-003 (B) :**

RF Exposure

Radiation Exposure Statement:

The device is compliance with RF exposure guidelines, users can obtain Canadian information on RF exposure and compliance. The minimum distance from body to use the device is 20cm.

Le présent appareil est conforme

Après examen de ce matériel aux conformité ou aux limites d' intensité de champ RF, les utilisateurs peuvent sur l' exposition aux radiofréquences et compliance d' acquérir les informations correspondantes. La distance minimale du corps à utiliser le dispositif est de 20cm.

**EU RF Power (EIRP) :** <16 dBm (2452MHz ~ 2474MHz)

**Caution :**

The max operating of the EUT is 45°C. and shouldn' t be lower than -10°C.

The device complies with RF specifications when the device used at 0mm from your body.

Declaration of Conformity.

We, Xiamen Huoshiquan Import & Export CO., LTD hereby, declare that the essential requirements compliance with the Directive 2014/53/EU, the RoHS Directive 2011/65/EU and Safety Directive 2009/48/EC have been fully fulfilled on our product with

**Indication Below:**

Product Name: REMOTE CONTROL MODEL/RADIO CONTROLLED

Model/Mark: HS360S/HOLYSTONE

The Statement of compliance is available at the following address:

[http://www.holystone.com/Download/CE/HS360S\\_EU\\_DOC.pdf](http://www.holystone.com/Download/CE/HS360S_EU_DOC.pdf)

This product can be used across EU member states.

**Manufacturer Information:**

Manufactured by Xiamen Huoshiquan Import & Export CO.,LTD

Address: Unit 1, Room 501, Hongxiang Building, No.258 Hubin Nan Road, Siming District, Xiamen, China

+1(855) 888-6699



MADE IN CHINA(CN)