



TOTAL HEADBORNE SYSTEM SOLUTIONS

PRODUCT CATALOG

www.ops-core.com

IT'S GO TIME

Gentex Corporation takes pride in our dedication to the mission of providing optimal protection and situational awareness to global defense forces, emergency responders, and industrial personnel operating in high-performance environments.

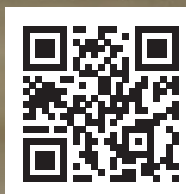

**CLICK OR SCAN TO
WATCH THE VIDEO**



OUR PROUD HISTORY

Gentex has been at the forefront of innovation for over 125 years, from product development to quality enhancement and performance. Our philosophy of continually reinvesting in our employees, our customers, our capabilities and technologies shows in the growth of our business and the game-changing innovations our people have created.

GENTEX[®]
CORPORATION



OUR PEERLESS QUALITY

Gentex Corporation ensures that our Quality Management Systems consistently provide products to meet our customers' requirements and enables process measurements to support continuous improvements. We comply with an ISO 9001-certified Quality Management System that is supplemented with additional quality system requirements that meet the AS9100D standard, a standard that provides strict requirements established for the aviation, space, and defense industries.



ENGINEERED AND TESTED

Whether it's a helmet system, a respiratory protection system, leading-edge optics, or a communication headset, Gentex Corporation takes the same all-in approach to product design and engineering. We aim to achieve the maximum protection, performance, and user comfort possible. Gentex Corporation's design and engineering teams transform customer challenges into solutions that work by working closely with end users to understand their challenges. Our best-in-class product solutions reflect that.

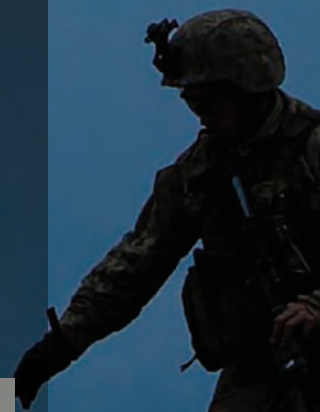
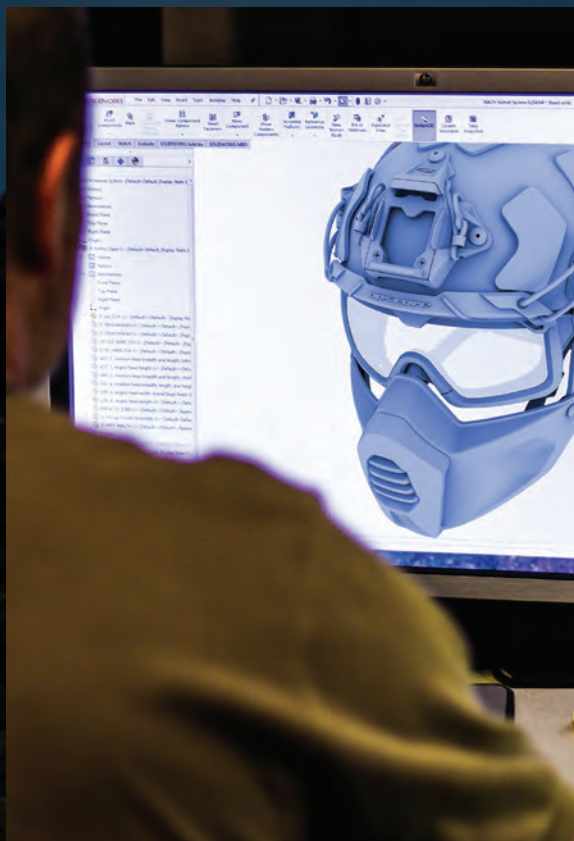

MISSION CONFIGURABLE

It's all about Open Architecture. Our approach to product integration results in systems with components that work together seamlessly, and allow the end user to focus on the mission at hand – not their equipment setup. Our system products are designed and engineered to easily integrate and work with Gentex Corporation and other third-party components. This approach gives end users limitless freedom for customization.

COMPLETE SYSTEM

TOTAL HEADBORNE SOLUTIONS

We are your experts for headborne protection, situational awareness, high-performance optics, and respiratory protection. Gear up for mission success.

EYEWEAR

Delivering eye protection from impact and fragmentation while providing light management and laser threat protection to enhance vision and increase survivability during highly dynamic operations.



VISORS

The STEP-IN® visor provides a new level of optical clarity, ballistic performance, and functionality – sealed or vented. It can be used with one hand, ensuring quick and easy use.



MANDIBLES

Built for protection against ballistic threats and blunt impacts. The conforming soft armor allows the user to comfortably obtain a solid cheek weld on their rifle, and the well-ventilated design enhances comfort and reduces lens fogging.



SHROUDS

Designed to be compatible with most NVG mount arms, our shrouds are sturdy, snag-resistant, and lightweight.



HELMET SUSPENSION

Available in an array of options, our helmet liners balance fit, comfort, and optimal ventilation with the capability to accommodate headsets. Some feature components are customizable and may be repositioned for optimal comfort.



SYSTEM INTEGRATION

RETENTION SYSTEMS

These systems deliver the assurance that a fully configured helmet remains comfortable, balanced, and secure. Our webbing maintains light, straight force lines, while our innovative Head-Loc retention system design enables one-handed tension adjustment.

HELMET COVERS

Tailored helmet covers offer the ability to add camouflage and surface protection without modifying the helmet. They are available in both stretch and mesh options.



COMMUNICATIONS

World-class 3D Hear-Through technology provides enhanced situational awareness with scalable hearing protection. Configure the AMP® Communication Headset to the mission profile with available mounting and connectivity components.



RESPIRATORY

For tactical ground forces, these products offer protection from a wide range of oil and non-oil-based particulates. The design offers seamless protection without interfering with the operator's TTP and interfaces with weapons systems for optimal effectiveness.



HEADBORNE PROTECTION SYSTEM-LEVEL PERFORMANCE

Protection and ongoing optimization

Every day, our expert team of designers and engineers pushes the limits of what's possible and works closely with end users to meet and exceed system requirements.

Our core innovation – Integrated Modular Design – has given rise to high-cut architecture helmet systems that feature performance-enhancing components, such as the Modular Bungee Shroud (MBS) and our PowerPath™ ARC Rails, which can be configured quickly and easily kitted for any operation type. This means the wearer can focus on the mission, not the helmet or its components.

Open Architecture is one of the keys to this advancement, which helps deliver maximum flexibility and forward compatibility and allows our products to integrate seamlessly with Ops-Core® and third-party components. The result? Individual customization that aligns with the wearer's specific needs.

FAST SF OVERVIEW



**CLICK OR SCAN TO
WATCH THE VIDEO**



1

BALLISTIC PROTECTION

We offer helmets in different ballistic materials giving end users more options in helmet system selection with varying levels of threat protection, pounds, and price. Our labs are at the forefront of handgun, frag, and rifle protection testing, pushing the limits of what's possible.



2

COMPLETE INTEGRATION

Our end users operate in the most challenging environments and conditions. We provide them with full headborne systems that integrate the latest communications, situational awareness, face, eye, and respiratory protection technology.



3

SCALABLE ACCESSORIES

A ballistic applique can be added for a transformative level of protection. Eye protection and vision enhancement can be added with our eyewear and ballistic visors. By having a variety of mandible configurations to choose from, wearers get the peace of mind of added face protection.

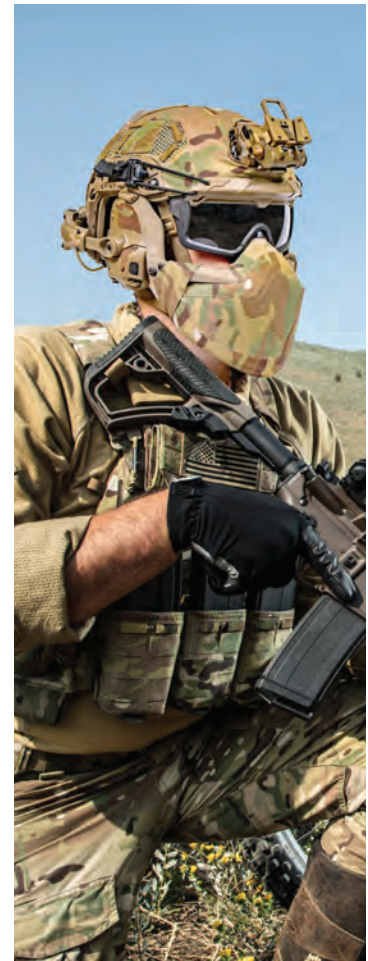

SITUATIONAL AWARENESS

3D HEAR-THROUGH TECHNOLOGY

Enhanced audio with scalable hearing protection

Always have a competitive advantage confronting threats. The AMP® Communication Headset features 3D Hear-Through Technology (3DHT) and advanced, scalable hearing protection. Its modular design allows easy configuration to meet a wide range of mission needs. Ops-Core helmet shells are designed to better accommodate communication headsets, and the geometry of the headset earcups is designed to accommodate a wide variety of helmet profiles. The AMP Communication Headset is CE-approved EN 352 and available in Berry Amendment-compliant configurations. Our situational awareness products are proudly assembled in Gentex's US factories.

AMP OVERVIEW



**CLICK OR SCAN TO
WATCH THE VIDEO**



1

HEARING ENHANCEMENT

World-class 3D Hear-Through Technology (3DHT) provides unprecedented audio quality, hearing restoration, and enhancement, and allows the operator to boost their "natural hearing" by up to +12dB.



2

ADAPTIVE MISSION PLATFORM

The AMP Communication Headset was developed to quickly convert between an ergonomic headband and a helmet-mounted configuration. The AMP Helmet Rail Mount Kit provides better comfort, a consistent earseal, and greater helmet stabilization with streamlined stowage capability.



3

SCALABLE HEARING PROTECTION

High-performance -22dB earseals with ergonomic fit provide a better seal and improved noise attenuation. The addition of wireless NFMI earplugs provides increased -34dB double hearing protection rivaling active noise reduction (ANR) while maintaining clear communications and hear-through audio.



HIGH-PERFORMANCE OPTICS

OPTIMAL THREAT VISIBILITY

From performance eyewear to ballistic visors

Gentex has a history of excellence in optics as a designer and manufacturer of precision polycarbonate lenses for both defense and commercial applications.

These advanced products – from eyewear with interchangeable lenses to ballistic and non-ballistic visors – offer enhanced visual acuity and protection to support any mission, optimizing and maintaining operational performance for elite defense, law enforcement, and security forces.

**STEP-IN VISOR
OVERVIEW**



**CLICK OR SCAN TO
WATCH THE VIDEO**

1

ADVANCED OPTICS

Gentex-manufactured lenses offer the highest quality and levels of protection. Lenses are available in Clear, Tint, Laser Dazzle, High Contrast, Advanced Laser Eye Protection (ALEP), and Photochromic. Future Lens options include Eclipse and Eclipse NIR integration with our STEP-IN Visor.



2

MISSION CONFIGURABLE

Our optics options – ranging from eyewear to visors to shields – are easily configurable to specific threats or conditions faced.



3

SCALABLE PROTECTION

Visors deliver eye or full-face protection from fragmentation to handgun threats. They feature anti-fog interior coatings and anti-scratch exteriors, with one-handed operation.



RESPIRATORY PROTECTION FOR TACTICAL OPERATIONS

50+ years of respiratory technology innovation

Gentex has decades of experience, supplying aircrews with leading-edge respiratory systems. We've put it to work on the ground; in threatening environments with oil, lead, asbestos, or ammo residue, and in situations our customers face on a regular basis, such as exiting a chopper that's kicking up debris, respiratory protection is essential. Ops-Core's signature respiratory products have a filtration effectiveness rating of P100, the highest particulate filtration rating attainable for mitigating exposure. Due to our unique, streamlined design, the wearer gets the highest level of protection and zero interference with mission-critical weapons and equipment.

99.97%
FILTRATION
EFFICIENCY

SOTR OVERVIEW

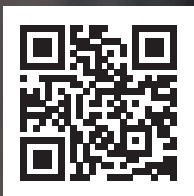

**CLICK OR SCAN TO
WATCH THE VIDEO**



1

FILTRATION EFFICIENCY

Delivers at minimum 99.97% filtration efficiency against airborne particulates. Field tested and proven to mitigate airborne lead, asbestos, lubricant mist, narcotics, and explosive gunfire residue.



2

SEAMLESS COMPATIBILITY

The low-profile design offers protection without interfering with the operator's tactics, techniques, and procedures. Our systems seamlessly integrate with weapons systems for optimal effectiveness, including an option that interfaces with communications headsets.

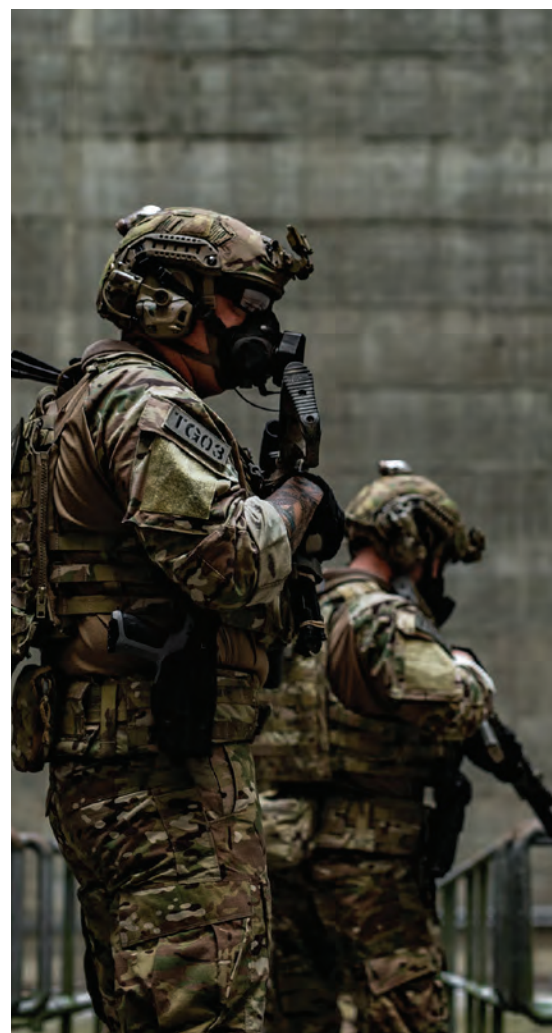





I-A



OUR EXPERTS BREAK IT DOWN

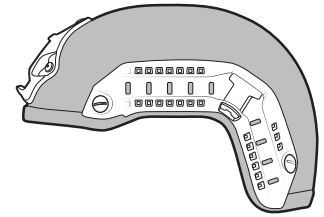

What to Consider in Helmet Selection

Outside of your weapon, your helmet is the one item that will stick with you the longest. This means choosing the correct headborne solution is not only mission-critical – it is also highly personal. At the locker or in the meeting room, helmet kitting is, understandably, a frequently discussed topic. After all, lives depend on the right configuration decisions. To help, our experts break the essential elements you should consider into three distinct categories:

PROTECTION

Protection: Knowing you have a helmet capable of protecting you against the most likely threat level is one of the key considerations in helmet selection. When it comes to protection, the Ops-Core FAST® helmet line offers a wide variety of choices for a wide variety of threats – from blunt force trauma to 7.62x39mm mild steel core rifle rounds. Our helmets meet or exceed their advertised testing standards. And it doesn't stop there. We test all FAST helmet sizes as part of our standard testing process, once again setting Ops-Core apart from the competition.

POUNDS

Pounds: Helmet weight will always be subordinate to helmet protection, but it should remain a top consideration, nonetheless. Weight determination is often a function of mission needs and duration, but the accessories necessary for configuration should also be a factor. After all, helmet kitting is key to mission success and therefore should be part of the decision-making process.

PRICE

Price: While safety should never be sacrificed for price, budgets are a reality in helmet selection and decision-making. As the premium product in the market, Ops-Core helmet systems offer tremendous value and a tremendous pedigree. Ops-Core FAST helmets adhere to critical design standards and are consistent in material and build quality. There's a reason FAST helmets have been the top choice for Tier 1 military and law enforcement operators stateside and overseas for more than a decade. Our best-in-class testing surpasses the typical "pass/fail" industry standard. This, along with our constant pursuit of perfection and innovation, has given Ops-Core a reputation for excellence, and we work hard to maintain it.

FIT OVERVIEW



CLICK OR SCAN TO
WATCH THE VIDEO

Fit: After the FAST helmet is selected, a good fit should be the next highest priority, which means a focus on sizing. A well-fitting helmet will be comfortable and secure, provide full head movement without slippage, and be free of pinching or tightness. Small issues with fit will become magnified the longer the helmet is worn especially when heavier accessories such as NVGs are added. Scan the QR code to watch a video illustrating proper helmet fitting.





FAST[®]

15

**FAST[®] HELMET FAMILY
15-YEAR ANNIVERSARY**



THE FIRST WORD IN TACTICAL HELMET SYSTEMS. THE FINAL WORD IN CONFLICT-TESTED HEADBORNE PROTECTION.

In 2008, Ops-Core's FAST helmets brought game-changing innovation to the world's most dangerous environments. With the help and feedback of elite military, law enforcement, and emergency personnel, FAST's mission-configurable, fully modular tactical helmet continues to be the standard-bearer to which all other brands aspire.



2008 //
FAST BALLISTIC HELMET
System-level-designed Ballistic
Tactical Helmet



2009 //
FAST CARBON HELMET
System-level-designed Carbon
Tactical Helmet



2010 //
FAST BASE JUMP HELMET
System-level-designed Training
Tactical Helmet



2010 //
FAST MARITIME
Super Light Weight 9mm Protection



2018 //
FAST SF
Lighter Weight 9mm/Frag Helmet



2018 //
FAST SF CARBON
COMPOSITE HELMET
Lighter weight Carbon Tactical Helmet



2021 //
FAST RF1 HELMET
7.62x39 MSC Rifle Protection



2022 //
FAST XR HELMET
Lead Core Rifle Protection

AUTHENTICATE YOUR GEAR

Authenticate your product by looking for both the Ops-Core Finished Goods sticker and the Ops-Core Shell sticker, both of which can be found on the interior of the helmet. For more information, go to www.gentexcorp.com/ops-core/authentic/





HELMETS

PROVEN HEADBORNE SYSTEMS





Ballistic - Rifle

FAST RF1

The FAST RF1 is the lightest helmet system on the market to offer protection against 7.62x39mm mild steel core rifle rounds. With a shell weight of only 2.59 lbs. (size L), the RF1 allows for sustained wear in high-threat environments without compromising comfort.

Protection: The RF1 offers ballistic protection up to 7.62x39mm mild steel core rifle rounds

Pounds: System Weight*: 3.5 lbs. (1564g)
Shell Weight: (size L) 2.59 lbs. (1175g)

Price: \$\$\$\$\$

- Lightweight Modular Bungee Shroud (MBS) reduces snag hazards and features carabiner clips to improve NVG retention and stability while reducing interference with other rail-mounted accessories
- PowerPath ARC Rail system provides a lightweight mounting solution for Ops-Core headborne ecosystems
- Vented Lux Liner with Occ-Dial® Universal Fitband offers comfort and ventilation
- Head-Loc retention chinstrap maintains security and stability
- External VELCRO® Brand loop kit allows for quick and easy attachment and detachment of headborne accessories
- Proprietary recessed groove accommodates over-the-head communication accessories with no interference and allows for helmet donning and doffing without headset removal



SHOWN WITH
PowerPath ARC Rails†

Color shown: Ranger Green

*(size L) Shell with Vented Lux Liner w/ Occ-Dial Universal Fitband
†Helmets built after July 1st, 2023 will feature the PowerPath ARC Rails

SPECIFICATIONS

Performance Specification: In accordance with Gentex PS-1368

Fragmentation Protection:

Projectile	Minimum V50 BL(P) at 0°(±5°) Obliquity (ft/s)	Minimum V50 BL(P) at 0°(±5°) Obliquity (m/s)
2 - Grain RCC	6,050	1,844
4 - Grain RCC	5,575	1,699
16 - Grain RCC	4,625	1,409
64 - Grain RCC	3,150	960
17 - Grain FSP	4,400	1,341

Resistance to Penetration**:

Projectile	V0 RTP at 0°(±3°) Obliquity (ft/s)	V0 RTP at 0°(±3°) Obliquity (m/s)
9mm FMJ RN	1,400	364
7.62 x 39mm MSC	2,380	725
7.62 x 51mm M80 Ball NATO FMJ	2,780	847
5.56mm M193 BT	3,250	990

**Qualified Internally, Size XL Only

Blunt Impact Protection: <150 G's at 10 ft/s per ACH CO/PD 05-04:2007

Compression Testing: Top-Bottom = .020" (0.51 mm) Max @ 400 lbs. (181.44 kg), Side-Side = .125" (3.18 mm) Max @ 300 lbs. (136.08 kg) per MICH Type II FQ/PD 06-35C: 2013

Environmental Resistance: Temperature -Storage and Operating at Ambient, Cold -60° F (-51° C), and Hot +160° F (71° C), Temperature Shock, Flame Resistance, Altitude, Vibration, Seawater, Field Agent Resistance, Weatherometer per ACH CO/PD 05-04:2007

Shell Construction: Two-Stage Non Slit

Shell Thickness: 0.400" (10.16mm)

Shell Geometry (Curvature): FAST

Cut Style (Side Protection): High Cut

Available Sizes: Medium (M), Large (L), X-Large (XL), XX-Large (XXL)

Available Colors:



Note: Additional product information, such as weight, protection specs, and product comparison charts, can be found at the back of this catalog



Ballistic - Rifle

FAST XR

The FAST XR offers rifle round levels of protection at a weight that makes it comfortable for extended use. Engineered to protect up to 7.62x39mm lead core rifle rounds and with a shell weight of just 1.72 lbs., the XR is the lightest helmet on the market to offer this level of protection while retaining quick-kit configurability for mission-critical accessories.

Protection: Advanced ballistic protection from 7.62x39mm lead core rifle rounds

Pounds: System Weight*: 2.81 lbs. (1275g)
Shell Weight: (size L) 1.72 lbs. (780g)

Price: \$\$\$\$

- Lightweight Modular Bungee Shroud (MBS) reduces snag hazards and features carabiner clips to improve NVG retention and stability while reducing interference with other rail-mounted accessories
- PowerPath ARC Rail system provides a lightweight mounting solution for Ops-Core headborne ecosystems
- Vented Lux Liner with Occ-Dial Universal Fitband offers comfort and ventilation
- Head-Loc retention chinstrap maintains security and stability
- External VELCRO® Brand loop kit allows for quick and easy attachment and detachment of headborne accessories
- Proprietary recessed groove accommodates over-the-head communication accessories with no interference and allows for helmet donning and doffing without headset removal



SHOWN WITH
PowerPath ARC Rails†
Color shown: MultiCam®

* (size L) Shell with Vented Lux Liner w/ Occ-Dial Universal Fitband
† Helmets built after July 1st, 2023 will feature the PowerPath ARC Rails

SPECIFICATIONS

Performance Specification: In accordance with Gentex PS1519

NIJ Standards: NIJ 0106.01 with NIJ 0108.01 Level IIIA (9mm FMJ / 44mag @ 1,400 ft/s) Threats

Fragmentation Protection:

Projectile	Minimum V50 BL(P) at 0°(±5°) Obliquity (ft/s)	Minimum V50 BL(P) at 0°(±5°) Obliquity (m/s)
2 - Grain RCC	5,300	1,615
4 - Grain RCC	4,360	1,329
16 - Grain RCC	3,315	1,010
64 - Grain RCC	2,210	674
17 - Grain FSP	3,250	991

Resistance to Penetration*:

Projectile	VO RTP at 0°(±3°) Obliquity (ft/s)	VO RTP at 0°(±3°) Obliquity (m/s)
9mm FMJ RN, 124 gr	1,470	448
9mm x 18mm SJLC, 105 gr	1,017	310
.44 Mag SWCGC, 240 gr	1,430	436
.44 Mag JHP, 240 gr	1,430	436
7.62mm x 23mm SJLC, 86 gr	1,475	450
7.62mm x 39mm LC, 123 gr	2,400	732
.40S&W GDHP, 180 gr	1,025	312

Blunt Impact Protection: <150 G's at 10 ft/s per ACH CO/PD 05-04: 2007

Compression Testing: Top-Bottom = .020" (0.51 mm) Max @ 400 lbs. (181.44 kg), Side-Side = .125" (3.18 mm) Max @ 300 lbs. (136.08 kg) per MICH Type II FQ/PD 06-35C: 2013

Environmental Resistance: Temperature -Storage and Operating at Ambient, Cold -60° F (-51° C), and Hot +160° F (71° C), Temperature Shock, Flame Resistance, Altitude, Vibration, Seawater, Field Agent Resistance, Weatherometer per ACH CO/PD 05-04:2007

Shell Construction: Two-Stage Non Slit

Shell Thickness: 0.280"(M) 0.290" (L/XL/XXL)

Shell Geometry (Curvature): FAST

Cut Style (Side Protection): High Cut

Available Sizes: Medium (M), Large (L), X-Large (XL), XX-Large (XXL)

Available Colors:





Ballistic - Pistol

FAST XP

The Fast XP provides pistol round protection for higher velocity 9mm rounds. With a slightly thicker shell than the SF, the XP offers a gain in protection: 205 ft/s increase in muzzle velocity for a 124g 9mm round in exchange for an increase of 0.28 lbs. in shell weight.

Protection: Elevated ballistic protection from 9mm rounds (1400 f/s)

Pounds: System Weight*: 2.81 lbs. (1275g)
Shell Weight: (size L) 1.72 lbs. (780g)

Price: \$\$\$\$

- Lightweight Modular Bungee Shroud (MBS) reduces snag hazards and features carabiner clips to improve NVG retention and stability while reducing interference with other rail-mounted accessories
- PowerPath ARC Rail system provides a lightweight mounting solution for Ops-Core headborne ecosystems
- Vented Lux Liner with Occ-Dial Universal Fitband offers comfort and ventilation
- Head-Loc retention chinstrap maintains security and stability
- External VELCRO® Brand loop kit allows for quick and easy attachment and detachment of headborne accessories
- Proprietary recessed groove accommodates over-the-head communication accessories with no interference and allows for helmet donning and doffing without headset removal



SHOWN WITH
PowerPath ARC Rails[†]

Color shown: Black

* (size L) Shell with Vented Lux Liner w/ Occ-Dial Universal Fitband
[†] Helmets built after July 1st, 2023 will feature the PowerPath ARC Rails

SPECIFICATIONS

Performance Specification: In accordance with Gentex PS-1063 Specification, Modified and Abbreviated US Army ACH Helmet CO/PD 05-04:2007 Specification

NIJ Standards: NIJ 0106.01 with NIJ 0108.01 Level IIIA (9mm FMJ @ 1,400 ft/s) Threat

Fragmentation Protection: In accordance with PS-1063 and MIL-STD-662F

Projectile	Minimum V50 (ft/s)	Minimum V50 (m/s)
2 - Grain RCC	4,200	1,280
4 - Grain RCC	3,475	1,059
16 - Grain RCC	42,475	754
64 - Grain RCC	1,750	533
17 - Grain FSP	2,378	725

9mm Protection: In accordance with PS-1063, Resistance to Penetration (RTP) and Backface Defamation (BFD): 9mm FMJ, 24gr FMJ at 1,400 ft/s (426 m/s) at 0° obliquity with BFD < 1.0 inch (25.4 mm) (Right, Left, Crown, Front and Back)

Blunt Impact Protection: <150 G's at 10 ft/s per ACH CO/PD 05-04:2007

Compression Testing: Top-Bottom = .020" (0.51 mm) Max @ 400 lbs. (181.44 kg), Side-Side = .125" (3.18 mm) Max @ 300 lbs. (136.08 kg) per MICH Type II FQ/PD 06-35C: 2013

Environmental Resistance: Temperature -Storage and Operating at Ambient, Cold -60° F (-51° C), and Hot +160° F (71° C), Temperature Shock, Flame Resistance, Altitude, Vibration, Seawater, Field Agent Resistance, Weatherometer per ACH CO/PD 05-04:2007

Shell Construction: Two-Stage Non Slit

Shell Thickness: 0.290" (7.37mm)

Shell Geometry (Curvature): FAST

Cut Style (Side Protection): High Cut

Available Sizes: Medium (M), Large (L), X-Large (XL), XX-Large (XXL)

Available Colors:





Ballistic - Pistol

FAST SF

The FAST SF is readily identified as the primary choice for USSOCOM and elite special operations forces worldwide.

Offering ballistic protection from 9mm rounds (1200 f/s) and with a shell weight of just 1.44 lbs. / 655g (size L), the SF sets the standard for lightweight, mission-configurable headborne solutions.

Protection: Baseline ballistic protection from 9mm rounds (1200 f/s)

Pounds: System Weight*: 2.40 lbs. (1089g)
Shell Weight: (size L) 1.44 lbs. (655g)

Price: \$\$\$\$

- Lightweight Modular Bungee Shroud (MBS) reduces snag hazards and features carabiner clips to improve NVG retention and stability while reducing interference with other rail-mounted accessories
- PowerPath ARC Rail system provides a lightweight mounting solution for Ops-Core headborne ecosystems
- Interior of the helmet features an expanded polypropylene (EPP) liner, offering enhanced impact protection, and molded-in vent holes provide increased airflow and reduce heat stress.
- Head-Loc retention Chinstrap maintains security and stability
- External VELCRO® Brand loop kit allows for quick and easy attachment and detachment of headborne accessories
- Proprietary recessed groove accommodates over-the-head communication accessories with no interference and allows for helmet donning and doffing without headset removal
- Available with Occ-Dial suspension system.



SHOWN WITH

PowerPath ARC Rails[†]

Color shown: Tan 499

* (size L) Shell with Vented Lux Liner w/ Occ-Dial Universal Fitband

[†] Helmets built after July 1st, 2023 will feature the PowerPath ARC Rails

SPECIFICATIONS

Performance Specification:** Modified and Abbreviated Family of Tactical Headborne Systems, dated June 30th 2017; Ops-Core Performance Specification FAST SF PS-1228

NIJ Standards: NIJ 0106.01 with NIJ 0108.01 Level IIIA (9mm FMJ @ 1,400 ft/s) Threat

Ballistic Testing:

**Not all suspension/retention options are tested to full stated standards.

Projectile	Minimum V50 BL(P) at 0°(±5°) Obliquity (ft/s)	Minimum V50 BL(P) at 0°(±5°) Obliquity (m/s)
2 - Grain RCC	4,200	1,280
4 - Grain RCC	3,475	1,059
16 - Grain RCC	2,475	754
64 - Grain RCC	1,750	533
17 - Grain FSP	2,297	700
124 - Grain 9mm FMJ***	1,195 (+50/-0)	364 (+15/-0)

***9mm is V0 tested at this velocity with Backface Transient Deformation (BTD) under 23.4mm (Crown), 27.1mm (Sides), 29mm (Front), and 19.1mm (Rear) when tested on multi-sized clay-filled headforms in accordance with the USSOCOM FTMS Specification.

Blunt Impact Protection: 150 g's maximum at 10 ft/s. Maximum allowable dent 0.023"

Compression Testing: Top-Bottom = .020" (0.51 mm) Max @ 400 lbs. (181.44 kg), Side-Side = .125" (3.18 mm) Max @ 300 lbs. (136.08 kg) lbs.

Environmental Resistance: Temperature -Storage and Operating at Ambient, Cold -60° F (-51° C), and Hot +160° F (71° C), Temperature Shock, Flame Resistance, Altitude, Seawater, Field Agent Resistance, Weatherometer

Shell Construction: Two-Stage Non Slit

Areal Density: 1.22 lbs/ft² (5957 g/m²)

Shell Thickness: 0.220" (5.58mm)

Shell Geometry (Curvature): FAST

Cut Style (Side Protection): High Cut

Available Sizes: Medium (M), Large (L), X-Large (XL), XX-Large (XXL)

Available Colors:



Tan 499



Black



Ranger Green



MultiCam®



Urban Gray

Note: Additional product information, such as weight, protection specs, and product comparison charts, can be found at the back of this catalog



Non-Ballistic

FAST SF Carbon Composite



The FAST SF Carbon Composite tactical helmet system is the ultimate non-ballistic solution for low-threat environments. With a shell weight of just .736 lbs., it provides enhanced impact protection from blunt-force trauma. Its rigid, non-flexing platform is engineered to be fully kitted for both day and night operations, accommodating NVGs and all Ops-Core accessories. The FAST SF Carbon Composite is ideal for rugged training, fast roping, and recce, airborne, and water missions. Operators interested in adding ballistic protection can do so with the addition of an Ops-Core FAST Low-Profile Ballistic Applique, sold separately.

Protection: Enhanced blunt-force trauma protection for use in non-ballistic environments; ideal for training operations and missions where accessory configuration is a priority

Pounds: System Weight*: 1.53 lbs. (692g)
Shell Weight: (size L) .736 lbs. (334g)

Price: \$\$\$\$\$

- Lightweight Modular Bungee Shroud (MBS) reduces snag hazards and features carabiner clips to improve NVG retention and stability while reducing interference with other rail-mounted accessories
- PowerPath ARC Rail system provides a lightweight mounting solution for Ops-Core headborne ecosystems
- Vented Lux Liner with Occ-Dial Universal Fitband offers comfort and ventilation
- Head-Loc retention Chinstrap maintains security and stability
- External VELCRO® Brand loop kit allows for quick and easy attachment and detachment of headborne accessories
- Proprietary recessed groove accommodates over-the-head communication accessories with no interference and allows for helmet donning and doffing without headset removal
- Add Ballistic Protection by adding FAST Low Profile Ballistic Applique (sold separately)

SHOWN WITH
PowerPath ARC Rails[†]

Color shown: Urban Gray

* (size L) Shell with Vented Lux Liner w/ Occ-Dial Universal Fitband
† Helmets built after July 1st, 2023 will feature the PowerPath ARC Rails

SPECIFICATIONS

Performance Specification:** Modified and Abbreviated Family of Tactical Headborne System, dated June 30th 2017 Ops-Core FAST SF Non-Ballistic Performance Spec PS-1144

**Not all suspension/retention options are tested to full stated standards.

Blunt Impact Protection: 150 g's maximum at 10 ft/s. Maximum allowable dent 0.023

Compression Testing: Top-Bottom = .020" (0.51 mm) Max @ 400 lbs. (181.44 kg),
Side-Side = .125" (3.18 mm) Max @ 300 lbs. (136.08 kg) lbs.

Environmental Resistance: Storage / Operating at Ambient, Cold, -60° F (-51° C), Hot +160° F (71° C),
Seawater, Weatherometer, Field Agent Resistance, Temperature Shock, Altitude

Shell Construction: Uni-Directional Non Slit

Shell Thickness: .079" (2mm)

Shell Geometry (Curvature): FAST

Cut Style (Side Protection): High Cut

Available Sizes: Medium (M), Large (L), X-Large (XL), XX-Large (XXL)

Available Colors:



Tan 499



Black



Ranger Green



MultiCam®



Urban Gray



Non-Ballistic

FAST Bump

The FAST Bump high-cut helmet system is primarily designed for use in training operations where no ballistic threat is present. Offering protection from blunt force trauma, the FAST Bump has a shell weight of (size L) 1.02 lbs. offering a lighter alternative to the FAST line of ballistic helmets and is ideal for training situations where helmets are configured in "mission ready" formats. The FAST Bump's rigid shell, complete with the same Modular Bungee Shroud as other helmets in its range, makes it an ideal helmet for Night Vision devices that require a rigid and stable platform. PowerPath ARC Rails allow for the mounting of other headborne accessories and The FAST Bump's Vented Lux Liner and Head-Loc retention system keep the wearer comfortable even during prolonged periods of rigorous training.

Protection: Baseline blunt-force trauma protection for use in non-ballistic environments; ideal for training operations and non-ballistic missions

Pounds: System Weight*: (size L) 1.84 lbs. (835g)
Shell Weight: (size L) 1.02 lbs. (463g)

Price: \$\$\$\$\$

- Lightweight Modular Bungee Shroud (MBS) reduces snag hazards and features carabiner clips to improve NVG retention and stability while reducing interference with other rail-mounted accessories
- PowerPath ARC Rail system provides a lightweight mounting for headborne ecosystems
- Lightweight high-cut rigid polymer
- Molded-in vent holes increase air flow and reduce heat stress
- Offers rear occipital lobe coverage without load carrier interference
- Optimized weight distribution increases stability, integration, balance, and comfort
- External VELCRO® Brand loop kit allows for quick and easy attachment and detachment of headborne accessories
- Painted, non-reflective shell



SHOWN WITH
PowerPath ARC Rails[†]

* (size L) Shell with Vented Lux Liner w/ Occ-Dial Universal Fitband
† Helmets built after July 1st, 2023 will feature the PowerPath ARC Rails

SPECIFICATIONS

Performance Specification: BS EN 1385: 2012, ACH CO/PD 05-04: 2007, PS-1145

Blunt Impact Protection: 150 g/s maximum at 10 ft/s. Maximum allowable dent 0.023"

Compression Testing: Top-Bottom = .020" (0.51 mm) Max @ 400 lbs. (181.44 kg), Side-Side = .125" (3.18 mm) Max @ 300 lbs. (136.08 kg) lbs.

Environmental Resistance: Temperature -Storage and Operating at Ambient, Cold -60° F (-51° C), and Hot +160° F (71° C), Temperature Shock, Flame Resistance, Altitude, Seawater, Field Agent Resistance, Weatherometer

Shell Construction: Injection Molded Glass Filled Nylon

Areal Density: N/A

Shell Thickness: 0.138" (3.50 mm)

Shell Geometry (Curvature): FAST

Cut Style (Side Protection): High Cut

Available Colors:



Available Sizes: Medium (M), Large (L), X-Large (XL), XX-Large (XXL)

Available Sizes	Medium	Large	X-Large	XX-Large
Head Size (Circumference)	20 7/8 - 22 in (53-56 cm)	22- 23 1/4 in (56-59 cm)	23 1/4 - 24 3/8 in (59-62 cm)	24 3/8 - 25 1/8 in (62-64 cm)
Square Coverage	132in ² (852 cm ²)	143 in ² (923 cm ²)	157 in ² (1013 cm ²)	165 in ² (1065 cm ²)
System Weight	1.75 lbs. (796g)	1.84 lbs. (835g)	1.96 lbs. (890g)	2.10 lbs. (957g)

Note: All measurements are +/- 3% tolerance



Non-Ballistic

Skull Mounting System

The Ops-Core Skull Mounting System is an ultra-lightweight stable platform for attaching mission-critical accessories. Weighing just 1.19 lbs., the Skull Mounting System is designed for low-threat environments where ballistic and bump protection are not necessary, but mission-configurable accessory integration remains a top priority. The unit includes a wire and cable management system that streamlines the routing. The Skull Mounting System is a one-size-fits-all solution thanks to three comfort adjustment dial knobs and two pad thickness options.

Protection: For use in non-ballistic and non-bump environments where primary use is training operations or operations where mission-configurable components are the primary need

Pounds: Unit Weight: Large 1.19 lbs. (835g)

Price: \$\$\$\$\$

- Ultra-lightweight stable platform for kitting helmet accessories
- Lightweight Modular Bungee Shroud (MBS) reduces snag hazards and features carabiner clips to improve NVG retention and stability while reducing interference with other rail-mounted accessories
- Wire and cable management system to streamline external wire and cable routing
- One size fits all; three adjustment dial knobs allow for comfort adjustments to any size or shape head.
- Available in left or right-eye dominant 4-Point Head-Loc Chinstrap and straight Accessory Rail Connectors (ARCs)
- Two pad thickness options (1/2" and 3/4") allow for fit customization and comfort
- Large and small counterweights balance the weight of the goggles when using the Skull Mount NVG Head Mount (counterweights sold separately)



SPECIFICATIONS

Weight: 1.19 lbs. (542 g)

Available Sizes: One size fits all

Available Colors:



Black

Note: All measurements are +/- 3% tolerance





U.S. Army Rangers of the 75th Ranger Regiment conduct field training for a unit TFT (Task Force Training) operation on Joint Base Lewis - McChord, Wa.

Photo By: Spc. Garrett Shreffler

SYSTEM COMPONENTS

YOUR MISSION, CONFIGURED





Component Mounts

PowerPath ARC Rails – FAST

Ops-Core PowerPath ARC Rails provide an optimal routing solution for battery cables that power NVGs. Creating a pathway under the rail protects cables from potential damage and eliminates the threat of snagging. Pathways are built into both rails to provide mounting solutions for a variety of NVG systems. PowerPath ARC Rails allow the integration of mission-enhancing components and accessories such as visors, mandibles, lights, and cameras.

Available Colors:



- Ideal routing of NVG power cables
- Weight saving of 30 grams over standard Ops-Core ARC Rail and Shims
- Upgrade the modularity and scalability of any FAST High Cut or Super High Cut helmet
- One size fits all
- Easily mounts to the sides of the helmet using existing chinstrap holes and bolts

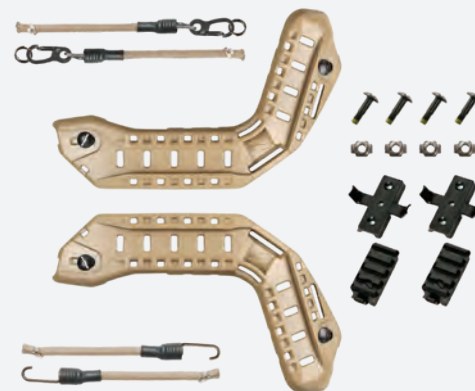

PowerPath ARC Rail

A Navy explosive ordnance disposal technician renders safe a simulated explosive device in Klaipeda, Lithuania.

Photo By: Navy Petty Officer 1st Class Scott Bigley



RAILINK[®]

RAILINK[®] POWERED AND DATA-ENABLED ARC RAILS FOR FAST HELMET SYSTEMS

Designed with extensive DoD user input and testing, RAILINK[®] ARC Rails are the backbone of a rapidly developing, scalable ecosystem that powers and connects your headborne system.

RAILINK OVERVIEW

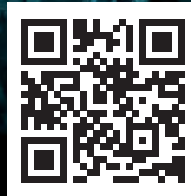

CLICK OR SCAN TO
WATCH THE VIDEO



Giving You the Connected Edge

Designed with extensive DoD user input and testing, RAILINK ARC Rails are the backbone of a rapidly developing, scalable ecosystem that powers and connects your headborne system.

RAILINK with FAST HELMET

Development Partners

- CORE Survival®: HEL-STAR® Rail Strobe
- Princeton Tec™: Switch MPLS®
- SureFire®: HL2



Features

- **RAILINK ARC Rails:** combine the industry standard dovetail track for mechanical accessory attachment with an integrated power and data transmission network.
- **Power and Data In a Single Source:** Separate circuits provide dedicated power and high bandwidth data to VAS/NVG and accessory systems, all powered from a single source.
- **Smart Nodes For Mechanical and Electronic Connections:** Accessories are connected to the system via a system of Smart Nodes providing mechanical attachment as well as electronic connection.
- **Connectivity Across Systems:** Using a communications protocol, power, and data are routed through the network from node to node and to the battery pack, which can serve as a controller to share information around the helmet or to other soldier systems so data can be shared across a network.
- **Backward and Forward Compatible:** RAILINK has been designed to be backward and forward-compatible with helmet systems.
- **Maximize Space And Simplicity:** Mounting outside of the ARC Rail dovetail track means more open space for other accessories. Drawing from a single power source means added simplicity for the user, eliminating the need for managing multiple types of batteries per device.
- **Universal VAS/NVG Interface:** Allows the use of a broad array of night vision systems using dedicated cables, streamlining fitment by removing the need for externally routed battery pack cables and reducing undesirable snag hazards.



Component Mounts

Counterweight Kit

A rear-mounted helmet weight management kit for use with NVGs that balances the platform, enhances comfort, and reduces neck strain.

- (5) 70g removable weights and (5) elastic pockets
- Maximum configurable weight is 0.85lbs (385g)
- Elastic pockets can stretch to fit (2) weights or (1) weight and (1) battery (AA, AAA, or 123)
- Mounts to the rear of the helmet with custom anchors using the existing helmet holes with longer ballistic screws (provided)

Available Colors:

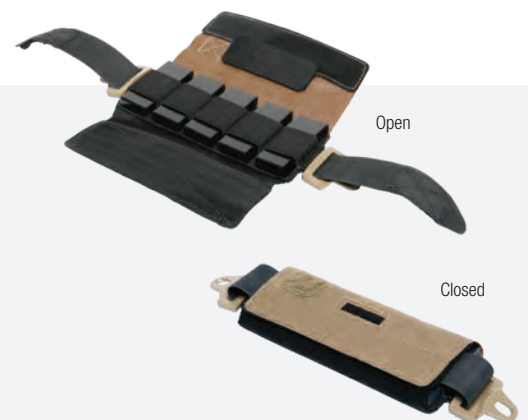



Helmet Cover

FAST SF

A lightweight accessory for shell protection and signature management, this helmet cover is easy to apply and compatible with FAST SF Ballistic, FAST SF Carbon Composite, and FAST MT Super High Cut helmets. Features paracord attachment points for natural foliage, camouflage material, or cable management.

Available Colors:



- Easy to don and doff using VELCRO® Brand fastener tabs
- Compatible with Ops-Core FAST SF Ballistic, MT, and SF Carbon Composite helmets
- Mesh areas allow for venting when used with non-ballistic helmets
- Paracord attachment points for natural foliage, camouflage material, or cable management



Suspension/Retention

Universal Loop Kit

The pattern is one-size-fits-all and is compatible with all new and legacy Ops-Core and Gentex helmets. Its irregular shape provides more attachment points while reducing NIR signature by breaking up the shapes. VELCRO® Brand fasteners allow for quick and easy on/off attachments with headborne accessories.

- One-size-fits-all pattern compatible with all new and legacy Ops-Core and Gentex helmets
- Irregular shape provides more attachment points without increasing NIR signature
- VELCRO® Brand hook and loop fastener allows for the secure, quick, and easy attachment and detachment of headborne accessories
- The Universal Exterior Loop Kit contains 11 VELCRO® fastener pieces and replacement guide



Shown in Tan 499

Available Colors:



Top View



Side View



Back View



Suspension/Retention

Vented Lux Liner

Designed for comfort during extended use with fully kitted helmets, it employs vents and a more streamlined geometry than the original Lux Liner for increased airflow, comfort, and a better fit. Durable, breathable, lightweight pads come in three different thicknesses to allow for a custom fit. The liners deliver 360 degrees of coverage in the Ops-Core FAST helmet systems. It is also offered with the Worm-Dial retention system, which provides a quick adjustment in a low-profile fit band.

- A suspension system that combines a one-piece, full-coverage impact layer with modular, breathable comfort pads that can be customized and repositioned for comfort and integration of communication headsets
- Available with Worm-Dial, Occ-Dial, and H-Nape retention and suspension options
- Designed for use with FAST Bump, RF1, SF, XP, and XR helmets.



Suspension/Retention

Lux Pux

Leveraging the premium materials that are used in the Vented Lux Liner, Ops-Core Lux Pux provides a one-size-fits-all, configurable pad system for TBH, ACH, and ECH-style helmet platforms. The 10-pad kit offers significant weight savings over comparable products without compromising comfort.

- Uses the same premium impact and comfort materials used in the Vented Lux Liner
- One size fits all
- Compatible with X-Nape, H-Nape, and Occ-Dial retention and suspension options
- Designed for use with TBH, ACH, and ECH-style helmets



Lux Pux Pad System



Suspension/Retention

EPP Liner System

Available for use in FAST, Sentry, and TBH helmet platforms. Kit includes front EPP pad, Occ-Dial Fitband, Head-Loc 4-Point Chinstrap, and 15/22mm hardware.

- Replacement kit for Occ-Dial Liners
- Fit all Ops-Core FAST, Sentry, and TBH helmets
- Kit includes (1) front EPP pad, (1) Occ-Dial Fitband, (1) Head-Loc 4-Point Chinstrap, and 15/22mm hardware, pending helmet
- Available in M, L, XL, and XXL sizes





Suspension/Retention

H-Nape Head-Loc[®] Chinstrap

Designed to counter NVG instability due to slippage on the head, this system is ideal for stabilizing heavier, front-mounted NVGs during rigorous activity. It prevents helmet rotation using a fifth adjustment tab on the nape pad. Patented Head-Loc tabs provide instant, one-handed, chinstrap adjustment.

- Designed to resolve the issue of NVG instability caused by helmets slipping on the head
- Features a fifth adjustment tab on the nape pad to provide extra support and prevent back-and-forth helmet rotation
- Patented Head-Loc tabs provide instant, one-handed, chinstrap adjustment while wearing the helmet



Suspension/Retention

Gas Mask Chinstrap Extender

Adds 3.5" to the chinstrap, allowing it to fasten over the CBRNE mask. Simple to attach and remove with one click of the buckle. Compatible with Head-Loc Chinstraps only.

- Adds 3.5" to the chinstrap, allowing it to fasten over the CBRNE mask
- Simple to attach and remove with one click of the buckle
- Compatible with Head-Loc Chinstraps only

Available Colors:



Suspension/Retention

Universal Nape Pad

Located on the nape cup of the Occ-Dial or Worm-Dial retention system, the pad can be adjusted vertically to customize fit with any head shape, enhancing stability and comfort.

- Significantly enhances the stability and comfort of the helmet by anchoring the back of the helmet across a large surface area on the occipital bone of the head.
- Large surface of the nape pad permits a broader distribution of weight, resulting in a more comfortable and stable helmet platform
- Compatible with Occ-Dial and Worm-Dial Fitbands





Suspension/Retention

FAST SF Upgrade Kit

The FAST SF Upgrade Kit allows any user with a legacy FAST helmet to upgrade the modularity of their entire helmet system to the level of a FAST SF. The kit includes the SHC Skeleton ARC Rail with Shim Kit, Universal Loop Kit (one size fits all), exterior VELCRO® Brand fastener, and Modular Bungee Shroud.



Modular Bungee Shroud

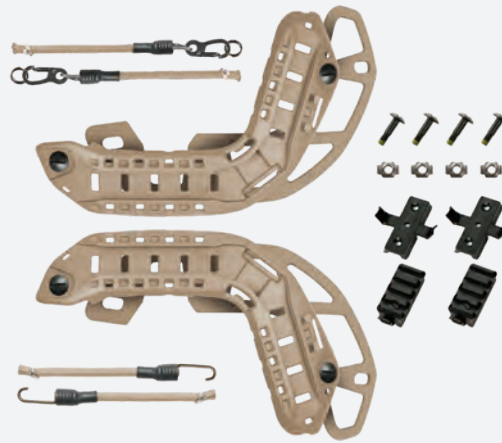

Skeleton Ops-Core ARC Rail with Shim Kit



Tan 499



Shown on FAST XP High-Cut helmet top



Suspension/Retention

ACH Upgrade Kit

The kit transforms ACH/TBH helmets into a platform capable of integrating system components while enhancing overall comfort, fit, and stability. The kit includes Skeleton Ops-Core ARC Rails, Skeleton One-Hole Shroud, and the Ops-Core 360 liner and retention system.



Skeleton One-Hole Shroud

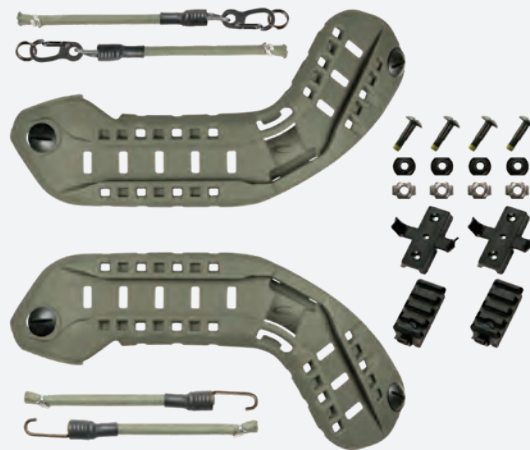

Skeleton Ops-Core ARC Rail



360 Liner Kit





Component Mounts

Modular Bungee Shroud

Our lightest, most stable NVG shroud features integrated bungee retention that prevents interference with other accessories and a low-profile design that resists snags. This shroud features a machined removable insert, designed to be changed out without removing the shroud from the helmet, to provide multiple mounting solutions within the same shroud platform.

- The most versatile and lightest night vision shroud available
- Comprised of a molded outer housing and a machined removable insert, designed to be changed out without removing the shroud from the helmet, to provide multiple mounting solutions within the same shroud platform
- Eliminates the need for rail-mounted bungees and serves as retention lanyards to secure NVGs
- The low-profile bungee helps prevent snag hazards while stabilizing NVGs



Component Mounts

MBS Adapter Inserts

The Modular Bungee System (MBS) Adapter Inserts allow the Modular Bungee Shroud to be used with a wide range of mount solutions without compromising weight or standoff from the helmet. Two inserts are available and are compatible with the Wilcox® GSGM and Wilcox® G66/G69.



Wilcox® GSGM
with compatible mount



Wilcox® GSGM









FACE PROTECTION

SAFETY FRONT AND CENTER





Mandible

FAST Ballistic

Designed for use with any FAST helmet equipped with Super High Cut Skeleton Ops-Core ARC Rails and Ops-Core ARC Shims, this one-size-fits-all mandible provides ballistic and blunt impact protection without occupying any space in the rail. Flexible armor allows for uncompromised weapon sighting.

Available Colors:



- Provides blunt impact and ballistic protection from 9mm 124gr at 1,195 fps
- One size fits all with fore-aft adjustment
- Flexible armor provides the ability to obtain a solid cheek weld
- Uninterrupted field of view
- Lightweight design easily attaches to ARC Shim and PowerPath ARC Rails
- Skeleton Ops-Core ARC Rails and Ops-Core ARC Shim available as an upgrade kit to any Ops-Core FAST Helmet



Mandible

FAST Carbon Composite

Designed for use with any FAST helmet equipped with Super High Cut Skeleton Ops-Core ARC Rails and Ops-Core ARC Shims, this one-size-fits-all mandible provides blunt impact protection without occupying any space in the rail. A pivoting vent plate on the front of the mandible prevents debris from entering while still allowing airflow.

Available Colors:



- Increased elemental and blunt impact protection
- One size fits all with fore-aft adjustment
- Uninterrupted field of view
- Pivoting vent plate to reduce fog, enable clear communication, and easy hydration access
- Lightweight design easily attaches to ARC Shim and PowerPath ARC Rails.
- Skeleton Ops-Core ARC Rails and Ops-Core ARC Shim available as an upgrade kit to any Ops-Core FAST Helmet



Mandible

Force-on-Force

Designed for use with any FAST, Sentry, or TBH style helmet equipped with Ops-Core ARC Rails, this one-size-fits-all mandible provides protection from training ammunition to the mouth, nose, ear, and neck areas. Adjustable fore-aft and vertically to enable an optimal fit on various platforms and sizes.

Available Colors:



- Compatible with any Ops-Core helmet system or helmet equipped with Ops-Core ARC Rails
- Flexible armor provides the ability to obtain a solid cheek weld
- Breathable soft armor reduces fogging
- Removable neck skirt to scale coverage





Applique

FAST Low Profile Ballistic Applique

While increasing the protection of a FAST SF Carbon Composite Helmet, this two-piece applique provides lightweight, scalable helmet protection against 9mm and frag threats. This quick, repeatable, and tool-less attachment uses the VELCRO® Brand fastener and the Ops-Core ARC Shim.

- Designed for Ops-Core FAST SF Carbon Composite Helmet
- Hybrid design using Carbon and uni-directional polyethylene materials
- Offers lightweight, scalable helmet protection against 9mm and frag threats
- Quick, repeatable, and tool-less attachment

Available Colors:









OPTICS

SUPERIOR VISUAL ACUITY





Optics

Mk1™ Performance Protective Eyewear

Ops-Core Mk1 PPE was designed to meet the need for more rugged, mission-configurable eyewear for elite forces. More than 50 years of Gentex experience and innovation in high performance optics manufacturing is delivered in every lens we create. Lens protection conforms to an abbreviated and modified ANSI Z87.1 in accordance with Ops-Core Mk1 Performance Specification PS-1310.

MK1 OVERVIEW



CLICK OR SCAN TO WATCH THE VIDEO

LENS OPTIONS

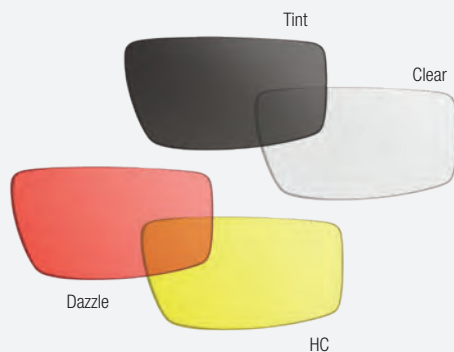

INSERT OPTIONS



- Compliant with portions of the ANSI Z87.1 optical standards
- Gentex-manufactured lenses offer the highest quality and levels of protection
- Lenses currently available in Clear, Tint, High Contrast, and Dazzle Laser Defense Eyewear (Gentex-patented lens technology for maintaining see-through color perception while providing the necessary protection from green and blue commercial lasers)
- Future lens options include Advanced Laser Eye Protection (ALEP), Enhanced Ballistic, and Variable Light Transmission

* Other Cerakote® frame colors are available. Please contact your rep for more information (minimum order quantities do apply).



*Black frames w/ Tinted Lens



Gray frames w/ Dazzle Lens



Tan frames w/ Tinted Lens



Green frames w/ Tinted Lens



Shield

Handgun Face Shield

This face shield can be added to helmets to defend against multiple impacts from handgun threats for law enforcement and military personnel. Rated to stop the NIJ IIIA handgun threats per NIJ standard 0101.06.

- Face shield assembly fits all sizes of Ops-Core FAST and Sentry helmets, and Gentex ACH/TBH style helmets equipped with Ops-Core ARC Rails
- Ballistic protective lens stops multiple hits of up to .44Mag at 1,400 fps
- Fore/Aft adjustment maintains effective seal with different helmet geometries as well as increases offset to accommodate masks and other equipment when needed
- Rail interface locking system provides a solid platform for the face shield
- Locking mechanism secures the face shield at any angle



Shield

Riot/Breaching Visor

The Ops-Core Riot/Breaching Visor offers modular, rapidly employed face protection for operators with Ops-Core ARC Rail-equipped helmets. The 3mm thick visor easily pivots up and down to provide full face protection when needed. Particularly useful for riot or breaching operations.

- Compatible with any helmet with an Ops-Core ARC Rail
- Pivots up and down and will remain in set position
- Rubber gasket seals against surface of helmet shell
- Attachment arms fold for smaller storage footprint
- Weighs 1.2 lbs
- Anti-scratch coating on outside of lens and anti-fog coating on inside



Shield

NVG Snap Shields

PVS-31

Attaches to PVS-31 Night Vision Goggles (NVGs) to help safeguard the eyes and face from fragments, water spray, and debris with minimal impact on peripheral vision. Easily integrates with all Ops-Core and Gentex helmet systems. Alternative to standard NVG rubber eyecups, which obstruct peripheral vision and can lead to fogging of the NVG ocular lens. Available in clear only.

- Developed as an alternative to standard NVG rubber eyecups, which compromise situational awareness (as they obstruct peripheral vision) and can lead to fogging of the NVG ocular lens
- Attaches to PVS-31 Night Vision Goggles (NVGs) to help safeguard the eyes and face from fragments and debris with minimal impact on peripheral vision
- Snap on and off without the use of tools
- Pass MIL-PRF-32432 5.8 grain at 650fps and 17 grain at 550 fps and are in conformance with an abbreviated and modified ANSI-Z87.1 optics and impact performance



PVS-31 (shown in clear)

PVS-31 mounted (shown in clear)





Visor

STEP-IN®

Designed to seamlessly integrate with Night Vision Goggles (NVGs), the Ops-Core STEP-IN Visor is the ideal solution for users requiring full eye protection in addition to NVG accessibility. Featuring removable gaskets and tool-less interchangeable lenses, the STEP-IN Visor assembly is easily configured for various mission requirements. The STEP-IN Visor is a low-profile, one-size-fits-all system that is fully compatible with Ops-Core and Gentex helmets that use Ops-Core ARC Rails.

Available Colors:



- STEP-IN Visor is designed to sit comfortably behind NVGs
- Tool-less installation of various lenses depending on mission requirements
- Includes a clear and a tinted lens
- Lenses available: Clear, Tinted, High Contrast, Laser Dazzle, and Photochromic
- Removable rubber side gaskets keep dirt and dust out of eyes when in use
- HC-13 anti-scratch coating on outside of lens and MGAF anti-fog coating on inside



Gaskets can be removed for additional ventilation as needed

LENS OPTIONS



Clear Lens



Tinted Lens



High Contrast Lens



Dazzle Lens



Photochromic Lens

PHOTOCHROMIC TECHNOLOGY FOR TACTICAL OPERATIONS



PHOTOCHROMIC
OVERVIEW



CLICK OR SCAN
TO LEARN MORE



GENTEX

LIGHT-ACTIVATED LENS TECHNOLOGY

Gentex Photochromic coating absorbs direct, or light filtered through an aircraft windscreen to activate the photochromic molecules causing the lens to darken or lighten when exposed or removed from light. This enables users to manage variable lighting conditions with one visor, ending the need to switch between clear and tinted visors during a mission. By reducing the burden and weight of carrying two visors, it increases the ease of product use, allowing for seamless mission configuration.

- Begins reacting instantly in direct sunlight and in vehicles (through canopies and windshields)
- Adapts seamlessly for day-to-night operations
- Clear state transmissions of greater than 85% PLT (Photopic Luminous Transmittance), offers a future opportunity for combining technologies
- Maintains a neutral gray color when in a darkened state
- External visor surface protected by Gentex's proprietary scratch-resistant hard coating
- Replaces the need for two visor (clear and tint) kits





SITUATIONAL AWARENESS

HEARING YOU LOUD AND CLEAR





Situational Awareness

AMP[®] Communication Headset

CONNECTORIZED

The Ops-Core AMP Communication Headset features 3D Hear-Through Technology (3DHT) and advanced scalable hearing protection. For optimal flexibility and performance, the modular headset can be easily configured to meet a wide range of mission needs.

- World-class audio quality provides the ability to operate in combat environments
- 3D Hear-Through Technology (3DHT) restores and enhances "natural hearing" of the outside environment for improved situational awareness
- Enhanced Hearing allows the operator to boost their hearing up to +12dB
- Mission Configurable Capability enables the headset to be quickly converted back and forth between an ergonomic headband and helmet-mounted configuration
- Quick-Release Downlead Connections on each earcup allow the operator to quickly configure between single left/right, dual, or no downlead configurations
- Optional NFMI (Near Field Magnetic Induction) Earplugs provide increased hearing protection while maintaining clear communications and 3D Hear-Through ability. NFMI Earplugs do not require wires or batteries. NOTE: Compatible with NFMI-enabled headsets only
- Fail-Safe Communications provides confidence that in the event of battery loss, 3DHT will power off, but the headset and earplugs will still be able to transmit and receive communication
- Ambidextrous Noise-Cancelling Microphone mitigates background noise enabling clear communication. Can be mounted to left or right earcup or removed as preferred, without tools
- Mask microphone compatibility via integrated microphone mounting & connection point enables easy integration with any U-173/U standard plug, commonly found on respirator, gas, and oxygen masks
- Ergonomic Earseals designed for optimal comfort and noise reduction utilizing superior materials
- The AMP Communication Headset is CE-approved EN 352
- Available in Berry Amendment-compliant configurations

Available Colors:



CE 2797 EN352

Connectorized



Situational Awareness

NFMI Earplugs

The addition of optional wireless NFMI earplugs provides increased hearing protection while maintaining clear communications and hear-through audio. When engaged, the NFMI earplug will seamlessly integrate, providing unrivaled hearing protection capability.

- Do not need batteries, recharging, or any wired connection
- The kit ships with standard, slim, and large Comply™ foam tips to accommodate a wide variety of users



Earplug case



Earplug sizes



Situational Awareness

AMP Helmet Rail Mount Kit

When a helmet-mounted headset is preferred, this kit provides unrivaled performance. Designed specifically for use with Ops-Core ARC Rails by the same company that pioneered them and revolutionized the helmet industry.

- Rail arms can be mounted to the rear of the ARC Rail systems, leaving the top portion of the rails free for other accessories while increasing helmet stabilization and counter-balancing Night Vision Devices
- A single point gimbal attachment to the earcups allows for 360° adjustment
- Better fit and a superior earseal, maintained throughout the range of motion of the user's head
- Earcups rotate to the side or rear of the helmet when not in use, creating a very low profile

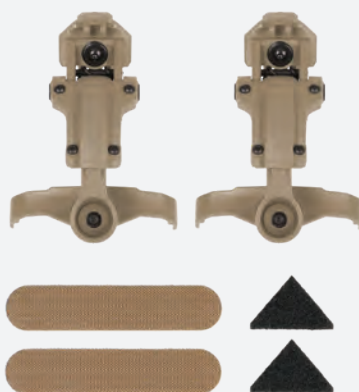

Fixed Downlead (shown mounted on rail)



Situational Awareness

AMP Skins

AMP Skins can be added to provide additional signature management.

Available Patterns:

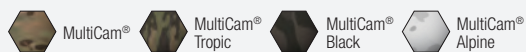

Shown in MultiCam®



Situational Awareness

AMP Communication Headset Downlead Cables

Multiple quick-release downlead cable options are available for the connectorized versions of the AMP Communication Headset. These allow the operator to quickly configure between single left/right, dual, or no downlead configurations. This also provides flexibility when connecting to systems with different wiring and connector requirements.

- Provides high-quality, environmentally sealed connection points



U174 Version



Amphenol Version



Fischer to U174



Situational Awareness

Push-To-Talks (PTTs)

Used to connect the AMP Communication Headset to various radios.

- Rugged over-molded construction
- Feature a reversible alligator clip
- Recessed activator prevents accidental keying while still accommodating gloved hand use
- Available with straight wired radio connections or modular, which allows for interchangeable radio downleads



Single Modular PPT Radio Cable



U94 PTT



Dual Modular PPT Radio Cable





RESPIRATORY

BREATHE EASY





Respiratory

SOTR

Half-mask Special Operations Tactical Respirator (SOTR) is designed to protect against a wide range of oil and non-oil-based particulate contaminants encountered by Special Operations forces during training and in operational environments. The low-profile design offers protection without interfering with the operator's tactics, techniques, and procedures (TTP) and seamlessly interfaces with weapon systems for optimal effectiveness.

- Offers P100 (99.97%) efficiency against airborne particulates, including lead, asbestos, fentanyl, lubricant mist, and explosive gunfire residue
- Central mounted filter to allow ambidextrous weapon sighting
- Two exhalation valves for easier breathing under extreme use
- Non-microphone and microphone versions available, compatible with standard ground communications headsets to enable radio communications



SOTR FOR
SOF INTERVIEW



CLICK OR SCAN TO
WATCH THE VIDEO

SOTR FOR
SWAT INTERVIEW



CLICK OR SCAN TO
WATCH THE VIDEO



SOTR O2 Strap Harness Accessory

Allows the user to quickly attach the SOTR to their helmet using the O2 clip receiver on the ARC Rail. The standard strap can be quickly unstrapped and replaced with the O2 version. Sold separately.



SOTR Replacement Filters

Easy to change out, keep a supply of these fresh, highly efficient filters at hand.



Respiratory

150 ohm Mask Mic

This noise-canceling dynamic respiratory mask microphone is designed for the Ops-Core SOTR.

- Optimal design seamlessly integrates into the respiratory mask for maximum performance



In mask (detail)



Shown with cable connection







PERFORMANCE DATA

BALLISTIC

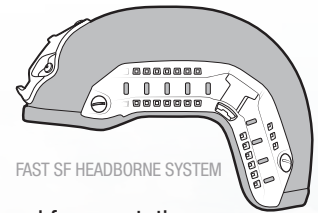

FAST SF HEADBORNE SYSTEM

Ballistic specs have primarily been derived from government contracts and law enforcement requirements for handgun, rifle, and fragmentation. From our beginnings, we've designed and tested to exceed the minimum standard being requested. Our goal is to give the wearer confidence that their helmet is going to perform even in the most demanding conditions.



MINIMUM V50

MINIMUM RTP

HELMET	FAST RF1	FAST XR	FAST XP	FAST SF
2 grain RCC	6,050 f/s (1,844 m/s)	5,300 f/s (1,615 m/s)	4,200 f/s (1,280 m/s)	4,200 f/s (1,280 m/s)
4 grain RCC	5,575 f/s (1,699 m/s)	4,360 f/s (1,329 m/s)	3,475 f/s (1,059 m/s)	3,475 f/s (1,059 m/s)
16 grain RCC	4,625 f/s (1,409 m/s)	3,315 f/s (1,010 m/s)	2,475 f/s (754 m/s)	2,475 f/s (754 m/s)
64 grain RCC	3,150 f/s (960 m/s)	2,210 f/s (674 m/s)	1,750 f/s (533 m/s)	1,750 f/s (533 m/s)
17 grain RCC	4,400 f/s (1,341 m/s)	3,250 f/s (991 m/s)	2,378 f/s (725 m/s)	2,297 f/s (700 m/s)
9mm FMJ RN, 124 grain	1,400 f/s (364 m/s)	1,470 f/s (448 m/s)	1,400 f/s (427 m/s)	1,195 f/s (364 m/s)
.44 Magnum 240g SWCGC	N/A	1,430 f/s (436 m/s)	N/A	N/A
9mm x 18mm SJLC, 105 grain	N/A	1,017 f/s (310 m/s)	N/A	N/A
.40 Cal S&W, GDHP, 180 grain	N/A	1,025 f/s (312 m/s)	N/A	N/A
7.62 x 39mm LC, 123 grain	N/A	2,400 f/s (732 m/s)	N/A	N/A
7.62 x 39mm MSC, 123 grain	2,380 f/s (847 m/s)	N/A	N/A	N/A

STANDARDS Testing performed in accordance with the following specifications:

1. Ops-Core RF1 Helmet Performance Specification PS-1368

1. Ops-Core XR Helmet Performance Specification PS1519

1. Ops-Core XP Helmet Performance Specification PS-1063
2. Modified and Abbreviated US Army Purchase Description Helmet, Advanced Combat (ACH) CO/PD-05-04 dated 30 October 2007

1. Ops-Core SF Helmet Performance Specification PS-1228
2. Modified and Abbreviated Family of Tactical Headborne Systems dated June 30 2017

PERFORMANCE DATA

WEIGHT

Ops-Core leads the industry in designing products that an industry leading protection to weight ratio. Our lightweight comfortable helmet systems provide the desired balance of protection, stability, and comfort to our users in the dynamic environments in which they operate.



FAST RF1

WEIGHT
(Size Large)

Shell Only**	2.59 lbs. (1175 g)
Complete System**†	3.5 lbs. (1564 g)



FAST XR

Shell Only**	1.72 lbs. (780 g)
Complete System**†	2.81 lbs. (1275 g)



FAST XP

Shell Only**	1.72 lbs. (780 g)
Complete System**†	2.81 lbs. (1275 g)



FAST SF

Shell Only**	1.44 lbs. (655 g)
Complete System**†	2.40 lbs. (1089 g)

(**Estimated calculations of weights) Note: All measurements are +/- 3% tolerance
**†(size L) Shell with Vented Lux Liner w/ Occ-Dial Universal Fitband

WEIGHT COMPARISON

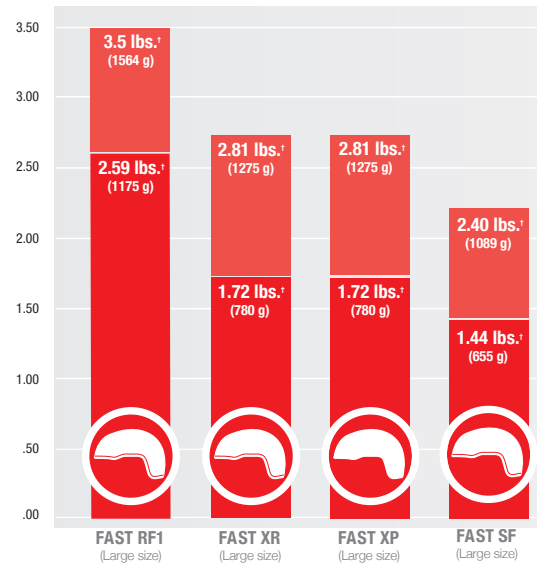

† Represents the lowest weight when configuring your helmet complete system

PERFORMANCE DATA



PROTECTIVE COMPONENTS	STEP-IN VISOR	HANDGUN FACE SHIELD	PVS-31 NVG SNAP SHIELDS	FAST BALLISTIC MANDIBLE	FAST LOW PROFILE BALLISTIC APPLIQUE
2 grain (V50)	N/A	N/A	N/A	4,075 f/s (1,242 m/s)	4075 f/s (1,242 m/s)
4 grain (V50)	650 f/s (195 m/s)	N/A	N/A	3,450 f/s (1,059 m/s)	3450 f/s (1,051 m/s)
16 grain (V50)	N/A	N/A	N/A	2,425 f/s (739 m/s)	2425 f/s (739m/s)
64 grain (V50)	N/A	N/A	N/A	1,700 f/s (518 m/s)	1700 f/s (518 m/s)
17 grain / 1.1FPS (V50)	N/A	N/A	550 f/s (168 m/s)	N/A	2379 f/s (725 m/s)
9mm FMJ RN (V0 at 0 Obliquity)	1,400 f/s (427 m/s)	1,400 f/s (427 m/s)	N/A	1,195 f/s (364 m/s)	1195 f/s (364 m/s)

STANDARDS

Testing performed in accordance with the following specifications:

Meets all the ANSI Z87.1 spectacle requirements for ballistics and optics. Provides MIL-PRF-32432 ballistic protection.

Modified and Abbreviated NJ Standard 0106.01 Ballistic Helmets using NJ Standard 0108.01 Ballistic Materials Level IIIA threats (9mm 124gr FMJ RN at 1400 fps and .44 Cal Magnum 240gr SWCGC at 1400 fps)

Class 1-Spectacle ballistic impact standards of (MIL-PRF-32432 Military Combat Eye Protection). The NVG Snap Shields meet ANSI z87.

Designed and tested in accordance with Gentex PRS-1009 Product Specification for the Ops-Core FAST Ballistic Mandible.

Designed and tested in accordance with Gentex PRS-1349 Product Specification for the Ops-Core Low Profile Ballistic Applique.



FORCE-ON-FORCE MANDIBLE*

Ballistic Resistance: RTP
7.62 x 51 UTM round at 375 f/s.

The Force-on-Force Mandible does not provide protection outside the coverage area designated by the rigid polymer frame and conformable fabric cover.



RIOT / BREACHING VISOR

Tested to EN 166:2001 Visor requirements and STANAG 2920 Ed3 criteria, 17gr frag v50 of 705ft/s

A steel ball of 6.35mm diameter is fired at the visor to both the front and side at a speed of 12m/second (approximately 270 mph).

*Mainly used for training purposes.

PERFORMANCE DATA

BLUNT IMPACT

This measure evaluates impacts from falls and flying objects in threat environments. A helmeted headform is mounted to a sliding rack and dropped onto an anvil. Two drops at each of seven locations on the helmet while under three temperature conditions are performed. Per ACH CO/PD-05-04, G-forces are then recorded with a maximum threshold of 150 Gs to prevent concussion or fracture. All Ops-Core helmets are tested to this exacting impact standard.†





FAST RF1	FAST XR	FAST XP	FAST SF	FAST SF CARBON COMPOSITE	FAST BUMP
----------	---------	---------	---------	--------------------------------	-----------

Vertical Drop Simulation onto Oval Anvil

All systems meet the requirement of 2 impacts on 7 locations with 10 f/s velocity all measurements < 150 Gs in ambient, hot, and cold conditions.





FAST BALLISTIC MANDIBLE	FAST CARBON COMPOSITE MANDIBLE
----------------------------	-----------------------------------

Vertical Drop Simulation onto Curbstone Anvil

All systems meet the requirement of 1 impact on 3 locations with 8.66 f/s velocity

†Does not include Skull Mounting System.



PERFORMANCE DATA

ENVIRONMENT

ENVIRONMENTAL TESTING

Gentex derives its tests from the toughest standardized military requirements. To test submersion, helmets are soaked in water for 12 hours. For temperature tolerance, helmets are subjected to heat at 160F/71C, ambient temperature, and cold at -40F/-40C. Then, they undergo a full battery of function, ballistic, and impact tests. Additionally, helmets are tested against caustic and corrosive agents like gasoline, DEET, salt spray, and petroleum products.

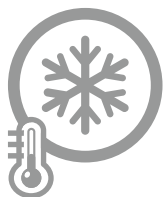

Cold Temperature Storage and Operating

- 60° F (- 51° C)
9mm 124gr FMJ RN Resistance to Penetration (RTP) and Ballistic Transient Deformation (BTD)

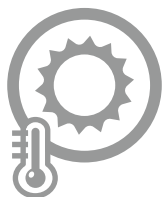

Hot Temperature Storage and Operating

+ 160° F (+ 71° C)
9mm 124gr FMJ RN Resistance to Penetration (RTP) and Back Face Deformation (BFD)



Sea Water Submersion

3 Hours / Salt Water
9mm 124gr FMJ RN Resistance to Penetration (RTP) and Ballistic Transient Deformation (BTD)*



Corrosion Resistance

24 Hours
Surface Testing / DEET Insect Repellent; Gasoline; Motor Oil; Hydraulic Fluid; Aviation Fuel; Rifle Bore Cleaning Fluid; Lubrication Oil; Face Paint



Flame Resistance

2 Seconds
Surface Testing / Open Flame Self-Extinguishing Shell

*FAST LE and Sentry LE does not include Ballistic Transient Deformation (BTD) conditions.

COMPRESSION RESISTANCE

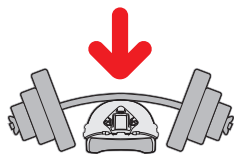

400 lbs
Top to Bottom Compression

0.020"
(0.508 mm) max dimensional change after compression @ 400 lbs (181 kg)

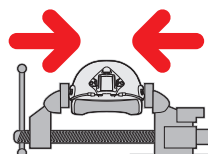

300 lbs
Side to Side Compression

0.125"
(3.175 mm) max dimensional change after compression @ 300 lbs (136 kg)





WE ARE HERE

We Serve Customers Worldwide

We work to serve our customers wherever they need us, supporting militaries and security teams in the U.S. and around the world for over 100 years. Dedicated teams at our four facilities in the U.S., three European operations, and a global network of sales offices and agents in over 40 countries are ready to support you.

Facility Location and Areas of Expertise

Carbondale (Headquarters), PA, USA: Helmets, Optics

Rancho Cucamonga, CA, USA: Defense Respiratory

Manchester, NH, USA: Situational Awareness

Norwood, Mass, USA: Concept Development

Letchworth, U.K.: Helmets, Industrial Respiratory

Haydock, Saint Helens, U.K.: Filters

Stranraer, U.K.: Helmets, Industrial Respiratory

Salisbury, Australia: Sales, Service, Distribution and Product Support

We Offer the Power of Gentex Corporation Locally

Partner with a local authorized Gentex Corporation distributor/agent to get our industry-leading products, plus all the benefits of working with a local company. To find a location near you, visit

www.gentexcorp.com/find-a-distributor/

Air Force Senior Airman Fermin Garcia III readies a fuel hose for storage at Libby Army Airfield, Ariz., during Bushwhacker, an exercise focused on dynamic force employment.

Photo By: Air Force Staff Sgt. Sergio Gamboa

TO SERVE YOU

Responsive, World-Class Maintenance Support

To help maintain product performance, we offer replacement parts and maintenance programs for all our fielded systems. This keeps the equipment performing as well as it did when new, and in many cases, even better with the advancement of new components.



GENTEX[®]

CORPORATION

Gentex Corporation 324 N. Main Street Carbondale, PA 18407 Customer Service USA +1 888.894.1755 Outside the USA +1 570.282.3550

Copyright © 2023 Gentex Corporation. Gentex, Ops-Core, the Lightning Bolt, OC and Ops-Core logos, AMP, STEP-IN, FAST, RAILINK, Occ-Dial, and Head-Loc are registered trademarks of Gentex Corporation or its affiliates. Lux, SENTRY, PowerPath, and Ops-Core ARC are trademarks of Gentex Corporation or its affiliates. MultiCam is a registered trademark of LineWeight, LLC. Cerakote is a registered trademark of NIC INDUSTRIES INC. VELCRO is a registered trademark of Velcro BVBA, used with permission. Comply is a trademark of Hearing Components, Inc. MPLS Switch and Princeton Tec are registered trademarks of Princeton Tec. CORE Survival and Hel-Star are registered trademarks of Core Survival, Inc. Wilcox is a registered trademark of Wilcox Industries Corp. SureFire is a registered trademark of SureFire, LLC. Kevlar is a registered trademark of E. I. du Pont de Nemours and Company REV. 20221112.
For patent information, go to www.gentexcorp.com/patents

www.ops-core.com

The appearance of U.S. Department of Defense (DoD) visual information does not imply or constitute DoD endorsement.