

Northumbria Research Link

Citation: Trestian, Ramona, Comsa, Ioan-Sorin and Tuysuz, Mehmet Fatih (2018) Seamless Multimedia Delivery Within a Heterogeneous Wireless Networks Environment: Are We There Yet? IEEE Communications Surveys & Tutorials, 20 (2). pp. 945-977. ISSN 1553-877X

Published by: IEEE

URL: <https://doi.org/10.1109/COMST.2018.2789722>
<<https://doi.org/10.1109/COMST.2018.2789722>>

This version was downloaded from Northumbria Research Link:
<http://nrl.northumbria.ac.uk/id/eprint/44419/>

Northumbria University has developed Northumbria Research Link (NRL) to enable users to access the University's research output. Copyright © and moral rights for items on NRL are retained by the individual author(s) and/or other copyright owners. Single copies of full items can be reproduced, displayed or performed, and given to third parties in any format or medium for personal research or study, educational, or not-for-profit purposes without prior permission or charge, provided the authors, title and full bibliographic details are given, as well as a hyperlink and/or URL to the original metadata page. The content must not be changed in any way. Full items must not be sold commercially in any format or medium without formal permission of the copyright holder. The full policy is available online: <http://nrl.northumbria.ac.uk/policies.html>

This document may differ from the final, published version of the research and has been made available online in accordance with publisher policies. To read and/or cite from the published version of the research, please visit the publisher's website (a subscription may be required.)

Seamless Multimedia Delivery within a Heterogeneous Wireless Networks Environment: Are we there yet?

Ramona Trestian, Ioan-Sorin Comsa, and Mehmet Fatih Tuysuz

Abstract—The increasing popularity of live video streaming from mobile devices such as Facebook Live, Instagram Stories, Snapchat, etc. pressurises the network operators to increase the capacity of their networks. However, a simple increase in system capacity will not be enough without considering the provisioning of Quality of Experience (QoE) as the basis for network control, customer loyalty and retention rate and thus increase in network operators revenue. As QoE is gaining strong momentum especially with increasing users' quality expectations, the focus is now on proposing innovative solutions to enable QoE when delivering video content over heterogeneous wireless networks. In this context, this paper presents an overview of multimedia delivery solutions, identifies the problems and provides a comprehensive classification of related state-of-the-art approaches following three key directions: adaptation, energy efficiency and multipath content delivery. Discussions, challenges and open issues on the seamless multimedia provisioning faced by the current and next generation of wireless networks are also provided.

Index Terms—Adaptive Multimedia, Quality of Experience, Energy Efficiency, Heterogeneous Wireless Networks.

I. INTRODUCTION

LOOKING at the current trends, it can be noted that live video streaming from mobile devices plays an increasingly important role in everyone's daily life. Applications such as Facebook Live, Instagram Stories, Periscope, WhatsApp, Snapchat, etc. have become very popular and their usage is increasing rapidly. The popularity of rich multimedia applications together with the rapid development of mobile communications and the affordability of high-end mobile devices led to an explosion of mobile broadband data traffic that puts pressure on the underlying networks.

According to Cisco [1] by 2021, 86% of the total mobile data traffic will be generated by smartphones with 78% of world's mobile data traffic represented by video. However, one single radio access technology (RAT) cannot accommodate this increase in data traffic and also enable the provisioning of high Quality of Service (QoS) levels for the mobile users.

The promise of next generation mobile networks (5G) targets extremely ambitious key performance indicators (KPIs) such as very low latency, higher data rates, more capacity and higher mobile data volume. However, we are not there yet and the network operators are trying to find new solutions

R. Trestian is with Faculty of Science and Technology, Middlesex University, London, UK e-mail: r.trestian@mdx.ac.uk.

I-S. Comsa is with CEA-LETI Minatoc, Grenoble, France (e-mail: Ioan-Sorin.Comsa@cea.fr).

M. F. Tuysuz is with the Department of Computer Engineering, Harran University, Turkey, e-mail: ftuysuz@harran.edu.tr

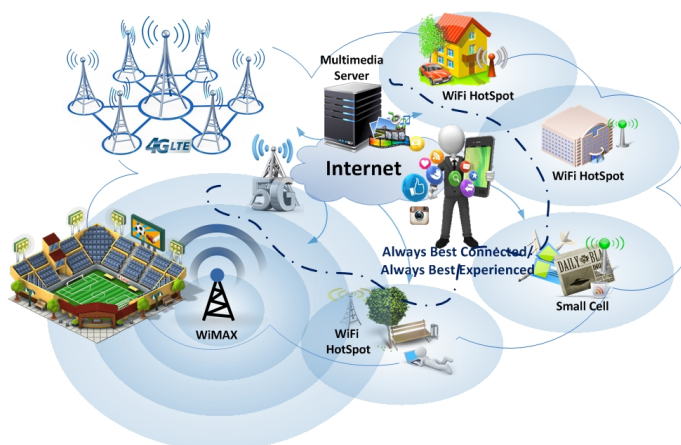

Fig. 1: Multimedia Delivery over a Heterogeneous Wireless Environment

to leverage of their existing wireless networks infrastructures in order to increase the capacity and ensure QoS to their customers. One popular solution is the dense deployment of small cells like Femtocells and Wi-Fi to enable the opportunistic offloading of the mobile traffic. This aims at increasing the wireless capacity and at enabling a cooperative heterogeneous wireless environment where the users will be *Always Best Connected (ABC)* at anytime and anywhere [2] as depicted in Fig. 1. Moreover, Cisco estimates that by 2021, 63% of the global mobile data traffic from cellular networks will be offloaded to Wi-Fi or small cells [1].

Even though this solution seems to present advantages for the network operators, at the mobile user side, a heterogeneous wireless networks small cell environment results in an increased number of handovers making the provisioning of high Quality of Service levels at the end-user a challenge. Thus, improving the system capacity only is not enough especially for the new emerging video-based services and the end users' Quality of Experience (QoE) must be considered as it will become the biggest differentiator between network operators.

Users spend more and more of their leisure time in front of screens (e.g., TV, smartphone, laptop, tablet, etc.) with more than 90% of their daily media interactions being screen based [3]. By spending on average more than 4 hours of their leisure time per day in front of screens [3] users are entitled at expecting *Always Best Experience*. The outstanding increase in both video traffic and user QoE expectations creates important challenges for the network operators as they will have to face the effects of serious network congestions (i.e. higher packet loss rates, increased and highly variable delays) that

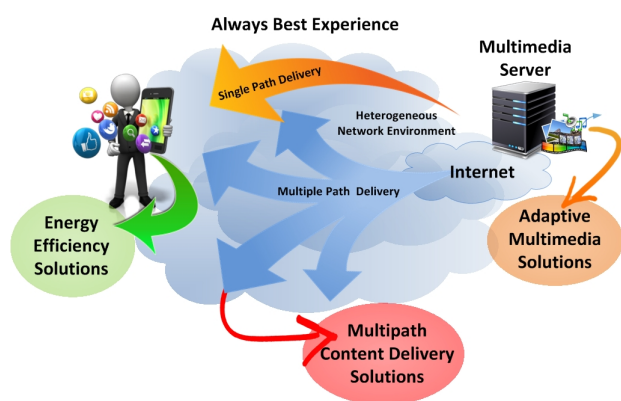

Fig. 2: Three Main Directions of the Survey

will impact negatively the QoE. Among the solutions proposed to enable QoE levels for multimedia services, adaptive mechanisms which dynamically adjust the video delivery parameters according to the underlying network conditions have been highly promising. Another option for the network operators to leverage of the heterogeneity of their wireless infrastructures is the use of multiple paths for data delivery over different networks. This will increase the performance and the capacity of their infrastructure while enabling QoS provisioning to the mobile users.

On the other hand, even though there are exceptional improvements in the performance of these multi-interface mobile devices with improved CPU, memory and graphics for better QoE, they still have severe limitations in terms of battery capacity. This represents a major restricting factor especially when dealing with multipath delivery and networked video-based services which drain the battery of the mobile devices quickly.

Therefore, balancing network performance, users' QoE and mobile device energy consumption still represents the main challenge for achieving seamless multimedia delivery over heterogeneous wireless networks environments.

A. Survey Novelty and Contributions

The survey considers the context of a user roaming within a heterogeneous wireless environment while performing video on demand as depicted in Fig 2. It represents an attempt to answer the question: *are we there yet?* in terms of seamless multimedia provisioning within a heterogeneous wireless environment to enable the mobile users with *Always Best Experience* at anytime, anywhere and from any device.

In this heterogeneous environment, mobile users equipped with multiple interface mobile devices have the possibility to access rich multimedia services through one or more radio access networks. In an attempt to ensure seamless multimedia experience to the mobile user, several adaptive multimedia solutions have been proposed in the literature. Generally, the adaptation of the multimedia stream is based on the underlying network conditions, mobile user preferences and mobile device characteristics. The heterogeneity of the wireless environment offers the possibility of selecting the best value network from a pool of available networks and stream the multimedia

services in a single path manner. However, due to the resource-constrained nature of the wireless networks, providing high quality rich media services to the mobile users with QoS provisioning remains a challenge. To overcome this challenge, and improve the network throughput and the overall system performance, many research efforts have been put into the use of multiple wireless networks simultaneously. Even though using multiple paths simultaneously for data deliver improves the QoS, it comes at the cost of increased energy consumption. Saving energy is an issue of high concern for today's mobile device users, especially as they rely on their mobile devices for their online activities. Thus, important research activity has been placed on proposing energy efficient solutions especially for multimedia-based services as they are the most power hungry of all applications.

In this context, this survey follows three main directions based on the current key challenges, such as: (1) adaptive multimedia solutions; (2) energy efficient solutions; and (3) multipath content delivery solutions.

B. Survey Structure

The rest of this paper is structured as follows:

- Section II looks into the existing related surveys and identifies the scope of this work.
- Section III aims to familiarise the reader with the technical background and implications of multimedia content delivery over heterogeneous wireless networks.
- Section IV identifies the standards and the current industry solutions that enable adaptive multimedia delivery.
- Section V, VI and VII survey and classify various state-of-the-art approaches for adaptive multimedia delivery, energy efficiency and multipath delivery, respectively.
- Section VIII provides discussions on the challenges and open issues related to the three directions surveyed.
- Section IX concludes the paper.

II. RELATED SURVEYS AND SCOPE

Extensive academic research has been done related to the key challenges we have identified previously, such as: adaptive multimedia delivery, energy efficiency and multipath delivery. This is captured in recent published surveys [4] - [15]. The main differences between the existing works, including the scope of this survey, are addressed in this section. Moreover, a summary of the existing surveys is captured in Table I.

Maia et al. [4] investigated various methodologies used to evaluate the quality of experience for video streaming services. Different video quality assessment methods are classified into subjective, objective and hybrid solutions. The authors conclude that the video quality assessment continues to face important challenges mainly due to the multitude of factors that strongly influence the quality of experience, such as: network-based parameters (jitter, delay, packet loss, and bandwidth), video characteristics (codec, spatial and temporal information, bitrate, Group of Picture), mobile device capabilities (graphics, CPU, battery life) and even the assessment approach and context (subjective, objective, and hybrid).

An investigation on QoE in online video transmission has also been conducted by Zhao et al. [5] with an emphasis on

TABLE I: Related Surveys

Ref.	Year	Scope	Observations
[4]	2015	Methodologies used for QoE assessment for video streaming services	The main focus is on video quality assessment only.
[5]	2017	QoE assessment and management in video transmission, with main focus on the system, context and human influence factors.	Deals with QoE management only.
[6]	2016	Tools and measurement methodologies for QoE	Focused mainly on QoE measurement methodologies
[7]	2013	QoE management for wireless networks	The focus is only on different QoE models and assessment methodologies applicable for different types of services.
[8]	2017	Adaptation techniques to support DASH-based content deliver	The main focus is on DASH-based applications only.
[9]	2015	QoE of HTTP Adaptive Streaming	The focus is only on QoE from human computer interaction and networking areas.
[10]	2014	Energy measurement and modelling solutions for m-learning systems.	The target is on energy saving solutions for mobile learning systems only.
[11]	2013	Energy management techniques at the software level for mobile devices.	The main focus is on six major areas of mobile device energy management from operating system and process migration to cloud and protocol optimisations.
[12]	2013	Energy efficiency for wireless content distribution with mobile-to-mobile cooperation.	The main focus is on energy-aware cooperative common content distribution.
[13]	2014	Energy efficient solutions for audio and video multimedia streaming to mobile devices over wireless environments.	The main focus is on presenting energy efficient solutions for wireless multimedia streaming according to different layers of the Internet protocol stack they utilize.
[14]	2015	Broad survey on network-layer multipath.	The main focus is on network-layer multipath solutions with detailed investigation of the control plane problem on how to compute and select the paths and the data plane problem on how to split the flow over the paths.
[15]	2016	Multipath solutions at each layer of the Internet protocol stack	The main focus is on multipath transmission, investigating various research problems from link, network, transport, application and cross layers.

the factors that influence the user experience on the video application or service. The authors group these influence factors into three categories: (1) *system influence factors* including content-related, media-related, network-related and device-related factors, (2) *context influence factors* including location, space, time, cost, social occasion factors, etc. and (3) *human influence factors* including physical, emotional, socio-economic factors, etc.

Juluri et al. [6] look into tools and measurement methodologies proposed in the literature to measure or predict the QoE of online video streaming services. The authors classify the QoE measurement methods based on the data-collection methodology and their location within the network.

Barakovic et al. [7] provide a survey on the QoE management for wireless networks with the main focus on three management aspects, such as: QoE modeling, monitoring and measurement, and adaptation and optimization.

A more recent survey [8] looked into rate adaptation techniques to support Dynamic Adaptive Streaming over HTTP (DASH) content delivery. The surveyed solutions are grouped based on the feedback signals used and the end-node where the adaptation takes place. QoE of HTTP Adaptive Streaming has also been surveyed by Seufert et al. in [9]. The main focus is on QoE related works from human computer interaction and networking domains. The solutions are structured according to the impact of video adaptation on QoE.

In terms of energy efficiency, there has been an important focus on this area in the recent years [10], [11], [12], [13]. Moldovan et al. [10] investigate the energy savings solutions that target the mobile learning systems. The authors focus on measurement and modelling aspects as key prerequisites to energy savings and connect them to m-learning by proposing a generic Energy-aware Adaptive M-learning System.

Vallina-Rodriguez et al. [11] cover the mobile device energy management techniques at the software level. The authors classified the solutions into six major categories: energy aware operating systems, energy measurements and power models, users' interaction with applications and computing resources, wireless interfaces and protocol optimisations, sensors optimisation and computation off-loading. Al-Kanj et al. [12] investigate the particular scenario of wireless content distribution with mobile-to-mobile cooperation and main focus on energy efficiency. The authors analyse the main features and limitations of existing architectures and design alternatives in the area of energy-aware cooperative common content distribution. Hoque et al. [13] look into energy efficient solutions for audio and video multimedia streaming to mobile devices over wireless environments. The authors classify the existing approaches based on the layers of the used Internet protocol stack.

In terms of multipath delivery, Qadir et al. [14] provide a comprehensive survey with the main focus on multipath routing. The authors provide a detailed investigation targeting two main design issues, such as: control plane problem on how to compute and select the routes and the data plane problem on how to split the flow over the computed paths. On the other side, Li et al. [15] investigate the multipath solutions at each layer of the Internet protocol stack including link, network, transport, application, and cross layers.

Even though some ideas of these studies might overlap with our interest, important aspects have been left out as summarized in Table I. To this extent, this paper differentiates itself from the other papers in the literature, through the following approaches:

- it adopts a three dimensional evaluation of multimedia delivery within the heterogeneous wireless environments,

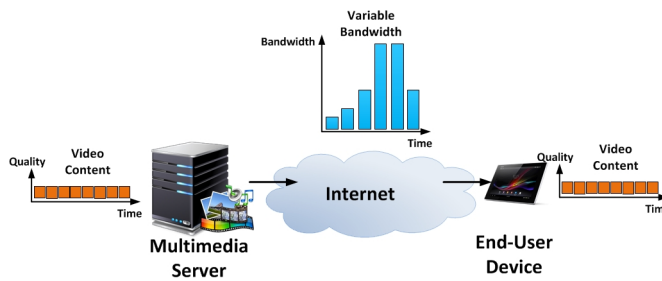

Fig. 3: Traditional Streaming Example

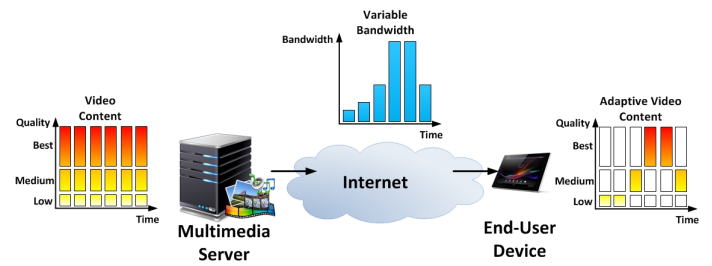

Fig. 4: Adaptive Streaming Example

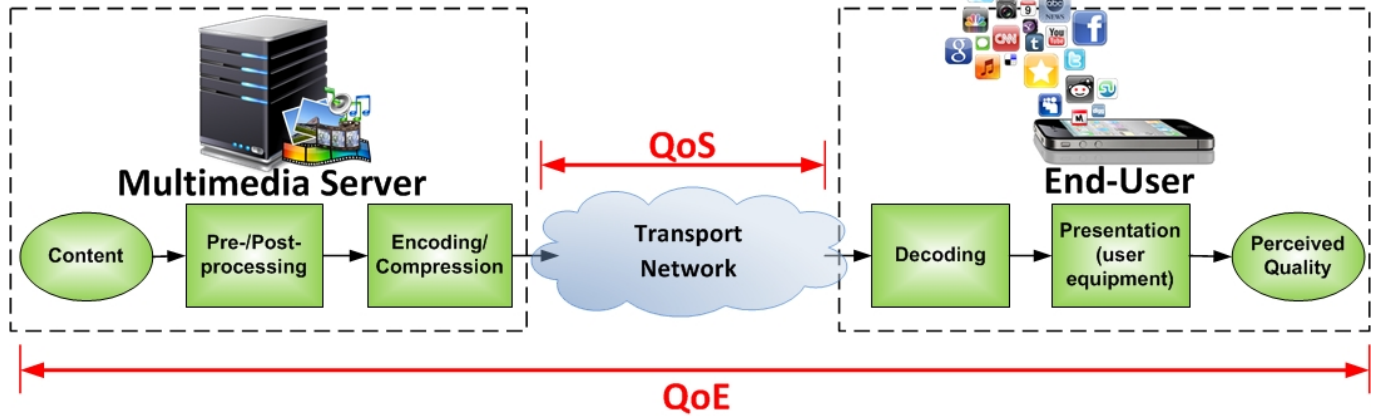

Fig. 5: QoS vs. QoE in Multimedia Content Delivery

such as: adaptation, energy efficiency and multipath delivery.

- discusses the current trending topics, technologies, and protocols for adaptive multimedia streaming.
- classifies, overviews and discusses various multimedia adaptation concepts, standards, industry solutions as well as state-of-the-art solutions starting from the more mature but well established ones (e.g., year 1994) to the most recent research literature (e.g., year 2017).

Furthermore, we refer the reader to the existing surveys for a more comprehensive and broad understanding of each of the topics individually. Additionally for each category, we provide a comprehensive survey on the solutions/proposals from industry, academia and standard bodies. Comprehensive discussions on the key challenges and open issues related to adaptive multimedia, energy efficiency and multipath delivery are also provided.

III. MULTIMEDIA CONTENT DELIVERY OVER HETEROGENEOUS WIRELESS NETWORKS

Current and future wireless network environments are based on the coexistence of multiple networks supported by various access technologies and deployed by different operators. In this heterogeneous multi-technology multi-application multi-terminal multi-user environment, as illustrated in Fig. 1, there is a general goal to keep mobile users 'Always Best Connected' anywhere and anytime, enabling the 'Always Best Experience'.

As wireless network deployments increase, their usage is also experiencing a significant growth. Due to advances in

technologies and the mass-market adoption of the new multi-mode high-end devices - smartphones, iPhones, netbooks, and laptops, with improved CPU, graphics, and display, the mobile users demands have increased significantly. Users are now expecting a better multimedia experience on their devices. But due to the fluctuating behavior and constraints of the wireless environment, and also user mobility, delivering high quality video-based services over wireless networks is more challenging than over wired networks. The main challenge for the high volume and real time services is to provide low latency data connectivity and negligible data loss.

A. Multimedia Content Delivery Methods

Multimedia content delivery refers to the process of delivery of media (e.g., movies, video clips, and live presentations) over a network in real or non-real time. Two distinct methods can be identified, for multimedia content delivery: downloading and streaming.

1) *Downloading*: The *downloading* method is considered to be the simplest form of multimedia delivery on the web, and is divided into two categories: (1) *traditional download* which implies that the user downloads the video file on the mobile device to be able to watch it locally. This method has the advantage that there is no expectation of real-time performance. However the main drawback is that the user has to wait for the file to be fully downloaded before watching the content, which can be a potentially long wait. (2) *progressive download* [17] where the user will be able to watch the multimedia content while is being received by the mobile device. This method makes use of common protocols, such

TABLE II: The G.1010 Model for User-Centric QoS Categories [16]

	Error Tolerant	Error Intolerant
Interactive (delay < 1 sec)	Conventional Voice and Video	Command/control (e.g., Telnet, interactive games)
Responsive (delay \approx 2 sec)	Voice and video messaging	Transactions (e.g., eCommerce, Web browsing, e-mail access)
Timely (delay \approx 10 sec)	Streaming audio and video	Messaging and downloads (e.g., FTP, still images)
Non-critical (delay > 10 sec)	Fax	Background (e.g., Usenet)

as Hyper Text Transport Protocol (HTTP) [18] or FTP which are based on the Transmission Control Protocol (TCP).

The service providers can encode the multimedia content at higher rates, but they have to maintain a trade-off between quality (higher rates) and waiting time (users willingness to wait until the download is finished).

2) *Streaming*: The second multimedia delivery method is *streaming*, which unlike the downloading method, requires a specialized multimedia streaming server. The streaming server delivers, on request, the exact amount of data required by the client, which plays the media content as it is delivered. With the streaming method, the video file is not downloaded on the users mobile device. Two categories can be identified here: traditional streaming and adaptive streaming [17].

- *Traditional Streaming*

A well-known traditional streaming protocol is Real-Time Streaming Protocol (RTSP) [19]. By using RTSP the client connects to the streaming server, which starts sending the multimedia stream as a series of small packets (1452 bytes for typical Real-Time Transport Protocol (RTP)/RTP Control Protocol (RTCP) [20] packet size) at only one real-time rate, usually it represents the bit rate at which the multimedia stream was encoded. An illustrative example of traditional streaming is presented in Fig.3 [17]. The server monitors the clients state (e.g., Play, Seek, and Pause) during the entire connection time, and only sends enough data packets to fill the client buffer. Usually the service providers using this technique need to encode the multimedia content at a certain data rate based on the available bandwidth so that it can be streamed to the client without problems.

- *Adaptive Streaming*

Adaptive streaming is considered to be a hybrid delivery method that combines *streaming* and *progressive download*. An example of adaptive streaming technique is illustrated in Fig. 4. The video content is stored on the server, encoded at different encoding rates (quality levels) and divided into small chunks. The client will switch between the chunks of different quality levels based on different parameters (e.g., estimated user bandwidth, CPU, resolution, etc.). In this way the users that have a good connection can avail of high quality multimedia stream (high data rate) whereas the users with poor connection will receive a lower data rate stream, meaning lower quality.

B. Transport Protocols for Multimedia Delivery

To enable the communication over the Internet the IP is used together with the Transmission Control Protocol (TCP).

TCP handles the transmission problems by reordering out-of-order packets and by requesting the re-transmission of the

lost packets. While this is essential for reliable file transmissions across the Internet (e.g., downloading a file), when it comes to video playback the re-transmissions can lead to increase latency (e.g., stalling the playback so that TCP receives the re-transmitted packet).

In case of real-time services, RTP runs over User Datagram Protocol (UDP) and is used in conjunction with RTCP. This makes RTP one of the most popular protocols for streaming applications, mainly used on managed internal networks. As UDP does not have any inherent transport layer-based rate-control mechanism, unlike TCP, makes it easier the implementation of an application layerbased adaptive mechanism suitable for low-latency and best-effort multimedia transmissions. The main disadvantage of using RTP/UDP is that it cannot traverse Internet firewalls and NAT devices as most of them are configured to restrict the UDP traffic.

In order to overtake this problem the HTTP is used, as it is the most common communication protocol used on the Internet being allowed by the majority of firewalls. HTTP uses TCP as the underlying transport protocol. This is the main reason for which the majority of the deployed adaptive multimedia solutions are based on HTTP, and hence TCP.

C. QoS and QoE in Wireless Multimedia Networks

When dealing with multimedia content delivery, two important concepts that need to be defined are Quality of Service (QoS) and Quality of Experience (QoE). Figure 5 illustrates the main difference between the two. In general, QoS is related to the underlying data transport network and measures network-related parameters (e.g., delay, jitter, packet loss, Round Trip Time (RTT), etc.). Whereas QoE is related to the service quality as perceived by the end-user. Starting from the content provisioning, as illustrated in Fig. 5, each stage within the content delivery process will add complexity to the QoE measurements.

Moreover, with the dynamics of the wireless environment, that is changing dynamically as people or objects move through the coverage area, QoS provisioning over heterogeneous wireless networks for multimedia streaming, presents great challenges. It is known that multimedia applications have strict QoS requirements in terms of packet loss ratio, delay, jitter (delay variations) and bandwidth. The Recommendation G.1010 End-user Multimedia QoS Categories [16] defines user-centric QoS classes for a range of services and applications. Eight QoS classes are defined for different multimedia applications based on the delay range and loss sensitivities, as illustrated in Table II.

As QoS looks more at measuring the performance from a network perspective, it does not have a direct impact in guaranteeing the end-user satisfaction. This shows that the video quality is dependent on a various range of parameters,

TABLE III: Parameters that Impact Mobile Users' Experience

Operator	Connection	Device	Application	Goals	Activity/Mobility	Environment	Culture
Services, Pricing Model	Speed, Reliability, Set-up	Operating System, Hardware, Software, Capabilities, Battery, Condition, Familiarity	Call, Text/SMS, Chat, Browsing, View video, send photos, online shopping, search local information, etc.	Communication, Information, Entertainment, Social interaction, Identity, Status, Logistics, etc.	walking, driving, stuck in traffic, waiting for the bus, waiting at the airport, in a coffee shop	Coverage area, Network conditions, noise, traffic, light, space, privacy, distractions, other people, etc.	religion, law, economics, social class

such as: the mobile device capabilities and characteristics, the type of RAT, the application requirements, network conditions, etc. That is why when talking about video quality and user satisfaction, QoE needs to be addressed. QoE defines the overall performance as being perceived subjectively by the end-user. In this case taking the scenario of a roaming mobile user, the main parameters that have an impact on the mobile user experience are identified, as listed in Table III.

The overall user experience may be affected by a wide range of factors, like: Operator (e.g., different pricing models for various class of services, etc.); Connection (e.g., the set-up of the connection, signal strength, reliability, speed, etc.); Device (e.g., various ranges of operating systems, hardware, software, capabilities, battery level, condition, familiarity, etc.); Application (e.g., video call, text/SMS, chat, browsing, online shopping, streaming, etc.); Goals (e.g., social interaction, entertainment, information, communication, etc.); Environment (e.g., coverage area, network conditions, noise, traffic, space, light, privacy, etc.); Activity/Mobility (e.g., walking, driving, stuck in traffic, etc.); Culture (e.g., religion, economics, social class, etc.). As it can be seen, the overall acceptability of the end-user is influenced by the entire end-to-end system effects, user expectations and context.

D. Approaches for Measuring the Video Quality

Different methodologies were developed to achieve the assessment of end-user perceived quality levels. These methodologies can be classified in two main categories: *subjective methods* and *objective methods*.

Subjective methods are more reliable because they are performed on human subjects, and there is a direct measurement of the user experience. On the other hand these methods have a high cost of implementation and they are time consuming, making them useless in case of real time assessment.

Objective methods can be classified into three main subgroups [21]: full reference methods, reduced reference methods, and no reference methods.

The *full reference methods* are based on the comparison of two sequence of signal: the original video and the distorted one. Usually these methods are more correlated with the subjective methods than the non-reference ones. This makes them more precise but the computational complexity involved is higher as they are based on pre-pixel processing and synchronization between the original video and the distorted one. According to the ITU-T recommendation P.910 [22], some of the typically used metrics in the full reference methods are: blockiness, blur, brightness, contrast, jerkiness, frame skips,

TABLE IV: The Mean Opinion Score Levels

MOS	Quality	Impairment
5	Excellent	Imperceptible
4	Good	Perceptible but not annoying
3	Fair	Slightly annoying
2	Poor	Annoying
1	Bad	Very Annoying

and freezes, etc. The main disadvantage of these methods is the need of both signals and also the high complexity makes them time and resource consuming.

The *reduced reference methods* represent a variation of the full reference methods. These methods are based on extracting specific features from the original video which are then transmitted to the receiver. At the receiver side, the same information is extracted from the distorted video and then compared with the ones of the original video.

The *no reference methods* are not dependent on the reference signal (original video), some complex algorithms are applied only to the distorted signal. This makes them more applicable as they present less computational complexity and can be used in analyzing live streams.

One of the most important metrics used in the video quality assessment of both subjective and objective methods is the Mean Opinion Score (MOS) [22]. Typically there are five MOS levels used for describing the quality and impairment of a multimedia stream as illustrated in Table IV [22], starting with Level 1 representing bad quality and ending with Level 5 representing excellent quality.

The most common and the most widely used objective method for video quality assessment is Peak Signal to Noise Ratio (PSNR), and it is given by eq. 1.

$$PSNR_{dB} = 20 \log_{10} \frac{255}{\sqrt{MSE}} \quad (1)$$

where, MSE represents the Mean Square Error and it can be defined as the cumulative squared error between the original and the processed video. The main advantage of PSNR is that it is very easy to compute. Various different approaches in defining PSNR appear in the literature. For example Lee et al. [24] define PSNR as in eq. 2.

$$PSNR_{dB} = 20 \log_{10} \frac{MAX_Bitrate}{\sqrt{(EXP_Thr - CRT_Thr)^2}} \quad (2)$$

where $MAX_Bitrate$ represents the bitrate of the multimedia stream after the encoding process, EXP_Thr represents the expected average throughput for the delivery of the multimedia stream over the network, and CRT_Thr represents the actual

TABLE V: Mapping PSNR, PSNR-HVS, PSNR-HVS-M, SSIM, MS-SSIM and VIFp Metrics to MOS Scale, Created using VQAMap [23]

MOS Level	MOS (0-100)	PSNR	PSNR-HVS	PSNR-HVS-M	SSIM	MS-SSIM	VIFp
5 (Excellent)	≥ 80 & ≤ 100	≥ 36	≥ 32	≥ 35	≥ 0.93	≥ 0.98	≥ 0.56
4 (Good)	≥ 60 & < 80	≥ 29 & < 36	≥ 26 & < 32	≥ 29 & < 35	≥ 0.85 & < 0.93	≥ 0.95 & < 0.98	≥ 0.40 & < 0.56
3 (Fair)	> 40 & < 60	> 22 & < 29	> 22 & < 26	> 25 & < 29	> 0.76 & < 0.85	> 0.89 & < 0.95	> 0.27 & < 0.40
2 (Poor)	≥ 20 & < 40	≥ 20 & < 24	≥ 19 & < 22	≥ 22 & < 25	≥ 0.62 & < 0.76	≥ 0.73 & < 0.89	≥ 0.16 & < 0.27
1 (Bad)	≥ 0 & < 20	< 20	< 19	< 22	< 0.62	< 0.73	< 0.16

average received throughput for the multimedia delivery over the network.

Some examples of no reference models are: Video Streaming Quality Index (VSQI) [25], Mobile TV Quality Index (MTQI), Video Telephony Quality Index (VTQI), and Perceptual Evaluation of Video Quality (PEVQ). The main disadvantage is that they are not open-source, being proprietary solutions. For example, VSQI takes the entire streamed video and assigns a MOS score to it based on various parameters: video codec used, total bit rate, duration of initial buffering, number and duration of re-buffering periods, and packet loss.

Nowadays, when delivering multimedia content over the Internet, one important parameter that has to be taken into account and that has a significant impact on the quality degradation as perceived by the user, is the buffering effect (initial buffering and the re-buffering periods). The biggest impediment for the research community is that all the video quality assessment solutions that consider the effect of re-buffering periods are proprietary.

Extensive work has been put into developing objective video quality assessment (VQA) metrics for automatic estimation of the video quality. Chikkerur et al. [26] provide a comprehensive review and classification of the VQA methods. Moreover, a performance comparison of the media-layer objective video quality models for standard and high definition video is provided. However, the Mean Opinion Scores (MOS) gathered from the users through subjective tests remains the most reliable measure of video quality. To this extent, Moldovan et al. [23] propose VQAMap, a mechanism that creates generic mapping rules of objective VQA metric values to the MOS scale. VQAMap takes as input subjective data from public VQA databases and automatically creates mapping rules for any VQA metric. Table V lists the VQAMap rules for mapping the values of several objective metrics, such as PSNR, PSNR-Human Visual System (PSNR-HVS) [27] which considers the Contrast Sensitivity Function (CSF), PSNR-HVS-M [28] which along CSF it also considers the between-coefficient contrast masking of Discrete Cosine Transform basis functions, Structural Similarity Index (SSIM) [29], Multi-scale-SSIM (MS-SSIM) [30] and Visual Information Fidelity pixel domain (VIFp) [31] to the MOS scale.

IV. STANDARDS AND INDUSTRY SOLUTIONS FOR ADAPTIVE STREAMING

The next generation of wireless networks is almost a reality and as multimedia applications have become widespread and mobile device capabilities have grown, users expect access to rich services at higher quality levels from their devices, even while roaming over different wireless networks. It is

known that the main attributes of multimedia data traffic are the large volume and real time requirements. Delivering streaming video with QoS provisioning over wireless networks is more challenging than in wired networks due to the radio constraints of wireless links, and user mobility. It is essential to provide QoS mechanisms to cater for multimedia throughput, delay, and jitter constraints, especially within the wireless environment where connections are prone to interference, high data loss rates, and/or disconnection. The aim of these mechanisms is to maintain high user perceived quality levels and make efficient use of the wireless network resources.

A. Standards which Support Adaptive Streaming

One of the hot topics in the multimedia networking environment is adaptive streaming techniques. Because of the continued growth of the video content, ensuring a seamless multimedia experience at high quality levels to the end-user has become a challenge. This has led to the definition and appearance of new standards and protocols related to adaptive streaming.

In TS 26.234 [32] (PSS; Protocols and Codecs) the 3rd Generation Partnership Project (3GPP) defines a new Adaptive HTTP Streaming (AHS) protocol that enables the video content delivery from a standard HTTP server to an HTTP streaming client. The new protocol consists of dividing the entire stream into segments. It is assumed that the HTTP streaming client has access to a Media Presentation Description (MPD) which contains the metadata information required by the client to access the corresponding segment. The streaming service could be on-demand or live and the segments could differ in bitrates, languages, resolutions, etc. The streaming session is controlled by the client which can adjust the bitrate or other attributes based on the mobile device state or user preferences in order to ensure a smooth streaming experience. An extension of the AHS version is provided in the TS 26.247 [33] specification, where a general framework is defined. The new version is referred to as 3GP-DASH and provides support for fast initial start up, seeking, adaptive bitrate switching, on-demand and live delivery, etc. Even though the MPD syntax, the segments format and delivery protocol are specified, there is no specification for content provisioning, client behaviour, and the transport of MPD.

The Open IPTV Forum (OIPF) [34] proposed an HTTP Adaptive Streaming (HAS) solution which is based on the 3GPP AHS specifications. In the case of HAS the streaming content is provided in multiple bitrates and segmented into temporally aligned and independently encoded chunks. The terminal may be able to adapt to variations in the available bandwidth by seamlessly switching between the chunks at higher or lower bitrate. The new HAS method is an extended

TABLE VI: Summary of Industry Solutions for Adaptive Multimedia

	GP-DASH	MPEG DASH	OIPF HAS	Move Networks	Microsoft Smooth Streaming	Adobe HTTP Dynamic Flash Streaming	Apple HTTP Live Streaming	Hulu Adaptive Streaming	Akamai adaptive HDTV Streaming
Type	Standard-based	Standard-based	Standard-based	Proprietary/Patent	Proprietary/Patent	Proprietary	Proprietary	Proprietary	Proprietary
Codec	H.264 AAC	H.264 AAC	H.264 AAC	VP7	H.264, VC-1 AAC, WMA	H.264, VP6 AAC, MP3	H.264 AAC, MP3	H.264	MPEG-4, H.264, VP6 AVC
Transport	RTP/RTSP HTTP	RTP/RTSP HTTP	RTP/RTSP HTTP	HTTP	HTTP	HTTP RTMP RTMFP	HTTP	RTMP	HTTP
Playback	3GPP compliant devices	MPEG compliant devices	Open IPTV compliant services & devices	Web browser plugin, Windows, Mac OS X	Silverlight, Windows 7 phones, STB, xBox	Flash, Air, Android phones, Connected TV	iPhone, iPad, Apple TV, Apple iOS, QTx	Hulu player, Flash	Flash, iOS, Silverlight, Windows, Mac, Linux
Adaptation Logic Control	Client	Client	Client	Server	Client	Client	Client	Client	Client
Default Quality Levels No	Configurable	Configurable	Configurable	Five	Configurable	Configurable	Configurable	Three	Three
Default Video Resolution	Configurable	Configurable	Configurable	Configurable	up to 1080p	Configurable	Configurable	288p, 360p, 480p	180-720p
Default Bitrates range	Configurable	Configurable	Configurable	100-2200kbps	300-2400kbps	Configurable	up to 1600kbps	640-1600kbps	300-3500kbps

version of the 3GPP AHS with support for MPEG-2 transport stream encoding.

The Moving Picture Experts Group (MPEG) adopted the 3GPP AHS as a baseline specification and started working on the development of Dynamic Adaptive Streaming over HTTP referred to as MPEG DASH [35]. The MPEG DASH ad-hoc group has been working on the delivery format and on the use of MPEG-2 Transport Streams as a media format. In January 2011 the group decided to start an evaluation experiment aiming to better understand the requirements for MPEG DASH in order to add a better support for Content Delivery Network (CDN) - based delivery.

B. Industry Solutions for Adaptive Streaming

In addition to the existing standards and ongoing work progressing adaptive streaming-based standards, some of the key market players have adopted their own proprietary solutions for adaptive streaming.

Move Networks is one of the first online video providers that has been granted a patent [36] for its HTTP-based adaptive streaming technology. The technology involves receiving and segmenting the media content in order to generate multiple sequential streamlets. Each streamlet will be encoded as a separate content file having identical time indices and a unique bitrate. The patent covers the encoding and the use of multiple bitrate streamlets. The novelty of the technology is the possibility of using standard HTTP web requests with ordinary web servers without the need for a dedicated streaming server. The adaptive mechanism will switch between the different quality streams according to the available bandwidth.

Another fierce competitor in the market is Microsoft with its IIS Smooth Streaming solution. In August 2011, Microsoft was granted a patent [37] on Seamless switching of scalable video bitstreams. The patent claims the concept behind smooth streaming, which involves switching between streams of dif-

ferent quality levels (high and low quality) according to the networks available bandwidth.

Adobe has deployed its own web-based dynamic streaming service [38], being available on any device running a browser with Adobe Flash plug-in. The Flash Media Server stores the video content encoded at different bit rates and it can receive commands to switch between the different versions. The adaptation can be done based on the users available bandwidth and the CPU load of the mobile device.

Apple has also released a client-side adaptive HTTP streaming solution that supports both live and on-demand H.264 video playout within the browser. The video content is segmented into chunks of different duration and bitrate and is adaptively streamed to the client. The new technology is available on the devices that run iPhone OS 3.0 or later, or on the devices with QuickTime version X or later, installed.

Hulu is an online video service that offers on-demand TV shows, movies, clips, news, etc. Hulu integrated the adaptive bitrate streaming mechanism into their new Hulu player, written in ActionScript 3. The mechanism adapts to the users available bandwidth by switching between different video bitrates and resolution. The user has the option to turn on the adaptive streaming options or to play the stream at a fixed resolution from the players settings menu.

The worldwide leading Content Delivery Network (CDN), Akamai, has launched an adaptive HDTV streaming service available for Adobe Flash, Microsoft Silverlight and iPhone. The video content is encoded at different bitrates and the switching between them is done based on the feedback received from the client (e.g., available bandwidth).

Apart from these key market players there are a number of others adopting or in the process of developing an adaptive streaming solution (e.g., Netflix, Limelight, Widevine, Qualvlive, etc.). A summary of the industry solutions is presented in Table VI.

TABLE VII: Adaptive Multimedia Solutions - Classification

Category	Description	Solutions	Limitations	Heterogeneity
Network Protocol-based Adaptive Solutions	Network delivery mechanisms, mainly protocols for adaptive streaming solutions. The sending rate is dictated by the transport protocol and the congestion control mechanism, based on various network-related parameters (e.g., loss rate, delay, round trip time, etc.).	Padhye et al. [39], Floyd et al. [40], [41], Rejaie et al. [42], Sisalem et al. [43], Talaat et al. [44], Song et al. [45], Sterca et al. [46], Yang et al. [47], Cen et al. [48], Chen et al. [49], Choi et al. [50], Bouras et al. [51], Kim et al. [52], Park et al. [53].	Additional loss discrimination methods are required for efficient wireless transmissions. Poor correlation with the actual end-user perceived quality of the multimedia stream.	Can be used over fixed, wireless and mobile networks in a single-path or multiple-path manner. Additional packet scheduling mechanisms are required for multipath transmissions to avoid packet re-ordering.
Scalable Video Coding Solutions	Focused on creating/using scalable compression formats to avoid the re-coding of the video content. The encoded video exposes multiple quality layers with the higher layers depending on the lower layers. The adaptation can be done in bitrate, frame rate, and resolution, by dropping selected parts of the scalable video content.	Rejaie et al. [54], Ding et al. [55], Zink et al. [56], Qin et al. [57], Huang et al. [58], Schaar et al. [59], Piri et al. [60], Krasic et al. [61], Balachandran et al. [62], Chen et al. [63], Wu et al. [64], Ghermezcheshmeh et al. [65].	The scalable compression cannot adapt to different codecs. Requires reliable bandwidth estimation.	Can be used over fixed, wireless and mobile networks in a single-path or multiple-path manner. For multipath transmissions, the base layer has to be sent on the most reliable path, whereas the enhancement layers can take alternative paths for enhanced video experience.
Transcoding-based Solutions	Involves non-scalable single-layer bitstreams transcoded on-the-fly. Performs live encoding of the video content based on the fluctuating behavior of the available bandwidth.	Yeadon et al. [66], Takaoka et al. [67], Prangl et al. [68], Vijaykumar et al. [69], Hiromoto et al. [70], Wang et al. [71], Medagama et al. [72], Chattopadhyay et al. [73], Essaili et al. [74], Timmerer et al. [75], Wei et al. [76].	Transcoding is very CPU intensive making difficult to be used for an increased number of clients. Reliable and efficient resource reservation scheme is required for cloud-based online transcoding solutions.	Can be used over fixed, wireless and mobile networks in a single-path or multiple-path manner. For multipath transmission multiple description video transcoding and intermediate nodes inside the network could be used.
Bitrate Switching Solutions	Concerns with the precoding of the media content at multiple formats and bit rates and storing them at the server side.	Muntean et al. [77], Mok et al. [78], Mukhtar et al. [79], Schierl et al. [80], Qiu et al. [81], Wisniewski et al. [82], Batalla et al. [83], Mushtaq et al. [84], Zou et al. [85], Go et al. [86] Evensen et al. [87].	The latency introduced by the switching between different quality levels. For multipath delivery the out-of-order packets may cause buffer underflow and throughput degradation leading to poor QoE.	Can be used over fixed, wireless and mobile networks in a single-path or multiple-path manner. Reliable network monitoring and resource scheduling mechanisms are required for multipath transmissions to avoid out-of-order packets.

V. ADAPTIVE MULTIMEDIA SOLUTIONS - RESEARCH AREA

To date there has been extensive academic research related to various techniques for adaptation of video delivery over the Internet. Various solutions have been proposed to address this problem of streaming video over the Internet while maintaining high user perceived quality levels.

In the following section, a representative selection of adaptive techniques from the literature are classified into four main categories: (1) *network protocol-based adaptive solutions* which relate to the actual network delivery mechanisms; (2) *scalable video coding solutions* which concern coding the video content in a scalable fashion (e.g., Multiple Description Coding (MDC), MPEG-2 scalability, MPEG-4 Fine Grain Scalability (FGS)) that enables adaptation by dropping or adding selected parts of the scalable-based encoded video; (3) *transcoding-based solutions* which adapt the video content by changing the target bitrate parameter of the transcoder on-the-fly, and (4) *bitrate switching solutions* which consist of storing multiple versions of the same video content pre-encoded at different formats and bitrates.

A. Network Protocol-based Adaptive Solutions

The *Network Protocol-based Adaptive* solutions are mainly focused on the sender-driven rate adaptation solutions. Generally, the server estimates the clients' current network condi-

tions related parameters and adapts the video stream accordingly.

One of the first adaptive multimedia solutions is the TCP-friendly rate control protocol (TFRC) [39]. The proposed mechanism consists of two parts: a sender-side protocol and a receiver-side protocol. At the sender-side, a TCP-rate equation-based model given by eq. 3 [88] is used to compute the sending rate considering the measured loss rate and the round trip time (RTT). The sending rate is computed at each defined time interval. The receiver sends ACK packets that contain the sequence number and timestamp for the acknowledging packets. Next the sender processes the ACK packets and computes the sending rate for the next time interval. The proposed solution does not have any built-in error recovery mechanism and when high losses occur the sending rate is reduced to very small values otherwise the rate is doubled.

$$T = \frac{s}{R\sqrt{\frac{2p}{3}} + t_{RTO}(3\sqrt{\frac{3p}{8}})p(1 + 32p^2)} \quad (3)$$

where T is the sending rate [bytes/sec], s is the packet size, R is the round trip time, p steady-state loss event rate, and t_{RTO} TCP re-transmission timeout.

Because TFRC adjusts the sending rate at fixed intervals, under more dynamic environment with lower time scale, the response of the protocol is poor [40]. To overcome this, along with TFRC's vulnerability to changes in RTT and sending

rate Floyd et al. [40], [41] proposed a new TCP-Friendly Rate Control, namely TFRC. Similar to TFRC, TFRC makes use of eq. 3 for computing the sending rate. However, in order to compute the loss rate, TFRC integrates a weighted average loss interval mechanism. Compared to TFRC, TFRC performs better over a wide range of timescales and provides a smoothly-changing sending rate compared to TCP.

Rejaie et al. [42] proposed an end-to-end TCP-friendly Rate Adaptation Protocol (RAP) which is mainly implemented at the sender side and works by adjusting the sending rate based on the loss rate and the estimated RTT. The proposed protocol addresses the following aspects: the decision function, the increase/decrease algorithm and the decision frequency. The decision function is defined as: if there is no congestion then the transmission rate is increased periodically otherwise, if congestion is detected then the transmission rate is immediately decreased. The increase/decrease algorithm is an additive increase multiplicative decrease (AIMD) algorithm. If there is no loss then the transmission rate is increased additively in a step-like fashion. If loss is detected then the transmission rate is decreased multiplicatively. The decision frequency is an important factor as changing the rate too often can result in oscillations whereas the delay in changing the rate can lead to an unresponsive behavior. RAP adjusts the transmission rate once every round-trip time (RTT).

In [43] the authors proposed an adaptive scheme referred to as loss-delay based adaptation algorithm (LDA+), which adapts the multimedia flows based on the current network conditions (e.g., loss, delay, RTT, bandwidth capacity). LDA+ makes use of real time transport protocol (RTP) for data delivery and RTCP for feedback information about the round trip time and losses. To estimate the RTT, a timestamp is included in the sender reports. Losses are estimated by counting the sequence numbers of the received data packets. LDA+ is an AIMD algorithm which works as follows: if there is no loss detected then the sender computes an additive increase value which will be added to the transmission rate; if loss is detected then the sender decreases the rate in a multiplicative manner. The performance of the proposed scheme was analyzed by extensive simulations and compared with another two adaptive schemes: TFRC and RAP. The results show that LDA+ achieves similar fairness as RAP or TFRC over a wide range of parameters. The authors argue the high efficiency of the LDA+ in achieving high network utilization and avoiding losses.

An Enhanced TCP-Friendly Rate Control (ETFRC) was proposed by Talaat et al. in [44]. ETFRC dynamically tunes the sending rate at the sender based on the feedback received from the receiver and some predefined limit values. The simulations results in NS-2 show that ETFRC outperforms TFRC for video traffic in terms of throughput, jitter, and packet loss over a simple and a more realistic Internet network topology. Similarly, Song et al. [45] make use of network state division and propose a new scheme, referred to as NSTC which identifies whether TFRC needs to control its sending rate. Basic NS-2 simulations show that NSTC reduces the packet loss rate significantly and improves the TCP friendliness. Sterca et al. [46] also modified the TFRC behavior and proposed an Utility-driven TFRC mechanism referred to as UTFRC. UTFRC

tracks the evolution of the stream's bitrate to provide smooth video transmission. Basic NS-2 simulation results show the benefits of UTFRC when compared to TFRC. However, these solutions do not consider a wireless scenario.

Yang et al. [47] proposed a new protocol for real-time video applications in wireless networks, referred to as the Video Transport Protocol (VTP). The goal of VTP is to provide smooth rate adaptation, to be efficient and robust to errors, and friendly to legacy TCP. VTP incorporates two major components: a loss discrimination algorithm and an estimation of the Achieved Rate (AR). The receiver measures the receiving rate and sends feedback to the sender. The sender uses an Exponential Weighted Moving Average (EWMA) in order to update the AR value. The end-to-end loss discrimination algorithm, Spike, is used in order to distinguish between congestion and error losses. The concept of VTP rate control is to reduce the rate by less when loss is detected, but stay at that rate for longer. The performance of the proposed protocol was tested in NS-2 and compared with another two adaptive mechanisms, TFRC wireless [48] and MULTFRC [49]. The results show that VTP performs better in terms of efficiency, smoothness and adaptivity in the presence of wireless errors.

Cen et al. [48] extended TFRC to provide better performance over wireless networks, referred to as *TFRC wireless*. The new proposed protocol makes use of UDP as the basic video transport protocol and of TFRC as the congestion control mechanism extended with a loss discrimination algorithm to distinguish between congestion losses and wireless error losses. When the receiver detects losses the loss discrimination algorithm is invoked to classify the losses. If congestion losses are detected then the receiver will consider them in the computation of the loss event rate, otherwise the losses are not included. If a packet is lost, it will not be retransmitted. The authors studied the performance of different loss discrimination algorithms, such as: Biaz, mBiaz, ZigZag, Spike and ZBS, and showed that the hybrid solution ZBS is the most suitable for both, wired and wireless networks.

Chen et al. [49] proposed an adaptive mechanism, referred to as MULTFRC which was built for wireless video streaming. The proposed solution makes use of multiple TFRC connections to increase the competitiveness of the current session. The number of connections is adjusted based on the measured RTT.

In [50] the authors proposed an adaptive cross-layer scheme for multimedia delivery by combining three adaptive strategies: (1) Adaptive MAC Layer Retransmission Limiting - makes use of UDP-Lite [89] in order to be able to receive packets which have a partially damaged payload; (2) Adaptive Application Layer FEC - makes use of the delay constraints of the application together with MAC layer ARQ with limited retransmissions in order to recover the errors, and (3) Adaptive Packet Size Decision - the size of the video packets is chosen adaptively based on the channel condition, delay constraint of the application, and the application FEC in order to maximize the goodput. The authors argue that the proposed cross-layer solution maximizes the achievable multimedia performance by adapting the system parameters to the varying network environment.

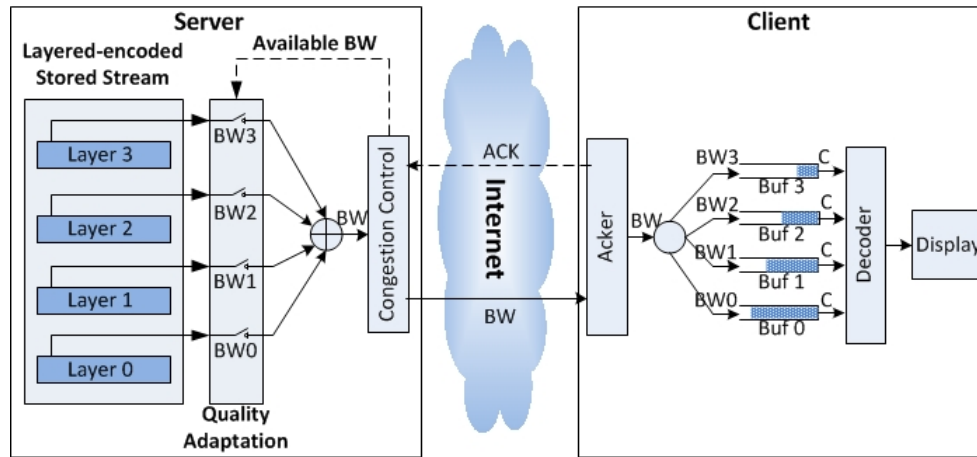

Fig. 6: Layered-based Quality Adaptation Mechanism

The authors in [51] proposed a power management cross-layer mechanism for video streaming over WLANs when using the TFRC protocol. The parameters taken into consideration are the transmission power collected at the physical layer and the packet loss information provided by the TFRC receivers reports to sender. The algorithm is based on thresholds which were defined by the authors after performing several experimentations using different values. The proposed mechanism was tested by simulations under NS-2 with the Evalvid-RA (Rate Adaptive) patch embedded to support rate-adaptive MPEG-4 multimedia transmissions. The mechanism was compared with the classical transmission without power management in terms of PSNR and energy consumption. The results show a slightly increase in PSNR leading to a slightly better user perceived quality but also an increase in energy consumption with no significant increase in performance.

When roaming within a heterogeneous environment where a number of wireless networks are available, the mobile user could either select the best available network to perform video on demand in a single path manner or could actually use several networks for multipath transmission. However, when using multiple paths, out-of-order packets can occur due to the different delays of the alternative paths which might affect the user's QoE. To overcome this, Kim et al. [52] proposed a packet scheduling scheme for multipath transmission referred to as Adaptive Packet Transmission Scheme (APTS). APTS makes use of TFRC for wireless networks to estimate the available bandwidth. Based on this, it distributes the TCP packets over multiple paths simultaneously to reduce the occurrence of out-of-order packets. Similarly, Park et al. [53] modified the TFRC algorithm to calculate the available bandwidth on each path and proposed a scheduling scheme to distribute the video packets over multiple wireless networks simultaneously to improve the quality of video streaming.

Even though all these solutions achieve a good performance in terms of QoS for multimedia delivery they have not been so popular lately. This is mainly because they require changes to the transport protocol in use and also because they provide a poor correlation with the actual end-user perceived quality of the multimedia stream.

B. Scalable Video Coding Solutions

Another promising technique aiming to enable flexible video transmission, is Scalable Video Coding (SVC) which contrary to the typical chunk-by-chunk rate adaptation, it enables frame-by-frame rate adaptation. The main advantages of this solution are that under a dynamic environment with frequent bandwidth variations, SVC could dynamically switch the video layers to adapt to the varying underlying network conditions.

An adaptation algorithm based on layered encoding is proposed by Rejaie et al. [54]. The proposed solution is distributed and consists of a client and a server as illustrated in Fig. 6. The server stores a layer-encoded version of the stream. The available bandwidth is determined using the congestion control mechanism and as the available bandwidth increases the server sends more layers of the encoded stream. The client will demultiplex the layers and send them into the buffers from where the data is send to the display. When the available bandwidth decreases, the server will drop some of the layers that are transmitted. The performance of the proposed mechanism was tested through extensive simulations using NS-2. The results show that the mechanism can efficiently cope with short term bandwidth variations.

In [55] Ding et al. make use of cumulative layered coding (LC) and propose an adaptive scheme for video streaming. In LC, the video stream is split into multiple interconnected layers. There is a base layer which will ensure the basic quality level, and the other layers which come to increase the quality. To decode a higher layer, the layer must be completely received and the lower layers are also required. The authors propose a system architecture which consists of two main components: the video server and the Stream Rate Adapter (SRA) responsible for adjusting the video stream bit rate based on the available bandwidth. To assess the proposed solution, the authors use spectrum, a novel video quality metric proposed by Zink et al. [56]. The authors in [56] have shown that using PSNR for assessing the video quality in the case of layered-encoded video is not suitable and they proposed spectrum, a new metric which takes the subjective assessment into consideration and also the frequency of changes of the quality levels. The authors argue that spectrum provides better

results than PSNR when it comes to layered video streams.

Qin et al. [57] propose an adaptive media streaming strategy for MANETs (Mobile Ad Hoc Networks) which is based on the layered video encoding schemes: Scalable Video Coding (SVC) and Multiple Description Coding (MDC). Both encoding schemes have a multi-layered structure. SVC splits the video stream into a base layer which can be decoded independently and several enhancement layers which can be added to the base layer to improve the video quality. MDC splits the video stream into several correlated layers which can be decoded independently. The proposed adaptive algorithm increases or decreases the number of layers to be streamed based on the available buffer size and distance. To analyze the performance of the proposed solution, the authors run simulations using NS-2 and argue 60% increase in the streaming probability with reasonably high video quality. However, neither subjective nor objective video quality assessment was carried out.

In [58] Huang et al. propose a video adaptation scheme for layered multicast systems using scalable video codec. The proposed scheme bases its adaptation mechanism on channel estimation, available bandwidth and packet loss rate. The system consists of several modules such as: scalable video layer creation, packet loss classification (PLC), bandwidth probing, and adaptive FEC insertion. The PLC is integrated to differentiate between the losses due to congestion and losses due to the wireless channel errors. To determine the available bandwidth the authors propose an embedded probing scheme which is done in advance preventing in this way the congestion. The performance of the system is evaluated through NS-2 simulations and the results show that the system adapts rapidly to the wired/wireless channel conditions.

Schaar et al. in [59] provide a solution for video transmission over WLANs, specifically IEEE 802.11a which offers theoretical bit rates of up to 54Mbps enabling the transmission of delay sensitive traffic. The authors propose an integrated cross-layer approach based on the MPEG-4 fine-grained scalability (FGS) and the join of APP and MAC layers. Based on the channel conditions and application requirements, the cross-layer approach comes to provide a tradeoff between throughput, reliability, and delay enhancing in this way the robustness and efficiency of the scalable video transmission.

In [60] Piri et al. propose a cross-layer architecture for streaming adaptive real-time multimedia over heterogeneous networks by integrating at the end hosts a Triggering Engine (TRG) and an Application Controller. The TRG is built on top of the new IEEE 802.21 standard, and its role is to facilitate the information exchange between the Media Independent Handover Function (MIHF) and higher layer entities and the Application Controller. The Application Controller adapts the video transmission based on the current transmission channel state. When a vertical handover occurs the Application Controller adjusts the video parameters (e.g. data rate and frame rate) during transmission based on fuzzy logic. The decision is made based on packet loss ratio (PLR), estimated received bit rate from application layer, and estimated channel signal-to-noise ratio (SNR) from the PHY or link layer. The authors describe a use case scenario, the performance evaluation of

the proposed architecture being part of the future work.

Krasic et al. in [61] introduce the idea of adaptive streaming through priority-drop. The data units of the media content are prioritized and sent through the network in priority order. The mechanism is using a TCP-based congestion control mechanism that decides the appropriate sending rate. When the sending rate is low, the quality of the media content is reduced smoothly by dropping the low-priority data units at the sender. The authors show that by combining the scalable video compression and the adaptive streaming through priority-drop a very effective adaptive streaming system is formed. However, no end-user perceived quality assessment was performed.

Previous studies [62] have shown that interruptions in the video playout due to buffer depletion have a great negative impact on the end-user QoE. To overcome this, the playout buffer should never get empty by accommodating the video bitrate into the available network bandwidth. Chen et al. [63] use the buffer as a metric that indicates whether there is a difference between the channel throughput and the video bitrate. The authors propose an adaptive layer switching algorithm for scalable video streaming by making use of the receiver Buffer Underflow Probability (BUP). Thus, for low BUP video layers are added and for high BUP video layers are removed. The performance evaluation was carried out using a prototype system and multiuser simulations. The results demonstrate that the proposed algorithm provides smooth playback experience to the end-user, in terms of PSNR.

Wu et al. [64] exploit the use of scalable transmission over heterogeneous networks to improve user experience. The idea is to use the macrocells for base layer video transmission to the majority of mobile users while the small cells (e.g., femtocells) to provide enhancement layers for the mobile users that could enjoy enhanced video experience. This scenario is depicted in Fig. 7. In this context, the authors investigated the layered structure of SVC and proposed two transmission schemes such as layered digital (LD) and layered hybrid digitalanalog (LHDA) transmissions. The stochastic geometrical approach is used to analyse the system performance over heterogeneous cellular networks in terms of outage probability, high definition probability, and average distortion, under orthogonal and nonorthogonal spectrum allocation methods. The results show that the proposed solutions enable the efficient provisioning of differentiated services for the end users.

Similarly, in [65] the authors look into the SVC transmission over heterogeneous cellular networks. The authors explore the umbrella coverage of a macrocell and propose the transmission of the base layer content over the macro base station, while the enhancement layer is transmitted over the femtocell access point due to higher data rate provisioning. Stochastic geometry is used to derive the rate distribution for the users receiving the base layer. Numerical results show that the proposed solution improves the high definition probability.

The main drawback of these solutions is the fact that the scalable compression cannot adapt to different codecs.

C. Transcoding-based Solutions

Transcoding-based Solutions provide immediate response to the end-users' current fluctuating network conditions by

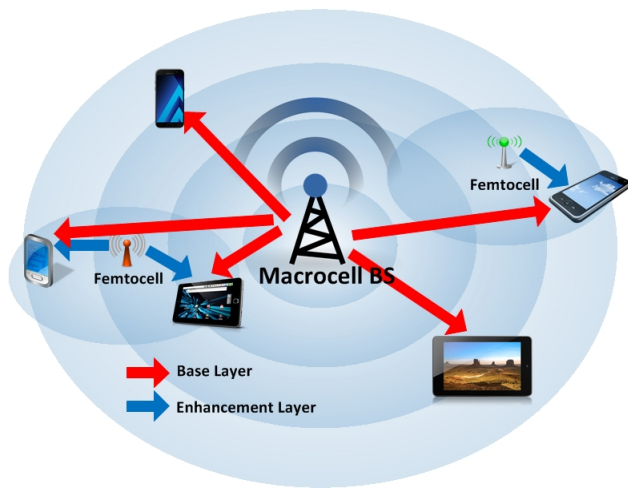

Fig. 7: SVC in Heterogeneous Environment Example

encoding the video stream on-the-fly.

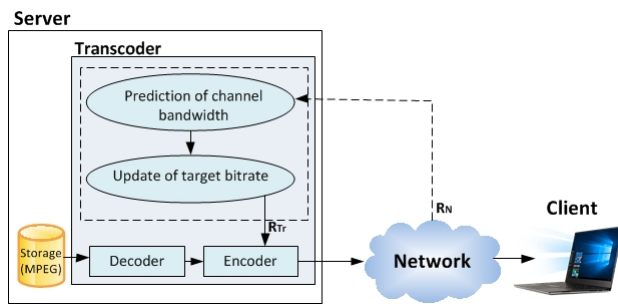

Fig. 8: Transcoding-based Transmission Model

One of the first transcoding-based solutions for multimedia delivery was proposed by Yeadon et al. in [66]. The authors propose the use of filters deployed in the distribution network. The solution considers a multicast delivery environment that makes use of filters to match the quality level required by the clients. Even though the filtering approach seems promising it requires significant processing time.

Takaoka et al. [67] propose the use of a MPEG video transcoder located at the server side to dynamically adjust the video stream over the network as illustrated in Fig. 8. The dynamic rate control scheme adjusts the target bitrate for the transcoder R_T , based on the predicted channel bandwidth R_N . The authors predict the channel bandwidth by using the data-processing speed information of the transcoder, such that fast data-processing speed means high throughput whereas slow data-processing speed means low throughput. This information is then used to adjust the target bitrate of the video content accordingly. The authors argue the effectiveness of their mechanism through simulations.

Prangl et al. [68] propose a server-side adaptation technique for TCP-based media delivery. The authors introduce an adaptation engine that enables on-the-fly content adaptation through transcoding. The adaptation of the video stream is done based on the measured TCP throughput at the server side. The authors argue that the proposed technique leads to smooth playback at the client side. However, no perceptual tests were carried out.

Vijaykumar et al. in [69] propose the use of a cross-layer framework, implemented at the AP, for adaptive video streaming over an IEEE 802.11 infrastructure mode network. The framework uses the retransmission information from the data-link layer to estimate the channel conditions. This information is then used at the application layer in order to vary the transcoding rate of the video content based on the channel conditions. The authors argue that the proposed mechanism can reach more than 2% decrease in packet loss when compared to a non-cross-layer solution.

Hiromoto et al. [70] propose a server-side dynamic rate control for TCP-based media streaming over high-speed mobile networks. The authors make use of a transcoder at the server-side which is controlled by a rate control algorithm. The rate control algorithm determines the target bitrate of the video content based on the transcode delay. The transcode delay is determined as the difference between the current time and the time stamp of the current transcoding frame. The authors argue that by using the transcode delay, the mechanism can achieve high-quality smooth streaming under unstable networks. However, no subjective nor objective video quality assessment is provided.

Wang et al. [71] propose an adaptive rate control strategy suitable for video transcoding from MPEG-2 to H.264. The proposed solution dynamically adjusts the target bitrate of the transcoded video content according to the output bandwidth fluctuations. The authors argue that the mechanism can be used for video transcoding from MPEG-1, MPEG-2, MPEG-4, H.263 to H.264.

A study on adaptive video streaming through transcoding is carried out by Medagama et al. in [72]. The authors investigate the variation of the transcoding parameters (e.g., quantization factor, frame rate, data rate) with respect to low bandwidth network in order to achieve an optimum quality. The assessment of the video quality is done through objective measurements. The authors argue that transcoding can be useful in low bandwidth situations to efficiently use the available resources, but the video quality is affected.

Chattopadhyay et al. in [73] propose an adaptive rate control for H.264 UDP-based video conferencing over wireless networks based on bandwidth estimation. The proposed system architecture is divided into three layers such as: application layer, middleware framework, and processing layer. The adaptation mechanism consists of two stages: the first adaptation is done in the audio and video codec and the second one is done in the packetization and transmission interval of the data. The bandwidth is estimated based on the time difference of RTT for the probe packets, and used afterwards in the video rate control, audio rate control, and the transmission rate control. In order to assess the performance of the proposed mechanism the solution was compared to H.264 reference code in terms of PSNR. The authors argue that the proposed solution achieves better performance in terms of speed and bit fluctuation.

Essaili et al. [74] introduce the concept of Multiple Description Video Transcoding (MDVT) which adapts the video transmission to a heterogeneous environment where path diversity exists. The idea is to take a single description encoded video and convert it into two or more descriptions at an intermediate

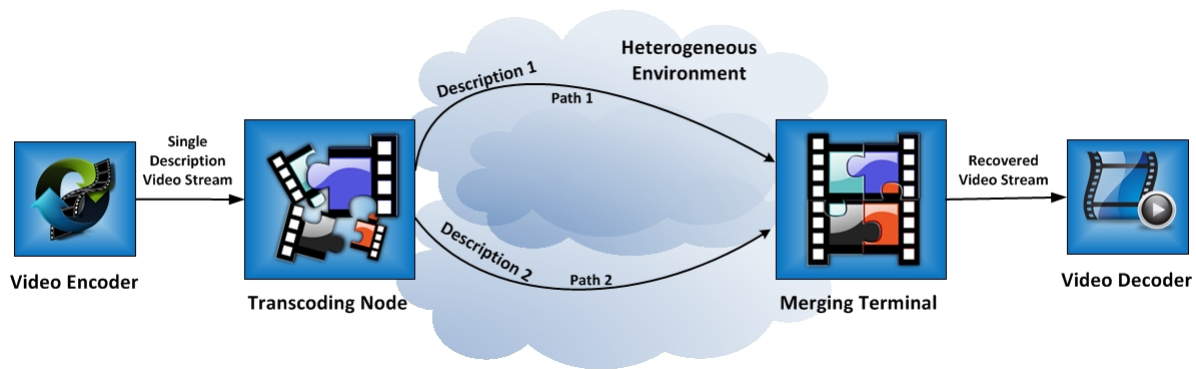

Fig. 9: Transcoding in Heterogeneous Environment Example

node within the network as illustrated in Fig. 9. The authors introduce a fast greedy method for real-time low complexity multiple description video transcoding.

In [75] the authors propose a distributed framework consisting of bitcodin for live transcoding and streaming-as-a-service platform and bitdash, an adaptive client. Bitcodin is deployed on a standard cloud that takes as input the live source and outputs multiple representations based on the MPEG-DASH standard. The framework enables high-quality streaming to heterogeneous clients using bitdash, a DASH client implementation. The performance evaluation results show that the proposed framework provides instant playback for live services with low start-up delay and avoids video stalling under dynamic network conditions. A cloud-based online video transcoding (COVT) system was also proposed by Wei et al. [76]. COVT aims to minimize the amount of CPU resources given specific QoS constrains, such as system delay and targeted chunk size. This is done by making use of profiling techniques for resource prediction and scheduling and queuing theory for modeling the cloud-based transcoding system. Experimental results are used to validate the proposed system.

The main advantage of on-the-fly transcoding is the immediate response time and the very fine granularity. However, due to the heterogeneity of the environment (e.g., different mobile devices, various networks and user preferences) this approach requires computing overhead being very computationally intensive relative to the other solutions. This makes it difficult to provide support for a large number of clients without adding a computational cost on the server. Moreover, for cloud-based online transcoding solutions a reliable and efficient resource reservation scheme is needed to enable the best trade-off between resource cost and QoS.

D. Bitrate Switching Solutions

Bitrate Switching solutions are the most common as they are easy to implement and they are also cost effective. Most of the commercial solutions are based on the bitrate switching technique. The common idea behind these solutions is that the server stores several versions of the same video stream encoded at different quality levels. In this case, the quality adaptation algorithm is the key component that decides when and to which quality level to switch to. Usually the network conditions are monitored and when changes in the available

bandwidth occur the adaptation algorithm is triggered. However, one important aspect to be considered is the quality perceived by the end-user.

Muntean et al [77] propose a Quality-Oriented Adaptation Scheme referred to as QOAS, which provides good results when streaming over wireless networks. The proposed architecture is distributed and consists of a server side and a client side as illustrated in Fig. 10. At the client side the estimated end-user perceived quality (e.g., PSNR) is monitored and feedback is sent to the server. The server stores multiple quality levels of the same video stream and when receives feedback from the client it adjusts the quality level accordingly. Perceptual and simulation tests validate the effectiveness of the proposed solutions when compared to a non-adaptive mechanism.

Even though integrating PSNR in the adaptation mechanism seems to provide good results, it does not fully reflect the impact of the quality levels transition from one level to the other on the user perceived quality. This is because PSNR is an objective metric and considers only the spatial quality.

Additive Increase Multiplicative Decrease (AIMD) is a common method used to change between quality levels. However, the multiplicative decrease provides a sharp degradation on the quality level which has a great impact on users' QoE [90].

Aiming at improving the QoE for the DASH system, Mok et al. [78] propose QDASH. QDASH integrates a probing methodology to detect changes in the network conditions and to measure the available bandwidth. The most suitable quality level is then selected. Moreover, subjective tests were carried out to understand the user perceived quality between the bit-stream switching. The authors make use of the video buffer and intermediate quality levels and propose a QoE-aware adaptive algorithm integrated into QDASH. The use of video buffer helps mitigating the short-term network fluctuations. Whereas inserting intermediate quality levels proves to provide better QoE than switching to the target level immediately. However, the overall performance of the QDASH system was not evaluated.

Mukhtar et al. in [79] propose an adaptive scheme for multimedia transmission over wireless channels, combining several techniques such as: adaptive modulation, adaptive channel coding, adaptive playback, and bit stream switching in order to ensure an uninterrupted video playback. The authors employ a distributed architecture with feedback loop. When

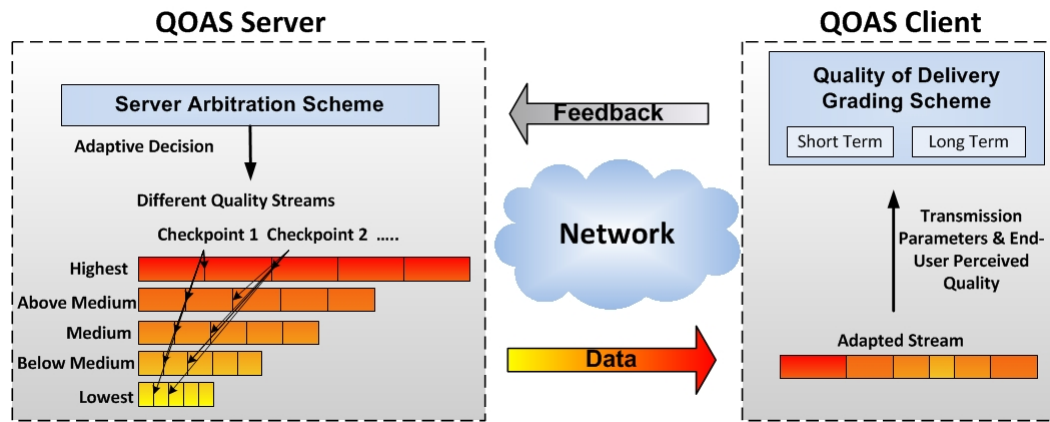

Fig. 10: Bitrate Switching Adaptation Mechanism

the server receives feedback from the client, the bit-stream switching module along with adaptive modulation module and adaptive channel coding module adapt the video stream according to the channel conditions and the client buffer occupancy. At the client side, an adaptive playback module is integrated. The performance evaluation results show that by combining the adaptive playback with the bit-stream switching mechanism, the client buffer starvation is eliminated. This implies degradation in the video quality but uninterrupted video playback. However, there is no comparison with other state-of-the-art solutions provided neither subjective tests carried out to see the impact on the users' QoE.

Schierl et al. [80] propose a 3GPP compliant adaptive streaming system which makes use of the client feedback information included in the Packet-switched Streaming Service (PSS) specified in the 3GPP standard. Based on the feedback received from the client, the transmission characteristics and the client buffer status are determined. The streaming server combines the bit-stream switching and the temporal scalability in order to switch between H.264 bit-streams characterized by the same encoding parameters but different quantization parameter. By adapting to the optimal data rate the proposed system avoids client buffer starvation and packet loss. However, the authors do not look into the impact on user perceived quality.

Qiu et al. in [81] propose an HTTP-based adaptive video streaming mechanism referred to as Intelligent Bitrate Switching-based Adaptive Video Streaming (ISAVS). The proposed solution makes use of the real-time and historical information about the available network bandwidth in order to select the proper quality level of the video content. The authors propose an optimization algorithm for choosing the best video quality level and show the advantages of their proposed solution in comparison to the IIS Smooth Streaming strategy in terms of total video freeze time, number of video freezing periods, and PSNR.

An Adaptation and Buffer Management Algorithm (ABMA) was proposed by Wisniewski et al. [82]. ABMA makes use of the estimated probability of the video re-buffering to perform the bit-stream switching. The probability is calculated using the measured segment download time characteristics. ABMA overcomes the short-term bandwidth variations by adjusting

the client buffer size whereas the long term bandwidth fluctuations are handled by switching the video quality. The effectiveness of ABMA was demonstrated through simulation and prototype experiments. An improved version of ABMA is presented in [83] which reduces the computational cost and allows its implementation on medium computing devices. The performance evaluation results show the effectiveness of ABMA when compared to other state-of-the-art solutions. However, the impact on user perceived quality was not considered.

The use of video player buffer within the adaptation algorithm was also proposed in [84], along with dropped of excess video frames per second, and available bandwidth. The performance of the proposed HTTP-based rate adaptive algorithm was evaluated under a real time dynamic Internet environment. The authors argue that the proposed solution maximizes user's QoE by avoiding video stalling during playback and enables efficient bandwidth utilization. However, neither subjective nor objective video quality assessment was carried out.

Zou et al. [85] propose a new approach by taking into consideration the type of end-user device when adapting the multimedia stream. The authors propose DOAS, a device-oriented adaptive multimedia solution for LTE networks. DOAS works jointly with the LTE scheduling algorithm to increase the efficiency of network resources and makes use of end-user device classification to improve the users' QoE. Simulation results validate the advantages of DOAS. However, no subjective tests were carried out.

Apart from the single network delivery, the bit-rate switching technique can be adapted to a multiple wireless networks environment. In this context, Go et al. [86] proposed an energy-efficient HTTP adaptive streaming algorithm with networking cost constraints where the video data is segmented and scheduled across the multiple networks. However, the proposed adaptation mechanism selects the same video bitrate for all the segments in a request segment block. The proposed solution was implemented based on the MPEG-DASH standard and tested under an experimental environment consisting of two wireless access networks (e.g., WLAN and LTE) as illustrated in Fig. 11.

Similarly Evensen et al. [87] proposed DAVVI for multilink support over heterogeneous environments. DAVVI is

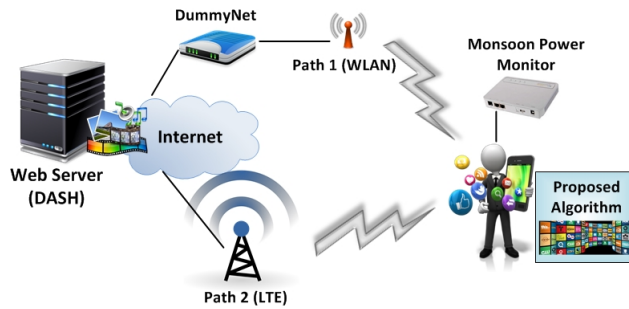

Fig. 11: Multiple Wireless Networks Testing Environment

an HTTP-based streaming system where the videos are encoded in multiple qualities and each video is divided into segments. Whenever a segment is requested, the quality can be adapted to the network conditions. Moreover, by using dynamic subsegment sizes calculated on the fly based on the links' performance an ideal amount of data can be allocated to each link.

The bitrate switching method is the most simple to implement and the most efficient in terms of the processing complexity. However, the main drawback is the latency introduced in the response time. This latency appears because of the switching between different quality levels that has to be done at selected key frame locations. Moreover, in case of using multiple access networks for simultaneous transmission, reliable network monitoring and resource scheduling is required to avoid out-of-order packet delivery. This may cause buffer underflow and throughput degradation which negatively impacts the users' QoE.

E. Discussions

In the current heterogeneous wireless network environment, QoE provisioning became a challenge for the network operators and innovative solutions are required. Among the various proposed solutions for enabling QoE levels for multimedia applications, the adaptive mechanisms that dynamically adjust the video quality level based on the underlying network conditions have been highly promising. Considering the heterogeneous environment, the adaptive video content could be delivered over a single path by selecting the best value network from the pool of available networks or using multiple networks for multipath delivery as illustrated in Fig. 12. Apart from the underlying network conditions, the user preferences (e.g., quality, cost, energy) and device characteristics (e.g. CPU, display, battery) play an important role in QoE provisioning. As it has been seen previously, there are a number of works offering different strategies for adaptation of the multimedia streaming. We summarized these approaches into four wide categories: (1) network-protocol based adaptive solutions; (2) scalable video coding solutions (3) transcoding-based solutions and (4) bitrate-switching solutions.

The approaches in the first category make use of the transport protocol and the congestion control mechanism to adjust the sending rate based on various network-related parameters (e.g., loss rate, delay, round trip time, etc.). Even though these solutions achieve good performance in terms of QoS, their

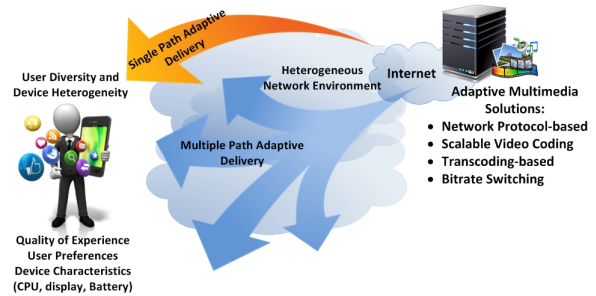

Fig. 12: Adaptive Multimedia Delivery over Heterogeneous Environment

main disadvantage is that they are not aware of the end-user perceived quality when performing the adaptation. The other three categories are mainly concerned with the representation and the coding of the video content. The scalable video coding solutions avoid the re-coding of the video content by using scalable compression formats where the encoded video exposes multiple quality layers with the higher layers depending on the lower layers. The adaptation is done in bitrate, frame rate, and resolution, by dropping selected parts of the scalable video content. However, one of the drawbacks is that scalable compression cannot adapt to different codecs. Another adaptive multimedia approach that involves non-scalable single-layer bitstreams is on-the-fly transcoding that includes live encoding of the video content based on the network conditions. Even though, this solution sounds promising as it offers immediate response time and very fine granularity, it requires excessive computational resources making it hard to scale. The fourth category involves precoding of the media content at different quality levels and stored at the server side. This is the most simple and cost-effective method that is widely adopted in the industry as well (e.g., Microsoft Smooth Streaming, Adobe OSMF, Netflix, Move Networks, Hulu, Vudu, Youtube etc.). However, the main drawback of these solutions is the latency of switching between different quality levels which has to be done at selected key frame locations.

From the OSI network protocol stack point of view a number of new protocols have been developed over the last years at different layers in the stack especially for multimedia applications:

- At the physical layer methods have been developed to help the data link layer to estimate the channel conditions and adjust the modulation and coding strategies [91].
- At the data link layer several strategies were defined to provide error control and frame scheduling [92].
- At the transport layer several methods were defined to provide network condition information in terms of available bandwidth, packet loss rate, and delay. Protocols such as RTP/RTCP can record, calculate and return network condition information. [19], [20], [93].
- At the application layer mechanisms which provide network-adaptive video coding were defined. Some of the existing technologies, where much research has been devoted to, are: Scalable Video Coding (SVC) [94], [95],

[96]; Multiple Description Coding [97], [98], [99]; and joint source-channel coding [100].

Some of the existing adaptive solutions provide good results in wired networks, for example LDA+ described in [43] adapts very well in highly loaded networks. TFRC proposed in [39] prevents data starvation and limits the aggressiveness with competing adaptive traffic opposed to LDA+ which acts aggressive. In order to provide better QoS support for multimedia streaming, Zhu et al. in [101] extended the TFRC mechanism and proposed TFRCC (TCP Friendly Rate Control with Compensation) which also provides good network fairness. All these solutions [43], [39], [101] and others [42], [44], [45], [46], [54], [61], [102], they all present good results in wired networks but they are not suitable when it comes to wireless networks.

To overcome this problem and also with the popularity of wireless networks new solutions were proposed [47], [48], [49], [50], [98], [79], [103], [104]. All these solutions are trying to differentiate between congestion-based losses and random losses due to the variation of the wireless channel in order to achieve a higher throughput and a higher user perceived quality level. Moreover, the dynamic ultra-dense heterogeneous networks deployment enables the delivery of video over multiple wireless networks simultaneously [52], [53]. Even though this approach sounds promising, due to the different characteristics of the wireless networks, the packets might reach the receiver out of order causing buffer underflow and throughput degradation. Thus, additional packet scheduling and efficient resource estimation mechanisms might be required.

Apart from these layered protocol architectures the concept of cross-layer design appeared, that aims to increase the effectiveness and the efficiency of the system as a whole by increasing the level of cooperation and communication among various network elements. In the cross-layer design, higher layers share the knowledge of lower layer conditions in order to improve the performance of the entire system. Recently there have been various cross-layer design proposals in the literature which are focusing on multimedia transmission [50], [51], [59], [60], [61], [105], [106], [107], [108]. In [105] a classification of the cross-layer solution is proposed, the need of a cross-layer optimization is examined and the authors proposed a joined APP, MAC and PHY layer solution. In [59] the authors proposed a joined APP and MAC adaptation scheme for MPEG-4 transmission. The authors in [109] addressed the issue of cross-layer design in wireless networks. Because of the numerous numbers of parameters involved in the whole adaptation process, the cross-layer adaptation can be a challenging process. It has been seen that the participation of the PHY and MAC layer is very important especially when it comes to wireless networks [110], [111], [112]. Some of the existing solutions make use also of the APP layer [59], [105]. Although the cross-layer approaches seem to be a good solution they exhibit different drawbacks for wireless multimedia networks in terms of complexity, limitations, used protocols, algorithms at various layers, and application requirements. Moreover, some of the cross-layer designs require implementation of new interfaces between

layers, merging of two or more adjacent layers, coupling two or more layers, etc.

However, nowadays the leading approach for adaptive content delivery is the bitstream-switching technique. An experimental evaluation of three commercial adaptive HTTP streaming players (e.g., Microsoft Smooth Streaming, Netflix player, Adobe OSMF) is presented in [113]. The Microsoft Smooth Streaming is effective under unrestricted and persistent available bandwidth fluctuations. It is able to adapt fast to the highest sustainable bitrate and accumulates a large playback buffer as well. However, it reacts too slow to the short-term bandwidth fluctuations and for too long causing unnecessary adaptation to a low quality level. The Netflix player shares the same shortcomings, however is more aggressive and aims to provide the highest possible video quality. Whereas, the Adobe OSMF player fails most of the times to adapt to an appropriate bitrate even when the available bandwidth has stabilized. The authors argue that the interaction between the rate-adaptation logic located at the application layer and the TCP congestion control at the transport layer remains a challenge for adaptive smooth streaming provisioning.

Famaey et al. [114] compare a SVC-based HTTP Adaptive Streaming (HAS) solution to an Advanced Video Codec (AVC) based HAS solution. The results show that AVC performs better under high latencies and SVC adapts easier to short-term bandwidth fluctuations when using a small buffer. Moreover, when considering a multiple clients scenario the authors argue the unfairness of both approaches, as they cannot balance the quality among the clients. However, for mobility scenarios within a heterogeneous wireless environment, with combined seamless handover and rate adaptation, SVC can maintain a better QoE for video streaming when compared to AVC [115]. An analysis comparing AVC to SVC in terms of end-to-end service delivery costs including the content storage cost, bandwidth cost, and the server computing cost is provided by Kalva et al. [116]. The authors conclude that the dominating factor is the bandwidth cost, whereas the storage cost becomes an issue only if there is a very small number of active sessions. Thus, even though the storage cost for SVC is lower than AVC, the total costs are lower for AVC.

Another promising solution for optimizing the Quality of Experience of the mobile user is the integration of reinforcement learning algorithms into the multimedia adaptation process [117], [118], [119], [120]. The works in [117] and [118] make use of Q-Learning approaches to design a HAS client. Based on the current network conditions, the HAS client dynamically learns the optimal behaviour to optimize the users' QoE. Similarly, Chiariotti et al. [119] design a DASH controller that uses reinforcement learning techniques to learn the temporal evolution of the system. Moreover, the Markov Decision Process optimization is used for the optimal selection of the representation which maximizes the long term reward. A more recent work that provides a good review of existing reinforcement learning approaches for video adaptation is presented by Gadaleta et al. in [120]. The authors, propose a D-DASH framework that combines the use of Deep Learning and Reinforcement Learning techniques to enable the QoE optimization at the end-user.

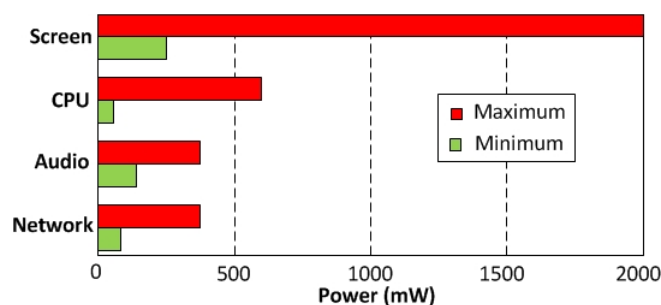

Fig. 13: Power Consumption Components for HTC Nexus One

Thus, in order to enable high *Quality of Experience* at the mobile user side the following aspects need to be addressed: avoiding re-buffering events and playback interruptions, minimizing the start-up delay and maximizing the video quality level, finding a trade-off between the stream switching frequency and the storage costs at the servers [121].

VI. ENERGY-EFFICIENT CONTENT DELIVERY SOLUTIONS

Another important factor encapsulated into defining QoE at the end-user side is the energy consumption of the mobile device. It is known that video-based applications are the most power hungry of all applications putting significant pressure on the energy consumption of the mobile device. In order to avoid mobile users running out of battery while enjoying a video session, which might negatively impact their QoE, mechanisms and solutions need to be put in place to conserve the energy of their devices while maintaining acceptable QoE.

Adaptive multimedia solutions could help with conserving the battery of the mobile device by adjusting the quality level of the multimedia stream to a lower quality level. This means that less data is received by the mobile device leading to energy conservation. However, a trade-off needs to be maintained between the end-user perceived quality and the energy savings. To this extent, other energy-aware solutions could be implemented to work along with the multimedia adaptation techniques.

Various studies were performed trying to understand how the energy is consumed and to determine an energy consumption pattern of different mobile devices. Researchers investigated the energy consumption in various conditions (e.g., different radio access technologies, time, device motion, etc.) trying to identify the main parameters that contribute to the energy consumption. Different solutions are trying to conserve the energy by: adaptive video streaming, decoding, reception, display (brightness compensation), transmission modes (ON/OFF), or interface switching (handover/network selection), etc. Consequently the existing energy efficient solutions were categorized in five wide categories: (1) surveys and studies on energy consumption, (2) energy efficient network selection, (3) operation modes-based energy efficiency, (4) cross layer solutions for energy conservation, and (5) energy efficient multimedia processing and delivery.

A. Surveys and Studies on Energy Consumption

Zhang et al. [122] present a survey on the major advances in power-aware multimedia. The main focus of the survey is

on video coding and video delivery. The authors identify the main challenges that come when designing energy efficient mobile multimedia communication devices, as: (1) real-time multimedia is delay-sensitive and bandwidth-intense making it also the most power consuming application, (2) the radio frequency environment is changing dynamically over time and space, (3) the diversity of mobile devices and their capabilities, (4) the video quality does not present a linear increase with the increase in complexity, and (5) the battery discharge behavior is nonlinear. The authors conclude that due to the dynamics involved, enabling power-aware mobile multimedia is extremely challenging. Many trade-offs are involved in the process, for example using high compression techniques to reduce the amount of data to be transmitted and therefore the energy involved in data delivery, but higher compression involves higher computation both at the client and the server, and therefore increased battery usage.

Kennedy et al. [123] provide a comprehensive study into the energy consumption across different functionalities and computations of a smart phone (e.g., HTC Nexus One). Figure 13 [124] illustrates the maximum and minimum power consumption over four main components of the Android mobile devices: screen, CPU, audio and network interface. In the case of multimedia transmission, the authors identify three major components to be the most significant energy consumers, such as the display screen, CPU and the network interface. The authors argue that while performing multimedia streaming, the display screen consumes eight times more power, CPU sixteen times more and the wireless network interface five times more than the no video streaming case.

A study on the energy consumption of YouTube in mobile devices was carried out by Xiao et al. [125]. The authors measured the energy consumption of a Nokia S60 mobile phone for three different use cases (e.g., progressive download, download-and-play, and local playback) and for two access network technologies (e.g., WCDMA and WLAN). Even though the results show that the WCDMA network consumes more energy than WLAN, they do not consider the impact of fluctuating network bandwidth nor the quality of the video.

Vallina-Rodriguez et al. [126] perform a study on collecting usage data of 18 Android OS users during a 2 weeks period (Feb. 2010) in order to understand the resource management and battery consumption pattern. The information collected from the mobile devices covers a wide range of parameters, more than 20 (e.g., CPU load, battery level, network type, network traffic, GPS status, etc.) being updated at every 10 seconds. The study shows the importance of contextual information when designing energy efficient algorithms. For example, by identifying where and when some resources are in high demand (50% of their time the users were subscribed to their top three most common base stations) a more energy efficient resource management can be proposed that uses this information.

Considering the heterogeneity of mobile devices (e.g., screen resolution, battery life, hardware performance) Zou et al. [127] proposes a mobile devices classification based on the characteristics of 4914 devices, as listed in Table VIII. For each device class, the authors make use of the utility theory

TABLE VIII: Mobile Devices Classification [127]

Device Classes	Class 1	Class 2	Class 3	Class 4	Class 5
Resolution Ranges	$\leq 1024 \times 768$	$(1024 \times 768, 800 \times 600]$	$(800 \times 600, 480 \times 360]$	$(480 \times 360, 320 \times 240]$	$< 320 \times 240$
Device Models	Samsung Galaxy S3	Samsung Galaxy S4 mini	Samsung Galaxy S2	Vodafone Smart Mini	Vodafone 858 Smart
Model Images					
Operating System	Android 4.2.2	Android 4.2.2	Android 4.1.2	Android 4.1.1	Android 4.0.4
Screen Types	Super AMOLED	Super AMOLED	Super AMOLED	TFT	TFT
Resolution	720×1280	540×960	480×800	320×480	240×320
Battery Capacity	2100 mAh	1900 mAh	1650 mAh	1400 mAh	1200 mAh
Battery Voltage	3.8 V	3.8 V	3.7 V	3.7 V	3.7 V
VLC Player	0.2.0-git	0.1.4	0.1.4	0.1.4	0.2.0-it

to model the energy consumption based on real data collected from both crowd-sourcing-based subjective tests and real test-bed energy measurements. Moreover, a solution that optimizes the trade-off between QoE and energy-saving models for different device classes is proposed. The authors argue that the mobile device heterogeneity impacts severely the end-user QoE.

A comprehensive study on the impact of the Wi-Fi network-related parameters (e.g., network load and signal quality level) on the power consumption of an Android mobile device in the context of video delivery is presented in [128]. The results show that a great amount of energy can be conserved just by employing video adaptation. Moreover, the network load and the signal quality level have a combined significant impact on the energy consumption while using TCP for video delivery seems to be more energy efficient than UDP. Another important factor that impacts the energy consumption is the location of the contending traffic. The bad location of some mobile users (e.g., near the cell border) could heavily penalize the users located near the AP in terms of poor user perceived quality of the multimedia stream [129]. The experimental results also show that the WLAN interface consumes less energy over the cellular interface.

A different approach is offered by Correia et al. [130] who address the problem of energy efficiency for mobile cellular networks (e.g., WCDMA/HSPA, LTE). The authors look at the energy efficiency of the entire system on three levels: (1) component level looking at the efficiency of the power amplifier; (2) link level looking at the discontinuous or continuous transmission modes of the base stations; and (3) network level looking at the deployment paradigm of the cellular networks. The authors conclude that a potential for energy consumption reduction at the network level would be by taking into account daily load patterns as well as the network architecture type (e.g., multi-hop transmission, ad-hoc meshed networks, etc.).

B. Energy Efficient Network Selection Solutions

By roaming through a heterogeneous wireless environment a mobile user has a choice of different radio access technologies to connect to. However, choosing the best value network that finds the optimal trade-off between various user preferences and underlying network conditions represents a challenge. For example, the context information (time, history, network conditions, device motion) is used in [131] by Rahmati et al.

to estimate current and future network conditions and automatically select the most energy efficient network (802.11b or GSM/EDGE). The authors collect usage information from 14 users (HTC Wizard Pocket PC, HTC Tornado, and HP iPAQ hw6925 phones) during a 6 months period (Sept. 2006 Feb. 2007). The authors argue that by using the context-based interface selection mechanism the average battery lifetime of the mobile device can reach 35% increase comparing with the case of using the cellular interface only.

Selecting the most energy efficient network to prolong the lifetime of the mobile device was addressed in [132], [133], [134], [135], [136] as well. Petander et al. [132] propose the use of traffic estimation of an Android mobile device in order to select between UMTS/HSDPA and WLAN. The traffic estimation is done by the Home Agent of the Mobile IPv6 protocol and sent to the mobile device which will take the handover decision based on the estimate. The results show that the energy consumption for data transfer over UMTS can be up to three hundred times higher than over WLAN. The authors in [133] propose a network selection algorithm based on AHP and GRA which selects the best network between CDMA, WiBro, and WLAN. The authors consider a wide range of parameters: QoS (e.g., bandwidth, delay, jitter, and BER), the monetary cost, the lifetime (transmission power, receiver power, and idle power) and user preferences. In [135] Liu et al. use a SAW function of available bandwidth, monetary cost, and power consumption to select between Wi-Fi, WiMAX, and 3G. Whereas in [134] the authors make use of TOPSIS to solve the multi criteria (available bandwidth, RSS, velocity, load rate, and power consumption) problem and select between 802.11a, 802.11b, and UMTS networks. Trestian et al. [136] propose an enhanced power-friendly access network selection solution, E-PoFANS for multimedia delivery over heterogeneous wireless networks. E-PoFANS maintains an acceptable user perceived quality by selecting the network that offers the best energy-quality trade-off. The authors argue that E-PoFANS can achieve up to 30% energy savings with insignificant degradation in video quality when compared to other state-of-the-art energy efficient network selection solution.

Recently, there has been much interest in using Visible Light Communication (VLC) as a possible solution for 5G integration [137]. Studies have shown that VLC offers higher data rates and lower energy consumption, high security, no radio frequency (RF) interference while making use of free

spectrum when compared to the conventional wireless access systems [138]. Despite these advantages the main drawbacks of VLC are poor performance for non-line-of-sight scenarios, small confined limited coverage and poor uplink performance. However, these limitations could be compensated by the integration with the RF technologies, which in turn offer extended coverage at lower throughput. Thus, because of their complementary nature many researchers have investigated the use of hybrid VLC/RF environments [139], [140], [141]. The energy efficiency has been studied by Kashef et al. [139] where the authors investigated the benefits of integrating VLC with RF-based networks and formulated the power and bandwidth allocation problems for energy efficiency maximization within the hybrid environment. The advantages of using a hybrid VLC/RF deployment to improve the system's overall rate performance have also been investigated by Basnayaka et al. [140]. The proposed mechanism connects all the users to the VLC network first and then migrates the ones with low achievable data rates to the RF system. Similarly, a two-stage Access Point Selection (APS) method for hybrid VLC/RF networks has been proposed in [141]. However, this method determines the users to be connected to the RF system first, assigning the remaining users to the VLC network and improving the overall network performance.

C. Operation Modes-based Energy Efficiency Solutions

By making use of the operation modes of the mobile devices (e.g., sleep, idle, active, etc.) could help at increasing the energy savings especially within a heterogeneous wireless environment.

A power management method for next-generation wireless networks with a focus on operation modes is presented by Kim et al. [142]. The authors provide a technical overview of power management in IEEE 802.16m and 3GPP LTE. IEEE 802.16m provides advanced power saving mechanisms based on enhanced versions of legacy IEEE 802.16 sleep and idle modes. Whereas, LTE adopts a Discontinuous Reception (DRX) mechanism for power saving. The authors conclude that alternating available and unavailable intervals can provide an efficient and basic power saving method. However, by doing this, extra power consumption will be spent on activating and deactivating components, so the number of mode changes needs to be kept low.

In [143], Lauridsen et al. investigate the use of combined operations of microsleep, Discontinuous Reception and Transmission, and a wake-up receiver to enhance the battery life of 5G mobile devices. The frame structure for 5G as illustrated in Fig. 14, provides a scheduling grant for uplink or downlink traffic one frame ahead of the data. In this way, the user will know in advance if it is scheduled for the following frame or not. In case it is not scheduled, it can enter a low-power mode, referred to as microsleep. Depending on the traffic type and user requirements, the authors estimate 20-90% longer battery life compared to LTE.

A simple ON-OFF scheme [144] can be used to save energy during video streaming. Initially the server pushes as much data as possible to the client who will turn the wireless interface off while playing the video. The wireless interface is

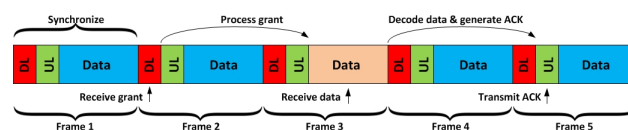

Fig. 14: Receiving Data in 5G

turned on again when the video buffer is almost empty. Even though this scheme is fairly simple, it is not optimal as it cannot adapt to the wireless access technology, user behaviour and preferences [145]. To maximise client satisfaction, an optimal start-up threshold could be used and the trade-off between the users' impatience and the probability of buffer starvation could be addressed [146]. For example, a user could decide to skip or quit while watching a video before the video reached its end which may lead to lots of energy and bandwidth wastage. To overcome this, [147] Hu et al. classify the video streaming into two modes, such as stable mode when the user is watching the video for a long time and unstable mode when the user tends to skip through the video. The authors propose an optimized ON-OFF scheme to be used for the stable mode and a modified bitrate streaming scheme for the unstable mode. The authors argue that the ON-OFF scheme reduces energy and bandwidth wastage whereas the modified bitrate streaming reduces the delay.

Lee et al. [148] propose a Content-Aware Streaming System (CASS) that aims at improving the energy efficiency in Mobile IPTV services. CASS uses information from the network and makes use of the Scalable Video Coding scheme in order to reduce the transmission of unnecessary bitstreams. To further increase the energy efficiency, CASS reduces the operating time of the client wireless NIC by switching it ON/OFF based on the client buffer.

Perrucci et al. [149] investigate the energy consumption of a Nokia N95 while performing VoIP. The authors propose the use of a lower energy consumption interface (e.g., GSM) as a signalling channel to wake up the WLAN interface and run the VoIP service. The authors argue that by using the wake-up signals the energy consumption can be reduced significantly in a VoIP scenario. The use of sleep and wake-up schedules is used by Namboodiri et al. [150] for energy saving during VoIP calls. The authors propose a GreenCall algorithm that keeps the WLAN interface of a laptop in sleep mode for significant periods during the VoIP calls. The maximum delay that a user can tolerate during a call is used to compute the sleep periods.

Saha et al. [151] conducted a detailed experimental study to investigate the power consumption in various states of the IEEE 802.11n/ac wireless interface and the trade-off between the throughput and power consumption in modern smartphones, such as Google Nexus S, Samsung Galaxy S3, Samsung Galaxy S4, and Samsung Galaxy S5. By studying the impact of different characteristics of 802.11n/ac on power consumption the authors conclude that the most power efficient option is to increase the modulation and coding schemes (MCS) and the least power efficient is to increase the channel width. Moreover, the authors argue that the more recent smartphone models are not necessarily more power efficient.

D. Cross Layer Solutions for Energy Conservation

Another efficient approach to reduce the energy consumption for multimedia transmission over wireless networks is the use of cross layer solutions combining the underlying network characteristics with video-based and device related parameters.

Li et al. in [152] propose joint optimization of video coder parameters, channel coder, and transmit power in order to minimize the power consumption in video transmission. Their results indicate that when transmitting over a slow fading wireless channel, the solution is very efficient and effective in terms of energy-efficiency. The consideration of more realistic channel models is part of their future work.

The authors in [153] propose a power savings cross layer solution for an adaptive multimedia delivery mechanism based on remaining battery level, remaining video stream duration, and packet loss rate level. The mechanism decides whether or not to adapt the multimedia stream in order to achieve power saving while maintaining good user perceived quality levels.

Song et al. [154] propose a novel cross-layer quality-oriented energy-efficient scheme for multimedia delivery applications, referred to as Q-PASTE. Q-PASTE operates near the user and shares information between the application and MAC layers for wise wireless network interface card scheduling to provide maximum energy efficiency and high QoS.

Another cross-layer optimization framework to improve the energy efficiency as well as the QoE within wireless multimedia broadcast networks is proposed in [155]. The authors consider the varying display types and energy constraints of the multimedia broadcast receives and propose a framework that combines the user composition-aware source coding rate (SVC) optimization, optimum time slicing for layer coded transmission, and a cross-layer adaptive modulation and coding scheme (MCS) for joint optimisation of QoE and energy efficiency. The authors argue that by using time slicing along with user heterogeneity and channel aware MCS energy consumption is significantly reduced and QoE increased.

Lu et al. [156] propose QP-CEE, a QoE perceptive cross-layer energy efficient scheme for video transmission on mobile devices. The authors model the energy efficiency problem as a joint optimization problem for QoE and energy consumption. The chaos particle swarm optimization algorithm is used to search for the optimal power level and video encoding rate. Thus, by dynamically adjusting the transmitting power level, modulation and coding scheme, and encoding bitrate of the video stream the energy consumption is reduced and the QoE is ensured. The authors validate the performance of the proposed solution through Matlab simulations.

E. Energy Efficient Multimedia Processing and Delivery

Baker et al. [157] propose a power saving mechanism at the decoding stage. The power-aware technique aims at reducing the decoding computation required for H.264 streams by using macro-block prioritization. This is done by allocating block priority levels in each frame of the video content, and omitting them, based on the allocated priority, at the decoder side. In this way the low priority block will be ignored by the decoder leading to decrease in computational workload.

Another technique that explores the energy saving in multimedia streaming is brightness compensation [158], [159], [160]. The authors in [158], [159] propose the use of a proxy server that performs on-the-fly transcoding and dynamic adaptation of the video content (brightness compensation) based on the feedback from the client. The proxy server will send back the control information to the client middleware which will change its system parameters (e.g., operating backlight level) accordingly. In [160] the authors propose a similar approach and model the problem as a dynamic backlight scaling optimization in order to determine the appropriate video content backlight level. The authors show that when the energy consumption presents a monotonic increase with the backlight level, their proposed algorithm is optimal in terms of energy savings.

Yang et al. [161] proposed a contrast-aware backlight control framework that enhances the brightness of the image displayed while dimming the brightness of the backlight of the device screen. Experimental measurements on an Acer Liquid S1 mobile device show that the proposed framework can decrease by up to 10-40% of the backlight brightness with 8-25% power savings while maintaining a good visual display quality.

Liu et al. [162] propose an energy efficient video streaming system that combines SVC and backlight control. The authors make use of a non-parametric signal prediction to forecast the network conditions and adjust the SVC encoder parameters accordingly. Moreover, to compensate for the image contrast loss after reducing the backlight, a histogram equalization is applied. The solution was implemented and tested under an experimental test-bed and two HTC Desire S smartphones. The results show that depending on the video content, (e.g., relatively static video scenes) the proposed solution can achieve energy saving ratios of up to 35%.

Varghese et al. [163] propose an eDASH player that makes use of bitrate and video brightness adaptation to determine the next chunk to download. Experimental measurements were conducted to quantify the power consumption of video streaming for a Samsung Galaxy S3. The authors argue that up to 45% energy savings could be achieved without significant impact on the end-user QoE.

Another solution that combines the use of adaptive coding and backlight control was proposed by Leu et al. in [164]. The authors use a network prediction scheme to predict the next step's network quality and adapt the video quality accordingly. Experimental measurements were conducted on a HTC Desire S smartphone and the authors concluded that the energy saving ratio relies on the video content. The authors argue that the energy savings are higher when the video scenes are relatively stationary.

F. Discussions

Until recently, there were not many concerns about the energy consumed by the Information and Communication Technologies (ICTs) and their impact on the environment and the main focus was on their performance and cost. However, the advances in technologies and the increasing emissions of

carbon dioxide (CO₂) shifted the focus of ICT towards energy efficient solutions. With the current trends, one can assume that the carbon emissions and the amount of energy consumption will continue to increase [165]. According to the SMART 2020 study [166], the CO₂ emissions of ICT present a 6% increase per year and it is expected to reach 12% of the worldwide emissions by 2020.

The current heterogeneous wireless environment consists of a dense deployment of different radio access technologies that differ in protocols, coverage, capacity, delay, available bandwidth which is essential to handle the current traffic demands. In turn, this led to energy consumption increases both at the network side and mobile client side representing one of the main current challenges with remarkable attention from both the industry and academia [167], [168], [169]. In an attempt to handle the energy efficiency, the Greentouch consortium [170] as well as major European projects like EARTH [171] and Mobile VCE [172] focused their aim on designing and implementing novel approaches for green operation of wireless networks at the system level. However, their attention was only on the optimization of homogeneous wireless systems.

The interworking of the wireless heterogeneous networks may increase the network capacity and performance and may enable seamless mobility for mobile devices, but at the cost of additional energy consumption especially at the mobile device side. This represents an important issue as mobile devices depend on their batteries lifetime limiting their running time. While the processing power doubles almost every two years according to the Moores law the progress in batteries did not even double over the last decade [173]. Thus, the bottleneck of the mobile and wireless systems is not only the transmission rate, but the energy limitation of the mobile devices, especially with the increase in rich multimedia-based services known to be energy-hungry services [174].

Many studies [123], [124], [125], [126], [127], [128] have tried to understand the energy consumption pattern of different mobile devices under various conditions such as different radio access technologies, dynamic network conditions, time, mobility and applications and tried to model it mathematically. In case of multimedia-based streaming applications more energy will be consumed for de/encoding, data processing and displaying making the display screen, CPU and network interface the three major components to be the most significant energy consumers within a mobile device [123]. Trying to find a trade-off between the energy consumption and the quality of the multimedia streaming services different solutions are proposed at various points in the transmission chain, such as: de/encoding, reception, display (brightness compensation), transmission modes (ON/OFF), adaptive video transmission, or interface switching (handover/network selection), etc.

In order to tackle the energy efficiency problem within a heterogeneous wireless networks environment many energy-centric solutions have been proposed with the main focus on selecting the best-value network from a pool of available networks. However, apart from selecting the most energy efficient network the next important step is the handover process, where the mobile device is changing its point of attachment from

one network to another. The handover procedure enables the mobile devices to dynamically associate with the most suitable radio access network among the available ones.

Within a heterogeneous wireless environment the mobile devices continuously seek channels to initiate either horizontal or vertical handover. In this context, an important factor in minimizing the energy consumption while still providing essential QoS, is the design of energy-aware well-performed vertical handover procedures. Moreover, the duration and accuracy of a handover process is crucial for energy efficiency. This is because, if a mobile device performs an improper association to a new network it may end up consuming even more energy than before until a proper association, if ever, is performed. To this extent, a general accepted opinion is that the Wi-Fi network interface is the least power consuming interface, whereas LTE and WiMAX seem to present similar power consumption for the same amount of throughput while the 3G interface consumes less power than both LTE and WiMAX [175].

However, when analysing the power consumption there are many factors involved, such as: received signal strength, interference, bit error rate, protocol, channel utilization, number of connected stations, etc. In this regard, a comparison is proposed in Table IX to summarize the features and amount of energy savings of some of the proposed energy-centric vertical handover solutions from the literature. A more comprehensive survey on energy-efficient vertical handover solutions can be found in [176].

VII. MULTIPATH MULTIMEDIA DELIVERY SOLUTIONS

The modern rise in the use of video-based applications such as Facebook Live, Instagram Stories, Snapchat, Facetime, etc. puts pressure on the existing network infrastructure and pressurises the network operators to come up with new solutions for network expansions. Moreover, with the emerging high-definition digital media formats, such as 4K and 8K that require a large amount of bandwidth, no one single access network technology would be able to accommodate these new traffic demands. One solutions in accommodating these high bandwidth multimedia-based application would be to split the traffic over multiple paths. As it is common for the high end mobile devices to have multiple heterogeneous network interfaces (e.g., Wi-Fi, cellular, bluetooth, etc.) we can anticipate that the upcoming 5G standard is expected to integrate multipathing.

A. MPTCP-based Solutions

One widespread solution for multipathing is the use of Multipath TCP (MPTCP) [189], [190], [191] which has been standardized by the Internet Engineering Task Force (IETF). MPTCP represents a major modification to TCP that enables the use of multiple paths simultaneously using a single transport connection. Apart from the congestion problem, MPTCP also solves the fairness issue when competing with TCP.

The congestion algorithms adopted by MPTCP makes use of packet loss to undertake load balancing and congestion control. However, the wireless environment is very dynamic

TABLE IX: Energy-Centric Vertical Handover Solutions - Summary

Ref	Operation	Parameters	Decision Strategy	Networks	Energy Gain
[167]	Prediction-based	Energy Cognitive Cycle	Dynamic selection of different strategies	any RATs	High
[174]	Estimation-based	RSS, Channel scanning, switching cost, CBT, traffic type, number of STA., WNIC power	Expected Energy Consumption Model	Wi-Fi 3G	Very high
[177]	Prediction-based	energy, QoS, RSS	Function-based	Any RATs	High
[178]	Estimation-based	user preferences, QoS, energy consumption, RSS	Fuzzy-logic Topsis	Any RATs	Very high
[179]	Estimation-based	SINR, list of cand. PoAs, WNIC power	expected energy-cons. model	LTE-A - Wi-Fi	Very high
[180]	Prediction-based	WNIC power, list of av. PoAs, locations, GPS	Context-aware	WiMax - Wi-Fi	Medium
[181]	Prediction-based	WNIC power, RSS, traffic load	Function-based	Wi-Fi 3G	Very high
[182]	Estimation-based	Data rate, WNIC power, data transfer delay	Expected Energy Consumption Model	3G Wi-Fi	High
[183]	Prediction-based	Bandwidth, jitter, BER, delay, cost, battery lifetime	Multi Attribute Decision Making (MADM)	CDMA, WiBro, Wi-Fi	High
[184]	Estimation-based	Channel fading fluctuations, BER, WNIC power, Channel scanning, VHO cost	MADM	Wi-Fi - WiMax	Very high
[185]	Prediction-based	SINR, network congestion, offered QoS, battery lifetime, user preferences	Context-aware	Any RATs	Medium
[186]	Prediction-based	battery status, QoS, Application type, energy consumed per bit	Function-based	Any RATs	Medium
[187]	Measurement-based	SINR, SINR fluctuations, congestion, battery lifetime, QoS	SINR measurement-based	Any RATs	Low
[188]	Prediction-based	RSS, data rate, monetary cost, speed, battery level	Fuzzy logic	Any RATs	Low

and loss might happen because of the wireless errors or handover rather than congestion. Thus, the MPTCP congestion control mechanism might be trigger when not needed and this may cause sever performance degradation. To overcome this situation, Dong et al. [192] propose mVeno, an enhanced MPTCP congestion control mechanism for concurrent multipath transfer over wireless networks. mVeno makes use of the fluid flow model and utility theory to model the relationship between the sending rate and the end-to-end packet loss rate. The proposed mechanism defines and adaptively adjusts weights for different subflows for rate control and load balancing while enabling fairness with regular TCP at the shared bottleneck. The performance of the proposed solution was validated through experiments under a real test-bed and compared against other algorithms from the literature.

Even though MPTCP offers a fully-reliable and fully-ordered service, it does not consider the application characteristics in terms of QoS requirements. For example, in case of multimedia applications where some loss can be tolerated, the perceived audio/video quality can be preserved despite packet loss. To this extent, Diop et al. [193] implement the concept of partial reliability in MPTCP for interactive video application based on the H.264 codec. The proposed concept avoids packet retransmission within an acceptable loss rate. The proposed QoS-oriented MPTCP was implemented in NS-2 and compared against classical MPTCP, TCP and UDP in terms of packet loss, delay and PSNR. However, the authors used a simple simulated network topology trying to simulate only the theoretical 3G+ network characteristics for performance evaluation.

Moreover, Cao et al. [194] argue that the partial reliability MPTCP only focuses on how MPTCP switches to PR-MPTCP extension and does not consider when the partially reliable service should be enabled over the MPTCP session.

To this extent, the author propose a context-aware QoE-oriented MPTCP Partial Reliability extension, referred to as PR-MPTCP+ for real multimedia applications. PR-MPTCP+ is context-aware so that the sender will be informed when to enable the partially reliable service over an MPTCP session. Moreover, PR-MPTCP+ makes use of the inter-frame priority, the lifetime-constrained nature of the multimedia frames and the varying network conditions to adaptively distribute the multimedia stream. The proposed solution was implemented in NS-3 and tested under a simple heterogeneous wireless environment consisting of Wi-Fi and WiMax. The authors argue that PR-MPTCP+ outperforms MPTCP and another partial reliability MPTCP solution in terms of PSNR, VQM and SSIM.

By using multiple paths simultaneously through MPTCP the overall network performance can be greatly improved, however this comes at the cost of higher energy consumption. The problem of energy efficiency for MPTCP was investigated in the literature [195], [196], [197], [198], [199], [200], [201]. Peng et al. [195] investigate the trade-off between throughput performance and energy consumption for mobile devices. In this context, the authors formulate global optimisation problems for two types of applications, such as video streaming and file transfer. The problems are solved in two steps: first a subset of optimal paths is selected so that a congestion control algorithm to adapt the rates on these paths based on both network congestion and energy consumption. A theoretical model for power consumption is used and the authors argue that the proposed solution can achieve up to 22% energy savings without throughput sacrifice when compared to baseline MPTCP.

Wu et al. [196], [197] propose EDAM, an energy-distortion aware MPTCP solution for heterogeneous wireless networks. The authors make use of utility maximization theory to model

a video flow rate allocation algorithm that minimizes the energy consumption while maintaining the targeted video quality. The performance evaluation shows that for the same video quality EDAM can achieve 26.3% and 40.6% energy savings when compared to the energy-based MPTCP from [195] and a baseline MPTCP, respectively.

Another energy-aware MPTCP-based content delivery scheme is eMPTCP proposed in [198]. eMPTCP is located at the mobile device side and increases the energy savings by offloading the traffic from the more energy-consuming interfaces to others. eMPTCP was implemented in NS-3 and compared against baseline MPTCP and single-path TCP in terms of throughput, energy and PSNR. The results show that eMPTCP can achieve up to 14% in energy savings when compared to MPTCP and up to 66% increase in PSNR when compared to single-path TCP.

Lim et al. [199], [200] use experimental measurements to develop a model for MPTCP energy consumption. The energy model is then used to propose an energy efficient MPTCP solution referred to as eMPTCP. The authors argue that eMPTCP achieves up to 8% more energy efficiency than baseline MPTCP.

Using the utility theory Minear et al. [201] formulate an optimization problem to determine the optimal relation between throughput and energy consumption for MPTCP. The authors determine the conditions under which MPTCP is more energy-efficient than single-path TCP using the power consumption measurements from [199], [200].

An overview of the energy efficient MPTCP-based solutions is presented in Table X.

B. Other Multipath Solutions

Apart from MPTCP, another transport protocol that supports multiple paths for multistreaming and multihoming is Stream Control Transmission Protocol (SCTP) [204]. However, the baseline SCTP does not support simultaneous data transfer over the multiple paths as they are considered just as backup for the primary path. To this extent, the SCTP extension, referred to as Concurrent Multipath Transfer (CMT-SCTP) [205] enables the simultaneous use of multiple paths.

However, SCTP has not been as widely deployed as MPTCP especially because it requires changes at the application layer and the data traffic might be blocked by middle boxes or firewalls. Whereas, MPTCP does not require application layer modifications and uses traditional TCP packets, making it the preferable choice.

On one side, using multiple parallel transmissions has the benefit of increasing the throughput. However, on the other side, because of different characteristics of the multiple paths (e.g., available bandwidth, delay, etc.) it might cause the receiver to receive the data out of order creating serious application-level performance degradation, especially for video streaming. To mitigate this effect, Xu et al. [206] propose a quality-aware adaptive concurrent multipath transfer (CMT-QA) solution. By periodically monitoring the multiple paths, CMT-QA selects only the qualified paths and distributes data chunks over these paths based on their different handling

capabilities mitigating the out of order data reception. Performance evaluation results show that for real time video delivery, CMT-QA could achieve up to 54.2% decrease in dropped frames when compared to baseline CMT.

Studying the multihomed high definition video communication with SCTP over heterogeneous wireless networks, Wu et al. [207] argue that the existing CMT-based schemes cannot effectively use the wireless resources for user perceived video quality maximization as they treat the data traffic in a content-agnostic fashion. To this extent, the authors propose a content-aware CMT (CMT-CA) solution which implements an unequal frame-level scheduling by identifying the video frame parameters. Using an online quality evaluation and the Markov decision process (MDP) the authors also propose a joint congestion control and data distribution scheme to minimize the total distortion of parallel video transmission over multiple wireless access networks. Using experimental tests CMT-CA was compared against CMT-QA [206] and the authors' previous solution distortion-aware CMT (CMT-DA) [208] in terms of PSNR, end-to-end video frame delay and goodput. The results show that CMT-CA achieves higher and smoother goodput and higher network utilization level than the other schemes.

Similarly Lee et al. [209] formulate a cost minimization problem for a multihomed mobile terminal that downloads and plays video-on-demand (VoD). The authors look into user's dissatisfaction due to playback disruptions and communication cost for downloading the VoD stream.

C. Available Implementations

Tachibana et al. [210] present a deployable CMT-SCTP scheme for seamless handover in the context of heterogeneous wireless access networks with off-the-shelf Android devices and protocol translation servers. Considering the scenario of mobile users joining/leaving the heterogeneous Wi-Fi networks frequently, the authors propose a modification of the dynamic address reconfiguration (DAR) extension of SCTP to ensure seamless handover. The solution was implemented on an Android mobile device and tested under a handover scenario between 3G/LTE and Wi-Fi. However, the proposed solution relies on a proxy function of the legacy Android application and cannot be applied to any applications if there is no support for the proxy function. To overcome this drawback, an improved version was proposed in [211]. The new solution, translates in a transparent manner the TCP flows into CMT-SCTP flows to avoid changes to the existing applications and legacy servers. The authors used a Sony Xperia (SOL21) to test the performance of their proposed approach under real experimental test-bed. The authors argue that the implementation works for *pre-installed Browser, Chrome, Firefox, Opera, Facebook, Youtube* and an FTP client application *FtpCafe*.

The IP Networking Lab in Belgium made available a Linux kernel implementation of Multipath TCP [212]. The authors provide a demo of their MPTCP Linux Kernel implementation over Ethernet/Wi-Fi/3G. A handover scenario is considered and the proposed deployment enables the continuity of the data session without interrupting the user-experience.

TABLE X: Energy Efficient MPTCP Solutions Summary

Ref	Mobile Device Energy	Networks	Application	Evaluation	Findings
[195]	power consumption model for mobile devices from [202]	Wi-Fi, 4G	video streaming, file transfer	simulations (simulator not mentioned)	22% energy savings for both applications without affecting the throughput when compared to a baseline MPTCP
[196]	energy consumption model for mobile devices from [203]	Cellular, WiMax, Wi-Fi	video streaming	emulation (Exata 2.1 network emulator)	26.3% and 40.6% energy savings compared to energy-based MPTCP [195] and baseline MPTCP, respectively for the same video quality. 25.5% and 39.3% increase in PSNR compared to the energy-based MPTCP [195] and baseline MPTCP, respectively for the same energy consumption.
[198]	NS-3 energy model	LTE, Wi-Fi	video streaming	simulations (Network Simulator ns-3)	eMPTCP achieves 14% energy savings compared to baseline MPTCP at the cost of 5.54dB drop in PSNR. Whereas, compared to single-path TCP there is a 66% and 13% increase in PSNR over Wi-Fi and LTE respectively.
[199]	energy model derived by the authors from experimental measurements on Samsung Galaxy S3	LTE, Wi-Fi	file download	experimental test-bed (an MPTCP server [189], Wi-Fi, a Samsung Galaxy S3 running Linux MPTCP kernel, the AT&T LTE network)	eMPTCP achieves up to 8% and 6% energy savings compared to baseline MPTCP and single-path TCP over Wi-Fi, respectively. However, eMPTCP is 22% slower than MPTCP.
[201]	energy model based on the power consumption measurements from [199]	Wi-Fi, LTE	video streaming, file download	theoretical analysis (theoretically formulation of the optimization problem and prove the problem is NP hard)	In some cases the throughput and energy consumption can be concurrently improved.

The Center for Advanced Internet Architectures with support from Cisco Systems and The FreeBSD Foundation, implemented Multipath TCP for FreeBSD. An experimental kernel patch was released that enables MPTCP support for FreeBSD-10.x [213].

iOS 7 [214] from Apple is the first commercial software that offers support for Multipath TCP and allows the simultaneous Wi-Fi and cellular connections. Thus, if the Wi-Fi connection fails, the data connectivity will continue to work on the LTE connection without interrupting the service. As there is no special hardware required for the technology it enables the existing devices to use it as well.

Samsung also comes with a solution referred to as *Download Booster* [215], integrated into the Galaxy S5 devices. The Download Booster enables the use of LTE and Wi-Fi simultaneously to increase the download speed.

While MPTCP is quite widely accepted and deployed, the CMT-SCTP extension is only available for FreeBSD [216]. A comparison between the two implementations of MPTCP and CMT-SCTP by using lab measurements as well as inter-continental test-bed (e.g., Europe and China) is provided by Becke et al. [216]. The authors show that the path management of MPTCP outperforms the one of CMT-SCTP in case of asymmetric paths. However, the authors argue that MPTCP may face scalability problems in more complex scenarios.

D. Discussions

With the new emerging 4K Ultra High Definition standard, 3D applications, omnidirectional videos and other interactive rich multimedia-based technologies it is safe to assume that the next generation networks will require new mechanisms to accommodate this amount of traffic. One possible solution is the use of multipath delivery over heterogeneous wireless network environments. However, as multipath delivery solves the capacity demand problem it opens up new challenges in terms of energy efficiency.

Mobile device network connectivity represents one important aspect to consider when dealing with the energy consumption of a multi-interface mobile device. When multiple simultaneous connections are used, the bandwidth requirements are split among multiple networks which in turn will drain the battery of the mobile device even faster than a single connection, as it requires additional resources as well as processing power [217]. Apart from energy efficiency, another important aspect is the monetary cost. This is because having multiple simultaneous connections will involve more complicated pricing schemes for the operators especially if different radio access technologies are used. Thus, it is important for mobile operators to be able to control and monitor how much traffic traverses over each network.

Another important challenge that still remains an open issue is the multipath data delivery over dissimilar paths. Dissimilar paths are defined as the paths that have different characteristics, such as: available bandwidth, delay, queuing behaviour, etc. Dissimilar paths are very common within a heterogeneous wireless environment. A common problem to consider is the packet re-ordering problem which affects the end-user perceived quality especially for real-time applications. Because of the dynamics of the wireless environments, the characteristics of the radio link are more complex and unstable when compared to the wired connections. In this context, cross layer solutions could be used to improve the performance of concurrent multipath transmissions over wireless networks [218]. Other negative effects when using concurrent multipath transmissions are the unnecessary fast retransmissions due to short-term bandwidth fluctuations, the overly conservative congestion window growth and increased acknowledgement traffic [205].

Trying to answer the question of *which network should an application use? Wi-Fi, LTE, or MPTCP running over both?* Deng et al. [219] present a study with data collected from crowd-sourced mobile application run by 750 users over 180

days in 16 different countries. The key findings are as follows:

- LTE outperforms Wi-Fi 40% of the time;
- for applications dominated by short flows MPTCP performs worse than single-path TCP. Thus, in order to achieve good performance in MPTCP, it is critical to select the correct network for the primary subflow;
- for application with longer flows MPTCP performs better provided a proper MPTCP congestion control algorithm is being used.

Furthermore, based on the findings from their study the authors raise several new research questions which remain open:

- *how can we automatically decide when to use single path TCP and when to use MPTCP?*
- *How should we decide which network to use for TCP, or which network to use for a subflow with MPTCP?*

VIII. CHALLENGES, LESSONS LEARNT AND REMAINING OPEN ISSUES

The rapid increase in the popularity of live streaming applications, such as Facebook Live, Instagram Stories, etc. accessible from any mobile device, has led to an explosion of broadband data traffic that network operators are facing. In order to handle the wireless traffic explosion, accommodate more users and enable the QoS provisioning the network operators resorted to the deployment of a large number of small cells, forming a *Heterogeneous Wireless Networks environment*. However, apart from expanding their networks to accommodate more users, another key factor that must be considered is the users' *Quality of Experience* which will become the main differentiator when selecting between network operators. Two main factors that are enclosed in the QoE definition are the *user perceived quality* of the service as well as the *energy consumption* of their mobile device. Receiving a high quality multimedia stream will not be beneficial to the user if their mobile device runs out of battery this will negatively impact their QoE.

Moreover, with the environmental impact of the telecommunications industry CO₂ emissions expected to reach 4% of the total CO₂ emissions worldwide by 2020 [220], it puts pressure on the future 5G system requirements for high energy efficiency and low battery consumption, along with demand for higher capacity, higher data rates and higher spectral efficiency. Thus, *energy conservation* along with *Quality of Experience* have become a critical issue and represent motivations for researchers to propose and develop techniques to manage the energy consumption vs. QoE trade-off in future wireless multimedia networks.

Roaming through the heterogeneous wireless environment several techniques have been identified that could help at improving the users' QoE, such as: adaptive multimedia streaming solutions working in conjunction with various energy efficient solutions applied at different points of the video transmission chain.

From all the possible *adaptive streaming solutions*, one of the most popular method currently adopted by Microsoft, Apple, or Adobe to deliver high definition video content is the

adaptive bitrate switching approach where the server stores several copies of the same video encoded at different quality levels. The video transmission cost is mainly dominated by the cost of bandwidth. However, as the bitrate switching method requires increased storage space, it is efficient only when the number of active user sessions is high to compensate for the storage costs. Thus, this method could be used in conjunction with another adaptive multimedia solution, such as *scalable video coding* or *on-the-fly transcoding* that have lower storage requirements. In this case, the bitrate switching method could be used for the popular videos, whereas for low demand videos, where the number of active sessions is very small, SVC or on-the-fly transcoding could be used instead.

Another important challenge for adaptive multimedia streaming solutions is the fact that they mainly rely on the *network resources availability estimation* and/or the *buffer state* at the end-user side. Thus, they require efficient and reliable resource estimation techniques as inaccurate resource estimation could lead to poor network utilisation and performance degradation with a negative impact on users' QoE. Additionally, considering the dynamics of the wireless environment, loss discrimination methods should be integrated to efficiently differentiate between the congestion losses and losses due to wireless errors to avoid unnecessary adaptation of the multimedia stream. It has been shown that if the changes in video quality levels are too frequent this could lead to degradation of users' QoE [113].

In terms of *energy efficiency*, the battery lifetime of the mobile devices still remains a challenge. Despite the advances in technologies, with improved CPU, graphics and displays the progress in batteries did not even double over the last decade [173]. This represents a concern especially with the emerging of new rich multimedia-based services known to be the most energy-hungry of all applications [174]. Thus, apart from adjusting the video quality level to meet the battery level of the mobile device, other solutions are trying to conserve the energy by decoding, reception, display (brightness compensation), transmission modes (ON/OFF), or interface switching (handover/network selection), etc.

Considering the current heterogeneous environment, using a hybrid solution could bring more benefits. For example, by combining both adaptive multimedia delivery and network selection, it could balance the benefits of multimedia content adaptation and of network selection which could lead to decrease in power consumption [221]. Thus, under the dynamic wireless networks conditions, the mechanism could find the best trade-off between energy vs. quality by deciding either to adapt the multimedia stream or to handover to a new network and perform the adaptation.

Due to the dynamics of the heterogeneous wireless environment and the high variability in the available bandwidth, the multimedia transmission still suffers from stalls, startup delay and quality degradation. To this end, a promising solution is to combine the available bandwidth on multiple network interfaces and make use of multipath delivery [222]. James et al. [223] investigated the impact of MPTCP on DASH video streaming and concluded that it can improve the user experience under ample and stable bandwidth. However, if

an unstable secondary path is used, then MPTCP can harm the user experience and single path transmission is a better option. Thus, deciding when to use single path or multiple paths transmissions remains a challenge.

The use of MPTCP raises another interesting question related to its energy efficiency: *can MPTCP save energy?*. According to Kaup et al. [224], using MPTCP on certain smartphone models could actually save up to 20% energy compared to the case of using the interfaces individually. However, the authors suggest that multiple interfaces should be used only if using a single interface cannot provide the requested data rate.

Thus, to enable seamless multimedia delivery to a mobile user within a heterogeneous wireless environment with QoE provisioning, a hybrid mechanism is required that based on the contextual information, device heterogeneity and user preferences dynamically selects between single or multiple path transmissions as well as decides on the use of the adaptive multimedia solution that finds the best trade-off between energy vs. quality while the user is roaming through the heterogeneous environment.

Based on the presented surveyed topics we summarize the major lessons we learnt as follows:

- Quality of Experience will become the main differentiator when selecting between network operators.
- Combining different adaptive multimedia approaches could be more efficient. For example, using bitrate switching for popular videos and SVC or on-the-fly transcoding for low demand videos.
- The mobile device heterogeneity impacts severely the end-user QoE [127].
- The more recent smartphone models are not necessarily more power efficient [151] and accurate energy estimation models are required considering the device heterogeneity. For example, in the case of a smartphone used by the same user, user behavior-based battery lifetime estimation models could be defined, as they are more reliable [225]. However, this can not apply to devices shared between multiple users (e.g., laptops, tablets, etc.).
- Hybrid mechanisms work better in a heterogeneous environment enabling the energy vs. quality trade-off. For example, under dynamic wireless environment, a hybrid approach could decide whether to adapt the multimedia stream or to handover to a new network and perform the adaptation [221].
- Under ample and stable bandwidth, multipath delivery could improve the overall performance [223]. However, for energy efficiency multiple interfaces should be used only if a single interface cannot provide the requested data rate [224].

IX. CONCLUSIONS AND FUTURE RESEARCH DIRECTIONS

The 5G vision promises to enable the Internet of Everything from connected cars, smart cities, smart homes to rich multimedia mobile experiences such as ultra high definition video-conferences or virtual reality live streaming. Along with the advances in technologies the users' expectations and demands

are also increasing. Users are now expecting more interactive and personalised services on their mobile devices, with access from anywhere at anytime and from any device. This makes the Quality of Experience to be the biggest differentiator between network operators.

This article aims to familiarize the readers with the *Always Best Experience* concept and with the different state-of-the-art adaptive multimedia approaches from the literature. The current trending topics, technologies and protocols for multimedia transmissions are discussed along with standards and industry solutions that enable adaptive multimedia streaming. Moreover, a comprehensive survey of the current research on multimedia delivery considering a three-dimensional evaluation, such as: adaptation, energy efficiency and multipath delivery is presented. State-of-the-art solutions are summarized and classified and the remaining challenges and open issues are identified and discussed.

Despite the amount of research done in terms of seamless multimedia delivery over heterogeneous wireless environments, there are still many open issues to address before a viable real implementation will be globally accepted and deployed especially for ensuring users' *Always Best Experience*. Thus, to answer to our question *Are we there yet?* the answer would be *Not just yet*.

As the area of multimedia-based services and applications is continuously evolving several further research directions could be identified. For example, with the emerging high-definition digital media formats, such as 4K and 8K, augmented and virtual reality applications, omnidirectional videos, it is clear that a big change is coming in how we watch video. Thus, the use of adaptive streaming solutions in the new mediums like virtual reality represents an interesting research direction.

Another important aspect is the accuracy of measuring the video quality at scale. The importance of video quality has been recognised by Netflix as well, by proposing a new video quality assessment method referred to as Video Multimethod Assessment Fusion (VMAF). VMAF represents an attempt at improving the video quality assessment measures in order to deliver the best video quality streams to their customers. VMAF is based on a machine learning model that is trained and tested using the results of a subjective experiment. Thus, an interesting approach that is gaining strong momentum is the use of machine learning techniques to solve various optimization and control problems within the telecommunication systems including Quality of Experience provisioning for video transmissions [226], [227], [228], [229], [230], [231].

REFERENCES

- [1] Cisco, "Cisco Visual Networking Index: Global Mobile Data Traffic Forecast Update, 2016-2021," White Paper, Feb 2017. [Online]. Available: <http://www.cisco.com/c/en/us/solutions/collateral/service-provider/visual-networking-index-vni/mobile-white-paper-c11-520862.html>
- [2] E. Gustafsson and A. Jonsson, "Always Best Connected," *IEEE Wireless Communications*, vol. 10, no. 1, pp. 49-55, Feb 2003.
- [3] Google, "The New Multi-screen World: Understanding Cross-platform Consumer Behavior," Technical Report, August 2012. [Online]. Available: https://ssl.gstatic.com/think/docs/the-new-multi-screen-world-study_research-studies.pdf

- [4] O. B. Maia, H. C. Yehia, and L. de Errico, "A concise review of the quality of experience assessment for video streaming," *Computer Communications*, vol. 57, pp. 1–12, 2015.
- [5] T. Zhao, Q. Liu, and C. W. Chen, "QoE in Video Transmission: A User Experience-Driven Strategy," *IEEE Communications Surveys Tutorials*, vol. 19, no. 1, pp. 285–302, Firstquarter 2017.
- [6] P. Juluri, V. Tamarapalli, and D. Medhi, "Measurement of Quality of Experience of Video-on-Demand Services: A Survey," *IEEE Communications Surveys Tutorials*, vol. 18, no. 1, pp. 401–418, Firstquarter 2016.
- [7] S. Barakovic and L. Skorin-Kapov, "Survey and Challenges of QoE Management Issues in Wireless Networks," *Journal Comp. Netw. and Commun.*, vol. 2013, pp. 165 146:1–165 146:28, 2013.
- [8] J. Kua, G. Armitage, and P. Branch, "A Survey of Rate Adaptation Techniques for Dynamic Adaptive Streaming over HTTP," *IEEE Communications Surveys Tutorials*, vol. PP, no. 99, pp. 1–1, 2017.
- [9] M. Seufert, S. Egger, M. Slanina, T. Zinner, T. Hofeld, and P. Tran-Gia, "A Survey on Quality of Experience of HTTP Adaptive Streaming," *IEEE Communications Surveys Tutorials*, vol. 17, no. 1, pp. 469–492, Firstquarter 2015.
- [10] A. N. Moldovan, S. Weibelzahl, and C. H. Muntean, "Energy-Aware Mobile Learning: Opportunities and Challenges," *IEEE Communications Surveys Tutorials*, vol. 16, no. 1, pp. 234–265, First 2014.
- [11] N. Vallina-Rodriguez and J. Crowcroft, "Energy Management Techniques in Modern Mobile Handsets," *IEEE Communications Surveys Tutorials*, vol. 15, no. 1, pp. 179–198, First 2013.
- [12] L. Al-Kanj, Z. Dawy, and E. Yaacoub, "Energy-Aware Cooperative Content Distribution over Wireless Networks: Design Alternatives and Implementation Aspects," *IEEE Communications Surveys Tutorials*, vol. 15, no. 4, pp. 1736–1760, Fourth 2013.
- [13] M. A. Hoque, M. Siekkinen, and J. K. Nurminen, "Energy Efficient Multimedia Streaming to Mobile Devices: A Survey," *IEEE Communications Surveys Tutorials*, vol. 16, no. 1, pp. 579–597, First 2014.
- [14] J. Qadir, A. Ali, K. L. A. Yau, A. Sathiseelan, and J. Crowcroft, "Exploiting the Power of Multiplicity: A Holistic Survey of Network-Layer Multipath," *IEEE Communications Surveys Tutorials*, vol. 17, no. 4, pp. 2176–2213, Fourthquarter 2015.
- [15] M. Li, A. Lukyanenko, Z. Ou, A. Yi-Jski, S. Tarkoma, M. Coudron, and S. Secci, "Multipath Transmission for the Internet: A Survey," *IEEE Communications Surveys Tutorials*, vol. 18, no. 4, pp. 2887–2925, Fourthquarter 2016.
- [16] "End-user multimedia QoS categories," ITU-T Recommendation G.1010, International Telecommunication Union, November 2001.
- [17] Microsoft. (2010) IIS Smooth Streaming Technical Overview.
- [18] R. Fielding *et al.*, *Hypertext Transfer Protocol - HTTP/1.1*, 1999, RFC 2616. [Online]. Available: <http://www.w3.org/Protocols/rfc2616/rfc2616.html>
- [19] H. Schulzrinne, A. Rao, and R. Lanphier, *RFC2326 - Real Time Streaming Protocol (RTSP)*, Std. rfc2326, April 1998. [Online]. Available: <http://www.ietf.org/rfc/rfc2326.txt>
- [20] H. Schulzrinne, S. L. Casner, R. Frederick, and V. Jacobson, "RTP: A Transport Protocol for Real-Time Applications," Internet RFC 3550, July 2003.
- [21] M. Carnec, P. L. Callet, and D. Barba, "Full reference and reduced reference metrics for image quality assessment," in *Seventh International Symposium on Signal Processing and Its Applications, 2003. Proceedings.*, vol. 1, July 2003, pp. 477–480 vol.1.
- [22] "Subjective Video Quality Assessment Methods for Multimedia Applications," ITU-T Recommendation P.910, International Telecommunication Union, September 1999.
- [23] A. N. Moldovan, I. Ghergulescu, and C. H. Muntean, "VQAMap: A Novel Mechanism for Mapping Objective Video Quality Metrics to Subjective MOS Scale," *IEEE Transactions on Broadcasting*, vol. 62, no. 3, pp. 610–627, Sept 2016.
- [24] S. B. Lee, G. M. Muntean, and A. F. Smeaton, "Performance-Aware Replication of Distributed Pre-Recorded IPTV Content," *IEEE Transactions on Broadcasting*, vol. 55, no. 2, pp. 516–526, June 2009.
- [25] Ascom, "Video Streaming Quality Measurement with VSQI," TEMS, Technical Paper, 2009. [Online]. Available: <http://www.cn.ascom.com/cn/vsqi.pdf>
- [26] S. Chikkerur, V. Sundaram, M. Reisslein, and L. J. Karam, "Objective Video Quality Assessment Methods: A Classification, Review, and Performance Comparison," *IEEE Transactions on Broadcasting*, vol. 57, no. 2, pp. 165–182, June 2011.
- [27] S. Toprak and Y. Yalman, "A new full-reference image quality metric based on just noticeable difference," *Computer Standards and Interfaces*, vol. 50, pp. 18–25, 2017.
- [28] N. Ponomarenko, F. Silvestri, K. Egiazarian, M. Carli, J. Astola, and V. Lukin, "On between-coefficient contrast masking of DCT basis functions," in *Proceedings of the Third International Workshop on Video Processing and Quality Metrics for Consumer Electronics (VPQM)*, 1 2007, pp. 25–26.
- [29] Z. Wang, L. Lu, and A. C. Bovik, "Video quality assessment based on structural distortion measurement," *Sig. Proc. Image Comm.*, vol. 19, no. 2, pp. 121–132, 2004.
- [30] Z. Wang, E. P. Simoncelli, and A. C. Bovik, "Multiscale structural similarity for image quality assessment," in *The Thirty-Seventh Asilomar Conference on Signals, Systems Computers, 2003*, vol. 2, Nov 2003, pp. 1398–1402 Vol.2.
- [31] H. R. Sheikh and A. C. Bovik, "Image information and visual quality," *IEEE Transactions on Image Processing*, vol. 15, no. 2, pp. 430–444, Feb 2006.
- [32] "Transparent end-to-end Packet-switched Streaming Service (PSS); Protocols and codecs," 3GPP TS 26.234.
- [33] "Transparent end-to-end Packet-switched Streaming Service (PSS); Progressive Download and Dynamic Adaptive Streaming over HTTP (3GP-DASH)," 3GPP TS 26.247.
- [34] "HTTP Adaptive Streaming V2.1," OIPF Specification Volume 2a, 2011.
- [35] *ISO-IEC_23001-6: Dynamic adaptive streaming over HTTP (DASH)*, Workgroup, MPEG Std., 2011.
- [36] D. F. Brueck and M. B. Hurst, "Apparatus, system, and method for multi-bitrate content streaming," U.S. Patent US8402156 B2, 2013.
- [37] F. Wu, S. Li, X. Sun, and Y.-Q. Zhang, "Seamless switching of scalable video bitstreams," U.S. Patent US7830958 B2, 2010.
- [38] D. Hassoun, "Dynamic stream switching with Flash Media Server 3." [Online]. Available: http://www.adobe.com/devnet/flashmediaserver/articles/dynamic_stream_switching.html
- [39] J. Padhye, J. Kurose, D. Towsley, and R. Koodli, "A Model Based TCP-Friendly Rate Control Protocol," in *in the 9th International Workshop on Network and Operating Systems Support for Digital Audio and Video (NOSSDAV'1999)*, 1999.
- [40] S. Floyd, M. Handley, J. Padhye, and J. Widmer, "Equation-based congestion control for unicast applications," in *SIGCOMM*, 2000, pp. 43–56.
- [41] —, "TCP Friendly Rate Control (TFRC): Protocol Specification," RFC 5348 (Proposed Standard), Internet Engineering Task Force, September 2008. [Online]. Available: <http://www.ietf.org/rfc/rfc5348.txt>
- [42] R. Rejaie, M. Handley, and D. Estrin, "RAP: An end-to-end rate-based congestion control mechanism for realtime streams in the Internet," in *INFOCOM '99. Eighteenth Annual Joint Conference of the IEEE Computer and Communications Societies. Proceedings. IEEE*, vol. 3, Mar 1999, pp. 1337–1345 vol.3.
- [43] D. Sisalem and A. Wolisz, "LDA+ TCP - Friendly Adaptation: A Measurement and Comparison Study," in *in the 10th International Workshop on Network and Operating Systems Support for Digital Audio and Video (NOSSDAV'2000)*, 2000, pp. 25–28.
- [44] M. A. Talaat, G. M. Attiya, and M. A. Koutb, "Enhanced TCP-friendly rate control for supporting video traffic over internet," *Canadian Journal of Electrical and Computer Engineering*, vol. 36, no. 3, pp. 135–140, Summer 2013.
- [45] Z. Song, Y. Zhang, and M. Zhou, "Enhanced TFRC congestion control mechanism based on refined network states division," in *2015 IEEE China Summit and International Conference on Signal and Information Processing (ChinaSIP)*, July 2015, pp. 938–942.
- [46] A. Sterca, H. Hellwagner, F. Boian, and A. Vancea, "Media-Friendly and TCP-Friendly Rate Control Protocols for Multimedia Streaming," *IEEE Transactions on Circuits and Systems for Video Technology*, vol. 26, no. 8, pp. 1516–1531, Aug 2016.
- [47] G. Yang, T. Sun, M. Gerla, M. Y. Sanadidi, and L.-J. Chen, "Smooth and efficient real-time video transport in the presence of wireless errors," *TOMCCAP*, vol. 2, no. 2, pp. 109–126, 2006.
- [48] S. Cen, P. C. Cosman, and G. M. Voelker, "End-to-end differentiation of congestion and wireless losses," *IEEE/ACM Transactions on Networking*, vol. 11, no. 5, pp. 703–717, Oct 2003.
- [49] M. Chen and A. Zakhor, "Rate control for streaming video over wireless," *IEEE Wireless Communications*, vol. 12, no. 4, pp. 32–41, Aug 2005.
- [50] B. Y. Choi, S. Song, Y. Wang, and E. K. Park, "Using RTT Variability for Adaptive Cross-Layer Approach to Multimedia Delivery in Heterogeneous Networks," *IEEE Transactions on Multimedia*, vol. 11, no. 6, pp. 1194–1203, Oct 2009.

- [51] C. Bouras, A. Gkamas, V. Kapoulas, V. Papapanagiotou, K. Stamos, and G. Zaoudis, "Video transposition over TFRC using cross-layer power management," pp. 333–337, Sept 2009.
- [52] D. Kim and K. Chung, "Adaptive packet transmission scheme to improve video streaming for multi-homed devices," in *2013 IEEE Globecom Workshops (GC Wkshps)*, Dec 2013, pp. 525–530.
- [53] S. Park, D. Kim, C. M. Yang, and C.-J. Song, "A packet scheduling scheme for seamless transmission of life media contents," in *2016 Eighth International Conference on Ubiquitous and Future Networks (ICUFN)*, July 2016, pp. 478–480.
- [54] R. Rejaie, M. Handley, and D. Estrin, "Layered quality adaptation for Internet video streaming," *IEEE Journal on Selected Areas in Communications*, vol. 18, no. 12, pp. 2530–2543, Dec 2000.
- [55] J.-W. Ding, Z.-Y. Chen, W.-T. Lee, and W.-M. Chen, "Adaptive bandwidth allocation for layered video streams over wireless broadcast channels," in *Fourth International Conference on Communications and Networking in China (ChinaCOM)*, 2009.
- [56] M. Zink, J. Schmitt, and R. Steinmetz, "Layer-encoded video in scalable adaptive streaming," *IEEE Transactions on Multimedia*, vol. 7, no. 1, pp. 75–84, Feb 2005.
- [57] M. Qin and R. Zimmermann, "Improving mobile ad-hoc streaming performance through adaptive layer selection with scalable video coding," in *ACM Multimedia*, R. Lienhart, A. R. Prasad, A. Hanjalic, S. Choi, B. P. Bailey, and N. Sebe, Eds. ACM, 2007, pp. 717–726.
- [58] C.-W. Huang, S. Sukittanon, J. A. Ritcey, A. Chindapol, and J.-N. Hwang, "An Embedded Packet Train and Adaptive FEC Scheme for VoIP Over Wired/Wireless IP Networks," in *2006 IEEE International Conference on Acoustics Speech and Signal Processing Proceedings*, vol. 5, May 2006, pp. V–V.
- [59] M. van der Schaar, S. Krishnamachari, S. Choi, and X. Xu, "Adaptive cross-layer protection strategies for robust scalable video transmission over 802.11 WLANs," *IEEE Journal on Selected Areas in Communications*, vol. 21, no. 10, pp. 1752–1763, Dec 2003.
- [60] E. Piri, T. Sutinen, and J. Vehkaper, "Cross-layer architecture for adaptive real-time multimedia in heterogeneous network environment," in *2009 European Wireless Conference*, May 2009, pp. 293–297.
- [61] C. Krasic, J. Walpole, and W. chi Feng, "Quality-adaptive media streaming by priority drop," in *NOSSDAV*, C. Papadopoulos and K. C. Almeroth, Eds. ACM, 2003, pp. 112–121.
- [62] A. Balachandran, V. Sekar, A. Akella, S. Seshan, I. Stoica, and H. Zhang, "Developing a Predictive Model of Quality of Experience for Internet Video," *SIGCOMM Comput. Commun. Rev.*, vol. 43, no. 4, pp. 339–350, Aug. 2013.
- [63] S. Chen, J. Yang, Y. Ran, and E. Yang, "Adaptive Layer Switching Algorithm Based on Buffer Underflow Probability for Scalable Video Streaming Over Wireless Networks," *IEEE Transactions on Circuits and Systems for Video Technology*, vol. 26, no. 6, pp. 1146–1160, June 2016.
- [64] L. Wu, Y. Zhong, W. Zhang, and M. Haenggi, "Scalable Transmission Over Heterogeneous Networks: A Stochastic Geometry Analysis," *IEEE Transactions on Vehicular Technology*, vol. 66, no. 2, pp. 1845–1859, Feb 2017.
- [65] M. Ghermezcheshmeh, V. Shah-Mansouri, and M. Ghanbari, "Transmission of scalable video coding over heterogeneous cellular networks," in *2016 IEEE 27th Annual International Symposium on Personal, Indoor, and Mobile Radio Communications (PIMRC)*, Sept 2016, pp. 1–6.
- [66] N. Yeadon, F. Garcia, D. Hutchison, and D. Shepherd, "Filters: QoS support mechanisms for multipeer communications," *IEEE Journal on Selected Areas in Communications*, vol. 14, no. 7, pp. 1245–1262, Sep 1996.
- [67] T. Takaoka, I. Nagayoshi, T. Hanamura, and H. Tominaga, "Network adaptive rate control for transcoder," in *2005 13th European Signal Processing Conference*, Sept 2005, pp. 1–4.
- [68] M. Prangl, I. Kofler, and H. Hellwagner, "Towards QoS Improvements of TCP-Based Media Delivery," in *Fourth International Conference on Networking and Services (icns 2008)*, March 2008, pp. 188–193.
- [69] M. Vijaykumar and S. Rao, "A cross-layer frame work for adaptive video streaming over wireless networks," in *2010 International Conference on Computer and Communication Technology (ICCCCT)*, Sept 2010, pp. 331–336.
- [70] M. Hiromoto, H. Tsutsui, H. Ochi, T. Osano, N. Ishikawa, and Y. Nakamura, "Dynamic Rate Control for Media Streaming in High-Speed Mobile Networks," in *2009 IEEE Wireless Communications and Networking Conference*, April 2009, pp. 1–6.
- [71] X. Wang, Y. Zhang, H. Li, and W. Zhu, "Adaptive rate control for dynamic bandwidth in video transcoding," in *2008 11th IEEE Singapore International Conference on Communication Systems*, Nov 2008, pp. 773–777.
- [72] M. Medagama, D. Dias, and S. Fernando, "Transcoding based optimum quality video streaming under limited bandwidth," in *2009 International Conference on Industrial and Information Systems (ICIIS)*, Dec 2009, pp. 62–67.
- [73] D. Chattopadhyay, A. Sinha, T. Chattopadhyay, and A. Pal, "Adaptive rate control for H.264 based video conferencing over a low bandwidth wired and wireless channel," pp. 1–6, May 2009.
- [74] A. E. Essaili, S. Khan, W. Kellerer, and E. Steinbach, "Multiple Description Video Transcoding," in *2007 IEEE International Conference on Image Processing*, vol. 6, Sept 2007, pp. VI – 77–VI – 80.
- [75] C. Timmerer, D. Weinberger, M. Smole, R. Grandl, C. Mller, and S. Lederer, "Live transcoding and streaming-as-a-service with MPEG-DASH," in *2015 IEEE International Conference on Multimedia Expo Workshops (ICMEW)*, June 2015, pp. 1–4.
- [76] L. Wei, J. Cai, C. H. Foh, and B. He, "QoS-Aware Resource Allocation for Video Transcoding in Clouds," *IEEE Transactions on Circuits and Systems for Video Technology*, vol. 27, no. 1, pp. 49–61, Jan 2017.
- [77] G. M. Muntean, P. Perry, and L. Murphy, "A new adaptive multimedia streaming system for all-IP multi-service networks," *IEEE Transactions on Broadcasting*, vol. 50, no. 1, pp. 1–10, March 2004.
- [78] R. K. P. Mok, X. Luo, E. W. W. Chan, and R. K. C. Chang, "QDASH: A QoE-aware DASH System," in *Proceedings of the 3rd Multimedia Systems Conference*, ser. MMSys '12. New York, NY, USA: ACM, 2012, pp. 11–22.
- [79] H. Mukhtar, M. Hassan, and T. Landolsi, "A Multi-Level Adaptive Scheme for Multimedia Transmission over Wireless Channels," in *2010 7th IEEE Consumer Communications and Networking Conference*, Jan 2010, pp. 1–5.
- [80] T. Schierl, T. Wiegand, and M. Kampmann, "3GPP compliant adaptive wireless video streaming using H.264/AVC," in *IEEE International Conference on Image Processing 2005*, vol. 3, Sept 2005, pp. III–696–9.
- [81] X. Qiu, H. Liu, D. Li, S. Zhang, D. Ghosal, and B. Mukherjee, "Optimizing HTTP-based Adaptive Video Streaming for wireless access networks," in *2010 3rd IEEE International Conference on Broadband Network and Multimedia Technology (IC-BNMT)*, Oct 2010, pp. 838–845.
- [82] P. Wisniewski, A. Beben, J. M. Batalla, and P. Krawiec, "On delimiting video rebuffering for stream-switching adaptive applications," in *2015 IEEE International Conference on Communications (ICC)*, June 2015, pp. 6867–6873.
- [83] J. M. Batalla, P. Krawiec, A. Beben, P. Wisniewski, and A. Chydzinski, "Adaptive Video Streaming: Rate and Buffer on the Track of Minimum Rebuffering," *IEEE Journal on Selected Areas in Communications*, vol. 34, no. 8, pp. 2154–2167, Aug 2016.
- [84] M. S. Mushtaq, B. Augustin, and A. Mellouk, "HTTP rate adaptive algorithm with high bandwidth utilization," in *10th International Conference on Network and Service Management (CNSM) and Workshop*, Nov 2014, pp. 372–375.
- [85] L. Zou, R. Trestian, and G. M. Muntean, "DOAS: Device-Oriented Adaptive Multimedia Scheme for 3GPP LTE systems," in *2013 IEEE 24th Annual International Symposium on Personal, Indoor, and Mobile Radio Communications (PIMRC)*, Sept 2013, pp. 2180–2184.
- [86] Y. Go, O. C. Kwon, and H. Song, "An Energy-Efficient HTTP Adaptive Video Streaming With Networking Cost Constraint Over Heterogeneous Wireless Networks," *IEEE Transactions on Multimedia*, vol. 17, no. 9, pp. 1646–1657, Sept 2015.
- [87] K. Evensen, D. Kaspar, C. Griwodz, P. Halvorsen, A. Hansen, and P. Engelstad, "Improving the Performance of Quality-adaptive Video Streaming over Multiple Heterogeneous Access Networks," in *Proceedings of the Second Annual ACM Conference on Multimedia Systems*, ser. MMSys '11. New York, NY, USA: ACM, 2011, pp. 57–68.
- [88] J. Padhye, V. Firoiu, D. Towsley, and J. Krusoe, "Modeling TCP Throughput: A Simple Model and its Empirical Validation," *Proceedings of the ACM SIGCOMM '98 conference on Applications, technologies, architectures, and protocols for computer communication*, pp. 303–314, 1998.
- [89] L.-A. Larzon, M. Degermark, S. Pink, L.-E. Jonsson, and G. Fairhurst, "The Lightweight User Datagram Protocol (UDP-Lite)," Internet RFC 3828, July 2004.
- [90] N. Feamster, D. Bansal, and H. Balakrishnan, "On the interactions between layered quality adaptation and congestion control for streaming video," in *in Proceedings of the International Packet Video Workshop (PV2001)*, 2001.

- [91] D. Raychaudhuri and N. D. Wilson, "ATM-based transport architecture for multiservices wireless personal communication networks," *IEEE Journal on Selected Areas in Communications*, vol. 12, no. 8, pp. 1401–1414, Oct 1994.
- [92] A. Roy and P. Venkataram, "Design of a Link Control Protocol for Multimedia Services in Wireless Local Communication," *Wireless Personal Communications*, vol. 18, no. 3, pp. 247–274, 2001.
- [93] J. Rosenberg, H. Schulzrinne, C. U. G. Camarillo, A. Johnston, J. Peterson, R. Sparks, and M. Handley, "SIP: session initiation protocol," in *IETF RFC 3261*, 2002.
- [94] W. P. K. Yiu, K. F. S. Wong, S. H. G. Chan, W.-C. Wong, Q. Zhang, W.-W. Zhu, and Y.-Q. Zhang, "Lateral error recovery for media streaming in application-level multicast," *IEEE Transactions on Multimedia*, vol. 8, no. 2, pp. 219–232, April 2006.
- [95] D. Wu, Y. T. Hou, and Y.-Q. Zhang, "Scalable video coding and transport over broadband wireless networks," *Proceedings of the IEEE*, vol. 89, no. 1, pp. 6–20, Jan 2001.
- [96] F. Wu, S. Li, and Y.-Q. Zhang, "A framework for efficient progressive fine granularity scalable video coding," *IEEE Transactions on Circuits and Systems for Video Technology*, vol. 11, no. 3, pp. 332–344, Mar 2001.
- [97] M. Zink and A. Mauthe, "P2P streaming using multiple description coded video," in *Proceedings. 30th Euromicro Conference, 2004.*, Aug 2004, pp. 240–247.
- [98] J.-W. Ding and S.-Y. Lan, "Quality-Adaptive Proxy Caching for Peer-to-Peer Video Streaming Using Multiple Description Coding," *J. Inf. Sci. Eng.*, vol. 25, no. 3, pp. 687–701, 2009.
- [99] X. Su and W. Web, "Multidescription video streaming with optimized reconstruction-based DCT and neural-network compensations," *IEEE Transactions on Multimedia*, vol. 3, no. 1, pp. 123–131, Mar 2001.
- [100] Z. He, J. Cai, and C. W. Chen, "Joint source channel rate-distortion analysis for adaptive mode selection and rate control in wireless video coding," *IEEE Transactions on Circuits and Systems for Video Technology*, vol. 12, no. 6, pp. 511–523, Jun 2002.
- [101] P. Zhu, W. Zeng, and C. Li, "Joint Design of Source Rate Control and QoS-Aware Congestion Control for Video Streaming Over the Internet," *IEEE Transactions on Multimedia*, vol. 9, no. 2, pp. 366–376, Feb 2007.
- [102] J. Yan, K. Katrinis, M. May, and B. Plattner, "Media- and TCP-friendly congestion control for scalable video streams," *IEEE Transactions on Multimedia*, vol. 8, no. 2, pp. 196–206, April 2006.
- [103] M. Chen and A. Zakhor, "Multiple TFRC Connections Based Rate Control for Wireless Networks," *IEEE Transactions on Multimedia*, vol. 8, no. 5, pp. 1045–1062, Oct 2006.
- [104] Z. Fu, X. Meng, and S. Lu, "TCP Friendly Rate Adaptation for Multimedia Streaming in Mobile ad hoc Networks," in *MMNS*, ser. Lecture Notes in Computer Science, A. Marshall and N. Agoulmine, Eds., vol. 2839. Springer, 2003, pp. 115–127.
- [105] M. van Der Schaar and S. S. N., "Cross-layer wireless multimedia transmission: challenges, principles, and new paradigms," *IEEE Wireless Communications*, vol. 12, no. 4, pp. 50–58, Aug 2005.
- [106] J. D. del Rio, O. del Rio Herrero, and M. F. Veiga, "A dynamic cross-layer architecture for QoS provisioning of multimedia services on all-IP based adaptive satellite networks," in *2009 International Workshop on Satellite and Space Communications*, Sept 2009, pp. 364–368.
- [107] Z. Li and J. Zhou, "Adaptive Cross-layer QoS for priority-based video streaming over wireless channel," in *2009 First International Conference on Future Information Networks*, Oct 2009, pp. 108–112.
- [108] X. Li, X. Wu, W. Li, and X. Wang, "An Adaptive Cross-Layer Scheduling Algorithm for Multimedia Networks," in *2008 International Conference on Intelligent Information Hiding and Multimedia Signal Processing*, Aug 2008, pp. 52–55.
- [109] S. Shakkottai, T. S. Rappaport, and P. C. Karlsson, "Cross-layer design for wireless networks," *IEEE Communications Magazine*, vol. 41, no. 10, pp. 74–80, Oct 2003.
- [110] S. Choudhury and J. D. Gibson, "Joint PHY/MAC based link adaptation for wireless LANs with multipath fading," in *IEEE Wireless Communications and Networking Conference, 2006. WCNC 2006.*, vol. 2, April 2006, pp. 757–762.
- [111] C. Verikoukis, L. Alonso, and T. Giamalis, "Cross-layer optimization for wireless systems: a European research key challenge," *IEEE Communications Magazine*, vol. 43, no. 7, pp. 1–3, July 2005.
- [112] J. Chen, T. Lv, and H. Zheng, "Joint Cross-Layer Design for Wireless QoS Content Delivery," *EURASIP J. Adv. Sig. Proc.*, vol. 2005, no. 2, pp. 167–182, 2005.
- [113] S. Akshabi, A. C. Begen, and C. Dovrolis, "An Experimental Evaluation of Rate-adaptation Algorithms in Adaptive Streaming over HTTP," in *Proceedings of the Second Annual ACM Conference on Multimedia Systems*, ser. MMSys '11. New York, NY, USA: ACM, 2011, pp. 157–168.
- [114] J. Famaey, S. Latr, N. Bouten, W. V. de Meerssche, B. D. Vleeschauwer, W. V. Leekwijck, and F. D. Turck, "On the merits of SVC-based HTTP Adaptive Streaming," in *2013 IFIP/IEEE International Symposium on Integrated Network Management (IM 2013)*, May 2013, pp. 419–426.
- [115] I. Politis, L. Dounis, and T. Dagiuklas, "H.264/SVC vs. H.264/AVC Video Quality Comparison Under QoE-driven Seamless Handoff," *Image Commun.*, vol. 27, no. 8, pp. 814–826, Sep. 2012.
- [116] H. Kalva, V. Adzic, and B. Furht, "Comparing MPEG AVC and SVC for adaptive HTTP streaming," in *2012 IEEE International Conference on Consumer Electronics (ICCE)*, Jan 2012, pp. 158–159.
- [117] M. Claeys, S. Latr, J. Famaey, T. Wu, W. V. Leekwijck, and F. D. Turck, "Design and optimisation of a (FA)Q-learning-based HTTP adaptive streaming client," *Connection Science*, vol. 26, no. 1, pp. 25–43, 2014.
- [118] V. Martin, J. Cabrera, and N. Garca, "Q-learning based control algorithm for HTTP adaptive streaming," in *2015 Visual Communications and Image Processing (VCIP)*, Dec 2015, pp. 1–4.
- [119] F. Chiariotti, S. D'Arconco, L. Toni, and P. Frossard, "Online Learning Adaptation Strategy for DASH Clients," in *Proceedings of the 7th International Conference on Multimedia Systems*, ser. MMSys '16. New York, NY, USA: ACM, 2016, pp. 8:1–8:12.
- [120] M. Gadaleta, F. Chiariotti, M. Rossi, and A. Zanella, "D-DASH: a Deep Q-learning Framework for DASH Video Streaming," *IEEE Transactions on Cognitive Communications and Networking*, vol. PP, no. 99, pp. 1–1, 2017.
- [121] G. Cofano, L. D. Cicco, and S. Mascolo, "Modeling and Design of Adaptive Video Streaming Control Systems," *IEEE Transactions on Control of Network Systems*, vol. PP, no. 99, pp. 1–1, 2016.
- [122] J. Zhang, D. Wu, S. Ci, H. Wang, and A. K. Katsaggelos, "Power-Aware Mobile Multimedia: a Survey (Invited Paper)," *JCM*, vol. 4, no. 9, pp. 600–613, 2009.
- [123] M. Kennedy, A. Ksentini, Y. Hadjadj-Aoul, and G. M. Muntean, "Adaptive Energy Optimization in Multimedia-Centric Wireless Devices: A Survey," *IEEE Communications Surveys Tutorials*, vol. 15, no. 2, pp. 768–786, Second 2013.
- [124] M. Kennedy, H. Venkataraman, and G. M. Muntean, "Dynamic stream control for energy efficient video streaming," in *2011 IEEE International Symposium on Broadband Multimedia Systems and Broadcasting (BMSB)*, June 2011, pp. 1–6.
- [125] Y. Xiao, R. S. Kalyanaraman, and A. Yla-Jaaski, "Energy Consumption of Mobile YouTube: Quantitative Measurement and Analysis," in *2008 The Second International Conference on Next Generation Mobile Applications, Services, and Technologies*, Sept 2008, pp. 61–69.
- [126] N. Vallina-Rodriguez, P. Hui, J. Crowcroft, and A. C. Rice, "Exhausting battery statistics: understanding the energy demands on mobile handsets," in *MobiHeld*, L. P. Cox and A. Wolman, Eds. ACM, 2010, pp. 9–14.
- [127] L. Zou, R. Trestian, and G. M. Muntean, "E3DOAS: Balancing QoE and Energy-Saving for Multi-Device Adaptation in Future Mobile Wireless Video Delivery," *IEEE Transactions on Broadcasting*, vol. PP, no. 99, pp. 1–15, 2017.
- [128] R. Trestian, A. N. Moldovan, O. Ormond, and G. M. Muntean, "Energy consumption analysis of video streaming to Android mobile devices," in *2012 IEEE Network Operations and Management Symposium*, April 2012, pp. 444–452.
- [129] R. Trestian, O. Ormond, and G. M. Muntean, "On the impact of wireless network traffic location and access technology on mobile device energy consumption," in *37th Annual IEEE Conference on Local Computer Networks*, Oct 2012, pp. 200–203.
- [130] L. M. Correia, D. Zeller, O. Blume, D. Ferling, Y. Jading, I. Gdor, G. Auer, and L. V. D. Perre, "Challenges and enabling technologies for energy aware mobile radio networks," *IEEE Communications Magazine*, vol. 48, no. 11, pp. 66–72, November 2010.
- [131] A. Rahmati and L. Zhong, "Context-Based Network Estimation for Energy-Efficient Ubiquitous Wireless Connectivity," *IEEE Transactions on Mobile Computing*, vol. 10, no. 1, pp. 54–66, Jan 2011.
- [132] H. Petander, "Energy-aware Network Selection Using Traffic Estimation," in *Proceedings of the 1st ACM Workshop on Mobile Internet Through Cellular Networks*, ser. MICNET '09. New York, NY, USA: ACM, 2009, pp. 55–60.
- [133] I. Joe, W. T. Kim, and S. Hong, "A Network Selection Algorithm considering Power Consumption in Hybrid Wireless Networks," in *2007 16th International Conference on Computer Communications and Networks*, Aug 2007, pp. 1240–1243.

- [134] I. Smaoui and F. Zarai, "Multi-criteria Dynamic Access Selection in Heterogeneous Wireless Networks," in *Proceedings of the 6th International Conference on Symposium on Wireless Communication Systems*, ser. ISWCS'09. Piscataway, NJ, USA: IEEE Press, 2009, pp. 338–342.
- [135] H. Liu, C. Maciocco, V. Kesavan, and A. L. Y. Low, "Energy efficient network selection and seamless handovers in Mixed Networks," in *2009 IEEE International Symposium on a World of Wireless, Mobile and Multimedia Networks Workshops*, June 2009, pp. 1–9.
- [136] R. Trestian, O. Ormond, and G. M. Muntean, "Enhanced Power-Friendly Access Network Selection Strategy for Multimedia Delivery Over Heterogeneous Wireless Networks," *IEEE Transactions on Broadcasting*, vol. 60, no. 1, pp. 85–101, March 2014.
- [137] S. Wu, H. Wang, and C. H. Youn, "Visible light communications for 5G wireless networking systems: from fixed to mobile communications," *IEEE Network*, vol. 28, no. 6, pp. 41–45, Nov 2014.
- [138] D. Karunatilaka, F. Zafar, V. Kalavally, and R. Parthiban, "LED Based Indoor Visible Light Communications: State of the Art," *IEEE Communications Surveys Tutorials*, vol. 17, no. 3, pp. 1649–1678, thirdquarter 2015.
- [139] M. Kashaf, M. Ismail, M. Abdallah, K. A. Qaraqe, and E. Serpedin, "Energy Efficient Resource Allocation for Mixed RF/VLC Heterogeneous Wireless Networks," *IEEE Journal on Selected Areas in Communications*, vol. 34, no. 4, pp. 883–893, April 2016.
- [140] D. A. Basnayaka and H. Haas, "Hybrid RF and VLC Systems: Improving User Data Rate Performance of VLC Systems," in *2015 IEEE 81st Vehicular Technology Conference (VTC Spring)*, May 2015, pp. 1–5.
- [141] X. Wu, D. Basnayaka, M. Safari, and H. Haas, "Two-stage access point selection for hybrid VLC and RF networks," in *2016 IEEE 27th Annual International Symposium on Personal, Indoor, and Mobile Radio Communications (PIMRC)*, Sept 2016, pp. 1–6.
- [142] R. Y. Kim and S. Mohanty, "Advanced power management techniques in next-generation wireless networks [Topics in Wireless Communications]," *IEEE Communications Magazine*, vol. 48, no. 5, pp. 94–102, May 2010.
- [143] M. Lauridsen, G. Berardinelli, F. M. L. Tavares, F. Frederiksen, and P. Mogensen, "Sleep Modes for Enhanced Battery Life of 5G Mobile Terminals," in *2016 IEEE 83rd Vehicular Technology Conference (VTC Spring)*, May 2016, pp. 1–6.
- [144] A. Rao, A. Legout, Y.-s. Lim, D. Towsley, C. Barakat, and W. Dabbous, "Network Characteristics of Video Streaming Traffic," in *Proceedings of the Seventh Conference on Emerging Networking EXperiments and Technologies*, ser. CoNEXT '11. New York, NY, USA: ACM, 2011, pp. 25:1–25:12.
- [145] M. A. Hoque, M. Siekkinen, J. K. Nurminen, and M. Aalto, "Dissecting mobile video services: An energy consumption perspective," in *2013 IEEE 14th International Symposium on "A World of Wireless, Mobile and Multimedia Networks" (WoWMoM)*, June 2013, pp. 1–11.
- [146] M. Bouzian, M. Bouhtou, T. En-Najjary, L. Sassatelli, and G. Urvoy-Keller, "QoE optimization of ON/OFF video streaming strategy in wireless networks," in *2016 Wireless Days (WD)*, March 2016, pp. 1–8.
- [147] W. Hu and G. Cao, "Energy-aware video streaming on smartphones," in *2015 IEEE Conference on Computer Communications (INFOCOM)*, April 2015, pp. 1185–1193.
- [148] S. Lee, J. Koo, and K. Chung, "Content-aware rate control scheme to improve the energy efficiency for mobile IPTV," in *2010 Digest of Technical Papers International Conference on Consumer Electronics (ICCE)*, Jan 2010, pp. 445–446.
- [149] G. P. Perrucci, F. H. P. Fitzek, G. Sasso, and M. D. Katz, "Energy Saving Strategies for Mobile Devices using Wake-up Signals," in *MobiMedia*, J. Huusko and T. Frantti, Eds. ICST, 2008.
- [150] V. Namboodiri and L. Gao, "Energy-Efficient VoIP over Wireless LANs," *IEEE Transactions on Mobile Computing*, vol. 9, no. 4, pp. 566–581, April 2010.
- [151] S. K. Saha, P. Deshpande, P. P. Inamdar, R. K. Sheshadri, and D. Koutsonikolas, "Power-throughput tradeoffs of 802.11n/ac in smartphones," in *2015 IEEE Conference on Computer Communications (INFOCOM)*, April 2015, pp. 100–108.
- [152] Z. Li, F. Zhai, and A. K. Katsaggelos, "Joint Video Summarization and Transmission Adaptation for Energy-Efficient Wireless Video Streaming," *EURASIP J. Adv. Sig. Proc.*, vol. 2008, 2008.
- [153] M. Kennedy, H. Venkataraman, and G. M. Muntean, "Battery and Stream-Aware Adaptive Multimedia Delivery for wireless devices," in *IEEE Local Computer Network Conference*, Oct 2010, pp. 843–846.
- [154] Y. Song, B. Ciubotaru, and G. M. Muntean, "A Cross-Layer Quality-Oriented Scheme for Energy-Efficient Multimedia Delivery in Wireless Networks," *IEEE Transactions on Vehicular Technology*, vol. 65, no. 10, pp. 8554–8566, Oct 2016.
- [155] C. Singhal, S. De, R. Trestian, and G. M. Muntean, "Joint Optimization of User-Experience and Energy-Efficiency in Wireless Multimedia Broadcast," *IEEE Transactions on Mobile Computing*, vol. 13, no. 7, pp. 1522–1535, July 2014.
- [156] Z. Lu, H. Zhang, Y. Chen, H. Shao, and X. Wen, "QoE Perceptive Cross-layer Energy Efficient Method for Mobile Video Devices," *Int. J. Distrib. Sen. Netw.*, vol. 2015, pp. 211:211–211:211, Jan. 2016.
- [157] M. A. Baker, V. Parameswaran, K. S. Chatha, and B. Li, "Power reduction via macroblock prioritization for power aware H.264 video applications," in *CODES+ISSS*, C. H. Gebotys and G. Martin, Eds. ACM, 2008, pp. 261–266.
- [158] H. V. Antwerpen, N. Dutt, R. Gupta, M. S. C. Pereira, N. Venkatasubramanian, and R. von Vignau, "Energy-aware system design for wireless multimedia," in *Proceedings Design, Automation and Test in Europe Conference and Exhibition*, vol. 2, Feb 2004, pp. 1124–1129 Vol.2.
- [159] S. Pasricha, S. Mohapatra, M. Luthra, N. D. Dutt, and N. Venkatasubramanian, "Reducing Backlight Power Consumption for Streaming Video Applications on Mobile Handheld Devices," in *ESTImedia*, G. Fohler and R. Marculescu, Eds., 2003, pp. 11–17.
- [160] P. C. Hsiu, C. H. Lin, and C. K. Hsieh, "Dynamic backlight scaling optimization for mobile streaming applications," in *IEEE/ACM International Symposium on Low Power Electronics and Design*, Aug 2011, pp. 309–314.
- [161] V. Yang, J. Y. Lin, K. S. H. Lo, C. H. Yeh, C. C. Kuo, and L. W. Kang, "Power saving on mobile devices through contrast-aware backlight control," in *2015 Asia-Pacific Signal and Information Processing Association Annual Summit and Conference (APSIPA)*, Dec 2015, pp. 946–951.
- [162] C. Y. Liu, Y. S. Chen, J. S. Leu, and T. Song, "Energy efficient streaming for smartphones by video adaptation and backlight control," in *2016 2nd International Conference on Intelligent Green Building and Smart Grid (IGBSG)*, June 2016, pp. 1–5.
- [163] B. Varghese, G. Jourjon, K. Thilakarathne, and A. Seneviratne, "e-DASH: Modelling an energy-aware DASH player," in *2017 IEEE 18th International Symposium on A World of Wireless, Mobile and Multimedia Networks (WoWMoM)*, June 2017, pp. 1–9.
- [164] J.-S. Leu, M.-C. Yu, C.-Y. Liu, A. P. B. Budiarsa, and V. Utomo, "Energy efficient streaming for smartphone by video adaptation and backlight control," *Computer Networks*, vol. 113, pp. 111 – 123, 2017.
- [165] S. Zeadally, S. U. Khan, and N. Chilamkurti, "Energy-efficient networking: past, present, and future," *The Journal of Supercomputing*, vol. 62, no. 3, pp. 1093–1118, 2012.
- [166] T. C. Group, "Smart 2020 - Enabling the low carbon economy in the information age." [Online]. Available: <http://www.smart2020.org/>
- [167] R. Mahapatra, A. D. Domenico, R. Gupta, and E. C. Strinati, "Green framework for future heterogeneous wireless networks," *Computer Networks*, vol. 57, no. 6, pp. 1518 – 1528, 2013.
- [168] K. Pentikousis, "In search of energy-efficient mobile networking," *IEEE Communications Magazine*, vol. 48, no. 1, pp. 95–103, January 2010.
- [169] E. C. Strinati, A. D. Domenico, and L. Herault, "Green Communications: An Emerging Challenge for Mobile Broadband Communication Networks," *Journal of Green Engineering*, vol. 1, pp. 267–301, 2011.
- [170] "Green Touch Initiative," 2012. [Online]. Available: <http://www.greentouch.org>
- [171] M. Gruber, O. Blume, D. Ferling, D. Zeller, M. A. Imran, and E. C. Strinati, "EARTH Energy Aware Radio and Network Technologies," in *2009 IEEE 20th International Symposium on Personal, Indoor and Mobile Radio Communications*, Sept 2009, pp. 1–5.
- [172] C. Han, T. Harrold, S. Armour, I. Krikidis, S. Videv, P. M. Grant, H. Haas, J. S. Thompson, I. Ku, C. X. Wang, T. A. Le, M. R. Nakhai, J. Zhang, and L. Hanzo, "Green radio: radio techniques to enable energy-efficient wireless networks," *IEEE Communications Magazine*, vol. 49, no. 6, pp. 46–54, June 2011.
- [173] G. P. Perrucci, F. H. P. Fitzek, and J. Widmer, "Survey on Energy Consumption Entities on the Smartphone Platform," in *2011 IEEE 73rd Vehicular Technology Conference (VTC Spring)*, May 2011, pp. 1–6.
- [174] M. F. Tuysuz, "An energy-efficient QoS-based network selection scheme over heterogeneous WLAN 3G networks," *Computer Networks*, vol. 75, Part A, pp. 113 – 133, 2014.
- [175] M. Deruyck, W. Vereecken, E. Tanghe, W. Joseph, M. Pickavet, L. Martens, and P. Demeester, "Comparison of power consumption

- of mobile WiMAX, HSPA and LTE access networks,” in *2010 9th Conference of Telecommunication, Media and Internet*, June 2010, pp. 1–7.
- [176] M. F. Tuysuz and R. Trestian, “Energy-Efficient Vertical Handover Parameters, Classification and Solutions over Wireless Heterogeneous Networks: A Comprehensive Survey,” *Wireless Personal Communications*, vol. 97, pp. 1155–1184, Nov 2017.
- [177] M. Z. Chowdhury, Y. M. Jang, C. S. Ji, S. Choi, H. Jeon, J. Jee, and C. Park, “Interface selection for power management in UMTS/WLAN overlaying network,” in *2009 11th International Conference on Advanced Communication Technology*, vol. 01, Feb 2009, pp. 795–799.
- [178] I. Chamodrakas and D. Martakos, “A utility-based fuzzy TOPSIS method for energy efficient network selection in heterogeneous wireless networks,” *Applied Soft Computing*, vol. 11, no. 4, pp. 3734 – 3743, 2011.
- [179] D. Xenakis, N. Passas, L. Merakos, and C. Verikoukis, “ARCHON: An ANDSF-assisted energy-efficient vertical handover decision algorithm for the heterogeneous IEEE 802.11/LTE-advanced network,” in *2014 IEEE International Conference on Communications (ICC)*, June 2014, pp. 3166–3171.
- [180] J. Bastos, M. Albano, H. Marques, J. Ribeiro, J. Rodriguez, and C. Verikoukis, “Smart interface switching for energy efficient vertical handovers in NS-2,” *IET Communications*, vol. 6, no. 14, pp. 2228–2238, September 2012.
- [181] M. Nam, N. Choi, Y. Seok, and Y. Choi, “WISE: energy-efficient interface selection on vertical handoff between 3G networks and WLANs,” in *2004 IEEE 15th International Symposium on Personal, Indoor and Mobile Radio Communications*, vol. 1, Sept 2004, pp. 692–698 Vol.1.
- [182] B. Kim, Y. Cho, and J. Hong, “AWNIS: Energy-Efficient Adaptive Wireless Network Interface Selection for Industrial Mobile Devices,” *IEEE Transactions on Industrial Informatics*, vol. 10, no. 1, pp. 714–729, Feb 2014.
- [183] I. Joe, W. T. Kim, and S. Hong, “A Network Selection Algorithm considering Power Consumption in Hybrid Wireless Networks,” in *2007 16th International Conference on Computer Communications and Networks*, Aug 2007, pp. 1240–1243.
- [184] C. Desset, N. Ahmed, and A. Dejonghe, “Energy Savings for Wireless Terminals through Smart Vertical Handover,” in *2009 IEEE International Conference on Communications*, June 2009, pp. 1–5.
- [185] D. Xenakis, N. Passas, L. D. Gregorio, and C. Verikoukis, “A Context-Aware Vertical Handover Framework Towards Energy-Efficiency,” in *2011 IEEE 73rd Vehicular Technology Conference (VTC Spring)*, May 2011, pp. 1–5.
- [186] I. Kanno, K. Yamazaki, Y. Ikeda, and H. Ishikawa, “Adaptive Energy Centric Radio Access Selection for Vertical Handover in Heterogeneous Networks,” in *2010 IEEE Wireless Communication and Networking Conference*, April 2010, pp. 1–6.
- [187] Y. Ikeda, K. Yamazaki, I. Kanno, Y. Hiehata, and H. Ishikawa, “Energy efficient wireless link monitoring using probability inequality for vertical handover,” in *21st Annual IEEE International Symposium on Personal, Indoor and Mobile Radio Communications*, Sept 2010, pp. 206–211.
- [188] A. Calhan and C. Ceken, “Speed sensitive-energy aware adaptive fuzzy logic based vertical handoff decision algorithm,” in *2011 18th International Conference on Systems, Signals and Image Processing*, June 2011, pp. 1–4.
- [189] C. Raiciu, C. Paasch, S. Barre, A. Ford, M. Honda, F. Duchene, O. Bonaventure, and M. Handley, “How Hard Can It Be? Designing and Implementing a Deployable Multipath TCP,” in *Proceedings of the 9th USENIX Conference on Networked Systems Design and Implementation*, ser. NSDI’12. Berkeley, CA, USA: USENIX Association, 2012, pp. 29–29.
- [190] D. Wischik, C. Raiciu, A. Greenhalgh, and M. Handley, “Design, Implementation and Evaluation of Congestion Control for Multipath TCP,” in *Proceedings of the 8th USENIX Conference on Networked Systems Design and Implementation*, ser. NSDI’11. Berkeley, CA, USA: USENIX Association, 2011, pp. 99–112.
- [191] A. Ford, C. Raiciu, M. Handley, and O. Bonaventure, “TCP Extensions for Multipath Operation with Multiple Addresses,” Internet Engineering Task Force (IETF), March 2011.
- [192] P. Dong, J. Wang, J. Huang, H. Wang, and G. Min, “Performance Enhancement of Multipath TCP for Wireless Communications With Multiple Radio Interfaces,” *IEEE Transactions on Communications*, vol. 64, no. 8, pp. 3456–3466, Aug 2016.
- [193] C. Diop, G. Dugué, C. Chassot, and E. Exposito, “QoS-aware multipath-TCP Extensions for Mobile and Multimedia Applications,” in *Proceedings of the 9th International Conference on Advances in Mobile Computing and Multimedia*, ser. MoMM ’11. New York, NY, USA: ACM, 2011, pp. 139–146.
- [194] Y. Cao, Q. Liu, G. Luo, Y. Yi, and M. Huang, “PR-MPTCP+: Context-aware QoE-oriented multipath TCP partial reliability extension for real-time multimedia applications,” in *2016 Visual Communications and Image Processing (VCIP)*, Nov 2016, pp. 1–4.
- [195] Q. Peng, M. Chen, A. Walid, and S. Low, “Energy Efficient Multipath TCP for Mobile Devices,” in *Proceedings of the 15th ACM International Symposium on Mobile Ad Hoc Networking and Computing*, ser. MobiHoc ’14. New York, NY, USA: ACM, 2014, pp. 257–266.
- [196] J. Wu, B. Cheng, and M. Wang, “Energy Minimization for Quality-Constrained Video with Multipath TCP over Heterogeneous Wireless Networks,” in *2016 IEEE 36th International Conference on Distributed Computing Systems (ICDCS)*, June 2016, pp. 487–496.
- [197] J. Wu, B. Cheng, M. Wang, and J. Chen, “Quality-Aware Energy Optimization in Wireless Video Communication With Multipath TCP,” *IEEE/ACM Transactions on Networking*, vol. PP, no. 99, pp. 1–18, 2017.
- [198] S. Chen, Z. Yuan, and G. M. Muntean, “An energy-aware multipath-TCP-based content delivery scheme in heterogeneous wireless networks,” in *2013 IEEE Wireless Communications and Networking Conference (WCNC)*, April 2013, pp. 1291–1296.
- [199] Y.-s. Lim, Y.-C. Chen, E. M. Nahum, D. Towsley, and R. J. Gibbens, “How Green is Multipath TCP for Mobile Devices?” in *Proceedings of the 4th Workshop on All Things Cellular: Operations, Applications, and Challenges*, ser. AllThingsCellular ’14. New York, NY, USA: ACM, 2014, pp. 3–8.
- [200] Y. Lim, Y. Chen, E. M. Nahum, D. Towsley, and R. J. Gibbens, “Improving Energy Efficiency of MPTCP for Mobile Devices,” *CoRR*, vol. abs/1406.4463, 2014.
- [201] L. Minear and E. Zhang, “Impact of Energy Consumption on Multipath TCP Enabled Mobiles,” *CoRR*, vol. abs/1412.7912, 2014. [Online]. Available: <http://arxiv.org/abs/1412.7912>
- [202] J. Huang, F. Qian, A. Gerber, Z. M. Mao, S. Sen, and O. Spatscheck, “A Close Examination of Performance and Power Characteristics of 4G LTE Networks,” in *Proceedings of the 10th International Conference on Mobile Systems, Applications, and Services*, ser. MobiSys ’12. New York, NY, USA: ACM, 2012, pp. 225–238.
- [203] E. Harjula, O. Kassinen, and M. Ylianttila, “Energy consumption model for mobile devices in 3G and WLAN networks,” in *2012 IEEE Consumer Communications and Networking Conference (CCNC)*, Jan 2012, pp. 532–537.
- [204] L. Ong and J. Yoakum, “An Introduction to the Stream Control Transmission Protocol (SCTP),” Internet RFC 3286, May 2002.
- [205] J. R. Iyengar, P. D. Amer, and R. Stewart, “Concurrent Multipath Transfer Using SCTP Multihoming Over Independent End-to-End Paths,” *IEEE/ACM Transactions on Networking*, vol. 14, no. 5, pp. 951–964, Oct 2006.
- [206] C. Xu, T. Liu, J. Guan, H. Zhang, and G. M. Muntean, “CMT-QA: Quality-Aware Adaptive Concurrent Multipath Data Transfer in Heterogeneous Wireless Networks,” *IEEE Transactions on Mobile Computing*, vol. 12, no. 11, pp. 2193–2205, Nov 2013.
- [207] J. Wu, C. Yuen, M. Wang, and J. Chen, “Content-Aware Concurrent Multipath Transfer for High-Definition Video Streaming over Heterogeneous Wireless Networks,” *IEEE Transactions on Parallel and Distributed Systems*, vol. 27, no. 3, pp. 710–723, March 2016.
- [208] J. Wu, B. Cheng, C. Yuen, Y. Shang, and J. Chen, “Distortion-Aware Concurrent Multipath Transfer for Mobile Video Streaming in Heterogeneous Wireless Networks,” *IEEE Transactions on Mobile Computing*, vol. 14, no. 4, pp. 688–701, April 2015.
- [209] J. Lee and S. Bahk, “On the MDP-Based Cost Minimization for Video-on-Demand Services in a Heterogeneous Wireless Network with Multihomed Terminals,” *IEEE Transactions on Mobile Computing*, vol. 12, no. 9, pp. 1737–1749, Sept 2013.
- [210] A. Tachibana and T. Hasegawa, “A deployable scheme of CMT-SCTP with off-the-shelf android smartphones,” in *2012 IEEE 8th International Conference on Wireless and Mobile Computing, Networking and Communications (WiMob)*, Oct 2012, pp. 861–868.
- [211] A. Tachibana, Y. Yoshida, M. Shibuya, and T. Hasegawa, “Implementation of a proxy-based CMT-SCTP scheme for Android smartphones,” in *2014 IEEE 10th International Conference on Wireless and Mobile Computing, Networking and Communications (WiMob)*, Oct 2014, pp. 660–665.
- [212] C. Paasch, S. Barre, J. Korkeaniemi, F. Duchene, and G. Detal, “MPTCP Linux Kernel Implementation.” [Online]. Available: <http://mptcp.info.ucl.ac.be>

- [213] "MPTCP Implementation for FreeBSD." [Online]. Available: <http://caia.swin.edu.au/urp/newtcp/mptcp/>
- [214] "Multipath TCP Support in iOS 7;" 2015. [Online]. Available: <https://support.apple.com/en-us/HT201373>
- [215] "Samsung Galaxy S5 Download Booster;" 2014. [Online]. Available: <http://galaxys5guide.com/samsung-galaxy-s5-features-explained/galaxy-s5-download-booster/>
- [216] M. Becke, H. Adhari, E. P. Rathgeb, F. Fa, X. Yang, and X. Zhou, "Comparison of Multipath TCP and CMT-SCTP based on intercontinental measurements," in *2013 IEEE Global Communications Conference (GLOBECOM)*, Dec 2013, pp. 1360–1366.
- [217] S. Fernandes and A. Karmouch, "Vertical Mobility Management Architectures in Wireless Networks: A Comprehensive Survey and Future Directions," *IEEE Communications Surveys Tutorials*, vol. 14, no. 1, pp. 45–63, First 2012.
- [218] X. Zhang, T.-M.-T. Nguyen, and G. Pujolle, "A Cross-layer approach to optimize the performance of Concurrent Multipath Transfer in wireless transmission," in *2009 2nd IFIP Wireless Days (WD)*, Dec 2009, pp. 1–5.
- [219] S. Deng, R. Netravali, A. Sivaraman, and H. Balakrishnan, "WiFi, LTE, or Both?: Measuring Multi-Homed Wireless Internet Performance," in *Proceedings of the 2014 Conference on Internet Measurement Conference*, ser. IMC '14. New York, NY, USA: ACM, 2014, pp. 181–194.
- [220] M. Ismail and W. Zhuang, "Network cooperation for energy saving in green radio communications," *IEEE Wireless Communications*, vol. 18, no. 5, pp. 76–81, October 2011.
- [221] R. Trestian, O. Ormond, and G. M. Muntean, "Energy-Quality-Cost Tradeoff in a Multimedia-Based Heterogeneous Wireless Network Environment," *IEEE Transactions on Broadcasting*, vol. 59, no. 2, pp. 340–357, June 2013.
- [222] B. Hayes, Y. Chang, and G. Riley, "Adaptive bitrate video delivery using HTTP/2 over MPTCP architecture," in *2017 13th International Wireless Communications and Mobile Computing Conference (IWCMC)*, June 2017, pp. 68–73.
- [223] C. James, E. Halepovic, M. Wang, R. Jana, and N. K. Shankaranarayanan, "Is Multipath TCP (MPTCP) Beneficial for Video Streaming over DASH?" in *2016 IEEE 24th International Symposium on Modeling, Analysis and Simulation of Computer and Telecommunication Systems (MASCOTS)*, Sept 2016, pp. 331–336.
- [224] F. Kaup, M. Wichtlhuber, S. Rado, and D. Hausheer, "Can Multipath TCP save energy? A measuring and modeling study of MPTCP energy consumption," in *2015 IEEE 40th Conference on Local Computer Networks (LCN)*, Oct 2015, pp. 442–445.
- [225] M. Ferroni, A. Cazzola, F. Trov, D. Sciuto, and M. D. Santambrogio, "On Power and Energy Consumption Modeling for Smart Mobile Devices," in *2014 12th IEEE International Conference on Embedded and Ubiquitous Computing*, Aug 2014, pp. 273–280.
- [226] B. Cheng, J. Yang, S. Wang, and J. Chen, "Adaptive Video Transmission Control System Based on Reinforcement Learning Approach Over Heterogeneous Networks," *IEEE Transactions on Automation Science and Engineering*, vol. 12, no. 3, pp. 1104–1113, July 2015.
- [227] J. van der Hooft, S. Petrangeli, M. Claeys, J. Famaey, and F. D. Turck, "A learning-based algorithm for improved bandwidth-awareness of adaptive streaming clients," in *2015 IFIP/IEEE International Symposium on Integrated Network Management (IM)*, May 2015, pp. 131–138.
- [228] M. Claeys, S. Latre, J. Famaey, and F. D. Turck, "Design and Evaluation of a Self-Learning HTTP Adaptive Video Streaming Client," *IEEE Communications Letters*, vol. 18, no. 4, pp. 716–719, April 2014.
- [229] V. Martn, J. Cabrera, and N. Garca, "Design, optimization and evaluation of a q-learning HTTP adaptive streaming client," *IEEE Transactions on Consumer Electronics*, vol. 62, no. 4, pp. 380–388, November 2016.
- [230] F. Z. Yousaf, O. Mmmel, and P. Mannersalo, "Reinforcement learning method for QoE-aware optimization of content delivery," in *2014 IEEE Wireless Communications and Networking Conference (WCNC)*, April 2014, pp. 3390–3395.
- [231] S. Petrangeli, M. Claeys, S. Latr, J. Famaey, and F. D. Turck, "A multi-agent Q-Learning-based framework for achieving fairness in HTTP Adaptive Streaming," in *2014 IEEE Network Operations and Management Symposium (NOMS)*, May 2014, pp. 1–9.

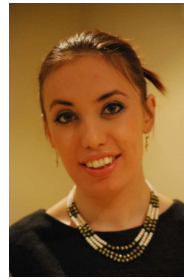

Ramona Trestian (S'08-M'12) received the B.Eng. degree in Telecommunications from the Electronics, Telecommunications and the Technology of Information Department, Technical University of Cluj-Napoca, Romania in 2007, and the Ph.D. degree from the School of Electronic Engineering, Dublin City University (DCU), Dublin, Ireland in 2012 for her research in adaptive multimedia systems and network selection mechanisms. She was with Dublin City University as an IBM/IRCSET Exascale Postdoctoral Researcher, from December 2011 to August 2013. She is currently a Senior Lecturer with the Design Engineering and Mathematics Department, Faculty of Science and Technology, Middlesex University, London, UK. She has published in prestigious international conferences and journals and has three edited books. Her research interests include mobile and wireless communications, multimedia streaming, user quality of experience, handover and network selection strategies, and software-defined networks. She is a reviewer for international journals and conferences and a member of the IEEE Young Professionals, IEEE Communications Society and IEEE Broadcast Technology Society.



Ioan-Sorin Comsa is a Research Engineer in 5G radio resource scheduling at CEA-LETI Minatec, Grenoble, France. He was awarded the B.Eng. and M.Sc. degrees in Telecommunications from the Electronics, Telecommunications and the Technology of Information Department, Technical University of Cluj-Napoca, Romania in 2008 and 2010 respectively. He received his Ph.D. degree from the Institute for Research in Applicable Computing, University of Bedfordshire, UK in June 2015. He was also a PhD Researcher with the Institute of Complex Systems, University of Applied Sciences of Western Switzerland, Switzerland. His research interests include intelligent radio resource and QoS management, reinforcement learning, distributed and parallel computing, dynamic spectrum management and cognitive radio.



Mehmet Fatih Tuysuz holds the B.Sc. degrees from an University, department of Electric and Electronic Engineering and Anatolian University, department of Business Administration. He holds the M.Sc. degree from Dokuz Eylul University, department of Electric and Electronic Engineering. During his M.Sc. thesis, he worked on the Quality of Service Enhancement of VoIP applications over wireless networks and published several papers in this area. He joined Gebze Institute of Technology, department of Computer Engineering in 2008 as a Ph.D. student and graduated his Ph.D in 2013. Currently, he has been working at Harran University, Computer Engineering Department as an assistant professor. His interest includes VoIP, Wireless QoS, energy-aware communications and energy optimization in wireless networks.