



**HAL**  
open science

## **POUCET: A Multi-Technology Indoor Positioning Solution for Firefighters and Soldiers**

Quentin Vey, François Spies, Baptiste Pestourie, Denis Genon-Catalot, Adrien van den Bossche, Thierry Val, Réjane Dalcé, Julien Schrive

► **To cite this version:**

Quentin Vey, François Spies, Baptiste Pestourie, Denis Genon-Catalot, Adrien van den Bossche, et al.. POU CET: A Multi-Technology Indoor Positioning Solution for Firefighters and Soldiers. Eleventh International Conference on Indoor Positioning and Indoor Navigation (IPIN 2021), Nov 2021, Lloret de mar, Spain. pp.1-8. hal-03353056

**HAL Id: hal-03353056**

**<https://ut3-toulouseinp.hal.science/hal-03353056v1>**

Submitted on 23 Sep 2021

**HAL** is a multi-disciplinary open access archive for the deposit and dissemination of scientific research documents, whether they are published or not. The documents may come from teaching and research institutions in France or abroad, or from public or private research centers.

L'archive ouverte pluridisciplinaire **HAL**, est destinée au dépôt et à la diffusion de documents scientifiques de niveau recherche, publiés ou non, émanant des établissements d'enseignement et de recherche français ou étrangers, des laboratoires publics ou privés.

# POUCET: A Multi-Technology Indoor Positioning Solution for Firefighters and Soldiers

Quentin Vey, François Spies  
Femto-ST laboratory  
Besançon Montbéliard, France  
quentin.vey@irit.fr; francois.spies@univ-fcomte.fr

Baptiste Pestourie, Denis Genon-Catalot  
LCIS laboratory  
Valence, France  
denis.genon-catalot@lcis.grenoble-inp.fr; baptiste.pestourie@lcis.grenoble-inp.fr

Adrien Van den Bossche, Thierry Val, Réjane Dalce, Julien Schrive  
CNRS-IRIT Laboratory  
Toulouse, France  
rejane.dalce@univ-jfc.fr; thierry.val@irit.fr; vandenbo@univ-tlse2.fr; julien.schrive@irit.fr

**Abstract**— A novel multi-technology indoor positioning system, *Poucet*, designed for military and firefighter operations, is introduced in this paper. A mobile agent, wearing a lightweight tracker, is located in real-time during indoor operations through a combination of outdoor stations and indoor beacons dropped by the agent on his way. Beacons and trackers integrate multiple radio positioning technologies, including Global Positioning System, (Long range Radio (LoRa 868MHz and 2.4 GHz), Ultrawide-band (UWB), and altimeters.

*Poucet*'s distributed architecture is presented along with the main features of each of the technologies used. A multi-input fusion algorithm provides continuous and reliable positioning. We report experimental results obtained during benchmarks scenarios conducted by the French National Defense on the presented prototypes.

**Keywords**— Indoor Positioning; LoRa; Radio Positioning; Sensor Fusion; UWB

## I. INTRODUCTION

Localization systems have long been widely covered in the scientific literature since the introduction of Global Navigation Satellite Systems (GNSS) systems half a century ago. If GNSS are well-established and reliable solutions for outdoor positioning, the case of indoor localization is still problematic, as buildings are typically GNSS-denied environments due to the absence of Line-of-Sight. Among the existing solutions, which include Inertial Measurement Units (IMU) [1], Altimeters [2], or Vision-based navigation systems [3], Radio-based positioning solutions in particular [4] have been particularly popular for over a decade with the widespread of the Internet of Things (IoT). Yet, the individual performances of these existing indoor positioning technologies are typically not satisfying for military or firefighter operations, which require reliable, accurate and large-scale performances, similar to what GNSS can provide outdoor. Combining multiple localization technologies to overcome these limitations is a very promising idea that has emerged quite recently in the field of sensor fusion [5]. Most of the current works on that topic are often based on theoretical considerations or simulation only, and rarely evaluated at a large experimental scale. Another issue related to existing solutions, especially the ones based on radio, is that indoor positioning systems typically require specific infrastructures, e.g., by installing beacons in the monitored buildings, and/or prior knowledge of the environment. Such

solutions do not suit applications that require to operate in unknown environments with very little preparation time, as it is the case in military and firefighter operations.

We introduce in this paper *Poucet*, a novel multi-technology indoor positioning system designed for military and firefighter applications. The proposed solution is based on the combination of Global Positioning System (GPS), Long Range Radio (LoRa) in the 868 MHz and 2.4 GHz frequency bands, Ultra-Wideband (UWB) and pressure altimeters. An operating agent wears a tracker and drops different types of nodes on his way during the operation. External nodes are also deployed around the building at the beginning of the operation by other agents. The operating agent is continuously located in real-time through the multi-hop and multi-radio network deployed.

The contributions are the following. Independent research works have been conducted on each of these technologies to evaluate and improve their performances, which are briefly summarized. These works have led to the development of several prototypes for each type of node, and a complete software architecture to collect, log and replay the location data, which is fully presented in this paper. Finally, the proposed solution has been evaluated in independent benchmarks tests conducted by the French National Defense, reproducing realistically the conditions of typical military operations. We present and discuss the results obtained during these evaluations, which demonstrate the potential of the proposed solution and highlight several possible improvements.

*Poucet*'s architecture is presented in section II; the evaluation results are discussed in section III; finally, we conclude in section IV.

## II. POUCKET, A MULTI-TECHNOLOGY ARCHITECTURE

### A. Hardware and Software Architecture

The hardware deployed in *Poucet* consists in four types of nodes: beacons; pebbles, dust nodes (DN) and trackers. The operating agent wears continuously a tracker on his or her helmet. *Pebbles* and *Dust Nodes (DNs)* are carried by the agent and dropped on his way. *Beacons* are quickly deployed around the buildings when starting the operation and allow positioning the local referential formed by the network in a

global GPS referential. Pebbles, Beacons and trackers, integrate transceivers for each of the wireless technologies involved, which are the GPS, LoRa-868 MHz, LoRa-2.4 GHz and UWB. They also include an altimeter. On the other hand, DNs are very lightweight nodes that only integrate an UWB transceiver. As a consequence, a soldier can carry dozens of DNs, along with a couple pebbles, typically less than ten. The details on the transceivers integrated into these different types of nodes are discussed in following sections.

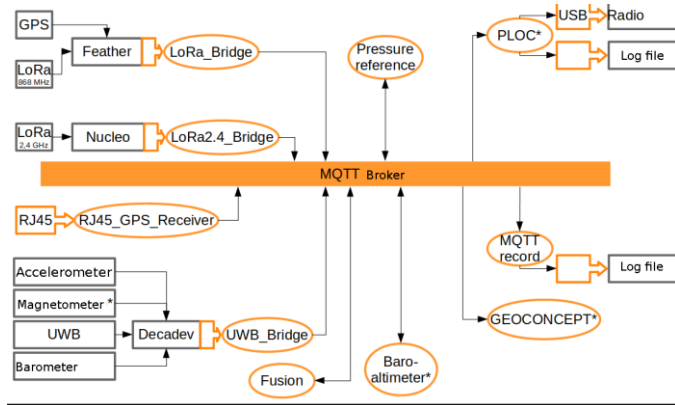

Fig. 1. Multi-task-software Architecture

Regarding the software architecture, trackers, beacons and pebbles are all built around a raspberry pi running Raspbian OS. On these nodes, several services are running, exchanging data over a local publish-subscribe MQTT software bus [6] (one broker per node, without direct exchanges with the brokers). On Fig. 1, this architecture creates a loose coupling between the services, allowing each of them to be developed independently, and to be robust to the failure of other services.

Each service can be put in one of 3 classes:

**Input/output services:** drivers handling communications over physical buses with the micro-controllers controlling the transceivers and external sensors. No data processing beyond simple formatting are performed by these services. They publish raw data on the MQTT bus.

**Computation services:** These services process the raw data and data produced by other computation services to generate more useful data. These services include Barometric altitude computation, reference pressure computation, LoRa weighting algorithm, and data fusion.

**Logging services:** These services log data according to the need of the application. In a development/testing setup, every message published on the MQTT bus is logged with its metadata (received date, topic, quality of service).

DNs carry only a microcontroller, they are running a specific firmware developed for POU CET, using standard and custom Arduino libraries. Notably, Decaduino and Ranger libraries [7] are used to handle the UWB ranging, and a localization library has been developed specifically for this project. Data pertaining to the different processes (ranging, localization, movement detection) are logged onto a SD card.

From a network point of view, 3 overlapping networks are used:

The LoRa-868MHz network is a mesh network, where access control is managed by a token passing protocol. Only the

beacons are transmitting in this network, the mobile node and the pebbles are only receiving data. This network has a dual purpose: transmitting data (beacon nodes positions, atmospheric pressure corrections) and providing a physical measure to compute a position.

The UWB network is also a mesh network that serves as a dual purpose of measuring distances and exchanging data (piggybacked on TWR exchanges). However, given that the network connectivity is low and the data rate is high, the access protocol is simpler: a node can initiate a ranging (i.e. access the channel) at any time, provided that it is not already involved in a ranging exchange.

The LoRa-2.4GHz network is a star network, where the mobile node controls the channel access by initiating the ranging protocols with the beacons and the pebbles.

The exchanges performed between these different types of nodes are summarized in Fig. 2.

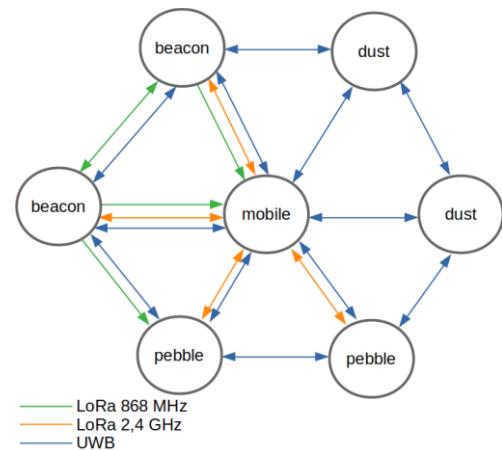

Fig. 2. Summarized network architecture

### B. Presentation of each positioning technology

We introduce in this section the research work conducted on each of the technologies involved in POU CET, including the hardware developed for the current prototypes.

#### 1) Long Range localization with LoRa-868MHz

In order to be able to deploy our indoor location architecture quickly and without any initialization phase, we must deploy elements outside the building to, on the one hand, build an absolute reference system and, on the other hand, use a long-distance communication that can communicate despite being placed on the ground. The absolute reference system relies on D-GNSS components using the beacon with the best satellite coverage as a base station. The other D-GNSS components remain in rover mode. Thus, the relative accuracy between the beacons can reach between 2 and 25cm under the best conditions. We used Ublox M8P chipsets with a patch antenna. In order to measure the distances between the exterior beacons and the mobile, we use an 868 MHz LoRa communication to increase the penetration capacity of walls and floors to cover interior and buried areas. The distance covered by a LoRa 868MHz signal reaches 10 km in line of sight and 1km in urban areas provided the antennas are placed high up. But when our first antenna model was less than 10 cm from the ground, we were only able to cover 40 m because the Fresnel ellipsoid [8] is mostly masked and the signal strength lost more than 25 dB at 10 m. The use of a half-wave antenna allowed us to partially compensate the signal

absorption in the ground and to reach 500 meters of coverage by placing the antennas on the ground. To communicate with the LoRa-868MHz signal, we use a HopeRF RFM95 transceiver controlled by an ARM cortex M0 processor at 48MHz. The accurate calculation of the distance cannot be based on a simple measurement of signal attenuation, as heterogeneity of the environment is a determining factor in this context [9]. This environmental absorption factor is estimated by the power level received from the signals exchanged between the beacons. By combining the distance measured by D-GNSS between two beacons and the attenuation of received signals crossing an entire building, we qualify the absorption characteristics of the building on this line segment. Then, we combine the 2 mitigation measures of the 2 external beacons received by the mobile to determine the relative proximity of the mobile to the 2 beacons. This measurement can be repeated with other combinations of 2 beacons in order to identify the location of the mobile in the building. The weighted attenuation algorithm called OWLPS [10] has been improved in this use case.

In order to maintain a high level of service availability, we have developed a radio channel access algorithm called “round robin interference avoidance” to obtain as many mitigation measures as possible from all beacons. For this, it is necessary that all the beacons communicate with fairness and without temporal overlap. This round robin is dynamic and manages the insertion of a new beacon at the end of the tour and the removal by reconstruction of the chaining after 3 consecutive reception failures of a beacon stopped or out of coverage. We have exploited a nearly property of interference free between 2 transmissions. In the event of simultaneous transmissions of 2 signals, collision can be avoided with such approaches, a receiver can receive and synchronize with one of the 2 transmissions [11]. We have therefore added to the messages exchanged, the identifier of the last message received, so that the beacon of the unreceived message can *a posteriori* detect its collision with the other beacon. The consequence will be that this beacon will have to reconnect at the end of the round robin to avoid any additional interference. This algorithm works on the condition that the outer beacons form a complete graph.

### 2) Medium-range ranging with LoRa 2.4 GHz

Poucet’s pebbles integrate LoRa 2.4 GHz-based ranging capabilities, which provide an advantageous solution between the range of LoRa-868 MHz and the accuracy of UWB, which is discussed in section 3). LoRa’s physical layer beneficiate from higher bandwidths and throughput in the 2.4 GHz ISM bands compared to sub-GHz bands, at the cost of a smaller range. These advantages have motivated Semtech’s to introduce SX1280 2.4 GHz transceiver in 2017, the first and currently only LoRa transceiver supporting time-of-flight (ToF) ranging capabilities. Several independent studies have demonstrated the potential and novelty of that technology [12, 13], showcasing a range reaching up to 1700 m outdoor with an accuracy typically below 5% of the measured range. In regards to Poucet’s aim, we have put more emphasis on the indoor performances of SX1280, which have been less studied in these previous works. Considering the significant integration constraints for pebbles, we have designed an easily integrable LoRa 2.4 GHz ranging node (visible in

Figure 3), based on an SX1280 integrated small form factor radio module (Lambda-80-RF Solutions), and an MCU-STM32 Nucleo L432 KC host microcontroller. The wired prototype weighs only 25 grams for a volume of 7.8 (L) x 1.1 (W) x 1.8 (H) cm<sup>3</sup>.

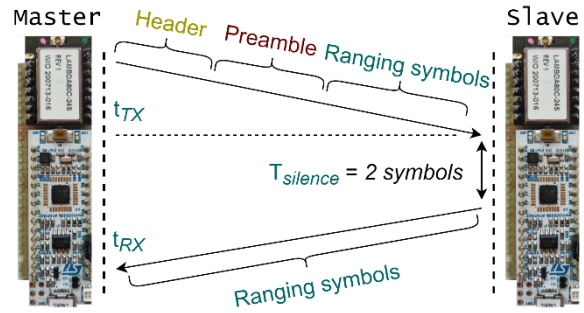

Fig. 3. Ranging protocol between 2 LoRa-2.4GHz ranging nodes

In a LoRa-2.4GHz ranging exchange, represented in Fig. 3, a master sends a request to a slave containing a variable-length preamble and header followed by 15 ranging symbols. After a silence of 2 ranging symbols, the slave replies with a frame containing 15 ranging symbols without header and preamble. The master records the time elapsed between the transmission of the request and the reception of the slave’s reply and subtracts the silence time to obtain the round-trip time-of-flight,  $ToF = t_{TX} - t_{RX}$ . The distance  $d$  is computed as  $d = (ToF / 2) \times c$ , with  $c$  the speed of light. Several frequencies can be selected to avoid limit the impact of fading on ToF estimations. On the field, the master node is worn by the foot soldier and process to perform ranging successively and continuously with all the pebbles within its range. It can perform from 25 to up to 500 ranging protocols per second depending on spreading factor [14] and bandwidth.

Our first experiments with pebbles have shown that in indoor scenarios, LoRa 2.4 GHz ranging nodes provide coverage of 50 meters in average while maintaining an accuracy equivalent to about 10% of the measured distance depending on the harshness of the indoor environment. Due to its significant kilometer-level outdoor range, it can also maintain a single-hop link between several buildings, and fills the gap between the short range of UWB modules and the limited accuracy of LoRa 868 MHz modules.

### 3) Short-range ranging with IR-UWB

One of the most accurate methods for locating connected objects in an indoor environment is based on the estimation of the time of flight (ToF), between the transmission instant of a radio frame by a transmitter, and the reception instant of this same frame by a remote receiver. This “ranging” operation can be carried out between any pairs of nodes within radio range of each other. The participating nodes can be considered as a client-server pair: the client initiates the ranging protocol with an available server (all active nodes are available servers, unless they are currently performing a ranging). One of the best transmission technologies for highly accurate ToF measurements today is Ultrawide-Band (UWB). High-resolution transmit and receive timestamps are possible thanks to a time stamp in the UWB frame, associated to 64 GHz clocks in the UWB transceivers used in Poucet. We have favored the use of DECAWAVE radio components,

now QORVO, leader in this technology. Ranging protocols based on optimized TWR (Two-Way Ranging) were used.

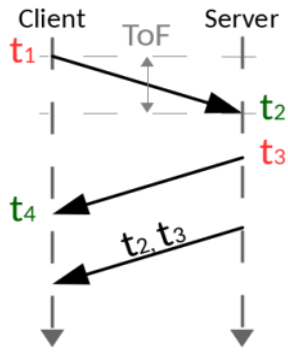

Fig. 4. Two-Way Ranging (TWR) protocol

The TWR protocol (Fig. 4) consists in a sequence of 3 messages. It is similar to the LoRa 2.4 GHz ranging protocol presented in Fig. 3, except that instead of relying pre-agreed reply times, the interrogated node transmits its recorded timestamps after replying in another frame. The START message is sent by the client at  $t_1$  and received by the server at  $t_2$ ; then ACK is sent by the server at  $t_3$  and received by the client at  $t_4$ ; at last, DATA\_REPLY is sent by the server to return the server timestamps ( $t_2$  and  $t_3$ ) to the client. This last message is used to piggyback other data, such as the position estimate of the server. The time-of-flight, and thus the distance between the two nodes, can be computed from the four timestamps.

The UWB part of a POU CET node is made of a Qorvo DWM1001 module, which implements an ARM Cortex-M4 32-bit MCU (Nordic nRF52832), an Ultra-Wide Band transceiver (Qorvo DW1000) and a 3-axis accelerometer (STM LIS2DH12TR). The module is present in the four node types: *tracker*, *beacon*, *pebble* and *DNs*. The dust nodes are based on Nomis, which are very tiny IoT board based on the DWM1001, with a LiPo-battery charger and a MicroSD card reader used for the logs. Their very small form-factor is interesting in the POU CET project, as they allow the agent to carry a significant number of DNs, typically 50.

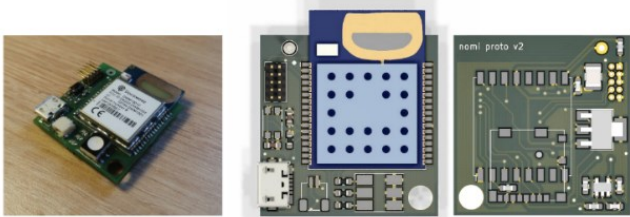

Fig. 5. Nomi nodes

The chosen deployment strategy (randomly picking a dust node from a bag and laying it on the ground or throwing it) requires the addition of a neighbor discovery step to the ranging process. Although all the nodes are programmed with a list of possible neighbors, messaging unreachable nodes is avoided by tracking which nodes have been detected by eavesdropping UWB transmissions during a set timeout period. The mobile node is always targeted even if it was not detected in order to bootstrap the discovery process between other types of nodes.

In order to execute TWR in an ad-hoc fashion, each TWR-client randomly picks a wait duration in a given interval (shorter than the timeout period). When this duration has elapsed, the client performs a ranging session. In the case of a static node (DN, pebble, beacon), the ranging session targets only one neighbor at a time, while the mobile's ranging session is a burst of ranging protocols that target a configurable number of neighbors.

To preserve battery power and to limit channel occupation when they are carried, DNs are put into sleep mode while their embedded IMU detects movements or until a pin is removed by the operator. The UWB transceiver is turned off in this mode. When exiting sleep mode, DNs clear their neighbor table and previous localization data, then enter in the ranging process described earlier.

#### 4) Altitude sensing

A simple method to compute the altitude of a node is to measure the local atmospheric pressure and use the formula taken from the ICAO atmospheric model:

$$P_n = P_0 \left(1 - \frac{0.0065 A_n}{288.15}\right)^{5.255} \quad (1)$$

With  $P_n$  the atmospheric pressure measured by the node,  $P_0$  the pressure at sea level and  $A_n$  the altitude of the node.

However, this method relies on the knowledge of the parameter  $P_0$  that varies significantly over the duration of the experiment, and also between experiments. The method we have implemented to tackle this issue is the following:

During the initialization of the mobile at a known location, the formula is used to compute  $P_0$  from the known altitude and the measured pressure. Stationary beacons broadcast every 2 minutes the pressure change they have measured over the last 2 minutes. Using these broadcasted measures, the mobile keeps track of the evolution of the local atmospheric pressure since its initialization, and corrects its raw pressure measurements accordingly.

This method was favored over a computation of  $P_0$  directly by the stationary beacons because the altitude of the beacons could not be measured precisely enough.

#### C. Indoor Localization Methods using a multi-input measurements fusion algorithm

The localization algorithm developed for this experiment is an extension of Uncertainty Weighted Localization (UWL [15]). UWL is a distributed localization algorithm based on ranging measurements. It relies on two intertwined optimizations:

**A local, explicit, optimization**, that is computed on each node. The inputs of this optimization are the distances measured between the current node and all its neighbors, and the current position estimates of all these neighbors (hatched circles in Fig. 6). The discrepancies between all the nodes position estimates are modeled as attractive or repulsive forces (dotted arrows) depending on whether the distance between position estimates is larger or smaller than the measured distance, and the weighted sum of these forces (net force, plain arrow) gives a direction. The current position estimate ( $\hat{x}_n$ ) is updated ( $\hat{x}_{n+1}$ ) in that direction, and the process is repeated until a stop condition is met. The weights used in the net force computation are inversely proportional

to the uncertainty of the position of the neighbor used to compute that individual force.

**A global, implicit optimization**, that is performed when node exchange new position estimates. Once a node has computed its position estimate, it broadcasts it to all its one-hop neighbors. These neighbors can then update their own position estimate because one of the inputs of their local optimization algorithm has changed. These new position estimates are then disseminated, propagating the position improvement in the network.

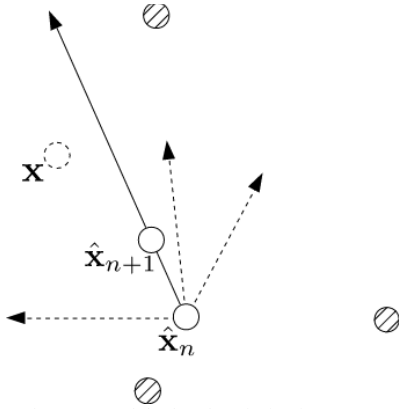

Fig. 6. Illustration of one step of the local optimization process

UWL was originally designed to use exclusively distance measurements as inputs. In Poucet, the mobile node has access to other types of measures, that can't be modeled in forces as the distances were. These new types of measures are:

**Position measurements:** both GPS receiver and weighted attenuation algorithm provide directly a position. In order to include these positions (and their uncertainties) into UWL process, each of these measures is modeled as a force pointing toward that position, whose magnitude is the distance between the current position estimate and that measured position.

**Altitude measurements:** the barometric altimeter provides an altitude. This measure is modeled as a vertical force, pointing downward (respectively upward) if the current position estimate is above (resp. below) the barometric altitude, whose magnitude is equal to the difference (in meter) between the altitudes.

UWL is running on the mobile node, on pebbles and on dusts. Each of these devices participate in the global optimization, the rationale being that pebbles should be able to compute their own position thanks to the LoRa 868 MHz weighted attenuation algorithm, and the dust nodes should be able to build a localization network around the pebbles thanks to their high-precision ranging measurements.

#### D. Log & Replay Engine

##### 1) Logging mechanisms

The architecture built around a MQTT bus also provides a natural and easy way to log and replay data as all the exchanges between processes happen in a single place, while identification and segregation of the data flows is made easy with the topics of MQTT. As none of the devices is equipped with a persistent clock, it was first required to synchronize them with a known time reference in order to analyze the logs produced by the logging service. The following raw data

(stored with their local timestamp in the logs) were used to compute the time offsets with UTC and shift all the dates in the logs accordingly:

The mobile node has logged the GPS dates computed by its GPS receiver, so this information was used as synchronization source.

Each UWB TWR transaction was logged on the two nodes involved in the ranging, including a unique sequence number. It was therefore possible to compute a time offset between the mobile node and all the nodes that performed an UWB ranging with it.

For nodes that did not performed a UWB ranging with the mobile node, intercorrelation of the raw atmospheric pressure measured by these nodes and a reference (synchronized) node was used to compute a time offset.

##### 2) Replaying tools

One of the goals of the MQTT-based software architecture was to easily replay raw data and test different versions of our algorithms. For that purpose, we have developed a reproducible event-driven framework with the following capabilities:

**Replaying recorded MQTT messages**, with respect to the original timeline of the messages. Given the separation of the different data exchange by topics, it is very easy to exclude the data produced by a given service. For example, it is possible to replay only the raw pressure measurements in order to test a new version of the altimeter algorithm.

**Accelerating or slowing down the replay**, i.e., the duration between two messages is reduced by a fixed factor. This requires small adaptations of our algorithms to correct the time factor where time is used in computations

**Injecting new MQTT messages at specific dates in the replayed flow of messages**, for example to emulate new transmissions, in a Hardware-in-the-Loop (HIL) fashion.

**Removing recorded MQTT messages** to emulate a harder environment with more packet losses.

### III. EXPERIMENTAL RESULTS

The prototypes developed for Poucet have been tested during simulation of typical military indoor operations conducted by the French Army Ground Forces. These evaluations are conducted one or twice a year as part of a competitive call for indoor positioning solutions, and Poucet is part of the six teams competing. Every prototype is submitted to the same experimental protocol by the National Defense, which means that the evaluation can be considered as independent and unbiased. We present in this section the test protocols and the results obtained during the last session, which took place in late January 2021.

#### A. Experimental protocol

Three benchmark scenarios have been tested on the proposed prototypes. In each of them, an infantryman wearing the tracker moves across a military campus, consisting of several buildings having multiple floors and occasionally underground connections, covering roughly half a square kilometer. The path taken by the soldier features multiple challenging areas, including for example underpasses (which strongly attenuate radio signals), rapid circular motions, jumps and rolls (which throw off accelerometers). Each

session lasts for about 42, minutes, and maximum time of 15 minutes is allocated for the deployment of the tested prototype prior to the session. Each tested solution must provide in real-time the GPS coordinates of the soldier throughout the evaluation. The only information given is the starting GPS coordinates of the soldier, which is relayed by a military GPS receiver through an ethernet link at the very beginning of the protocol. Otherwise, each tested prototype has to work without any prior information on the environment. The path taken by the soldier features multiple georeferenced points, which are used to evaluate the accuracy of each solution. The only difference between the three scenarios tested were their level of difficulty, based on the path taken by the soldier.

During Poucet's evaluation, four external beacons have been deployed during the 15 minutes-preparation time. The tracker has been attached to the infantryman's helmet, who was also given a special jacket that can fit 50 DNs and 6 pebbles. The instructions given to the infantryman were to drop a Nomi every time a door is passed, and drop a pebble when entering a new building.

### B. First results analysis

The main concerns regarding these experiments were about the radio coverage. Since the experiments cover multiple buildings and not just a single one it can be considered as quite challenging application of indoor positioning techniques. In particular, the underground parts are extremely problematic for radio solutions as keeping a link with the surface stations is difficult.

A chronogram of each technology availability during the 30 minutes experiments is shown below in Fig. 7. A description of events occurring on the infantryman's journey is given on the X-axis. A given radio protocol is considered as available if a message has been received within the last 2 seconds. The GPS is considered as available if a stable position can be received, which is typically not the case once entering a building.

Most of the indoor experiments were conducted in basements, despite of that at least one LoRa-868 beacon was heard by the mobile; it has been failing mainly in underpasses. Since computing trilateration with LoRa-868 requires three stations, OWLPS was not able to work when only one or two beacons were heard. Our paradigm is to calculate coordinates in a Markovian way in order to compute absolute coordinates. But to consider one or two beacons in reception at a time, we need to extend our calculation using the history of the last known coordinates. Because with less than 3 beacons we can only identify speed and/or direction.

Some parts of the path taken by the infantryman were outdoor, when transitioning between building. In these parts, the system can rely on GPS; thus, the agent was instructed not to drop pebbles or DNs, which justifies that UWB is typically not available outside. During indoor displacements, UWB feature a good availability as the link has only been lost occasionally.

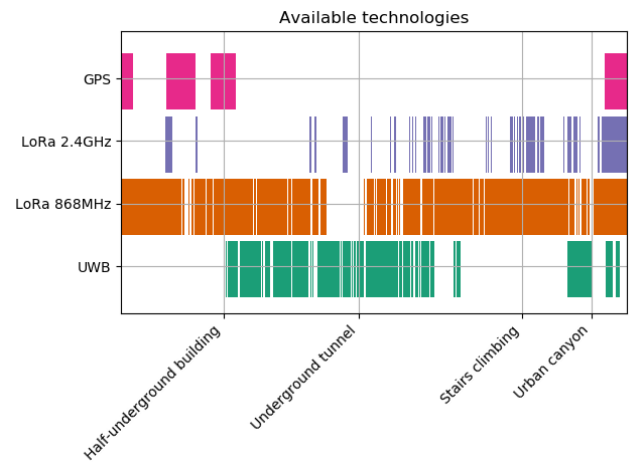

Fig. 7. Chronogram of the availability of each radio technology during the evaluation

That happened mainly when reaching stairs and transitioning from one floor to another: not dropping a pebble halfway in the stairs would lead to lose temporary the UWB link. LoRa 2.4 GHz is currently integrated only within the pebbles and not into the DNs. Considering the wide surface covered, and the fact that only a few LoRa-2.4 nodes were deployed, the technology is mainly available right after dropping a pebble and only until the agent moves a few dozen meters away.

The track submitted during the evaluation in real-time was unstable due to filtering flaws that led gibberish distances to reach the multilateration algorithm. After addressing these flaws, the recorded data have been replayed using the MQTT replay engine discussed previously. The track obtained is shown in Fig. 8.



Fig. 8. Track obtained for the military evaluation scenario

The track suffers mostly from the period radio link losses shown in Fig. 7. Because of that, the error compared to ground truth on some of the georeferenced points reached sometimes a few hundred meters. However, in areas where a decent coverage was achieved, an error of only a few dozen meters has been obtained (see Fig. 8). These low-coverage areas are mostly due to the complexity of the environment. The surface covered is particularly large for an indoor scenario and the operative scenario was designed to be challenging, considering the multiple underpasses crossed.

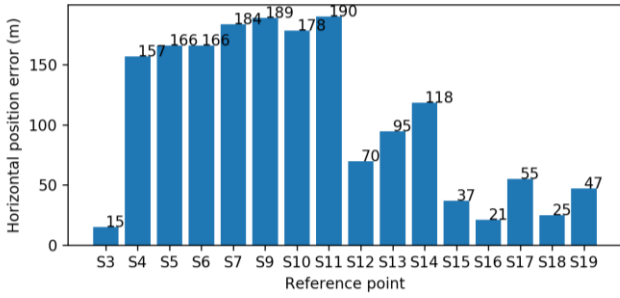

Fig. 9. Horizontal position error on georeferenced control points

The system has performed particularly well on the altitude measurements, as shown in Fig. 10. The measurements reported by the barometer-based altitude sensor have provided a meter-level accuracy throughout the experiments.

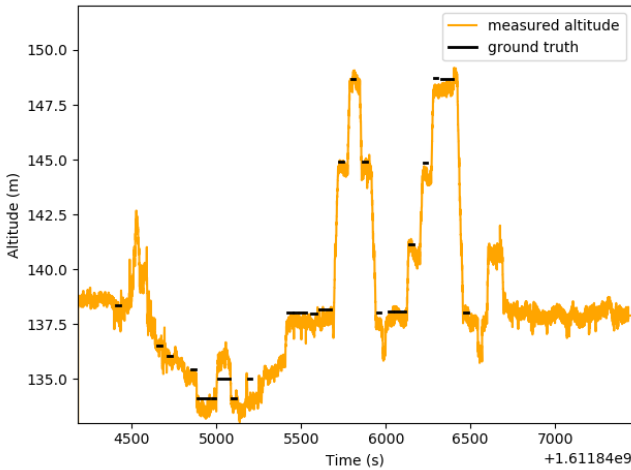

Fig. 10. Measured altitude vs ground truth during the evaluation

Indeed, the absolute altitude error was comprised between 10 cm and 1 m throughout the experiments, for an average of 36 cm. Thus, the floor detection in multi-level buildings was reliable and steady.

Considering these results, we discuss the pitfalls of the chosen approach and how we can address them in the next section

### C. Discussion and analysis

The first limitation uncovered by this evaluation is that the harshness of the environment, in terms of radio propagation often prevents the tracker from hearing three LoRa-868 beacons at the same time. This problem also applies for UWB: even if the tracker was benefiting from a relatively continuous UWB link indoor, it was only rarely receiving three of them simultaneously. Considering the complexity of the partially underground test environment, the radio coverage was not sufficient to provide a reliable positioning service in several areas. An important note is that the prototypes had to comply to civilian radio regulations during the experiments, and enabling military transmission power on these devices would alone considerably increase that coverage.

There are two main way to address this. The first one is to enhance the fusion algorithm so it can compute solutions with degraded accuracy when receiving only one or two nodes. The second one is to increase the number of pebbles and DNs. The first step to achieve that is to reduce their weight and

volume of the different types of nodes. We are currently working on a more lightweight version of the current prototypes. Integrating LoRa-2.4 GHz in DNs would also allow exploiting more efficiently that technology. However, that does not reduce the constraint represented by dropping regularly nodes during operations. If this can eventually consist an issue for infantry, the proposed approach has actually received very positive echoes from the firefighter's perspective. Indeed, it fits fairly well their typical operating mode. First, firefighters drop on their way fire-proof LEDs during their operations, which could potentially integrate radio transceivers. Second, the hose deployed to extinguish the fire, which is power-supplied, could also integrate several beacons. Also, the surfaces covered during indoor operations are typically much smaller than the one used for the military evaluation.

## IV. CONCLUSION

We introduced in this paper the architecture of Poucet, a multi-radio indoor positioning solution, combining GPS, Long Range Radio in the 868 MHz and 2.4 GHz frequency bands, UWB, and altimeters. The core principles of each technology involved have been discussed, followed by a presentation of the hardware designed for the current prototypes. These prototypes have been independently tested by the French national Defense in real-scale tests reproducing typical military operations. Despite the difficulty of the test environment, the proposed solution has showcased promising results. The main limitations were the degraded performances in area with poor radio coverage, such as underpasses. Increasing the number of nodes on the field can largely help addressing that problem.

Regarding that issue, we are currently working on designing integrated circuits supporting multiple radio protocols at once that could reduce further the weight and volume of the current prototypes. We also plan to improve the multi-input fusion algorithm for multilateration to provide more reliable results in degraded conditions. Finally, we aim to collaborate with the firefighter to eventually integrate the proposed solution within their existing hardware. Thus, we believe that Poucet is a valuable and promising indoor positioning solution for public safety.

## ACKNOWLEDGMENT

This work is supported by the funding of the French national Research Institute (ANR) and the Directorate General of Armaments (DGA), as part of the ASTRID Program. We thank the DGA to authorize our participation to the MALIN Indoor Positioning Challenge. We would also like to thank Digichrone and Geoconcept for their collaboration.



## REFERENCES

- [1] Jang, S., Park, S. bog, Moon, S. bok, Kim, J.M. and Lee, S. uk 2018. Comparison of camera based and inertial measurement unit based motion analysis. *SENSORNETS 2018 - Proceedings of the 7th International Conference on Sensor Networks*. 2018-Janua, Sensornets 2018 (2018), 161–167. DOI:<https://doi.org/10.5220/0006716601610167>.
- [2] Lim, J.H., Yoo, W.J., Kim, L.W., Lee, Y.D. and Lee, H.K. 2018. Augmentation of GNSS by low-cost MEMS IMU, OBD-II, and digital altimeter for improved positioning in urban area. *Sensors (Switzerland)*. 18, 11 (2018). DOI:<https://doi.org/10.3390/s18113830>.
- [3] Yang, S., Ma, L., Jia, S. and Qin, D. 2020. An Improved Vision-Based Indoor Positioning Method. *IEEE Access*. 8, 2 (2020), 26941–26949. DOI:<https://doi.org/10.1109/ACCESS.2020.2968958>.
- [4] Yassin, M. and Rachid, E. 2015. A survey of positioning techniques and location based services in wireless networks. *2015 IEEE International Conference on Signal Processing, Informatics, Communication and Energy Systems, SPICES 2015*. (2015). DOI:<https://doi.org/10.1109/SPICES.2015.7091420>.
- [5] Ahmed, A.U., Arablouei, R., De Hoog, F., Kusy, B. and Jurdak, R. 2019. Multi-radio data fusion for indoor localization using bluetooth and WiFi. *PECCS 2019 - Proceedings of the 9th International Conference on Pervasive and Embedded Computing and Communication Systems*. (2019), 13–24. DOI:<https://doi.org/10.5220/0007954100130024>.
- [6] Light, R.A. 2017. Mosquitto: server and client implementation of the MQTT protocol. *The Journal of Open Source Software*. 2, 13 (2017), 265. DOI:<https://doi.org/10.21105/joss.00265>.
- [7] Bossche, A. Van Den, Dalce, R., Fofana, N.I., Val, T., Bossche, A. Van Den, Dalce, R., Fofana, N.I., Val, T. and An, D. 2017. DecaDuino : An Open Framework for Wireless Time-of-Flight Ranging Systems To cite this version : HAL Id : hal-01558445. (2017).
- [8] Tomasi, W. 1987. *Advanced electronic communications systems*.
- [9] Zafari, F., Gkelias, A. and Leung, K.K. 2019. A Survey of Indoor Localization Systems and Technologies. *IEEE Communications Surveys and Tutorials*. 21, 3 (2019), 2568–2599. DOI:<https://doi.org/10.1109/COMST.2019.2911558>.
- [10] Jacq, D., Chatonnay, P., Bloch, C., Canalda, P. and Spies, F. 2017. Towards zero-configuration for Wi-Fi Indoor Positioning System. (2017).
- [11] Liao, C.H., Zhu, G., Kuwabara, D., Suzuki, M. and Morikawa, H. 2017. Multi-Hop LoRa Networks Enabled by Concurrent Transmission. *IEEE Access*. 5, (2017), 21430–21446. DOI:<https://doi.org/10.1109/ACCESS.2017.2755858>.
- [12] Wolf, F., Le Deroff, K., De Rivaz, S., Deparis, N., Dehmas, F. and Cances, J.P. 2019. Benchmarking of narrowband LPWA physical layer ranging technologies. *2019 16th Workshop on Positioning, Navigation and Communication, WPNC 2019*. (2019). DOI:<https://doi.org/10.1109/WPNC47567.2019.8970248>.
- [13] Janssen, T., Bnilam, N., Aernouts, M., Berkvens, R. and Weyn, M. 2020. Lora 2.4 ghz communication link and range. *Sensors (Switzerland)*. 20, 16 (2020), 1–12. DOI:<https://doi.org/10.3390/s20164366>.
- [14] Zorbas, D., Papadopoulos, G.Z., Maille, P., Montavont, N. and Douligieris, C. 2018. Improving LoRa Network Capacity Using Multiple Spreading Factor Configurations. *2018 25th International Conference on Telecommunications, ICT 2018*. (2018), 516–520. DOI:<https://doi.org/10.1109/ICT.2018.8464901>.
- [15] Vey, Q., Dalce, R., Van Den Bossche, A. and Val, T. 2020. A distributed algorithm for range-based localization in sparse wireless networks. *2020 30th International Telecommunication Networks and Applications Conference, ITNAC 2020* (2020).