

VULCRAFT® STEEL DECK

NUCOR®
VULCRAFT

VULCRAFT® DECK SOLUTIONS



Catalog Solutions



Web Based Solutions

General

Product Offer Information



Bekaert Steel Fiber Information

Pour Stop Selection Table

Non-Composite Slab Design

Cellular Deck Design Guidance

Acoustical Solutions



Acoustical Roof Deck – NRC Ratings

2.0D FormLok® Deck-Slab - STC & IIC Ratings

3.5D FormLok® Deck-Slab - STC & IIC Ratings

UL Fire Ratings



UL Fire Ratings - Roof Deck

UL Fire Ratings - Floor Deck

Hanging Solutions



Sammy X-Press for Roof Deck

Wedge-Nut for FormLok® Dovetail Deck-Slab



Steel Deck Roving Load - Web Based Design Tool

Approvals - Download PDF

IAPMO UES Report ER-652 for Vulcraft Deck and Deck-Slabs

IAPMO UES Report ER-423 for Dovetail Deck and Deck-Slabs



FM Approval Reports

Vulcraft Deck CSI Guide Spec

Dovetail Deck CSI Guide Spec

Roof Deck



Steel Deck Uniform Loads - Web Based Design Tool

Steel Deck Web-Crippling - Web Based Design Tool

Steel Deck Diaphragm Strength - Web Based Design Tool

ASD Roof Deck (Properties and Vertical Load Tables)

2.0D Dovetail Roof Deck

3.5D Dovetail Roof Deck

1.5B-36/1.5BI-36/1.5PLB-36 GR50 Roof Deck

1.5B-36/1.5BI-36/1.5PLB-36 GR80 Roof Deck

3NL-32/3NI-32/3PLN-32 GR50 Roof Deck

3NL-32/3NI-32/3PLN-32 GR80 Roof Deck

3N-24/3NI-24 Roof Deck

2.0DA Dovetail Acoustical Roof Deck

3.5DA Dovetail Acoustical Roof Deck

1.5BA-36/1.5BIA-36/1.5PLBA-36 GR50 Acoustical Roof Deck

1.5BA-36/1.5BIA-36/1.5PLBA-36 GR80 Acoustical Roof Deck

3NLA-32/3NIA-32/3PLNA-32 GR50 Acoustical Roof Deck

3NLA-32/3NIA-32/3PLNA-32 GR80 Acoustical Roof Deck

3NA-24/3NIA-24 Acoustical Roof Deck



LRFD Roof Deck (Properties and Vertical Load Tables) - Download PDF

VULCRAFT® DECK SOLUTIONS



Catalog Solutions



Web Based Solutions

Composite Deck



Unshored Span - Web Based Design Tool

Composite Deck-Slab Strength (Superimposed Load) - Web Based Design Tool

Composite Deck Diaphragm Strength - Web Based Design Tool

ASD Composite Deck (Properties and Superimposed Load Tables)

2.0D FormLok® Dovetail Deck-Slab

3.5D FormLok® Dovetail Deck-Slab



1.5VL-36/1.5VLI-36/1.5PLVLI-36 Composite Deck-Slab

1.5VLR-36 Composite Deck-Slab

2VLI-36/2VLJ-36/2PLVLI-36 Composite Deck-Slab

3VLI-36/3VLJ-36/3PLVLI-36 Composite Deck-Slab



LRFD Composite Deck (Properties and Superimposed Load Tables) - Download PDF

Non-Composite Deck

ASD Non-Composite Deck (Properties and Vertical Load Tables)

0.6C-30/0.6C-35 Non-Composite Deck

0.6C-36 Non-Composite Deck



1.0C-32 Non-Composite Deck

1.0C-33 Non-Composite Deck

1.0C-36 Non-Composite Deck

1.3C-32 Non-Composite Deck

1.5C-36 Non-Composite Deck

2C-36 Non-Composite Deck

3C-36 Non-Composite Deck



LRFD Non-Composite Deck (Properties and Vertical Load Tables)

Cellular Deck

ASD Cellular Deck (Properties Tables)

1.5BP-36/1.5PLBP-36/1.5VLP-36/1.5PLVLP-36 Cellular Deck

1.5BPA-36/1.5PLBPA-36/1.5VLPA-36/1.5PLVLP-36 Acoustical Cellular Deck

3NP-32/3PLNP-32 Cellular Deck

3NPA-32/3PLNPA-32 Acoustical Cellular Deck



3NP-24 Cellular Deck

3NPA-24 Acoustical Cellular Deck

2VLP-36/2PLVLP-36 Cellular Deck

2VLPA-36/2PLVLP-36 Acoustical Cellular Deck

3VLP-36/3PLVLP-36 Cellular Deck

3VLPA-36/3PLVLP-36 Acoustical Cellular Deck



LRFD Cellular Deck (Properties Tables) - Download PDF



GENERAL

VULCRAFT® DECK PRODUCT OFFER

ROOF DECKS

1.5B ROOF DECKS

COVER WIDTHS: 30", 36"

GAGES: 24, 22, 20, 19, 18, 16

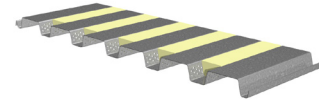
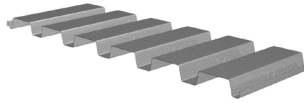

32" WIDE 3N ROOF DECKS

COVER WIDTH: 32"

GAGES: 22, 20, 19, 18, 16

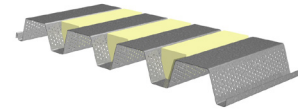
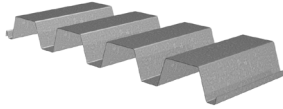

24" WIDE 3N ROOF DECKS

COVER WIDTH: 24"

GAGES: 22, 20, 19, 18, 16

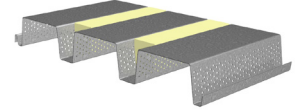
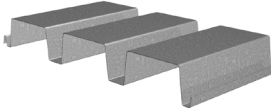

DOVETAIL DECKS

2.0D DOVETAIL DECKS

COVER WIDTH: 24.5"

GAGES: 22, 20, 19, 18, 16

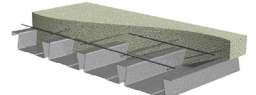
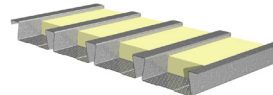
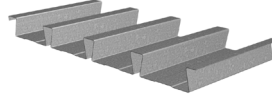

3.5D DOVETAIL DECKS

COVER WIDTH: 24"

GAGES: 20, 19, 18, 16

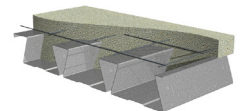
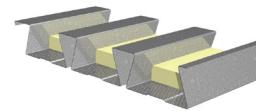
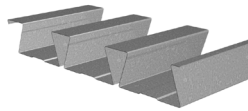

COMPOSITE DECKS

1.5VL COMPOSITE DECKS

COVER WIDTH: 36"

GAGES: 22, 20, 19, 18, 16

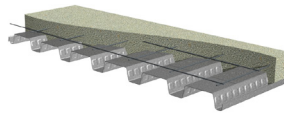

1.5VLR COMPOSITE DECKS

COVER WIDTH: 36"

GAGES: 22, 20, 19, 18, 16

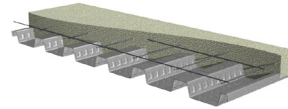

2VLI COMPOSITE DECKS

COVER WIDTH: 36"

GAGES: 22, 20, 19, 18, 16

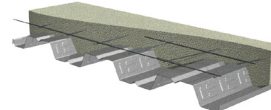

3VLI COMPOSITE DECKS

COVER WIDTH: 36"

GAGES: 22, 20, 19, 18, 16

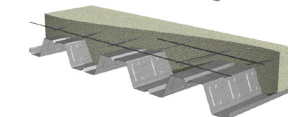

NON-COMPOSITE DECKS

0.6C NON-COMPOSITE DECKS

COVER WIDTHS: 30", 35", 36"

GAGES: 28, 26, 24, 22

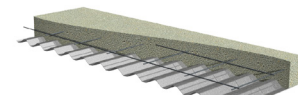

1.0C NON-COMPOSITE DECKS

COVER WIDTHS: 32", 33", 36"

GAGES: 26, 24, 22, 20

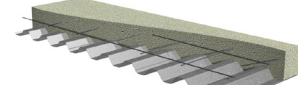

1.3C NON-COMPOSITE DECKS

COVER WIDTH: 32"

GAGES: 26, 24, 22, 20

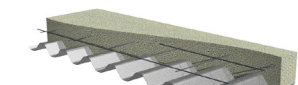

1.5C NON-COMPOSITE DECKS

COVER WIDTHS: 30", 36"

GAGES: 24, 22, 20, 18

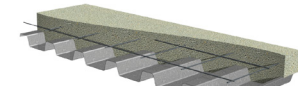

2C NON-COMPOSITE DECKS

COVER WIDTH: 36"

GAGES: 22, 20, 18, 16

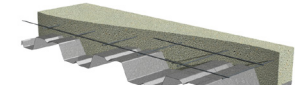
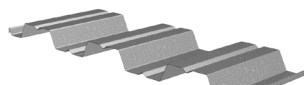

3C NON-COMPOSITE DECKS

COVER WIDTH: 36"

GAGES: 22, 20, 18, 16

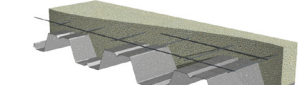
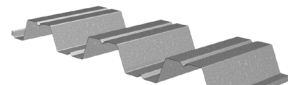

VULCRAFT® DECK PRODUCT OFFER

CELLULAR DECK PRODUCT OFFER

1.5BP CELLULAR DECKS

COVER WIDTH: 24", 36"

GAGES: 20/20, 20/18, 18/20, 18/18,
18/16, 16/18, 16/16

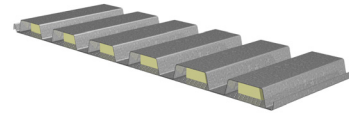
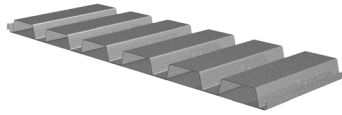

1.5VLP CELLULAR DECKS

COVER WIDTH: 24", 36"

GAGES: 20/20, 20/18, 18/20, 18/18,
18/16, 16/18, 16/16

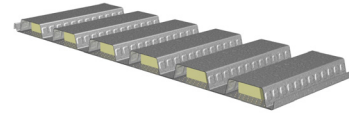
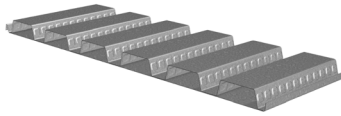

32" WIDE 3NP CELLULAR DECKS

COVER WIDTH: 32"

GAGES: 20/20, 20/18, 18/20, 18/18,
18/16, 16/18, 16/16

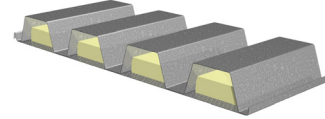
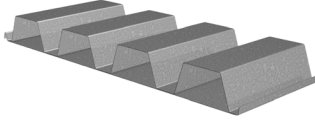

24" WIDE 3NP CELLULAR DECKS

COVER WIDTH: 24"

GAGES: 20/20, 20/18, 18/20, 18/18,
18/16, 16/18, 16/16

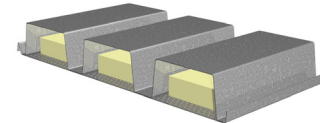
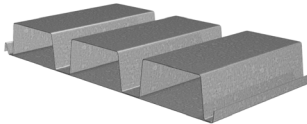

2VLP CELLULAR DECKS

COVER WIDTH: 24", 36"

GAGES: 20/20, 20/18, 18/20, 18/18,
18/16, 16/18, 16/16

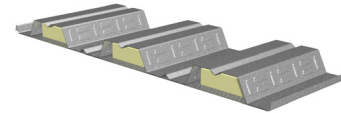
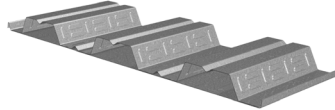

3VLP CELLULAR DECKS

COVER WIDTH: 24", 36"

GAGES: 20/20, 20/18, 18/20, 18/18,
18/16, 16/18, 16/16

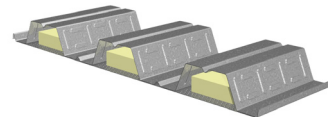
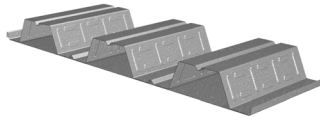

VULCRAFT® COMPOSITE DECKS with BEKAERT DRAMIX® STEEL FIBERS

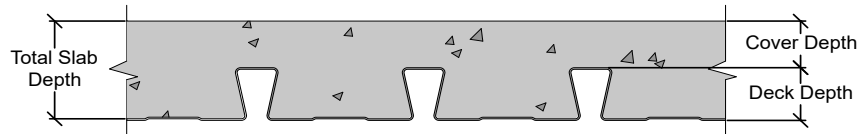

Minimum Reinforcing Options for Temperature and Shrinkage $f'_c = 3000$ psi

Cover Depth (in.)	Min. A_s for T&S (in. ²)	Recommended Reinforcing for Temperature and Shrinkage	
		WWR	(OR) Bekaert Dramix® Steel Fiber Alternate to WWR (lb/yd ³) 4D 65/60BG
Normal Weight Concrete (145 pcf)			
2	0.028	6x6-W1.4xW1.4	23
2¼	0.028	6x6-W1.4xW1.4	20
2½	0.028	6x6-W1.4xW1.4	18
2¾	0.028	6x6-W1.4xW1.4	16
3	0.028	6x6-W1.4xW1.4	15
3¼	0.029	6x6-W2.1xW2.1	15
3½	0.032	6x6-W2.1xW2.1	15
3¾	0.034	6x6-W2.1xW2.1	15
4	0.036	6x6-W2.1xW2.1	15
4¼	0.038	6x6-W2.1xW2.1	15
4½	0.041	6x6-W2.1xW2.1	15
4¾	0.043	6x6-W2.9xW2.9	15
5	0.045	6x6-W2.9xW2.9	15
6	0.054	6x6-W2.9xW2.9	15
Light Weight Concrete (110 pcf)			
2	0.028	6x6-W1.4xW1.4	33
2¼	0.028	6x6-W1.4xW1.4	28
2½	0.028	6x6-W1.4xW1.4	25
2¾	0.028	6x6-W1.4xW1.4	22
3	0.028	6x6-W1.4xW1.4	20
3¼	0.029	6x6-W2.1xW2.1	20
3½	0.032	6x6-W2.1xW2.1	20
3¾	0.034	6x6-W2.1xW2.1	20
4	0.036	6x6-W2.1xW2.1	20
4¼	0.038	6x6-W2.1xW2.1	20
4½	0.041	6x6-W2.1xW2.1	20
4¾	0.043	6x6-W2.9xW2.9	20
5	0.045	6x6-W2.9xW2.9	20
6	0.054	6x6-W2.9xW2.9	20

Notes:

1. FRC reinforcement is based on IAPMO UES ER-465.
2. Dramix® fibers may be used in UL or ULC fire rated assemblies in lieu of WWR. See UL file R19307 for additional information.

For information on Bekaert Dramix® fibers contact 770-514-2295 or infobuilding@bekaert.com.

VULCRAFT® COMPOSITE DECKS with BEKAERT DRAMIX® STEEL FIBERS

3½" Deep Decks

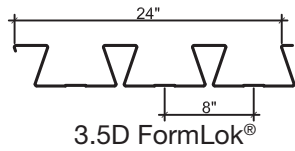

3" Deep Decks

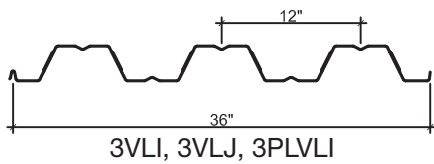

2" Deep Decks

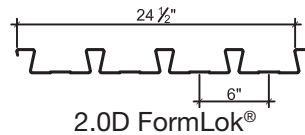
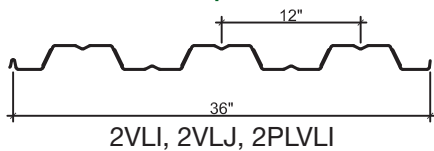

1½" Deep Decks

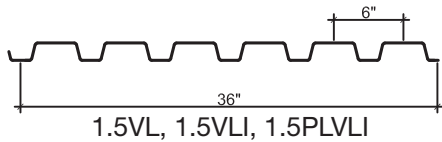

Composite Deck Slab

Total Slab Depth (in.)	Cover Depth (in.)			
	3½" Deep Decks	3" Deep Decks	2" Deep Decks	1½" Deep Decks
	Vulcraft Composite Decks			
	3.5D	3VLI, 3VLJ, 3PLVLI	2VLI, 2VLJ, 2PLVLI, 2.0D	1.5VL, 1.5VLI, 1.5PLVLI, 1.5VLR
3 1/2	-	-	-	2
3 3/4	-	-	-	2 1/4
4	-	-	2	2 1/2
4 1/4	-	-	2 1/4	2 3/4
4 1/2	-	-	2 1/2	3
4 3/4	-	-	2 3/4	3 1/4
5	-	2	3	3 1/2
5 1/4	-	2 1/4	3 1/4	3 3/4
5 1/2	2	2 1/2	3 1/2	4
5 3/4	2 1/4	2 3/4	3 3/4	4 1/4
6	2 1/2	3	4	4 1/2
6 1/4	2 3/4	3 1/4	4 1/4	4 3/4
6 1/2	3	3 1/2	4 1/2	5
6 3/4	3 1/4	3 3/4	4 3/4	5 1/4
7	3 1/2	4	5	5 1/2
7 1/4	3 3/4	4 1/4	5 1/4	5 3/4
7 1/2	4	4 1/2	5 1/2	6
7 3/4	4 1/4	4 3/4	5 3/4	-
8	4 1/2	5	6	-

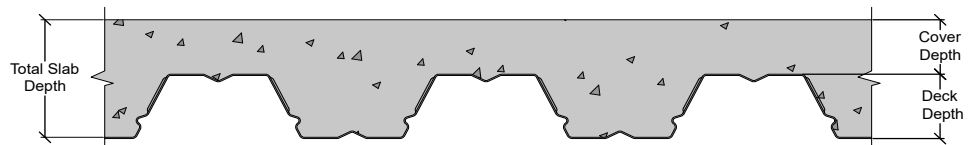

NOTICE: Design defects that could cause injury or death may result from relying on the information in this document without independent verification by a qualified professional. The information in this document is provided "AS IS". Nucor Corporation and its affiliates expressly disclaim: (i) any and all representations, warranties and conditions and (ii) all liability arising out of or related to this document and the information in it.

NUCOR, VULCRAFT, VERCO, and FORMLOK are registered trademarks of Nucor. DRAMIX is a registered trademark of Bekaert.

SDI POUR STOP SELECTION



Pour Stop Gage

Slab Depth (in.)	Overhang (in.)													Design Thickness (in.)		
	0	1	2	3	4	5	6	7	8	9	10	11	12			
4.00	20	20	20	20	18	18	16	14	12	12	12	10	10			
4.25	20	20	20	18	18	16	16	14	12	12	12	10	10			
4.50	20	20	20	18	18	16	16	14	12	12	12	10	10			
4.75	20	20	18	18	16	16	14	14	12	12	10	10	10			
5.00	20	20	18	18	16	16	14	14	12	12	10	10				
5.25	20	18	18	16	16	14	14	12	12	12	10	10				
5.50	20	18	18	16	16	14	14	12	12	12	10	10				
5.75	20	18	16	16	14	14	12	12	12	12	10	10				
6.00	18	18	16	16	14	14	12	12	12	10	10	10				
6.25	18	18	16	14	14	12	12	12	12	10	10					
6.50	18	16	16	14	14	12	12	12	12	10	10					
6.75	18	16	14	14	14	12	12	12	10	10	10					
7.00	18	16	14	14	12	12	12	12	10	10	10					
7.25	16	16	14	14	12	12	12	10	10	10						
7.50	16	14	14	12	12	12	12	10	10	10						
7.75	16	14	14	12	12	12	10	10	10	10						
8.00	14	14	12	12	12	12	10	10	10					20	0.0358	
8.25	14	14	12	12	12	10	10	10	10					18	0.0474	
8.50	14	12	12	12	12	10	10	10						16	0.0598	
8.75	14	12	12	12	12	10	10	10						14	0.0747	
9.00	14	12	12	12	10	10	10							12	0.1046	
9.25	12	12	12	12	10	10	10							10	0.1345	
9.50	12	12	12	10	10	10										
9.75	12	12	12	10	10	10										
10.00	12	12	10	10	10	10										
10.25	12	12	10	10	10											
10.50	12	12	10	10	10											
10.75	12	10	10	10												
11.00	12	10	10	10												
11.25	12	10	10													
11.50	10	10	10													
11.75	10	10														
12.00	10	10														

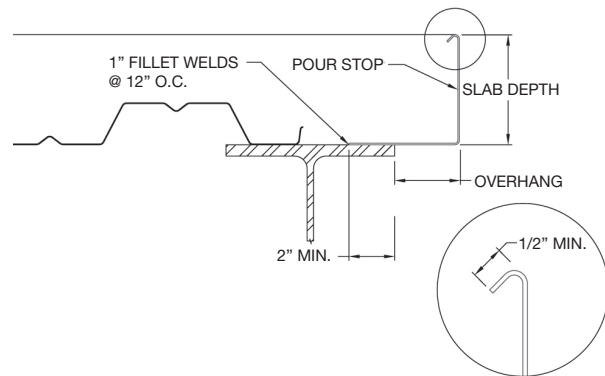

NOTES:

1. Normal weight concrete 150 PCF
2. Horizontal and vertical deflection is limited to 1/4" maximum for dead load
3. Design stress is limited to 20 KSI for concrete dead load temporarily increased by one-third for construction live load of 20 PSF
4. Pour Stop Selection Chart does not consider the effect of performance, deflection, or rotation of the pour stop support which may include both the supporting deck and/or the frame
5. Vertical leg return lip is recommended for all gages
6. This selection table is not meant to replace the judgment of experienced structural engineers and should be considered as a reference only

NON-COMPOSITE SLAB DESIGN

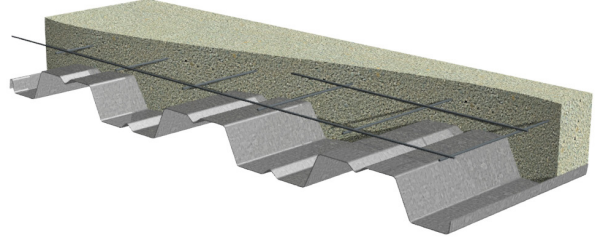
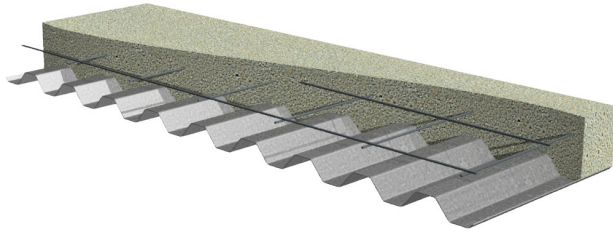

Design Notes for Reinforced Concrete Slabs

Concrete Design - Design of concrete slabs in accordance with ACI is the responsibility of the structural engineer of record. Values listed in these tables are provided as an aid in selecting the appropriate deck and Vulcraft does not assume responsibility for the design of the slab.

Temperature and Shrinkage Reinforcing - Temperature and shrinkage effects in the concrete shall be controlled by methods permitted by ACI 318. The designer shall be permitted to consider only the area of concrete above the deck.

Shoring - Slabs temporarily shored during construction must deduct the weight of the slab from the calculated capacity of the reinforced concrete slab.

Deck Finish - Galvanized form deck can be considered a permanent support in most applications. When uncoated or painted deck is used, the weight of the concrete slab shall be deducted from the calculated capacity of the reinforced concrete slab.

Allowable Slab Loads - These tables are based on an interior three span condition using moment coefficients from ACI 318- 14 Section 6.5.2. Moment coefficients must be adjusted for end spans, single spans, or double spans.

$f'_c = 3,000 \text{ psi}$	$\phi = 0.90$	$b = 12 \text{ in}$	$+ M = (W L^2)/16$	$+ M_c = T (d-a/2)/12$
$f_y = 60,000 \text{ psi}$	$T = A_s f_y$	$a = T/0.85 f'_c b$	$- M = (W L^2 (L \leq 10 \text{ ft.}))/12$	$- M_c = T (d-na)/12$
			$- M = (W L^2 (L > 10 \text{ ft.}))/10$	$M_L = \phi M_c/1.6$

Serviceability - Tabulated values are not evaluated for deflection.

Span Ratio - The tabulated concrete cover thicknesses (t) for the table values shown meet the ratio of span/28 per ACI 318-14 Section 7.3.1.5.

Reinforcing Placement - Reinforcing shall be located at center of topping.

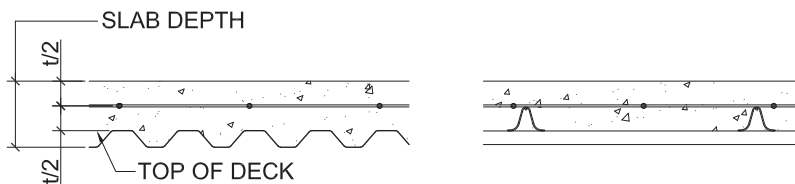

Venting Non-Composite Deck - Check with Vulcraft representative for availability.



SLOT VENTS

- 0.6C, 1.0C and 1.3C – Do not include slot vents in bottom flange. Sidelap vents optional.
- 0.6CSV, 1.0CSV and 1.3CSV – Specify if bottom flange slot vents are required.

NOTICE: Design defects that could cause injury or death may result from relying on the information in this document without independent verification by a qualified professional. The information in this document is provided "AS IS". Nucor Corporation and its affiliates expressly disclaim: (i) any and all representations, warranties and conditions and (ii) all liability arising out of or related to this document and the information in it.

REINFORCED CONCRETE SLABS ON NC DECK

ALLOWABLE SUPERIMPOSED UNIFORM LOADS (psf) FOR 0.6C DECK

3 Span Condition

Slab Depth		Reinforcement		Clear Span (ft-in.)											
Total	Topping	WWR	A _s	2'-0"	2'-3"	2'-6"	2'-9"	3'-0"	3'-3"	3'-6"	3'-9"	4'-0"	4'-6"	5'-0"	
2"	1½"	6x6-W2.1xW2.1	0.042	251	198	161	133	112	95	82					
		6x6-W2.9xW2.9	0.058	339	268	217	179	151	128	111					
		6x6-W4.0xW4.0	0.080	400	358	290	240	201	172	148					
2½"	2"	6x6-W2.9xW2.9	0.058	400	365	295	244	205	175	151	131	115	91		
		6x6-W4.0xW4.0	0.080	400	400	398	329	276	236	203	177	156	123		
		4x4-W2.9xW2.9	0.087	400	400	400	355	298	254	219	191	168	133		
3"	2½"	6x6-W2.9xW2.9	0.058	400	400	374	309	260	221	191	166	146	115	93	
		6x6-W4.0xW4.0	0.080	400	400	400	400	351	299	258	225	198	156	127	
		4x4-W2.9xW2.9	0.087	400	400	400	400	380	324	279	243	214	169	137	
3½"	3"	6x6-W4.0xW4.0	0.080	400	400	400	400	400	363	313	273	240	190	154	
		4x4-W2.9xW2.9	0.087	400	400	400	400	400	393	339	295	260	205	166	
		4x4-W4.0xW4.0	0.120	400	400	400	400	400	400	400	398	350	276	224	
4"	3½"	6x6-W4.0xW4.0	0.080	400	400	400	400	400	400	368	321	282	223	181	
		4x4-W2.9xW2.9	0.087	400	400	400	400	400	400	399	348	305	241	196	
		4x4-W4.0xW4.0	0.120	400	400	400	400	400	400	400	400	400	326	264	
4½"	4"	4x4-W2.9xW2.9	0.087	400	400	400	400	400	400	400	400	351	278	225	
		4x4-W4.0xW4.0	0.120	400	400	400	400	400	400	400	400	400	376	305	
		#3 @ 9" o.c.	0.147	400	400	400	400	400	400	400	400	400	400	368	

ALLOWABLE SUPERIMPOSED UNIFORM LOADS (psf) FOR 1.0C DECK

3 Span Condition

Slab Depth		Reinforcement		Clear Span (ft-in.)											
Total	Topping	WWR	A _s	3'-0"	3'-3"	3'-6"	3'-9"	4'-0"	4'-6"	5'-0"	5'-6"	6'-0"	6'-6"	7'-0"	
2½"	1½"	6x6-W2.1xW2.1	0.042	112	95	82	71								
		6x6-W2.9xW2.9	0.058	151	128	111	96								
		6x6-W4.0xW4.0	0.080	201	172	148	129								
3"	2"	6x6-W2.9xW2.9	0.058	205	175	151	131	115	91						
		6x6-W4.0xW4.0	0.080	276	236	203	177	156	123						
		4x4-W4.0xW4.0	0.120	397	338	292	254	223	176						
3½"	2½"	6x6-W2.9xW2.9	0.058	260	221	191	166	146	115	93	77				
		6x6-W4.0xW4.0	0.080	351	299	258	225	198	156	127	105				
		4x4-W4.0xW4.0	0.120	400	400	374	326	287	226	183	152				
4"	3"	6x6-W4.0xW4.0	0.080	400	363	313	273	240	190	154	127	107	91	78	
		4x4-W2.9xW2.9	0.087	400	393	339	295	260	205	166	137	115	98	85	
		4x4-W4.0xW4.0	0.120	400	400	400	398	350	276	224	185	156	133	114	
4½"	3½"	6x6-W4.0xW4.0	0.080	400	400	368	321	282	223	181	149	125	107	92	
		4x4-W2.9xW2.9	0.087	400	400	399	348	305	241	196	162	136	116	100	
		4x4-W4.0xW4.0	0.120	400	400	400	400	400	326	264	219	184	156	135	
5"	4"	4x4-W2.9xW2.9	0.087	400	400	400	400	351	278	225	186	156	133	115	
		4x4-W4.0xW4.0	0.120	400	400	400	400	400	376	305	252	212	180	156	
		#3 @ 9" o.c.	0.147	400	400	400	400	400	400	368	304	256	218	188	

REINFORCED CONCRETE SLABS ON NC DECK

ALLOWABLE SUPERIMPOSED UNIFORM LOADS (psf) FOR 1.3C DECK

3 Span Condition

Slab Depth		Reinforcement		Clear Span (ft-in.)										
Total	Topping	WWR	A _s	4'-0"	4'-6"	5'-0"	5'-6"	6'-0"	6'-6"	7'-0"	7'-6"	8'-0"	8'-6"	9'-0"
3 ⁵ / ₁₆ "	2"	6x6-W2.9xW2.9	0.058	115	91									
		6x6-W4.0xW4.0	0.080	156	123									
		4x4-W2.9xW2.9	0.087	168	133									
3 ¹³ / ₁₆ "	2½"	6x6-W2.9xW2.9	0.058	146	115	93	77							
		6x6-W4.0xW4.0	0.080	198	156	127	105							
		4x4-W2.9xW2.9	0.087	214	169	137	113							
4 ⁵ / ₁₆ "	3"	6x6-W4.0xW4.0	0.080	240	190	154	127	107	91	78				
		4x4-W2.9xW2.9	0.087	260	205	166	137	115	98	85				
		4x4-W4.0xW4.0	0.120	350	276	224	185	156	133	114				
4 ¹³ / ₁₆ "	3½"	6x6-W4.0xW4.0	0.080	282	223	181	149	125	107	92	80	71		
		4x4-W2.9xW2.9	0.087	305	241	196	162	136	116	100	87	76		
		4x4-W4.0xW4.0	0.120	400	326	264	219	184	156	135	118	103		
5 ⁵ / ₁₆ "	4"	4x4-W2.9xW2.9	0.087	351	278	225	186	156	133	115	100	88	78	69
		4x4-W4.0xW4.0	0.120	400	376	305	252	212	180	156	136	119	106	94
		#3 @ 9" o.c.	0.147	400	400	368	304	256	218	188	164	144	127	114
5 ¹³ / ₁₆ "	4½"	4x4-W4.0xW4.0	0.120	400	400	345	285	240	204	176	154	135	120	107
		#3 @ 9" o.c.	0.147	400	400	400	345	290	247	213	186	163	145	129
		#4 @ 12" o.c.	0.196	400	400	400	400	378	322	278	242	213	188	168

ALLOWABLE SUPERIMPOSED UNIFORM LOADS (psf) FOR 1.5C DECK

3 Span Condition

Slab Depth		Reinforcement		Clear Span (ft-in.)										
Total	Topping	WWR	A _s	4'-0"	4'-6"	5'-0"	5'-6"	6'-0"	6'-6"	7'-0"	7'-6"	8'-0"	8'-6"	9'-0"
3½"	2"	6x6-W2.9xW2.9	0.058	115	91									
		6x6-W4.0xW4.0	0.080	156	123									
		4x4-W2.9xW2.9	0.087	168	133									
4"	2½"	6x6-W2.9xW2.9	0.058	146	115	93	77							
		6x6-W4.0xW4.0	0.080	198	156	127	105							
		4x4-W2.9xW2.9	0.087	214	169	137	113							
4½"	3"	6x6-W4.0xW4.0	0.080	240	190	154	127	107	91	78				
		4x4-W2.9xW2.9	0.087	260	205	166	137	115	98	85				
		4x4-W4.0xW4.0	0.120	350	276	224	185	156	133	114				
5"	3½"	6x6-W4.0xW4.0	0.080	282	223	181	149	125	107	92	80	71		
		4x4-W2.9xW2.9	0.087	305	241	196	162	136	116	100	87	76		
		4x4-W4.0xW4.0	0.120	400	326	264	219	184	156	135	118	103		
5½"	4"	4x4-W2.9xW2.9	0.087	351	278	225	186	156	133	115	100	88	78	69
		4x4-W4.0xW4.0	0.120	400	376	305	252	212	180	156	136	119	106	94
		#3 @ 9" o.c.	0.147	400	400	368	304	256	218	188	164	144	127	114
6"	4½"	4x4-W4.0xW4.0	0.120	400	400	345	285	240	204	176	154	135	120	107
		#3 @ 9" o.c.	0.147	400	400	400	345	290	247	213	186	163	145	129
		#4 @ 12" o.c.	0.196	400	400	400	400	378	322	278	242	213	188	168

REINFORCED CONCRETE SLABS ON NC DECK

ALLOWABLE SUPERIMPOSED UNIFORM LOADS (psf) FOR 2C DECK

3 Span Condition

Slab Depth		Reinforcement		Clear Span (ft-in.)										
Total	Topping	WWR	A _s	5'-0"	5'-6"	6'-0"	6'-6"	7'-0"	7'-6"	8'-0"	8'-6"	9'-0"	9'-6"	10'-0"
4½"	2½"	6x6-W2.9xW2.9	0.058	93	77									
		6x6-W4.0xW4.0	0.080	127	105									
		4x4-W2.9xW2.9	0.087	137	113									
5"	3"	6x6-W2.9xW2.9	0.058	113	93	78	67	58						
		6x6-W4.0xW4.0	0.080	154	127	107	91	78						
		4x4-W2.9xW2.9	0.087	166	137	115	98	85						
5½"	3½"	6x6-W4.0xW4.0	0.080	181	149	125	107	92	80	71				
		4x4-W2.9xW2.9	0.087	196	162	136	116	100	87	76				
		4x4-W4.0xW4.0	0.120	264	219	184	156	135	118	103				
6"	4"	4x4-W2.9xW2.9	0.087	225	186	156	133	115	100	88	78	69		
		4x4-W4.0xW4.0	0.120	305	252	212	180	156	136	119	106	94		
		#3 @ 9" o.c.	0.147	368	304	256	218	188	164	144	127	114		
6½"	4½"	4x4-W4.0xW4.0	0.120	345	285	240	204	176	154	135	120	107	96	86
		#3 @ 9" o.c.	0.147	400	345	290	247	213	186	163	145	129	116	104
		#4 @ 12" o.c.	0.196	400	400	378	322	278	242	213	188	168	151	136
7"	5"	4x4-W4.0xW4.0	0.120	386	319	268	228	197	172	151	134	119	107	96
		#3 @ 9" o.c.	0.147	400	386	325	277	239	208	183	162	144	130	117
		#4 @ 12" o.c.	0.196	400	400	400	361	312	271	239	211	188	169	153

ALLOWABLE SUPERIMPOSED UNIFORM LOADS (psf) FOR 3C DECK

3 Span Condition

Slab Depth		Reinforcement		Clear Span (ft-in.)										
Total	Topping	WWR	A _s	6'-6"	7'-0"	7'-6"	8'-0"	8'-6"	9'-0"	9'-6"	10'-0"	10'-6"	11'-0"	11'-6"
5"	2"	6x6-W2.9xW2.9	0.058	44	38	33	29	26	23					
		6x6-W4.0xW4.0	0.080	59	51	44	39	34	31					
		4x4-W2.9xW2.9	0.087	64	55	48	42	37	33					
5½"	2½"	6x6-W2.9xW2.9	0.058	55	48	42	36	32	29	26	23			
		6x6-W4.0xW4.0	0.080	75	65	56	49	44	39	35	32			
		4x4-W4.0xW4.0	0.120	109	94	82	72	63	57	51	46			
6"	3"	6x6-W4.0xW4.0	0.080	91	78	68	60	53	47	43	38	29	26	24
		4x4-W2.9xW2.9	0.087	98	85	74	65	57	51	46	42	31	29	26
		4x4-W4.0xW4.0	0.120	133	114	100	87	77	69	62	56	42	39	35
6½"	3½"	6x6-W4.0xW4.0	0.080	107	92	80	71	62	56	50	45	34	31	28
		4x4-W2.9xW2.9	0.087	116	100	87	76	68	60	54	49	37	34	31
		4x4-W4.0xW4.0	0.120	156	135	118	103	92	82	73	66	50	46	42
7"	4"	4x4-W2.9xW2.9	0.087	133	115	100	88	78	69	62	56	42	39	35
		4x4-W4.0xW4.0	0.120	180	156	136	119	106	94	84	76	58	53	48
		#3 @ 9" o.c.	0.147	218	188	164	144	127	114	102	92	70	63	58
7½"	4½"	4x4-W4.0xW4.0	0.120	204	176	154	135	120	107	96	86	65	59	54
		#3 @ 9" o.c.	0.147	247	213	186	163	145	129	116	104	79	72	66
		#4 @ 12" o.c.	0.196	322	278	242	213	188	168	151	136	103	94	86

CELLULAR DECK DESIGN GUIDANCE

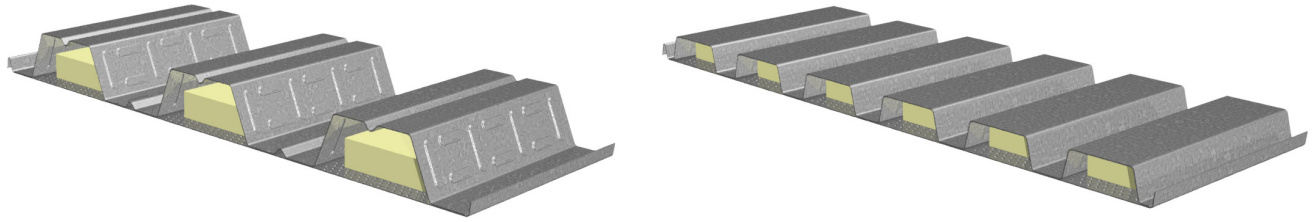

CELLULAR DECK DESIGN

Cellular and cellular acoustical decks may be designed for out-of-plane loads, shoring and diaphragm loads based on the published properties. Superimposed loads are based on the profile and gage of the fluted top section.

Cellular and cellular acoustical decks may be designed based on their fluted top sections ignoring the contribution of the bottom pan, in accordance with the guidelines below. Please contact your Vulcraft representative if more detailed information is required.

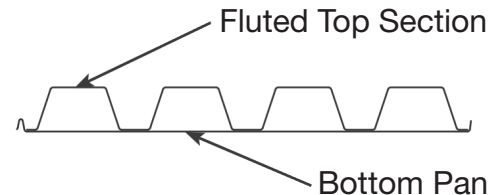

Cellular Roof Decks

- **Out-of-Plane Loads:** Cellular and cellular acoustical decks may be designed for out-of-plane loads based on fluted deck of the same gage and profile as the fluted top section of the cellular deck.
- **Diaphragm Design:** Diaphragm shear strength and stiffness for cellular and cellular acoustical decks may be based on fluted deck of the same profile as the fluted top section but with the gage of the bottom pan.

Cellular Composite Decks

- **Unshored Clear Spans:** Determination of maximum unshored clear spans of cellular and cellular acoustical decks may be based on fluted deck of the same gage and profile as the fluted top section of the cellular deck.

Cellular Composite Deck-Slabs

- **Superimposed Loads:** Superimposed loads for cellular composite and cellular acoustical composite decks with a given concrete type and thickness are based on composite deck of the same profile, gage and concrete as the fluted top section of the cellular deck.
- **Diaphragm Design:** Diaphragm shear strength and stiffness for cellular composite and cellular acoustical composite decks with a given concrete type and thickness may be based on fluted composite deck of the same profile as the fluted top section but with the gage of the bottom pan.

NOTICE: Design defects that could cause injury or death may result from relying on the information in this document without independent verification by a qualified professional. The information in this document is provided "AS IS". Nucor Corporation and its affiliates expressly disclaim: (i) any and all representations, warranties and conditions and (ii) all liability arising out of or related to this document and the information in it.

VULCRAFT NRC ACOUSTICAL SOLUTIONS

DOVETAIL ACOUSTICAL DECKS

REDUCE INTERIOR NOISE WITH THE SOUND ABSORPTION CAPABILITIES OF VULCRAFT ACOUSTICAL ROOF DECK

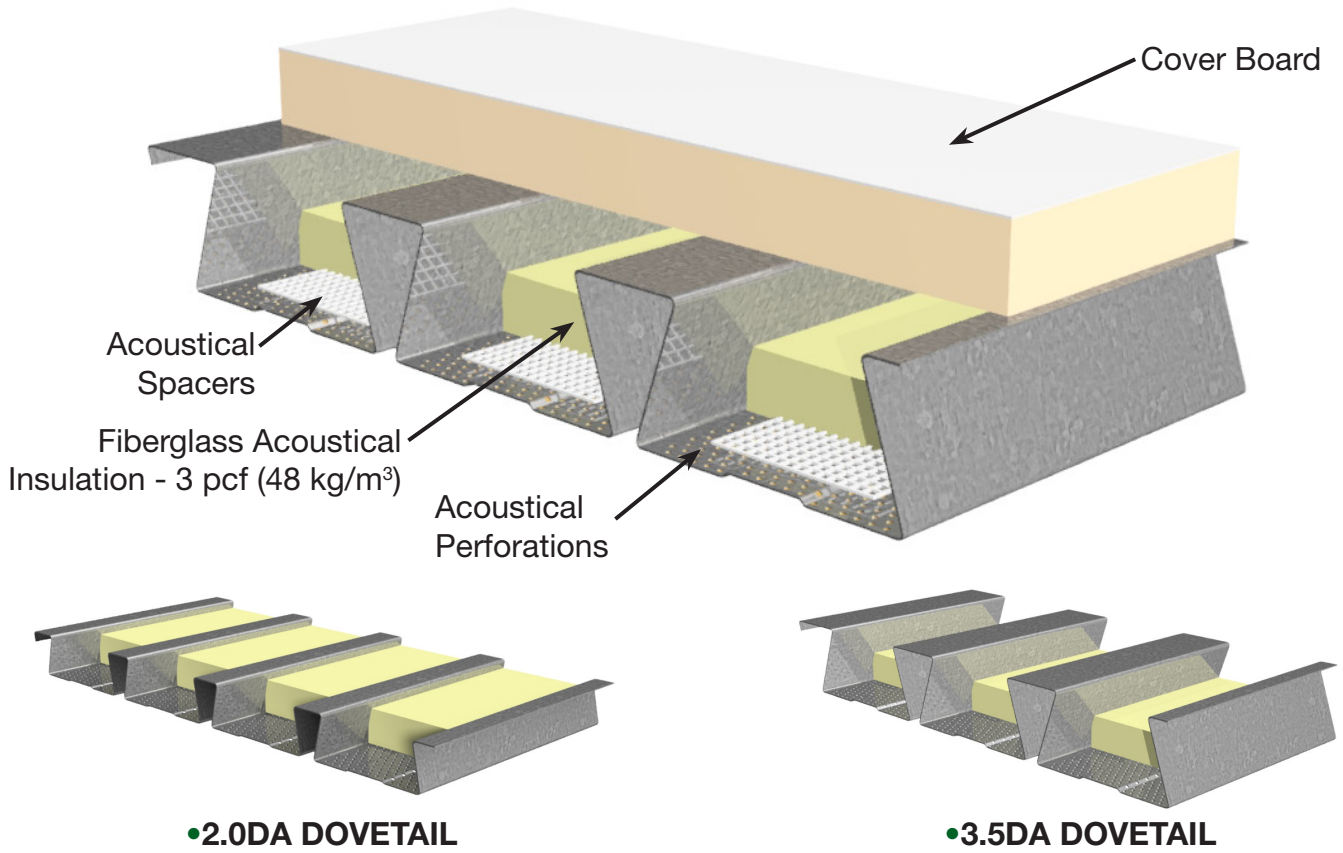

Roof Insulation	AC Insulation	Absorption Coefficients						SSA	NRC	Test. No.
		125 Hz	250 Hz	500 Hz	1000 Hz	2000 Hz	4000 Hz			
2.0DA DOVETAIL										
Poly-Iso	Plain	0.19	0.54	1.15	1.07	1.01	0.79	0.95	0.95	A14-170
	Encapsulated	0.35	0.82	1.15	0.99	0.97	0.72	0.96	1.00	A14-167
Fiberglass	Plain	0.74	1.40	1.25	1.03	0.98	0.80	1.14	1.15	A14-169
	Encapsulated	0.62	1.18	1.08	0.93	0.97	0.77	1.02	1.05	A14-168
½" Roof Board	Plain	0.17	0.51	1.05	1.05	0.85	0.77	0.85	0.85	A19-101
	Encapsulated	0.30	0.56	1.02	0.99	0.92	0.78	0.86	0.85	A19-102
3.5DA DOVETAIL										
Poly-Iso	Plain	0.25	0.74	1.13	1.06	0.97	0.75	0.96	1.00	A14-186
	Encapsulated	0.38	0.86	1.18	1.03	0.93	0.65	0.98	1.00	A14-189
Fiberglass	Plain	0.92	1.51	1.13	1.06	0.98	0.78	1.14	1.15	A14-187
	Encapsulated	0.97	1.50	1.09	1.00	0.91	0.67	1.10	1.15	A14-188
½" Roof Board	Plain	0.21	0.71	1.06	0.91	0.88	0.68	0.88	0.90	AB21-132
	Encapsulated	0.15	0.82	1.07	0.98	0.89	0.68	0.93	0.95	AB21-130

Note:

1. Plain 3.0 pcf (48 kg/m³) fiberglass acoustical insulation standard. Inquire regarding lead time for encapsulated insulation.

VULCRAFT NRC ACOUSTICAL SOLUTIONS

FLUTED ACOUSTICAL DECKS

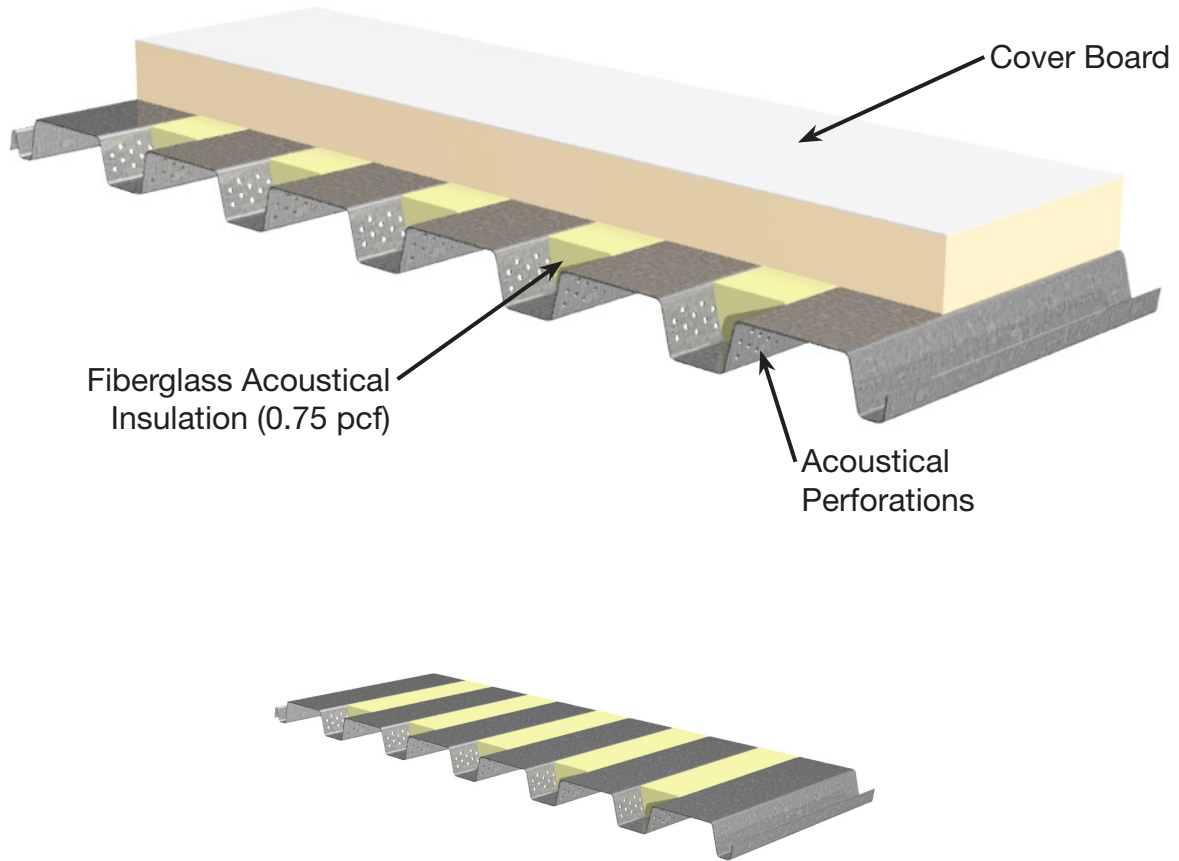

• **1.5BA-36 / 1.5BIA-36 / 1.5PLBA-36**

Roof Insulation	AC Insulation	Absorption Coefficients						SSA	NRC	Test. No.
		125 Hz	250 Hz	500 Hz	1000 Hz	2000 Hz	4000 Hz			
1.5BA-36 / 1.5BIA-36 / 1.5PLBA-36										
Poly-Iso	Plain	0.09	0.20	0.47	0.86	0.55	0.32	0.55	0.55	A15-125
	Encapsulated	0.14	0.35	0.74	0.76	0.44	0.27	0.57	0.55	A15-124
Fiberglass	Plain	0.68	1.16	1.17	0.96	0.52	0.31	0.95	0.95	A15-126
	Encapsulated	0.75	0.83	0.78	0.68	0.42	0.28	0.67	0.70	A15-123

Note:

1. Plain 0.75 pcf (12 kg/m³) fiberglass acoustical insulation standard for all BA decks. Inquire regarding lead time for encapsulated insulation.

VULCRAFT NRC ACOUSTICAL SOLUTIONS

FLUTED ACOUSTICAL DECKS

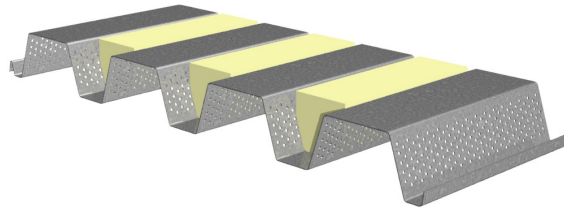

•3NLA-32 / 3NIA-32 / 3PLNA-32

Roof Insulation	AC Insulation	Absorption Coefficients						SSA	NRC	Test. No.
		125 Hz	250 Hz	500 Hz	1000 Hz	2000 Hz	4000 Hz			
3NLA-32 / 3NIA-32 / 3PLNA-32										
2" Poly-Iso	Plain	0.23	0.42	0.85	0.95	0.50	0.41	0.68	0.70	A19-032
	Encapsulated	0.30	0.62	1.09	0.79	0.52	0.31	0.74	0.75	A19-111
2" Fiberglass	Plain	0.78	1.17	1.20	0.98	0.50	0.41	0.96	0.95	A19-031
	Encapsulated	0.89	1.08	1.09	0.74	0.46	0.30	0.83	0.85	A19-110
½" Roof Board	Plain	0.21	0.41	0.81	0.89	0.49	0.41	0.64	0.65	A19-033

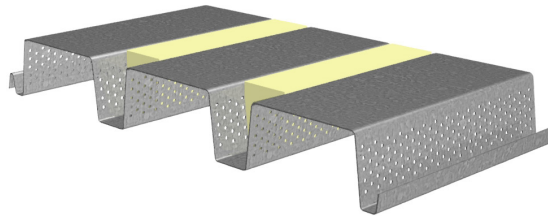

•3NA-24 / 3NIA-24

Roof Insulation	AC Insulation	Absorption Coefficients						SSA	NRC	Test. No.
		125 Hz	250 Hz	500 Hz	1000 Hz	2000 Hz	4000 Hz			
3NA-24 / 3NIA-24										
Poly-Iso	Plain	0.19	0.33	0.73	0.83	0.48	0.33	0.59	0.60	A15-130
	Encapsulated	0.17	0.39	0.94	0.86	0.48	0.27	0.67	0.65	A15-138
Fiberglass	Plain	0.81	1.16	1.15	0.91	0.47	0.27	0.92	0.90	A15-128
	Encapsulated	1.07	1.13	1.04	0.81	0.43	0.26	0.85	0.85	A15-137

Note:

1. Plain 0.75 pcf (12 kg/m³) fiberglass acoustical insulation standard for all NA decks. Inquire regarding lead time for encapsulated insulation.

VULCRAFT NRC ACOUSTICAL SOLUTIONS

CELLULAR ACOUSTICAL DECKS

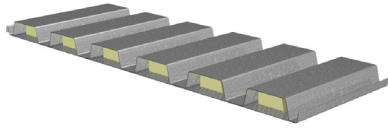

- 1.5BPA-36 / 1.5PLBPA-36 ROOF DECK
- 1.5VLPA-36 / 1.5PLVLPA-36 COMPOSITE DECK

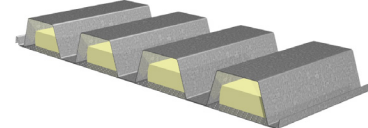

- 3NPA-32 / 3PLNPA-32 ROOF DECK

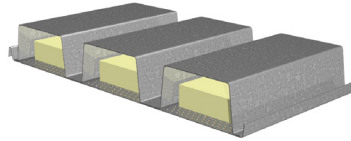

- 3NPA-24 / 3PLNPA-24 ROOF DECK

Roof Insulation	AC Insulation	Absorption Coefficients							SSA	NRC	Test. No.
		125 Hz	250 Hz	500 Hz	1000 Hz	2000 Hz	4000 Hz				
1.5BPA-36 / 1.5PLBPA-36 ROOF DECK OR 1.5VLPA-36 / 1.5PLVLPA-36 COMPOSITE DECK											
Poly-Iso	Plain	0.27	0.32	0.70	1.02	0.80	0.52	0.69	0.70	A15-114	
	Encapsulated	0.26	0.44	0.84	0.98	0.67	0.45	0.72	0.75	A15-115	
3NPA-32 / 3PLNPA-32 ROOF DECK											
Poly-Iso	Plain	0.47	0.61	1.08	1.03	0.83	0.67	0.90	0.90	A22-125	
	Encapsulated	0.52	0.71	1.12	0.80	0.62	0.45	0.83	0.80	A22-188	
3NPA-24 / 3PLNPA-24 ROOF DECK											
Poly-Iso	Plain	0.39	0.56	1.05	0.91	0.67	0.61	0.81	0.80	A19-386	
	Encapsulated	0.39	0.62	1.19	0.74	0.66	0.44	0.80	0.80	A15-231	

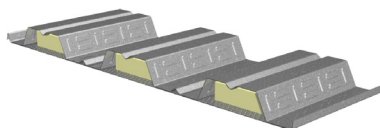

- 2VLPA-36 / 2PLVLPA-36 COMPOSITE DECK

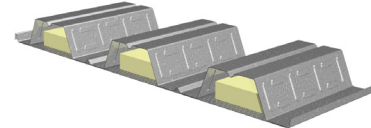

- 3VLPA-36 / 3PLVLPA-36 COMPOSITE DECK

Floor	AC Insulation	Absorption Coefficients						SSA	NRC	Test. No.
		125 Hz	250 Hz	500 Hz	1000 Hz	2000 Hz	4000 Hz			
2VLPA-36 / 2PLVLPA-36 COMPOSITE DECK										
Concrete	Plain	0.31	0.44	0.72	0.77	0.47	0.47	0.60	0.60	A15-120
	Encapsulated	0.39	0.45	0.87	0.66	0.31	0.19	0.58	0.55	A15-119
3VLPA-36 / 3PLVLPA-36 COMPOSITE DECK										
Concrete	Plain	0.48	0.56	1.00	0.75	0.49	0.49	0.69	0.70	A15-121
	Encapsulated	0.51	0.63	0.83	0.49	0.39	0.28	0.58	0.60	A15-122

Note:

1. Factory installed plain 3.0 pcf (48 kg/m³) fiberglass acoustical insulation standard for all cellular decks. Inquire regarding lead time for encapsulated insulation.

NOTICE: Design defects that could cause injury or death may result from relying on the information in this document without independent verification by a qualified professional. The information in this document is provided "AS IS". Nucor Corporation and its affiliates expressly disclaim: (i) any and all representations, warranties and conditions and (ii) all liability arising out of or related to this document and the information in it.

2.0D DOVETAIL FORMLOK® DECK-SLAB ACOUSTICAL SOLUTIONS

ACHIEVE QUIET SPACES WITH PREMIUM FINISHES BY USING THE SUPERIOR STC AND IIC RATINGS OF 2.0D FORMLOK DECK-SLABS

2.0D FORMLOK DECK-SLAB

- 2" (51 mm) Deep Composite Deck
- 5½" (140 mm) Total Slab Depth
- Normal Weight Concrete (145 pcf / 2325 kg/m³)
- Exposed Deck Ceiling

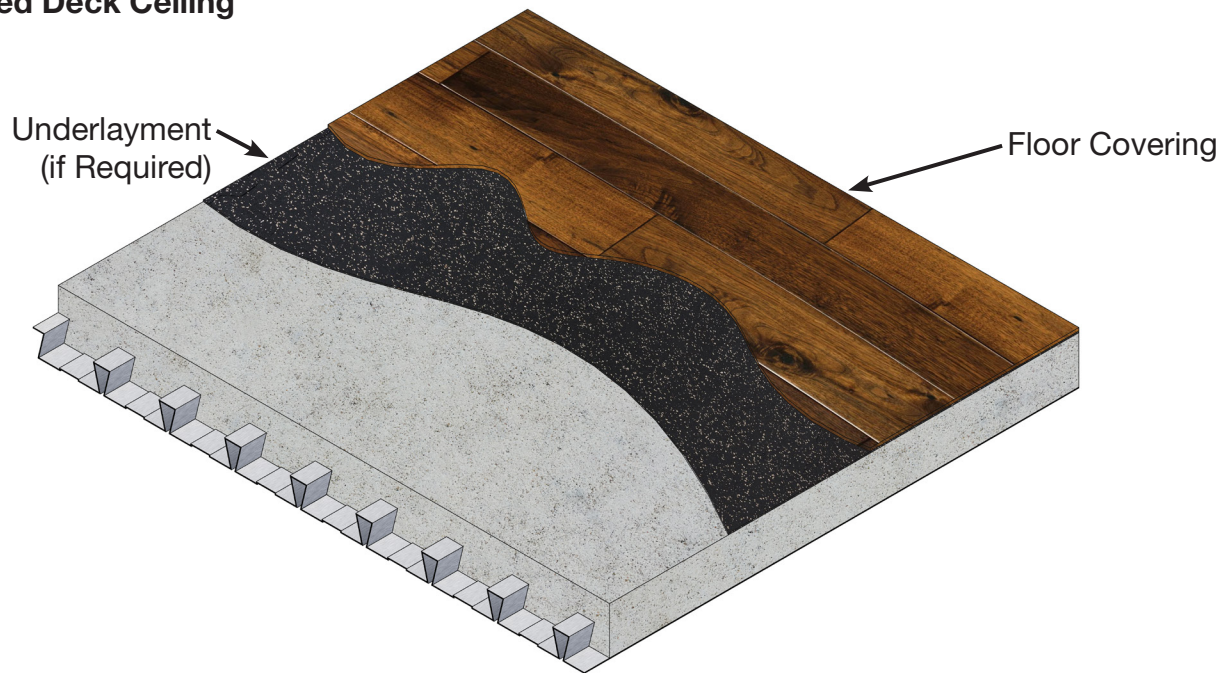

Exposed Deck (No Ceiling)

Floor Covering	Underlayment	STC	IIC	Intertek Test No.
Ceramic Tile	5 mm ECOsilence	51	41	H7786.06
Engineered Wood	5 mm ECOsilence	50	50	H7786.05
Fusion Hybrid Vinyl Plank	2 mm ECOsilence	46	51	H7786.02
Attain Luxury Vinyl Tile	5 mm ECOsilence	52	51	H7786.03
Forest Rx Rubber Backed Sheet Vinyl	None	51	51	H7786.04
Exposed Concrete	None	52	23	H7786.01

2.0D DOVETAIL FORMLOK® DECK-SLAB ACOUSTICAL SOLUTIONS

2.0D FORMLOK DECK-SLAB

- 2" (51 mm) Deep Composite Deck
- 5½" (140 mm) Total Slab Depth
- Normal Weight Concrete (145 pcf / 2325 kg/m³)
- Gypsum Board Ceiling

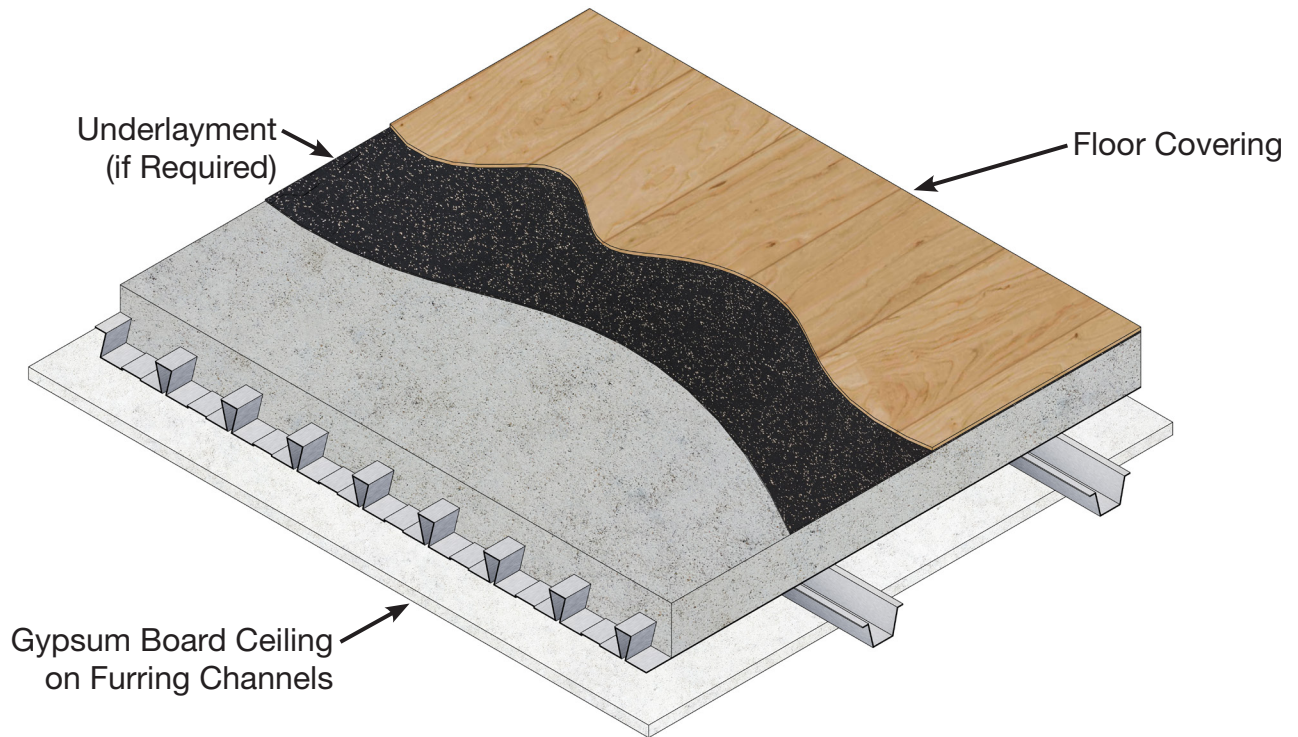

Gypsum Board Ceiling on Furring Channels Directly Attached to Deck

Floor Covering	Underlayment	STC	IIC	Intertek Test No.
Ceramic Tile	5 mm ECOsilence	53	47	H7786.12
Engineered Wood	5 mm ECOsilence	50	50	H7786.11
Fusion Hybrid Vinyl Plank	2 mm ECOsilence	51	50	H7786.08
Attain Luxury Vinyl Tile	2 mm ECOsilence	52	50	H7786.09
Forest Rx Rubber Backed Sheet Vinyl	None	50	50	H7786.10
Exposed Concrete	None	52	32	H7786.07

Note:

1. Values shown are for gypsum board on furring channels directly connected to the underside of the slab. Gypsum board ceilings attached to the deck by methods providing acoustical separation will provide improved STC and IIC values.

2.0D DOVETAIL FORMLOK® DECK-SLAB ACOUSTICAL SOLUTIONS

2.0D FORMLOK DECK-SLAB

- 2" (51 mm) Deep Composite Deck
- 5½" (140 mm) Total Slab Depth
- Normal Weight Concrete (145 pcf / 2325 kg/m³)
- Suspended Gypsum Board Ceiling

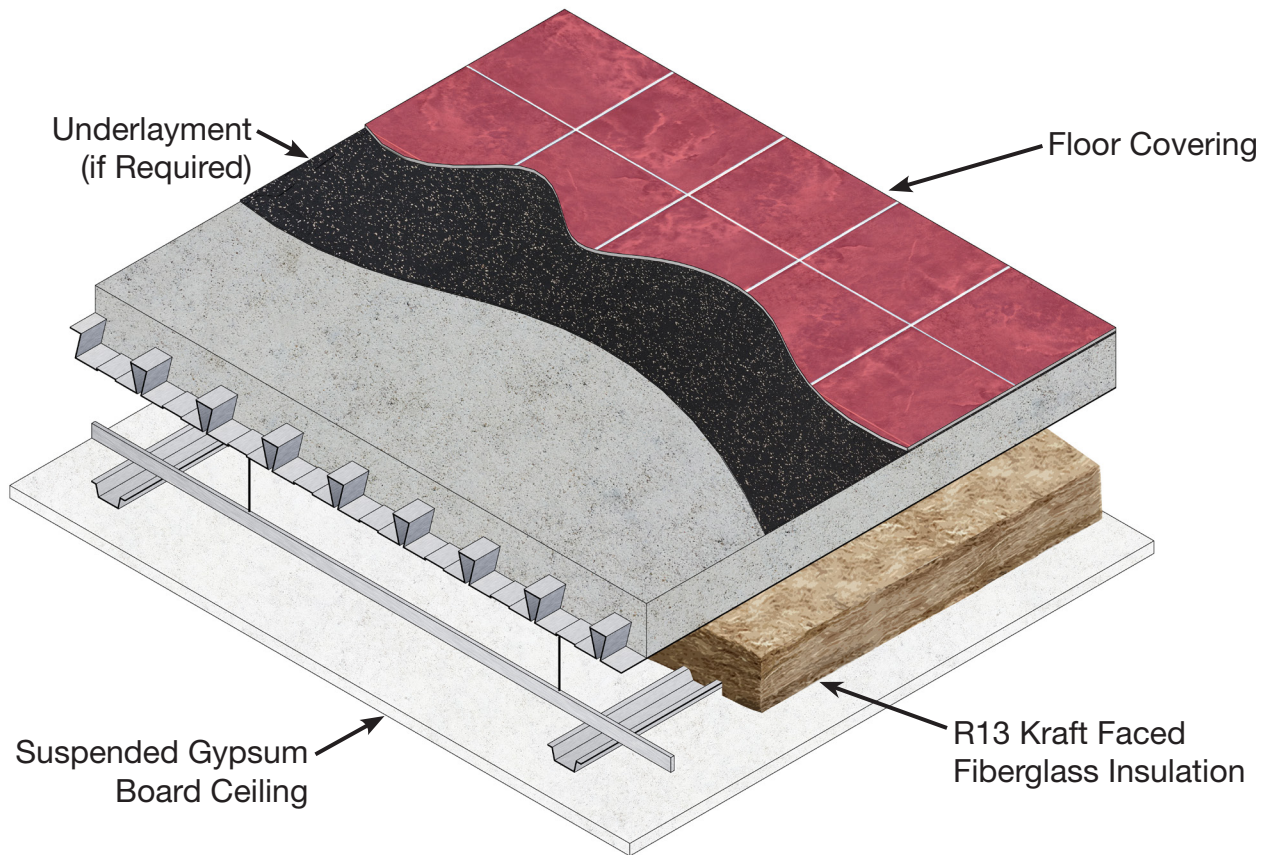

Suspended Gypsum Board Ceiling

Floor Covering	Underlayment	STC	IIC	Intertek Test No.
Ceramic Tile	5 mm ECOsilence	62	60	I5133.01

Note:

1. Laboratory tests determining STC and IIC for Dovetail FormLok deck with a suspended ceiling were conducted with ceramic tile and underlayment. Adding a suspended ceiling to the ceramic tile assembly improved the STC rating by 11 and the IIC rating by 19 compared to an assembly with no ceiling. Other flooring types can expect similar improvement in performance.

2.0D DOVETAIL FORMLOK® DECK-SLAB

Notes:

1. The acoustical test reports with complete assembly details are available from www.dovetaildeck.com.
2. The testing was performed in accordance with the following standards:
 - **ASTM E90-09 (2016)**, *Standard Test Method for Laboratory Measurement of Airborne Sound Transmission Loss of Building Partitions*
 - **ASTM E492-09(2016)e1**, *Standard Test Method for Laboratory Measurement of Impact Sound Transmission Through Floor-Ceiling Assemblies Using the Tapping Machine*

NOTICE: Design defects that could cause injury or death may result from relying on the information in this document without independent verification by a qualified professional. The information in this document is provided "AS IS". Nucor Corporation and its affiliates expressly disclaim: (i) any and all representations, warranties and conditions and (ii) all liability arising out of or related to this document and the information in it.

3.5D DOVETAIL FORMLOK® DECK-SLAB ACOUSTICAL SOLUTIONS

ACHIEVE QUIET SPACES WITH PREMIUM FINISHES BY USING THE SUPERIOR STC AND IIC RATINGS OF 3.5D FORMLOK DECK-SLABS

3.5D FORMLOK DECK-SLAB

- 3½" (89 mm) Deep Composite Deck
- 6" (152 mm) Total Slab Depth
- Normal Weight Concrete (145 pcf / 2325 kg/m³)
- Exposed Deck Ceiling

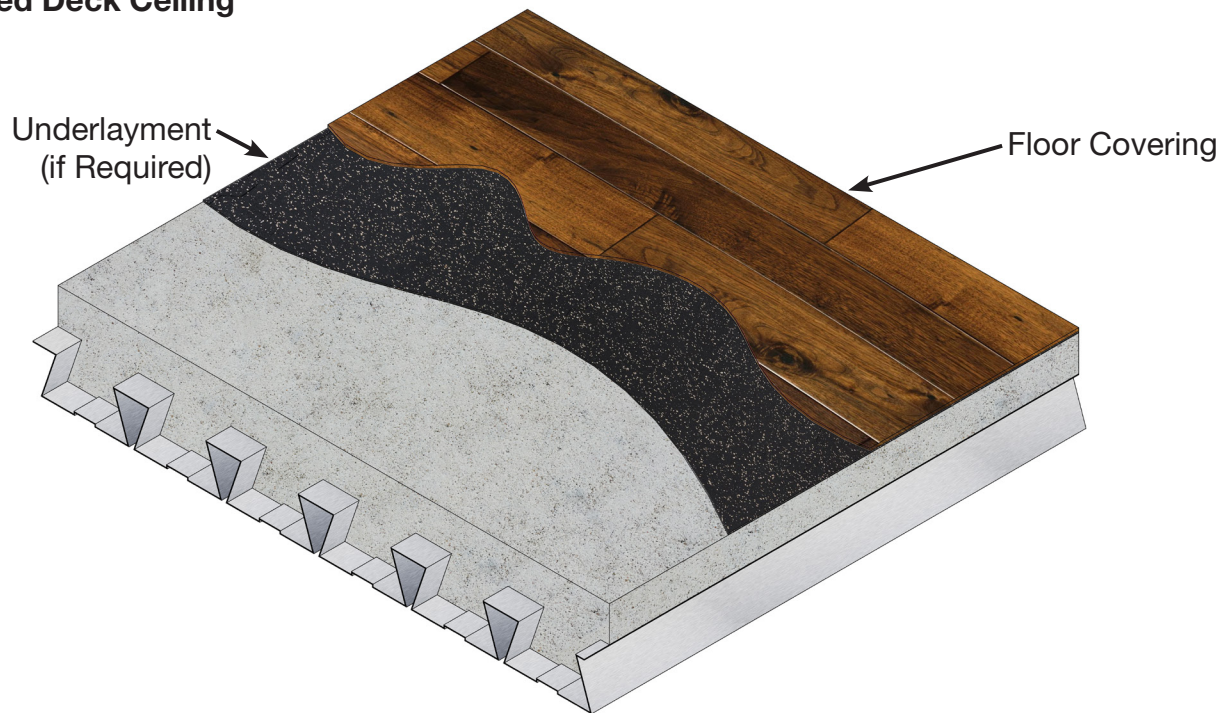

Exposed Deck (No Ceiling)

Floor Covering	Underlayment	STC	IIC	Intertek Test No.
Ceramic Tile	5 mm ECOsilence	50	42	H7787.06
Engineered Wood	5 mm ECOsilence	45	46	H7787.05
Fusion Hybrid Vinyl Plank	2 mm ECOsilence	47	47	H7787.02
Attain Luxury Vinyl Tile	5 mm ECOsilence	50	50	H7787.03
Forest Rx Rubber Backed Sheet Vinyl	None	49	49	H7787.04
Exposed Concrete	None	50	24	H7787.01

3.5D DOVETAIL FORMLOK® DECK-SLAB ACOUSTICAL SOLUTIONS

3.5D FORMLOK DECK-SLAB

- 3½" (89 mm) Deep Composite Deck
- 6" (152 mm) Total Slab Depth
- Normal Weight Concrete (145 pcf / 2325 kg/m³)
- Gypsum Board Ceiling

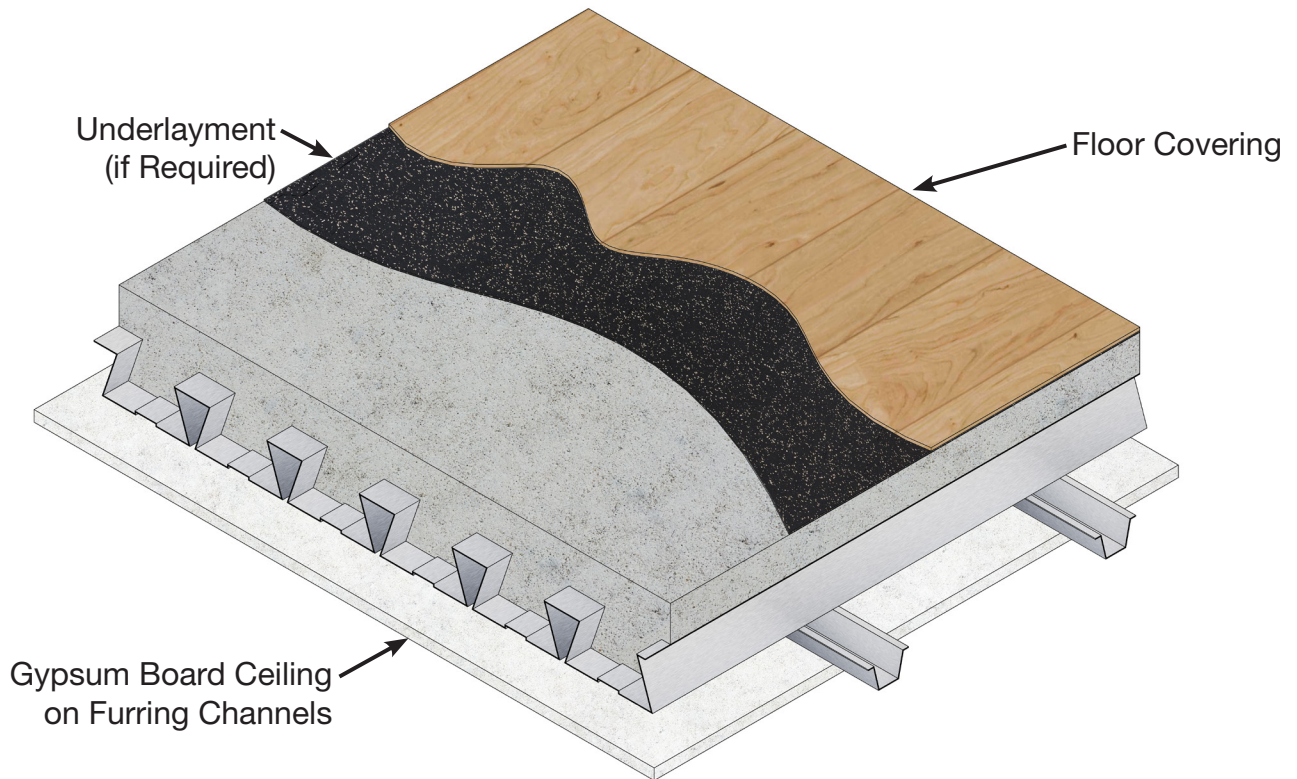

Gypsum Board Ceiling on Furring Channels Directly Attached to Deck

Floor Covering	Underlayment	STC	IIC	Intertek Test No.
Ceramic Tile	5 mm ECOsilence	56	49	H7787.12
Engineered Wood	5 mm ECOsilence	55	52	H7787.11
Fusion Hybrid Vinyl Plank	2 mm ECOsilence	55	53	H7787.08
Attain Luxury Vinyl Tile	5 mm ECOsilence	56	52	H7787.09
Forest Rx Rubber Backed Sheet Vinyl	None	55	52	H7787.10
Exposed Concrete	None	55	32	H7787.07

Note:

1. Values shown are for gypsum board on furring channels directly connected to the underside of the slab. Gypsum board ceilings attached to the deck by methods providing acoustical separation will provide improved STC and IIC values.

3.5D DOVETAIL FORMLOK® DECK-SLAB ACOUSTICAL SOLUTIONS

3.5D FORMLOK DECK-SLAB

- 3½" (89 mm) Deep Composite Deck
- 6" (152 mm) Total Slab Depth
- Normal Weight Concrete (145 pcf / 2325 kg/m³)
- Suspended Gypsum Board Ceiling

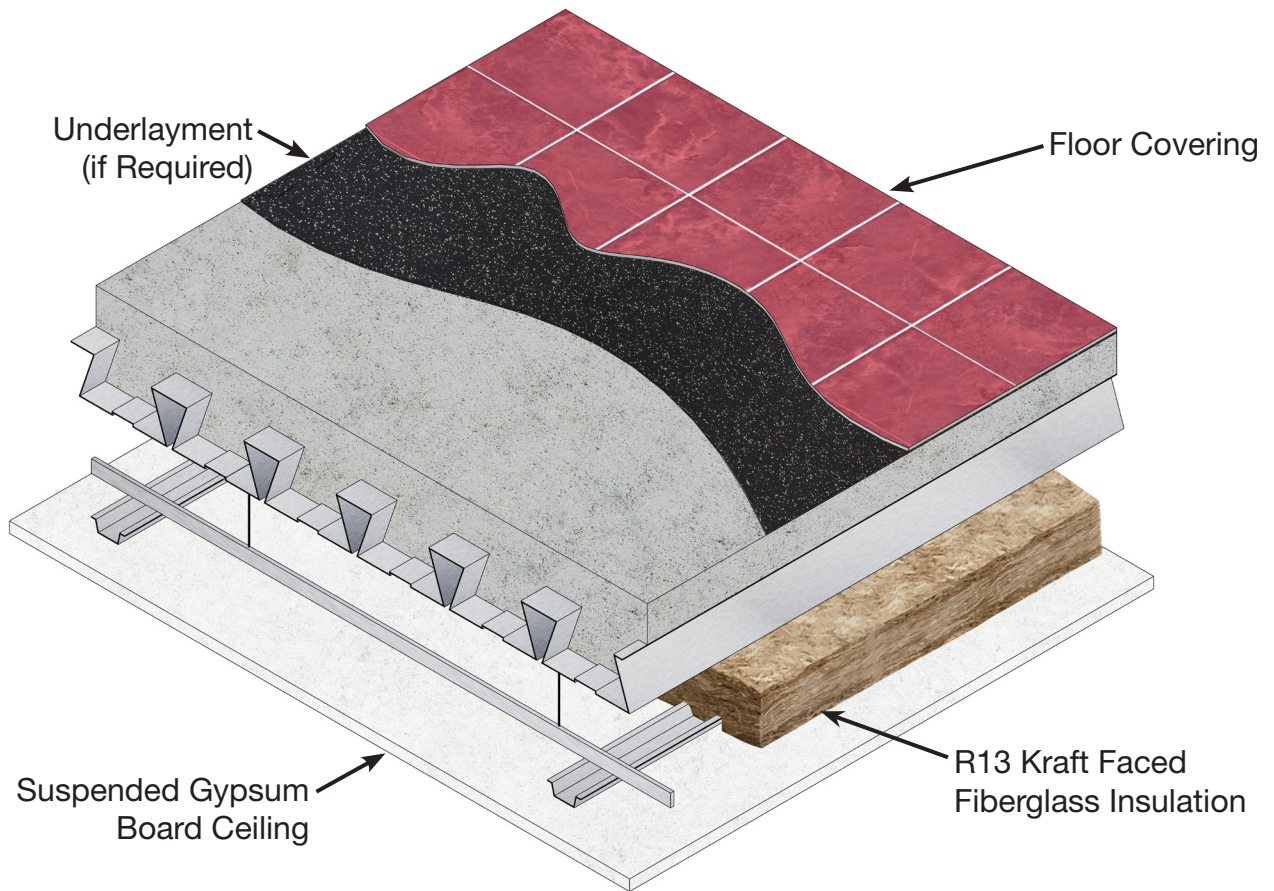

Suspended Gypsum Board Ceiling

Floor Covering	Underlayment	STC	IIC	Intertek Test No.
Ceramic Tile	5 mm ECOsilence	62	62	I5133.02

Note:

1. Laboratory tests determining STC and IIC for Dovetail FormLok deck with a suspended ceiling were conducted with ceramic tile and underlayment. Adding a suspended ceiling to the ceramic tile assembly improved the STC rating by 12 and the IIC rating by 20 compared to an assembly with no ceiling. Other flooring types can expect similar improvement in performance.

3.5D DOVETAIL FORMLOK® DECK-SLAB

Notes:

1. The acoustical test reports with complete assembly details are available from www.dovetaildeck.com.
2. The testing was performed in accordance with the following standards:
 - **ASTM E90-09 (2016)**, *Standard Test Method for Laboratory Measurement of Airborne Sound Transmission Loss of Building Partitions*
 - **ASTM E492-09(2016)e1**, *Standard Test Method for Laboratory Measurement of Impact Sound Transmission Through Floor-Ceiling Assemblies Using the Tapping Machine*

NOTICE: Design defects that could cause injury or death may result from relying on the information in this document without independent verification by a qualified professional. The information in this document is provided "AS IS". Nucor Corporation and its affiliates expressly disclaim: (i) any and all representations, warranties and conditions and (ii) all liability arising out of or related to this document and the information in it.

USE UL RECOGNIZED VULCRAFT ROOF DECKS FOR YOUR FIRE RATED ASSEMBLIES

- Vulcraft steel decks may be used in assemblies which are required to meet hourly fire ratings. Approved hourly fire rated assemblies are a combination of specific proprietary materials as listed in UL fire resistance ratings.

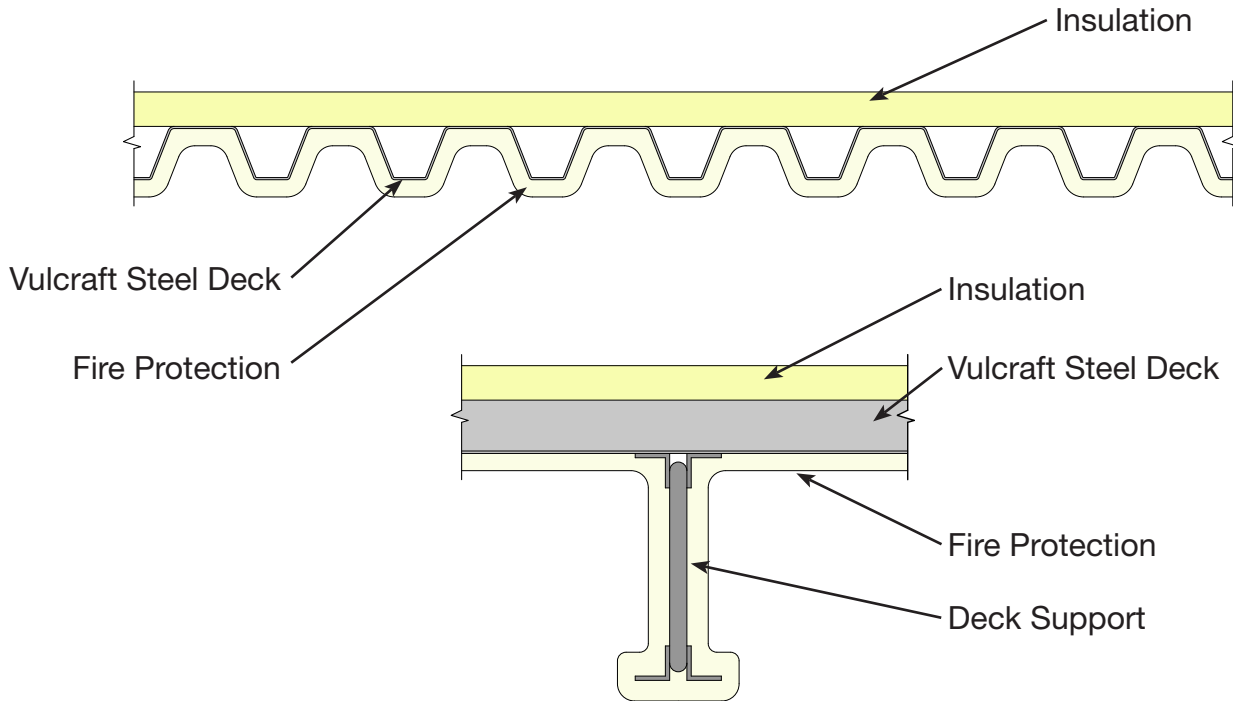

REPRESENTATIVE FIRE RATED ASSEMBLY

Refer to the table on the following pages for a listing of UL fire-rated assemblies utilizing Vulcraft steel deck profiles. Refer to the particular UL assembly being considered for full details of construction, including specific information about fill or fireproofing thicknesses and span limitations.

UL Fire Resistance Ratings

Restrained Assembly Ratings (hr.)	Type of Protection	Type of Insulation	UL Design No.	Deck Type					Unrestrained Beam Rating (hr.)	
				B	32" 3N	24" 3N	2.0D	3.5D		
1	Exposed Grid	Rigid Insulation	P211+	✓						
			P214+	✓					1	
			P225+	✓	✓	✓			1, 1½	
			P227+	✓						
			P230+	✓					1, 1½	
			P235+	✓					1	
			Insulating Fill	P214+	✓					1
	Gypsum Board	Rigid Insulation	P510+	✓	✓	✓				
			P514	✓						
	Cementitious	Rigid Insulation	P701*	✓	✓	✓			1, 1½, 2	
			P711*	✓	✓	✓			1, 1½, 2	
			P717*	✓	✓	✓			1, 1½, 2	
	Sprayed Fiber	Rigid Insulation	P801*	✓	✓	✓			1, 1½, 2, 3	
			P815*	✓	✓	✓			1, 1½, 2, 3	
			P819*	✓	✓	✓			1, 1½, 2	
	Unprotected Deck	Insulating Fill	P902	✓	✓	✓			1, 1½, 2	
			P907	✓	✓	✓			1, 1½, 2	
			P908	✓	✓	✓	✓	✓	1, 1½, 2	
			P919	✓	✓	✓			1, 1½	
			P920	✓	✓	✓			1, 1½, 2	
			P921	✓	✓	✓	✓	✓	1, 1½, 2	
			P922	✓	✓	✓			1, 1½, 2	
			P923	✓	✓	✓			1, 1½, 2	
			P937				✓	✓		
P938						✓	✓	1, 1½, 2		
1½	Exposed Grid	Rigid Insulation	P225+	✓	✓	✓			1, 1½	
			P227+	✓					1, 1½	
			P230+	✓					1, 1½	
	Metal Lath	Rigid Insulation	P404+	✓						
	Gypsum Board	Rigid Insulation	P510+	✓	✓	✓				
			P701*	✓	✓	✓			1, 1½, 2	
	Cementitious	Rigid Insulation	P711*	✓	✓	✓			1, 1½, 2	
			P717*	✓	✓	✓			1, 1½, 2	

UL Fire Resistance Ratings (continued)

Restrained Assembly Ratings (hr.)	Type of Protection	Type of Insulation	UL Design No.	Deck Type					Unrestrained Beam Rating (hr.)
				B	32" 3N	24" 3N	2.0D	3.5D	
1½	Sprayed Fiber	Rigid Insulation	P801*	✓	✓	✓			1,1½,2
			P815*	✓	✓	✓			1,1½,2,3
			P819*	✓	✓	✓			1,1½,2,3
	Unprotected Deck	Insulating Fill	P902	✓	✓	✓			1,1½,2
			P907	✓	✓	✓			1,1½,2
			P908	✓	✓	✓	✓	✓	1,1½,2
			P919	✓	✓	✓			1,1½
			P920	✓	✓	✓			1,1½,2
			P921	✓	✓	✓	✓	✓	1,1½,2
			P922	✓	✓	✓			1,1½,2
			P923	✓	✓	✓			1,1½,2
			P937				✓	✓	
			P938				✓	✓	1,1½,2
			2	Exposed Grid	Rigid Insulation	P237+	✓		
Metal Lath	Rigid Insulation	P404+		✓					
Gypsum Board	Rigid Insulation	P514+		✓					
Cementitious	Rigid Insulation	P701*		✓	✓	✓			1,1½,2
		P711*		✓	✓	✓			1,1½,2
		P717*		✓	✓	✓			1,1½,2
Sprayed Fiber	Rigid Insulation	P801*		✓	✓	✓			1,1½,2
		P815*		✓	✓	✓			1,1½,2
		P819*		✓	✓	✓			1,1½,2,3
		P902		✓	✓	✓			1,1½,2
		P907		✓	✓	✓			1,1½,2
		P908		✓	✓	✓	✓	✓	1,1½,2
		P920		✓	✓	✓			1,1½,2
		P921		✓	✓	✓	✓	✓	1,1½,2
Unprotected Deck	Insulating Fill	P922	✓	✓	✓			1,1½,2	
		P923	✓	✓	✓			1,1½,2	
		P937				✓	✓		
		P938				✓	✓	1,1½,2	

Notes:

1. Refer to the UL “Fire Resistance Directory” for the necessary construction details.
2. Deck finish shall be galvanized unless noted otherwise.
 - + Deck finish is not critical for fire resistance when used in P2--, P4--, & P5-- Series designs. Deck finish shall be galvanized or painted.
 - * Denotes deck finish is critical for fire resistance. Deck finish shall be galvanized or painted. This gray paint is a special type of paint and is compatible with the spray-applied fire protection and is U.L. approved for use in the denoted P7-- & P8-- Series designs.
3. B = 1.5B, 1.5BI, and 1.5PLB
32” 3N = 32” Wide 3NL, 3NI, and 3PLN
24” 3N = 24” Wide 3N and 3NI

NOTICE: Design defects that could cause injury or death may result from relying on the information in this document without independent verification by a qualified professional. The information in this document is provided “AS IS”. Nucor Corporation and its affiliates expressly disclaim: (i) any and all representations, warranties and conditions and (ii) all liability arising out of or related to this document and the information in it.

VULCRAFT® COMPOSITE & NON-COMPOSITE DECK UL FIRE RATED ASSEMBLIES

USE UL RECOGNIZED COMPOSITE AND NON-COMPOSITE DECKS FOR YOUR FIRE RATED ASSEMBLIES WITH STRUCTURAL CONCRETE FILL

- Vulcraft composite and non-composite slabs may be used to meet hourly fire ratings. The type and thickness of concrete specified will generally determine whether fireproofing will be required on the underside of the composite or non-composite deck.

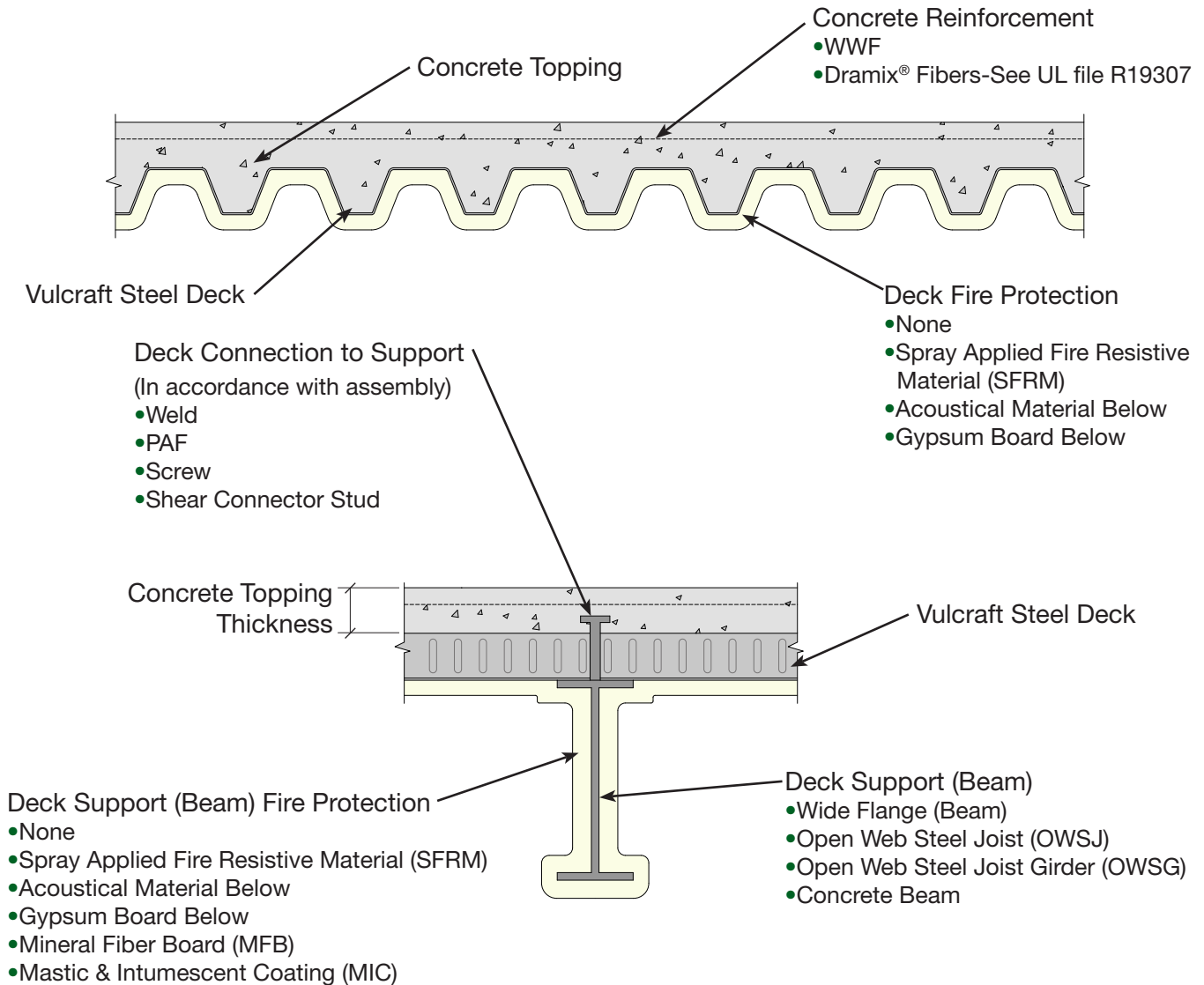

REPRESENTATIVE FIRE RATED ASSEMBLY

The table on the following pages lists the UL fire rated assemblies that include Vulcraft composite and non-composite decks profiles. This summary table is provided to assist in identification of assemblies to meet specific project requirements. Refer to the particular UL assembly for full details of construction including, specific information about concrete slab, framing, type of fire protection, deck types and span limitations.

VULCRAFT® COMPOSITE DECK

UL FIRE RATED ASSEMBLIES



UL Fire Resistance Ratings

Restrained Assembly Ratings (hr.)	Type of Protection	Concrete Thickness & Type	UL Design No.	Deck Type						Unrestrained Beam Rating (hr.)
				1.5VL	2VL	3VL	1.5VLP	2VLP	3VLP	
3/4	Unprotected Deck	2 1/2" LW	D914 #	✓	✓	✓	✓	✓	✓	1
			D916 #	✓	✓	✓	✓	✓	✓	1, 1 1/2, 2, 3
1	Exposed Grid	2 1/2" NW	D216 +	✓	✓	✓		✓	✓	2, 3
		2" NW & LW	D743 *		✓	✓		✓	✓	1, 1 1/2, 2, 3
	Cementitious	2 1/2" NW & LW	D703 *	✓	✓	✓	✓	✓	✓	1 1/2
			D712 *		✓	✓			✓	2
			D722 *		✓	✓		✓	✓	1, 1 1/2, 2
			D739 *	✓	✓	✓	✓	✓	✓	1, 1 1/2, 2, 3, 4
			D759 *	✓	✓	✓	✓	✓	✓	1, 1 1/2, 2, 3
			D859 *		✓	✓		✓	✓	1, 1.5, 2, 3
	Sprayed Fiber	2 1/2" NW & LW	D832 *	✓	✓	✓	✓	✓	✓	1, 1 1/2, 2, 3
			D847 *		✓	✓		✓	✓	1, 1 1/2, 3
			D858 *		✓	✓		✓	✓	1, 1 1/2, 2, 3, 4
			D871 *		✓	✓		✓	✓	1, 1 1/2, 2, 3
D902 #			✓	✓	✓	✓	✓	✓	1, 1 1/2, 2, 3	
Unprotected Deck	2 1/2" LW	D914 #	✓	✓	✓	✓	✓	✓	1	
		D916 #	✓	✓	✓	✓	✓	✓	1, 1 1/2, 2, 3	
		D919 #	✓	✓	✓	✓	✓	✓	1, 1 1/2	
	3 1/2" NW	D902 #	✓	✓	✓	✓	✓	✓	1, 1 1/2, 2, 3	
		D916 #	✓	✓	✓	✓	✓	✓	1, 1 1/2, 2, 3	
		D919 #	✓	✓	✓	✓	✓	✓	1, 1 1/2	
1 1/2	Gypsum Board	2 1/2" NW	D502 *	✓	✓	✓		✓	✓	1 1/2, 2
		2" NW & LW	D743 *		✓	✓		✓	✓	1, 1 1/2, 2, 3
	Cementitious	2 1/2" NW & LW	D703 *	✓	✓	✓	✓	✓	✓	1 1/2
			D712 *		✓	✓			✓	2
			D722 *		✓	✓		✓	✓	1, 1 1/2, 2
			D739 *	✓	✓	✓	✓	✓	✓	1, 1 1/2, 2, 3, 4
			D759 *	✓	✓	✓	✓	✓	✓	1, 1 1/2, 2, 3

✓ + 1.5VLI Only

(continued on next page)

VULCRAFT® COMPOSITE DECK

UL FIRE RATED ASSEMBLIES



UL Fire Resistance Ratings (continued)

Restrained Assembly Ratings (hr.)	Type of Protection	Concrete Thickness & Type	UL Design No.	Deck Type						Unrestrained Beam Rating (hr.)	
				1.5VL	2VL	3VL	1.5VLP	2VLP	3VLP		
1½	Sprayed Fiber	2" NW & LW	D859 *		✓	✓		✓	✓	1,1½,2,3	
			D832 *	✓	✓	✓	✓	✓	✓	1,1½,2,3	
		2½" NW & LW	D847 *		✓	✓		✓	✓	1,1½,3	
			D858 *		✓	✓		✓	✓	1,1½,2,3,4	
			D871 *		✓	✓		✓	✓	1,1½,2,3	
	Unprotected Deck	3" LW	D902 #	✓	✓	✓	✓	✓	✓	1,1½,2,3	
			D916 #	✓	✓	✓	✓	✓	✓	1,1½,2,3	
		4" NW	D919 #	✓	✓	✓	✓	✓	✓	1,1½	
			D902 #	✓	✓	✓	✓	✓	✓	1,1½,2,3	
			D916 #	✓	✓	✓	✓	✓	✓	1,1½,2,3	
	D919 #	✓	✓	✓	✓	✓	✓	1,1½			
	Exposed Grid	2½" NW	D216 +	✓	✓	✓		✓	✓	2,3	
	Gypsum Board	2½" NW	D502 +	✓	✓	✓		✓	✓	1½,2	
	2	Cementitious	2" NW & LW	D743 *		✓	✓		✓	✓	1,1½,2,3
				D746 *	✓						1,1½,2,3
2½" LW			D752 *	✓	✓	✓	✓	✓	✓	1,1½,2,	
			D703 *	✓	✓	✓	✓	✓	✓	1½	
D712 *				✓	✓			✓	2		
D716 *			✓	✓	✓		✓	✓	1½,2		
D722 *				✓	✓		✓	✓	1,1½,2		
2½" NW & LW			D739 *		✓	✓	✓	✓	✓	1,1½,2,3,4	
			D745 *		✓	✓				1,1½,2	
			D750 *	✓	✓	✓				1½,2	
2½" NW		D755*	✓	✓	✓	✓	✓	✓	1,1½,2,3		
		D759*	✓	✓	✓	✓	✓	✓	1,1½,2,3		
		D760 *	✓+	✓	✓				1,1½,2,3,4		
		D730 *		✓	✓		✓	✓			
		D742 *	✓	✓	✓				1,1½		

✓+ 1.5VLI Only

(continued on next page)

VULCRAFT® COMPOSITE DECK UL FIRE RATED ASSEMBLIES



UL Fire Resistance Ratings (continued)

Restrained Assembly Ratings (hr.)	Type of Protection	Concrete Thickness & Type	UL Design No.	Deck Type						Unrestrained Beam Rating (hr.)	
				1.5VL	2VL	3VL	1.5VLP	2VLP	3VLP		
2	Sprayed Fiber	2" NW & LW	D859 *		✓	✓			✓	✓	1,1½,2,3
			D822 *		✓	✓			✓	✓	1
			D825 *	✓	✓	✓			✓	✓	1,1½,2
		D831 *		✓	✓			✓	✓	1,1½,2	
		D832 *	✓	✓	✓	✓		✓	✓	1,1½,2,3	
		D833 *	✓	✓	✓			✓	✓	1½	
		D847 *		✓	✓			✓	✓	1,1½,3	
		D858 *		✓	✓			✓	✓	1,1½,2,3,4	
		D861 *		✓	✓					1,1½	
		D871 *		✓	✓			✓	✓	1,1½,2,3	
	D862 *		2½" LW		✓	✓					1
	D860 *		¾" LW		✓	✓					1,1½,2
	D826 #	✓		✓	✓	✓	✓	✓	✓	✓	1,1½,2
	D840 #	✓		✓	✓	✓	✓	✓	✓	✓	1,1½
	D902 #	✓		✓	✓	✓	✓	✓	✓	✓	1,1½,2,3
	D907 #	✓		✓	✓	✓	✓	✓	✓	✓	1,2
	D913 #	✓		✓	✓	✓	✓	✓	✓	✓	1
	D916 #	✓		✓	✓	✓	✓	✓	✓	✓	1,1½,2,3
	D919 #	✓		✓	✓	✓	✓	✓	✓	✓	1,1½
	D920 #			✓	✓			✓	✓		1½
D902 #	✓		✓	✓	✓	✓	✓	✓	✓	1,1½,2,3	
D916 #	✓		✓	✓	✓	✓	✓	✓	✓	1,1½,2,3	
D919 #	✓		✓	✓	✓	✓	✓	✓	✓	1,1½	

✓⁺ 1.5VLI Only

(continued on next page)

VULCRAFT® COMPOSITE DECK

UL FIRE RATED ASSEMBLIES



UL Fire Resistance Ratings (continued)

Restrained Assembly Ratings (hr.)	Type of Protection	Concrete Thickness & Type	UL Design No.	Deck Type						Unrestrained Beam Rating (hr.)		
				1.5VL	2VL	3VL	1.5VLP	2VLP	3VLP			
3	Exposed Grid	3¼" NW	D216 +	✓	✓	✓		✓	✓	2,3		
		2" NW & LW	D743 *		✓	✓		✓	✓	1,1½,2,3		
		2½" LW	D746 *	✓						1,1½,2,3		
	Cementitious	2½" NW & LW		D703 *	✓	✓	✓	✓	✓	✓	1½	
				D708 *	✓+	✓	✓	✓	✓	✓	1½,3	
				D739 *	✓	✓	✓	✓	✓	✓	1,1½,2,3,4	
				D755	✓	✓	✓	✓	✓	✓	1,1½,2,3	
				D759	✓	✓	✓	✓	✓	✓	1,1½,2,3	
				D760 *	✓+	✓	✓				1,1½,2,3,4	
				D754 *	✓	✓	✓				1½,2	
		3¼" LW	D754 *	✓	✓	✓				1½,2		
		3¼" NW	D742 *	✓	✓	✓				1,1½		
		2" NW & LW	D859 *		✓	✓		✓	✓	1,1½,2,3		
		Sprayed Fiber	2½" NW & LW		D816 *	✓	✓	✓		✓	✓	1½,2
				D831 *		✓	✓		✓	✓	1,1½,2	
				D832 *	✓	✓	✓	✓	✓	✓	1,1½,2,3	
				D833 *	✓	✓	✓		✓	✓	1½	
				D858*		✓	✓		✓	✓	1,1½,2,3,4	
				D871 *		✓	✓		✓	✓	1,1½,2,3	
		3¼" LW	D860 *		✓	✓				1,1½,2		
		Unprotected Deck	5¼" NW		D902 #	✓	✓	✓	✓	✓	✓	1,1½,2,3
	D916 #			✓	✓	✓	✓	✓	✓	1,1½,2,3		
	D919 #			✓	✓	✓	✓	✓	✓	1,1½		
	D902 #			✓	✓	✓	✓	✓	✓	1,1½,2,3		
	D916 #			✓	✓	✓	✓	✓	✓	1,1½,2,3		
	D919 #			✓	✓	✓	✓	✓	✓	1,1½		
4	Cementitious	2½" NW & LW		D760 *	✓+	✓	✓			1,1½,2,3,4		
				D739 *	✓	✓	✓	✓	✓	1,1½,2,3,4		
				D754 *	✓	✓	✓			1½,2		
	Sprayed Fiber	2½" NW & LW		D858 *		✓	✓		✓	✓	1,1½,2,3,4	
				D860 *		✓	✓				1,1½,2	

✓+ 1.5VLI Only

(continued on next page)

VULCRAFT® NON-COMPOSITE DECK UL FIRE RATED ASSEMBLIES



UL Fire Resistance Ratings

Restrained Assembly Ratings (hr.)	Type of Protection	Concrete Thickness & Type	UL Design No.	Deck Type				Unrestrained Beam Rating (hr.)
				0.6C	1.0C	1.3C	1.5C	
1	Exposed Grid	2½" NW	G256 +	✓	✓	✓	✓	1,2,3
	Cementitious	2½" NW & LW	G701	✓	✓	✓	✓	1,1½,2,3
			G705	✓	✓	✓	✓	1,1½,2,3
	Sprayed Fiber	2¾" NW & LW	G801	✓	✓	✓	✓	1,1½,2
1½	Exposed Grid	2" NW	G229 +	✓	✓	✓	✓	1½,2,3
		2½" NW	G228 +	✓	✓	✓	✓	1½,2
			G243 +	✓	✓	✓	✓	1½,2
			G213 +	✓	✓	✓	✓	1½,2,3
	Gypsum Board	2" NW & LW	G502 +	✓	✓	✓	✓	
	Cementitious	2½" NW & LW	G701	✓	✓	✓	✓	1,1½,2,3
			G705	✓	✓	✓	✓	1,1½,2,3
	Sprayed Fiber	2¾" NW & LW	G801	✓	✓	✓	✓	1,1½,2
2	Exposed Grid	2½" NW	G227 +	✓	✓	✓	✓	2,3
			G228 +	✓	✓	✓	✓	1½,2
			G229 +	✓	✓	✓	✓	1½,2,3
			G243 +	✓	✓	✓	✓	1½,2
			G256 +	✓	✓	✓	✓	1,2,3
			G213 +	✓	✓	✓	✓	1½,2,3
	Gypsum Board	2" NW	G505 +	✓	✓	✓	✓	
		2½" NW & LW	G529 +	✓	✓	✓	✓	2,3
			G514 +	✓	✓	✓	✓	3
		2½" NW	G523 +	✓	✓	✓	✓	2,3
Cementitious	2½" NW & LW	G701	✓	✓	✓	✓	1,1½,2,3	
		G705	✓	✓	✓	✓	1,1½,2,3	
Sprayed Fiber	2¾" NW & LW	G801	✓	✓	✓	✓	1,1½,2	
3	Exposed Grid	3¼" NW	G229 +	✓	✓	✓	✓	1½,2,3
		3½" NW	G213 +	✓	✓	✓	✓	1½,2,3
			G256 +	✓	✓	✓	✓	1½,2,3
	Gypsum Board	3¼" NW & LW	G529 +	✓	✓	✓	✓	2,3
	Cementitious	2¾" NW & LW	G701	✓	✓	✓	✓	1,1½,2,3
			G705	✓	✓	✓	✓	1,1½,2,3
Sprayed Fiber	2¾" NW & LW	G801	✓	✓	✓	✓	1,1½,2	

VULCRAFT® DOVETAIL FORMLOK® DECK UL FIRE RATED ASSEMBLIES



UL Fire Resistance Ratings

Restrained Assembly Ratings (hr.)	Type of Protection	Concrete Thickness & Type	UL Design No.	Deck Type		Unrestrained Beam Rating (hr.)
				2D	3.5D	
1¹⁰	Unprotected Deck	2" LW & 2¾" NW	D904	✓		¾
			D961	✓		¾
			D917	✓		
			D928	✓		¾
1½	Unprotected Deck	2" LW & 2" NW	D947		✓	
			D964		✓	
			D984		✓	
2	Unprotected Deck	2½" LW, 3" SLW & 3¼" NW	D904	✓		1
			D961	✓		1
			D917	✓		¾
			D928	✓		1
		2" LW & 2¼" NW	D506		✓	1
			D947		✓	¾
			D964		✓	¾
			D984		✓	¾
3	Unprotected Deck	3¼" LW, 4" SLW & 4¾" NW	D904	✓		1
			D961	✓		1
			D917	✓		¾
			D928	✓		1
		2¼" LW & 3¾" NW	D947		✓	1½
			D964		✓	1½
			D984		✓	1½

VULCRAFT® COMPOSITE & NON-COMPOSITE DECK UL FIRE RATED ASSEMBLIES

Notes:

1. Refer to the UL “Fire Resistance Directory” for the necessary construction details.
2. 1.5VL = 1.5VL, 1.5VLI, and 1.5PLVLI
 2VL = 2VLI, 2VLJ, and 2PLVLI
 3VL = 3VLI, 3VLJ, and 3PLVLI
 1.5VLP = 1.5VLP and 1.5PLVLP
 2VLP = 2VLP, and 2PLVLP
 3VLP = 3VLP, and 3PLVLP
3. Concrete thickness is thickness of slab above deck, in.
4. 1.5VLR may be used in designs D832, D902, and D916.
5. All Dovetail FormLok composite deck assemblies are subject to an upper live load limit of 130 psf.
6. Fluted deck finish shall be galvanized unless noted otherwise.
 - + Denotes fluted deck finish is not critical when used in D2-- & D5-- Series designs. Deck finish shall be galvanized or phosphatized/painted.
 - * Fluted deck finish is critical for fire resistance. Fluted deck finish shall be galvanized or phosphatized/painted. This gray paint is a special type of paint and is compatible with the spray-applied fire protection and is U.L. approved for use in the denoted D7-- & D8-- Series designs.
 - # Denotes fluted deck finish is not critical for fire resistance. Fluted deck finish shall be galvanized or phosphatized/painted.
7. Vulcraft cellular deck used in the listed assemblies shall be galvanized.
8. Vulcraft cellular deck units are approved by UL for use as electrical raceways under UL Standard 209.
9. Dramix® fibers may be used in UL or ULC fire rated assemblies in lieu of WWR. See UL file R19307 for additional information.
10. Restrained Assembly Rating is 1½ hr with listed NW concrete thickness.

Concrete Thickness

(in.)	(mm)
2	51
2½	64
2¾	70
3¼	83
3½	89
4	102
4 ³ / ₁₆	106
4½	114
4¾	121
5¼	133

NOTICE: Design defects that could cause injury or death may result from relying on the information in this document without independent verification by a qualified professional. The information in this document is provided “AS IS”. Nucor Corporation and its affiliates expressly disclaim: (i) any and all representations, warranties and conditions and (ii) all liability arising out of or related to this document and the information in it.

VERCO® COMPOSITE & NON-COMPOSITE DECK UL FIRE RATED ASSEMBLIES

Notes:

1. Refer to the UL “Fire Resistance Directory” for complete assembly requirements.
2. “B” = PLB-36 and B-36 FormLok
“BR” = BR-36 FormLok
“N3” = PLN3-32 and N3-32 FormLok
“N24” = PLN-24 and N-24 FormLok
“W2” = PLW2-36 and W2-36 FormLok
“W3” = PLW3-36 and W3-36 FormLok
“SV” & “DV” = Shallow Vercor or Deep Vercor, respectively
“2.0D” = 2.0D FormLok Dovetail Deck
“3.5D” = 3.5D FormLok Dovetail Deck
3. “SFRM” = Spray-Applied Fire Resistive Materials
“MFB” = Mineral Fiber Board
“MIC” = Mastic and Intumescent Coating
4. Vercor steel decks in the assemblies listed above may be galvanized or painted, excluding assemblies D904, D917, D928, D947, D961, D964, and D984 which shall be galvanized only. Painted deck is bare (un-galvanized) steel deck with UL recognized Vercor gray primer paint on the bottom side only.
5. Galvanized decks with UL recognized Vercor gray primer paint on the bottom side only are approved for use in limited fire-rated systems. Refer to specific UL assemblies for complete information.
6. Cellular versions of the Vercor steel decks in the assemblies listed above may be used, excluding assemblies D742, D750, D754, D760, D771, D775, D777, D779, D780, D782, D798, D904, D917, D924, D928, D947, D961, D964, D969, D973, D981, D984, D996, E707 and G710 which shall be non-cellular decks.
7. Cellular acoustical versions of the Vercor steel decks may be used in all listed D9xx assemblies except D904, D917, D924, D928, D947, D961, D964, D969, D973, D981, D984, D996, and all listed Gxx assemblies except G710.
8. Topping thickness varies based on selected acoustical material.
9. Carbonate Aggregate Normal Weight Concrete
10. Siliceous Aggregate Normal Weight Concrete
11. For 1 hr rating, concrete topping thickness may be reduced to 2 1/2 in. when composite or non-composite joist are used. For 1 1/2 or 2 hr ratings, concrete topping thickness may be reduced to 2 1/2 in. when non-composite joist are used.
12. Dramix® fibers may be used in UL or ULC fire rated assemblies in lieu of WWR. See UL file R19307 for additional information.

NOTICE: Design defects that could cause injury or death may result from relying on the information in this document without independent verification by a qualified professional. The information in this document is provided “AS IS”. Nucor Corporation and its affiliates expressly disclaim: (i) any and all representations, warranties and conditions and (ii) all liability arising out of or related to this document and the information in it.

VULCRAFT ROOF DECK SAMMY X-PRESS HANGING SOLUTIONS

HANG SPRINKLER PIPES FROM VULCRAFT ROOF AND ACOUSTICAL ROOF DECK



MAXIMUM SPRINKLER PIPE DIAMETER			GR50/GR40 DECK		
SAMMY X-Press Type			Deck Type		
Part Number	Model Number	Rod Size (in.)	Deck Gage	Solid (in.)	Perforated (in.)
8150922	XP 20	3/8	22	2 1/2 / 2	2 / 1 1/2
8294922	SXP 20	3/8	20	2 1/2 / 2 1/2	2 / 2
8272957	SXP 2.0	1/2	19	3 / 2 1/2	2 1/2 / 2
			18	3 1/2 / 3	2 1/2 / 2 1/2
8153299	XP 35	3/8			
8295922	SXP 35	3/8	16	4 / 4	3 1/2 / 3
8271957	SXP 3.5	1/2			



Notes:

1. Maximum fire sprinkler pipe size in accordance with NFPA 13.
2. The strength of the steel deck, Sammy X-Press connector, or threaded rod, bolt, and other connecting hardware shall be equal to or greater than the governing load combination as stipulated in the IBC or ASCE/SEI 7 including the fire sprinkler system loading.
3. SAMMY X-Press connectors shall be installed per manufacturer's instructions.

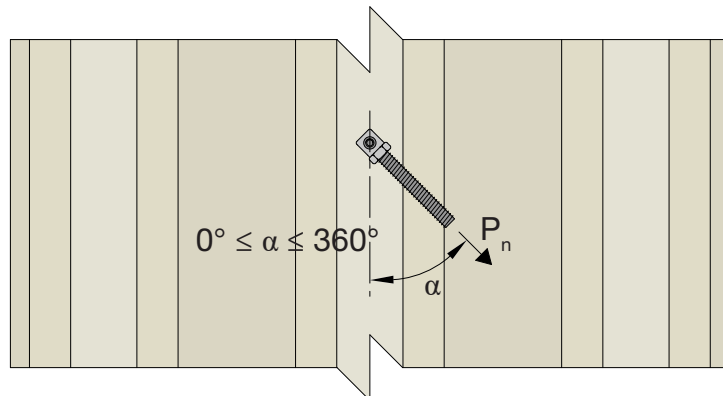
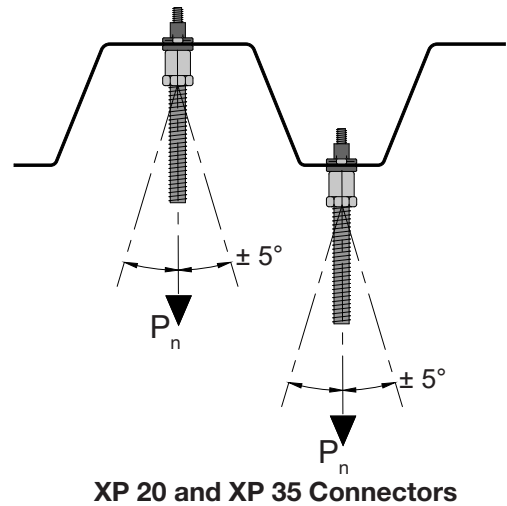
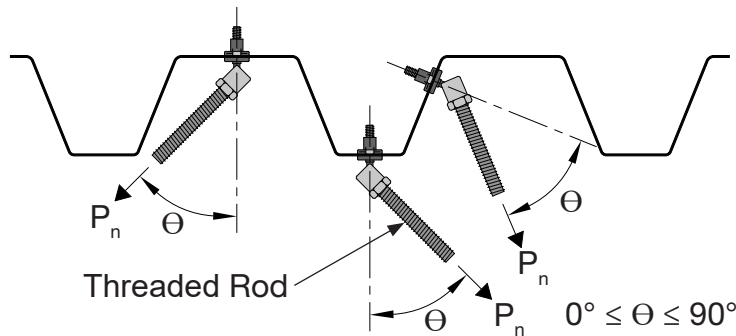

SXP 20, SXP 2.0, SXP 35 and SXP 3.5 Connectors

NOTICE: Design defects that could cause injury or death may result from relying on the information in this document without independent verification by a qualified professional. The information in this document is provided "AS IS". Nucor Corporation and its affiliates expressly disclaim: (i) any and all representations, warranties and conditions and (ii) all liability arising out of or related to this document and the information in it.

DOVETAIL FORMLOK® DECK-SLAB WEDGE-NUT HANGING SOLUTIONS

HANG YOUR MECHANICAL SYSTEMS FROM DOVETAIL FORMLOK COMPOSITE DECK-SLABS

DOVETAIL FORMLOK WEDGE-NUTS

- IAPMO UES ER-423
- UL Listed



HANGING LOAD

$f'_c = 2500$ psi (min.) NWC or LWC

Profile	Part Number	Connection Strength	
		Allowable P_n / Ω (lbs)	Design ϕP_n (lbs)
2.0D FormLok	2.0D-WN-3/8NC	1392	2297
	2.0D-WN-1/2NC		
3.5D FormLok	3.5D-WN-3/8NC	1996	3294
	3.5D-WN-1/2NC		

MAXIMUM SPRINKLER PIPE DIAMETER



Profile	Part Number	NPS	UL No.
		Diameter (in.)	
2.0D FormLok	2.0D-WN-3/8NC	4	EX27777
	2.0D-WN-1/2NC	6	
3.5D FormLok	3.5D-WN-3/8NC	4	EX27777
	3.5D-WN-1/2NC	8	

Notes:

1. The strength of the Dovetail FormLok Composite steel deck-slab, Wedge-Nut, or threaded rod, bolt, and other connecting hardware shall be equal or greater than the governing load combination as stipulated in the IBC or ASCE/SEI 7 including the fire sprinkler system loading.
2. Wedge-Nut connections shall be installed per manufacturer's instructions.

DOVETAIL FORMLOK® DECK-SLAB WEDGE-NUT HANGING SOLUTIONS

DOVETAIL FORMLOK WEDGE-NUT INSTALLATION

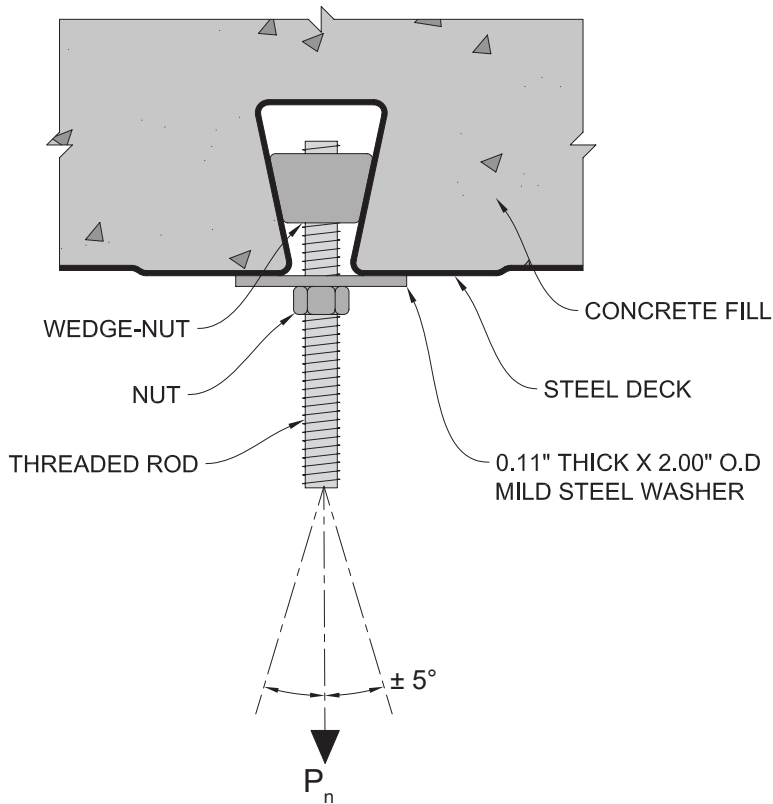

Figure 1

1. Deck ribs shall be free of foreign material to ensure the wedge-nut bears directly on the steel deck.
2. Insert wedge-nut and rotate to seat the surface against the webs of the steel deck as shown in Figure 1.
3. Position wedge-nut in the center of the rib with the threaded rod or bolt perpendicular to the bottom surface of the steel deck as shown in Figure 1.
4. Tighten the $\frac{3}{8}$ " threaded rod or bolt 1 to $1\frac{1}{2}$ turns beyond snug tight.
5. Tighten the $\frac{1}{2}$ " threaded rod or bolt $\frac{1}{2}$ to 1 turn beyond snug tight.

NOTICE: Design defects that could cause injury or death may result from relying on the information in this document without independent verification by a qualified professional. The information in this document is provided "AS IS". Nucor Corporation and its affiliates expressly disclaim: (i) any and all representations, warranties and conditions and (ii) all liability arising out of or related to this document and the information in it.

The image shows a close-up, perspective view of several interlocking metal roof decking panels. The panels are a light grey color with a slightly textured surface. They are arranged in a row, overlapping each other. A solid green horizontal banner is superimposed over the middle of the panels, containing the text "ROOF DECK" in white, bold, uppercase letters.

ROOF DECK

2.0D DOVETAIL ROOF DECK GRADE 40 STEEL

ASD

2.0D DOVETAIL ROOF DECK

- Enhanced 2-Coat Polyester Paint
- White Factory Primer Paint
- Galvanized Finish
- FM Listed

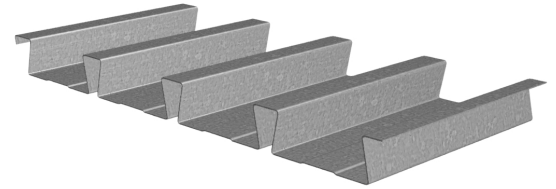

Nominal Dimensions

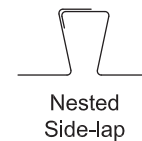
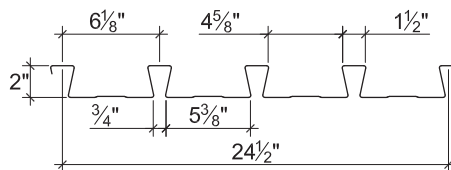

Section Properties

Deck Gage	Deck Weight w_{dd} (psf)	Base Metal Thickness t (in.)	Yield Strength F_y (ksi)	Effective Moment of Inertia at Service Load $I_d = (2I_e + I_p)/3$		Effective Section Modulus at $F_y = 40$ ksi		Allowable Moment		Vertical Web Shear V_n/Ω (lb/ft)
				I_{d+} (in ⁴ /ft)	I_{d-} (in ⁴ /ft)	S_{e+} (in ³ /ft)	S_{e-} (in ³ /ft)	M_{n+}/Ω (lb-ft/ft)	M_{n-}/Ω (lb-ft/ft)	
22	2.1	0.0295	40	0.387	0.359	0.272	0.272	543	543	2896
20	2.6	0.0358	40	0.472	0.447	0.343	0.334	684	666	3498
18	3.4	0.0474	40	0.626	0.612	0.463	0.450	924	898	4584
16	4.3	0.0598	40	0.792	0.791	0.587	0.576	1172	1150	5723

Allowable Reactions at Supports Based on Web Crippling, R_n/Ω (lb/ft)

Deck Gage	Bearing Length of Webs											
	One-Flange Loading						Two-Flange Loading					
	End Bearing				Interior Bearing		End Bearing				Interior Bearing	
	1 1/2"	2"	3"	4"	3"	5"	1 1/2"	2"	3"	4"	3"	5"
22	653	717	826	917	1281	1516	702	757	848	925	1567	1877
20	931	1020	1170	1296	1823	2146	1058	1136	1266	1376	2258	2690
18	1556	1697	1933	2132	3036	3544	1893	2023	2239	2422	3813	4507
16	2378	2582	2926	3215	4629	5360	3043	3237	3563	3837	5866	6880

Standard Features

- ASTM A653 SS GR 40 Min. with G90
- Standard lengths – 6'-0" to 42'-0"
- Tables conform to ANSI/SDI RD-2017
- IAPMO UES ER-423, FM and UL Listed

Optional Features

- Inquire regarding cost and lead times for:
 - 19 gage
 - Short cuts < 6'-0"
 - Alternative metallic and painted finishes
- Acoustical Version

2.0D DOVETAIL ROOF DECK GRADE 40 STEEL

Inward Uniform Allowable Loads, ASD (psf)

Deck Gage	Spans	Criteria	Span (ft-in.)										
			4'-0"	5'-0"	6'-0"	7'-0"	8'-0"	9'-0"	10'-0"	11'-0"	12'-0"	13'-0"	14'-0"
22	Single	W_n / Ω	272	174	121	89	68	54	43	36	30	26	22
		L/240	---	---	117	74	50	35	25	19	15	12	9
	Double	W_n / Ω	264	171	119	88	67	53	43	36	30	26	22
		L/240	---	---	---	---	---	---	---	---	---	---	21
	Triple	W_n / Ω	327	212	148	109	84	67	54	45	38	32	28
		L/240	---	---	---	---	---	61	44	33	26	20	16
20	Single	W_n / Ω	342	219	152	112	86	68	55	45	38	32	28
		L/240	---	---	143	90	60	42	31	23	18	14	11
	Double	W_n / Ω	324	209	146	108	83	65	53	44	37	31	27
		L/240	---	---	---	---	---	---	---	---	---	---	26
	Triple	W_n / Ω	401	260	182	134	103	82	66	55	46	39	34
		L/240	---	---	---	---	---	76	55	42	32	25	20
18	Single	W_n / Ω	462	296	205	151	115	91	74	61	51	44	38
		L/240	---	---	190	120	80	56	41	31	24	19	15
	Double	W_n / Ω	436	282	197	145	111	88	72	59	50	42	37
		L/240	---	---	---	---	---	---	---	---	---	---	35
	Triple	W_n / Ω	539	350	245	181	139	110	89	74	62	53	46
		L/240	---	---	---	---	---	104	76	57	44	34	28
16	Single	W_n / Ω	586	375	260	191	146	116	94	77	65	55	48
		L/240	---	---	240	151	101	71	52	39	30	24	19
	Double	W_n / Ω	558	361	252	186	143	113	92	76	64	54	47
		L/240	---	---	---	---	---	---	---	---	---	---	46
	Triple	W_n / Ω	688	447	313	231	178	141	114	94	79	68	58
		L/240	---	---	---	---	---	134	98	74	57	45	36

Notes:

1. Table does not account for web crippling. Required bearing should be determined based on specific span conditions.
2. The symbol “---” indicates that the uniform allowable load based on deflection exceeds the allowable load based on stress.

NOTICE: Design defects that could cause injury or death may result from relying on the information in this document without independent verification by a qualified professional. The information in this document is provided “AS IS”. Nucor Corporation and its affiliates expressly disclaim: (i) any and all representations, warranties and conditions and (ii) all liability arising out of or related to this document and the information in it.

3.5D DOVETAIL ROOF DECK GRADE 40 STEEL

ASD

3.5D DOVETAIL ROOF DECK

- Enhanced 2-Coat Polyester Paint
- White Factory Primer Paint
- Galvanized Finish
- FM Listed

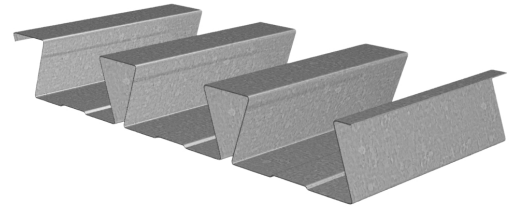

Nominal Dimensions

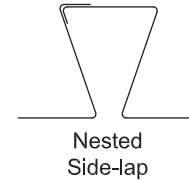
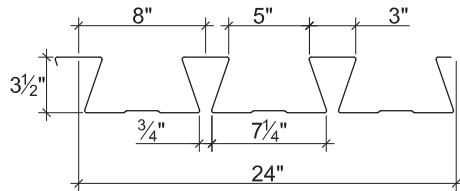

Section Properties

Deck Gage	Deck Weight w_{dd} (psf)	Base Metal Thickness t (in.)	Yield Strength F_y (ksi)	Effective Moment of Inertia at Service Load $I_d = (2I_e + I_g)/3$		Effective Section Modulus at $F_y = 40$ ksi		Allowable Moment		Vertical Web Shear V_n/Ω (lb/ft)
				I_{d+} (in ⁴ /ft)	I_{d-} (in ⁴ /ft)	S_{e+} (in ³ /ft)	S_{e-} (in ³ /ft)	M_{n+}/Ω (lb-ft/ft)	M_{n-}/Ω (lb-ft/ft)	
20	3.3	0.0358	40	1.762	1.646	0.676	0.781	1349	1559	3435
18	4.3	0.0474	40	2.415	2.272	0.980	1.070	1956	2136	6012
16	5.4	0.0598	40	3.133	2.968	1.317	1.377	2629	2749	8313

Allowable Reactions at Supports Based on Web Crippling, R_n/Ω (lb/ft)

Deck Gage	Bearing Length of Webs											
	One-Flange Loading						Two-Flange Loading					
	End Bearing				Interior Bearing		End Bearing				Interior Bearing	
	2"	3"	4"	5"	4"	6"	2"	3"	4"	5"	4"	6"
20	693	794	880	955	1459	1670	714	796	865	926	1724	1991
18	1168	1330	1467	1588	2422	2753	1310	1450	1568	1672	2927	3360
16	1793	2032	2233	2410	3681	4162	2137	2352	2533	2693	4515	5157

Standard Features

- ASTM A653 SS GR 40 Min. with G90
- Standard lengths – 6'-0" to 42'-0"
- Tables conform to ANSI/SDI RD-2017
- IAPMO UES ER-423, FM and UL Listed

Optional Features

- Inquire regarding cost and lead times for:
 - 19 gage
 - Short cuts < 6'-0"
 - Alternative metallic and painted finishes
- Acoustical Version

3.5D DOVETAIL ROOF DECK GRADE 40 STEEL

Inward Uniform Allowable Loads, ASD (psf)

Deck Gage	Spans	Criteria	Span (ft-in.)										
			11'-0"	12'-0"	13'-0"	14'-0"	15'-0"	16'-0"	17'-0"	18'-0"	19'-0"	20'-0"	21'-0"
20	Single	W_n / Ω	89	75	64	55	48	42	37	33	30	27	24
		L/240	87	67	53	42	34	28	24	20	17	14	12
	Double	W_n / Ω	101	85	73	63	55	48	43	38	34	31	28
		L/240	---	---	---	---	---	---	---	---	---	---	28
	Triple	W_n / Ω	125	106	90	78							
		L/240	---	---	---	74							
18	Single	W_n / Ω	129	109	93	80	70	61	54	48	43	39	35
		L/240	119	92	72	58	47	39	32	27	23	20	17
	Double	W_n / Ω	139	117	100	86	75	66	59	52	47	43	39
		L/240	---	---	---	---	---	---	---	---	---	---	---
	Triple	W_n / Ω	173	146	125	108							
		L/240	---	---	---	102							
16	Single	W_n / Ω	174	146	124	107	93	82	73	65	58	53	48
		L/240	154	119	93	75	61	50	42	35	30	26	22
	Double	W_n / Ω	180	151	129	111	97	85	76	68	61	55	50
		L/240	---	---	---	---	---	---	---	---	---	---	---
	Triple	W_n / Ω	224	188	161	139							
		L/240	---	---	---	134							

Notes:

1. Table does not account for web crippling. Required bearing should be determined based on specific span conditions.
2. The symbol "---" indicates that the uniform allowable load based on deflection exceeds the allowable load based on stress.

NOTICE: Design defects that could cause injury or death may result from relying on the information in this document without independent verification by a qualified professional. The information in this document is provided "AS IS". Nucor Corporation and its affiliates expressly disclaim: (i) any and all representations, warranties and conditions and (ii) all liability arising out of or related to this document and the information in it.

1.5B-36/1.5BI-36/1.5PLB-36 ROOF DECKS GRADE 50 STEEL

ASD

1.5B ROOF DECKS

- 1.5B-36 Deck used with Side-lap Screws
- 1.5BI-36 Deck used with TSWs or BPs
- 1.5PLB-36 Deck used with PunchLok® II System

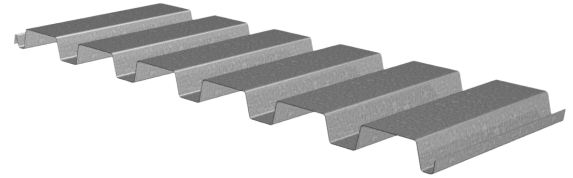

Nominal Dimensions

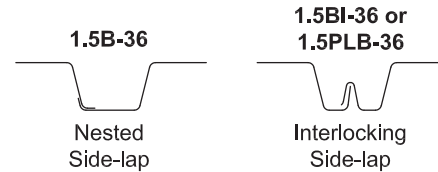
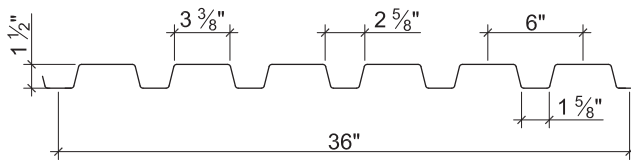

Section Properties

Deck Gage	Deck Weight w_{dd} (psf)	Base Metal Thickness t (in.)	Yield Strength F_y (ksi)	Effective Moment of Inertia at Service Load $I_d = (2I_e + I_g)/3$		Effective Section Modulus at $F_y = 50$ ksi		Allowable Moment		Vertical Web Shear V_n/Ω (lb/ft)
				I_{d+} (in ⁴ /ft)	I_{d-} (in ⁴ /ft)	S_{e+} (in ³ /ft)	S_{e-} (in ³ /ft)	M_{n+}/Ω (lb-ft/ft)	M_{n-}/Ω (lb-ft/ft)	
22	1.6	0.0295	50	0.155	0.178	0.169	0.179	422	447	2654
20	2.0	0.0358	50	0.197	0.217	0.224	0.229	559	571	3207
19	2.3	0.0418	50	0.239	0.257	0.266	0.278	663	693	3728
18	2.6	0.0474	50	0.277	0.290	0.306	0.318	763	793	4209
16	3.3	0.0598	50	0.364	0.367	0.393	0.402	981	1003	5261

Allowable Reactions at Supports Based on Web Crippling, R_n/Ω (lb/ft)

Deck Gage	Bearing Length of Webs											
	One-Flange Loading						Two-Flange Loading					
	End Bearing				Interior Bearing		End Bearing				Interior Bearing	
	1 1/2"	2"	3"	4"	3"	4"	1 1/2"	2"	3"	4"	3"	4"
22	807	887	1021	1115	1482	1602	842	908	1017	1093	1834	1994
20	1153	1263	1448	1574	2127	2289	1274	1368	1525	1632	2662	2881
19	1532	1674	1913	2071	2839	3043	1766	1891	2100	2239	3579	3859
18	1931	2105	2398	2588	3586	3831	2297	2454	2716	2887	4546	4884
16	2958	3212	3639	3900	5517	5855	3713	3950	4347	4590	7050	7523

Standard Features

- ASTM A653 SS GR50 Min., with G60 or G90, white or gray primer optional
- ASTM A1008 SS GR50 Min. with gray primer
- Standard lengths – 6'-0" to 42'-0"
- IAPMO UES ER-0652, UL, and FM Listed
- Tables conform to ANSI/SDI RD-2017

Optional Features

- Inquire regarding cost and lead times for:
 - Short cuts < 6'-0"
 - Sheet Lengths > 42'-0"
 - Alternative metallic and painted finishes
- Web Perforated Acoustical Versions

1.5B-36/1.5BI-36/1.5PLB-36 ROOF DECKS GRADE 50 STEEL

ASD

Inward Uniform Allowable Loads, ASD (psf)

Deck Gage	Spans	Criteria	Span (ft-in.)										
			2'-0"	3'-0"	4'-0"	5'-0"	6'-0"	7'-0"	8'-0"	9'-0"	10'-0"	11'-0"	12'-0"
22	Single	W_n / Ω	843	375	211	135	94	69	53	42	34	28	23
		L/240	---	---	159	81	47	30	20	14	10	8	6
	Double	W_n / Ω	823	382	219	141	98	72	56	44	36	29	25
		L/240	---	---	---	---	---	---	55	39	28	21	16
	Triple	W_n / Ω	997	470	271	175	122	90	69	55	44	37	31
		L/240	---	---	---	---	102	64	43	30	22	17	13
20	Single	W_n / Ω	1117	497	279	179	124	91	70	55	45	37	31
		L/240	---	478	202	103	60	38	25	18	13	10	7
	Double	W_n / Ω	1044	487	279	180	126	93	71	56	46	38	32
		L/240	---	---	---	---	---	---	67	47	34	26	20
	Triple	W_n / Ω	1260	598	345	223	156	115	88	70	57	47	40
		L/240	---	---	---	215	124	78	52	37	27	20	16
19	Single	W_n / Ω	1327	590	332	212	147	108	83	66	53	44	37
		L/240	---	580	245	125	73	46	31	21	16	12	9
	Double	W_n / Ω	1257	589	338	218	152	112	86	68	55	46	38
		L/240	---	---	---	---	---	---	79	56	41	30	23
	Triple	W_n / Ω	1514	722	417	271	189	140	107	85	69	57	48
		L/240	---	---	---	254	147	93	62	44	32	24	18
18	Single	W_n / Ω	1527	679	382	244	170	125	95	75	61	50	42
		L/240	---	673	284	145	84	53	35	25	18	14	11
	Double	W_n / Ω	1435	673	386	249	174	128	98	78	63	52	44
		L/240	---	---	---	---	---	---	89	63	46	34	27
	Triple	W_n / Ω	1727	825	477	310	217	160	123	97	79	65	55
		L/240	---	---	---	287	166	105	70	49	36	27	21
16	Single	W_n / Ω	1962	872	490	314	218	160	123	97	78	65	54
		L/240	---	---	373	191	110	70	47	33	24	18	14
	Double	W_n / Ω	1811	850	488	315	220	162	124	99	80	66	56
		L/240	---	---	---	---	---	---	113	79	58	44	34
	Triple	W_n / Ω	2177	1041	603	391	274	202	155	123	100	82	69
		L/240	---	---	---	363	210	132	89	62	45	34	26

Notes:

1. Table does not account for web crippling. Required bearing should be determined based on specific span conditions.
2. The symbol "----" indicates that the uniform allowable load based on deflection exceeds the allowable load based on stress.

NOTICE: Design defects that could cause injury or death may result from relying on the information in this document without independent verification by a qualified professional. The information in this document is provided "AS IS". Nucor Corporation and its affiliates expressly disclaim: (i) any and all representations, warranties and conditions and (ii) all liability arising out of or related to this document and the information in it.

1.5B-36/1.5BI-36/1.5PLB-36 ROOF DECKS

GRADE 80 STEEL

ASD

1.5B ROOF DECKS

- 1.5B-36 Deck used with Side-lap Screws
- 1.5BI-36 Deck used with TSWs or BPs
- 1.5PLB-36 Deck used with PunchLok® II System

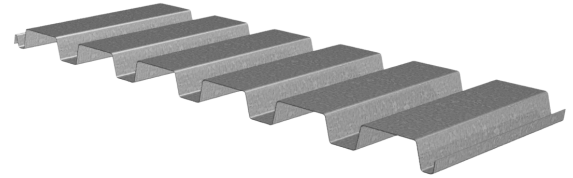

Nominal Dimensions

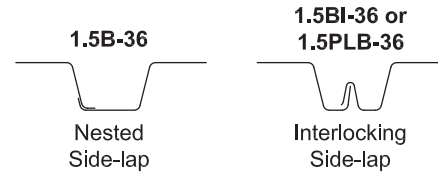
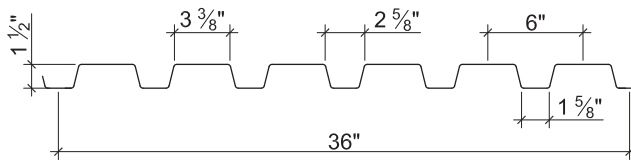

Section Properties

Deck Gage	Deck Weight w_{dd} (psf)	Base Metal Thickness t (in.)	Yield Strength F_y (ksi)	Effective Moment of Inertia at Service Load $I_d = (2I_e + I_g)/3$		Effective Section Modulus at $F_y = 60$ ksi		Allowable Moment		Vertical Web Shear V_n/Ω (lb/ft)
				I_{d+} (in ⁴ /ft)	I_{d-} (in ⁴ /ft)	S_{e+} (in ³ /ft)	S_{e-} (in ³ /ft)	M_{n+}/Ω (lb-ft/ft)	M_{n-}/Ω (lb-ft/ft)	
24	1.3	0.0239	60	0.118	0.138	0.120	0.131	359	392	1551
22	1.6	0.0295	60	0.151	0.175	0.162	0.173	485	518	3186
20	2.0	0.0358	60	0.192	0.217	0.215	0.223	644	668	3848
19	2.3	0.0418	60	0.232	0.254	0.263	0.271	787	811	4473
18	2.6	0.0474	60	0.272	0.290	0.302	0.315	904	943	5051

Allowable Reactions at Supports Based on Web Crippling, R_n/Ω (lb/ft)

Deck Gage	Bearing Length of Webs											
	One-Flange Loading						Two-Flange Loading					
	End Bearing				Interior Bearing		End Bearing				Interior Bearing	
	1 1/2"	2"	3"	4"	3"	4"	1 1/2"	2"	3"	4"	3"	4"
24	657	724	837	918	1197	1300	639	691	778	840	1460	1594
22	969	1065	1226	1338	1778	1922	1011	1089	1220	1312	2201	2392
20	1383	1515	1737	1888	2553	2747	1529	1641	1830	1959	3195	3458
19	1839	2009	2295	2486	3406	3652	2120	2269	2520	2687	4295	4631
18	2317	2526	2878	3105	4303	4597	2757	2944	3260	3464	5455	5861

Standard Features

- ASTM A653 SS GR80, with G60 or G90, white or gray primer optional
- ASTM A1008 SS GR80 with gray primer
- Standard lengths – 6'-0" to 42'-0"
- IAPMO UES ER-0652, UL, and FM Listed
- Tables conform to ANSI/SDI RD-2017

Optional Features

- Inquire regarding cost and lead times for:
 - Short cuts < 6'-0"
 - Sheet Lengths > 42'-0"
 - Alternative metallic and painted finishes
- Web Perforated Acoustical Versions

1.5B-36/1.5BI-36/1.5PLB-36 ROOF DECKS

GRADE 80 STEEL

ASD

Inward Uniform Allowable Loads, ASD (psf)

Deck Gage	Spans	Criteria	Span (ft-in.)										
			2'-0"	3'-0"	4'-0"	5'-0"	6'-0"	7'-0"	8'-0"	9'-0"	10'-0"	11'-0"	12'-0"
24	Single	W_n / Ω	719	319	180	115	80	59	45	35	29	24	20
		L/240	---	287	121	62	36	23	15	11	8	6	4
	Double	W_n / Ω	663	321	187	122	85	63	48	38	31	26	22
		L/240	---	---	---	---	---	---	43	30	22	16	13
	Triple	W_n / Ω	781	389	229	150	106	78	60	48	39	32	27
		L/240	---	---	---	137	79	50	33	23	17	13	10
22	Single	W_n / Ω	970	431	243	155	108	79	61	48	39	32	27
		L/240	---	367	155	79	46	29	19	14	10	7	6
	Double	W_n / Ω	960	444	254	164	114	84	64	51	41	34	29
		L/240	---	---	---	---	---	81	54	38	28	21	16
	Triple	W_n / Ω	1164	547	315	203	142	105	80	64	52	43	36
		L/240	---	---	---	173	100	63	42	30	22	16	13
20	Single	W_n / Ω	1287	572	322	206	143	105	80	64	51	43	36
		L/240	---	466	197	101	58	37	25	17	13	9	7
	Double	W_n / Ω	1225	570	326	211	147	108	83	66	53	44	37
		L/240	---	---	---	---	---	100	67	47	34	26	20
	Triple	W_n / Ω	1481	701	404	261	183	135	103	82	66	55	46
		L/240	---	---	---	215	124	78	52	37	27	20	16
19	Single	W_n / Ω	1575	700	394	252	175	129	98	78	63	52	44
		L/240	---	563	238	122	70	44	30	21	15	11	9
	Double	W_n / Ω	1478	690	396	255	178	131	101	80	65	53	45
		L/240	---	---	---	---	---	117	78	55	40	30	23
	Triple	W_n / Ω	1782	847	489	317	222	164	126	99	81	67	56
		L/240	---	---	---	252	146	92	61	43	31	24	18
18	Single	W_n / Ω	1808	804	452	289	201	148	113	89	72	60	50
		L/240	---	660	279	143	83	52	35	24	18	13	10
	Double	W_n / Ω	1709	800	459	297	207	153	117	93	75	62	52
		L/240	---	---	---	---	---	134	89	63	46	34	27
	Triple	W_n / Ω	2057	982	568	368	258	190	146	116	94	78	65
		L/240	---	---	561	287	166	105	70	49	36	27	21

Notes:

1. Table does not account for web crippling. Required bearing should be determined based on specific span conditions.
2. The symbol "----" indicates that the uniform allowable load based on deflection exceeds the allowable load based on stress.

NOTICE: Design defects that could cause injury or death may result from relying on the information in this document without independent verification by a qualified professional. The information in this document is provided "AS IS". Nucor Corporation and its affiliates expressly disclaim: (i) any and all representations, warranties and conditions and (ii) all liability arising out of or related to this document and the information in it.

3NL-32/3NI-32/3PLN-32 ROOF DECKS GRADE 50 STEEL

ASD

32" WIDE 3N ROOF DECKS

- 3NL-32 Deck used with Side-lap Screws
- 3NI-32 Deck used with TSWs or BPs
- 3PLN-32 Deck used with PunchLok® II System

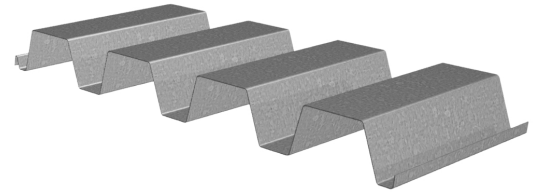

Nominal Dimensions

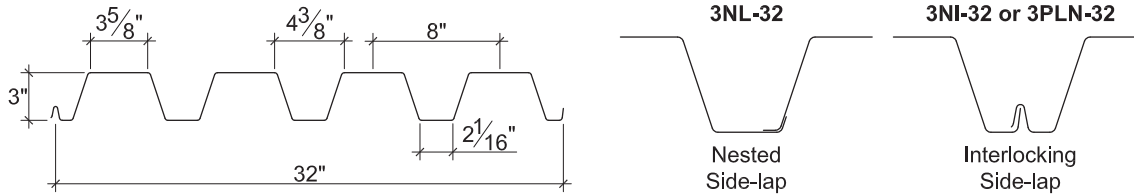

Section Properties

Deck Gage	Deck Weight w_{dd} (psf)	Base Metal Thickness t (in.)	Yield Strength F_y (ksi)	Effective Moment of Inertia at Service Load $I_d = (2I_e + I_g)/3$		Effective Section Modulus at $F_y = 50$ ksi		Allowable Moment		Vertical Web Shear V_n/Ω (lb/ft)
				I_{d+} (in ⁴ /ft)	I_{d-} (in ⁴ /ft)	S_{e+} (in ³ /ft)	S_{e-} (in ³ /ft)	M_{n+}/Ω (lb-ft/ft)	M_{n-}/Ω (lb-ft/ft)	
22	1.8	0.0295	50	0.643	0.715	0.345	0.372	861	928	2176
20	2.2	0.0358	50	0.806	0.886	0.448	0.476	1118	1187	3761
19	2.6	0.0418	50	0.965	1.052	0.554	0.579	1382	1445	5127
18	2.9	0.0474	50	1.123	1.200	0.660	0.675	1647	1684	6598
16	3.7	0.0598	50	1.479	1.524	0.869	0.885	2168	2208	9064

Allowable Reactions at Supports Based on Web Crippling, R_n/Ω (lb/ft)

Deck Gage	Bearing Length of Webs											
	One-Flange Loading						Two-Flange Loading					
	End Bearing				Interior Bearing		End Bearing				Interior Bearing	
	1 1/2"	2"	3"	4"	4"	8"	1 1/2"	2"	3"	4"	4"	8"
22	536	589	678	753	1185	1377	508	547	613	669	1380	1620
20	774	848	972	1077	1697	2101	788	846	944	1026	2014	2529
19	1036	1132	1294	1430	2258	2842	1112	1190	1322	1433	2715	3471
18	1313	1432	1631	1799	2847	3565	1464	1563	1731	1872	3454	4397
16	2031	2206	2499	2746	4365	5416	2414	2568	2826	3043	5374	6781

Standard Features

- ASTM A653 SS GR50 Min., with G60 or G90, white or gray primer optional
- ASTM A1008 SS GR50 Min. with gray primer
- Standard lengths – 6'-0" to 42'-0"
- IAPMO UES ER-0652, UL, and FM Listed
- Tables conform to ANSI/SDI RD-2017

Optional Features

- Inquire regarding cost and lead times for:
 - Short cuts < 6'-0"
 - Sheet Lengths > 42'-0"
 - Alternative metallic and painted finishes
- Web Perforated Acoustical Versions

3NL-32/3NI-32/3PLN-32 ROOF DECKS

GRADE 50 STEEL

ASD

Inward Uniform Allowable Loads, ASD (psf)

Deck Gage	Spans	Criteria	Span (ft-in.)										
			4'-0"	6'-0"	8'-0"	9'-0"	10'-0"	11'-0"	12'-0"	14'-0"	16'-0"	18'-0"	20'-0"
22	Single	W_n / Ω	431	191	108	85	69	57	48	35	27	21	17
		L/240	---	---	82	58	42	32	24	15	10	7	5
	Double	W_n / Ω	409	194	112	89	73	60	51	37	29	23	18
		L/240	---	---	---	---	---	---	---	---	28	19	14
	Triple	W_n / Ω	489	237	138	110	90	75	63	47			
		L/240	---	---	---	---	88	66	51	32			
20	Single	W_n / Ω	559	248	140	110	89	74	62	46	35	28	22
		L/240	---	245	103	72	53	40	31	19	13	9	7
	Double	W_n / Ω	552	255	146	116	94	78	65	48	37	29	24
		L/240	---	---	---	---	---	---	---	---	34	24	17
	Triple	W_n / Ω	671	315	181	143	117	97	81	60			
		L/240	---	---	---	---	110	82	63	40			
19	Single	W_n / Ω	691	307	173	136	111	91	77	56	43	34	28
		L/240	---	293	124	87	63	48	37	23	15	11	8
	Double	W_n / Ω	681	313	178	141	114	95	80	59	45	36	29
		L/240	---	---	---	---	---	---	---	---	41	28	21
	Triple	W_n / Ω	832	386	221	175	142	118	99	73			
		L/240	---	---	---	---	130	98	75	47			
18	Single	W_n / Ω	823	366	206	163	132	109	91	67	51	41	33
		L/240	---	341	144	101	74	55	43	27	18	13	9
	Double	W_n / Ω	802	366	208	165	134	111	93	68	52	41	34
		L/240	---	---	---	---	---	---	---	---	46	32	24
	Triple	W_n / Ω	983	453	258	205	167	138	116	85			
		L/240	---	---	---	204	149	112	86	54			
16	Single	W_n / Ω	1084	482	271	214	173	143	120	89	68	54	43
		L/240	---	449	189	133	97	73	56	35	24	17	12
	Double	W_n / Ω	1056	481	273	216	175	145	122	90	69	54	44
		L/240	---	---	---	---	---	---	---	88	59	41	30
	Triple	W_n / Ω	1296	596	339	269	219	181	152	112			
		L/240	---	---	---	259	189	142	109	69			

Notes:

1. Table does not account for web crippling. Required bearing should be determined based on specific span conditions.
2. The symbol "----" indicates that the uniform allowable load based on deflection exceeds the allowable load based on stress.

NOTICE: Design defects that could cause injury or death may result from relying on the information in this document without independent verification by a qualified professional. The information in this document is provided "AS IS". Nucor Corporation and its affiliates expressly disclaim: (i) any and all representations, warranties and conditions and (ii) all liability arising out of or related to this document and the information in it.

3NL-32/3NI-32/3PLN-32 ROOF DECKS

GRADE 80 STEEL

ASD

32" WIDE 3N ROOF DECKS

- 3NL-32 Deck used with Side-lap Screws
- 3NI-32 Deck used with TSWs or BPs
- 3PLN-32 Deck used with PunchLok® II System

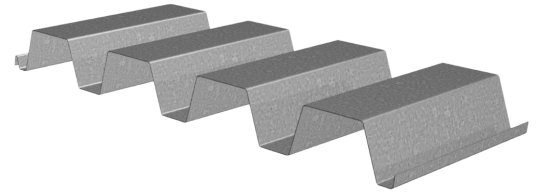

Nominal Dimensions

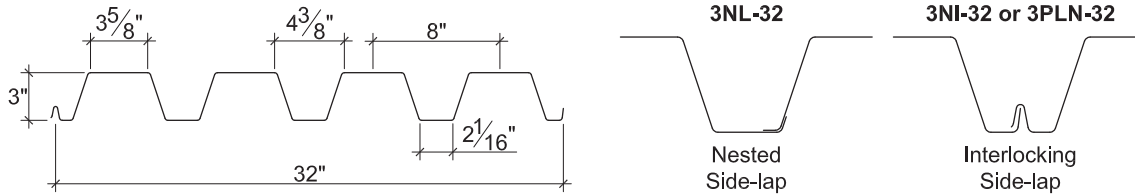

Section Properties

Deck Gage	Deck Weight w_{dd} (psf)	Base Metal Thickness t (in.)	Yield Strength F_y (ksi)	Effective Moment of Inertia at Service Load $I_d = (2I_e + I_g)/3$		Effective Section Modulus at $F_y = 60$ ksi		Allowable Moment		Vertical Web Shear V_n/Ω (lb/ft)
				I_{d+} (in ⁴ /ft)	I_{d-} (in ⁴ /ft)	S_{e+} (in ³ /ft)	S_{e-} (in ³ /ft)	M_{n+}/Ω (lb-ft/ft)	M_{n-}/Ω (lb-ft/ft)	
22	1.8	0.0295	60	0.635	0.707	0.335	0.346	1003	1036	2176
20	2.2	0.0358	60	0.794	0.876	0.434	0.463	1299	1386	3899
19	2.6	0.0418	60	0.950	1.040	0.536	0.563	1605	1686	5616
18	2.9	0.0474	60	1.103	1.195	0.637	0.659	1907	1973	7227

Allowable Reactions at Supports Based on Web Crippling, R_n/Ω (lb/ft)

Deck Gage	Bearing Length of Webs											
	One-Flange Loading						Two-Flange Loading					
	End Bearing				Interior Bearing		End Bearing				Interior Bearing	
	1 1/2"	2"	3"	4"	4"	8"	1 1/2"	2"	3"	4"	4"	8"
22	643	707	814	904	1422	1653	610	657	736	802	1656	1944
20	929	1017	1166	1292	2036	2522	946	1016	1132	1231	2417	3035
19	1244	1359	1552	1716	2709	3410	1334	1428	1586	1719	3257	4165
18	1576	1718	1957	2159	3416	4279	1756	1876	2077	2246	4145	5276

Standard Features

- ASTM A653 SS GR80, with G60 or G90, white or gray primer optional
- ASTM A1008 SS GR80 with gray primer
- Standard lengths – 6'-0" to 42'-0"
- IAPMO UES ER-0652, UL, and FM Listed
- Tables conform to ANSI/SDI RD-2017

Optional Features

- Inquire regarding cost and lead times for:
 - Short cuts < 6'-0"
 - Sheet Lengths > 42'-0"
 - Alternative metallic and painted finishes
- Web Perforated Acoustical Versions

3NL-32/3NI-32/3PLN-32 ROOF DECKS

GRADE 80 STEEL

ASD

Inward Uniform Allowable Loads, ASD (psf)

Deck Gage	Spans	Criteria	Span (ft-in.)										
			4'-0"	6'-0"	8'-0"	9'-0"	10'-0"	11'-0"	12'-0"	14'-0"	16'-0"	18'-0"	20'-0"
22	Single	W_n / Ω	501	223	125	99	80	66	56	41	31	25	20
		L/240	---	193	81	57	42	31	24	15	10	7	5
	Double	W_n / Ω	445	214	124	99	81	67	56	42	32	25	21
		L/240	---	---	---	---	---	---	---	41	27	19	14
	Triple	W_n / Ω	527	260	152	122	100	83	70	52			
		L/240	---	---	---	120	88	66	51	32			
20	Single	W_n / Ω	650	289	162	128	104	86	72	53	41	32	26
		L/240	---	241	102	71	52	39	30	19	13	9	7
	Double	W_n / Ω	633	295	169	134	109	90	76	56	43	34	28
		L/240	---	---	---	---	---	---	---	50	34	24	17
	Triple	W_n / Ω	764	363	209	167	136	112	95	70			
		L/240	---	---	---	149	108	81	63	40			
19	Single	W_n / Ω	802	357	201	158	128	106	89	66	50	40	32
		L/240	---	288	122	85	62	47	36	23	15	11	8
	Double	W_n / Ω	789	363	207	164	133	110	93	68	52	41	34
		L/240	---	---	---	---	---	---	---	60	40	28	21
	Triple	W_n / Ω	961	448	257	204	166	137	116	85			
		L/240	---	---	251	177	129	97	74	47			
18	Single	W_n / Ω	954	424	238	188	153	126	106	78	60	47	38
		L/240	---	335	141	99	72	54	42	26	18	12	9
	Double	W_n / Ω	934	428	243	193	156	129	109	80	61	49	39
		L/240	---	---	---	---	---	---	---	69	46	32	24
	Triple	W_n / Ω	1141	529	302	240	195	161	136	100			
		L/240	---	---	289	203	148	111	86	54			

Notes:

1. Table does not account for web crippling. Required bearing should be determined based on specific span conditions.
2. The symbol "---" indicates that the uniform allowable load based on deflection exceeds the allowable load based on stress.

NOTICE: Design defects that could cause injury or death may result from relying on the information in this document without independent verification by a qualified professional. The information in this document is provided "AS IS". Nucor Corporation and its affiliates expressly disclaim: (i) any and all representations, warranties and conditions and (ii) all liability arising out of or related to this document and the information in it.

3N-24/3NI-24 ROOF DECKS GRADE 40 STEEL

ASD

24" WIDE 3N ROOF DECKS

- 3N-24 Deck used with Side-lap Screws
- 3NI-24 Deck used with TSWs or BPs

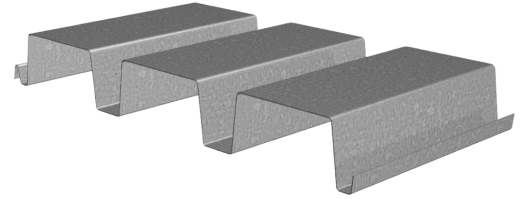

Nominal Dimensions

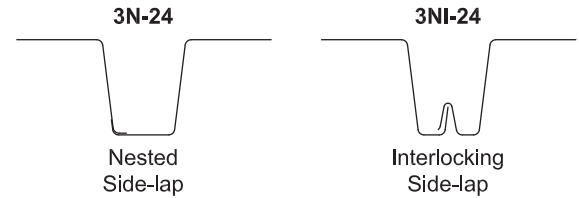
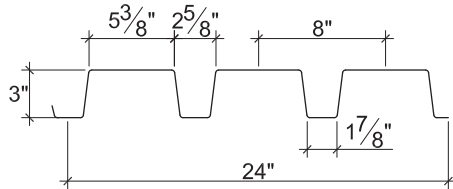

Section Properties

Deck Gage	Deck Weight w_{dd} (psf)	Base Metal Thickness t (in.)	Yield Strength F_y (ksi)	Effective Moment of Inertia at Service Load $I_d = (2I_e + I_g)/3$		Effective Section Modulus at $F_y = 40$ ksi		Allowable Moment		Vertical Web Shear V_n/Ω (lb/ft)
				I_{d+} (in ⁴ /ft)	I_{d-} (in ⁴ /ft)	S_{e+} (in ³ /ft)	S_{e-} (in ³ /ft)	$M_n +/\Omega$ (lb-ft/ft)	$M_n -/\Omega$ (lb-ft/ft)	
22	2.0	0.0295	40	0.714	0.869	0.368	0.419	735	837	2436
20	2.5	0.0358	40	0.901	1.071	0.482	0.530	962	1058	3589
19	2.9	0.0418	40	1.088	1.252	0.584	0.637	1166	1271	4894
18	3.3	0.0474	40	1.268	1.421	0.674	0.731	1346	1459	5738
16	4.1	0.0598	40	1.682	1.795	0.876	0.934	1749	1864	7204

Allowable Reactions at Supports Based on Web Crippling, R_n/Ω (lb/ft)

Deck Gage	Bearing Length of Webs											
	One-Flange Loading						Two-Flange Loading					
	End Bearing				Interior Bearing		End Bearing				Interior Bearing	
	1 1/2"	2"	3"	4"	4"	8"	1 1/2"	2"	3"	4"	4"	8"
22	463	509	586	651	1014	1178	444	478	535	584	1189	1395
20	667	731	838	928	1451	1796	686	737	821	893	1733	2176
19	893	976	1115	1232	1930	2430	966	1034	1148	1244	2334	2984
18	1130	1233	1404	1548	2433	3047	1269	1355	1501	1623	2967	3777
16	1745	1895	2147	2359	3726	4624	2086	2219	2442	2630	4609	5816

Standard Features

- ASTM A653 SS GR40 Min., with G60 or G90, white or gray primer optional
- ASTM A1008 SS GR40 Min. with gray primer
- Standard lengths – 6'-0" to 42'-0"
- IAPMO UES ER-0652, UL, and FM Listed
- Tables conform to ANSI/SDI RD-2017

Optional Features

- Inquire regarding cost and lead times for:
 - Short cuts < 6'-0"
 - Sheet Lengths > 42'-0"
 - Alternative metallic and painted finishes
- Web Perforated Acoustical Versions

3N-24/3NI-24 ROOF DECKS GRADE 40 STEEL

ASD

Inward Uniform Allowable Loads, ASD (psf)

Deck Gage	Spans	Criteria	Span (ft-in.)										
			4'-0"	6'-0"	8'-0"	9'-0"	10'-0"	11'-0"	12'-0"	14'-0"	16'-0"	18'-0"	20'-0"
22	Single	W_n / Ω	367	163	92	73	59	49	41	30	23	18	15
		L/240	---	---	91	64	47	35	27	17	11	8	6
	Double	W_n / Ω	384	179	102	81	66	55	46	34	26	21	17
		L/240	---	---	---	---	---	---	---	---	---	---	---
	Triple	W_n / Ω	465	220	127	101	82	68	57	42			
		L/240	---	---	---	---	---	---	---	39			
20	Single	W_n / Ω	481	214	120	95	77	64	53	39	30	24	19
		L/240	---	---	115	81	59	44	34	22	14	10	7
	Double	W_n / Ω	496	228	130	103	84	69	58	43	33	26	21
		L/240	---	---	---	---	---	---	---	---	---	---	---
	Triple	W_n / Ω	605	282	161	128	104	86	73	54			
		L/240	---	---	---	---	---	---	---	48			
19	Single	W_n / Ω	583	259	146	115	93	77	65	48	36	29	23
		L/240	---	---	139	98	71	54	41	26	17	12	9
	Double	W_n / Ω	605	276	157	124	101	83	70	52	40	31	25
		L/240	---	---	---	---	---	---	---	---	---	---	25
	Triple	W_n / Ω	740	342	195	155	126	104	88	64			
		L/240	---	---	---	---	---	---	---	56			
18	Single	W_n / Ω	673	299	168	133	108	89	75	55	42	33	27
		L/240	---	---	162	114	83	62	48	30	20	14	10
	Double	W_n / Ω	695	317	180	143	116	96	81	59	45	36	29
		L/240	---	---	---	---	---	---	---	---	---	---	28
	Triple	W_n / Ω	852	393	224	178	144	119	101	74			
		L/240	---	---	---	---	---	---	---	64			
16	Single	W_n / Ω	874	389	219	173	140	116	97	71	55	43	35
		L/240	---	---	215	151	110	83	64	40	27	19	14
	Double	W_n / Ω	887	405	230	182	148	122	103	76	58	46	37
		L/240	---	---	---	---	---	---	---	---	---	---	35
	Triple	W_n / Ω	1086	501	286	227	184	153	128	95			
		L/240	---	---	---	---	---	---	---	81			

Notes:

1. Table does not account for web crippling. Required bearing should be determined based on specific span conditions.
2. The symbol "----" indicates that the uniform allowable load based on deflection exceeds the allowable load based on stress.

NOTICE: Design defects that could cause injury or death may result from relying on the information in this document without independent verification by a qualified professional. The information in this document is provided "AS IS". Nucor Corporation and its affiliates expressly disclaim: (i) any and all representations, warranties and conditions and (ii) all liability arising out of or related to this document and the information in it.

2.0DA ACOUSTICAL DOVETAIL ROOF DECK GRADE 40 STEEL

ASD

2.0DA ACOUSTICAL DOVETAIL ROOF DECK

- Enhanced 2-Coat Polyester Paint
- White Factory Primer Paint
- Galvanized Finish
- FM Listed

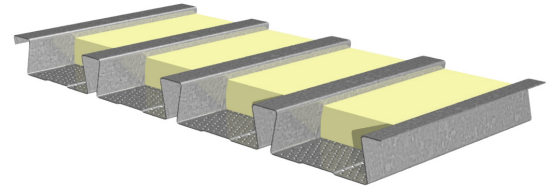

Nominal Dimensions

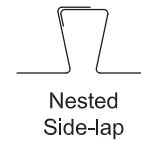
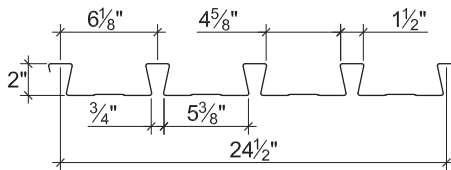

Section Properties

Deck Gage	Deck Weight w_{dd} (psf)	Base Metal Thickness t (in.)	Yield Strength F_y (ksi)	Effective Moment of Inertia at Service Load $I_d = (2I_e + I_p)/3$		Effective Section Modulus at $F_y = 40$ ksi		Allowable Moment		Vertical Web Shear V_n/Ω (lb/ft)
				I_{d+} (in ⁴ /ft)	I_{d-} (in ⁴ /ft)	S_{e+} (in ³ /ft)	S_{e-} (in ³ /ft)	M_{n+}/Ω (lb-ft/ft)	M_{n-}/Ω (lb-ft/ft)	
22	2.0	0.0295	40	0.340	0.310	0.261	0.258	521	515	2896
20	2.4	0.0358	40	0.415	0.385	0.330	0.317	659	633	3498
18	3.2	0.0474	40	0.551	0.528	0.445	0.427	888	852	4584
16	4.0	0.0598	40	0.697	0.684	0.564	0.546	1126	1090	5723

Allowable Reactions at Supports Based on Web Crippling, R_n/Ω (lb/ft)

Deck Gage	Bearing Length of Webs											
	One-Flange Loading						Two-Flange Loading					
	End Bearing				Interior Bearing		End Bearing				Interior Bearing	
	1 1/2"	2"	3"	4"	3"	5"	1 1/2"	2"	3"	4"	3"	5"
22	653	717	826	917	1281	1516	702	757	848	925	1567	1877
20	931	1020	1170	1296	1823	2146	1058	1136	1266	1376	2258	2690
18	1556	1697	1933	2132	3036	3544	1893	2023	2239	2422	3813	4507
16	2378	2582	2926	3215	4629	5360	3043	3237	3563	3837	5866	6880

Standard Features

- ASTM A653 SS GR 40 Min. with G90
- Standard lengths – 6'-0" to 42'-0"
- Tables conform to ANSI/SDI RD-2017
- IAPMO UES ER-423 and FM Listed

Optional Features

- Inquire regarding cost and lead times for:
 - 19 gage
 - Short cuts < 6'-0"
 - Alternative metallic and painted finishes

2.0DA ACOUSTICAL DOVETAIL ROOF DECK GRADE 40 STEEL

Inward Uniform Allowable Loads, ASD (psf)

Deck Gage	Spans	Criteria	Span (ft-in.)										
			4'-0"	5'-0"	6'-0"	7'-0"	8'-0"	9'-0"	10'-0"	11'-0"	12'-0"	13'-0"	14'-0"
22	Single	W_n / Ω	260	167	116	85	65	51	42	34	29	25	21
		L/240	---	---	103	65	44	31	22	17	13	10	8
	Double	W_n / Ω	251	162	113	83	64	51	41	34	29	24	21
		L/240	---	---	---	---	---	---	---	---	28	22	18
	Triple	W_n / Ω	311	201	141	104	80	63	51	42	36	30	26
		L/240	---	---	---	---	75	53	38	29	22	17	14
20	Single	W_n / Ω	329	211	146	108	82	65	53	44	37	31	27
		L/240	---	---	126	79	53	37	27	20	16	12	10
	Double	W_n / Ω	309	199	139	102	79	62	50	42	35	30	26
		L/240	---	---	---	---	---	---	---	---	---	28	22
	Triple	W_n / Ω	382	247	173	128	98	78	63	52	44	37	32
		L/240	---	---	---	---	93	65	48	36	28	22	17
18	Single	W_n / Ω	444	284	197	145	111	88	71	59	49	42	36
		L/240	---	---	167	105	71	50	36	27	21	16	13
	Double	W_n / Ω	415	268	187	138	106	84	68	56	47	40	35
		L/240	---	---	---	---	---	---	---	---	---	38	30
	Triple	W_n / Ω	513	333	233	172	132	104	85	70	59	50	43
		L/240	---	---	---	---	128	90	65	49	38	30	24
16	Single	W_n / Ω	563	360	250	184	141	111	90	74	63	53	46
		L/240	---	---	212	133	89	63	46	34	26	21	17
	Double	W_n / Ω	530	343	239	176	135	107	87	72	60	51	44
		L/240	---	---	---	---	---	---	---	---	---	49	39
	Triple	W_n / Ω	655	425	297	220	169	133	108	90	75	64	55
		L/240	---	---	---	---	165	116	85	64	49	39	31

Notes:

1. Table does not account for web crippling. Required bearing should be determined based on specific span conditions.
2. The symbol "----" indicates that the uniform allowable load based on deflection exceeds the allowable load based on stress.

NOTICE: Design defects that could cause injury or death may result from relying on the information in this document without independent verification by a qualified professional. The information in this document is provided "AS IS". Nucor Corporation and its affiliates expressly disclaim: (i) any and all representations, warranties and conditions and (ii) all liability arising out of or related to this document and the information in it.

3.5DA ACOUSTICAL DOVETAIL ROOF DECK GRADE 40 STEEL

ASD

3.5DA ACOUSTICAL DOVETAIL ROOF DECK

- Enhanced 2-Coat Polyester Paint
- White Factory Primer Paint
- Galvanized Finish
- FM Listed

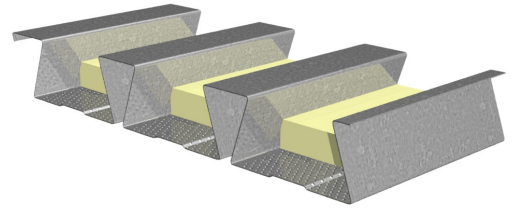

Nominal Dimensions

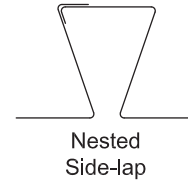
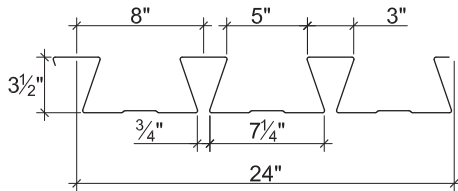

Section Properties

Deck Gage	Deck Weight w_{dd} (psf)	Base Metal Thickness t (in.)	Yield Strength F_y (ksi)	Effective Moment of Inertia at Service Load $I_d = (2I_e + I_g)/3$		Effective Section Modulus at $F_y = 40$ ksi		Allowable Moment		Vertical Web Shear V_n/Ω (lb/ft)
				I_{d+} (in ⁴ /ft)	I_{d-} (in ⁴ /ft)	S_{e+} (in ³ /ft)	S_{e-} (in ³ /ft)	M_{n+}/Ω (lb-ft/ft)	M_{n-}/Ω (lb-ft/ft)	
20	3.1	0.0358	40	1.531	1.430	0.655	0.657	1307	1311	3435
18	4.1	0.0474	40	2.098	1.950	0.934	0.928	1864	1852	6012
16	5.1	0.0598	40	2.719	2.533	1.255	1.241	2505	2477	8313

Allowable Reactions at Supports Based on Web Crippling, R_n/Ω (lb/ft)

Deck Gage	Bearing Length of Webs											
	One-Flange Loading						Two-Flange Loading					
	End Bearing				Interior Bearing		End Bearing				Interior Bearing	
	2"	3"	4"	5"	4"	6"	2"	3"	4"	5"	4"	6"
20	693	794	880	955	1459	1670	714	796	865	926	1724	1991
18	1168	1330	1467	1588	2422	2753	1310	1450	1568	1672	2927	3360
16	1793	2032	2233	2410	3681	4162	2137	2352	2533	2693	4515	5157

Standard Features

- ASTM A653 SS GR 40 Min. with G90
- Standard lengths – 6'-0" to 42'-0"
- Tables conform to ANSI/SDI RD-2017
- IAPMO UES ER-423 and FM Listed

Optional Features

- Inquire regarding cost and lead times for:
 - 19 gage
 - Short cuts < 6'-0"
 - Alternative metallic and painted finishes

3.5DA ACOUSTICAL DOVETAIL ROOF DECK GRADE 40 STEEL

Inward Uniform Allowable Loads, ASD (psf)

Deck Gage	Spans	Criteria	Span (ft-in.)										
			11'-0"	12'-0"	13'-0"	14'-0"	15'-0"	16'-0"	17'-0"	18'-0"	19'-0"	20'-0"	21'-0"
20	Single	W_n / Ω	86	73	62	53	46	41	36	32	29	26	24
		L/240	75	58	46	37	30	25	20	17	15	13	11
	Double	W_n / Ω	85	72	61	53	46	41	36	32	29	26	24
		L/240	---	---	---	---	---	---	---	---	---	---	---
	Triple	W_n / Ω	106	89	76	66							
		L/240	---	---	---	65							
18	Single	W_n / Ω	123	104	88	76	66	58	52	46	41	37	34
		L/240	103	80	63	50	41	34	28	24	20	17	15
	Double	W_n / Ω	121	102	87	75	66	58	51	46	41	37	34
		L/240	---	---	---	---	---	---	---	---	---	---	33
	Triple	W_n / Ω	151	127	109	94							
		L/240	---	---	---	88							
16	Single	W_n / Ω	166	139	119	102	89	78	69	62	56	50	45
		L/240	134	103	81	65	53	44	36	31	26	22	19
	Double	W_n / Ω	162	137	117	101	88	77	68	61	55	49	45
		L/240	---	---	---	---	---	---	---	---	---	---	43
	Triple	W_n / Ω	202	170	145	125							
		L/240	---	---	143	114							

Notes:

1. Table does not account for web crippling. Required bearing should be determined based on specific span conditions.
2. The symbol "---" indicates that the uniform allowable load based on deflection exceeds the allowable load based on stress.

NOTICE: Design defects that could cause injury or death may result from relying on the information in this document without independent verification by a qualified professional. The information in this document is provided "AS IS". Nucor Corporation and its affiliates expressly disclaim: (i) any and all representations, warranties and conditions and (ii) all liability arising out of or related to this document and the information in it.

1.5BA-36/1.5BIA-36/1.5PLBA-36 ACOUSTICAL ROOF DECKS GRADE 50 STEEL

ASD

1.5B ACOUSTICAL ROOF DECKS

- 1.5BA-36 Deck used with Side-lap Screws
- 1.5BIA-36 Deck used with TSWs or BPs
- 1.5PLBA-36 Deck used with PunchLok® II System

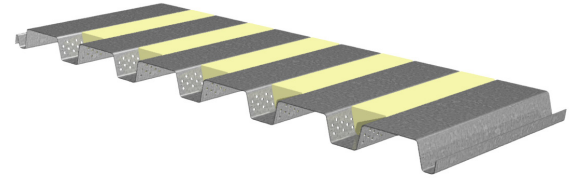

Nominal Dimensions

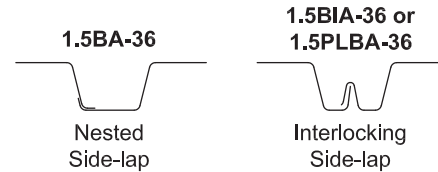
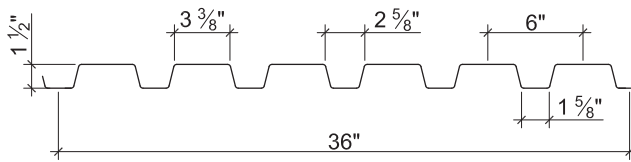

Section Properties

Deck Gage	Deck Weight w_{dd} (psf)	Base Metal Thickness t (in.)	Yield Strength F_y (ksi)	Effective Moment of Inertia at Service Load $I_d = (2I_e + I_g)/3$		Effective Section Modulus at $F_y = 50$ ksi		Allowable Moment		Vertical Web Shear V_n/Ω (lb/ft)
				I_{d+} (in ⁴ /ft)	I_{d-} (in ⁴ /ft)	S_{e+} (in ³ /ft)	S_{e-} (in ³ /ft)	M_{n+}/Ω (lb-ft/ft)	M_{n-}/Ω (lb-ft/ft)	
22	1.5	0.0295	50	0.148	0.169	0.161	0.170	402	424	2008
20	1.9	0.0358	50	0.187	0.206	0.213	0.218	532	544	2421
19	2.2	0.0418	50	0.227	0.244	0.253	0.264	631	659	2809
18	2.5	0.0474	50	0.263	0.276	0.290	0.302	723	753	3166
16	3.2	0.0598	50	0.346	0.348	0.374	0.382	933	953	3941

Allowable Reactions at Supports Based on Web Crippling, R_n/Ω (lb/ft)

Deck Gage	Bearing Length of Webs											
	One-Flange Loading						Two-Flange Loading					
	End Bearing		Interior Bearing				End Bearing		Interior Bearing			
	1 1/2"	2"	3"	4"	3"	4"	1 1/2"	2"	3"	4"	3"	4"
22	783	861	991	1082	1476	1595	798	859	963	1035	1792	1949
20	1122	1230	1410	1532	2120	2281	1214	1304	1453	1556	2608	2823
19	1495	1634	1867	2022	2829	3033	1691	1810	2011	2144	3512	3787
18	1887	2058	2344	2530	3575	3819	2207	2357	2609	2773	4466	4799
16	2899	3148	3567	3822	5501	5838	3585	3814	4198	4432	6941	7407

Standard Features

- ASTM A653 SS GR50 Min., with G60 or G90, white or gray primer optional
- ASTM A1008 SS GR50 Min. with gray primer
- Standard lengths – 6'-0" to 42'-0"
- IAPMO UES ER-0652 and FM Listed
- Tables conform to ANSI/SDI RD-2017

Optional Features

- Inquire regarding cost and lead times for:
 - Short cuts < 6'-0"
 - Sheet Lengths > 42'-0"
 - Alternative metallic and painted finishes

1.5BA-36/1.5BIA-36/1.5PLBA-36 ACOUSTICAL ROOF DECKS GRADE 50 STEEL

ASD

Inward Uniform Allowable Loads, ASD (psf)

Deck Gage	Spans	Criteria	Span (ft-in.)										
			2'-0"	3'-0"	4'-0"	5'-0"	6'-0"	7'-0"	8'-0"	9'-0"	10'-0"	11'-0"	12'-0"
22	Single	W_n / Ω	804	357	201	129	89	66	50	40	32	27	22
		L/240	---	---	152	78	45	28	19	13	10	7	6
	Double	W_n / Ω	750	355	205	133	93	68	53	42	34	28	23
		L/240	---	---	---	---	---	---	52	37	27	20	15
	Triple	W_n / Ω	895	434	253	164	115	85	65	52	42	35	29
		L/240	---	---	---	---	97	61	41	29	21	16	12
20	Single	W_n / Ω	1063	473	266	170	118	87	66	53	43	35	30
		L/240	---	454	192	98	57	36	24	17	12	9	7
	Double	W_n / Ω	948	453	262	170	119	88	67	53	43	36	30
		L/240	---	---	---	---	---	---	64	45	33	24	19
	Triple	W_n / Ω	1127	551	322	210	147	109	84	66	54	45	38
		L/240	---	---	---	204	118	74	50	35	25	19	15
19	Single	W_n / Ω	1262	561	316	202	140	103	79	62	50	42	35
		L/240	---	551	233	119	69	43	29	20	15	11	9
	Double	W_n / Ω	1136	545	316	205	144	106	81	65	52	43	36
		L/240	---	---	---	---	---	---	75	53	39	29	22
	Triple	W_n / Ω	1347	663	388	254	178	132	101	80	65	54	45
		L/240	---	---	---	242	140	88	59	41	30	23	17
18	Single	W_n / Ω	1447	643	362	231	161	118	90	71	58	48	40
		L/240	---	639	269	138	80	50	34	24	17	13	10
	Double	W_n / Ω	1295	622	361	235	164	121	93	74	60	50	42
		L/240	---	---	---	---	---	---	85	60	44	33	25
	Triple	W_n / Ω	1533	756	443	290	204	151	116	92	75	62	52
		L/240	---	---	---	273	158	100	67	47	34	26	20
16	Single	W_n / Ω	1866	829	466	299	207	152	117	92	75	62	52
		L/240	---	---	354	181	105	66	44	31	23	17	13
	Double	W_n / Ω	1631	786	456	297	208	153	118	93	76	63	53
		L/240	---	---	---	---	---	---	107	75	55	41	32
	Triple	W_n / Ω	1929	954	560	366	257	190	147	116	94	78	66
		L/240	---	---	---	345	199	126	84	59	43	32	25

Notes:

1. Table does not account for web crippling. Required bearing should be determined based on specific span conditions.
2. The symbol "----" indicates that the uniform allowable load based on deflection exceeds the allowable load based on stress.

NOTICE: Design defects that could cause injury or death may result from relying on the information in this document without independent verification by a qualified professional. The information in this document is provided "AS IS". Nucor Corporation and its affiliates expressly disclaim: (i) any and all representations, warranties and conditions and (ii) all liability arising out of or related to this document and the information in it.

1.5BA-36/1.5BIA-36/1.5PLBA-36 ACOUSTICAL ROOF DECKS GRADE 80 STEEL

ASD

1.5B ACOUSTICAL ROOF DECKS

- 1.5BA-36 Deck used with Side-lap Screws
- 1.5BIA-36 Deck used with TSWs or BPs
- 1.5PLBA-36 Deck used with PunchLok® II System

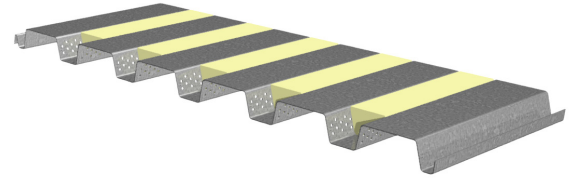

Nominal Dimensions

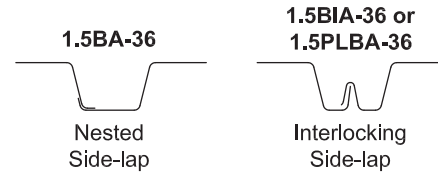
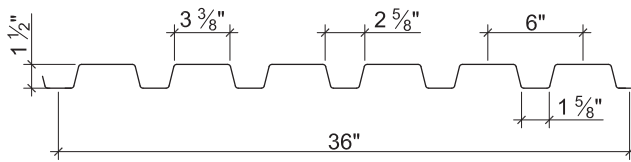

Section Properties

Deck Gage	Deck Weight w_{dd} (psf)	Base Metal Thickness t (in.)	Yield Strength F_y (ksi)	Effective Moment of Inertia at Service Load $I_d = (2I_e + I_g)/3$		Effective Section Modulus at $F_y = 60$ ksi		Allowable Moment		Vertical Web Shear V_n/Ω (lb/ft)
				I_{d+} (in ⁴ /ft)	I_{d-} (in ⁴ /ft)	S_{e+} (in ³ /ft)	S_{e-} (in ³ /ft)	M_{n+}/Ω (lb-ft/ft)	M_{n-}/Ω (lb-ft/ft)	
22	1.5	0.0295	60	0.144	0.166	0.154	0.164	461	491	2409
20	1.9	0.0358	60	0.183	0.206	0.204	0.212	611	635	2904
19	2.2	0.0418	60	0.221	0.241	0.250	0.257	749	769	3370
18	2.5	0.0474	60	0.259	0.276	0.287	0.299	859	895	3799

Allowable Reactions at Supports Based on Web Crippling, R_n/Ω (lb/ft)

Deck Gage	Bearing Length of Webs											
	One-Flange Loading						Two-Flange Loading					
	End Bearing				Interior Bearing		End Bearing				Interior Bearing	
	1 1/2"	2"	3"	4"	3"	4"	1 1/2"	2"	3"	4"	3"	4"
22	940	1033	1190	1299	1771	1915	957	1031	1155	1242	2151	2338
20	1347	1475	1691	1839	2543	2737	1457	1564	1744	1867	3130	3388
19	1794	1961	2240	2426	3395	3639	2029	2173	2413	2573	4215	4544
18	2265	2470	2813	3036	4289	4583	2648	2828	3131	3327	5360	5758

Standard Features

- ASTM A653 SS GR80, with G60 or G90, white or gray primer optional
- ASTM A1008 SS GR80 with gray primer
- Standard lengths – 6'-0" to 42'-0"
- IAPMO UES ER-0652 and FM Listed
- Tables conform to ANSI/SDI RD-2017

Optional Features

- Inquire regarding cost and lead times for:
 - Short cuts < 6'-0"
 - Sheet Lengths > 42'-0"
 - Alternative metallic and painted finishes

1.5BA-36/1.5BIA-36/1.5PLBA-36 ACOUSTICAL ROOF DECKS GRADE 80 STEEL

ASD

Inward Uniform Allowable Loads, ASD (psf)

Deck Gage	Spans	Criteria	Span (ft-in.)										
			2'-0"	3'-0"	4'-0"	5'-0"	6'-0"	7'-0"	8'-0"	9'-0"	10'-0"	11'-0"	12'-0"
22	Single	W_n / Ω	922	410	231	148	102	75	58	46	37	30	26
		L/240	-	350	148	76	44	28	18	13	9	7	5
	Double	W_n / Ω	875	413	238	154	108	79	61	48	39	32	27
		L/240	---	---	---	---	---	76	51	36	26	20	15
	Triple	W_n / Ω	1047	505	293	191	134	99	76	60	49	40	34
		L/240	---	---	---	164	95	60	40	28	21	15	12
20	Single	W_n / Ω	1222	543	305	195	136	100	76	60	49	40	34
		L/240	---	444	187	96	56	35	23	16	12	9	7
	Double	W_n / Ω	1114	530	306	198	139	102	79	62	50	42	35
		L/240	---	---	---	---	---	95	64	45	33	24	19
	Triple	W_n / Ω	1327	646	377	246	172	127	98	78	63	52	44
		L/240	---	---	---	204	118	74	50	35	25	19	15
19	Single	W_n / Ω	1497	665	374	240	166	122	94	74	60	49	42
		L/240	---	537	226	116	67	42	28	20	14	11	8
	Double	W_n / Ω	1337	639	370	240	168	124	95	75	61	51	43
		L/240	---	---	---	---	---	111	74	52	38	29	22
	Triple	W_n / Ω	1587	778	455	297	208	154	119	94	76	63	53
		L/240	---	---	---	239	138	87	58	41	30	22	17
18	Single	W_n / Ω	1719	764	430	275	191	140	107	85	69	57	48
		L/240	---	629	265	136	79	50	33	23	17	13	10
	Double	W_n / Ω	1543	741	429	279	195	144	111	88	71	59	49
		L/240	---	---	---	---	---	127	85	60	44	33	25
	Triple	W_n / Ω	1827	900	528	345	242	179	138	109	89	73	62
		L/240	---	---	---	273	158	100	67	47	34	26	20

Notes:

1. Table does not account for web crippling. Required bearing should be determined based on specific span conditions.
2. The symbol "---" indicates that the uniform allowable load based on deflection exceeds the allowable load based on stress.

NOTICE: Design defects that could cause injury or death may result from relying on the information in this document without independent verification by a qualified professional. The information in this document is provided "AS IS". Nucor Corporation and its affiliates expressly disclaim: (i) any and all representations, warranties and conditions and (ii) all liability arising out of or related to this document and the information in it.

3NLA-32/3NIA-32/3PLNA-32 ACOUSTICAL ROOF DECKS GRADE 50 STEEL

ASD

32" WIDE 3N ACOUSTICAL ROOF DECKS

- 3NLA-32 Deck used with Side-lap Screws
- 3NIA-32 Deck used with TSWs or BPs
- 3PLNA-32 Deck used with PunchLok® II System

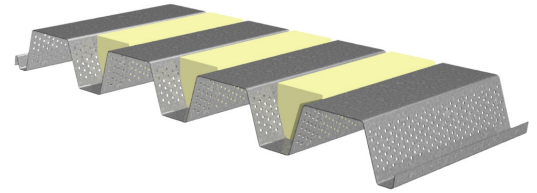

Nominal Dimensions

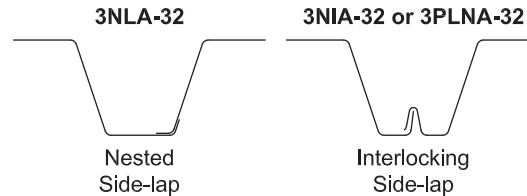
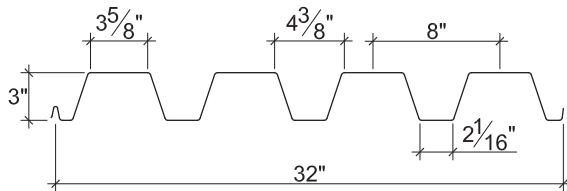

Section Properties

Deck Gage	Deck Weight w_{dd} (psf)	Base Metal Thickness t (in.)	Yield Strength F_y (ksi)	Effective Moment of Inertia at Service Load $I_d = (2I_e + I_g)/3$		Effective Section Modulus at $F_y = 50$ ksi		Allowable Moment		Vertical Web Shear V_n/Ω (lb/ft)
				I_{d+} (in ⁴ /ft)	I_{d-} (in ⁴ /ft)	S_{e+} (in ³ /ft)	S_{e-} (in ³ /ft)	M_{n+}/Ω (lb-ft/ft)	M_{n-}/Ω (lb-ft/ft)	
22	1.7	0.0295	50	0.611	0.680	0.328	0.353	819	881	1632
20	2.1	0.0358	50	0.766	0.842	0.426	0.452	1063	1128	2821
19	2.4	0.0418	50	0.917	1.000	0.526	0.550	1313	1372	3845
18	2.8	0.0474	50	1.067	1.140	0.627	0.641	1565	1599	4948
16	3.5	0.0598	50	1.405	1.448	0.826	0.841	2061	2098	6798

Allowable Reactions at Supports Based on Web Crippling, R_n/Ω (lb/ft)

Deck Gage	Bearing Length of Webs											
	One-Flange Loading						Two-Flange Loading					
	End Bearing				Interior Bearing		End Bearing				Interior Bearing	
	1 1/2"	2"	3"	4"	4"	8"	1 1/2"	2"	3"	4"	4"	8"
22	510	561	645	717	1178	1369	459	495	554	604	1331	1561
20	741	812	931	1031	1688	2090	724	777	866	942	1950	2448
19	997	1089	1244	1375	2246	2827	1031	1103	1225	1328	2635	3370
18	1267	1381	1573	1735	2833	3549	1366	1459	1616	1747	3361	4277
16	1968	2138	2422	2661	4346	5394	2277	2422	2666	2871	5247	6620

Standard Features

- ASTM A653 SS GR50 Min., with G60 or G90, white or gray primer optional
- ASTM A1008 SS GR50 Min. with gray primer
- Standard lengths – 6'-0" to 42'-0"
- IAPMO UES ER-0652 and FM Listed
- Tables conform to ANSI/SDI RD-2017

Optional Features

- Inquire regarding cost and lead times for:
 - Short cuts < 6'-0"
 - Sheet Lengths > 42'-0"
 - Alternative metallic and painted finishes

3NLA-32/3NIA-32/3PLNA-32 ACOUSTICAL ROOF DECKS GRADE 50 STEEL

ASD

Inward Uniform Allowable Loads, ASD (psf)

Deck Gage	Spans	Criteria	Span (ft-in.)										
			4'-0"	6'-0"	8'-0"	9'-0"	10'-0"	11'-0"	12'-0"	14'-0"	16'-0"	18'-0"	20'-0"
22	Single	W_n / Ω	409	182	102	81	65	54	45	33	26	20	16
		L/240	---	---	78	55	40	30	23	15	10	7	5
	Double	W_n / Ω	365	179	104	83	68	57	48	35	27	22	17
		L/240	---	---	---	---	---	---	---	---	26	18	13
	Triple	W_n / Ω	428	215	128	102	84	70	59	44			
		L/240	---	---	---	---	---	63	49	31			
20	Single	W_n / Ω	531	236	133	105	85	70	59	43	33	26	21
		L/240	---	232	98	69	50	38	29	18	12	9	6
	Double	W_n / Ω	504	238	137	109	88	73	62	46	35	28	22
		L/240	---	---	---	---	---	---	---	---	32	23	17
	Triple	W_n / Ω	604	291	169	135	110	91	77	57			
		L/240	---	---	---	---	104	78	60	38			
19	Single	W_n / Ω	656	292	164	130	105	87	73	54	41	32	26
		L/240	---	278	117	82	60	45	35	22	15	10	8
	Double	W_n / Ω	627	292	167	133	108	90	75	56	43	34	27
		L/240	---	---	---	---	---	---	---	---	39	27	20
	Triple	W_n / Ω	756	359	207	165	134	111	94	69			
		L/240	---	---	---	---	124	93	72	45			
18	Single	W_n / Ω	782	348	196	155	125	103	87	64	49	39	31
		L/240	---	324	137	96	70	53	40	25	17	12	9
	Double	W_n / Ω	741	343	196	155	126	105	88	65	50	39	32
		L/240	---	---	---	---	---	---	---	---	44	31	23
	Triple	W_n / Ω	899	423	243	193	157	130	110	81			
		L/240	---	---	---	---	141	106	82	51			
16	Single	W_n / Ω	1031	458	258	204	165	136	115	84	64	51	41
		L/240	---	426	180	126	92	69	53	34	22	16	12
	Double	W_n / Ω	979	452	258	204	166	137	116	85	65	52	42
		L/240	---	---	---	---	---	---	---	83	56	39	29
	Triple	W_n / Ω	1190	557	319	254	206	171	144	106			
		L/240	---	---	---	246	179	135	104	65			

Notes:

1. Table does not account for web crippling. Required bearing should be determined based on specific span conditions.
2. The symbol "----" indicates that the uniform allowable load based on deflection exceeds the allowable load based on stress.

NOTICE: Design defects that could cause injury or death may result from relying on the information in this document without independent verification by a qualified professional. The information in this document is provided "AS IS". Nucor Corporation and its affiliates expressly disclaim: (i) any and all representations, warranties and conditions and (ii) all liability arising out of or related to this document and the information in it.

3NLA-32/3NIA-32/3PLNA-32 ACOUSTICAL ROOF DECKS GRADE 80 STEEL

ASD

32" WIDE 3N ACOUSTICAL ROOF DECKS

- 3NLA-32 Deck used with Side-lap Screws
- 3NIA-32 Deck used with TSWs or BPs
- 3PLNA-32 Deck used with PunchLok® II System

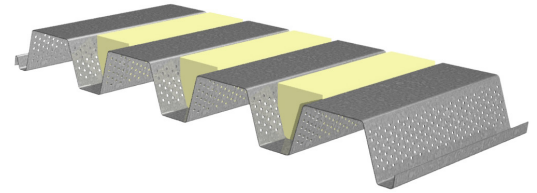

Nominal Dimensions

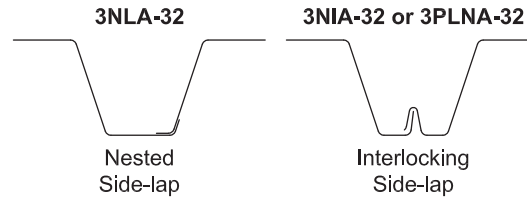
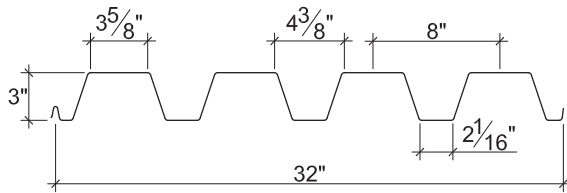

Section Properties

Deck Gage	Deck Weight w_{dd} (psf)	Base Metal Thickness t (in.)	Yield Strength F_y (ksi)	Effective Moment of Inertia at Service Load $I_d = (2I_e + I_g)/3$		Effective Section Modulus at $F_y = 60$ ksi		Allowable Moment		Vertical Web Shear V_n/Ω (lb/ft)
				I_{d+} (in ⁴ /ft)	I_{d-} (in ⁴ /ft)	S_{e+} (in ³ /ft)	S_{e-} (in ³ /ft)	M_{n+}/Ω (lb-ft/ft)	M_{n-}/Ω (lb-ft/ft)	
22	1.7	0.0295	60	0.604	0.672	0.318	0.329	952	985	1632
20	2.1	0.0358	60	0.754	0.832	0.412	0.440	1234	1317	2924
19	2.4	0.0418	60	0.903	0.989	0.509	0.535	1524	1602	4213
18	2.8	0.0474	60	1.048	1.136	0.605	0.626	1811	1874	5420

Allowable Reactions at Supports Based on Web Crippling, R_n/Ω (lb/ft)

Deck Gage	Bearing Length of Webs											
	One-Flange Loading						Two-Flange Loading					
	End Bearing				Interior Bearing		End Bearing				Interior Bearing	
	1 1/2"	2"	3"	4"	4"	8"	1 1/2"	2"	3"	4"	4"	8"
22	612	673	775	860	1413	1643	551	594	665	725	1597	1874
20	889	974	1117	1237	2025	2508	868	932	1040	1130	2340	2938
19	1196	1307	1493	1650	2696	3393	1237	1324	1470	1594	3162	4043
18	1520	1657	1888	2082	3400	4258	1640	1751	1939	2097	4033	5133

Standard Features

- ASTM A653 SS GR80, with G60 or G90, white or gray primer optional
- ASTM A1008 SS GR80 with gray primer
- Standard lengths – 6'-0" to 42'-0"
- IAPMO UES ER-0652 and FM Listed
- Tables conform to ANSI/SDI RD-2017

Optional Features

- Inquire regarding cost and lead times for:
 - Short cuts < 6'-0"
 - Sheet Lengths > 42'-0"
 - Alternative metallic and painted finishes

3NLA-32/3NIA-32/3PLNA-32 ACOUSTICAL ROOF DECKS GRADE 80 STEEL

ASD

Inward Uniform Allowable Loads, ASD (psf)

Deck Gage	Spans	Criteria	Span (ft-in.)										
			4'-0"	6'-0"	8'-0"	9'-0"	10'-0"	11'-0"	12'-0"	14'-0"	16'-0"	18'-0"	20'-0"
22	Single	W_n / Ω	476	212	119	94	76	63	53	39	30	24	19
		L/240	---	183	77	54	40	30	23	14	10	7	5
	Double	W_n / Ω	393	196	115	92	75	63	53	39	30	24	19
		L/240	---	---	---	---	---	---	---	39	26	18	13
	Triple	W_n / Ω	456	234	140	113	93	77	65	49			
		L/240	---	---	---	---	83	62	48	30			
20	Single	W_n / Ω	617	274	154	122	99	82	69	50	39	30	25
		L/240	---	229	97	68	49	37	29	18	12	8	6
	Double	W_n / Ω	574	274	159	126	103	85	72	53	41	32	26
		L/240	---	---	---	---	---	---	---	48	32	23	16
	Triple	W_n / Ω	682	334	195	156	127	106	89	66			
		L/240	---	---	---	141	103	77	60	38			
19	Single	W_n / Ω	762	339	190	151	122	101	85	62	48	38	30
		L/240	---	274	116	81	59	44	34	22	14	10	7
	Double	W_n / Ω	723	339	195	155	126	104	88	65	50	39	32
		L/240	---	---	---	---	---	---	---	57	38	27	20
	Triple	W_n / Ω	870	416	241	192	156	130	109	81			
		L/240	---	---	239	168	122	92	71	45			
18	Single	W_n / Ω	906	403	226	179	145	120	101	74	57	45	36
		L/240	---	318	134	94	69	52	40	25	17	12	9
	Double	W_n / Ω	860	400	229	182	148	122	103	76	58	46	37
		L/240	---	---	---	---	---	---	---	65	44	31	22
	Triple	W_n / Ω	1040	492	283	225	184	152	128	95			
		L/240	---	---	275	193	141	106	81	51			

Notes:

1. Table does not account for web crippling. Required bearing should be determined based on specific span conditions.
2. The symbol "---" indicates that the uniform allowable load based on deflection exceeds the allowable load based on stress.

NOTICE: Design defects that could cause injury or death may result from relying on the information in this document without independent verification by a qualified professional. The information in this document is provided "AS IS". Nucor Corporation and its affiliates expressly disclaim: (i) any and all representations, warranties and conditions and (ii) all liability arising out of or related to this document and the information in it.

3NA-24/3NIA-24 ACOUSTICAL ROOF DECKS GRADE 40 STEEL

ASD

24" WIDE 3N ACOUSTICAL ROOF DECKS

- 3NA-24 Deck used with Side-lap Screws
- 3NIA-24 Deck used with TSWs or BPs

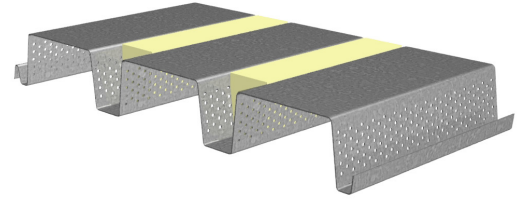

Nominal Dimensions

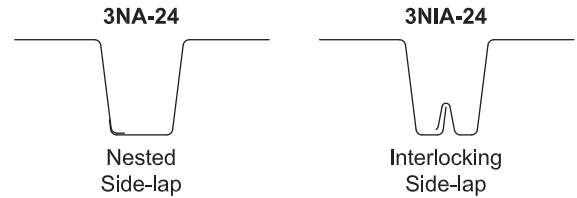
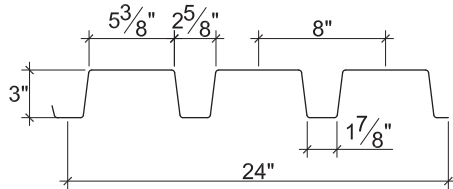

Section Properties

Deck Gage	Deck Weight w_{dd} (psf)	Base Metal Thickness t (in.)	Yield Strength F_y (ksi)	Effective Moment of Inertia at Service Load $I_d = (2I_e + I_g)/3$		Effective Section Modulus at $F_y = 40$ ksi		Allowable Moment		Vertical Web Shear V_n/Ω (lb/ft)
				I_{d+} (in ⁴ /ft)	I_{d-} (in ⁴ /ft)	S_{e+} (in ³ /ft)	S_{e-} (in ³ /ft)	M_{n+}/Ω (lb-ft/ft)	M_{n-}/Ω (lb-ft/ft)	
22	1.9	0.0295	40	0.679	0.826	0.349	0.398	696	795	1816
20	2.4	0.0358	40	0.856	1.017	0.458	0.503	914	1004	2673
19	2.8	0.0418	40	1.033	1.189	0.555	0.605	1108	1208	3641
18	3.1	0.0474	40	1.204	1.350	0.640	0.695	1277	1387	4266
16	3.9	0.0598	40	1.598	1.705	0.832	0.887	1660	1771	5346

Allowable Reactions at Supports Based on Web Crippling, R_n/Ω (lb/ft)

Deck Gage	Bearing Length of Webs											
	One-Flange Loading						Two-Flange Loading					
	End Bearing				Interior Bearing		End Bearing				Interior Bearing	
	1 1/2"	2"	3"	4"	4"	8"	1 1/2"	2"	3"	4"	4"	8"
22	440	483	556	618	1007	1171	400	431	483	526	1144	1343
20	638	699	801	887	1442	1786	628	674	752	817	1675	2103
19	857	937	1070	1183	1920	2417	893	956	1061	1150	2263	2893
18	1088	1187	1352	1491	2421	3032	1181	1262	1397	1511	2883	3670
16	1688	1834	2077	2283	3710	4603	1963	2088	2298	2475	4494	5671

Standard Features

- ASTM A653 SS GR40 Min., with G60 or G90, white or gray primer optional
- ASTM A1008 SS GR40 Min. with gray primer
- Standard lengths – 6'-0" to 42'-0"
- IAPMO UES ER-0652 and FM Listed
- Tables conform to ANSI/SDI RD-2017

Optional Features

- Inquire regarding cost and lead times for:
 - Short cuts < 6'-0"
 - Sheet Lengths > 42'-0"
 - Alternative metallic and painted finishes

3NA-24/3NIA-24 ACOUSTICAL ROOF DECKS GRADE 40 STEEL

ASD

Inward Uniform Allowable Loads, ASD (psf)

Deck Gage	Spans	Criteria	Span (ft-in.)										
			4'-0"	6'-0"	8'-0"	9'-0"	10'-0"	11'-0"	12'-0"	14'-0"	16'-0"	18'-0"	20'-0"
22	Single	W_n / Ω	348	155	87	69	56	46	39	28	22	17	14
		L/240	---	---	87	61	45	33	26	16	11	8	6
	Double	W_n / Ω	349	166	96	76	62	52	43	32	25	19	16
		L/240	---	---	---	---	---	---	---	---	---	---	---
	Triple	W_n / Ω	415	202	118	94	77	64	54	40			
		L/240	---	---	---	---	---	---	---	37			
20	Single	W_n / Ω	457	203	114	90	73	60	51	37	29	23	18
		L/240	---	---	110	77	56	42	32	20	14	10	7
	Double	W_n / Ω	454	213	122	97	79	65	55	41	31	25	20
		L/240	---	---	---	---	---	---	---	---	---	---	---
	Triple	W_n / Ω	547	261	151	120	98	81	69	51			
		L/240	---	---	---	---	---	---	---	46			
19	Single	W_n / Ω	554	246	138	109	89	73	62	45	35	27	22
		L/240	---	---	132	93	68	51	39	25	17	12	8
	Double	W_n / Ω	558	259	148	117	95	79	66	49	38	30	24
		L/240	---	---	---	---	---	---	---	---	---	---	23
	Triple	W_n / Ω	676	318	183	146	118	98	83	61			
		L/240	---	---	---	---	---	---	---	54			
18	Single	W_n / Ω	639	284	160	126	102	84	71	52	40	32	26
		L/240	---	---	154	108	79	59	46	29	19	14	10
	Double	W_n / Ω	643	298	170	135	110	91	76	56	43	34	28
		L/240	---	---	---	---	---	---	---	---	---	---	27
	Triple	W_n / Ω	779	366	211	167	136	113	95	70			
		L/240	---	---	---	---	---	---	---	61			
16	Single	W_n / Ω	830	369	208	164	133	110	92	68	52	41	33
		L/240	---	---	205	144	105	79	61	38	26	18	13
	Double	W_n / Ω	818	379	217	172	140	116	97	72	55	44	35
		L/240	---	---	---	---	---	---	---	---	---	---	34
	Triple	W_n / Ω	991	467	269	213	174	144	121	89			
		L/240	---	---	---	---	---	---	---	77			

Notes:

1. Table does not account for web crippling. Required bearing should be determined based on specific span conditions.
2. The symbol "----" indicates that the uniform allowable load based on deflection exceeds the allowable load based on stress.

NOTICE: Design defects that could cause injury or death may result from relying on the information in this document without independent verification by a qualified professional. The information in this document is provided "AS IS". Nucor Corporation and its affiliates expressly disclaim: (i) any and all representations, warranties and conditions and (ii) all liability arising out of or related to this document and the information in it.

COMPOSITE DECK

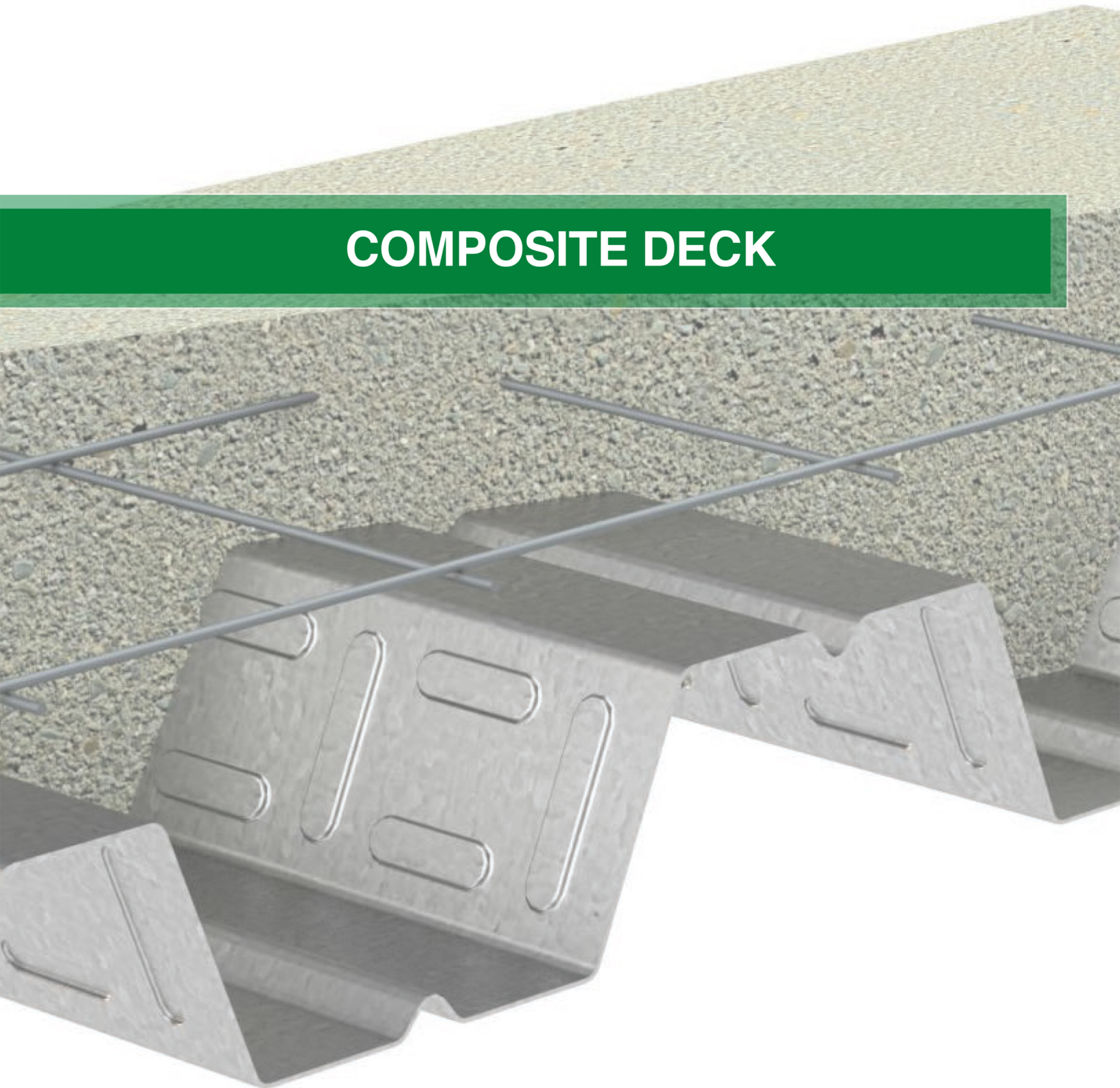

2.0D FORMLOK DOVETAIL DECK

- Enhanced 2-Coat Polyester Paint
- White Factory Primer Paint
- Galvanized Finish
- UL Listed

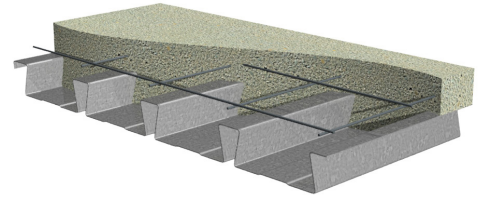

Nominal Dimensions

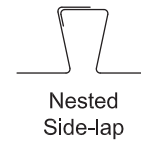
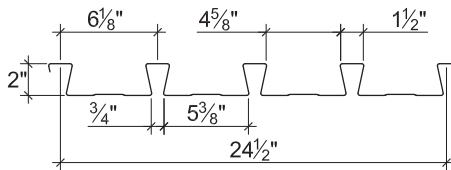

Section Properties

Deck Gage	Deck Weight w_{dd} (psf)	Base Metal Thickness t (in.)	Yield Strength F_y (ksi)	Effective Moment of Inertia at Service Load $I_d = (2I_e + I_g)/3$		Effective Section Modulus at $F_y = 40$ ksi		Allowable Moment		Vertical Web Shear V_n/Ω (lb/ft)
				I_{d+} (in ⁴ /ft)	I_{d-} (in ⁴ /ft)	S_{e+} (in ³ /ft)	S_{e-} (in ³ /ft)	M_{n+}/Ω (lb-ft/ft)	M_{n-}/Ω (lb-ft/ft)	
22	2.1	0.0295	40	0.387	0.359	0.272	0.272	543	543	2896
20	2.6	0.0358	40	0.472	0.447	0.343	0.334	684	666	3498
18	3.4	0.0474	40	0.626	0.612	0.463	0.450	924	898	4584
16	4.3	0.0598	40	0.792	0.791	0.587	0.576	1172	1150	5723

Allowable Reactions at Supports Based on Web Crippling, R_n/Ω (lb/ft)

Deck Gage	Bearing Length of Webs											
	One-Flange Loading						Two-Flange Loading					
	End Bearing				Interior Bearing		End Bearing				Interior Bearing	
	1 1/2"	2"	3"	4"	3"	5"	1 1/2"	2"	3"	4"	3"	5"
22	653	717	826	917	1281	1516	702	757	848	925	1567	1877
20	931	1020	1170	1296	1823	2146	1058	1136	1266	1376	2258	2690
18	1556	1697	1933	2132	3036	3544	1893	2023	2239	2422	3813	4507
16	2378	2582	2926	3215	4629	5360	3043	3237	3563	3837	5866	6880

Standard Features

- ASTM A653 SS GR 40 Min. with G90
- Standard lengths – 6'-0" to 42'-0"
- Tables conform to ANSI/SDI C-2017
- IAPMO UES ER-423 and UL Listed

Optional Features

- Inquire regarding cost and lead times for:
 - 19 gage
 - Short cuts < 6'-0"
 - Alternative metallic and painted finishes

2.0D FORMLOK® DOVETAIL DECK-SLAB NORMAL WEIGHT CONCRETE (145 pcf)

ASD

Slab Depth		Maximum Unshored Spans			Composite Deck-Slab Properties				
		Deck Gage	Maximum Unshored Construction Clear Span			Concrete + Deck (psf)	Deflection $I_d = (I_{cr} + I_u)/2$ (in ⁴ /ft)	Moment M_{no}/Ω (kip-ft/ft)	Shear V_{no}/Ω (kip/ft)
Total	Topping		1	2	3				
4"	2"	22	6'-10"	7'-11"	8'-1"	46.0	5.75	3.44	3.97
		20	7'-11"	8'-9"	9'-0"	46.5	6.16	4.09	3.97
		18	9'-6"	10'-1"	10'-5"	47.3	6.85	5.22	3.97
		16	10'-11"	11'-4"	11'-9"	48.2	7.50	6.38	3.97
5¼"	¾"	22	6'-3"	7'-2"	7'-4"	61.1	12.19	4.44	5.21
		20	7'-2"	7'-11"	8'-2"	61.6	13.03	5.29	5.21
		18	8'-7"	9'-2"	9'-5"	62.4	14.42	6.79	5.21
		16	9'-10"	10'-4"	10'-8"	63.3	15.75	8.32	5.21
5½"	¾"	22	6'-1"	7'-0"	7'-2"	64.1	13.87	4.64	5.38
		20	7'-1"	7'-9"	8'-0"	64.6	14.81	5.53	5.46
		18	8'-5"	9'-0"	9'-3"	65.4	16.39	7.11	5.46
		16	9'-8"	10'-1"	10'-6"	66.3	17.90	8.73	5.46

Note:

1. Maximum unshored spans do not consider web-crippling. Required bearing should be determined based on specific span conditions.

Total Slab Depth		Deck Gage	Superimposed Allowable Load, W_n/Ω , Limited by L/360 (psf)								NWC (145 pcf), $f'_c = 3000$ psi
			Span (ft.-in.)								
			10'-0"	11'-0"	12'-0"	13'-0"	14'-0"	15'-0"	16'-0"	18'-0"	20'-0"
4"	22		229	181	145	114	91	74	61	39	22
	20		269	202	155	122	98	79	65	46	33
	18		299	224	173	136	109	88	73	51	37
	16		327	246	189	149	119	97	80	56	40
5¼"	22		293	232	185	148	119	96	77	48	27
	20		361	288	232	188	154	126	103	68	44
	18		480	386	314	258	214	178	149	105	73
	16		602	487	398	313	250	203	168	118	86
5½"	22		307	242	193	155	125	100	80	50	28
	20		378	301	242	197	161	132	108	71	46
	18		503	404	329	271	224	187	156	110	76
	16		631	510	418	346	285	231	190	134	97

Notes:

1. For high loads long term concrete creep should be considered.
2. See Composite Deck-Slab Strength Web Based Solutions for alternate slabs or LRFD design.

2.0D FORMLOK® DOVETAIL DECK-SLAB LIGHT WEIGHT CONCRETE (110 pcf)

ASD

Slab Depth		Maximum Unshored Spans			Composite Deck-Slab Properties				
		Deck Gage	Maximum Unshored Construction Clear Span			Concrete + Deck (psf)	Deflection $I_d = (I_{cr} + I_u)/2$ (in ⁴ /ft)	Moment M_{no}/Ω (kip-ft/ft)	Shear V_{no}/Ω (kip/ft)
Total	Topping		1	2	3				
4"	2"	22	7'-6"	8'-8"	8'-10"	35.4	4.43	3.30	3.97
		20	8'-8"	9'-7"	9'-11"	35.9	4.79	3.90	3.97
		18	10'-6"	11'-0"	11'-5"	36.7	5.36	4.96	3.97
		16	11'-10"	12'-5"	12'-10"	37.6	5.89	6.02	3.97
4½"	2½"	22	7'-2"	8'-4"	8'-6"	40.0	6.11	3.68	4.32
		20	8'-4"	9'-3"	9'-6"	40.5	6.59	4.36	4.47
		18	10'-1"	10'-8"	11'-0"	41.3	7.36	5.55	4.47
		16	11'-6"	11'-11"	12'-4"	42.2	8.09	6.76	4.47
5¼"	3¼"	22	6'-10"	7'-11"	8'-1"	46.9	9.33	4.27	4.60
		20	7'-11"	8'-9"	9'-0"	47.4	10.04	5.08	5.15
		18	9'-6"	10'-1"	10'-5"	48.2	11.21	6.48	5.21
		16	10'-11"	11'-4"	11'-9"	49.1	12.30	7.91	5.21

Note:

- Maximum unshored spans do not consider web-crippling. Required bearing should be determined based on specific span conditions.

Total Slab Depth		Deck Gage	Superimposed Allowable Load, W_n/Ω , Limited by L/360 (psf)								LWC (110 pcf), $f'_c = 3000$ psi
			Span (ft-in.)								
			10'-0"	11'-0"	12'-0"	13'-0"	14'-0"	15'-0"	16'-0"	18'-0"	20'-0"
4"	22		193	145	112	88	70	57	47	33	24
	20		209	157	121	95	76	61	51	35	26
	18		234	175	135	106	85	69	57	40	29
	16		257	193	149	117	93	76	62	44	32
4½"	22		254	200	154	121	97	79	65	45	33
	20		287	216	166	131	104	85	70	49	35
	18		321	241	186	146	117	95	78	55	40
	16		353	265	204	160	128	104	86	60	44
5¼"	22		294	235	190	155	127	105	86	58	38
	20		358	288	234	192	159	130	107	75	54
	18		470	367	283	222	178	145	119	83	61
	16		537	403	311	244	195	159	131	92	67

Notes:

- For high loads long term concrete creep should be considered.
- See Composite Deck-Slab Strength Web Based Solutions for alternate slabs or LRFD design.

2.0D FORMLOK® DOVETAIL DECK-SLAB

ASD

2.0D FormLok Deck-Slab Information

$f'_c = 3000$ psi

Total Slab Depth (in.)	Cover Depth (in.)	Theoretical Concrete Volume (yd ³ /100 ft ²)	Min. A _s for T&S (in. ²)	Recommended Reinforcing for Temperature and Shrinkage	
				WWR	(OR) Bekaert Dramix® Steel Fiber Alternate to WWR (lb/yd ³)
					4D 65/60BG
Normal Weight Concrete (145 pcf)					
4	2	1.12	0.028	6x6-W1.4xW1.4	23
4½	2½	1.28	0.028	6x6-W1.4xW1.4	18
4¾	2¾	1.35	0.028	6x6-W1.4xW1.4	16
5	3	1.43	0.028	6x6-W1.4xW1.4	15
5¼	3¼	1.51	0.029	6x6-W2.1xW2.1	15
5½	3½	1.58	0.032	6x6-W2.1xW2.1	15
6	4	1.74	0.036	6x6-W2.1xW2.1	15
6¾	4¾	1.97	0.043	6x6-W2.9xW2.9	15
Light Weight Concrete (110 pcf)					
4	2	1.12	0.028	6X6-W1.4xW1.4	33
4½	2½	1.28	0.028	6x6-W1.4xW1.4	25
5	3	1.43	0.028	6x6-W1.4xW1.4	20
5¼	3¼	1.51	0.029	6x6-W2.1xW2.1	20
5½	3½	1.58	0.032	6x6-W2.1xW2.1	20
6	4	1.74	0.036	6x6-W2.1xW2.1	20

Notes:

1. FRC reinforcement is based on IAPMO UES ER-465.
2. Dramix® fibers may be used in UL or ULC fire rated assemblies in lieu of WWR. See UL file R19307 for additional information.

For information on Bekaert Dramix® fibers contact 770-514-2295 or infobuilding@bekaert.com.

NOTICE: Design defects that could cause injury or death may result from relying on the information in this document without independent verification by a qualified professional. The information in this document is provided "AS IS". Nucor Corporation and its affiliates expressly disclaim: (i) any and all representations, warranties and conditions and (ii) all liability arising out of or related to this document and the information in it. DRAMIX is a registered trademark of Bekaert.

3.5D FORMLOK DOVETAIL DECK

- Enhanced 2-Coat Polyester Paint
- White Factory Primer Paint
- Galvanized Finish
- UL Listed

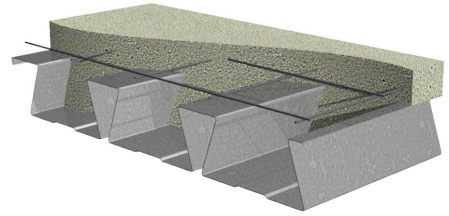

Nominal Dimensions

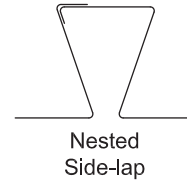
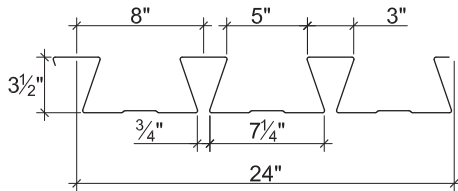

Section Properties

Deck Gage	Deck Weight w_{dd} (psf)	Base Metal Thickness t (in.)	Yield Strength F_y (ksi)	Effective Moment of Inertia at Service Load $I_d = (2I_e + I_g)/3$		Effective Section Modulus at $F_y = 40$ ksi		Allowable Moment		Vertical Web Shear V_n/Ω (lb/ft)
				I_{d+} (in ⁴ /ft)	I_{d-} (in ⁴ /ft)	S_{e+} (in ³ /ft)	S_{e-} (in ³ /ft)	M_{n+}/Ω (lb-ft/ft)	M_{n-}/Ω (lb-ft/ft)	
20	3.3	0.0358	40	1.762	1.646	0.676	0.781	1349	1559	3435
18	4.3	0.0474	40	2.415	2.272	0.980	1.070	1956	2136	6012
16	5.4	0.0598	40	3.133	2.968	1.317	1.377	2629	2749	8313

Allowable Reactions at Supports Based on Web Crippling, R_n/Ω (lb/ft)

Deck Gage	Bearing Length of Webs											
	One-Flange Loading						Two-Flange Loading					
	End Bearing				Interior Bearing		End Bearing				Interior Bearing	
	2"	3"	4"	5"	4"	6"	2"	3"	4"	5"	4"	6"
20	693	794	880	955	1459	1670	714	796	865	926	1724	1991
18	1168	1330	1467	1588	2422	2753	1310	1450	1568	1672	2927	3360
16	1793	2032	2233	2410	3681	4162	2137	2352	2533	2693	4515	5157

Standard Features

- ASTM A653 SS GR 40 Min. with G90
- Standard lengths – 6'-0" to 42'-0"
- Tables conform to ANSI/SDI C-2017
- IAPMO UES ER-423 and UL Listed

Optional Features

- Inquire regarding cost and lead times for:
 - 19 gage
 - Short cuts < 6'-0"
 - Alternative metallic and painted finishes

3.5D FORMLOK® DOVETAIL DECK-SLAB NORMAL WEIGHT CONCRETE (145 pcf)

ASD

		Maximum Unshored Spans			Composite Deck-Slab Properties				
Slab Depth	Deck Gage	Maximum Unshored Construction Clear Span			Concrete + Deck (psf)	Deflection $I_d = (I_{cr} + I_u)/2$ (in ⁴ /ft)	Moment M_{no}/Ω (kip-ft/ft)	Shear V_{no}/Ω (kip/ft)	
		1	2	3					
5½"	2"	20	10'-11"	12'-2"	12'-7"	59.9	14.40	6.87	4.52
		18	13'-6"	14'-3"	14'-8"	60.9	15.99	8.74	4.52
		16	14'-9"	16'-1"	16'-7"	62.0	17.61	10.32	4.52
5¾"	2¼"	20	10'-9"	11'-11"	12'-4"	62.9	16.27	7.13	4.72
		18	13'-3"	14'-0"	14'-5"	63.9	18.03	9.13	4.72
		16	14'-7"	15'-9"	16'-4"	65.0	19.75	11.10	4.72
6"	2½"	20	10'-6"	11'-9"	12'-1"	65.9	18.29	7.39	4.93
		18	13'-0"	13'-9"	14'-2"	66.9	20.24	9.47	4.93
		16	14'-5"	15'-6"	16'-0"	68.0	22.14	11.59	4.93

Note:

- Maximum unshored spans do not consider web-crippling. Required bearing should be determined based on specific span conditions.

Superimposed Allowable Load, W_n/Ω , Limited by L/360 (psf)

NWC (145 pcf), $f'_c = 3000$ psi

Total Slab Depth	Deck Gage	Span (ft.-in.)								
		15'-0"	16'-0"	17'-0"	18'-0"	19'-0"	20'-0"	21'-0"	23'-0"	25'-0"
5½"	20	184	153	128	107	91	77	64	44	28
	18	207	170	142	119	101	87	75	57	44
	16	228	187	156	131	112	96	83	63	49
5¾"	20	190	159	134	113	95	79	66	44	28
	18	233	192	160	135	114	98	85	64	50
	16	255	210	175	147	125	107	93	70	55
6"	20	196	165	138	116	97	81	68	45	28
	18	262	215	180	151	128	110	95	72	54
	16	286	236	196	165	141	120	104	79	61

Notes:

- For high loads long term concrete creep should be considered.
- See Composite Deck-Slab Strength Web Based Solutions for alternate slabs or LRFD design.

3.5D FORMLOK® DOVETAIL DECK-SLAB LIGHT WEIGHT CONCRETE (110 pcf)

ASD

		Maximum Unshored Spans			Composite Deck-Slab Properties				
Slab Depth Total	Topping	Deck Gage	Maximum Unshored Construction Clear Span			Concrete + Deck (psf)	Deflection $I_d = (I_{cr} + I_u)/2$ (in ⁴ /ft)	Moment M_{no}/Ω (kip-ft/ft)	Shear V_{no}/Ω (kip/ft)
			1	2	3				
5½"	2"	20	12'-2"	13'-5"	13'-10"	46.2	11.18	6.37	4.52
		18	14'-10"	15'-8"	16'-2"	47.2	12.69	7.86	4.52
		16	15'-9"	17'-8"	18'-2"	48.3	14.26	9.44	4.52
5¾"	2¼"	20	11'-11"	13'-2"	13'-8"	48.5	12.57	6.81	4.72
		18	14'-8"	15'-5"	15'-11"	49.5	14.13	8.35	4.72
		16	15'-7"	17'-4"	17'-11"	50.6	15.75	9.88	4.72
8"	4½"	20	10'-5"	11'-7"	12'-0"	69.1	31.09	9.31	5.61
		18	12'-10"	13'-7"	14'-0"	70.1	34.56	11.92	6.57
		16	14'-4"	15'-4"	15'-10"	71.2	37.85	14.57	6.57

Note:

- Maximum unshored spans do not consider web-crippling. Required bearing should be determined based on specific span conditions.

Superimposed Allowable Load, W_n/Ω , Limited by L/360 (psf)

LWC (110 pcf), $f'_c = 3000$ psi

Total Slab Depth	Deck Gage	Span (ft.-in.)								
		15'-0"	16'-0"	17'-0"	18'-0"	19'-0"	20'-0"	21'-0"	23'-0"	25'-0"
5½"	20	144	119	99	83	71	61	52	40	31
	18	164	135	112	95	80	69	59	45	35
	16	184	152	126	106	90	77	67	51	39
5¾"	20	162	134	111	94	80	68	59	45	35
	18	182	150	125	105	90	77	66	50	39
	16	203	168	140	118	100	86	74	56	44
8"	20	262	221	188	160	137	117	99	71	50
	18	353	302	259	224	194	168	146	110	82
	16	446	384	332	283	241	206	178	135	105

Notes:

- For high loads long term concrete creep should be considered.
- See Composite Deck-Slab Strength Web Based Solutions for alternate slabs or LRFD design.

3.5D FORMLOK® DOVETAIL DECK-SLAB

ASD

3.5D FormLok Deck-Slab Information

$f'_c = 3000$ psi

Total Slab Depth (in.)	Cover Depth (in.)	Theoretical Concrete Volume (yd ³ /100 ft ²)	Min. A _s for T&S (in. ²)	Recommended Reinforcing for Temperature and Shrinkage	
				WWR	(OR) Bekaert Dramix® Steel Fiber Alternate to WWR (lb/yd ³)
Normal Weight Concrete (145 pcf)					
5½	2	1.44	0.028	6x6-W1.4xW1.4	23
5¾	2¼	1.52	0.028	6x6-W1.4xW1.4	20
6	2½	1.60	0.028	6x6-W1.4xW1.4	18
6½	3	1.75	0.028	6x6-W1.4xW1.4	15
7	3½	1.91	0.032	6x6-W2.1xW2.1	15
7¼	3¾	1.98	0.034	6x6-W2.1xW2.1	15
7½	4	2.06	0.036	6x6-W2.1xW2.1	15
8	4½	2.22	0.041	6x6-W2.1xW2.1	15
Light Weight Concrete (110 pcf)					
5½	2	1.44	0.028	6x6-W1.4xW1.4	33
5¾	2¼	1.52	0.028	6x6-W1.4xW1.4	28
6	2½	1.60	0.028	6x6-W1.4xW1.4	25
6½	3	1.75	0.028	6x6-W1.4xW1.4	20
7	3½	1.91	0.032	6x6-W2.1xW2.1	20
7½	4	2.06	0.036	6x6-W2.1xW2.1	20
8	4½	2.22	0.041	6x6-W2.1xW2.1	20

Notes:

1. FRC reinforcement is based on IAPMO UES ER-465.
2. Dramix® fibers may be used in UL or ULC fire rated assemblies in lieu of WWR. See UL file R19307 for additional information.

For information on Bekaert Dramix® fibers contact 770-514-2295 or infobuilding@bekaert.com.

NOTICE: Design defects that could cause injury or death may result from relying on the information in this document without independent verification by a qualified professional. The information in this document is provided "AS IS". Nucor Corporation and its affiliates expressly disclaim: (i) any and all representations, warranties and conditions and (ii) all liability arising out of or related to this document and the information in it. DRAMIX is a registered trademark of Bekaert.

1.5VL-36/1.5VLI-36/1.5PLVLI-36 COMPOSITE DECKS GRADE 50 STEEL

ASD

1.5VL COMPOSITE DECKS

- 1.5VL-36 Deck used with Side-lap Screws
- 1.5VLI-36 Deck used with TSWs or BPs
- 1.5PLVLI-36 Deck used with PunchLok® II System

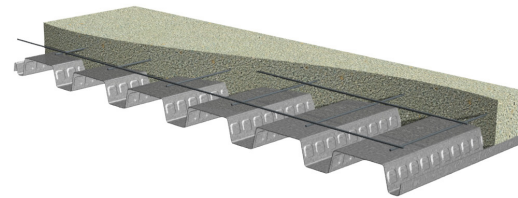

Nominal Dimensions

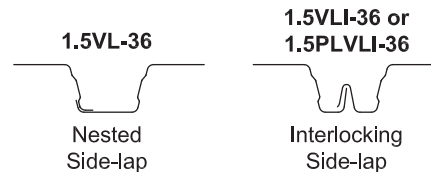
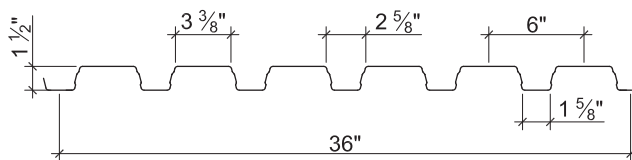

Section Properties

Deck Gage	Deck Weight w_{dd} (psf)	Base Metal Thickness t (in.)	Yield Strength F_y (ksi)	Effective Moment of Inertia at Service Load $I_d = (2I_e + I_p)/3$		Effective Section Modulus at $F_y = 50$ ksi		Allowable Moment		Vertical Web Shear V_n/Ω (lb/ft)
				I_{d+} (in ⁴ /ft)	I_{d-} (in ⁴ /ft)	S_{e+} (in ³ /ft)	S_{e-} (in ³ /ft)	M_{n+}/Ω (lb-ft/ft)	M_{n-}/Ω (lb-ft/ft)	
22	1.6	0.0295	50	0.155	0.178	0.169	0.179	422	447	2654
20	2.0	0.0358	50	0.197	0.217	0.224	0.229	559	571	3207
19	2.3	0.0418	50	0.239	0.257	0.266	0.278	663	693	3728
18	2.6	0.0474	50	0.277	0.290	0.306	0.318	763	793	4209
16	3.3	0.0598	50	0.364	0.367	0.393	0.402	981	1003	5261

Allowable Reactions at Supports Based on Web Crippling, R_n/Ω (lb/ft)

Deck Gage	Bearing Length of Webs											
	One-Flange Loading						Two-Flange Loading					
	End Bearing				Interior Bearing		End Bearing				Interior Bearing	
	1 1/2"	2"	3"	4"	3"	4"	1 1/2"	2"	3"	4"	3"	4"
22	807	887	1021	1115	1482	1602	842	908	1017	1093	1834	1994
20	1153	1263	1448	1574	2127	2289	1274	1368	1525	1632	2662	2881
19	1532	1674	1913	2071	2839	3043	1766	1891	2100	2239	3579	3859
18	1931	2105	2398	2588	3586	3831	2297	2454	2716	2887	4546	4884
16	2958	3212	3639	3900	5517	5855	3713	3950	4347	4590	7050	7523

Standard Features

- ASTM A653 SS GR50 Min., with G60 or G90, white or gray primer bottom optional
- ASTM A1008 SS GR50 Min. with gray primer bottom
- Standard lengths – 6'-0" to 42'-0"
- IAPMO UES ER-0652 and UL Listed
- Tables conform to ANSI/SDI C-2017

Optional Features

- Inquire regarding cost and lead times for:
 - Short cuts < 6'-0"
 - Sheet Lengths > 42'-0"
 - Alternative metallic and painted finishes
- Factory Hanger Tabs

1.5VL-36/1.5VLI-36/1.5PLVLI-36 COMPOSITE DECK-SLABS

NORMAL WEIGHT CONCRETE (145 pcf)

ASD

			Maximum Unshored Spans			Composite Deck-Slab Properties			
Slab Depth		Deck Gage	Maximum Unshored Construction Clear Span			Concrete + Deck (psf)	Deflection $I_d = (I_{cr} + I_u)/2$ (in ⁴ /ft)	Moment M_{no}/Ω (kip-ft/ft)	Shear V_{no}/Ω (kip/ft)
Total	Topping		1	2	3				
3½"	2"	22	6'-5"	7'-6"	7'-8"	32.2	2.64	1.84	2.01
		20	7'-9"	9'-1"	9'-2"	32.6	2.85	2.16	2.01
		19	8'-4"	9'-11"	10'-3"	32.9	3.03	2.47	2.01
		18	8'-9"	10'-7"	11'-0"	33.2	3.19	2.74	2.01
		16	9'-6"	11'-10"	11'-8"	33.9	3.52	3.30	2.01
5"	3½"	22	5'-7"	6'-7"	6'-8"	50.3	7.62	3.22	3.29
		20	6'-9"	7'-10"	7'-11"	50.7	8.18	3.83	3.29
		19	7'-3"	8'-8"	8'-10"	51.0	8.68	4.40	3.29
		18	7'-8"	9'-3"	9'-6"	51.3	9.12	4.90	3.29
		16	8'-4"	10'-4"	10'-4"	52.0	10.02	6.00	3.29
6"	4½"	22	5'-3"	6'-1"	6'-2"	62.4	13.11	4.24	4.27
		20	6'-3"	7'-3"	7'-5"	62.8	14.02	5.05	4.27
		19	6'-10"	8'-0"	8'-2"	63.1	14.85	5.81	4.27
		18	7'-2"	8'-7"	8'-10"	63.4	15.57	6.50	4.27
		16	7'-10"	9'-7"	9'-8"	64.1	17.06	7.98	4.27

Note:

1. Maximum unshored spans do not consider web-crippling. Required bearing should be determined based on specific span conditions.

Superimposed Allowable Load, W_n/Ω , Limited by L/360 (psf) NWC (145 pcf), $f'_c = 3000$ psi

Total Slab Depth	Deck Gage	Span (ft-in.)								
		4'-0"	5'-0"	6'-0"	7'-0"	8'-0"	9'-0"	10'-0"	11'-0"	12'-0"
3½"	22	886	555	375	267	197	149	114	86	66
	20	974	659	448	320	237	170	124	93	72
	19	974	757	515	370	258	181	132	99	76
	18	974	772	574	406	272	191	139	104	80
	16	973	771	637	448	300	210	153	115	88
5"	22	1560	980	665	475	352	267	207	162	128
	20	1593	1174	800	574	427	327	255	202	161
	19	1592	1264	925	666	498	383	300	239	193
	18	1592	1263	1038	749	561	433	341	272	221
	16	1591	1263	1043	887	697	540	427	329	253
6"	22	2055	1292	878	629	467	355	276	217	172
	20	2074	1552	1058	761	568	435	341	270	217
	19	2073	1646	1228	885	663	510	401	321	259
	18	2073	1646	1361	997	749	578	456	366	297
	16	2072	1645	1360	1156	933	724	574	463	379

Notes:

- For high loads long term concrete creep should be considered.
- See Composite Deck-Slab Strength Web Based Solutions for alternate slabs or LRFD design.

1.5VL-36/1.5VLI-36/1.5PLVLI-36 COMPOSITE DECK-SLABS LIGHT WEIGHT CONCRETE (110 pcf)

ASD

			Maximum Unshored Spans			Composite Deck-Slab Properties			
Slab Depth		Deck Gage	Maximum Unshored Construction Clear Span			Concrete + Deck (psf)	Deflection $I_d = (I_{cr} + I_u)/2$ (in ⁴ /ft)	Moment M_{no}/Ω (kip-ft/ft)	Shear V_{no}/Ω (kip/ft)
Total	Topping		1	2	3				
3½"	2"	22	6'-11"	8'-2"	8'-3"	24.8	2.07	1.74	2.01
		20	8'-5"	9'-10"	10'-0"	25.2	2.24	2.04	2.01
		19	9'-2"	10'-9"	11'-2"	25.5	2.39	2.31	2.01
		18	9'-7"	11'-6"	11'-10"	25.8	2.52	2.56	2.01
		16	10'-5"	12'-10"	12'-5"	26.5	2.79	3.07	2.01
4"	2½"	22	6'-8"	7'-10"	7'-11"	29.4	3.06	2.14	2.41
		20	8'-0"	9'-4"	9'-7"	29.8	3.31	2.52	2.41
		19	8'-8"	10'-4"	10'-8"	30.1	3.54	2.87	2.41
		18	9'-1"	11'-0"	11'-4"	30.4	3.73	3.18	2.41
		16	9'-10"	12'-3"	12'-0"	31.1	4.12	3.84	2.41
4¾"	¾"	22	6'-3"	7'-4"	7'-5"	36.3	5.07	2.84	3.06
		20	7'-7"	8'-10"	8'-11"	36.7	5.48	3.36	3.06
		19	8'-2"	9'-8"	10'-0"	37.0	5.85	3.84	3.06
		18	8'-6"	10'-4"	10'-8"	37.3	6.17	4.27	3.06
		16	9'-3"	11'-7"	11'-5"	38.0	6.81	5.18	3.06

Note:

1. Maximum unshored spans do not consider web-crippling. Required bearing should be determined based on specific span conditions.

Superimposed Allowable Load, W_n/Ω , Limited by L/360 (psf) LWC (110 pcf), $f'_c = 3000$ psi

Total Slab Depth	Deck Gage	Span (ft-in.)								
		4'-0"	5'-0"	6'-0"	7'-0"	8'-0"	9'-0"	10'-0"	11'-0"	12'-0"
3½"	22	843	531	361	258	176	123	90	67	52
	20	982	626	427	285	191	134	97	73	56
	19	981	715	484	305	204	143	104	78	60
	18	981	779	510	321	215	151	110	82	63
	16	980	779	564	355	238	167	121	91	70
4"	22	1040	655	446	319	238	181	133	100	77
	20	1176	776	530	381	282	198	144	108	83
	19	1175	888	608	438	301	212	154	116	89
	18	1175	934	676	475	318	223	162	122	94
	16	1174	933	772	524	351	246	179	135	104
4¾"	22	1386	874	595	428	319	244	191	151	121
	20	1492	1039	710	512	383	295	232	180	138
	19	1492	1186	817	590	443	342	255	192	148
	18	1492	1186	912	660	496	369	269	202	156
	16	1491	1185	981	808	581	408	297	223	172

Notes:

- For high loads long term concrete creep should be considered.
- See Composite Deck-Slab Strength Web Based Solutions for alternate slabs or LRFD design.

1.5VL-36/1.5VLI-36/1.5PLVLI-36 COMPOSITE DECK-SLABS

ASD

1.5VL-36/1.5VLI-36/1.5PLVLI-36 Composite Deck-Slab Information

$f'_c = 3000$ psi

Total Slab Depth (in.)	Cover Depth (in.)	Theoretical Concrete Volume (yd ³ /100 ft ²)	Min. A _s for T&S (in. ²)	Recommended Reinforcing for Temperature and Shrinkage	
				WWR	(OR) Bekaert Dramix® Steel Fiber Alternate to WWR (lb/yd ³)
				4D 65/60BG	
Normal Weight Concrete (145 pcf)					
3½	2	0.78	0.028	6x6-W1.4xW1.4	23
4	2½	0.94	0.028	6x6-W1.4xW1.4	18
4½	3	1.09	0.028	6x6-W1.4xW1.4	15
5	3½	1.24	0.032	6x6-W2.1xW2.1	15
5½	4	1.40	0.036	6x6-W2.1xW2.1	15
6	4½	1.55	0.041	6x6-W2.1xW2.1	15
Light Weight Concrete (110 pcf)					
3½	2	0.78	0.028	6x6-W1.4xW1.4	33
4	2½	0.94	0.028	6x6-W1.4xW1.4	25
4½	3	1.09	0.028	6x6-W1.4xW1.4	20
4¾	3¼	1.17	0.029	6x6-W2.1xW2.1	20
5	3½	1.24	0.032	6x6-W2.1xW2.1	20
5¾	4¼	1.48	0.038	6x6-W2.1xW2.1	20

Notes:

1. FRC reinforcement is based on IAPMO UES ER-465.
2. Dramix® fibers may be used in UL or ULC fire rated assemblies in lieu of WWR. See UL file R19307 for additional information.

For information on Bekaert Dramix® fibers contact 770-514-2295 or infobuilding@bekaert.com.

NOTICE: Design defects that could cause injury or death may result from relying on the information in this document without independent verification by a qualified professional. The information in this document is provided "AS IS". Nucor Corporation and its affiliates expressly disclaim: (i) any and all representations, warranties and conditions and (ii) all liability arising out of or related to this document and the information in it. DRAMIX is a registered trademark of Bekaert.

1.5VLR-36 COMPOSITE DECK GRADE 50 STEEL

ASD

1.5VLR COMPOSITE DECK

- 1.5VLR-36 Deck used with Side-lap Screws

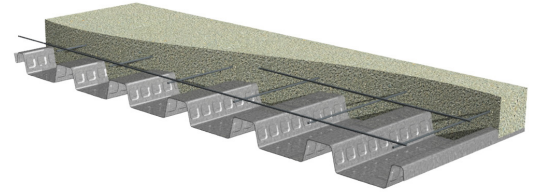

Nominal Dimensions

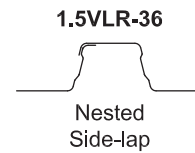
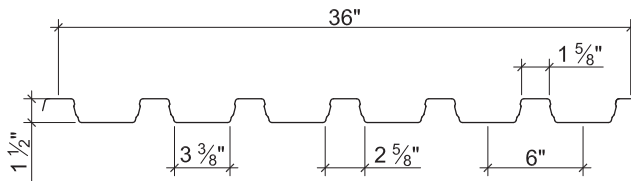

Section Properties

Deck Gage	Deck Weight w_{dd} (psf)	Base Metal Thickness t (in.)	Yield Strength F_y (ksi)	Effective Moment of Inertia at Service Load $I_d = (2I_e + I_g)/3$		Effective Section Modulus at $F_y = 50$ ksi		Allowable Moment		Vertical Web Shear V_n/Ω (lb/ft)
				I_{d+} (in ⁴ /ft)	I_{d-} (in ⁴ /ft)	S_{e+} (in ³ /ft)	S_{e-} (in ³ /ft)	M_{n+}/Ω (lb-ft/ft)	M_{n-}/Ω (lb-ft/ft)	
22	1.6	0.0295	50	0.178	0.155	0.179	0.169	447	422	2654
20	2.0	0.0358	50	0.217	0.197	0.229	0.224	571	559	3207
19	2.3	0.0418	50	0.257	0.239	0.278	0.266	693	663	3728
18	2.6	0.0474	50	0.290	0.277	0.318	0.306	793	763	4209
16	3.3	0.0598	50	0.367	0.364	0.402	0.393	1003	981	5261

Allowable Reactions at Supports Based on Web Crippling, R_n/Ω (lb/ft)

Deck Gage	Bearing Length of Webs											
	One-Flange Loading						Two-Flange Loading					
	End Bearing				Interior Bearing		End Bearing				Interior Bearing	
	1 1/2"	2"	3"	4"	3"	4"	1 1/2"	2"	3"	4"	3"	4"
22	807	887	1021	1115	1482	1602	842	908	1017	1093	1834	1994
20	1153	1263	1448	1574	2127	2289	1274	1368	1525	1632	2662	2881
19	1532	1674	1913	2071	2839	3043	1766	1891	2100	2239	3579	3859
18	1931	2105	2398	2588	3586	3831	2297	2454	2716	2887	4546	4884
16	2958	3212	3639	3900	5517	5855	3713	3950	4347	4590	7050	7523

Standard Features

- ASTM A653 SS GR50 Min., with G60 or G90, white or gray primer bottom optional
- ASTM A1008 SS GR50 Min. with gray primer bottom
- Standard lengths – 6'-0" to 42'-0"
- IAPMO UES ER-0652 and UL Listed
- Tables conform to ANSI/SDI C-2017

Optional Features

- Inquire regarding cost and lead times for:
 - Short cuts < 6'-0"
 - Sheet Lengths > 42'-0"
 - Alternative metallic and painted finishes

1.5VLR-36 COMPOSITE DECK-SLABS NORMAL WEIGHT CONCRETE (145 pcf)

ASD

			Maximum Unshored Spans			Composite Deck-Slab Properties			
Slab Depth		Deck Gage	Maximum Unshored Construction Clear Span			Concrete + Deck (psf)	Deflection $I_d = (I_{cr} + I_u)/2$ (in ⁴ /ft)	Moment M_{no}/Ω (kip-ft/ft)	Shear V_{no}/Ω (kip/ft)
Total	Topping		1	2	3				
3½"	2"	22	6'-5"	7'-5"	7'-7"	37.5	3.43	2.60	3.36
		20	7'-6"	8'-7"	8'-10"	37.9	3.68	3.08	3.36
		19	8'-2"	9'-4"	9'-7"	38.2	3.91	3.53	3.36
		18	8'-6"	9'-11"	10'-3"	38.5	4.11	3.93	3.36
		16	9'-2"	11'-3"	11'-3"	39.2	4.50	4.79	3.36
5"	3½"	22	5'-8"	6'-6"	6'-8"	55.6	9.34	3.80	5.03
		20	6'-7"	7'-6"	7'-9"	56.0	9.97	4.53	5.21
		19	7'-3"	8'-2"	8'-5"	56.3	10.55	5.22	5.21
		18	7'-6"	8'-9"	9'-0"	56.6	11.05	5.84	5.21
		16	8'-1"	9'-10"	10'-0"	57.3	12.09	7.18	5.21
6"	4½"	22	5'-4"	6'-1"	6'-3"	67.7	15.62	4.84	5.59
		20	6'-2"	7'-0"	7'-3"	68.1	16.63	5.78	6.10
		19	6'-10"	7'-7"	7'-10"	68.4	17.55	6.67	6.33
		18	7'-1"	8'-2"	8'-5"	68.7	18.36	7.48	6.33
		16	7'-8"	9'-2"	9'-5"	69.4	20.03	9.23	6.33

Note:

1. Maximum unshored spans do not consider web-crippling. Required bearing should be determined based on specific span conditions.

Superimposed Allowable Load, W_n/Ω , Limited by L/360 (psf) NWC (145 pcf), $f'_c = 3000$ psi

Total Slab Depth	Deck Gage	Span (ft-in.)								
		4'-0"	5'-0"	6'-0"	7'-0"	8'-0"	9'-0"	10'-0"	11'-0"	12'-0"
3½"	22	1261	793	539	386	287	205	150	112	86
	20	1501	947	646	464	314	220	160	120	93
	19	1640	1091	746	498	333	234	170	128	98
	18	1639	1219	830	523	350	246	179	134	103
	16	1639	1303	911	573	384	269	196	147	113
5"	22	1845	1160	789	565	419	319	248	195	155
	20	2210	1394	951	684	510	391	306	243	195
	19	2546	1614	1104	796	596	459	361	288	233
	18	2545	1813	1241	897	673	520	410	329	267
	16	2545	2024	1538	1115	840	652	517	396	305
6"	22	2351	1480	1007	722	537	410	319	252	201
	20	2822	1782	1216	875	654	502	394	314	253
	19	3095	2066	1414	1020	765	590	465	372	302
	18	3095	2324	1593	1152	866	669	529	425	346
	16	3094	2461	1980	1436	1083	841	668	540	443

Notes:

- For high loads long term concrete creep should be considered.
- See Composite Deck-Slab Strength Web Based Solutions for alternate slabs or LRFD design.

1.5VLR-36 COMPOSITE DECK-SLABS LIGHT WEIGHT CONCRETE (110 pcf)

ASD

			Maximum Unshored Spans			Composite Deck-Slab Properties			
Slab Depth		Deck Gage	Maximum Unshored Construction Clear Span			Concrete + Deck (psf)	Deflection $I_d = (I_{cr} + I_u)/2$ (in ⁴ /ft)	Moment M_{no}/Ω (kip-ft/ft)	Shear V_{no}/Ω (kip/ft)
Total	Topping		1	2	3				
3½"	2"	22	6'-11"	8'-2"	8'-3"	28.8	2.66	2.49	3.36
		20	8'-3"	9'-4"	9'-8"	29.2	2.87	2.94	3.36
		19	8'-11"	10'-2"	10'-6"	29.5	3.06	3.36	3.36
		18	9'-3"	10'-10"	11'-2"	29.8	3.22	3.73	3.36
		16	10'-0"	12'-2"	12'-0"	30.5	3.54	4.52	3.36
4"	2½"	22	6'-8"	7'-9"	7'-11"	33.4	3.85	2.86	3.91
		20	7'-10"	8'-11"	9'-3"	33.8	4.15	3.38	3.95
		19	8'-6"	9'-8"	10'-0"	34.1	4.42	3.87	3.95
		18	8'-10"	10'-5"	10'-9"	34.4	4.65	4.31	3.95
		16	9'-6"	11'-8"	11'-7"	35.1	5.11	5.24	3.95
4¾"	¾"	22	6'-4"	7'-4"	7'-6"	40.3	6.20	3.43	4.26
		20	7'-5"	8'-5"	8'-8"	40.7	6.68	4.07	4.76
		19	8'-1"	9'-2"	9'-6"	41.0	7.11	4.67	4.88
		18	8'-4"	9'-10"	10'-2"	41.3	7.47	5.21	4.88
		16	9'-0"	11'-1"	11'-1"	42.0	8.22	6.36	4.88

Note:

1. Maximum unshored spans do not consider web-crippling. Required bearing should be determined based on specific span conditions.

Superimposed Allowable Load, W_n/Ω , Limited by L/360 (psf) LWC (110 pcf), $f'_c = 3000$ psi

Total Slab Depth	Deck Gage	Span (ft-in.)								
		4'-0"	5'-0"	6'-0"	7'-0"	8'-0"	9'-0"	10'-0"	11'-0"	12'-0"
3½"	22	1214	766	523	338	226	159	116	87	67
	20	1439	910	580	365	244	172	125	94	72
	19	1648	1044	619	389	261	183	133	100	77
	18	1648	1125	651	410	274	193	140	105	81
	16	1647	1239	717	451	302	212	154	116	89
4"	22	1396	881	601	433	323	230	168	126	97
	20	1658	1049	718	518	354	248	181	136	104
	19	1903	1205	826	563	377	264	193	145	111
	18	1938	1344	923	592	396	278	203	152	117
	16	1937	1542	1034	651	436	306	223	167	129
4¾"	22	1674	1057	722	519	388	298	234	186	150
	20	1995	1262	864	624	468	361	285	219	168
	19	2294	1453	997	721	542	420	310	233	179
	18	2398	1625	1116	808	609	448	326	245	189
	16	2397	1909	1371	996	701	492	359	269	207

Notes:

- For high loads long term concrete creep should be considered.
- See Composite Deck-Slab Strength Web Based Solutions for alternate slabs or LRFD design.

1.5VLR-36 COMPOSITE DECK-SLABS

ASD

1.5VLR-36 Composite Deck-Slab Information

$f'_c = 3000$ psi

Total Slab Depth (in.)	Cover Depth (in.)	Theoretical Concrete Volume (yd ³ /100 ft ²)	Min. A _s for T&S (in. ²)	Recommended Reinforcing for Temperature and Shrinkage	
				WWR	(OR) Bekaert Dramix® Steel Fiber Alternate to WWR (lb/yd ³)
				4D 65/60BG	
Normal Weight Concrete (145 pcf)					
3½	2	0.92	0.018	6x6-W1.4xW1.4	23
4	2½	1.07	0.023	6x6-W1.4xW1.4	18
4½	3	1.22	0.027	6x6-W1.4xW1.4	15
5	3½	1.38	0.032	6x6-W2.1xW2.1	15
5½	4	1.53	0.036	6x6-W2.1xW2.1	15
6	4½	1.69	0.041	6x6-W2.1xW2.1	15
Light Weight Concrete (110 pcf)					
3½	2	0.92	0.018	6x6-W1.4xW1.4	33
4	2½	1.07	0.023	6x6-W1.4xW1.4	25
4½	3	1.22	0.027	6x6-W1.4xW1.4	20
4¾	3¼	1.30	0.029	6x6-W2.1xW2.1	20
5	3½	1.38	0.032	6x6-W2.1xW2.1	20
5¾	4¼	1.61	0.038	6x6-W2.1xW2.1	20

Notes:

1. FRC reinforcement is based on IAPMO UES ER-465.
2. Dramix® fibers may be used in UL or ULC fire rated assemblies in lieu of WWR. See UL file R19307 for additional information.

For information on Bekaert Dramix® fibers contact 770-514-2295 or infobuilding@bekaert.com.

NOTICE: Design defects that could cause injury or death may result from relying on the information in this document without independent verification by a qualified professional. The information in this document is provided "AS IS". Nucor Corporation and its affiliates expressly disclaim: (i) any and all representations, warranties and conditions and (ii) all liability arising out of or related to this document and the information in it. DRAMIX is a registered trademark of Bekaert.

2VLI-36/2VLJ-36/2PLVLI-36 COMPOSITE DECKS

GRADE 50 STEEL

ASD

2VLI COMPOSITE DECKS

- 2VLI Deck-36 used with TSWs or BPs
- 2VLJ Deck-36 used with Side-lap Screws
- 2PLVLI Deck-36 used with PunchLok® II System

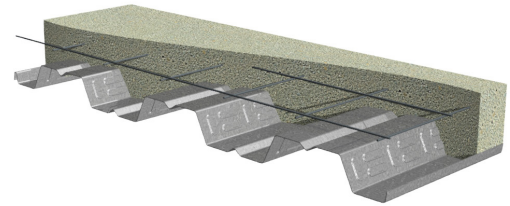

Nominal Dimensions

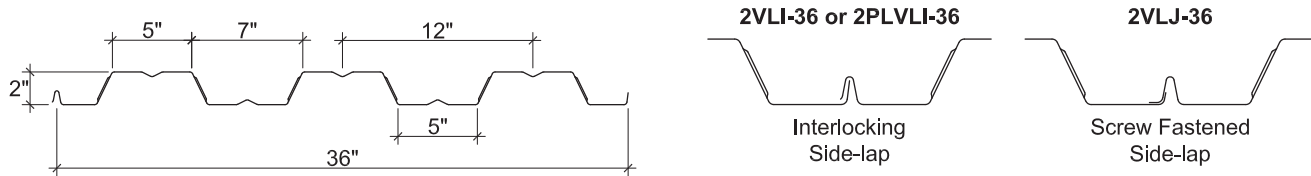

Section Properties

Deck Gage	Deck Weight w_{dd} (psf)	Base Metal Thickness t (in.)	Yield Strength F_y (ksi)	Effective Moment of Inertia at Service Load $I_d = (2I_e + I_g)/3$		Effective Section Modulus at $F_y = 50$ ksi		Allowable Moment		Vertical Web Shear V_n/Ω (lb/ft)
				I_{d+} (in ⁴ /ft)	I_{d-} (in ⁴ /ft)	S_{e+} (in ³ /ft)	S_{e-} (in ³ /ft)	M_{n+}/Ω (lb-ft/ft)	M_{n-}/Ω (lb-ft/ft)	
22	1.6	0.0295	50	0.324	0.324	0.244	0.255	609	637	1641
20	1.9	0.0358	50	0.409	0.407	0.326	0.337	813	841	2419
19	2.2	0.0418	50	0.490	0.488	0.409	0.421	1020	1050	2863
18	2.5	0.0474	50	0.557	0.557	0.485	0.500	1210	1247	3240
16	3.2	0.0598	50	0.703	0.703	0.643	0.652	1604	1627	4069

Allowable Reactions at Supports Based on Web Crippling, R_n/Ω (lb/ft)

Deck Gage	Bearing Length of Webs											
	One-Flange Loading						Two-Flange Loading					
	End Bearing				Interior Bearing		End Bearing				Interior Bearing	
	1½"	2"	3"	4"	4"	6"	1½"	2"	3"	4"	4"	6"
22	363	399	460	511	767	882	362	390	437	476	924	1071
20	522	571	655	726	1098	1257	554	595	663	721	1342	1550
19	696	761	869	960	1462	1667	775	829	921	998	1805	2078
18	879	959	1092	1205	1843	2095	1013	1082	1198	1296	2292	2631
16	1354	1470	1666	1830	2825	3194	1654	1759	1936	2085	3554	4059

Standard Features

- ASTM A653 SS GR50 Min., with G60 or G90, white or gray primer bottom optional
- ASTM A1008 SS GR50 Min. with gray primer bottom
- Standard lengths – 6'-0" to 42'-0"
- IAPMO UES ER-0652 and UL Listed
- Tables conform to ANSI/SDI C-2017

Optional Features

- Inquire regarding cost and lead times for:
 - Short cuts < 6'-0"
 - Sheet Lengths > 42'-0"
 - Alternative metallic and painted finishes
- Factory Hanger Tabs

2VLI-36/2VLJ-36/2PLVLI-36 COMPOSITE DECK-SLABS

NORMAL WEIGHT CONCRETE (145 pcf)

ASD

			Maximum Unshored Spans			Composite Deck-Slab Properties			
Slab Depth		Deck Gage	Maximum Unshored Construction Clear Span			Concrete + Deck (psf)	Deflection $I_d = (I_{cr} + I_u)/2$ (in ⁴ /ft)	Moment M_{no}/Ω (kip-ft/ft)	Shear V_{no}/Ω (kip/ft)
Total	Topping		1	2	3				
4"	2"	22	7'-10"	9'-1"	9'-3"	37.9	4.14	2.41	3.03
		20	9'-5"	10'-5"	10'-9"	38.2	4.43	2.86	3.07
		19	10'-1"	11'-7"	12'-0"	38.5	4.68	3.27	3.07
		18	10'-6"	12'-8"	12'-7"	38.8	4.92	3.64	3.07
		16	11'-4"	14'-1"	13'-3"	39.5	5.39	4.43	3.07
5½"	3½"	22	6'-11"	7'-11"	8'-1"	56.0	10.32	3.46	3.84
		20	8'-3"	9'-2"	9'-5"	56.3	11.00	4.12	4.55
		19	9'-0"	10'-2"	10'-6"	56.6	11.60	4.73	4.67
		18	9'-4"	11'-1"	11'-6"	56.9	12.14	5.28	4.67
		16	10'-1"	12'-8"	12'-1"	57.6	13.25	6.47	4.67
6½"	4½"	22	6'-5"	7'-4"	7'-7"	68.1	16.78	4.40	4.44
		20	7'-8"	8'-6"	8'-9"	68.4	17.83	5.26	5.15
		19	8'-5"	9'-6"	9'-10"	68.7	18.77	6.05	5.55
		18	8'-9"	10'-4"	10'-8"	69.0	19.61	6.77	5.87
		16	9'-6"	11'-9"	11'-7"	69.7	21.36	7.91	5.87

Note:

1. Maximum unshored spans do not consider web-crippling. Required bearing should be determined based on specific span conditions.

Superimposed Allowable Load, W_n/Ω , Limited by L/360 (psf) NWC (145 pcf), $f'_c = 3000$ psi

Total Slab Depth	Deck Gage	Span (ft-in.)								
		6'-0"	7'-0"	8'-0"	9'-0"	10'-0"	11'-0"	12'-0"	13'-0"	14'-0"
4"	22	498	356	263	200	155	121	96	76	60
	20	597	428	319	244	190	145	111	88	70
	19	688	495	370	280	204	153	118	93	74
	18	770	555	416	294	214	161	124	97	78
	16	945	684	459	323	235	176	136	107	85
5½"	22	713	509	376	286	221	173	136	107	85
	20	859	616	458	350	273	216	172	138	111
	19	994	715	534	410	321	256	206	167	136
	18	1116	805	603	464	365	292	236	193	158
	16	1379	998	750	581	459	369	301	248	206
6½"	22	910	650	482	366	284	223	176	140	111
	20	1099	789	588	450	352	279	223	180	146
	19	1274	918	687	528	415	331	267	217	178
	18	1435	1036	777	599	472	378	307	251	207
	16	1688	1222	919	711	563	453	369	304	253

Notes:

- For high loads long term concrete creep should be considered.
- See Composite Deck-Slab Strength Web Based Solutions for alternate slabs or LRFD design.

2VLI-36/2VLJ-36/2PLVLI-36 COMPOSITE DECK-SLABS

LIGHT WEIGHT CONCRETE (110 pcf)

ASD

			Maximum Unshored Spans			Composite Deck-Slab Properties			
Slab Depth		Deck Gage	Maximum Unshored Construction Clear Span			Concrete + Deck (psf)	Deflection $I_d = (I_{cr} + I_u)/2$ (in ⁴ /ft)	Moment M_{no}/Ω (kip-ft/ft)	Shear V_{no}/Ω (kip/ft)
Total	Topping		1	2	3				
4"	2"	22	8'-7"	9'-11"	10'-2"	29.1	3.19	2.31	2.65
		20	10'-5"	11'-4"	11'-9"	29.4	3.44	2.72	3.07
		19	11'-1"	12'-8"	13'-0"	29.7	3.66	3.10	3.07
		18	11'-5"	13'-9"	13'-5"	30.0	3.85	3.45	3.07
		16	12'-1"	15'-0"	14'-2"	30.7	4.25	4.17	3.07
4½"	2½"	22	8'-3"	9'-6"	9'-9"	33.7	4.44	2.64	2.84
		20	9'-11"	10'-11"	11'-3"	34.0	4.78	3.11	3.55
		19	10'-7"	12'-2"	12'-7"	34.3	5.08	3.55	3.57
		18	11'-0"	13'-3"	13'-0"	34.6	5.35	3.95	3.57
		16	11'-8"	14'-6"	13'-8"	35.3	5.89	4.79	3.57
5¼"	3¼"	22	7'-9"	8'-11"	9'-2"	40.6	6.89	3.16	3.15
		20	9'-4"	10'-3"	10'-7"	40.9	7.40	3.74	3.86
		19	10'-0"	11'-6"	11'-10"	41.2	7.86	4.27	4.26
		18	10'-5"	12'-6"	12'-5"	41.5	8.27	4.76	4.39
		16	11'-2"	13'-11"	13'-1"	42.2	9.09	5.79	4.39

Note:

1. Maximum unshored spans do not consider web-crippling. Required bearing should be determined based on specific span conditions.

Superimposed Allowable Load, W_n/Ω , Limited by L/360 (psf) LWC (110 pcf), $f'_c = 3000$ psi

Total Slab Depth	Deck Gage	Span (ft-in.)								
		6'-0"	7'-0"	8'-0"	9'-0"	10'-0"	11'-0"	12'-0"	13'-0"	14'-0"
4"	22	483	347	259	190	139	104	80	63	50
	20	575	414	293	205	150	112	86	68	54
	19	659	466	312	219	159	120	92	72	58
	18	735	491	329	231	168	126	97	76	61
	16	860	542	363	255	185	139	107	84	67
4½"	22	552	396	295	226	177	140	112	88	70
	20	658	474	355	273	208	156	120	95	76
	19	755	545	409	304	222	166	128	101	80
	18	843	610	456	320	233	175	135	106	85
	16	1029	747	503	353	257	193	149	117	93
5¼"	22	660	474	353	271	211	168	134	108	88
	20	789	569	426	328	258	206	166	136	111
	19	908	656	492	380	300	241	196	156	125
	18	1016	735	553	428	339	271	209	164	131
	16	1244	903	681	529	397	298	229	180	144

Notes:

- For high loads long term concrete creep should be considered.
- See Composite Deck-Slab Strength Web Based Solutions for alternate slabs or LRFD design.

2VLI-36/2VLJ-36/2PLVLI-36 COMPOSITE DECK-SLABS

ASD

2VLI-36/2VLJ-36/2PLVLI-36 Composite Deck-Slab Information

$f'_c = 3000$ psi

Total Slab Depth (in.)	Cover Depth (in.)	Theoretical Concrete Volume (yd ³ /100 ft ²)	Min. A _s for T&S (in. ²)	Recommended Reinforcing for Temperature and Shrinkage	
				WWR	(OR) Bekaert Dramix® Steel Fiber Alternate to WWR (lb/yd ³)
4D 65/60BG					
Normal Weight Concrete (145 pcf)					
4	2	0.93	0.028	6x6-W1.4xW1.4	23
4½	2½	1.08	0.028	6x6-W1.4xW1.4	18
5	3	1.23	0.028	6x6-W1.4xW1.4	15
5½	3½	1.39	0.032	6x6-W2.1xW2.1	15
6	4	1.54	0.036	6x6-W2.1xW2.1	15
6½	4½	1.70	0.041	6x6-W2.1xW2.1	15
Light Weight Concrete (110 pcf)					
4	2	0.93	0.028	6x6-W1.4xW1.4	33
4½	2½	1.08	0.028	6x6-W1.4xW1.4	25
5	3	1.23	0.028	6x6-W1.4xW1.4	20
5¼	3¼	1.31	0.029	6x6-W2.1xW2.1	20
5½	3½	1.39	0.032	6x6-W2.1xW2.1	20
6¼	4¼	1.62	0.038	6x6-W2.1xW2.1	20

Notes:

1. FRC reinforcement is based on IAPMO UES ER-465.
2. Dramix® fibers may be used in UL or ULC fire rated assemblies in lieu of WWR. See UL file R19307 for additional information.

For information on Bekaert Dramix® fibers contact 770-514-2295 or infobuilding@bekaert.com.

NOTICE: Design defects that could cause injury or death may result from relying on the information in this document without independent verification by a qualified professional. The information in this document is provided "AS IS". Nucor Corporation and its affiliates expressly disclaim: (i) any and all representations, warranties and conditions and (ii) all liability arising out of or related to this document and the information in it. DRAMIX is a registered trademark of Bekaert.

3VLI-36/3VLJ-36/3PLVLI-36 COMPOSITE DECKS

GRADE 50 STEEL

ASD

3VLI COMPOSITE DECKS

- 3VLI-36 Deck used with TSWs or BPs
- 3VLJ-36 Deck used with Side-lap Screws
- 3PLVLI-36 Deck used with PunchLok® II System

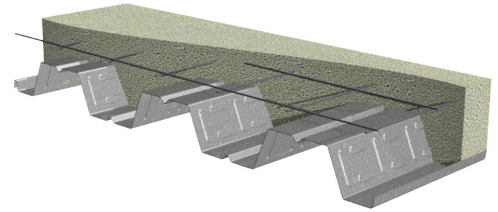

Nominal Dimensions

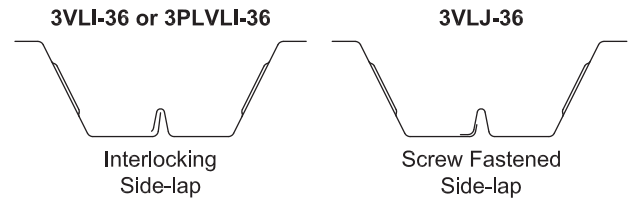
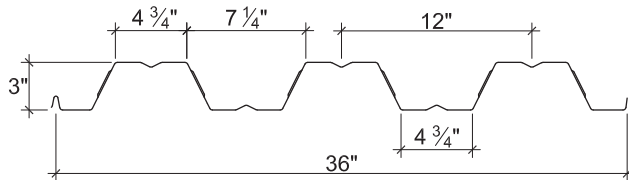

Section Properties

Deck Gage	Deck Weight w_{dd} (psf)	Base Metal Thickness t (in.)	Yield Strength F_y (ksi)	Effective Moment of Inertia at Service Load $I_d = (2I_e + I_g)/3$		Effective Section Modulus at $F_y = 50$ ksi		Allowable Moment		Vertical Web Shear V_n/Ω (lb/ft)
				I_{d+} (in ⁴ /ft)	I_{d-} (in ⁴ /ft)	S_{e+} (in ³ /ft)	S_{e-} (in ³ /ft)	M_{n+}/Ω (lb-ft/ft)	M_{n-}/Ω (lb-ft/ft)	
22	1.7	0.0295	50	0.732	0.737	0.387	0.410	966	1023	1407
20	2.1	0.0358	50	0.919	0.921	0.512	0.539	1277	1345	2485
19	2.4	0.0418	50	1.099	1.101	0.639	0.669	1595	1669	3389
18	2.7	0.0474	50	1.253	1.253	0.761	0.794	1899	1981	4361
16	3.5	0.0598	50	1.580	1.580	1.013	1.013	2528	2528	6126

Allowable Reactions at Supports Based on Web Crippling, R_n/Ω (lb/ft)

Deck Gage	Bearing Length of Webs											
	One-Flange Loading						Two-Flange Loading					
	End Bearing				Interior Bearing		End Bearing				Interior Bearing	
	1 1/2"	2"	3"	4"	4"	8"	1 1/2"	2"	3"	4"	4"	8"
22	353	388	446	496	783	910	333	359	402	439	910	1068
20	510	559	640	709	1121	1388	518	556	620	674	1328	1668
19	683	747	853	943	1493	1879	731	783	869	942	1792	2291
18	866	944	1075	1186	1881	2356	963	1028	1138	1231	2279	2900
16	1339	1455	1648	1811	2884	3579	1589	1690	1860	2003	3546	4474

Standard Features

- ASTM A653 SS GR50 Min., with G60 or G90, white or gray primer bottom optional
- ASTM A1008 SS GR50 Min. with gray primer bottom
- Standard lengths – 6'-0" to 42'-0"
- IAPMO UES ER-0652 and UL Listed
- Tables conform to ANSI/SDI C-2017

Optional Features

- Inquire regarding cost and lead times for:
 - Short cuts < 6'-0"
 - Sheet Lengths > 42'-0"
 - Alternative metallic and painted finishes
- Factory Hanger Tabs

3VLI-36/3VLJ-36/3PLVLI-36 COMPOSITE DECK-SLABS

NORMAL WEIGHT CONCRETE (145 pcf)

ASD

			Maximum Unshored Spans			Composite Deck-Slab Properties			
Slab Depth		Deck Gage	Maximum Unshored Construction Clear Span			Concrete + Deck (psf)	Deflection $I_d = (I_{cr} + I_u)/2$ (in ⁴ /ft)	Moment M_{no}/Ω (kip-ft/ft)	Shear V_{no}/Ω (kip/ft)
Total	Topping		1	2	3				
5"	2"	22	10'-0"	10'-9"	11'-1"	44.0	7.54	3.47	3.16
		20	11'-9"	12'-6"	12'-11"	44.4	8.04	4.13	3.74
		19	12'-3"	13'-11"	14'-5"	44.7	8.49	4.73	3.74
		18	12'-8"	15'-2"	14'-10"	45.0	8.89	5.28	3.74
		16	13'-4"	16'-8"	15'-8"	45.8	9.72	6.45	3.74
6½"	3½"	22	8'-10"	8'-7"	9'-9"	62.1	15.94	4.57	3.94
		20	10'-5"	11'-1"	11'-5"	62.5	16.93	5.45	4.93
		19	11'-4"	12'-4"	12'-9"	62.8	17.82	6.26	5.31
		18	11'-8"	13'-6"	13'-8"	63.1	18.62	7.00	5.31
		16	12'-4"	15'-2"	14'-6"	63.9	20.27	8.57	5.31
7½"	4½"	22	8'-3"	7'-6"	8'-6"	74.2	24.12	5.36	4.52
		20	9'-8"	10'-4"	10'-8"	74.6	25.57	6.40	5.51
		19	10'-9"	11'-7"	11'-11"	74.9	26.87	7.36	6.33
		18	11'-2"	12'-7"	13'-0"	75.2	28.04	8.24	6.47
		16	11'-10"	14'-3"	13'-11"	76.0	30.47	10.12	6.47

Note:

1. Maximum unshored spans do not consider web-crippling. Required bearing should be determined based on specific span conditions.

Superimposed Allowable Load, W_n/Ω , Limited by L/360 (psf) NWC (145 pcf), $f'_c = 3000$ psi

Total Slab Depth	Deck Gage	Span (ft-in.)								
		8'-0"	9'-0"	10'-0"	11'-0"	12'-0"	13'-0"	14'-0"	15'-0"	16'-0"
5"	22	389	298	233	185	148	120	97	79	64
	20	471	363	285	228	184	150	124	102	84
	19	546	422	333	267	214	168	135	109	90
	18	615	476	377	291	224	176	141	115	94
	16	760	582	424	319	245	193	154	125	103
6½"	22	509	389	303	240	191	154	124	100	80
	20	618	475	373	297	240	195	159	131	107
	19	719	555	437	350	284	233	192	159	132
	18	811	627	496	399	325	268	222	185	155
	16	1007	782	622	502	412	341	286	240	204
7½"	22	595	455	354	280	223	179	144	116	93
	20	725	557	437	348	281	228	186	153	125
	19	845	651	513	411	333	273	225	186	155
	18	954	738	584	469	382	314	261	217	182
	16	1189	923	733	593	486	403	337	283	240

Notes:

- For high loads long term concrete creep should be considered.
- See Composite Deck-Slab Strength Web Based Solutions for alternate slabs or LRFD design.

3VLI-36/3VLJ-36/3PLVLI-36 COMPOSITE DECK-SLABS

LIGHT WEIGHT CONCRETE (110 pcf)

ASD

			Maximum Unshored Spans			Composite Deck-Slab Properties			
Slab Depth		Deck Gage	Maximum Unshored Construction Clear Span			Concrete + Deck (psf)	Deflection $I_d = (I_{cr} + I_u)/2$ (in ⁴ /ft)	Moment M_{no}/Ω (kip-ft/ft)	Shear V_{no}/Ω (kip/ft)
Total	Topping		1	2	3				
5"	2"	22	11'-1"	11'-10"	12'-3"	33.8	5.75	3.33	2.69
		20	12'-7"	13'-8"	14'-2"	34.2	6.19	3.94	3.68
		19	13'-1"	15'-3"	15'-5"	34.5	6.59	4.51	3.74
		18	13'-6"	16'-8"	15'-10"	34.8	6.94	5.02	3.74
		16	14'-3"	17'-9"	16'-9"	35.6	7.66	6.11	3.74
5½"	2½"	22	10'-7"	11'-4"	11'-9"	38.4	7.51	3.66	2.88
		20	12'-2"	13'-2"	13'-7"	38.8	8.07	4.34	3.86
		19	12'-9"	14'-8"	14'-11"	39.1	8.57	4.97	4.24
		18	13'-2"	16'-0"	15'-5"	39.4	9.02	5.54	4.24
		16	13'-10"	17'-3"	16'-3"	40.2	9.93	6.74	4.24
6¼"	3¼"	22	10'-0"	10'-9"	11'-1"	45.2	10.78	4.21	3.17
		20	11'-9"	12'-6"	12'-11"	45.6	11.57	5.00	4.16
		19	12'-3"	13'-11"	14'-4"	45.9	12.27	5.72	4.99
		18	12'-8"	15'-2"	14'-10"	46.2	12.89	6.38	5.04
		16	13'-4"	16'-7"	15'-8"	47.0	14.16	7.77	5.04

Note:

1. Maximum unshored spans do not consider web-crippling. Required bearing should be determined based on specific span conditions.

Superimposed Allowable Load, W_n/Ω , Limited by L/360 (psf) LWC (110 pcf), $f'_c = 3000$ psi

Total Slab Depth	Deck Gage	Span (ft-in.)								
		8'-0"	9'-0"	10'-0"	11'-0"	12'-0"	13'-0"	14'-0"	15'-0"	16'-0"
5"	22	381	294	232	186	145	114	91	74	61
	20	458	355	270	203	156	123	98	80	66
	19	528	395	287	216	166	131	104	85	70
	18	592	416	303	227	175	138	110	89	74
	16	654	459	334	251	193	152	122	99	81
5½"	22	419	323	254	203	165	135	111	91	76
	20	504	390	308	248	202	160	128	104	86
	19	581	451	358	281	216	170	136	111	91
	18	652	507	394	296	228	179	143	116	96
	16	801	595	433	325	251	197	158	128	105
6¼"	22	481	370	291	233	188	154	126	104	86
	20	579	448	354	284	232	190	158	132	110
	19	669	518	411	332	271	224	187	157	130
	18	750	583	463	375	308	255	205	166	137
	16	924	720	574	464	358	281	225	183	151

Notes:

- For high loads long term concrete creep should be considered.
- See Composite Deck-Slab Strength Web Based Solutions for alternate slabs or LRFD design.

3VLI-36/3VLJ-36/3PLVLI-36 COMPOSITE DECK-SLABS

ASD

3VLI-36/3VLJ-36/3PLVLI-36 Composite Deck-Slab Information

$f'_c = 3000$ psi

Total Slab Depth (in.)	Cover Depth (in.)	Theoretical Concrete Volume (yd ³ /100 ft ²)	Min. A _s for T&S (in. ²)	Recommended Reinforcing for Temperature and Shrinkage	
				WWR	(OR) Bekaert Dramix® Steel Fiber Alternate to WWR (lb/yd ³)
4D 65/60BG					
Normal Weight Concrete (145 pcf)					
5	2	1.08	0.028	6x6-W1.4xW1.4	23
5½	2½	1.23	0.028	6x6-W1.4xW1.4	18
6	3	1.39	0.028	6x6-W1.4xW1.4	15
6½	3½	1.54	0.032	6x6-W2.1xW2.1	15
7	4	1.70	0.036	6x6-W2.1xW2.1	15
7½	4½	1.85	0.041	6x6-W2.1xW2.1	15
Light Weight Concrete (110 pcf)					
5	2	1.08	0.028	6x6-W1.4xW1.4	33
5½	2½	1.23	0.028	6x6-W1.4xW1.4	25
6	3	1.39	0.028	6x6-W1.4xW1.4	20
6¼	3¼	1.47	0.029	6x6-W2.1xW2.1	20
6½	3½	1.54	0.032	6x6-W2.1xW2.1	20
7¼	4¼	1.77	0.038	6x6-W2.1xW2.1	20

Notes:

1. FRC reinforcement is based on IAPMO UES ER-465.
2. Dramix® fibers may be used in UL or ULC fire rated assemblies in lieu of WWR. See UL file R19307 for additional information.

For information on Bekaert Dramix® fibers contact 770-514-2295 or infobuilding@bekaert.com.

NOTICE: Design defects that could cause injury or death may result from relying on the information in this document without independent verification by a qualified professional. The information in this document is provided "AS IS". Nucor Corporation and its affiliates expressly disclaim: (i) any and all representations, warranties and conditions and (ii) all liability arising out of or related to this document and the information in it. DRAMIX is a registered trademark of Bekaert.

NON-COMPOSITE DECK

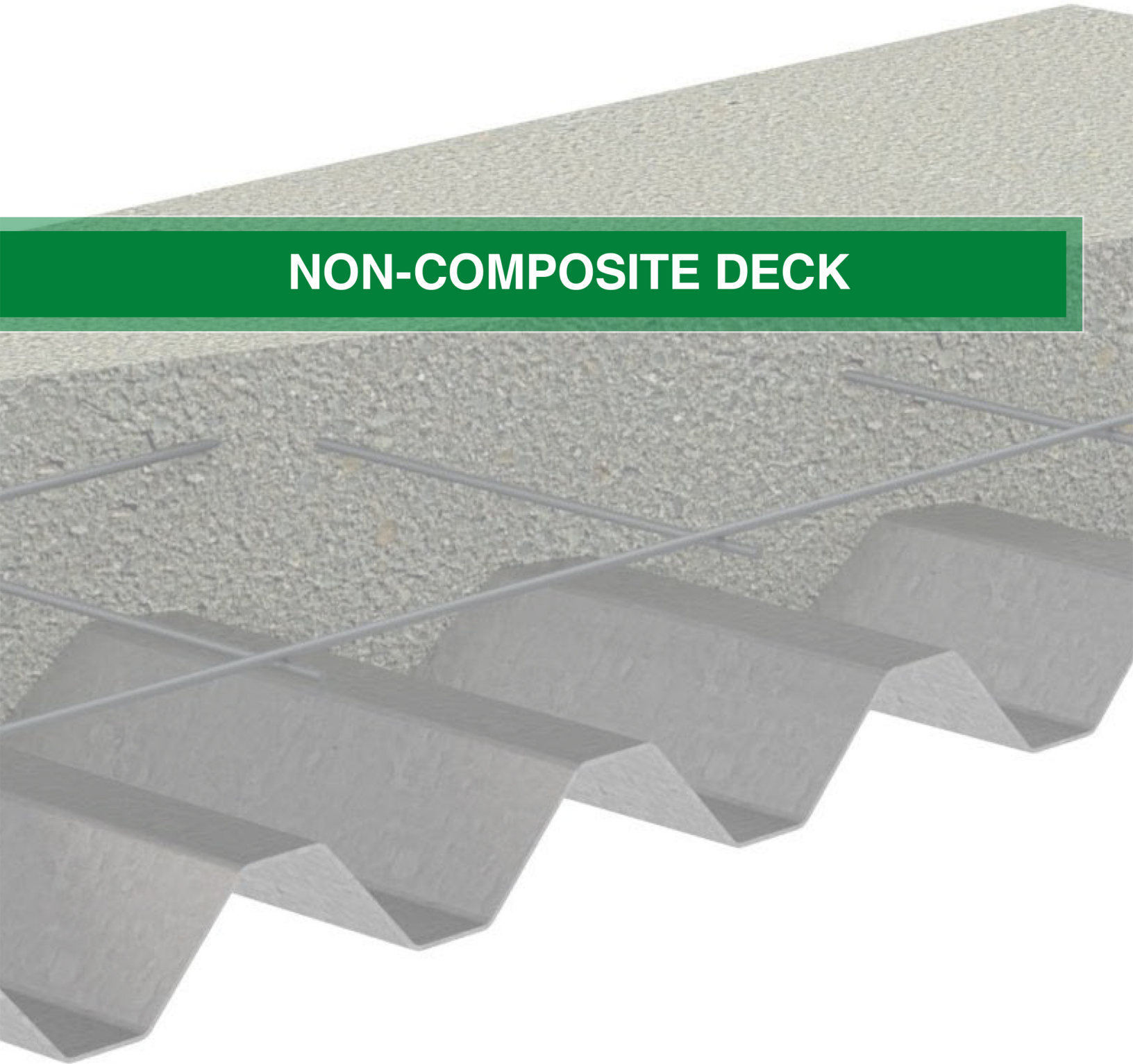

0.6C-30/0.6C-35 NON-COMPOSITE & ROOF DECKS GRADE 80 STEEL

ASD

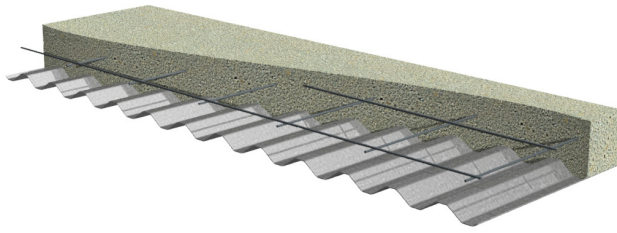

Nominal Dimensions

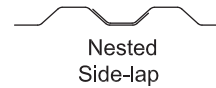
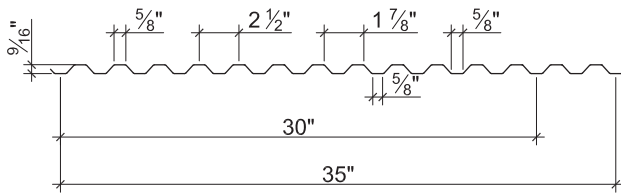

Section Properties

Deck Gage	Deck Weight w_{dd} (psf)	Base Metal Thickness t (in.)	Yield Strength F_y (ksi)	Effective Moment of Inertia at Service Load $I_d = (2I_e + I_g)/3$		Effective Section Modulus at $F_y = 60$ ksi		Allowable Moment		Vertical Web Shear V_n/Ω (lb/ft)
				I_{d+} (in ⁴ /ft)	I_{d-} (in ⁴ /ft)	S_{e+} (in ³ /ft)	S_{e-} (in ³ /ft)	M_{n+}/Ω (lb-ft/ft)	M_{n-}/Ω (lb-ft/ft)	
28	0.7	0.0149	60	0.011	0.011	0.033	0.034	99	102	1326
26	0.9	0.0179	60	0.013	0.013	0.042	0.042	126	126	1589
24	1.2	0.0239	60	0.017	0.017	0.056	0.056	168	168	2107
22	1.4	0.0295	60	0.021	0.021	0.069	0.068	207	204	2584

Allowable Reactions at Supports Based on Web Crippling, R_n/Ω (lb/ft)

Deck Gage	Bearing Length of Webs One-Flange Loading			
	End Bearing		Interior Bearing	
	1 1/2"	2"	1 1/2"	2"
28	491	527	567	604
26	690	738	834	885
24	1176	1251	1507	1589
22	1729	1830	2295	2409

Standard Features

- ASTM A653 SS GR80 with G60
- Standard lengths – 6'-0" to 42'-0"
- IAPMO UES ER-0652 and UL Listed
- Tables conform to ANSI/SDI NC-2017 and RD-2017

Optional Features

- Inquire regarding cost and lead times for:
 - Short cuts < 6'-0"
 - Sheet Lengths > 42'-0"
 - Alternative metallic and painted finishes
- Side-lap or bottom flange slot venting

0.6C-30/0.6C-35 NON-COMPOSITE & ROOF DECKS GRADE 80 STEEL

ASD

Inward Uniform Allowable Loads, ASD (psf)

Deck Gage	Spans	Criteria	Span (ft-in.)										
			1'-0"	1'-6"	2'-0"	2'-6"	3'-0"	3'-6"	4'-0"	4'-6"	5'-0"	5'-6"	6'-0"
28	Single	W_n / Ω	790	351	198	126	88	65	49	39	32	26	22
		L/240	721	214	90	46	27	17	11	8	6	4	3
	Double	W_n / Ω	760	351	200	129	90	66	51	40	32	27	23
		L/240	---	---	---	111	64	41	27	19	14	10	8
	Triple	W_n / Ω	925	433	248	160	112	82	63	50	41	34	28
		L/240	---	403	170	87	50	32	21	15	11	8	6
26	Single	W_n / Ω	1006	447	251	161	112	82	63	50	40	33	28
		L/240	852	253	107	55	32	20	13	9	7	5	4
	Double	W_n / Ω	935	432	247	159	111	82	63	49	40	33	28
		L/240	---	---	---	131	76	48	32	23	16	12	10
	Triple	W_n / Ω	1136	533	306	198	138	102	78	62	50	41	35
		L/240	---	477	201	103	60	38	25	18	13	10	7
24	Single	W_n / Ω	1341	596	335	215	149	109	84	66	54	44	37
		L/240	1114	330	139	71	41	26	17	12	9	7	5
	Double	W_n / Ω	1246	576	329	212	148	109	83	66	53	44	37
		L/240	---	---	---	172	99	63	42	29	21	16	12
	Triple	W_n / Ω	1513	710	408	264	184	136	104	82	67	55	46
		L/240	---	623	263	135	78	49	33	23	17	13	10
22	Single	W_n / Ω	1653	735	413	264	184	135	103	82	66	55	46
		L/240	1377	408	172	88	51	32	22	15	11	8	6
	Double	W_n / Ω	1515	700	400	257	179	132	101	80	65	54	45
		L/240	---	---	---	212	123	77	52	36	27	20	15
	Triple	W_n / Ω	1841	863	495	320	223	165	126	100	81	67	56
		L/240	---	770	325	166	96	61	41	29	21	16	12

Notes:

1. Table does not account for web crippling. Required bearing should be determined based on specific span conditions.
2. The symbol "---" indicates that the uniform allowable load based on deflection exceeds the allowable load based on stress.

NOTICE: Design defects that could cause injury or death may result from relying on the information in this document without independent verification by a qualified professional. The information in this document is provided "AS IS". Nucor Corporation and its affiliates expressly disclaim: (i) any and all representations, warranties and conditions and (ii) all liability arising out of or related to this document and the information in it.

0.6C-36 NON-COMPOSITE & ROOF DECKS GRADE 80 STEEL

ASD

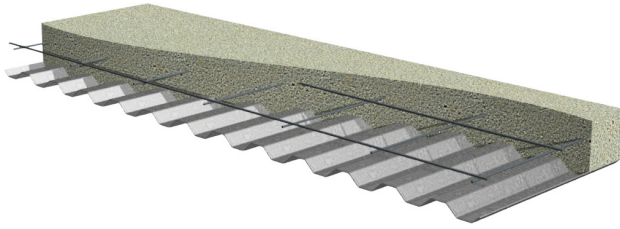

Nominal Dimensions

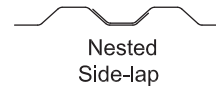
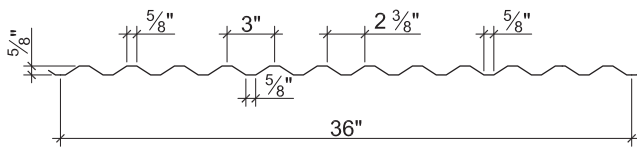

Section Properties

Deck Gage	Deck Weight w_{dd} (psf)	Base Metal Thickness t (in.)	Yield Strength F_y (ksi)	Effective Moment of Inertia at Service Load $I_d = (2I_e + I_g)/3$		Effective Section Modulus at $F_y = 60$ ksi		Allowable Moment		Vertical Web Shear V_n/Ω (lb/ft)
				I_{d+} (in ⁴ /ft)	I_{d-} (in ⁴ /ft)	S_{e+} (in ³ /ft)	S_{e-} (in ³ /ft)	M_{n+}/Ω (lb-ft/ft)	M_{n-}/Ω (lb-ft/ft)	
28	0.7	0.0149	60	0.012	0.012	0.034	0.035	102	105	1191
26	0.9	0.0179	60	0.015	0.015	0.043	0.043	129	129	1719
24	1.1	0.0239	60	0.020	0.020	0.058	0.058	174	174	2391
22	1.4	0.0295	60	0.023	0.023	0.071	0.071	213	213	2943

Allowable Reactions at Supports Based on Web Crippling, R_n/Ω (lb/ft)

Deck Gage	Bearing Length of Webs One-Flange Loading			
	End Bearing		Interior Bearing	
	1 1/2"	2"	1 1/2"	2"
28	348	387	469	515
26	490	543	676	740
24	833	919	1186	1292
22	1227	1349	1782	1933

Standard Features

- ASTM A653 SS GR80 with G60
- Standard lengths – 6'-0" to 42'-0"
- IAPMO UES ER-0652 and UL Listed
- Tables conform to ANSI/SDI NC-2017 and RD-2017

Optional Features

- Inquire regarding cost and lead times for:
 - Short cuts < 6'-0"
 - Sheet Lengths > 42'-0"
 - Alternative metallic and painted finishes
- Side-lap or bottom flange slot venting

0.6C-36 NON-COMPOSITE & ROOF DECKS GRADE 80 STEEL

ASD

Inward Uniform Allowable Loads, ASD (psf)

Deck Gage	Spans	Criteria	Span (ft-in.)										
			1'-0"	1'-6"	2'-0"	2'-6"	3'-0"	3'-6"	4'-0"	4'-6"	5'-0"	5'-6"	6'-0"
28	Single	W_n / Ω	814	362	204	130	90	66	51	40	33	27	23
		L/240	787	233	98	50	29	18	12	9	6	5	4
	Double	W_n / Ω	767	358	205	132	92	68	52	41	33	28	23
		L/240	---	---	---	121	70	44	30	21	15	11	9
	Triple	W_n / Ω	927	439	253	164	115	85	65	51	42	34	29
		L/240	---	---	186	95	55	35	23	16	12	9	7
26	Single	W_n / Ω	1030	458	257	165	114	84	64	51	41	34	29
		L/240	983	291	123	63	36	23	15	11	8	6	5
	Double	W_n / Ω	965	444	253	163	114	84	64	51	41	34	29
		L/240	---	---	---	152	88	55	37	26	19	14	11
	Triple	W_n / Ω	1174	548	314	203	141	104	80	63	51	42	36
		L/240	---	---	232	119	69	43	29	20	15	11	9
24	Single	W_n / Ω	1389	617	347	222	154	113	87	69	56	46	39
		L/240	1311	388	164	84	49	31	20	14	10	8	6
	Double	W_n / Ω	1306	600	342	220	153	113	86	68	55	46	39
		L/240	---	---	---	202	117	74	49	35	25	19	15
	Triple	W_n / Ω	1592	741	424	274	191	141	108	85	69	57	48
		L/240	---	733	309	158	92	58	39	27	20	15	11
22	Single	W_n / Ω	1701	756	425	272	189	139	106	84	68	56	47
		L/240	1508	447	188	96	56	35	24	17	12	9	7
	Double	W_n / Ω	1599	735	418	269	188	138	106	84	68	56	47
		L/240	---	---	---	232	135	85	57	40	29	22	17
	Triple	W_n / Ω	1950	908	519	335	234	172	132	104	85	70	59
		L/240	---	843	356	182	105	66	44	31	23	17	13

Notes:

1. Table does not account for web crippling. Required bearing should be determined based on specific span conditions.
2. The symbol "---" indicates that the uniform allowable load based on deflection exceeds the allowable load based on stress.

NOTICE: Design defects that could cause injury or death may result from relying on the information in this document without independent verification by a qualified professional. The information in this document is provided "AS IS". Nucor Corporation and its affiliates expressly disclaim: (i) any and all representations, warranties and conditions and (ii) all liability arising out of or related to this document and the information in it.

1.0C-32 NON-COMPOSITE & ROOF DECK GRADE 80 STEEL

ASD

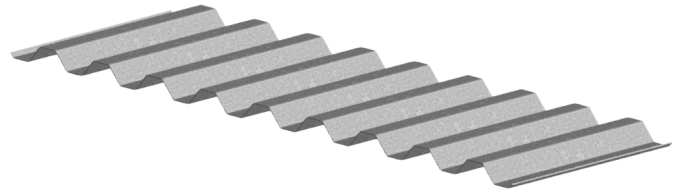
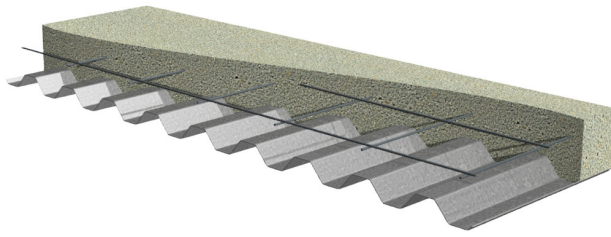

Nominal Dimensions

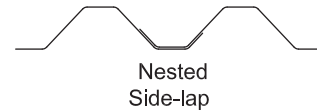
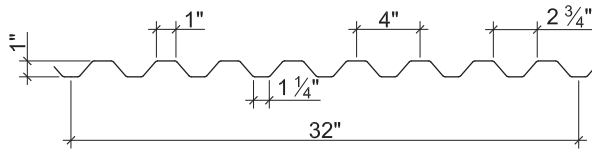

Section Properties

Deck Gage	Deck Weight w_{dd} (psf)	Base Metal Thickness t (in.)	Yield Strength F_y (ksi)	Effective Moment of Inertia at Service Load $I_d = (2I_e + I_g)/3$		Effective Section Modulus at $F_y = 60$ ksi		Allowable Moment		Vertical Web Shear V_n/Ω (lb/ft)
				I_{d+} (in ⁴ /ft)	I_{d-} (in ⁴ /ft)	S_{e+} (in ³ /ft)	S_{e-} (in ³ /ft)	M_{n+}/Ω (lb-ft/ft)	M_{n-}/Ω (lb-ft/ft)	
26	0.9	0.0179	60	0.041	0.043	0.067	0.071	201	213	1673
24	1.2	0.0239	60	0.057	0.058	0.098	0.103	293	308	2922
22	1.5	0.0295	60	0.071	0.071	0.130	0.134	389	401	3598
20	1.9	0.0358	60	0.090	0.090	0.168	0.166	503	497	4353

Allowable Reactions at Supports Based on Web Crippling, R_n/Ω (lb/ft)

Deck Gage	Bearing Length of Webs One-Flange Loading					
	End Bearing			Interior Bearing		
	1 1/2"	2"	3"	1 1/2"	2"	3"
26	479	530	617	724	792	906
24	815	899	1039	1250	1361	1547
22	1198	1317	1516	1856	2014	2278
20	1707	1870	2144	2668	2884	3247

Standard Features

- ASTM A653 SS GR80 with G60
- Standard lengths – 6'-0" to 42'-0"
- IAPMO UES ER-0652 and UL Listed
- Tables conform to ANSI/SDI NC-2017 and RD-2017

Optional Features

- Inquire regarding cost and lead times for:
 - Short cuts < 6'-0"
 - Sheet Lengths > 42'-0"
 - Alternative metallic and painted finishes
- Side-lap or bottom flange slot venting

1.0C-32 NON-COMPOSITE & ROOF DECK GRADE 80 STEEL

ASD

Inward Uniform Allowable Loads, ASD (psf)

Deck Gage	Spans	Criteria	Span (ft-in.)										
			2'-0"	2'-6"	3'-0"	3'-6"	4'-0"	4'-6"	5'-0"	5'-6"	6'-0"	6'-6"	7'-0"
26	Single	W_n / Ω	401	257	178	131	100	79	64	53	45	38	33
		L/240	336	172	100	63	42	29	22	16	12	10	8
	Double	W_n / Ω	405	264	185	137	105	83	67	56	47	40	35
		L/240	---	---	---	---	---	75	54	41	31	25	20
	Triple	W_n / Ω	497	325	229	170	131	103	84	70	59	50	43
		L/240	---	---	197	124	83	58	43	32	25	19	16
24	Single	W_n / Ω	587	376	261	192	147	116	94	78	65	56	48
		L/240	467	239	138	87	58	41	30	22	17	14	11
	Double	W_n / Ω	596	386	270	199	153	121	98	81	68	58	50
		L/240	---	---	---	---	143	101	73	55	42	33	27
	Triple	W_n / Ω	735	478	335	248	190	151	122	101	85	73	63
		L/240	---	459	266	167	112	79	57	43	33	26	21
22	Single	W_n / Ω	778	498	346	254	195	154	125	103	86	74	64
		L/240	582	298	172	109	73	51	37	28	22	17	14
	Double	W_n / Ω	773	501	351	259	199	157	128	106	89	76	65
		L/240	---	---	---	---	175	123	90	67	52	41	33
	Triple	W_n / Ω	951	620	435	322	247	196	159	132	111	94	82
		L/240	---	562	325	205	137	96	70	53	41	32	26
20	Single	W_n / Ω	1006	644	447	328	251	199	161	133	112	95	82
		L/240	738	378	219	138	92	65	47	35	27	21	17
	Double	W_n / Ω	956	620	434	320	246	195	158	131	110	94	81
		L/240	---	---	---	---	222	156	114	85	66	52	41
	Triple	W_n / Ω	1175	767	538	398	306	243	197	163	137	117	101
		L/240	---	713	413	260	174	122	89	67	52	41	32

Notes:

1. Table does not account for web crippling. Required bearing should be determined based on specific span conditions.
2. The symbol "---" indicates that the uniform allowable load based on deflection exceeds the allowable load based on stress.

NOTICE: Design defects that could cause injury or death may result from relying on the information in this document without independent verification by a qualified professional. The information in this document is provided "AS IS". Nucor Corporation and its affiliates expressly disclaim: (i) any and all representations, warranties and conditions and (ii) all liability arising out of or related to this document and the information in it.

1.0C-33 NON-COMPOSITE DECK & ROOF DECK GRADE 80 STEEL

ASD

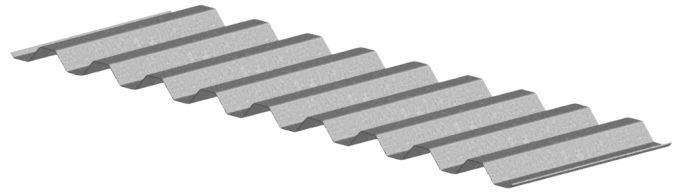
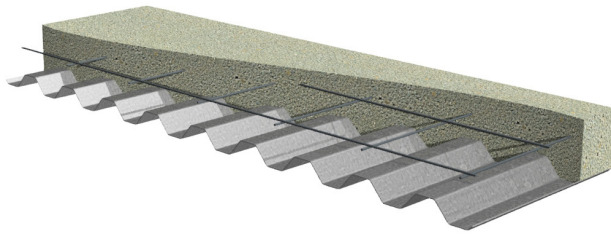

Nominal Dimensions

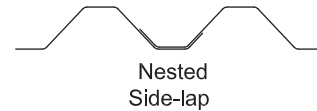
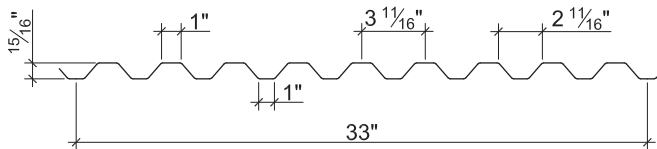

Section Properties

Deck Gage	Deck Weight w_{dd} (psf)	Base Metal Thickness t (in.)	Yield Strength F_y (ksi)	Effective Moment of Inertia at Service Load $I_d = (2I_e + I_g)/3$		Effective Section Modulus at $F_y = 60$ ksi		Allowable Moment		Vertical Web Shear V_n/Ω (lb/ft)
				I_{d+} (in ⁴ /ft)	I_{d-} (in ⁴ /ft)	S_{e+} (in ³ /ft)	S_{e-} (in ³ /ft)	M_{n+}/Ω (lb-ft/ft)	M_{n-}/Ω (lb-ft/ft)	
26	0.9	0.0179	60	0.036	0.036	0.065	0.068	195	204	1606
24	1.2	0.0239	60	0.050	0.049	0.096	0.097	287	290	2131
22	1.5	0.0295	60	0.062	0.062	0.121	0.120	362	359	2613
20	1.8	0.0358	60	0.076	0.076	0.147	0.146	440	437	3148

Allowable Reactions at Supports Based on Web Crippling, R_n/Ω (lb/ft)

Deck Gage	Bearing Length of Webs One-Flange Loading					
	End Bearing			Interior Bearing		
	1 1/2"	2"	3"	1 1/2"	2"	3"
26	482	534	572	509	557	592
24	832	917	978	965	1050	1111
22	1232	1354	1437	1508	1636	1723
20	1769	1938	2046	2256	2439	2556

Standard Features

- ASTM A653 SS GR80 with G60
- Standard lengths – 6'-0" to 42'-0"
- IAPMO UES ER-0652 and UL Listed
- Tables conform to ANSI/SDI NC-2017 and RD-2017

Optional Features

- Inquire regarding cost and lead times for:
 - Short cuts < 6'-0"
 - Sheet Lengths > 42'-0"
 - Alternative metallic and painted finishes
- Side-lap or bottom flange slot venting

1.0C-33 NON-COMPOSITE & ROOF DECK GRADE 80 STEEL

ASD

Inward Uniform Allowable Loads, ASD (psf)

Deck Gage	Spans	Criteria	Span (ft-in.)										
			2'-0"	2'-6"	3'-0"	3'-6"	4'-0"	4'-6"	5'-0"	5'-6"	6'-0"	6'-6"	7'-0"
26	Single	W_n / Ω	389	249	173	127	97	77	62	51	43	37	32
		L/240	295	151	87	55	37	26	19	14	11	9	7
	Double	W_n / Ω	388	253	177	131	101	80	65	53	45	38	33
		L/240	---	---	---	---	89	62	45	34	26	21	17
	Triple	W_n / Ω	476	312	219	162	125	99	81	67	56	48	41
		L/240	---	285	165	104	70	49	36	27	21	16	13
24	Single	W_n / Ω	575	368	255	188	144	114	92	76	64	54	47
		L/240	410	210	121	76	51	36	26	20	15	12	10
	Double	W_n / Ω	550	359	252	186	143	113	92	76	64	55	47
		L/240	---	---	---	180	121	85	62	47	36	28	23
	Triple	W_n / Ω	672	442	311	231	178	141	115	95	80	68	59
		L/240	---	388	225	141	95	67	49	36	28	22	18
22	Single	W_n / Ω	725	464	322	237	181	143	116	96	81	69	59
		L/240	508	260	151	95	64	45	33	24	19	15	12
	Double	W_n / Ω	680	443	311	230	177	140	114	94	79	68	58
		L/240	---	---	---	228	153	107	78	59	45	36	29
	Triple	W_n / Ω	830	546	385	285	220	175	142	117	99	84	73
		L/240	---	491	284	179	120	84	61	46	36	28	22
20	Single	W_n / Ω	880	563	391	287	220	174	141	116	98	83	72
		L/240	623	319	185	116	78	55	40	30	23	18	15
	Double	W_n / Ω	826	539	379	280	215	171	139	115	96	82	71
		L/240	---	---	---	280	188	132	96	72	56	44	35
	Triple	W_n / Ω	1009	664	468	347	267	212	172	143	120	103	89
		L/240	---	602	348	219	147	103	75	57	44	34	27

Notes:

1. Table does not account for web crippling. Required bearing should be determined based on specific span conditions.
2. The symbol "---" indicates that the uniform allowable load based on deflection exceeds the allowable load based on stress.

NOTICE: Design defects that could cause injury or death may result from relying on the information in this document without independent verification by a qualified professional. The information in this document is provided "AS IS". Nucor Corporation and its affiliates expressly disclaim: (i) any and all representations, warranties and conditions and (ii) all liability arising out of or related to this document and the information in it.

1.0C-36 NON-COMPOSITE & ROOF DECK GRADE 80 STEEL

ASD

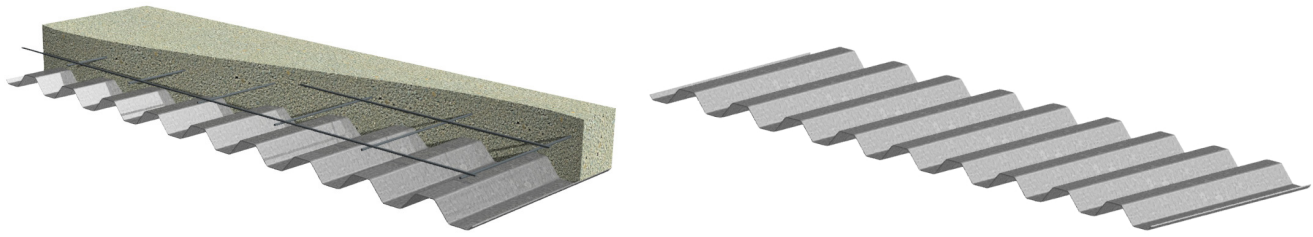

Nominal Dimensions

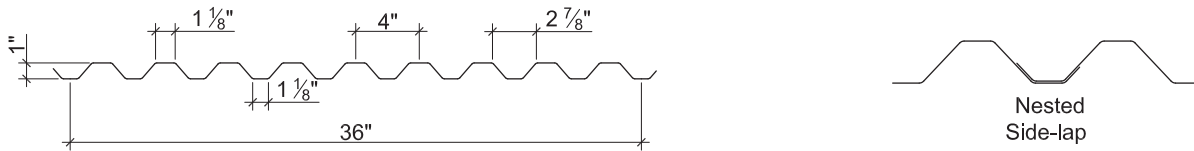

Section Properties

Deck Gage	Deck Weight w_{dd} (psf)	Base Metal Thickness t (in.)	Yield Strength F_y (ksi)	Effective Moment of Inertia at Service Load $I_d = (2I_e + I_g)/3$		Effective Section Modulus at $F_y = 60$ ksi		Allowable Moment		Vertical Web Shear V_n/Ω (lb/ft)
				I_{d+} (in ⁴ /ft)	I_{d-} (in ⁴ /ft)	S_{e+} (in ³ /ft)	S_{e-} (in ³ /ft)	M_{n+}/Ω (lb-ft/ft)	M_{n-}/Ω (lb-ft/ft)	
26	0.9	0.0179	60	0.039	0.039	0.065	0.068	195	204	1656
24	1.2	0.0239	60	0.057	0.057	0.099	0.103	296	308	2754
22	1.5	0.0295	60	0.070	0.070	0.129	0.131	386	392	3389
20	1.8	0.0358	60	0.083	0.083	0.160	0.160	479	479	4100

Allowable Reactions at Supports Based on Web Crippling, R_n/Ω (lb/ft)

Deck Gage	Bearing Length of Webs One-Flange Loading					
	End Bearing			Interior Bearing		
	1 1/2"	2"	3"	1 1/2"	2"	3"
26	464	514	598	658	720	825
24	792	873	1010	1154	1257	1429
22	1167	1283	1477	1730	1877	2122
20	1665	1824	2091	2504	2707	3047

Standard Features

- ASTM A653 SS GR80 with G60
- Standard lengths – 6'-0" to 42'-0"
- IAPMO UES ER-0652 and UL Listed
- Tables conform to ANSI/SDI NC-2017 and RD-2017

Optional Features

- Inquire regarding cost and lead times for:
 - Short cuts < 6'-0"
 - Sheet Lengths > 42'-0"
 - Alternative metallic and painted finishes
- Side-lap or bottom flange slot venting

1.0C-36 NON-COMPOSITE & ROOF DECK GRADE 80 STEEL

ASD

Inward Uniform Allowable Loads, ASD (psf)

Deck Gage	Spans	Criteria	Span (ft-in.)										
			2'-0"	2'-6"	3'-0"	3'-6"	4'-0"	4'-6"	5'-0"	5'-6"	6'-0"	6'-6"	7'-0"
26	Single	W_n / Ω	389	249	173	127	97	77	62	51	43	37	32
		L/240	320	164	95	60	40	28	20	15	12	9	7
	Double	W_n / Ω	389	253	177	131	101	80	65	54	45	38	33
		L/240	---	---	---	---	96	68	49	37	29	22	18
	Triple	W_n / Ω	478	312	220	163	125	99	81	67	56	48	41
		L/240	---	309	179	113	75	53	39	29	22	18	14
24	Single	W_n / Ω	593	379	263	194	148	117	95	78	66	56	48
		L/240	467	239	138	87	58	41	30	22	17	14	11
	Double	W_n / Ω	594	385	269	199	153	121	98	81	68	58	50
		L/240	---	---	---	---	141	99	72	54	42	33	26
	Triple	W_n / Ω	731	477	334	247	190	151	122	101	85	73	63
		L/240	---	452	261	165	110	77	56	42	33	26	21
22	Single	W_n / Ω	772	494	343	252	193	153	124	102	86	73	63
		L/240	574	294	170	107	72	50	37	28	21	17	13
	Double	W_n / Ω	754	489	342	253	194	154	125	103	87	74	64
		L/240	---	---	---	---	173	121	88	66	51	40	32
	Triple	W_n / Ω	926	605	425	314	242	191	155	129	108	92	80
		L/240	---	554	321	202	135	95	69	52	40	32	25
20	Single	W_n / Ω	958	613	426	313	240	189	153	127	106	91	78
		L/240	680	348	202	127	85	60	44	33	25	20	16
	Double	W_n / Ω	920	597	418	309	237	188	152	126	106	90	78
		L/240	---	---	---	306	205	144	105	79	61	48	38
	Triple	W_n / Ω	1130	738	518	383	295	234	190	157	132	113	97
		L/240	---	657	380	240	161	113	82	62	48	37	30

Notes:

1. Table does not account for web crippling. Required bearing should be determined based on specific span conditions.
2. The symbol "---" indicates that the uniform allowable load based on deflection exceeds the allowable load based on stress.

NOTICE: Design defects that could cause injury or death may result from relying on the information in this document without independent verification by a qualified professional. The information in this document is provided "AS IS". Nucor Corporation and its affiliates expressly disclaim: (i) any and all representations, warranties and conditions and (ii) all liability arising out of or related to this document and the information in it.

1.3C-32 NON-COMPOSITE DECK & ROOF DECK GRADE 80 STEEL

ASD

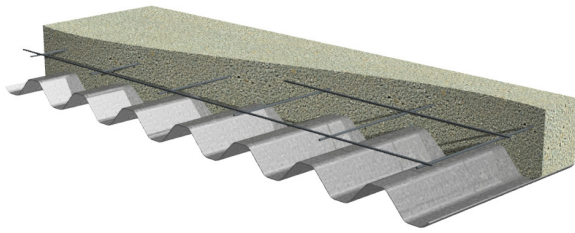

Nominal Dimensions

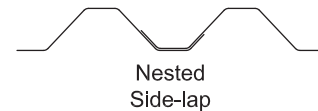
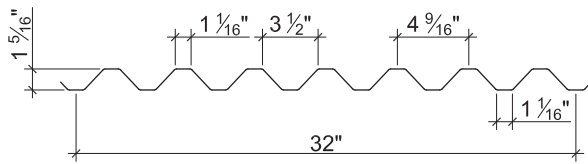

Section Properties

Deck Gage	Deck Weight w_{dd} (psf)	Base Metal Thickness t (in.)	Yield Strength F_y (ksi)	Effective Moment of Inertia at Service Load $I_d = (2I_e + I_g)/3$		Effective Section Modulus at $F_y = 60$ ksi		Allowable Moment		Vertical Web Shear V_n/Ω (lb/ft)
				I_{d+} (in ⁴ /ft)	I_{d-} (in ⁴ /ft)	S_{e+} (in ³ /ft)	S_{e-} (in ³ /ft)	M_{n+}/Ω (lb-ft/ft)	M_{n-}/Ω (lb-ft/ft)	
26	0.9	0.0179	60	0.067	0.067	0.080	0.089	240	266	1422
24	1.3	0.0239	60	0.093	0.092	0.126	0.130	377	389	2538
22	1.6	0.0295	60	0.116	0.116	0.163	0.163	488	488	3481
20	1.9	0.0358	60	0.139	0.139	0.197	0.197	590	590	4211

Allowable Reactions at Supports Based on Web Crippling, R_n/Ω (lb/ft)

Deck Gage	Bearing Length of Webs One-Flange Loading					
	End Bearing			Interior Bearing		
	1 1/2"	2"	3"	1 1/2"	2"	3"
26	353	391	454	393	430	492
24	614	677	783	746	812	923
22	915	1006	1158	1166	1265	1431
20	1318	1444	1656	1744	1885	2122

Standard Features

- ASTM A653 SS GR80 with G60
- Standard lengths – 6'-0" to 42'-0"
- IAPMO UES ER-652 and UL Listed
- Tables conform to ANSI/SDI NC-2017 and RD-2017

Optional Features

- Inquire regarding cost and lead times for:
 - Short cuts < 6'-0"
 - Sheet Lengths > 42'-0"
 - Alternative metallic and painted finishes
- Side-lap or bottom flange slot venting

1.3C-32 NON-COMPOSITE DECK & ROOF DECK GRADE 80 STEEL

ASD

Inward Uniform Allowable Loads, ASD (psf)

Deck Gage	Spans	Criteria	Span (ft-in.)										
			4'-0"	4'-6"	5'-0"	5'-6"	6'-0"	6'-6"	7'-0"	7'-6"	8'-0"	9'-0"	10'-0"
26	Single	W_n / Ω	120	95	77	63	53	45	39	34	30	24	19
		L/240	69	48	35	26	20	16	13	10	9	6	4
	Double	W_n / Ω	130	103	84	69	59	50	43	38	33	26	21
		L/240	---	---	---	64	49	39	31	25	21	15	11
	Triple	W_n / Ω	160	128	104	86	73	62	54	47	41	33	26
		L/240	130	91	66	50	38	30	24	20	16	11	8
24	Single	W_n / Ω	189	149	121	100	84	71	62	54	47	37	30
		L/240	95	67	49	37	28	22	18	14	12	8	6
	Double	W_n / Ω	191	152	123	102	86	73	63	55	48	38	31
		L/240	---	---	116	87	67	53	42	34	28	20	15
	Triple	W_n / Ω	237	188	153	127	107	91	79	69	60	48	39
		L/240	178	125	91	68	53	41	33	27	22	16	11
22	Single	W_n / Ω	244	193	156	129	108	92	80	69	61	48	39
		L/240	119	83	61	46	35	28	22	18	15	10	8
	Double	W_n / Ω	240	191	155	128	108	92	79	69	61	48	39
		L/240	---	---	147	110	85	67	53	43	36	25	18
	Triple	W_n / Ω	298	237	193	159	134	115	99	86	76	60	49
		L/240	224	158	115	86	66	52	42	34	28	20	14
20	Single	W_n / Ω	295	233	189	156	131	112	96	84	74	58	47
		L/240	142	100	73	55	42	33	27	22	18	12	9
	Double	W_n / Ω	290	230	187	155	130	111	96	84	73	58	47
		L/240	---	---	176	132	102	80	64	52	43	30	22
	Triple	W_n / Ω	361	286	233	193	162	138	120	104	92	73	59
		L/240	269	189	138	103	80	63	50	41	34	24	17

Notes:

1. Table does not account for web crippling. Required bearing should be determined based on specific span conditions.
2. The symbol "---" indicates that the uniform allowable load based on deflection exceeds the allowable load based on stress.

NOTICE: Design defects that could cause injury or death may result from relying on the information in this document without independent verification by a qualified professional. The information in this document is provided "AS IS". Nucor Corporation and its affiliates expressly disclaim: (i) any and all representations, warranties and conditions and (ii) all liability arising out of or related to this document and the information in it.

1.5C-36 NON-COMPOSITE DECK GRADE 50 STEEL

ASD

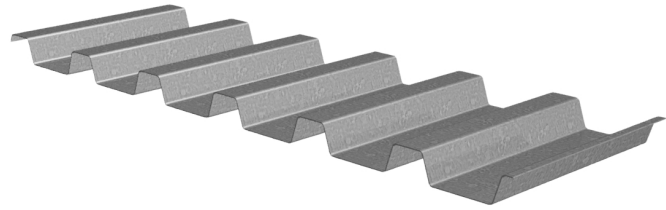
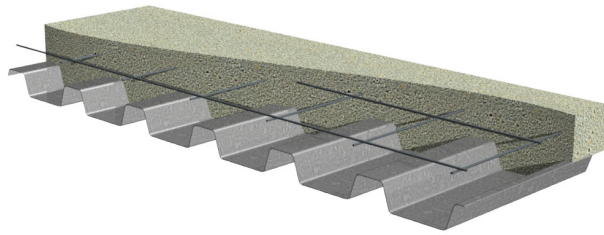

Nominal Dimensions

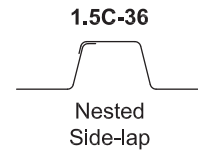
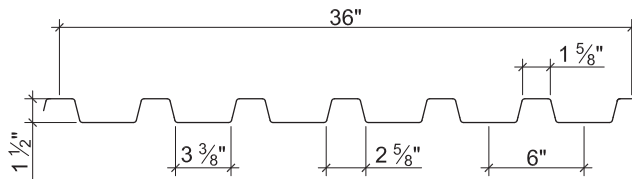

Section Properties

Deck Gage	Deck Weight w_{dd} (psf)	Base Metal Thickness t (in.)	Yield Strength F_y (ksi)	Effective Moment of Inertia at Service Load $I_d = (2I_e + I_g)/3$		Effective Section Modulus at $F_y = 50$ ksi		Allowable Moment		Vertical Web Shear V_n/Ω (lb/ft)
				I_{d+} (in ⁴ /ft)	I_{d-} (in ⁴ /ft)	S_{e+} (in ³ /ft)	S_{e-} (in ³ /ft)	M_{n+}/Ω (lb-ft/ft)	M_{n-}/Ω (lb-ft/ft)	
24	1.3	0.0239	60	0.138	0.118	0.131	0.120	392	359	1551
22	1.6	0.0295	50	0.178	0.155	0.179	0.169	447	422	2654
20	2.0	0.0358	50	0.217	0.197	0.229	0.224	571	559	3207
18	2.6	0.0474	50	0.290	0.277	0.318	0.306	793	763	4209

Allowable Reactions at Supports Based on Web Crippling, R_n/Ω (lb/ft)

Deck Gage	Bearing Length of Webs											
	One-Flange Loading					Two-Flange Loading						
	End Bearing				Interior Bearing		End Bearing				Interior Bearing	
	1 1/2"	2"	3"	4"	3"	4"	1 1/2"	2"	3"	4"	3"	4"
24	657	724	837	918	1197	1300	639	691	778	840	1460	1594
22	807	887	1021	1115	1482	1602	842	908	1017	1093	1834	1994
20	1153	1263	1448	1574	2127	2289	1274	1368	1525	1632	2662	2881
18	1931	2105	2398	2588	3586	3831	2297	2454	2716	2887	4546	4884

Standard Features

- ASTM A653 SS GR50 Min. with G60 -SS GR80 ($F_y=60$) for 24 gage
- Standard lengths – 6'-0" to 42'-0"
- IAPMO UES ER-0652 and UL Listed
- Tables conform to ANSI/SDI NC-2017

Optional Features

- Inquire regarding cost and lead times for:
 - Short cuts < 6'-0"
 - Sheet Lengths > 42'-0"
 - Alternative metallic and painted finishes

1.5C-36 NON-COMPOSITE DECK GRADE 50 STEEL

ASD

Inward Uniform Allowable Loads, ASD (psf)

Deck Gage	Spans	Criteria	Span (ft-in.)										
			4'-0"	4'-6"	5'-0"	5'-6"	6'-0"	6'-6"	7'-0"	7'-6"	8'-0"	9'-0"	10'-0"
24	Single	W_n / Ω	196	155	126	104	87	74	64	56	49	39	31
		L/240	141	99	72	54	42	33	26	21	18	12	9
	Double	W_n / Ω	173	137	112	93	78	67	58	50	44	35	29
		L/240	---	---	---	---	---	---	54	44	36	26	19
	Triple	W_n / Ω	212	170	138	115	97	83	72	63	55	44	36
		L/240	---	160	117	88	68	53	43	35	29	20	15
22	Single	W_n / Ω	223	176	143	118	99	85	73	64	56	44	36
		L/240	182	128	93	70	54	42	34	28	23	16	12
	Double	W_n / Ω	207	164	133	110	93	79	68	60	52	41	34
		L/240	---	---	---	---	---	---	---	58	48	34	24
	Triple	W_n / Ω	256	204	166	137	116	99	85	74	65	52	42
		L/240	---	---	153	115	89	70	56	45	37	26	19
20	Single	W_n / Ω	286	226	183	151	127	108	93	81	71	56	46
		L/240	222	156	114	86	66	52	41	34	28	20	14
	Double	W_n / Ω	273	217	176	146	123	105	91	79	69	55	45
		L/240	---	---	---	---	---	---	---	74	61	43	31
	Triple	W_n / Ω	338	269	219	181	153	131	113	98	87	69	56
		L/240	---	268	195	147	113	89	71	58	48	33	24
18	Single	W_n / Ω	397	313	254	210	176	150	130	113	99	78	63
		L/240	297	209	152	114	88	69	55	45	37	26	19
	Double	W_n / Ω	372	296	240	199	168	143	124	108	95	75	61
		L/240	---	---	---	---	---	---	---	104	85	60	44
	Triple	W_n / Ω	460	366	298	248	209	178	154	134	118	94	76
		L/240	---	---	274	206	159	125	100	81	67	47	34

Notes:

1. Table does not account for web crippling. Required bearing should be determined based on specific span conditions.
2. The symbol "---" indicates that the uniform allowable load based on deflection exceeds the allowable load based on stress.

NOTICE: Design defects that could cause injury or death may result from relying on the information in this document without independent verification by a qualified professional. The information in this document is provided "AS IS". Nucor Corporation and its affiliates expressly disclaim: (i) any and all representations, warranties and conditions and (ii) all liability arising out of or related to this document and the information in it.

2C-36 NON-COMPOSITE DECK GRADE 50 STEEL

ASD

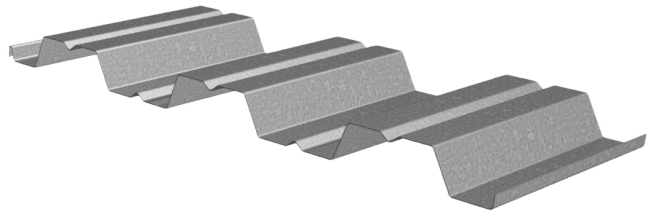
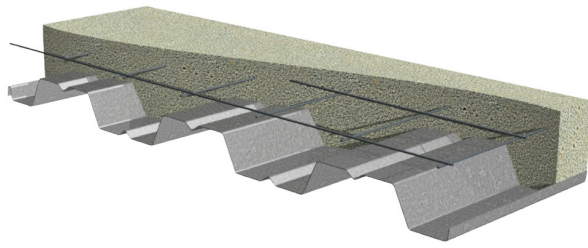

Nominal Dimensions

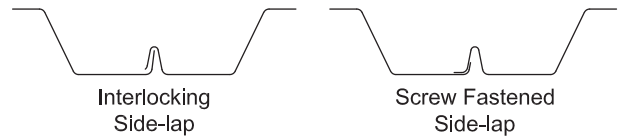
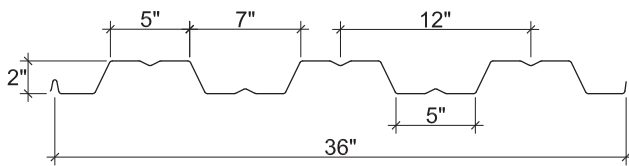

Section Properties

Deck Gage	Deck Weight w_{dd} (psf)	Base Metal Thickness t (in.)	Yield Strength F_y (ksi)	Effective Moment of Inertia at Service Load $I_d = (2I_e + I_g)/3$		Effective Section Modulus at $F_y = 50$ ksi		Allowable Moment		Vertical Web Shear V_n/Ω (lb/ft)
				I_{d+} (in ⁴ /ft)	I_{d-} (in ⁴ /ft)	S_{e+} (in ³ /ft)	S_{e-} (in ³ /ft)	M_{n+}/Ω (lb-ft/ft)	M_{n-}/Ω (lb-ft/ft)	
22	1.6	0.0295	50	0.324	0.324	0.244	0.255	609	637	1641
20	1.9	0.0358	50	0.409	0.407	0.326	0.337	813	841	2419
18	2.5	0.0474	50	0.557	0.557	0.485	0.500	1210	1247	3240
16	3.2	0.0598	50	0.703	0.703	0.643	0.652	1604	1627	4069

Allowable Reactions at Supports Based on Web Crippling, R_n/Ω (lb/ft)

Deck Gage	Bearing Length of Webs											
	One-Flange Loading						Two-Flange Loading					
	End Bearing				Interior Bearing		End Bearing				Interior Bearing	
	1½"	2"	3"	4"	4"	6"	1½"	2"	3"	4"	4"	6"
22	363	399	460	511	767	882	362	390	437	476	924	1071
20	522	571	655	726	1098	1257	554	595	663	721	1342	1550
18	879	959	1092	1205	1843	2095	1013	1082	1198	1296	2292	2631
16	1354	1470	1666	1830	2825	3194	1654	1759	1936	2085	3554	4059

Standard Features

- ASTM A653 SS GR50 Min. with G60
- Standard lengths – 6'-0" to 42'-0"
- IAPMO UES ER-652 and UL Listed
- Tables conform to ANSI/SDI NC-2017

Optional Features

- Inquire regarding cost and lead times for:
 - Short cuts < 6'-0"
 - Sheet Lengths > 42'-0"
 - Alternative metallic and painted finishes
- Factory Hanger Tabs

2C-36 NON-COMPOSITE DECK GRADE 50 STEEL

ASD

Inward Uniform Allowable Loads, ASD (psf)

Deck Gage	Spans	Criteria	Span (ft-in.)										
			5'-0"	5'-6"	6'-0"	6'-6"	7'-0"	7'-6"	8'-0"	8'-6"	9'-0"	10'-0"	11'-0"
22	Single	W_n / Ω	195	161	135	115	99	87	76	67	60	49	40
		L/240	170	128	98	77	62	50	41	35	29	21	16
	Double	W_n / Ω	190	159	135	115	100	88	77	69	61	50	41
		L/240	---	---	---	---	---	---	---	---	---	---	38
	Triple	W_n / Ω	231	194	165	142	123	108	95	85	76	62	51
		L/240	---	---	---	---	117	95	78	65	55	40	30
20	Single	W_n / Ω	260	215	181	154	133	116	102	90	80	65	54
		L/240	214	161	124	98	78	64	52	44	37	27	20
	Double	W_n / Ω	254	212	179	154	133	116	103	91	82	66	55
		L/240	---	---	---	---	---	---	---	---	---	64	48
	Triple	W_n / Ω	310	260	221	189	164	144	127	113	101	82	68
		L/240	---	---	---	183	147	119	98	82	69	50	38
18	Single	W_n / Ω	387	320	269	229	198	172	151	134	120	97	80
		L/240	292	219	169	133	106	87	71	59	50	37	27
	Double	W_n / Ω	372	311	264	226	196	172	152	135	120	98	81
		L/240	---	---	---	---	---	---	---	---	---	88	66
	Triple	W_n / Ω	453	380	323	278	242	212	187	167	149	122	101
		L/240	---	---	319	251	201	163	135	112	95	69	52
16	Single	W_n / Ω	513	424	356	304	262	228	201	178	158	128	106
		L/240	369	277	213	168	134	109	90	75	63	46	35
	Double	W_n / Ω	483	404	343	294	255	224	197	175	157	128	106
		L/240	---	---	---	---	---	---	---	---	152	111	83
	Triple	W_n / Ω	587	493	420	361	314	275	243	217	194	158	131
		L/240	---	---	403	317	254	206	170	142	119	87	65

Notes:

1. Table does not account for web crippling. Required bearing should be determined based on specific span conditions.
2. The symbol “---” indicates that the uniform allowable load based on deflection exceeds the allowable load based on stress.

NOTICE: Design defects that could cause injury or death may result from relying on the information in this document without independent verification by a qualified professional. The information in this document is provided “AS IS”. Nucor Corporation and its affiliates expressly disclaim: (i) any and all representations, warranties and conditions and (ii) all liability arising out of or related to this document and the information in it.

3C-36 NON-COMPOSITE DECK GRADE 50 STEEL

ASD

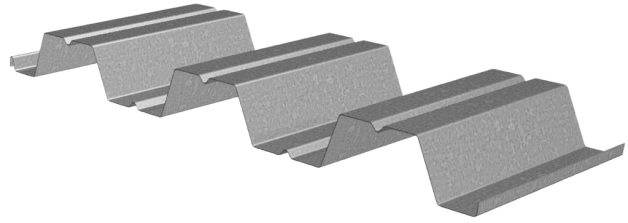
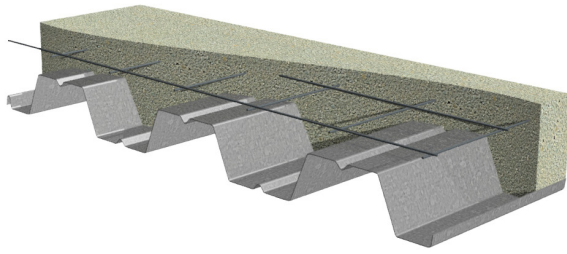

Nominal Dimensions

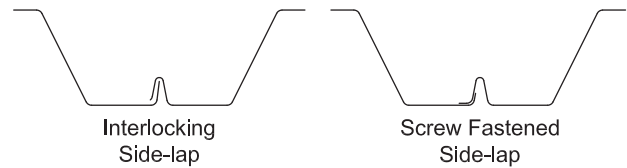
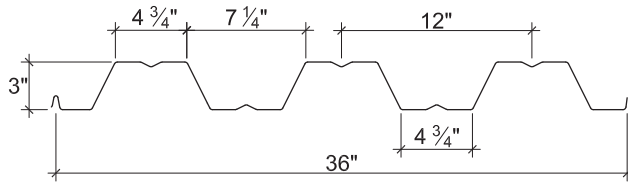

Section Properties

Deck Gage	Deck Weight w_{dd} (psf)	Base Metal Thickness t (in.)	Yield Strength F_y (ksi)	Effective Moment of Inertia at Service Load $I_d = (2I_e + I_g)/3$		Effective Section Modulus at $F_y = 50$ ksi		Allowable Moment		Vertical Web Shear V_n/Ω (lb/ft)
				I_{d+} (in ⁴ /ft)	I_{d-} (in ⁴ /ft)	S_{e+} (in ³ /ft)	S_{e-} (in ³ /ft)	M_{n+}/Ω (lb-ft/ft)	M_{n-}/Ω (lb-ft/ft)	
22	1.7	0.0295	50	0.732	0.737	0.387	0.410	966	1023	1407
20	2.1	0.0358	50	0.919	0.921	0.512	0.539	1277	1345	2485
18	2.7	0.0474	50	1.253	1.253	0.761	0.794	1899	1981	4361
16	3.5	0.0598	50	1.580	1.580	1.013	1.013	2528	2528	6126

Allowable Reactions at Supports Based on Web Crippling, R_n/Ω (lb/ft)

Deck Gage	Bearing Length of Webs											
	One-Flange Loading						Two-Flange Loading					
	End Bearing				Interior Bearing		End Bearing				Interior Bearing	
	1 1/2"	2"	3"	4"	4"	8"	1 1/2"	2"	3"	4"	4"	8"
22	353	388	446	496	783	910	333	359	402	439	910	1068
20	510	559	640	709	1121	1388	518	556	620	674	1328	1668
18	866	944	1075	1186	1881	2356	963	1028	1138	1231	2279	2900
16	1339	1455	1648	1811	2884	3579	1589	1690	1860	2003	3546	4474

Standard Features

- ASTM A653 SS GR50 Min. with G60
- Standard lengths – 6'-0" to 42'-0"
- IAPMO UES ER-652 and UL Listed
- Tables conform to ANSI/SDI NC-2017

Optional Features

- Inquire regarding cost and lead times for:
 - Short cuts < 6'-0"
 - Sheet Lengths > 42'-0"
 - Alternative metallic and painted finishes
- Factory Hanger Tabs

3C-36 NON-COMPOSITE DECK GRADE 50 STEEL

ASD

Inward Uniform Allowable Loads, ASD (psf)

Deck Gage	Spans	Criteria	Span (ft-in.)										
			6'-0"	7'-0"	7'-6"	8'-0"	8'-6"	9'-0"	9'-6"	10'-0"	11'-0"	12'-0"	13'-0"
22	Single	W_n / Ω	215	158	137	121	107	95	86	77	64	54	46
		L/240	---	140	114	94	78	66	56	48	36	28	22
	Double	W_n / Ω	194	148	131	116	104	94	85	77	64	54	47
		L/240	---	---	---	---	---	---	---	---	---	---	---
	Triple	W_n / Ω	230	177	157	140	126	114	103	94	79	67	57
		L/240	---	---	---	---	---	---	---	91	69	53	42
20	Single	W_n / Ω	284	209	182	160	141	126	113	102	84	71	60
		L/240	279	176	143	118	98	83	70	60	45	35	27
	Double	W_n / Ω	272	205	180	159	142	127	115	104	86	73	62
		L/240	---	---	---	---	---	---	---	---	---	---	---
	Triple	W_n / Ω	329	249	219	195	174	156	141	128	107	90	77
		L/240	---	---	---	---	---	---	133	114	86	66	52
18	Single	W_n / Ω	422	310	270	237	210	188	168	152	126	105	90
		L/240	380	239	195	160	134	113	96	82	62	48	37
	Double	W_n / Ω	412	308	270	238	212	190	171	155	128	108	92
		L/240	---	---	---	---	---	---	---	---	---	---	90
	Triple	W_n / Ω	501	377	331	293	261	234	211	191	159	134	115
		L/240	---	---	---	---	253	213	181	155	117	90	71
16	Single	W_n / Ω	562	413	359	316	280	250	224	202	167	140	120
		L/240	480	302	246	202	169	142	121	104	78	60	47
	Double	W_n / Ω	531	396	347	306	272	243	219	198	164	138	118
		L/240	---	---	---	---	---	---	---	---	---	---	114
	Triple	W_n / Ω	649	486	427	377	336	301	271	245	204	172	147
		L/240	---	---	---	---	318	268	228	196	147	113	89

Notes:

1. Table does not account for web crippling. Required bearing should be determined based on specific span conditions.
2. The symbol "---" indicates that the uniform allowable load based on deflection exceeds the allowable load based on stress.

NOTICE: Design defects that could cause injury or death may result from relying on the information in this document without independent verification by a qualified professional. The information in this document is provided "AS IS". Nucor Corporation and its affiliates expressly disclaim: (i) any and all representations, warranties and conditions and (ii) all liability arising out of or related to this document and the information in it.



CELLULAR DECK

1.5BP/1.5VLP CELLULAR DECKS GRADE 50 STEEL

ASD

BP CELLULAR ROOF DECK

- 1.5BP Deck used with TSWs or BPs
- 1.5PLBP Deck used with PunchLok® II System

VLP CELLULAR COMPOSITE DECK

- 1.5VLP Deck used with TSWs or BPs
- 1.5PLVLP Deck used with PunchLok® II System

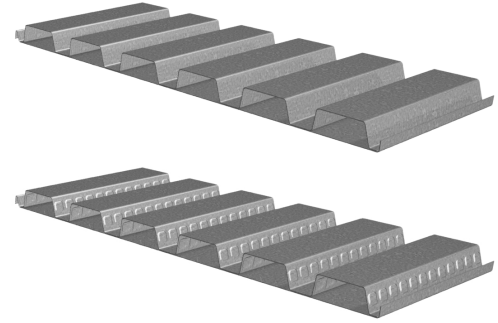

Nominal Dimensions

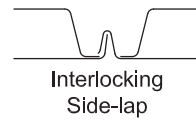
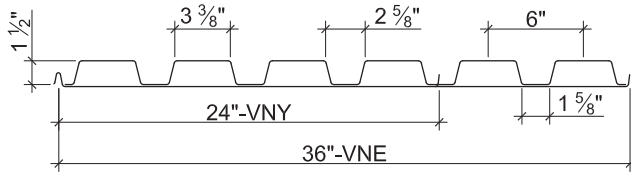

Plant	Cover Width
VNY	24"
VNE	36"

Section Properties

Deck Gage	Deck Weight w_{dd} (psf)	Base Metal Thickness t (in.)	Yield Strength F_y (ksi)	Effective Moment of Inertia at Service Load $I_d = (2I_e + I_g)/3$		Effective Section Modulus at $F_y = 50$ ksi		Allowable Moment		Vertical Web Shear V_n/Ω (lb/ft)
				I_{d+} (in ⁴ /ft)	I_{d-} (in ⁴ /ft)	S_{e+} (in ³ /ft)	S_{e-} (in ³ /ft)	M_{n+}/Ω (lb-ft/ft)	M_{n-}/Ω (lb-ft/ft)	
20/20	3.6	0.0358/0.0358	50	0.393	0.293	0.272	0.240	679	599	3207
20/18	4.1	0.0358/0.0474	50	0.428	0.315	0.280	0.259	699	646	3207
18/20	4.1	0.0474/0.0358	50	0.504	0.369	0.405	0.312	1010	778	4209
18/18	4.6	0.0474/0.0474	50	0.551	0.396	0.415	0.330	1035	823	4209
18/16	5.1	0.0474/0.0598	50	0.594	0.423	0.425	0.350	1060	873	4209
16/18	5.3	0.0598/0.0474	50	0.667	0.479	0.579	0.400	1445	998	5261
16/16	5.8	0.0598/0.0598	50	0.721	0.510	0.591	0.421	1475	1050	5261

Allowable Reactions at Supports Based on Web Crippling, R_n/Ω (lb/ft)

Deck Gage	Bearing Length of Webs											
	One-Flange Loading						Two-Flange Loading					
	End Bearing				Interior Bearing		End Bearing				Interior Bearing	
	1 1/2"	2"	3"	4"	3"	4"	1 1/2"	2"	3"	4"	3"	4"
20/XX	1153	1263	1448	1574	2127	2289	1274	1368	1525	1632	2662	2881
18/XX	1931	2105	2398	2588	3586	3831	2297	2454	2716	2887	4546	4884
16/XX	2958	3212	3639	3900	5517	5855	3713	3950	4347	4590	7050	7523

Standard Features

- ASTM A653 SS GR50 Min., with G60
- Standard lengths – 6'-0" to 42'-0"
- IAPMO UES ER-0652, UL, and FM Listed
- Tables conform to ANSI/SDI RD-2017 and C-2017

Optional Features

- Inquire regarding cost and lead times for:
 - Short Cuts < 6'-0"
 - Sheet Lengths > 42'-0"
 - Alternative metallic finishes
- Cellular Acoustical Versions

NOTICE: Design defects that could cause injury or death may result from relying on the information in this document without independent verification by a qualified professional. The information in this document is provided "AS IS". Nucor Corporation and its affiliates expressly disclaim: (i) any and all representations, warranties and conditions and (ii) all liability arising out of or related to this document and the information in it.

1.5BPA/1.5VLP CELLULAR ACOUSTICAL DECKS GRADE 50 STEEL

ASD

BP CELLULAR ACOUSTICAL ROOF DECK

- 1.5BPA Deck used with TSWs or BPs
- 1.5PLBPA Deck used with PunchLok® II System

VLP CELLULAR ACOUSTICAL COMPOSITE DECK

- 1.5VPLA Deck used with TSWs or BPs
- 1.5PLVPA Deck used with PunchLok® II System

Nominal Dimensions

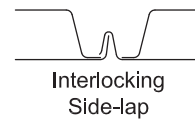
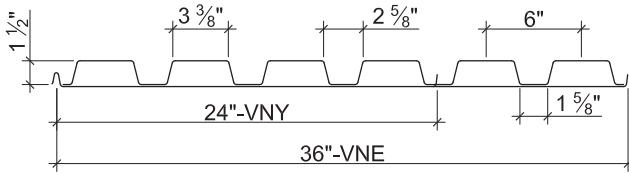
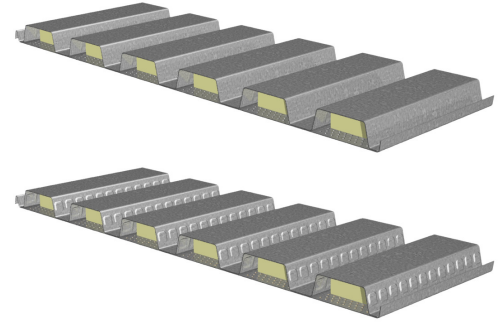

Plant	Cover Width
VNY	24"
VNE	36"

Section Properties

Deck Gage	Deck Weight w_{dd} (psf)	Base Metal Thickness t (in.)	Yield Strength F_y (ksi)	Effective Moment of Inertia at Service Load $I_d = (2I_e + I_g)/3$		Effective Section Modulus at $F_y = 50$ ksi		Allowable Moment		Vertical Web Shear V_n/Ω (lb/ft)
				I_{d+} (in ⁴ /ft)	I_{d-} (in ⁴ /ft)	S_{e+} (in ³ /ft)	S_{e-} (in ³ /ft)	M_{n+}/Ω (lb-ft/ft)	M_{n-}/Ω (lb-ft/ft)	
20/20	3.3	0.0358/0.0358	50	0.380	0.293	0.270	0.240	674	599	3207
20/18	3.8	0.0358/0.0474	50	0.414	0.315	0.277	0.259	691	646	3207
18/20	4.0	0.0474/0.0358	50	0.485	0.369	0.400	0.312	998	778	4209
18/18	4.4	0.0474/0.0474	50	0.530	0.395	0.411	0.330	1025	823	4209
18/16	4.9	0.0474/0.0598	50	0.572	0.407	0.420	0.311	1048	776	4209
16/18	5.1	0.0598/0.0474	50	0.641	0.478	0.571	0.400	1425	998	5261
16/16	5.6	0.0598/0.0598	50	0.692	0.492	0.583	0.380	1455	948	5261

Allowable Reactions at Supports Based on Web Crippling, R_n/Ω (lb/ft)

Deck Gage	Bearing Length of Webs											
	One-Flange Loading						Two-Flange Loading					
	End Bearing				Interior Bearing		End Bearing				Interior Bearing	
	1 1/2"	2"	3"	4"	3"	4"	1 1/2"	2"	3"	4"	3"	4"
20/XX	1153	1263	1448	1574	2127	2289	1274	1368	1525	1632	2662	2881
18/XX	1931	2105	2398	2588	3586	3831	2297	2454	2716	2887	4546	4884
16/XX	2958	3212	3639	3900	5517	5855	3713	3950	4347	4590	7050	7523

Standard Features

- ASTM A653 SS GR50 Min., with G60
- Standard lengths – 6'-0" to 42'-0"
- IAPMO UES ER-0652, UL, and FM Listed
- Tables conform to ANSI/SDI RD-2017 and C-2017

Optional Features

- Inquire regarding cost and lead times for:
 - Short Cuts < 6'-0"
 - Sheet Lengths > 42'-0"
 - Alternative metallic finishes

NOTICE: Design defects that could cause injury or death may result from relying on the information in this document without independent verification by a qualified professional. The information in this document is provided "AS IS". Nucor Corporation and its affiliates expressly disclaim: (i) any and all representations, warranties and conditions and (ii) all liability arising out of or related to this document and the information in it.

3NP-32/3PLNP-32 CELLULAR DECK GRADE 50 STEEL

ASD

32" WIDE 3NP CELLULAR ROOF DECK

- 3NP-32 Deck used with TSWs or BPs
- 3PLNP-32 Deck used with PunchLok® II System

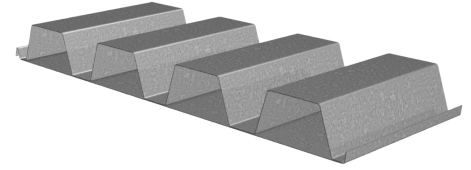

Nominal Dimensions

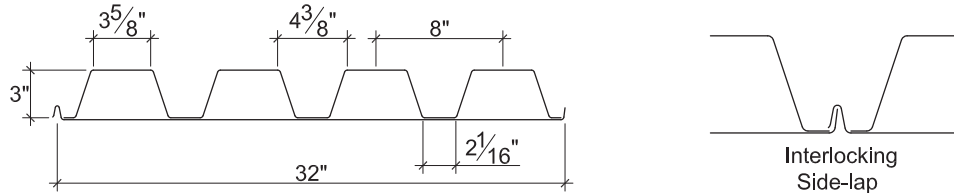

Section Properties

Deck Gage	Deck Weight w_{dd} (psf)	Base Metal Thickness t (in.)	Yield Strength F_y (ksi)	Effective Moment of Inertia at Service Load $I_d = (2I_e + I_g)/3$		Effective Section Modulus at $F_y = 50$ ksi		Allowable Moment		Vertical Web Shear V_n/Ω (lb/ft)
				I_{d+} (in ⁴ /ft)	I_{d-} (in ⁴ /ft)	S_{e+} (in ³ /ft)	S_{e-} (in ³ /ft)	M_{n+}/Ω (lb-ft/ft)	M_{n-}/Ω (lb-ft/ft)	
20/20	3.7	0.0358/0.0358	50	1.519	1.153	0.496	0.492	1238	1228	3761
20/18	4.2	0.0358/0.0474	50	1.645	1.248	0.523	0.552	1305	1377	3761
18/20	4.4	0.0474/0.0358	50	1.931	1.460	0.786	0.674	1961	1682	6598
18/18	4.9	0.0474/0.0474	50	2.094	1.568	0.806	0.733	2011	1829	6598
18/16	5.5	0.0474/0.0598	50	2.243	1.699	0.806	0.822	2011	2051	6598
16/18	5.7	0.0598/0.0474	50	2.549	1.901	1.093	0.901	2727	2248	9064
16/16	6.2	0.0598/0.0598	50	2.732	2.046	1.116	0.998	2784	2490	9064

Allowable Reactions at Supports Based on Web Crippling, R_n/Ω (lb/ft)

Deck Gage	Bearing Length of Webs											
	One-Flange Loading						Two-Flange Loading					
	End Bearing				Interior Bearing		End Bearing				Interior Bearing	
	1 1/2"	2"	3"	4"	4"	8"	1 1/2"	2"	3"	4"	4"	8"
20/XX	774	848	972	1077	1697	2101	788	846	944	1026	2014	2529
18/XX	1313	1432	1631	1799	2847	3565	1464	1563	1731	1872	3454	4397
16/XX	2031	2206	2499	2746	4365	5416	2414	2568	2826	3043	5374	6781

Standard Features

- ASTM A653 SS GR50 Min., with G60
- Standard lengths – 6'-0" to 42'-0"
- IAPMO UES ER-0652 and FM Listed
- Tables conform to ANSI/SDI RD-2017

Optional Features

- Inquire regarding cost and lead times for:
 - Short Cuts < 6'-0"
 - Sheet Lengths > 42'-0"
 - Alternative metallic finishes
- Cellular Acoustical Versions

NOTICE: Design defects that could cause injury or death may result from relying on the information in this document without independent verification by a qualified professional. The information in this document is provided "AS IS". Nucor Corporation and its affiliates expressly disclaim: (i) any and all representations, warranties and conditions and (ii) all liability arising out of or related to this document and the information in it.

3NPA-32/3PLNPA-32 CELLULAR ACOUSTICAL DECK GRADE 50 STEEL

ASD

32" WIDE 3NPA CELLULAR ACOUSTICAL ROOF DECK

- 3NPA-32 Deck used with TSWs or BPs
- 3PLNPA-32 Deck used with PunchLok® II System

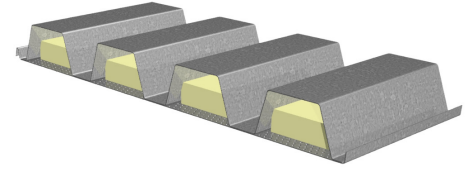

Nominal Dimensions

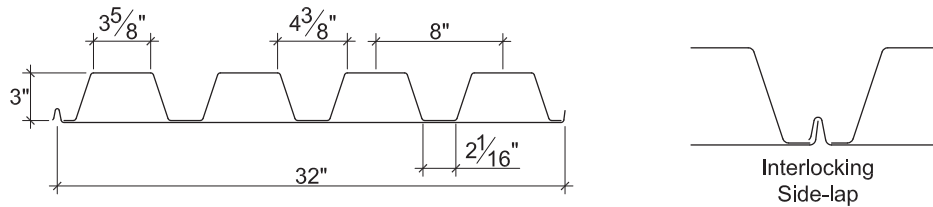

Section Properties

Deck Gage	Deck Weight w_{dd} (psf)	Base Metal Thickness t (in.)	Yield Strength F_y (ksi)	Effective Moment of Inertia at Service Load $I_d = (2I_e + I_g)/3$		Effective Section Modulus at $F_y = 50$ ksi		Allowable Moment		Vertical Web Shear V_n/Ω (lb/ft)
				I_{d+} (in ⁴ /ft)	I_{d-} (in ⁴ /ft)	S_{e+} (in ³ /ft)	S_{e-} (in ³ /ft)	M_{n+}/Ω (lb-ft/ft)	M_{n-}/Ω (lb-ft/ft)	
20/20	3.6	0.0358/0.0358	50	1.458	1.152	0.491	0.492	1225	1228	3761
20/18	4.0	0.0358/0.0474	50	1.578	1.247	0.504	0.552	1257	1377	3761
18/20	4.3	0.0474/0.0358	50	1.851	1.459	0.775	0.674	1934	1682	6598
18/18	4.7	0.0474/0.0474	50	2.007	1.567	0.795	0.733	1984	1829	6598
18/16	5.2	0.0474/0.0598	50	2.151	1.636	0.797	0.745	1989	1859	6598
16/18	5.5	0.0598/0.0474	50	2.439	1.900	1.078	0.901	2690	2248	9064
16/16	6.0	0.0598/0.0598	50	2.613	1.980	1.101	0.908	2747	2265	9064

Allowable Reactions at Supports Based on Web Crippling, R_n/Ω (lb/ft)

Deck Gage	Bearing Length of Webs											
	One-Flange Loading						Two-Flange Loading					
	End Bearing				Interior Bearing		End Bearing				Interior Bearing	
	1 1/2"	2"	3"	4"	4"	8"	1 1/2"	2"	3"	4"	4"	8"
20/XX	774	848	972	1077	1697	2101	788	846	944	1026	2014	2529
18/XX	1313	1432	1631	1799	2847	3565	1464	1563	1731	1872	3454	4397
16/XX	2031	2206	2499	2746	4365	5416	2414	2568	2826	3043	5374	6781

Standard Features

- ASTM A653 SS GR50 Min., with G60
- Standard lengths – 6'-0" to 42'-0"
- IAPMO UES ER-0652 and FM Listed
- Tables conform to ANSI/SDI RD-2017

Optional Features

- Inquire regarding cost and lead times for:
 - Short Cuts < 6'-0"
 - Sheet Lengths > 42'-0"
 - Alternative metallic finishes

NOTICE: Design defects that could cause injury or death may result from relying on the information in this document without independent verification by a qualified professional. The information in this document is provided "AS IS". Nucor Corporation and its affiliates expressly disclaim: (i) any and all representations, warranties and conditions and (ii) all liability arising out of or related to this document and the information in it.

3NP-24 CELLULAR DECK GRADE 40 STEEL

ASD

24" WIDE 3NP CELLULAR ROOF DECK

- 3NP-24 Deck used with TSWs or BPs
- 3NPLP-24 Deck used with PunchLok® II System

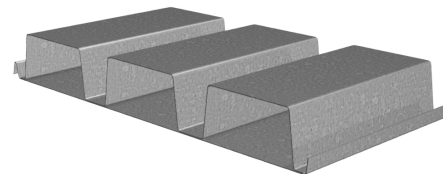

Nominal Dimensions

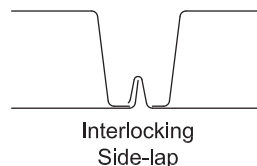
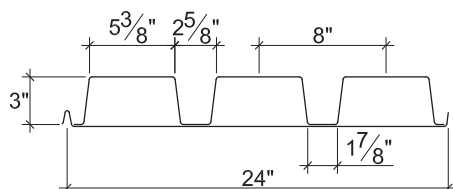

Section Properties

Deck Gage	Deck Weight w_{dd} (psf)	Base Metal Thickness t (in.)	Yield Strength F_y (ksi)	Effective Moment of Inertia at Service Load $I_d = (2I_e + I_g)/3$		Effective Section Modulus at $F_y = 40$ ksi		Allowable Moment		Vertical Web Shear V_n/Ω (lb/ft)
				I_{d+} (in ⁴ /ft)	I_{d-} (in ⁴ /ft)	S_{e+} (in ³ /ft)	S_{e-} (in ³ /ft)	M_{n+}/Ω (lb-ft/ft)	M_{n-}/Ω (lb-ft/ft)	
20/20	3.9	0.0358/0.0358	40	1.754	1.420	0.528	0.543	1054	1084	3589
20/18	4.5	0.0358/0.0474	40	1.897	1.564	0.528	0.628	1054	1253	3589
18/20	4.7	0.0474/0.0358	40	2.246	1.774	0.821	0.707	1639	1411	5738
18/18	5.2	0.0474/0.0474	40	2.455	1.938	0.841	0.791	1679	1579	5738
18/16	5.8	0.0474/0.0598	40	2.641	2.136	0.858	0.921	1713	1838	5738
16/18	6.0	0.0598/0.0474	40	3.019	2.323	1.156	0.952	2307	1900	7204
16/16	6.6	0.0598/0.0598	40	3.259	2.543	1.180	1.082	2355	2160	7204

Allowable Reactions at Supports Based on Web Crippling, R_n/Ω (lb/ft)

Deck Gage	Bearing Length of Webs											
	One-Flange Loading						Two-Flange Loading					
	End Bearing				Interior Bearing		End Bearing				Interior Bearing	
	1 1/2"	2"	3"	4"	4"	8"	1 1/2"	2"	3"	4"	4"	8"
20/XX	667	731	838	928	1451	1796	686	737	821	893	1733	2176
18/XX	1130	1233	1404	1548	2433	3047	1269	1355	1501	1623	2967	3777
16/XX	1745	1895	2147	2359	3726	4624	1745	1895	2147	2359	3726	5816

Standard Features

- ASTM A653 SS GR40 Min., with G60
- Standard lengths – 6'-0" to 42'-0"
- IAPMO UES ER-0652 and FM Listed
- Tables conform to ANSI/SDI RD-2017

Optional Features

- Inquire regarding cost and lead times for:
 - Short Cuts < 6'-0"
 - Sheet Lengths > 42'-0"
 - Alternative metallic finishes
- Cellular Acoustical Versions

NOTICE: Design defects that could cause injury or death may result from relying on the information in this document without independent verification by a qualified professional. The information in this document is provided "AS IS". Nucor Corporation and its affiliates expressly disclaim: (i) any and all representations, warranties and conditions and (ii) all liability arising out of or related to this document and the information in it.

3NPA-24 CELLULAR ACOUSTICAL DECK GRADE 40 STEEL

ASD

24" WIDE 3NP CELLULAR ACOUSTICAL ROOF DECK

- 3NPA-24 Deck used with TSWs or BPs
- 3NPLPA-24 Deck used with PunchLok® II System

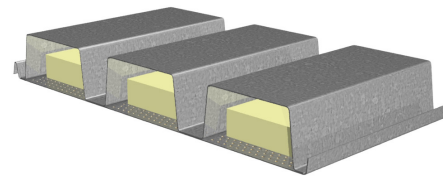

Nominal Dimensions

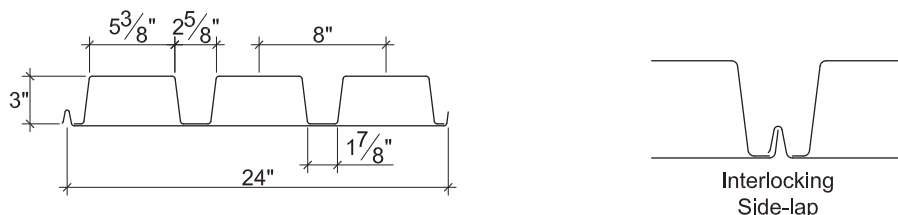

Section Properties

Deck Gage	Deck Weight w_{dd} (psf)	Base Metal Thickness t (in.)	Yield Strength F_y (ksi)	Effective Moment of Inertia at Service Load $I_d = (2I_e + I_g)/3$		Effective Section Modulus at $F_y = 40$ ksi		Allowable Moment		Vertical Web Shear V_n/Ω (lb/ft)
				I_{d+} (in ⁴ /ft)	I_{d-} (in ⁴ /ft)	S_{e+} (in ³ /ft)	S_{e-} (in ³ /ft)	M_{n+}/Ω (lb-ft/ft)	M_{n-}/Ω (lb-ft/ft)	
20/20	3.8	0.0358/0.0358	40	1.684	1.419	0.522	0.543	1042	1084	3589
20/18	4.3	0.0358/0.0474	40	1.834	1.563	0.537	0.628	1072	1253	3589
18/20	4.6	0.0474/0.0358	40	2.151	1.773	0.809	0.707	1615	1411	5738
18/18	5.0	0.0474/0.0474	40	2.351	1.937	0.829	0.791	1655	1579	5738
18/16	5.6	0.0474/0.0598	40	2.532	2.035	0.847	0.797	1691	1591	5738
16/18	5.9	0.0598/0.0474	40	2.883	2.321	1.139	0.952	2273	1900	7204
16/16	6.4	0.0598/0.0598	40	3.111	2.434	1.163	0.955	2321	1906	7204

Allowable Reactions at Supports Based on Web Crippling, R_n/Ω (lb/ft)

Deck Gage	Bearing Length of Webs											
	One-Flange Loading						Two-Flange Loading					
	End Bearing				Interior Bearing		End Bearing				Interior Bearing	
	1 1/2"	2"	3"	4"	4"	8"	1 1/2"	2"	3"	4"	4"	8"
20/XX	667	731	838	928	1451	1796	686	737	821	893	1733	2176
18/XX	1130	1233	1404	1548	2433	3047	1269	1355	1501	1623	2967	3777
16/XX	1745	1895	2147	2359	3726	4624	1745	1895	2147	2359	3726	5816

Standard Features

- ASTM A653 SS GR40 Min., with G60
- Standard lengths – 6'-0" to 42'-0"
- IAPMO UES ER-0652 and FM Listed
- Tables conform to ANSI/SDI RD-2017

Optional Features

- Inquire regarding cost and lead times for:
 - Short Cuts < 6'-0"
 - Sheet Lengths > 42'-0"
 - Alternative metallic finishes

NOTICE: Design defects that could cause injury or death may result from relying on the information in this document without independent verification by a qualified professional. The information in this document is provided "AS IS". Nucor Corporation and its affiliates expressly disclaim: (i) any and all representations, warranties and conditions and (ii) all liability arising out of or related to this document and the information in it.

2VLP CELLULAR COMPOSITE DECK GRADE 50 STEEL

ASD

2VLP CELLULAR COMPOSITE DECK

- 2VLP Deck used with TSWs or BPs
- 2PLVLP Deck used with PunchLok® II System

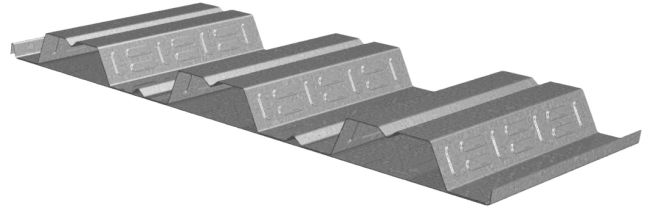

Nominal Dimensions

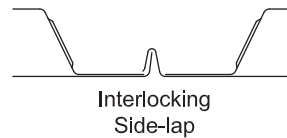
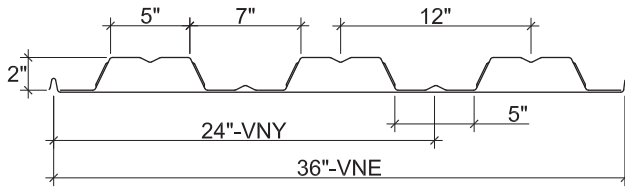

Plant	Cover Width
VNY	24"
VNE	36"

Section Properties

Deck Gage	Deck Weight w_{dd} (psf)	Base Metal Thickness t (in.)	Yield Strength F_y (ksi)	Effective Moment of Inertia at Service Load $I_d = (2I_e + I_g)/3$		Effective Section Modulus at $F_y = 50$ ksi		Allowable Moment		Vertical Web Shear V_n/Ω (lb/ft)
				I_{d+} (in ⁴ /ft)	I_{d-} (in ⁴ /ft)	S_{e+} (in ³ /ft)	S_{e-} (in ³ /ft)	M_{n+}/Ω (lb-ft/ft)	M_{n-}/Ω (lb-ft/ft)	
20/20	3.3	0.0358/0.0358	50	0.670	0.491	0.369	0.303	921	756	2419
20/18	3.8	0.0358/0.0474	50	0.714	0.526	0.378	0.341	943	851	2419
18/20	3.9	0.0474/0.0358	50	0.854	0.635	0.547	0.432	1365	1078	3240
18/18	4.4	0.0474/0.0474	50	0.914	0.675	0.556	0.469	1387	1170	3240
18/16	5.0	0.0474/0.0598	50	0.967	0.716	0.565	0.511	1410	1275	3240
16/18	5.0	0.0598/0.0474	50	1.099	0.830	0.731	0.602	1824	1502	4069
16/16	5.6	0.0598/0.0598	50	1.165	0.877	0.742	0.643	1851	1604	4069

Allowable Reactions at Supports Based on Web Crippling, R_n/Ω (lb/ft)

Deck Gage	Bearing Length of Webs											
	One-Flange Loading						Two-Flange Loading					
	End Bearing				Interior Bearing		End Bearing				Interior Bearing	
	1½"	2"	3"	4"	4"	6"	1½"	2"	3"	4"	4"	6"
20/XX	522	571	655	726	1098	1257	554	595	663	721	1342	1550
18/XX	879	959	1092	1205	1843	2095	1013	1082	1198	1296	2292	2631
16/XX	1354	1470	1666	1830	2825	3194	1654	1759	1936	2085	3554	4059

Standard Features

- ASTM A653 SS GR50 Min., with G60
- Standard lengths – 6'-0" to 42'-0"
- IAPMO UES ER-0652 and UL Listed
- Tables conform to ANSI/SDI C-2017

Optional Features

- Inquire regarding cost and lead times for:
 - Short Cuts < 6'-0"
 - Sheet Lengths > 42'-0"
 - Alternative metallic finishes
- Cellular Acoustical Versions

NOTICE: Design defects that could cause injury or death may result from relying on the information in this document without independent verification by a qualified professional. The information in this document is provided "AS IS". Nucor Corporation and its affiliates expressly disclaim: (i) any and all representations, warranties and conditions and (ii) all liability arising out of or related to this document and the information in it.

2VLPA CELLULAR ACOUSTICAL COMPOSITE DECK GRADE 50 STEEL

ASD

2VLP CELLULAR ACOUSTICAL COMPOSITE DECK

- 2VLPA Deck used with TSWs or BPs
- 2PLVLPA Deck used with PunchLok® II System

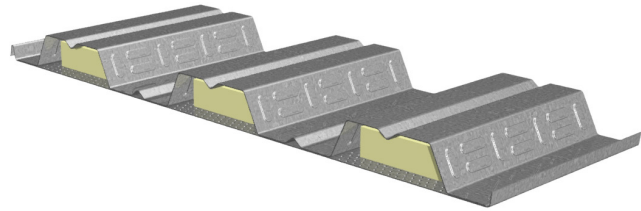

Nominal Dimensions

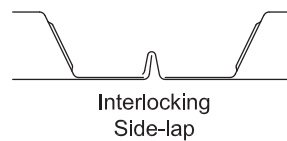
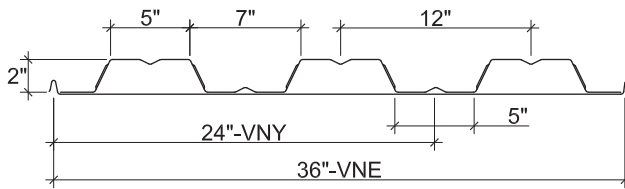

Plant	Cover Width
VNY	24"
VNE	36"

Section Properties

Deck Gage	Deck Weight w_{dd} (psf)	Base Metal Thickness t (in.)	Yield Strength F_y (ksi)	Effective Moment of Inertia at Service Load $I_d = (2I_e + I_g)/3$		Effective Section Modulus at $F_y = 50$ ksi		Allowable Moment		Vertical Web Shear V_n/Ω (lb/ft)
				I_{d+} (in ⁴ /ft)	I_{d-} (in ⁴ /ft)	S_{e+} (in ³ /ft)	S_{e-} (in ³ /ft)	M_{n+}/Ω (lb-ft/ft)	M_{n-}/Ω (lb-ft/ft)	
20/20	3.2	0.0358/0.0358	50	0.655	0.491	0.367	0.303	916	756	2419
20/18	3.7	0.0358/0.0474	50	0.699	0.526	0.376	0.341	938	851	2419
18/20	3.8	0.0474/0.0358	50	0.834	0.634	0.543	0.432	1355	1078	3240
18/18	4.3	0.0474/0.0474	50	0.892	0.675	0.553	0.469	1380	1170	3240
18/16	4.8	0.0474/0.0598	50	0.945	0.716	0.562	0.511	1402	1275	3240
16/18	4.9	0.0598/0.0474	50	1.073	0.830	0.726	0.602	1811	1502	4069
16/16	5.4	0.0598/0.0598	50	1.137	0.877	0.737	0.643	1839	1604	4069

Allowable Reactions at Supports Based on Web Crippling, R_n/Ω (lb/ft)

Deck Gage	Bearing Length of Webs											
	One-Flange Loading						Two-Flange Loading					
	End Bearing				Interior Bearing		End Bearing				Interior Bearing	
	1½"	2"	3"	4"	4"	6"	1½"	2"	3"	4"	4"	6"
20/XX	522	571	655	726	1098	1257	554	595	663	721	1342	1550
18/XX	879	959	1092	1205	1843	2095	1013	1082	1198	1296	2292	2631
16/XX	1354	1470	1666	1830	2825	3194	1654	1759	1936	2085	3554	4059

Standard Features

- ASTM A653 SS GR50 Min., with G60
- Standard lengths – 6'-0" to 42'-0"
- IAPMO UES ER-0652 and UL Listed
- Tables conform to ANSI/SDI C-2017

Optional Features

- Inquire regarding cost and lead times for:
 - Short Cuts < 6'-0"
 - Sheet Lengths > 42'-0"
 - Alternative metallic finishes

NOTICE: Design defects that could cause injury or death may result from relying on the information in this document without independent verification by a qualified professional. The information in this document is provided "AS IS". Nucor Corporation and its affiliates expressly disclaim: (i) any and all representations, warranties and conditions and (ii) all liability arising out of or related to this document and the information in it.

3VLP CELLULAR COMPOSITE DECK GRADE 50 STEEL

ASD

3VLP CELLULAR COMPOSITE DECK

- 3VLP Deck used with TSWs or BPs
- 3PLVLP Deck used with PunchLok® II System

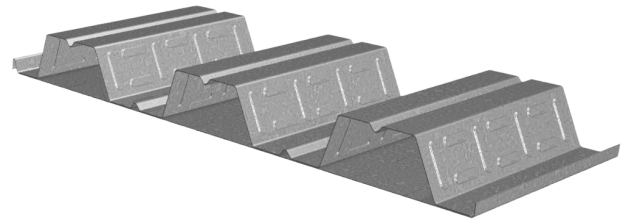

Nominal Dimensions

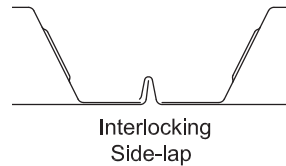
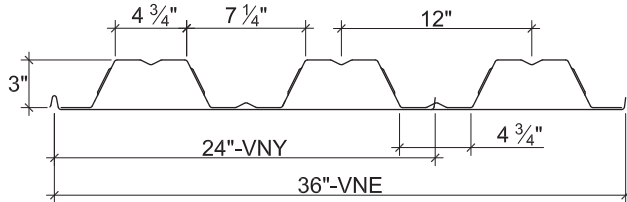

Plant	Cover Width
VNY	24"
VNE	36"

Section Properties

Deck Gage	Deck Weight w_{dd} (psf)	Base Metal Thickness t (in.)	Yield Strength F_y (ksi)	Effective Moment of Inertia at Service Load $I_d = (2I_e + I_g)/3$		Effective Section Modulus at $F_y = 50$ ksi		Allowable Moment		Vertical Web Shear V_n/Ω (lb/ft)
				I_{d+} (in ⁴ /ft)	I_{d-} (in ⁴ /ft)	S_{e+} (in ³ /ft)	S_{e-} (in ³ /ft)	M_{n+}/Ω (lb-ft/ft)	M_{n-}/Ω (lb-ft/ft)	
20/20	3.5	0.0358/0.0358	50	1.490	1.082	0.545	0.465	1360	1160	2485
20/18	4.0	0.0358/0.0474	50	1.575	1.152	0.573	0.512	1430	1277	2485
18/20	4.2	0.0474/0.0358	50	1.881	1.398	0.860	0.670	2146	1672	4361
18/18	4.7	0.0474/0.0474	50	2.011	1.477	0.871	0.715	2173	1784	4361
18/16	5.2	0.0474/0.0598	50	2.127	1.579	0.869	0.798	2168	1991	4361
16/18	5.3	0.0598/0.0474	50	2.415	1.820	1.152	0.917	2874	2288	6126
16/16	5.9	0.0598/0.0598	50	2.557	1.932	1.169	1.002	2917	2500	6126

Allowable Reactions at Supports Based on Web Crippling, R_n/Ω (lb/ft)

Deck Gage	Bearing Length of Webs											
	One-Flange Loading						Two-Flange Loading					
	End Bearing				Interior Bearing		End Bearing				Interior Bearing	
	1 1/2"	2"	3"	4"	4"	8"	1 1/2"	2"	3"	4"	4"	8"
20/XX	510	559	640	709	1121	1388	518	556	620	674	1328	1668
18/XX	866	944	1075	1186	1881	2900	963	1028	1138	1231	2279	2900
16/XX	1339	1455	1648	1811	2884	3579	1589	1690	1860	2003	3546	4474

Standard Features

- ASTM A653 SS GR50 Min., with G60
- Standard lengths – 6'-0" to 42'-0"
- IAPMO UES ER-0652 and UL Listed
- Tables conform to ANSI/SDI C-2017

Optional Features

- Inquire regarding cost and lead times for:
 - Short Cuts < 6'-0"
 - Sheet Lengths > 42'-0"
 - Alternative metallic finishes
- Cellular Acoustical Versions

NOTICE: Design defects that could cause injury or death may result from relying on the information in this document without independent verification by a qualified professional. The information in this document is provided "AS IS". Nucor Corporation and its affiliates expressly disclaim: (i) any and all representations, warranties and conditions and (ii) all liability arising out of or related to this document and the information in it.

3VLPA CELLULAR ACOUSTICAL COMPOSITE DECK GRADE 50 STEEL

ASD

3VLP CELLULAR ACOUSTICAL COMPOSITE DECK

- 3VLPA Deck used with TSWs or BPs
- 3PLVLP Deck used with PunchLok® II System

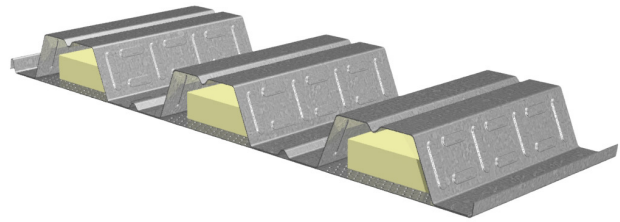

Nominal Dimensions

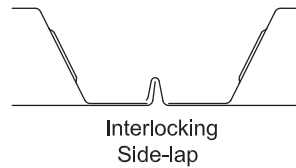
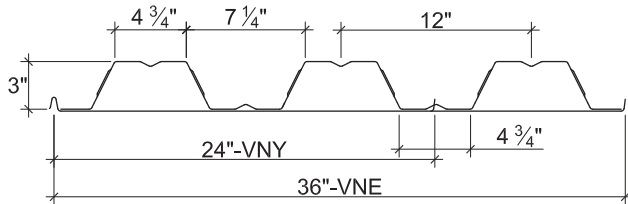

Plant	Cover Width
VNY	24"
VNE	36"

Section Properties

Deck Gage	Deck Weight w_{dd} (psf)	Base Metal Thickness t (in.)	Yield Strength F_y (ksi)	Effective Moment of Inertia at Service Load $I_d = (2I_e + I_g)/3$		Effective Section Modulus at $F_y = 50$ ksi		Allowable Moment		Vertical Web Shear V_n/Ω (lb/ft)
				I_{d+} (in ⁴ /ft)	I_{d-} (in ⁴ /ft)	S_{e+} (in ³ /ft)	S_{e-} (in ³ /ft)	M_{n+}/Ω (lb-ft/ft)	M_{n-}/Ω (lb-ft/ft)	
20/20	3.4	0.0358/0.0358	50	1.457	1.082	0.543	0.465	1355	1160	2485
20/18	3.9	0.0358/0.0474	50	1.542	1.151	0.571	0.512	1425	1277	2485
18/20	4.1	0.0474/0.0358	50	1.837	1.398	0.853	0.670	2128	1672	4361
18/18	4.5	0.0474/0.0474	50	1.965	1.477	0.866	0.715	2161	1784	4361
18/16	5.0	0.0474/0.0598	50	2.078	1.578	0.864	0.798	2156	1991	4361
16/18	5.2	0.0598/0.0474	50	2.359	1.819	1.142	0.917	2849	2288	6126
16/16	5.7	0.0598/0.0598	50	2.496	1.931	1.159	1.002	2892	2500	6126

Allowable Reactions at Supports Based on Web Crippling, R_n/Ω (lb/ft)

Deck Gage	Bearing Length of Webs											
	One-Flange Loading						Two-Flange Loading					
	End Bearing				Interior Bearing		End Bearing				Interior Bearing	
	1 1/2"	2"	3"	4"	4"	8"	1 1/2"	2"	3"	4"	4"	8"
20/XX	510	559	640	709	1121	1388	518	556	620	674	1328	1668
18/XX	866	944	1075	1186	1881	2900	963	1028	1138	1231	2279	2900
16/XX	1339	1455	1648	1811	2884	3579	1589	1690	1860	2003	3546	4474

Standard Features

- ASTM A653 SS GR50 Min., with G60
- Standard lengths – 6'-0" to 42'-0"
- IAPMO UES ER-0652 and UL Listed
- Tables conform to ANSI/SDI C-2017

Optional Features

- Inquire regarding cost and lead times for:
 - Short Cuts < 6'-0"
 - Sheet Lengths > 42'-0"
 - Alternative metallic finishes

NOTICE: Design defects that could cause injury or death may result from relying on the information in this document without independent verification by a qualified professional. The information in this document is provided "AS IS". Nucor Corporation and its affiliates expressly disclaim: (i) any and all representations, warranties and conditions and (ii) all liability arising out of or related to this document and the information in it.