



2025 US & CANADA  
**WATER FEATURES  
CATALOG**

**Your Paradise. Our Passion.®**

[aquascapeinc.com](http://aquascapeinc.com)



## We connect people to water the way nature intended.

That's why we invented and patented an ecosystem approach to designing, building, and maintaining water features that relies on a natural balance of circulation, filtration, plants, fish, and rocks and gravel to ensure sustainability. Flip through our catalog to enjoy our line of time-tested products like pumps, filters, water feature kits, and more.

Be sure to explore our new line of products for 2025 which includes large Fountain Bowls with accessories, and our extra-large sphere and urn fountains. For great looking pond plants, you'll want to stock up on our new aquatic planters and Once-a-Year Pond Plant Fertilizer. Your waterlilies will reward you with amazing blooms throughout the season!

Aquascape is the only manufacturer of water feature equipment on the planet that builds and maintains water features every day with our own crew! That's why we created the new Rock Pad Sling to make placement of large boulders easier than ever.

We're passionate about sharing our projects and adventures on our various social media channels, so be sure to follow along and be inspired! You'll discover an endless, watery world of creativity.

– Greg Wittstock , *The Pond Guy*  
 Founder and CEO Aquascape, Inc.

*Greg Wittstock*  
*The Pond Guy*



When it comes to building work of art, one-of-a-kind, custom creations, we don't create with canvas, acrylics, or a paint brush. We use rock, gravel, and water as our media.



### Full-Color, Hardcover Coffee Table Book

Hands of the Artist won't disappoint. Page-by-page and build-by-build, you'll be mesmerised by the stunning artistry of our work.



### #86455 Aquascape Hands of the Artist V5

Packaged Weight: 4 lb.

Packaged Dimensions: 11.25" L x 10.25" W x 1" H



## Table of Contents

<b>K</b>	Kits .....	5
<b>F</b>	Filtration.....	25
<b>P</b>	Pumps .....	44
<b>A</b>	Aerators .....	65
<b>L</b>	Lighting.....	71
<b>PA</b>	Power Accessories.....	84
<b>WT</b>	Water Treatments .....	87
<b>PC</b>	Predator Control.....	110
<b>SC</b>	Seasonal Care .....	113
<b>FC</b>	Fish Care .....	117
<b>PPC</b>	Pond Plant Care .....	126
<b>D</b>	Decorative .....	131
<b>LUG</b>	Liner, Underlayment, and Geotextile .....	169
<b>PP</b>	Pipe and Plumbing .....	175
<b>IT</b>	Installation Tools.....	182
<b>RH</b>	Rainwater Harvesting .....	187

### Living the Aquascape Lifestyle®

Our passion is to help you create your own personal paradise that incorporates a beautiful pond, waterfall, fountain - or any combination of these refreshing water features.

With decades of experience designing and field-testing water features and their products, you can rest assured that you're getting the best quality for the best value when you choose Aquascape. Flip through the pages of this catalog and be inspired to create your own personal paradise in your very own yard.



**NEW**

# Aquascape New Products

### Heavy-Duty Aquatic Plant Pots

Ideal for use with waterlilies, aquatic plants, and more! Heavy-duty nylon straps make it easy to lift and maneuver in and out of the pond.

[See page 128](#)



### Once-A-Year Pond Plant Fertilizer

Special time-release fertilizer blend is optimized for water lilies, lotus, and other aquatic plants.

[See page 127](#)

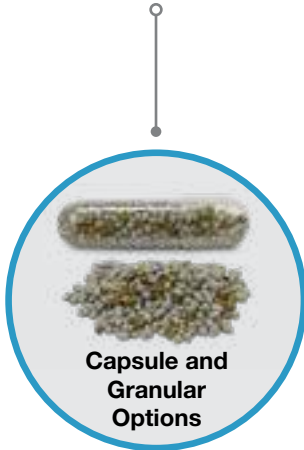

### Spillway Bowl, Basin, and Stand

Introducing a sleek, new color: Iron Ore. Available in two sizes. [See page 148-149](#)



### Fountain Bowl

Get more creative than ever with redesigned patio ponds, shelves, and more! Square and round bowls available in a variety of sizes and colors. [See pages 156-157](#)



Add up to 4 shelves

### Faux Rock Fish Caves

Provides pond fish shelter from predators, such as herons. Available in two sizes.

[See page 111](#)



### Rock Pad Sling

An easier way to move rocks and boulders on the jobsite.

[See page 173](#)



### Faux Rock Covers

Cover unsightly landscape or pond components. Available in two sizes.

[See page 167](#)



### EPDM Liner One Sided Cover Tape

[See page 186](#)



### Stacked Slate Sphere 6' Dia. (1.8 m)

Add this giant sphere to display features or large scale projects!

[See page 146](#)



## Pond, Waterfall, and Fountain Kits

Transform your outdoor living space with an Aquascape pond, waterfall, or fountain kit. We've bundled the necessary components into convenient kits, making it easier than ever to create naturally balanced, low-maintenance water features.

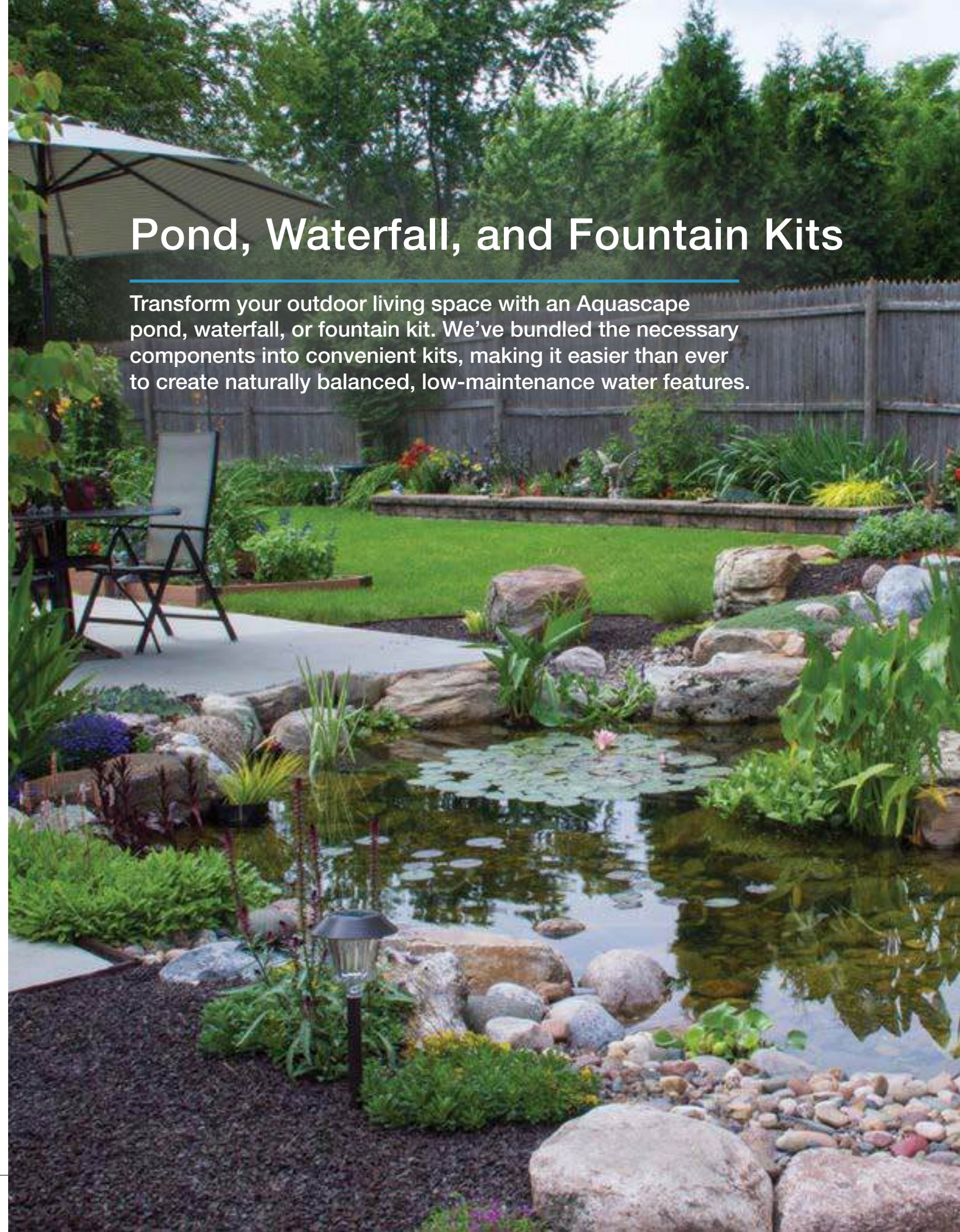

K | F | P | A | L | PWR | WT | PC | SC | FC | PPC | D | LUG | PP | IT | RH



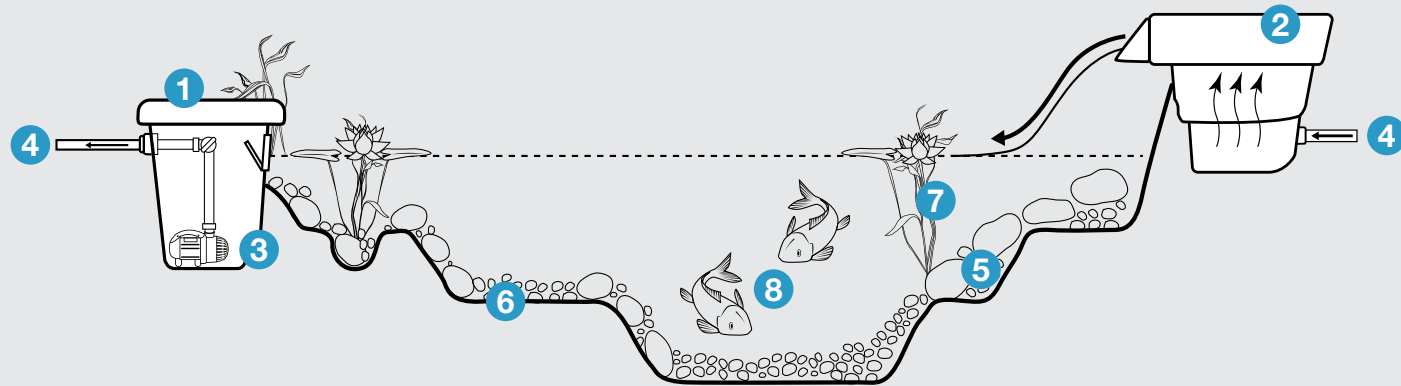

Features

- 1 Pond Skimmer**  
Pre-filters water, houses pump, collects debris, and reduces maintenance
- 2 BioFalls® Filter**  
Provides surface area for beneficial bacteria to colonize and removes excess nutrients from the water
- 3 Pond Pump**  
Pumps water from the pond skimmer to the BioFalls Filter to create a waterfall
- 4 Pipe**  
Directs water from the skimmer to the BioFalls Filter
- 5 Rocks and Gravel (not included)**  
Protects the liner, naturalizes the pond bottom, and provides surface area for beneficial bacteria to break down excess nutrients
- 6 Pond Liner and Underlayment**  
Forms the pond's foundation, containing the water and allowing gases to escape from beneath the pond
- 7 Plants (not included)**  
Filter pond water, minimizing maintenance and improving water conditions
- 8 Fish (not included)**  
Provide nutrients for pond plants



DIY Backyard Pond Kit 8' x 11' Shown

Aquascape DIY Backyard Pond Kits

	4' x 6'	6' x 8'	8' x 11'
Item Number	99763	99764	99765
Skimmer	Signature Series 200 Pond Skimmer		
BioFalls	Signature Series 1000 BioFalls		
BioBalls Filter Media	✓		
Pump	EcoWave 2000		
Pipe	Kink-Free 1.5" x 25'		
Liner Material	45 mil EPDM fish safe		
Liner Size	8' x 10' (2.4 x 3 m)	10' x 12' (3 x 3.6 m)	12' x 15' (3.6 x 4.5 m)
Finished Pond Size*	4'L x 6'W x 2' Max Depth	6'L x 8'W x 2' Max Depth	8'L x 11'W x 2' Max Depth
Underlayment	80 sq. ft. (24.3 m)	120 sq. ft. (36.5 m)	180 sq. ft. (24.3 m)
Installation Kit	✓		
Packaged Weight	71.5 lb. (32.4 kg)	85 lb. (38.5 kg)	105 lb. (47.6 kg)
Packaged Dimensions	34"L x 22"W x 23"H		

\*May vary based on pond shape and rock size



### Professional-Grade Skimmer

Provides professional features such as rigid debris basket, high-quality filter mat, locking weir door, and more

### Professional-Grade BioFalls® Filter

Provides professional features such as ESA filter mats, rock tray, and water-tight plumbing connection



### Warm White Pond Lighting

Brings ponds to life at night (included with medium and large kits)

### Dosing System SL

Automatically adds water treatments to your pond

### Pond Pump Options

Variety of pump options makes it easy to choose the perfect pump

Medium Pond Kit 11' x 16' Shown

## Aquascape Ecosystem Pond Kits

	Small Pond Kit 8' x 11'	Medium Pond Kit 11' x 16'	Large Pond Kit 21' x 26'	Medium Deluxe Pond Kit 11' x 16'	Large Deluxe Pond Kit 21' x 26'
Item Number	53033	53034   53035	53036   53037   53063	53066	53067
Skimmer	Signature Series 400 Pond Skimmer	Signature Series 1000 Pond Skimmer			
BioFalls	Signature Series 1000 BioFalls	Signature Series 2500 BioFalls	Signature Series 6000 BioFalls	Signature Series 2500 BioFalls	Signature Series 6000 BioFalls
BioFalls Rock Tray	✓				
BioBalls Filter Media	✓				
Pump	AquaSurge 3000	AquaSurge 2000-4000 (Kit #53034) 3-PL 3000 (Kit #53035)	AquaSurge 4000-8000 (Kit #53036) 9-PL 7000 (Kit #53037) SLD 5000-9000 (Kit #53063)	AquaSurge 2000-4000	AquaSurge 4000-8000
Pond Powerhead	-			✓	
Faux Driftwood 30"	-			✓	
Pipe	Flexible PVC 1.5" x 25'	Flexible PVC 2" x 25'	Flexible PVC 2" x 50'	Flexible PVC 2" x 25'	Flexible PVC 2" x 50'
Duel Union Check Valve 2.0	✓				
45 mil EPDM Liner	12' x 15'	15' x 20'	25' x 30'	15' x 20'	25' x 30'
Finished Pond Size*	8'L x 11'W x 2'D	11'L x 16'W x 2'D	21'L x 26'W x 2'D	11'L x 16'W x 2'D	21'L x 26'W x 2'D
Underlayment	180 sq. ft.	300 sq. ft.	750 sq. ft.	300 sq. ft.	750 sq. ft.
Lighting	-	LED Lighting Package		LED Color-Changing Lighting Package	
Automated Dosing System with Starter Water Treatment	Dosing System SL			Smart Pond Dosing System XT	
App/WiFi Connected	-	53034	53036   53063	✓	
Installation Kit	✓				
Packaged Weight	145 lb. (65.7 kg)	290 lb. (131.5 kg)	488 lb. (221.3 kg)	315 lb. (142.8 kg)	513 lb. (232.6 kg)
Packaged Dimensions	25"L x 40"W x 30"H	48"L x 40"W x 31"H palletized	48"L x 40"W x 41"H palletized	48"L x 40"W x 31"H palletized	48"L x 40"W x 41"H palletized

\*May vary based on pond shape and rock size



### All Professional-Grade Pond Kits Include:

Dosing System SL with included Maintain for Ponds SL water treatment

- Automatically adds treatment throughout the day
- Helps keep ponds clean, clear, and healthy

[See page 90](#)



### Deluxe Pond Kits

Include enhancements to take your pond to the next level, including:

- Color-changing lighting system
- Smart control for pump and lights
- Faux Driftwood 30"
- Pond Powerhead





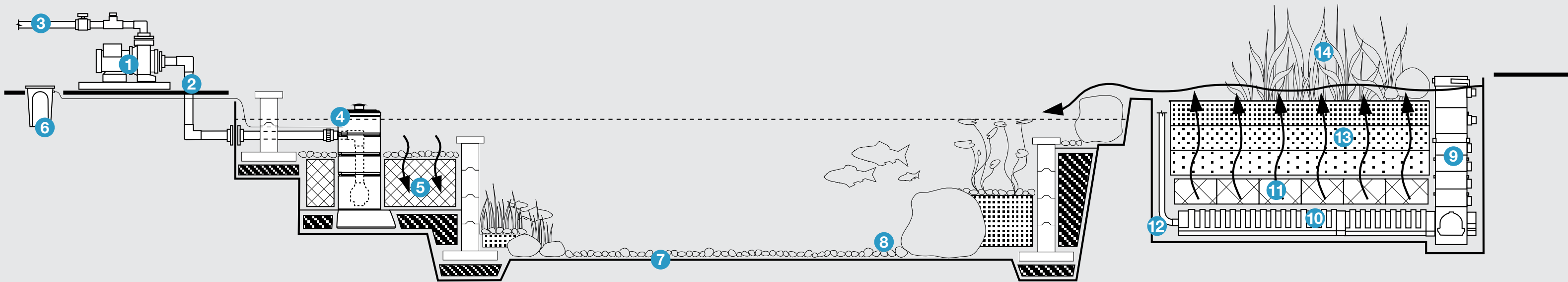

## Skimmer Intake/Pump Assembly

### 1 EXT Pond Pump

Ideal for providing recirculating water in recreational ponds that require an external style of pump. The high flow rates of the EXT pumps make them perfect for supplying water to waterfalls, wetland filters, and recirculating water jets.

### 2 EXT Plumbing Kit

Includes fittings, flanges, valves, and hardware needed to install the EXT pump at the perimeter of the pond's edge.

### 3 Flexible PVC Pipe

Easy-to-install flexible PVC pipe reduces the need for elbows and couplings to insure maximum water flow, reducing the total dynamic head between the intake bay, wetland filter system, and recirculation jets.

### 4 Pondless® Waterfall Vault and Extension

The vault is a convenient structure to house the pump intake and piping system while protecting the pump from rock and debris.

### 5 AquaBlox® Water Storage Modules

AquaBlox® create a structural void space that diffuses the incoming water velocity while effectively removing floating debris from the surface of the pond. The internal web of water matrices thoroughly mixes the water to increase water quality.

### 6 Smart Pond Dosing System XT

Automatically adds water treatments to keep your recreational pond clean and clear.

## Deep Water Recreational Pond

### 7 Liner, Underlayment, and Rock Pad

The latest technology in water containment creates a flexible waterproof membrane in the skimmer intake/pump assembly, deep water recreational pond, and wetland filter system. Liner paired with specialized geotextiles help to stabilize the subsoils while providing additional structural integrity to protect the membrane from damage. Rock Pads are used with liner and underlayment to provide additional protection under heavy boulders.

### 8 Rock, Gravel, and Sand (not included)

Protects the liner, naturalizes the pond bottom, and provides surface area for beneficial bacteria to break down excess nutrients.

## Wetland Filtration System

### 9 Snorkel® Vault, Extensions, and Cap

Provides a convenient access point to the sediment trap for yearly maintenance procedures.

### 10 Centipede® Module

Positioned at the lowest point of the filter to reduce water velocity by 93%, allowing the sedimentation process to occur.

### 11 AquaBlox® Water Storage Modules

Provides lateral distribution of water to insure optimal contact with the filter bed while providing uniform distribution of dissolved oxygen.

### 12 Flexible PVC Pipe

Easy-to-install flexible PVC pipe reduces the need for elbows and couplings to insure maximum water flow, reducing the total dynamic head between the intake bay, wetland filter system, and recirculation jets.

### 13 Rocks and Gravel (not included)

Specifically graded river rock provides a natural surface for microbial colonization to insure optimal water quality.

### 14 Plants (not included)

Aquatic plants complete the filtration cycle by capturing and storing the remaining dissolved nutrients from the water column. The root systems penetrate deep within the filter bed, creating a symbiotic relationship with the filter, and mimicking nature's time-tested strategy for healthy aquatic ecosystems.





**Recreational Pond Kit 9' x 20'**  
**#53073 (US)**  
**#53073C (Canada)**



Item	Item Number	Qty
Pondless® Waterfall Vault	49000	1
Pondless® Waterfall Vault Extension	49001	2
Large Snorkel® Vault and Cap	29064	1
Large Snorkel® Vault Extension	29068	1
Large Centipede® Module	29065	1
Half Centipede® Module	29066	1
AquaBlox® Water Storage Module - Small	29491	20
AquaBlox® Water Storage Module - Large	29492	8
EXT 12000 Pond Pump	45049	1
Flexible PVC Pipe 3" x 50'	29025	1
Flexible PVC Pipe 2" x 25'	29023	1
EXT Pump 2"-3" Plumbing Kit	48027	1
PVC Manifold Kit for 2" or 3"	29156	1
45 mil EPDM Liner Roll - 25' x 50'	29200	1
45 mil EPDM Liner Boxed - 20' x 25'	85004	1
Heavy-Duty Underlayment 15' x 100'	42148	1
Rock Pad Roll	25001	1
Smart Pond Dosing System XT	40040	1
Maintain for Ponds XT - 1 Gal	40049	1
IonGen™ System G2	95027	1
Water Feature Installation Kit	22008	1

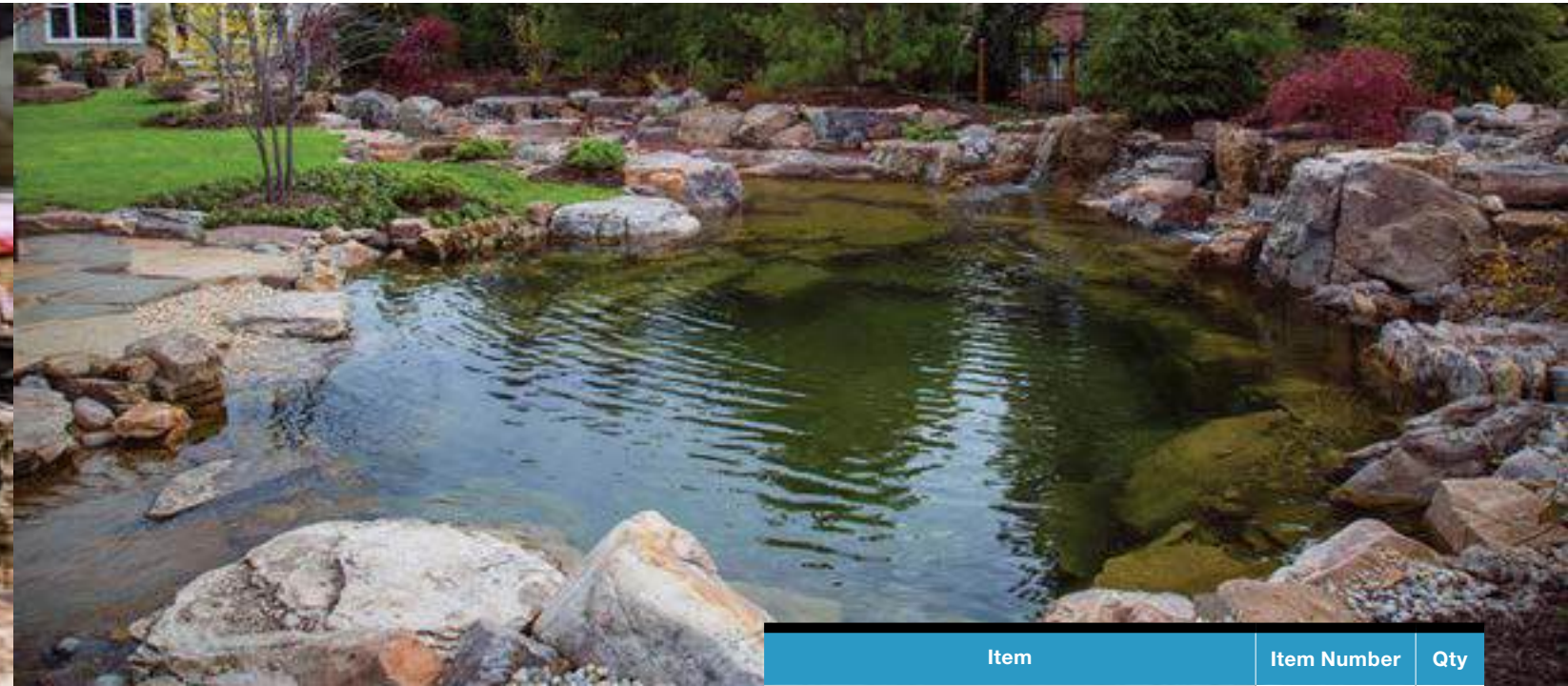

**Recreational Pond Kit 19' x 24'**  
**#53074 (US)**  
**#53074C (Canada)**



Item	Item Number	Qty
Pondless® Waterfall Vault	49000	1
Pondless® Waterfall Vault Extension	49001	2
Large Snorkel® Vault and Cap	29064	1
Large Snorkel® Vault Extension	29068	1
Large Centipede® Module	29065	3
Half Centipede® Module	29066	1
AquaBlox® Water Storage Module - Small	29491	56
AquaBlox® Water Storage Module - Large	29492	16
EXT 18000 Pond Pump	45050	1
Flexible PVC Pipe 3" x 50'	29025	1
Flexible PVC Pipe 2" x 25'	29023	1
EXT Pump 2"-3" Plumbing Kit	48027	1
PVC Manifold Kit for 2" or 3"	29156	1
45 mil EPDM Liner Roll - 40' x 50'	29206	1
45 mil EPDM Liner Roll - 25' x 50'	29200	1
Heavy-Duty Underlayment 15' x 100'	42148	2
Rock Pad Roll	25001	1
Smart Pond Dosing System XT	40040	1
Maintain for Ponds XT - 1 Gal	40049	1
IonGen™ System G2	95027	1
Water Feature Installation Kit	22008	1



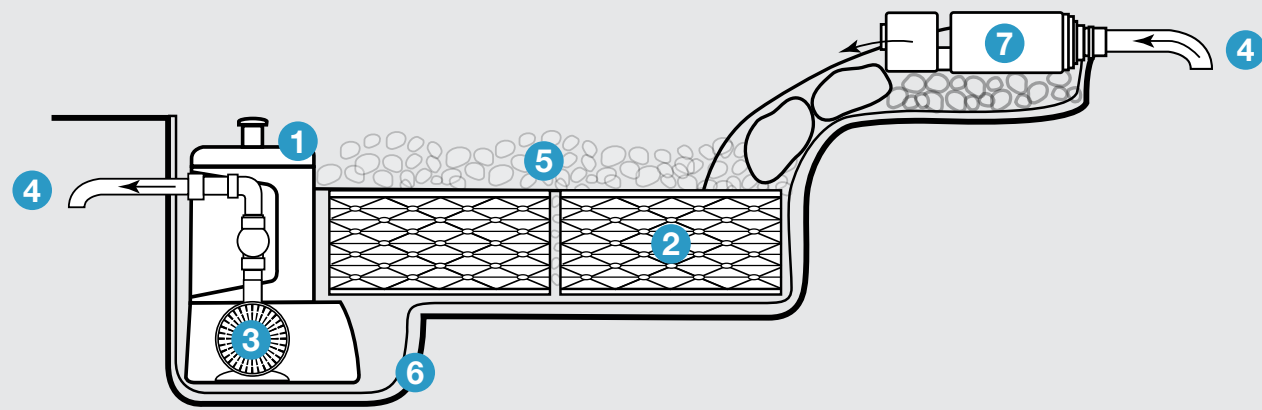

## Features

- 1 **Pondless® Waterfall Vault**  
Houses and protects pump
- 2 **AquaBlox® Water Storage Modules**  
Provides water storage
- 3 **Pond Pump**  
Pumps water from the underground reservoir to the spillway to create a waterfall
- 4 **Pipe**  
Directs water from the basin/reservoir to the Waterfall Spillway
- 5 **Rocks and Gravel (not included)**  
Naturalizes the waterfall, protects the liner, and filters the water
- 6 **Liner and Underlayment**  
Creates the form of the waterfall and holds water in the water storage area
- 7 **Waterfall Spillway**  
Provides a smooth, flowing waterfall



DIY Backyard Waterfall Kit Shown

## DIY Backyard Pondless® Waterfall Kit

Item Number	83001
Waterfall Spillway	✓
Pondless® Waterfall Vault	✓
AquaBlox®	(2) Small
Pump	EcoWave 2000
Pipe	Kink-Free 1.5" x 25'
Liner Material	45 mil EPDM fish safe
Liner Size	10' x 12' (3 x 3.6 m)
Underlayment	105 sq. ft. (32 m)
Installation Kit	✓
Waterfall and Stream Size*	3' (0.9 m)
Packaged Weight	113 lb. (51.2 kg)
Packaged Dimensions	41"L x 20"W x 25"H

\*May vary based on shape and rock size



# Professional-Grade Pondless® Waterfall Kits

**Pondless® Waterfall Vault**  
Extremely durable with quick and easy pump access

**Flexible PVC Pipe**  
High-quality, durable, and easy to install

**AquaBlox® Water Storage Modules**  
Provide the ideal water storage capacity for each kit size

**Warm White Pond Lighting**  
Brings ponds to life at night (included with medium and large kits)

**Pond Pump Options**  
Variety of pump options makes it easy to choose the perfect pump

Medium Pondless® Waterfall Kit 16" Stream Shown



## All Professional-Grade Pondless® Waterfall Kits Include:

Dosing System SL with included Prevent for Fountains and Waterfalls SL water treatment

- Automatically adds treatment throughout the day
- Helps keep waterfall clean, clear, and healthy

[See page 90](#)

# Professional-Grade Pondless® Waterfall Kits

## Aquascape Pondless® Waterfall Kits

	Small Pondless Waterfall Kit (6' Stream)	Medium Pondless Waterfall Kit (16' Stream)	Large Pondless Waterfall Kit (26' Stream)	Medium Deluxe Pondless Waterfall Kit (16' Stream)	Large Deluxe Pondless Waterfall Kit (26' Stream)
Item Number	53038	53039   53040   53064	53041   53042   53065	53068	53069
Waterfall Spillway	✓				
Pondless® Waterfall Vault	✓				
AquaBlox® Water Storage	(3) Small	(5) Small	(5) Large	(5) Small	(5) Large
Pump	AquaSurge 2000-4000	AquaSurge 2000-4000 (Kit #53039) 3-PL 3000 (Kit #53040) SLD 4000-7000 (Kit #53064)	AquaSurge 4000-8000 (Kit #53041) 5-PL 5000 (Kit #53042) SLD 5000-9000 (Kit #53065)	AquaSurge 2000-4000	AquaSurge 4000-8000
Faux Driftwood 35"	-			✓	
Pipe	Flexible PVC 1.5" x 25'	Flexible PVC 2" x 25'	Flexible PVC 2" x 50'	Flexible PVC 2" x 25'	Flexible PVC 2" x 50'
Duel Union Check Valve 2.0	✓				
45 mil EPDM Liner	10' x 10' (Reservoir) 8' x 10' (Stream)	10' x 12' (Reservoir) 10' x 20' (Stream)	10' x 15' (Reservoir) 10' x 30' (Stream)	10' x 12' (Reservoir) 10' x 20' (Stream)	10' x 15' (Reservoir) 10' x 30' (Stream)
Underlayment	100 sq. ft. (30 m)	120 sq. ft. (36.5 m)	180 sq. ft. (54.8 m)	120 sq. ft. (36.5 m)	180 sq. ft. (54.8 m)
Lighting	-	LED Lighting Package		LED Color-Changing Lighting Package	
Automated Dosing System with Starter Water Treatment	Dosing System SL			Smart Pond Dosing System XT	
App/WiFi Connected	✓	53039   53064	53041   53065	✓	
Installation Kit	✓				
Packaged Weight	149 lb. (67.5 kg)	298 lb. (135 kg)	379 lb. (172 kg)	323 lb. (146.5 kg)	404 lb. (183.2 kg)
Packaged Dimensions	37"L x 24"W x 28"H	48"L x 40"W x 24"H palletized	48"L x 40"W x 31"H palletized	48"L x 40"W x 24"H palletized	48"L x 40"W x 31"H palletized



## Deluxe Pondless® Waterfall Kits

Includes enhancements to take your waterfall to the next level:

- Color-changing lighting system
- Smart control for pump and lights
- Faux Driftwood 35"





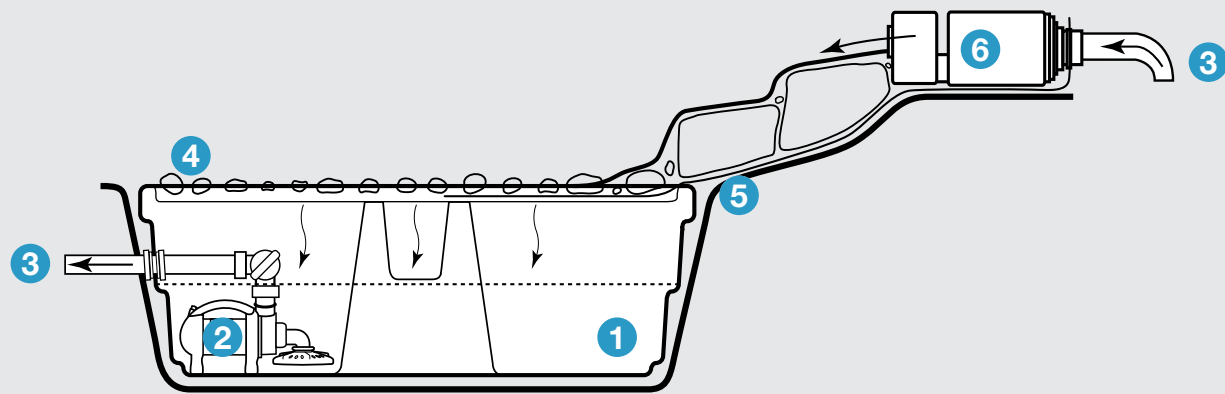

### Features

- 1 **AquaBasin® 45**  
Provides a reservoir for water storage and protects the pump
- 2 **Pond Pump**  
Pumps water from the AquaBasin® to the spillway to create a waterfall
- 3 **Pipe**  
Directs water from the basin to the spillway
- 4 **Rocks and Gravel (not included)**  
Naturalizes the waterfall and filters the water
- 5 **Liner and Underlayment**  
Creates the form of the waterfall and stream
- 6 **Waterfall Spillway**  
Provides a smooth, flowing waterfall



Backyard Waterfall Landscape Fountain Kit Shown

### Aquascape Backyard Waterfall Landscape Fountain Kit

Item Number	83013
Waterfall Spillway	12" (30.4 cm)
Reservoir	AquaBasin 45
Pump	AquaSurge 2000 with Low Suction Intake Attachment
Pipe	Flexible PVC 1.5" x 15'
Liner Material	45 mil EPDM fish safe
Liner Size	7.5' x 7.5' (2.3 x 2.3 m)
Underlayment	(2) 7.5' x 1' (2.2 x 0.3 m)
Installation Kit	✓
Waterfall and Stream Size*	3' (0.9 m)
Packaged Dimensions	48"L x 40"W x 35"H palletized

\*May vary based on shape and rock size



**Fountain**  
Fiber-Resin Composite, GFRC, and natural stone options available

**Pipe**  
Silicone or kink-free pipe included



**Pump**  
Ultra Water Pump provides ideal water flow for each fountain

**AquaBasin® 45**  
Heavy-duty reservoir stores up to 98 gallons of water

Stacked Slate Sphere 32" Dia.. (81 cm) Fountain Kit Shown

## Features

- 1 **Fountain**  
Choose from a variety of fountain options
- 2 **Pump**  
Pumps water from the AquaBasin® through the fountain
- 3 **AquaBasin® 45**  
Provides a reservoir for water storage
- 4 **Rocks and Gravel (not included)**  
Disguises the AquaBasin and naturalizes the water feature
- 5 **Pipe**  
Carries water from the basin to the fountain

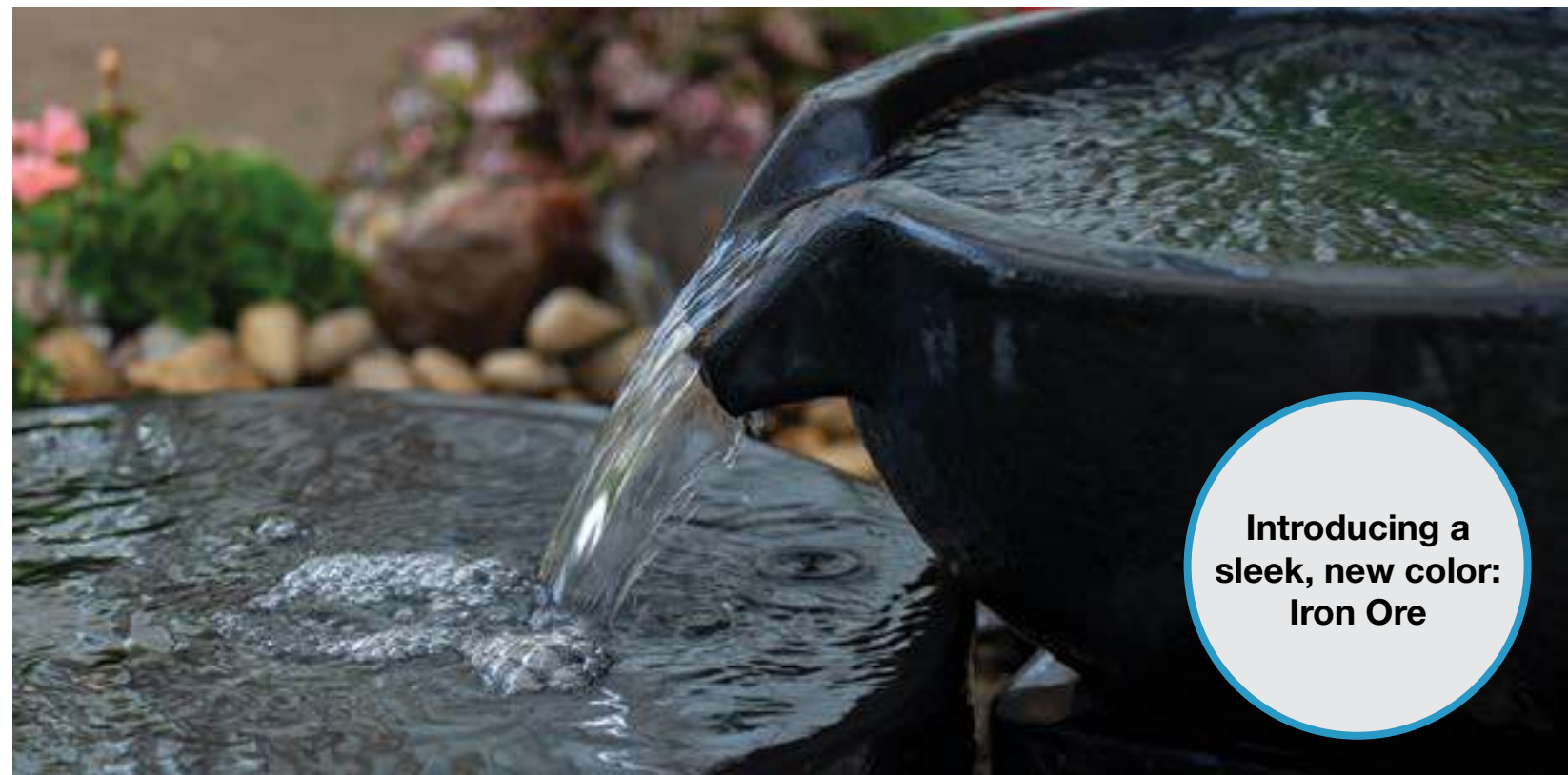
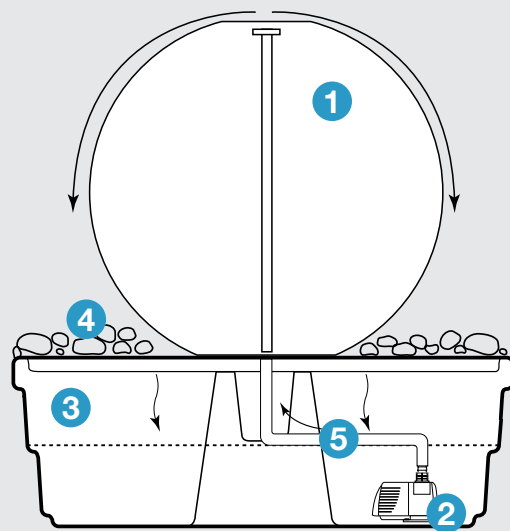

Introducing a sleek, new color: **Iron Ore**

**NEW COLOR**  
**Iron Ore**

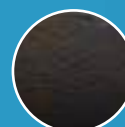

Spillway Bowl and Basin  
19"/21" Dia. (49/52 cm)

Stacked Slate Sphere  
18" Dia. (46 cm)

Stacked Slate Urn  
24" H (61 cm)

Faux Basalt Column  
24" H (61 cm)

Item Number	78427   78248	78249	78250	78251
Material	GFRC	Fiber-Resin Composite		
Finish	Iron Ore or Patina	-		
Pump	Ultra 800 Water Pump	Ultra 550 Water Pump		
Pipe	3/4" Silicone Tubing with Splitter	3/4" Silicone Tubing		
Packaged Weight	113.5 lb. (51.5 kg)	40.5 lb. (18.3 kg)	45.5 lb. (20.6 kg)	35.5 lb. (16 kg)
Packaged Dimensions	30"L x 30"W x 30"H	30"L x 30"W x 30"H	30"L x 30"W x 27"H	30"L x 30"W x 20"H





Faux Basalt Column Set of 3  
24", 30", 36" H (61, 76, 91 cm)



Stacked Slate Urn  
45" H (114 cm)



Scalloped Urn  
45" H (114 cm)



Stacked Slate Sphere  
32" Dia. (81 cm)



Stacked Slate Wall  
32" H (81 cm)



Spillway Bowl and Basin  
32"/40" Dia. (81/102 cm)

Item Number	78366	58090	78270
Material	Fiber-Resin Composite		
Pump	Ultra 2000 Water Pump	Ultra 1100 Water Pump	
Pipe	Flexible Tubing 3 pcs.	3/4" Silicone Tubing	
Packaged Weight	185 lb. (84 kg)	180 lb. (81.6 kg)	145 lb. (65.7 kg)
Packaged Dimensions	40"L x 48"W x 31"H	40"L x 48"W x 54"H	40"L x 48"W x 52"H

NOTE: Faux Basalt Columns not compatible with Fire and Water Torches

Item Number	78290	78269	78426   58087
Material	Fiber-Resin Composite		GFRC
Finish	-		Iron Ore or Patina
Pump	Ultra 1500 Water Pump	Ultra 2000 Water Pump	
Pipe	3/4" Silicone Tubing	(3) 3/4" Silicone Tubing	Corrugated
Packaged Weight	195 lb. (88.4 kg)	157 lb. (71 kg)	380 lb. (172 kg)
Packaged Dimensions	40"L x 48"W x 46"H	40"L x 48"W x 54"H	40"L x 48"W x 66"H





Stone Basalt Fountain Kit

Create an impressive, recirculating, stone fountain with Mongolian basalt columns. Each stone is core-drilled for installation easy. You'll enjoy the look and feel of real stone while watching water cascade beautifully over the sides of your fountain.



Mongolian Basalt Columns Set of 3

Item Number	58089
Material	Natural Stone
Pump	Ultra 2000 Water Pump
Pipe	Corrugated PE Pipe- 3/4" X 15' (4.57 m)
Packaged Weight	963 lb. (436.8 kg)
Packaged Dimensions	40"L x 48"W x 31"H

Pond and Waterfall Filtration

To keep your pond or water feature looking beautiful, it is important to provide proper filtration.

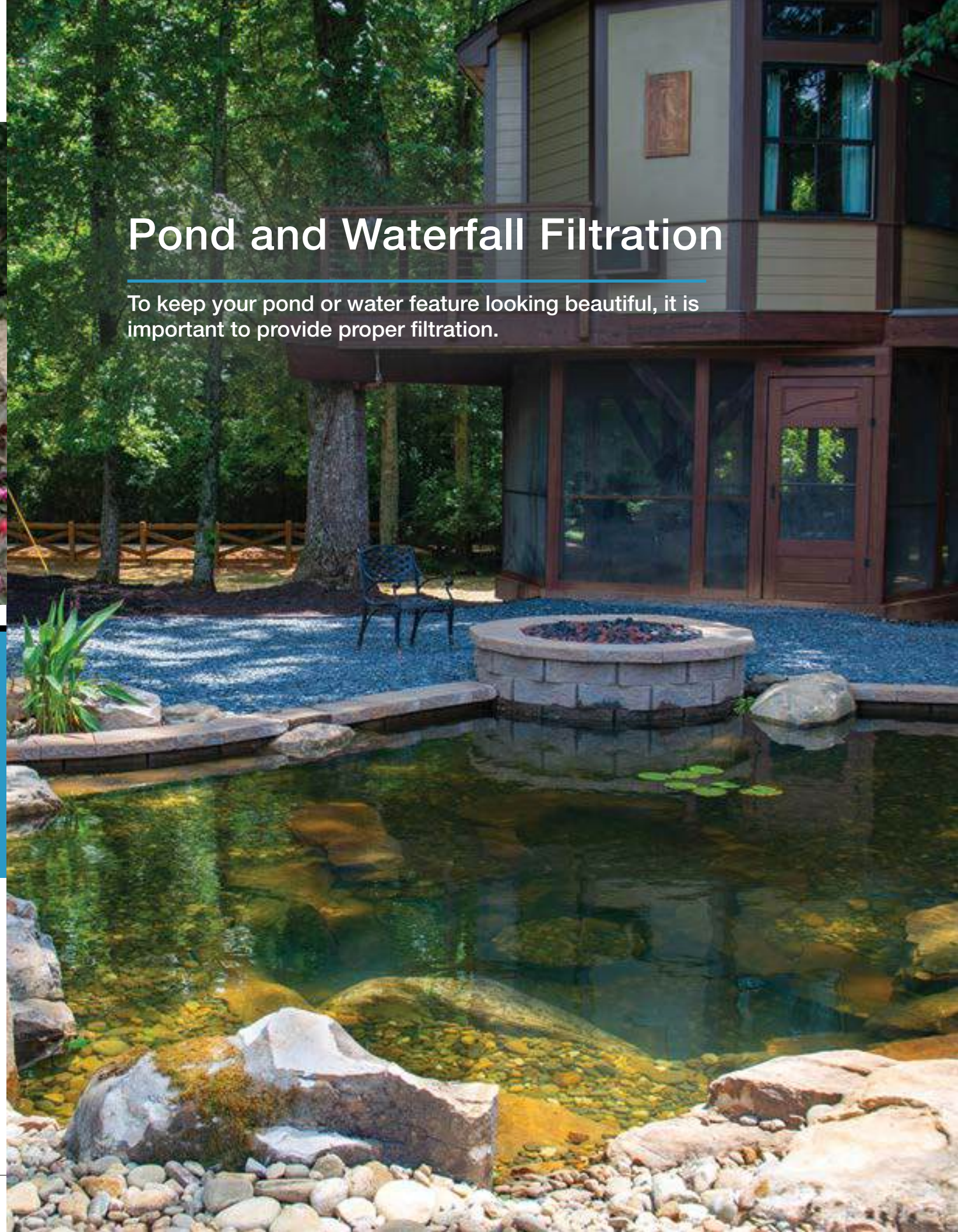



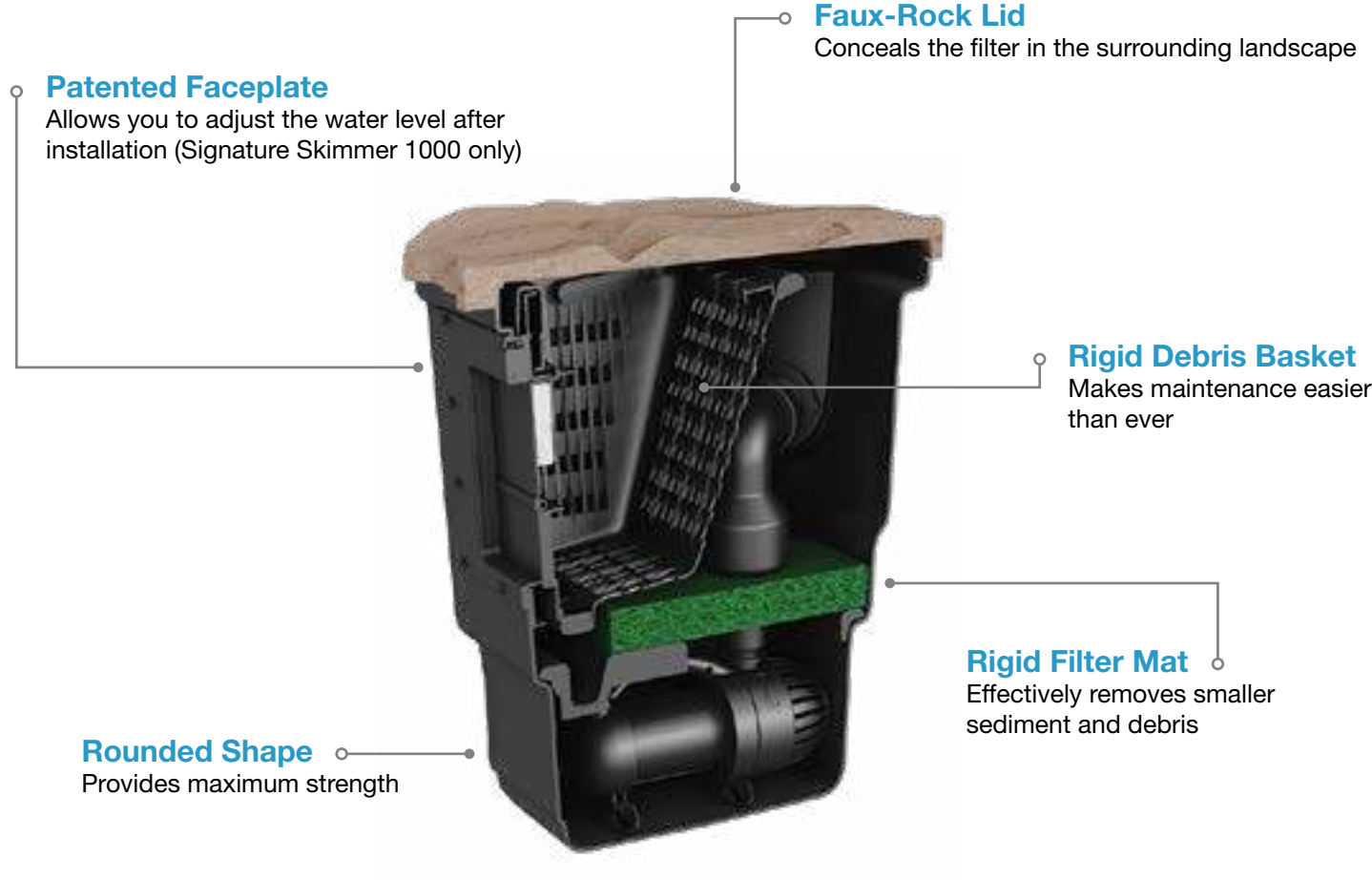

Signature Series 1000 Pond Skimmer Shown

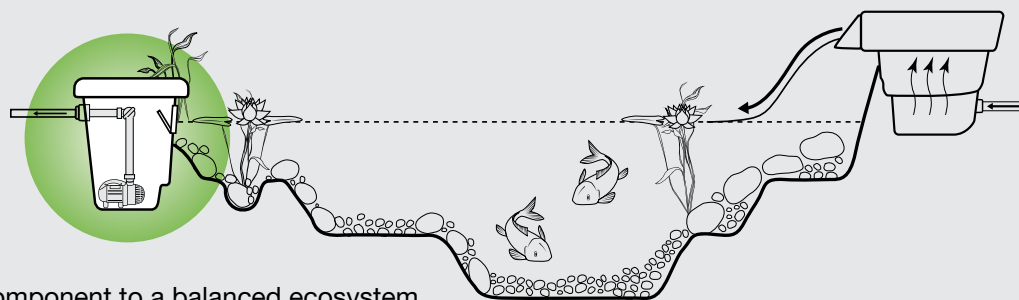

Pond skimmers are an integral component to a balanced ecosystem pond. Pond skimmers continuously sweep the surface of the water, drawing in leaves and floating debris to reduce maintenance and keep water clean.

## Aquascape Skimmers

	Signature Series 200 Pond Skimmer	Signature Series 400 Pond Skimmer	Signature Series 1000 Pond Skimmer
<b>U.S. Patent 7,144,501</b>			
<b>Item Number</b>	43020	43021	43022
<b>Pond Size</b>	Up to 200 sq. ft.	Up to 400 sq. ft.	Up to 1,000 sq. ft.
<b>Pump Flow Rate</b>	Up to 3,000 GPH / 11,500 LPH	Up to 4,000 GPH / 15,000 LPH	Up to 10,000 GPH / 38,000 LPH*
<b>Recommended Pumps</b>	EcoWave and AquaSurge Pumps	EcoWave, AquaSurge, AquaSurge Adjustable Flow, and PL Pumps	EcoWave, AquaSurge, AquaSurge and SLD Adjustable Flow, and PL Pumps
<b>Weir Size</b>		6"	8"
<b>Adjustable Height Face Plate</b>		—	✓
<b>Locking Weir Door</b>	—		✓
<b>Debris Net/Basket</b>	Net		Rigid Basket
<b>Filter Brush Cartridge</b>	Optional		—
<b>Overflow</b>	Optional		✓
<b>Filter Mat</b>	—		✓
<b>Faux-Rock Lid</b>	—		✓
<b>Dimensions</b>	20"L x 17.5"W x 17.5"H	21.4"L x 18"W x 21"H	21"L x 22"W x 26.5"H
<b>Warranty</b>	Limited Lifetime		
<b>Packaged Weight</b>	14.75 lb. (6.7 kg)	25 lb. (11.3 kg)	34 lb. (15.4 kg)
<b>Packaged Dimensions</b>	22.5"L x 20"W x 18.5"H	25.75"L x 20.5"W x 25"H	25"L x 24"W x 26.75"H

Note: 12PN-10,000 and AquascapePRO 10,000 pumps are too large to fit in these skimmers. Multiple pumps can be used to achieve up to 10,000 gallons per hour.



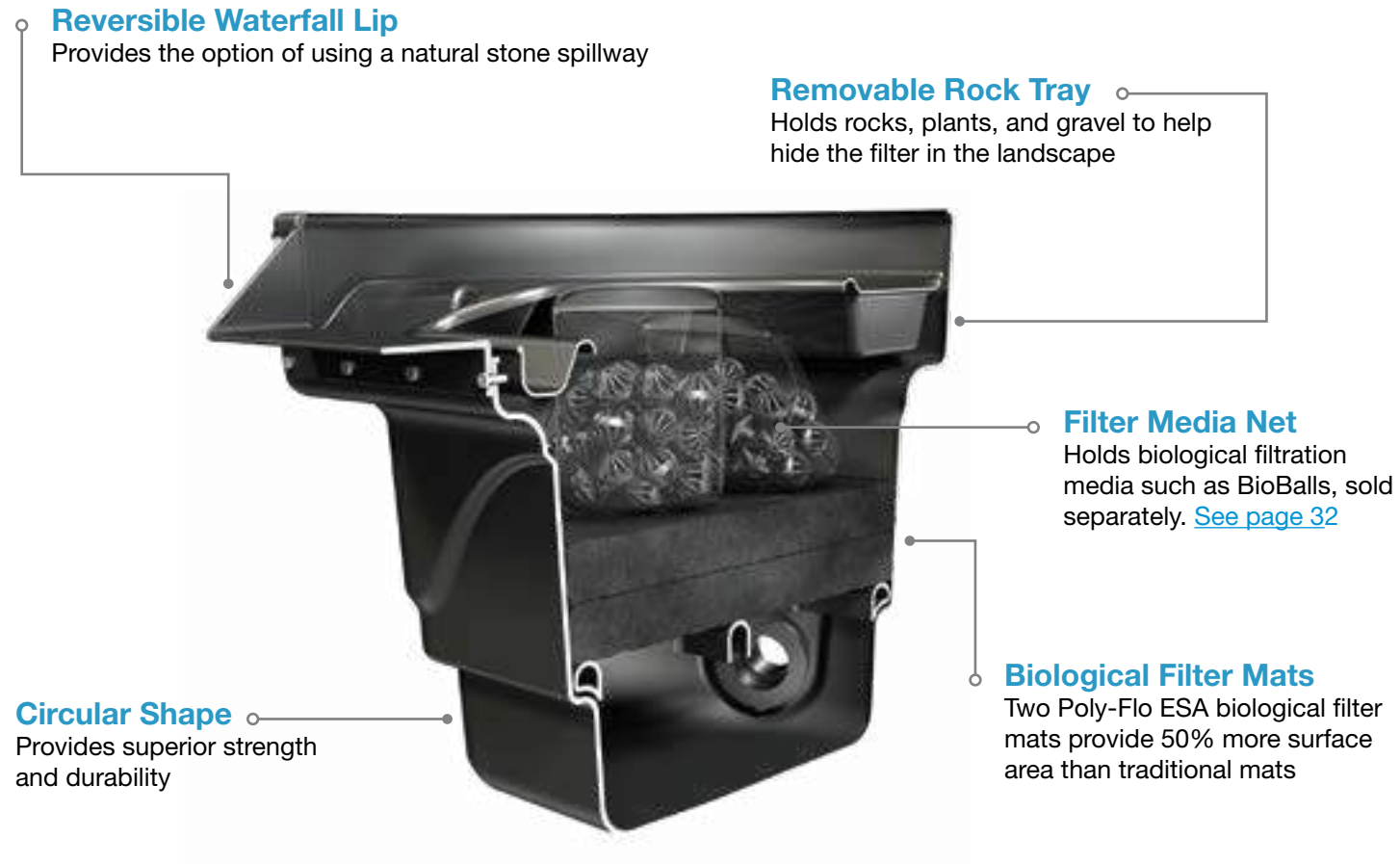

**Circular Shape**  
Provides superior strength and durability

**Reversible Waterfall Lip**  
Provides the option of using a natural stone spillway

**Removable Rock Tray**  
Holds rocks, plants, and gravel to help hide the filter in the landscape

**Filter Media Net**  
Holds biological filtration media such as BioBalls, sold separately. [See page 32](#)

**Biological Filter Mats**  
Two Poly-Flo ESA biological filter mats provide 50% more surface area than traditional mats

Signature Series 6000 BioFalls® Filter Shown

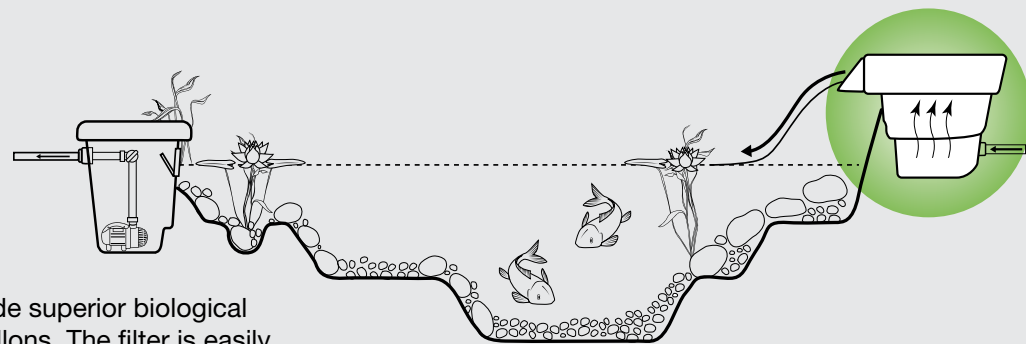

Aquascape BioFalls Filters provide superior biological filtration in ponds up to 6,000 gallons. The filter is easily concealed into the landscape and creates the perfect start of a waterfall or stream.



Item Number	99774	09020	29319	29384
Filters Ponds up to	1,000 gal. / 3,800 L	2,500 gal. / 9,500 L	6,000 gal. / 22,700 L	
Pump Flow Rate	Up to 3,000 GPH / 11,400 LPH	Up to 5,000 GPH / 18,900 LPH	Up to 15,000 GPH / 56,800 LPH	
Spillway Width	15"	21.5"	28"	
Bulkhead Port	Single 2"	Dual 2"		Dual 3"
Fittings Included	1.5" PVC slip and 1.5" kink-free insert	Two 2" PVC slip		Two 3" PVC slip
Rock Tray	Sold Separately (#98285)	✓		
Filter Mats	(2) Standard	(2) Poly-Flo ESA		
BioBalls	Sold Separately (#98464)			
Minimum BioBalls Quantity	100	200	400	
Filter Media Nets	1 Included	2 Included	3 Included	
Dimensions	17.5"L x 20.5"W x 17"H	24"L x 29.5"W x 20"H	40"L x 45"W x 29.5"H	
Warranty	Limited Lifetime			
Packaged Weight	11 lb. (5 kg)	28.8 lb. (13 kg)	55 lb. (25 kg)	57 lb. (25.8 kg)
Packaged Dimensions	18.5"L x 20.5"W x 17.5"H	30"L x 24"W x 24"H	40"L x 45"W x 29.5"H	



# Fountain Bowl Biological Filter Kits

**NEW**

## Introducing the New Fountain Bowls!

These bowls are a new take on our old Patio Ponds. We have made the Fountain Bowls versatile, and customizable, allowing you to get creative and use them in many different ways.

Each of the bowls below can be turned into a biological filter. Simply select a bowl and add a Fountain Bowl Biological Filter Kit from page 31, creating a beautiful and functional filter for any pond or waterfall

### Lunar Gray



#78395  
32" Dia. (81 cm)



#78396  
40" Dia. (102 cm)

### Green Slate



#78399  
32" Dia. (81 cm)



#78400  
40" Dia. (102 cm)

### Merlot



#78391  
32" Dia. (81 cm)



#78392  
40" Dia. (102 cm)

### Gray Slate



#78403  
27" Sq. (69 cm)



#78404  
33" Sq. (84 cm)

### Fountain Bowl Shown as Biological Filter



See next page for Biological Filter Kit components and part numbers



For more ways to customize the Fountain Bowls see [pages 156-159](#)

# Fountain Bowl Biological Filter Kits

**NEW**

## Make Your Fountain Bowl A Biological Filter

Add a Biological Filter Kit to your choice of Fountain Bowl (not included) to add a decorative filter to any pond or waterfall. Kits are available for both round and square bowls.

**Internal Shelves**  
Included to support filter materials

**Rigid Filter Mat**  
Delivers ideal filtration and effortless cleaning

**BioBalls Biological Filter Media and Media Net**  
Maximize surface area for optimal biological filtration

**Plumbing Fittings**  
Includes plumbing fittings for easy installation

\*Note: kits not available for 50" and 60" (127 cm or 152 cm) Fountain Bowls.

	Biological Filter Kits for Round Bowls		Biological Filter Kits for Square Bowls	
*Item #	80016	80017	80018	80019
Fits Bowl Size	32" Dia. (81 cm)	40" Dia. (108 cm)	27" Dia. (69 cm)	33" Dia. (84 cm)
Filters Ponds up to	1,750 gal. / 6,600 L	3,500 gal. / 13,200 L	1,500 gal. / 5,700 L	2,500 gal. / 9,400 L
Pump Flow Rate (minimum recommended)	750 GPH / 2,839 LPH			
Fittings Included	1.5" Rubber Bulkhead and PVC Tee-Fitting			
Support Shelves (4)	✓	✓	✓	✓
Filter Mat	✓	✓	✓	✓
BioBalls Included (Qty)	300	400	300	400
Filter Media Nets	✓	✓	✓	✓
Packaged Dimensions	28" L x 28" W x 10" H	36" L x 36" L x 12" H	24" L x 24" W x 10" H	30" L x 30" W x 10" H

\*Filtration components also available separately

Select your desired bowl from a variety of colors and sizes (sold separately). Options include square Gray Slate or round Lunar Gray, Merlot and Green Slate. See page 157 for Fountain Bowl options.

**Fountain Bowls Sold Separately**



### Keeps Ponds Clean

Provides textured surface area for beneficial bacteria to clean the water

### Center Channel

Allows the balls to be strung together making cleaning easier



### Compact Size

Allows for placement into smaller areas

### Paddle Wheel Design

Helps to degas and aerate water

### Ideal Filter Media

Easy to clean, long lasting, and lightweight

BioBalls Biological Filter Media Shown

### 10' Long and 56" Wide

Easily cut to desired size/shape



### Popular Media

Used in skimmer and biological filters

Coarse Filter Media Roll Shown

### Rigid Filter Media Mats

Provides efficient mechanical and biological filtration for your pond

### Three Options

Available in 3 different densities

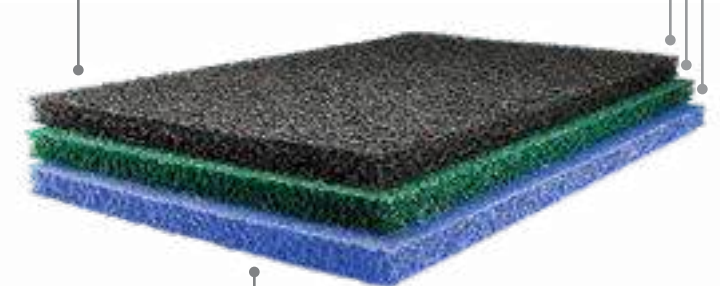

### Measures 24" by 39"

Easily cut to desired shape/size

### Filter Rolls and Mats



BioBalls Biological Filter Media  
100 Count

BioBalls Biological Filter Media  
1,000 Count

BioBalls Filter Media Net

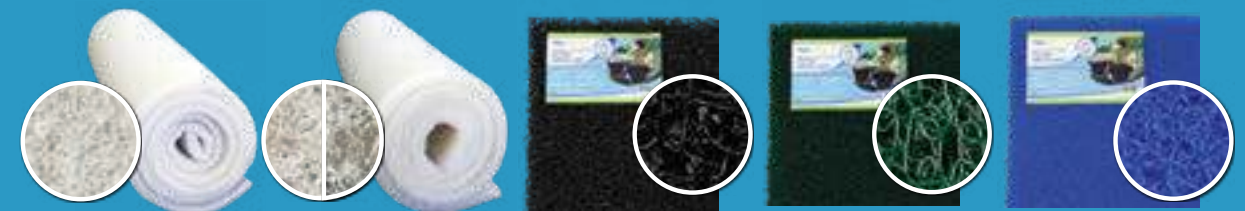

Dense Filter Media Roll  
1" Thick

Coarse Filter Media Roll  
1.25" | 2" Thick

Low Density Rigid Filter Mat  
1.5" Thick

Medium Density Rigid Filter Mat  
1.5" Thick

High Density Rigid Filter Mat  
1.5" Thick

Item Number	98464	56014	29069
Count	100 BioBalls	1,000 BioBalls	1 Net
Size	1.5" Dia.		24" x 28"
Media Net	Included	Sold Separately	—
Packaged Weight	2.25 lb. (1 kg)	24 lb. (10.8 kg)	.25 lb. (113 g)
Packaged Dimensions	8"L x 8"W x 6.5"H	18"L x 12"W x 14"H	7.25"L x 10.5"W x 1"H

Item Number	99325	99321   99323	80003	80004	80005
Packaged Weight	8.75 lb. (4 kg)	8.25 lb.   10 lb. (3.7 kg)   (4.5 kg)	4.25 lb. (2 kg)	3.5 lb. (1.6 kg)	3.25 lb. (1.5 kg)
Packaged Dimensions	10'L x 56"W		24" x 39"W		

### Filter Media Rolls

Aquascape filter media rolls provide efficient mechanical and biological filtration, reducing maintenance and improving water quality. The bulk rolls provide the ability to cut the material precisely to the shape and size of any pond filter, useful in a wide variety of applications.

### Rigid Filter Mats

Aquascape rigid filter mats provide efficient mechanical and biological filtration for your pond. The filter mat can be easily cut to your desired size and shape for installation in a wide variety of skimmer boxes and filters.



### Cage and Filter Sponge

Effectively capture debris before it enters the filter or pump



Submersible Pond Filter Shown

### Ceramic Filtration Rings

Clean water using biological filtration

### Adjustable Spray Bar

Creates surface movement and oxygenation



Container Water Garden Filter Shown

### Ideal DIY Solution

Easy and cost-effective way to add filtration to small ponds



Pond Waterfall Filter Shown

## Add-On Filters



Pond Waterfall Filter



Submersible Pond Filter



Container Water Garden Filter

Item Number	77020	95110	77005
Pond Volume	1,000 gal. / 3,785 L	Up to 800 gal. / 3,028 L	Up to 50 gal. / 189 L
Maximum Flow Rate	5,000 GPH / 18,500 LPH	—	—
Recommended Pump	—	Ultra 1100 Water Pump (#91008)	—
Fittings Included	1", 1.25", 1.5"	3/4", 1", 1.25"	Multiple Fittings Included
Filter Dimensions	20"L x 15"W x 12.5"H	13"L x 11"W x 5"H	2"L x 1.5"W x 7"H
Warranty	5-Year Limited	3-Year Limited	1-Year Limited
Packaged Weight	8.6 lb. (3.9 kg)	11 lb. (5 kg)	1 lb. (.45 kg)
Packaged Dimensions	21.5"L x 16.5"W x 14.5"H	12"L x 6"W x 12.75"H	4.25"L x 3.25"W x 8"H

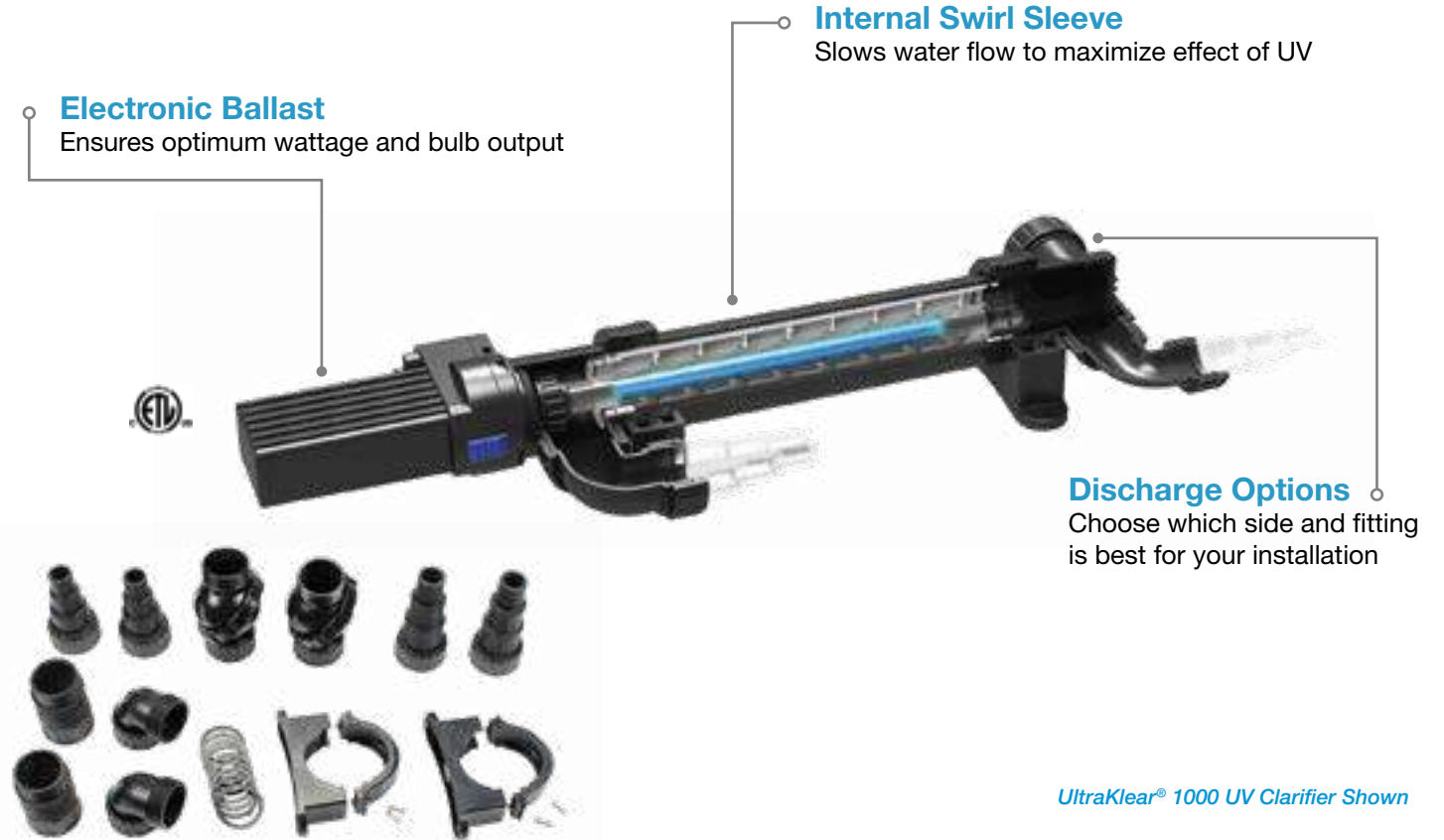

### Electronic Ballast

Ensures optimum wattage and bulb output

### Internal Swirl Sleeve

Slows water flow to maximize effect of UV

### Discharge Options

Choose which side and fitting is best for your installation

UltraKlear® 1000 UV Clarifier Shown

## UltraKlear UV Clarifier

	UltraKlear 1000	UltraKlear 2500	UltraKlear 5000
Item Number	95036	95037	95038
Average Pond Size Recommendation	1,000 gal. / 3,500 L	2,500 gal. / 9,000 L	5,000 gal. / 18,500 L
Max Flow Rate	500 GPH / 1,500 LPH	1,000 GPH / 3,500 LPH	1,500 GPH / 5,500 LPH
UV Wattage	14	28	55
Power Cord Length	20'		
Discharge Hose Diameter	1", 1.25", 1.5"		
Dimensions	23.5"L x 5.5"W x 3.75"H	33.5"L x 5.5"W x 3.75"H	43"L x 5.5"W x 3.75"H
Warranty	3-Year Limited		
Packaged Weight	6.5 lb. (2.9 kg)	8.75 lb. (3.9 kg)	10 lb. (4.5 kg)
Packaged Dimensions	24"L x 11"W x 4"H	34"L x 9.5"W x 4"H	44.5"L x 9.5"W x 4"H





## UltraKlean Pond Filters

	UltraKlean 2000	UltraKlean 3500
Item Number	95053	95054
Average Pond Size Recommendation	2,000 gal. / 7,500 L	3,500 gal. / 13,000 L
Max Flow Rate	2,700 GPH / 10,000 LPH	5,200 GPH / 19,500 LPH
UV Wattage	14	28
Power Cord Length	20'	
Discharge Hose Diameter	1", 1.25", 1.5"	
Dimensions	13"L x 13"W x 17"H	13"L x 13"W x 21.5"H
Warranty	3-Year Limited	
Packaged Weight	17 lb. (7.7 kg)	22 lb. (10 kg)
Packaged Dimensions	14"L x 14"W x 18"H	14"L x 14"W x 22.5"H



## UltraKlean Pond Filter Kits

	UltraKlean 1500 Kit	UltraKlean 2500 Kit	UltraKlean 3500 Kit
Item Number	95058	95059	95060
Average Pond Size Recommendation	Up to 1,500 gal. / 5,500 L	Up to 2,500 gal. / 9,000 L	Up to 3,500 gal. / 13,000 L
Filter Model	UltraKlean 2000		UltraKlean 3500
UV Clarifier	14		28
Included Pump	AquaForce 1000	AquaForce 2700	AquaForce 5200
Pipe	Kink-Free 1.5" x 25'		
Stainless Steel Clamps	4	4	7
2-Way Flow Control Valve	—		✓
Packaged Weight	39.75 lb. (18 kg)	40 lb. (18.1 kg)	48.5 lb. (22 kg)
Packaged Dimensions	23.5"L x 21.5"W x 21"H	23.5"L x 21.5"W x 22.5"H	23.5"L x 21.5"W x 23.5"H



# Waterfall Spillway



Waterfall Spillway 22" Shown

## Waterfall Spillways

	Waterfall Spillway 12"	Waterfall Spillway 22"
Item Number	77023	77000
Bulkhead Port	Single 2"	
Fittings Included	2" PVC Slip, and 1.5" Barbed Hose Fitting	
Maximum Flow Rate	4,000 GPH / 15,000 LPH	7,500 GPH / 28,000 LPH
Dimensions	10.5"L x 14"W x 5"H	17.5"L x 24"W x 5"H
Packaged Weight	4.5 lb. (2 kg)	9 lb. (4 kg)
Packaged Dimensions	14"L x 15"W x 5.5"H	24"L x 17"W x 5"H

The Waterfall Spillway provides the ideal starting point for waterfalls and streams, using strategically-positioned internal barriers to diffuse the water and optimize the flow.

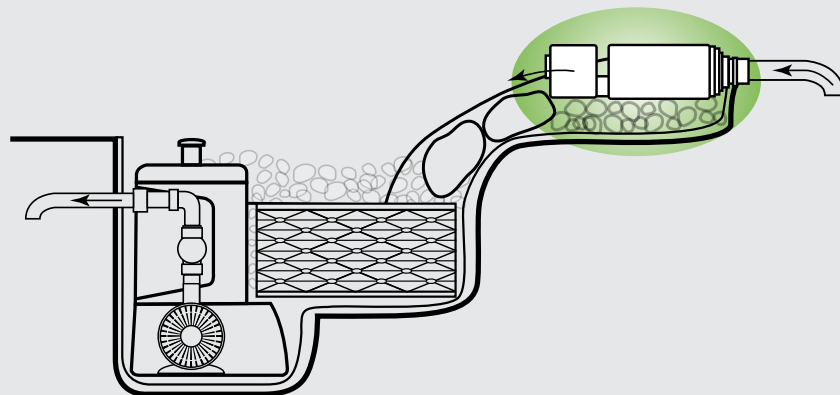

# Pondless® Waterfall Vault



	Pondless® Waterfall Vault	Pondless® Waterfall Vault Extension
Item Number	49000	49001
Maximum Flow Rate	Up to 12,500 GPH / 47,000 LPH	—
Access Opening Dimensions	16"L x 16"W	
Dimensions	23"L x 17"W x 25.5"H	16"L x 16"W x 9"H
Packaged Weight	14 lb. (6.4 kg)	5 lb. (2.3 kg)
Packaged Dimensions	23"L x 18"W x 22.5"H	16"L x 16"W x 10"H

The vault is designed to integrate with Aquascape AquaBlox® Water Storage Modules, effectively protecting pumps while making installation quick, precise, and simple. Its durable, rotationally molded, rounded polyethylene shape structural strength fits a wide range of pump sizes.

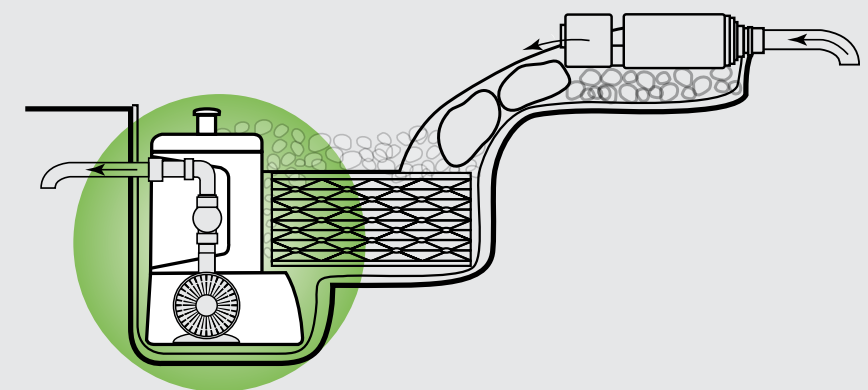



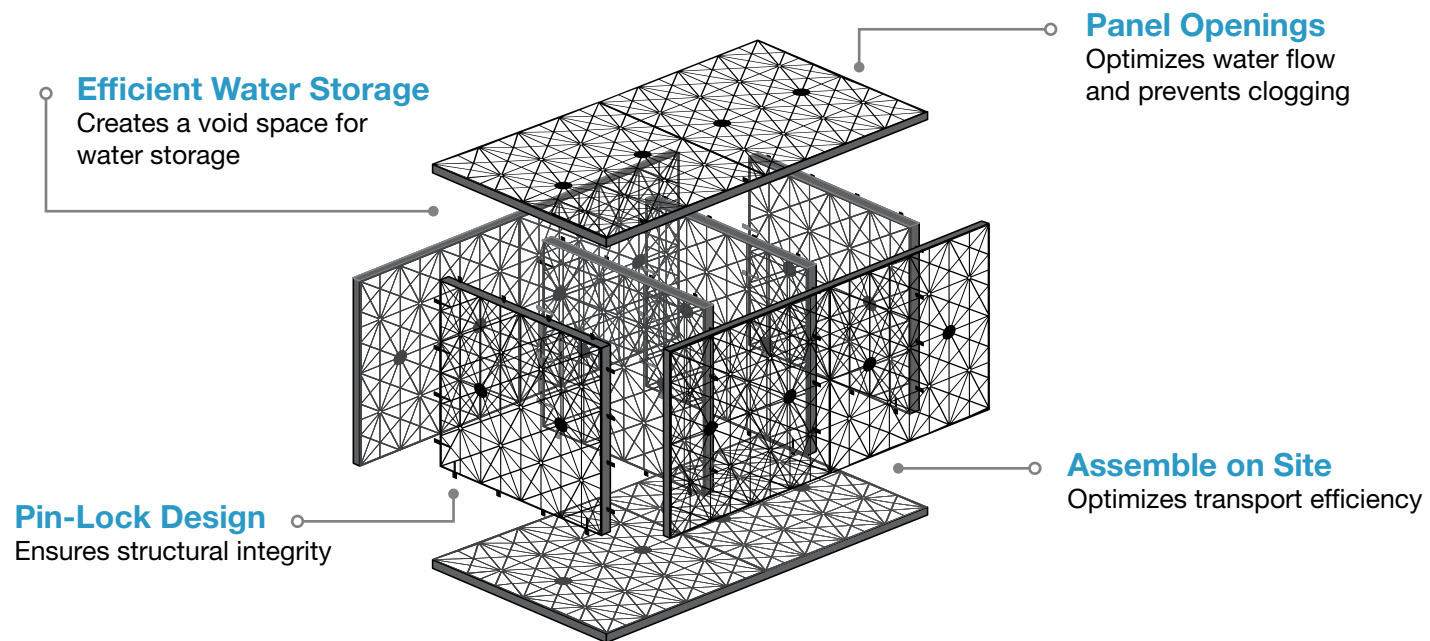

AquaBlox® Water Storage Modules

	Small	Large
Item Number	29491*	29492*
Volume	17 gal. / 64.35 L	32 gal. / 121.13 L
Load Bearing Weights	5,472 lb./sq. ft.	
Dimensions	26.5"L x 16"W x 9.5"H	26.5"L x 16"W x 17.5"H
Packaged Weight	11 lb. (4 kg)	16 lb. (7.3 kg)
Packaged Dimensions	27"L x 16"W x 4"H	27"L x 16"W x 6"H

\*AquaBlox® are available in bulk quantities, call for information

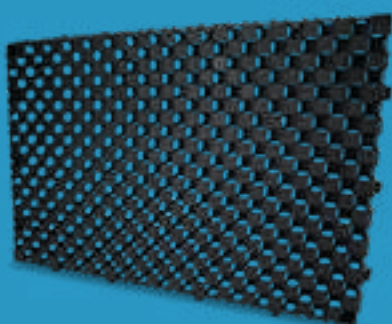

### Flo-Cell 30MM Drainage Cell

Uses for these versatile Flo-Cell panels for the following:

- Weight displacement for AquaBasin® or AquaBlox® Water Storage Module Systems
- Shimming rocks to a desired level
- Removable/cleanable interlocking panels for AquaBlox® Water Storage Module Systems
- Various drainage solutions

Packaged Weight: 1.5 lb (.68 kg)  
Packaged Dimensions: 24"L x 16"W x 1.25"H

#94012

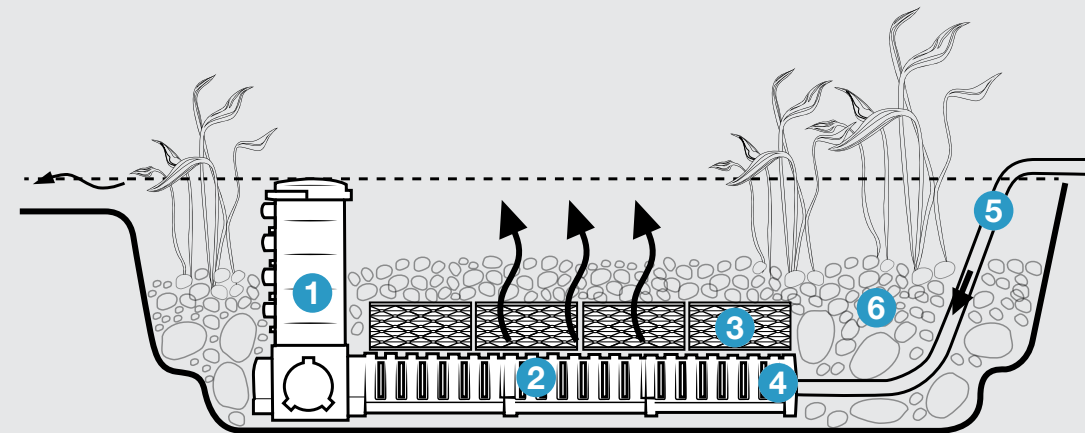

## Features

- 1 Snorkel® Vault**  
Provides an easy way to remove captured sediment from wetland filters. Simply drop in a cleanout pump to quickly clean the system.
- 2 Large Centipede® Module**  
Sits at the lowest point to ensure maximum water distribution and allows for efficient sediment removal during cleaning
- 3 AquaBlox® Water Storage Module**  
Provides water storage
- 4 Rubber Coupling**  
Creates a water-tight seal
- 5 Flex PVC Piping**  
Directs water to Centipede Module
- 6 Rocks and Gravel**  
Provides valuable filtrations while naturalizing the wetland area



Large Snorkel® Vault and Cap



Large Snorkel® Vault Extension



Large Centipede® Module

Item Number	29064	29068	29065
Packaged Weight	27 lb. (12 kg)	10 lb. (4.5 kg)	29 lb. (13 kg)



**Electrical Connections**  
Quick-connect simplify installation



**Control Panel**  
Use to adjust ionization levels and indicate when probe is exhausted



**Flow Chamber**  
Positions probe at an angle to prevent clogging and optimize results



Only Available for Sale in the USA

**#95027 IonGen™ System G2**  
Packaged Weight: 5 lb. (2.3 kg)  
Packaged Dimensions: 18"L x 4.5"W x 14"H



The following accessories and test kits can be used in conjunction with the IonGen™ System.

**#95028 IonGen™ Probe for the G2 System**

- For 2nd generation flow chamber
  - Includes 5 foot quick-connect cable
- Packaged Weight: .5 lb. (.23 kg)  
Packaged Dimensions: 3"L x 2"W x 6"H



**#95077 IonGen™ G2 Probe Holder**

- Allows for installation of G2 Probe without flow chamber
  - Can be used in a filter, such as a skimmer or a Pondless® Waterfall Vault
  - Straps onto any pipe or check valve from 1–4 inches in Dia.
- Packaged Weight: 1.5 lb. (0.6 kg)



**#96020 Copper Test Kit**

- Measures residual copper
  - 25 tests per kit
- Packaged Weight: .2 lb. (0.09 kg)  
Packaged Dimensions: 4"L x 1.5"W x 5"H



**#96019 KH/Alkalinity Test Kit**

- Measures KH/alkalinity
  - 60 tests per kit
- Packaged Weight: .2 lb. (0.09 kg)  
Packaged Dimensions: 4"L x 1.5"W x 5"H



Option 1: Probe can be installed directly into the water feature plumbing  
Option 2: Probe can be placed in an area with good water circulation or connected to the check valve using the included probe holder

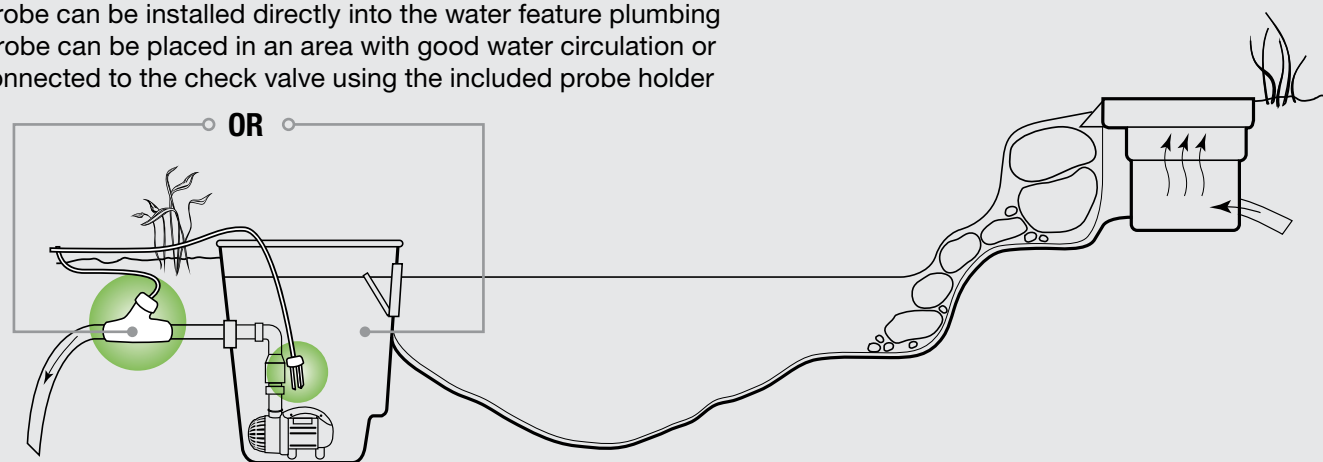

Only Available for Sale in the USA



# Pond, Waterfall, and Fountain Pumps

Pumps are the heart of any water feature, circulating water and providing aeration to help create a stable ecosystem.

## Control The Flow of Your Waterfall

### Aquascape Adjustable Flow Pumps

Turn up the pump speed for a more voluminous “party-style” waterfall, or dial it down for a quieter, more relaxing waterfall. Options include AquaSurge®, SLD, and AquaForce®.



AquaSurge®



SLD



AquaForce®

### Smart Pump Receiver

Adjustable flow pumps include the Aquascape Smart Pump Receiver to provide on-board flow control adjustment and the option to connect pumps to the Aquascape Smart Control App.



#### Features

- 1 WiFi Pairing Light
- 2 Integrated Control Panel
- 3 Flow Adjustment Controls
- 4 On/Off Controls
- 5 Protective Hinged Cover
- 6 Durable Metal Housing

### Smart Control App

With built-in WiFi connectivity you can control pumps from anywhere using your smartphone or tablet!

Connecting to the App provides a variety of wireless control functions, including flow adjustment, customized scheduling, and the ability to monitor your energy usage.





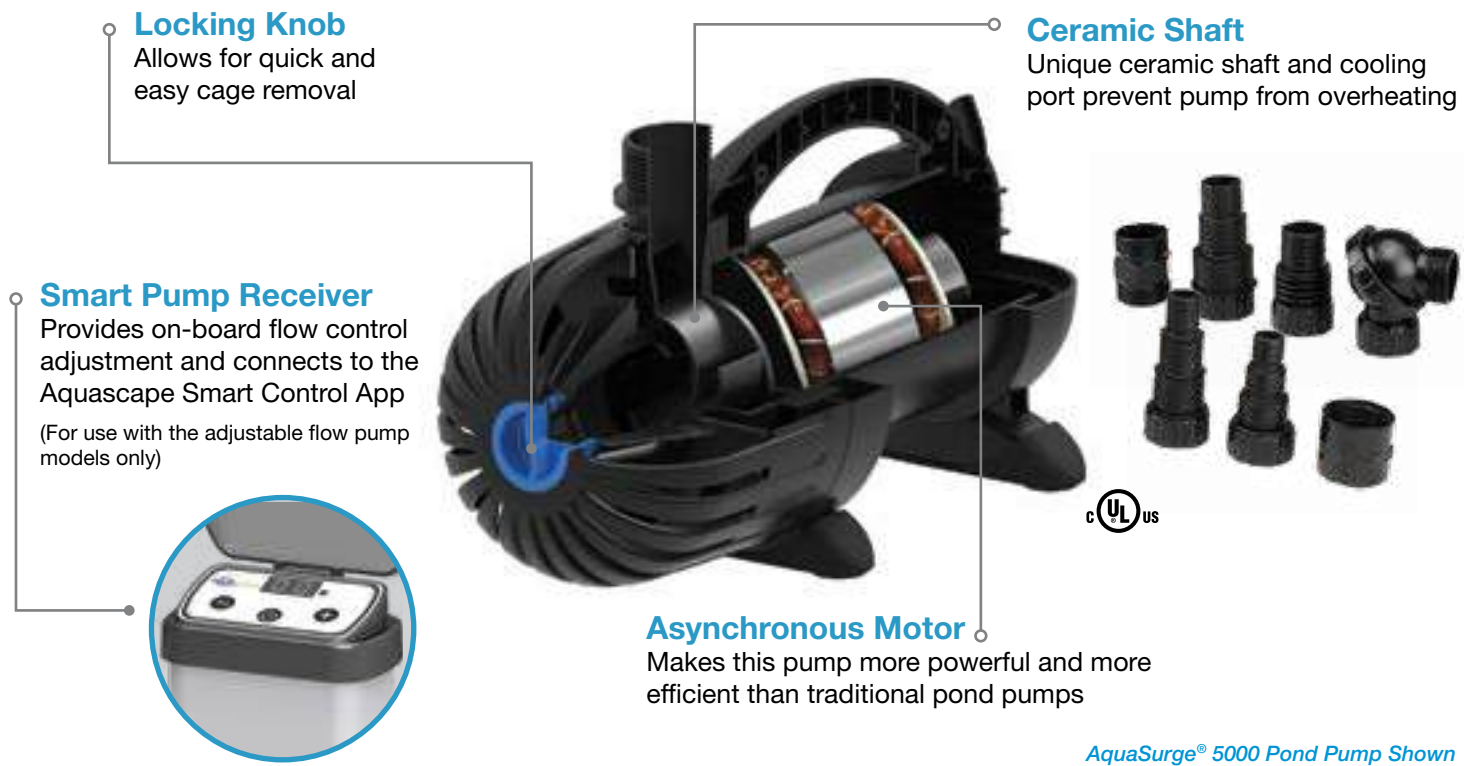

AquaSurge® and AquaSurge® Adjustable Flow Pond Pump Models

	2000	3000	4000	5000	2000-4000 Adjustable Flow	4000-8000 Adjustable Flow
Item Number	91017	91018	91019	91020	45009	45010
Maximum Flow Rate	2,193 GPH 8,000 LPH	3,196 GPH 12,000 LPH	3,947 GPH 14,500 LPH	5,284 GPH 20,000 LPH	3,947 GPH 14,500 LPH	7,793 GPH 29,500 LPH
Adjustable Flow	-				✓	
Maximum Head Height	12.5' (3.8 m)	15' (4.6 m)	18.5' (5.6 m)	24' (7.3 m)	18.5' (5.6 m)	28' (8.5 m)
Motor Type	Asynchronous					
Wattage	160	165	215	360	180 to 215	500 to 660
Amperage	1.3	1.4	1.82	3	1.82	5.5
Power Cord Length	20' (6 m)					
Pump Discharge Diameter	1.5" MPT					
Ideal Pipe Diameter	1.5" or 2"					2" or 3"
App/WiFi Connected	-				✓	
Pump Dimensions	12"L x 5.5"W x 7"H			14"L x 6"W x 7.5"H		
Warranty	3-Year Limited					
Packaged Weight	10 lb. (4.5 kg)	10.25 lb. (4.6 kg)	12.75 lb. (5.8 kg)	14 lb. (6.4 kg)	13 lb. (5.9 kg)	16 lb. (7.3 kg)
Packaged Dimensions	13.25"L x 9"W x 9"H	13.25"L x 9"W x 9.75"H	15"L x 9.25"W x 10.5"H	15"L x 9.25"W x 11.25"H	15"L x 9.5"W x 10.5"H	15"L x 9.5"W x 12"H



Universal Remote for Adjustable Flow Pumps

- For use with adjustable flow pumps only
- Packaged Weight: .3 lb. (.13 kg)  
Packaged Dimensions: 5"L x 2.75"W x 1.25"H  
#45041



Low Suction Intake Attachment

- Not compatible with AquaSurge 4000-8000
- Packaged Weight: .5 lb. (.23 kg)  
Packaged Dimensions: 5.75"L x 4.5"W x 5.75"H  
#91117



Adjustable Flow Pump Extension Cord

- Extend pumps 25' from the receiver
  - For use with adjustable flow pumps only
- Packaged Weight: 2 lb. (0.9 kg)  
Packaged Dimensions: 14"L x 4.25"W x 4.25"H  
#45048

Aquascape AquaSurge asynchronous pumps are designed for use in skimmer and waterfall-filter systems.

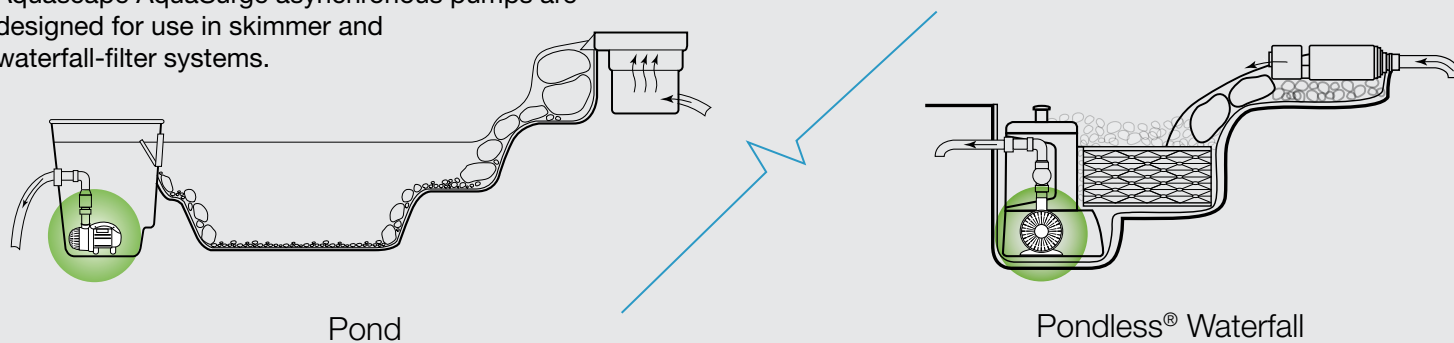

AquaSurge and AquaSurge Adjustable Flow Pond Pump Flow Chart (GPH)

Model	Max Head Height	Application Head Height							
		0'	5'	10'	15'	20'	25'	30'	35'
2000	12.5'	2193	1850	1465	0	GPH			
3000	15'	3196	2700	2350	0	GPH			
4000	18.5'	3947	3750	3350	2250	0	GPH		
5000	24'	5284	5000	4750	3250	1750	0	GPH	
2000-4000	18.5'	3947	3750	3350	2250	0	GPH		
4000-8000	45'	7793	7350	7000	5850	4300	2000	0	GPH

■ BEST Operating Zone    ■ MAXIMUM Operating Zone



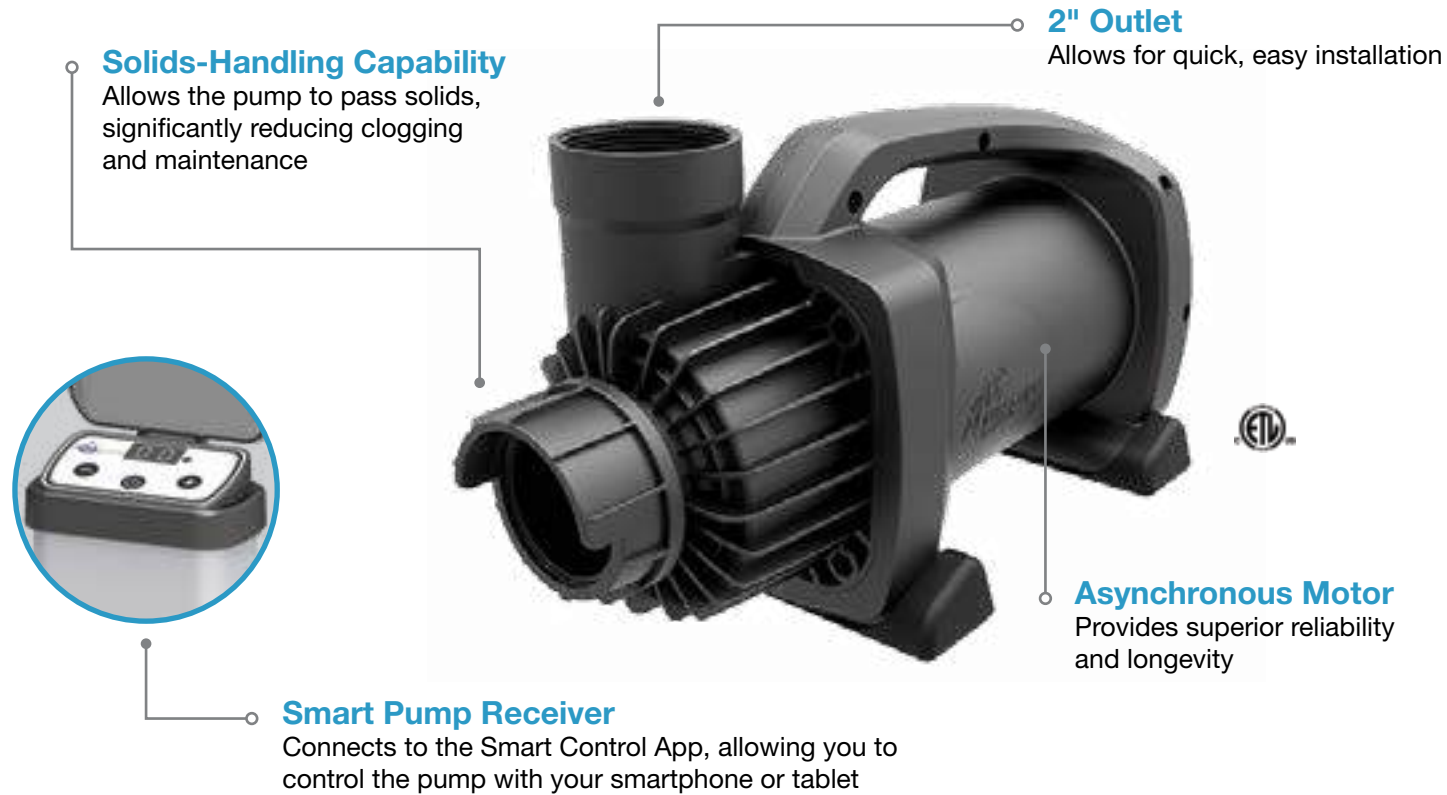

SLD 4000-7000 Adjustable Flow Pond Pump Shown

SLD and SLD Adjustable Flow Pond Pump Models

	5000	7000	9000	2000-5000	4000-7000	5000-9000
Item Number	45066	45067	45068	45046	45036	45037
Maximum Flow Rate	5,144 GPH 19,472 LPH	7,127 GPH 26,978 LPH	9,574 GPH 36,241 LPH	5,144 GPH 19,472 LPH	7,127 GPH 26,978 LPH	9,574 GPH 36,241 LPH
Adjustable Flow	-			✓		
Maximum Head Height	16.7' (5 m)	25' (7.6 m)	33' (10 m)	16.7' (5 m)	25' (7.6 m)	33' (10 m)
Motor Type	Asynchronous					
Wattage	340	660	1060	340	660	1060
Amperage	2.81	6.6	8.9	2.81	6.6	8.9
Power Cord Length	20' (6,1 m)			20' (6,1 m)		
Pump Discharge Diameter	2" FPT					
Ideal Pipe Diameter	2" or 3"					
App/WiFi Connected	-			✓		
Pump Dimensions	13"L x 6.25"W x 7"H					
Warranty	3-Year Limited					
Packaged Weight	13.5 lb. (6 kg)	16.5 lb. (2.7 kg)	17.5 lb. (8 kg)	14.5 lb. (1.8 kg)	17.6 lb. (8 kg)	18.75 lb. (8.5 kg)
Packaged Dimensions	15"L x 11.5"W x 9.5"H	15"L x 11.75"W x 9.5"H	15"L x 11.75"W x 10.75"H	15"L x 11.5"W x 9.5"H	15.25"L x 12"W x 9.5"H	15.25"L x 12"W x 10.75"H

SLD and SLD Adjustable Flow Pond Pump Flow Chart (GPH)

Model	Max Head Height	Application Head Height							
		0'	5'	10'	15'	20'	25'	30'	35'
5000	16.7'	5144	3769	2484	1256	0	GPH		
7000	25'	7126	6148	5044	3802	1957	0	GPH	
9000	33'	9574	8808	7742	6412	5069	3576	1355	0 GPH
2000-5000	16.7'	5144	3769	2484	1256	0	GPH		
4000-7000	25'	7126	6148	5044	3802	1957	0	GPH	
5000-9000	33'	9574	8808	7742	6412	5069	3576	1355	0 GPH

■ BEST Operating Zone ■ MAXIMUM Operating Zone

**Universal Remote for Adjustable Flow Pumps**

- For use with adjustable flow pumps only

Packaged Weight: .3 lb. (.14 kg)  
Packaged Dimensions: 5"L x 2.75"W x 1.25"H

#45041



**Adjustable Flow Pump Extension Cord**

- Extend pumps 25' from the receiver
- For use with adjustable flow pumps only

Packaged Weight: 2 lb. (0.9 kg)  
Packaged Dimensions: 14"L x 4.25"W x 4.25"H

#45048

Aquascape SLD Pond Pumps are ideal for use in ponds, Pondless® Waterfalls, and other water feature applications

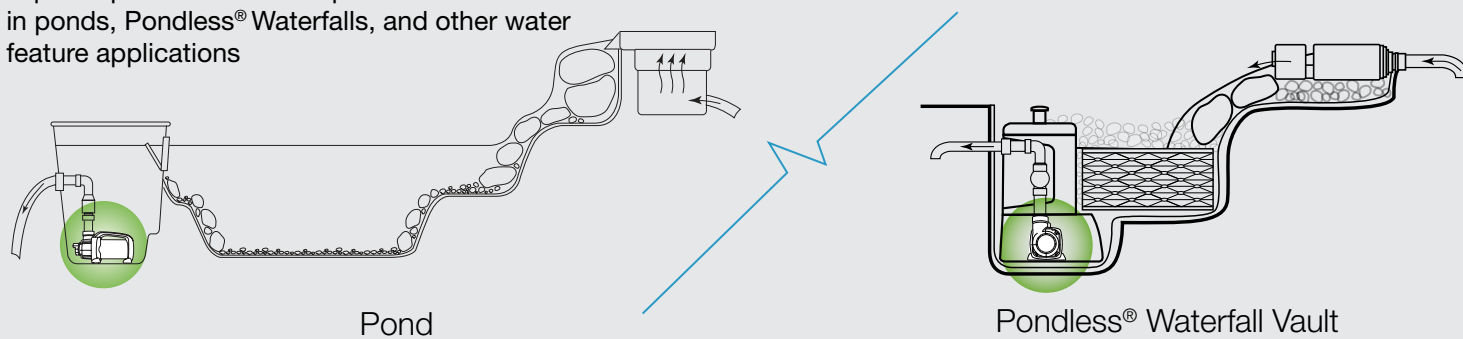



**Overload Protection**

Built in thermal overload protection prevents pump from overheating

**Shielded Intake**

Prevents air from entering pump when used in shallow water applications

**Unmatched Dependability**

Double mechanical silicone carbide seals and oil lifter provide unmatched dependability



5-PL 5000 Solids-Handling Pond Pump Shown

**High Efficiency**

Continuous duty motor operates at lower temperature which extends pump life

**Reinforced Power Cord**

Anti-wicking, watertight design improves durability and prevents issues with electrical shorting

**High Volume Flow**

Channel impeller and specially designed volute allows for efficient, high volume water flow



12-PN 10000 Solids-Handling Pond Pump Shown

Aquascape PL and PN Solids-Handling Pond Pump Models

	3-PL	5-PL	9-PL	8-PN	12-PN
Item Number	29975	29976	29977	29495	30391
Maximum Flow Rate	3,000 GPH 11,400 LPH	5,300 GPH 20,000 LPH	7,300 GPH 27,500 LPH	5,548 GPH 21,000 LPH	10,000 GPH 37,500 LPH
Maximum Head Height	14' (4.3 m)	23' (7 m)	35' (10.6 m)	56' (17 m)	23' (7 m)
Motor Type	Direct Drive				
Wattage	330	620	1000		900
Amperage	3.2	5.6	8.6	9.1	
Power Cord Length	20'				
Pump Discharge Diameter	2"				3"
Ideal Pipe Diameter	2"	2" or 3"			3"
Pump Dimensions	11.7"L x 5.6"W x 7.1"H	13.2"L x 5.9"W x 7.3"H	14"L x 5.9"W x 7.3"H	9.3"L x 6.4"W x 15"H	11.7"L x 7.7"W x 15.1"H
Warranty	2-Year Limited				
Packaged Weight	16 lb. (7.3 kg)	19 lb. (8.6 kg)	23 lb. (10.4 kg)	24 lb. (10.8 kg)	36 lb. (16.3 kg)
Packaged Dimensions	13"L x 9.75"W x 9.5"H	15"L x 9.75"W x 9.5"H	15"L x 9.75"W x 9.5"H	17.25"L x 10.25"W x 9"H	12.5"L x 9"W x 17.75"H

Aquascape PL & PN Series Pump Flow Chart (GPH)

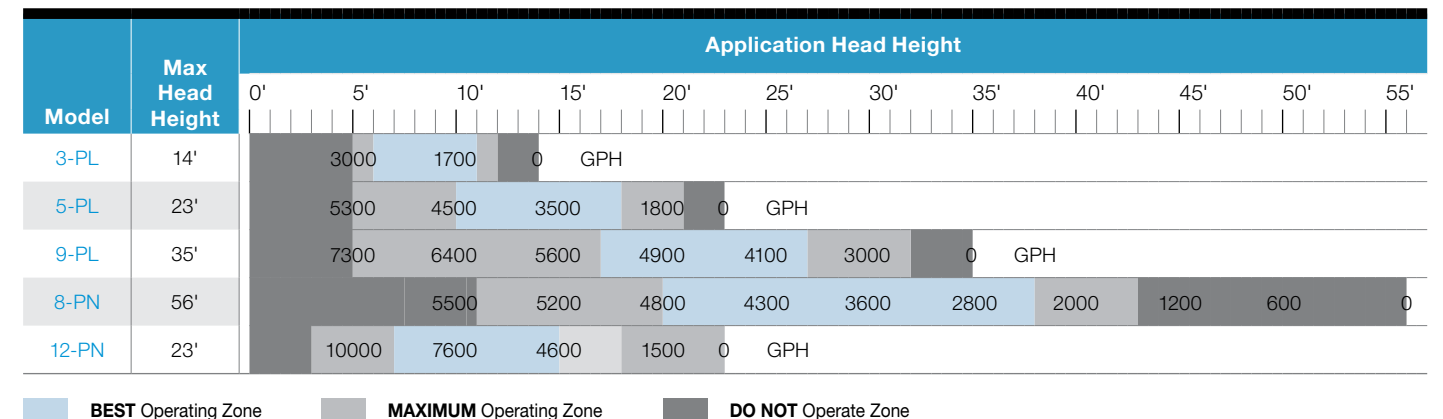



### External/In-Line Pump

Ideal for water features requiring high flow in a non-submersible application



**TEFC**  
Totally enclosed fan-cooled motor

**Customized Electrical**  
Junction box located on pump motor allows 115V or 230V electric to be customized on site



EXT 18000 Pond Pump Shown

### EXT Pump 2"-3" Plumbing Kit

- Includes fittings, flanges, valves, and hardware to install the EXT pump at the perimeter of the pond's edge.

Packaged Weight: 21 lb.  
Packaged Dimensions: 12.5"L x 12.5"W x 12"H

#48027

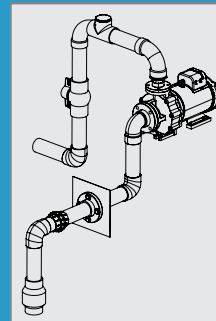

### EXT Pump 3" Plumbing Kit

- Includes fittings, flanges, valves, and hardware to install the EXT pump at the perimeter of the pond's edge.

Packaged Weight: 25 lb.  
Packaged Dimensions: 12.5"L x 12.5"W x 12"H

#48044

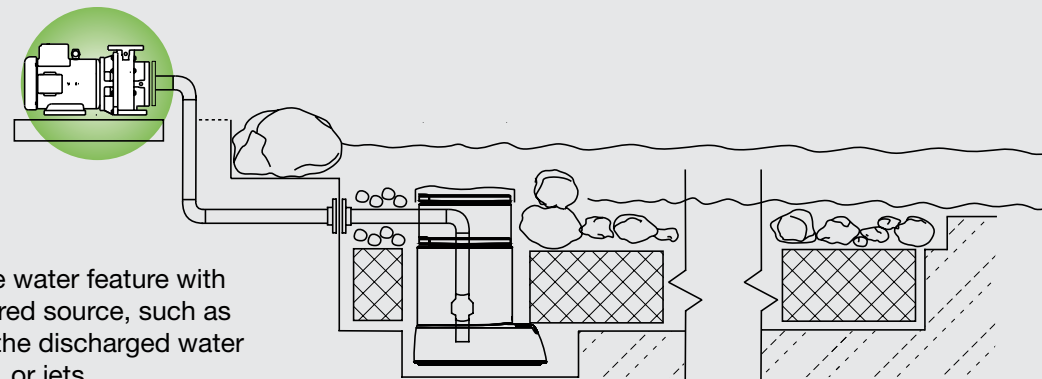

EXT pumps are installed near the water feature with the intake pulling from a pre-filtered source, such as a Pondless® Waterfall Vault and the discharged water sent to wetland filters, waterfalls, or jets.

### EXT Pond Pump Models

	12000	12000-3P	18000	18000-3P
Item Number	45049	45051	45050	45052
Maximum Flow Rate	12,500 GPH / 47,318 LPH		18,400 GPH / 69,652 LPH	
Maximum Head Height	21'		45'	
Motor Type/HP	143JM / 3/4 hp	143JM / 1 HP	184JM / 3 HP	
Wattage	1,100	736	3,300	1,932
Maximum Current Amps @	115V - 10 A / 230V - 5 A	230V - 3.2 A / 460V - 1.6 A	115V - 30 A / 230V - 15 A	230V - 8.4 A / 460V - 4.2 A
Power Cord Length	10 ft	-		
Pump Discharge Diameter	2"			
Pump Inlet Diameter	3"			
Ideal Pipe Diameter	3"			
Phase	Single	3-Phase	Single	3-Phase
Pump Dimensions	19.3"L x 11.9"W x 11.75"H		21.15"L x 12.9"W x 11.75"H	21.9"L x 12.65" W x 11.75"H
Warranty	5-Year Limited			
Packaged Weight	114 lb. (51.7 kg)	115 lb. (52 kg)	114 lb. (51.7 kg)	115 lb. (52 kg)
Packaged Dimensions	30"L x 17.5"W x 18"H			

### EXT Pond Pump Flow Chart (GPH)

Model	Max Head Height	Application Head Height											
		0'	5'	10'	15'	20'	25'	30'	35'	40'	45'	50'	
12000	21'	12000	11500	9916	7760	4245	0	GPH					
12000-3P	21'	12000	11500	9916	7760	4245	0	GPH					
18000	45'	18000	17000	16500	15660	14332	13000	11700	9832	7720	3600	0	GPH
18000-3P	45'	18000	17000	16500	15660	14332	13000	11700	9832	7720	3600	0	GPH

BEST Operating Zone
MAXIMUM Operating Zone
DO NOT Operate Zone



### 3-Year Warranty

Confidence in the advantages of today's technology and reliable construction

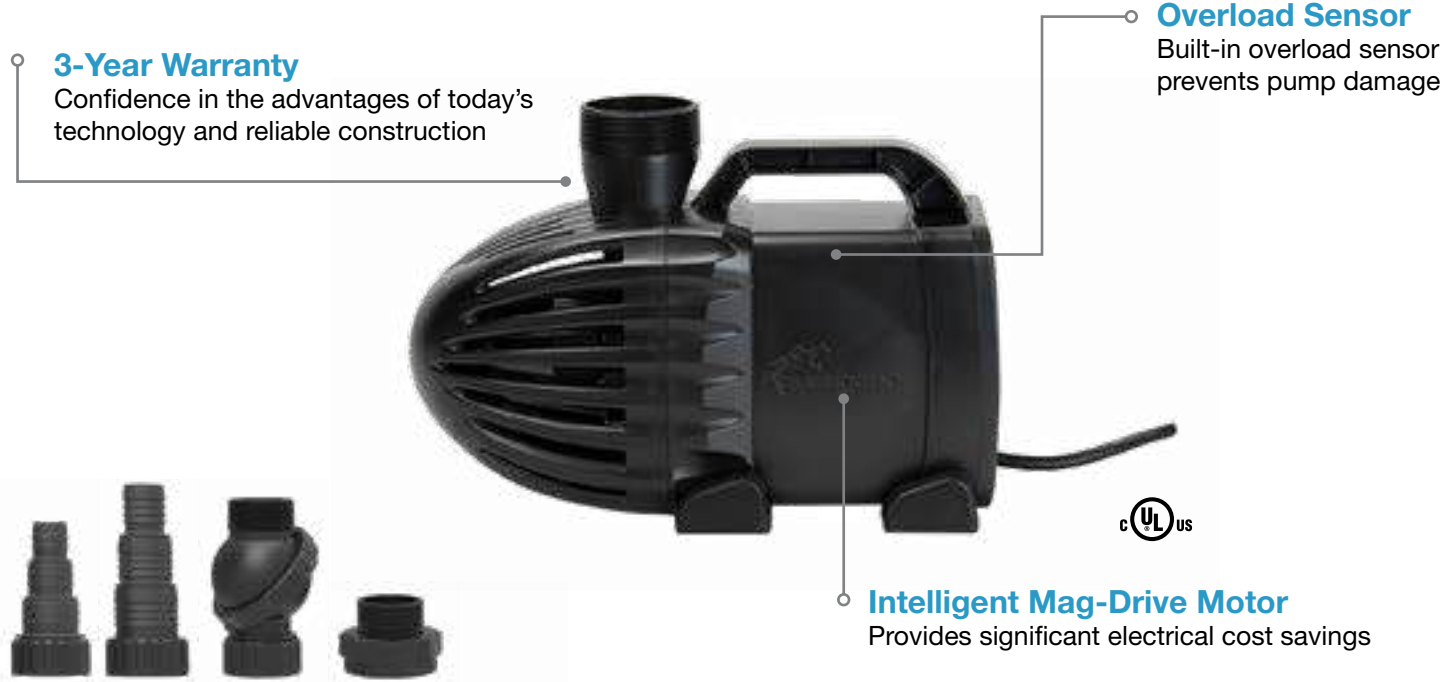

**Overload Sensor**  
Built-in overload sensor prevents pump damage

**Intelligent Mag-Drive Motor**  
Provides significant electrical cost savings

EcoWave® 4000 Pond Pump Shown



### Low Suction Intake Attachment

- Allows pumps to be operated in shallow applications such as the AquaBasin® 45.
- Compatible with the EcoWave® 2000 & 3000.

Packaged Weight: .5 lb. (.23 kg)  
Packaged Dimensions: 5.75"L x 4.5"W x 5.75"H

#91117

Note: Not compatible with EcoWave Pump models 4000 and 5000



### Check Valve Adapter for EcoWave Pond Pump - 2"

- Designed to make it quick and easy to connect EcoWave® pumps to the Dual Union Check Valve 2.0 (#48026).

Packaged Weight: .5 lb. (.23 kg)  
Packaged Dimensions: 3.75"L x 3.75"W x 4"H

#88058

Note: Compatible with EcoWave Pump models 2000-5000

EcoWave pond pumps are ideal for use in pond skimmer and Pondless® Waterfall Vault applications with lower head heights.

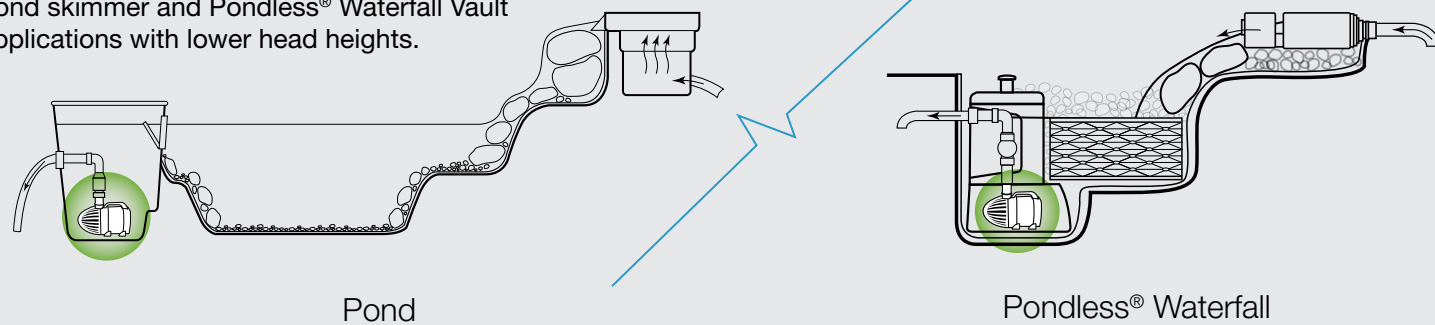

## EcoWave Pond Pump Models

	2000	3000	4000	5000
Item Number	91131	91132	91133	91134
Maximum Flow Rate	2,020 GPH / 7,500 LPH	2,960 GPH / 11,000 LPH	4,000 GPH / 15,000 LPH	5,000 GPH / 18,500 LPH
Maximum Head Height	14.4' (4.4 m)	17.5' (5.3 m)	20' (6 m)	21' (6.4 m)
Motor Type	Mag-Drive			
Wattage	65	90	130	150
Amperage	0.54	.75	1.08	1.25
Power Cord Length	20'			
Pump Discharge Diameter	2" MPT			
Ideal Pipe Diameter	1.5" - 2"			2"
Pump Dimensions	11"L x 5.75"W x 7.5"H			
Warranty	3-Year Limited			
Packaged Weight	10.25 lb. (4.6 kg)	11.5 lb. (5.2 kg)	13 lb. (5.9 kg)	14 lb. (6.4 kg)
Packaged Dimensions	13"L x 11"W x 10.5"H	13"L x 11"W x 11.75"H	13"L x 11"W x 13"H	13"L x 11"W x 14"H

## EcoWave Pond Pump Flow Chart (GPH)

Model	Max Head Height	Application Head Height											
		0'	2.5'	5'	7.5'	10'	12.5'	15'	17.5'	20'	22.5'	25'	
2000	14.4'	2020	1350	860	650	400	150	0	GPH				
3000	17.5'	2960	2150	1470	1100	850	550	300	0	GPH			
4000	20'	4000	2950	2210	1650	1250	1000	750	400	0	GPH		
5000	21'	5000	4050	3205	2450	1850	1450	1100	750	300	0	GPH	

BEST Operating Zone    
  MAXIMUM Operating Zone



**Protective Cage**  
Prevents large debris from clogging or damaging pump, reducing maintenance

**Powerful and Efficient Motor**  
Asynchronous motor technology makes this pump more powerful and more efficient than traditional "mag-drive," or magnetically driven pond pumps

**Smart Pump Receiver**  
Connects to the Smart Control App, allowing you to control the pump with your smartphone or tablet  
(For use with the AquaForce Adjustable Flow Solids-Handling Pond Pump only)

**Threaded Disconnect**  
Allows for the pump to be easily removed from the pond for maintenance or winterization without removing hose clamps or plumbing assembly

*AquaForce 4000-8000 Adjustable Flow Solids-Handling Pond Pump Shown*

**Universal Remote for Adjustable Flow Pumps**

- For use with adjustable flow pumps only

Packaged Weight: .3 lb. (.13 kg)  
Packaged Dimensions: 5"L x 2.75"W x 1.25"H  
#45041

**Adjustable Flow Pump Extension Cord**

- Extend pumps 25' from the receiver
- For use with adjustable flow pumps only

Packaged Weight: 2 lb. (0.9 kg)  
Packaged Dimensions: 14"L x 4.25"W x 4.25"H  
#45048

The AquaForce® protective pre-filter cage allows the pump to be placed directly into the pond.

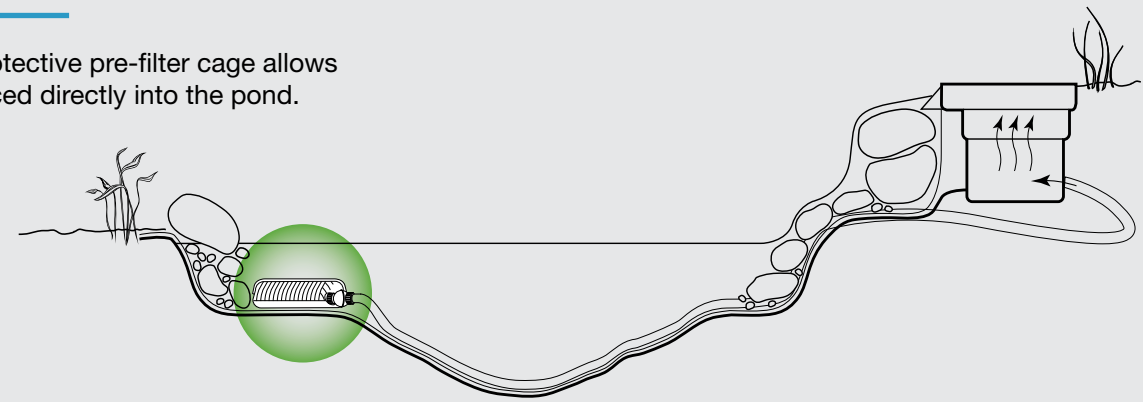

AquaForce Solids-Handling and AquaForce Adjustable Flow Solids-Handling Pond Pump Models

	1000	1800	2700	3600	5200	Adjustable Flow 4000-8000
Item Number	91011	91112	91012	91113	91013	91104
Maximum Flow Rate	1,070 GPH 4,000 LPH	2,149 GPH 8,000 LPH	2,695 GPH 10,000 LPH	3,868 GPH 14,500 LPH	5,284 GPH 20,000 LPH	7,793 GPH 29,500 LPH
Adjustable Flow						✓
Maximum Head Height	10' (3 m)	16.5' (5 m)	14' (4.3 m)	18' (5.5 m)	24' (7.3 m)	28' (8.5 m)
Motor Type	Asynchronous					
Wattage	55	160	147	215	360	500 to 660*
Amperage	0.51	1.33	1.25	1.8	3	5.5
Power Cord Length	25'					20'
Pump Discharge Diameter	1.5" MPT					
Ideal Pipe Diameter	1" - 1.5"		1.5" - 2"		2"	2" - 3"
App/WiFi Connected						✓
Pump Dimensions	14"L x 14"W x 6.5"H					
Warranty	3-Year Limited					
Packaged Weight	11 lb. (5 kg)	12.25 lb. (5.6 kg)	12 lb. (5.4 kg)	14.5 lb. (6.6 kg)		18.5 lb. (8.4 kg)
Packaged Dimensions	14.25"L x 14.25"W x 9"H	14.25"L x 15.25"W x 9"H	14.25"L x 15.75"W x 9"H	14.25"L x 16.25"W x 9"H	14.25"L x 16.75"W x 9"H	14.25"L x 18.75"W x 9"H

\*Wattage range depending on flow setting

AquaForce Pond Pump Flow Chart (GPH)

Model	Max Head Height	Application Head Height							
		0'	5'	10'	15'	20'	25'	30'	35'
1000	10'	1070	850	0	GPH				
1800	16.5'	2149	1806	1320	260	0 GPH			
2700	14'	2695	2425	1840	0		GPH		
3600	18'	3868	3613	3254	2100	0		GPH	
5200	24'	5284	5116	4250	3186	1500	0 GPH		
4000-8000	28'	7794	7150	6440	5320	3950	1800	0 GPH	

BEST Operating Zone
MAXIMUM Operating Zone



### Diverter and Flow Control

Allows water to be used for fountainhead, circulation, and additional equipment like spitters or external filters and waterfalls

### Adjustable Height

The adjustable riser stem allows for easy height adjustment from 10 to 20 inches

### Pump Cage Clips

Makes it easy to open to perform pump maintenance or remove debris



AquaJet® 1300 Pond Pump Shown

## Add a New Dimension to Your Pond

Each AquaJet pump comes complete with riser stems, multi-hose fitting, diverter valve, and three fountain heads, including foaming jet, daisy, and waterbell



Foaming Jet



Daisy



Waterbell

The AquaJet protective pre-filter cage allows the pump to be placed directly into the pond.

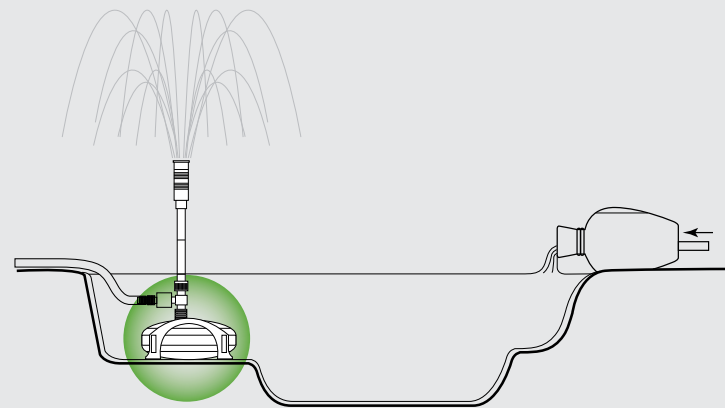

## AquaJet Pond Pump Models

	600	1300	2000
Item Number	91014	91015	91016
Pond Size Recommendation	1,200 gal. / 4,800 L	1,300 gal. / 5,200 L	2,000 gal. / 8,000 L
Maximum Fountain Height (Daisy Fountain)	Up to 47"	Up to 62"	Up to 65"
Motor Type	Mag-Drive		
Wattage	33	110	250
Amperage	0.55	1.00	2.60
Power Cord Length	25'		
Pump Discharge Diameter on Diverter	1/2", 3/4"		1/2", 3/4", 1"
Pump Dimensions	12"L x 12"W x 6"H		
Warranty	3-Year Limited		
Packaged Weight	6.5 lb. (2.9 kg)	9 lb. (4 kg)	9.5 lb. (4.3 kg)
Packaged Dimensions	13"L x 9"W x 14"H	13.25"L x 8.75"W x 15"H	13.25"L x 9"W x 15.75"H

## AquaJet Pond Pump Flow Chart (GPH)

Model	Max Head Height	Application Head Height													
		0'	2.5'	5'	7.5'	10'	12.5'	15'	17.5'	20'	22.5'	25'			
600	7.5'	525		300	0	GPH									
1300	13.5'	1350		1050		625	0	GPH							
2000	20'	2000		1800		1525		1075	0	GPH					

BEST Operating Zone    
  MAXIMUM Operating Zone



**Locking Knob**  
Convenient for quick and easy cage removal



**Mag-Drive Motor**  
Makes this pump energy efficient and simple to maintain



Fittings included with 400/550/800



Fittings included with 1100/1500/2000



**Stable**  
The wide, flat base and rubber feet make the pump stable and reduces vibration

Ultra 1100 Water Pump Shown

## Ultra Water Pump Models

	400	550	800	1100	1500	2000
Item Number	91005	91006	91007	91008	91009	91010
Maximum Flow Rate	370 GPH 1,000 LPH	528 GPH 1,500 LPH	793 GPH 3,000 LPH	1,110 GPH 4,000 LPH	1,480 GPH 5,500 LPH	1,982 GPH 7,500 LPH
Maximum Head Height	7.5' (0.3 m)	8' (2.4 m)	9' (2.7 m)	12' (3.6 m)	16.5' (5 m)	20' (6 m)
Motor Type	Mag-Drive					
Wattage	24	33	58	92	153	250
Amperage	0.40	0.55	0.80	0.85	1.46	2.60
Power Cord Length	12'			25'		
Pump Discharge Diameter	1/2", 3/4", 1", and 1.25"					
Ideal Pipe Diameter	1/2" - 1"			3/4" - 1.25"		
Pump Dimensions	5.5"L x 4"W x 3.5"H	6"L x 4"W x 4"H		9"L x 5"W x 6"H	9.5"L x 6"W x 7"H	
Warranty	3-Year Limited					
Packaged Weight	2.5 lb. (1 kg)	3 lb. (1.4 kg)	4.5 lb. (2 kg)	5.25 lb. (2.4 kg)	8 lb. (3.6 kg)	9 lb. (4 kg)
Packaged Dimensions	9"L x 5"W x 5"H	9"L x 5.25"W x 5.25"H	9"L x 6.5"W x 6"H	9.5"L x 6.75"W x 7"H	10.5"L x 8"W x 8"H	10.5"L x 8"W x 9"H

### Small Ultra Pump Fountain Head Kit

Packaged Weight: .5 lb. (.23 kg)  
Packaged Dimensions: 5.5"L x 3.5"W x 7.25"H

#91045

Ideal for Ultra 400, 550, and 800

### Large Ultra Pump Fountain Head Kit

Packaged Weight: .5 lb. (.23 kg)  
Packaged Dimensions: 6"L x 3"W x 9"H

#91046

Ideal for Ultra 1100, 1500, and 2000

Included fittings integrate seamlessly into Aquascape AquaBasin®



## Ultra Water Pump Flow Chart (GPH)

Model	Max Head Height	Application Head Height										
		0'	2.5'	5'	7.5'	10'	12.5'	15'	17.5'	20'	22.5'	25'
400	7.5'	370	300	200	0	GPH						
550	8'	528	425	300	75	GPH						
800	9'	793	675	500	275	0	GPH					
1100	12'	1110	1000	800	600	300	0	GPH				
1500	16.5'	1480	1350	1200	1050	825	575	200	0	GPH		
2000	20'	1985	1875	1750	1600	1375	1125	800	450	0	GPH	

■ BEST Operating Zone    ■ MAXIMUM Operating Zone

# Statuary Water Pump

**Mag-Drive Motor**  
Makes this pump energy efficient and simple to maintain



**Flow Control**  
Allows you to create a customized water flow

**Intake Strainer**  
Prevents the pump from running dry or pulling in air in shallow applications

90 GPH Water Pump Shown

## Statuary Water Pump Models

	70	90	180	320
Item Number	91023	91024	91025	91026
Maximum Flow Rate	70 GPH / 250 LPH	90 GPH / 300 LPH	180 GPH / 650 LPH	320 GPH / 1,200 LPH
Maximum Head Height	2' (0.6 m)	3' (0.9 m)	4' (1.2 m)	5.5' (1.7 m)
Motor Type	Mag-Drive			
Wattage	3.0	4.3	9.3	17.6
Amperage	.037	.061	.175	.339
Power Cord Length	6'			
Pump Discharge Diameter	1/2", 5/8"			
Pump Dimensions	2"L x 1.5"W x 1.25"H	2.5"L x 1.75"W x 2"H	3"L x 2.5"W x 2"H	4"L x 3.25"W x 2.5"H
Warranty	3-Year Limited			
Packaged Weight	.75 lb. (340 g)		1.25 lb. (0.6 kg)	2 lb. (0.9 kg)
Packaged Dimensions	4"L x 4"W x 2.75"H	4.25"L x 4"W x 3.25"H	4"L x 4"W x 4"H	4"L x 4"W x 4.75"H

# Pond Powerhead

**Propeller**  
Designed to provide water movement in stagnant areas of the pond

**Standalone Pump**  
Does not require any pipe or plumbing



**Adjustable Head**  
Allows for directional flow control

## #91142 Pond Powerhead

Packaged Weight: 9.5 lb.  
Packaged Dimensions: 13.25"L x 9"W x 15.75"H

Maximum Flow Rate	2,000 GPH / 7,647 LPH	Motor Type	Mag-Drive
Wattage	40	Amperage	3.33
Voltage	12V	Frequency	60 Hz
Power Cord Length	25'	Pump Dimensions	9"L x 5.5"W x 5.25"H
Warranty	3-Year Limited		

## Typical Application

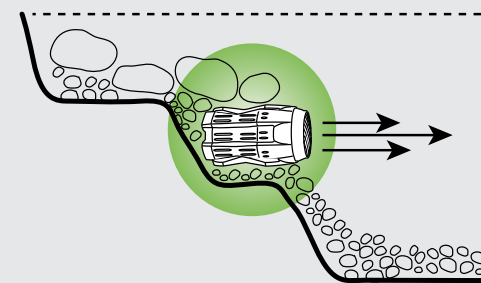

The Aquascape Pond Powerhead is designed to create water movement and eliminate stagnant areas in ponds and water gardens.

## Winter Application

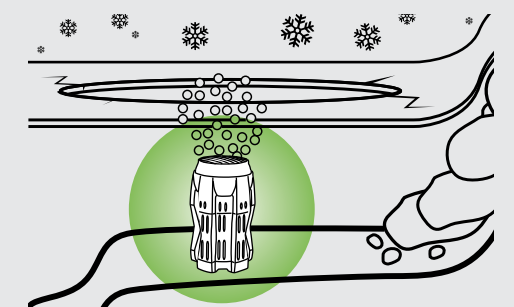

Stand on end and create surface agitation in the winter months, helping to keep a hole in the ice for proper gas exchange.



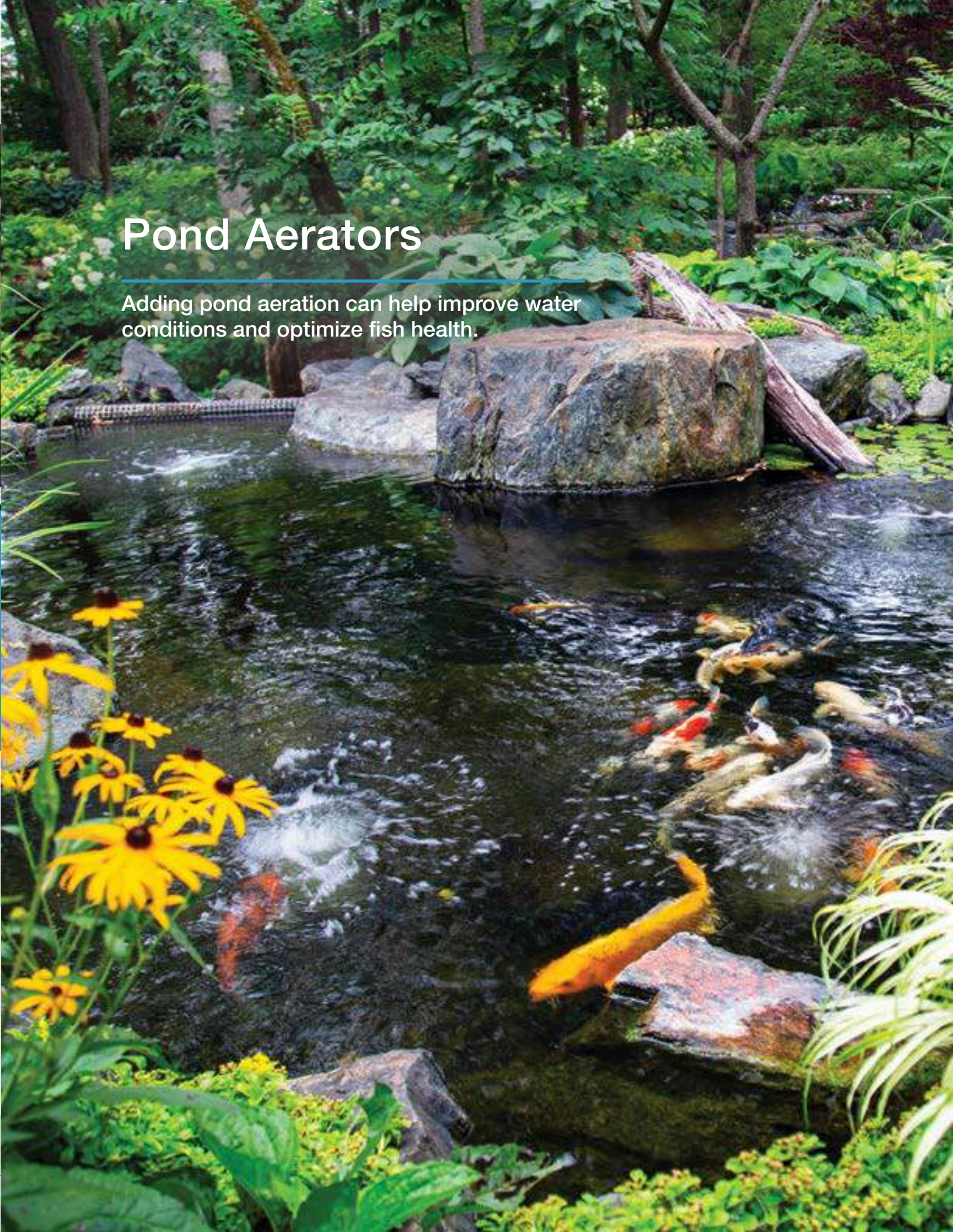

## Pond Aerators

Adding pond aeration can help improve water conditions and optimize fish health.



Pump Cleaner Maintenance Solution



LSR Cleanout Pump



Cleanout Pump Discharge Hose 50'

Item Number	91143	45063	48019
Packaged Weight	.75 lb. (340 g)	28 lb. (12.7 kg)	14.75 lb. (6.7 kg)
Packaged Dimensions	8 oz. bottle	9.25"L x 9.25"W x 11.38"H	22.5"L x 22.5"W x 9"H

The Aquascape Pump Cleaner Maintenance Solution (#91143) uses cutting-edge cleaning compounds to remove scale and biofilm to restore the pump.

Before



After







4-Outlet Pond Aeration Kit Shown



**Pond Aerator Aeration Disc**  
Packaged Weight: .5 lb. (.23 kg)  
Packaged Dimensions: 5"L x 9"W x 1"H  
**#75005**

Heat and excess debris can cause low oxygen levels in your pond. Adding an Aquascape pond aerator will help ensure your pond is oxygenated properly, creating a healthy and safe environment for your fish.

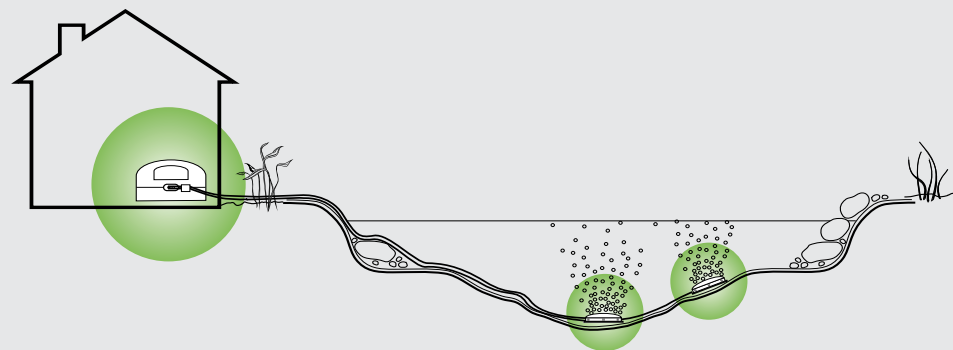

2-Outlet and 4-Outlet Pond Aeration Kits

	2-Outlet Pond Aeration Kit	4-Outlet Pond Aeration Kit
Item Number	75000	75001
Pond Size	Up to 2,000 gal. / 7,570 L	Up to 3,500 gal. / 13,428 L
Maximum Recommended Pond Depth	8.5' (2.6 m)	9' (2.7 m)
Maximum Air Flow Rate (Loaded)	0.28 CFM (8 L/min)	0.49 CFM (14 L/min)
Maximum Air Depth (Loaded)	3.70 psi (0.26 kgf/cm <sup>2</sup> )	3.98 psi (0.28 kgf/cm <sup>2</sup> )
Number of Aeration Discs	2	4
Wattage	6	11
Check Valve	Included and pre-installed	
Power Cord Length	6'	
Length of Airline	(2) 25' rolls 3/16" silicone	(4) 25' rolls 3/16" silicone
Pump Dimensions	5.25"L x 4.75"W x 3.5"H	7.75"L x 7.25"W x 6.25"H
Warranty	3-Year Limited	
Packaged Weight	3.5 lb. (1.6 kg)	6.25 lb. (2.8 kg)
Packaged Dimensions	15.5"L x 4"W x 12"H	17.75"L x 5.5"W x 11.75"H



**Understanding Aeration**

Every biological process that occurs in ponds is dependent on oxygen. This is especially important in warmer temperatures or at night when plants are not converting sunlight into oxygen. Pond aerators supply dissolved oxygen directly to ponds and other water features, helping all biological processes and resulting in healthier fish and plants.



# Pro Air Pond Aeration Kits



## Pro Air Pond Aeration Kits

	Pro Air 20	Pro Air 60
Item Number	61009	61008
Pond Size	Up to 5,000 gal. / 20,000 L	Up to 15,000 gal. / 60,000 L
Maximum Recommended Pond Depth	6.5' (2 m)	11.5' (3.5 m)
Maximum Air Flow Rate (Loaded)	0.71 CFM (20 L/min)	2.1 CFM (60 L/min)
Maximum Air Depth (Loaded)	2.90 psi (0.20 kgf/cm <sup>2</sup> )	5.08 psi (0.36 kgf/cm <sup>2</sup> )
Number of Outlets	1	2 (Includes 2-Way Manifold)
Number of Diffusers	1	2
Wattage	15	45
Check Valve	Included and pre-installed	
Power Cord Length	6'	
Airline Length	(1) 30' Roll 3/8" Braided Vinyl	(2) 30' Roll 3/8" Braided Vinyl
Pump Dimensions	6"L x 5.5"W x 4.25"H	7.75"L x 7.25"W x 6.25"H
Aeration Diffuser Dimensions	10"L x 4"H	
Warranty	3-Year Limited	
Packaged Weight	11.5 lb. (5.2 kg)	22 lb. (10 kg)
Packaged Dimensions	12"L x 11"W x 10"H	14.25"L x 12.75"W x 9"H

# Pro Air Pond Aeration Accessories



Pro Air 20 Aeration Compressor

Pro Air 60 Aeration Compressor

Item Number	61017	61016
Pond Size	Up to 5,000 gal. / 20,000 L	Up to 15,000 gal. / 60,000
Maximum Recommended Pond Depth	6.5' (2 m)	11.5' (3.5 m)
Maximum Air Flow Rate (Loaded)	0.71 CFM (20 L/min)	2.1 CFM (60 L/min)
Maximum Air Depth (Loaded)	2.90 psi (0.20 kgf/cm <sup>2</sup> )	5.08 psi (0.36 kgf/cm <sup>2</sup> )
Number of Outlets	1	2
Wattage	15	45
Power Cord Length	6'	
Dimensions	6"L x 5.5"W x 4.25"H	7.75"L x 7.25"W x 4"H
Aeration Diffuser	Sold Separately	
Length of Airline	Sold Separately	
Check Valve	Sold Separately	
Warranty	3-Year Limited	
Packaged Weight	5.75 lb. (2.6 kg)	11.5 lb. (5.2 kg)
Packaged Dimensions	8.75"L x 7.5"W x 7"H	9.5"L x 7.75"W x 8.25"H



## Seasonal Care

The aeration compressor can be used during winter months, when bubbles and water movement created at the surface help to maintain a small opening in the ice for oxygenation.





Weighted Aeration Tubing 3/8" x 25'

Weighted Aeration Tubing 3/8" x 100'

10" Rubber Membrane Aeration Diffuser

2-Way Aeration Compressor Manifold

Pond Aerator PRO – Check Valve

Barbed Coupling 3/8"

Item Number	61011	61014	61010	61012	61003	99159
Packaged Weight	7.3 lb. (3.3 kg)	32 lb. (14.5 kg)	2.75 lb. (1.3 kg)	.25 lb. (.11 kg)	.2 lb. (0.9 kg)	.25 lb. (.11 kg)
Packaged Dimensions	13"L x 13"W x 4.75"H	18"L x 14"W x 9"H	11.75"L x 4"W x 4"H	-	-	-

## Pond and Landscape Lighting

The complete line of Aquascape LED pond lights and garden lighting makes it easy to enjoy your water feature or garden at night!

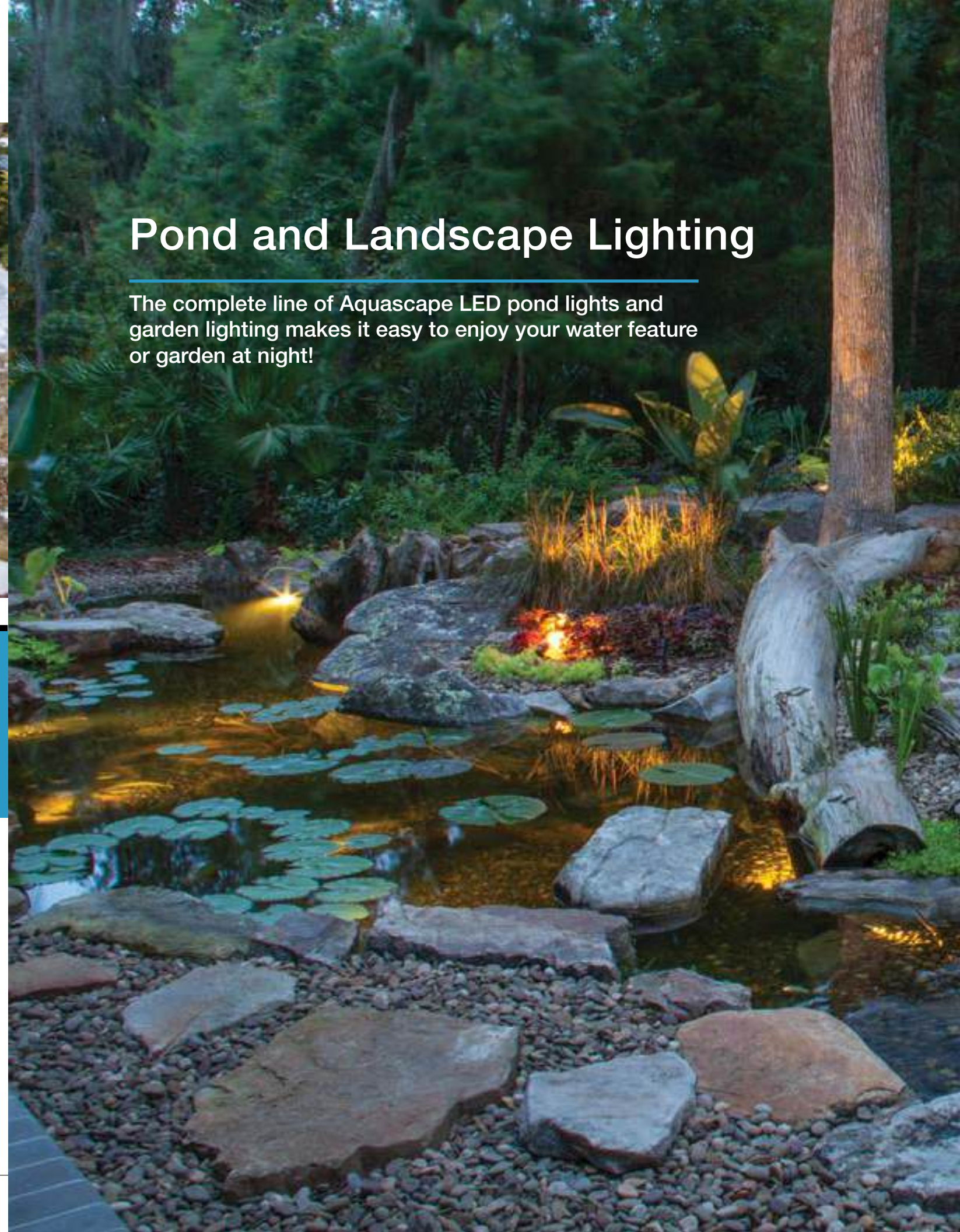



L

Color-Changing Lights

**Durable Metal Housing**

Fully-sealed die-cast with protective finish

**Diodes**

Two rows of high output color-changing and white diodes

**Optical Lenses**

Optimized for a wide and horizontal 90-degree beam pattern with dual beam cut offs

**Universal Mount Adapter**

(included with light)

Allows for a variety of mounting options

11-Watt Color-Changing Wide-Angle Light Shown

**#84080 Light Stake**

Packaged Weight: 0.3 lb

Packaged Dimensions: 5" L x 10.5" W x 3" H

Only for use with the Universal Mount Adapter

**#84081 Flexible Light Stand**

Packaged Weight: 0.4 lb.

Packaged Dimensions: 10.75" L x 13" W x 1" H

Color-Changing Lights

L

LED Color-Changing Lights

2-Watt  
Color-Changing  
Waterfall Light4.5-Watt  
Color-Changing  
Spotlight8-Watt  
Color-Changing  
Spotlight11-Watt  
Color-Changing  
Wide-Angle Light

Item Number	84057	84059	84060	84076
Lumens	52 lm / White	128 lm / White	223 lm / White	640 lm / White
Wattage	2W±10%	4.5W±10%	8W±10%	11W±10%
Voltage Min-Max	10.8V – 15V			
Temperature in Kelvin	3,000 K			
Color Rendering Index (CRI)	70 / White			
Beam Angle Spread	30°			90°
Bulb Life	40,000 Hours			50,000 hours
12V Quick-Connect Fitting	✓			
Fixture Material	Die-Cast Metal			
Smart Control Hub #84074 Required (Sold Separately)	✓			
Cord Length	15'			25'
Ground Stake	–	✓		Sold Separately
Flexible Light Stand	✓			Sold Separately
Light Dimensions	2" Dia. x 1.5"H	3" Dia. x 3"H		2.7"L x 3.8"W x 2.9"H
Warranty	5-Year Limited			
Packaged Weight	1.25 lb. (.56 kg)	2.75 lb. (1.2 kg)		2.53 lb. (1.1 kg)
Packaged Dimensions	4.75"L x 4.5"W x 7.5"H	5.25"L x 5.25"W x 13.25"H	6.25"L x 6.25"W x 16.25"H	5.27"L x 5.27"W x 4.37"H

!

Color-changing lights require a Smart Control Hub and 12V transformer

Smart Control Hub

Packaged Weight: .75 lb. (340 g)

Packaged Dimensions: 4.75"L x 2"W x 4.75"H

#84074

12V Transformers

See page 86

Color-Changing Light Remote

Allows wireless control without the use of a smartphone or tablet

#84073

Wiring Diagram

Simple and Easy to Connect

K | F | P | A | L | PWR | WT | PC | SC | FC | PPC | D | LUG | PP | IT | RH

K | F | P | A | L | PWR | WT | PC | SC | FC | PPC | D | LUG | PP | IT | RH

72 (866) US-PONDS | CAN (866) 766-3426 | Current pricing available at [aquascapeinc.com/pond-lighting](http://aquascapeinc.com/pond-lighting)(866) US-PONDS | CAN (866) 766-3426 | Current pricing available at [aquascapeinc.com/pond-lighting](http://aquascapeinc.com/pond-lighting) 73





Color-Changing Fountain Light

Color-Changing Fountain Light Kit  
*Note: All in one kit, not WiFi compatible*

Item Number	84072	84055
Lumens	20 lm / White	
Wattage	2W±10%	
Voltage Min-Max	10.8V – 15V	
Temperature in Kelvin	3,000 K	
Color Rendering Index (CRI)	70 / White	
Beam Angle Spread	30°	
Bulb Life	40,000 Hours	
Fixture Material	Plastic	
Includes Required Transformer	–	✓
Smart Control Hub #84074 Required (Sold Separately)	✓	Not compatible
Cord Length	15'	
Light Dimensions	1.5 in Dia. x 2.5 in H	
Acceptable Pipe Diameter	1/2" – 3/4"	
Packaged Weight	0.5 lb. (226 g)	2.25 lb. (1 kg)
Packaged Dimensions	3.75"L x 1.75"W x 8.25"H	5.5"L x 2.75"W x 7.75"H



25' Color-Changing Light Extension Cable



25' 5-Outlet Color-Changing Light Extension Cable



3-Way Color-Changing Light Splitter



6-Way Color-Changing Light Splitter

Item Number	84069	84070	84062	84068
Quick-Connect Connections	1	5	3	6
Type of Quick-Connect	4-Prong			
Cord Length	25'		12"	12"
Packaged Weight	1.25 lb. (.56 kg)	1.5 lb. (.68 kg)	.25 lb. (.11 kg)	.75 lb. (340 g)
Packaged Dimensions	7.25"L x 1.75"W x 5.75"H	7"L x 2.5"W x 6.25"H	4"L x 1.5"W x 3"H	7.25"L x 1.75"W x 2"H

#### Color-Changing Light Extension Cables

The color-changing lighting extension cables allow for simple extension of Aquascape color-changing lighting. They are ideal for use with our 12-volt quick-connect transformers and 3-way and 6-way splitters. The 12-volt quick-connect components eliminate the need to cut wires and provide a weatherproof seal. Not compatible with Aquascape LED white lights.

#### Color-Changing Light Splitters

Aquascape color-changing splitters provide a simple connection of three or six color-changing fixtures to a single power source. Multiple 3-way and 6-way splitters can be chained together to attach additional fixtures. Not compatible with Aquascape LED white lights.





3-Light Spotlight Kit Shown

## 3-Light Spotlight Kit Includes

-  • Three pre-wired 1-watt LED lighting fixtures
-  • Adjustable stands and landscape stakes
-  • 6-watt/12 V transformer
-  • Pond and Landscape Quick-Connect Photocell with Timer

## 3-Light Spotlight Kit

Item Number	84030
Lumens	140
Wattage	3
Temperature in Kelvin	3,000 K
Bulb Life	40,000 Hours
Cord Length	15'
Warranty	5-Year Limited
Packaged Weight	4 lb. (1.8 kg)
Packaged Dimensions	16.5"L x 3.5"W x 12"H

## Wiring Diagram

- 1 (3) 1-Watt LED Spotlights (included)
- 2 Quick-Connect Photocell (included)
- 3 6-Watt Low Voltage Quick-Connect Transformer (included)

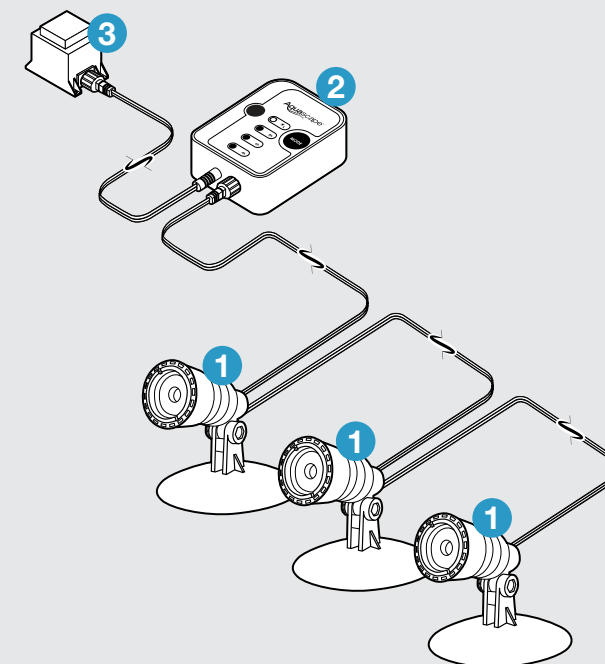



**Durable Metal Housing**

Fully-sealed die-cast with protective finish

**Diodes**

Two rows of high output white diodes

**Optical Lenses**

Optimized for a wide and horizontal 90-degree beam pattern with dual beam cut offs

**Universal Mount Adapter**(Included with light)  
Allows for a variety of mounting options

8-Watt Wide-Angle Light Shown

**#84080 Light Stake**Packaged Weight: 0.3 lb.  
Packaged Dimensions: 5" L x 10.5" W x 3" H**#84081 Flexible Light Stand**Packaged Weight: 0.4 lb.  
Packaged Dimensions: 10.75" L x 13" W x 1" HOnly for use with the  
Universal Mount Adapter**Wiring Diagram**

Simple and Easy to Connect

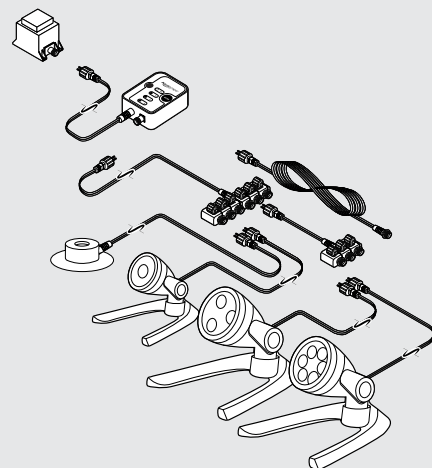
[Click here to see how](#)

## Pond and Landscape LED Lights

1-Watt  
Waterfall Light

1-Watt Spotlight



3-Watt Spotlight



6-Watt Spotlight

8-Watt  
Wide-Angle Light

Note: All pond and landscape lights require 12V transformer

Item Number	84032	84031	84033	84034	84077
Lumens	45 lm		150 lm	340 lm	840 lm
Wattage	1.2W±10%		3W±10%	5.8W±10%	8W±10%
Voltage Min-Max	9V – 15V				10.8V – 15V
Temperature in Kelvin	3,000 K				
Color Rendering Index (CRI)	75				70
Beam Angle Spread	30°				90°
Bulb Life	40,000 Hours				50,000 Hours
Fixture Material	Die-Cast Metal				
Cord Length	14.5'				25'
Ground Stake	—	✓			Sold Separately
Flexible Light Stand	✓				Sold Separately
Light Dimensions	2" Dia. x 1.5"H	1.25" Dia. x 2"H	3" Dia. x 3"H		2.7"L x 3.8"W x 2.9"H
Warranty	5-Year Limited				
Packaged Weight	1 lb. (453 g)		2.5 lb. (1.1 kg)	2.75 lb. (1.2 kg)	2.53 lb. (1.1 kg)
Packaged Dimensions	4.75"L x 4.5"W x 7.5"H	4.75"L x 3.75"W x 11"H	5"L x 5"W x 13"H	6.25"L x 6"W x 14"H	5.27"L x 5.27"W x 4.37"H



## Available in a 6-Pack!

• 1-Watt Waterfall Light 6-Pack  
#84046• 3-Watt Spotlight 6-Pack  
#84047• 1-Watt Spotlight 6-Pack  
#84045• 6-Watt Spotlight 6-Pack  
#84048



L

Warm White Fountain Lights

Low Voltage Accessories

L

Note: All pond and landscape lights require 12V transformer

LED Fountain Light

Fountain Light Kit with Transformer

25'  
Quick-Connect  
Extension Cable25' 5-Outlet  
Quick-Connect  
Extension Cable3-Way  
Quick-Connect  
Splitter6-Way  
Quick-Connect  
Splitter

Item Number	84008	84009
Lumens	24 lm	
Wattage	2.5W±10%	
Voltage Min-Max	10.8V – 15V	
Temperature in Kelvin	3,000 K	
Color Rendering Index (CRI)	70	
Beam Angle Spread	30°	
Bulb Life	40,000 Hours	
12V Quick-Connect Fitting	✓	
Fixture Material	Plastic	
Cord Length	15' (4.6 m)	
Light Dimensions	1.5" Dia. x 2.5"H	
Acceptable Pipe Diameter	1/2" – 3/4"	
Warranty	5-Year Limited	
Packaged Weight	1 lb. (453 g)	2 lb. (0.9 kg)
Packaged Dimensions	2.75"L x 2.5"W x 8.25"H	5.5"L x 2.5"W x 7.25"H

Item Number	98998	84023	98489	84022
Quick-Connect Connections	1	5	3	6
Type of Quick-Connect	2-Prong			
Cord Length	25' (7.6 m)		8" (20.3 cm)	36" (91.4 cm)
Packaged Weight	1 lb. (.45 kg)		.5 lb. (.23 kg)	.75 lb. (340 g)
Packaged Dimensions	5.75"L x 2.75"W x 5.75"H		2.5"L x 1.5"W x 3.75"H	8"L x 8"W x 2"H

Quick-Connect Photocell with Timer

- Can be used to control Aquascape white and color-changing lights
- Auto on at dusk/off at dawn or 4, 6, 8 hour timer option
- Built-in memory setting in case of power loss
- Integrates easily with other 12-volt quick-connect components
- Up to 60-Watt capacity

Packaged Weight: .75 lb.  
Packaged Dimensions: 2"L x 1.25"W x 3.25"H with a 36" cord

#84039

K | F | P | A | L | PWR | WT | PC | SC | FC | PPC | D | LUG | PP | IT | RH

K | F | P | A | L | PWR | WT | PC | SC | FC | PPC | D | LUG | PP | IT | RH

80 (866) US-PONDS | CAN (866) 766-3426 | Current pricing available at [aquascapeinc.com/pond-lighting](http://aquascapeinc.com/pond-lighting)(866) US-PONDS | CAN (866) 766-3426 | Current pricing available at [aquascapeinc.com/pond-lighting](http://aquascapeinc.com/pond-lighting) 81





### Aquascape LED Lights

Each fixture features durable brass construction with an antique bronze finish, providing a long-lasting, professional-quality light that can be enjoyed year after year.

### Path and Area Landscape Lights



Hat Top

Dome Top

Note: All path and area landscape lights require 12V transformer

Item Number	84063	84064
Lumens	270 lm	
Wattage	3W±10%	
Voltage Min-Max	9V – 15V	
Temperature in Kelvin	2,700 K	
Color Rendering Index (CRI)	80	
Beam Angle Spread	120°	90°
Bulb Life	25,000 Hours	
Fixture Material	Brass	
Cord Length	3' (.91 m)	
Light Dimensions	6.5" Dia. x 18.25"H	
Warranty	5-Year Limited	
Packaged Weight	1.75 lb. (.79 kg)	
Packaged Dimensions	5.75"L x 5.75"W x 9.25"H	



Available in a 6-Pack!



- Hat Top Path and Area Landscape Light 6-Pack #84065
- Dome Top Path and Area Landscape Light 6-Pack #84066



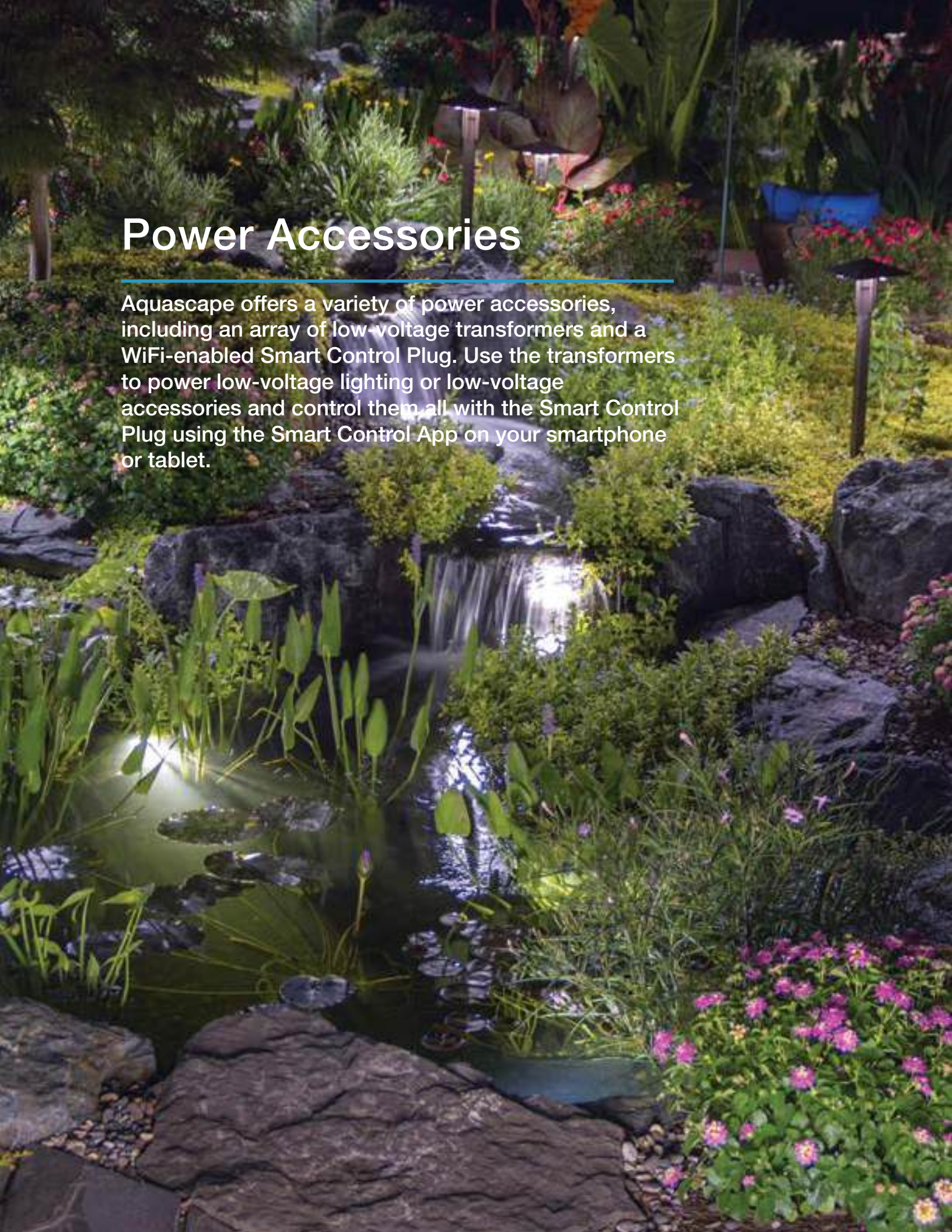

# Power Accessories

Aquascape offers a variety of power accessories, including an array of low-voltage transformers and a WiFi-enabled Smart Control Plug. Use the transformers to power low-voltage lighting or low-voltage accessories and control them all with the Smart Control Plug using the Smart Control App on your smartphone or tablet.

## Smart Control Plug

PWR



**WiFi Pairing Button/Indicator**  
Allows for quick and easy connection to your smartphone or tablet

**Integrated Hang Tag**  
Provides secure mounting option

**Numbered Outlets**  
Allow simple, clear setup

**Waterproof Caps**  
Protects unit when not in use

**#82001 Smart Control Plug**  
Packaged Weight: .5 lb. (.23 kg)  
Dimensions: 6"L x 1.5"W x 5.5"H with 6" cord  
Packaged Dimensions: 7"L x 2"W x 6"H

Control Aquascape water features with your smartphone or tablet

Monitor your energy usage on the Aquascape Smart Control App to make informed decisions about your energy consumption.







Low Voltage Transformers



Item Number	98375	98485	98486	99070	01002
Quick-Connect Connections	1			3	
Type of Quick-Connect	2-Prong				
Photocell Included	-			✓	
Transformer Dimensions	3"L x 1.5"W x 2.25"H	4"L x 1.75"W x 2.5"H	3"L x 6"W x 3"H	3.5"L x 7"W x 2.5"H	47"L x 7"W x 3.5"H
Packaged Weight	1 lb. (453 g)	1.75 lb. (.79 kg)	3.5 lb. (1.6 kg)	4 lb. (1.8 kg)	8 lb. (3.6 kg)
Packaged Dimensions	6.5"L x 3"W x 4.5"H	6.25"L x 2"W x 4"H	6"L x 2"W x 4"H	8.75"L x 7.5"W x 4.25"H	7.75"L x 4"W x 4"H

## Water Treatments

Aquascape has a variety of options to clean and maintain your pond, waterfall or fountain. Select from simple solutions, beneficial bacteria, problem solving, algae fighting, water conditioners, sludge fighting, fountain treatments, and lake and large pond treatments.





## Aquascape Simple Solutions Water Treatments Are Designed to Make Your Life Easier!

By combining our best water treatments into four treatments for ponds and two for waterfalls and fountains, we have a solution for the most common water feature issues. Choose a simple pump top or use the dosing system versions and prepare to be amazed at the results.

### Simple Solutions Treatments for Ponds



#### Maintain for Ponds

Staple water treatment for ponds, designed to keep ponds clean and healthy

**What It Does**

- Reduces maintenance
- Supports a healthy ecosystem
- Provides healthy and crystal-clear water conditions

**How It Works**

- Combines our most effective water treatments into one powerful formulation (like a multivitamin)
- Uses a beneficial bacteria blend, phosphate binder, flocculant clarifier, and detoxifier

#### Clear for Ponds

Use to clear unsightly water conditions, including cloudy and discolored water

**What It Does**

- Clarifies water and resolves water quality problems
- Mitigates cloudy or discolored water and issues with debris attached to rocks and gravel

**How It Works**

- Uses a concentrated formula of clarifiers and a phosphate binder which work to prevent and eliminate issues with water clarity and debris buildup



#### Clean for Ponds

Use to naturally reduce organic sludge and debris

**What It Does**

- Reduces organic waste caused by uneaten fish food, fish waste, and leaves or debris
- Naturally cleans rocks, gravel, and filters
- Keeps ponds looking clean and clear

**How It Works**

- Uses a powerful blend of heterotrophic bacteria to digest organic waste and sludge

#### Protect for Ponds

Use to protect pond fish such as koi and goldfish. Great for use after transporting/handling fish or cleanouts.

**What It Does**

- Reduces fish stress
- Prevents parasites and infections
- Accelerates healing of superficial wounds, scrapes and breeding abrasions

**How It Works**

- Uses an all-natural formulation of tea tree oil and other plant-based biopolymers

## Simple Solutions Treatments for Fountains and Waterfalls



#### Prevent for Fountains

Staple product for fountains; cleans and clarifies

**What It Does**

- Controls white-scale buildup, foam, and stains
- Helps to clear unsightly water conditions and debris that attaches to surfaces

**How It Works**

- Contains a special blend of clarifiers and scale remover that will not damage fountain surface

Note: Not for use with water features containing fish

#### Clean for Fountains

Used to clear unsightly suspended debris

**What It Does**

- Keeps waterfalls and fountains clean, clear, and healthy
- Reduces maintenance and improves water quality

**How It Works**

- Uses a flocculant clarifier and phosphate binder to help clear and prevent debris



### Application Options

Choose between simple pump top options or one of our automated treatment devices which automatically add treatment, so you don't have to!



Ideal for Ponds, Waterfalls, and Fountains up to 2,250 Gallons

**Hood Design**  
Designed to hide and protect mounted control panels from weather conditions

**Easy-to-Use Controller**  
Simply set for your water feature size and enjoy the benefits

**Compact Design**  
Sleek and compact to easily hide near smaller water features

**Storage Capacity**  
Store up to 32 oz. of water treatment

**Durable Housing**  
Built to last and can be buried to conceal

**#96085 Dosing System SL**

- Treats smaller water features up to 2,250 gallons
- Includes: enclosure, control panel, treatment intake, internal and external tubing, and low-voltage transformer
- Controller Wattage: 4.5W
- Transformer Wattage: 6W
- Cord Length: 13 ft. (4.3 m)
- Tubing Length: 6 ft. (2 m)
- Packaged Weight: 3 lb. (1.4 kg)
- Packaged Dimensions: 6"L x 4"W x 10"H



**Water Treatments Sold Separately**

For more treatment options [see page 91](#)

**Size Comparison with XT**

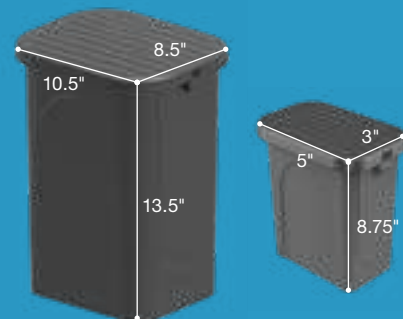

**SL Water Treatments for Ponds and Fountains**

Designed for use with the Dosing System SL and the Automatic Dosing System



Maintain for Ponds    Clear for Ponds    Clean for Ponds    Protect for Ponds    Prevent for Fountains    Clean for Fountains

Item Number	96090	96091	96092	96093	96094	96095
Package Size	32 oz. / 946 ml					
Packaged Weight	2.5 lb. (1.1 kg)					
Usage	Refer to page 88			Refer to page 89		



Ideal for Ponds, Waterfalls, and Fountains up to 75,000 Gallons

**Durable Enclosure**

Stores up to a gallon of treatment for longer durations between refills

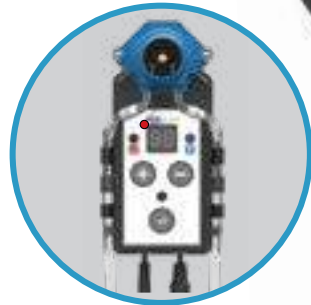

**Mounted Controller**

Push-button design makes it easy to set for your water feature size

**Smart Control**

Connect to the app to control, monitor, and receive alerts on your smartphone or tablet



**#40040 Smart Pond Dosing System XT**

- Treats larger water features with ease (30,000 gallons for over a month)

Includes: enclosure, (1) control panel, (1) treatment intake with low treatment alert, internal and external treatment tubing, and low-voltage transformer

Controller Wattage: 6W  
Transformer Wattage: 12W  
Volts: 12V  
Cord Length: 13 ft.  
Tubing Length: 6 ft.  
Packaged Weight: 6 lb.  
Packaged Dimensions: 11.5"L x 9.75"W x 15.25"H

**Low-Treatment Alert**

Alerts you when the treatment is 90% empty



**Water Treatments Sold Separately**

For more treatment options [see page 93](#)

**Add Two Different Treatments Simultaneously!**

**Smart Pond Dosing System Controller Add-On Kit**

- Add to Smart Pond Dosing System XT to dose two 64 oz. treatments simultaneously
- Includes intake assembly, tubing, and power cable

Packaged Weight: .75 lb. (340 g)  
Packaged Dimensions: 11"L x 4.75"W x 3.75"H

#40042

**XT Water Treatments for Ponds and Fountains**

Designed only for use with the Smart Pond Dosing System XT. Refer to page 88-89 for usage

Maintain for Ponds				
Item Number	40048	40049	40032	40033
Concentration	Standard 1X		3X	
Package Size	64 oz. / 1.89 L	1 gal. / 3.78 L	64 oz. / 1.89 L	1 gal. / 3.78 L
Packaged Weight	4.4 lb. (2 kg)	8.7 lb. (3.9 kg)	4.4 lb. (2 kg)	8.7 lb. (3.9 kg)



Clear for Ponds				
Item Number	40050	40051	40034	40035
Concentration	Standard 1X		3X	
Package Size	64 oz. / 1.89 L	1 gal. / 3.78 L	64 oz. / 1.89 L	1 gal. / 3.78 L
Packaged Weight	4.4 lb. (2 kg)	8.7 lb. (3.9 kg)	4.4 lb. (2 kg)	8.7 lb. (3.9 kg)



Clean for Ponds				
Item Number	40052	40053	40036	40037
Concentration	Standard 1X		3X	
Package Size	64 oz. / 1.89 L	1 gal. / 3.78 L	64 oz. / 1.89 L	1 gal. / 3.78 L
Packaged Weight	4.4 lb. (2 kg)	8.7 lb. (3.9 kg)	4.4 lb. (2 kg)	8.7 lb. (3.9 kg)



Protect for Ponds				
Item Number	40054	40055	40038	40039
Concentration	Standard 1X		3X	
Package Size	64 oz. / 1.89 L	1 gal. / 3.78 L	64 oz. / 1.89 L	1 gal. / 3.78 L
Packaged Weight	4.4 lb. (2 kg)	8.7 lb. (3.9 kg)	4.4 lb. (2 kg)	8.7 lb. (3.9 kg)



Prevent for Fountains		Clean for Fountains		
Item Number	40056	40057	40058	40059
Package Size	64 oz. / 1.89 L	1 gal. / 3.78 L	64 oz. / 1.89 L	1 gal. / 3.78 L
Packaged Weight	4.4 lb. (2 kg)	8.7 lb. (3.9 kg)	4.4 lb. (2 kg)	8.7 lb. (3.9 kg)





# Simple Solutions Pump-Top for Ponds

[Click here to learn more about how each treatment works](#)

Maintain for Ponds				
Item Number	96057	96058	96059	96060
Package Size	8 oz. / 236 ml	16 oz. / 473 ml	32 oz. / 946 ml	1 gal. / 3.78 L
1 Pump Treats	100 gal. / 378 L			600 gal. / 2,268 L
1 Bottle Treats	5,000 gal. / 18,900 L	10,000 gal. / 37,800 L	20,000 gal. / 75,600 L	80,000 gal. / 302,400 L
Packaged Weight	.75 lb. (340 g)	1.25 lb. (.56 kg)	2.5 lb. (1.1 kg)	8 lb. (3.6 kg)



Clear for Ponds				
Item Number	96065	96066	96067	96068
Package Size	8 oz. / 236 ml	16 oz. / 473 ml	32 oz. / 946 ml	1 gal. / 3.78 L
1 Pump Treats	100 gal. / 378 L			600 gal. / 2,268 L
1 Bottle Treats	5,000 gal. / 18,900 L	10,000 gal. / 37,800 L	20,000 gal. / 75,600 L	80,000 gal. / 302,400 L
Packaged Weight	.75 lb. (340 g)	1.25 lb. (.56 kg)	2.5 lb. (1.1 kg)	8 lb. (3.6 kg)



Clean for Ponds				
Item Number	96061	96062	96063	96064
Package Size	8 oz. / 236 ml	16 oz. / 473 ml	32 oz. / 946 ml	1 gal. / 3.78 L
1 Pump Treats	100 gal. / 378 L			600 gal. / 2,268 L
1 Bottle Treats	5,000 gal. / 18,900 L	10,000 gal. / 37,800 L	20,000 gal. / 75,600 L	80,000 gal. / 302,400 L
Packaged Weight	.75 lb. (340 g)	1.25 lb. (.56 kg)	2.5 lb. (1.1 kg)	8 lb. (3.6 kg)



Protect for Ponds				
Item Number	96069	96070	96071	96072
Package Size	8 oz. / 236 ml	16 oz. / 473 ml	32 oz. / 946 ml	1 gal. / 3.78 L
1 Pump Treats	100 gal. / 378 L			600 gal. / 2,268 L
1 Bottle Treats	5,000 gal. / 18,900 L	10,000 gal. / 37,800 L	20,000 gal. / 75,600 L	80,000 gal. / 302,400 L
Packaged Weight	.75 lb. (340 g)	1.25 lb. (.56 kg)	2.5 lb. (1.1 kg)	8 lb. (3.6 kg)



# Simple Solutions Pump-Top for Fountains



[Click here to learn more about how each treatment works](#)

Prevent for Fountains				
Item Number	96073	96074	96075	96076
Package Size	8 oz. / 236 ml	16 oz. / 473 ml	32 oz. / 946 ml	1 gal. / 3.78 L
1 Pump Treats	100 gal. / 378 L			600 gal. / 2,268 L
1 Bottle Treats	5,000 gal. / 18,900 L	10,000 gal. / 37,800 L	20,000 gal. / 75,600 L	80,000 gal. / 302,400 L
Packaged Weight	.75 lb. (340 g)	1.25 lb. (.56 kg)	2.5 lb. (1.1 kg)	8 lb. (3.6 kg)



Note: Not for use with water features containing fish

Clean for Fountains				
Item Number	96077	96078	96079	96080
Package Size	8 oz. / 236 ml	16 oz. / 473 ml	32 oz. / 946 ml	1 gal. / 3.78 L
1 Pump Treats	100 gal. / 378 L			600 gal. / 2,268 L
1 Bottle Treats	5,000 gal. / 18,900 L	10,000 gal. / 37,800 L	20,000 gal. / 75,600 L	80,000 gal. / 302,400 L
Packaged Weight	.75 lb. (340 g)	1.25 lb. (.56 kg)	2.5 lb. (1.1 kg)	8 lb. (3.6 kg)





# Beneficial Bacteria

▶ [Click here to learn more about how each treatment works](#)

## Beneficial Bacteria

- Contains 8 strains of bacteria including photosynthetic strains
- Contains marigold and vitamin B



Item Number	98886	98887	98888	98885
Package Size	8 oz. / 236 ml	16 oz. / 473 ml	32 oz. / 946 ml	1 gal. / 3.78 L
1 Pump Treats	100 gal. / 378 L			600 gal. / 2,268 L
1 Bottle Treats	5,000 gal. / 18,900 L	10,000 gal. / 37,800 L	20,000 gal. / 75,600 L	80,000 gal. / 302,400 L
Packaged Weight	.75 lb. (340 g)	1.25 lb. (.56 kg)	2.5 lb. (1.1 kg)	8 lb. (3.6 kg)

## Beneficial Bacteria Concentrate

- Contains eight strains of bacteria including photosynthetic strains
- Contains marigold and vitamin B
- Ideal for larger ponds



Item Number	98925	98948	98949	98950
Package Size	4.4 oz. / 125 g	8.8 oz. / 250 g	1.1 lb. / 500 g	7 lb. / 3.2 kg
1 Scoop Treats	1,300 gal. / 4,914 L			
1 Container Treats	26,000 gal. / 98,280 L	52,000 gal. / 196,560 L	104,000 gal. / 393,120 L	660,400 gal. / 2,499,886 L
Packaged Weight	.25 lb. (.11 kg)	.75 lb. (340 g)	1.25 lb. (.56 kg)	7.5 lb. (3.4 kg)

## Cold Water Beneficial Bacteria

- Reduces ammonia, nitrite, and organic debris
- Ideal for use in water colder than 50°F (5°C)



Item Number	98892	98893	98894	96021
Package Size	8 oz. / 236 ml	16 oz. / 473 ml	32 oz. / 946 ml	1 gal. / 3.78 L
1 Pump Treats	100 gal. / 378 L			600 gal. / 2,268 L
1 Bottle Treats	5,000 gal. / 18,900 L	10,000 gal. / 37,800 L	20,000 gal. / 75,600 L	80,000 gal. / 302,400 L
Packaged Weight	.75 lb. (340 g)	1.25 lb. (.56 kg)	2.5 lb. (1.1 kg)	8 lb. (3.6 kg)

# Beneficial Bacteria

▶ [Click here to learn more about how each treatment works](#)

## Pond Starter Bacteria

- Quickly establishes biological ecosystem
- Great for spring startups and new ponds
- Safe for fish, plants, and animals



Item Number	96013	96014	96015	96008
Package Size	8 oz. / 236 ml	16 oz. / 473 ml	32 oz. / 946 ml	1 gal. / 3.78 L
1 Pump Treats	100 gal. / 378 L			600 gal. / 2,268 L
1 Bottle Treats	5,000 gal. / 18,900 L	10,000 gal. / 37,800 L	20,000 gal. / 75,600 L	80,000 gal. / 302,400 L
Packaged Weight	.75 lb. (340 g)	1.25 lb. (.56 kg)	2.5 lb. (1.1 kg)	8 lb. (3.6 kg)

## Bacteria Bubble Tabs

- Keeps pond water clean and clear
- Maintains a balanced ecosystem
- Reduces pond maintenance



Item Number	98951	98930
Package Size	36 Tabs	72 Tabs
1 Tablet Treats	100 gal. / 378 L	
1 Container Treats	3,600 gal. / 13,608 L	7,200 gal. / 27,216 L
Packaged Weight	.25 lb. (.11 kg)	.75 lb. (.34 g)



[Click here to learn more about how each treatment works](#)

### Pond Sludge Remover Packs

- Eliminates and prevents pond sludge
- Water soluble packs make it easy to spot treat and treat hard-to-reach areas
- Keeps rocks, gravel, and filters clean



Item Number	96081	96084	96082
Package Size	18 Packs	36 Packs	72 Packs
1 Pack Treats	1,000 gal. / 3,780 L		
1 Container Treats	18,000 gal. / 68,040 L	36,000 gal. / 120,960 L	72,000 gal. / 272,550 L
Packaged Weight	.5 lb. (.23 kg)	1 lb. (.45 kg)	2.5 lb. (1.1 kg)

### Sludge & Filter Cleaner

- Biological pond and filter cleaner
- Contains five strains of heterotrophic bacteria
- Contains marigold and humic acid
- Safe for fish, plants, and animals



Item Number	98889	98890	98891	98883
Package Size	8 oz. / 236 ml	16 oz. / 473 ml	32 oz. / 946 ml	1 gal. / 3.78 L
1 Pump Treats	100 gal. / 378 L			600 gal. / 2,268 L
1 Bottle Treats	5,000 gal. / 18,900 L	10,000 gal. / 37,800 L	20,000 gal. / 75,600 L	80,000 gal. / 302,400 L
Packaged Weight	.75 lb. (.340 g)	1.25 lb. (.56 kg)	2.5 lb. (1.1 kg)	8 lb. (3.6 kg)

[Click here to learn more about how each treatment works](#)

### Pond Detoxifier

- Makes tap water safe for fish and plants
- Removes and detoxifies chlorine
- Neutralizes ammonia
- Detoxifies and chelates copper and heavy metal



Item Number	98876	98877	40005	96010
Package Size	8 oz. / 236 ml	16 oz. / 473 ml	32 oz. / 946 ml pouch	1 gal. / 3.78 L
1 Pump Treats	100 gal. / 378 L			600 gal. / 2,268 L
1 Bottle Treats	5,000 gal. / 18,900 L	10,000 gal. / 37,800 L	20,000 gal. / 75,600 L	80,000 gal. / 302,400 L
Packaged Weight	.75 lb. (.340 g)	1.25 lb. (.56 kg)	2.25 lb.	8 lb. (3.6 kg)

### Ammonia Neutralizer

- Neutralizes large concentrations of toxic ammonia
- Makes pond water safe for fish and plants
- Detoxifies chloramine in tap water



Item Number	96050	96051	96052
Package Size	16 oz. / 473 ml	32 oz. / 946 ml Pouch	1 gal. / 3.78 L
1 Pump Treats	100 gal. / 378 L		600 gal. / 2,268 L
1 Bottle Treats	10,000 gal. / 37,800 L	20,000 gal. / 75,600 L	80,000 gal. / 302,400 L
Packaged Weight	1.25 lb. (.56 kg)	2.25 lb. (1 kg)	8 lb. (3.6 kg)



### #96027 #96028 Alkalinity Booster

- Keeps pond water clean and clear
- Maintains a balanced ecosystem
- Reduces pond maintenance



### #80000 Activated Pond Carbon

- Removes discoloration and odors
- Made with bamboo carbon
- Clarifies pond water



### #98909 Pond Foam Free

- Safely eliminates foam near waterfalls
- Helps keep water clean and clear of foam
- Safe for fish, animals, and plants

Item Number	96027	96028	80000	98909
Package Size	1.1 lb. / 500 g	9 lb. / 4.08 kg	2.25 lb. / 1 kg	8 oz. / 236 ml
1 Scoop/Pump Treats	125 gal. / 472 L		25 gal. / 95 L	100 gal. / 378 L
1 Container/Bottle Treats	5,000 gal. / 18,900 L	40,750 gal. / 154,035 L	800 gal. / 3,024 L	5,000 gal. / 18,900 L
Packaged Weight	3 lb. (1.4 kg)	9.75 lb. (4.4 kg)	2.25 lb. (1 kg)	.75 lb. (340 g)



▶ [Click here to learn more about how each treatment works](#)

▶ [Click here to learn more about how each treatment works](#)



### Algaecide

- No more algae growth
- Controls string algae
- Clears green water
- Can be used on ponds with fish and plants



Item Number	96022	96023	96024	96026	96053
Package Size	8 oz. / 236 ml	16 oz. / 473 ml	32 oz. / 946 ml	1 gal. / 3.78 L	2.5 gal. / 3.78 L
1 Tsp. Treats	50 gal. / 189 L				
1 Bottle Treats	2,500 gal. / 9,450 L	5,000 gal. / 18,900 L	10,000 gal. / 37,800 L	40,000 gal. / 151,400 L	100,000 gal. / 378,541 L
Packaged Weight	.75 lb. (340 g)	1.25 lb. (.56 kg)	2.5 lb. (1.1 kg)	2.25 lb. (1 kg)	8 lb. (3.6 kg)



### EcoBlast™ Contact Granular Algaecide

- Eliminates algae from water features on contact
- Can be used at any water temperature
- For use in water features containing live fish and plants



Item Number	29311	29312	29313
Package Size	8.8 oz. / 250 g	38.4 oz. / 1.1 kg	7 lb. / 3.2 kg
1 Container Treats	200 sq. ft.	780 sq. ft.	2,275 sq. ft.
Packaged Weight	1 lb. (.45 kg)	3 lb. (1.4 kg)	7 lb. (3 kg)



### Pond & Debris Clarifier

- Quickly cleans unsightly debris
- Scientifically blended to quickly restore the water quality
- Reduces pond maintenance



Item Number	96002	96003	96005	96006
Package Size	8 oz. / 236 ml	16 oz. / 473 ml	32 oz. / 946 ml	1 gal. / 3.78 L
1 Tsp. Treats	50 gal. / 189 L			
1 Bottle Treats	2,500 gal. / 9,450 L	5,000 gal. / 18,900 L	10,000 gal. / 37,800 L	100,000 gal. / 378,541 L
Packaged Weight	.75 lb.	1.25 lb.	2.5 lb.	8 lb.

### SAB Stream & Pond Cleaner

- Breaks down debris
- Maintains a balanced ecosystem
- Reduces pond maintenance
- Phosphate binder



Item Number	98898	98899	98900	98896
Package Size	4.4 oz. / 125 g	8.8 oz. / 250 g	1.1 lb. / 500 g	7 lb. / 3.2 kg
1 Scoop Treats	120 gal. / 454 L			1,420 gal. / 5,368 L
1 Container Treats	1,200 gal. / 4,536 L	2,400 gal. / 9,072 L	4,900 gal. / 18,597 L	31,240 gal. / 118,256 L
Packaged Weight	.25 lb. (.11 kg)	.75 lb. (340 g)	1.25 lb. (.56 kg)	7.5 lb. (3.4 kg)

### Barley Straw Extract

- Promotes clean, clear water conditions in ponds and streams
- Starts working instantly
- Concentrated formulation with added enzymes



Item Number	98903	98904	98905	96012
Package Size	8 oz. / 326 ml	16 oz. / 473 ml	32 oz. / 946 ml	1 gal. / 3.78 L
1 Pump Treats	100 gal. / 378 L			600 gal. / 2,268 L
1 Bottle Treats	5,000 gal. / 18,900 L	10,000 gal. / 37,800 L	20,000 gal. / 75,600 L	80,000 gal. / 302,400 L
Packaged Weight	.75 lb. (340 g)	1.25 lb. (.56 kg)	2.5 lb. (1.1 kg)	8 lb. (3.6 kg)

## Say Goodbye to String Algae!



Before

After

For more information, [see pages 42-43](#)



**Rapid Clear Flocculant**

- Quickly clears cloudy water by clumping debris
- Works within 24 hours
- For best results, use in combination with a Rapid Clear Fine Filter Pad (#80001)



**#80001 Rapid Clear Fine Filter Pads**

- Speeds-up filtering of flocculated particles
- Works within 24 hours
- For best results, use in combination with Rapid Clear Flocculant water treatments
- Enhances water quality
- Includes three pads



Item Number	98879	96049	40006	96007	80001
Package Size	8 oz. / 236 ml	16 oz. / 473 ml	32 oz. / 946 ml	1 gal. / 3.78 L	12"W x 24"L
1 Pump Treats	100 gal. / 378 L		—	600 gal. / 2,268 L	—
1 Bottle Treats	5,000 gal. / 18,900 L	10,000 gal. / 37,800 L	20,000 gal. / 75,600 L	80,000 gal. / 302,400 L	—
Packaged Weight	.75 lb. (340 g)	1.25 lb. (.56 kg)	2.25 lb.	85 lb. (38.5 kg)	.75 lb. (340 g)



**Rapidly Resolves Pond Problems, Including Cloudy Water**

Helps Control Organic Waste and Debris



Targets Ammonia, Nitrite, and Phosphate

**Sits in a Solution Containing Special Blend of Treatments**

Provides an instantaneous bio-available food source to maximize metabolic activity

Innovative Gummy For Quick and Easy Application



**Each Gummy Contains**

- 320 billion viable bacteria cultures specifically selected for their ability to quickly resolve a variety of pond problems
- Free enzymes which trigger digestion to help break down organics

**#96083 QuickFix Pond Gummy**

Packaged Weight: .25 lb. (.11 kg)  
1 Package Treats 3,000 gal. / 11,340 L

[Click here to learn more about how each treatment works](#)



**#96029 Concentrated Barley Straw Pellets**

- Fast-acting, natural way to clarify pond water
- Comes in a resealable mesh bag
- Contains a blend of bacteria and enzymes



**#98884 Black Pond Dye**

- Filters sunlight and cools water
- Contains humic acid and enzymes to help balance the pond ecosystem
- Creates a shimmering effect
- One dosage lasts up to 6 weeks



**#98882 Blue Pond Dye**

- Added enzymes help balance the pond ecosystem
- One dosage lasts up to 6 weeks

Item Number	96029	98884	98882
Package Size	5 lb. / 2.3 kg	8 oz. / 236 ml	
1 Pump Treats	—	100 gal. / 378 L	
1 Container Treats	1,000 gal. / 3,780 L	5,000 gal. / 1,890 L	
Packaged Weight	5.5 lb. (2.5 kg)	.75 lb. (340 g)	



Simply Open And Pour Into Your Pond

Cases Ship In Convenient Tear-Away Box!





Formulated for Use with Aquascape AquaGardens



### Specialized Water Treatment

For use with the Aquascape AquaGarden Mini Pond Kits (#78325, #78333) and AquaGarden Tabletop Fountain Kits (#78346, #78347)



### 4-in-1 Formulation

A powerful blend of beneficial bacteria and clarifiers, with scale and foam removers, keeps water clean, clear, healthy, and maintenance free

### Convenient Dropper

Allows for precise dosing in smaller container water gardens

### AquaGarden Maintenance 4-in-1

	96097	96098
Item Number	96097	96098
For use with	AquaGarden Tabletop Fountain Kit	AquaGarden Mini Pond Kit
Package Size	2 fl. oz. / 59 ml	4 fl. oz. / 177 ml
Treatment Rate	Add 1 to 2 droppers every week	Add 5 droppers (2 tsp.) every week
1 Bottle Lasts	7 to 12 months	Up to 3 months
Packaged Weight	4.4 oz. / 130 ml	8.4 oz. / 248 ml

[Click here to learn more about how each treatment works](#)



### #40004 Patio Pond Maintenance Tabs

- Targeted treatment for container water gardens
- Contains eight pure strains of beneficial bacteria
- Helps optimize water quality
- Safe for fish, animals, and plants



### #98908 Fountain Foam Free

- Safely eliminates foam from water features
- Helps maintain the beauty of your water feature
- Helps keep water clean and clear of foam
- Safe for fish, animals, and plants



### #96055 Rock & Fountain Cleaner

- Quickly eliminates debris from waterfalls, fountains, or streams
- Easy-to-use spray bottle application
- Safe for fish, animals, and plants



### #40007 #96056 Fountain Maintenance

- Safely eliminates scale and debris build-up from water features
- Maintains the beauty of your water feature
- Helps maintain perfect water quality
- Prevents white scale build-up without damaging feature
- Safe for fish, animals, and plants



### #98907 Fountain Scale Free

- Safely removes calcium and scale from water features
- Helps keep water clean and clear of hard water deposits, white scale, and foam
- Adds the fresh clean scent of lavender
- Safe for fish, animals, and plants

Item Number	40004	98908	96055	40007	96056	98907
Package Size	36 Tabs	8 oz. / 236 ml	32 oz. / 946 ml	8 oz. / 236 ml	16 oz. / 473 ml	8 oz. / 236 ml
1 Tablet Treats	100 gal. / 378 L			—		
1 Container Treats	3,600 gal. / 13,608 L			—		
1 Pump Treats	—	10 gal. / 37.8 L	—		10 gal. / 37.8 L	
1 Bottle Treats	—	500 gal. / 1,890 L	up to 300 sq. ft.	500 gal. / 1,890 L	1,000 gal. / 3,785 L	500 gal. / 1,890 L
Packaged Weight	.25 lb. (.11 kg)	.75 lb. (340 g)	2.5 lb. (1.1 kg)	.75 lb. (340 g)	1.25 lb. (.56 kg)	.75 lb. (340 g)



▶ [Click here to learn more about how each treatment works](#)



**#30406 Beneficial Bacteria Professional Grade**

- Provides clean, clear, and healthy water conditions
- Contains photosynthetic bacteria
- Contains marigold and vitamin B

**#30407 Beneficial Bacteria Concentrate Professional Grade**

- Provides clean, clear, and healthy water conditions
- Contains eight strains of bacteria
- Contains photosynthetic bacteria

**#98895 Cold Water Beneficial Bacteria Professional Grade**

- Provides clean, clear, and healthy water conditions
- Reduces ammonia, nitrite, and organic debris
- Ideal for use in water colder than 50°F (5°C)



**#40011 Pond Starter Bacteria Professional Grade**

- Establishes biological ecosystem
- Great for spring start-up and new ponds

**#98897 Wetland Pond & Lake Bacteria Professional Grade**

- Naturally reduces ammonia, nitrate, and excess nutrients
- Includes eight pure strains of beneficial bacteria, including photosynthetic bacteria
- Maintains a balanced ecosystem

**#30412 Rapid Clear Flocculant Professional Grade**

- Clears discolored or cloudy water
- Clumps suspended debris (flocculation)
- Clears most ponds in 24 hours

Item Number	30406	30407	98895	40011	98897	30412
Option	●	●	●	●	●	●
Package Size	1 gal / 3.78 L	9 lb / 4.08 kg	1 gal / 3.78 L			
1 Scoop Treats	6,000 gal. / 22,680 L	48,000 gal. / 181,440 L	6,000 gal. / 22,680 L		48,000 gal. / 181,440 L	6,000 gal. / 22,712 L
1 Container Treats	96,000 gal. / 362,880 L	870,000 gal. / 3,293,308 L	96,000 gal. / 362,880 L		768,000 gal. / 2,903,040 L	96,000 gal. / 363,400 L
Packaged Weight	9 lb. (4 kg)	9.5 lb. (4.3 kg)	9 lb. (4 kg)			

● Beneficial Bacteria ● Problem Solving

▶ [Click here to learn more about how each treatment works](#)



**#40010 Pond & Debris Clarifier Professional Grade**

- Quickly cleans unsightly debris
- Restores water quality
- Reduces pond maintenance

**#30409 SAB Stream & Pond Cleaner Professional Grade**

- Keeps pond water clean and crystal clear
- Reduces pond maintenance
- Reduces ammonia and nitrates
- Phosphate binder

**#30413 Waterfall & Rock Cleaner Professional Grade**

- Spot treats the trouble areas on water features
- Quickly eliminates debris from waterfalls and rocks
- Reduces pond maintenance
- Goes to work instantly



**#98906 Barley Straw Extract Professional Grade**

- Natural way to clarify water
- Provides clear, clean pond conditions
- Starts working instantly
- Concentrated formulation with added enzymes

**#40012 Ammonia Neutralizer Professional Grade**

- Makes pond water safe for fish and plants
- Detoxifies chloramine in tap water
- Instantly neutralizes large concentrations of toxic ammonia

**#30410 Pond Detoxifier Professional Grade**

- Makes tap water safe for fish and plants
- Removes and detoxifies chlorine and chloramines
- Neutralizes ammonia
- Detoxifies and chelates copper and heavy metals

**#30408 Sludge & Filter Cleaner Professional Grade**

- Biological pond and filter cleaner
- Contains five strains of heterotrophic bacteria
- Contains marigold and humic acid

Item Number	40010	30409	30413	98906	40012	30410	30408
Option			●		●		●
Package Size	1 gal / 3.78 L	9 lb / 4.08 kg		1 gal / 3.78 L			
1 Scoop Treats	6,000 gal. / 22,712 L	3,000 gal. / 11,340 L	151-200 sq. ft.	6,000 gal. / 22,680 L			
1 Container Treats	96,000 gal. / 363,400 L	45,000 gal. / 170,000 L	3,650 sq. ft.	96,000 gal. / 362,880 L			
Packaged Weight	9.5 lb. (4.3 kg)			9.75 lb. (4.4 kg)	9 lb. (4 kg)	9.5 lb. (4.3 kg)	9.25 lb. (4.2 kg)

● Problem Solving ● Water Conditioners ● Sludge Fighting



# Lake and Large Pond Treatments

▶ [Click here to learn more about how each treatment works](#)

**NOTE:** Aquascape lake treatments are optimized specifically for larger bodies of water and can cause issues when used in smaller water features.



### #40013, #40014, #40015 Lake Bacteria Packs

- Restores the ecosystem, keeping water clean, clear, and healthy
- Easy-to-use water soluble packs make it easy to treat hard-to-reach areas
- Significantly reduces maintenance
- Fortified with prebiotics to enhance water quality

### #40016 Lake Bacteria

- Restores the ecosystem, keeping water clean, clear, and healthy
- Significantly reduces maintenance
- Fortified with prebiotics to enhance water quality

Item Number	40013	40014	40015	40016
Package Size	24 Packs	48 Packs	192 Packs	1 gal / 3.78 L
4 Packs Treat	1/4 acre for 1 month			—
1 Container Treats	Up to 1.5 acres	Up to 3 acres	Up to 12 acres	1/4 acre for 1-3 months
Packaged Weight	.75 lb. (340 g)	1.25 lb. (.56 kg)	2.5 lb. (1.1 kg)	9.25 lb. (4 kg)



### #40017, #40018, #40019 Lake Sludge Remover Packs

- Quickly eliminates organic sludge and muck
- Easy-to-use water soluble packs make it easy to spot treat and treat hard-to-reach areas
- All active ingredients with no fillers or binders
- Slowly releases oxygen to maximize sludge reduction
- Added macrobiotics and carbon source

Item Number	40017	40018	40019
Package Size	192 Packs	384 Packs	1,152 Packs
1 Pack Treats	250 ft <sup>2</sup>		
1 Container Treats	48,000 ft <sup>2</sup>	96,000 ft <sup>2</sup>	288,000 ft <sup>2</sup>
Packaged Weight	4.75 lb. (2.2 kg)	9.5 lb. (4.3 kg)	37 lb. (16.8 kg)

# Lake and Large Pond Treatments

▶ [Click here to learn more about how each treatment works](#)

**NOTE:** Aquascape lake treatments are optimized specifically for larger bodies of water and can cause issues when used in smaller water features.



### #40020, #40021, #40022 Lake Blue Dye Packs

- Shades water to prevent water quality issues
- Easy-to-use water soluble packs
- Significantly reduces maintenance, filters sunlight, and cools water temperature

### #40023 Lake Flocculant Clarifier

- Quickly clears cloudy water caused by suspended particles
- Optimized to clarify clay, mineral material, and sediment issues
- Significantly reduces maintenance

Item Number	40020	40021	40022	40023
Package Size	2 Packs	4 Packs	16 Packs	1 gal. / 3.78 L
1 Pack Treats	1.5 acre ft.			—
1 Container Treats	Up to 3 acre ft.	Up to 6 acre ft.	Up to 24 acre ft.	1/4 acres for 1-3 months
Packaged Weight	.75 lb. (340 g)	1.25 lb. (.56 kg)	2.5 lb. (1.1 kg)	9.25 lb. (4 kg)



### #40024, #40025, #40026 Lake Phosphate Binder Packs

- Quickly binds phosphates to clean and clear water
- Easy-to-use water soluble packs
- Prevents and eliminates floating debris and debris that attaches to rocks and gravel
- Significantly reduces maintenance
- Binds orthophosphate

### #40027, #40028, #40029 Lake Treatment Booster Packs

- Turbo boost the effects of all lake treatments
- Easy-to-use water soluble packs
- Adds oxygen directly to the water to accelerate nutrient uptake and sludge digestion
- Increases bacterial growth by up to ten times
- Great for non-aerated or highly eutrophic bodies of water

Item Number	40024	40025	40026	40027	40028	40029
Package Size	192 Packs	384 Packs	1,152 Packs	192 Packs	384 Packs	1,152 Packs
1 Pack Treats	250 ft <sup>2</sup>					
1 Container Treats	48,000 ft <sup>2</sup>	96,000 ft <sup>2</sup>	288,000 ft <sup>2</sup>	48,000 ft <sup>2</sup>	96,000 ft <sup>2</sup>	288,000 ft <sup>2</sup>
Packaged Weight	5 lb. (2.3 kg)	9.25 lb. (4 kg)	29 lb. (13kg)	4.75 lb. (2 kg)	9.5 lb. (4.3 kg)	27.75 lb. (12.6 kg)



# Predator Control

Add a little fun to your pond while helping to keep your koi and other pond fish safe.



**NEW**



Faux Rock Fish Cave - Small

Faux Rock Fish Cave - Large

Faux Log Fish Cave

Item Number	78418	78419	78324
Dimensions	25"L x 15"W x 9.5"H	30"L x 18"W x 11"H	19"L x 12"W x 10"H
Primary Material	Fiber-Resin Composite	Fiber-Resin Composite	Polyresin
Packaged Weight	10.5 lb. (4.7 kg)	14 lb. (6.3 kg)	11.5 lb. (5.2 kg)
Packaged Dimensions	25.25"L x 18.25"W x 12.25"H	32"L x 20.5"W x 15"H	22"L x 15"W x 13"H





## Seasonal Care

Aquascape ecosystem ponds are naturally balanced and require very little care. You can easily maintain the health of your pond throughout the year with our comprehensive line of seasonal products.



Blue Heron Decoy



Floating Alligator Decoy



Floating Swan Decoy

Item Number	81030	93000	74014
Dimensions	9"L x 6"W x 26"H	34"L x 6"W x 4"H	31"L x 15"W x 18"H
Primary Material	Polyresin		
Packaged Weight	2.25 lb. (1 kg)	2.5 lb. (1 kg)	5 lb. (2.3 kg)
Packaged Dimensions	28"L x 9"W x 6.25"H	11.5"L x 7.5"W x 10"H	31.25"L x 14.75"W x 9.25"H

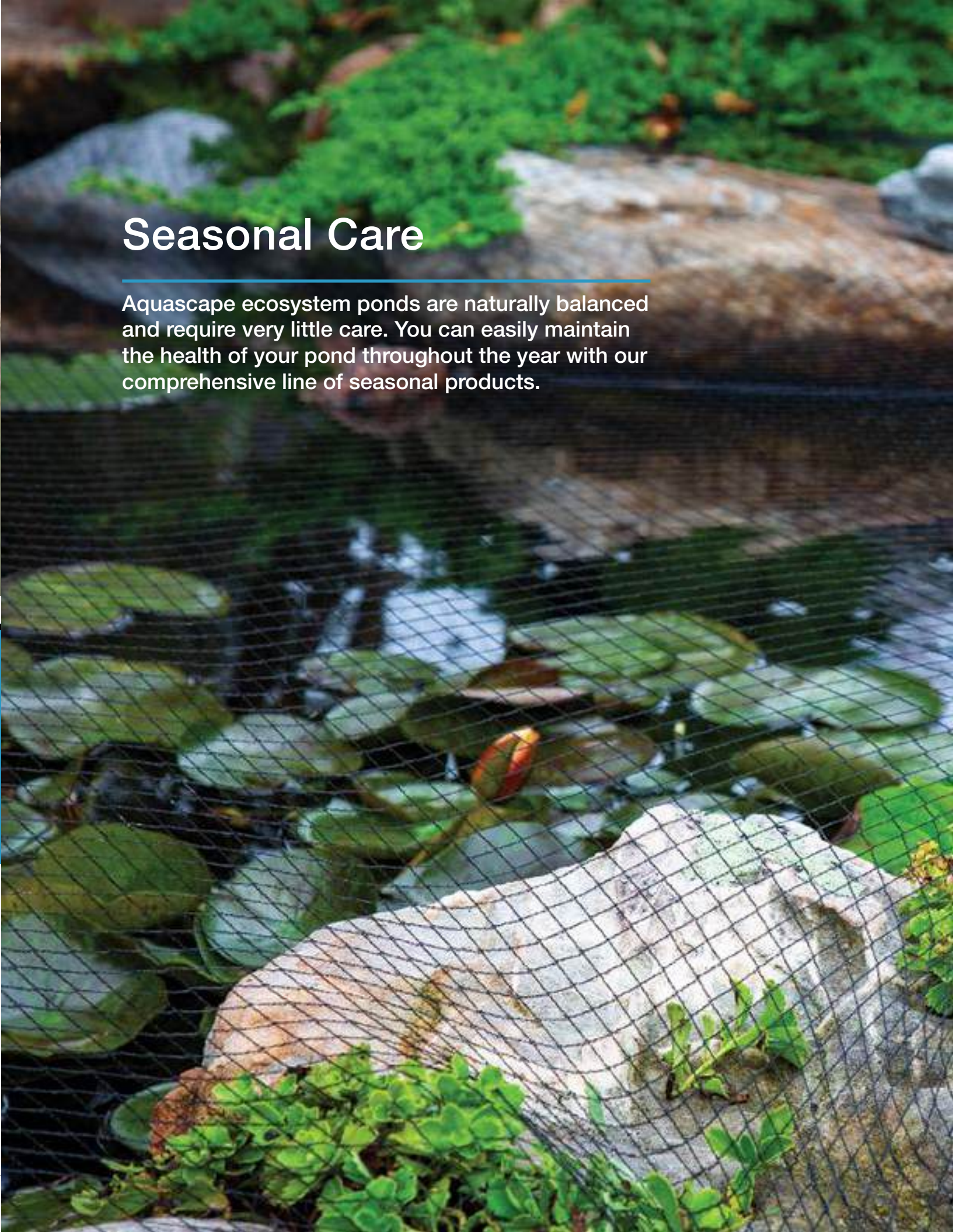



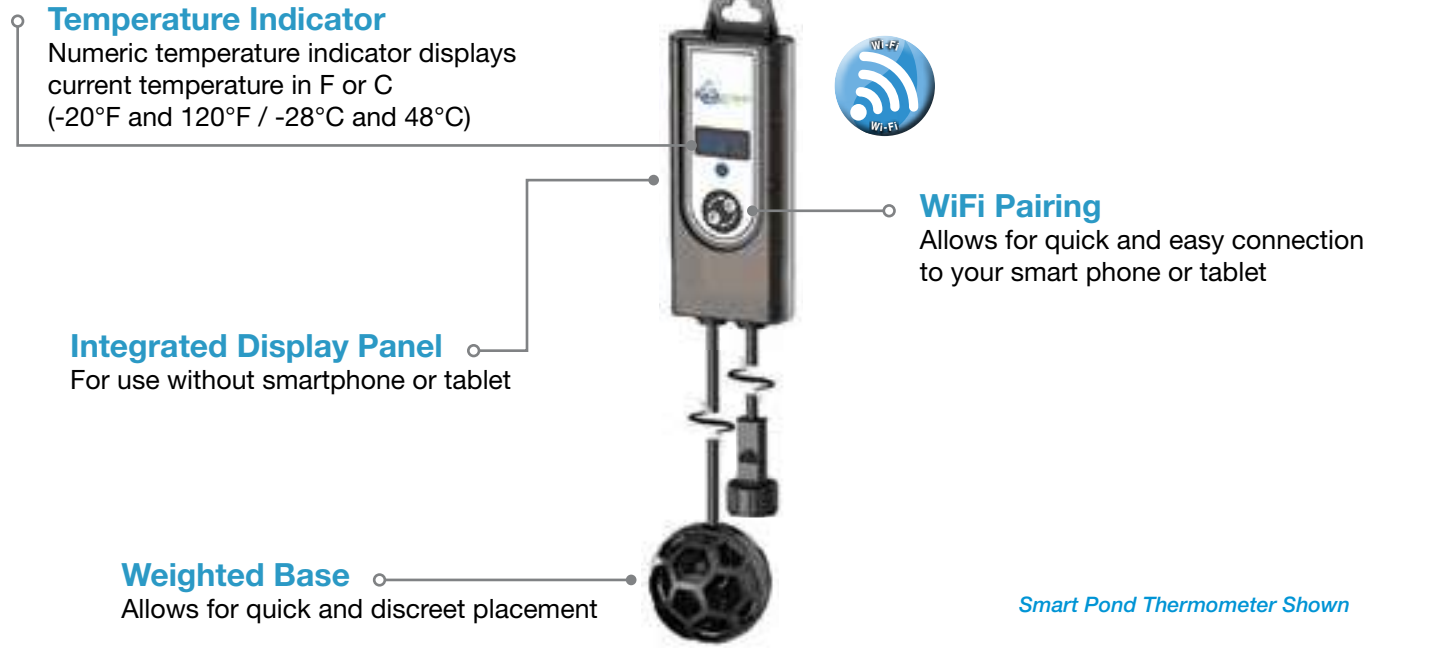

	Smart Pond Thermometer	Smart Pond Thermometer with Transformer
Item Number	74012	74013
Wattage	1	
12V Transformer	Required (Sold Separately)	✓
Probe Size	1.75" Dia.	
Power Cord Length	3'	
Probe Cord Length	20'	
Warranty	3-Year Limited	
Packaged Weight	1 lb. (453 g)	1.5 lb. (.68 kg)
Packaged Dimensions	5.5"L x 2.55"W x 5.7"H	



**Submersible Pond Thermometer**  
Packaged Weight: .25 lb. (.11 kg)  
Packaged Dimensions: 5"L x 9"W x 1"H  
**#74000**



**#39000 300-Watt Pond De-Icer**  
Packaged Weight: 4.5 lb. (2 kg)  
Dimensions: 5.5" Dia. x 4"H with 22' Cord  
Packaged Dimensions: 9"L x 9"W x 7"H



**300-Watt Pond De-Icer**  
The Aquascape 300-Watt Pond De-Icer is ideal for keeping a small hole in the ice during cold winter months and ensures proper gas exchange, helping keep fish alive throughout the winter. Maintaining an opening in the surface of the ice is paramount for the safety of pond fish.



# Protective Pond Netting



Protective Pond Netting 14' x 20' Shown



Perforated hole for easy dispensing

Bulk Protective Pond Netting 20' x 100' Shown

## Protective Pond Netting

	7' x 10'	14' x 20'	28' x 30'	Bulk 10' x 100'	Bulk 20' x 100'	Bulk 30' x 100'
Item Number	98000	98001	98002	74007	74002	74003
Packaged Weight	.75 lb. (340 g)	1.1 lb. (.49 kg)	2.5 lb. (1.1 kg)	8 lb. (3.6 kg)	14.5 lb. (6.6 kg)	20.5 lb. (9.3 kg)
Packaged Dimensions	5.5"L x 3"W x 9"H	7.25"L x 4.75"W x 15"H	10.5"L x 50"W x 5"H	20"L x 18"W x 10"H	20"L x 18"W x 13"H	21"L x 23"W x 18"H



### U-Shaped Ground Stakes - 100 pieces

Ideal for securing or anchoring netting over ponds and waterfalls. The durable and sturdy landscape staples are three-inches long with 11-gauge thickness, making them perfect for use around the perimeter of water features.

Packaged Weight: 1.75 lb. (.79 kg)

Packaged Dimensions: 7"L x 1.5"W x 8"H

#74008

## Fish Care

Keep your fish happy and healthy with Aquascape koi and pond fish products. From fish food to pond nets, you'll find what you need to care for your finned friends.

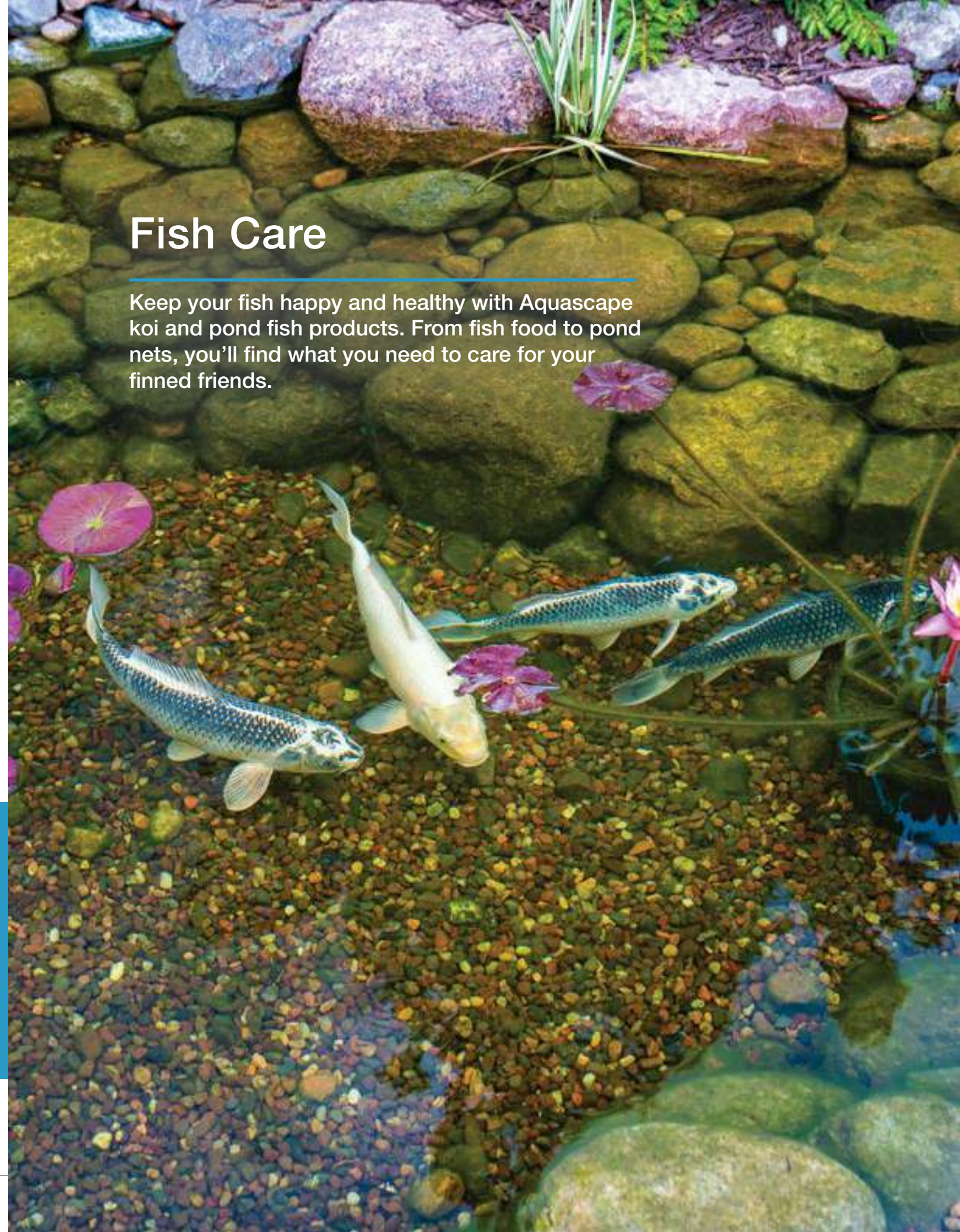



# Premium Staple Fish Food Pellets

**High-Quality Protein**  
Contains high-quality protein, including herring and shrimp



**Healthy**  
Rich in amino acids, fats, minerals, and stabilized vitamins such as vitamin C

**Reduces Maintenance**  
Low in phosphates and minimizes fish waste

**Probiotics and Prebiotics**  
Aids in proper digestion, optimizes growth, and helps keep water clean

Premium Staple Fish Food Pellets

Item Number	98867	98868	98869	81049	50003	81050	81051	81052	81053
Weight	1.1 lb. 500 g	2.2 lb. 1 kg	4.4 lb. 2 kg	11 lb. 5 kg	44 lb. 20 kg	1.1 lb. 500 g	2.2 lb. 1 kg	4.4 lb. 2 kg	11 lb. 5 kg
Pellet Size	Small		Large			Mixed			
Feeding Temperature	Minimum water temperature of 60°F/15°C								
Recommendation	Ideal for fish from 3" (8 cm) and above		Ideal for fish from 8" (20 cm) and above			Ideal for all size fish			

# Premium Color Enhancing Fish Food Pellets

**Color Enhancing**  
Formulated to enhance and brighten colors in pond fish



**Healthy**  
Provides all the same health benefits as our staple formula

**High-Quality Ingredients**  
Protein sources include krill, herring, and shrimp

**Reduces Maintenance**  
Low in phosphates and minimizes fish waste

Premium Color Enhancing Fish Food Pellets

Item Number	98873	98874	98875	81048	81006
Weight	1.1 lb. / 500 g	2.2 lb. / 1 kg	4.4 lb. / 2 kg	11 lb. / 5 kg	44 lb. / 20 kg
Pellet Size	Small		Large		
Feeding Temperature	Minimum water temperature of 60°F/15°C				
Recommendation	Ideal for fish from 3" (8 cm) and above		Ideal for large fish from 8" (20 cm) and above		



**Cold Water Formula**  
Can be fed in water temps as cold as 50°F



**Nutrition**  
Includes stabilized multivitamin

**Wheatgerm**  
Includes wheatgerm to help prepare the fish for a healthy winter

**Protective Packaging**  
Resealable foil bag to protect from moisture, air and light

Premium Cold Water Fish Food Pellets

Item Number	98870	98871	98872	81047	81004
Weight	1.1 lb. / 500 g	2.2 lb. / 1 kg	4.4 lb. / 2 kg	11 lb. / 5 kg	44 lb. / 20 kg
Pellet Size	Small		Large		
Feeding Temperature	Minimum water temperature of 50°F/10°C				
Recommendation	Ideal for fish from 3" (8 cm) and above		Ideal for large fish from 8" (20 cm) and above		

**Color-Enhancing**  
Formulated to enhance and brighten colors in all pond fish



**Probiotics**  
Easy to digest and reduces fish waste

**#98878 Premium Fish Food Flakes 4.2 oz. / 119 g**  
Packaged Weight: .5 lb.  
Packaged Dimensions: 3.5"L x 3.5"W x 7.5"H

**Ideal For Hand Feeding**  
The size, shape, and taste of the Koi Krunchies make them a perfect tool for training your fish to hand feed



**Nutritious Treat**  
Contains high-quality ingredients and natural citrus flavors

**Great Source of Vitamin C**  
Aquascape Koi Krunchies aid in proper tissue formation, digestion, and disease resistance

**#81000 Koi Krunchies 14.1 oz. / 400 g**  
Packaged Weight: 1.25 lb.  
Packaged Dimensions: 6"L x 6"W x 10"H





Fish Treatments



Praziquantel Treatment  
8 oz. / 236 ml



Fungus Treatment  
8 oz. / 236 ml



Parasite & Ich Treatment  
8 oz. / 236 ml



Ulcer & Bacterial Treatment  
8.8 oz. / 250 g



Pond Salt  
2 lb. / 0.9 kg | 9 lb. / 4.08 kg  
40 lb. / 18.16 kg

Item Number	81041	81040	81039	81038	99416   99417   40003
Packaged Weight	.5 lb.		.75 lb.	.5 lb.	2.25 lb.   10 lb.   41.5 lb.
5 ml Treats	25 gal. / 94 L			—	
1 Scoop Treats	—			125 gal. / 472 L	190 gal. / 718 L
1 Container Treats	1,250 gal. / 4,725 L			4,875 gal. / 18,472 L	Up to 1,520 gal. / 5,745 L Up to 6,840 gal. / 25,835 L Up to 30,400 gal. / 114,912 L
Available In	Only Available for Sale in the USA				Available for Sale in the USA & Canada

Symptoms and Possible Treatments

Fish Symptom	Possible Problems	Treatment
Erratic movement, flashing or rubbing on rocks and surfaces throughout the pond	<ul style="list-style-type: none"> <li>Parasite Problem</li> </ul>	<ul style="list-style-type: none"> <li>Aquascape Parasite &amp; Ich Treatment</li> <li>Aquascape Praziquantel Treatment</li> <li>Aquascape Pond Salt</li> </ul>
Growths that look like “cotton balls”	<ul style="list-style-type: none"> <li>Fungal Infection</li> </ul>	<ul style="list-style-type: none"> <li>Aquascape Fungus Treatment</li> </ul>
Open wounds or ulcers	<ul style="list-style-type: none"> <li>Bacterial Infection</li> </ul>	<ul style="list-style-type: none"> <li>Aquascape Ulcer &amp; Bacterial Infection Treatment</li> </ul>
Fins appear to be rotting away	<ul style="list-style-type: none"> <li>Fin Rot</li> <li>Bacterial Infection</li> </ul>	<ul style="list-style-type: none"> <li>Aquascape Ulcer &amp; Bacterial Infection Treatment</li> <li>Aquascape Pond Salt</li> </ul>
Red streaks in the fins	<ul style="list-style-type: none"> <li>Bacterial Infection</li> <li>Parasite Problem</li> <li>Ammonia Poisoning</li> </ul>	<ul style="list-style-type: none"> <li>Aquascape Parasite &amp; Ich Treatment</li> <li>Aquascape Praziquantel Treatment</li> <li>Aquascape Pond Salt and water change using Aquascape Pond Detoxifier</li> <li>Aquascape Ammonia Neutralizer</li> </ul>
Small, white spots that look like salt stuck to the body of the fish	<ul style="list-style-type: none"> <li>Ich</li> <li>Parasite Problem</li> </ul>	<ul style="list-style-type: none"> <li>Aquascape Parasite &amp; Ich Treatment</li> <li>Aquascape Pond Salt</li> </ul>
Gasping at the surface of the water	<ul style="list-style-type: none"> <li>Oxygen Depletion</li> </ul>	<ul style="list-style-type: none"> <li>Aerate the pond and agitate the pond surface</li> <li>Reduce fish load</li> </ul>
Bulging eyes	<ul style="list-style-type: none"> <li>Bacterial Infection</li> </ul>	<ul style="list-style-type: none"> <li>Aquascape Ulcer &amp; Bacterial Infection Treatment</li> </ul>
Scales protruding from a swollen body like a pine cone	<ul style="list-style-type: none"> <li>Dropsy</li> <li>Bacterial Infection</li> </ul>	<ul style="list-style-type: none"> <li>Difficult to treat; treat the pond as a preventative measure</li> <li>Aquascape Ulcer &amp; Bacterial Infection Treatment</li> </ul>
Difficulty swimming underwater floating at the surface upright	<ul style="list-style-type: none"> <li>Swim Bladder Disease</li> </ul>	<ul style="list-style-type: none"> <li>If the fish is still feeding, feed fish with canned peas or a Spirulina-based fish food</li> </ul>
Red or swollen gills	<ul style="list-style-type: none"> <li>Parasite Problem</li> </ul>	<ul style="list-style-type: none"> <li>Aquascape Parasite &amp; Ich Treatment</li> <li>Aquascape Praziquantel Treatment</li> <li>Aquascape Pond Salt</li> </ul>



Fish Health

Fish add color and life to your pond, and no one likes to see their fish become sick or encumbered in any way. Aquascape offers a basic line of fish treatments that target most issues experienced by pond fish. Use our handy chart below to identify the problem, and treat with the corresponding product.





Pond Nets



Pond Nets



Pond Skimmer Net with Extendable Handle

Heavy Duty Pond Skimmer Net with Extendable Handle

Professional-Grade Pond Skimmer Net

Pond Shark

Pond Shark Pro

Koi Sock Net

Kid's Pond Explorer Net

Professional-Grade Pond Net

Pond Net with Extendable Handle

Heavy Duty Pond Net with Extendable Handle

Professional Fish Net with Extendable Handle

Item Number	98559	98562	50001	74004	74005
Handle Length	32", extends to 63"	36", extends to 63"	40"	Extends up to 60"	Extends up to 96"
Packaged Weight	.75 lb.	1.4 lb.	2 lb.	2.1 lb.	
Dimensions	12"L x 7"W	15"L x 15"W	23"L x 20.5"W Net	12"L x 8"W x 12"D	
Recommended Usage	Removing fine debris				

Item Number	81057	98556	50000	98558	98560	98561
Handle Length	8"	12"	40"	32", extends up to 63"	36", extends up to 69"	32", extends up to 69"
Packaged Weight	1.2 lb.	.2 lb.	2 lb.	.75 lb.	1.4 lb.	2.1 lb.
Dimensions	24"L x 13"W x 38.5"D	10"L x 7"W	23"L x 20.5"W Net	12"L x 7"W	15"L x 15"W	22" Dia. head
Recommended Usage	Catching/transporting fish	Catching small fish or removing debris	Catching fish and removing large debris			Catching fish



# Aquatic Plant Care

Aquatic plants are an important part of the water garden. They provide beauty and naturalization with a huge array of plant choices. Most importantly, they help balance the pond's ecosystem and provide valuable biological filtration that removes nitrogen, ammonia, nitrates, and other minerals from pond water.



**NEW**

**Once-A-Year Pond Plant Fertilizer**

- Formulated specifically for pond plants
- Once-a-year, time-released formula provides impressive growth throughout the entire season
- High potassium blend ensures incredible flowering
- Low phosphorus helps prevent algae issues
- Available in granular or capsule form



Item Number	89010	89011	89013	89014
Package Size	6-Pack	12-Pack	-	-
Packaged Weight	.75 lb. (340 g)	1.3 lb. (589 g)	2 lb. (907 g)	7 lb. (3.2 kg)

Refer to the website or product label for how much fertilizer to use for your plants.



**NEW**

**Aquascape Heavy-Duty Aquatic Plant Pots**  
Provide a more heavy-duty, professional alternative to our standard Aquatic Planters.

**Available in Three Sizes!**  
Ideal for use with waterlilies, lotuses, aquatic plants, and more



**Specialized Geotextile Fabric**

Allows for proper root development due to increased access to oxygen and nutrients, resulting in more robust and faster growing plants

**Heavy-duty Nylon Straps**

Make it easy to lift and maneuver in and out of the pond

Heavy-Duty Aquatic Plant Pots

Item Number	47003	47004	47005
Planter Dimensions	12" Dia. x 6" H (30.5 cm Dia. x 15.2 cm H)	16" Dia. x 7" H (40.6 cm Dia. x 17.8 cm H)	20" Dia. x 8" H (50.8 cm Dia. x 20.3 cm H)
Potting Media Capacity	432 cubic inches / 0.0071 cubic meters	864 cubic inches / 0.0142 cubic meters	1,512 cubic inches / 0.0248 cubic meters



**Pond Plant Potting Media**

Pond Plant Potting Media is an all-natural, non-toxic alluvial planting media perfect for supporting the growth of pond plants. Each bag is free of peat moss or compost and completely safe for your pond fish.



Aquatic Planters



Item Number	98501	98502	98500	98929	89006
Packaged Weight	.25 lb. (113 g)			.5 lb. (227 g)	
Dimensions	6" Dia. x 6"H	8" Dia. x 6"H	12" Dia. x 8"H	14" Dia. x 7"H	15"L x 11"W x 4"H
Packaged Dimensions	6.5"L x 7"W x 1"H	11.5"L x 8"W x 1"H	12"L x 8"W x 5"H	12"L x 9.5"W x 1"H	16"L x 4"W x 12.5"H



**All-Natural**

Non-toxic alluvial planting media



**Fine-Grained Media**

Perfect for planting or re-potting waterlilies, marginals and other aquatic plants

**Peat Moss and Compost Free**

Supports growth of aquatic plants and safe for pond fish

Pond Plant Potting Media

Pond Plant Potting Media		
Item Number	89002	89003
Covers	215 cubic inches / 0.0035 cubic meters	432 cubic inches / 0.007 cubic meters



**Pond Plant Potting Media**

Aquascape Pond Plant Potting Media is an all-natural, non-toxic alluvial planting media perfect for supporting the growth of aquatic plants. Each bag is free of peat moss or compost and completely safe for your pond fish.

## Decorative Water Features

Decorative water features are a unique and easy way to add a splash of water or a flicker of fire to any outdoor living space.







### Proprietary Brass Burner Torches

Combines fire and water into unique, impressive design



### Complete Kit

Includes everything to add torches to 3 columns



### Control Box

Match-Lit Flame Control System for easy start-up and flame adjustment

### #58103 Fire and Water 3-Piece Basalt Torch System

Packaged Weight: 20 lb.  
Packaged Dimensions: 18"L x 14"W x 14"H  
Recommended Pump: Ultra 2000 Water Pump #91010

### Includes

- (3) torches
- Water tubing
- Rubber gas line
- Match-Lit Flame Control System
- Gas tubing with splitter
- Propane tank regulator

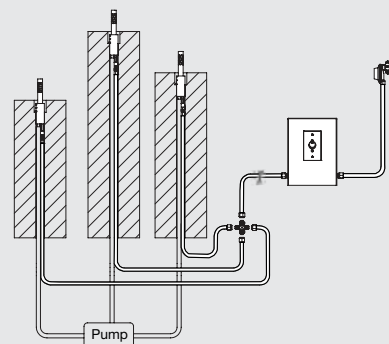

### Enhance Aquascape Natural Basalt Columns with Fire!

These innovative torches install quickly into the top of the column. Compatible with Aquascape Natural Mongolian Basalt Columns. Pump and basalt columns sold separately.

**NOTE: Not compatible with Aquascape Faux Basalt Columns.**

Customize your own installation using the a la carte components



Item Number	58101	58102	58111	58112	58109	58104
Dimensions	9.5"H x 1.125"D	7.25"L x 7"W x 10"H	3/8" x 10'	3/8" x 20'	2.5"L x 2.5"W x .75"H	3/8" x 10'
Includes	<ul style="list-style-type: none"> <li>• Water tubing—1/2" x 6'</li> <li>• Rubber gas hose—1/4" x 6' with 3/8" connection</li> </ul>			—		
Recommended Pump	Ultra 2000 Water Pump #91010			—		
Packaged Weight	1 lb.	12 lb.	1.5 lb.	2.5 lb.	1 lb.	1.25 lb
Packaged Dimensions	10"L x 2"W x 2"H	15.75"L x 12"W x 10"H	10"L x 10"W x 2.5"H	12"L x 14"W x 2.5"H	3"L x 3"W x 1"H	8"L x 8"W x 3"H

**NOTE: Fire and Water Torches not compatible with Faux Basalt Columns**



**CSA Certified System**

Certified system with thermocouple sensor ensures safe operation

**Automatic Ignition**

Quick and easy startup with the press of a button

**High-End Burner System**

12" stainless steel burner ring provides impressive 60,000 BTU flame output

**Flame Control System**

Push-button ignition with internal safety valve

**Easy Setup**

Weather-proof power connection and 3/8" flared gas hookup

**Easy Flame Adjustment**

Simply turn the knob for seamless flame height control

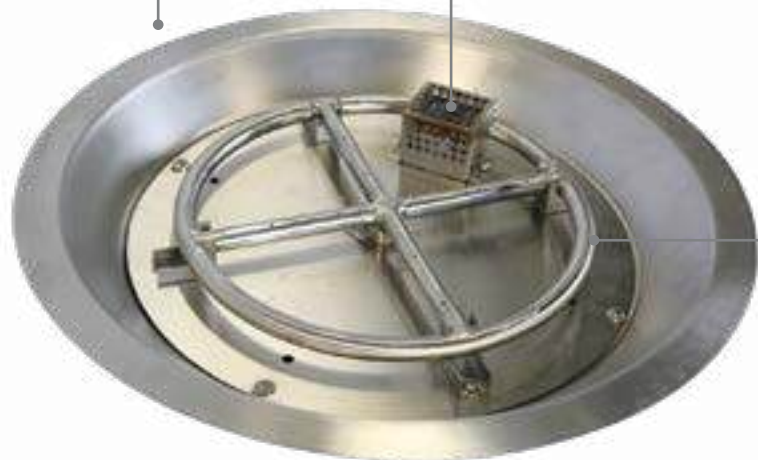

Fire Media  
Sold Separately  
[See page 138](#)



Fire and Water Spillway Bowl



Fire and Water Spillway Basin

Item Number	58092	58116
Dimensions	34"L x 32"W x 15"H	40"L x 40"W x 16"H
Primary Material	Fiber-Resin Composite	
Includes	Fire and water feature, control system, gas tubing, power cable, water tubing, and propane tank regulator	
Recommended Pump	Ultra 2000 Water Pump #91010 (Sold Separately)	
Recommended Basin	AquaBasin 45 or custom using AquaBlox	
Packaged Weight	73 lb.	109 lb.
Packaged Dimensions	35"L x 35"W x 17.5"H	51"L x 42.5"W x 20"H

Each Auto-Ignite Feature Includes:



• Feature with Burner System



• Flame Control System



• Propane Tank Regulator



• Gas Hose and Power Cable



• Water Tubing





Fire Media  
Sold Separately  
See page 138



Fire and Water Stacked Slate Sphere



Fire and Water Stacked Slate Urn



Fire Media  
Sold Separately  
See page 138



Faux Stone Fire Pit

Item Number	58093	58114
Dimensions	32" Dia. x 24"H	35.5"L x 35.5"W x 55"H
Primary Material	Fiber-Resin Composite	
Includes	Fire and water feature, control system, gas tubing, power cable, water tubing, and propane tank regulator	
Recommended Pump	Ultra 2000 Water Pump #91010	
Recommended Basin	AquaBasin 45 or custom using AquaBlox	Custom using AquaBlox
Packaged Weight	127.75 lb.	203 lb.
Packaged Dimensions	35"L x 35"W x 21.75"H	38"L x 37.5"W x 34.6"H

Item Number	58091
Dimensions	41.54"L x 34.25"W x 14.25"H
Primary Material	GFRC
Includes	Fire pit, control system, gas tubing, power cable, and propane tank
Packaged Weight	175.5 lb.
Packaged Dimensions	43.5"L x 35.5"W x 15.75"H





Mixed Tumbled Lava Stones Shown



1/4" Reflective Black Fire Glass Shown



Fire Media

	Medium Tumbled Lava Stones	Large Tumbled Lava Stones	Mixed Tumbled Lava Stones	1/4" Reflective Black Fire Glass	1/4" Reflective Cobalt Blue Glass	1/4" Aquamarine Fire Glass
Item Number	78316	78317	78318	78262	78263	78264
Packaged Weight	25 lb.		50 lb.	10.5 lb.		



Propane Tank Covers



Item Number	78336	78345	58115
Primary Material	GFRC	Fiber-Resin Composite	Stainless Steel
Dimensions	16.5"L x 16.5"W x 21.25"H	15"L x 15"W x 18"H	21.25" Dia. x 1.75"H
Packaged Weight	41.25 lb.	14 lb.	5.25 lb.
Packaged Dimensions	19.5"L x 19.5"W x 23.5"H	17.5"L x 17.5"W x 21"H	21"L x 24"W x 2.5"H



AquaBasin underground reservoirs make it easy to install a variety of Aquascape water features

**Pump Access**

Large corner panel fits larger pumps and sits elevated to prevent gravel from falling into the basin

**Deck Cylinders**

Provide endless plumbing and lighting port configurations, while reinforcing basin strength

**Drainage Slots**

Located throughout the deck to maximize water circulation

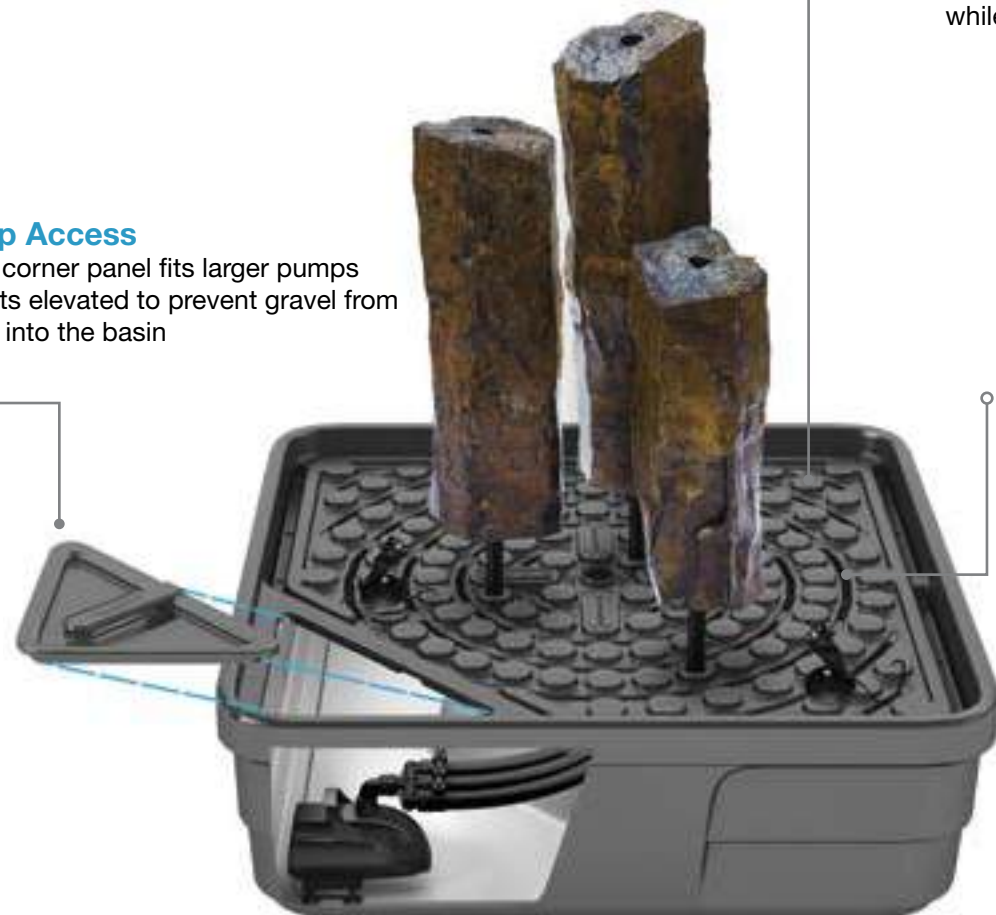

AquaBasin® 45 Shown



**Trouble-Free and Easy to Install**

Aquascape AquaBasins® make decorative water feature installations quick, easy, and trouble-free. Install natural stone fountains, bubbling urns, spillway bowls, and even small waterfalls with ease. Multiple versions are available depending on the size of your decorative water feature.



Water Feature Basins

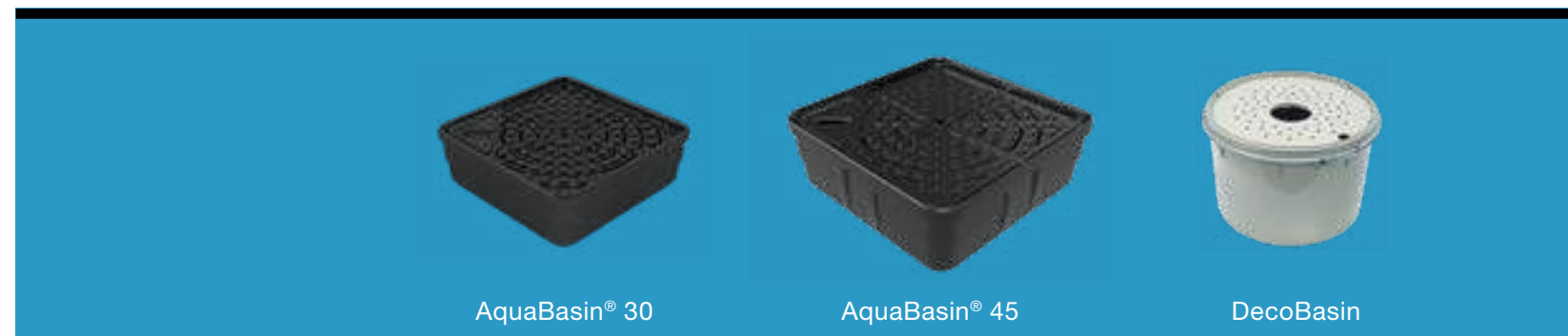

AquaBasin® 30

AquaBasin® 45

DecoBasin

Item Number	78223	78224	60000
Dimensions	30"L x 30"W x 12"H	44.5"L x 44.5"W x 16"H	22" Dia. x 14.25"H
Water Storage Capacity	27 gal.	98 gal.	15 gal.
Maximum Flow Rate	2,000 GPH	4,000 GPH	1,500 GPH
Weight Capacity	500 lb.	1,500 lb.	100 lb.
Warranty	Limited Lifetime		1-Year Limited
Packaged Weight	22 lb.	60 lb.	9 lb.



**Natural Stone Appearance**  
Molded from real stone for natural look and feel

**Water Outlet**  
Recessed water outlet with included tubing and fitting for easy install

**Lightweight and Durable**  
Handmade using fiberglass, resin, and real stone

**Sturdy Base**  
Provides support to stabilize the fountain



Faux Basalt Columns - Set of 3 Shown



Faux Basalt Columns - Set of 3



Faux Basalt Columns - Set of 5

Item Number	78367	78368
Dimensions	See column dimensions on page 161	
Primary Material	Fiber-Resin Composite	
Included Tubing	(3) 3/4" x 6'	(5) 3/4" x 6'
Recommended Pump	Ultra 2000 Water Pump #91010	AquaSurge 2000 Pond Pump #91017
Recommended Basin	AquaBasin 45 #78224	Custom using AquaBlox
Packaged Weight	52 lb.	86 lb.

**NOTE: Faux Basalt Columns not compatible with Fire and Water Torches**



**Illuminate the Water As It Rises!**  
Bring your fountain to life at night with AquaScape LED Fountain Lights! Each light installs easily into the top of the fountain. Choose between Warm White (see page 79) or Color-Changing (see page 74).



**Kit Available**  
See page 22



18" H (46 cm)    24" H (61 cm)    30" H (76 cm)    36" H (91 cm)    42" H (107 cm)

Item Number	78361	78362	78363	78364	78365
Dimensions	18"H with 10" Base	24"H with 10" Base	30"H with 10" Base	36"H with 12" x 10" Base	42"H with 12" x 10" Base
Primary Material	Fiber-Resin Composite				
Includes Tubing	✓				
Recommended Pump	Ultra 400 Water Pump #91005	Ultra 800 Water Pump #91007		Ultra 1100 Water Pump #91008	
Recommended Basin	AquaBasin 30 #78223 or DecoBasin #60000		AquaBasin 45 #78224 or custom using AquaBlox		
Packaged Weight	12 lb.	15 lb.	17 lb.	20 lb.	22 lb.

**NOTE: Faux Basalt Columns not compatible with Fire and Water Torches**



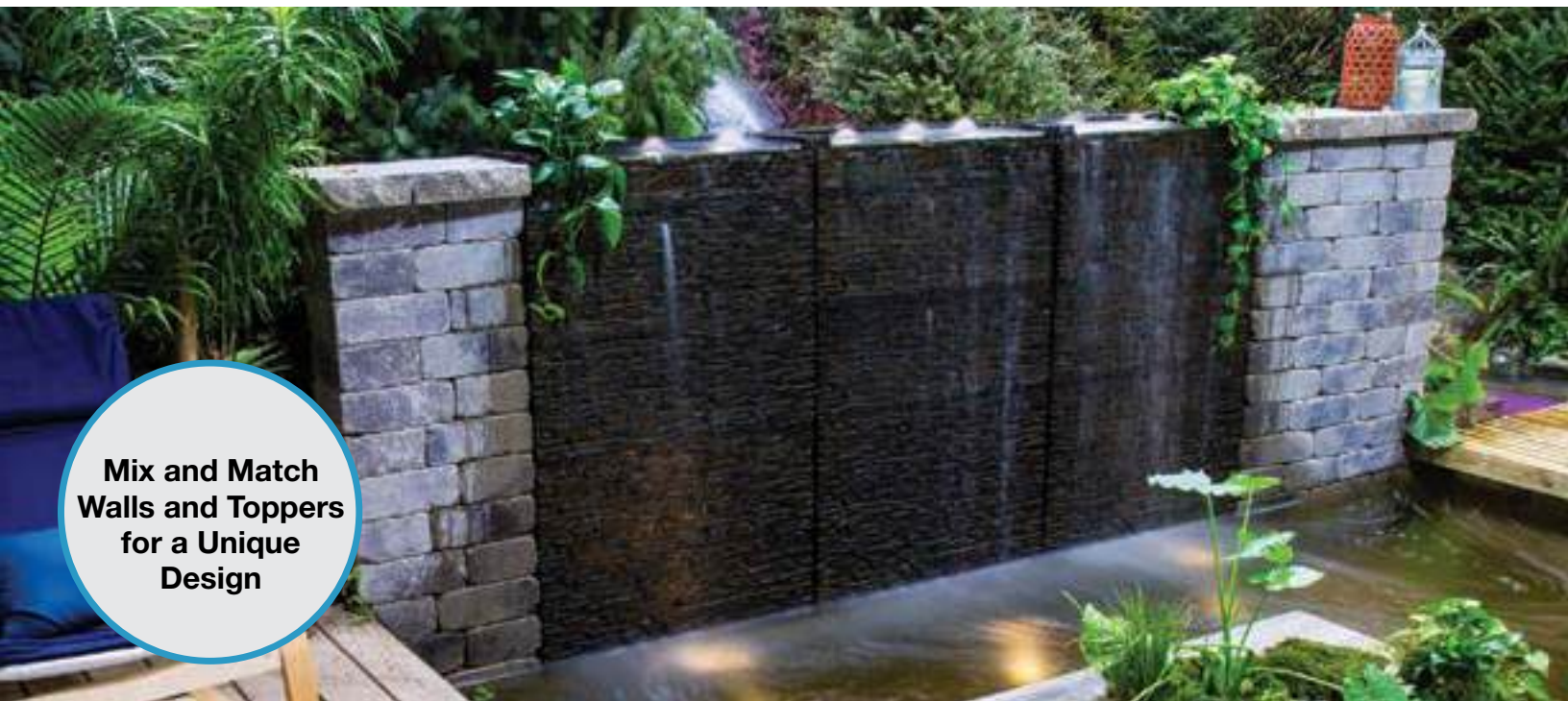

Mix and Match Walls and Toppers for a Unique Design

Kit Available  
See page 23



Stacked Slate Wall Topper Straight Quad-Spill    Stacked Slate Wall Topper Straight Front-Spill    Stacked Slate Wall Base 13" H (33 cm)    Stacked Slate Wall Base 26" H (66 cm)

Item Number	78280	78281	78279	78278
Dimensions	36"L x 12"W x 6"H		36"L x 12"W x 13"H	36"L x 12"W x 26"H
Primary Material	Fiber-Resin Composite			
Included Tubing	✓		—	
Recommended Pump	—		Ultra 2000 Water Pump #91010	
Recommended Basin	—		AquaBasin 45 #78224 or custom using AquaBlox	
Packaged Weight	18.75 lb.		24 lb.	41 lb.



Stacked Slate Wall Topper Curved Front-Spill    Stacked Slate Wall Topper Curved Rear-Spill    Stacked Slate Wall Topper Curved Quad-Spill    Stacked Slate Wall Base Curved 13" H (33 cm)    Stacked Slate Wall Base Curved 26" H (66 cm)

Item Number	78284	78285	78286	78283	78282
Dimensions	36"L x 12"W x 6"H			36"L x 12"W x 13"H	36"L x 12"W x 26"H
Primary Material	Fiber-Resin Composite				
Included Tubing	✓			—	
Recommended Pump	—			Ultra 2000 Water Pump #91010	
Recommended Basin	—			AquaBasin 45 #78224 or custom using AquaBlox	
Packaged Weight	19.25 lb.	17.5 lb.	19.25 lb.	22.75 lb.	39 lb.





Item 78428, 6' Dia. Shown

## Stacked Slate Spheres

	18" Dia. (46 cm)	24" Dia. (61 cm)	32" Dia. (81 cm)	40" Dia. (102 cm)	6' Dia. (1.8 m)
Item Number	78358	78287	78288	78289	78428
Dimensions	18.25" Dia. x 16.25"H (46 cm)	24" Dia. x 22"H (61 cm)	32" Dia. x 30"H (81 cm)	40" Dia. x 37.5"H (101.6 cm)	6' Dia. x 5'H (1.8 m)
Primary Material	Fiber-Resin Composite				
Included Tubing	Silicone 3/4" x 35"	Silicone 3/4" x 35"	Silicone 3/4" x 47"	Silicone 3/4" x 55"	—
Recommended Pump	Ultra 550 Water Pump #91006	Ultra 800 Water Pump #91007	Ultra 1500 Water Pump #91009	Ultra 2000 Water Pump #91010	—
Recommended Basin	AquaBasin 30 #78223	AquaBasin 45 #78224		Custom using pond liner and AquaBlox	
Packaged Weight	18.5 lb.	26 lb.	68 lb.	111 lb.	284 lb.



Item 78247, 8' H Shown

## Stacked Slate Urns

	13" H (34 cm)	24" H (61 cm)   33.5" H (85 cm)	45" H (114 cm)	55" H (140 cm)	8' H (2.44 m)
Item Number	58014	78359   98939	78207	98940	78247
Dimensions	10"L x 10"W x 13.5"H	15" Dia. x 24"H 21.25" Dia. x 33.5"H	27" Dia. x 45"H	35.5" Dia. x 55"H	5' Dia. x 8'H
Primary Material	Fiber-Resin Composite				
Included Tubing	Silicone 1/2" x 34"	Silicone 3/4" x 53"	Silicone 3/4" x 55"	Silicone 3/4" x 71"	—
Recommended Pump	320 GPH Water Pump #91026	Ultra 550 Water Pump #91006	Ultra 1100 Water Pump #91008	Ultra 2000 Water Pump #91010	—
Recommended Basin	AquaBasin 30 #78223 or DecoBasin #60000		AquaBasin 45 #78224	Custom using AquaBlox	
Packaged Weight	6.5 lb.	19.75 lb.   34.5 lb.	56 lb.	104 lb.	262 lb.



## Fire Fountain Add-On Kit

Prepare to be amazed at the difference fire can make for your fountain. Ideal for use with Stacked Slate Spheres and Stacked Slate Urns.

[#78221](#)

Note: Not compatible with #78428 or #78247



## Stacked Slate Urn Fountain Kit 33.5" H (85 cm)

Packaged Weight: 38 lb.

Dimensions: 21.25" Dia. x 33.5"H

Basin Dimensions: 22" Dia. x 14.25"H

Packaged Dimensions: 22.5"L x 22.5"W x 37.75"H

[#58064](#)



**NEW  
COLOR**



**NEW  
COLOR**

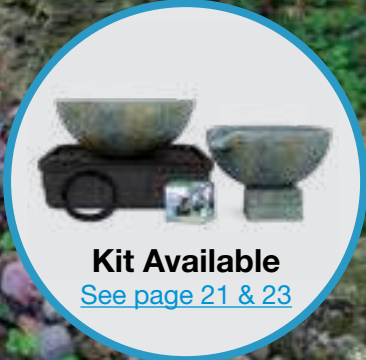

Spillway Bowl  
19" Dia. (49 cm)

Spillway Basin  
21" Dia. (52 cm)

Spillway Bowl Stand  
6" H (15 cm)

Item Number	78422   78355	78423   78356	78425   78357
Dimensions	19"L x 19"W x 7.25"H	20.5L x 20.5W x 7"H	11"L x 11"W x 6"H
Primary Material	GFRC		
Finish	Iron Ore or Patina	Iron Ore or Patina	Iron Ore or Patina
Recommended Pump	Ultra 550 Water Pump #91006	Ultra 800 Water Pump #91007	—
Recommended Basin	AquaBasin 30 #78223		—
Packaged Weight	33.5 lb.	33.5 lb.	14.25 lb.



Spillway Bowl  
32" Dia. (81 cm)

Spillway Basin  
40" Dia. (102 cm)

Spillway Bowl Stand -  
each 4" H (10 cm) (2-pack)

Item Number	78420   78204	78421   78205	78424   78206
Dimensions	32"L x 32"W x 14.5"H	40"L x 40"W x 16"H	13.5"L x 13.5"W x 4"H
Primary Material	GFRC		
Finish	Iron Ore or Patina	Iron Ore or Patina	Iron Ore or Patina
Recommended Pump	Ultra 2000 Water Pump #91010		—
Recommended Basin	AquaBasin 45 #78224		—
Packaged Weight	70.25 lb.	119 lb.	33.5 lb.



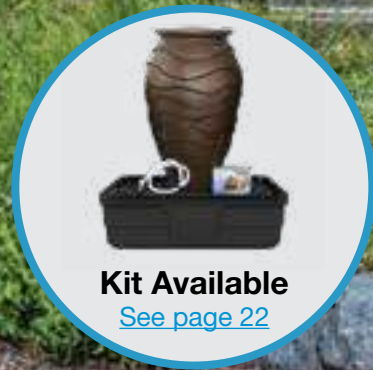

**Kit Available**  
See page 22

Scalloped Urns

	32" H (81 cm)	45" H (114 cm)	56" H (142 cm)
Item Number	78238	78239	78240
Dimensions	20" Dia. x 32"H	27" Dia. x 45"H	38" Dia. x 56"H
Primary Material	Fiber-Resin Composite		
Included Tubing	Silicone 3/4" x 53"	Silicone 3/4" x 55"	Silicone 3/4" x 71"
Recommended Pump	Ultra 550 Water Pump #91006	Ultra 1100 Water Pump #91008	Ultra 2000 Water Pump #91010
Recommended Basin	AquaBasin 30 #78223 or DecoBasin #60000	AquaBasin 45 #78224	Custom using AquaBlox
Packaged Weight	26 lb.	50 lb.	93 lb.



**Kit Available**  
See page 24

Natural Mongolian Basalt Columns

	24" H (61 cm)	30" H (76 cm)	36" H (91 cm)	Set of 3
Item Number	58038	98503	98969	58062
Dimensions	10" Dia. x 24"H	10" Dia. x 30"H	10" Dia. x 36"H	24", 30", & 36" x 10" Dia.
Included Tubing	—			
Recommended Pump	Ultra 800 Water Pump #91007			Ultra 2000 Water Pump #91010
Recommended Basin	AquaBasin 30 #78223	AquaBasin 45 #78224		
Packaged Weight	200 lb.	335 lb.	375 lb.	850 lb.



#### Fire Fountain Add-On Kit

Prepare to be amazed at the difference fire can make for your fountain. Ideal for use with Scalloped Urns.

#78260



#### Want to Add Fire?

Enhance your new or existing Aquascape basalt columns with the mesmerizing therapeutic effects of fire. Aquascape Fire and Water 3-Piece Basalt Torch System (#58103) installs quickly and easily into the top of any existing or new Aquascape basalt column.

See page 132

NOTE: Fire and Water Torches not compatible with Faux Basalt Columns



# AquaGarden Mini Pond Kit

**Innovative Design**

Makes it easy to add a water garden to any location

**Pump Included**

Pump with low-suction attachment maximizes water usage and circulation

**Integrated Light**

Illuminates the waterfall

**Media Included**

Kit includes two types of decorative gravel plus grow media for the upper waterfall

**Kit Includes**

- Plant and Waterfall Filter
- Waterfall Light
- Pump
- Decorative and Grow Media



AquaGarden Mini Pond Kit - Mocha Shown

# AquaGarden Mini Pond Kit Accessories



AquaGarden Mini Pond Kit - Mocha

Packaged Weight: 19 lb.  
Dimensions: 23.5" Dia. x 9.875"H  
Packaged Dimensions: 24"L x 24"W x 14"H

#78325



AquaGarden Mini Pond Kit - Gray

Packaged Weight: 19 lb.  
Dimensions: 23.5" Dia. x 9.875"H  
Packaged Dimensions: 24"L x 24"W x 14"H

#78333



AquaGarden Plant Light



AquaGarden Stand

Item Number	78332	78331
Features	Low-voltage transformer included	Durable, powder coated iron construction
Dimensions	8"L x 3.75"W x 18.25"H	13.25" Dia. x 16"H
Packaged Dimensions	20.5"L x 9"W x 4.25"H	15"L x 14"W x 4.5"H
Packaged Weight	1 lb.	8.8 lb.



## AquaGarden Maintenance 4-in-1

This treatment is formulated specifically for use with Aquascape AquaGardens and other small container water gardens. This 4-in-1 formulation combines an ecosystem bacteria blend with special clarifiers, scale reducers, and foam reducers to keep your feature clean, clear, and maintenance free. [See page 104](#)



# Calming Qualities

Add a compact water garden to any indoor location. This complete kit includes everything you need to get started, and its compact size makes it great for offices, kitchens, and other indoor locations.



## AquaGarden Tabletop Fountain Kit

D

### Media Included

Includes grow media and decorative gravel for both the waterfall and pond

### Overhead Plant Light

Illuminates the AquaGarden while helping plants grow

### Plant and Waterfall Filter

Ideal location for plants while acting as a biological filter to keep the water clean and clear

### Kit Includes

- Plant and Waterfall Filter
- Plant Light
- Waterfall Light
- Pump
- Controller with Transformer
- Decorative and Grow Media



AquaGarden Tabletop Fountain Kit - Gray Shown



AquaGarden Tabletop Fountain Kit - Mocha

Packaged Weight: 5.25 lb.  
Dimensions: 11" Dia. x 5"H  
Packaged Dimensions: 12.2"L x 12.2"W x 6.3"H

#78346



AquaGarden Tabletop Fountain Kit - Gray

Packaged Weight: 5.25 lb.  
Dimensions: 11" Dia. x 5"H  
Packaged Dimensions: 12.2"L x 12.2"W x 6.3"H

#78347



### AquaGarden Maintenance 4-in-1

This treatment is formulated specifically for use with Aquascape AquaGardens and other small container water gardens. This 4-in-1 formulation combines an ecosystem bacteria blend with special clarifiers, scale reducers, and foam reducers to keep your feature clean, clear, and maintenance free. [See page 104](#)



**Discover a new take on our Patio Ponds.** These new Fountain Bowls are fully customizable. Use as a container water garden or use to create beautiful spilling fountains.

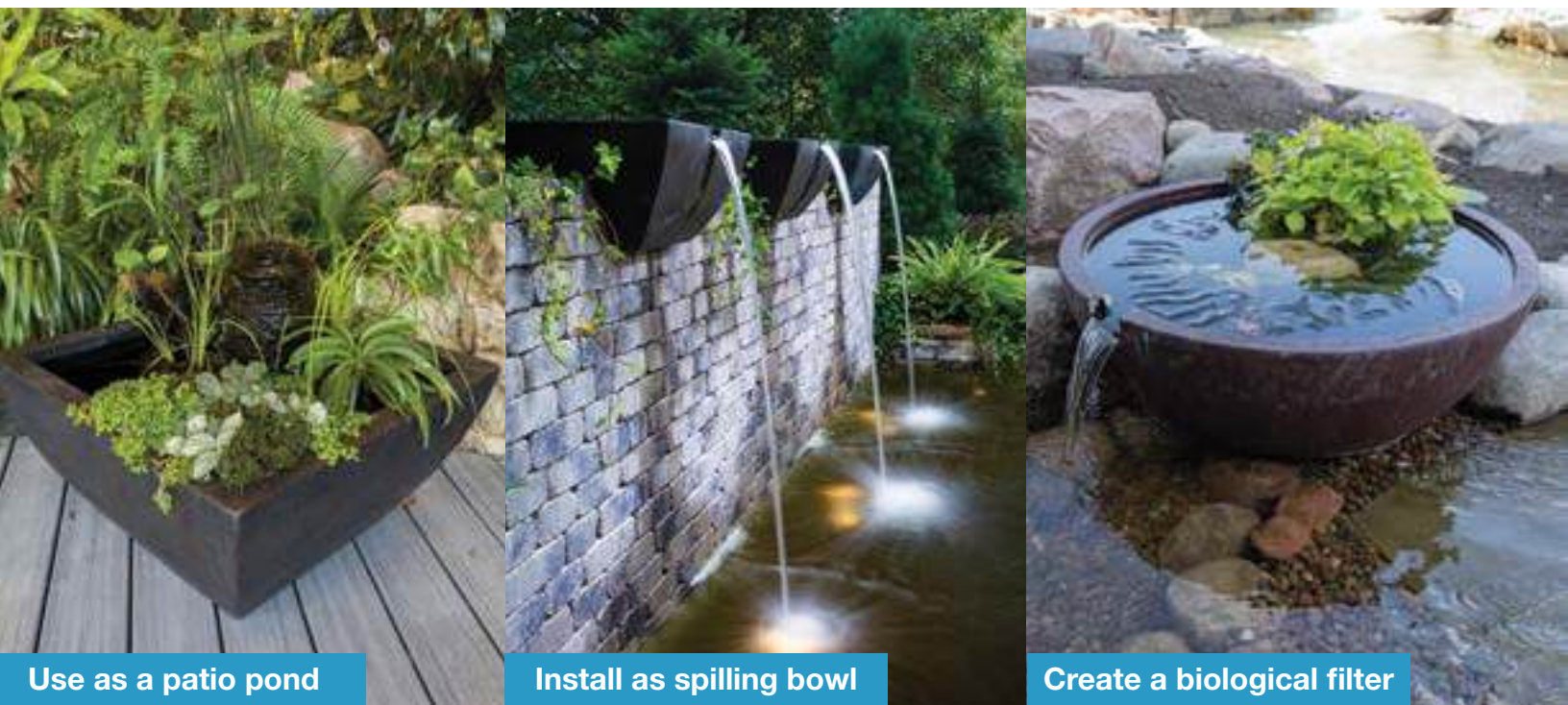

Use as a patio pond

Install as spilling bowl

Create a biological filter

**NEW**



**Versatile Applications**

Easy to install as a decorative bowl in ponds, waterfalls, and more

**Customizable Shelves**

Allows you to configure a variety of designs (shelves sold separately)



**Durable and Lightweight**

Fiber-Resin Composite Construction

Item Number	Color	Dimensions	Holds up to Gal/Liter
78391	Merlot	32" Dia x 14" H (81 Dia x 36 H cm)	29/109
78392		40" Dia x 16" H (102 Dia x 41 H cm)	69/261
78393		50" Dia x 20" H (127 Dia x 51 H cm)	109/412
78394		60" Dia x 22" H (152 Dia x 56 H cm)	180/681
78395	Lunar Gray	32" Dia x 14" H (81 Dia x 36 H cm)	29/109
78396		40" Dia x 16" H (102 Dia x 41 H cm)	69/261
78397		50" Dia x 20" H (127 Dia x 51 H cm)	109/412
78398		60" Dia x 22" H (152 Dia x 56 H cm)	180/681
78399	Green Slate	32" Dia x 14" H (81 Dia x 36 H cm)	29/109
78400		40" Dia x 16" H (102 Dia x 41 H cm)	69/261
78401		50" Dia x 20" H (127 Dia x 51 H cm)	109/412
78402		60" Dia x 22" H (152 Dia x 56 H cm)	180/681
78403	Gray Slate	27" Sq x 14" H (69 Sq x 36 H cm)	28/106
78404		33" Sq x 16" H (84 Sq x 41 H cm)	49/185



**Go Bigger!**

Extra large 50" and 60" diameter bowls available in round!





NEW

**Fountain Bowl Shelves**

Make it easy to take your design to the next level

**Durable and Lightweight**

Sturdy Fiber-Resin Composite construction

**Multiple Openings**

Allow for tubing, water flow, etc.

**Round and Square Options**

Available for both round and square bowls



Item Number	Fits Bowl Size
78405	Fits 32" Dia (81 cm)
78407	Fits 40" Dia (102 cm)
78409	Fits 27" Sq (69 cm)
78411	Fits 33" Sq (84 cm)

Note: Shelves not available for 50" and 60" bowls

**Installs in Seconds**

Place shelf into desired position

**Customize Fountain Bowls**

Add up to four shelves and position as desired

**Get Creative!**

Use shelves to create ledges for plants, rocks, fountain spitters, and more



K | F | P | A | L | PWR | WT | PC | SC | FC | PPC | D | LUG | PP | IT | RH

NEW

**Fountain Bowl Hanging Planters**

Add interest to the edge of Fountain Bowls

**Round and Square Options**

Available for both round and square bowls

Item Number	Description
78413	Fits round bowls
78414	Fits square bowls

Includes fasteners

**Add Plants and More**

Great for small plants such as impatiens, Creeping Jenny, and more

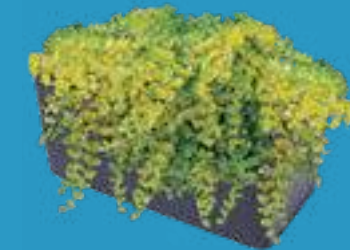

NEW

**Turn Your Fountain Bowl into a Biological Filter**

The Fountain Bowls are both beautiful and functional! Add a Fountain Bowl Biological Filter Kit to the bowls to create a unique filter for any pond or waterfall.

[See page 30 for more information](#)

K | F | P | A | L | PWR | WT | PC | SC | FC | PPC | D | LUG | PP | IT | RH





### Add Some Whimsy to Your Water Feature

These spitters look great in streams or along the edges of ponds and waterfalls. You can even add them to container water gardens.

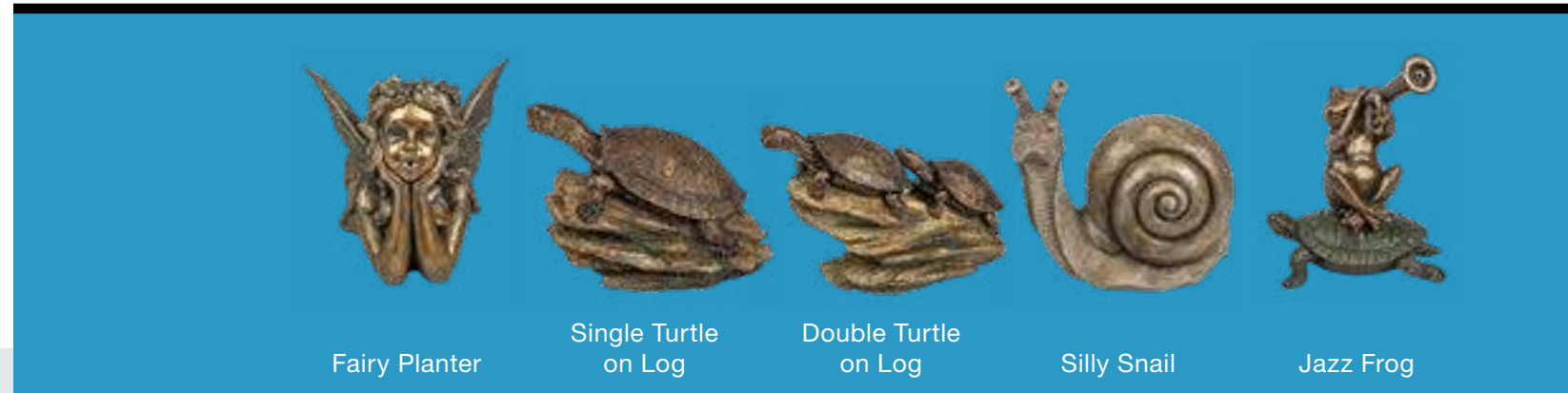

Item Number	78370	78371	78372	78373	78374
Dimensions	8.5"L x 12"W x 9.5"H	12"L x 6.5"W x 8"H	15.5"L x 6.25"W x 10"H	14.5"L x 7.5"W x 13.5"H	12.25"L x 13"W x 14.75"H
Included Tubing	1/2" ID x 48" (122 cm) Rubber Tubing				
Primary Material	Polystone				
Packaged Dimensions	17.1"L x 10.6"W x 15.7"H	10.6"L x 8.5"W x 14.4"H	17.9"L x 8.5"W x 12.6"H	17.1"L x 10.6"W x 15.7"H	15.4"L x 14.2"W x 16.9"H
Recommended Pump	90 GPH Water Pump #91024 (minimum)			180 GPH Water Pump #91025 (minimum)	
Packaged Weight	5.5 lb.	3.7 lb.	4.8 lb.	6.8 lb.	6.8 lb.





Toucan



Naughty Dog



Lazy Frog on Lily Pad

Man in Barrel Spitter  
\*barrel not included

Deer Scarer



Pouring 3-Tier



Adjustable Pouring

Item Number	78309	78310	78311	78315
Dimensions	15"L x 9"W x 16"H	17"L x 12"W x 12.75"H	12"L x 10"W x 5"H	37.5"L x 8"W x 12"H Head: 8.5"L x 11"W x 8"H Hand: 4.5"L x 5"W x 3"H
Included Tubing	1/2" ID x 48" (122 cm) Rubber Tubing	1/4" ID x 48" (122 cm) Rubber Tubing		
Primary Material	Polyresin			
Recommended Pump	90 GPH Water Pump #91024			
Packaged Weight	10.25 lb.	8.5 lb.	4.25 lb.	3.75 lb.
Packaged Dimensions	19"L x 12.5"W x 19.5"H	20.5"L x 12"W x 12.75"H	13"L x 12"W x 7.5"H	12"L x 9"W x 14.5"H

Item Number	78306	78307	78308
Dimensions	5.5"L x 4"W x 14"H	5"L x 3.25"W x 15.5"H	18-30"L x 4.5"W x 10"H
Included Tubing	1/4" ID x 48" (122 cm) Rubber Tubing		
Primary Material	Polyresin		
Packaged Dimensions	18"L x 7"W x 8"H	18.5"L x 7.25"W x 7.5"H	22.25"L x 7.5"W x 9"H
Recommended Pump	90 GPH Water Pump #91024		
Packaged Weight	4.25 lb.	3.25 lb.	5.75 lb.





Fountain Cover Sphere  
24" Dia. (61 cm)



Fountain Cover Sphere  
32" Dia. (81 cm)



Fountain Cover Sphere  
40" Dia. (102 cm)



Fountain Cover Spillway  
Bowl 32" Dia. (81 cm)



Fountain Cover Spillway  
Basin 40" Dia. (102 cm)



Fountain Cover Urn  
32" H (81 cm)



Fountain Cover Urn  
45" H (114 cm)



Fountain Cover Urn  
56" H (142 cm)

Item Number	78375	78376	78377	78381
Dimensions	25"L x 25"W x 21.5"H	33"L x 33"W x 28"H	41"L x 41"W x 35"H	34"L x 34"W x 14"H
Primary Material	900 Denier, 18 oz. PVC coated polyester			
Packaged Weight	2.6 lb.	3.2 lb.	4.25 lb.	2.5 lb.
Packaged Dimensions	13.5"L x 8.25"W x 3.25"H		13.5"L x 8.25"W x 4"H	13.5"L x 8.25"W x 3.25"H

Item Number	78382	78378	78379	78380
Dimensions	41"L x 41"W x 15.5"H	22"L x 22"W x 32"H	30"L x 30"W x 44"H	36.5"L x 36.5"W x 54.5"H
Primary Material	900 Denier, 18 oz. PVC coated polyester			
Packaged Weight	3.2 lb.	2.5 lb.	3.9 lb.	5.7 lb.
Packaged Dimensions	13.5"L x 8.25"W x 3.25"H			13.5"L x 8.25"W x 4"H





Item Number	78276	78277	78324	78418	78419
Features	Ideal for concealing hard-to-hide water feature components, such as skimmers and spillways		Provides pond fish shelter from predators	25"L x 15"W x 9.5"H	30"L x 18"W x 11"H
Primary Material	Polyresin			Fiber-Resin Composite	
Dimensions	30"L x 4"W x 4"H	35"L x 4"W x 5"H	19"L x 12"W x 10"H	25"L x 15"W x 9.5"H	30"L x 18"W x 11"H
Packaged Weight	4.5 lb.	7.5 lb.	11.5 lb.	10.5 lb. (4.7 kg)	14 lb. (6.3 kg)
Packaged Dimensions	31.75"L x 7"W x 10.5"H	36"L x 8"W x 10.75"H	22"L x 15"W x 13"H	25.25"L x 18.25"W x 12.25"H	32"L x 20.5"W x 15"H

Item Number	78259	78416	78417
Features	Great for hiding outdoor electrical outlets, power cords and transformers		
Primary Material	Polyresin	Fiber-Resin Composite	
Dimensions	15" Dia. x 18.5"H	25"L x 15"W x 9.5"H	30"L x 18"W x 11"H
Packaged Weight	19 lb.	10.5 lb.	14 lb.
Packaged Dimensions	18"L x 18"W x 21"H	25.25"L x 18.25"W x 12.25"H	32"L x 20.5"W x 15"H





## Liner, Underlayment, and Geotextile

Liner, underlayment, and geotextile are the pond's foundation.

With a large selection of liners available, it is important to always determine whether the liner you choose is safe for fish that may inhabit the pond.



Fountain Shims  
(set of 6)



Tumbled Lava Stones



Decorative River  
Pebbles-Black



Decorative River  
Pebbles-Mixed

Item Number	78159	78316   78317   78318	78160	78161
Features	Ideal for leveling resin, concrete, stone, or GFRC water fountains	Attractive accent to your water feature		
Dimensions	4.25"L x 1"W x 7"H	Medium   Large   Mixed	3" to 5"	
Surface Coverage	—	1.5 sq. ft.		
Packaged Weight	.5 lb.	25 lb.   25 lb.   50 lb.	22 lb.	
Packaged Dimensions	4"L x 1"W x 7"H	9"L x 3.5"W x 14"H		

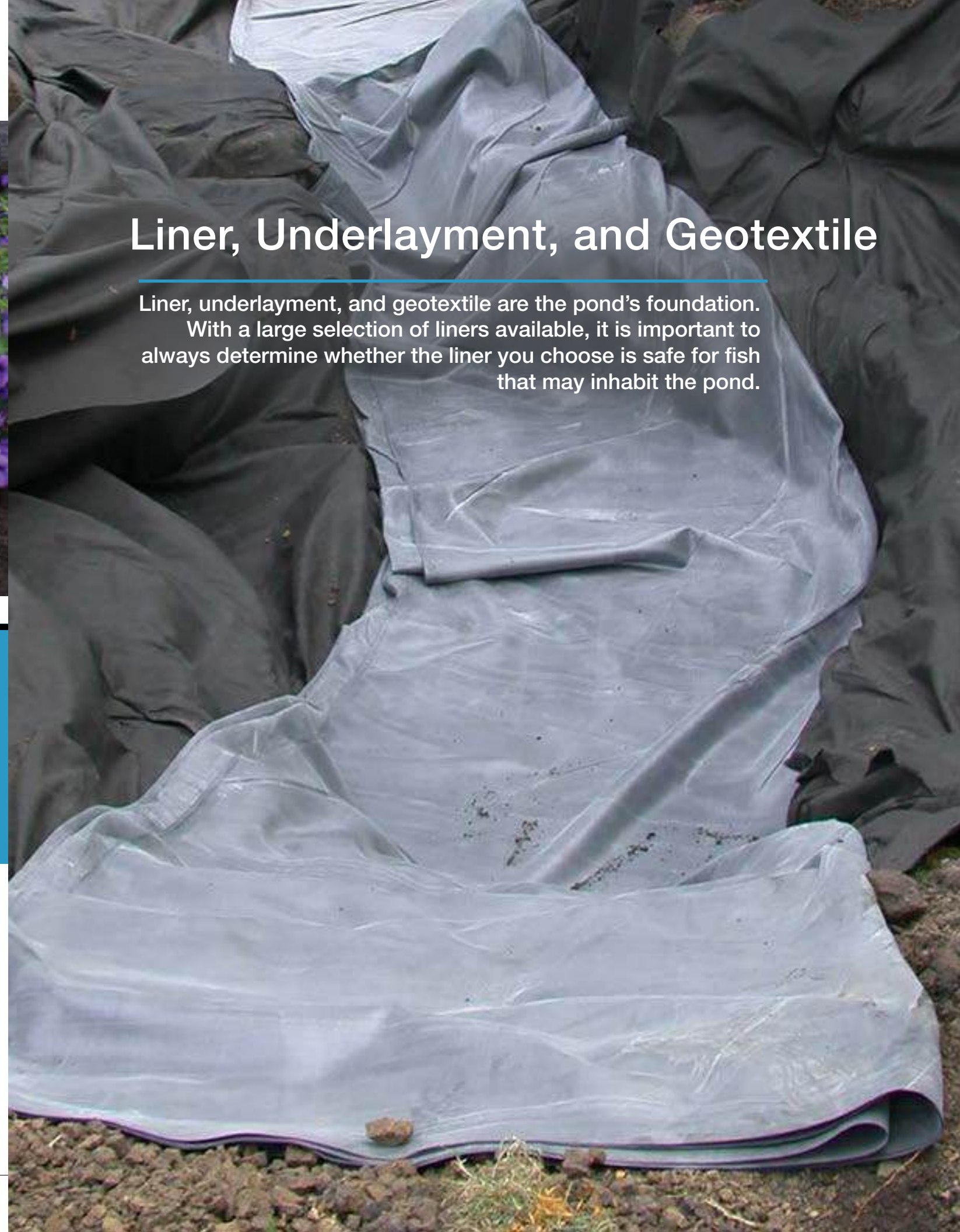





Fish Safe 45 mil EPDM Liner Rolls

Item Number	Roll Dimensions	Packaged Weight
42002	5' x 100'	164 lb.
29188	10' x 50'	164 lb.
29189	10' x 100'	324 lb.
29192	15' x 50'	243 lb.
29193	15' x 100'	486 lb.
29196	20' x 50'	324 lb.
29197	20' x 100'	648 lb.
29200	25' x 50'	402 lb.
29201	25' x 100'	810 lb.
29202	30' x 50'	486 lb.
29203	30' x 100'	972 lb.
29206	40' x 50'	678 lb.
29207	40' x 100'	1,295 lb.
29210	50' x 50'	810 lb.
29211	50' x 100'	1,635 lb.

### 20-Year Guarantee

Leads the industry in quality and reliability. Exceptional resistance to solar UV, ozone, and oxidation



### Safe for Fish and Plants

Free of harmful chemicals that can leach into the pond water

### Easy Installation

Superior elongation and lay-flat characteristics

45 mil EPDM Boxed Liner

Item Number	Liner Dimensions	Packaged Dimensions	Packaged Weight
85009	8' x 10'	12"L x 12"W x 12"H	26 lb.
29607	10' x 10'	20"L x 15.5"W x 9.5"H	33 lb.
85000	10' x 12'	16"L x 11"W x 14.5"H	39 lb.
29612	10' x 20'	20"L x 16"W x 13"H	65 lb.
29616	10' x 30'	17.5"L x 24"W x 14"H	98 lb.
85001	12' x 15'	18"L x 11.5"W x 14.5"H	59 lb.
85002	15' x 15'	20"L x 25.5"W x 15"H	74 lb.
85003	15' x 20'	19"L x 17"W x 19"H	98 lb.
85004	20' x 25'	21"L x 18"W x 22"H	164 lb.



### Don't see the liner type or size that you need here?

We have many other liner options available including 150' & 200' lengths of 45 mil EPDM, and up to 200' rolls of 60 mil EPDM. We also have custom sizes of Reinforced Polyethylene (RPE) and Linear Low-Density Polyethylene (LLDPE) liners in multiple thicknesses.



## Compact Underlayment Roll

Fits in any size truck bed

## Made from Non-Woven Polypropylene

Allows for any gases to escape properly



## Quick and Easy Installation

Lightweight, spreads easily, and has a non-slippery surface

## Trouble-Free Protection

Protects your pond liner from rocks, roots, and other sharp objects

### Rolled Underlayment

Item Number	Grade	Liner Dimensions	Packaged Weight
42147	Heavy-Duty	15' x 50' Compact Roll	44 lb.
42148	Heavy-Duty	15' x 100' Compact Roll	82.25 lb.
42154	Heavy-Duty	15' x 300'	212 lb.
42157	Standard	5' x 300'	62 lb.
42156	Standard	7.5' x 300'	81 lb.
42155	Standard	15' x 300'	201 lb.

### Boxed Underlayment

Item Number	Grade	Liner Dimensions	Packaged Weight
42135	Heavy-Duty	5' x 10'	2.7 lb.
42136	Heavy-Duty	7.5' x 7.5'	2.8 lb.
42137	Heavy-Duty	8' x 10'	3.2 lb.
42138	Heavy-Duty	10' x 10'	3.5 lb.
42139	Heavy-Duty	10' x 12'	3.9 lb.
42140	Heavy-Duty	10' x 15'	4.4 lb.
42141	Heavy-Duty	10' x 20'	5.25 lb.
42142	Heavy-Duty	12' x 15'	5 lb.
42149	Heavy-Duty	15' x 15'	6 lb.
42143	Heavy-Duty	15' x 20'	7 lb.
42144	Heavy-Duty	15' x 25'	8.25 lb.

## Rock Pad Sling

Constructed of Extra-Thick, Non-Woven Polypropylene  
Protects liner from sharp edges during and after installation.

## Rock Padding

Simply leave the sling in place to protect the liner from sharp edges



**NEW**

**Integrated Hand Holes**  
Makes moving rocks and boulders easier on the jobsite

### Rock Pads

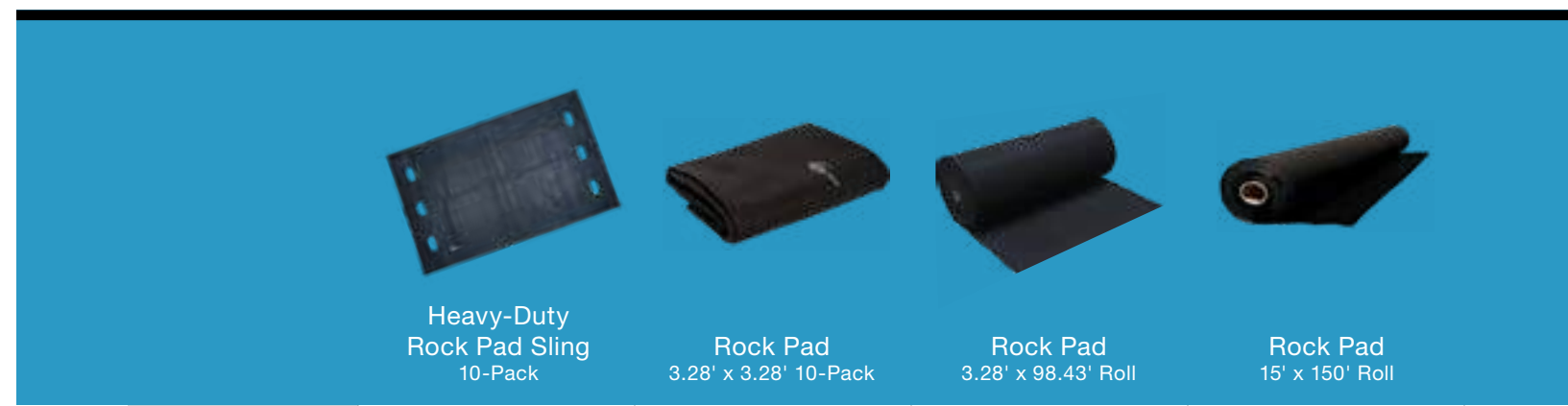

Item Number	42088	42072	42073	25001
Packaged Weight	20 lb.	16.5 lb.	37.5 lb.	260 lb.

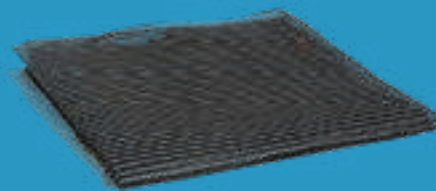

Rock Pad, Woven Microgrid Geotextile, and Concrete Cloth

Woven Microgrid  
Geotextile  
8' x 270' RollWoven Microgrid  
Geotextile  
4' x 4'Concrete  
Cloth Roll  
3.375' x 30'

Item Number	42016	42015	85026
Packaged Weight	65 lb.	.5 lb.	141 lb.

 Only Available for  
Sale in the USA

Aquascape offers a wide variety of liner, underlayment, and geotextiles to help take the guesswork out of building your water feature.



#### 1 Rock Pad

Extra-thick, non-woven polypropylene fabric provides a significant cushion between the liner and large rocks, effectively protecting the liner from rips or tears

#### 2 Woven Microgrid Geotextile

Provides a long-lasting barrier to prevent rock and debris from entering sub-surface water reservoirs while allowing water to easily infiltrate the storage basin

#### 3 EPDM Pond Liner

The ideal membrane for retaining water in ponds, Pondless® Waterfalls, and other water features

#### 4 Non-Woven Geotextile Underlayment

Used to protect pond and water feature liner from rocks, roots, and other sharp objects that may damage the liner

#### 5 Concrete Cloth

Flexible cement-impregnated fabric that hardens upon hydration to form a durable concrete layer, protecting liner from digging animals, human traffic, or damage from setting large rocks or boulders

## Pipe and Plumbing

Complete your water feature with high quality plumbing products. Whether you're starting a new project, or updating an existing water feature, you can trust Aquascape to provide what you need to get the job done right.



**High-Quality Pipe**

Has the durability to be glued into standard schedule 40 PVC fittings



Flexible PVC Pipe 1" x 50' Shown

**Flexible PVC Pipe**

Item Number	Pipe Dimensions	Packaged Weight
48015	1" x 50'	14.5 lb.
29021	1.5" x 25'	13 lb.
29022	1.5" x 50'	24 lb.
29023	2" x 25'	14 lb.
29024	2" x 50'	30.75 lb.
29025	3" x 50'	31 lb.
29026	3" x 100'	118 lb.

**Ideal for Recirculating Water**

No need for PVC glue



Black Vinyl Tubing 1/2" x 100' Shown

**Black Vinyl Tubing**

Item Number	Pipe Dimensions	Packaged Weight
94008	3/8" x 100'	7 lb.
94009	1/2" x 100'	6 lb.
94010	3/4" x 50'	11.75 lb.

**Extremely Flexible**

Resistant to crimping or collapsing around tight curves



Kink-Free Pipe 1" x 100' Shown

**Kink-Free Pipe**

Item Number	Pipe Dimensions	Packaged Weight
98288	1/2" x 100'	9.25 lb.
94002	3/4" x 25'	3.5 lb.
94003	3/4" x 100'	17.75 lb.
94001	1" x 25'	4 lb.
94004	1" x 100'	16.75 lb.
94000	1.25" x 25'	6 lb.
94005	1.25" x 100'	23 lb.
94006	1.5" x 25'	5.75 lb.
94007	1.5" x 100'	38.5 lb.

**Flexible and Crush Proof**

Great for fountain applicaitons, this pipe is made to last. It will not kink, crush, or split.



**Corrugated PE Pipe**

Item Number	Pipe Dimensions	Packaged Weight
88070	3/4" x 6' (1.83 m)	0.6 lb.
88071	3/4" x 7' (2.13 m)	0.7 lb.
88072	3/4" x 50' (15.24 m)	5.4 lb.
88074	3/4" x 15' (4.57 m)	1.6 lb.

(PE = Polyethylene)



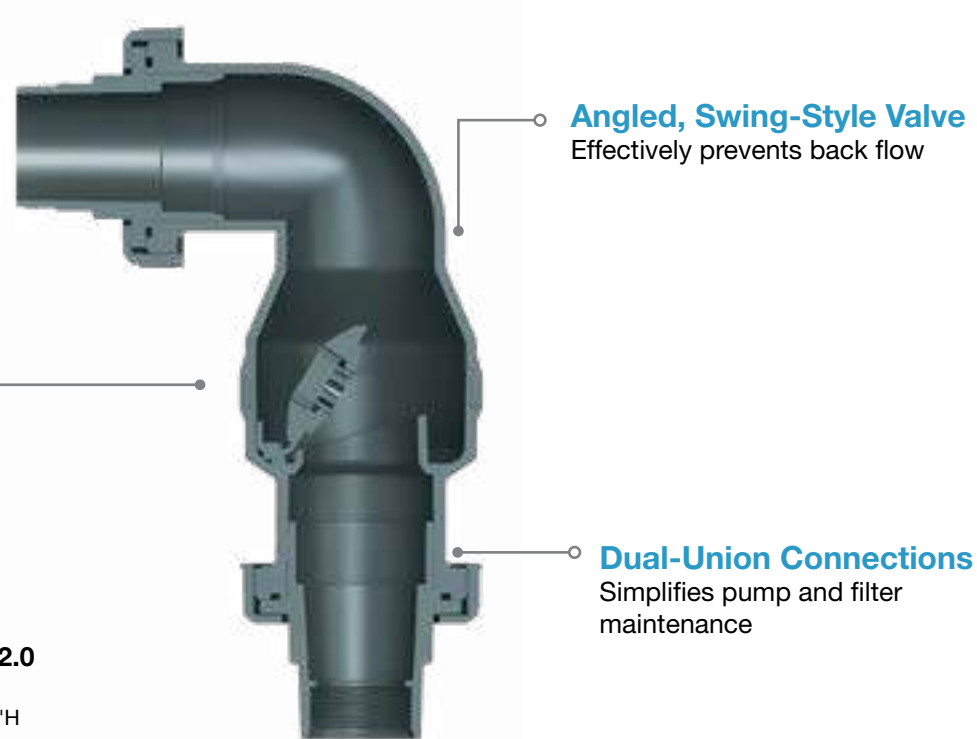

**Heavy-Duty Flapper**  
Ensures longevity

**Angled, Swing-Style Valve**  
Effectively prevents back flow

**Dual-Union Connections**  
Simplifies pump and filter maintenance

**#48026 Dual Union Check Valve 2.0**  
Packaged Weight: 3.75 lb.  
Packaged Dimensions: 14"L x 9"W x 4.75"H



**! Reversible Fittings Eliminate Guesswork**



Dual Union 3" Check Valve



2-Way Flow Control Valve



Check Valve Adapter for EcoWave® Pond Pump - 2"



Christy's Red Hot Blue Glue



**Seamless Integration**

The Dual Union Check Valve 2.0 provides a professional pump and plumbing connection inside skimmer filter systems, as well as Pondless® Waterfall Vaults.

Item Number	29098	88005	88058	29969
Packaged Weight	7.5 lb.	1.5 lb.	.5 lb.	.4 lb.
Packaged Dimensions	24"L x 9"W x 9"H	9"L x 4.5"W x 8"H	3.75"L x 3.75"W x 4"H	-

Visit our website <https://www.aquascapeinc.com/product-category/pipe-plumbing/valves-fittings> and choose from a large variety of fittings and valves designed to fit all your plumbing needs.



### Automatically Adds Water to Features When Needed

Reduces the time-consuming maintenance of manually filling water features with a hose



**Eliminates Large Water Chemistry Swings**  
Including chlorine/chloramine levels that occur during manual top-offs

*Compact Water Fill Valve Shown*

Water Fill Valves



Compact Water Fill Valve

Water Fill Valve 200

Hudson Water Fill Valve

Item Number	88006	29272	29469
Features	Small size fits in any skimmer, Pondless® Waterfall Vault, or AquaBasin.	Reliable mechanical arm-style fill valve. Brass hardware with poly float.	Mounting plate allows for 4-inch setting adjustments. Use Fill Valve Irrigation Conversion Kit (#01008) to connect to 1/2" PVC.
GPM	Up to 1.5 gal.	Up to 3 gal.	Up to 1.5 gal.
PSI	0-100		8-65
Fittings	1/4", 1/2" poly-pipe, 1/2" pvc pipe (pipe sold separately)	1/2" poly-pipe, 1/2" pvc pipe (pipe sold separately)	Quick-connect for 1/4" poly-pipe (pipe sold separately)
Packaged Weight	.75 lb.	1 lb.	1.25 lb.



Fill Valve Spigot 1/4" Quick-Connect

Garden Hose Adapter Assembly

Fill Valve Irrigation Conversion Kit

WFV Poly Pipe Roll 1/4" x 100' / 1/2" x 100'

Item Number	07000	29517	01008	29350   29470
Connection	1/4" poly pipe to garden spigot	1/2" poly pipe to garden spigot	-	
Conversion	-		1/4" Hudson Water Fill Valve up to 1/2" poly pipe or PVC	-
Packaged Weight	.25 lb.		.05 lb.	1.25 lb.   5 lb.



# Installation Tools

Whether you are a do-it-yourselfer or professional water feature contractor, Aquascape has all the pieces and parts you need for successful water feature installation or repair.



Pond and Waterfall Foam Sealant



Professional Black Waterfall Foam



Professional Foam Gun Cleaner



Waterfall Foam Gun Applicator

Item Number	82002	30096	22011	54003
Application	Applicator straw included. No Foam Gun required	Foam Gun Applicator required	Cleans Foam Gun Applicator	Use with item #30096 & #22011
Packaged Weight	1 lb.	2 lb.	1.25 lb.	1.5 lb.





Installation Kit

Black  
Silicone Sealant  
4.7 oz / 10.1 ozClear  
Silicone Sealant  
10.1 ozQuickSeam  
Pond Liner Repair Kit

QuickScrubber Kit

EPDM Tape Primer

Item Number	22008	22010   29186	82000
Application	Applicator straw included No Foam Gun required	Used for sealing joints where liner attaches to BioFalls® lip and skimmer faceplate. Fish safe.	
Packaged Weight	2.25 lb.	.5 lb.	.75 lb.

Item Number	42023	54009	54008
Kit Includes	6" x 6" QuickSeam patches, bottle of LVOC primer (2 oz. / 57 ml), scrubber pad, patch roller, pair of disposable gloves	30 scrub pads, 4 holders designed for the application of EPDM Tape Primer	—
Packaged Weight	.5 lb.	.75 lb.	2 lb.





## Rainwater Harvesting

The Aquascape Rainwater Harvesting System adds the beauty of a water feature to a rainwater collection system for capturing, filtering, and reusing our most precious resource – water! Whether you choose a Pondless® Waterfall or bubbling urn to add to your landscape, you'll be happy knowing your rainwater harvesting system not only looks great but is beneficial for the environment too.

**NEW**



EPDM  
Liner Patch



EPDM Liner  
One-Sided  
Cover Tape  
12" x 25' (30.5 cm x 7.6 m)



EPDM Liner  
One-Sided  
Cover Tape  
6" x 25' / 6" x 100'



EPDM Liner  
Double-Sided  
Seam Tape  
3" x 25' / 3" x 100'

Item Number	22018	42161	22003   22005	22017   22020
Packaged Weight	.25 lb.	13 lb.	6.25 lb.   20 lb.	2 lb.   20 lb.

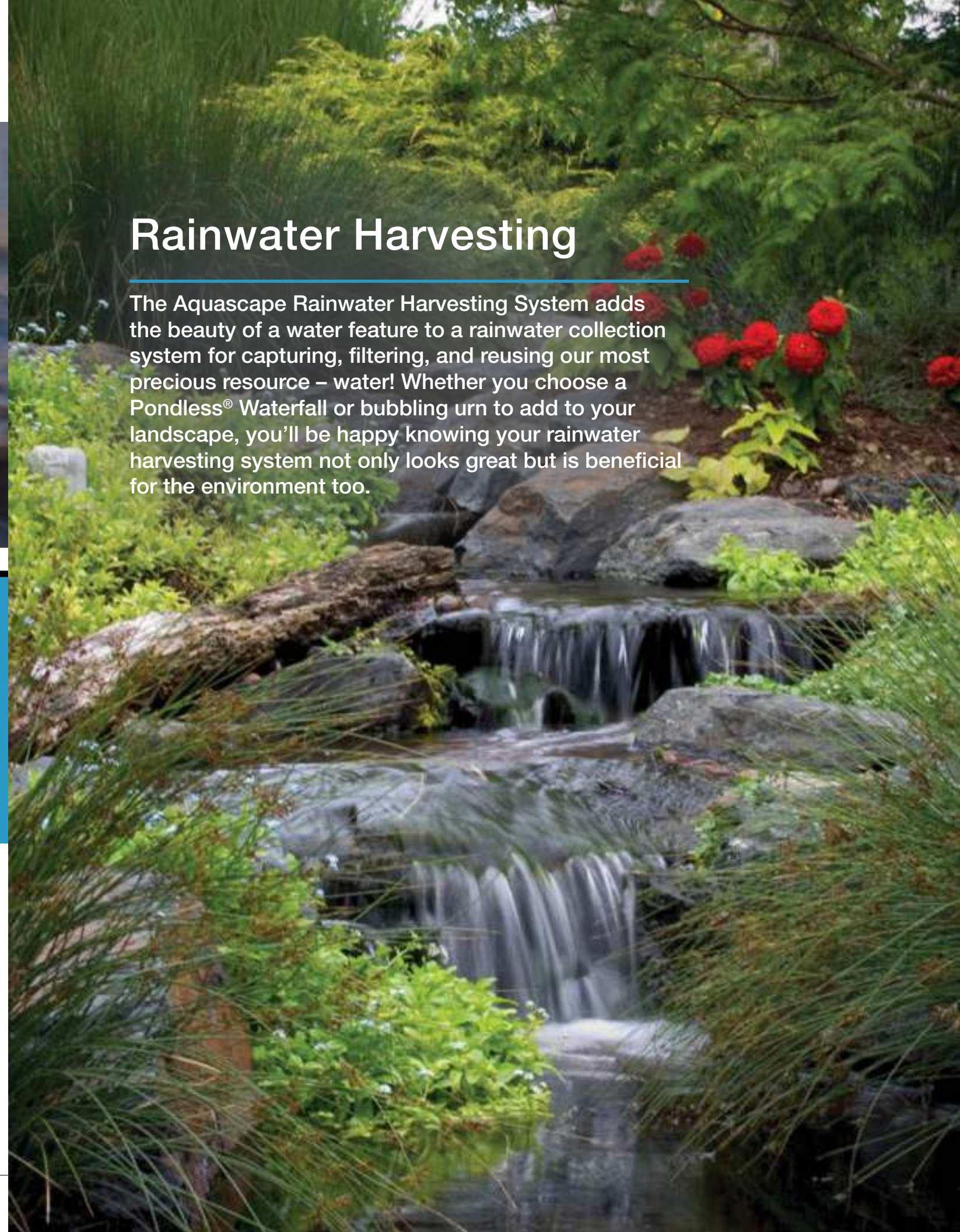



## STEP 1: Choose The Water Storage System

Each Aquascape Rainwater Harvesting System water storage kit includes: Pondless® Waterfall Vault Extensions(s), AquaBlox®, 45 mil EPDM Liner, and two pieces of non-woven geotextile, underlayment (one to surround the AquaBlox® and one to surround the exterior of the EPDM liner).



Water Storage Kits

	500 Gallon	1000 Gallon	1500 Gallon	2000 Gallon	2500 Gallon	3000 Gallon
Item Number	30097	30099	30102	30105	30108	30112
Basin Size	6' x 9' x 4'	6' x 9' x 5'	8' x 9' x 5'	9' x 11' x 5'	11' x 12' x 5'	9' x 11' x 6'
AquaBlox Large Water Storage Modules	16	32	48	64	80	96
45 mil EPDM Liner	15' x 20'	20' x 25'	25' x 25'	25' x 30'		
Underlayment	(2) 300 sq. ft.	(2) 500 sq. ft.	(2) 625 sq. ft.	(2) 750 sq. ft.		
Pondless Waterfall Vault Extensions	1	4				6

## STEP 2: Choose The Water Feature



#44001 Rainwater Harvesting Pondless® Waterfall Add-On Kit

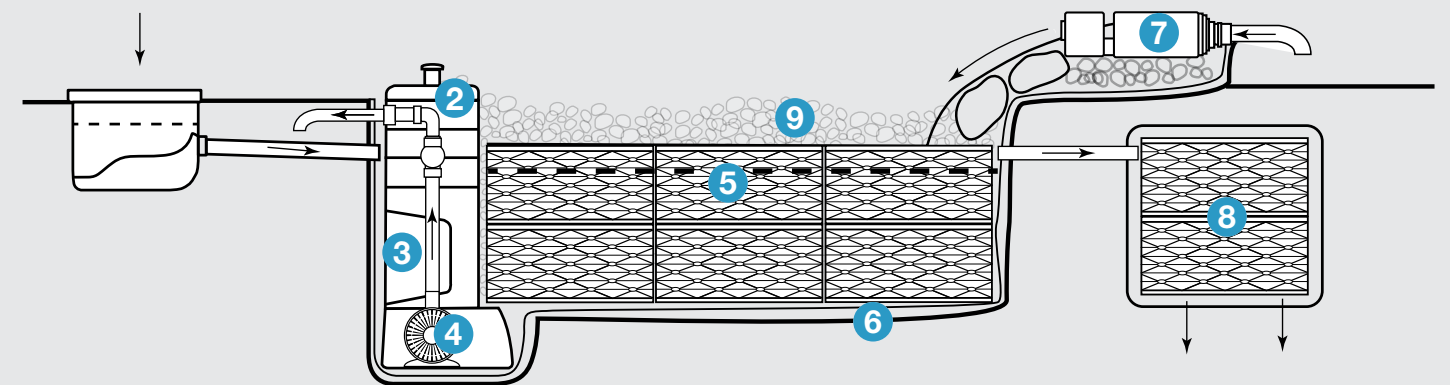

### Pondless® Waterfall Components

- 1 Downspout Filter
- 2 Pondless® Waterfall Vault Extensions
- 3 Pondless® Waterfall Vault
- 4 Pump
- 5 AquaBlox® Water Storage Modules
- 6 Liner and Underlayment
- 7 Waterfall Spillway
- 8 Overflow Drainage
- 9 Rocks and Gravel



## STEP 2: Choose The Water Feature

**Pondless® Waterfall Vault**  
Perfect for pump placement and access

**Flexible PVC Pipe**  
Includes 3/4" 25 ft. pipe and overflow kit to manage excess water



**OPTION 2**

**AquaSurge 2000-4000 Adjustable Flow Pond Pump**  
Provides customizable water flow rates using a handheld, wireless remote control

#44000 Rainwater Harvesting Fountain Add-On Kit

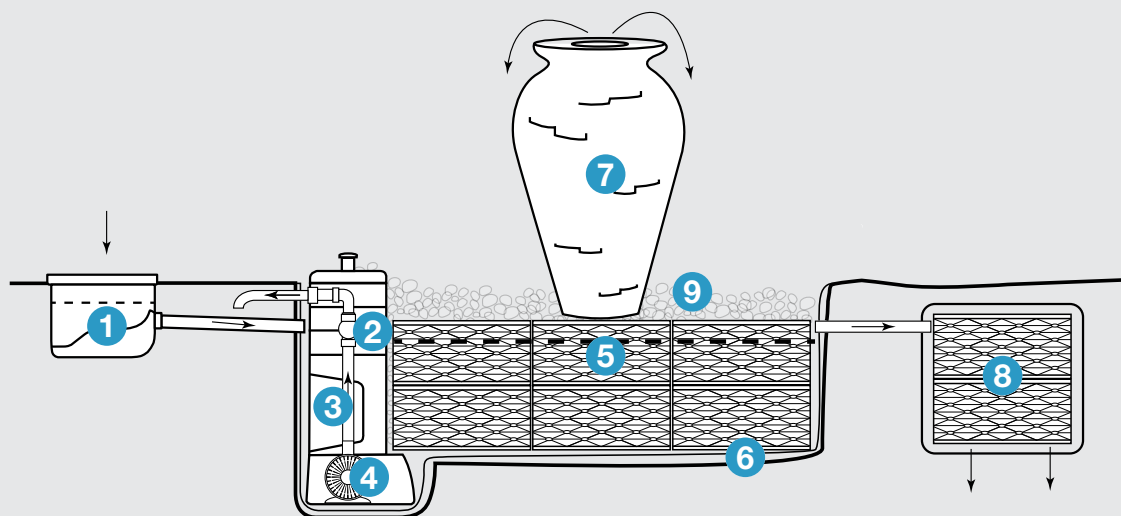

### Fountain Components

- 1 Downspout Filter
- 2 Pondless® Waterfall Vault Extensions
- 3 Pondless® Waterfall Vault
- 4 Pump
- 5 AquaBlox® Water Storage Modules
- 6 Liner and Underlayment
- 7 Decorative Fountain
- 8 Overflow Drainage
- 9 Rocks and Gravel

## STEP 3: Choose The Decorative Fountain



Item Number	78287	78239	58062	98939
For more information, see page	164	166	168	165

For more fountain options, see page 142-151



**Rainwater Harvesting Downspout Filter**  
Packaged Weight: 10 lb.  
Packaged Dimensions: 27"L x 25.25"W x 15"H  
#30166



### Add a Downspout Filter

The Downspout Filter is installed at the base of the downspout ready to capture rainwater and remove a variety of debris. Incoming rainwater is passed through a series of mechanical filters that remove leaves, twigs, seeds, and small sediment that accumulate on the surface of the roof between rain events. Add a Downspout Filter to any fountain or Pondless® Waterfall feature and make it sustainable!



2-Outlet and 4-Outlet Pond Aeration Kits **66, 67**  
 2-Outlet Pond Aeration Kit **67**  
 2-Way Aeration Compressor Manifold **70**  
 2-Way Flow Control Valve **179**  
 3-Light Spotlight Kit **76, 77**  
 4 in 1 AquaGarden Maintenance **152**  
 4-Outlet Pond Aeration Kit **66, 67**  
 4-Way 3/8" Splitter with Caps **133**  
 8-Watt Wide-Angle Light **79**  
 10" Rubber Membrane Aeration Diffuser **70**  
 11-Watt Color-Changing Wide-Angle Light **73**  
 300-Watt Pond De-Icer **115**

## A

Activated Pond Carbon **99**  
 Add-On Pond Filters **34**  
 – Container Water Garden Filter **34**  
 – Pond Waterfall Filter **34**  
 – Submersible Pond Filter **34**  
 Adjustable Flow Pump Extension Cord **46, 48, 56**  
 Algaecide **100**  
 Alkalinity Booster **99**  
 Ammonia Neutralizer **99, 107, 123**  
 Ammonia Neutralizer Professional Grade **107**  
 AquaBasin® 30 **141, 147, 150, 151**  
 AquaBasin® 45 **18, 19, 20, 54, 135, 136, 140, 141, 142, 143, 144, 145, 146, 147, 148, 149, 150, 151**  
 AquaBlox® **15**  
 AquaBlox® Water Storage Modules **14, 16, 40**  
 AquaForce® Adjustable Flow Solids-Handling Pond Pump **57**  
 AquaForce® Solids-Handling Pond Pump **37, 56, 57**  
 AquaForce Pond Pump **57**  
 AquaGarden Maintenance 4-in-1 **152, 155**  
 AquaGarden Mini Pond Kit **152, 153**  
 AquaGarden Plant Light **153**  
 AquaGarden Stand **153**  
 AquaGarden Tabletop Fountain Kit **155**  
 AquaJet® Pond Pump **58, 59**  
 AquaSurge® Adjustable Flow Pond Pump **47**  
 AquaSurge® Pond Pump **46, 47**  
 Aquatic Lily Planter **129**  
 Aquatic Planters **128, 129**  
 Auto-Ignite Fire Features **134, 135, 136, 137**

## B

Backyard Waterfall Landscape Fountain Kit **18, 19**  
 Bacteria Bubble Tabs **97**  
 Bamboo Fountains **160**  
 – Adjustable Pouring **163**  
 – Deer Scarer **163**  
 – Pouring 3-Tier **163**  
 Barbed Coupling 3/8" **70**  
 Barley Straw Extract **101, 107**  
 Barley Straw Extract Professional Grade **107**  
 Beneficial Bacteria **87, 96, 106**  
 Beneficial Bacteria Concentrate **96**  
 Beneficial Bacteria Concentrate Professional Grade **106**  
 Beneficial Bacteria Professional Grade **106**  
 BioFalls® Filters  
 – Signature Series 1000 BioFalls **9, 29**

– Signature Series 2500 BioFalls **9, 29**  
 – Signature Series 6000 BioFalls  
 – with 2" Bulkhead **29**  
 – Signature Series 6000 BioFalls  
 – with 3" Bulkhead **29**  
 Biological Filter Kits for Round Bowls **31**  
 Biological Filter Kits for Square Bowls **31**  
 Black Pond Dye **103**  
 Black Silicone Sealant **184**  
 Black Vinyl Tubing **176**  
 Blue Heron Decoy **112**  
 Blue Pond Dye **103**

## C

Centipede® **41**  
 – Large Centipede® Module **41**  
 Check Valve Adapter for EcoWave® Pond Pump **179**  
 Check Valve Adapter for EcoWave Pond Pump - 2" **54**  
 Christy's Red Hot Blue Glue **179**  
 Cleanout Pump **64**  
 Cleanout Pump Discharge Hose 50' **64**  
 Clear Silicone Sealant **184**  
 Cold Water Beneficial Bacteria **96**  
 Cold Water Beneficial Bacteria Professional Grade **106**  
 Color-Changing Light Extension Cables **75**  
 – 3-Way Color-Changing Light Splitter **75**  
 – 6-Way Color-Changing Light Splitter **75**  
 – 25' 5-Outlet Color-Changing Light Extension Cable **75**  
 – 25' Color-Changing Light Extension Cable **75**  
 Color-Changing Light Remote **72**  
 Color-Changing Lights **72, 73, 74**  
 – 2-Watt Color-Changing Waterfall Light **73**  
 – 4.5-Watt Color-Changing Spotlight **73**  
 – 8-Watt Color-Changing Spotlight **73**  
 – Color-Changing Fountain Light **74**  
 – Color-Changing Fountain Light Kit **74**  
 Compact Water Fill Valve **180**  
 Concentrated Barley  
 Straw Pellets **103**  
 Concrete Cloth Roll **174**  
 Copper Test Kit **43**  
 Corrugated PE Pipe **177**  
 Curved Stacked Slate Walls **145**

## D

DecoBasin **141, 147, 150**  
 Decorative Accessories **164, 165, 166, 167, 168**  
 Decorative River Pebbles **168**  
 DIY Backyard Pond Kits **7**  
 – 4' x 6' **7**  
 – 6' x 8' **7**  
 – 8' x 11' **7, 9**  
 DIY Backyard Pondless® Waterfall Kit **15**  
 Dome Top Path and Area Landscape Light 6-Pack **83**  
 Dosing System SL **8, 16, 17, 90, 91**  
 Dual Union 3" Check Valve **179**  
 Dual Union Check Valve 2.0 **54, 178**

## E

EcoBlast™ Contact Granular Algaecide **100**  
 Economy Foam Gun Applicator **183**  
 EcoWave® 2000 Pond Pump **15**  
 EcoWave® Pond Pump **54, 55, 179**  
 EcoWave 2000 Pond Pump **7**  
 EPDM Boxed Liner **171**  
 EPDM Liner Double-Sided Seam Tape **186**  
 EPDM Liner One-Sided Cover Tape **186**  
 EPDM Liner One Sided Cover Tape **4**  
 EPDM Liner Patch **186**  
 EPDM Liner Rolls **170**  
 EPDM Liner/Underlayment **7**  
 EXT Pond Pump **52, 53**  
 EXT Pump Plumbing Kit **52**  
 Extra Small Stacked Slate Sphere 18" **21**

## F

Faux Basalt Columns **21, 22, 142, 143**  
 – Faux Basalt Column Set of 3 **22**  
 – Faux Basalt Columns - Set of 3 **142**  
 – Faux Basalt Columns - Set of 5 **142**  
 Faux Driftwood **9, 17, 166**  
 Faux Log Fish Cave **111, 166**  
 Faux Oak Stump Cover **167**  
 Faux Rock Cover - Large **167**  
 Faux Rock Covers **4**  
 Faux Rock Cover - Small **167**  
 Faux Rock Fish Cave - Large **111**  
 Faux Rock Fish Caves **4**  
 Faux Rock Fish Cave - Small **111, 166**  
 Faux Stone Fire Pit **137**  
 Fill Valve Irrigation Conversion Kit **181**  
 Fill Valve Spigot 1/4" Quick-Connect **181**  
 Filter Media **7, 9, 28, 29, 31, 32, 33**  
 – BioBalls Biological Filter Media **32**  
 – BioBalls Filter Media Net **32**  
 – Course Filter Media Roll **33**  
 – Dense Filter Media Roll **33**  
 – High Density Rigid Filter Mat **33**  
 – Low Density Rigid Filter Mat **33**  
 – Medium Density Rigid Filter Mat **33**  
 Fire and Water 3-Piece Basalt Torch System **132**  
 Fire and Water Basalt Column Torch **133**  
 Fire and Water Spillway Basin **135**  
 Fire and Water Spillway Bowl **135**  
 Fire and Water Stacked Slate Sphere **136**  
 Fire and Water Stacked Slate Urn **136**  
 Fire Fountain Add-On Kit **146, 150**  
 Fire Glass **138**  
 Fire Media **135, 136, 137, 138**  
 Fish Food Flakes **121**  
 Fish Treatments **122, 123**  
 Flexible PVC Pipe **16, 19, 176, 189, 190**  
 Flexible Stand **72, 73, 78, 79**  
 Floating Alligator Decoy **112**  
 Floating Plant Island **129**  
 Floating Swan Decoy **112**  
 Fountain Bowl **4**

Fountain Bowl Accessories **158, 159**  
 Fountain Bowl Biological Filter Kits **30, 31**  
 Fountain Bowl Hanging Planters **159**  
 Fountain Bowls **156**  
 Fountain Bowl Shelves **158**  
 Fountain Cover Sphere 24" **164**  
 Fountain Cover Sphere 32" **164**  
 Fountain Cover Sphere 40" **164**  
 Fountain Cover Spillway Basin 40" **165**  
 Fountain Cover Spillway Bowl 32" **164**  
 Fountain Cover Urn 32" **165**  
 Fountain Cover Urn 45" **165**  
 Fountain Cover Urn 56" **165**  
 Fountain Foam Free **105**  
 Fountain Kits **5, 20, 21, 22, 23, 24, 104**  
 – Faux Basalt Column 24" H (61 cm) **21**  
 – Faux Basalt Column 24" H (61 cm) **21**  
 – Faux Basalt Column Set of 3 24", 30", 36" H (61, 76, 91 cm) **22**  
 – Mongolian Basalt Columns Set of 3 **24**  
 – Scalloped Urn 45" H (114 cm) **22**  
 – Spillway Bowl and Basin 19"/21" Dia. (49/52 cm) **21**  
 – Spillway Bowl and Basin 32"/40" Dia. (81/102 cm) **23**  
 – Stacked Slate Sphere 18" Dia. (46 cm) **21**  
 – Stacked Slate Sphere 32" Dia. (81 cm) **23**  
 – Stacked Slate Urn 24" H (61 cm) **21**  
 – Stacked Slate Urn 45" H (114 cm) **22**  
 – Stacked Slate Wall 32" H (81 cm) **23**  
 Fountain Maintenance **105**  
 Fountain Scale Free **105**  
 Fountain Shims **168**  
 Fountain Spitters **160, 161, 162, 163**  
 – Double Turtle on Log **161**  
 – Fairy Planter **161**  
 – Jazz Frog **161**  
 – Lazy Frog on Lily Pad **162**  
 – Man in Barrel Spitter **162**  
 – Naughty Dog **162**  
 – Silly Snail **161**  
 – Single Turtle on Log **161**  
 – Toucan **162**  
 Fungus Treatment **122, 123**

## G

Garden Hose Adapter Assembly **181**

## H

Heavy Duty Pond Net with Extendable Handle **125**  
 Heavy Duty Pond Skimmer Net  
 with Extendable Handle **124**  
 Hudson Water Fill Valve **180, 181**

## I

Installation Kit **7, 9, 15, 17, 19, 184**  
 IonGen™ G2 Probe Holder **43**  
 IonGen™ Probe for the G2 System **43**  
 IonGen™ System G2 **12, 13, 42, 43, 63, 78**



**K**

KH/Alkalinity Test Kit **43**  
 Kid's Pond Explorer Net **125**  
 Kink-Free Pipe **7, 15, 37, 177**  
 Koi Krunchies **121**  
 Koi Sock Net **125**

**L**

Lake Bacteria **108**  
 Lake Bacteria Packs **108**  
 Lake Blue Dye Packs **109**  
 Lake Flocculant Clarifier **109**  
 Lake Phosphate Binder Packs **109**  
 Lake Sludge Remover Packs **108**  
 Lake Treatment Booster Packs **109**  
 Large Curved Wall Base **145**  
 Light Stake **72, 78**  
 Low Suction Intake Attachment **19, 46, 54**  
 Low Voltage Accessories **81**

- 3-Way Quick-Connect Splitter **81**
- 6-Way Quick-Connect Splitter **81**
- 25' 5-Outlet Quick-Connect Extension Cable **81**
- 25' Quick-Connect Extension Cable **81**

**M**

Match-Lit Flame Control System **132, 133**

**N**

Natural Mongolian Basalt Columns **151**

**O**

Once-A-Year Pond Plant Fertilizer **4, 127**

- 2 lb. Granular **127**
- 6-Pack Capsules **127**
- 7 lb. Granular **127**
- 12-Pack Capsules **127**

**P**

Parasite & Ich Treatment **122**  
 Path and Area Landscape Lights **82, 83**

- Dome Top **83**
- Dome Top Path and Area Landscape Light 6-Pack **83**
- Hat Top **82, 83**
- Hat Top Path and Area Landscape Light 6-Pack **83**

 Patio Pond Maintenance Tabs **105**  
 PL Solids-Handling Pond Pump **50, 51**  
 PN Solids-Handling Pond Pump **50, 51**  
 Pond Aeration Kits **66, 67, 68**  
 Pond Aerator Aeration Disc **66**  
 Pond Aerator Pro Check Valve **70**  
 Pond and Waterfall Foam Sealant **183**  
 Pond & Debris Clarifier **101**  
 Pond & Debris Clarifier Professional Grade **107**  
 Pond Detoxifier **99, 107, 123**  
 Pond Detoxifier Professional Grade **107**  
 Pond Filtration **7**  
 Pond Foam Free **99**  
 Pondless® Waterfall Vault **14, 15, 16, 17, 39, 43, 54, 180, 188, 189**

Pondless® Waterfall Vault Extension **39**  
 Pond Nets **124, 125**  
 Pond Net with Extendable Handle **125**  
 Pond Plant Potting Media **130**  
 Pond Powerhead **9, 63**  
 Pond Salt **122, 123**  
 Pond Shark **124**  
 Pond Shark Pro **124**  
 Pond Skimmer Net with Extendable Handle **124**  
 Pond Sludge Remover Packs **98**  
 Pond Starter Bacteria **97, 106**  
 Pond Starter Bacteria Professional Grade **106**  
 Pond Thermometers **114**  
 Praziquantel Treatment **122, 123**  
 Premium Cold Water Fish Food Pellets **120**  
 Premium Color Enhancing Fish Food Pellets **119**  
 Premium Fish Food Flakes **121**  
 Premium Staple Fish Food Pellets **118**  
 Pro Air 20 Aeration Compressor **69**  
 Pro Air 60 Aeration Compressor **69**  
 Pro Air Pond Aeration Kits **68**

- Pro Air 20 **68, 69**
- Pro Air 60 **68, 69**

 Professional Black Waterfall Foam **183**  
 Professional Fish Net with Extendable Handle **125**  
 Professional Foam Gun Cleaner **183**  
 Professional-Grade BioFalls® Filter **8**  
 Professional Grade Pond Kits **8, 9**

- Large Deluxe Pond Kit 21' x 26' **9**
- Large Pond Kit 21' x 26' **9**
- Medium Deluxe Pond Kit 11' x 16' **9**
- Medium Pond Kit 11' x 16' **9**
- Small Pond Kit 8' x 11' **9**

 Professional Grade Pondless® Waterfall Kits
 

- Large Deluxe Pondless® Waterfall Kit (26' Stream) **17**
- Large Pondless® Waterfall Kit (26' Stream) **17**
- Medium Deluxe Pondless® Waterfall Kit (16' Stream) **17**
- Medium Pondless® Waterfall Kit (16' Stream) **17**
- Small Pondless® Waterfall Kit (6' Stream) **17**

 Professional Grade Pond Net **125**  
 Professional Grade Pond Skimmer Net **124**  
 Professional-Grade Skimmer **8**  
 Propane Tank Covers **139**

- Faux Stone **137, 139**
- Faux Stump **139**
- Stainless Steel Fire Pan Cover **139**

 Propane Tank Regulator and Hose **133**  
 Protective Pond Netting **116**  
 Pump Cleaner Maintenance Solution **64**

**Q**

Quad-Spill Curved Topper **145**  
 Quick-Connect Photocell with Timer **76, 81**  
 QuickFix Pond Gummy **102**  
 QuickPrime Plus-EPDM Liner Seaming Tape Primer **185**  
 QuickScrubber Kit **185**

**R**

Rainwater Harvesting Downspout Filter **191**  
 Rainwater Harvesting Fountain Add-On Kit **190**  
 Rainwater Harvesting Pondless® Waterfall Add-On Kit **189**  
 Rainwater Harvesting System Water Storage Kit **188**  
 Rapid Clear Fine Filter Pads **102**  
 Rapid Clear Flocculant **102, 106**  
 Rapid Clear Flocculant Professional Grade **106**  
 Recreational Pond Kits **10, 11, 12, 13**  
 Rock & Fountain Cleaner **105**  
 Rock Pad **173, 174**  
 Rock Pad Sling **4**  
 Rubber Gas Hose **133**

**S**

SAB Stream & Pond Cleaner **101, 107**  
 SAB Stream & Pond Cleaner Professional Grade **107**  
 Scalloped Urn **22**  
 Scalloped Urns **150**  
 Simple Solutions Pump Top For Fountains **95**  
 Simple Solutions Pump Top For Ponds **94**  
 Simple Solutions Water Treatments **88, 89**  
 Skimmer Filters **26, 27**

- Signature Series 200 Pond Skimmer **27**
- Signature Series 400 Pond Skimmer **27**
- Signature Series 1000 Pond Skimmer **27**

 SLD Adjustable Flow Pond Pump **48, 49**  
 SL Dosing System **90**  
 Sludge & Filter Cleaner **98, 107**  
 Sludge & Filter Cleaner Professional Grade **107**  
 SL Water Treatments **91**  
 Small Curved Wall Base **145**  
 Small Stacked Slate Urn Fountain Kit **147**  
 Smart Control App **45, 46, 48, 56, 84, 85**  
 Smart Control Hub **72, 73, 74**  
 Smart Control Plug **84, 85**  
 Smart Control Receiver **45, 46, 48, 56**  
 Smart Pond Dosing System Controller Add-On Kit **92**  
 Smart Pond Dosing System XT **92**  
 Smart Pond Thermometer **114**  
 Smart Pond Thermometer with Transformer **114**  
 Snorkel® **41**

- Large Snorkel® Vault and Cap **41**
- Large Snorkel® Vault Extension **41**

 Spillway Basin **135, 148, 149, 165**  
 Spillway Bowl **23, 135, 148, 149, 164**  
 Spillway Bowl and Basin **21, 23**  
 Spillway Bowl, Basin, and Stand **4, 148, 149**  
 Stacked Slate Sphere **4, 21, 23, 136**  
 Stacked Slate Spheres **146**  
 Stacked Slate Urn **21, 22, 136**  
 Stacked Slate Urns **146, 147**  
 Stacked Slate Wall **23**  
 Stainless Steel Fire Pan Cover **139**  
 Statuary Water Pump **62**  
 Stone Basalt Columns **132, 151**  
 Stone Basalt Fountain Kit **24**  
 Straight Stacked Slate Walls **144**  
 Submersible Pond Thermometer **114**

**T**

Transformers **86**  
 Tumbled Lava Stones **138, 168**

**U**

Ulcer & Bacterial Treatment **122**  
 Ultra 550 Water Pump **21**  
 Ultra 800 Water Pump **21**  
 Ultra 1100 Water Pump **22**  
 Ultra 1500 Water Pump **23**  
 Ultra 2000 Water Pump **22, 23, 24**  
 UltraKlean Pond Filter Kits **37**

- UltraKlean 1500 Kit **37**
- UltraKlean 2500 Kit **37**
- UltraKlean 3500 Kit **37**

 UltraKlean Pond Filters **36**

- UltraKlean 2000 **36, 37**
- UltraKlean 3500 **36, 37**

 UltraKlear UV Clarifier **35**

- UltraKlear 1000 **35**
- UltraKlear 2500 **35**
- UltraKlear 5000 **35**

 Ultra Pump Fountain
 

- Large Ultra Pump Fountain Head Kit **60**
- Small Ultra Pump Fountain Head Kit **60**

 Ultra Water Pump **20, 60, 61**  
 Underlayment **172**  
 Universal Remote for Adjustable Flow Pumps **46, 48, 56**  
 U-Shaped Ground Stakes **116**

**W**

Warm White Lights **78, 79**

- 1-Watt Spotlight **79**
- 1-Watt Spotlight 6-Pack **79**
- 1-Watt Waterfall Light **79**
- 1-Watt Waterfall Light 6-Pack **79**
- 3-Watt Spotlight **79**
- 3-Watt Spotlight 6-Pack **79**
- 6-Watt Spotlight **79**
- 6-Watt Spotlight 6-Pack **79**
- Fountain Light **74, 80**
- Fountain Light Kit with Transformer **80**

 Waterfall & Rock Cleaner Professional Grade **107**  
 Waterfall Spillway **14, 15, 17, 18, 19, 38, 189**  
 Water Feature Basins **140, 141**  
 Water Fill Valve 200 **180**  
 Water Fill Valves **180**  
 Water Storage Kits **188**  
 Weighted Aeration Tubing **70**  
 Weighted Aeration Tubing 3/8" x 100' **70**  
 Wetland Pond & Lake Bacteria Professional Grade **106**  
 WFV Poly Pipe Roll **181**  
 Woven Microgrid Geotextile **174**

**X**

XT Water Treatments **93**



# Inspiration & Education

Learn more about water features and Living the Aquascape Lifestyle®



Shop on Our  
Website



Follow Us on  
Facebook



Watch Us on  
YouTube



Follow Us on  
Instagram



Get Inspired on  
Pinterest



Pondside  
E-Newsletter



Aquascape Lifestyles  
E-Magazine



Greg Wittstock, The Pond Guy



TEAM Aquascape



Ed The Pond Professor



901 Aqualand Way • St. Charles, IL 60174  
Toll Free: (866) US-PONDS or (866) 877-6637  
support.aquascapeinc.com  
Email: emails@aquascapeinc.com

1200 Creditstone Rd., Unit 1  
Concord, Ontario L4K 5T2  
Toll Free: (866) 766-3426  
Email: customerservicecanada@aquascapeinc.com