

From: "Advances in Discrete and Computational Geometry", B. Chazelle, J.E. Goodman and R. Pollack, eds., Contemporary Mathematics vol. 223(1999). AMS, Providence, RI. Pp.163 - 199.

Branko Grünbaum:

## ACOPTIC POLYHEDRA<sup>1</sup>

**Abstract.** Acoptic polyhedra are polyhedra in 3-space, with simple polygons as faces and with no selfintersections. These polyhedra are generalizations of convex polyhedra, and present a variety of interesting properties and open problems. Among the most challenging is the "general realizability conjecture," according to which every cell-complex decomposition of an orientable 2-manifold (satisfying some natural conditions) is isomorphic to an acoptic polyhedron. The known partial results on this conjecture are given. Definitions and concepts that may be useful in future studies are presented, together with a variety of illustrative examples and additional open questions.

### 1. General introduction.

The theory of convex polytopes has had a phenomenal flowering during the last fifty or so years, and is at present a mature field<sup>2</sup>. Hence it seems to be the appropriate time to start the systematic study of more general, not necessarily convex, polyhedra and polytopes.

There are many reasons for such activity:

(i) The collection of objects to be studied is vastly greater and more interesting if not restricted by requiring convexity. In particular, such polyhedra can be used to model a variety of orientable and non-orientable maps in a visually accessible manner.

(ii) Convexity is not essential for many results in the formulation of which it is assumed. But regardless of whether a certain property characterizes convex polyhedra or not, the investigation of its range of applicability is bound to produce new insights. Is convexity just a convenient assumption, which makes it possible to carry out

---

<sup>1</sup> Research supported in part by NSF grant DMS-9300657. Many of the new results and insights presented were obtained in long-term collaboration with G. C. Shephard, but the author alone is responsible for the views and statements formulated in the paper.

<sup>2</sup> An attractive and up-to-date introduction to this topic is Ziegler's book [Z1].

a certain proof, or do there exist some limitations on the validity of the theorem in the nonconvex case; if so — what are the limitations, and what happens if they are exceeded?

A good example of such developments is Cauchy's uniqueness theorem for convex polyhedra, which implies the rigidity of cardboard models<sup>3</sup>

. It has been known for more than two centuries that the uniqueness theorem does not hold if nonconvex polyhedra are admitted. However, in the class of polyhedra without selfintersections, Cauchy's theorem is valid not only for convex polyhedra, but for some nonconvex ones as well; how can these polyhedra be characterized? How can polyhedra with only a finite number of realizations be characterized? What is the relation between the maximal number of distinct realizations and the number of faces or vertices? Continuously movable polyhedra without selfintersections are known<sup>4</sup>, but there is no characterization or even a general way of generating such polyhedra. The exciting "bellows conjecture" that the volume enclosed by a movable polyhedron is constant has just been decided<sup>5</sup>. Still unsolved is the question whether the space of realizations of a movable polyhedron is always simply connected<sup>6</sup>.

(iii) Many interesting families of polyhedra form continua which are not inherently limited to convex polyhedra. A simple example of this possibility is shown in Figure 1; additional illustrations are furnished by the isogonal polyhedra discussed in Section 7.

(iv) If duality or polarity of polyhedra are to be concepts applicable to even mildly nonconvex polyhedra (such as those with convex faces and no selfintersections), one has to admit polyhedra with selfintersections, and even polyhedra

---

<sup>3</sup> Cauchy's proof appeared in [C1]; it was reproduced in some editions of Hadamard's well-known geometry text [H2], but excluded from other editions because of flaws in the proof as noted by Hadamard [H1] and Steinitz [S11]. Partial correction of a minor flaw in the proof of the combinatorial lemma can be found in Lebesgue [L2]. A complete proof appears in Steinitz-Rademacher [S12], as well as in the books of Aleksandrov [A2] and Lyusternik [L5]. For other proofs see [H6], [S14]. Simplifications of Steinitz's proof of the geometric lemma are given in [E2] and [S4].

<sup>4</sup> See the descriptions of such polyhedra in Connelly [C2], [C3], Kuiper [K1], Aleksandrov [A3]; selfintersecting movable polyhedra have been known for more than a century, see Bricard [B18], Lebesgue [L3]. Various aspects of rigidity and uniqueness are discussed in Crapo-Whiteley [C9], Connelly [C5], Sabitov [S1], Maksimov [M1].

<sup>5</sup> See the discussions of the conjecture in Connelly [C4], Sabitov [S2], Aleksandrov [A3]; the solution appears in Connelly *et al.* [C6].

<sup>6</sup> It is known that in the case of the selfintersecting movable octahedra of Bricard the realizations space is not simply connected, see [B22].

with selfintersecting faces<sup>7</sup>. In fact, one is forced to go to the very general definitions in order to have consistent and usable concepts. This is the topic of a paper in preparation.

In each of this directions, any results that are obtained yield also additional understanding of convex polytopes or polyhedra.

In recent years papers discussing various aspects of polyhedra more general than the convex ones have started appearing in increasing numbers. However, no general framework is available, and the last attempt to give a comprehensive survey of such more general polyhedra was in Brückner's well known book [B20], almost a whole century ago! As any critical reading shows, Brückner failed to make the basic definitions consistent<sup>8</sup>, is woefully incomplete concerning the topics he discusses, and has probably greatly contributed to the long-lasting neglect of the whole field by the mathematical community. The present paper overlaps several recent surveys<sup>9</sup>, which the reader may wish to consult for additional references and for different views on various questions.

When attempting to give an overview of the available information on these polyhedra, two basic facts need to be taken into account at the outset:

(1) At this time there is no experience, and no experimental material, to guide the formulation of a reasonable program of investigation in dimensions higher than 3.<sup>10</sup> Hence the thrust of the present exposition is confined to polyhedra in Euclidean 3-space  $\mathbb{E}^3$ .

(2) There are many different classes of polyhedra that make reasonable topics of investigation.<sup>11</sup> They differ not only by the hierarchical level of generality considered, but also by the point of view regarding what is a polyhedron. In some contexts polyhedra are best interpreted as "solids"; this is also the traditional approach,

---

<sup>7</sup> For a discussion of problems in this context, and the inadequacy of the "folk wisdom" regarding duality, see [G16].

<sup>8</sup> Details concerning the inconsistencies and other shortcomings of Brückner's book [B20] are given in [G10], [G11].

<sup>9</sup> Particularly near to the topics discussed here is the work of Brehm and Wills [B17]. Their polyhedral manifolds are essentially the same as our AC-polyhedra. See also Martini [M2], Brehm and Schulte [BrS].

<sup>10</sup> Nearly the only exception are investigations concerning regular polytopes of various degrees of generality and abstraction; for a guide to this literature see, for example, Coxeter [C7], Johnson [J6], McMullen-Schulte [M4].

<sup>11</sup> See, for example, Cromwell [C10] for a survey of the various kinds of polyhedra and their history.

going back to antiquity. Examples of such interpretations can be found in works on the *stellation* and *facetting* of various regular or other polyhedra<sup>12</sup>, in the studies of polyhedral scenes<sup>13</sup>, and in investigations of the "convex ring"<sup>14</sup>. In other situations, it is most appropriate to consider polyhedra as surfaces built up from simple planar polygons, or else, to consider them as built up from planar polygons but interpreting these not as patches of the plane but as collections of straight-line segments some of which may intersect each other<sup>15</sup>. For convex polyhedra these different points of view essentially coalesce, due to the famous Steinitz Theorem<sup>16</sup>.

We are concentrating on the latter type of interpretations, and in Figure 9 we illustrate the differences that arise from this distinction. As we go along, we introduce several specific classes of polyhedra, with appropriate terminology and notation. We hope that this will facilitate the development of the field, and that the various open problems and conjectures will present tempting challenges.

In order to avoid excessive length, we discuss here only polyhedra we call **acoptic**, that is polyhedra with no selfintersections (including no selfintersecting faces). Precise definitions are given below. Certain aspects of more general polyhedra, with selfintersections allowed, have been discussed in [G10] and [G11], but much additional work remains to be done.

One of the obstacles encountered already in the study of acoptic polyhedra, and with even stronger effect if the polyhedra have selfintersections, is the problems of

---

<sup>12</sup> Stellations of polyhedra are discussed, among others, by Wenninger [W2], [W3], Hudson and Kingston [H7], and Messer [M8]; the latter contains many references to other relevant books and papers. For facetting see, for example, Bridge [B19].

<sup>13</sup> See, for example, Shirai [S9].

<sup>14</sup> Introduced by Hadwiger [H3], for more recent accounts see McMullen-Schneider [M3]; see also [G18] for related material.

<sup>15</sup> Even more general types of polyhedra, in which the faces are polygons that need not be planar, have been considered (and may find applications in crystallography and other fields); we shall not deal with them here. For some points of view and various results about these polyhedra see, for example, Grünbaum [G8], Dress [D1], [D2], Burt [B21], Molnár [M11], Farris [F1], [F2], McMullen and Schulte [M5]. In the terminology of Grünbaum [G10, page 50], the present exposition is restricted to *epipedal* polyhedra, that is, polyhedra in which each face is a planar polygon.

<sup>16</sup> First announced in [S11, page 77], with several different detailed proofs in [S12]. However, these expositions are written in quite cumbersome form, and the result has remained not widely known for a long time. It appears in Lyusternik [L5], but the proof there is deeply flawed, ignoring the depth of the required arguments. One of Steinitz's proofs appears in [G5]; additional proofs of the result are given in [B8] and [Z1].

visualization. A perusal of this paper shows the use of several methods of presentation, but it must be admitted that none is quite satisfactory for any but the simplest situations. It is to be hoped that computer-based modes of presentation will alleviate this difficulty in the near future.

Even with the limitation to acoptic polyhedra, it has been necessary to exclude many topics which fit the aim of the paper. These will be discussed in other venues. The paper is organized as follows. Acoptic polyhedra, and some other concepts, are defined and illustrated in Section 2, which proposes a terminology for the subject. Sections 3, 4 and 5 are devoted to results on the realization of various maps by polyhedra, while more general questions of realizability are considered in Section 6. Isogonal polyhedra and their dynatograms and panoramas are the subject of Section 7. In Section 8 we discuss the known results on monohedral polyhedra, while the concluding Section 9 is concerned with spanning trees in the graphs of polyhedra.

## 2. Acoptic polyhedra, and some general considerations.

To judge from all appearances and experience, there is no single class of polyhedra that deserves to be considered as *the* general kind deserving investigation. Different levels of generality are appropriate in different situations. This is no problem in itself, but in order to avoid difficulties and misunderstandings, precise definitions and terminology are required. Without pretending that the following are more than possibly suitable categories of polyhedra, here are several definitions.

To begin with, we consider polyhedra as certain collections of **planar, compact, simply-connected polygonal regions**; the boundary of such a region is called a **simple polygon** and the region itself is referred to as a **face** of the polyhedron. A simple polygon consists of a finite number of line segments of positive length (the **edges** of the polygon); the endpoints of the edges are the **vertices** of the polygon. Each vertex of a polygon belongs to precisely two edges (said to be mutually adjacent), and the edges form a simple circuit (Jordan polygon). It should be noted that we made no assumption of convexity, and that edges (adjacent or nonadjacent) may be collinear; examples may be seen below, in Figure 2. For brevity, we call faces, edges and vertices of a polyhedron its **elements**.

In general, the conditions under which a finite collection of polygons (as described above, or of some other type) is called a **polyhedron** are:

- (P1) each edge is shared by precisely two faces;

(P2) all faces containing a given vertex form a single circuit of at least three faces; and

(P3) no proper subfamily has both these properties.

In most cases, we find it convenient to restrict the polyhedra considered by imposing additional conditions. The following are examples of such restrictions. They determine the **acoptic** polyhedra (from Greek *acoptos*, uncut) which are the main topic of this report, and several of their subclasses.

A polyhedron is **acoptic**<sup>17</sup> if

(P4) the faces are simple polygonal regions; and

(P5) the relative interiors of its elements are disjoint.

This definition does not preclude the possibility that distinct faces (contiguous or not) are coplanar, and that two faces have several common edges and/or vertices. It implies that the polyhedron has a well-defined bounded **interior**, and an unbounded **exterior**. It also implies that the polyhedron is homeomorphic to a **cell-decomposition**<sup>18</sup> (or **map**)  $C(P)$  of a compact, orientable 2-manifold  $M(P)$ ; the vertices, edges and faces (countries) of the map  $C(P)$  are in bijective correspondence with those of  $P$ , hence we may say that  $P$  and  $C(P)$  are **combinatorially equivalent**. (Two polyhedra or maps are called *combinatorially equivalent*, or of the same *combinatorial type*, provided there exists an incidence-preserving bijection between their sets of vertices, edges, and faces.) We also say that  $P$  is a **realization** of  $C(P)$ ; in fact, it is an imbedding of  $C(P)$  in the Euclidean 3-space  $\mathbb{E}^3$ .

---

<sup>17</sup> The meaning of the word "acoptic" as used here differs from the usage in [G10], [G11]. The earlier concept corresponds to "weakly acoptic", as defined below.

<sup>18</sup> A cell-complex decomposition of a 2-manifold  $M$  is a finite collection of closed topological disks ("faces") whose union is  $M$ , with each two faces meeting in at most a finite number of arcs ("edges") and singleton points, each disk meeting at least three other disks along edges, and no two edges having coinciding endpoints ("vertices"). This definition is more general than the one in [G5], where the disks were assumed to be convex; this latter has been used by many other authors. However, the present definition is more restrictive than the usual topological concept. The prohibition of multiple edges between the same pair of vertices excludes some maps which are acceptable in the topological literature. This condition also shows that (with this interpretation) there is no duality possible among the cell-decompositions of a 2-manifold, since there is no prohibition of two faces having more than one edge in common. Duality can be restored only by allowing much more general cell complexes. In this context, the examples and discussion in [G16] are instructive. It should be noted that some authors use "*polyhedral map*" for the different concept of a cell-decomposition of a 2-manifold in which there is no assumption that the faces are polygons, but only that any two meet in either a common arc, or a common point or not at all. See, for example, Pulapaka and Vince [P1].

We come now to several other conditions imposed frequently on polyhedra. For obvious reasons, a polyhedron is said to be **convex-faced** if

(P6) each face is a convex polygon.

A polyhedron is called **conservative** if

(P7) distinct elements have distinct affine hulls.

An acoptic polyhedron is **strictly acoptic** if

(P8) there are no overarching elements<sup>19</sup>.

The class of convex-faced conservative acoptic polyhedra is the most-studied type of polyhedra more general than the convex ones.<sup>20</sup> Obviously, convex polyhedra are acoptic polyhedra which are convex-faced, conservative, and for which the associated 2-manifold is a sphere. Conversely, by Steinitz's Theorem, acoptic polyhedra with these properties are combinatorially equivalent to convex polyhedra. While the combinatorial types of "small" convex polyhedra have been enumerated to the limits of feasibility (see, for example, Federico [F3]), essentially nothing is known regarding the number  $t(f)$  of combinatorial types of acoptic polyhedra with  $f$  faces that are not realizable by convex polyhedra. It is easy to see<sup>21</sup> that  $t(f) = 0$  for  $f \leq 5$ , and  $t(6) = 3$  (see Figure 3), but already  $t(7)$  is not known with certainty. The only publication I am aware of with some information on the numbers  $t(n)$  is Gardner [G2, pp. 32, 77]. Gardner states<sup>22</sup> that  $t(7) = 26$  and  $t(8) = 277$ . It is not clear what these numbers are expressing; no class I could think of yields these values. With the definitions adopted here, I find that  $t(7) = 17$ ; the 17 types are shown in Figure 4. On the other hand, for other classes of polyhedra, or under some other classification principles, the number of types changes, see Figures 5 to 9. A decision concerning what constitutes convenient distinctions between polyhedra seems to depend in an essential way on the context. However, it is appropriate to formulate here as a major open question the following:

---

<sup>19</sup> A cell complex or polyhedron has *overarching elements* if it contains two vertices and two faces that are mutually incident but are not all incident with one edge. The three polyhedra in Figure 3 have overarching elements; the Kepler-Poinsot regular polyhedra  $\{5, 5/2\}$  and  $\{5/2, 5\}$  have overarching elements as well. Convex-faced acoptic polyhedra are automatically free of overarching elements. Other formulations of this condition can be found in [B4].

<sup>20</sup> Hajós and Heppes [H4] describe the construction of conservative polyhedra  $P$  with the following startling property: every vertex of  $P$  is exposed (that is, there is a supporting plane of  $P$  which intersects  $P$  at this vertex only) and every supporting plane of  $P$  meets  $P$  at vertices only.

<sup>21</sup> See Norgate [N2], where nonacoptic pentahedra are investigated as well.

<sup>22</sup> Gardner [G2] gives no reference for these results, nor a definition of the polyhedra whose types he counts.

**Enumeration problem.** Determine — at least for small  $n$  — the possible combinatorial types of acoptic polyhedra with  $n$  faces (or with  $n$  vertices). More specialized enumerations, such as those of conservative, or simple, or simplicial polyhedra, or by the genus of the associated map, would also be of interest.

A convex-faced acoptic polyhedron in which all vertices are convex is itself convex. It follows that every acoptic polyhedron of positive genus must have a nonconvex vertex<sup>23</sup>. The question how many such vertices must be present in convex-faced polyhedra of various kinds was investigated by several authors; the most inclusive results are those of Betke and Gritzmann [B10]. In this paper it is shown that every convex-faced acoptic polyhedron of positive genus must have at least five nonconvex vertices, and that for every positive genus there is such a polyhedron with precisely five nonconvex vertices.

For classifications of polyhedra finer than by combinatorial type it is convenient to distinguish three possible types of edges. An edge  $E$  of an acoptic polyhedron  $P$  is said to be **convex** (resp. **flat**, **concave**) if the dihedral angle of the two faces of  $P$  that contain  $E$ , measured in the interior of  $P$ , is less than  $\pi$  (resp. equals  $\pi$ , is greater than  $\pi$ ). Edges  $E, E'$  of polyhedra  $P, P'$  have the same **convexity character** if both are convex, or both flat, or both concave. Polyhedra  $P, P'$  are **isomorphic** (or have the same **isomorphism type**) if there is a map establishing  $P$  and  $P'$  as combinatorially equivalent, such that corresponding edges have the same convexity character. An example of combinatorially equivalent but nonisomorphic polyhedra is shown in Figure 6. Polyhedra  $P, P'$  are **equiform** if they are isomorphic and there exists a continuous family  $P(t)$ ,  $0 \leq t \leq 1$ , of polyhedra isomorphic to  $P$ , such that  $P(0) = P$  and  $P(1)$  is congruent to  $P'$  or the mirror image of  $P'$ . An example of isomorphic but not equiform polyhedra is shown in Figure 7. Analogous examples can easily be constructed with acoptic polyhedra of genus 1, but we conjecture that isomorphic acoptic polyhedra of genus 0 are equiform. The analogous result is known to be valid for polygons, see [G7]. These concepts can be refined further; we say that two equiform polyhedra are *symmetrically equiform* if they, and all the polyhedra involved in the isotopy connecting them, have the same symmetry group. The polyhedra in the continuous family in Figure 1 are symmetrically equiform, but the example in Figure 8 shows that symmetric equiformity is more restrictive than equiformity.

---

<sup>23</sup> A vertex  $V$  of an acoptic polyhedron  $P$  is **convex** provided there is a neighborhood  $N$  of  $V$  such that the plane of every face incident with  $V$  is a supporting plane of  $N \cap V$ ; in other words, if the 2-manifold  $P$  is locally convex at  $V$ .



When attention is restricted to convex polyhedra, combinatorial equivalence is a useful equivalence relation. Although it is too coarse an equivalence to be very useful in the more general context of acoptic polyhedra, it is sufficient in certain contexts which occupy us first. The more detailed classifications just described, various levels of which may be appropriate in different situations, are considered in some specific cases later.

For polyhedra of any particular class, two kinds of general constructions are often used. In one construction, limits of sequences of polyhedra of the same combinatorial type are taken, with convergence in the Hausdorff metric. This can be interpreted in two ways. If — as is often customary — the polyhedra are considered just as polyhedral sets of points, ignoring the combinatorial structure they possess, then the class of convex polyhedra is closed under such limits (if subdimensional limit sets are included)<sup>24</sup>. However, a much more interesting concept arises if the convergence is understood as requiring that the mutually corresponding elements form convergent sequences, and the limit is considered as having the same combinatorial type as the terms of the sequence. In case the class under consideration is that of convex polyhedra, the resulting limits form the **weakly convex polyhedra**. An example of such a polyhedron is shown in Figure 10; other examples appear in Figure 15 and in Figure 18 (for  $a = 0$ , or  $b = 0$ , or  $a = b$ ). In case the point-sets of two polyhedra coincide, we shall say that they are **isomegetic**<sup>25</sup>.

If the class of polyhedra whose limits are taken is that of acoptic polyhedra, the resulting limit polyhedra are **weakly acoptic**. Examples of weakly acoptic but not acoptic polyhedra are shown in Figure 5. Weakly acoptic polyhedra can be interpreted as images of cell decompositions in which distinct vertices may be represented by the same point, edges may have zero length, relative interiors of elements may have nonempty intersection, and various other coincidences are possible. However, if the relative interiors of two faces (or a face and an edge, or two edges) of a weakly acoptic polyhedron intersect, the two elements must be coplanar. A different, direct definition of weakly acoptic polyhedra (called there "acoptic") was given in [G10] and [G11].

The second general question of interest in connection with any given class of polyhedra is whether the class admits **duality**<sup>26</sup>. It is well known that the class of

---

<sup>24</sup> The numbers of elements of the limit polyhedron may be smaller than for the terms of the sequence; see [E3] for a discussion of the lower semicontinuity of the numbers of elements.

<sup>25</sup> From Greek μέγεθος — extent, bulk.

<sup>26</sup> Two polyhedra are *duals* of each other if there exists an incidence-reversing bijection between their sets of elements.

convex polyhedra is, in fact, closed under duality. For a satisfactory duality among more general acoptic polyhedra one would wish to have corresponding edges (or all corresponding elements) exhibit the same convexity character. For example, isogonal icosahedra (such as the one shown in Figure 11(a), which has been considered by Jessen [J5]) are dual in this sense to the isohedral dodecahedra (such as the one in Figure 11(b), described in [O1] and [S13], and more generally in [G17]). Many pairs of dual acoptic polyhedra can be found such that a dual correspondence between their elements is more or less satisfactory from the point of view of their convexity character. However, no general framework for examples of this kind has been proposed, and it is doubtful that it exists. The only consistent approach to duality of (acoptic, or more general) polyhedra is via **polarity**. However, as shown in Grünbaum-Shephard [G16], with this construction the duals of acoptic polyhedra are often nonacoptic. This fact is one of the reasons for the desirability of considering more general concepts of polyhedra. We shall expand on this topic in a separate note.

One other problem that arises in connection with the concepts introduced above is finding characterizations of each class of polyhedra through orientable maps  $C$  homeomorphic to  $C(P)$  for some polyhedron  $P$  in the class considered. For example, the famous theorem of Steinitz characterizes convex polyhedra as combinatorially equivalent to spherical maps with 3-connected graphs. Many of the results discussed below can be considered as giving support to the following conjecture<sup>27</sup>, which seems rather preposterous, but nevertheless is still undefeated.

**General Realizability Conjecture.** Every cell-complex decomposition, without overarching elements, of any compact orientable 2-manifold is realizable by a strictly acoptic polyhedron.

While a proof of the General Realizability Conjecture would characterize strictly acoptic polyhedra, at present time there is no analogous conjecture attempting to characterize the class of all acoptic polyhedra, or the subclasses consisting of those that are convex-faced, or convex-faced and conservative. Also, there is no proposed characterization of weakly acoptic polyhedra, or of weakly convex ones.

---

<sup>27</sup> Variants of this conjecture were first proposed in several talks I gave in the mid-1980's. A formulation was also included in a manuscript [G15], several copies of which were privately circulated; however, this paper was never submitted for publication since major parts of it were rendered obsolete by other developments. The conjecture was also mentioned by Barnette *et al.* [B7], and Ljubic' [L4].

**3. Realizations of triangulations by acoptic polyhedra.** Restricted to triangulations of 2-manifolds, the General Realizability Conjecture appears to have been first formulated in [G5, p. 253]<sup>28</sup>. Clearly, in this case any acoptic polyhedron realizing the triangulation is automatically convex-faced and, using admissible perturbations, may be assumed conservative as well. It should be stressed that despite several attempts to establish the conjecture at least for triangulations of the torus, even this special case is still undecided. The first examples of triangulations of the torus seem to go back to Möbius [M10] and Reinhardt [R2], but it is not clear exactly what kinds of polyhedra they had in mind -- whether combinatorial, topological or geometric. Császár [C11] described a realization by an acoptic polyhedron of the 7-vertex triangulation of the torus (which is a neighborly polyhedron). Other triangulated tori realized by acoptic polyhedra were described by Altshuler [A4], [A5]. Various toroidal acoptic polyhedra were described by Alaoglu and Giese [A1]; their results and other works concerning polyhedra of positive genus that have certain regularity properties are discussed in more detail in Section 8.

One approach to the proof of the realizability conjecture for triangulations<sup>29</sup> of the torus is by first showing that there is a finite number of "irreducible" triangulations, then finding acoptic realizations of these maps, and finally showing that if one can realize by an acoptic polyhedron a triangulation resulting by a "reduction" of a given triangulation, then the given triangulation can be realized by an acoptic polyhedron as well. The first step, in which a triangulation is called **irreducible** if the contraction of any edge results in a complex which is not a map in the sense used here, has been carried out repeatedly. Independently of each other, this enumeration was carried out in the early 1970's by R. A. Duke and the present author, by D. W. Barnette, and at a later time by S. A. Lavrenchenko; only Lavrenchenko published the list of the 21 irreducible triangulations, see [L1]. These irreducible triangulations are shown in Figure 12<sup>30</sup>. The

---

<sup>28</sup> Various aspects of the triangulations case of the General Realizability Conjecture have been discussed, among others, by Altshuler [A4], [A5], Barnette [B4], Duke [D3], and Reay [R1]; many additional references can be found in these papers. Certain cases in which triangulations of the torus can be realized by an acoptic polyhedron are presented in [A4], [A5].

<sup>29</sup> Another approach, mentioned in [G5, p.253] in connection with the triangulation of the torus with 7 vertices, finds the given map as a subcomplex of the 2-skeleton of a convex 4-polytope, and obtains an imbedding in 3-space by considering the Schlegel diagram of the polytope. For elaboration of this approach see [D3], [A6] and the references given there.

<sup>30</sup> The statements in Barnette [B4] and Schipper [S3] that there are 24 resp. 22 such triangulations are erroneous.

feasibility of the second step is also known. However, the last step has so far resisted all attempts at proof.

In analogy to the first step above, Barnette and Edelson [B5], [B6] showed that **every** 2-manifold has only finitely many irreducible triangulations; Nakamoto and Ota [N1] showed that the number of vertices in any irreducible triangulation of a 2-manifold  $M$  is bounded from above by a linear function of the Euler characteristic of  $M$ . Algorithmic aspects of this result have been considered by Schipper [S3].

For triangulations of 2-manifolds of genus greater than 1 only a few specific instances have been decided, by the construction of appropriate polyhedra. In particular, acoptic polyhedra that realize triangulations of orientable 2-manifolds of genus 2, 3, and 4 having the minimal possible number of vertices<sup>31</sup> (10, 10, and 11, respectively) have been obtained by Brehm [B14], [B15] and by Bokowski and Brehm [B11]<sup>32</sup>. The minimal triangulations of the 2-manifolds of genus 5 and 6 have 12 vertices (in particular, for genus 6 the graph is the complete 12-vertex graph), but so far no realizations by acoptic polyhedra have been reported. Since the number of vertices of minimal triangulations of 2-manifolds of genus  $g$  grows only as  $\sqrt{g}$ , for sufficiently high genus if a realization by an acoptic polyhedron exists it will have more "holes" than vertices<sup>33</sup>. This was often deemed as an unlikely situation, leading to expressions of disbelief in the existence of such realizations<sup>34</sup>. However, this argument is invalid; in fact, McMullen, Schulz and Wills [M6] constructed acoptic polyhedra of genus  $g$  with  $O(g/\log g)$  vertices. Their smallest example showing the possibility of genus exceeding the number of vertices occurs for  $g = 577$ , with 576 vertices.

**4. Realizations of toroidal quadrangulations and other maps by acoptic polyhedra.** Realizations by acoptic polyhedra of certain cell-complex decompositions of the torus into quadrangles, or into hexagons, have been described already by Becker [B9] (see also Brückner [B20, p 221]). Realizations of toroidal maps without overarching elements by convex-faced conservative acoptic polyhedra were considered by Simutis [S7]; see also [B4]. Among other results she showed that various classes of

---

<sup>31</sup> According to Ringel and Youngs [R3], the minimal number of vertices in a triangulation of an orientable 2-manifold of genus  $g$  equals the least integer  $\geq (7 + \sqrt{48g + 1})/2$  if  $g \neq 2$ , and 10 if  $g = 2$ .

<sup>32</sup> For information about maps having complete graphs as their 1-skeleton see [A7].

<sup>33</sup> The first case in which this happens is  $g = 20 > 19 =$  number of vertices in a minimal triangulation of the manifold of genus 20.

<sup>34</sup> For example, in Schulz [S6].

toroidal maps can be realized by such polyhedra, while other maps cannot be realized under these restrictions. However, many of Simutis' unrealizable examples are obtained by face-splitting from realizable maps, and hence can be realized if the polyhedra are not required to be conservative<sup>35</sup>. In other cases in which Simutis shows that the map is not realizable, no convex-faced acoptic polyhedron — conservative or not — can realize the map. This includes, in particular, the well-known 3-valent toroidal map of 7 hexagons<sup>36</sup>, and the 9-quadrangles map shown in Figure 13 (the "twisted triangular picture frame"); however, both maps are realizable by acoptic polyhedra which have some nonconvex faces. For realizations of the former map, found by Szilassi, there are illustrations in several publications<sup>37</sup>. In contrast, it seems that no illustration is available in the literature of the Ljubic' torus [L4], which is a realization of the latter map and was described by Ljubic' at a regional meeting of the AMS in 1987; one version of the Ljubic' torus is shown in Figure 13.

There are many quadrangulations and other cell-decompositions of the torus for which the existence of a realization by an acoptic polyhedron is undecided. Three small maps of this kind, which are prime candidates for counterexamples for the General Realization Conjecture, are shown in Figure 14.

**5. Realizations of regular maps by acoptic polyhedra.** For **regular maps**<sup>38</sup> on the torus it was shown by Schwörbel [S7] that every such map is realizable by an acoptic polyhedron; this is especially remarkable for the maps consisting of quadrangles, and of hexagons. Two special cases are presented in [S8].

It is known that for every  $p \geq 3$  and  $q \geq 3$  there exist regular maps with  $p$ -gonal faces and  $q$ -valent vertices<sup>39</sup>. According to a private communication from Prof. S. E. Wilson, such regular maps exist even if one requires them to be without overarching elements. The General Realizability Conjecture implies that all such maps can be

---

<sup>35</sup> This applies, in particular, to the examples in Figures 16 and 18 of [S10].

<sup>36</sup> 3-valent maps can be realized by convex-faced acoptic polyhedra only if they are of genus 0, see [G5, p. 206], [B4]. For far-reaching generalizations of this observation see [B7] and the references given there.

<sup>37</sup> See, for example, Gardner [G1], Stewart [S13], Szilassi [S15].

<sup>38</sup> A map (cell decomposition) or polyhedron is **regular** if the group of its combinatorial automorphisms acts transitively on its **flags**, where each flag is a triplet consisting of a vertex, an edge, and a face, all mutually incident.

<sup>39</sup> This conjecture from [G9] has been proved by Vince [V1] and Wilson [G3].

realized by acoptic polyhedra. Unfortunately, a proof of such a far-reaching generalization of Schwörbel's results appears unlikely in the near future.

For an account of the known other cases in which a regular map is realized by a convex-faced acoptic polyhedron, or by an acoptic polyhedron, and for references to the original papers, see Bokowski and Wills [B12], Brehm and Wills [B17], Schulte and Wills [S5], and their references. The list of such maps is quite short. Specifically, convex-faced acoptic realizations are known for:

- (i) The triangulations of genus 3 usually denoted  $\{3,7\}_8$  and  $\{3,8\}_6$  and named after Klein and Dyck, respectively.
- (ii) Quadrangulations (of valences 6 and 8) usually denoted  $\{4,6 \mid 3\}$  and  $\{4,8 \mid 3\}$ , which are most easily visualized as "thickened" versions of the 1-skeleton of the Schlegel diagram in 3-space of the regular 4-simplex and the regular 24-cell; their genera are 6 and 73. In suitable realizations these have the full tetrahedral resp. octahedral groups as symmetry group.<sup>40</sup>
- (iii) The two maps  $\{6,4 \mid 3\}$  and  $\{8,4 \mid 3\}$  dual (as maps) to the ones in (ii).
- (iv) An infinite family of maps  $\{4,k \mid 4^{\lfloor p/2 \rfloor - 1}\}$  for  $k \geq 4$ , of genus  $1 + (k-4)2^{p-3}$ , constructed in [M6] and [M7], and their dual maps.
- (v) A realization of the well-known Fricke-Klein map  $(3,8)_{12}$  of genus 5 by an acoptic isogonal polyhedron is described below and shown in Figure 19.

**6. Acoptic polyhedra with prescribed face-vectors or f-vectors.** The General Realization Conjecture and related approaches to other classes of polyhedra aim at a very detailed description of possible combinatorial types. A coarser classification is provided by Eberhard-type theorems, which have been investigated for convex polyhedra for over a century<sup>41</sup>. These results deal with realizations by polyhedra of a given class of sequences that specify the number of  $k$ -gonal faces (or  $k$ -valent vertices) for various values of  $k$ . The basic restrictions on the sequences involved usually stem from the

---

<sup>40</sup> As pointed out by Prof. J. M. Wills, acoptic realizations with full icosahedral symmetry group have not been found for any regular map. Possibly, none exist.

<sup>41</sup> The first results are those of Eberhard [E1], dealing with convex polyhedra. For a more accessible presentation of Eberhard's results see [G5]. The topic has had (and continues to have) many extensions, specializations and related developments; for some of these see [G19], [J1], [J4] and the references given there. It is interesting to note that the constructions used by Eberhard have recently been rediscovered by chemists investigating the "Fullerene" forms of carbon; see, for example, Fowler and Redmond [F4] and the references given there.

Euler relation (and, in some cases, from more specific constraints); in many cases, the difficult part is the construction of the polyhedra.

In more recent times the topic also attracted interesting extensions to convex-faced acoptic polyhedra of positive genus, see [J2], [J7], [J3], [G4]. There seem to have been no corresponding examinations of the case in which other classes of acoptic polyhedra are admitted. However, there has been considerable work done on the question of realization of even coarser data sets. In particular, investigations that dealt with the realization by convex-faced acoptic polyhedra of the **f-vectors** (whose components are the numbers of elements of different dimensions of the polyhedron in question) or some other global characteristic (such as the **valence-functional**<sup>42</sup>) have led to very interesting results. Concerning the latter, we mention here only the following result from [B7]:

If  $P$  is a convex-faced acoptic polyhedron of genus  $g \geq 1$  then  $\delta(P) \geq 2 + 2g$ . This is best possible for  $g = 1$ .

Many other results and open problems on valence functionals of convex-faced acoptic polyhedra, dealing also with polyhedra realizable in higher-dimensional spaces and with non-orientable polyhedra, are presented in [B7] together with references to earlier literature.

**7. Isogonal acoptic polyhedra.** Another direction of investigation concerns the acoptic polyhedra which possess a high degree of symmetry. If the group of (isometric) symmetries of a polyhedron acts transitively on its vertices (or edges, or faces) then the polyhedron is said to be **isogonal** (or **isotoxal**, or **isohedral**, respectively). For convex polyhedra and for the analogously defined maps on the sphere, the possibilities have been studied in some detail for close to two centuries<sup>43</sup>. Results on one aspect of this topic, dealing with maps on the sphere and convex polyhedra appear in Grünbaum and Shephard [G13], while the existence of isogonal acoptic polyhedra of higher genus

---

<sup>42</sup> Following [B7], the *valence functional*  $\delta(P)$  of a polyhedron  $P$  is  $\delta(P) = \sum (\text{valence}(V)-3)$ , where the summation is over all the vertices  $V$ . It is a way of measuring the departure of the polyhedron or map from being simple (3-valent). It is likely that analogous results may hold for the similarly defined functionals  $\sum (\text{valence}(V)-4)$  and  $\sum (\text{valence}(V)-6)$ .

<sup>43</sup> For the early history see Brückner [B20]; a recent account is given by Martini [M2].

was established in [G14]<sup>44</sup>. The construction of isogonal acoptic tori is discussed in some detail in [G11]; there are two main kinds, with vertex symbols (3.3.3.3.3.3) and (3.3.3.4.4). For each kind there are distinct combinatorial types that depend on two discrete parameters; each combinatorial type depends (up to similarity) on a continuous parameter. As shown by Schwörbel, the regular toroidal map  $\{3,6\}_{2,2}$  (in the notation of Coxeter and Moser [C8]) can be realized by an acoptic torus. Slightly different realizations of the map  $\{3,6\}_{2,2}$  are provided by members of the continuous family of isogonal tori shown in Figure 15. Another type of highly symmetric polyhedra is described by Wills [W4].

In order to present information about isogonal polyhedra of a given combinatorial type in a convenient manner, we use **dynatograms**<sup>45</sup> and **panoramas**. Both representations are possible because each such family depends on at most two parameters. In a dynatogram we show the regions (or arcs) that correspond to parameter values that yield isomorphic polyhedra, while in a panorama small copies of views of polyhedra are placed in positions that correspond (approximately) to the parameter values that determine representative examples of the type. As an illustration, we show in Figure 16 a parametrization of isogonal polyhedra of the combinatorial type of the snub cube (3.3.3.3.4). The dynatogram of this family is shown in Figure 17, while a panorama appears in Figure 18. These tools lead to various insights; the following are some examples.

(i) Despite appearances, the weakly acoptic polyhedron that corresponds to  $(a,b) = (1,0)$  is not isomegetic with the cuboctahedron; in the notation of Figure 16, pairs of vertices such as D and F coincide, hence (proper) triangles ADE and ADF also coincide, but extend into the *interior* of the cuboctahedron!

(ii) It is obvious on contemplating Figure 18 that the nonconvex acoptic polyhedra with  $a > b$  are all isomorphic, and that the nonconvex ones with  $a < b$  are also all isomorphic — but the polyhedra in two families are not isomorphic to each other.

(iii) The Boolean sum<sup>46</sup> of a polyhedron with  $b < 0$  with its convex hull yields an acoptic isogonal polyhedron of genus 5, while the same construction on a

---

<sup>44</sup> According to [K2] and [B17, p. 547], the "flat tori" mentioned in Brehm and Kühnel [B16], which were described by Brehm [B13] in 1978, are isogonal; however, the published accounts do not mention any symmetry properties. According to Kurth [K2], these polyhedra have been independently discovered by H. Leitzke.

<sup>45</sup> From the Greek δυνατοσ — possible.

<sup>46</sup> The Boolean sum of two acoptic polyhedra is obtained from the union of the elements of both by deleting the faces that occur in both polyhedra.



polyhedron with  $b > 1$  leads to an acoptic isogonal polyhedron of genus 7; these polyhedra have been described in [G14].

(iv) The Boolean sum of the polyhedron that corresponds to  $(a,b) = (1/3,1/6)$  with the mirror image of the polyhedron with  $(a,b) = (1/3,-1/6)$  is the new realization of the regular map  $(3,8)_{12}$  of genus 5 mentioned earlier (see Figure 19). For more details concerning polyhedral realizations of this map see [G12].

As another illustration we show in Figure 21 a dynatogram of the acoptic isogonal icosahedra (3.3.3.3.3), using the notation of Figure 20, and with explanations analogous to those in the caption of Figure 18. Comments similar to (i), (ii) and (iii) above apply in this case as well.

Analogous dynatograms and panoramas can be presented for many other families of polyhedra. A panorama of those acoptic polyhedra of the combinatorial type of the regular dodecahedron, which have a plane of symmetry, is shown in Figure 1. A systematic exposition of dynatograms and panoramas for acoptic polyhedra that are isogonal, or isotoxal, or isohedral is being prepared.

**8. Monohedral polyhedra.** Several different directions of investigation concern polyhedra that are **monohedral**, that is, have all faces mutually congruent but not necessarily equivalent under symmetries of the polyhedron. The common shape of faces of a monohedral polyhedron is called its **protoface**. A well-known example of a convex monohedral but not isohedral polyhedron is shown in Figure 22(a). It is remarkable that the following question, widespread in the folklore, is still open:

**Conjecture.** If the simple polygon  $F$  is the protoface of a strictly convex monohedral polyhedron then  $F$  is also the protoface of an isohedral polyhedron.<sup>47</sup>

The requirement of strict convexity is essential for the validity of the conjecture, as shown by the example of the monohedral polyhedron in Figure 10; its protoface is a 3 by 1 rectangle, which is not the protoface of any isohedral polyhedron. The conjecture is analogous to one part of Problem 18 of Hilbert's famous collection [H5] concerning monohedral tilings of the plane. The tiling analog of the conjecture is known to fail, but

---

<sup>47</sup> It seems that the protoface of the polyhedron in Figure 22 is the only quadrangle which is the protoface of a strictly convex monohedral but not isohedral polyhedron. No pentagon with a similar property is known.

the complete determination of strictly convex protofaces of monohedral tilings is still open; see [G17] for details and references.<sup>48</sup>

A different type of question, first raised long ago by Tom Banchoff<sup>49</sup> for icosahedra, is the following: For any given polyhedron  $P$ , all faces of which have the same number of sides, determine all monohedral acoptic polyhedra  $Q$  combinatorially equivalent to  $P$ . In particular, one may ask what are the different isomorphism types of such polyhedra  $Q$ , what polygons  $F$  may serve as protofaces for the  $Q$ 's, and how many distinct polyhedra  $Q$  there are for a given protoface  $F$ . Various results on these and similar questions were presented by the author in talks and courses at the University of Washington since 1990; detailed expositions are planned. These results include the following.

(1) Every triangle is the protoface of a convex monohedral polyhedron combinatorially equivalent to the regular octahedron. Moreover, every monohedral acoptic polyhedron combinatorially equivalent to the regular octahedron is isohedral. Each scalene acute triangle is the protoface of four distinct monohedral octahedra; if symmetry groups are taken into account, these four are of two distinct isomorphism types. Additional information is contained in the dynatogram in Figure 23, in which the parameters  $a$  and  $b$  are the sides of the triangular protoface, with  $a \leq b \leq c = 1$ , and in the "panorama" in Figure 24. For parameter values in  $E$  and  $G$ , one of the polyhedra is weakly acoptic but not acoptic. If  $P$  is a simplicial convex polyhedron such that every triangle is the protoface of a monohedral convex polyhedron combinatorially equivalent with  $P$ , then  $P$  is combinatorially equivalent to the regular octahedron.<sup>50</sup>

(2) Banchoff's original question about monohedral acoptic polyhedra of the combinatorial type of the regular icosahedron is much more complicated, and is not fully answered.<sup>51</sup> It is known that there are many distinct isomorphism types, even if only

---

<sup>48</sup> One particularly attractive open question concerning monohedral tilings is whether the prototile of some such tiling is *aperiodic*, that is, *every* monohedral tiling with this prototile has no symmetries besides the identity. Analogously, it is not known whether there exists a polygon  $F$  such that every acoptic monohedral polyhedron with protoface  $F$  has only the identity symmetry.

<sup>49</sup> Private communication, some twenty years ago.

<sup>50</sup> For some of these results see also Webber [W1].

<sup>51</sup> The convex ones among them were investigated by E. Miller, in an undergraduate research project directed by Banchoff. Among Miller's results is the discovery that a unique convex icosahedron has a right-angled protoface. A publication is being prepared [M9].

those polyhedra are considered which have three mutually orthogonal axes of halfturn symmetry. As indicated in Figure 25, these polyhedra have nine transitivity classes of edges, but all faces are equivalent under (combinatorial) automorphisms compatible with the orbits of the edges. A dynatogram for such polyhedra, obtained by numerical calculations, is shown in Figure 26. It shows, among other facts, the possibility of two distinct convex polyhedra with the same scalene protoface; this shows that the formulation of Cauchy's rigidity theorem has to be formulated more carefully than is often done. Many of the polyhedra of this kind are visually quite attractive, as shown by the examples in Figure 27. However, many additional types of monohedral icosahedra with other symmetries are possible; so far these have been explored only superficially. Several examples with isosceles triangles as protofaces are shown in Figure 28.

(3) There exist convex polyhedra for which no isomorphic polyhedron is monohedral. An example is shown in Figure 29(a). It is realizable by a weakly convex monohedral polyhedron, but the polyhedron in Figure 29(b) admits no such realization. The polyhedron in Figure 30 admits no realization as a monohedral acoptic polyhedron. All these are the smallest examples of their kind known to me.

(4) For any given triangle  $T$  the number of monohedral convex polyhedra with protoface  $T$  is finite, but for suitable  $T$  it can be arbitrarily large.

In this context we also have the following

**Conjecture.** If  $f > 120$  there are at most three convex monohedral polyhedra with precisely  $f$  faces.

A different direction concerns the study of monohedral tori, which was started by Alaogly and Giese [A1]. They describe 6-valent triangle-faced as well as 4-valent quadrangle-faced monohedral tori. Additional examples can be found in [S13]. Recently Webber [W1] has developed methods of construction of many interesting kinds of 6-valent triangle-faced monohedral tori. Webber's tori can have arbitrarily large numbers of faces, and even can be knotted. It is interesting to note that the question whether there exist monohedral tori with hexagonal protoface is still open.<sup>52</sup>

---

<sup>52</sup> It may be mentioned that the isogonal acoptic tori described in [G14] and [G11], with vertex symbols  $(3.3.3.3.3.3)$ , have polars which are 3-valent monohedral (even isohedral) realizations of hexagon-faced toroidal maps; however, these polar polyhedra are not acoptic, see [G16].

**Conjecture.** There exist no monohedral acoptic polyhedra of genus greater than 1 in which all vertices have the same valence.

**9. Spanning trees.** Barnette [B3] proved that each toroidal convex-faced acoptic polyhedron has a spanning tree of maximal valence 3. Does this extend to polyhedra of higher genus, or to more general acoptic polyhedra without overarching elements? As can be seen from Figure 31, an extension is not possible without some conditions on overarching elements. Earlier, in [B1], Barnette established the existence of such trees for convex polyhedra. In this context, an old question from [G6, p. 1148], which would extend Barnette's result, may be mentioned:

**Conjecture.** Every convex polyhedron admits a spanning tree of maximal valence 3 such that in the dual polyhedron there is a spanning tree of maximal valence 3 which uses only edges that correspond to edges not used in the spanning tree of the starting polyhedron.

With obvious definitions, this can be reformulated as saying that each convex polyhedron admits simultaneously a spanning vertex-tree and a spanning face-tree, both of maximal valence 3 and with no edge used in both. In this version it is possible to inquire what happens for convex-faced toroidal polyhedra, or for other classes of polyhedra.

\* \* \* \* \*

Many additional topics, results and problems dealing with acoptic polyhedra could have been included in the above discussion. Although limitations of time and space require us to stop, it is our hope that the presentation will arouse the curiosity of the reader concerning the many questions about acoptic polyhedra — whether posed above or not — and lead to interesting new developments.

### References.

[A1] L. Alaoglu and J. H. Giese, Uniform isohedral tori. Amer. Math. Monthly 53(1946), 14 - 17.

[A2] A. D. Aleksandrov, Convex Polyhedra. [In Russian]. Moscow 1950. German translation: A. D. Alexandrow, Konvexe Polyeder, Akademie-Verlag, Berlin 1958.

[A3] V. A. Aleksandrov, A new example of a flexible polyhedron. Siberian Math. J. 36(1995), 1049 - 1057.

[A4] A. Altshuler, Polyhedral realizations in  $\mathbb{R}^3$  of triangulations of the torus and 2-manifolds in cyclic 4-polytopes. *Discrete Math.* 1(1971), 211 - 238.

[A5] A. Altshuler, Construction and enumeration of regular maps on the torus. *Discrete Math.* 4(1973), 201 - 217.

[A6] A. Altshuler and U. Brehm, A non-Schlegelian polyhedral map on the torus. *Mathematika*, 31(1984), 83 - 88.

[A7] A. Altshuler and U. Brehm, Neighborly maps with few vertices. *Discrete Comput. Geom.* 8(1992), 93 - 104.

[B1] D. W. Barnette, Trees in polyhedral graphs. *Canad. J. Math.* 18(1966), 731 - 736.

[B2] D. W. Barnette, Graph theorems for manifolds. *Israel J. Math.* 16(1973), 62 - 72.

[B3] D. W. Barnette, 3-trees in polyhedral maps. *Israel J. Math.* 79(1992), 251 - 256.

[B4] D. W. Barnette, Polyhedral maps of 2-manifolds. *Convexity and Related Combinatorial Geometry*. Proc. Second University of Oklahoma Conference, D. C. Kay and M. Breen, eds. Dekker, New York 1982, 7 - 19.

[B5] D. W. Barnette and A. L. Edelson, All orientable 2-manifolds have finitely many minimal triangulations. *Israel J. Math.* 62(1988), 90 - 98.

[B6] D. W. Barnette and A. L. Edelson, All 2-manifolds have finitely many minimal triangulations. *Israel J. Math.* 67(1989), 123 - 128.

[B7] D. W. Barnette, P. Gritzmann and R. Höhne, On valences of polyhedra. *J. Combinat. Theory A* 58(1991), 279 - 300.

[B8] D. W. Barnette and B. Grünbaum, On Steinitz's theorem concerning convex 3-polytopes and on some properties of planar graphs. In "The Many Facets of Graph Theory", G. Chartrand and S. F. Kapoor, eds. *Lecture Notes in Math*, 110(1969), 27 - 40. Springer, Berlin-Heidelberg-New York 1969.

[B9] J. K. Becker, Über Polyeder. *Z. Math. Phys.* 14(1869), 65 ff.

[B10] U. Betke and P. Gritzmann, Polyedrische 2-Mannigfaltigkeiten mit wenigen nicht-convexen Ecken. *Monatshefte Math.* 97(1984), 1 - 21.

[B11] J. Bokowski and U. Brehm, A polyhedron of genus 4 with minimal number of vertices and maximal symmetry. *Geom. Dedicata* 29(1989), 53 - 64.

[B12] J. Bokowski and J. M. Wills, Regular polyhedra with hidden symmetries. *Math. Intelligencer* 10(1988), 27 - 32.

[B13] U. Brehm, Polyeder gegebenen Geschlechtes mit minimaler Eckenzahl. *Tagungsbericht Oberwolfach* 19(1978), 5.

[B14] U. Brehm, Polyeder mit zehn Ecken vom Geschlecht 3. *Geom. Dedicata* 11(1981), 119 - 124.

[B15] U. Brehm, A maximally symmetric polyhedron of genus 3 with 10 vertices. *Mathematika* 34(1987), 237 - 242.

[B16] U. Brehm and W. Kühnel, Smooth approximation of polyhedral surfaces regarding curvatures. *Geometriae Dedicata* 12(1982), 435 - 461.

[BrS] U. Brehm and E. Schulte, Polyhedral maps. In "Handbook of Computational Geometry", J. E. Goodman and J. O'Rourke, eds. CRC Press 1997, pp. 345 - 358.

[B17] U. Brehm and J. M. Wills, Polyhedral manifolds. Chapter 2.4 in "Handbook of Convex Geometry", P. M. Gruber and J. M. Wills, eds. North-Holland, Amsterdam 1993. Vol. A, pp. 535 - 554.

[B18] R. Bricard, Mémoire sur la théorie de l'octaèdre articulé. *J. Math. Pures Appl., Ser. 5*, 3(1897), 113 - 148.

[B19] N. J. Bridge, Facetting the dodecahedron. *Acta Crystallographica* A30(1974), 548 - 552.

[B20] M. Brückner, Vielecke und Vielflache. Theorie und Geschichte. Teubner, Leipzig 1900.

[B21] M. Burt, Spatial arrangement and polyhedra with curved surfaces and their architectural applications. M.Sc. Thesis, Technion, Haifa, Israel, 1966.

[B22] A. V. Bushmelev and I. H. Sabitov, Configuration spaces of the Bricard octahedra. [In Russian] *Ukrain. Geom. Sbornik* 33(1990), 36 - 41.

[C1] A. L. Cauchy, Sur les polygones et les polyèdres. Second Mémoire. *J. École Polytechn.* 9(1813), pp. 87 - . (= *Oeuvres Complètes d'Augustin Cauchy*, 2<sup>e</sup> Série, Tome 1 (1905), pp. 26 - 38.)

[C2] R. Connelly, A counterexample to the rigidity conjecture for polyhedra. *Publ. Math. I. H. E. S.* 47(1978), 333 - 338.

[C3] R. Connelly, A flexible sphere. *Math. Intelligencer* 1(1978), 130 - 131.

[C4] R. Connelly, Conjectures and open questions in rigidity. *Proc. Internat. Congress of Math. Helsinki 1978*, pp. 407 - 414.

[C5] R. Connelly, Rigidity. In "Handbook of Convex Geometry", P. M. Gruber and J. M. Wills, eds. North-Holland, Amsterdam 1993. Vol. A, pp. 223 - 271.

[C6] R. Connelly, I. Sabitov and A. Walz, The bellows conjecture. *Beiträge zur Algebra und Geometrie* (to appear).

[C7] H. S. M. Coxeter, *Regular Polytopes*. 3rd ed., Dover, New York 1973.

- [C8] H. S. M. Coxeter and W. O. J. Moser, *Generators and Relations for Discrete Groups*. 4th ed. Springer, Berlin 1980.
- [C9] H. Crapo and W. Whiteley, *The Geometry of Rigid Structures*. (In preparation)
- [C10] P. Cromwell, *Polyhedra*. Cambridge Univ. Press 1997.
- [C11] A. Császár, A polyhedron without diagonals. *Acta Sci. Math. Szeged* 13(1949/50), 140 - 142.
- [D1] A. W. M. Dress, A combinatorial theory of Grünbaum's new regular polyhedra, Part I: Grünbaum's new regular polyhedra and their automorphism group. *Aequationes Math.* 23(1981), 252 - 265.
- [D2] A. W. M. Dress, A combinatorial theory of Grünbaum's new regular polyhedra, Part II: Complete enumeration. *Aequationes Math.* 29(1985), 222 - 243.
- [D3] R. A. Duke, Geometric embedding of complexes. *Amer. Math. Monthly* 77(1970), 597 - 603.
- [E1] V. Eberhard, *Zur Morphologie der Polyeder*, Teubner, Leipzig 1891.
- [E2] W. Egloff, Eine Bemerkung zu Cauchy's Satz über die Starrheit konvexer Vielflache. *Abh. Math. Sem. Hamburg* 20(1956), 253 - 256.
- [E3] H. G. Eggleston, B. Grünbaum and V. Klee, Some semicontinuity theorems for convex polytopes and cell complexes. *Comment. Math. Helvet.* 39(1964), 165 - 188.
- [F1] S. L. Farris, Completely classifying all vertex-transitive and edge-transitive polyhedra, part I: necessary class conditions. *Geometriae Dedicata* 26(1988), 111 - 124.
- [F2] S. L. Farris, Completely classifying all vertex-transitive and edge-transitive polyhedra, part II: finite, fully-transitive polyhedra. (In preparation).
- [F3] P. J. Federico, The number of polyhedra. *Philips Res. Reports* 30(1975), 220\* - 231\*.
- [F4] P. W. Fowler and D. B. Redmond, Symmetry aspects of leapfrog and truncated polyhedra. *MATCH Communications in Mathematical and Computer Chemistry* 33(1996), 101 - 119.
- [G1] M. Gardner, *Mathematical Games*. *Scientific American* 239(1978), No. 5, pp. 22 - 32.
- [G2] M. Gardner, *My Best Mathematical and Logic Puzzles*. Dover, New York 1994.
- [G3] A. Gray and S. Wilson, A more elementary proof of Grünbaum's conjecture. *Congressus Numerantium* 72(1990), 25 - 32.

- [G4] P. Gritzmann, The toroidal analogue to Eberhard's theorem. *Mathematika* 30(1983), 274 - 290.
- [G5] B. Grünbaum, *Convex Polytopes*. Interscience Monographs in Pure and Applied Mathematics, Vol. XVI. John Wiley & Sons, London-New York-Sydney, 1967, xiv + 456 pp.
- [G6] B. Grünbaum, Polytopes, graphs, and complexes. *Bull. Amer. Math. Soc.* 76(1970), 1131 - 1201.
- [G7] B. Grünbaum, Polygons. "The Geometry of Metric and Linear Spaces", L. M. Kelly, ed. *Lecture Notes in Mathematics* Number 490, pp. 147 - 184. Springer-Verlag, Berlin-Heidelberg-New York 1975.
- [G7] B. Grünbaum, Regular polyhedra -- old and new. *Aequationes Math.* 16(1977), 1 - 20.
- [G9] B. Grünbaum, Regularity of graphs, complexes and designs. *Problèmes Combinatoires et Théorie des Graphes. Colloq. Internat. C.N.R.S. No. 260, Paris 1978*, pp. 191 - 197.
- [G10] B. Grünbaum, Polyhedra with hollow faces. In "POLYTOPES: Abstract, Convex and Computational", Proc. NATO - ASI Conference, Toronto 1993. T. Bisztriczky, P. McMullen, R. Schneider and A. Ivic' Weiss, eds. Kluwer Acad. Publ., Dordrecht 1994. Pp. 43 - 70.
- [G11] B. Grünbaum, Isogonal prisms. *Discrete and Comput. Geometry* (to appear).
- [G12] B. Grünbaum, Polyhedral realizations of a regular map of genus 5. (In preparation.)
- [G13] B. Grünbaum and G. C. Shephard, Spherical tilings with transitivity properties. In "The Geometric Vein - The Coxeter Festschrift", Chandler Davis, Branko Grünbaum and F. A. Sherk, eds. Springer-Verlag, New York 1982, pp. 65 - 98.
- [G14] B. Grünbaum and G. C. Shephard, Polyhedra with transitivity properties. *Math. Reports Acad. Sci. Canada* 6(1984), 61 - 66.
- [G15] B. Grünbaum and G. C. Shephard, On the geometry of polygons and polyhedra, unpublished manuscript. 1985-1988.
- [G16] B. Grünbaum and G. C. Shephard, Duality of polyhedra. In "Shaping Space: A Polyhedral Approach", Proc. "Shaping Space" Conference, Smith College, April 1984. M. Senechal and G. Fleck, eds. Birkhäuser, Boston 1988, pp. 205 - 211.
- [G17] B. Grünbaum and G. C. Shephard, *Tilings and Patterns*. Freeman, New York 1987.
- [G18] B. Grünbaum and G. C. Shephard, A new look at Euler's theorem for polyhedra. *Amer. Math. Monthly* 101(1994), 109 - 128. Response to comments by P. Hilton and J. Pedersen, *ibid.* pp. 961 - 962.



- [G19] B. Grünbaum and J. Zaks, The existence of certain planar maps. *Discrete Math.* 10(1974), 93 - 115.
- [H1] J. Hadamard, Erreurs des mathématiciens. *Interméd. Math.* 14(1907), 31. See also: Problème 3456, *Interméd. Math.* 15(1908), 222.
- [H2] J. Hadamard, *Leçons de Géométrie élémentaire. Vol. II. Géométrie dans l'espace.* 2nd ed. Paris 1910; 4th ed. Paris 1921; 7th ed. Paris 1931; 8th ed. Paris 1949.
- [H3] H. Hadwiger, *Eulers Charakteristik und kombinatorische Geometrie.* *J. reine angew. Math.* 194(1955), 101 - 110.
- [H4] G. Hajós and A. Heppes, On a special kind of polyhedra. *Acta Math. Acad. Sci. Hungar.* 21(1970), 101 - 103.
- [H5] D. Hilbert, *Mathematische Probleme.* *Göttinger Nachrichten*, 1900, pp. 253 - 297; English translation: *Mathematical problems.* *Bull. Amer. Math. Soc.* 8(1902), 437 - 479; reprinted in F. E. Browder, ed., *Mathematical Developments Arising From Hilbert's Problems*, *Proc. Sympos. Pure Math.* vol. 28, Amer. Math. Soc., Providence RI, 1876, pp. 1 - 34.
- [H6] H. Hopf, *Selected Topics in Geometry.* Lecture Notes, New York University 1946.
- [H7] J. L. Hudson and J. G. Kingston, Stellating polyhedra. *Math. Intelligencer* 10(1988), 50 - 61.
- [J1] S. Jendrol, On face vectors and vertex vectors of convex polyhedra. *Discrete Math.* 118(1993), 119 - 144.
- [J2] S. Jendrol and E. Jucovic, On the toroidal analogue of Eberhard's theorem. *Proc. London Math. Soc.* (3)25(1972), 385 - 398.
- [J3] S. Jendrol and E. Jucovic, Generalization of a theorem by V. Eberhard. *Math. Slovaca* 27(1977), 383 - 407.
- [J4] S. Jendrol and P. J. Owens, Pentagonal 3-polytopal graphs with edges of only two types and shortness parameters. *Discrete Math.* 137(1995), 251 - 263.
- [J5] B. Jessen, Orthogonal icosahedra. *Nordisk Matem. Tidsk.* 15(1967), 90 - 96.
- [J6] N. W. Johnson, *Uniform Polytopes.* Cambridge University Press (to appear).
- [J7] E. Jucovic, On the face-vectors and vertex-vectors of cell-decompositions of orientable 2-manifold. *Math. Nachrichten* 73(1976), 285 - 295.
- [K1] N. H. Kuiper, Sphères polyédriques flexibles dans  $E^3$ , d'après Robert Connelly. *Séminaire Bourbaki* 30(1977/78), No. 514. *Lecture Notes in Mathematics* #710, Springer, New York 1979, pp. 147 - 168.

[K2] W. Kurth, Enumeration of Platonic maps on the torus. *Discrete Math.* 61(1986), 71 - 83.

[L1] S. A. Lavrenchenko, Irreducible triangulations of the torus. [In Russian] *Ukrain. Geom. Sbornik* 30(1987), 52 - 62.

[L2] H. Lebesgue, Démonstration complète du théorème du Cauchy sur l'égalité des polyèdres convexes. *Interméd. Math.* 16(1909), 113 - 120.

[L3] H. Lebesgue, Octaèdres articulés de Bricard. *Enseign. Math.*, (2) 13(1967), 175 - 185.

[L4] D. Ljubic', A twisted quadrangulated torus. Abstract 835-52-08, *Abstracts Amer. Math. Soc.* 8(1987), p. 302.

[L5] L. A. Lyusternik, *Convex Figures and Polyhedra*. [In Russian]. English translation by T. J. Smith, Dover, New York 1963. English translation by D. L. Barnett, Heath, Boston 1966.

[M1] I. G. Maksimov, Polyhedra with bendings and Riemann surfaces. *Russian Math. Surveys* 50(1995), 821 - 823.

[M2] H. Martini, A hierarchical classification of Euclidean polytopes with regularity properties. In "POLYTOPES: Abstract, Convex and Computational", Proc. NATO - ASI Conference, Toronto 1993. T. Bisztriczky, P. McMullen, R. Schneider and A. Ivic' Weiss, eds. Kluwer Acad. Publ., Dordrecht 1994. Pp. 71 -96.

[M3] P. McMullen and R. Schneider, Valuations on convex bodies. In "Convexity and its Applications", P. M. Gruber and J. M. Wills, eds. Birkhäuser, Basel 1983, pp. 170 - 247.

[M4] P. McMullen and E. Schulte, Abstract Regular Polytopes. (In preparation)

[M5] P. McMullen and E. Schulte, Regular polytopes in ordinary space. (To appear).

[M6] P. McMullen, C. Schulz and J. M. Wills, Polyhedral 2-manifolds in  $E^3$  with unusually large genus. *Israel J. Math.* 46(1983), 127 - 144. Correction in: Two remarks on equivelar manifolds, *ibid.* 52(1985), 28 - 32.

[M7] P. McMullen, E. Schulte and J. M. Wills, Infinite series of combinatorially regular polyhedra in three-space. *Geometriae Dedicata* 26(1988), 299 - 307.

[M8] P. W. Messer, Stellation of the rhombic triacontahedron and beyond. *Structural Topology* 21 (1995), 25 -46.

[M9] E. N. Miller, Icosahedra constructed with congruent triangles. (In preparation.)

[M10] A. F. Möbius, Über die Bestimmung des Inhalts eines Polyëders. *Ber. Verh. Sächs. Ges. Wiss., Math.-Phys. Klasse* 17(1885), 31 - 68. (= *Gesammelte Werke*, Vol. 2, pp. 473 - 512. Hirzel, Leipzig 1886.)

- [M11] J. Molnár, Diamond polyhedra I. Simple diamond polyhedra. *Ann. Univ. Sci. Budapest. Eötvös Sect. Math.* 19(1976), 129 - 139.
- [N1] A. Nakamoto and K. Ota, Note on irreducible triangulations of surfaces. *J. Graph Theory* 20(1995), 227 - 233.
- [N2] M. Norgate, Non-convex pentahedra. *Math. Gazette* 54(1970), 115 - 124.
- [O1] J. Ounsted, An unfamiliar dodecahedron. *Mathematics Teaching* 83(1978), 46 - 47.
- [P1] H. Pulapaka and A Vince, Nonrevisiting paths on surfaces. *Discrete Comput. Geom.* 15(1996), 353 - 357.
- [R1] J. Reay, Can neighborly polyhedra be realized geometrically? In "Shaping Space: A Polyhedral Approach", Proc. "Shaping Space" Conference, Smith College, April 1984. M. Senechal and G. Fleck, eds. Birkhäuser, Boston 1988, pp. 251 - 253, 259.
- [R2] C. Reinhardt, Zu Möbius' Polyedertheorie. *Ber. Verh. sächs. Gesellschaft der Wissenschaften, Math.-phys. Cl.* 37(1885), 106 - 125.
- [R3] G. Ringel and J. W. T. Youngs, Solution of the Heawood map-coloring problem. *Proc. Nat. Acad. Sci. USA* 60(1968), 438 - 445.
- [S1] I. K. Sabitov, Local theory of bending of surfaces. In "Geometry III. Theory of Surfaces", Y. D. Burago and V. A. Zalgaller, eds. *Encyclop. of Math. Sci.* vol. 48. Springer, Berlin 1992, pp.
- [S2] I. K. Sabitov, On the problem of invariance of the volume of a flexible polyhedron. *Russian Math. Surveys* 50(1995), 452 - 452.
- [S3] H. Schipper, Generating triangulations of 2-manifolds. In "Computational Geometry – Methods, Algorithms and Applications", Proc. Internat. Workshop on Comput. Geom CG '91, Bern 1991. Springer, New York 1991, pp. 237 - 248.
- [S4] I. J. Schoenberg and S. K. Zaremba, On Cauchy's lemma concerning convex polygons. *Canad. J. Math.* 19(1967), 1062 - 1071.
- [S5] E. Schulte and J. M. Wills, Combinatorially regular polyhedra. In: *Symmetry of Discrete Mathematical Structures and Their Symmetry Groups*, ed. by K. H. Hoffman and R. Wille. Heldermann, Berlin 1990, pp. 49 - 88.
- [S6] C. Schulz, Geometrische Realisierungen geschlossener Flächen mit wenigen Ecken. *Geom. Dedicata* 11(1981), 309 - 314.
- [S7] J. Schwörbel, Die kombinatorisch regulären Tori. Thesis, Siegen University, 1988.
- [S8] J. Schwörbel and J. M. Wills, The two Pappus-tori. *Geom. Dedicata* 28(1988), 359 - 362.
- [S9] Y. Shirai, *Three-Dimensional Computer Vision*. Springer, New York 1987.

[S10] J. S. Simutis, Geometric realization of toroidal maps. Ph. D. thesis, University of California, Davis, CA, 1977.

[S11] E. Steinitz, Polyeder und Raumteilungen. Encykl. Math. Wissenschaften vol. 3(1922), Geometrie, Part 3AB12, pp. 1 - 139.

[S12] E. Steinitz and H. Rademacher, Vorlesungen über die Theorie der Polyeder. Springer, Berlin 1934.

[S13] B. M. Stewart, Adventures Among the Toroids. The author, Okemos, MI, 1980.

[S14] J. J. Stoker, Geometrical problems concerning polyhedra in the large. Comm. Pure Appl. Math. 21(1968), 119 - 168.

[S15] L. Szilassi, Regular toroids. Structural Topology, 13(1986), 69 - 80.

[V1] A. Vince, Regular combinatorial maps. J. Combinat. Theory 35(1983), 256 - 277.

[W1] W. T. Webber, Monohedral idemvalent toroidal polyhedra. Ph. D. thesis, University of Washington, Seattle 1994.

[W2] M. J. Wenninger, Polyhedron Models. Cambridge Univ. Press, 1971.

[W3] M. J. Wenninger, Dual Models. Cambridge Univ. Press 1983.

[W4] J. M. Wills, On polyhedra with transitivity properties. Discrete Comput. Geom. 1(1986), 195 - 199.

[W5] S. E. Wilson, New techniques for the construction of regular maps. Ph. D. thesis, University of Washington, Seattle 1976.

[Z1] G. M. Ziegler, Lectures on Polytopes. Graduate Texts in Mathematics #152, Springer, New York 1995.

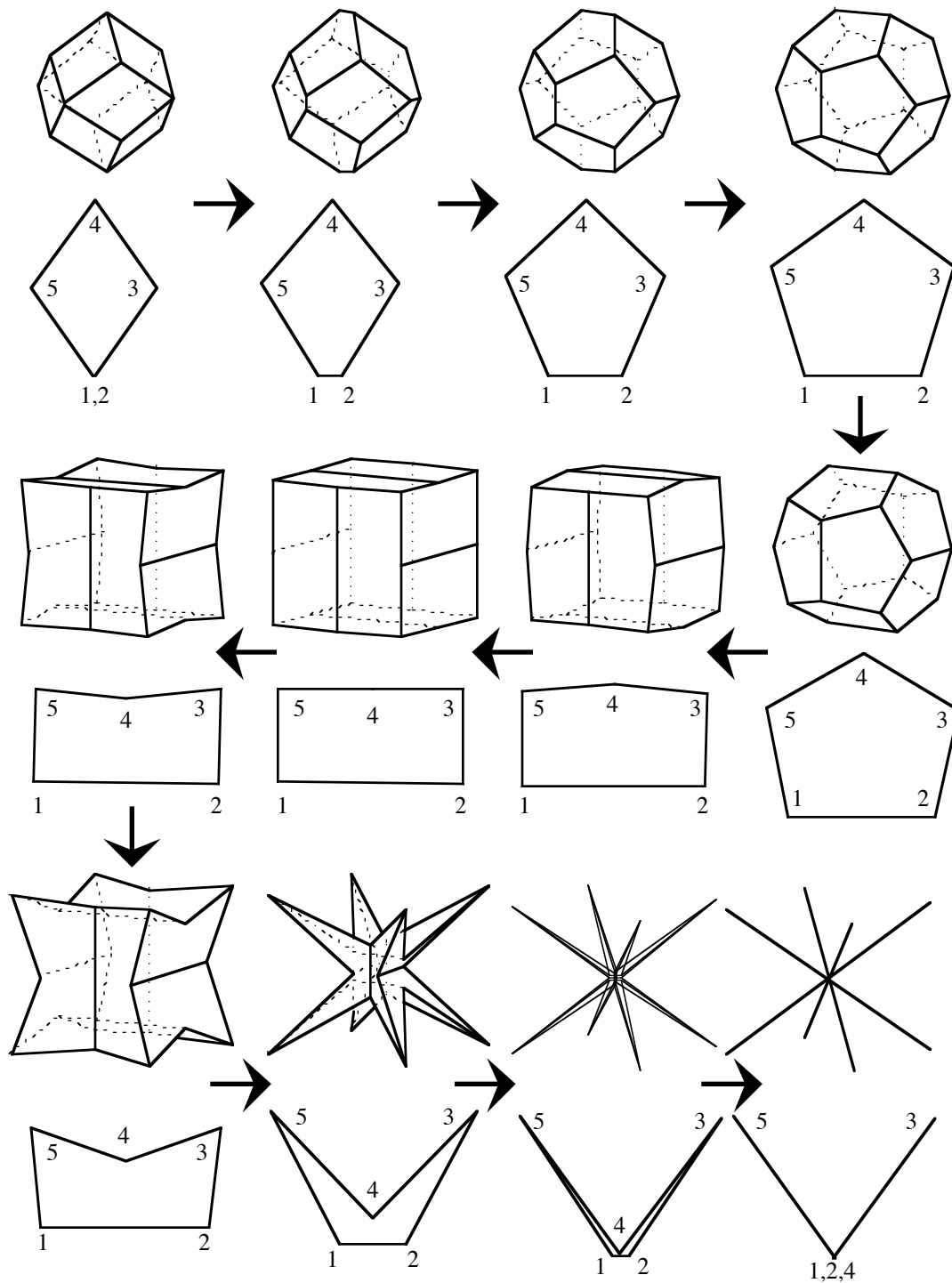

Figure 1. The continuum of *isohedral acoptic* polyhedra of type [3.3.3.3.3] with a plane of symmetry, starting with a *weakly convex* polyhedron *isomegetic* with the rhombic dodecahedron, and ending with a *weakly acoptic* polyhedron. The *protoface* of each polyhedron is shown below a perspective view of the polyhedron itself. Unfamiliar terms (*italicized*) are explained later in the text.

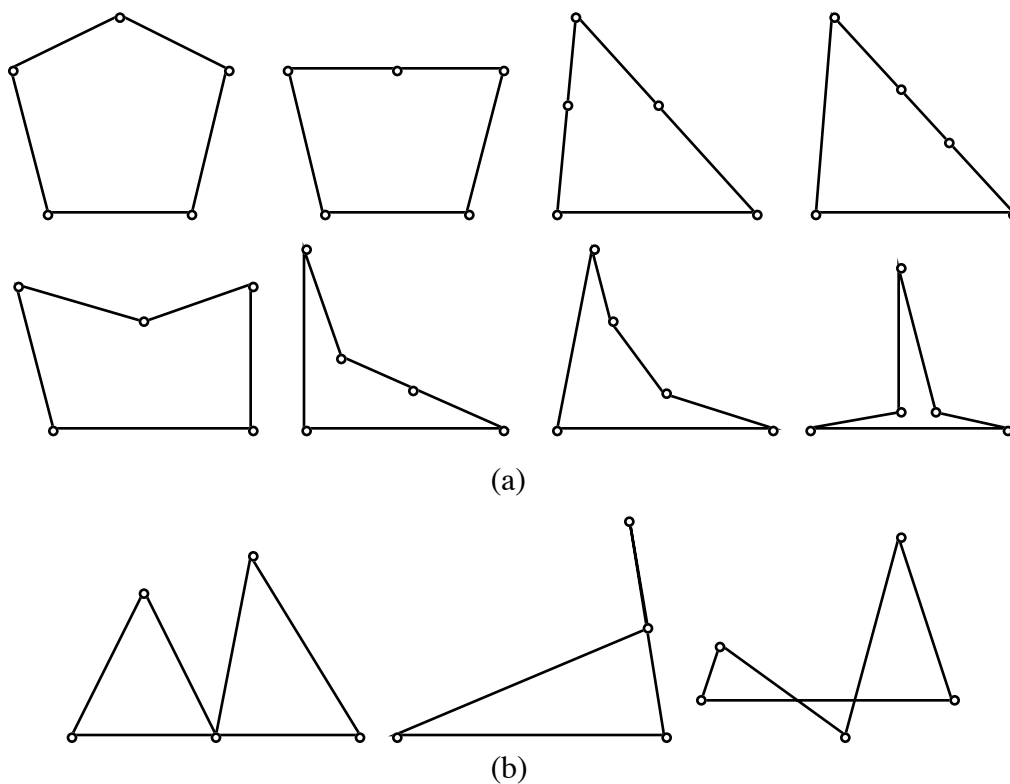

Figure 2. Examples of (a) simple polygons, and (b) polygons which are not simple. All polygons shown are pentagons.

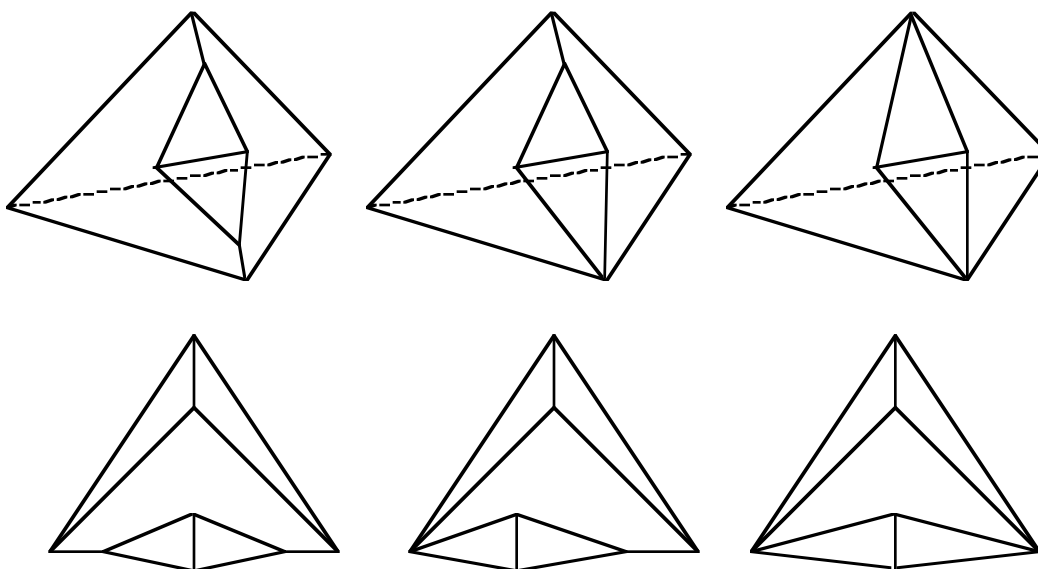

Figure 3. Examples of the three combinatorial types of acoptic hexahedra that cannot be represented by convex polyhedra. One polyhedron of each type is shown in perspective view in the top row. Beneath each is shown a "pseudo-Schlegel" diagram, which gives a planar view of the combinatorial structure of the polyhedron. Pseudo-Schlegel diagram of this kind are possible for all acoptic polyhedra of genus 0.

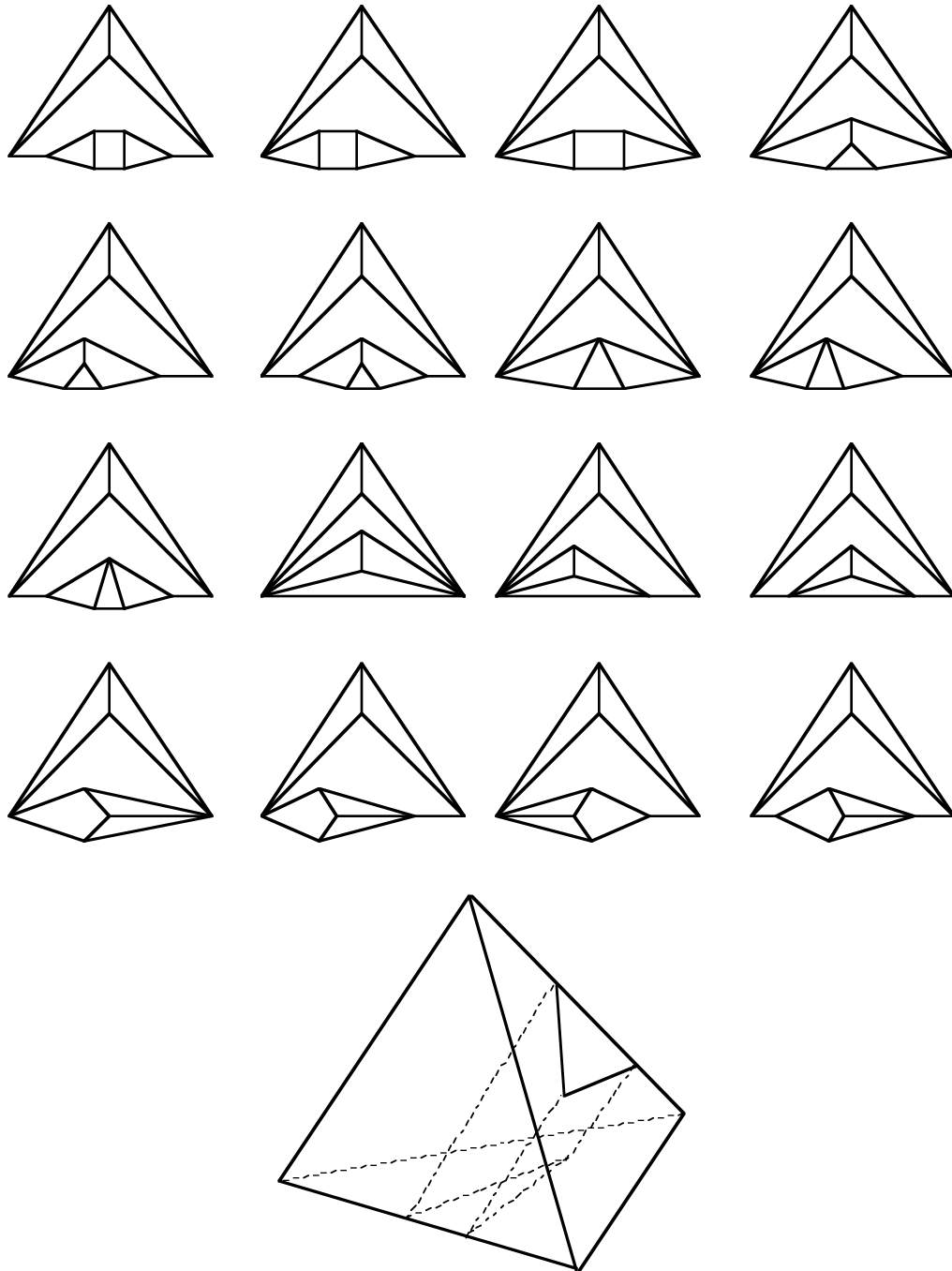

Figure 4. Representatives of the 17 types of acoptic heptahedra known to the author; they may be conjectured to be the only possible types. The first 16 have genus 0, and are shown by pseudo-Schlegel diagrams; all are easily derivable from the tetrahedron. The last polyhedron is toroidal, and is shown in a perspective view.

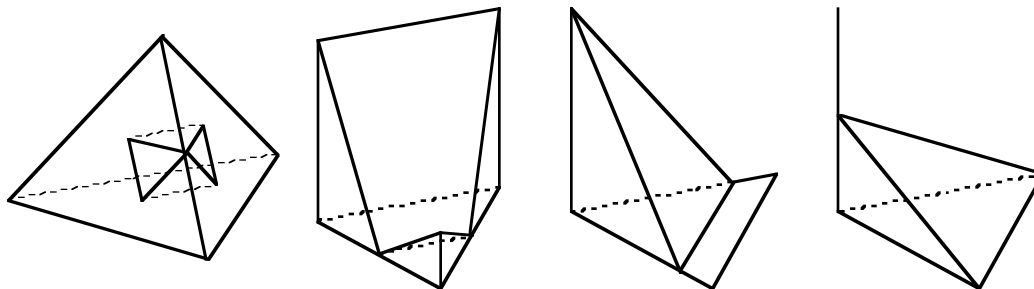

Figure 5. Examples of weakly acoptic polyhedra which are not acoptic.

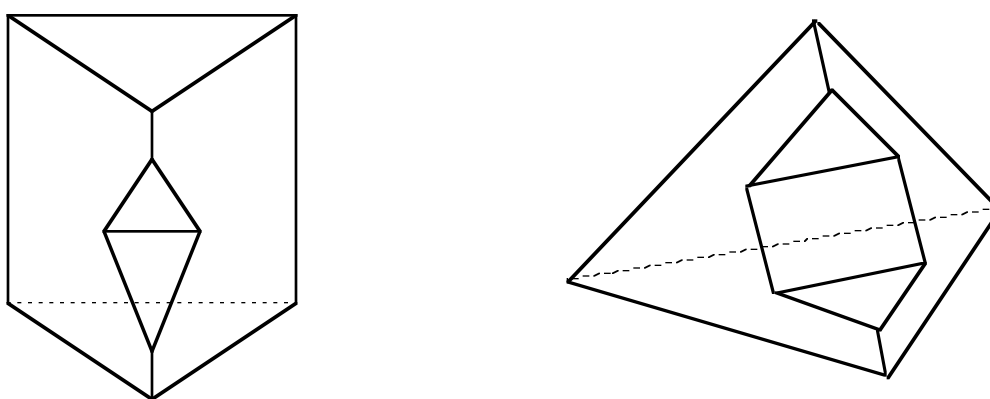

Figure 6. Two combinatorially equivalent acoptic heptahedra. In many geometric respects they are sufficiently different to be distinguished in a classification finer than the one by combinatorial type -- they are not isomorphic.

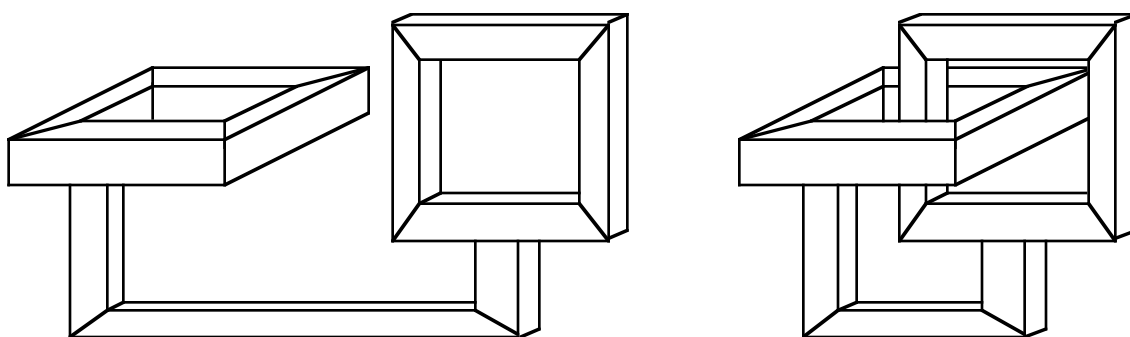

Figure 7. Two isomorphic but not equiform acoptic polyhedra of genus 2.



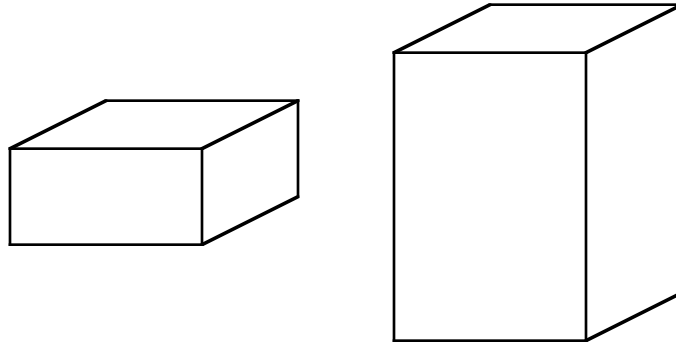

Figure 8. Two convex polyhedra that have the same symmetry group and are equiform, but are not symmetrically equiform since they cannot be connected by a continuous family of isomorphic polyhedra with the same symmetry group.

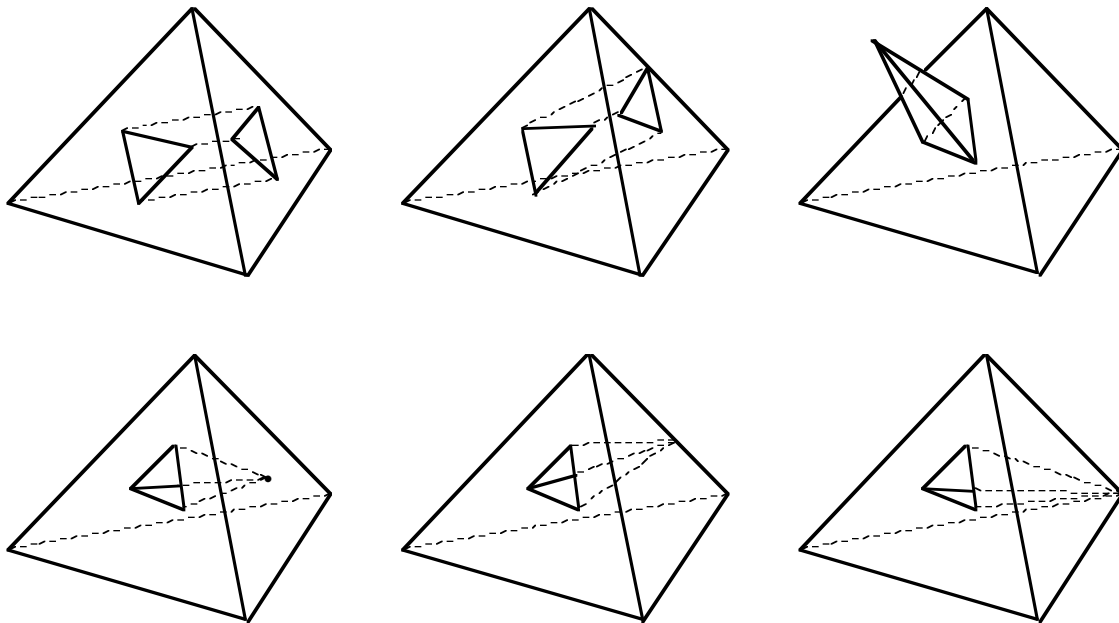

Figure 9. Examples of "polyhedral solids" which are not polyhedra under our definitions, since not all their "faces" are simply-connected or limits of simply connected polygons.

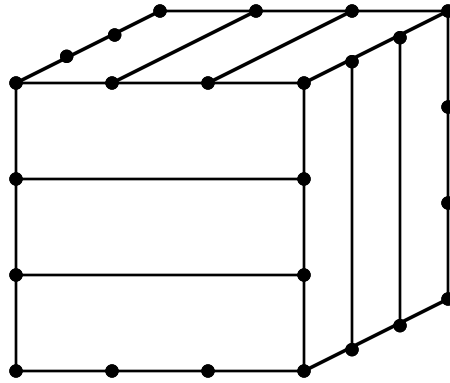

Figure 10. An example of a weakly convex polyhedron. The point set determined by the polyhedron and its interior is convex, but the facial structure of this **convex** polyhedron does not coincide with the given weakly convex one. The polyhedron is isomegetic to a cube.

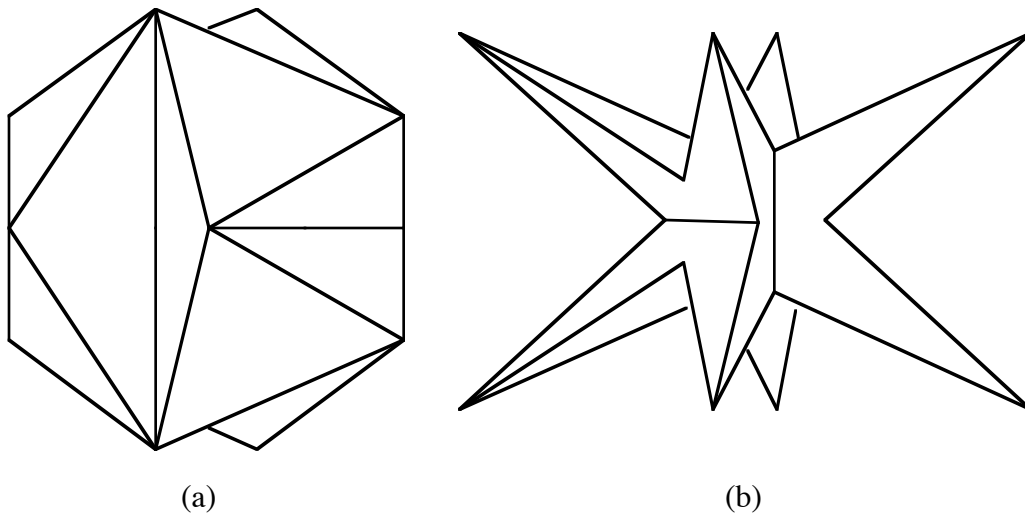

Figure 11. An acoptic isogonal icosahedron and an acoptic isohedral dodecahedron which can be considered dual to each other in a correspondence under which corresponding elements have analogous convexity character. However, no general duality theory exists which acts on all acoptic polyhedra under preservation of the convexity character of corresponding elements.

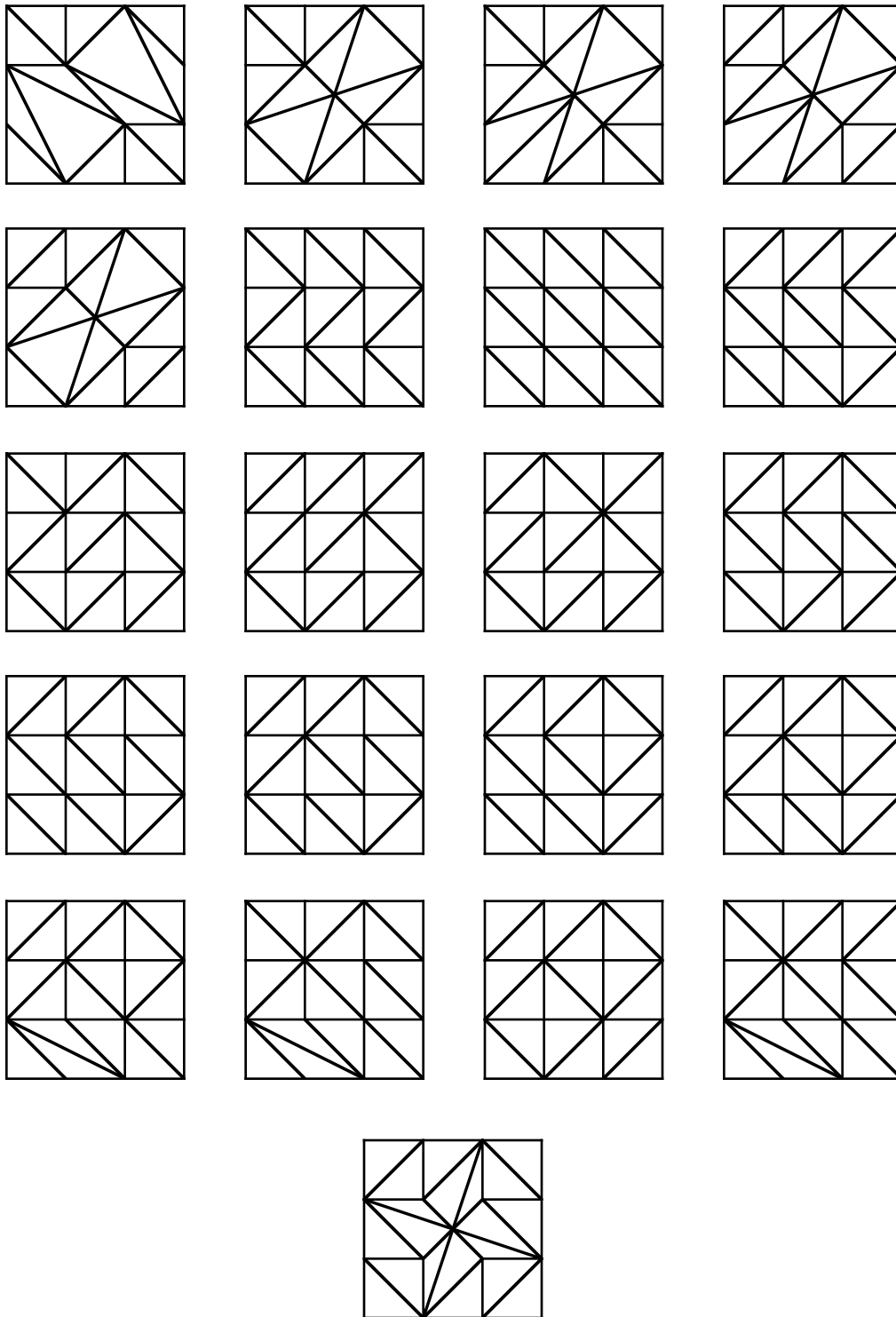

Figure 12. The 21 irreducible triangulations of the torus. In each part, the standard identification of the top and bottom, and of the side margins, yields the toroidal triangulation.

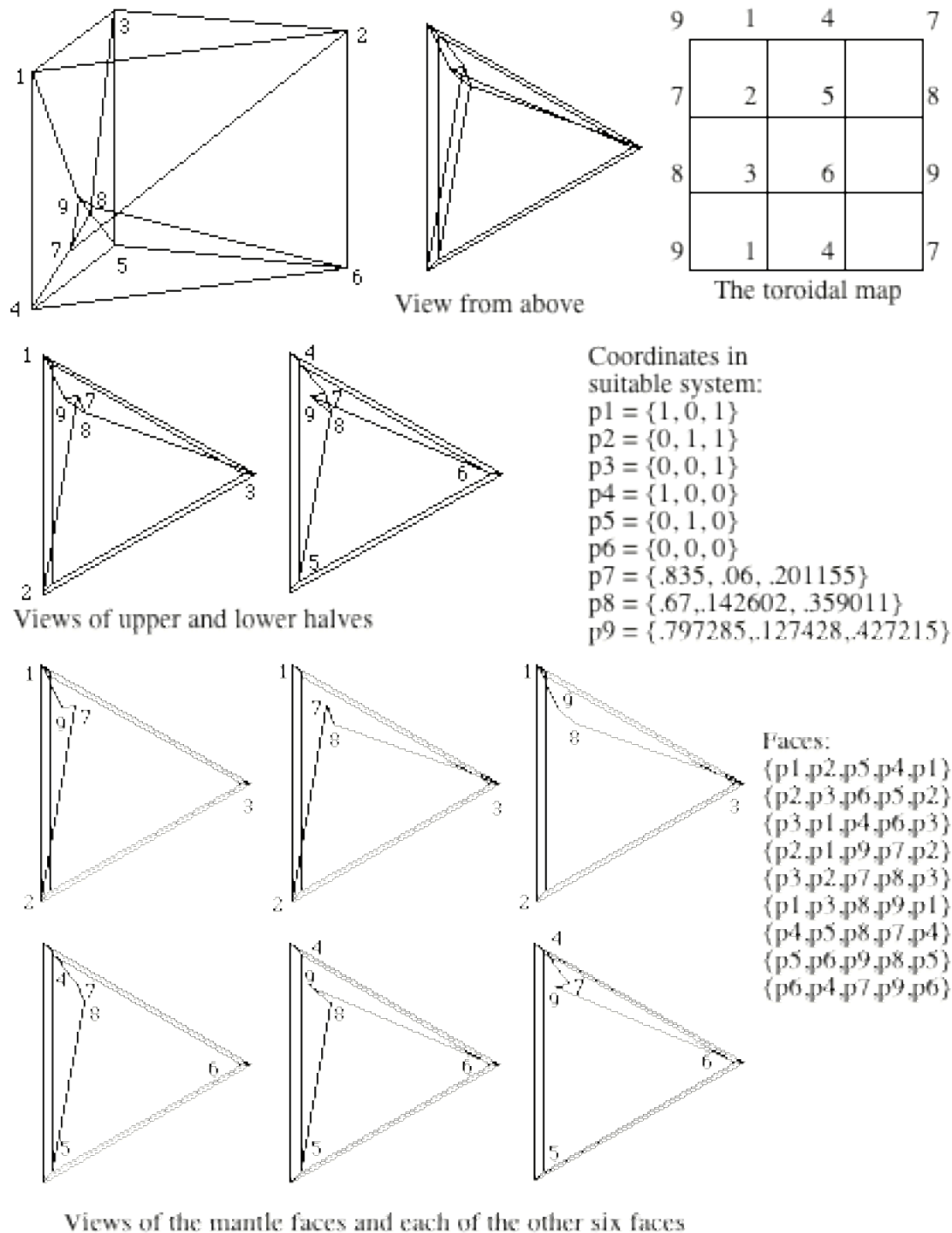

Figure 13. The Ljubic' torus, an acoptic realization of the 9-face quadrangulation shown top right, that is not realizable by convex-faced acoptic polyhedra.

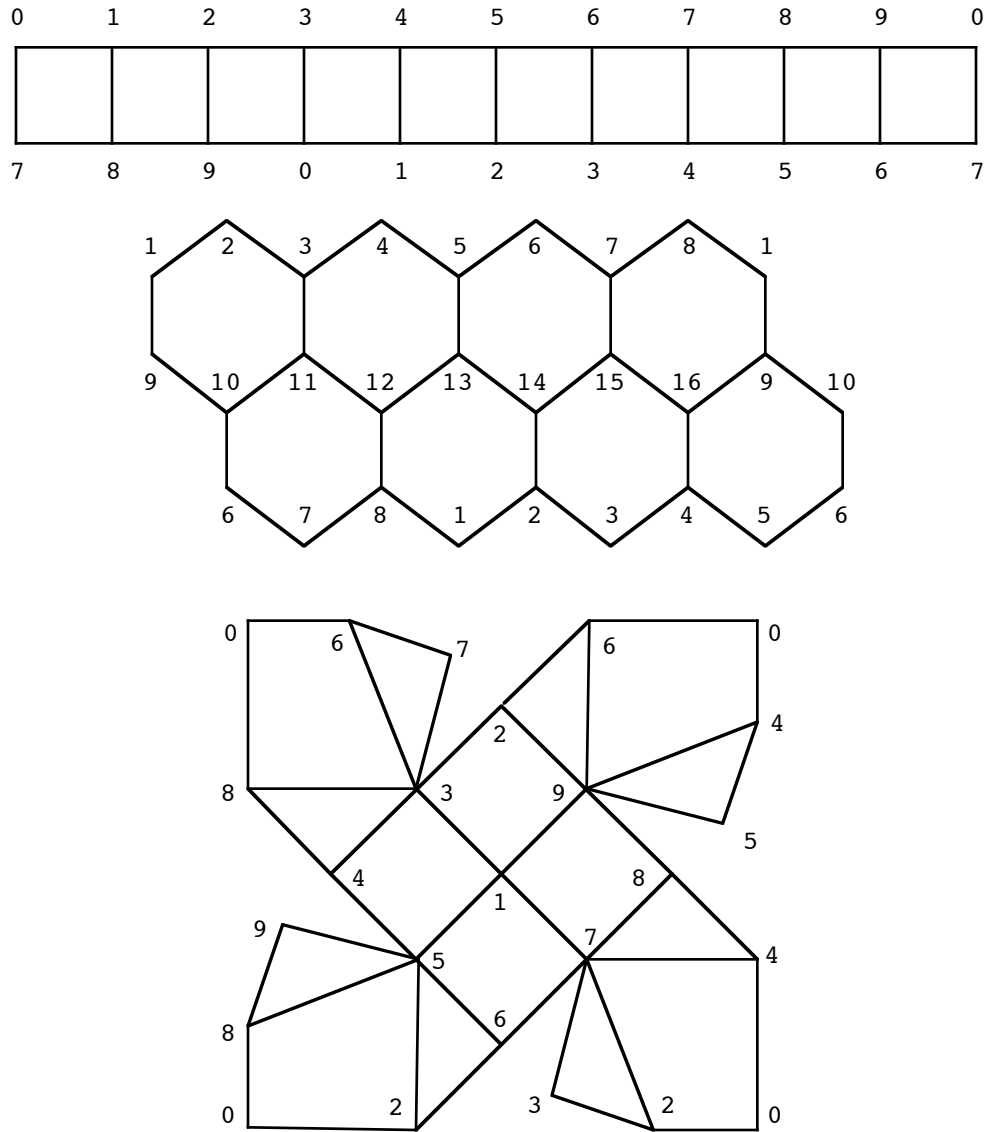

Figure 14. Three maps without overarching elements, for which it is not known whether they can be realized by acoptic polyhedra. The first two are toroidal, the last has genus 2 and appears in [P1] as an example in a different context.

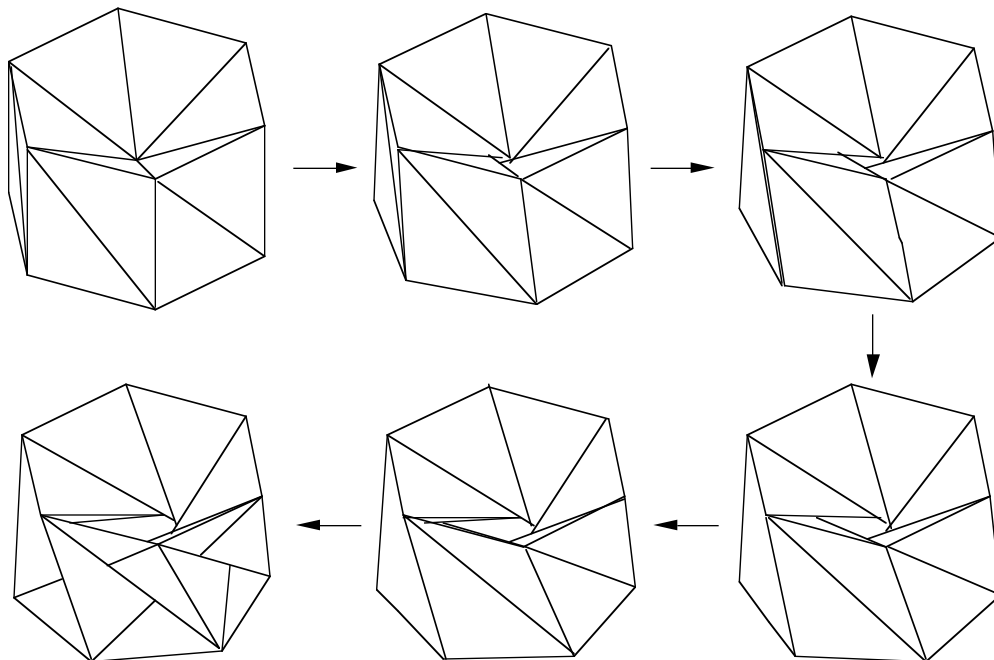

Figure 15. Several isogonal tori that realize the regular map  $\{3,6\}_{2,2}$ . All are acoptic except the first and the last, which are weakly acoptic.

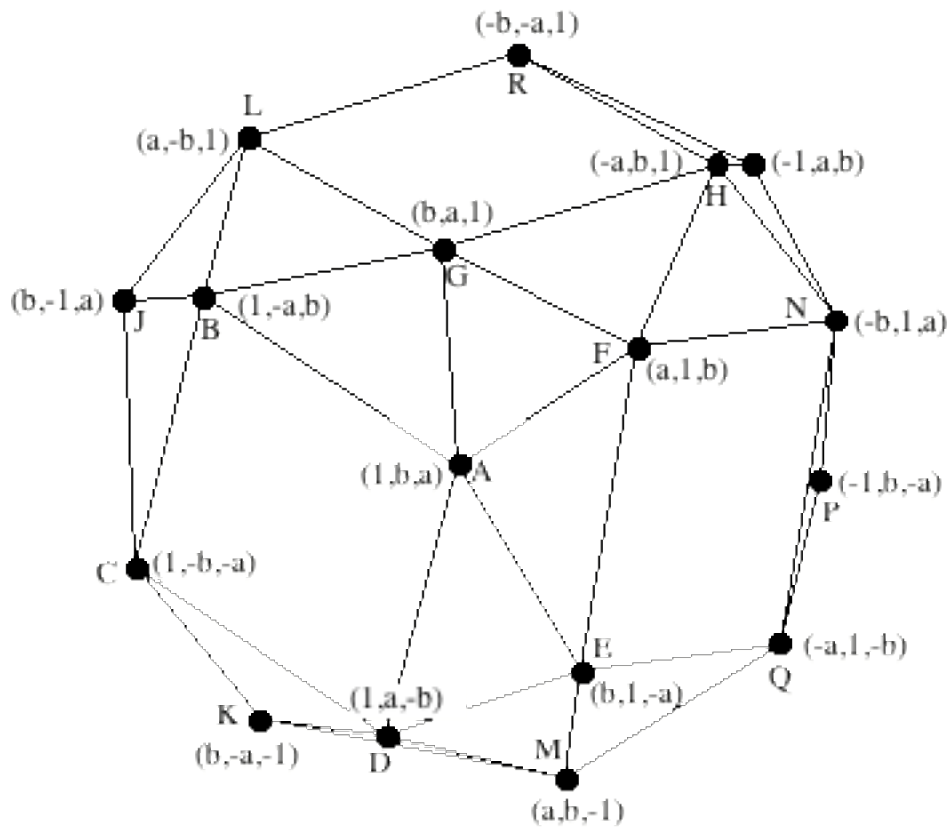

Figure 16. A snub cube  $(3.3.3.3.4)$ , with notation for its vertices, and with indication of a parametrization of the vertices which is convenient for isogonal polyhedra of this combinatorial type.

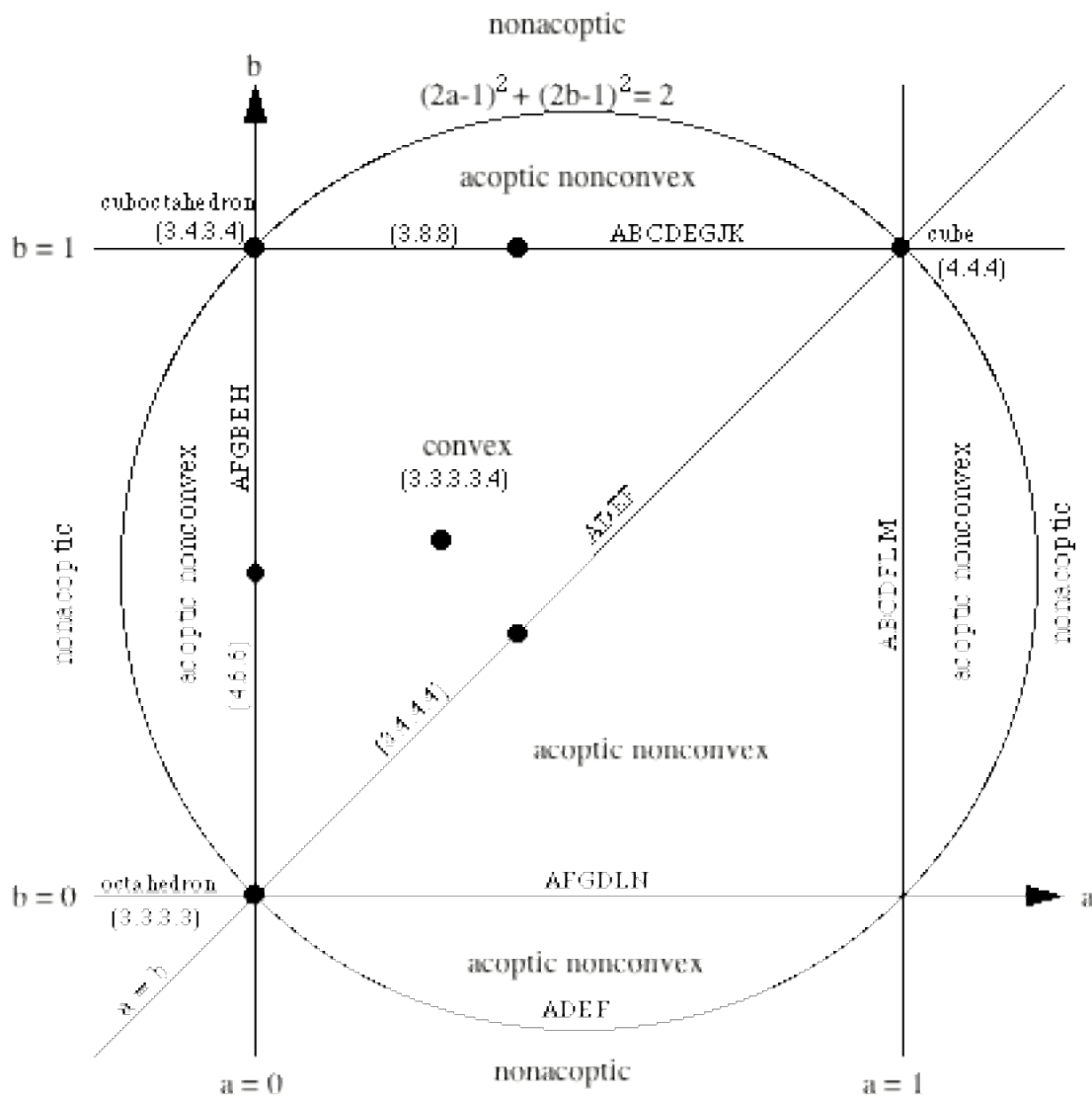

Figure 17. Dynatogram for acoptic isogonal polyhedra of combinatorial type of the snub cube,  $(3.3.3.3.4)$ . The parameters  $a$  and  $b$  determine the coordinates of the vertices, as shown in Figure 16. All regions outside of the large circle correspond to nonacoptic polyhedra, while the polyhedra with parameter values on the circle are weakly acoptic. The strings of capital letters near the lines and the circle indicate (in the notation of Figure 16) examples of sets of coplanar vertices. The symbols for isogonal polyhedra near the lines and near three of the vertices of the square indicate to which isogonal polyhedra the polyhedra of type  $(3.3.3.3.4)$  are isomegetic (that is, consist of the same set of points). The solid dots indicate the parameter values for which the polyhedra of type  $(3.3.3.3.4)$  are isomegetic to a uniform (Archimedean) polyhedra. The uniform (Archimedean) snub cube  $(3.3.3.3.4)$  corresponds to the parameter values  $a = 0.29955977$ ,  $b = 0.5436890$ .

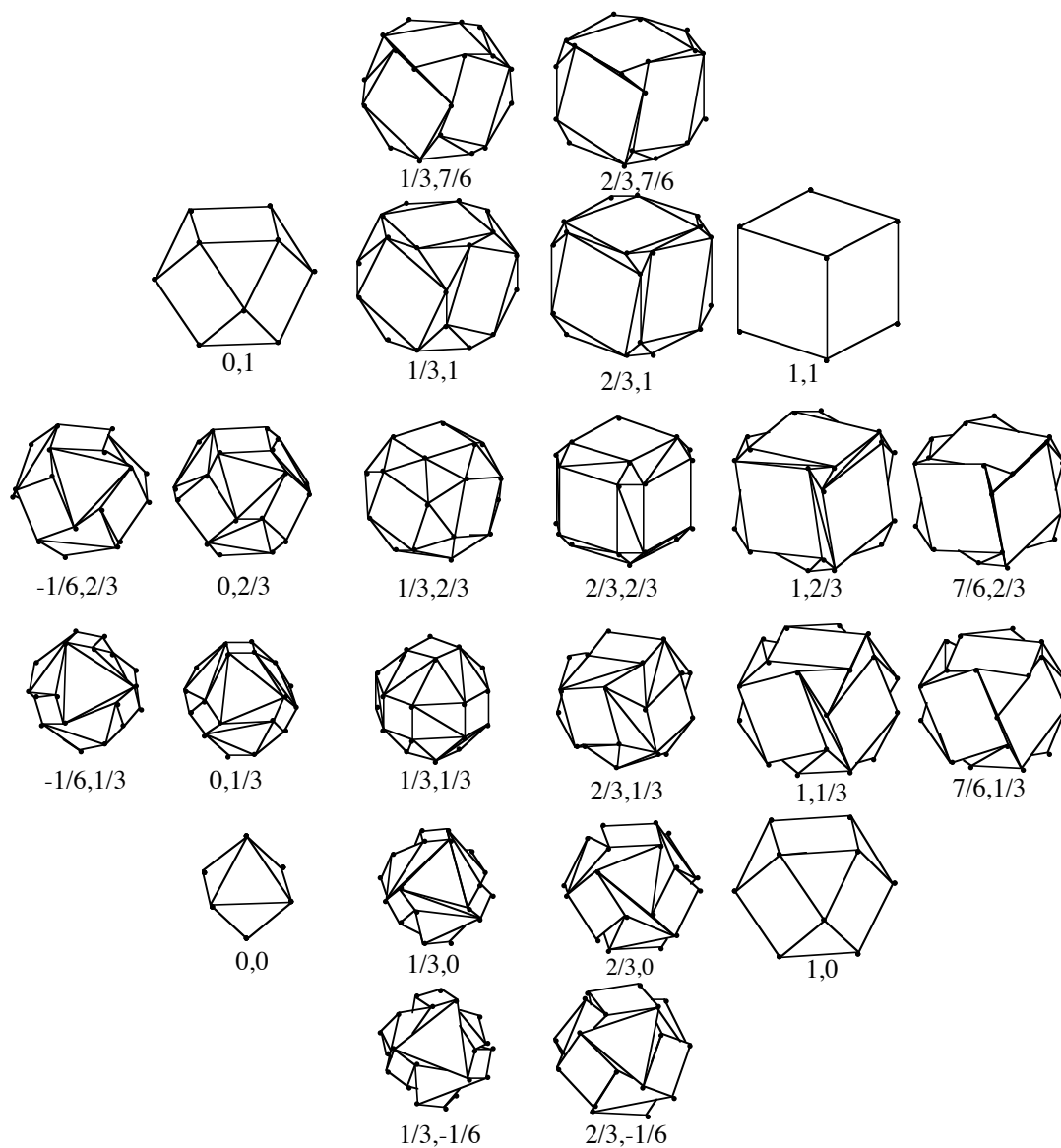

Figure 18. A panorama of acoptic isogonal polyhedra combinatorially equivalent to the snub cube (3.3.3.3.4). This panorama corresponds to the dynatogram in Figure 17. The values of the parameters  $a$  and  $b$  are given under each polyhedron.



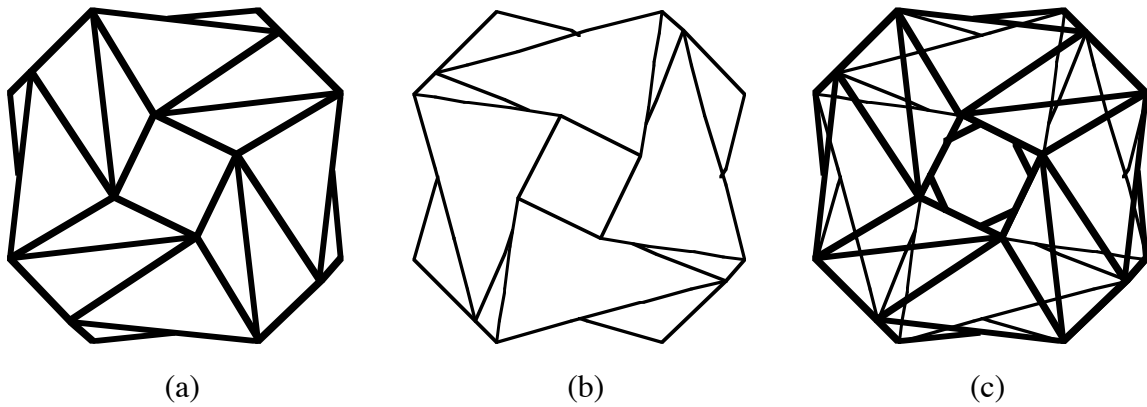

Figure 19. The Boolean sum of the polyhedron in (a) which corresponds to  $(a,b) = (1/3, 1/6)$ , with the polyhedron in (b) for which  $(a,b) = (1/3, -1/6)$ , yields the isogonal acoptic polyhedron in (c); the elimination of the square faces makes the bottom part of the polyhedron visible in (c). The polyhedron in (c) is a realization of the regular map  $(3,8)_{12}$  (which is map #96.162 in Wilson's catalog [W5] of regular maps).

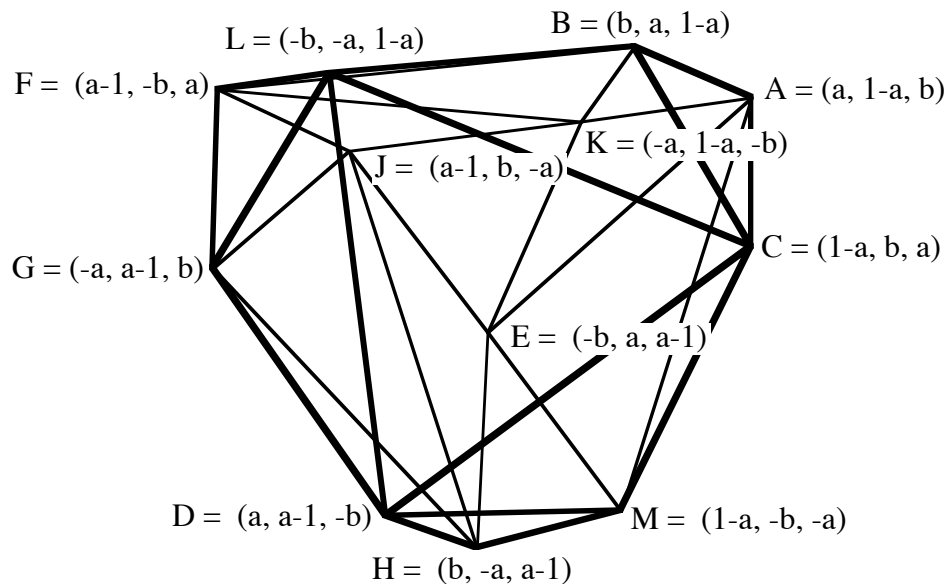

Figure 20. An icosahedron  $(3.3.3.3.3)$ , with notation for its vertices, and with indication of a parametrization of its vertices which is convenient for isogonal polyhedra of this combinatorial type.

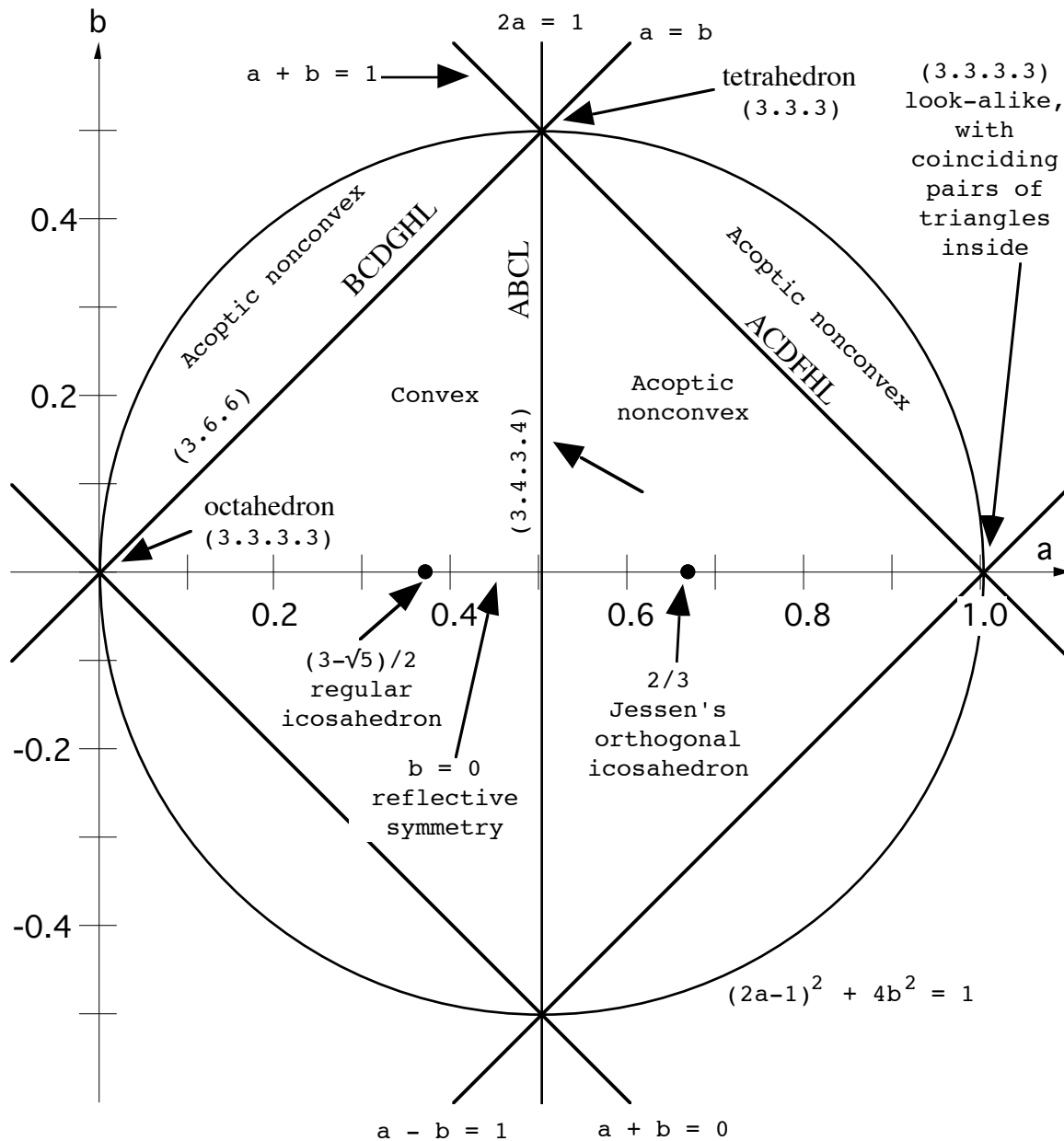

Figure 21. Dynatogram for acoptic isogonal polyhedra of combinatorial type of the icosahedron, (3.3.3.3.3). As shown in Figure 20, the parameters  $a$  and  $b$  determine the coordinates of the vertices; they are given (in Cartesian coordinates) by all cyclic permutations of  $(\pm a, \pm(1-a), \pm b)$  with an even number of minus signs. The similarity of many features of this dynatogram with the dynatogram of snub cubes in Figure 17 is not surprising since icosahedra can be interpreted as "snub tetrahedra". However, since triangles here play the roles played by both triangles and squares in the case of snub cubes, polyhedra corresponding to the bottom part of the dynatogram are congruent mirror images of the polyhedra corresponding to the upper part; polyhedra with  $b = 0$  have mirror-symmetry.

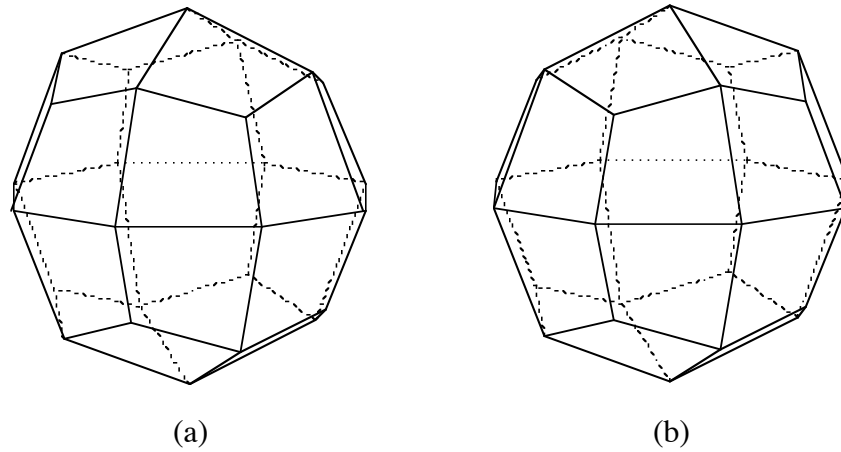

Figure 22. (a) A monohedral polyhedron which is not isohedral. It is the polar of the pseudorhombicuboctahedron. (b) An isohedral polyhedron with the same protoface; it is the polar of the rhombicuboctahedron.

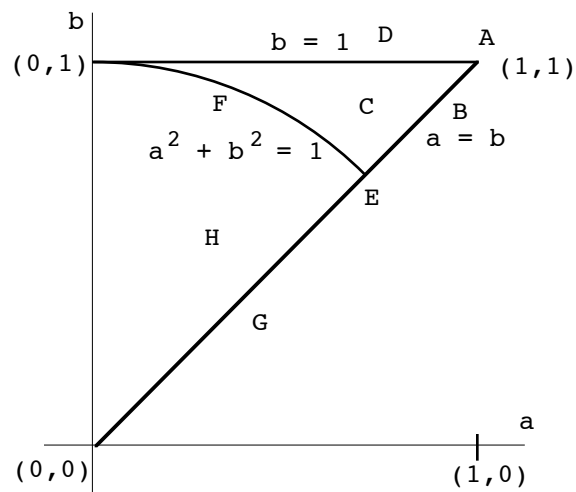

Figure 23. A dynatogram of monohedral (and isohedral) octahedra that have as prototile a triangle with sides  $a \leq b \leq c = 1$ .

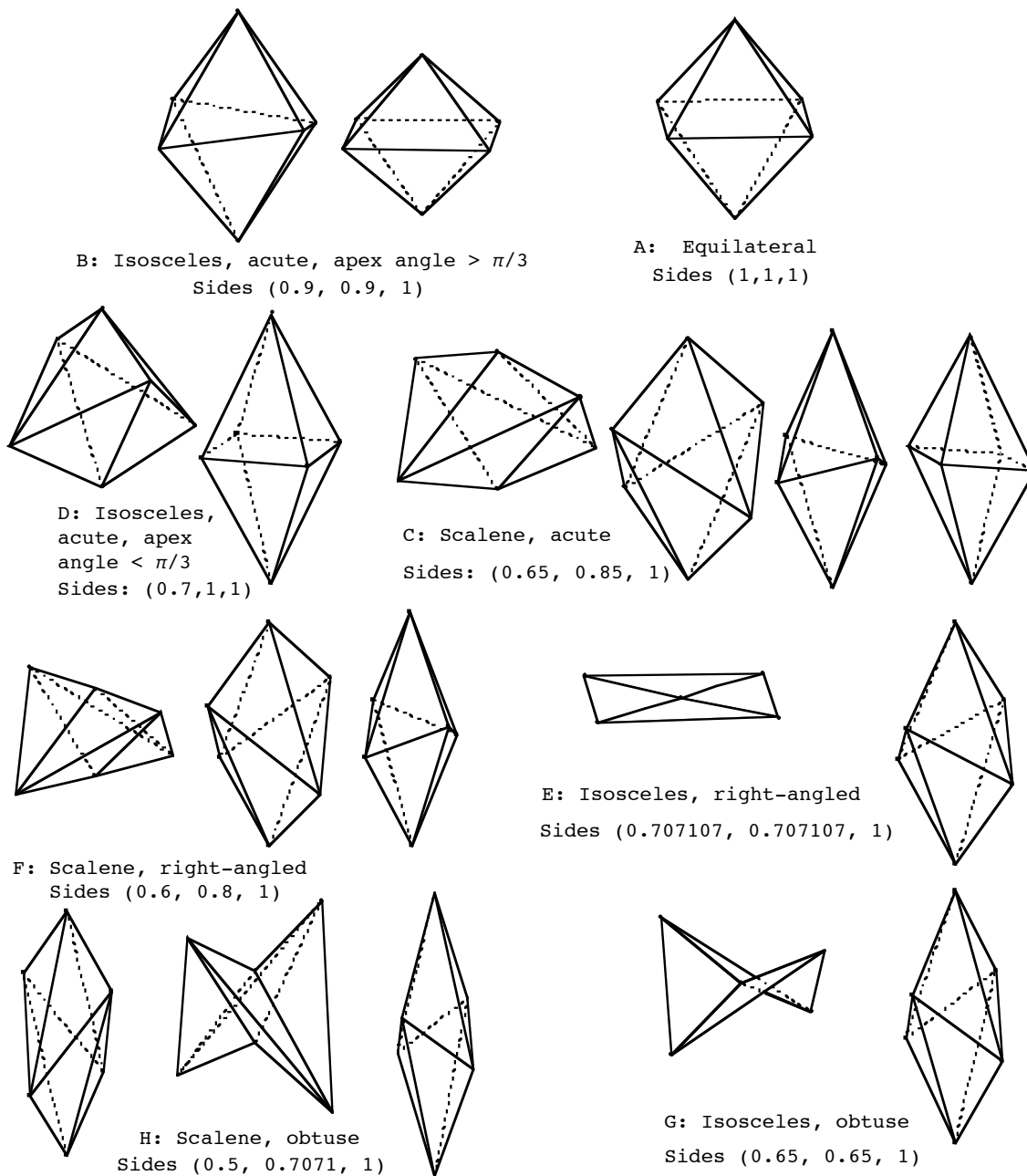

Figure 24. A panorama of the monohedral octahedra, corresponding to the dynatogram in Figure 23. The panorama is greatly distorted, due to the necessity of accomodating up to four polyhedra at one location.

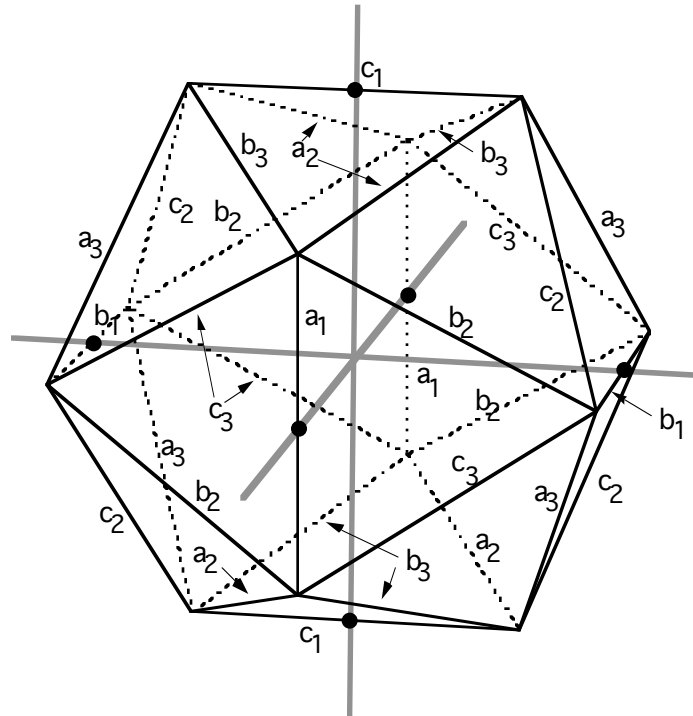

Figure 25. Notation used in Figure 26, for the edges of one type of monohedral acoptic icosahedra combinatorially equivalent to the regular icosahedron. The polyhedra in question have three mutually perpendicular axes of halfturn symmetry, indicated by the shaded lines.

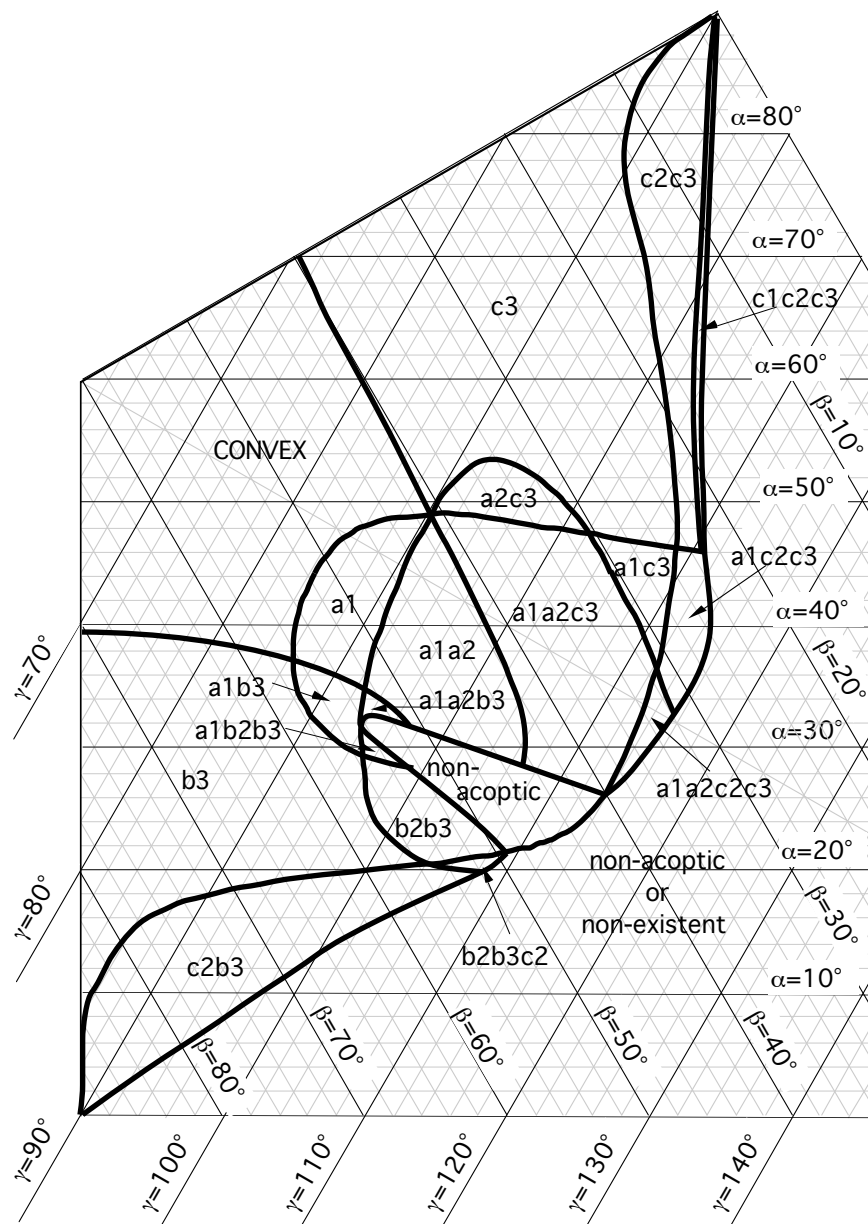

Figure 26. An empirical dynatogram of the convexity types of the kind of acoptic polyhedra isomorphic to the regular icosahedron described in Figures 24 and 25.. The symbols designate the nonconvex edges, in the notation of Figure 25. The parameters are the angles of the protoface, and the presentation of the dynatogram is in trilinear coordinates.

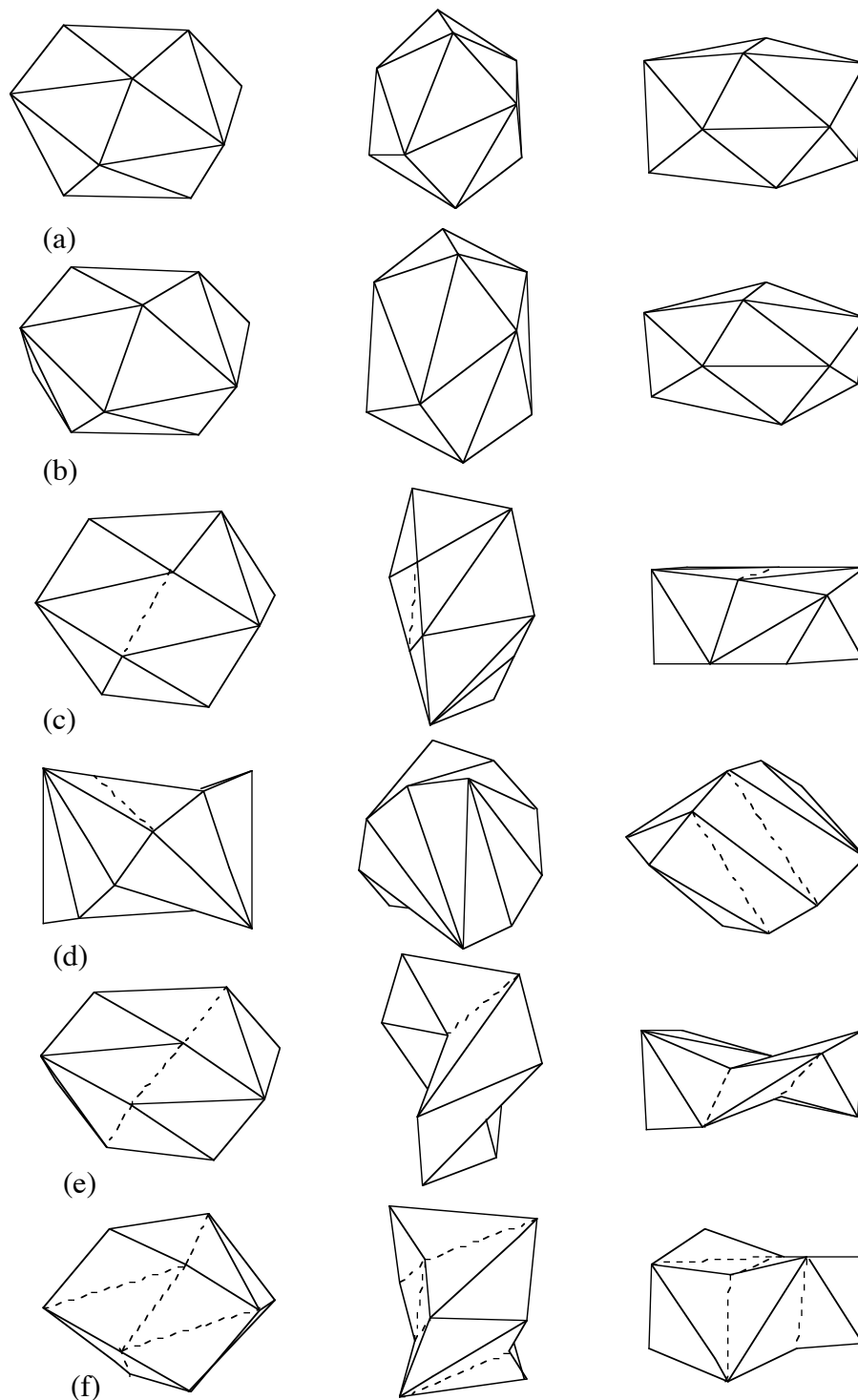

Figure 27. Examples of monohedral icosahedra with three mutually perpendicular axes of 2-fold symmetry. Each is shown in perspective views from three different direction (close to — but not coinciding with — the three axes of symmetry); concave edges are indicated by dashed lines. (a) and (b) show the two distinct convex icosahedra having as protoface a  $45^\circ$ - $60^\circ$ - $75^\circ$  triangle. The protoface in (c) is a  $45^\circ$ - $45^\circ$ - $90^\circ$  triangle, and in (d) a  $24.4^\circ$ - $77.8^\circ$ - $77.8^\circ$  triangle. In both only the edges of one orbit are concave, but it is a 2-edge orbit in (c) and a 4-edge orbit in (d). The two icosahedra with a  $34^\circ$ - $46^\circ$ - $100^\circ$  triangle as protoface are shown in (e) and (f); the former has edges of two orbits concave, while the latter has edges of three orbits concave.

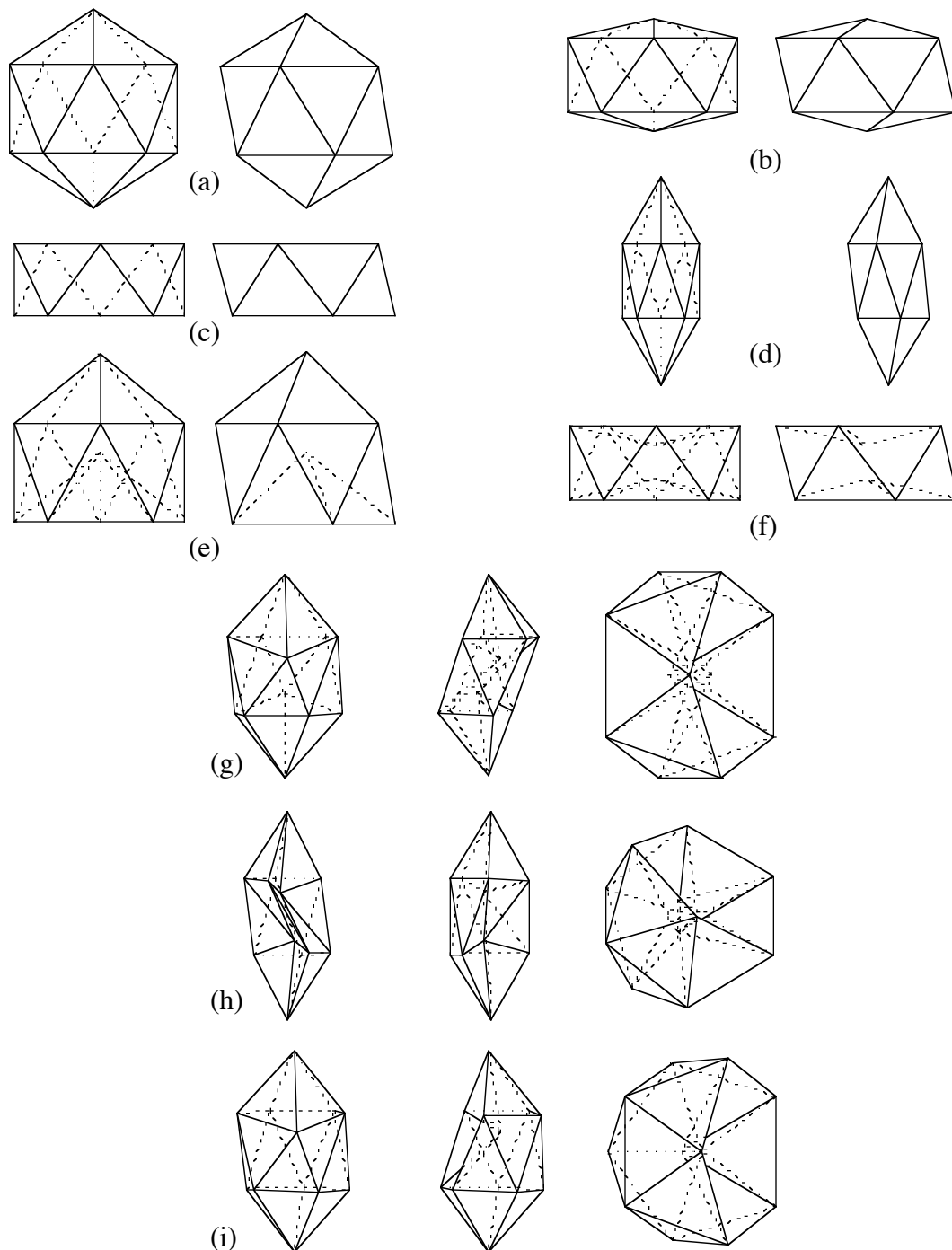

Figure 28. Examples of monohedral polyhedra with isosceles triangles as protofaces, and combinatorially equivalent to the regular icosahedron. The first six have an axis of 5-fold rotational symmetry; the axis is taken as vertical, and each polyhedron is presented by two views in horizontal, mutually perpendicular directions. The last three polyhedra are shown in views from three mutually perpendicular directions. The symmetry groups are: (a)  $[3,5]$ ; (b), (c), (d), (f)  $[2,5]$ ; (e)  $[5]$ ; (g)  $[2,1]$ ; (h)  $[2]^+$ ; (i)  $[1]$ . If symmetry groups are taken into account, all polyhedra shown are of different isomorphism types, except for (b) and (d); these two have the same isomorphism type and are equiform but not symmetrically equiform.



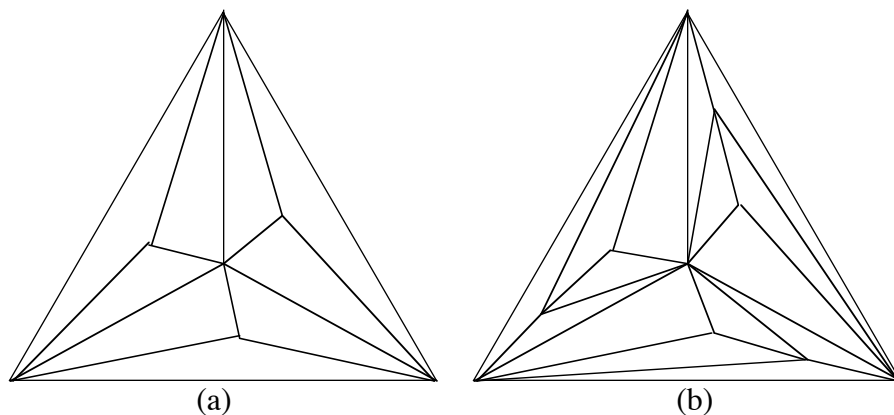

Figure 29. Schlegel diagrams of two convex polyhedra; the polyhedron in (a) does not have a monohedral realization as a convex polyhedron, while the one in (b) cannot be monohedrally realized even with a weakly convex polyhedron.

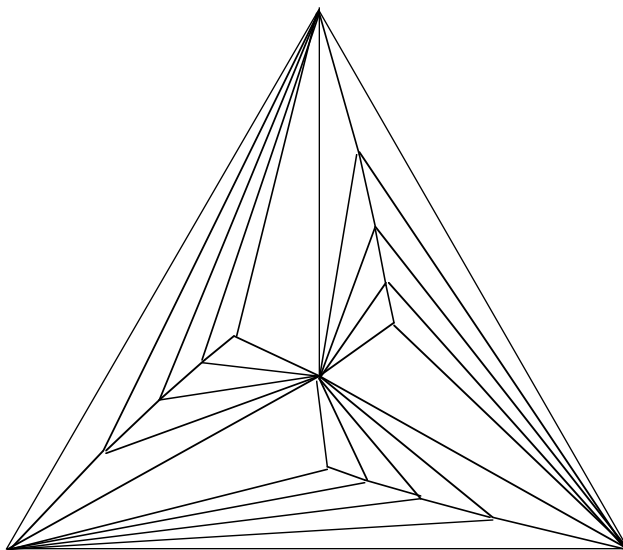

Figure 30. A Schlegel diagram of a convex polyhedron for which no combinatorially equivalent acoptic polyhedron is monohedral.

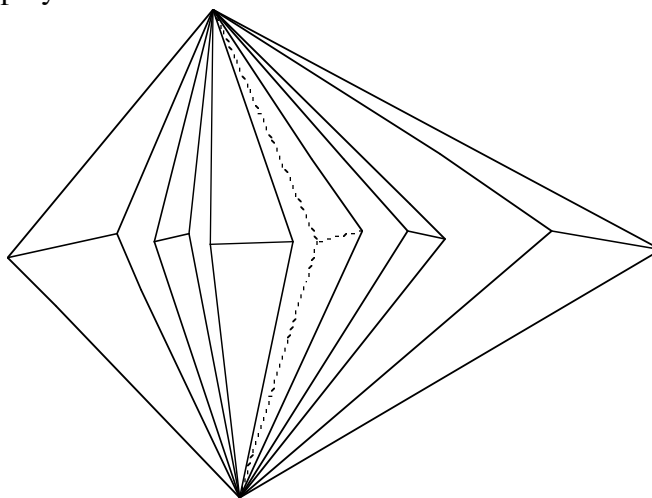

Figure 31. An acoptic polyhedron of genus 0 with no spanning tree of valence  $\leq 3$ .

