

CONSTRUCTION EQUIPMENT

Since 1983

2023-2024

V.12

WTR WESTCHESTER TOOL RENTALS

**RENTALS • SALES • SERVICE
CONTRACTOR • HOMEOWNER**



wtrrentals.com

**11 VREELAND AVE ELMSFORD • 914-592-2016
1075 WASHINGTON ST PEEKSKILL • 914-739-9000**

40 YEAR
ANNIVERSARY

1983 — 2023

To Our Customers...

It is our goal that our catalog will help guide you in the selection of the tools and equipment you need. Please keep in mind this catalog does not represent our total inventory. It is a small depiction of the hundreds of new and used items we have available. So if you don't see what you need please give us a call, we probably have it, but if not we can get it for you. Sincerely, Karin Puff, President Westchester Tool Rentals.

SOME THINGS YOU SHOULD KNOW

Hours

7:00 am -5pm Monday thru Saturday
Closed Sundays and Major Holidays
(Sunday and Holiday rentals available)

These are abbreviated terms - Full terms and conditions can be found on the rental contract and our website.

Rental Day

The rental day is based on an 8 hour period. Any equipment used double shift will be charged one and a half times the daily rate; triple shift two times the rate. Special arrangements can be made for 5:00 p.m. pick ups for the next day rentals. Equipment is charged for time out, not time used. Come early for maximum use/greatest value!

Sunday & Holidays

A one-day minimum charge applies to all tools picked up on the eve before the holiday and returned by 8:00 a.m. the next business day. If the tool is used for two days, the two day charge applies.

Overtime Charges

Overtime charges will be assessed for equipment not returned on time. Arrangements for late returns must be approved as equipment due back is often scheduled for rental.

Long Term Rentals

Call for more information.

Terms & Conditions

A cash deposit and/or a major credit card is taken on all rentals and varies depending on the rentals rate and length of rentals. Adequate identification is required for all rentals.

Open Account

Credit may be extended to select accounts

with a completed application. Terms are net 30; past due accounts will be closed.

Delivery Rates

Delivery is available for larger rental equipment and is charged based upon location. Rental time begins when equipment leaves our premises. Customer must call to schedule a pick up. A pick up number will be given to document the call and time equipment is taken off rental. All rental items remain on rental until a pick up is scheduled. We do not automatically pickup equipment at the end of the work day.

Customer is responsible for all items until they are picked up.

Fuel

Customer pays for all fuel used. All equipment is rented full of fuel and must be returned full or a refueling charge will be applied.

Reservations

We will gladly reserve equipment in advance whenever possible. If for any reason a reservation cannot be kept it is the obligation of the customer to call not later than 8:00 am on the day of the reservation. These terms must be met or a one day charge will be billed and future reservations will not be honored.

Loss

In the event equipment is lost or stolen customer will be billed for replacement cost plus accrued rental charges to time of notification.

Damage Waiver

Customers may obtain our damage waiver on most equipment for a charge of 12% of the rental. This waiver covers 80% of the repair cost and limits the customer to 20% of the replacement cost of equipment damaged beyond repair. Damage waiver does not cover abuse, theft or lost parts.

Ready for Rental

All equipment is inspected, tested and operated before leaving our premises to verify good working order. A charge will be assessed for any items returned damaged, with excessive wear, or exceptionally dirty.

**Hydraulic Hoses Made
While-U-Wait**



Dig Safely. New York
Call 811
before you dig



**No Truck? No Time? No Problem!
We Deliver to Your Door or Job!**

Open Monday to Saturday 7am-5pm

**914-592-2016 ELMSFORD
914-739-9000 PEEKSKILL**

TABLE OF CONTENTS:



4-7

CONTRACTOR



8-9

**CONCRETE
EQUIPMENT**



10-13

**FLOOR CARE
SURFACE PREP**



14-15

**COOLING
HEATING**



16-20

**LAWN &
GARDEN**



21

UTVS



21

**GROUND
HEATER**



22-24

**GENERATORS &
POWER DISTRO.**



25

AIR COMPRESSORS



26-31

EARTH MOVING



32

**TRAILERS &
DUMP TRUCK**



33

COMPACTION



34-35

LIFTS & BOOMS



36-37

**MATERIAL
HANDLING**



38-40

**SCAFFOLDING
& LADDERS**



41

**PRESSURE
WASHERS**



42-43

PLUMBING



44

PUMPS



45-47

POWER TOOLS



48-49

WELDING



50

MISC.



52-57

PARTY PAGES



914-592-2016 | 914-739-9000
OPEN MONDAY - SATURDAY 7 TO 5

NO TRUCK? NO TIME?
NO PROBLEM! WE DELIVER!



#602 MASONRY SAW 47"
WET | 14" BLADE INCL.
\$195 DAY | \$585 WK



#147 BLOCK SAW
WET | 14" BLADE INCL.
\$100 DAY | \$395 WK



#603 DRI-CUT BLOCK CUTTER
DRY | 14" BLADE INCL.
\$116 DAY | \$464 WK

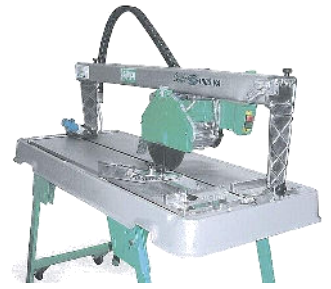

#601 TILE SAW 24"
WET | 10" BLADE INCL.
\$110 DAY | \$440 WK



#70 CORE DRILL RIG
ELEC. 2" TO 14" CAPACITY
\$125 DAY | \$375 WK



#71 CORE DRILL VACUUM
ELEC. | GASKETS INCL.
\$23 DAY | \$92 WK



#72 CORE DRILL
HAND HELD | ELEC. | 3" CAP.
\$90 DAY | \$360 WK



#649 HAND WATER PUMP TANK
PORTABLE | HAND HELD
\$15 DAY | \$45 WK



**CORE BITS
AVAILABLE TO RENT & BUY**



#335 INSULATION BLOWER
INCL. 100' OF HOSE
\$88 DAY | \$352 WK



#348 STUD GUN
10 SHOT | .27 LV
\$40 DAY | \$120 WK



#347 STUD GUN
SINGLE SHOT | .22 LV
\$33 DAY | \$132 WK



#140 SHEETROCK LIFTER
11' TILTING | UP TO 12' LONG
\$46 DAY | \$184 WK



#137 SHEETROCK DOLLY
3,000 LB CAP.
\$20 DAY | \$60 WK



#337 DRYWALL SANDER/VACUUM
SANDER & VACUUM IN ONE
\$66 DAY | \$264 WK



#334 HEPA AIR SCRUBBER
(FILTERS SOLD SEPARATELY)
\$35 DAY | \$140 WK

"NEGATIVE AIR"





CALL TODAY FOR MONTHLY RATE!

#638 DUST COLLECTION KIT

*DOES NOT INCL. VACUUM
\$13 DAY | \$ 39 WK



#93 POST / STAKE DRIVER

44 LB | GAS
\$83 DAY | \$332 WK



#90 DEMO HAMMER

50 LB | HILTI BITS | ELECTRIC
\$80 DAY | \$320 WK



#95 PAVEMENT BREAKER *

HAMMER | 28 LB | HILTI TE
\$90DAY | \$360 WK



#94 DEMO HAMMER

68 LB | 1-1/8" STEEL | ELECTRIC
\$100 DAY | \$395 WK

Gas - 2 cycle



**WE SELL & RENT
DIAMOND BLADES!**



#283 CUT OFF SAW *

14" | 2 CYCLE | GAS
\$80 DAY | \$320 WK



#40 ROTARY HAMMER DILL

CHIPPING DRILL 2" | SDS
\$80 DAY | \$320 WK



#91 ROTARY HAMMER DRILL

CHIPPING DRILL 1-1/2" | SDS
\$55 DAY | \$220 WK

Gas - 2 cycle



DRILL BITS SDS & TE

*FOR SALE OR RENT



#284 DIAMOND CHAIN SAW *

14" | 2 CYCLE | GAS
\$145 DAY | \$580 WK



#287 HILTI VACUUM

9.5 GAL CAPACITY
\$72 DAY | \$288 WK



#286 HILTI CUT-OFF SAW *

12" | UP TO 4-3/4" | ELEC
\$60 DAY | \$240 WK



914-592-2016 | 914-739-9000
OPEN MONDAY - SATURDAY 7 TO 5

**NO TRUCK? NO TIME?
NO PROBLEM! WE DELIVER!**



**#426 LIGHT TOWER W/
GENERATOR**

4 LIGHT | 4000 WATT | DIESEL
\$176 DAY | \$495 WK



#121 POST SHORING JACK

ADJ. 7' - 11'
\$13 DAY | \$26 WK



#120 SCREW JACK

20 TON
\$15 DAY | \$30 WK



#126 BOTTLE JACK

20 TON | HYDRAULIC
\$23 DAY | \$46 WK

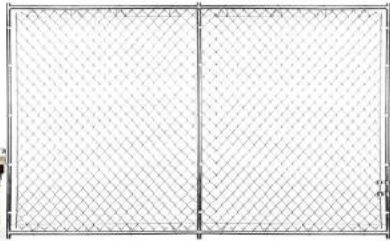

#596 TEMPORARY FENCE

8' X 8' PANEL
\$13 WK | \$33 MO



**#599 BASE PLATE
FOR TEMPORARY FENCE**
\$6 WK | \$11 MO



#589 TEMPORARY FENCE

8' BIKE RACK
\$29 DAY | \$43 WK



#370 VENTILATION BLOWER

GAS | 8" DUCT
\$46 DAY | \$185 WK



#371 VENTILATION BLOWER

ELECTRIC | 8" DUCT
\$53 DAY | \$211 WK



#565 VENTILATION BLOWER

ELECTRIC | 12" DUCT
\$53 DAY | \$212 WK



#171 PEDESTAL FAN 24"

\$35 DAY | \$105 WK



#570 BUILDERS LEVEL

AUTOMATIC
\$50 DAY | \$200 WK



#138 TRANSIT / LEVEL

\$46 DAY | \$184 WK



#139 LASER LEVEL

EXTERIOR | W/ RECEIVER
\$57 DAY | \$229 WK



#172 FLOOR FAN 42"

\$46 DAY | \$138 WK



#520 TRASH CHUTE HOPPER
WINDOW OR ROOF
\$33 DAY | \$66 WK

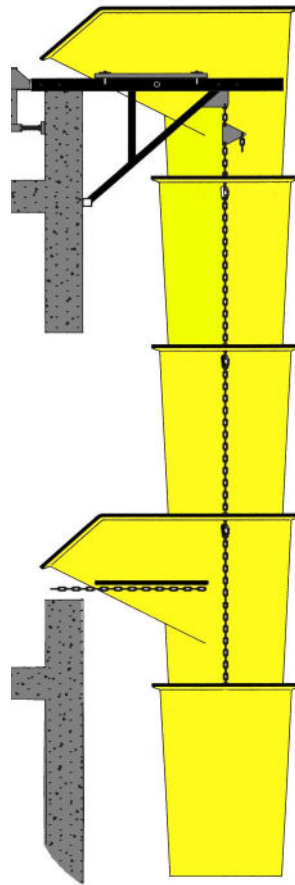

SAMPLE TRASH CHUTE

#518 TRASH CHUTE WINCH KIT
\$66 DAY | \$198 WK



#428 ARROW BOARD
25 LIGHT
\$138 DAY | \$414 WK

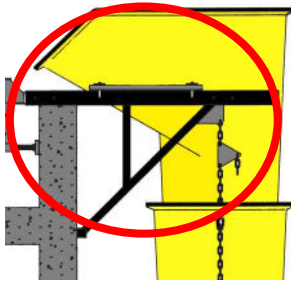

#519 PARAPIT OUTRIGGER
TRASH HOPPER BRACKET ONLY
\$13 DAY | \$26 WK

CALL TODAY FOR
MONTHLY RATE!



#522 WINDOW HOPPER
TRASH CHUTE
\$33 DAY | \$66 WK

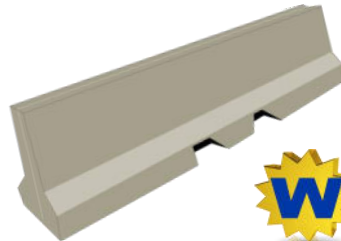

#1221 JERSEY BARRIER
10' | 4,000 #
\$165 WK | \$330 MO



#427 MESSAGE BOARD
126" X 76" FULL MATRIX
\$260 DAY | \$780 WK



#521 TRASH CHUTE
30" X 4'
\$28 DAY | \$56 WK



#860 DURA-DECK
PLASTIC PROTECTIVE MATTING
4' X 8' X 1/2"
USE IN PLACE OF PLYWOOD
\$11 DAY | \$28 WK

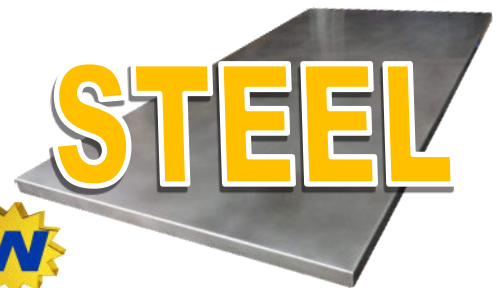

#480 ROAD PLATE
5' X 8' OR 6' X 12' | 1" THICKNESS
\$100 WEEK | \$300 MO



914-592-2016 | 914-739-9000
OPEN MONDAY - SATURDAY 7 TO 5

NO TRUCK? NO TIME?
NO PROBLEM! WE DELIVER!



#46 CONCRETE SAW *
14" | GAS | PUSH
\$95 DAY | \$380 WK



#392 ELECTRIC SAW *
18" | 5 HP 220V | 1 PHASE
\$150 DAY | \$600 WK



#45 CONCRETE SAW *
20" SELF PROPELLED | 20HP
\$185 DAY | \$740 WK



#550 ROAD SAW*
30" | SELF PROPELLED | 35HP GAS
\$325 DAY | \$1,430 WK



#283 CUT-OFF SAW *
14" GAS | 2 CYCLE
\$80 DAY | \$320 WK



#286 CUT-OFF SAW *
12" ELECTRIC 110 VOLT
\$60DAY | \$240 WK



CHAINS ARE A SALE ITEM
#284 DIAMOND CHAIN *
14" | 2 CYCLE | GAS
\$145 DAY | \$580 WK



#444 REBAR CUTTER
BENDER HAND
\$29 DAY | \$87 WK

*** DIAMOND BLADES & CHAINS ARE FOR SALE OR RENT! CALL FOR MONTHLY RATES!**

Supplies Available by the Bag or Pallet!



We Sell, Service and Repair Your Favorite Brands



**We have a huge
selection of**

Diamond Blades & Core Bits





#661 ELECTRIC REBAR CUTTER

#3 TO #8
\$66 DAY | \$198 WK



#660 ELECTRIC REBAR BENDER

#3 TO #8
\$165 DAY | \$495 WK

CALL TODAY FOR MONTHLY RATE!

#36 TRACK BUGGY
16 CU. FT. GAS | RIDE-ON
\$210 DAY | \$840 WK

#37 TRACK BUGGY
16 CU FT PIVOT DUMP
GAS | RIDE-ON
\$230 DAY | \$920 WK



RUBBER TRACKS!



#38 CONCRETE BUGGY

21 CU. FT. | RIDE-ON
\$145 DAY | \$580 WK



#49 CONCRETE MIXER

3 CU. FT. | ELECTRIC
\$48 DAY | \$192 WK



#53 CONCRETE MIXER

9 CU. FT. | 1-1/2 BAG | GAS
\$90 DAY | \$360 WK



#54 MORTAR MIXER

1-1/2 BAG | 9 CU. FT. | GAS
\$88 DAY | \$352 WK



#35 CONCRETE CHUTE

12' ALUMINUM
\$18 DAY | \$54 WK



#52 GAS VIBRATOR

BACKPACK | 10' SHAFT
\$77 DAY | \$308 WK



#50 PENCIL VIBRATOR

3/4" HEAD | 9' SHAFT
\$57 DAY | \$228 WK



#48 CONCRETE VIBRATOR

2" HEAD | 14' SHAFT
\$64 DAY | \$256 WK



#265 WHEELBARROW

8 CU. FT. - FLAT FREE TIRES
\$13 DAY | \$26 WK



#544 BULL FLOAT

8" X 48" ADJ. PITCH | 6' HANDLES
\$30 DAY | \$90 WK



#51 POWER SCREED

1 MAN | 10' / 12'
\$92 DAY | \$368 WK



#47 POWER TROWEL *

36" | 4 BLADE | GAS
\$92 DAY | \$368 WK

* FLOAT BLADES AVAILABLE



914-592-2016 | 914-739-9000
OPEN MONDAY - SATURDAY 7 TO 5

**NO TRUCK? NO TIME?
NO PROBLEM! WE DELIVER!**



#80 BUFFER 16"
\$42 DAY | \$167 WK



#943 FLOOR SCRAPER
FOR ELECTRIC HAMMERS
\$20 DAY | \$60 WK



#80CS TCAD
\$40 DAY | \$120 WK



#80HW DIAMA BRUSH
HARDWOOD SCRAPER
\$88 DAY | \$352 WK



#80MR DIAMA BRUSH
MASTIC REMOVAL
\$110 DAY | \$330 WK



#80CP DIAMA BRUSH
CONCRETE PREP BRUSH
\$88 DAY | \$352 WK



#80DD DRIVER DISK
\$22 DAY | \$66 WK



#586 DIAM-A-TACH DIAMOND
SEGMENT GRINDING SYSTEM
\$50 DAY | \$150 WK EACH



#587 DIAM-A-TACH DIAMOND
SEGMENT GRINDING SYSTEM
\$50 DAY | \$150 WK EACH



#235 SCRAPE-A-TACH FLOOR
COATING REMOVAL SYSTEM
\$15 DAY | \$45 WK EACH

ATTACHMENT	GRIND CONCRETE FLOORS	ROUGHEN CONCRETE FLOORS	REMOVE THINSET	CLEAN CONCRETE FLOORS	REMOVE MATERIAL BUILD-UP	REMOVE FLOOR EPOXIES	REMOVE FLOOR PAINT	REMOVE FLOOR URETHANE	GRIND ASPHALT SURFACE
	✓	✗	✗	✓	✗	✓	✓	✓	✓
	✓	✗	✗	✓	✗	✓	✓	✓	✓
	✗	✗	✓	✗	✓	✓	✓	✓	✗

Preferred Method
 Acceptable Performance
 Limited Performance



#578 CONCRETE POLISHER *
ELECTRIC | *DIAMOND POLISHING PADS NOT INCLUDED*
\$105 DAY | \$420 WK

50 TO 800 GRIT
AVAILABLE FOR SALE
DIAMOND POLISHING PADS NOT INCLUDED



#579 CONCRETE DUST VACUUM ATTACHMENT
\$75 DAY | \$300 WK



#577 DUST COLLECTOR
110 V | ELECTRIC
\$88 DAY | \$352 WK



#233 FLOOR GRINDER *
DUAL HEAD | GAS
\$120 DAY | \$480 WK



#236 FLOOR GRINDER *
DUAL HEAD | 110 V | 30 AMP ELECTRIC
\$110 DAY | \$440 WK



#584 FLOOR GRINDER *
SINGLE HEAD | ELECTRIC
\$90 DAY | \$360 WK



#75 FLOOR STRIPPER *
ELECTRIC | 110 V | 1 PHASE
\$80 DAY | \$320 WK



#583 SURFACE PLANER 8"*
ELECTRIC | 220V | 1 PHASE
\$84 DAY | \$336 WK



#237 SURFACE PLANER 8" *
8" | 5.5 HP GAS
\$100 DAY | \$400 WK



#580 SURFACE PLANER 10" *
10" | 13 HP GAS
\$140 DAY | \$560 WK

*** BLADES SOLD OR RENTED SEPERATELY**

ATTACHMENT TYPE	VINYL TILE	LINOLEUM	RUBBER-BACKED CARPET	JUTE-BACKED CARPET	CERAMICTILE	MASTIC ADHESIVE	MEMBRANES	THIN SET	MATERIAL BUILD-UP
Mastic Removal	X	X	X	X	X	✓	✓	X	✓
Dual Reveled	✓	✓	✓	X	X	X	X	X	X
Scoring	✓	✓	✓	✓	X	X	✓	X	X
Single Reveled	✓	✓	✓	X	X	X	X	X	X



#581 10" PLANER FLAIL CARBIDE BLADE KIT
\$140 DAY | \$560 WK

#582 8" PLANER FLAIL CARBIDE BLADE KIT
\$110 DAY | \$440 WK



914-592-2016 | 914-739-9000
OPEN MONDAY - SATURDAY 7 TO 5

**NO TRUCK? NO TIME?
NO PROBLEM! WE DELIVER!**



#668 FLOOR SCRUBBER *
15" BRUSH | BATTERY
\$92 DAY | \$368 WK



#667 FLOOR SCRUBBER *
DUEL HEAD | BATTERY
\$185 DAY | \$740 WK



#627 FLOOR STEAMER
\$69 DAY | \$277 WK



#328 POWER BRUSH ATTACHMENT
\$23 DAY | \$92 WK



#665 CARPET CLEANER *
HOT WATER | 110 V | ELEC
\$75 DAY | \$300 WK



#329 CLEANER/EXTRACTOR *
CARPETS & UPHOLSTERY
\$35 DAY | \$140 WK



#628 CARPET CLEANER *
COMPACT WALK BEHIND
\$35 DAY | \$140 WK



**#327 UPHOLSTERY/
STAIR ATTACHMENT**
\$11 DAY | \$44 WK



#342 HYDROXYL GENERATOR
OCCUPANCY SAFER FOR ODOR
\$60 DAY | \$240 WK



#333 O-ZONE GENERATOR
FOR ODOR REMEDIATION
\$57 DAY | \$228 WK



#307 FLOOD SUCKER
VACUUM & PUMP
\$69 DAY | \$276 WK



#254 SHOP VACUUM *
WET / DRY | 10 GAL.
\$40 DAY | \$158 WK



**180 CFM
80 Pints**

#67 DEHUMIDIFIER
HEAVY DUTY 15 GALLON
\$44 DAY | \$176 WK



**325 CFM
130 Pints**

#336 DEHUMIDIFIER
EXTRA HEAVY DUTY
\$60 DAY | \$240 WK



#330 TURBO DRYER
110 VOLT | ELECTRIC
\$29 DAY | \$87 WK



#341 STUDEBAKER AIR MOVER
110 VOLT | ELECTRIC
\$40 DAY | \$120 WK

“NEGATIVE AIR UNIT”



#334 AIR SCRUBBER *
(FILTERS SOLD SEPARATELY)
\$35 DAY | \$140 WK



**#292 CARPET STRETCHER
POWER KIT**
\$44 DAY | \$132 WK



#55 CARPET KNEE KICKER
\$17 DAY | \$33 WK



#325 CARPET IRON *
110 VOLT | ELECTRIC
\$24 DAY | \$72 WK

Cleaning and finishing products available for sale



#01 SANDER & EDGER KIT
 \$95 DAY | \$380 WK



FLOOR AND CARPET



#77 PNEUMATIC FLOOR NAILER*
 2" T-NAILS
 \$45 DAY | \$180 WK



#68 UNDER RADIATOR FLOOR SANDER *
 \$35 DAY | \$140 WK



#76 FLOOR SANDER *
 EDGER 7"
 \$36 DAY | \$144 WK



#81 FLOOR DRUM SANDER*
 8" WIDE | VELCRO PAPER
 \$66 DAY | \$264 WK



#79 FACE NAILER*
 HARDWOOD FLOORS | 2" T-NAILS
 \$33 DAY | \$132 WK



#78 FLOOR NAILER*
 2" T-NAILS
 \$33 DAY | \$132 WK



#326 ORBITAL FLOOR *
 SANDER/BUFFER/POLISHER
 \$66 DAY | \$264 WK



#80 FLOOR BUFFER 16" *
 ATTACHMENTS AVAILABLE
 \$42 DAY | \$167 WK



#65 LAMINATE STAPLER *
 3/8 STAPLER
 \$35 DAY | \$140 WK



#104 LINOLEUM ROLLER
 \$18 DAY | \$72 WK



#57 FLOOR TILE VINYL CUTTER 12"
 \$23 DAY | \$69 WK

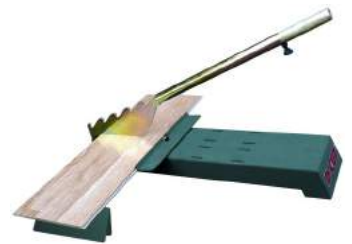

#297 LAMINATE CUTTER
 13" CAPACITY
 \$23 DAY | \$69 WK



#324 CARPET STAPLER
 \$18 DAY | \$54 WK



#149 TILE SAW
 WET | 7" BLADE INCL.
 \$44 DAY | \$176 WK



#148 TILE SAW
 WET | 10" BLADE INCL.
 \$80 DAY | \$320 WK



#601 TILE SAW 10"
 WET | 24" CAP. | BLADE INCL.
 \$110 DAY | \$440 WK

* RELATED ITEMS FOR SALE



914-592-2016 | 914-739-9000
 OPEN MONDAY - SATURDAY 7 TO 5

**NO TRUCK? NO TIME?
 NO PROBLEM! WE DELIVER!**

CALL TODAY FOR MONTHLY RATE!



1 hp



1/3 hp



#2088 EVAPORATIVE COOLER
1 HP | OSCILLATING | 110V
\$220 DAY | \$440 WK

#2087 EVAPORATIVE COOLER
1/3 HP | OSCILLATING | 110V
\$165 DAY | \$330 WK

#171 PEDESTAL FAN 24"
\$35 DAY | \$105 WK

#172 FLOOR FAN 42"
\$46 DAY | \$138 WK



NARROW



NARROW



#2131 AIR CONDITIONING
1.5 TONS | 110 V | 20 AMPS
\$121 DAY | \$363 WK

#2113 AIR CONDITIONING
5 TON | 220 V | 3 PHASE
\$462 DAY | \$1,270 WK

#2114 AIR CONDITIONING
12 TON | 220 V | 3 PHASE
\$600 DAY | \$1,800 WK

#2104 AIR CONDITIONING
20 TON | 220 V | 3 PHASE
\$1,650 DAY | \$3,300 WK



#2112 AIR CONDITIONING
20 TON | 460 V | 3 PHASE
\$1,848 DAY | \$2,722 WK



#2166 18" DUCT
\$30 DAY | \$45 WK



#2162 14" DUCT
\$28 DAY | \$42 WK



#811 12" DUCT
\$20 DAY | \$30 WK

AIR CONDITIONED TENTS

Training | Seminars | Safety Courses | Appreciation Events

We Sell Kerosene & Propane

CALL TODAY FOR MONTHLY RATE!

K1 KEROSENE BY THE GALLON



HEATING

ELECTRIC



#2119 60 KW HEATER
205,000 BTU | 480V
3 PHASE | 75 AMP
\$360 DAY | \$900 WK



3 Phase
#98 HEATER
220V | 50 AMP | 61K BTU
\$92 DAY | \$276 WK



1 Phase
#790 HEATER
220V | 50 AMP | 30K BTU
\$46 DAY | \$138 WK



#96 HEATER
110V | 15 AMP | 5,100 BTU
\$17 DAY | \$34 WK

KEROSENE



#791 HEATER 125 BTU
KEROSENE | RADIANT
\$57 DAY | \$172 WK



#97 HEATER
KEROSENE | 75K BTU
\$23 DAY | \$69 WK



#99 HEATER
KEROSENE | 175K BTU
\$42 DAY | \$125 WK



#100 HEATER
KEROSENE | 350K BTU
\$75 DAY | \$225 WK

IN-DIRECT



#784 INDIRECT HEATER
KEROSENE | 100,000 BTU
\$88 DAY | \$264 WK



#2092 INDIRECT HEATER
KEROSENE | 200,000 BTU
\$230 DAY | \$690 WK



#2091 HEATER INDIRECT
KEROSENE | 500K BTU
\$385 DAY | \$1,155 WK



#2093 INDIRECT HEATER
KEROSENE | 700,000 BTU
\$495 DAY | \$1,485 WK

PROPANE



#102 PROPANE HEATER
RADIANT | 200K BTU
\$18 DAY | \$36 WK



#101 HEATER
PROPANE | 80K BTU
\$46 DAY | \$138 WK



#103 HEATER
PROPANE | 170K BTU
\$92 DAY | \$276 WK



#788 HEATER
PROPANE | 350K BTU
\$176 DAY | \$528 WK

DUEL FUEL



914-592-2016 | 914-739-9000
OPEN MONDAY - SATURDAY 7 TO 5

**NO TRUCK? NO TIME?
NO PROBLEM! WE DELIVER!**

STIHL®



#695 CHAIN SAW
BATTERY | 40 VOLT
\$40 DAY | \$160 WK



#205 CHAINSAW
16" | ELECTRIC
\$44 DAY | \$176 WK



Gas - 2 cycle
#179 CHAINSAW
16" | 2 CYCLE
\$55 DAY | \$220 WK



Gas - 2 cycle
#204 CHAINSAW
20" | 2 CYCLE
\$66 DAY | \$264 WK

#155 BRUSH CUTTER—10'
"HANDLE BAR"
\$50 DAY | \$200 WK



#1401 STIHL COMBO
PLUS ATTACHMENTS AT
\$25/DAY
\$46 DAY | \$185 WK



#34 STRING TRIMMER
\$46 DAY | \$184 WK

EXTENDS 7" TO 11'

GAS - 2 CYCLE



#178 POWER POLE SAW
12" BLADE | TELESCOPIC
\$57 DAY | \$228 WK



#142 BACKPACK BLOWER
2 CYCLE | GAS
\$46 DAY | \$184 WK



#1402 KOMBI POWER BROOM
\$29 DAY | \$114 WK



#1403 KOMBI EXTENSION SHAFT
\$11 DAY | \$33 WK



#1404 KOMBI HEDGE TRIMMER
\$30 DAY | \$120 WK



#434 TREE DOLLY
1,500 LB CAPACITY
\$29 DAY | \$57 WK



STIHL®
 DEALER WEBSITE QR CODE
 SEE ALL OF STIHL'S PRODUCTS

LAWN | GARDEN



#108 TRIMMER
 19" ELEC. DOUBLE EDGE
 \$23 DAY | \$69 WK



#107 TRIMMER
 30" 2 CYCLE | GAS
 \$50 DAY | \$200 WK



#144 PUSH BLOWER
 13 HP | GAS
 \$66 DAY | \$264 WK



#142 BACKPACK BLOWER
 2 CYCLE
 \$46 DAY | \$184 WK

WE STOCK AND SELL NEW **STIHL®** EQUIPMENT



CHAIN SAWS
 CUT-OFF SAWS
 BLOWERS
 TRIMMERS
 OIL & LUBRICANTS
 PARTS - SERVICE
 PRESSURE WASHERS
 SAFETY APPAREL



914-592-2016 | 914-739-9000
 OPEN MONDAY - SATURDAY 7 TO 5

NO TRUCK? NO TIME?
 NO PROBLEM! WE DELIVER!



#492 THATCHER

30" | PUSH | GAS | 9HP
\$92 DAY | \$368 WK



#493 THATCHER

22" | PUSH | GAS | 5 HP
\$69 DAY | \$276 WK



#192 THATCHER

18" | PUSH | GAS | 5HP
\$69 DAY | \$276 WK



#135 ROLLER

250LB | PUSH | POLY DRUM
\$13 DAY | \$26 WK



#180 OVERSEEDER

22" | PUSH | GAS
\$88 DAY | \$352 WK



#152 CORE AERATOR

18" | PUSH | GAS
\$69 DAY | \$276 WK



#153 CORE AERATOR

25" | SELF PROPELLED | GAS
\$92 DAY | \$368 WK



#683 CORE AERATOR

TOW BEHIND | 52"
\$66 DAY | \$264 WK



#134 LAWN MOWER

21" | PUSH W/BAG
\$40 DAY | \$120 WK



#154 LAWN MOWER

48" | COMMERCIAL WALK BEHIND
\$100 DAY | \$400 WK



#1425 RIDE ON LAWNMOWER

55" | HYDROSTATIC | GAS
\$220 DAY | \$880 WK



#680 FINISH MOWER

3-POINT HITCH
\$92 DAY | \$368 WK



#156 HIGH WEED FLAIL

BLADE MOWER | 32"
\$180 DAY | \$720 WK



#681 KUBOTA BRUSH CUTTER

48"
\$120 DAY | \$480 WK



#467 BOBCAT BRUSH HOG

60"
\$180 DAY | \$720 WK



#151 LAWN EDGER

10" | GAS
\$46 DAY | \$185 WK

CALL TODAY FOR MONTHLY RATE!



#1030 TREE CHIPPER
18" | 173 HP | DIESEL
\$770 DAY | \$3,080 WK



#495 STUMP GRINDER
14" | SELF PROPELLED | 27 HP
\$145 DAY | \$580 WK



#496 STUMP GRINDER
24" | SELF PROPELLED | 35 HP
\$305 DAY | \$1,220 WK



#249 TREE CHIPPER
4" | GAS | AUTO FEED
\$250 DAY | \$875 WK



#250 TREE CHIPPER
12" | 80 HP | DIESEL
\$375 DAY | \$1,500 WK



#497 STUMP GRINDER
20" | SELF PROPELLED | 31 HP
\$330 DAY | \$1,320 WK



#455 TRENCHER
5" X 26" | WALK BEHIND
\$176 DAY | \$704 WK



#682 TILLER
3 PT HITCH | 58" WIDE
\$120 DAY | \$480 WK



#145 LOG SPLITTER
VERTICAL | 20 TON GAS
\$90 DAY | \$360 WK



#494 PIPE PULLER
VIBRATORY PLOW | DIESEL
\$300 DAY | \$1,200 WK



#230 ROTO-TILLER
MINI MANTIS
\$44 DAY | \$176 WK



#231 ROTO-TILLER 24"
FRONT TINE - 5 HP
\$66 DAY | \$264 WK



#232 ROTO-TILLER 20"
REAR TINE | HYDRAULIC
\$120 DAY | \$480 WK



914-592-2016 | 914-739-9000
OPEN MONDAY - SATURDAY 7 TO 5

NO TRUCK? NO TIME?
NO PROBLEM! WE DELIVER!



Optional Auger Bits Available 6" - 36"

Rented Separately

CALL TODAY FOR MONTHLY RATE!



#461 AUGER ATTACHMENT
BOBCAT | 6" TO 36" AVAIL
\$92 DAY | \$368WK



#486 AUGER ATTACHMENT
MIN-SKID | 4" TO 36" AVAIL
\$75 DAY | \$300 WK

#575 SCREENING PLANT

PORTABLE | 110V | 12 AMP
\$250 DAY | \$1,000 WK



#176 POST HOLE DIGGER
1 MAN | HYDRAULIC 3" - 14"
\$92 DAY | \$370 WK



#765 UNDER SIDEWALK ATTACHMENT
FOR POST HOLE DIGGER 3" X 10'
\$33 DAY | \$132 WK



#397 DUMP TRAILER
2 YD | 7,500# CAP
\$145 DAY | \$580 WK



#398 UTILITY TRAILER
4' X 6' | 500 # CAP. |
\$40 DAY | \$120 WK



#424 CONVEYOR BELT
20' W/ HOPPER | ELEC.
\$150 DAY | \$600 WK

20' OR 24'!



#425 CONVEYOR BELT
24' W/ HOPPER | ELEC.
\$175 DAY | \$700 WK



CALL TODAY FOR MONTHLY RATE!

UTVS



#8951 UTILITY CARRY ALL 1500—2 PASSENGER

\$242 DAY | \$495 WK

**POWERTRAIN KAWASAKI 20.1
HP-RATED GASOLINE ENGINE
CAPACITY 1,200 LB
BED LOAD CAPACITY STANDARD 800 LB (363 KG);
HIGH CAPACITY OPTION 1,050 LB (476 KG)
TOP SPEED 25 MPH**



#8952 UTILITY CARRY ALL 1700—4 PASSENGER

\$275 DAY | \$550 WK

**FOUR-PASSENGER WITH INTELLITRAK™
AUTOMATIC ALL-WHEEL DRIVE
POWERTRAIN KUBOTA 20 HP-RATED (15.0 KW)
DIESEL ENGINE
TOTAL VEHICLE CAPACITY 1,600 LB (726 KG)
BED LOAD CAPACITY 800 LB (363 KG)
TOP SPEED 25 MPH
ADDS TWO ADDITIONAL FORWARD FACING SEATS, WITH-
OUT CUTTING CARGO SPACE.**

#1020 GROUND HEATER

\$1,100 DAY | \$3,850 WK



**GROUND THAWING CAPACITY 5,600 FT²
CONCRETE CURING CAPACITY 11,200 FT²
TEMPORARY HEATING CAPACITY 12,000 FT²
HEATER CAPACITY 273,000 BTUH HEATING FUEL INPUT
FIELD HOSES 4 - 700 FT
MANIFOLDS (SUPPLY & RETURN) 4 - 5/8" & 1 - 1 1/4" QUICK
CONNECT
ELECTRICAL REQUIREMENTS 2 - 120V AC 20A CIRCUIT
UNIT HAS 7KW DIESEL GENERATOR
GLYCOL TANK CAPACITY 96 US GAL
FUEL TANK CAPACITY 192 US GAL
RUN TIME UP TO 120 HOURS
WEIGHT (FUEL TANK FULL/EMPTY) 4,700 / 6,080#
LENGTH (FROM HITCH) 12' WIDTH 80" HEIGHT 80"
ON BOARD DIESEL GENERATOR 7KW**

GROUND HEATER



**914-592-2016 | 914-739-9000
OPEN MONDAY - SATURDAY 7 TO 5**

**NO TRUCK? NO TIME?
NO PROBLEM! WE DELIVER!**

**CALL TODAY FOR
MONTHLY RATE!**

Generators Sold & Serviced

**Generator Rates are for
Single Shift use.**

**4,000
watts
of light**



#426 LIGHT TOWER

6 KW WATT GENERATOR
\$176 DAY | \$495 WK

#82 GENERATOR
10.5 KW | DIESEL
\$154 DAY | \$616 WK



#86 GENERATOR

3,000 WATT | GAS
\$60 DAY | \$240 WK



#87 GENERATOR

5-6,000K | GAS
\$90 DAY | \$360 WK



#84 GENERATOR

2,000 WATT | GAS | SUPER QUIET
\$40 DAY | \$160 WK



#954 GENERATOR

3,000 WATT | GAS | SUPER QUIET
\$75 DAY | \$300 WK



#2004 GENERATOR

6,500 WATT | GAS | SUPER QUIET
\$140 DAY | \$560 WK



#590 GENERATOR

8,000 WATT | GAS
\$115 DAY | \$460 WK

Shift Rates May Apply

GENERATORS



#83 GENERATOR
 25KW | 3 PHASE | DIESEL
 60 AMP MAIN BREAKER

WTR # 83	MP 25
Kw/Kva	20 kw / 25
Fuel Cap	51.5 gal
Run Time @ 100%	31 hours
Decibels 23'	63 dba
Single Phase 120v	60 x2 amps
Single Phase 240v	60 amps
Three Phase 208v	65 amps
Three Phase 240v	60 amps
Three Phase 480v	30 amps



#89 GENERATOR
 65KW | 3 PHASE | DIESEL
 175 AMP MAIN BREAKER

WTR # 89	MMD 65
Kw/Kva	63 kw/50
Fuel Cap	106 gal
Run Time@100%	27 hours
Decibels @ 23'	65 dba
Single Phase 120v	152 x 2 amps
Single Phase 240v	152 amps
Three Phase 208v	167 amps
Three Phase 240v	152 amps
Three Phase 480v	76 amps



#88 GENERATOR
 125KW | 3 PHASE | DIESEL
 300 AMP MAIN BREAKER

WTR # 88	MQ DCA125
Kw/Kva	100 kw / 125
Fuel Cap	169 gal
Run Time @ 100%	23 hours
Decibels 23'	65 dba
Single Phase 120v	300 x 2 amps
Single Phase 240v	300 amps
Three Phase 208v	338 amps
Three Phase 240v	300 amps
Three Phase 480v	150 amps



#2126 GENERATOR
 300KW | 3 PHASE | DIESEL
 800 AMP MAIN BREAKER
 CALL FOR RATE

WTR # 2126	DCA300SSC
Kw/Kva	240/300
Fuel Cap	129 gal
Run Time@100%	22 hours
Decibels 23'	73 dba
Single Phase 120v	666 X 2 amp
Single Phase 240v	333 amps
Three Phase 240v	722 amps
Three Phase 480v	361 amps



#2005 TRANS CUBE
 125 GALLON CAPACITY
 \$110 DAY | \$275 WK



#2008 TRANS CUBE
 260 GALLON CAPACITY
 \$138 DAY | \$276 WK

*** DOUBLE WALLED**
*** 110% FUEL CONTAINMENT**
*** 110 VOLT TRANSFER PUMP**



#2125 GENERATOR
 150KW | 3 PHASE | DIESEL
 400 AMP MAIN BREAKER
 \$600 DAY | \$2,100 WK

WTR # 2125	MMD 150
Kw/Kva	120 kw /150
Fuel Cap	215 gal
Run Time @ 100%	25 hour
Decibels 23'	68 dba
Single Phase 120v	363 X 2 amps
Single Phase 240v	363 amps
Three Phase 208v	394 amps
Three Phase 240v	361 amps
Three Phase 480v	180 amps



914-592-2016 | 914-739-9000
 OPEN MONDAY - SATURDAY 7 TO 5

**NO TRUCK? NO TIME?
 NO PROBLEM! WE DELIVER!**



EXTENSION CORD 12/3
10', 25', 50', 100'
\$7 TO \$20



#2041 1 PHASE CORD
6/4 - 25 AMP | 1 PHASE
\$29 DAY | \$58 WK



#2015 DISTRO BOX PASS THROUGH
100 AMP | 3 PHASE
\$150 DAY | \$225 WK



#2013 DEAD END DISTRO BOX
100 AMP | 3 PHASE
\$150 DAY | \$225 WK



#2043 50' EXTENSION CORD
6/4 - 50 AMP | 3 PHASE
\$46 DAY | \$92 WK



#2042 25' EXTENSION CORD
6/4 - 50 AMP | 3 PHASE
\$29 DAY | \$58 WK



#2048 DISTRO BOX
220V | 1 PHASE
\$85 DAY | \$110 WK



#2031 DISTRO BOX PASS
3-50 AMP | 3 PHASE
\$150 DAY | \$225 WK



#2006 CABLE RAMP 36"
CABLE COVERS
\$25 DAY | \$50 WK



#2022 PIGTAIL KIT
"WHIPS" FOR TIE-INS
100 AMP | 3 PHASE
\$30 DAY | \$30 WK

Cam Lock Cables



	SET 5PC	DAY	WK
#2019	10'-2/0	\$23	\$46
#2020	25'-2/0	\$35	\$70
#2017	50'-2/0	\$57	\$114
#2036	100'-2/0	\$114	\$228



#2053 SIAMESE SPLITTER
\$11 DAY | \$22 WK (EACH)



#2050 CAM LOCK "T"
5 PIECE KIT
\$22 DAY | \$44 WK



#2052 CAM GENDER CHANGER
M-M | FM-FM—EACH
\$6 DAY | \$12 WK



#2010 TRANSFORMER
75KVA | 480V-208V | 3 PHASE
\$250 DAY | \$625 WK



#820 SOIL AIR PICK
\$28 DAY | \$84 WK



#700 AIR HOSE 50'
\$15 DAY | \$30 WK



#6 HYDRAULIC ROCK SPLITTER KIT
1-3/4 X 26" HOLE REQUIRED
\$350 DAY | \$1,400 WK



#197 SANDBLASTER
300 # POT W/REMOTE
\$116 DAY | \$464 WK



#19 CHIPPING HAMMER
18 # | AIR
\$35 DAY | \$140 WK

CALL TODAY FOR MONTHLY RATE!



#196 SANDBLASTER
100 LB POT W/REMOTE
\$72 DAY | \$288 WK



#8 AIR COMPRESSOR
70 CFM GAS
\$100 DAY | \$400 WK



#12 AIR COMPRESSOR
400 CFM DIESEL
\$320 DAY | \$1,280 WK



#14 AIR COMPRESSOR
185 CFM DIESEL
\$160 DAY | \$480 WK



#17 ROCK DRILL
55 # | 1" STEEL
\$64 DAY | \$256 WK



#18 PAVEMENT BREAKER
30 # | 1" STEEL
\$42 DAY | \$168 WK



#16 PAVEMENT BREAKER
60 # | 1-1/8" STEEL
\$44 DAY | \$176 WK



#15 PAVEMENT BREAKER
90 # | 1-1/8" STEEL
\$44 DAY | \$176 WK

We Rent & Sell

**Points
Chisels
Rock Bits**



#4 AIR COMPRESSOR
15.4 CFM GAS
\$53 DAY | \$208 WK



#3 AIR COMPRESSOR
7.3 CFM | ELECTRIC
\$46 DAY | \$184 WK



#2 AIR COMPRESSOR
4.2 CFM | ELECTRIC
\$35 DAY | \$140 WK



914-592-2016 | 914-739-9000
OPEN MONDAY - SATURDAY 7 TO 5

**NO TRUCK? NO TIME?
NO PROBLEM! WE DELIVER!**

CALL TODAY FOR MONTHLY RATE!



#456 TRACTOR LOADER / BACKHOE

\$285 DAY | \$1,140 WK



KUBOTA B26	WTR # 456
HORSE POWER	26 HP
WIDTH	5'4"
LENGTH	11'1"
WEIGHT	6,480#
MAX DUMP	9'9"
BUCKET WIDTH	72"
LOAD RATING	1,850#
DIGGING DEPTH	7 FT

3 POINT HITCH W/ PTO

COMPACT



#680 FINISH MOWER 60"

\$92 DAY | \$368 WK



#681 BRUSHCUTTER

\$120 DAY | \$480 WK



#682 ROTOTILLER 58"

\$120 DAY | \$480 WK



**#683 CORE AERATOR—
TOW BEHIND**

52"

No Truck? No Time? No Problem! WE DELIVER!

#471 JOHN DEERE 310SK TRACTOR LOADER BACKHOE

4 WHEEL DRIVE | DIG DEPTH. 17'-10"
 HEAT AND AC | EXTEND-A-HOE
 \$578 DAY | \$1,734 WK



HORSE POWER	78 HP
WEIGHT	17,250 LBS
WIDTH	7'2"
LENGTH	23'3"
HEIGHT	9'-2"
BACKHOE DIGGING DEPTH	17'-10"
BACKHOE MAX DUMP HEIGHT	8'-11"
BACKHOE BUCKET WIDTH"	2'-6"
LOADER BUCKET	86"
DUMP HEIGHT	11'-2"

**4 WHEEL DRIVE
 ENCLOSED CAB!**

HORSE POWER	45 HP
WEIGHT	7,173 LBS
WIDTH	72.5"
LENGTH	19'7"
BACKHOE DIGGING DEPTH	10'1"
BACKHOE MAX DUMP HEIGHT	7'6"
BACKHOE BUCKET WIDTH"	18"
LOADER DUMP HEIGHT	9'5"
BUCKET WIDTH	72"

#460 KUBOTA TRACTOR LOADER BACKHOE

HYDROSTATIC | ALL WHEEL DRIVE
 72" BUCKET | 10' DIG DEPTH
 \$350 DAY | \$1,400 WK



3 POINT HITCH W/ PTO



**CAN USE MOST
 BOBCAT ATTACHMENTS**



914-592-2016 | 914-739-9000
 OPEN MONDAY - SATURDAY 7 TO 5

**NO TRUCK? NO TIME?
 NO PROBLEM! WE DELIVER!**



#454 HYDRAULIC HAMMER

500 # CLASS
\$230 DAY | \$920 WK



#450T TOOTH BUCKET



#450S SMOOTH BUCKET

INCLUDES 1 BUCKET WITH BOBCAT RENTAL

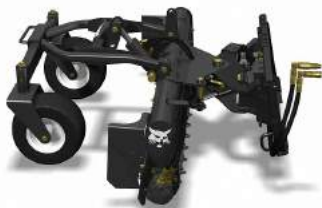

#469 SOIL CONDITIONER 72"

\$176 DAY | \$704 WK



#488 LANDSCAPE RAKE 72"

\$140 DAY | \$560 WK



#446 YORK RAKE 72"

3 POINT HITCH
\$72 DAY | \$286 WK



#467 BRUSH HOG 60"

\$180 DAY | \$720 WK



#465 14" STANDARD FLOW PLANER

INCLUDES WATER TANK

\$350 DAY | \$1,400 WK



#457 SOLID TIRE SET

\$72 DAY | \$216 WK



#461 POST HOLE

\$92 DAY | \$368 WK



#466 AUGER

6" - 9" - 12" - 18"
\$24 DAY | \$72 WK



#459 SWEEPER W/HOPPER 72"

\$195 DAY | \$780 WK



#489 ANGLE BROOM 68"

\$180 DAY | \$720 WK



#458 FORKS

\$40 DAY | \$160 WK



#447 GRAPPLE

\$92 DAY | \$368 WK



CALL TODAY FOR MONTHLY RATE!

BOBCAT

#450 SKID STEER

RUBBER TIRE | S175/S570
\$275 DAY | \$1,100 WK



HORSE POWER	61 HP
WIDTH	67"
LENGTH	11'1"
WEIGHT	6,480 LBS
MAX DUMP HEIGHT	7'6"
BUCKET WIDTH	68"
LOAD RATING	1,950 LBS
AUX HYDRAULICS	17.1 GPM

INCLUDES CHOICE OF 1 BUCKET



#473 BOBCAT LOADER

RUBBER TRACK | T590
\$400 DAY | \$1,400 WK



HORSE POWER	66 HP
WIDTH	67"
LENGTH	11'1"
WEIGHT	7,822 LBS
MAX DUMP HEIGHT	91.3"
BUCKET WIDTH	68"
LOAD RATING	2,100 LBS
AUX HYDRAULICS	17.1 GPM

INCLUDES CHOICE OF 1 BUCKET

#474 BOBCAT LOADER

RUBBER TRACK | T650
\$495 DAY | \$1,980 WK



HORSE POWER	74 HP
WIDTH	73"
LENGTH	12'25"
WEIGHT	10,250 LBS
MAX DUMP HEIGHT	8'3"
BUCKET WIDTH	80"
LOAD RATING	2,900
AUX HYDRAULICS	30.5 GPM



INCLUDES CHOICE OF 1 BUCKET

CAB DOORS AVAILABLE FOR MOST MODELS—VARIOUS MODELS IN RENTAL FLEET



914-592-2016 | 914-739-9000
OPEN MONDAY - SATURDAY 7 TO 5

NO TRUCK? NO TIME?
NO PROBLEM! WE DELIVER!

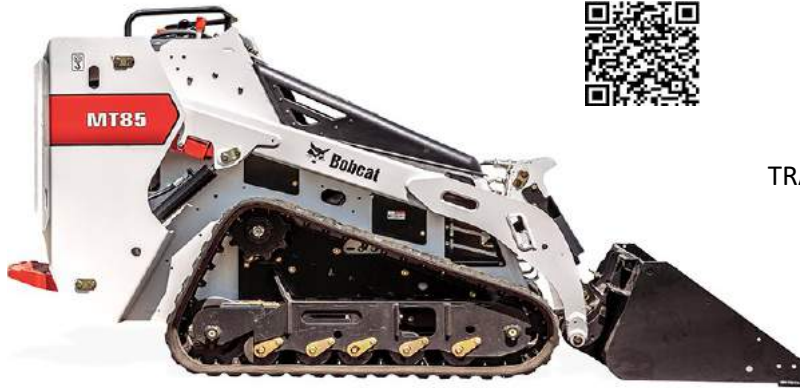

#481 MINI SKID STEER

TRACKED | ATTACHMENTS AVAILABLE
\$220 DAY | \$880 WK



#486 AUGER ATTACHMENT

36" CAPACITY | 6" TO 36" AVAIL
\$75 DAY | \$300 WK



#484 SOIL CONDITIONER 48"

MINI SKID STEER ATTACHMENT
\$125 DAY | \$500 WK



#485 MINI SKID BROOM

48" WIDE
\$95 DAY | \$475 WK

**RUNS 8 HOURS ON 1 CHARGE.
"0" EMISSION**



**NO TRUCK? NO TIME? NO PROBLEM!
WE DELIVER TO YOUR DOOR OR JOB!**



#875 BATTERY POWERED EXCAVATOR

2,060 #

9VXB | REACH 5'-2" | 12" BUCKET | RUBBER TRACKS



#453 HYDRAULIC HAMMER

750 # CLASS

\$325 DAY | \$1298 WK



#475 HYDRAULIC HAMMER

1,000 # CLASS

\$440 DAY | \$1,760 WK

CALL TODAY FOR MONTHLY RATE!

EARTH MOVING

	WTR # 451	WTR # 452	WTR # 470	WTR # 477
Class	35	55	85	100
Max Digging Depth	10'11"	12'7"	14'2"	16'
Max Digging Height	17'	18'5"	22'8"	25'10"
Max Dumping Height	12'	13'0"	16'1"	16'10"
Horse Power	23 hp	55 hp	57 hp	72 hp
Weight:	8,082 #	12,733 #	18,775 #	21,550 #
Width	5'1"	6'6"	7'3"	7'7"
Length	14'7"	17'7"	19'10"	21'4"
Height	8'2"	8'5"	8'6"	9'3"
Bucket Width	18/24"	24"	30"	36"
Hydraulic Thumb	✓	✓	✓	✓
Back Fill Blade	✓	✓	✓	✓
A-F Pattern Valve	✓	✓	✓	✓



#477 EXCAVATOR

21,550 #

SV1002A 116' REACH | 36" BUCKET

\$695 DAY | \$2,780 WK

**DIFFERENT BUCKETS AVAILABLE*



#451 MINI EXCAVATOR

8,000 #

8'-6" | 18" BUCKET | RUBBER TRACK
\$350 DAY | \$1,400 WK



#452 MINI EXCAVATOR

12,000 #

55N | 12' REACH | 24" BUCKET
\$465 DAY | \$1,860 WK



#470 MINI EXCAVATOR

19,000 #

80NX | 15' REACH | 30" BUCKET
\$625 DAY | \$2,500 WK



914-592-2016 | 914-739-9000
OPEN MONDAY - SATURDAY 7 TO 5

NO TRUCK? NO TIME?
NO PROBLEM! WE DELIVER!



#1025 FORD F550 DUMP TRUCK

\$440 DAY | \$1,320 WK
50 MILES INCLUDED— \$.40/MILE

FORD F550 DUMP TRUCK

19,000 GVW
3-4 YARD
GAS ENGINE
4 WD
AUTOMATIC

INCLUDES TARP & ASPHALT CHUTE
INSURANCE RIDER RECOMMENDED

#397 DUMP TRAILER

2 YARD—7,500 CAP
ELECTRIC BRAKES



TRAILER ACCESSORIES

- CHAINS
- BINDERS
- NYLON STRAPS
- PINTLE HOOK

AVAILABLE FOR RENT



#401 EQUIPMENT TRAILER

9,900 # CAP | 8' X 16' | SURGE BRAKES
\$100 DAY | \$400 WK



#406 3 TON ROLLER TRAILER

9,900# CAP | 5' X 10' | ELECTRIC BRAKES
\$100 DAY | \$400 WK



#399 EQUIPMENT TRAILER

9 TON | W/RAMPS | ELECTRIC BRAKES
\$160 DAY | \$640 WK



#400 EQUIPMENT TRAILER

3,000 # CAP | 6' 5"X12' | SURGE BRAKES
\$80 DAY | \$320 WK



CALL TODAY FOR MONTHLY RATE!

#595 PLATE COMPACTOR

20" REVERSIBLE
\$116 DAY | \$464 WK



SPEEDS OF UP TO 5,500 VIBRATIONS PER MINUTE AND 350 SQUARE METERS PER HOUR!

MOST POPULAR



#228 PLATE COMPACTOR

20" TAMPER W/WATER TANK
\$90 DAY | \$360 WK

USE ON PAVERS



#309 JUMPING JACK

11" | 4 CYCLE RAMMER
\$92 DAY | \$370 WK



#229 PLATE COMPACTOR

24" REVERSIBLE
\$139 DAY | \$556 WK



#227 PLATE COMPACTOR

12" | GAS
\$69 DAY | \$276 WK



#228P 20" PAVER POLYURETHANE PAD

\$21 DAY | \$84 WK



#188 TRENCH ROLLER

SHEEP'S FOOT W/ REMOTE
\$396 DAY | \$1,386 WK



#187 DOUBLE ROLLER

26" VIBRATING
\$185 DAY | \$740 WK



#189 VIBRATORY ROLLER

3 TON | ARTICULATED
\$325 DAY | \$1,300 WK



#191 VIBRATORY ROLLER

1-1/2 TON | ARTICULATED
\$225 DAY | \$900 WK



#190 ASPHALT TORCH

*PROPANE NOT INCLUDED
\$13 DAY | \$26 WK



#225 ASPHALT HAND ROLLER

\$23 DAY | \$69 WK



#406 3 TON TRAILER

9,900 # CAP | 5' X 10'
ELECTRIC BRAKES
\$100 DAY | \$400 WK



#400 TRAILER 1-1/2 TON

3,000 # CAP | 6'-5" X 12'
SURGE BRAKES
\$80 DAY | \$320 WK



914-592-2016 | 914-739-9000
OPEN MONDAY - SATURDAY 7 TO 5

**NO TRUCK? NO TIME?
NO PROBLEM! WE DELIVER!**

CALL TODAY FOR MONTHLY RATE!



WTR #240 SKYJACK 3219

\$150 DAY | \$330 WK

WORKING HEIGHT	25'
PLATFORM HEIGHT	19'
HEIGHT STOWED	78.5"
HEIGHT RAILS COLLAPSED	65"
WEIGHT	2,580 #
LENGTH / WIDTH	70"/30"
DECK EXTENSION	36"
MAX CAPACITY	500 #



WTR #241 GENIE GS2632

\$150 DAY | \$375 WK

WORKING HEIGHT	32'
PLATFORM HEIGHT	26'1"
HEIGHT STOWED	7'6"
HEIGHT RAILS COLLAPSED	6'4"
WEIGHT	4,413 #
LENGTH / WIDTH	8'/2'8"
DECK EXTENSION	3'
MAX CAPACITY	500 #



WTR #238 SKYJACK 4626

\$150 DAY | \$375 WK

WORKING HEIGHT	32'
PLATFORM HEIGHT	26'
HEIGHT STOWED	84.5"
HEIGHT RAILS COLLAPSED	70.5"
WEIGHT	4700 #
LENGTH/WIDTH	91"/46"
DECK EXTENSION	4'
MAX CAPACITY	700 #



WTR #239 GENIE 3369 RT

\$300 DAY | \$900 WK

WORKING HEIGHT	38'8"
PLATFORM HEIGHT	32'8"
HEIGHT STOWED	8'6"
HEIGHT RAILS COLLAPSED	6'3.5"
WEIGHT	8,449 #
LENGTH/WIDTH	12'4"/5'9"
DECK EXTENSION	60"
MAX CAPACITY	1000 #



WTR # 248 NIFTY TM50

\$330 DAY | \$1,320 WK

WORKING HEIGHT	56'
PLATFORM HEIGHT	49'6"
HORIZONTAL REACH	28'6"
WEIGHT	4,890 #
LENGTH	20'4"
WIDTH RIGGERS UP	5'5"
WIDTH RIGGERS DN	14'5"
MAX CAPACITY	500 #



WTR # 245 NIFTY TM50

\$230 DAY | \$920 WK

WORKING HEIGHT	40'5"
PLATFORM HEIGHT	34"
HORIZONTAL REACH	16'6"
WEIGHT	3,400 #
LENGTH	18'10"
WIDTH RIGGERS UP	3'7"
WIDTH RIGGERS DN	8'10"
MAX CAPACITY	500 #



WTR # 252 POWER LIFT M20

\$75 DAY | \$225 WK

WORKING HEIGHT	20'.3"
PLATFORM HEIGHT	14'.3"
WEIGHT	278 #
LENGTH	20'4"
WIDTH	12'.9
LENGTH	51'.2"
MAX CAPACITY	350 #



WTR# 242 JLG 25 AM DC

\$120 DAY | \$300 WK

WORKING HEIGHT	31'
PLATFORM HEIGHT	25'2"
HEIGHT STOWED	6'6"
WEIGHT	905 #
LENGTH STOWED	4'1"
WIDTH STOWED	2'5"
OUT RIGGER LENGTH	5'2"
OUT RIGGER WIDTH	4'5"
MAX CAPACITY	350 #

#244 BOOM LIFT - ARTICULATED

65' | DUEL FUEL | 4 WD
\$600 DAY | \$1,725 WK

WTR #244 GENIE Z-62/40

WORKING HEIGHT	67'11"
PLATFORM HEIGHT	62'
HORIZONTAL REACH	40-9"
WEIGHT	22,690 #
LENGTH	30'3"
WIDTH	8'6"
MAX CAPACITY	500 #



BOOM LIFTS



65'



CALL TODAY FOR MONTHLY RATE!



45'



#247 BOOM LIFT - ARTICULATED

50' | DIESEL | 4WD
\$460 DAY | \$1,380 WK

NIFTY SD50

WTR # 247

WORKING HEIGHT	56'
PLATFORM HEIGHT	49'6"
HORIZONTAL REACH	28'6"
WEIGHT	6,000 #
LENGTH	18'4"
WIDTH OUT RIGGERS UP	5'3"
WIDTH OUT RIGGERS DOWN	14'5"
MAX CAPACITY	500 #

50'

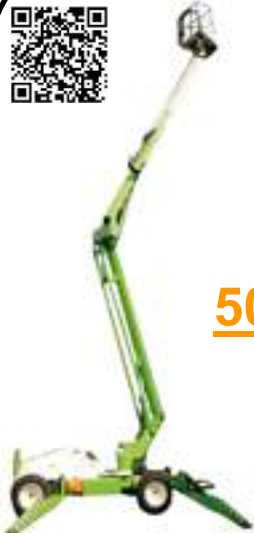

#243 BOOM LIFT - ARTICULATED

45' | DUEL FUEL | 4 WD
\$475 DAY | \$1,425 WK

Genie Z45

WTR # 243

Working Height	51'-6"
Platform Height	45'-6"
Horizontal Reach	24'9"
Weight	16,360 #
Length	21'-10"
Width	7'6"
Max Capacity	500 #

CALL TODAY FOR MONTHLY RATE!



914-592-2016 | 914-739-9000
OPEN MONDAY - SATURDAY 7 TO 5

**NO TRUCK? NO TIME?
NO PROBLEM! WE DELIVER!**

MATERIAL HANDLING



#430 MATERIAL LIFT
18 FT. | 650# CAP
\$100 DAY | \$300 WK



#432 CONTRACTOR LIFT
12 FT. 400# CAP
\$75 DAY | \$225 WK



#726 ELECTRIC PALLET JACK
4,500 # CAPACITY
\$165 DAY | \$650 WK



#122 PALLET JACK
6,000 # CAPACITY
\$35 DAY | \$140 WK



#558 COUNTER BALANCE LIFT
15' LIFT | 800 # CAPACITY
\$143 DAY | \$429 WK



#728 CARPET POLE
10' X 2 1/2"
\$45 DAY | \$135 WK



#562 GANTRY
3/4 TON CAP
\$116 DAY | \$348 WK

#560 GANTRY
2 TON CAP
\$116 DAY | \$348 WK

#365 CHAIN HOIST
3 TON | 20' CHAIN
\$57 DAY | \$225 WK



#367 CHAIN HOIST
1 TON | 20' | **ELECTRIC**
\$150 DAY | \$600 WK



#30 JOHNSON BAR
FOR LEVERAGE
\$23 DAY | \$46 WK



**1,500 #
CAPACITY**



#435 STAIR CLIMBING
HAND TRUCK | **BATTERY**
\$90 DAY | \$360 WK



#29 APPLIANCE
HAND TRUCK
\$18 DAY | \$54 WK



#31 HAND TRUCK
\$18 DAY | \$36 WK



#33 MOVERS DOLLY
\$11 DAY | \$22 WK



#433 WAREHOUSE DOLLY
30" X 60" | 1,500 CAP
\$35 DAY | \$105 WK



Certification Classes Available

CALL TODAY FOR MONTHLY RATE!

FORKLIFT

#440 FORK LIFT 15'

5,000 # | DUEL FUEL
\$250 DAY | \$875 WK

5,000 lb



#443 FORK LIFT 15'

6,000 # | DUEL FUEL
\$280 DAY | \$910 WK

6,000 lb



#735 FORK LIFT 15'

10,000 # | DUEL FUEL
\$425 DAY | \$1,500 WK

10,000 lb



WTR # 440 KOMATSU FG25-16

Power	Gasoline / LPG
Capacity @ 24"	5,000 #
Fork Length	48"
Max Mast Height	176"
Max Fork Height	128"
Weight	7,941 #
Length w/ Forks	148.8"
Width	45.3"
Stowed Height	85.4"

WTR # 443 KOMATSU FG30-HT

Power	Gasoline / LPG
Capacity @ 24"	6,000 #
Fork Length	48"
Max Mast Height	176"
Max Fork Height	128"
Weight	9,405 #
Length w/ Forks	148.8"
Width	48.6"
Stowed Height	85"

WTR # 735 KOMATSU FG50TU-10

Power	Gasoline/LPG
Capacity @ 24"	10,000 #
Fork Length	60"
Max Mast Height	171.8"
Max Fork Height	118.1"
Weight	15,928 #
Length w/ Forks	185.4"
Width	72"
Stowed Height	101.8"

#730 TELEHANDLER 19'

5,000 # | DIESEL
\$286 DAY | \$858 WK

5,000 lb



#442 TELEHANDLER 32'

6,000 # | DIESEL
\$396 DAY | \$1,320 WK

6,000 lb



#732 TELEHANDLER 44'

8,000 # | 4 WD
\$600 DAY | \$1,750 WK

8,000 lb



WTR #730 GENIE 5519

CAPACITY	5,511 #
MAX LIFT HEIGHT	18.8'
MAX HORIZONTAL REACH	11.3'
STOWED HEIGHT	6.5'
STOWED LENGTH	12.2'
WIDTH	5.9'
WEIGHT	10,000 #

WTR #442 GRADALL 524D-3S

CAPACITY	6,000 #
MAX LIFT HEIGHT	32'
MAX HORIZONTAL REACH	21'
STOWED HEIGHT	94"
STOWED LENGTH	180"
WIDTH	96"
WEIGHT	15,926 #

WTR #732 GENIE GTH 844

CAPACITY	8,000 #
MAX LIFT HEIGHT	44'
MAX HORIZONTAL REACH	27'
STOWED HEIGHT	8'9"
STOWED LENGTH	20'
WIDTH	8'5"
WEIGHT	22,500 #



914-592-2016 | 914-739-9000
OPEN MONDAY - SATURDAY 7 TO 5

**NO TRUCK? NO TIME?
NO PROBLEM! WE DELIVER!**

CALL TODAY FOR MONTHLY RATE!



Aluminum Pick

#396 J-BRAKE
10'-6"
\$70 DAY | \$210 WK

#395 J-BRAKE
8'-6"
\$70 DAY | \$210 WK

#394 J-BRAKE
6'-6"
\$70 DAY | \$210 WK

#511 12" X 24' \$46 DAY \$138 WK
#510 20" X 16' \$30 DAY \$90 WK
#513 20" X 24' \$46 DAY \$138 WK

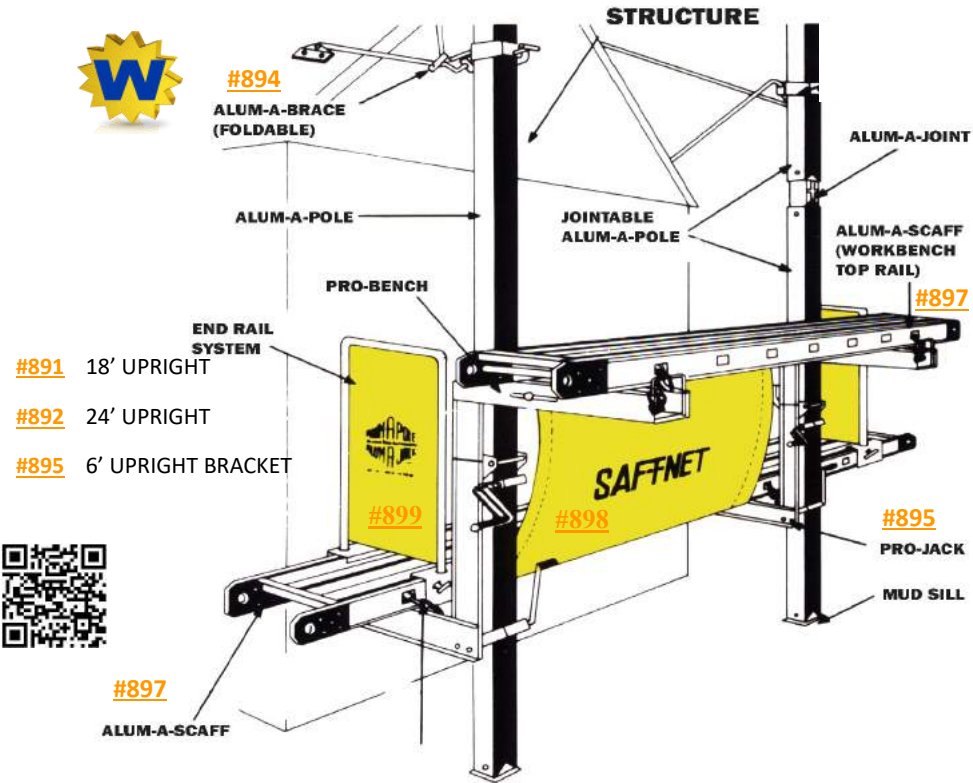

#890	24' H X 24' W KIT	\$145	\$290
#891	18' UPRIGHT BY THE PIECE	\$17	\$51
#892	24' UPRIGHT	\$17	\$51
#893	6' UPRIGHT	\$12	\$36
#894	BRACE "ABF"	\$6	\$18
#895	PROJACK "AP"	\$17	\$51
#896	PROBENCH BRACKET "APB"	\$6	\$18
#897	24' ALUM-A-SCAFFOLD 14"	\$46	\$138
#898	SAF-T-NET 22'	\$12	\$36
#899	ENDRAIL SAFETY SYSTEM	\$6	\$18



#670 PLATFORM HOIST
16' TO 44' | 400 #
\$125 DAY | \$500 WK

#679 SOLAR PANEL ATTACHMENT
ALSO PLYWOOD, PANELING
\$23 DAY | \$69 WK



#273



INTERIOR SCAFFOLD

		DAY	WEEK
#279	6' X 30" X 6' PRO-JAX	\$40	\$100
#289	6' X 30" X 3' PRO-JAX 1/2 SECTIONS	\$15	\$30
#273	6' GUARDRAIL KIT	\$20	\$50
#274	PRO-JAX OUTRIGGER	\$18	\$36

PIPE SCAFFOLD

		WEEK	MONTH
#500	5'X5' END FRAME	\$7	\$21
#526	5'X6'4" MASON END FRAME	\$9	\$27
#501	7' CROSS BRACE	\$1	\$3
#504	LEVELING JACK	\$6	\$18
#527	BASE PLATE	\$1	\$3
#505	8" CASTER WHEEL	\$7	\$21
#503	CATWALK 7' X 20"	\$10	\$30
#506	SIDE ARM 20"	\$7	\$21
#524	OUTRIGGER	\$7	\$21
#507	WELL WHEEL	\$20	\$60
#509	WELL WHEEL HOIST ARM	\$13	\$39
#536	GUARD RAIL 5' END	\$13	\$39
#537	GUARD RAIL 7' SIDE	\$8	\$24
#539	GUARD RAIL MID POST	\$8	\$24
#515	DIAGONAL BRACE 7'	\$7	\$21
#538	TOE BOARD	\$8	\$24

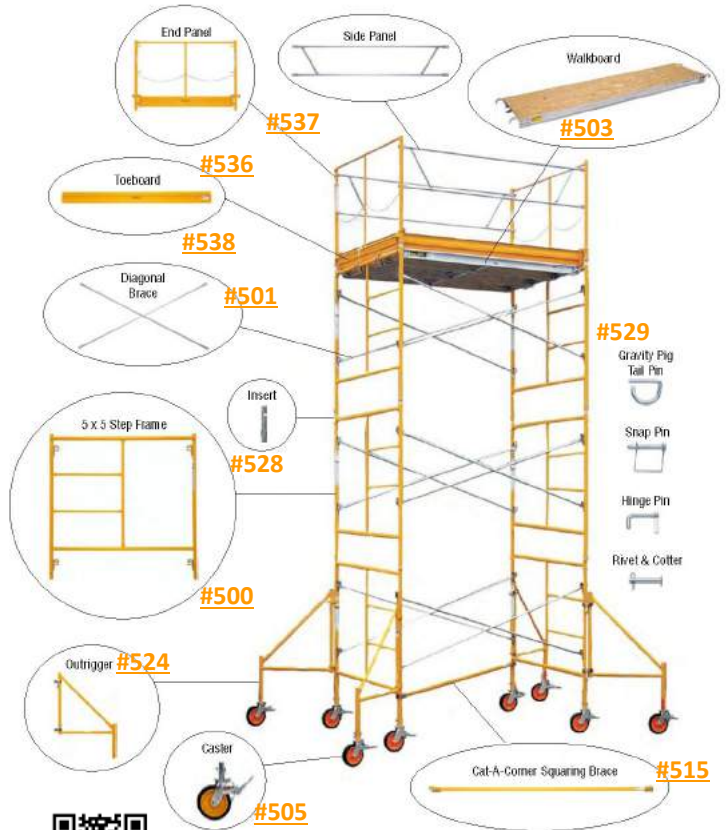

#2502 SCAFFOLD STAIR KIT

CALL FOR DETAILS

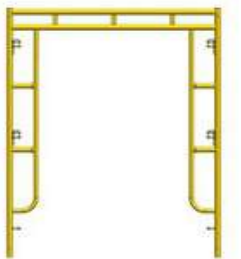

#526 MASON END FRAME

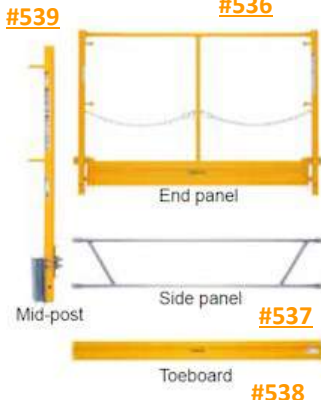

#504



#121 POST SHORING JACK
7' TO 11'

\$13 DAY | \$26 WK

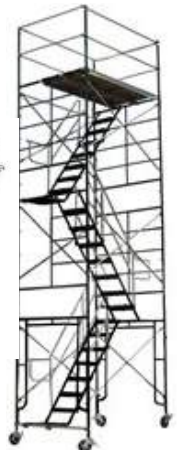

914-592-2016 | 914-739-9000
OPEN MONDAY - SATURDAY 7 TO 5

NO TRUCK? NO TIME?
NO PROBLEM! WE DELIVER!

LADDERS

STEP LADDERS - T1A FIBERGLASS		DAY	WEEK
#128	8'	\$22	\$66
#133	12'	\$26	\$75
#517	16'	\$50	\$150
#332	LITTLE GIANT ADJUSTABLE LADDER	\$30	\$90
4' FT TO 7' STEP / 9' TO 15' EXTENSION			



CALL TODAY FOR MONTHLY RATE!

EXTENSION LADDERS -T1A		DAY	WEEK
#129	24' ALUMINUM	\$30	\$90
#131	32' ALUMINUM	\$35	\$105
#130	40' ALUMINUM	\$50	\$150
#516	60' ALUMINUM	\$90	\$360
#127	LADDER STABILIZER	\$9	\$18
#132	LADDER BRACKET	\$11	\$22



**WE STOCK NEW
PRESSURE WASHERS**



#378 PRESSURE WASHER HOT WATER
1,500 PSI | 2.6 GPM | ELECTRIC
\$110 DAY | \$440 WK



#379 PRESSURE WASHER HOT WATER
3,500 PSI | 2.6 GPM | GAS
\$180 DAY | \$720 WK



#540 PRESSURE WASHER
6,000 PSI | 3.7 GPM | GAS
\$230 DAY | \$920 WK



#376 PRESSURE WASHER
4,000 PSI | 3.5 GPM | GAS
\$116 DAY | \$464 WK



#369 PRESSURE WASHER
2,000 PSI | 3.0 GPM | GAS
\$72 DAY | \$288 WK



#375 PRESSURE WASHER
3,000 PSI | 4 GPM | GAS
\$92 DAY | \$368 WK

Most Popular

Extension Wand!

**Cleaners &
Soaps Sold
In Our
Stores!**



**#377 EXTENDED REACH
WAND ADJUSTABLE TO 18'
\$20 DAY | \$60 WK**



**#622 SURFACE CLEANER
20" | PUSH | ATTACHMENT
\$30 DAY | \$90 WK**



**#374 PRESSURE WASHER
1,200 PSI | 110 V ELECTRIC
\$60 DAY | \$240 WK**



914-592-2016 | 914-739-9000
OPEN MONDAY - SATURDAY 7 TO 5

**NO TRUCK? NO TIME?
NO PROBLEM! WE DELIVER!**

PIPE WRENCH



#169 PIPE THREADER
1/4" - 2" | ELECTRIC
\$90 DAY | \$360 WK



#350 PIPE & DIE SET
1/4" - 2"
\$25 DAY | \$50 WK



#616 POWER THREADER
1/2" - 2" | HAND HELD | ELEC
\$57 DAY | \$228 WK



#164 2' \$11 D \$22 W
#163 3' \$13 D \$26 W
#163L 4' \$13 D \$26 W



#160 PLUMBERS PIPE STAND | VISE | 1/2" - 4"
\$17 DAY | \$34 WK



#161 - 1/2" - 4" PIPE CUTTER
\$13 DAY | \$26 WK



#162 - 4" PIPE CUTTER
\$25 DAY | \$75 WK



#166 CAST IRON PIPE CUTTER
\$40 DAY | \$160 WK



#619 PEX EXPANSION TOOL
1/2" - 3/4" - 1"
\$40 DAY | \$160 WK



#618 PROGRESS
1/2" - 3/4" - 1" - 1-1/4"
\$125 DAY | \$375 WK



#548 WATER TANK
300 GALLON
\$33 DAY | \$66 WK



WE CARRY A FULL LINE OF SAFETY PRODUCTS
GLOVES
GOGGLES
SAFETY GLASSES
SAFETY VEST
HARD HATS AND MORE

Check out our line of accessories for rent and sale

**CALL TODAY
FOR MONTHLY
RATES!**



#168 PIPE THAWER
110 VOLT | 400 AMP
\$176 DAY | \$528 WK



#352 PIPE FREEZE KIT 3/8"-3"
CO2 TANK ADDITIONAL
\$40 DAY | \$160 WK

*Extends
up to 120'*



#351 DRAIN SNAKE 25'
1" - 3" | ELECTRIC | VSR
\$44 DAY | \$176 WK



#354 SNAKE 50'
1" - 3" | ELECTRIC | VSR
\$50 DAY | \$200 WK



#349 SEWER SNAKE 75'
AUTO-FEED | UP TO 3" DIAM.
\$92 DAY | \$368 WK



*Additional Cables
Available*

#215 SEWER SNAKE 50'
2" - 4" SECTIONAL CABLES
\$92 DAY | \$368 WK



#268 WATER RAM KIT
\$18 DAY | \$72 WK



#608 CAMERA LOCATOR
FOR #606 & #607 CAMERA
\$60 DAY | \$240 WK



#606 INSPECTION CAMERA
200' | COLOR HEAD | SELF LEVEL
\$275 DAY | \$963 WK



#429 ROUST-A-BOUT
25' LIFT | 1,500 LB. CAP.
\$116 DAY | \$348 WK



#300 HYDROSTATIC PUMP
GAS POWERED
\$88 DAY | \$352 WK



#301 HYDROSTATIC TEST PUMP
ELECTRIC | 110 VOLT
\$94 DAY | \$376 WK



#269 WATER JET KIT 100'
CLEANS 1-1/2" TO 4" DRAIN
1,500 PSI | 1.76 PM
\$120 DAY | \$480 WK



914-592-2016 | 914-739-9000
OPEN MONDAY - SATURDAY 7 TO 5

**NO TRUCK? NO TIME?
NO PROBLEM! WE DELIVER!**

CALL TODAY FOR MONTHLY RATE!

#40 ROTARY HAMMER *
 DRILL 2" CAP | SDS
 \$80 DAY | \$320 WK



#94 DEMOLITION *
 HAMMER 68 LB | 1-1/8"
 \$100 DAY | \$395 WK



#95 PAVEMENT BREAKER *
 HAMMER | 28 LB | HILTI TE
 \$90 DAY | \$360 WK



#90 DEMOLITION *
 HAMMER 50 LB | HILTI BITS
 \$80 DAY | \$320 WK



#42 GRINDER *
 RIGHT ANGLE | 7 - 9"
 \$22 DAY | \$66 WK



#41 GRINDER *
 RIGHT ANGLE | 4"
 \$18 DAY | \$36 WK



#39 HAMMER DRILL *
 SDS PLUS | VSR
 \$23 DAY | \$69 WK



#91 ROTARY HAMMER *
 DRILL 1-1/2" CAP | SDS
 \$55 DAY | \$220 WK



#222 BAND SAW
 3-1/4" CAP | VS
 \$23 DAY | \$92 WK



#634 DEEP CUT BAND
 4-3/4" CAP | VS
 \$29 DAY | \$116 WK



#361 CHOP SAW *
 14" BLADE
 \$30 DAY | \$120 WK



#74 MAGNETIC DRILL PRESS
 1/2" CHUCK
 \$72 DAY | \$286 WK



#211 SAWZALL *
VARIABLE SPEED
\$18 DAY | \$36 WK



#209 CIRCULAR SAW *
7-1/4" BLADE
\$18 DAY | \$36 WK



#208 WORM DRIVE SAW *
7-1/4" BLADE
\$22 DAY | \$44 WK



#202 JIG SAW *
VARIABLE SPEED
\$18 DAY | \$36 WK



#206 ELECTRIC PLANER
3 -1/4" BLADE
\$33 DAY | \$66 WK



#212 ROUTER
1/4" COLLET VS | PLUNGE BASE
\$18 DAY | \$36 WK



#221 COMPOUND MITER * *
SAW 12" BLADE
\$44 DAY | \$176 WK



#219 SLIDING COMPOUND* *
MITER SAW 12" BLADE
\$46 DAY | \$184 WK



#423 SCREW GUN *
BATTERY OPERATED VSR
\$18 DAY | \$54 WK



#213 SCREW GUN *
VSR | ELECTRIC
\$18 DAY | \$36 WK



#210 TABLE SAW *
10" BLADE
\$50 DAY | \$200 WK



#636 JAMB/UNDERCUT * *
SAW 6-1/2" BLADE
\$29 DAY | \$116 WK



#220 HOLE HAWG
1/2" JOIST DRILL
\$28 DAY | \$84 WK



#60 DRILL *
1/2" RIGHT ANGLE | VSR
\$18 DAY | \$36 WK



#61 DRILL *
1/2" | D-HANDLE | VSR
\$18 DAY | \$36 WK



#635 TOE KICK SAW *
3/4" CUT
\$29 DAY | \$116 WK



914-592-2016 | 914-739-9000
OPEN MONDAY - SATURDAY 7 TO 5

**NO TRUCK? NO TIME?
NO PROBLEM! WE DELIVER!**

CALL TODAY FOR MONTHLY RATE!



#199 BELT SANDER *
4" X 24" | VARIABLE SPEED
\$18 DAY | \$36 WK



#198 BELT SANDER *
3" X 21" | VARIABLE SPEED
\$18 DAY | \$36 WK



#223 PALM SANDER
\$13 DAY | \$26 WK



#200 DISC 7" SANDER *
\$18 DAY | \$36 WK



#299 BUFFER
7" | VARIABLE SPEED
\$18 DAY | \$54 WK



#217 HEAT GUN
500° - 750° F
\$18 DAY | \$36 WK



#295 QUICK DRIVE *
FLOORING SCREW GUN
\$18 DAY | \$54 WK



**#77 PNEUMATIC FLOOR *
NAILER 2"**
\$45 DAY | \$180 WK



#66 ROOFING NAILER *
3/4"-1-3/4" COIL NAIL
\$29 DAY | \$116 WK



#346 SIDING NAILER *
1-1/2" - 3" COIL NAIL
\$29 DAY | \$116 WK



#270 1" CROWN STAPLER
PNEUMATIC LATHING
\$29 DAY | \$87 WK



#344 BRAD NAILER *
5/8"-2-1/8" 18 GA BRADS
\$20 DAY | \$60 WK



#63 FINISH NAILER *
1-1/4" - 2 1/2" 20 GA STAPLE
\$29 DAY | \$116 WK



#64 FRAMING NAILER *
STICK | 6-16D
\$29 DAY | \$116 WK



541
GPM

#304 TRASH PUMP
4" | PORTABLE | GAS
\$95 DAY | \$380 WK



383
GPM

#303 TRASH PUMP
3" | PORTABLE | GAS
\$75 DAY | \$300 WK



163
GPM

#302 TRASH PUMP
2" | PORTABLE | GAS
\$57 DAY | \$228 WK



29
GPM

#185 PUMP
1" CENTRIFUGAL | GAS
\$35 DAY | \$140 WK



88
GPM

#186 DIAPHRAGM PUMP
3" PORTABLE | GAS
\$70 DAY | \$280 WK



Submersible

79
GPM

#311 TRASH PUMP 2"
ELECTRIC | 110 VOLT
\$40 DAY | \$160 WK



Submersible

89
GPM

#312 PUMP 2"
ELECTRIC | 110 VOLT
\$40 DAY | \$160 WK



Submersible

121
GPM

#313 PUMP 3"
ELECTRIC | 110V | 220V
\$92 DAY | \$368 WK



DISCHARGE HOSE

- #704 | 3/4 X 50' | \$9 DAY
- #705 | 1 1/2 X 50' | \$12 DAY
- #706 | 2 X 50' | \$14 DAY



SUCTION HOSE

- #708 | 2" X 20' | \$11 DAY
- #709 | 3" X 20' | \$13 DAY
- #716 | 4" X 20' | \$17 DAY



Submersible

#182 PUMP
3/4" SUBMERSIBLE
\$18 DAY | \$36 WK



#307 FLOOD SUCKER
VACUUM & PUMP
\$69 DAY | \$276 WK

**We Stock NEW
Pumps, Hoses & Fittings**



20
GPM

#448 FUEL TRANSFER PUMP
110 VOLT
\$40 DAY | \$140 WK



28
GPM

#545 FUEL TRANSFER PUMP
110 VOLT
\$60 DAY | \$240 WK



914-592-2016 | 914-739-9000
OPEN MONDAY - SATURDAY 7 TO 5

**NO TRUCK? NO TIME?
NO PROBLEM! WE DELIVER!**

MISC.



#124 FLOOR JACK
3 TON
\$23 DAY | \$69 WK



#362 TRANSMISSION JACK
2,000 LB. CAPACITY
\$57 DAY | \$228 WK



#62 ENGINE CRANE
1,500 LB. CAPACITY
\$54 DAY | \$216 WK



#410 PORTA POWER KIT
10 TON
\$44 DAY | \$176 WK



#277 LINE STRIPER *
AEROSOL
\$18 DAY | \$36 WK



#356 HVLP SPRAY GUN KIT
\$85 DAY | \$340 WK



#280 AIRLESS PAINT SPRAYER | .54 GPM
\$100 DAY | \$400 WK



#409 PORTA-POWER
4 TON KIT
\$33 DAY | \$132 WK



#21 IMPACT GUN 3/4"
ELECTRIC
\$29 DAY | \$116 WK



#20 IMPACT GUN 1/2"
ELECTRIC
\$23 DAY | \$96 WK



#203 BATTERY CHARGER
\$28 DAY | \$112 WK



#416 PAPER SHREDDER
\$65 DAY | \$260 WK



#555 HOPPER
1 CUBIC YARD SELF DUMP
\$33 DAY | \$99 WK



#257 WALLPAPER STEAMER
ELECTRIC
\$35 DAY | \$140 WK



#9030 GREEN MONSTER
STAKE PULLER HYDRAULIC
\$110 DAY | \$440 WK



#69 CABLE PULLER
2,000 LB CAP.
\$18 DAY | \$54 WK



#436 SUCTION CUP 6"
\$17 DAY | \$34 WK



#438 BANDING KIT
1/2" & 5/8" CAP.
\$18 DAY | \$54 WK



#414 ROLLING MAGNET 30"
"MAGNETIC BROOM"
\$17 DAY | \$51 WK



#419 METAL DETECTOR
"ACE 250 SPORT"
\$29 DAY | \$116 WK



#422 METAL DETECTOR
PIPE | HEAVY DUTY
\$29 DAY | \$116 WK



#32 BOLT CUTTERS
MANUAL
\$18 DAY | \$36 WK



#214 COMPOSITE
SHINGLE CUTTER
\$28 DAY | \$84 WK



#276 HAVE-A-HART TRAP
\$17 DAY | \$34 WK



#605 INSPECTION CAMERA
3' TO 6'
\$29 DAY | \$116 WK



#405 POST PULLER
\$83 DAY | \$249 WK



#2040 FIRE EXTINGUISHER
NO. 10 ABC (PLUS RECHARGE)
\$17 DAY | \$34 WK



#114 PINTLE HOOK
BALL COMBO HITCH
\$15 DAY | \$30 WK



#530 FOLDING RAMPS
1,000 # CAPACITY
\$23 DAY | \$92 WK

#1530 MAN HOLE LIFT
CONFINED SPACE LIFT
\$85 DAY | \$340 WK





CALL TODAY FOR MONTHLY RATE!

#82 WELDER
300 AMP | DIESEL
\$154 DAY | \$616 WK

We sell welding gloves and supplies



#262 WELDER
100 AMP | GAS
\$66 DAY | \$264 WK



#261 WELDER
110 VOLT | GAS OPTIONAL
\$46 DAY | \$184 WK



#266 PLASMA CUTTER
110/220 VOLT | 3/8" CAP
\$69 DAY | \$276 WK



#222 BAND SAW *
3-1/4" CAP. | VARIABLE SPEED
\$23 DAY | \$92 WK



#41 RIGHT ANGLE GRINDER *
4" | ELECTRIC
\$18 DAY | \$36 WK



#42 RIGHT ANGLE *
GRINDER 7" - 9"
\$22 DAY | \$66 WK



TANKS NOT AVAILABLE

#28 ACETYLENE TORCH KIT
\$33 DAY | \$132 WK



#634 DEEP CUT BAND *
SAW 4-3/4" CAP
\$29 DAY | \$116 WK



#74 MAGNETIC DRILL
PRESS | 1/2" CHUCK
\$72 DAY | \$286 WK



#361 CHOP SAW *
12" BLADE
\$30 DAY | \$120 WK



#630 METAL CIRCULAR
SAW 8" | ELECTRIC
\$20 DAY | \$80 WK



#246 NIBBLERS
16 GA
\$29 DAY | \$116 WK

BEST SELLING ACCESSORIES AND SUPPLIES IN STOCK!



DIAMOND BLADES



WHEELBARROWS
ASSEMBLED



BROOMS, PICKS &
SHOVELS



SLEDGE HAMMERS

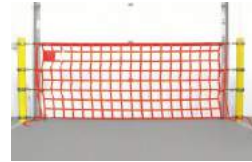

SAFETY FENCE
4' X 100'



QUIKRETE
PRODUCTS



RATCHET BINDERS



TOOL KIT



TIE DOWN STRAPS



NYLON SLINGS



COMBO HITCHES



TOWING



RAIN GEAR



SAFETY APPAREL



HAND TOOLS



ASSORTED GLOVES



MARKING PAINT &
MORE



TRAFFIC SAFETY
SUPPLIES



ROCK BITS
& DRILL STEEL



POINTS & CHISELS
ASPHALT CUTTERS



HAMMER DRILL BITS
SPLINE & SDS



AIR & WATER HOSES



OIL AND FUEL
FILTERS



FUEL MIXES AND OILS



HYDRAULIC OIL
AW 32 & 46



HYDRAULIC HOSES
MADE HERE



GREASE GUNS



ASSORTED MASON
TOOLS



ABRASIVE CUTTING &
GRINDING BLADES



GET 10 REFILLS AND
THE NEXT IS ON US

We Sell, Service and Repair Your Favorite Brands



914-592-2016 | 914-739-9000
OPEN MONDAY - SATURDAY 7 TO 5

NO TRUCK? NO TIME?
NO PROBLEM! WE DELIVER!

PARTY LINE

TENT RENTALS
partylinerentals.com • 914-592-1200

WEDDINGS - CORPORATE - PRIVATE



PROVIDING THE ULTIMATE RENTAL EXPERIENCE FOR OVER 30 YEARS

PARTY PACKAGES

Visit our Store. *Come and Explore!*



Event Layout ♦ On-Site Technicians & Service Available 24/7

Life just got easier with our complete party packages for 20 to 100 guests. Tent, tables, chairs, and lighting for a value packed event.



Complete Packages for Training, Luncheons & Parties Heated & Air Conditioned Tents

Call 914-592-1200 or visit www.partylinerentals.com to rent a professionally installed tent!



20 Guest Party Package
16'x16' Tent
#7950

- 20X
- 3X
- 1X
- 1X



30 Guest Party Package
20'x20' Tent
#7953

- 30X
- 3X
- 1X
- 1X



50 Guest Party Package
20'x30' Tent
#7951

- 50X
- 5X
- 1X
- 2X



70 Guest Party Package
30'x30' Tent
#7954

- 70X
- 7X
- 2X
- 2X



100 Guest Party Package
30'x40' Tent
#7952

- 100X
- 10X
- 2X
- 3X

OPEN: MONDAY- FRIDAY 8AM TO 5:30PM
SATURDAY 9AM-3PM

PARTY LINE

914-592-1200

PARTY LINE RENTALS
 @PARTYLINERENTALS

POPULAR TENTS

Party Line has the largest selection of Frame, Clear Top, Sailcloth, Century, Canopies and Structures in Westchester.

Professional Tent Installations for Patios, Decks, Driveways, Lawns and Rooftops.



Popular Sizes	16x20	25x25	50x50
	16x28	25x30	50x60
10x10	16x36	20x35	50x80
10x20	16x40	30x30	50x100
12x24	16x48	30x40	60x100
12x30	18x38	30x50	60x180
12x36	20x25	30x60	80x70
14x21	20x40	40x40	80x100
14x28	20x50	40x60	80x130
14x38	20x60	40x80	80x160
14x42	20x80	40x100	80x190

TABLES

Rectangular

- 4' x 30" Seats 4 -6
- 6' x 24" Seats 6 -8
- 6' x 30" Seats 6 -8
- 6' x 36" Seats 6 -8
- 6' x 42" Seats 6 -8
- 8' x 24" Seats 8 -10
- 8' x 30" Seats 8 -10
- 8' x 36" Seats 8 -10
- 8' x 42" Seats 8 -10

Round

- 42" Seats 4-6
- 48" Seats 6 - 8
- 54" Seats 8 -10
- 60" Seats 8 -10
- 72" Seats 10 -12

Pedestal

- 24" Seats 4-6
- 30" Seats 6 - 8
- 36" Seats 8 -10

Tables start at \$13.20/each



Custom Sizes Available!
CALL FOR MORE INFO + PRICING!

CHAIRS

Garden Chairs



\$4.00

Folding Chairs



\$1.95-\$2.25

Chivari Chairs



\$8.75-10.00

Ghost Chairs



\$13.75

Chair Cushion



\$.75 & up

X20 Chairs



\$12.00



DESIGN CENTER: 1 NEPPERHAN AVENUE ELMSFORD NY 10523

914-592-1200

STAGES

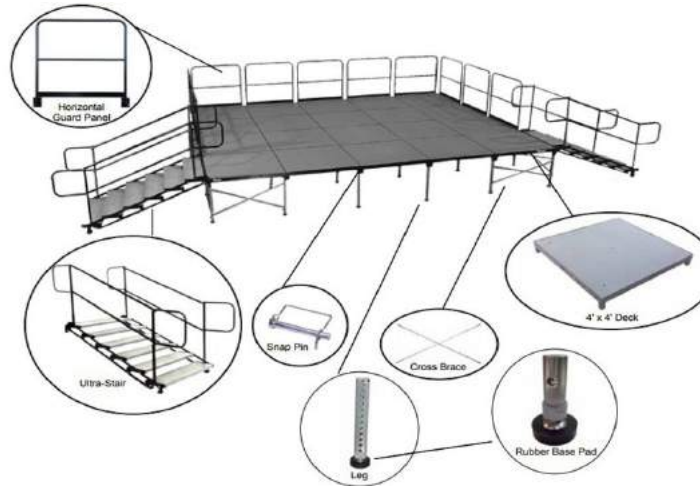

Bil-Jax Flooring System is the ideal product to use when you want to place a tent with floor in an area that has an unlevel surface! Great for Stages - Bands - Presentations - Weddings!

BARS & BARWARE

- Modular Flash Bar **Starts at \$176 & up**
- Pewter Bar 4' & 6' **\$66-\$88**
- Rolling Bar **\$126.50**
* skirt sold separately
- Ice Chest 120 QT **\$26.40**
- Ice Tongs **\$2.20**
- White Ice Tub **\$14.85**
- Ice Scooper **\$1.75**
- Bar Pitcher **\$2.75**
- Cocktail Shaker **\$7.70**
- Wine Ice Bucket w/ Stand **\$13.20**



Dance Floor

- White
- Black
- Checkered
- Wood



**All Sizes Available
Call For More Information!**

RUSTIC COLLECTION



- Farm Table 42" x 8" **\$180**
- Round Farm Table 60" **\$60**
- Cross Back Chair **\$12**
- Cross Back Bar Chair **\$18**
- Farm Bench 8" **\$28.60**
- High Pub Table 36" x 36" **\$60**

VISIT OUR DESIGN CENTER TODAY!

OPEN: MONDAY- FRIDAY 8AM TO 5:30PM
SATURDAY 9AM-3PM



914-592-1200

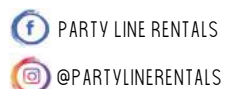

GRILLS

BBQ Charcoal 2'x3' \$55



BBQ Charcoal 2'x5' \$88



BBQ Charcoal w/ Electric Rotisserie \$170.50

BBQ Propane 2'x6' \$176
** propane sold separately



BBQ Propane 2'x42" \$100
** propane sold separately



Aluminum Cooktop Tent 6' X 10' \$140

Propane Tanks 20# - 40# - 60# - 100# Market

Propane Deep Fryer 40# \$154
** propane sold separately

Table Top Deep Fryer \$60
Electric | 110V

Check out website for full line of cooking equipment, appliances, pots & pans and more.

Picnic Tables with Benches



\$42

Patio Umbrella



\$27.45

9ft Market Umbrella



\$33.90

11 ft Market Umbrella



\$67.50

Rhino Patio Heater



\$110

Lava Light



\$165

OUTDOOR

DINING

FILM & PRODUCTION

Directors Chair W/ Tray \$22



Bull Horn \$22

Hair & Makeup Chair \$22

Makeup Mirrors \$27.50



Red Carpet \$110

8' Red/Black Rope \$7.15

Stanchion w/ Retractable \$20

Stanchion Chrome \$11

Ceremonial Scissors \$33



We offer an extensive line of gas and electric powered climate control rental items.



HEATING & COOLING

A/C Units

Call for pricing

Barricades

\$28

Generators

Call for pricing

Heaters

Call for pricing

Light Towers

\$176

Pedestal Fans

\$60-66



DESIGN CENTER: 1 NEPPERHAN AVENUE ELMSFORD NY 10523

914-592-1200

CONCESSION & KIDS

- Popcorn & Popper Machine \$115.50
- Popcorn & Popper Cart \$27.50
- Cotton Candy Machine \$95
- Cotton Candy Cart \$27.50
- Sno-Cone Machine \$85
- Sno-Cone Cart \$27.50
- Ice Cream Cart \$215
- Hot Dog Cart W/ Umbrella \$154
- Frozen Drink Machine \$148
- Funnel Cake Machine \$88



Kids Folding Chairs

\$2.15



Kids Chivari Chairs

\$5-\$5.50



Chalkboard Table

\$18



Kids Banquet Table 6'

\$15

Kids Round Table 42'

\$15



VISIT OUR WEBSITE FOR CHINA - GLASSWARE - FLATWARE!

PICK UP TODAY!



Solid and pattern table covers are available in various colors, sizes and shapes.



Plastic cutlery, plates and cups available



Popcorn, cotton candy, sno-cone, frozen drinks, funnel cake and more!



We sell cook pans/lids, trays and sternos.



OPEN: MONDAY- FRIDAY 8AM TO 5:30PM
SATURDAY 9AM-3PM

PARTY LINE



914-592-1200



PARTY LINE RENTALS



@PARTYLINERENTALS

3 GENERATIONS OF FAMILY OWNED BUSINESS

Westchester Tool Rentals offers a comprehensive Tool & Equipment Rental and Retail inventory while providing the best personalized customer service not only for municipalities and the big contractor but also for the homeowner and 'do-it-yourselfer'. Family owned and operated, WTR has been serving the community for over 36 years, and just like an old fashion general store, we probably have what you need, but if we don't we'll be more than happy to find it for you. We are proud to be recognized as one of the top Rental Supply Houses in the NY Metro Region as well as being highly regarded in the rental industry nationally.

Tools have always been in the Puff blood. We had our first garage and tool rental store in Silver Lake, White Plains NY. WTR now includes 2 locations in Elmsford and Peekskill, NY with over 36,000 sq feet of tools and equipment. In 1990, the tool-rental business diversified into the party-rental biz, creating a sister company, Party Line Tent Rentals. The result is that Party Line is much more than just tents: It supplies generators, air-conditioners, cooking equipment, China table-top, and chairs, as well.



Buddy, Kenny & Ben Puff



The Puff family first garage and tool rental in Silver Lake, White Plains NY



**WTR is proud to be a
Women Led Business Enterprise
led by Karin Puff, President.**



A Whole Lot More Than a Rental Store

Rentals - Sales - Service

FILL UP

**Propane and Kerosene
Filling Station**



REPAIR & SERVICE

**Hydraulic Hoses, Fittings, Adapters & Custom Made
Hydraulic Hose Assemblies**

Express Hose Center



WTR WESTCHESTER TOOL RENTALS

wtrrentals.com

Rentals • Sales • Service



Why Buy when you can
Rent and **SAVE?**
We also **Sell** NEW and USED
Equipment if you want to
Buy!



Serving the NY Tri-State from
Northern and Central
Westchester

Quality Products. Competitive
Prices. Professional Service



Family Owned since 1983



11 Vreeland Ave Elmsford 914-592-2016
1075 Washington St Peekskill 914-739-9000