

Food Service Faucets and Plumbing

CATALOG
2024



- ✓ Pre Rinse Units
- ✓ Spray Valves
- ✓ Pantry Faucets
- ✓ Hose Reels
- ✓ Waste Valves

Without Price

ON DEMAND CUSTOM FAUCETS FOR COMMERCIAL KITCHEN



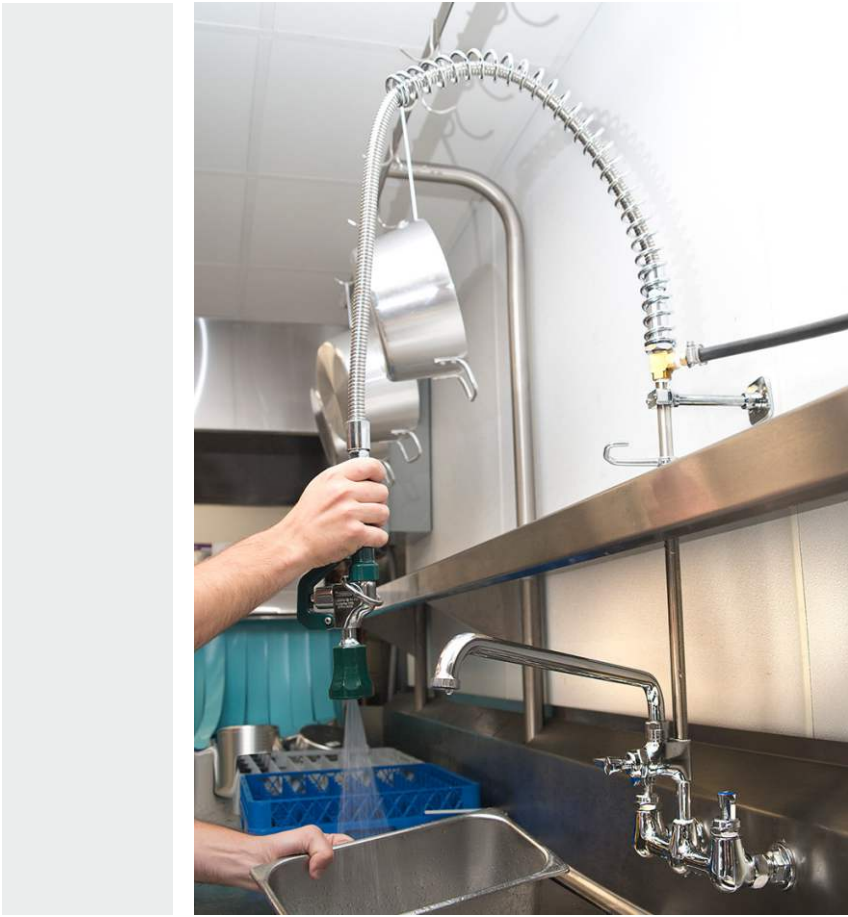

About Us

Art & Performance Blended Together

ALUIDS - brand is a name derived from fluids which is born in Atlanta, GA, Aluids is a brand of **KROME USA INC.**, A company with more than 45 years of experience in field of plumbing.

ALUIDS offers the most innovative range of products & accessories for food service, commercial plumbing, industrial and institutional markets. We offer complete range of Basic to Exclusive Commercial Kitchen, Plumbing Products & its accessories for a broad spectrum of consumers. Aluids has its own manufacturing plant which brings us to top level in Quality and Process.

With a unique combination of features and designs, ALUIDS has been able to win the trust of many over the years, making it a brand of choice for projects worldwide.

Core Values

- ✓ **Putting the customer first** - Our business prioritize our customer ahead of anything and everything else.
- ✓ **Integrity** - We believe our business should be done in fair, honest and in transparent way.

Quality

Everything at ALUIDS comes with a seal of exceptional quality. We follow stringent quality procedures to make sure every product exceeds customer expectations.

The expert's team at ALUIDS are specialists in casting, electroplating, assembling, sanding and finishing our products to the highest level.



— 4 Year —
Limited Warranty



Lead is Harmful



*4 Years Warranty on all Heavy Duty Pre Rinse Faucets and Commercial Kitchen Accessories.

CONTENTS

Pre Rinse Units

- 8" Center Wall Mount Pre Rinse
- 8" Center Deck Mount Pre Rinse
- Eco line Single Hole Deck mount Pre Rinse
- Single Hole Deck Mount Pre Rinse
- Add on Faucet
- Pre Rinse Repair Kits
- Spray Valve
- Spray Valve Repair Kits
- SS Flexible Hose & Assemblies
- Pre Rinse Accessories
- Chemical Tee



Pantry Faucets

- 8" Center Double Lever Deck Mount Faucets
- 4" Center Double Lever Deck Mount Faucets
- Single Hole Single Lever Deck Mount Faucets
- Single Hole Double Lever Deck Mount Faucets
- 8" Center Double Lever Wall Mount Faucets
- Single Hole Single Lever Wall Mount Faucets
- Ecoline Pantry faucets
- Standard Hand Sinks
- Side Splash Hand Sinks
- Pot Filler Faucets
- Pot Filler
- Utility Spray
- Wok Faucets
- Manual Wok Faucet
- P - Trap
- Wrist Handle Accessories
- Pantry Faucets Repair Kit
- Standard Swing Spouts/Nozzles
- Double Joint Swing Nozzles
- Cast Swing Spouts/Nozzles
- Swing Gooseneck
- Rigid Gooseneck
- Wall & Deck Nozzles
- Supply Inlets
- Water Line Kits
- Pantry Faucets Accessories



Glass Filler

Hose Reel

Drains

- Twist Handle Waste Drains
- Ball Waste Valve Drains
- Replacement Parts

Sink Drains

Shelves

Foot Pedal Valve

- Repair Kit for Pedal Valve

Dipper Well

Glass Rinser

Soap Dispenser





**CLASSIC
CARTRIDGE**

**CERAMIC
CARTRIDGE**

Platinum Series offers heavy duty construction which is hard to damage in a commercial work space. Constructed from lead free brass and complies with international norms.



Typical feature of the Ecoline series is, it is easy on the pocket. We have included the most affordable Equipment in this series. Product assemblies are made with high quality material. All the products of this series can be used for commercial as well as for home use.



Section 1417 of the Safe Drinking Water Act prohibiting the use of lead in plumbing components. Most of the products of Aluids are made with Lead free Brass. Lead free Brass replaces the Lead with Silicon, Bismuth or Mixed Copper Alloys, Which help address those issues. It is safe for Food, Drink or Any other Form of Bodily Intake. Our Customer's health and safety is our first priority.

PRE - RINSE UNIT



Pre Rinse Faucet Spring:
Reduces the stress on
the hose at key points.

Reinforced
Hose

Riser Tubes: Ideal for floor
mount Faucet installation.

Spray Valve: Heavy-Duty spray
valves with 1.42 GPM Designed for
use in Commercial Kitchens.

Swing Nozzle: Stream
Regulator Suitable for
all Aluids Faucets.

Double Pantry Wall Mounted Faucet:
The perfect solution when
you are required with Steady
water fixture in your facility.

Lever Handle with cold
Index : Pressure of
20 - 126 psi at temperature
of 40 F to 140 F.

Classic
Cartridge

Ceramic
Cartridge
(Suffix CE)

High Performance cartridge valves
that are designed for longevity.

Pre-rinse units are must-have equipment in all commercial kitchens. The efficient high-pressure water stream of pre-rinse units reduces turnaround time and effort in the cleaning process.

Aluids offers commercial pre-rinse units in three categories – wall mount, deck mount and Economy. Built to last long with reliable brass material and coated with food safe chrome plating. With all these qualities, pre-rinse units are a great tool to have and we have best of the lot.

PRE - RINSE UNIT

Wall Mount



Platinum
SERIES

Part #	Part Name
C8141	Pre-Rinse Unit: 1.15 GPM, 8" Center Wall Mount with Knife Jet Valve
C8198	Pre-Rinse Unit: 1.42 GPM, 8" Center Wall Mount
C9551-1.15	Pre-Rinse Unit: 1.15 GPM, 8" Center Wall Mount

- ✓ Faucet with 8" Centers
- ✓ Built-in Cartridges
(Quarter Turn Cartridge with Integral Spring Check Lever)
- ✓ Inlet Kit (C8112) Sold Separately.
- ✓ Include 6" Wall Bracket.
- ✓ 44" SS Flexible Pipe Assembly.
- ✓ 18" Riser Tube.



C8198



Low Water Flow
Spray Valve

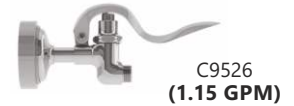
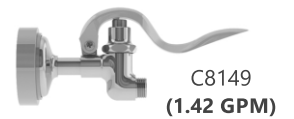
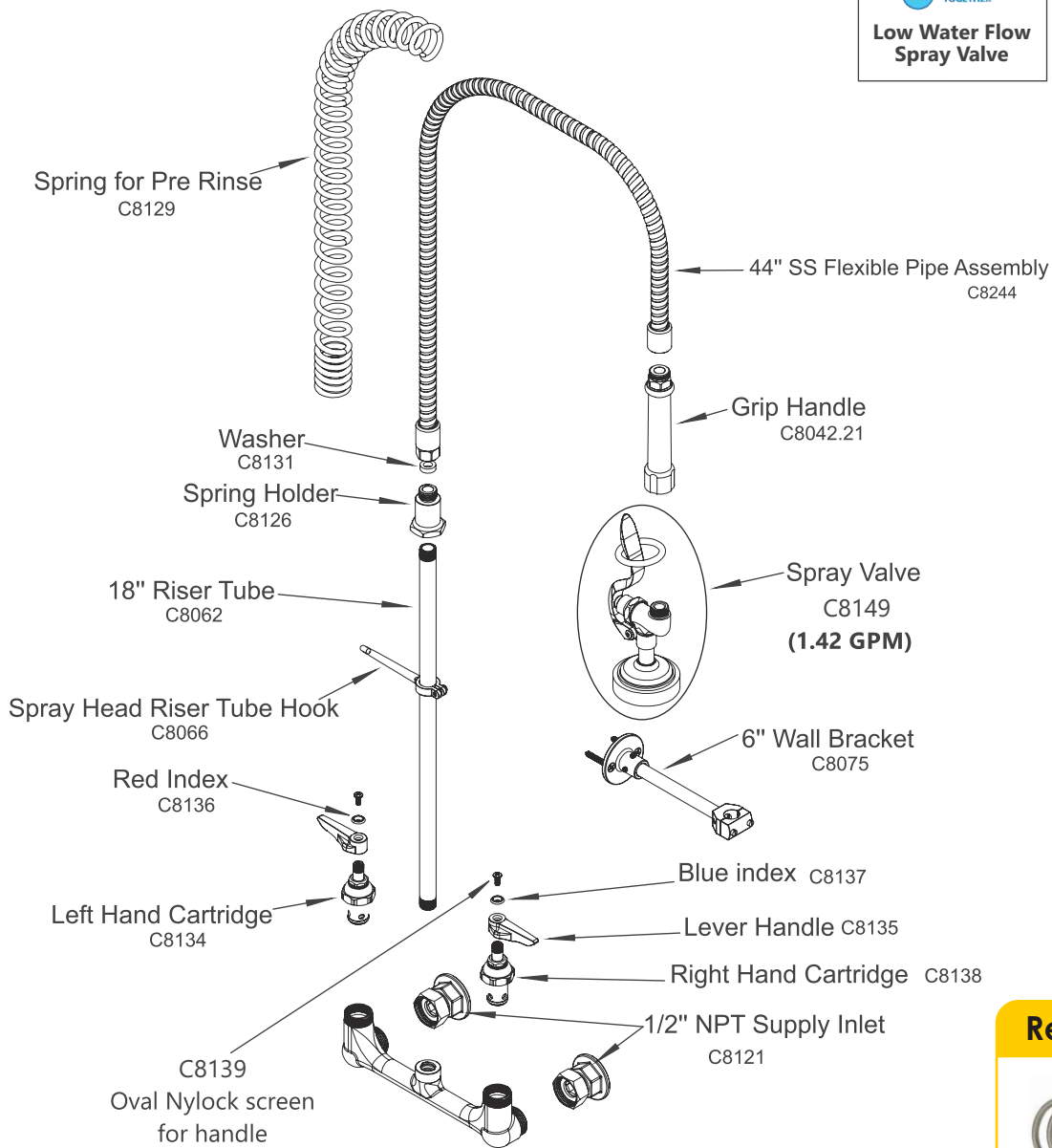

Required to Install



PRE - RINSE UNIT

Wall Mount



Platinum
SERIES

Part #	Part Name
C8466	8" Center Wall Mount Pre-Rinse with Wall Bracket and Add on Faucet with 12" Spout - 1.15 Knife Jet Valve
C8467	8" Center Wall Mount Space Saver Pre-Rinse -1.42 GPM and Add on Faucet with 8" Spout
C8466-1.15	8" Center Wall Mount Pre-Rinse with Wall Bracket and Add on Faucet with 12" Spout - 1.15 GPM Spray Valve
C8467-1.15	8" Center Wall Mount Space Saver Pre-Rinse -1.15 GPM and Add on Faucet with 8" Spout

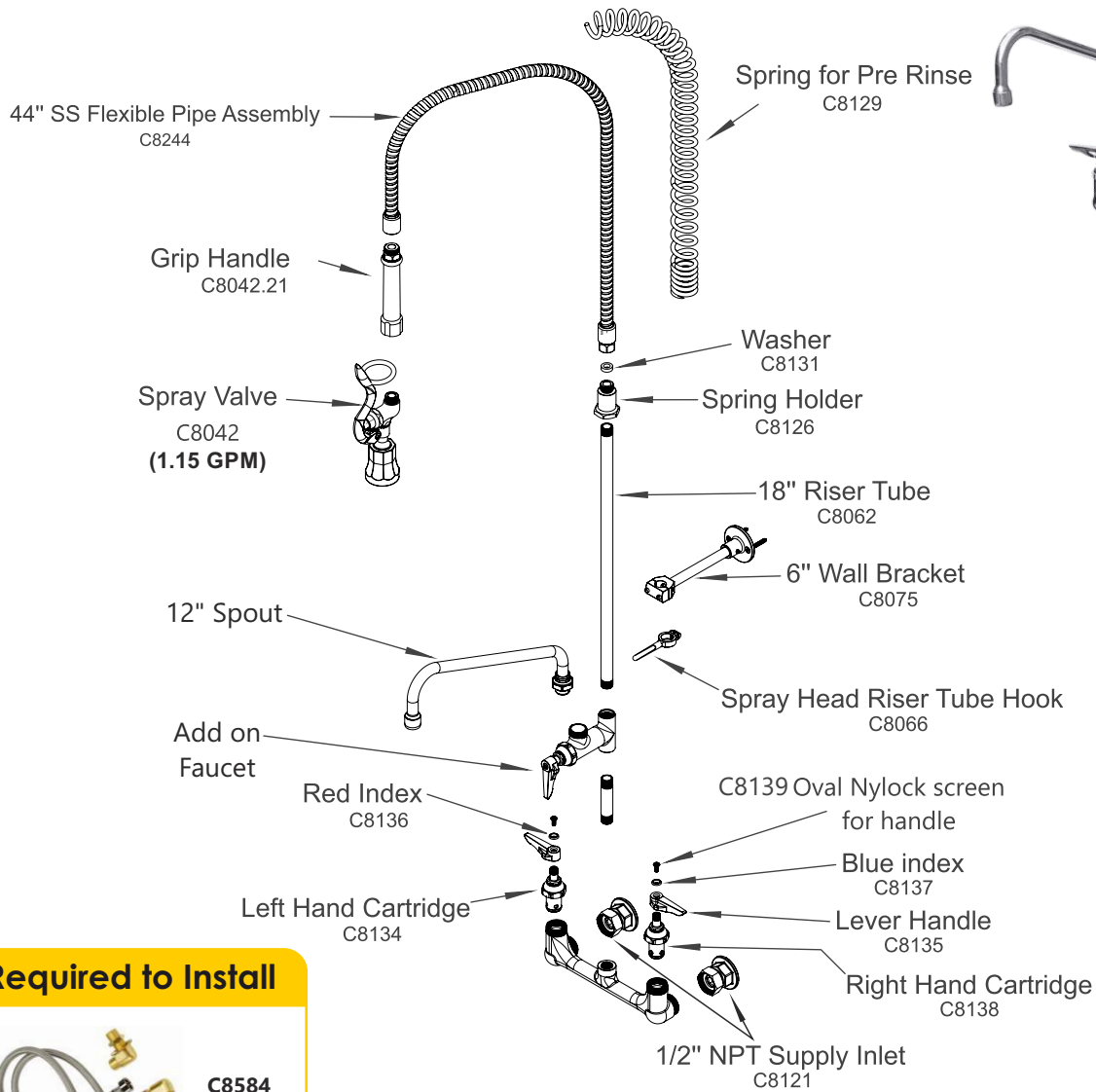

Required to Install

C8584

C8466



ALUIDS

1.15
GPM

SAVE HOT WATER , SAVE ENERGY
INCREASE EFFICIENCY
REDUCE OPERATIONAL COST

PRE - RINSE UNIT

Deck Mount



Platinum
SERIES

Part #	Part Name
C8200	Pre-Rinse Unit: 1.42 GPM, 8" Center Deck Mount
C8199	Pre-Rinse Unit: 1.15 GPM, 8" Center Deck Mount with Knife Jet Valve
C8200-1.15	Pre-Rinse Unit: 1.15 GPM, 8" Center Deck Mount

- ✓ Faucet with 8" Centers
- ✓ Built-in Cartridges.
(Quarter Turn Cartridge with Integral Spring Check Lever)
- ✓ Inlet Kit (C8118) Sold Separately.
- ✓ 44" SS Flexible Pipe Assembly.
- ✓ 18" Riser Tube.

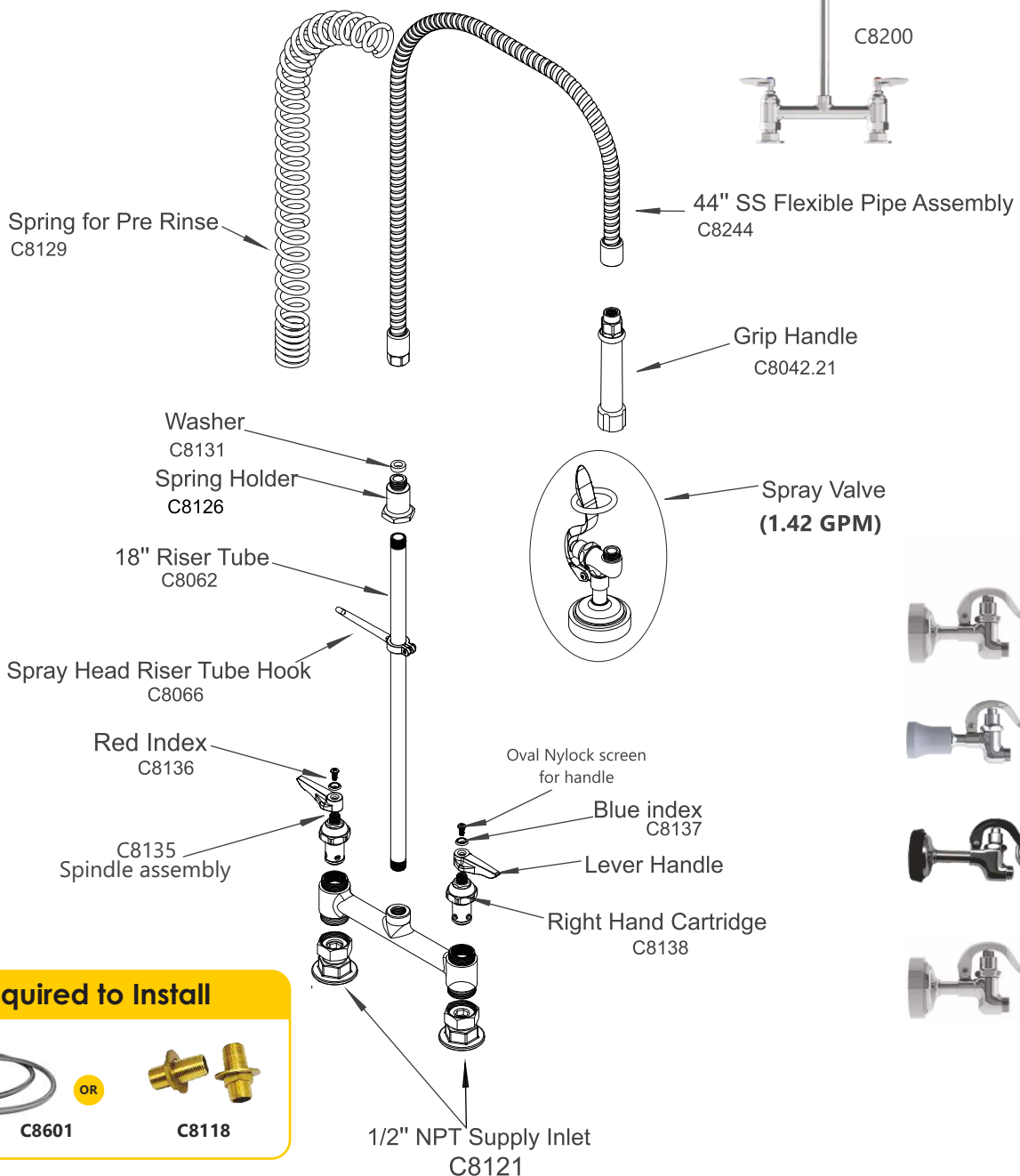

Required to Install

C8601 OR C8118

Deck Mount



Platinum
SERIES

Part #	Part Name
C8468	8" Center Deck Mount Pre-Rinse with Wall Bracket and Add on Faucet with 12" Spout with 1.15 Knife Jet Valve
C8470	8" Center Deck Mount Space Saver Pre-Rinse and Add-On Faucet with 8" spout with 1.15 Knife Jet Valve
C8469	8" Center Deck Mount Space Saver Pre-Rinse and Add-On Faucet with 6" spout with 1.15 Knife Jet Valve
C8573	4" Center Deck Mount Pre-Rinse with Wall Bracket and Add on Faucet with 8" Spout with 1.15 Knife Jet Valve
C8567	4" Center Deck Mount Pre-Rinse with Wall Bracket and Add on Faucet with 6" Spout with 1.15 Knife Jet Valve
C8572	4" Center Deck Mount Long Height Pre-Rinse, Double Lever with 1.15 Knife Jet Valve
C8468-1.15	8" Center Deck Mount Pre-Rinse with Wall Bracket and Add on Faucet with 12" Spout with 1.15 GPM
C8470-1.15	8" Center Deck Mount Space Saver Pre-Rinse and Add-On Faucet with 8" spout with 1.15 GPM
C8469-1.15	8" Center Deck Mount Space Saver Pre-Rinse and Add-On Faucet with 6" spout with 1.15 GPM
C8573-1.15	4" Center Deck Mount Pre-Rinse with Wall Bracket and Add on Faucet with 8" Spout with 1.15 GPM
C8567-1.15	4" Center Deck Mount Pre-Rinse with Wall Bracket and Add on Faucet with 6" Spout with 1.15 GPM
C8572-1.15	4" Center Deck Mount Long Height Pre-Rinse, Double Lever with 1.15 GPM

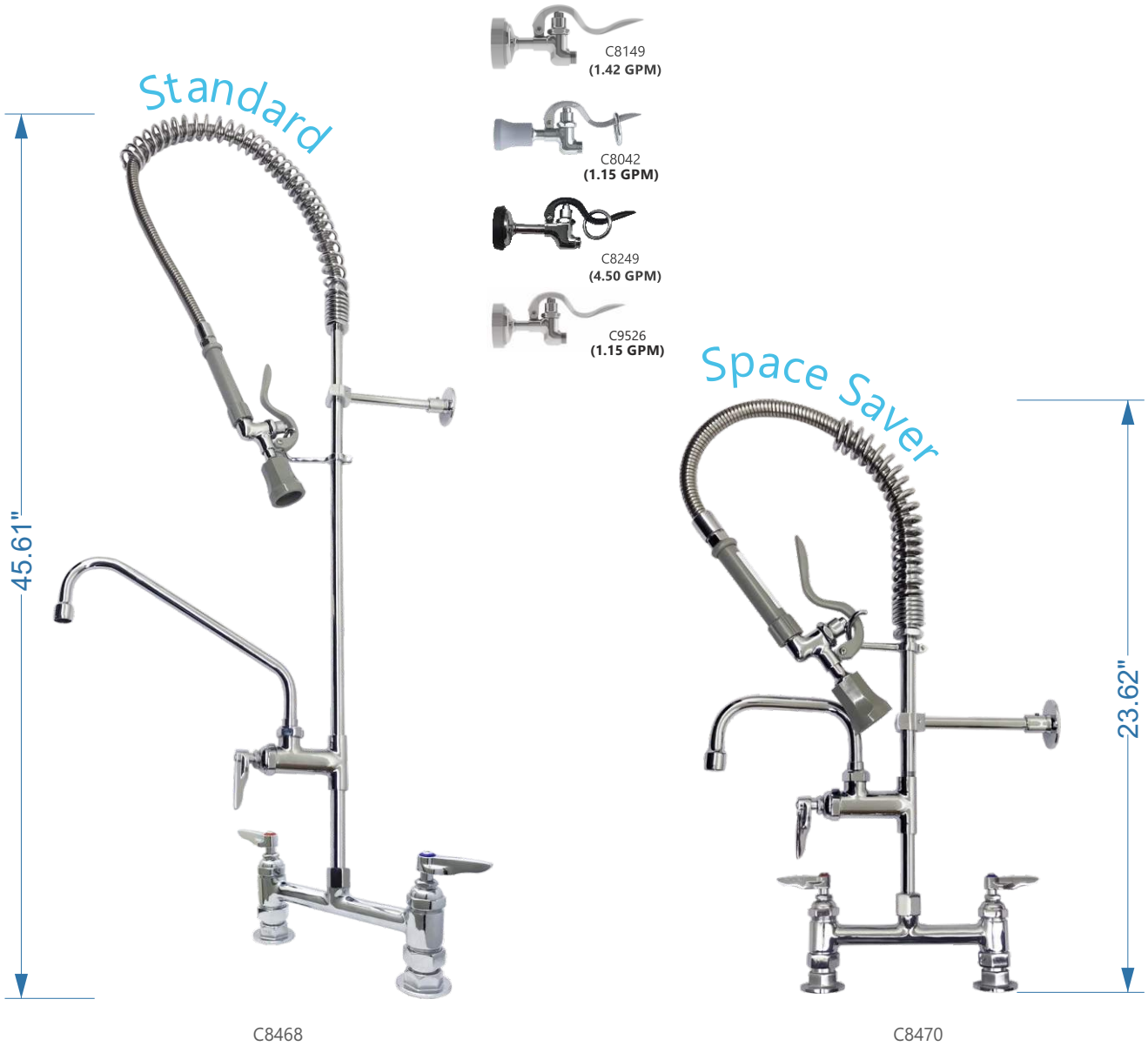

PRE - RINSE UNIT



Part #	Part Name
C8219	Pre-Rinse Unit: Single Lever Deck Mount Faucet with High Flow Spray Valve

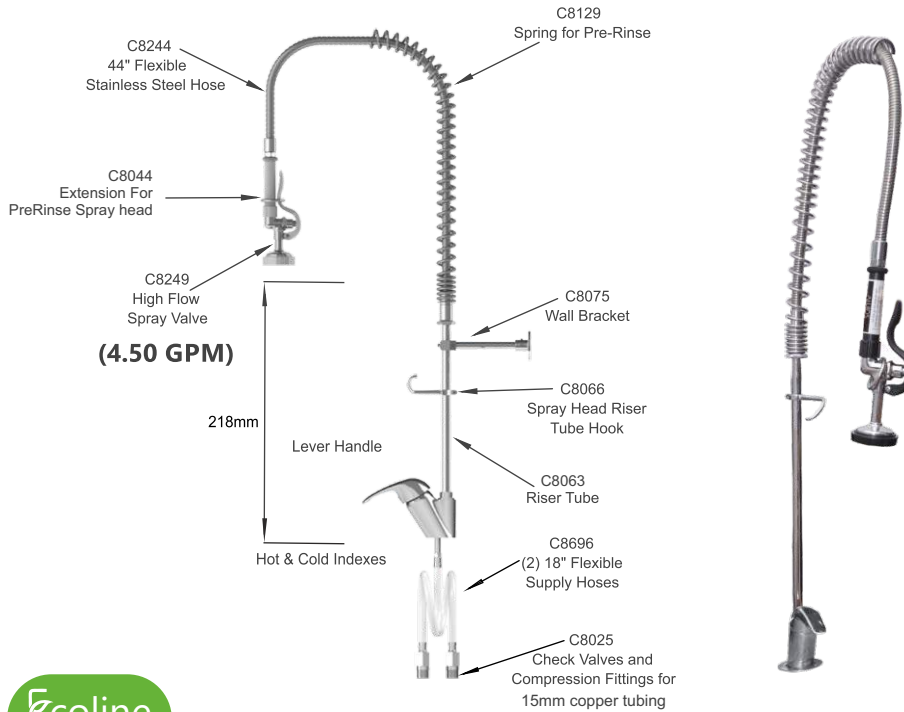

Part #	Part Name
C8220	Pre-Rinse Unit: Single Hole Deck Mount, High Flow Spray Valve, Add-On Faucet and 12" Nozzle

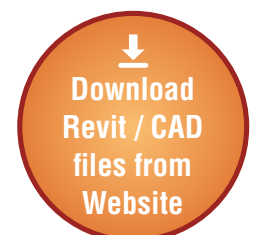
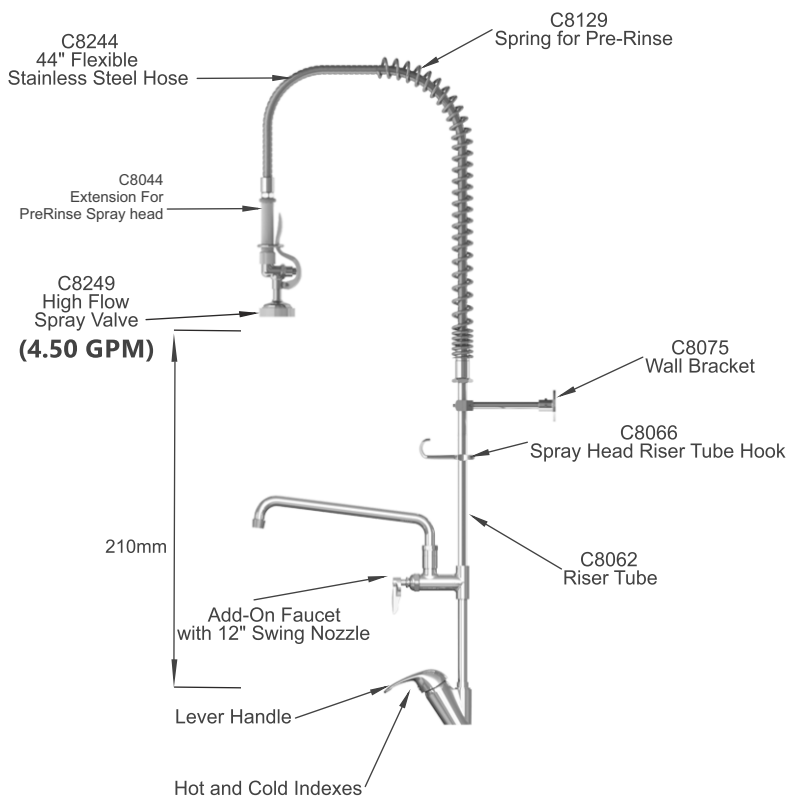

PRE - RINSE UNIT



Part #	Part Name
C8441	Pre Rinse Unit- Short Height Double Lever,Single Hole Deck Mount Highflow Spray valve with Hoses
C8436	Ecoline Pre-Rinse Unit:Short Height Double Lever, Single Hole, Deck Mount,4.50GPM Spray Valve

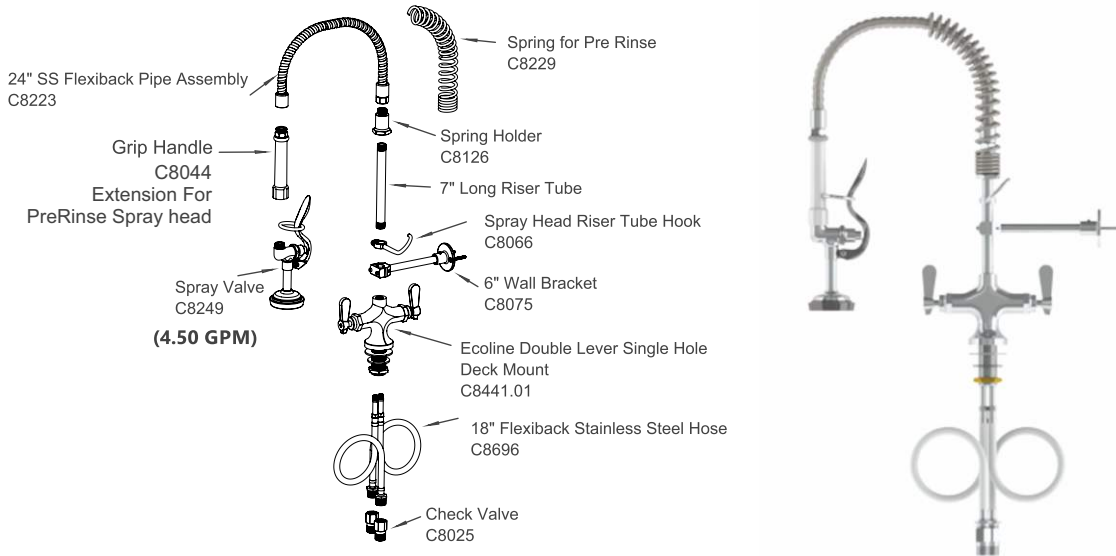

Part #	Part Name
C8221	Pre-Rinse Unit: Short Height, Single Hole Deck Mount, High Flow Spray Valve
C8025	Check Valve for 15 mm OD Copper Tubing Assembly (1/2 male and 1/2 female)

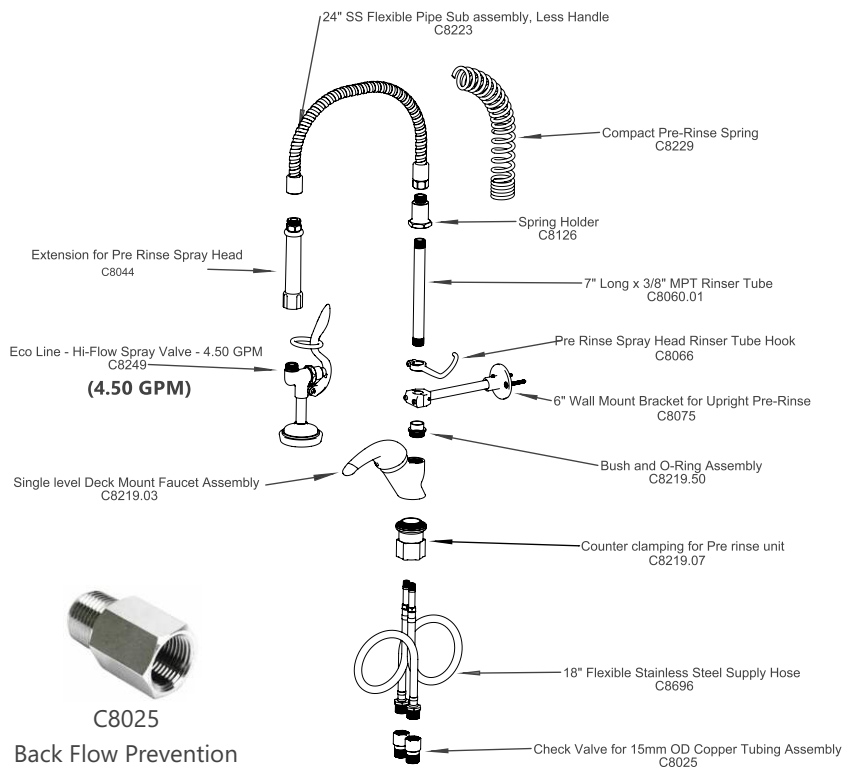

PRE - RINSE UNIT

Deck Mount



Part #	Part Name
C8442	Pre Rinse Unit Deck Mount Single Hole, Double Lever (Ecoline)
C8443	Pre-Rinse Unit: Long Height Double Lever Single Hole Deck Mount, High Flow Spray Valve
C8443-1.15	Pre-Rinse Unit: Long Height Double Lever Single Hole Deck Mount, 1.15 GPM Spray Valve

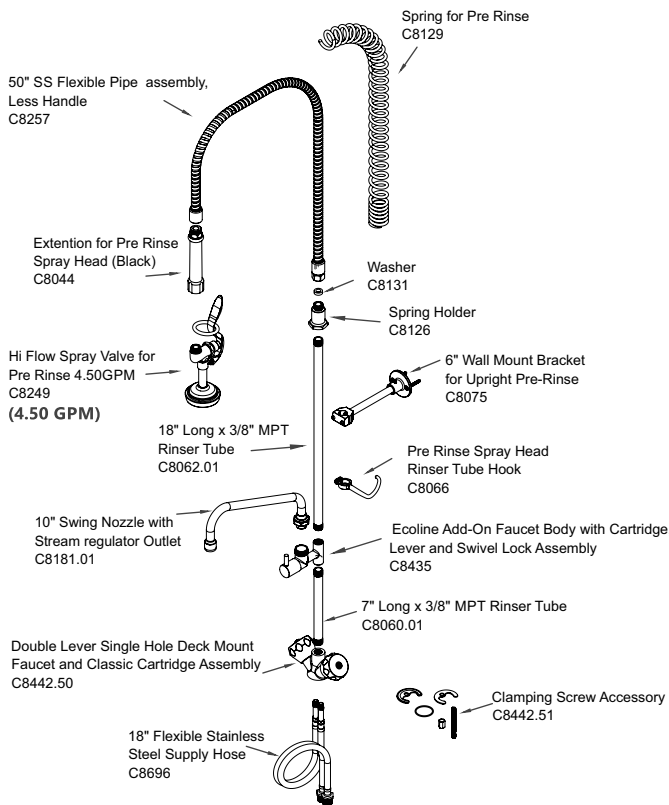

C8442

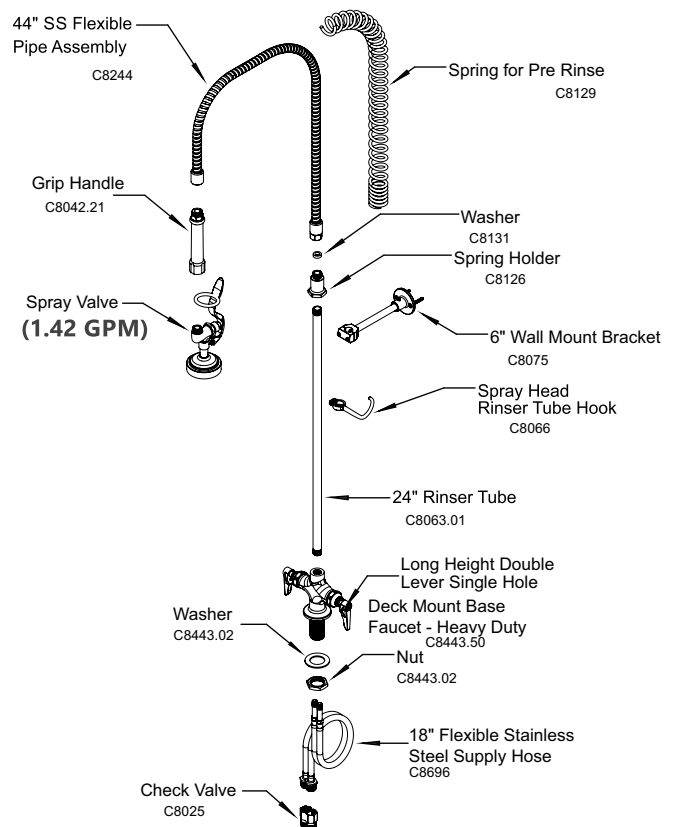

C8443

ADD ON FAUCET



(Quarter Turn Classic Cartridge)*



C8203



C8173

Part #	Part Name
C8173	Add on Faucet Body
C8203	Add-on Faucet w/ 6" Swing Nozzle
C8204	Add-on Faucet w/ 12" Swing Nozzle
C8205	Add-on Faucet w/ 18" Swing Nozzle
C8210	Add-on Faucet w/ 10" Swing Nozzle

PRE - RINSE UNIT

Deck Mount



Platinum
SERIES

Part #	Part Name
C8444	Single Hole Deck Mount Space Saver Pre-Rinse and Add-On Faucet with 8" Spout with Knife Jet Valve
C8445	Pre-Rinse Unit Long Height Double Lever Single Hole Deck Mount and Add-on Faucet with 12" spout with Knife Jet Valve
C8444-1.15	Single Hole Deck Mount Space Saver Pre-Rinse and Add-On Faucet with 8" Spout with 1.15 GPM Spray Valve
C8445-1.15	Pre-Rinse Unit Long Height Double Lever Single Hole Deck Mount and Add-on Faucet with 12" spout with 1.15 GPM Spray Valve

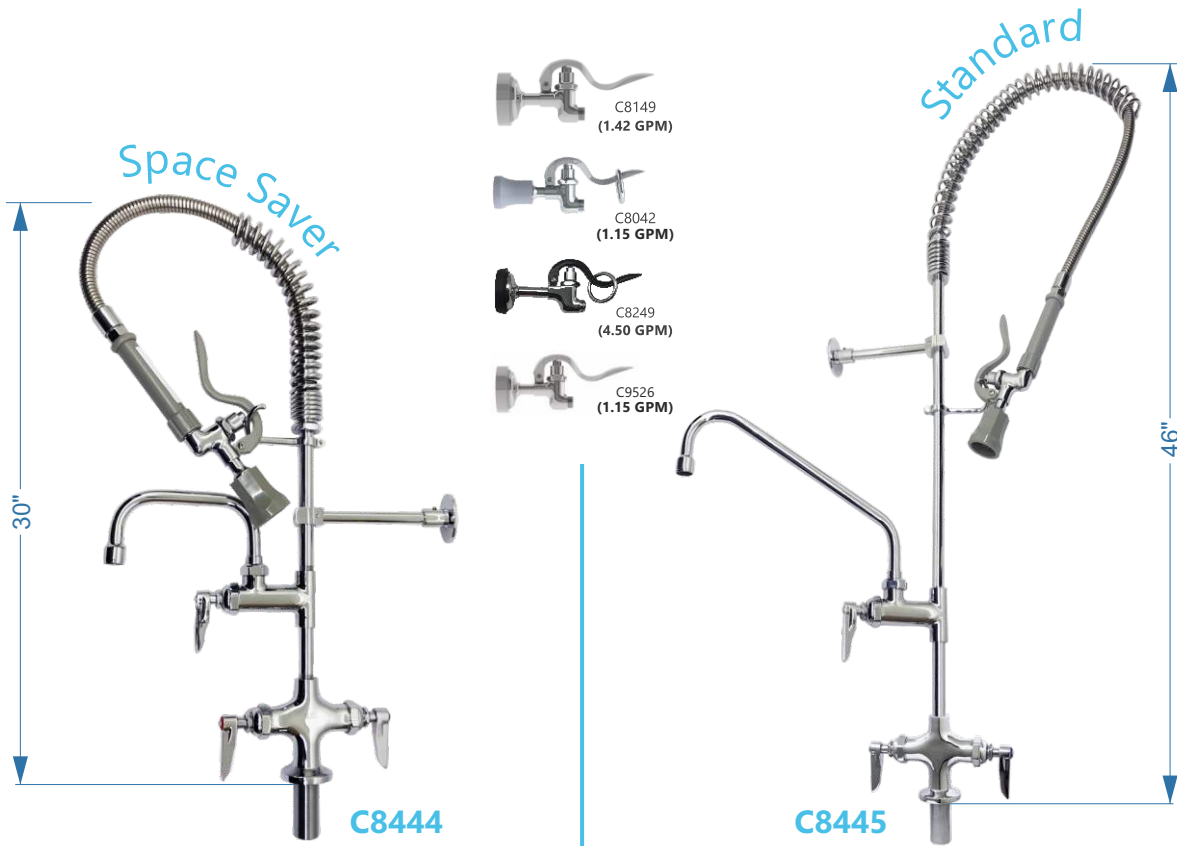

STANDARD OR
LOW-PROFILE
DESIGNS

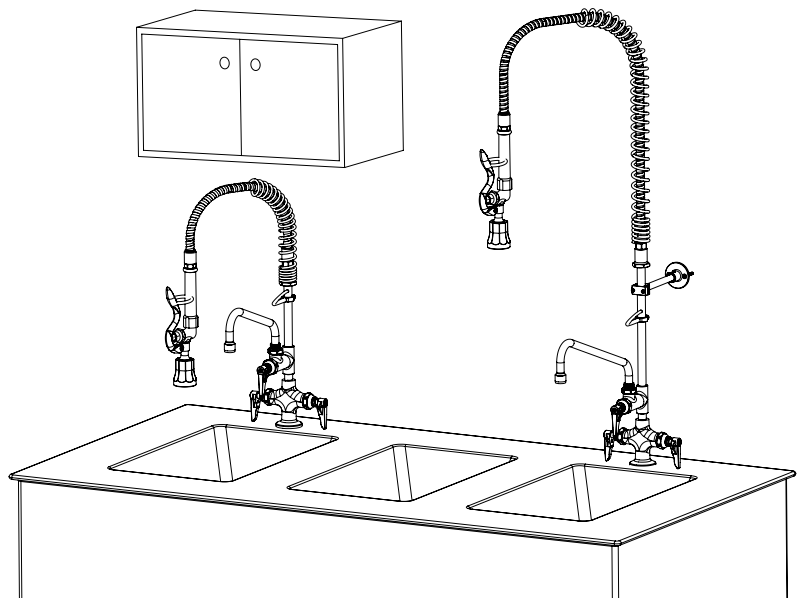

REPAIR KIT FOR PRE RINSER FAUCET

Part #	Part Name
C8171	Spring Check Spindle Assembly Replacements
C9516	Swivel Repair Kit
C9517	Spray Valve(Gray C8149) Repair Kit
C9518	Repair Kit for Swivel Nozzle
C9521	C8149 Spray Base, Bumper & Screw Repair Kit
C9522	Replacement Parts Kit for Classic Cartridge
C9525	Quarter Turn Classic Cartridge with Spring Check Parts Kit
C8125x12	White Washer for Eccentric Coupling Flange Assembly



C8171



C9516



C9517



C9518



C9521



C9522



C9525



C8125x12



C9502



C9503



C9504



C9505



C8139

Part #	Part Name
C9502	Lever Handle Kit
C9503	Economy Lever Handle Kit
C9504	Economy Lever Handle With - COLD Index & Screw
C9505	Economy Lever Handle With - HOT Index & Screw
C8139	Handle Screw

New
Angled
Design

Spray Valves

Save money per store by
choosing our low flow
faucets & pre-rinse spray valves



With Brush



Sharp Knife Jet



Pot Filler



High Flow



Low Flow



Angled Spray Valve

SPRAY VALVES



C9519



C9523



C9520



C8249



C8149



C9526

Part #	Part Name
C8149	Spray Valve For Pre Rinse - 1.42GPM
C8249	High Flow Spray Valve for Pre Rinse 4.50GPM
C9519	Angled Pre-Rinse Spray Head-1.42 GPM
C9520	Standard Spray Valve with Brush-1.42 GPM
C9523	Pot Filler Spray Valve
C9526	Spray Valve for Pre Rinse 1.15 GPM

S.No.	Part #	Part Name
1	C8042.09	Handle for Pre-Rinse Spray Head
2	C8042.08	Ring for Pre-Rinse Spray Head
3	C8042.51	Valve Assembly for Pre-Rinse Spray Head
4	C8042.19	Binding Post Screw
5	C8149.01.05	Pre Rinser Body Base Holder Screw
6	C8149.01.03	Pre Rinser Body Plastic Base
7	C8149.01.04	Pre Rinser Body Bumper (Rubber Base)
8	C8149.01.01	Pre Rinser body base
9	C8149.01.02	Pre Rinser Body Pipe
10	C8042.18	Binding Post Nut



⑦ Black

C8249.01.04



⑦ Grey

C8149.01.04

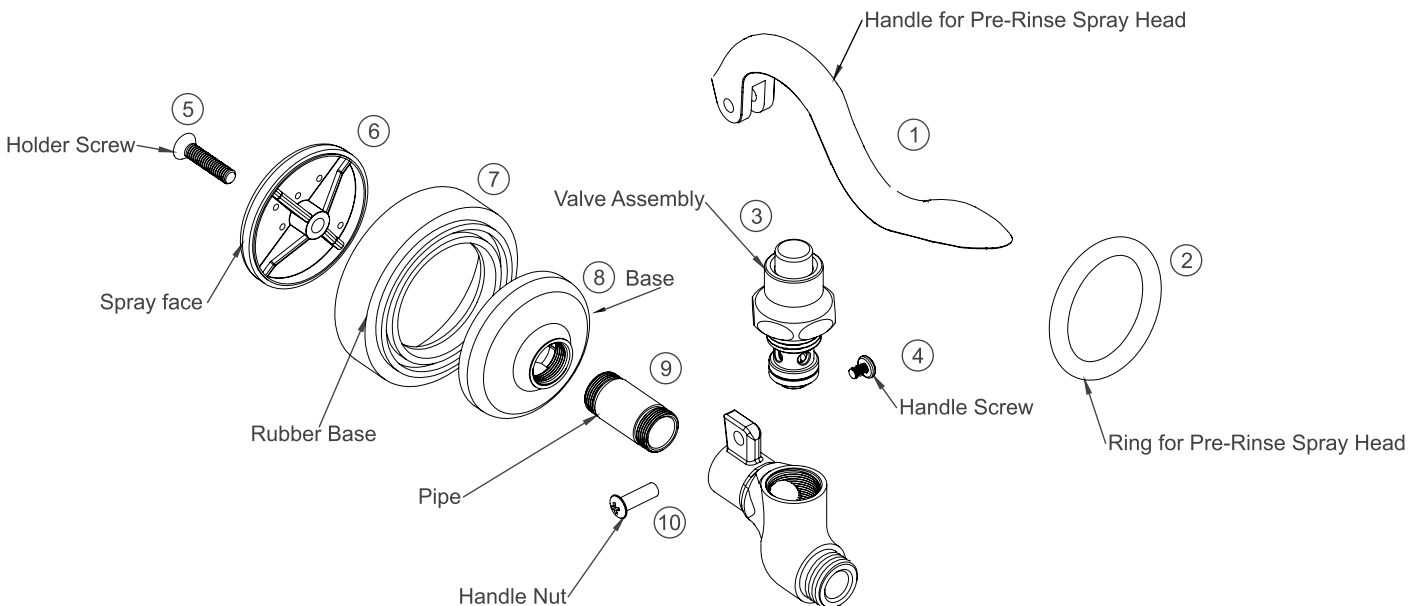

Part #	Part Name
C8042	Low Flow Spray Valve for Pre Rinse - 1.15 GPM

**1.15
GPM**



C8042

— Water Saving —
— Energy Saving —
Environment Friendly



Sharp Knife Jet
Spray Pattern



Sharp Knife Jet
Spray Pattern

S.No.	Part #	Part Name
1	C8042.01	Pre Rinser Spray Head Body
2	C8042.03	Dish Guard Bumper Assembly
3	C8042.51	Valve Assembly for PreRinse Spray Head
4	C8042.12	Brass Washer for Pre Rinse Spray Head
5	C8042.04	Nozzle for Pre- Rinse Spray Head
6	C8042.07	Nozzle Adapter For pre-Rinse Spray Head
7	C8042.08	Ring for Pre-Rinse Spray Head
8	C8042.09	Handle for Pre-Rinse Spray Head
9	C8042.10	Small O Ring for Pre-Rinse Spray Head
10	C8042.11	O ring for Pre-Rinse Spray Head
11	C8042.18	Binding Post Nut
12	C8042.19	Binding Post Screw



C8042.04



C8042.03

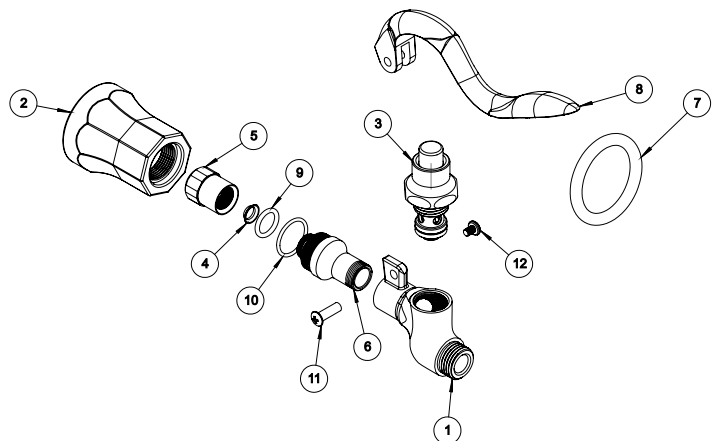

Part #	Part Name
C9510	Spray Valve Repair Kit

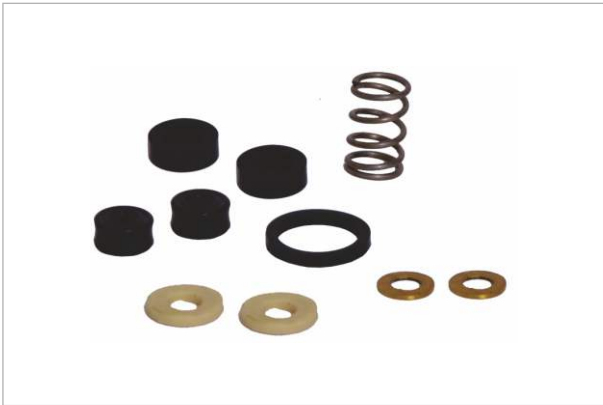

Valve Assembly

Part #	Part Name
C9509	Pre Rinse Valve Assembly Repair Kit



Valve Assembly



SS FLEXIBLE HOSES & HOSE ASSEMBLIES

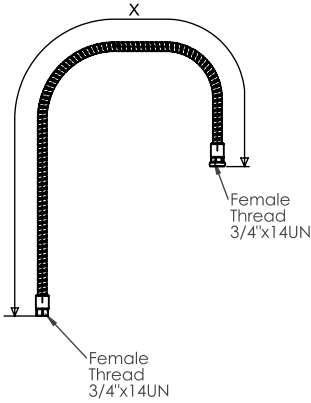

*C8240 Recommended

Flexible Hose Less Handle

Part #	Part Name	Size(x)
C8223	SS Flexible pipe Assembly & Less Handle	24"
C8225	SS Flexible pipe Assembly & Less Handle	26"
C8227	SS Flexible pipe Assembly & Less Handle	28"
C8231	SS Flexible pipe Assembly & Less Handle	32"
C8140	SS Flexible pipe Assembly - Less Handle	36"
C8240	SS Flexible pipe Assembly & Less Handle	40"
C8242	SS Flexible pipe Assembly & Less Handle	42"
C8244	SS Flexible pipe Assembly & Less Handle	44"
C8257	SS Flexible pipe Assembly & Less Handle	50"
C8253	SS Flexible pipe Assembly & Less Handle	54"
C8255	SS Flexible pipe Assembly & Less Handle	56"
C8268	SS Flexible pipe Assembly & Less Handle	68"

Flexible Hose With Grip Handle

Part #	Part Name	Size(x)
C8218	18" SS Flexible pipe Assembly & Grip Handle	18"
C8224	24" SS Flexible pipe Assembly & Grip Handle	24"
C8226	26" SS Flexible pipe Assembly & Grip Handle	26"
C8228	28" SS Flexible pipe Assembly & Grip Handle	28"
C8232	32" SS Flexible pipe Assembly & Grip Handle	32"
C8236	36" SS Flexible Pipe Assembly & Grip Handle	36"
* C8147	44" SS Flexible pipe Assembly & Grip Handle	44"
C8248	48" SS Flexible pipe Assembly & Grip Handle	48"
C8258	50" SS Flexible pipe Assembly & Grip Handle	50"
C8254	54" SS Flexible pipe Assembly & Grip Handle	54"
C8256	56" SS Flexible pipe Assembly & Grip Handle	56"
C8267	68" SS Flexible pipe Assembly & Grip Handle	68"

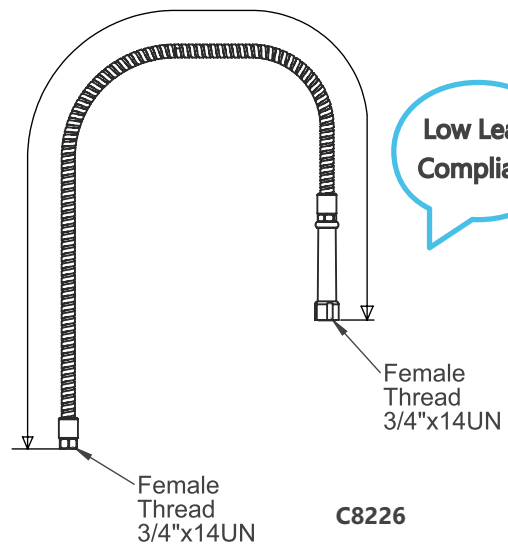

C8226

RISER TUBE



Part #	Part Name
C8060	7" long x 3/8" MPT - Riser Tube
C8061	12" long x 3/8" MPT - Riser Tube
C8062	18" long x 3/8" MPT - Riser Tube
C8063	24" long x 3/8" MPT - Riser Tube
C8064	32" long x 3/8" MPT - Riser Tube

Part #	Part Name
C8066	Pre rinse Spray head riser tube Hook
C8067	Pre rinse Spray head riser tube Hook - Short

SPRAY HEAD RISER TUBE HOOK



SPRING



Part #	Part Name
C8129	Pre-rinse Faucet spring
C8229	Compact Pre-rinse Spring

Part #	Part Name
C8074	3" Wall mount Bracket for Upright pre-rinse
C8075	6" Wall mount Bracket for Upright pre-rinse
C8076	9" Wall mount Bracket for Upright pre-rinse
C8077	12" Wall mount Bracket for Upright pre-rinse
C8078	15" Wall mount Bracket for Upright pre-rinse
C8079	18" Wall mount Bracket for Upright pre-rinse
C8080	21" Wall mount Bracket for Upright pre-rinse
C8081	24" Wall mount Bracket for Upright pre-rinse

WALL BRACKETS





Part #	Part Name
C8589	Rigid Chemical Tee Assembly, Chrome Plated

SWIVEL

S.No.	Part #	Part Name
1	C8124	Swivel Adapter for Pre Rinse Spray Valve
2	C8127	Swivel assembly for Pre-Rinse Faucet
3	C8131x12	Rubber Washer for Pre Rinse Spray Assembly

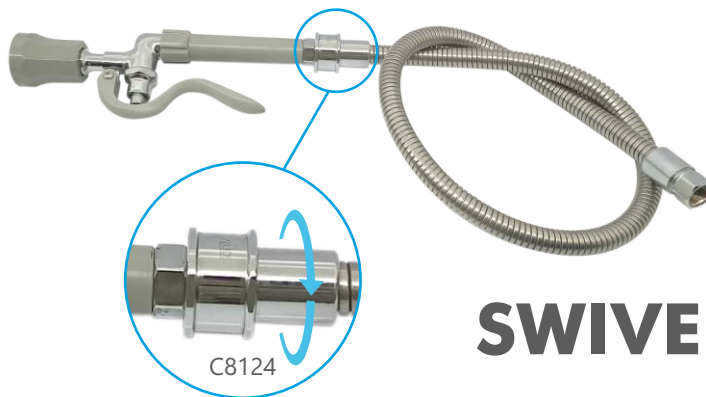
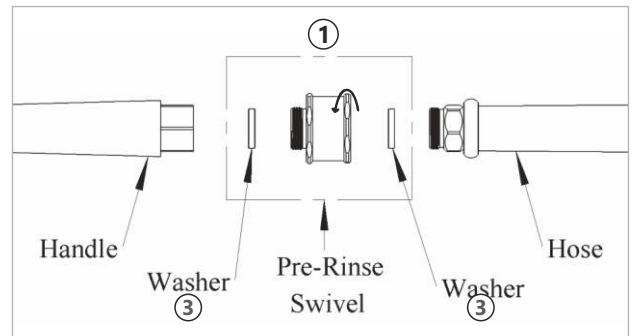

SWIVEL 360°

PRE-RINSE REPLACEMENT (LESS BASE FAUCET)



Part #	Part Name
C9527	Pre-Rinse with 18" Riser, 44" Hose & 1.15GPM Shower Spray Valve- Less Base Faucet



Part #	Part Name
C9528	Pre-Rinse with 18" Riser, 44" Hose & 1.15GPM with Knife Jet Valve- Less Base Faucet

REPLACEMENT PRE RINSE BASES (COMPATIBLE WITH ANY BRAND)



C8443.50



C8108



C8277.50 (Rigid)



C8183



C8239.50



C8447 (Rigid)



Commercial Faucets

Available With

Classic Cartridge

Standard Performance



Ceramic Cartridge

High Performance

With Inbuilt Check Valve



Add Suffix **CE** at end of part number for Ceramic Cartridge option.

Cartridge Water Saving - GPM Chart

	At 60 psi	At 60 psi (With Spring Checks)
Classic Cartridge	8 GPM per side	6 GPM per side
Ceramic Cartridge	6 GPM per side	5 GPM per side

UP Gradable Cartridge

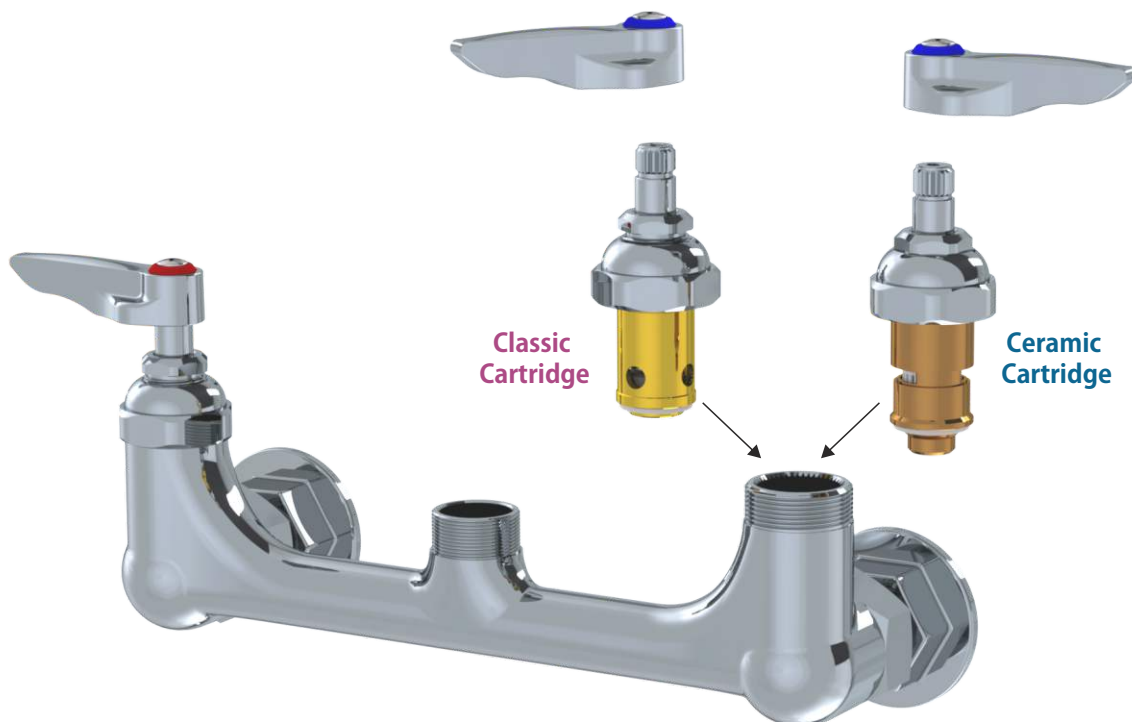

Example Table

Part No.	Cartridge
C XXXX	Classic
C XXXX-CE	Ceramic

**Just Add SUFFIX - CE At End of Any Faucet Part Number
For Ceramic Cartridge Version of Same Faucet**

Double Pantry Wall Mounted Faucet:
The perfect solution when you are required with steady water fixture in your facility.

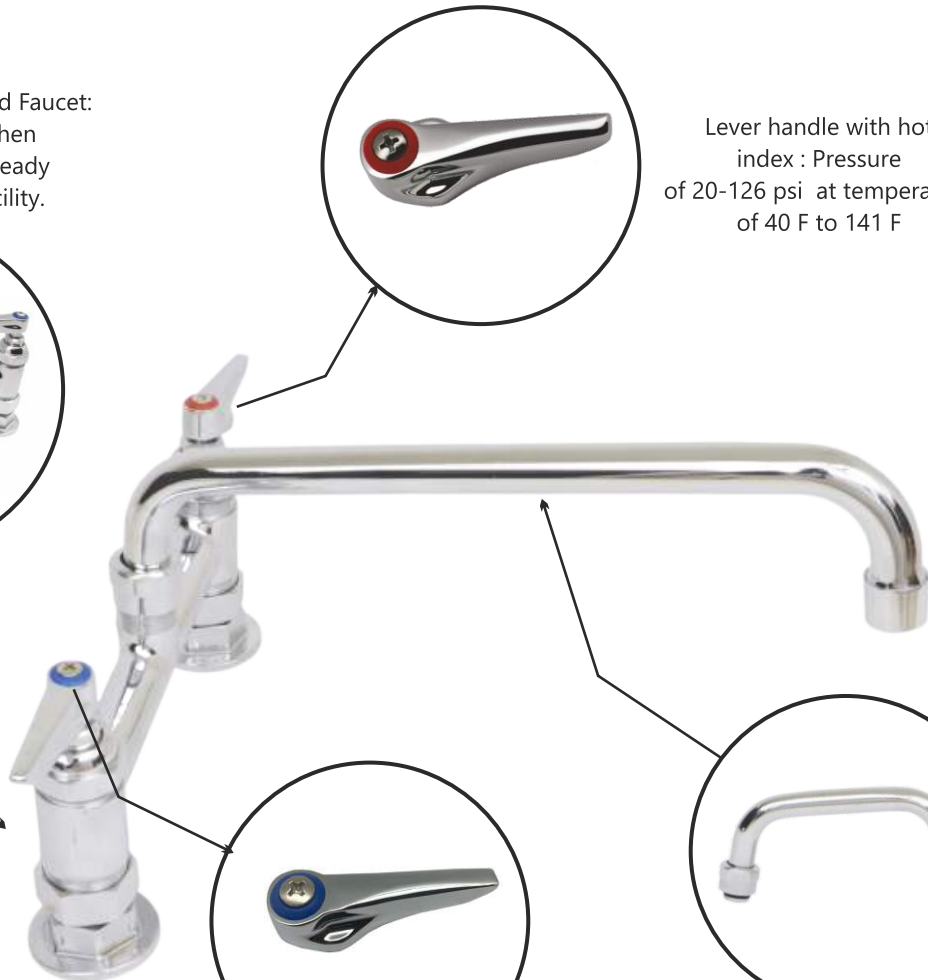

Lever handle with hot index : Pressure of 20-126 psi at temperature of 40 F to 141 F



Lever Handle with cold Index : Pressure of 20 - 126 psi at temperature of 40 F to 140 F.



Swing Nozzle: Stream Regulator Suitable for all Aluids Faucets.



Pantry faucets are ideal to use as an extra source of water inside commercial kitchens. These faucets are elegant by design and cost-effective. Our selection of pantry faucets includes a variety of options in terms of shape, number of knobs, attachment type, mount position and neck length.

These faucets are all made from brass with chrome polish. The design ensures that the faucets are drip and clog free. Wide range of Durable and Modular Solution for COMMERCIAL KITCHENS are available here.

- ✓ Having seen our range of swing nozzles, let's dive into our faucet base collection.
- ✓ Wondering why we have them separately? Well, that's because we want you to have the best of both worlds.
- ✓ It is all about giving you the product that suits your needs!

DECK MOUNT BASE FAUCETS

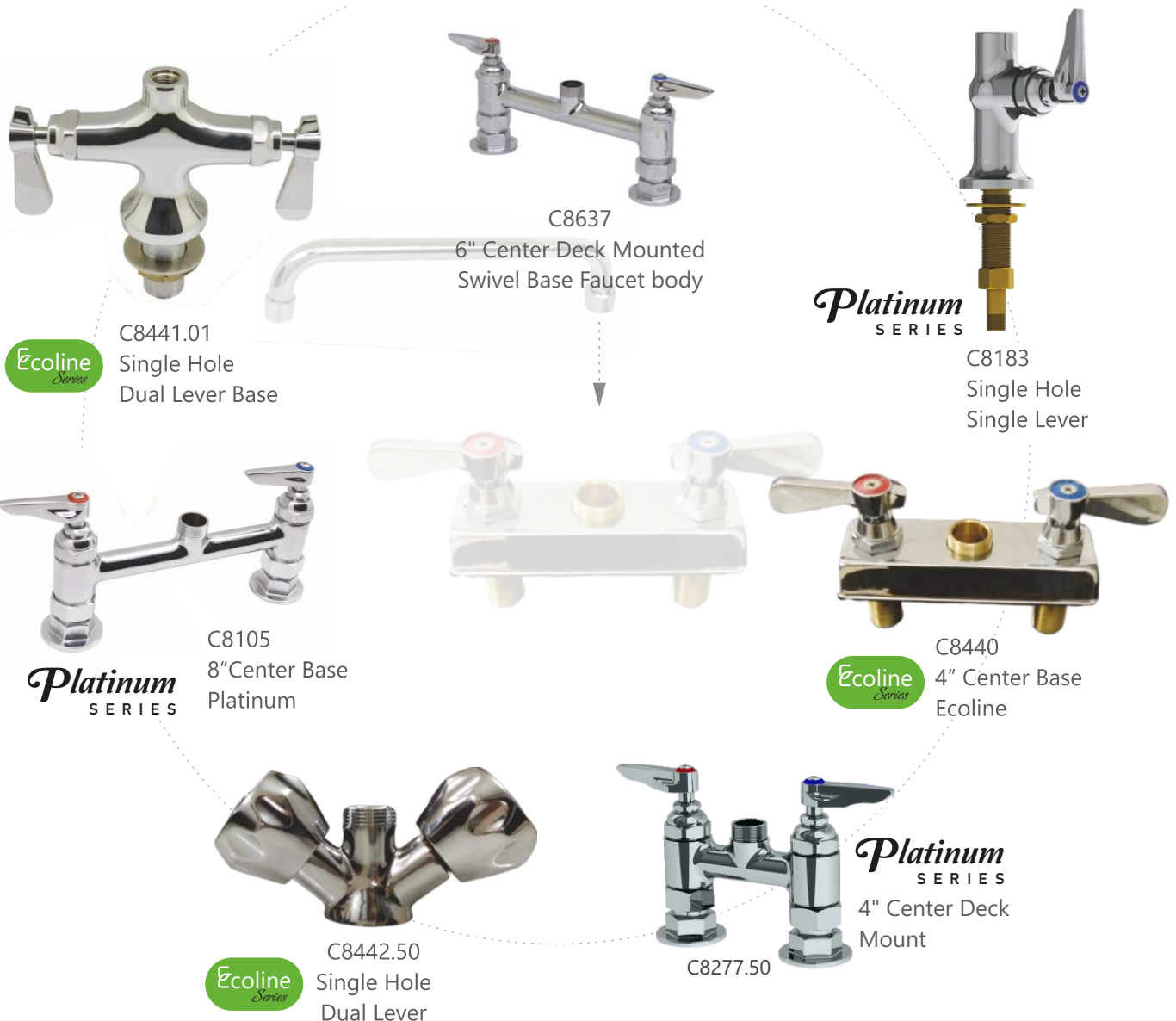

- ✓ Deck-Mount style faucet is fixed directly on the pantry sink.
- ✓ Double pantry faucet – has two cartridges for both hot and cold water lines.
- ✓ All the various nozzles that we have, the Swivel Gooseneck, and Swing nozzle can be used with this faucet category.
- ✓ The double pantry faucet bases come with 4" and 8" centers and can be chosen according to the width of your sink.
- ✓ These pantry faucets are available in Platinum as well as Ecoline model.

- ✓ Wall-Mount style pantry faucet, as the name suggests, is fixed on the wall itself directly above the pantry basin with only the nozzle above it.
- ✓ Any of our swing nozzles can be used with this base.
- ✓ These double pantry faucet bases come with 4" and 8" centers and can be chosen according to the width of your sink.
- ✓ These pantry faucets are available in Platinum as well as in Ecoline model.

WALL MOUNT BASE FAUCET



Platinum
SERIES C8106
4" Center
Dual Lever
Platinum

Platinum
SERIES C8109
8" Center
Dual Lever
Platinum

Ecoline
Series C8438
4" Center
Ecoline

Platinum
SERIES C8447
Single Wall
Base Body

- ✓ Made from brass with chrome plated finish. The design ensures that the faucets are drip & clog free.
- ✓ The hot & cold lever style handles are labeled & color coded for easy identification.

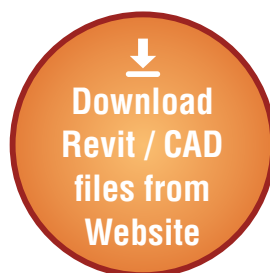

8" Center Deck Mount



Use Suffix **.kit** if you need faucet with kit

Required to Install



C8601

Inlet Supply Nipple Kit
with 24" Flexible Hoses - 3/8" Compression

OR



C8118

Deck Faucet Mounting Kit

PANTRY FAUCETS

8" Center Deck Mount



Part #	Part Name
C8105	Double Pantry Deck Mount Swivel Base Faucet, 8" Center
C8108	Double Pantry Deck Mount Rigid Base Faucet , 8" Center
C8578	Double Pantry Faucet, Double Hole Base, 8" Deck Mount, 6" Cast Spout
C8612	Double Pantry Faucet, Double Hole Base, 8" Deck Mount, 8" Cast Spout
C8185	Double Pantry Deck Mount Swivel Base Faucet with 6" Swing Nozzle
C8186	Double Pantry Deck Mount Swivel Base Faucet with 8" Swing Nozzle
C8187	Double Pantry Deck Mount Swivel Base Faucet with 10" Swing Nozzle
C8188	Double Pantry Deck Mount Swivel Base Faucet with 12" Swing Nozzle
C8195	Double Pantry Deck Mount Swivel Base Faucet with 14" Swing Nozzle
C8189	Double Pantry Deck Mount Swivel Base Faucet with 18" Swing Nozzle
C8196	Double Pantry Faucet, Deck Mount, 8" Centers, 3-1/2" WIDE Swivel Gooseneck, Lever Handles
C8194	Double Pantry Faucet, Deck Mount, 8" Centers, Swivel/Rigid Gooseneck, Lever Handles
C8197	Double Pantry Faucet, Deck Mount, 8" Centers, 8-1/2" Swivel Gooseneck, Lever Handles
C8233	Double Pantry Faucet, Deck Mount, 8" Centers, 3-3/4" WIDE Rigid Gooseneck, Lever Handles
C8234	Double Pantry Faucet, Deck Mount, 8" Centers, 5 11/16" WIDE Rigid Gooseneck, Lever Handles

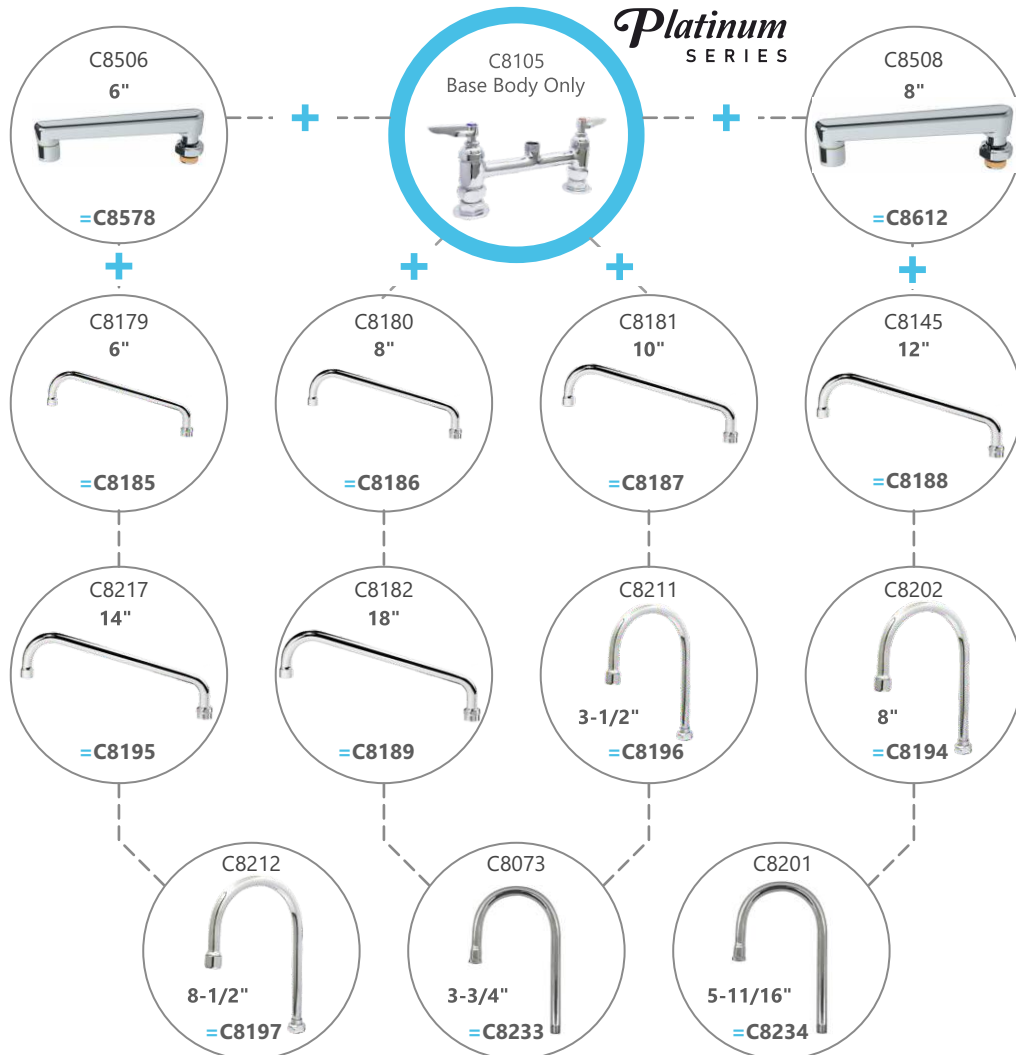

Aerators:



Suffix	Description
E1	0.20 GPM
E2	0.50 GPM
E3	1.00 GPM
E4	1.50 GPM
E5	1.80 GPM
E6	2.20 GPM

Suffix	Description
G1	0.35 GPM
G2	0.50 GPM
G3	1.00 GPM
G4	1.50 GPM

Suffix	Description
H1	0.35 GPM
H2	0.50 GPM
H3	1.00 GPM
H4	1.50 GPM

Suffix	Description
F1	0.50 GPM
F2	1.50 GPM

4" Center Deck Mount



Use Suffix **.kit** if you need faucet with kit

>>> **Required to Install** >>>



C8601

Inlet Supply Nipple Kit
with 24" Flexible Hoses - 3/8" Compression

OR



C8118

Deck Faucet Mounting Kit

PANTRY FAUCETS

4" Center Deck Mount



Part #	Part Name
C8277.50	Double Pantry Deck Mount, 4" Center, Swivel Base Faucet
C8577	Double Pantry Faucet, Double Hole Base, 4" Deck Mount, 6" Cast Spout
C8611	Double Pantry Faucet, Double Hole Base, 4" Deck Mount, 8" Cast Spout
C8366	4" Center-Double Pantry Deck Mount Swivel Base Faucet with 6" Swing Nozzle
C8367	4" Center-Double Pantry Deck Mount Swivel Base Faucet with 8" Swing Nozzle
C8368	4" Center-Double Pantry Deck Mount Swivel Base Faucet with 10" Swing Nozzle
C8369	4" Center-Double Pantry Deck Mount Swivel Base Faucet with 12" Swing Nozzle
C8370	4" Center-Double Pantry Deck Mount Swivel Base Faucet with 14" Swing Nozzle
C8371	4" Center-Double Pantry Deck Mount Swivel Base Faucet with 18" Swing Nozzle
C8278	Double Pantry Faucet, Deck Mount, 4" Centers, 5-11/16" wide Swivel Gooseneck
C8279	Double Pantry Faucet, Deck Mount, 4" Centers, 8-1/2" wide Swivel Gooseneck
C8277	Double Pantry Faucet, Deck Mount, 4" Centers, 3-1/2" wide Swivel Gooseneck

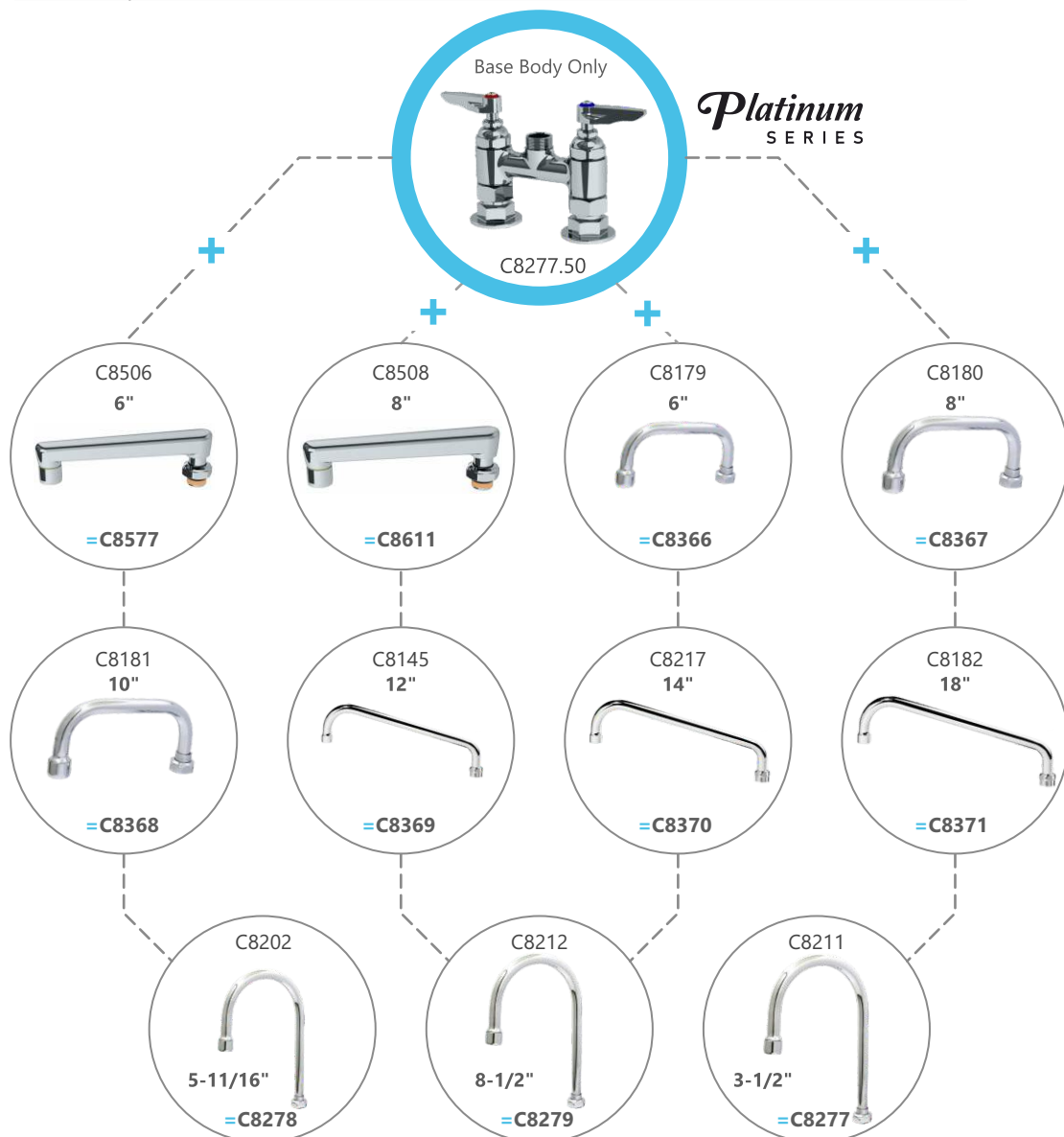

Aerators:

Standard	
Suffix	Description
E1	0.20 GPM
E2	0.50 GPM
E3	1.00 GPM
E4	1.50 GPM
E5	1.80 GPM
E6	2.20 GPM

Vandal Resistant	
Suffix	Description
G1	0.35 GPM
G2	0.50 GPM
G3	1.00 GPM
G4	1.50 GPM

Vandal Resistant Laminar Flow Outlet	
Suffix	Description
H1	0.35 GPM
H2	0.50 GPM
H3	1.00 GPM
H4	1.50 GPM

Laminar Flow Outlet	
Suffix	Description
F1	0.50 GPM
F2	1.50 GPM

Single Hole Single Lever Deck Mount

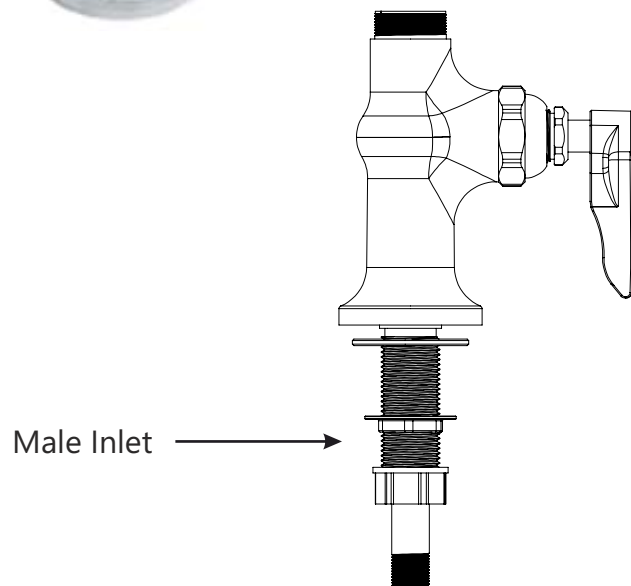

Single Hole Single Lever Deck Mount



Part #	Part Name
C8574	Single Pantry Faucet, Single Hole Base, Deck Mount, 6" Cast Spout
C8608	Single Pantry Faucet, Single Hole Base, Deck Mount, 8" Cast Spout
C8432	Single Hole Deck Mount Pantry Faucet, Single Lever with 6" Spout
C8433	Single Hole Deck Mount Pantry Faucet, Single Lever with 12" Spout
C8437	Single Hole Deck Mount Pantry Faucet, Single Lever with 3-1/2" Wide Gooseneck Spout
C8472	Single Hole Deck Mount Pantry Faucet, Single Lever with 5 11/16" Wide Swivel Gooseneck Spout
C8522	Single Hole Deck Mount Pantry Faucet, Single Lever with 8-1/2" Wide Swivel Gooseneck Spout

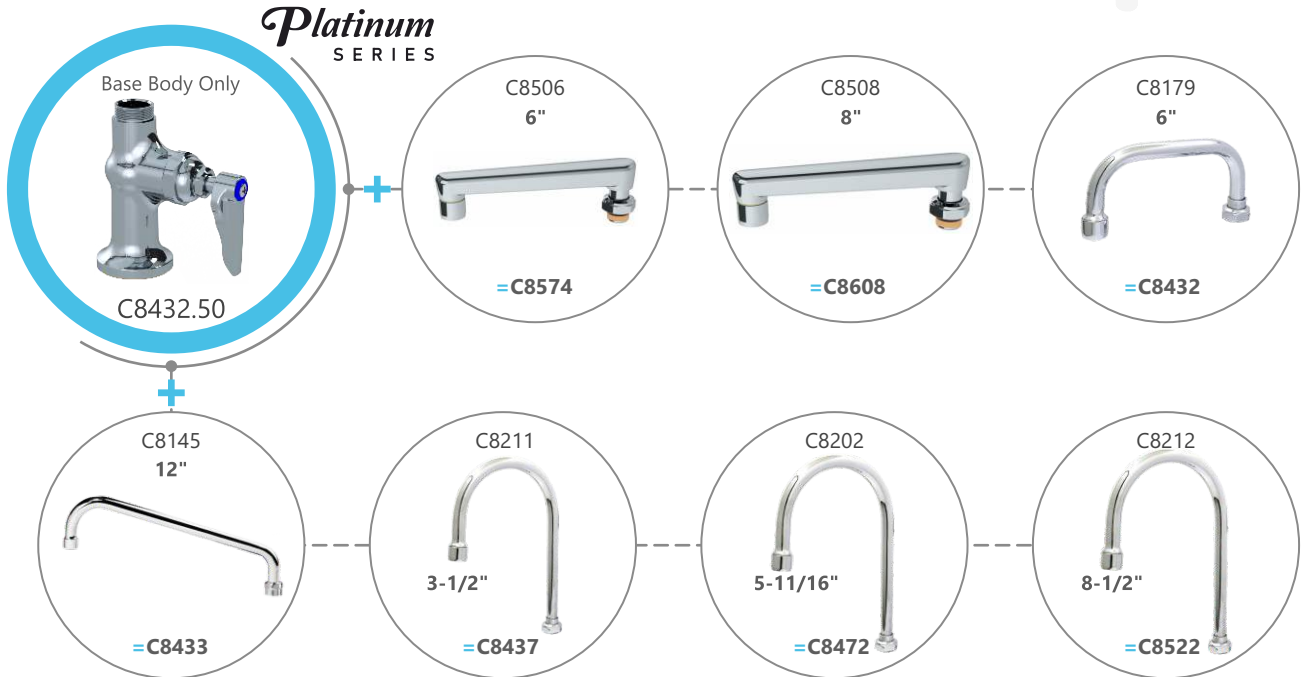

Single Hole Single Lever Deck Mount



(Quarter Turn Cartridge with Integral Spring Check Lever)*

Part #	Part Name
C8450	Single Hole Single Temperature Commercial Deck Mount Faucet , Lever Handle , 5 1/2" Rigid Gooseneck w/stream regulator & 1/2" NPSM Male Inlet
C8451	Single Hole Single Temperature Commercial Deck Mount Faucet , Lever Handle , 5 1/2" Rigid Gooseneck w/stream regulator & 1/2" NPSM Male Inlet
C8427	Single Hole Single Temperature Commercial Deck Mount Faucet , Lever Handle , 8-1/2" Rigid Gooseneck w/stream regulator & 1/2" NPSM Male Inlet
C8471	Single Hole Single Temperature Commercial Deck Mount Faucet , Lever Handle , 3 3/4" Rigid Gooseneck w/stream regulator & 1/2" NPSM Male Inlet



Aerators:

Standard	
Suffix	Description
E1	0.20 GPM
E2	0.50 GPM
E3	1.00 GPM
E4	1.50 GPM
E5	1.80 GPM
E6	2.20 GPM

Vandal Resistant	
Suffix	Description
G1	0.35 GPM
G2	0.50 GPM
G3	1.00 GPM
G4	1.50 GPM

Vandal Resistant Laminar Flow Outlet	
Suffix	Description
H1	0.35 GPM
H2	0.50 GPM
H3	1.00 GPM
H4	1.50 GPM

Laminar Flow Outlet	
Suffix	Description
F1	0.50 GPM
F2	1.50 GPM

Single Hole Double Lever Deck Mount

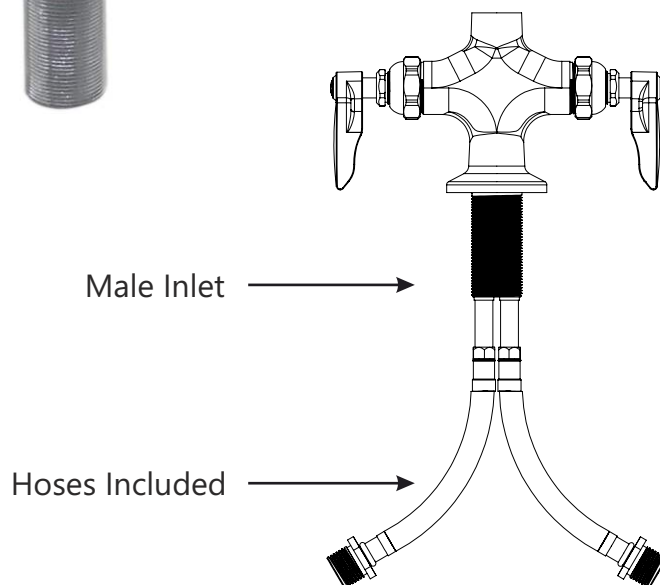

Single Hole Double Lever Deck Mount



Part #	Part Name
C8443.50	Double Lever Single Hole Deck Mount Rigid Spout Base Faucet
C8496	Double Pantry Faucet, Single Hole Base, 6" Spout
C8497	Double Pantry Faucet, Single Hole Base, 12" Spout
C8498	Double Pantry Faucet, Single Hole Base, 5-11/16" Swivel Gooseneck
C8499	Double Pantry Faucet, Single Hole Base, 8-1/2" Swivel Gooseneck
C8429	Double Pantry Faucet, Single Hole Base, 3 1/2" Swivel Gooseneck
C8504	Double Pantry Faucet, Single Deck Hole Base, 3-3/4" Rigid Gooseneck
C8505	Double Pantry Faucet, Single Deck Hole Base, 5-11/16" Rigid Gooseneck
C8507	Double Pantry Faucet, Single Deck Hole Base, 8" Rigid Gooseneck



Aerators:

Standard	
Suffix	Description
E1	0.20 GPM
E2	0.50 GPM
E3	1.00 GPM
E4	1.50 GPM
E5	1.80 GPM
E6	2.20 GPM

Vandal Resistant	
Suffix	Description
G1	0.35 GPM
G2	0.50 GPM
G3	1.00 GPM
G4	1.50 GPM

Vandal Resistant Laminar Flow Outlet	
Suffix	Description
H1	0.35 GPM
H2	0.50 GPM
H3	1.00 GPM
H4	1.50 GPM

Laminar Flow Outlet	
Suffix	Description
F1	0.50 GPM
F2	1.50 GPM

Double Hole Wall Mount

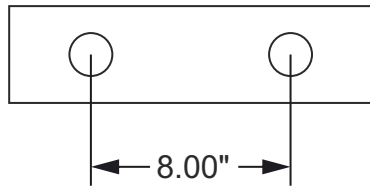

Acentric Holes for easy Adjustment

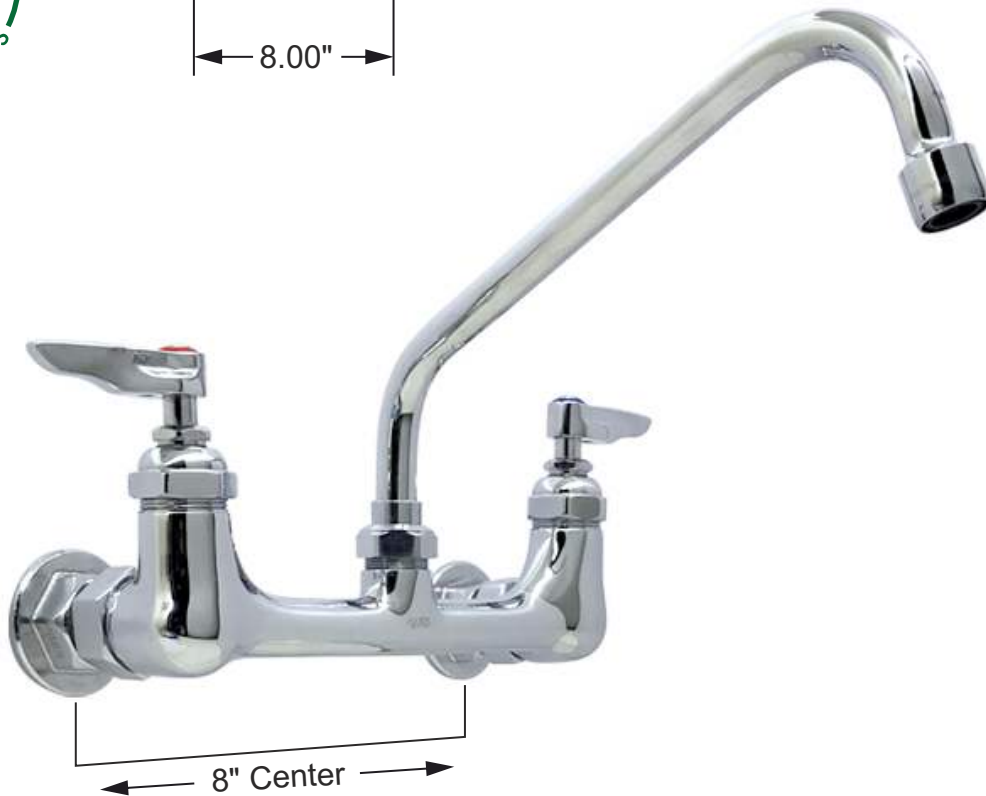

Use Suffix **.kit** if you need faucet with kit

Required to Install



C8584

3/8" Wall Mount Faucet Water Line Kit-
24" Length With mounting Hardware

Double Hole Wall Mount

Platinum SERIES

Part #	Part Name
C8109	Double Pantry Wall Mount Swivel Base Faucet, 8" Center, Less Nozzle
C8190	Double Pantry Wall Mount Swivel Base Faucet with 6" Swing Nozzle
C8453	Double Pantry Wall Mount Swivel Base Faucet with 8" Swing Nozzle
C8191	Double Pantry Wall Mount Swivel Base Faucet with 10" Swing Nozzle
C8192	Double Pantry Wall Mount Swivel Base Faucet with 12" Swing Nozzle
C8454	Double Pantry Wall Mount Swivel Base Faucet with 14" Swing Nozzle
C8193	Double Pantry Wall Mount Swivel Base Faucet with 18" Swing Nozzle
C8576	Double Pantry Faucet, Double Hole Base, 8" Wall Mount, 6" Cast Spout
C8610	Double Pantry Faucet, Double Hole Base, 8" Wall Mount, 8" Cast Spout
C8455	Double Pantry Wall Mount Swivel Base Faucet with 15" Swing Nozzle
C8456	Double Pantry Wall Mount Swivel Base Faucet with 24" Swing Nozzle
C8458	Double Pantry Faucet, Wall Mount, 8" Centers, 3-1/2" Wide Swivel Gooseneck, Lever Handles
C8459	Double Pantry Faucet, Wall Mount, 8" Centers, 8-1/2" Wide Swivel Gooseneck, Lever Handles
C8430	Double Pantry Faucet, Wall Mount, 8" Centers, 5-11/16" Wide Swivel Gooseneck, Lever Handles
C8237	Double Pantry Faucet, Wall Mount, 8" Centers, 3 3/4" Wide Rigid Gooseneck, Lever Handles
C8238	Double Pantry Faucet, Wall Mount, 8" Centers, 5 11/16" Wide Rigid Gooseneck, Lever Handles
C8239	Double Pantry Faucet, Wall Mount, 8" Centers, 8" Wide Rigid Gooseneck, Lever Handles



Platinum SERIES



Swivel Base Faucet

- C8190 - 6" Swing Nozzle
- C8453 - 8" Swing Nozzle
- C8191 - 10" Swing Nozzle
- C8192 - 12" Swing Nozzle
- C8454 - 14" Swing Nozzle
- C8193 - 18" Swing Nozzle

Cast Spout

- C8576 - 6" Cast Spout
- C8610 - 8" Cast Spout

Swivel Base Faucet

- C8455 - 15" Swing Nozzle
- C8456 - 24" Swing Nozzle

Swivel Gooseneck

- C8458 - 3-1/2" Swivel Gooseneck
- C8459 - 8-1/2" Swivel Gooseneck
- C8430 - 5-11/16" Swivel Gooseneck

Rigid Gooseneck

- C8237 - 3-3/4" Rigid Gooseneck
- C8238 - 5-11/16" Rigid Gooseneck
- C8239 - 8" Rigid Gooseneck

Aerators:



Standard

Suffix	Description
E1	0.20 GPM
E2	0.50 GPM
E3	1.00 GPM
E4	1.50 GPM
E5	1.80 GPM
E6	2.20 GPM

Vandal Resistant

Suffix	Description
G1	0.35 GPM
G2	0.50 GPM
G3	1.00 GPM
G4	1.50 GPM

Vandal Resistant Laminar Flow Outlet

Suffix	Description
H1	0.35 GPM
H2	0.50 GPM
H3	1.00 GPM
H4	1.50 GPM

Laminar Flow Outlet

Suffix	Description
F1	0.50 GPM
F2	1.50 GPM

Single Hole Wall Mount



Use Suffix **.kit** if you need faucet with kit



Required to Install



C8584

3/8" Wall Mount Faucet Water Line Kit-
24" Length With mounting Hardware

PANTRY FAUCETS

Single Hole Wall Mount



Part #	Part Name
C8447	Single Wall Base Body
C8575	Single Pantry Faucet, Single Hole Base, Wall Mount, 6" Cast Spout
C8609	Single Pantry Faucet, Single Hole Base, Wall Mount, 8" Cast Spout
C8448	Single Pantry Faucet, Single Hole Base, Wall Mount, 6" Swing Nozzle
C8449	Single Pantry Faucet, Single Hole Base, Wall Mount, 12" Swing Nozzle
C8564	Single Pantry Faucet, Single Hole Base, Wall Mount, 12" Double Joint Swing Nozzle
C8565	Single Pantry Faucet, Single Hole Base, Wall Mount, 15" Double Joint Swing Nozzle
C8566	Single Pantry Faucet, Single Hole Base, Wall Mount, 18" Double Joint Swing Nozzle
C8598	Single Pantry Faucet, Single Hole Base, Wall Mount, 3 1/2" Swivel gooseneck
C8599	Single Pantry Faucet, Single Hole Base, Wall Mount, 5 11/16" Swivel gooseneck
C8600	Single Pantry Faucet, Single Hole Base, Wall Mount, 8 1/2" Swivel gooseneck

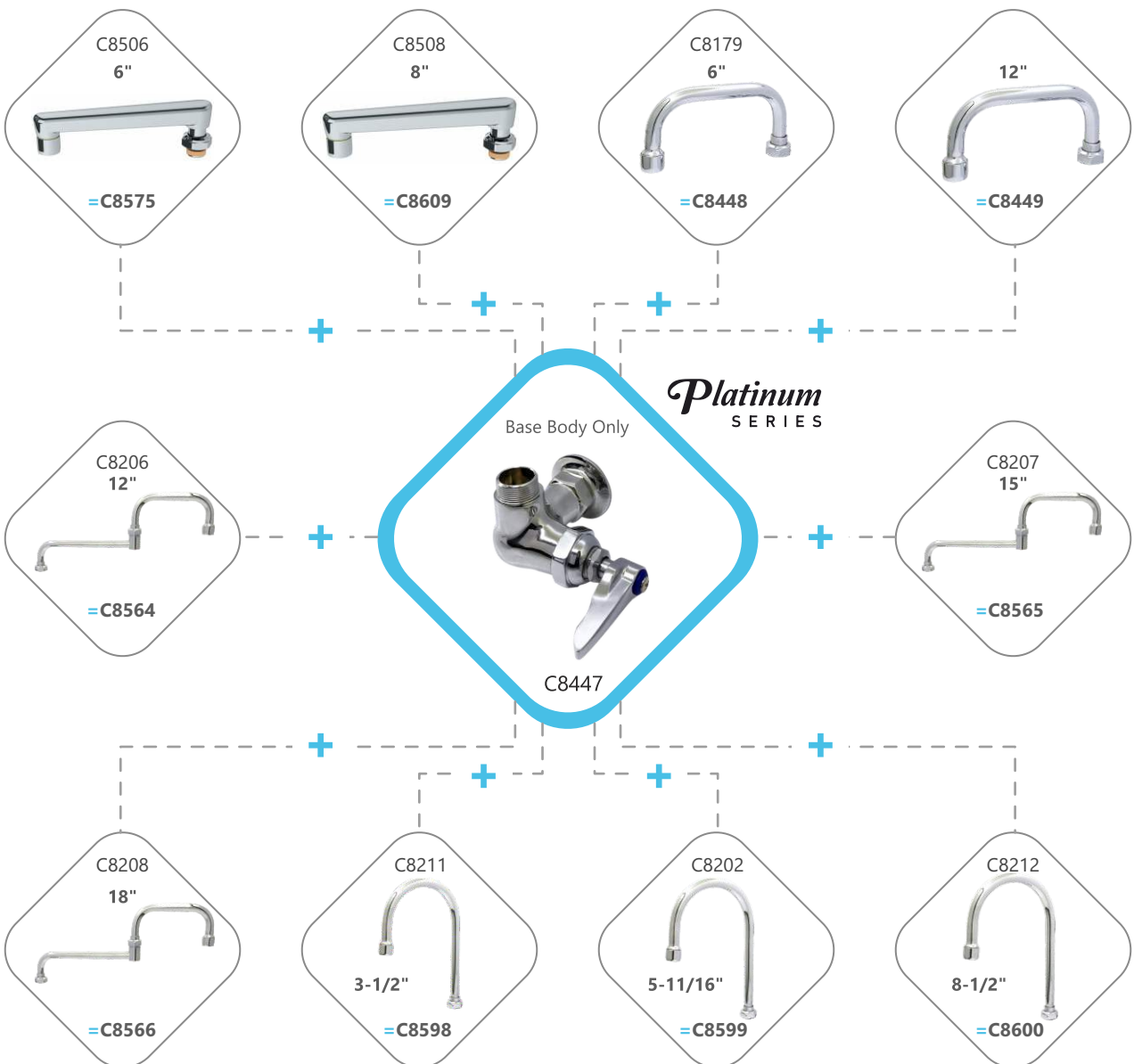

Aerators:

Standard

Suffix	Description
E1	0.20 GPM
E2	0.50 GPM
E3	1.00 GPM
E4	1.50 GPM
E5	1.80 GPM
E6	2.20 GPM

Vandal Resistant

Suffix	Description
G1	0.35 GPM
G2	0.50 GPM
G3	1.00 GPM
G4	1.50 GPM

Vandal Resistant Laminar Flow Outlet

Suffix	Description
H1	0.35 GPM
H2	0.50 GPM
H3	1.00 GPM
H4	1.50 GPM

Laminar Flow Outlet

Suffix	Description
F1	0.50 GPM
F2	1.50 GPM

WORKBOARD FAUCET

Wall Mount



Platinum
SERIES

(Quarter Turn Cartridge with Integral Spring Check Lever)*

Part #	Part Name
C8106	Wall Mount Workboard Faucet - 4" Center (Base Only)



Platinum
SERIES



Deck Mount

(Quarter Turn Cartridge with Integral Spring Check Lever)*

Part #	Part Name
C8107	Deck Mount Workboard Faucet - 4" Center (Base Only)

PANTRY FAUCETS



Platinum
SERIES

Part #	Part Name
C8183	US Single Pantry Base Faucet - Heavy Duty - Lead Free Brass



Part #	Part Name
C8439	Deck mounted base without spout- for heavy duty spouts

Part #	Part Name
C8452	1/4" NPT Tailpiece & Nut



ECOLINE WORKBOARD FAUCET



C8438



C8440



Part #	Part Name
C8438	Ecoline Wall Mount Workboard Faucet - 4" Center (Base Only)
C8440	Ecoline Deck Mount Workboard Faucet - 4" Center (Base Only)

PLATINUM WORKBOARD SPOUT



Swing Gooseneck *Platinum* SERIES

Part #	Part Name
C8202	Swivel Gooseneck, 5-11/16" Spread, 10-3/8" Height, 6-3/8" Clearance
C8211	Swivel Gooseneck, 3-1/2" Spread, 7-1/2" Height
C8212	Swivel Gooseneck, 8-1/2" Spread, 12-1/16" Height

ECOLINE WORKBOARD SPOUT

Ecoline Swing Gooseneck



Part #	Part Name
C8259	Economy Swivel Gooseneck Spout, 7-1/2" Height, 3-1/2" Spread, 5" Clearance
C8276	4" Wall Mount Work Board Faucet with 3-1/2" Wide Gooseneck Spout



C8276



STANDARD HAND SINKS

• Includes 1 7/8" Drain (Unless noted) • Includes Wall mounting bracket

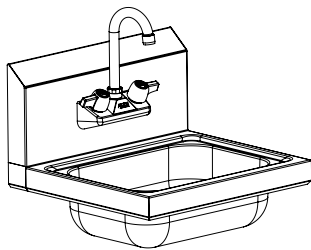

C9300-F

C9300 - Hand sink for 4" Splash Mount Faucet

Part #	Unit Size (L x B)	Bowl Size (L x W x D)	Faucet Center	Faucet	P-Trap
C9300-F	17" x 15-1/2"	14" x 10" x 5"	4" Center	C8276	-
C9300-PT-F	17" x 15-1/2"	14" x 10" x 5"	4" Center	C8276	C8356
C9300-8C	17" x 15-1/2"	14" x 10" x 5"	8" Center	-	-
C9300-8C-F	17" x 15-1/2"	14" x 10" x 5"	8" Center	C8440-8	-
C9300-1	17" x 15-1/2"	14" x 10" x 5"	1 Hole	-	-

C9400 - Hand sink for 4" Deck Mount Faucet

Part #	Unit Size (L x B)	Bowl Size (L x W x D)	Faucet Center	Faucet	P-Trap
C9400-F	17" x 15-1/2"	14" x 10" x 5"	4" Center	C8440	-
C9400-PT-F	17" x 15-1/2"	14" x 10" x 5"	4" Center	C8440	C8356
C9400-1	17" x 15-1/2"	14" x 10" x 5"	1 Hole	-	-

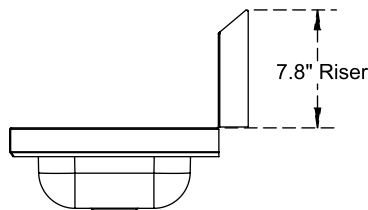
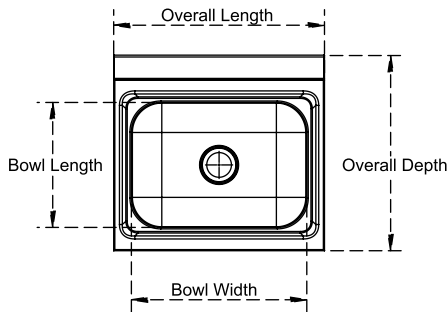

C8276

Ecoline 4" Wall Mount Workboard Faucet with 3-1/2" Wide Gooseneck Spout



C8106

Platinum 4" Wall Mount Workboard Faucet with 3-1/2" Wide Gooseneck Spout



C8440

Ecoline 4" Deck Mount Workboard Faucet with 3-1/2" Wide Gooseneck Spout



C8107

Platinum 4" Deck Mount Workboard Faucet with 3-1/2" Wide Gooseneck Spout



C8356

Brass P-Trap **without** Cleanout Plug - 1-1/2" - 17 GA



Available in pallets of 48

SIDE SPLASH HAND SINKS

• Includes 1 7/8" Drain (Unless noted) • Includes Wall mounting bracket

C9300 - Hand sink for 4" Splash Mount Faucet

Part #	Unit Size (L x B)	Bowl Size (L x W x D)	Faucet Center	Faucet	Side Splash	P-Trap
C9300-RS	17" x 15-1/2"	14" x 10" x 5"	4" Center	-	Right	-
C9300-RS-F	17" x 15-1/2"	14" x 10" x 5"	4" Center	C8276	Right	-
C9300-LS	17" x 15-1/2"	14" x 10" x 5"	4" Center	-	Left	-
C9300-LS-F	17" x 15-1/2"	14" x 10" x 5"	4" Center	C8276	Left	-
C9300-DS	17" x 15-1/2"	14" x 10" x 5"	4" Center	-	Dual	-
C9300-DS-F	17" x 15-1/2"	14" x 10" x 5"	4" Center	C8276	Dual	-
C9300-DS-F-PT	17" x 15-1/2"	14" x 10" x 5"	4" Center	C8276	Dual	C8356

C9400 - Hand sink for 4" Deck Mount Faucet

Part #	Unit Size (L x B)	Bowl Size (L x W x D)	Faucet Center	Faucet	Side Splash	P-Trap
C9400-DS	17" x 15-1/2"	14" x 10" x 5"	4" Center	-	Dual	-
C9400-DS-F	17" x 15-1/2"	14" x 10" x 5"	4" Center	C8440	Dual	-
C9400-DS-F-PT	17" x 15-1/2"	14" x 10" x 5"	4" Center	C8440	Dual	C8356
C9400-1-DS	17" x 15-1/2"	14" x 10" x 5"	1 Hole	-	Dual	-

304 Stainless Steel Sink

A 18 gauge 304 stainless steel sink is your ideal choice. It is durable and easy to clean, anti-rust and wear-resistant.

Convenient Back Splash

Featuring a high backsplash, aims to avoid making a mess and also keeps surroundings away from dirty water.

Oversized Bowl 14"X10"

An oversized bowl perfectly accommodate fruits & vegetables, which makes it more efficient to do the washing.

Round Arc Corner

Well protected & not scratches your hands when using it. The design of rounded corners makes you easy to clean up the sink.



C8276

Ecoline 4" Wall Mount Work Board Faucet with 3-1/2" Wide Gooseneck Spout



C8106

Platinum 4" Wall Mount Workboard Faucet with 3-1/2" Wide Gooseneck Spout



C8440

Ecoline 4" Deck Mount Workboard Faucet with 3-1/2" Wide Gooseneck Spout



C8107

Platinum 4" Deck Mount Workboard Faucet with 3-1/2" Wide Gooseneck Spout



C8356

Brass P-Trap **without** Cleanout Plug - 1-1/2" - 17 GA

Special Purpose Products

Aluids offer special purpose products like Wok Faucets, Pot Filler, Utility Spray all in stock and ready to ship.



POT FILLER FAUCETS



Part #	Part Name
C8558	Double Hole Wall Mount Pot Filler Faucet with 8" Center- 6" Spout
C8559	Double Hole Wall Mount Pot Filler Faucet with 8" Center- 12" Jointed Spout
C8542	Double Hole Wall Mount Pot Filler Faucet with 8" Center- 18" Jointed Spout
C8560	Double Hole Wall Mount Pot Filler Faucet with 8" Center- 24" Jointed Spout



Part #	Part Name
C8606	Single Hole Deck Mount Pot Filler Faucet with 6" Spout
C8607	Single Hole Deck Mount Pot Filler Faucet with 12" Jointed Spout
C8544	Single Hole Deck Mount Pot Filler Faucet with 18" Jointed Spout
C8625	Single Hole Deck Mount Pot Filler Faucet with 24" Jointed Spout



Part #	Part Name
C8626	Single Hole Wall Mount Pot Filler Faucet with 6" Spout
C8627	Single Hole Wall Mount Pot Filler Faucet with 12" Jointed Spout
C8543	Single Hole Wall Mount Pot Filler Faucet with 18" Jointed Spout
C8628	Single Hole Wall Mount Pot Filler Faucet with 24" Jointed Spout

Part #	Part Name
C8493-13	Wall Mounted Wok Range Faucet with 13" Swing Nozzle, 2.2 GPM Aerator, and 3/8" NPT Male Inlet
C8494-13	Wall Mounted Wok Wand Range Faucet with 13" Swing Spout, 2.2 GPM Aerator, and 3/8" NPT Female Inlet
C8495-13	Wok/ Range faucet with 13" Swing Nozzle - Full Flow -1/2" BSP Male Inlet
C8860-13	Pedestal Chinese Wok Faucet with 13" Swing Nozzle, 1/2" NPT Male Inlet, 6" Outlet Clearance
C8493-17	Wall Mounted Wok Range Faucet with 17" Swing Nozzle, 2.2 GPM Aerator, and 3/8" NPT Male Inlet
C8494-17	Wall Mounted Wok Wand Range Faucet with 17" Swing Spout, 2.2 GPM Aerator, and 3/8" NPT Female Inlet
C8495-17	Wok/ Range faucet with 17" Swing Nozzle - Full Flow -1/2" BSP Male Inlet
C8860-17	Pedestal Chinese Wok Faucet with 17" Swing Nozzle, 1/2" NPT Male Inlet, 6" Outlet Clearance
C8841-13	Extended Pedestal Chinese Wok Faucet, 1/2" NPT Male Inlet, 16" Outlet Clearance-13" Swing Spout
C8841-17	Extended Pedestal Chinese Wok Faucet, 1/2" NPT Male Inlet, 16" Outlet Clearance-17" Swing spout

3/8" NPT MALE



C8493 - 13"



C8493 - 17"

1/2" BSP MALE



C8495 - 13"



C8495 - 17"

3/8" NPT FEMALE



C8494 - 13"



C8494 - 17"

1/2" NPT MALE



C8860 - 17"

C8860 - 13"



C8492
Repair Kit for Wok Range Faucet
\$10.02

MANUAL WOK FAUCETS

Part #	Part Name
C8846	Manual Wok Range Faucet -6" Swivel Spout
C8848	Manual Wok Range Faucet -8" Swivel Spout
C8859	Manual Wok Range Faucet -10" Swivel Spout
C8881	Manual Wok Range Faucet -12" Swivel Spout
C8882	Manual Wok Range Faucet -14" Swivel Spout
C8883	Manual Wok Range Faucet -18" Swivel Spout



POT FILLER



C8554



C8555



C8553



C8556



C8557

Part #	Part Name
C8553	8" Center Wall Mount Pot Filler
C8554	Single Wall Mount Pot Filler
C8555	Single Hole Double Lever Deck Mount Pot Filler
C8605	4" Center Deck Mount Pot Filler
C8556	8" Center Deck Mount Pot Filler
C8557	Single Hole Single Lever Deck Mount Pot Filler
C8553.WVB	8" Center Wall Mount Pot Filler
C8554.WVB	Single Wall Mount Pot Filler
C8555.WVB	Single Hole Double Lever Deck Mount Pot Filler
C8605.WVB	4" Center Deck Mount Pot Filler
C8556.WVB	8" Center Deck Mount Pot Filler
C8557.WVB	Single Hole Single Lever Deck Mount Pot Filler

WVB = Without Vacuum Breaker

UTILITY SPRAY

Part #	Part Name
C8593	8" Center Wall Mount Utility Spray
C8594	Single Wall Mount Utility Spray
C8595	Single Hole Double Lever Deck Mount Utility Spray
C8597	Single Hole Single Lever Deck Mount Utility Spray
C8629	4" Center Deck Mount Utility Spray
C8596	8" Center Deck Mount Utility Spray
C8593.WVB	8" Center Wall Mount Utility Spray
C8594.WVB	Single Wall Mount Utility Spray
C8595.WVB	Single Hole Double Lever Deck Mount Utility Spray
C8597.WVB	Single Hole Single Lever Deck Mount Utility Spray
C8629.WVB	4" Center Deck Mount Utility Spray
C8596.WVB	8" Center Deck Mount Utility Spray

WVB = Without Vacuum Breaker



C8594



C8593



C8595



C8596



C8597

VACUUM BREAKER



Part #	Part Name
C8579	Vacuum Breaker, 1/2" NPT Inlet & Outlet, Atmospheric
C8552	Vacuum Breaker, 3/8" NPT Inlet & Outlet, Atmospheric

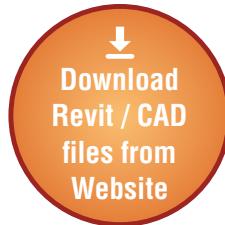
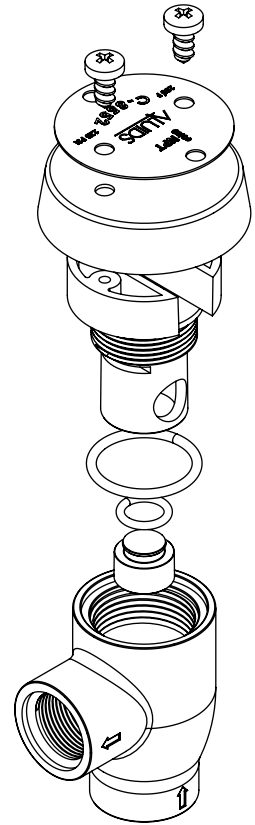

WALL HOOK

Part #	Part Name
C9538	Wall Hook for Pot Filler & Utility Spray



AI147

Part #	Part Name
AI147	Food Safe Lubricant

P - TRAP



C8356



C8340

Part #	Part Name
C8356	Brass P-Trap without Cleanout Plug - 1-1/2" - 17 GA
C8340	Brass P-Trap with Cleanout Plug - 1-1/2" - 17 GA
C8340-CA	Cast Brass P-Trap with Cleanout Plug - 1-1/2" - 17 GA

Part #	Part Name
C9531	Wrist Handle Kit



C9531



C9532

C9533

Part #	Part Name
C9532	Ceramic Cartridge With Lever Handle, Index, Screw - HOT
C9533	Ceramic Cartridge With Lever Handle, Index, Screw - COLD

Part #	Part Name
C9534	Ceramic Cartridge With Wrist Handle, Index, Screw - HOT
C9535	Ceramic Cartridge With Wrist Handle, Index, Screw - COLD



C9535

C9534



C9537

C9536

Part #	Part Name
C9536	Wrist Handle With - COLD Index & Screw
C9537	Wrist Handle With - HOT Index & Screw

Part #	Part Name
C8171	Spring Check Spindle Assembly Replacements
C9516	Swivel Repair Kit
C9518	Repair Kit for Swivel Nozzle
C9522	Replacement Parts Kit for Classic Cartridge
C9524	Repair Kit for Spray Valve & Foot Pedal Valve
C9525	Quarter Turn Classic Cartridge with Spring Check Parts Kit
C8125x12	White Washer for Eccentric Coupling Flange Assembly



C8125x12



Classic Cartridge

C8171



C9516



C9518



C9522



C9524



C9525



C9502



C9503



C9504



C9505



C8139

Part #	Part Name
C9502	Lever Handle Kit
C9503	Economy Lever Handle Kit
C9504	Economy Lever Handle With - COLD Index & Screw
C9505	Economy Lever Handle With - HOT Index & Screw
C8139	Handle Screw

NOZZLES, GOOSENECKS & SPOUTS



C8179



C8145

Platinum Spouts



Platinum
SERIES

Part #	Part Name
C8179	6" Swing Nozzle
C8180	8" Swing Nozzle
C8181	10" Swing Nozzle
C8182	18" Swing Nozzle
C8145	12" Swing Nozzle
C8217	14" Swing Nozzle

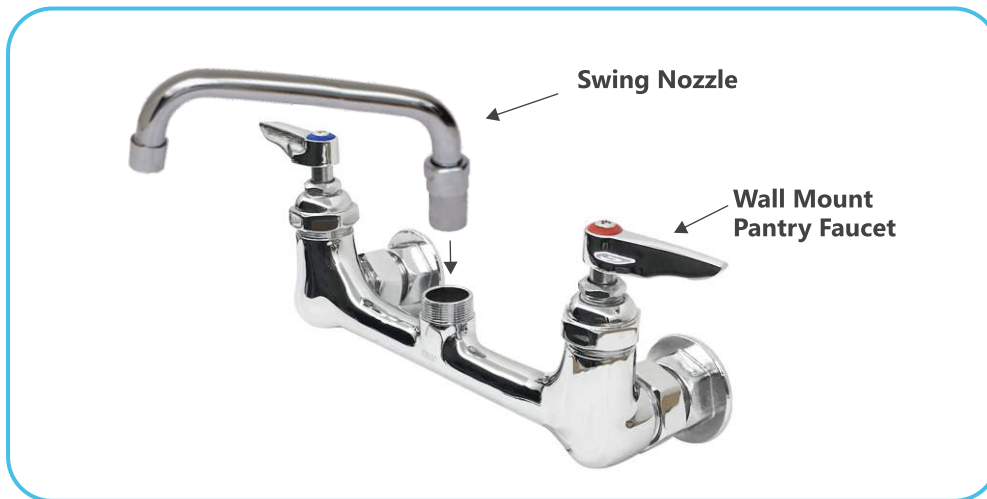

Spout Adapter



C8141.02

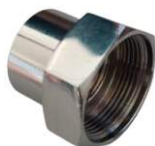

C8141.03

Part #	Part Name
C8141.02	Adapter to Convert Rigid Pantry Faucet to Swivel Spout
C8141.03	Adapter to Convert Swivel Pantry Faucet to Rigid Spout

Double Joint Swing Nozzle



Part #	Part Name
C8206	12" Double Joint Swing Nozzle, (6" Back Section, 6" Front Section)
C8207	15" Double Joint Swing Nozzle, (9" Back Section, 6" Front Section)
C8208	18" Double Joint Swing Nozzle, (12" Back Section, 6" Front Section)
C8222	24" Double Joint Swing Nozzle, (12" Back Section, 12" Front Section)



C8206



C8209

Standard Swing Nozzle



Part #	Part Name
C8209	6" Standard Swing Nozzle

Cast Spout - Heavy Duty

Part #	Part Name
C8506	6"-Swivel Cast Spout
C8508	8"-Swivel Cast Spout



C8506



C8202

Swing Gooseneck

Part #	Part Name
C8202	Swivel Gooseneck, 5-11/16" Spread, 10-3/8" Height, 6-3/8" Clearance
C8211	Swivel Gooseneck, 3-1/2" Spread, 7-1/2" Height
C8212	Swivel Gooseneck, 8-1/2" Spread, 12-1/16" Height

Rigid Gooseneck

Part #	Part Name
C8201	Rigid Gooseneck, 5-1/2" Spread, 10-1/4" Height, 5-5/16" Clearance
C8073	3-3/4" Wide Rigid Gooseneck Spout
C8213	8-1/2" Wide Rigid Gooseneck Spout



C8201



Wall Faucet Nozzle

Part #	Part Name
C8478	Swing Nozzle Assembly, Flanged Wall Mount, 6" Spread
C8479	Swing Nozzle Assembly, Flanged Wall Mount, 8" Spread
C8480	Swing Nozzle Assembly, Flanged Wall Mount, 10" Spread
C8477	3-1/2" wide Swivel Gooseneck, Wall Mount,



Deck Faucet Nozzle

Part #	Part Name
C8483	3-1/2" wide Swivel Gooseneck, Deck Mount
C8484	Swing Nozzle Assembly, Deck Mount, 6" Spread
C8485	Swing Nozzle Assembly, Deck Mount, 8" Spread
C8486	Swing Nozzle Assembly, Deck Mount, 10" Spread



SUPPLY INLETS



Part #	Part Name
C8112	Wall Faucet Mounting Kit with 1/2 npt Male x Female Ells
C8588	Kit for Wall monted Faucet-Short Elbow (1/2" NPT Female X Male)
C8580	Professional Choice Wall Mounting Kit



Part #	Part Name
C8121	1/2" NPT Female Eccentric Flange assembly with washer
C8122	3/4" NPT Female Eccentric Flange assembly with washer
C8123	3/8" NPT Female Eccentric Flange assembly with washer
C8125x12	White Washer for Eccentric Coupling Flange Assembly



C8121



C8230



Part #	Part Name
C8230	Ecoline 1/2" NPT Female Eccentric Flange Assembly With Washer

Part #	Part Name
C8118	Deck Faucet Mounting Kit - 1/2" NPS x 2" long Brass Nipples
C8243	Deck Faucet Mounting Kit - 1/2" NPS x 3-1/2" long Brass Nipples



C8118

Water Line Kit

Soldering or Teflon Tape not Required.

Part #	Part Name
C8581	3/8" Wall Mount Faucet Water Line Kit-22" Length - 3/8" Compression
C8582	1/2" Water Line Kit For Wall Mount Faucet -18" Length
C8586	3/8" Straight Copper Water Line Kit – 14" Length
C8587	1/2" High Volume Wall Mount Faucet Water Line Kit-24" Length



C8582



C8586

Water Line Kit with Mounting Hardware

Soldering or Teflon Tape not Required.

Part #	Part Name
C8583	3/8" Wall Mount Faucet Water Line Kit-22" Length With mounting Hardware
C8584	3/8" Wall Mount Faucet Water Line Kit-24" Length With mounting Hardware
C8585	3/8" Wall Mount Faucet Water Line Kit-30" Length With mounting Hardware
C8601	Inlet Supply Nipple Kit with 24" Flexible Hoses - 3/8" Compression



C8601



C8584



C8583

PRE RINSE FAUCET ACCESSORIES



Part #	Part Name
C8160	Classic Cartridge With Lever Handle, Index, Screw - COLD
C8159	Classic Cartridge With Lever Handle, Index, Screw - HOT



Part #	Part Name
C8161	Quarter Turn Classic Cartridge HOT for Manual Faucet
C8162	Quarter Turn Classic Cartridge COLD for Manual Faucet
C8163	Classic Cartridge - HOT for Manual Faucet
C8164	Classic Cartridge - COLD for Manual Faucet



Part #	Part Name
C8157	Quarter Turn Cartridge With Integral Spring Check, Lever Handle, Screw, Index - HOT
C8158	Quarter Turn Cartridge With Integral Spring Check, Lever Handle, Screw, Index - COLD



Part #	Part Name
C8154	Lever Handle With - COLD Index & Screw

Part #	Part Name
C8155	Lever Handle With - HOT Index & Screw



Classic Faucet Cartridge Durable Design

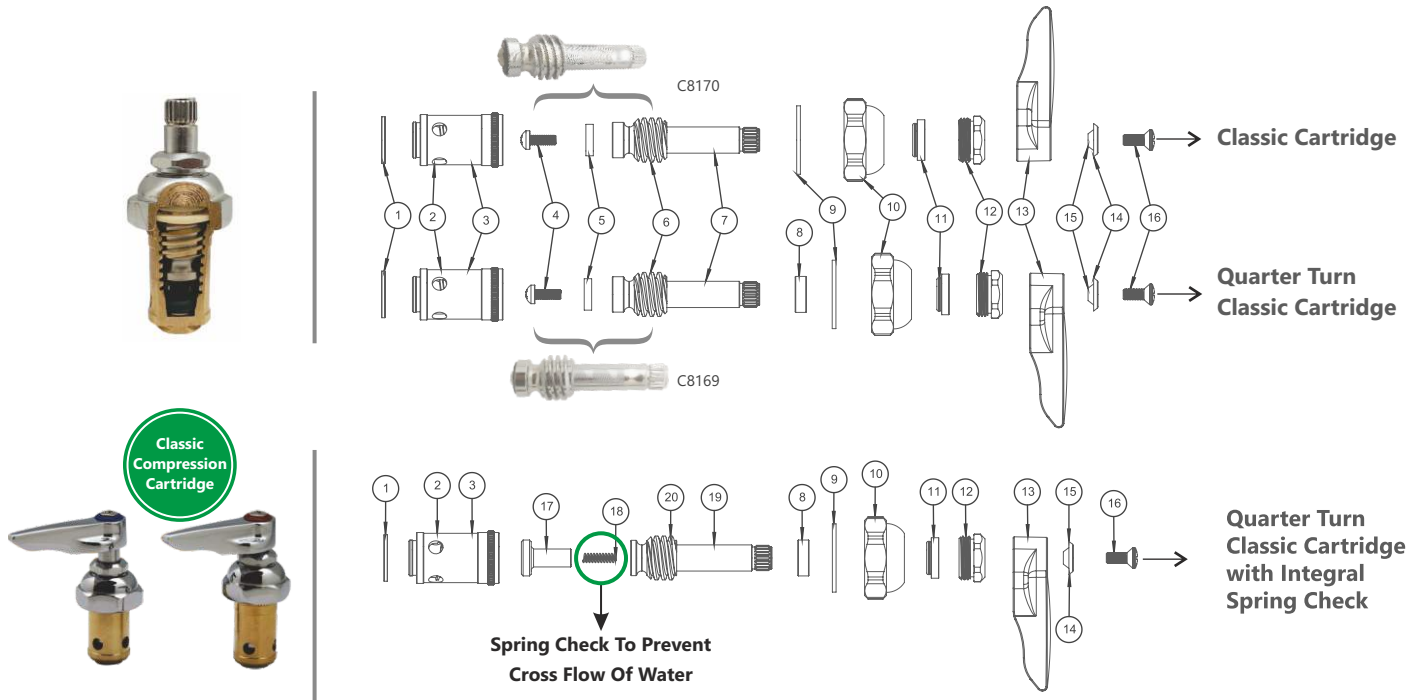

S.No.	Part #	Part Name
1	C8134.09	Seat Washer for Spindle Assembly
2	C8138.02	Chamber for Spindle Assembly- Cold (LH)
3	C8134.02	Chamber for Spindle Assembly- Hot (RH)
4	C8169.03	Seat Screw
5	C8169.02	Seat Washer
6	C8169.01	Spindle for Hot Side (RH)
7	C8170.01	Spindle for Cold Side (LH)
8	C8134.05	Spacer For Spindle assembly
9	C8134.06	Bonnet Washer for Spindle Assembly
10	C8134.04	Bonnet for Spindle Assembly
11	C8134.10	Rubber Washer for Spindle Assembly
12	C8134.11	Hex Nut for Spindle Assembly
13	C8135	Lever
14	C8137	Cold Index (Blue)
15	C8136	Hot Index (Red)
16	C8139	Oval (Raised Head) Nylock Screw for Handle
17	C8134.07	Check Valve for Spindle Assembly
18	C8134.08	Spring for Spindle Assembly
19	C8138.01	Spindle for Cold Side (LH)
20	C8134.01	Spindle for Hot Side (RH)

Ceramic Faucet Cartridge High Performance

High Performance Cartridge Valves That Are Designed For Longevity.

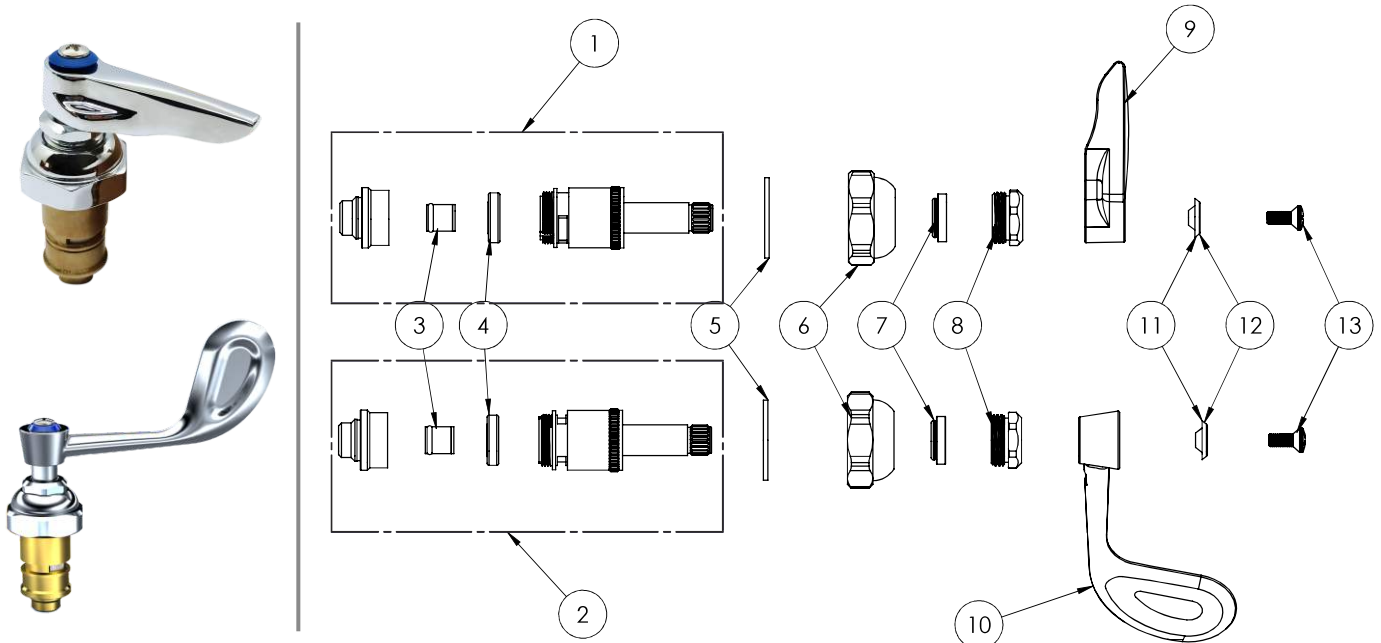

S.No.	Part #	Part Name
1	C8634-L	Quarter Turn Ceramic Cartridge with Check Valve - Hot
2	C8634-R	Quarter Turn Ceramic Cartridge with Check Valve - Cold
3	C8634.10	Non-Return Check Valve
4	C8634.09	End Seal
5	C8134.06	Bonnet Washer for Spindle Assembly
6	C8134.04	Bonnet for Spindle Assembly
7	C8134.10	Rubber Washer for Spindle Assembly
8	C8134.11	Hex Nut for Spindle Assembly
9	C8135	Lever
10	C8859.04	4-1/8" Wrist Action Handle
11	C8137	Cold Index (Blue)
12	C8136	Hot Index (Red)
13	C8139	Oval (Raised Head) Nylock Screw for Handle

GLASS FILLER STATION

Part #	Part Name
C8861	Glass Filler Water Station

Glass fillers & water stations are designed for bars, restaurants & commercial food service kitchens. A glass filler can easily fill cups with fresh drinking water by the simple push of a glass. Available for deck mount applications, .

- ✓ Deck Mount Glass filler with 8" Pedestal height
- ✓ Push back glass filler with 8" clearance from tip to the pan.
- ✓ Adjustable flange on the shank of the pedestal
- ✓ Dedicated to consistent performance, product dependability and overall value.
- ✓ Fits your need and the quality that you can trust.
- ✓ Rounded edges to support the sink within the countertop



C8861



Part #	Part Name
C768	Lavatory Grid Strainer- 6"
C769	Lavatory Grid Strainer- 8"

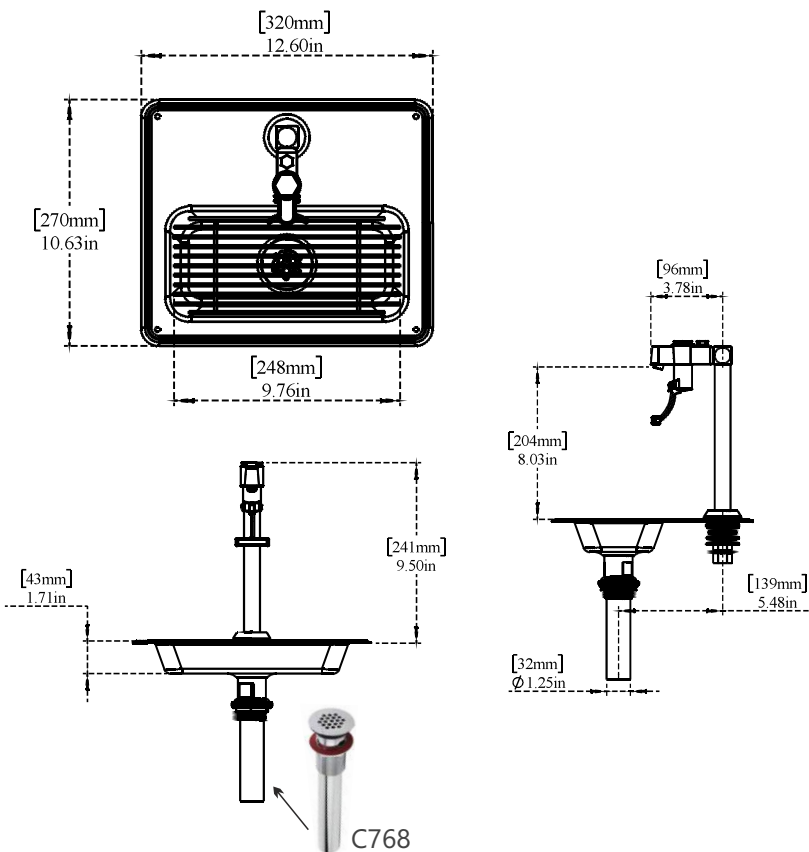

Part #	Part Name
C4219x4	Surface Mount Clip Set for Kitchen Sinks
C4219x6	Surface Mount Clip Set for Kitchen Sinks
C4219x8	Surface Mount Clip Set for Kitchen Sinks



C4219x4



Hose I.D	Hose O.D
10 mm	17 mm

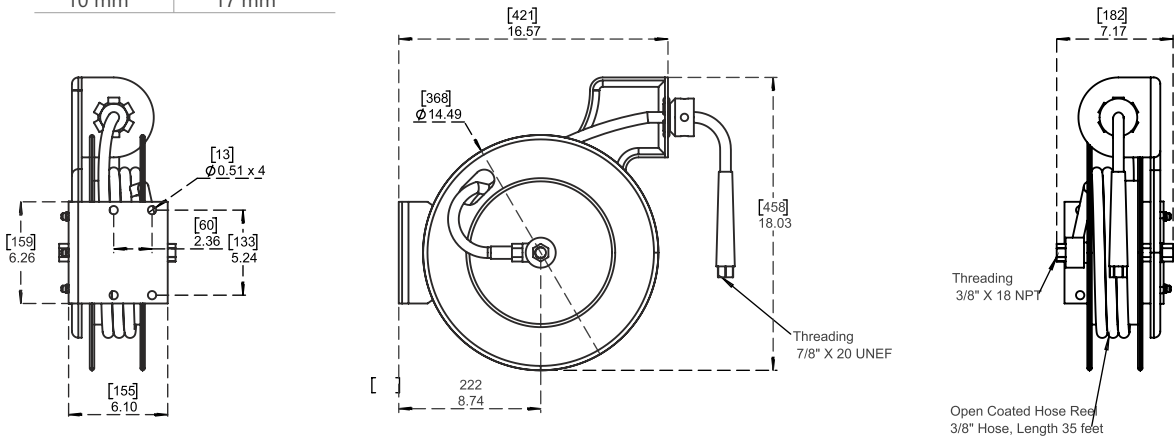

Part #	Part Name
C8249	Hi-Flow Spray Valve for Pre Rinse 4.50GPM
C8251	Front trigger water gun
C8269	Kitchen Cleaning Water Hose Reel 16mtr
C8270	Kitchen Cleaning Water Hose Reel 11mtr

CHOOSE FROM THESE OPTIONS



C8249



* C8251 Recommended



C8124

SWIVEL 360° ADAPTER



C8270

The hose reel is lightweight that is compact enough to be used in applications where too much space is present.

It can be mounted on the deck or the wall as per the space availability and the convenience.

FEATURES :

- ✓ Length of the hose is available in 11 m and 16 m ,**Heavy duty**
- ✓ Ideal for food-service, commercial kitchens, restaurants, & hotel applications
- ✓ Body material - **Steel**
- ✓ Hose material - **TPU Rubber**
- ✓ Spray gun not included (Purchase Separately)
- ✓ Multipurpose use.
- ✓ Body Material - Powder Coated Steel to Resist Corrosion.

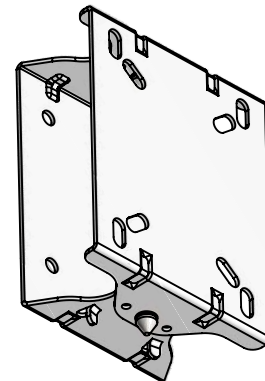

Hose Reel Mounting Bracket

Part #	Part Name
C9269	Stainless Steel Hose Reel Swing Bracket - Wall Mount

Extended Spray Valve

Part #	Part Name
C8687	Hose Reel Extended Spray Valve with 3/8" NPT Female Inlet

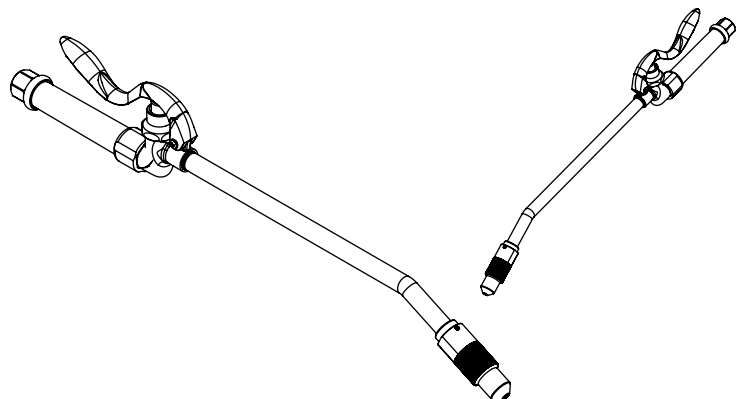

WASTE DRAIN VALVE

The strainer plate obstructs large food particles from entering the water pipe and the waste water flow can be controlled by rotating the twist handle. They also come with overflow tube and head option.



Part #	Part Name
C8089	3-1/2" Sink Opening Waste Drain With Twist Handle, NPT Adapter & Overflow Assembly
C8102	3-1/2" Sink Opening Waste Drain With Twist Handle, NPT Adapter, Overflow Option
C8090	3" Sink Opening Waste Drain With Twist Handle, NPT Adapter, Overflow Option

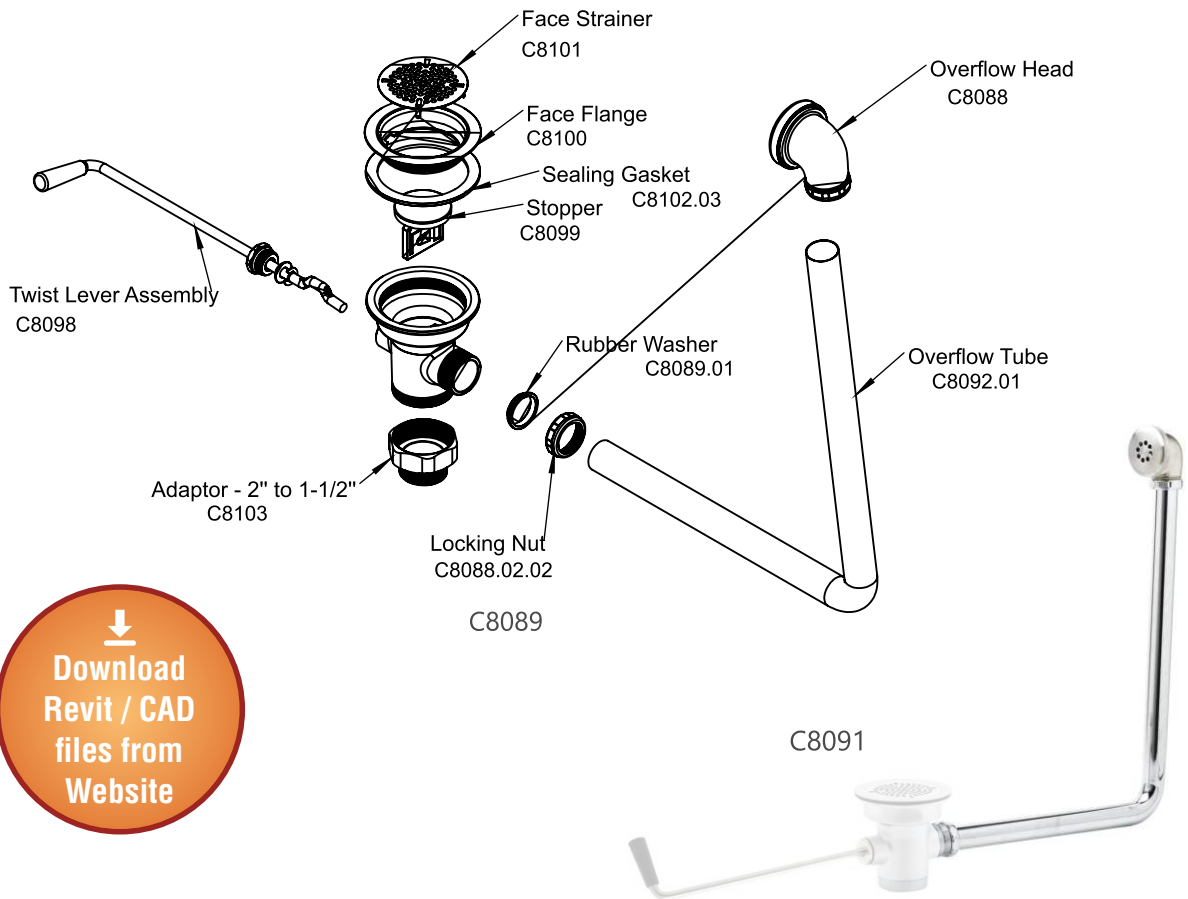

Part #	Part Name
C8103	Adapter for waste drain 2" x 1-1/2"
C8091	Overflow Assembly
C8102.50	3-1/2" Waste Valve twist lever
C8245	Adapter For Waste Drain 1-1/4" NPT Outlet Connection



WASTE VALVE REPLACEMENT PARTS

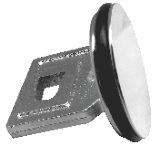

C8099



C8088

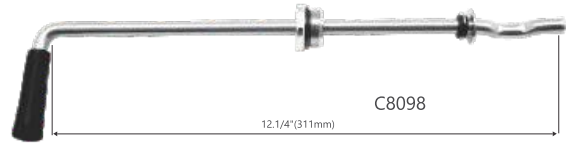

C8098



C8102.02



C8101



C8094



C8095

Part #	Part Name
C8088	Replacement Overflow Head
C8092	Overflow Elbow Tube
C8094	Replacement Face Flange for 3" Waste Drains
C8100	Face Flange for 3-1/2" Waste Drains
C8095	Replacement Face Strainer for 3" Waste Drains
C8101	Face Strainer for 3-1/2" Waste Drains
C8099	Replacement Stopper with O-ring for Waste Drains
C8098	Twist Handle Assembly
C8102.02	Waste Valve Drain Overflow Sealing Cap

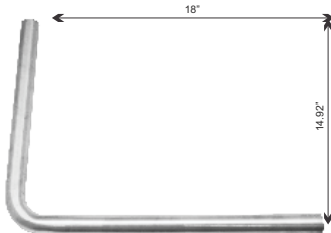

C8092

Part #	Part Name
C8348	Continuous Waste, for 2 or 3-compartment, sinks

- » Call for Price.
- » Custom Length Available.



C8348

DRAIN & CLEANOUT



Dome Strainer

Part #	Part Name
C8965	Aluminum Dome Strainer for 12" Floor Sink 5-1/2" Diameter

WASTE DRAIN VALVE

The strainer plate obstructs large food particles from entering the water pipe and the waste water flow can be controlled by rotating the twist handle. They also come with overflow tube and head option.

ALL
SS304
PARTS

C8481

BALL waste valve with
flat strainer



Solid
Brass Body

Part #	Part Name
C8481	Ball waste valve with flat strainer
C8482	Ball waste valve with locking basket strainer

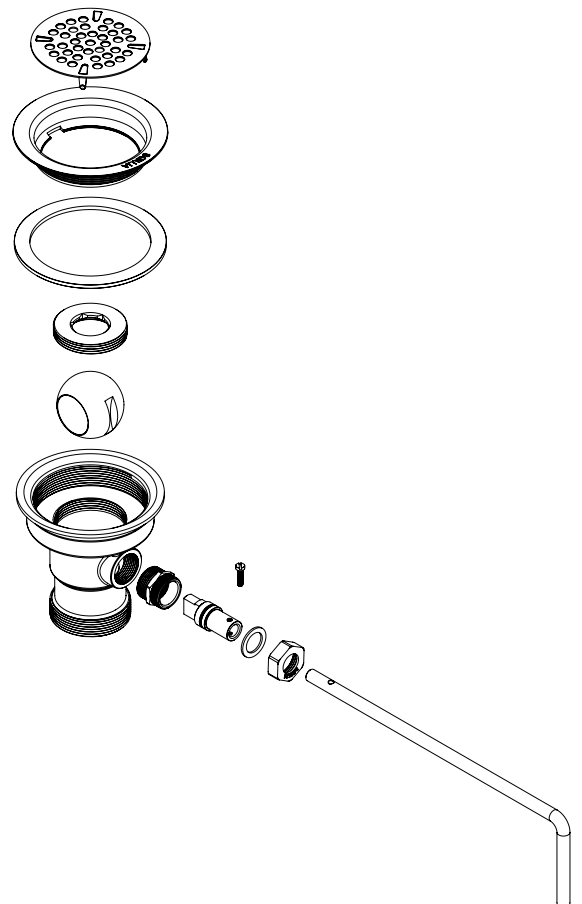

C8482

BALL waste valve with
locking basket strainer



STAINLESS STEEL

Overflow Tubes and Pipes

Part #	Part Name
C8388	7. 1/2" Bar Sink Overflow Pipe
C8399	10" Bar Sink Overflow Pipe



Part #	Part Name
C662.04	1-1/2" Full Flange Stainless steel Drain
C8034.01	Face Strainer for SS Sink Strainer

CAST DRAINS

Part #	Part Name
C8621	1" Drain – 1.5" Long
C8620	1/2" Drain – 1.5" Long



PLASTIC

Overflow Tubes and Pipes

Part #	Part Name
C8043	7" Bar Sink Overflow Pipe
C8048	11" Bar Sink Overflow Pipe





18GA
1.2mm



Tubular Slant shelves

Part #	Part Name
C8271	Tubular Slant Shelf 24"
C8272	Tubular Slant Shelf 36"
C8273	Tubular Slant Shelf 48"
C8274	Tubular Slant Shelf 60"

- ✓ High Grade Stainless Steel Body
- ✓ Heavy Duty & Durable
- ✓ All Edges are finished Providing Safety, Burr-Free
- ✓ Installation is Simple & Quick

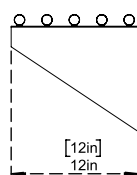
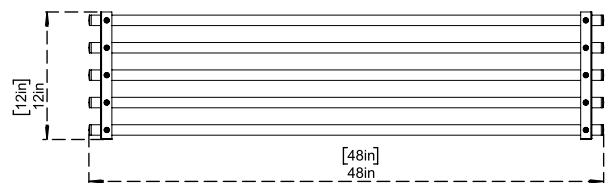

Stainless Steel Wall Mount Shelving

18GA
1.2mm

Great Pricing



6" Width

Ecoline Series

Part #	Part Name
C9306	18" x 6" x 5"
C9306-24	24" x 6" x 5"
C9306-30	30" x 6" x 5"
C9306-36	36" x 6" x 5"
C9306-48	48" x 6" x 5"

8" Width

Ecoline Series

Part #	Part Name
C9308	18" x 8" x 5"
C9308-24	24" x 8" x 5"
C9308-30	30" x 8" x 5"
C9308-36	36" x 8" x 5"
C9308-48	48" x 8" x 5"

12" Width

Platinum SERIES

Part #	Part Name
C9224	18" x 12" x 5"
C9224-24	24" x 12" x 5"
C9224-30	30" x 12" x 5"
C9224-36	36" x 12" x 5"
C9224-48	48" x 12" x 5"
C9224-60	60" x 12" x 5"
C9224-72	72" x 12" x 5"
C9224-84	84" x 12" x 5"
C9224-96	96" x 12" x 5"

ALWAYS IN STOCK



Corrosion Proof



Water Proof



Oil Proof

Platinum SERIES | Stainless Steel 304 Grade

Ecoline Series | Stainless Steel 430 Grade

- ✓ Real 18 Gauge Stainless Steel
- ✓ Brushed Finish
- ✓ Includes 2 support brackets
- ✓ Makes the most of unused wall space
- ✓ Appropriate for every commercial kitchen
- ✓ Shipped Knock Down
- ✓ Mounting Fasteners Included

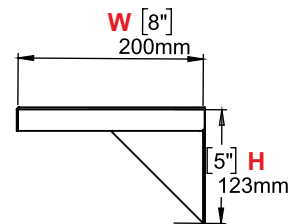
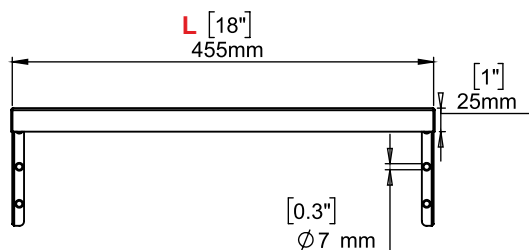

DOUBLE PEDAL VALVE

C8852

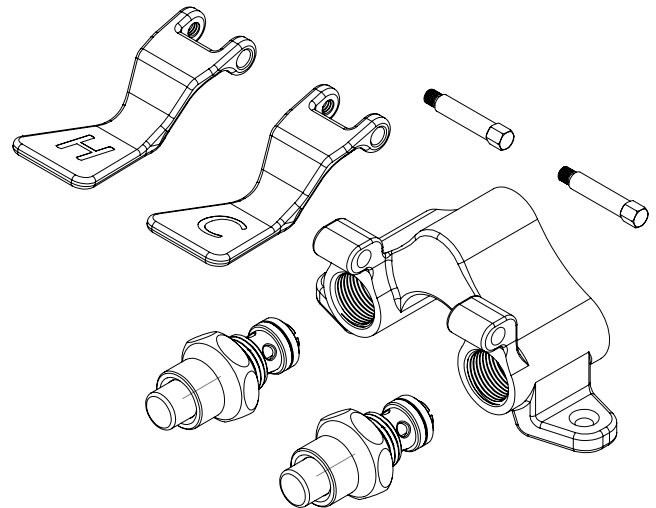
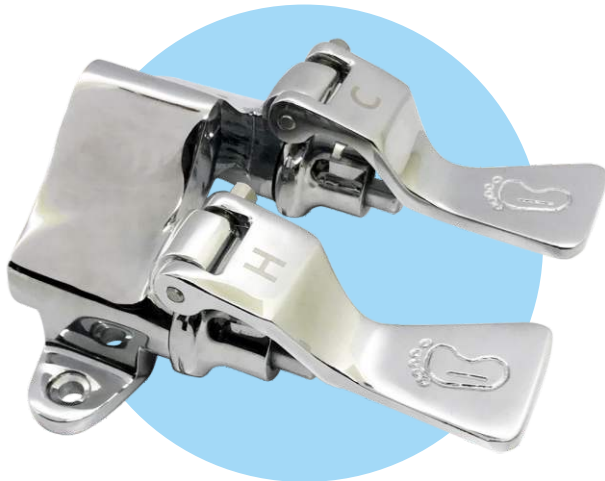
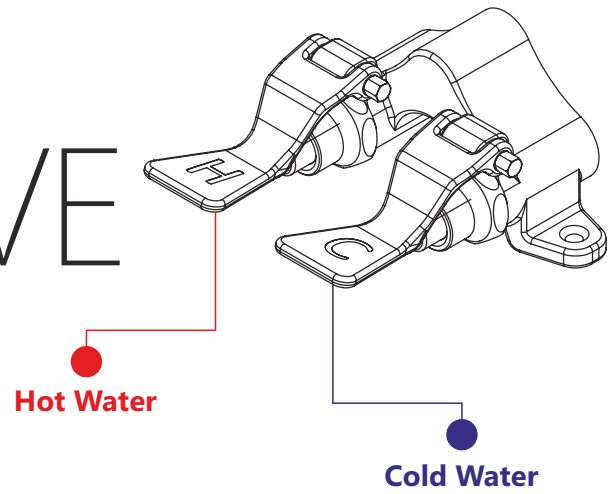

- ✓ Floor mount double pedal valve
- ✓ Hot and cold pedals
- ✓ Metering cartridges
- ✓ Material: Polished chrome plated brass body and pedals
- ✓ 1/2" NPT female Inlets
- ✓ 1/2" NPT female outlet
- ✓ Mounting screws included

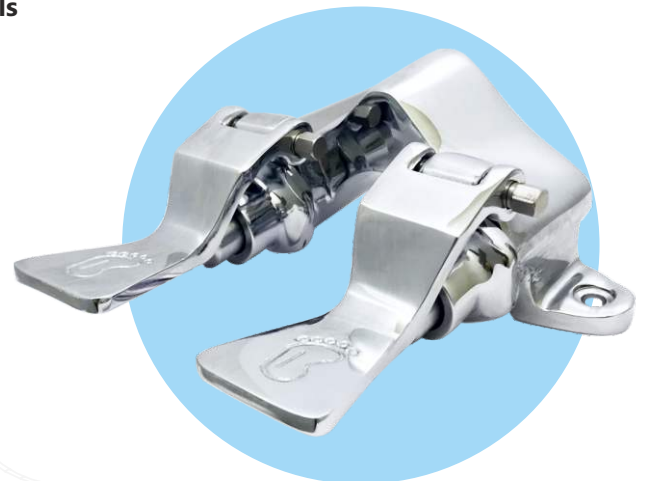

Part #	Part Name
C8852	Double Pedal Valve 1/2" NPT Female Inlets & Outlet

Required to Install



C8601

Part #	Part Name
C8853	Single pedal valve 1/2" Male Inlet and Outlet
C8854	Single Pedal Valve 1/2" Female inlet x Female Outlet – Lead Free



C8853

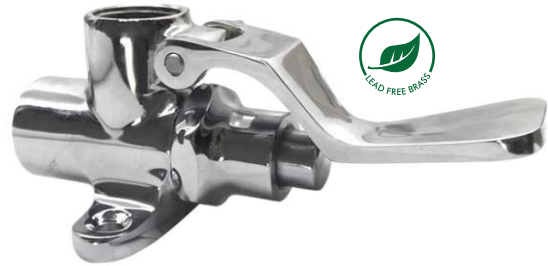

C8854

Part #	Part Name
C8855	Single Pedal Valve Rigid with Swivel Gooseneck spout
C8856	Single Pedal Valve, Floor Mount, 1/2" NPT Inlet, Rigid Gooseneck
C8961	Outdoor Hand Wash Station

Foot Pedal Kits with Spout



C8855

C8856



C8961



Part #	Part Name
C8042.51	Valve Assembly for Foot Pedal Valve

REPAIR KIT FOR PEDAL VALVE

Part #	Part Name
C9524	Repair Kit for Pedal Valve



Part #	Part Name
C9510	Foot Pedal Valve Repair Kit

SERVICE SINK FAUCET

Nickle Plated
Rough Brass
Finish

Part #	Part Name
C8908	Service Sink Faucet

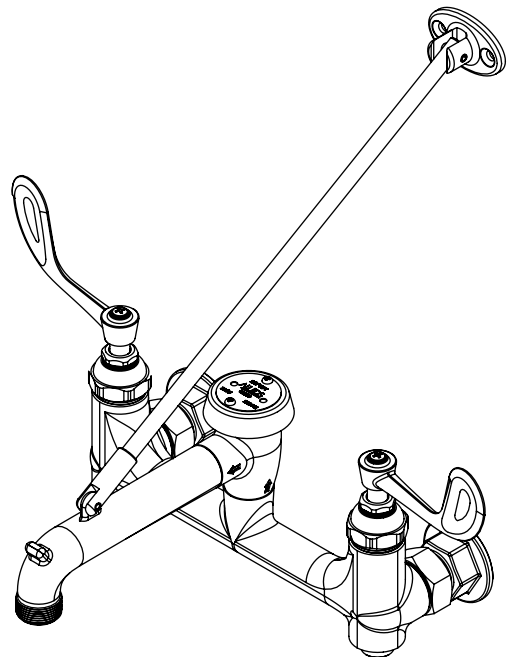

DIPPER WELL

Dipper well Faucet Drain Assembly to keep ice cream scoops and paddles clean and ready for the next use. Widely in coffee shops too.

Mounted on the corner of the wash basin or fit into the countertop cut-out space for it. Keep your workbench clean and clutter free and your tools within reach.



Part #	Part Name
C8953	Dipper Well Faucet with Bowl and Drain Assembly



Part #	Part Name
C353	Dipper Well Faucet



Part #	Part Name
C8952	Dipper Well Bowl



GLASS RINSER

Part #	Part Name
C4061	Drop-in Glass Rinser



Part #	Part Name
C360	11-3/8" x 6-3/8" Glass Rinser Drip Tray -Brushed Stainless – With Drain

Part #	Part Name
C360.50	Glass Rinser Spray Assembly – Replacement



Part #	Part Name
C4051-1	3-3/4" Glass Rinser Subassembly for Drip Tray

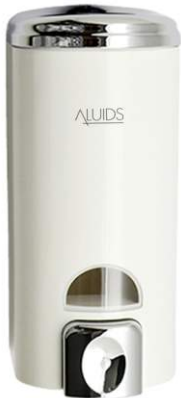

Part #	Part Name
US1120	Wall Mounted Soap Dispenser (30oz)



Part #	Part Name
US1125	Wall Mounted Soap Dispenser (7oz)



Check our website for more products.

Fabricator Series



WE CARE



Whether you have a large commercial kitchen or a small tea room, it's worth conserving water. It will save you money and help save water! Using water efficient appliances and fixtures from ALUIDS. can make a big difference to the amount of water and money one uses in the kitchen area.



Most of our products pre-rinse units, spray valves, flexible hoses, riser tubes, swing nozzles, pantry faucets are promised to be free of lead content.

All our products represented by  are completely lead free.

 **What is the acceptable lead content?**

The Environmental Protection Agency (EPA) of the United States federal government is the body that defines the standard – called the maximum contaminant level goals (MCLG) in accordance with the Safe Drinking Water Act. Lead in water is regulated under both Clean Water Act and Safe Drinking Water Act.



The accepted level of lead in drinking water is 0. Yes, zero tolerance. This is because lead is a toxic metal that can be harmful to human health even at low exposure levels.

Bathing and showering in water with low lead content doesn't cause harm since our skin doesn't absorb lead from the water.

 **How does lead get into water?**

Lead can enter water when plumbing material such as pipes and fixtures containing lead are corroded, especially where the water has high acidity or low mineral content.

 **The solution**

In order to combat this menace, there have been rapid developments to make products that come in contact with water, lead-free.

We at Aluids adhere to highest quality and safety standards and accordingly have made most of our products free of any lead exposure. Products indicated by this image are our lead-free products and components – which includes replacement parts.



TERMS & CONDITIONS

Purchaser understands and agrees that this document sets forth the terms and conditions ("Terms and Conditions") pursuant to which the purchaser ("Purchaser") will purchase and Kromeusainc. ("Seller") will sell the products, accessories and attachments (collectively the "Products") ordered by Purchaser. These Terms and Conditions shall govern and apply to the sale of Seller's Products to Purchaser, regardless of any terms and conditions appearing on any purchase order or other forms submitted by Purchaser to Seller or the inconsistency of any terms therein and herein. In the interest of clarity, it is reiterated that the Purchaser shall be deemed to have made an unqualified acceptance of Terms and Conditions unless the Seller expressly agrees in writing to any of the terms of the Purchaser. Such proposal of additional, different or varying terms by Purchaser shall not operate as a rejection of the Seller's offer except to the extent such variances are in the terms of the description, quantity, price or place or date of delivery of the Products, and the Seller's offer shall be deemed accepted without such additional, different or varying terms.

1. PRICES: All previous prices are currently withdrawn.

2. ACCEPTANCE: If the terms and conditions herein (the "Terms and Conditions") differ in any way from the terms and conditions of Buyer's order, or if these Terms and Conditions are construed as an acceptance or confirmation acting as an acceptance, then the Seller's acceptance is EXPRESSLY CONDITIONED ON BUYER'S ACCEPTANCE OF AND AGREEMENT TO ANY TERMS AND CONDITIONS SET FORTH HEREIN, THAT ARE DIFFERENT FROM OR ADDITIONAL TO THOSE IN BUYER'S ORDER. In addition, this writing shall constitute notice of objection to any terms and conditions in Buyer's order that differ from, or are in addition to, the Terms and Conditions herein. If the Terms and Conditions herein are construed as an offer, acceptance of such offer is EXPRESSLY LIMITED TO THE TERMS AND CONDITIONS SET FORTH HEREIN. In any event, Buyer's acceptance of goods from Seller shall constitute Buyer's acceptance of and agreement to the Terms and Conditions. These Terms and Conditions shall not be supplemented or modified except as agreed to in writing and signed by Seller.

3. GENERAL: Seller reserves the right at all times to reject any and all orders for any reason. For Orders other than standard items or standard lengths, cancellation of the same shall not be entertained if Purchaser fails to notify the Seller to the contrary within 2 days after the receipt of the order. Purchaser may not alter or modify its order or any part thereof without the Seller's prior, written consent. Purchaser must seek a prior written permission from the Seller before listing the Products on any of the marketplace whether online or brick mortar, and undertake to abide by the laws and regulation of the states where the Purchasers intend to sell the Products, and further if the Purchaser commingle Seller's Products with competitors' products, must ensure to rightly attribute the Products of the Seller. The Seller reserves the right to change the price, terms of payment and delivery dates for any Products affected by any alterations or modification to which it consents. Orders or mutually agreed change orders are subject to all provisions of these Terms and Conditions whether or not the order or change order so states.

4. PRICE: Except as otherwise provided otherwise, all prices set forth on any purchase order or other document are F.O.B. the Sellers' facility or distribution point, as may be determined by Seller ("F.O.B Point"). All prices are exclusive of any and all taxes, including, but not limited to, excise, sales, use, property or transportation taxes related to the sale or use of the Products, now or hereafter imposed, together with all penalties and expenses. Purchaser shall be responsible for collecting and/or paying any and all such taxes, whether or not they are stated in any invoice for the Products. Unless otherwise specified herein, all prices are exclusive of inland transportation, freight, insurance and other costs and expenses relating to the shipment of the Products form the F.O.B Point to Purchaser's facility. Any prepayment by Seller of freight insurance and other costs shall be for the account of Purchaser and shall be repaid to Seller

5. PAYMENT TERMS: Seller reserves the right to alter payment terms. Seller reserves the right to hold shipments against the past due payments. Payment of invoices will be due 30 days after shipment of Products. All payments must be received within 30 days failing which a service charge at the lesser of 1.5% per month (18% per annum) or the highest rate permitted by applicable law will be added to all past due invoices from the due date until paid. Purchaser agrees to reimburse the Seller for all costs and fees incurred by the Seller in collecting any sums owed by Purchaser to the Seller including, without limitation, attorneys' fees and repossession fees. Purchaser shall not set off any claims against amounts due to the Seller. Prices are stated and payable in U.S. dollars.

6. FREIGHT TERMS: All shipments are F.O.B Point of shipment as designated in these Terms & Conditions, and title shall pass at the F.O.B. Point. Delivery to the initial common carrier shall constitute delivery to the Purchaser. Any claims for loss or damage during shipment are to be filed with carrier by the Purchaser. Seller will not

assume responsibility for the performance of the carrier, even if the Seller agrees to arrange for transportation as a courtesy to Purchaser. Orders with different numbers and dates shall be considered a separate and independent transaction. Backorders will be shipped in the most practical fashion with charges consistent with our freight policy established with the original order.

7. UPS SHIPMENTS: A handling charge, in accordance with current UPS regulations, will apply to any article that is not fully encased in an outside shipping container. Minimum charge for a package measuring over 84- inches in length and girth combined will be equal to the charge of a package weighting 30 lbs. plus the handling charge. This applies to all UPS air and surface transportation.

8. DELIVERY, DAMAGES, SHORTAGES: Seller shall use reasonable efforts to attempt to cause the Products to be delivered as provided for in these Terms & Conditions. Delivery to the initial common carrier shall constitute the delivery to the Purchaser. Seller's responsibility, insofar as transportation risks are concerned ceases upon the delivery of the Products in good condition to such carrier at the F.O.B. Point and all the Products shall be shipped at the purchaser's risk. Seller shall not be responsible or liable for any loss or damage whatsoever, including loss of income and/or profits, or incidental, special, consequential damages resulting from Seller's delayed performance in shipment and delivery.

9. RETURN OF DEFECTIVE PRODUCTS: Defective or failed material shall be held at the Purchaser's premises until a prior written return material approval ("RMA") has been granted by Seller to return or dispose of Products. Products that are to be returned for final inspection must be returned Freight Prepaid in the most economical way. Credit will be issued for the material found to be defective upon Seller's inspection based on the prices prevailing at the time of purchase.

10. PRODUCTS ORDERED IN ERROR: Standard package Products only may be returned, provided that claim is made and Seller is notified within 7 days of receipt of Products, and the Products are in the original Purchaser's possession not more than 30 days prior to return, subject to Seller's approval. If Products are accepted for return, they must be Freight Prepaid, and Purchaser will be charged a minimum of 15% re handling charge, plus a charge back for outbound freight charges if the original order was shipped prepaid. Returns are not accepted for any Products that are specially manufactured to meet the Purchaser's requirement of either specifications or large quantities.

11. PRODUCTS SHIPPED IN ERROR: Purchaser must notify within 7 days of receipt of Products any Products shipped in error. Upon notification, Products are to be returned to Seller either via truck on a Freight Collect basis or via UPS on a Freight Prepaid basis. The purchaser will be reimbursed for costs of Products, plus any additional freight which may have been incurred due to shipping error.

12. SECURITY INTEREST: Purchaser hereby grants to Seller and Seller hereby retains a continuing purchase money security interest in the Products sold and delivered by Seller to Purchaser, whether presently in the possession of Purchaser or hereafter acquired, and all spare parts and components therefore, together with any and all proceeds of sale or other disposition of the Products, including but not limited to, cash, accounts, contract rights, and chattel paper. Purchaser shall keep the Products free from any adverse lien, security interest or encumbrance and will not store the Products or any part thereof or use the Products in violation of any statute or ordinance. In the even Purchaser shall be in default under these terms and conditions. Seller shall have the remedies of a secured party under the Uniform Commercial Code in force in the state where the Products are located. Purchaser is hereby made aware that a copy of these Terms and Conditions may be filed as a financing statement with appropriate authorities at any time to perfect the Seller's security interest, or in the alternative, Purchaser hereby agrees to execute the appropriate UCC forms upon request of the Seller to perfect the Seller's purchase money security interest.

13. CAUTIONARY STATEMENT: All Products are in the nature of commodities and they are sold by published specifications and not for particular purposes, uses or applications. Purchaser shall first determine their suitability for the intended purposes, uses or applications and shall either conducts its own engineering studies or tests, or retain qualified engineers, consultants or testing laboratories and consult with them before determining the proper use, suitability or propriety of the merchandise or Products for the intended purposes, uses or applications Seller does not recommend the merchandise or Products for any particular purpose, use or application, and the Purchaser or user thereof shall assume full responsibility for the suitability, propriety, use and application of the merchandise or Products. Purchaser shall follow all instructions contained in Seller's catalogs, brochures, technical bulletins and other documents regarding the product. The merchandise or Products, including but not limited to, hose, tubing, or couplings, may fail due to the use or conveyance of substances at elevated or lowered temperatures or at excessive

TERMS & CONDITIONS

pressure, the conveyance of abrasive, injurious, flammable, explosive or damaging substances. Valves are manufactured and designed for beer Kegs /containers strictly and must not be used for any other purpose. Valves should be replaced, adjusted or re-tightened for the avoidance of leakage, for the prevention of injuries or damages, and for general safety purposes. Except as indicated in its Limited Warranty, Seller shall not be liable or responsible for direct or indirect injuries or damages caused by or attributed to the failure of malfunction of any merchandise or products sold or distributed by it. Purchasers or users of the Products should frequently and consistently undertake inspections and protective measures with respect to the use and application of Products, which should include the examination of tube and cover, conditions of the hose or tubing, and the identification, repair or replacement of sections showing cracking, blistering, separations, internal and external abrasions, leaking or slipped couplings or connections and make proper proof tests.

14. LIMITED WARRANTY: The merchandise or Products sold or distributed by Seller are warranted to its customers to be free from defects in material and workmanship at the time of shipment by us, subject to the following provisions. ALL WARRANTY CLAIMS SHALL BE MADE WITHIN 1 YEAR AFTER SELLER SHIPPED THE PRODUCTS. SELLER'S LIABILITY HEREUNDER IS LIMITED AT SELLER'S EXCLUSIVE DISCRETION, TO 1) THE PURCHASE PRICE OF ANY PRODUCTS WHICH IS PROVED TO BE DEFECTIVE ON SELLER'S INSPECTION. 2) REPAIR OF ANY DEFECTIVE PRODUCT OR PART THEREOF, OR 3) REPLACEMENT OF ANY DEFECTIVE PRODUCT OR PART UPON ITS AUTHORIZED RETURN TO SELLER. THE SELLER SHALL NOT BE LIABLE TO PURCHASER, OR TO ANYONE CLAIMING UNDER PURCHASER, FOR ANY OTHER OBLIGATIONS OR LIABILITIES, INCLUDING, BUT NOT LIMITED TO, OBLIGATIONS OR LIABILITIES ARISING OUT OF BREACH OF TERMS AND CONDITIONS OR WARRANTY, NEGLIGENCE OR OTHER TORT OR ANY THEORY OF STRICT LIABILITY, WITH RESPECT TO THE PRODUCTS OR THE SELLER'S ACTS OR OMISSIONS OR OTHERWISE. THE SELLER AND PURCHASER AGREE THAT THE EXPRESS WARRANTIES DESCRIBED ABOVE ARE EXCLUSIVE AND IN LIEU OF ALL OTHER WARRANTIES WHETHER EXPRESSED, IMPLIED, STATUTORY OR OTHERWISE CREATED UNDER APPLICABLE LAW INCLUDING BUT NOT LIMITED TO, THE WARRANTY OF MERCHANTABILITY AND THE WARRANTY OF FITNESS FOR A PARTICULAR PURPOSE. ALL OTHER EXPRESS WARRANTIES ARE DISCLAIMED. IN NO EVENT SHALL SELLER OR THE MANUFACTURER OF THE PRODUCTS BE LIABLE FOR SPECIAL, INCIDENTAL, OR CONSEQUENTIAL DAMAGE, INCLUDING LOSS OF PROFITS, WHETHER OR NOT CAUSED BY OR RESULTING FROM THE NEGLIGENCE OF SELLER AND/OR THE MANUFACTURER OF THE PRODUCT. UNLESS SPECIFICALLY PROVIDED HEREIN, IN ADDITION, THIS WARRANTY SHALL NOT APPLY TO ANY PRODUCTS OR PORTIONS THEREOF WHICH HAVE BEEN SUBJECTED TO ABUSE, MISUSE, IMPROPER INSTALLATION, MAINTENANCE, OR OPERATION, ELECTRICAL FAILURE OR ABNORMAL CONDITIONS, AND TO PRODUCTS WHICH HAVE BEEN TAMPERED WITH ALTERED, MODIFIED, REPAIRED, REWORKED BY ANYONE NOT APPROVED BY SELLER, OR USED IN ANY MANNER INCONSISTENT WITH PROVISIONS OF THE "CAUTIONARY STATEMENT" ABOVE OR ANY INSTRUCTIONS OR SPECIFICATIONS PROVIDED WITH OR FOR THE PRODUCT.

15. FORCE MAJEURE: Seller's obligation hereunder are subject to, and Seller shall not be held responsible for, any delay or failure to make delivery of all or any part of the Product due to labor difficulties, fires, casualties, accident, acts of the elements, acts of God, transportation difficulties, delay by a common carrier, inability to obtain Product, materials or components or qualified labor sufficient to timely perform part of or all of the obligations contained in these terms and conditions, governmental regulations or actions, strikes, shortage of material, damage to or destruction in whole or part of manufacturing plant, riots, terrorist attacks or incidents, civil commotions, warlike conditions, flood, tidal waves, typhoon, hurricane, earthquake, lightning, explosion or any other causes, contingencies, or circumstances within or without the United States not subject to the Seller's control which prevent or hinder the manufacture or delivery of the Products or make the fulfillment of these terms and conditions impracticable. In the event of the occurrence of any of the foregoing, at the option of Seller, Seller shall be excused from the performance under these Terms and Conditions without incurring any liability therefore, or the performance of the Seller shall be correspondingly extended.

16. GOVERNING LAW, JURISDICTION, VENUE AND WAIVER OF TRIAL BY JURY: Except for the perfection of any security interest or lien in any other state, and except as otherwise provided herein, these terms and conditions will be governed and construed in all respect by the Internal laws and decisions, other than any conflict of laws provisions, of the State of Georgia, including without limitation, all matters of construction, validity, enforce ability, and performance. PURCHASER (I) CONSENTS AT SELLER'S ELECTION AND WITHOUT LIMITING SELLER'S RIGHT TO COMMENCE AN ACTION IN ANY OTHER JURISDICTION, TO THE EXCLUSIVE JURISDICTION AND VENUE OF ANY COURT (FEDERAL, STATE, OR LOCAL) SITUATED IN THE STATE OF GEORGIA (II) WAIVES ANY OBJECTION TO IMPROPER VENUE AND

FORUM NON-CONVENIENS; AND (III) CONSENTS TO SERVICE OF PROCESS BY CERTIFIED MAIL, POSTAGE PREPAID, ADDRESSED TO PURCHASER AT ITS ADDRESS AS SET FORTH HEREIN. PURCHASER HEREBY WAIVES TRIAL BY JURY. Purchaser shall bring any action arising out of the sale of Products by Seller only in the federal or state courts in the State of Georgia. In the event Purchaser institutes any action in any court other than a court located in the State of Georgia, Purchaser shall assume all of Seller's costs in transferring said proceeding to a court located in the State of Georgia, including, without limitation, reasonable attorneys' fees. Any action brought must be commenced within one year after delivery of the Products, notwithstanding any statutory limitation to the contrary.

17. SEVERABILITY; WAIVER: The invalidity of any provision or clause of these terms and Conditions shall not affect the validity of any other provision or clause hereof. The waiver by Seller of a breach of any of these terms and conditions shall not be construed as a waiver of any other breach. Seller's acceptance of less than full payment shall not be a waiver of any of its rights.

18. COMPLIANCE WITH LAWS: Purchaser agrees to comply with all laws and regulations applicable to the purchase, transport, use, storage, sale, lease and/or disposal of the Products including, without limitation, to the extent applicable, Proposition 65 as stated below in Section 17, the U.S. Export Administration Act and all regulations thereunder, and Purchaser shall cause its employees and agents to comply with such laws and regulations.

19. CALIFORNIA RESIDENTS / PROPOSITION 65: California's Proposition 65 requires that California consumers receive warnings about any products which contain chemicals known to the State of California to cause cancer or birth defects or other reproductive harm, The State of California requires the following notice: WARNING: This product can expose you to lead, which is known to the State of California to cause cancer and birth defects or other reproductive harm. For more information go to www.P65Warnings.ca.gov

20. INDEMNIFICATION OF THE SELLER: Purchaser hereby releases and agrees to promptly defend, indemnify and hold the Seller and its affiliates and its and their shareholders, directors, officers, employees, successors and assigns (collectively, "Seller Parties") harmless from and against all liabilities, losses, claims, judgments, actions, fines, penalties, costs, damages, attorneys' fees and expenses (collectively, "Damages") arising out of or relating to (a) the alleged violation of any law by Purchaser or any of its employees, agents, successors or assigns ("Purchaser Parties"), (b) bodily injuries, deaths or property damage caused by the negligent or wrongful act or omission of Purchaser or any of the Purchaser Parties, (c) any breach of these Terms and Conditions by Purchaser or any of the Purchaser Parties, (d) any failure to install or maintain Products in accordance with the Seller's written instructions, (e) Purchaser's infringement of the patents or proprietary rights of any individual or entity, and/or (f) improper use of the Products. Prior to settling any claim, the Purchaser will give the Seller an opportunity to participate in the defense and/or settlement of such claim. Purchaser shall not settle any claim without the Seller's written consent. The provisions of this section shall be effective whether or not such loss, damage or injury was proximately caused by the sole or partial negligent acts or omissions of the Seller or any Seller Parties.

21. RESTOCKING FEES :- 20% Restocking fees or minimum \$ 15% will be charged on orders fulfilled correctly. Restocking fees or minimum restocking charges also apply to a refusal of orders which have already left the facility. Also, orders other than standard items or standard lengths may not be subject to return for credit. Return privileges, if available, on such order material will involve restocking fee.

22. MISCELLANEOUS: (a) These terms and conditions constitute the entire agreement between Seller and Purchaser as it relates to terms and conditions of sale, and supersedes any and all prior oral or written agreements, correspondence, quotations, or understandings heretofore in force between the parties relating to the subject matter hereof. There are no agreements between Seller and Purchaser with respect to the Product herein except those specifically set forth in and made part of these terms and conditions. Any additional terms, conditions and/or prices are rejected by Seller. (b) No course of prior dealings between the parties and no usage of trade shall be relevant or admissible to supplement, explain, or vary any of these terms and conditions. Acceptance of or acquiescence in a course of performance rendered under this or any prior agreement shall not be relevant or admissible to determine the meaning of these terms and conditions even though the accepting or acquiescing party has knowledge of the nature of the performance and an opportunity to make an objection. (c) These terms and conditions may be modified, canceled or rescinded only by a written agreement of both parties executed by their duly authorized agents.

23. TERMS AND CONDITIONS RECEIPT: PURCHASER AGREES TO AND ACKNOWLEDGES RECEIPT OF THESE TERMS AND CONDITIONS IRRESPECTIVE OF IN HAND DELIVERED.





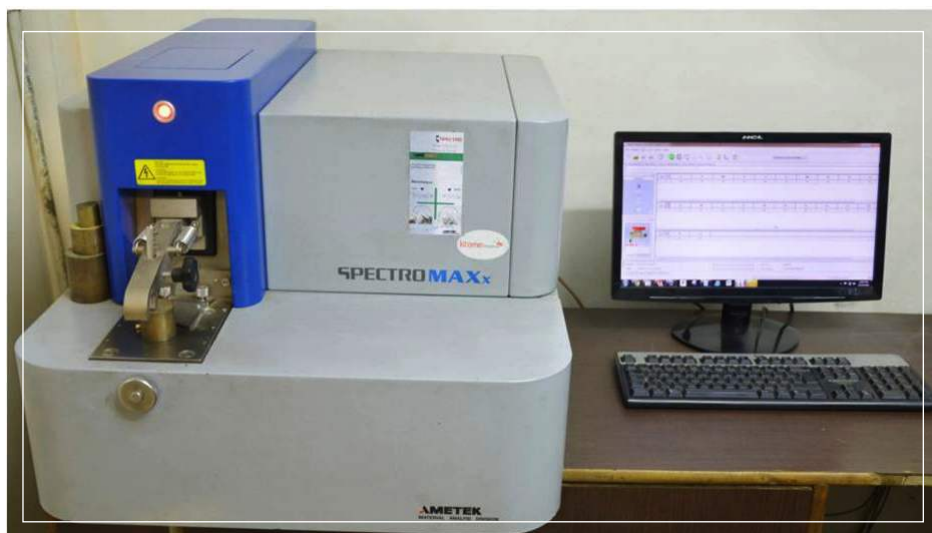









Our world-class machinery makes accurate measurements possible & enables us to provide you durable and high-quality products.



ALUIDS WORLD



- | | | | |
|---------------------------|-------------------------------------------------------------------------------------|---------------|---------------------------------------------------------------------------------------|
| Atlanta, GA - Head Office |  | Punjab, India |  |
| Canada |  | Mumbai |  |
| United Kingdom |  | Dubai |  |
| Germany |  | South Africa |  |
| Spain |  | Australia |  |
| California |  | New Zealand |  |
| | | Sweden |  |

If you want to become distributor, please contact us.
www.aluids.com

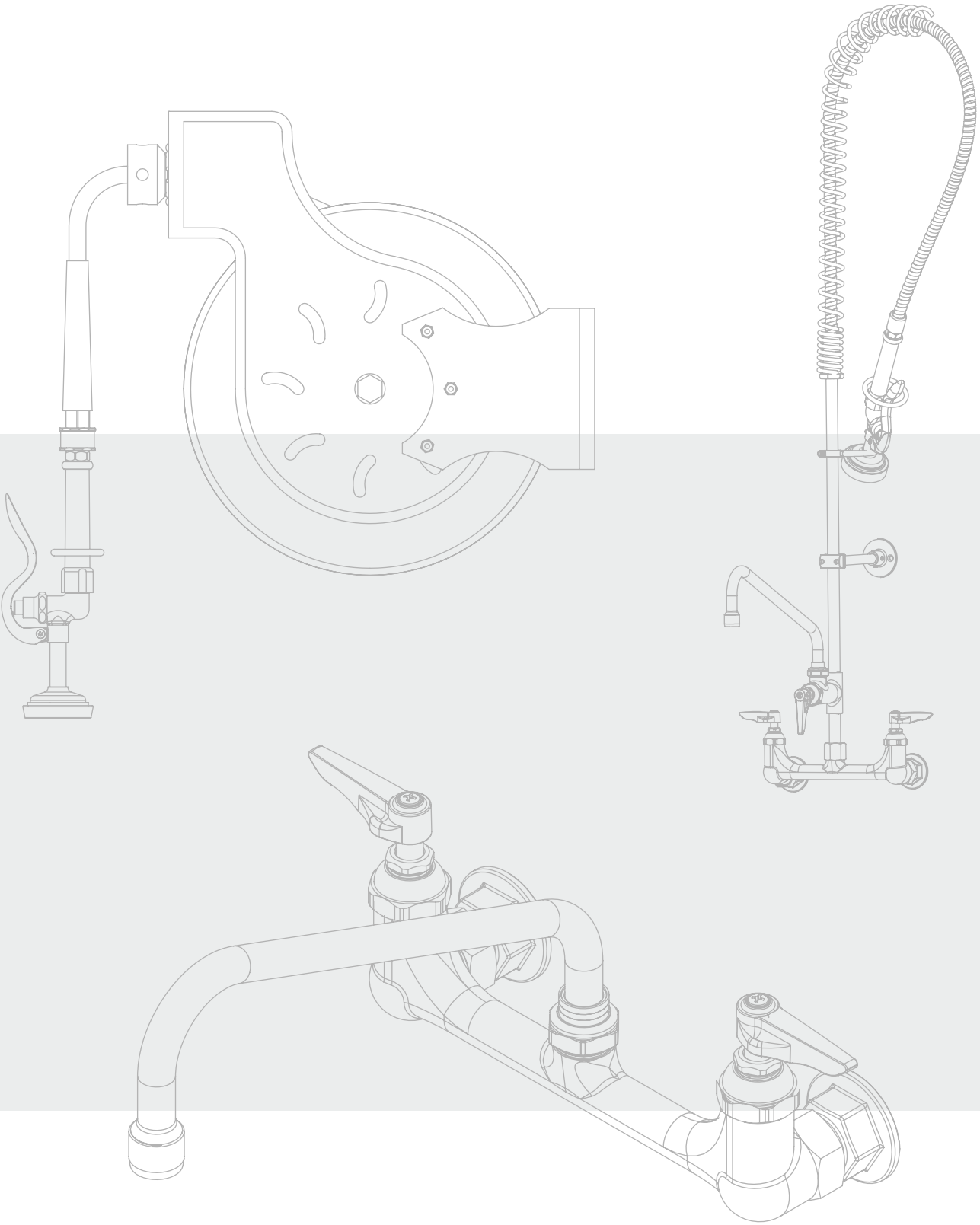

ALUIDS