

The logo for Atlantic Oase, featuring a stylized circular icon on the left, followed by the word "Atlantic" in a bold sans-serif font, a vertical line separator, and the word "Oase" in a similar font with a wave-like flourish above the letter 'e'.

Atlantic | Oase

A photograph of a water fountain with a textured, golden-brown wall. Several arched spouts are mounted on the wall, each pouring water into a pool below. The pool is lined with a green, hexagonal-patterned mesh. Above the fountain, a large, bright fire burns along the top edge of the wall, creating a dramatic contrast between water and fire. The background shows trees with yellow autumn leaves under a clear sky.

2025

www.ATLANTIC-OASE.com

Hey! It's Jeff. It's that time again, a new season, new products and new opportunities with the 2025 Atlantic-Oase Catalog, and I've got plenty to share with you!

First, a revolutionary upgrade. Already the premier smart pump in its class, the AquaMax Premium line has been enhanced with Pulse 6 technology. I'll leave the details to the techies, but the upshot is, these great little pumps that are impervious to freezing and can't be damaged by clogging or low water levels are now more powerful, more economical and even quieter than before. As an added bonus the four new models now connect to the Oase Control system, offering variable speed and pump monitoring.

Next, an exciting update. After years of industry-wide issues with unreliable component supply that made consistency impossible, and three years of constant torture testing, we are bringing Color Changing Lighting back into the fold. We've enhanced just about every component, manufacturing process and quality control standard. We designed new easy-to-use connectors, built beefier drivers and upgraded the three-outlet controllers. We developed the new integrated Atlantic Control application, for Lighting, Ionizer and Variable Speed Control, to simplify remote command of all three. And we secured UL approval for lighting products, to provide the peace of mind that you, and we, need from this high demand category.

Third, new products to help maintain your water features, including a new line of Lake Therapy treatments that we're really excited about. These completely new formulations actually penetrate deep into the muck at the bottom of the pond or lake bringing their own oxygen with them, to achieve rates of organic digestion greater than anything previous. And if nutrient removal on a grand scale still isn't enough, we've brought an EPA registered algaecide into the fold.

And we continue to see an upswing in interest in high end water features – dedicated koi ponds and recreational ponds, as well as European style Natural Swimming Pools – which require the best possible water quality and clarity under the most demanding conditions. We stand ready to provide you the best filters and broadest filtration line on the planet, from the modular Gravity Flow ProfiClear system designed for NSPs and depended on world-wide for decades, to the next generation FiltoClear that can be used almost anywhere, to tiny Filtral all-in-one units for even the smallest features, all offering the Clear Water Guarantee, unmatched in the industry.

And as always, Atlantic-Oase is dedicated to supporting you with our printed media, in-house training classes, a growing library of product videos, our strong social media presence and best-in-class customer service.

I hope you enjoy the 2025 Catalog as much as we've enjoyed assembling it for you. Have a great season!
Jeff Weemhoff, President, & the Atlantic-Oase Team

TABLE OF CONTENTS

6	F	FOUNTAIN FOUNTAIN BASINS / ACCESSORIES / ECO-RISE & DIVERTER / HAMMERED BRASS BOWLS / AURA VASES / BASALT COLUMNS / WATER TRIO & QUINTET / FLEXIBLE BASINS / NOZZLES / PROFESSIONAL NOZZLES
28	FS	FORMAL SPILLWAY BASIN KITS / BASINS / FLEXIBLE BASINS / COPPER SPILLWAY BOWLS / WALL SPOUTS / COLORFALLS / COLOR CHANGING COLORFALLS / SPILLWAYS / WATERWALLS / SPLASH RINGS / PROJECT BUNDLES
44	PF	POND-FREE ECO-BLOX / POND-FREE KITS / PUMP VAULTS / FASTFALLS
52	WG	WATER GARDEN FILTRAL UVC / BIOPRESS / FILTOCLEAR / SKIMMERS / IN-POND SKIMMERS / BIOSMART / BIOTEC SCREENMATIC ² / PROFICLEAR PREMIUM & MODULES / VITRONIC / BITRON C / FILTERFALLS / WATER GARDEN KITS
80	P	PUMP FP-SERIES / FOUNTAIN / AQUARIUS ECO EXPERT / MD-SERIES / WATERFALL / AQUAMAX ECO CLASSIC / AQUAMAX ECO PREMIUM / TT-SERIES / AQUAMAX ECO EXPERT / PAF-SERIES / A-SERIES / L-SERIES / ACCESSORIES
102	I	INSTALLATION CHECK VALVES / INSTALLATION PRODUCTS / FITTINGS & TUBING / EPDM LINER
110	L	LIGHTING SPOTLIGHTS / HARDSCAPE LIGHTS / FOUNTAIN LIGHTING / SPECIALTY LIGHTING / POND LIGHTING / WIRING / INFCOLOR SMART MODULE / WIRING KITS / TRANSFORMERS / PROFILUX LIGHTING / GARDEN CLOUD CONTROLLER
124	M	MAINTENANCE IONIZER / PONDOVACS / AIR PUMPS / AQUAOXY / OXYTEX / TREATMENTS / POND DE-ICER / TOOLS & ACCESSORIES / NETTING
140	P&L	POND & LAKE DIFFUSERS / COMPRESSORS / TUBING / TREATMENTS / SHALLOW WATER SYSTEMS / DEEP WATER SYSTEMS / FLOATING FOUNTAINS
152	TD	TECHNICAL DATA, POP, ACCESSORIES & PARTS

 Products proudly manufactured in the United States

 Products proudly manufactured in Germany

 Video available through our website

 Eco-friendly product with outstanding energy balance

 CAD drawing available through our website

 3D model available on our website

 Oase Control (OC) product

 Clear Water Guarantee (CWG) product

WHAT'S NEW FOR 2025?

PUMPS



AquaMax Eco Premium Pumps with Pulse 6 Technology - Page 92

MAINTENANCE



Algaecide Water Treatment - Page 135

LIGHTING



Color Changing Lighting - Page 113-121

2024 - 2025 CONTRACTOR TRAINING DATES

Are you looking for more experience installing water features? Want to add new revenue to your bottom line? Or broaden your understanding of the water feature business? We designed our Atlantic-Oase Contractor Training for you!



DATES:

SESSION 1: FOUNTAIN, FORMAL SPILLWAY & POND-FREE SYSTEMS

- Tuesday, November 12, 2024 - Thursday, November 14, 2024
- Tuesday, January 7, 2025 - Thursday, January 9, 2025
- Tuesday, February 18, 2025 - Thursday, February 20, 2025

SESSION 2: WATER GARDEN SYSTEMS, MAINTENANCE & BIOLOGY

- Tuesday, December 10, 2024 - Thursday, December 12, 2024
- Tuesday, February 4, 2025 - Thursday, February 6, 2025
- Tuesday, March 11, 2025 - Thursday, March 13, 2025

SESSION 3: FOUNTAINS & FORMAL SPILLWAYS FOR HARDSCAPES

- Tuesday, January 21, 2025 - Thursday, January 23, 2025

More information on page 178



Visit www.atlantic-oase.com/training or scan the QR code for more information and our most up-to-date schedule!

OASE LAKE THERAPY



PROFESSIONAL



Oase Lake Therapy products are award-winning, innovative products that are holistic and environmentally friendly for lake and pond management companies, golf courses and resorts, wineries, zoos, municipalities and HOAs, private landowners and more. We offer the most effective solutions to your toughest lake and pond problems, whether it's too much organic sludge, too many nutrients or too little oxygen.

Our proprietary formulations are developed and engineered in Germany to the highest quality standards in the industry and are now made and distributed in North America after decades of success in Europe. We use nature to our advantage, leaving nothing behind but beautiful, healthy water.



SchlixX Plus

An advanced solution to your organic sediment and phosphate issues.

- Adds oxygen and reduces organic sediment in a sustainable and environmentally friendly way
- Adds beneficial bacteria to enhance water quality and accelerates sediment digestion
- Permanently binds phosphates to remove excess nutrient load
- Greatly reduces the need for disruptive and costly dredging

SchlixX

The solution to your organic sediment and related phosphate issues.

- Permanently binds phosphates and enhances water quality
- Adds oxygen at the sediment level
- Reduces organic sediment in a sustainable and environmentally friendly way
- Buffers pH at the bottom which improves activity and overall biological efficiency

SeDox

The solution to your nutrient and water quality issues.

- 50 lbs of SeDox binds 1 lb of phosphate
- Releases oxygen into the water and balances pH
- Promotes the decomposition of organic sludge

OptiLake

The solution to your pH Stabilization issues.

- Stabilizes water chemistry creating a healthy, natural environment
- Rapidly regulates and buffers pH and carbonate hardness
- Reduces toxic ammonia and nitrite levels

8lb Block

The solution to your water quality issues using beneficial bacteria.

- Significantly reduces noxious odors caused by hydrogen sulfide, dead plant material and fish waste
- Reduces ammonia and nitrogen levels
- Improves dissolved oxygen levels
- Consumes dead organic sediment



Scan the QR code or visit www.oaselaketherapy.com for more information on all of these products.



F

FOUNTAIN

Atlantic's Fountain Systems are the easiest, fastest, and strongest way to build a water feature on or into any horizontal surface. Heavy-duty matched components make setting, plumbing and running your feature simple. Components are designed to work together to beautify any landscape. With systems that will handle any size, any shape and any load, the only limit is your imagination!

- » Systems can be installed in hardscapes or landscapes, in-ground or above-ground, indoors or outdoors for maximum versatility
- » Fountain Basins with integrated internal supports handle more weight with greater stability
- » Two sizes of Three Way Diverters make plumbing and flow control of multiple fountain pieces simple and easy
- » Topside plumbing and tubing channels allow for above water installation and adjustment, no need to get wet
- » Eco-Rise System with Atlantic's Eco-Blox modular reservoirs support any weight, any size, and any number of decorative elements in any configuration
- » Oase Water Entertainment delights the senses with illuminated laminar streams and dancing jets



FOUNTAIN SYSTEM

- 1 Molded as one piece, support cones from the bottom of the basins are fused to the flat top panel, integrating the two planes for exceptional strength.
- 2 Large access door makes pump installation and maintenance easy.
- 3 Complete plumbing kits for decorative items include flow controls and pump connections for FP, MD and TT Pumps.
- 4 3-Way Diverters split pump flow to three outlets. True ball valves with removable handles enable independent flow adjustments to each outlet without moving the decorative gravel.

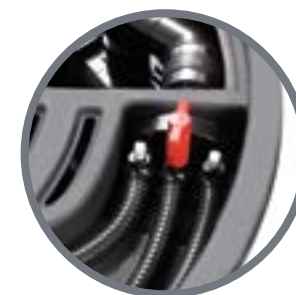

- 5 Built-in channels allow the plumbing to run on top of the basin, simplifying installation and adjustments.
- 6 Recesses allow 1/2" conduit to be installed within the radius of the basin, providing easy access to the pump cord and lighting wires when the basin is installed. 1/2" cord stoppers are supplied with all Fountain Basin Plumbing Kits.
- 7 The ability to install and access an Auto Fill Valve eliminates the need to manually add water to the system.
- 8 Pair Warm White and Color Changing Lighting with Fountain Systems to add dramatic appeal after dark.

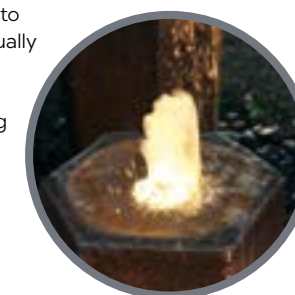

FOUNTAIN BASINS & ACCESSORIES



74958

92803

92802

- Fountain Basins support decorative features while concealing water reservoir, pump, plumbing and accessories
- Atlantic Fountain Basins are the easiest way for anyone to add a water feature to your landscape, ideal for both the beginners and the professional
- Easily installed, Basins may be set at, above or below grade in landscapes, hardscapes, poolscapes and interiors

- Recessed channels allow fast installation of 1" tubing, up to 1½" in the center channel (FB3500 & FB4700), without fear of kinking and crushing
- Square corners provide more usable area for decorative toppers
- Reinforced injection molded pump access panel provides support without warping or shifting (FB3500 & FB4700)

ITEM	74958	92803	92802
MODEL	FB2400	FB3500	FB4700
DESCRIPTION	24" Fountain Basin	35" Fountain Basin	47" Fountain Basin
DIMENSIONS	24"L x 24"W x 10"H	35"L x 35"W x 13"H	47"L x 47"W x 13"H
MAX PUMP FLOW	750 gph	2,000 gph	4,000 gph
PLUMBING SIZE	Up to ¾"	up to 1½"	up to 1½"
CAPACITY	20 gallons	42 gallons	75 gallons
MAX LOAD	200 lbs.	600 lbs.	1,200 lbs.
WARRANTY		Lifetime	

FOUNTAIN BASIN FEATURES:

- One-piece rotomolded construction provides exceptional strength.
- Built-in channels protect plumbing below the top of the basin, no crushing or kinking and fit 1½" elbows in the center channel (FB3500/FB4700).
- Closely spaced cones, 19 in the FB4700 and 7 in the FB3500, connect directly to the top panel for greater stability.
- Topside valve pocket holds adjustment valves and 3-Way Diverter to individually adjust flows above water level.
- 1½" conduit recess in perimeter allow for clean installations in surrounding masonry without notching (FB3500 & FB4700).
- Flat panel accommodates optional AF1000 Automatic Fill Valves.

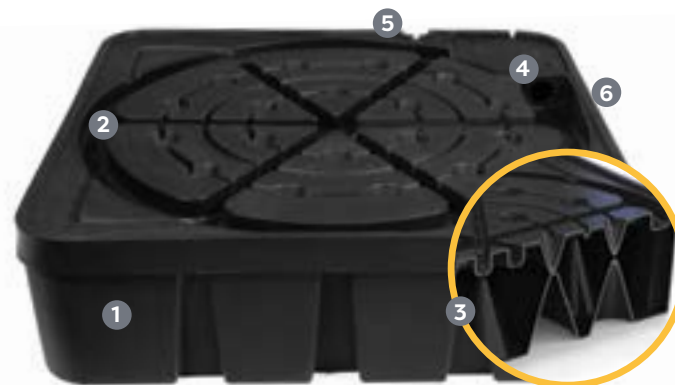

92802 shown

TRITON 3-WAY DIVERTER



ITEM	73814
MODEL	TR3WAY
DESCRIPTION	3-Way Diverter for Fountain Basin
DIMENSIONS	5 5/8"L x 4 1/2"W x 2 7/8"H
INLET	1 1/2" FIPT
OUTLET	(3) 3/4" Insert
INCLUDES	(2) removable "T" handles
FOR USE WITH	FB4700
WARRANTY	1-year

- Atlantic Triton 3-Way Diverter works with the FB4700 Fountain Basin to provide individual flow control to multiple fountain pieces
- Diverter allows adjustment above water level without having to access the pump inside the pump chamber

- The 1½" inlet allows unrestricted flow into the Diverter and out to three valved outlets
- Ball valves with removable handles enable independent flow adjustment of each outlet

PLUMBING KITS



93457

- Atlantic's Plumbing Kits facilitate installation and adjustment of flow to decorative toppers with precisely engineered specialty fittings
- Compact 1½" male thread by spigot elbows mount pumps in Fountain Basins, Vaults and Flexible Basins at exactly the right height
- 1½" Universal Union with choice of outlets - 1½" socket, 1½" male thread or 1" socket - offer unparalleled versatility in mounting and dismounting pumps and toppers



93456

- All components made of Sch40 PVC for complete compatibility with standard fittings
- FBKIT1 includes all necessary fittings to plumb single Aura Vases or other single features on Fountain Basins
- Use FBKIT3 to plumb Basalt Columns or up to three smaller features on Fountain Basins

ITEM	93457	93456
MODEL	FBKIT1	FBKIT3
DESCRIPTION	Fountain Basin Plumbing Kit - Single	Fountain Basin Plumbing Kit - Triple
FOR USE WITH	MD1000 - MD1500 & TT1500 - TT2000	MD1000 - MD1500 & TT1500 - TT3000
VALVE	Single	Triton 3-Way Diverter
TUBING	9' of 1" Flexible PVC	20' of 3/4" Kink-free
STANDPIPE SEALANT	(1) strip	(3) strips
FITTINGS	1 1/2" Pump Discharge, 1 1/2" Single Union Ball Valve, 1 1/2" Universal Union (soc x soc / mpt)	1 1/2" Universal Union (soc x soc / mpt), 1 1/2" Pump Discharge, 3-Way Diverter (TR3WAY / 73814)
CORD STOPPER		1 1/2" for conduit sleeve
WARRANTY		1-year

ECO-RISE SYSTEM

ECO-RISE



88837

74970

- Atlantic's innovative weight distribution risers raise and support fountain pieces directly on Eco-Blox Reservoirs
- Pipe and cord chases provide space for plumbing and light cords to pass under and into decorative pieces without damage
- The Eco-Rise System solves weight and splash limitations of traditional molded fountain basins with a weight capacity of 1,200 or 3,000 pounds per respective Eco-Rise
- Reinforced radial structure distributes the weight of statuary, vases and columns over multiple Eco-Blox vertical support panels
- Inverted design of 12" injection molded Eco-Rise allows pre-plumbed, drop-in installation of decorative pieces

ITEM	88837	74970
MODEL	ECORISE12	ECORISE20
DESCRIPTION	12" Eco-Rise Water Feature Riser	20" Eco-Rise Water Feature Riser
DIMENSIONS	12"W x 12"D x 2 3/4"H	20"W x 20"D x 3"H
PLUMBING SIZE	3/4" to 1 1/2"	
MAX LOAD	1,200 lbs.	3,000 lbs.
WARRANTY	Lifetime	

DID YOU KNOW?

If you need to supply and adjust the flow from one pump to three bubblers, you could go to the store, find all the fittings, spend \$80, cut the nipples, clean, prime and glue everything together, make the assembly fit and somehow hide the valve handles - and you'll end up with THIS - or you can buy the Eco-Rise Diverter for half the money, no messy assembly and it's easier to hide. Don't forget to remove the handles!



ECO-RISE DIVERTER & PLUMBING KIT



ITEM	89581	90163
MODEL	ER3WAY	ERKIT3
DESCRIPTION	Eco-Rise Diverter 3 x 1"	Eco-Rise Plumbing Kit (Triple)
DIMENSIONS	9 3/4"W x 6"D x 4"H	---
INLET	1 1/2" socket / 2" spigot	---
OUTLET	(3) 1" socket	---
MAX FLOW	3,750 gph	---
INCLUDES	(3) removable "T" handles	Eco-Rise Diverter, 25' of 1" Flexible PVC, (3) 1 1/2" x 1" Reducer Bushings
WARRANTY	1-year	

- Diverters split a single source to multiple adjustable outlets
- Atlantic's revolutionary Eco-Rise Diverter accepts 1 1/2" or 2" plumbing and provides 3 valved 1" outlets for ultimate flow control
- Single union ball valves accommodate 1" Sch40 PVC and have removable handles to hide valve and prevent tampering
- Economical diverter saves time, space and money over traditional manifolds
- Seamlessly integrating with newly redesigned PV7500 Pump Vault, Diverter mounts directly into the recessed pockets in the top of the vault
- Eco-Rise Plumbing Kit includes Eco-Rise Diverter, 25' of 1" Flexible PVC Pipe and three 1 1/2" x 1" reducer bushings for connection to all Aura Vase and Hammered Brass Bowls

ECO-RISE SYSTEM

- Eco-Rise System features new 12" Eco-Rise, PV7500 Pump Vault, Small Eco-Blox and Eco-Rise Diverter
 - Create lined reservoirs of any size by combining the Eco-Rise components with underlayment and EPDM liner
 - Small Eco-Blox, 12" Eco-Rise and Eco-Rise Diverter make System easier to install than before, require less excavation and deliver greater flows
1. Create reservoirs of practically any size, shape or volume, supporting any number of decorative items with Eco-Blox Water Matrix Blocks in a lined excavation
 2. Small Eco-Blox at 9" tall require half the excavation but maintain full weight capacity of Large Eco-Blox
 3. Individually control up to 6 decorative features with every PV7500 pump vault, using dual pumps and dual Eco-Rise Diverters
 4. Eco-Rise raises, supports and allows effortless adjustment of decorative items without damage to lighting and plumbing
 5. Mounted into molded pocket, Eco-Rise Diverter directs up to 1,250 gph per 1" outlet to each of up to 3 high flow features
 6. Plumb and illuminate any size, number or configuration of decorative fountain pieces

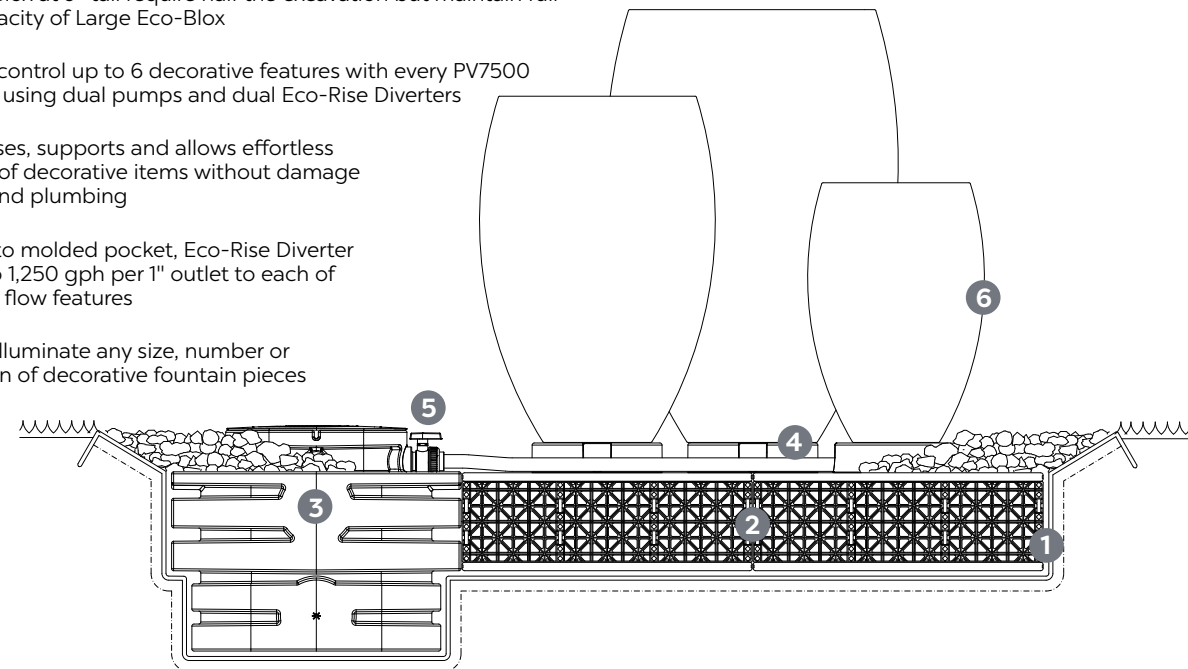



HAMMERED BRASS BOWLS & KIT

HAMMERED BRASS BOWLS



88832

88833

88834

- Fountain Bowls compliment any landscape, hardscape or poolscape with the timeless beauty of brass
- Atlantic Hammered Brass Bowls are handcrafted of solid brass in two styles, with matching pedestal for dual bowl installations
- Unlike painted treatments, acid wash finish permanently imparts an attractive, unique patina that will not chip or peel

- Solid brass standpipes create a bubbling fountain effect at the top of both overflowing and spillway styles and support Atlantic Ring Lights
- Dual 1½" inlets allow water supply to be plumbed independently of lighting cords using Atlantic's Cord Seal Fitting

ITEM	88832	88833	88834
MODEL	HB30R4	HB36R0	HB16P
DESCRIPTION	30" Hammered Brass Bowl w/ 4" Spillway	36" Hammered Brass Bowl	16" Hammered Brass Pedestal
DIMENSIONS	30"W x 33"D x 14½"H	36"W x 14½"H	16"L x 16"W x 8"H
FLOW RATE	400 gph	2,000 - 3,000 gph	---
INLET	(2) 1½" FIPT		---
FOR USE WITH	FB4600/Eco-Rise System		
WARRANTY	3-year		

DID YOU KNOW?

Atlantic's Hammered Brass offers some significant advantages over other materials. Time-honored brass has always been a favorite for sculptors and artists for its strength and durability. Impervious to winter and weather, brass is a non-reactive metal that does not corrode and whose patina deepens naturally over time. To kickstart the natural process, acid washing permanently imparts an attractive patina that cannot chip or peel, unlike painted finishes.

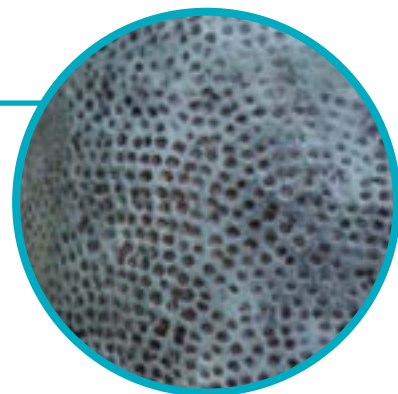

HAMMERED BRASS BOWL KIT



- Hammered Brass Bowl Kits come with everything needed to create stunning water features in very little time
- The secret lies in the newly redesigned Eco-Rise System, with Small Eco-Blox, Pump Vault, Eco-Rise Diverter and Eco-Rises to minimize excavation and effort
- Included Eco-Rise Diverter accommodates Sch40 1" PVC for high flow and maximum durability with single union valves for convenient adjustment
- Includes Triton Check Valve, fittings, teflon tape and glue for complete installation

ITEM	92709
MODEL	FKHBB
DESCRIPTION	2 Pc Hammered Brass Bowl Kit - 30/36
TUBING SIZE	25' of 1" & 21' of 1½" Flexible PVC
LINER SIZE	13' x 13'
PUMP VAULT	PV7500
UNDERLAYMENT	(2) 12' x 12'
ECO-BLOX	(5) ECOBLOX-SMALL
ECO-RISE	ECORISE12 & ECORISE20
PUMP	TT4000
WARRANTY	3-year

TECH TIP

To ensure a perfect installation every time, detailed technical drawings precisely outline procedures and specifications. In drawing at left the layout of the components including the tubing, fittings and structural base are all clearly indicated, simplifying installation. Find similar drawings highlighting what you need to know for seamless installation in our Technical Data section. You can find our Hammered Brass Bowl Kit drawing on page 153.

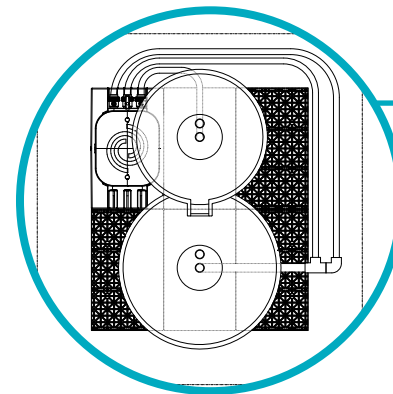



AURA VASES & KITS



88826

88828

88830

88827

88829

88831

- Vases complement any landscape, hardscape or poolscape with the timeless beauty of brass
- Atlantic Aura Vases are hand-hammered of solid brass in three sizes and two styles
- Unlike painted treatments, acid wash finish permanently imparts an attractive, unique patina that will not chip or peel

- Solid brass standpipes create a bubbling fountain effect at the top of both overflowing and spillway styles and support Atlantic Ring Lights
- Dual threaded inlets allow water supply to be plumbed independently from lighting cords using Atlantic's Cord Seal Fitting

ITEM	88826	88827	88828	88829	88830	88831
MODEL	AV24HB	AV24HB-S	AV32HB	AV32HB-S	AV40HB	AV40HB-S
DESCRIPTION	24" Aura Vase	24" Aura Vase - 4" Spillway	32" Aura Vase	32" Aura Vase - 6" Spillway	40" Aura Vase	40" Aura Vase - 8" Spillway
FLOW RATE	500 - 1,000 gph	400 gph	750 - 1,500 gph	600 gph	1,000 - 2,000 gph	800 gph
INLET	(2) 1½" FIPT					
DIMENSIONS	16¼"W x 24"H		21¼"W x 32"H		27"W x 40"H	
WARRANTY	3-year					

AURA VASE KITS



93835



93836



93837



93838



92707



92708

- Aura Vase Kits come with two basin options, each with specially designed fittings, to create stunning water features quickly and easily
- In all Kits an individual valve controls flow to each Vase, then its handle removes to prevent tampering
- Single Aura Vase Kits feature Pump, Fountain Basin and Plumbing Kit with discharge elbow and single union valve

- 3-piece Aura Vase Kits utilize Eco-Rise System with Pump, Pump Vault, Small Eco-Blox, 12" Eco-Rise and Plumbing Kit with Triton Check Valve and Eco-Rise Diverter
- Kits include 1" Sch40 Flexible PVC for high flow and maximum durability and custom fittings for complete installation

ITEM	93835	93836	93837	93838	92707	92708
MODEL	FKAV32	FKAVS32	FKAV40	FKAVS40	FKAVX3	FKAVSX3
DESCRIPTION	32" Aura Vase Kit	32" Aura Vase w/ Spillway Kit	40" Aura Vase Kit	40" Aura Vase w/ Spillway Kit	3 Pc. Aura Vase Kit - 24/32/40	3 Pc. Aura Vase Kit w/ Spillways - 24/32/40
BASIN	FB3500		FB4700		---	
PUMP	TT1500	MD1000	TT2000	TT1500	TT4000	TT2000
PLUMBING KIT	FBKIT1				ERKIT3	
LINER SIZE	---				13' x 13'	
PUMP VAULT	---				PV7500	
UNDERLAYMENT	---				(2) 12' x 12'	
ECO-BLOX	---				(5) ECOBLOX-SMALL	
ECO-RISE	---				(3) ECORISE12	
WARRANTY	3-year					

BASALT COLUMNS & KITS

BASALT COLUMNS



- 91802**
 - Attractive natural stones are drilled to create overflowing water features
 - Hexagonal pillars have a sawn base for stability and snapped top that emphasizes the stone's natural beauty
 - Volcanic basalt oxidizes to form attractive multi-colored patina over time
- 73778**
- 73779**
 - Atlantic's Basalt Columns are generously core-drilled to 1 1/8" to fit up to 1" Sch 40 PVC or 3/4" kink-free tubing plus a light cord
 - A 2" diameter, 5" deep socket at the top recesses Atlantic's Fountain Light (page 116) and buffers the water plume
 - Available in single or three piece sets for design flexibility
- 73780**

ITEM	91802	73778	73779	73780	92241	73781
MODEL	NBC18	NBC24	NBC30	NBC36	NBCX3-1830	NBCX3-2436
DESCRIPTION	18" Natural Basalt Column	24" Natural Basalt Column	30" Natural Basalt Column	36" Natural Basalt Column	3 Pc Natural Basalt Columns - 18/24/30	3 Pc Natural Basalt Columns - 24/30/36
ESTIMATED WEIGHT	92 lbs.	122 lbs.	155 lbs.	188 lbs.	367 lbs.	463 lbs.
APPROXIMATE DIMENSIONS	10"W x 18"H	10"W x 24"H	10"W x 30"H	10"W x 36"H	---	
RECOMMENDED BASIN SIZE	FB2400		FB3500		FB4700	
RECOMMENDED PUMP	FP400		FP500		TT2000	
RECOMMENDED PLUMBING KIT	---				FBKIT3	
WARRANTY	3-year					

BASALT COLUMN KITS



73809

92242



73811

- Atlantic Basalt Kits have everything included to create a natural stone water feature with minimal time and effort
- The plumbing sits directly on top of the basin protected in recessed channels so there is no chance crushing the tubing during installation
- Choose from single 24" and 30" tall Basalt Kits or triple Basalt Kits with 18" to 30" or 24" to 36" columns for installations in a range of locations
- Add Fountain Lights (page 116) to create an illuminated torch effect after dark

ITEM	73809	92242	73811
MODEL	FKNBC24	FKNBCX3-1830	FKNBCX3-2436
DESCRIPTION	24" Natural Basalt Kit	3 Pc Natural Basalt Kit	3 Pc Natural Basalt Kit
ESTIMATED WEIGHT	190 lbs.	399 lbs.	499 lbs.
APPROXIMATE DIMENSIONS	10"W x 24"H	---	
BASIN	FB2400	FB3500	FB4700
PUMP	FP400	TT2000	
PLUMBING KIT	3/4" Kink-free Tubing & (1) Standpipe Sealant		FBKIT3
WARRANTY	3-year		

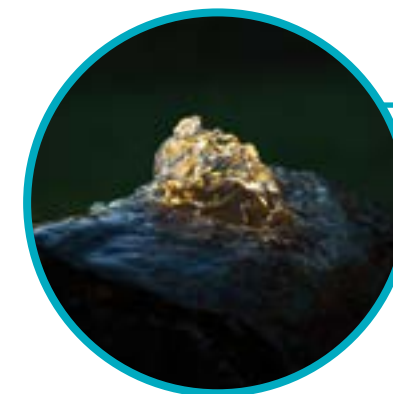

DID YOU KNOW?

Did you know Atlantic's Basalt Columns have a larger bore hole, a full 2" diameter at the top 5" deep, to minimize splash and turbulence and to accommodate Atlantic's Fountain Light? The rest of the column is bored to a generous 1 1/8" diameter, to accommodate 3/4" Kink-free tubing and the cord of the Fountain Light. The epoxy encased Fountain Light generates a warm white flood of illumination at 2800K to integrate perfectly with existing warm white lighting. Page 116.

WATER TRIO & QUINTET



50353

- Water entertainment combines water and light to bring pleasing sound and stimulating movement to the landscape or hardscape
- Oase Water Trio and Quintet include everything you need to create an enchanting water feature right out of the box
- Nine pre-programmed effects vary both fountain height and lighting
- Robust floor plate adapts to a wide variety of substrates and protects unit against damage



50354

- Each individually adjustable nozzle projects a 1/4" jet illuminated by 6 warm white LEDs
- Compact, easy to conceal external control system features a remote with a range of up to 250 feet without obstruction and can connect up to 10 systems



ITEM	50353	50354
DESCRIPTION	Water Trio	Water Quintet
MAX HEIGHT	55"	
WATTS	40	50
MIN DEPTH	3 1/4"	
MAX DEPTH	11"	
CORD LENGTH	8' + 26'	
DIMENSIONS	8 1/2"L x 7 1/4"W x 12"H - Base / 8 1/2"L x 7 1/4"W x 12"H - Control Box	
INCLUDES	12 volt pumps, nozzles with extensions, remote control, external control unit with weather resistant cover, ground stake, 120 volt outdoor transformer	
WARRANTY	2-year + 1	

DID YOU KNOW?

Both the Trio and Quintet can be disassembled and unmounted from the floor plate to enter Creative Mode. Simply remove the cover and unscrew the pumps from the floor plate. The generous 22' cables allow each pump and nozzle assembly to be located remotely in any configuration you desire. Pumps may be set as deep as 11" below the surface of the water with included 4" extensions.



FLEXIBLE FOUNTAIN BASINS



73788
73791
73794
73785
73797
73800

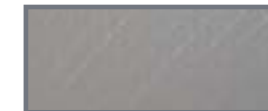

73789
73792
73795
73786
73798
73801



73790
73793
73796
73787
73799
73802

- Flexible Basins instantly create open reservoirs below grade or inside raised walls
- Atlantic's Flexible Fountain Basins are designed to work with most popular manufactured wall stones and colors
- Reinforced PVC construction with fold out flaps and punched glue points anchors liner under capstones for security and durability
- Unlike improvised EPDM liner basins, welded corner construction eliminates folds and wrinkles for a neat professional appearance
- Welded PVC cord channel hides pump and light cords for a clean and attractive installation
- Basins are available in tan, grey and black to complement any surround up to eight-feet wide
- Can be used with Atlantic Fountain Nozzles, Copper Bowls and Formal Spillway products – Spillways, WaterWalls and Spouts
- Open basins not recommended for use with Colorfalls, unless a FiltoClear is used in combination, see page 58

ITEM	MODEL	DESCRIPTION	COLOR	DIMENSIONS	CAPACITY	WARRANTY
73788	FF4416B	4' Square Flexible Fountain Basin	Black	4'W x 4'L x 16"H	160 gallons	1-year
73789	FF4416G		Grey			
73790	FF4416T		Tan			
73791	FF4616B	4' x 6' Rectangular Flexible Fountain Basin	Black	4'W x 6'L x 16"H	240 gallons	1-year
73792	FF4616G		Grey			
73793	FF4616T		Tan			
73794	FF4816B	4' x 8' Rectangular Flexible Fountain Basin	Black	4'W x 8'L x 16"H	320 gallons	1-year
73795	FF4816G		Grey			
73796	FF4816T		Tan			
73785	FF4016B	4' Round Flexible Fountain Basin	Black	4'W x 16"H	125 gallons	1-year
73786	FF4016G		Grey			
73787	FF4016T		Tan			
73797	FF6016B	6' Round Flexible Fountain Basin	Black	6'W x 16"H	280 gallons	1-year
73798	FF6016G		Grey			
73799	FF6016T		Tan			
73800	FF8016B	8' Round Flexible Fountain Basin	Black	8'W x 16"H	500 gallons	1-year
73801	FF8016G		Grey			
73802	FF8016T		Tan			



FOUNTAIN NOZZLES

4-PATTERN NOZZLE SET

- Nozzles create decorative displays of water in small reservoirs
- Oase Nozzle Set creates attractive displays connected directly to Fountain Pumps with ½" MIPT outlets
- Aerates and decorates ponds, fountains, and containers
- Diverter valve with adjustable flow control allows for separate circulation of reservoir during operation of fountain nozzle
- 4-Pattern Nozzle Set features telescoping nozzle, diverter valve, flow control and 4 different heads that are easily interchangeable



ITEM	DESCRIPTION	MIN HEIGHT	MAX HEIGHT	INLET	FOR USE WITH	WARRANTY
51262	4-Pattern Nozzle Set	11"	15¼"	½" FIPT	Fountain Pumps with ½" MIPT outlets	1-year

VULKAN 37-2.5 K

- Creates a dramatic, eye-catching vertical spray
- Made of durable plastic

ITEM	DESCRIPTION	INLET	DIMENSIONS	WARRANTY
55882	Vulkan 37-2.5 K	1" MIPT	3"W x 6"H	1-year

ITEM	SPRAY HEIGHT	2' - 12'					
		2'	4'	6'	8'	10'	12'
55882	GPM / GPH	8 / 450	11 / 660	13.5 / 810	16 / 960	18 / 1050	20 / 1200
	PSI / HEAD	1.5 / 3.5	2.1 / 4.8	2.8 / 6.5	3.6 / 8.3	4.5 / 10.5	5.9 / 13.5
	SPREAD	22"	40"	62"	75"	88"	108"



NOZZLE EXTENSION

- Allows adjustment of Fountain Nozzle display height
- Telescoping Extension is constructed of durable plastic

ITEM	DESCRIPTION	MIN HEIGHT	MAX HEIGHT	INLET	WARRANTY
53227	Nozzle Extension	11"	20"	1" MIPT	1-year



PROFESSIONAL FOUNTAIN NOZZLES

Oase Professional Fountain Nozzles direct water in decorative patterns or shapes in larger fountain applications. Made of high quality brass and stainless steel, these commercial grade nozzles all perform well in fresh water; check the bullets for which to use in non-freshwater applications. Level dependent Nozzles must be set at the recommended water level to achieve the described performance and appearance. Use an adjustable overflow plus an autofill to maintain a constant water level. Visit our website for additional nozzle specifications.

SCHAUMSPRUDLER - FROTHY

- Schaumsprudler or Frothy Nozzles generate a thick, wind resistant display that uses little water
- Foamy white water offers a strong contrast to surroundings while enriching oxygen content
- Fresh water only (53224, 50986, 50987), Fresh & pool water (50768); water level independent



ITEM	DESCRIPTION	INLET	FOR USE WITH	DIMENSIONS	REQUIRES	WARRANTY
53224	Frothy 35-10 E	1"	Fresh water only	2¾"W x 6¾"H	-	3-year
50986	Schaumsprudler 55 - 10 E	1" G	Fresh water only	3¼"W x 7"H	51026 - G/NPT Adapter	2-year
50987	Schaumsprudler 55 - 15 E	1½" G	Fresh water only	3¼"W x 7"H	51027 - G/NPT Adapter	2-year
50768	Schaumsprudler 75 - 20 Silver	2" G	Fresh & pool water	4"W x 9½"H	51028 - G/NPT Adapter	2-year

ITEM	SPRAY HEIGHT	0'-10" - 32'-10"									
		0'-10"	3'-3"	4'-11"	6'-7"	9'-10"	13'-1"	16'-5"	23'	29'-6"	32'-10"
53224	GPM / GPH	12 / 744	21 / 1275	26 / 1533	29 / 1753						
	HEAD	3.3	9.3	13.3	17.3						
50986	GPM / GPH	16 / 950	32 / 1927	38 / 2300	44 / 2622	53 / 3169					
	HEAD	3.7	13.3	19.3	25.0	36.4					
50987	GPM / GPH		46 / 2786	57 / 3438	66 / 3985	82 / 4902	95 / 5674	106 / 6355	126 / 7540		
	HEAD		6.3	9.3	12.7	19.3	25.7	32.3	45.4		
50768	GPM / GPH		87 / 5191	106 / 6345	122 / 7320	149 / 8961	172 / 10348	193 / 11574	228 / 13709	254 / 15248	273 / 16416
	HEAD		6.7	9.7	13.0	19.3	26.0	32.3	44.4	58.4	65.0



PROFESSIONAL FOUNTAIN NOZZLES

COMET



- Comet nozzles generate a single clearwater jet that is stable in wind
- Use singly or in groups, using pivoting ball joint to adjust display up to 15° off vertical
- Small to medium sized nozzles generate fountain jet heights from 20" to 43'
- Fresh water only; water level independent



ITEM	89012	89013	89014	89015	89016	89017	89018
DESCRIPTION	Comet 3 - 6 T / NPT	Comet 5 - 8 T / NPT	Comet 5 - 10 T / NPT	Comet 10 - 12 T / NPT	Comet 10 - 14 T / NPT	Comet 15 - 17 T / NPT	Comet 15 - 20 T / NPT
INLET	3/8" MIPT	1/2" MIPT	1/2" MIPT	1" MIPT	1" MIPT	1 1/2" MIPT	1 1/2" MIPT
FOR USE WITH	Fresh water only						
DIMENSIONS	7/8"W x 2 1/4"H	1 1/4"W x 3 1/2"H	1 1/4"W x 3 1/2"H	1 3/4"W x 4 3/4"H	1 3/4"W x 4 3/4"H	2 1/2"W x 6"H	2 1/2"W x 6"H
WARRANTY	2-year						

ITEM	SPRAY HEIGHT	1'-8"	3'-3"	4'-11"	6'-7"	9'-10"	13'-1"	16'-5"	23'	29'-6"	42'-8"
89012	GPM / GPH	1.3 / 6	1.9 / 98	2.6 / 158	3.2 / 191	4.1 / 246					
	HEAD	2.0	4.0	6.0	8.3	13.3					
89013	GPM / GPH	2.5 / 150	3.3 / 199	4.5 / 268	5.4 / 324	6.9 / 412	8.1 / 485				
	HEAD	2.3	4.3	6.0	8.0	13.0	18.0				
89014	GPM / GPH	3.9 / 237	5.5 / 332	7.4 / 442	8.7 / 521	10.8 / 647	12.9 / 774	15.8 / 947			
	HEAD	2.7	4.7	6.7	9.3	14.7	20.0	30.7			
89015	GPM / GPH	5.5 / 332	8.2 / 489	10 / 616	12 / 726	15 / 916	18 / 1074	22 / 1326	26 / 1547		
	HEAD	2.0	3.7	5.7	7.7	11.7	16.0	24.7	33.4		
89016	GPM / GPH	8 / 474	12 / 695	15 / 868	17 / 1026	21 / 1279	25 / 1484	31 / 1832	35 / 2116	40 / 2384	
	HEAD	2.0	4.0	6.0	8.0	12.3	16.7	25.0	33.7	42.7	
89017	GPM / GPH	11 / 663	16 / 979	20 / 1200	23 / 1405	29 / 1737	33 / 2005	41 / 2479	48 / 2874	54 / 3221	
	HEAD	2.0	3.7	5.7	7.3	11.3	15.3	23.3	31.3	39.4	
89018	GPM / GPH	16 / 932	23 / 1389	29 / 1737	34 / 2021	42 / 2495	48 / 2905	60 / 3584	69 / 4153	77 / 4642	92 / 5526
	HEAD	2.0	4.3	5.7	7.3	11.3	15.0	23.0	30.7	38.7	54.7



PROFESSIONAL FOUNTAIN NOZZLES

LAVA



- Lava Nozzles create a quiet bell of transparent water
- Attractive, adjustable closed water veil is best used indoors or in areas protected from wind
- Modern stainless steel Lava Nozzles are particularly attractive when illuminated
- Fresh water only; water level independent



ITEM	DESCRIPTION	INLET	FOR USE WITH	DIMENSIONS	REQUIRES	WARRANTY
50889	Lava 30 - 10 E	1" G	Fresh water only	3 1/4"W x 13 1/4"H	51026 - G/NPT Adapter	2-year
50890	Lava 45 - 10 E	1" G	Fresh water only	3 1/4"W x 19"H	51026 - G/NPT Adapter	2-year
50891	Lava 60 - 10 E	1" G	Fresh water only	3 1/4"W x 25"H	51026 - G/NPT Adapter	2-year

ITEM	SPREAD	1'	1'-4"	1'-8"	2'	2'-4"	2'-11"	3'-7"
50889	GPM / GPH	9 / 553	11 / 679	13 / 805	16 / 932	18 / 1058		
	HEAD	3.7	4.3	5.3	6.7	8.3		
50890	GPM / GPH		11 / 679	13 / 805	16 / 932	18 / 1058	20 / 1184	
	HEAD		4.7	5.7	7.0	9.7	11.0	
50891	GPM / GPH			13 / 805	16 / 932	18 / 1058	20 / 1184	22 / 1311
	HEAD			6.0	7.3	9.0	11.0	13.3



PROFESSIONAL FOUNTAIN NOZZLES

CLUSTER ECO

- Cluster Eco Nozzles generate a single voluminous water jet by combining many smaller jets
- Oase deflecting blade technology stabilizes display; efficient nozzles lower water consumption
- Cluster Eco nozzles with 21 and 64 single jets respectively create single columns up to 33' high
- For fresh and pool water; water level independent



ITEM	DESCRIPTION	INLET	FOR USE WITH	DIMENSIONS	REQUIRES	WARRANTY
45480	Cluster Eco 15 - 38	1½" G	Fresh & pool water	2"W x 4¼"H	51027 - G/NPT Adapter	2-year
51882	Cluster Eco 30 - 67	3" G	Fresh & pool water	3½"W x 6"H	51029 - G/NPT Adapter	2-year

ITEM	SPRAY HEIGHT	3'-3"	6'-7"	9'-10"	13'-1"	16'-5"	19'-8"	23'	26'-3"	29'-6"	32'-10"
45480	GPM / GPH	15 / 884	21 / 1247	25 / 1500	29 / 1753	33 / 1989	36 / 2179	39 / 2337	44 / 2621	47 / 2811	50 / 3000
	HEAD	4.7	8.7	12.3	16.3	20.0	24.0	28.0	30.0	33.4	36.0
51882	GPM / GPH	39 / 2368	57 / 3411	71 / 4247	83 / 4989	95 / 5716	105 / 6284	115 / 6917	125 / 7484	133 / 8005	140 / 8432
	HEAD	4.7	8.3	11.7	15.7	20.3	24.3	28.7	32.7	37.0	41.7

GRAND VULCAN 30

- Grand Vulcan is a multi jet nozzle whose clear single jets resist wind deflection
- Circular arrangement of jets maintain a consistent height with one another
- Fresh water only; water level independent



ITEM	DESCRIPTION	INLET	FOR USE WITH	DIMENSIONS	REQUIRES	WARRANTY
50376	Grand Vulcan 30	3" G	Fresh water only	3½"W x 10"H	51029 - G/ NPT Adapter	2-year

ITEM	SPRAY HEIGHT	9'-10"	11'-6"	13'-1"	14'-9"	16'-5"	19'-8"	23'	26'-3"
50376	GPM / GPH	118 / 7105	128 / 7689	137 / 8211	145 / 8716	153 / 9189	168 / 10074	181 / 10879	194 / 11637
	HEAD	15.0	17.7	20.3	22.7	25.3	30.7	35.7	41.0

VULCAN 43 - 3

- Vulcan 43 - 3 Nozzles generate attractive tiered patterns with individual wind stable jets
- Nozzle can be disassembled for easy cleaning
- Fresh and pool water; water level independent



ITEM	DESCRIPTION	INLET	FOR USE WITH	DIMENSIONS	REQUIRES	WARRANTY
50766	Vulcan 43 - 3 Silver	1" G	Fresh & pool water	3½"W x 4½"H	51026 - G/ NPT Adapter	2-year

ITEM	SPRAY HEIGHT	1'-8"	2'-6"	3'-3"	4'-11"	6'-7"	8'-2"	9'-10"	11'-6"	13'-1"
50766	GPM / GPH	11 / 663	13 / 789	16 / 947	20 / 1200	24 / 1421	27 / 1611	30 / 1768	32 / 1911	34 / 2053
	HEAD	3.3	5.0	6.7	10.0	13.3	16.7	20.0	25.3	29.3

VULCAN 300

- Vulcan 300 generate a bundle of tiered, clear jets that are stable in wind
- 19 Comet nozzles can be adjusted individually as desired or removed for cleaning
- Fresh and pool water; water level independent



ITEM	DESCRIPTION	INLET	FOR USE WITH	DIMENSIONS	REQUIRES	WARRANTY
50977	Vulcan 300 / 19 - 8 Silver	3" G	Fresh & pool water	11½"W x 10½"H	51029 - G/ NPT Adapter	2-year

ITEM	SPRAY HEIGHT	9'-10"	16'-5"	23'	29'-6"	36'-1"	42'-8"	49'-3"
50977	GPM / GPH	89 / 5353	116 / 6979	138 / 8289	157 / 9426	174 / 10453	189 / 11368	204 / 12253
	HEAD	12.7	21.3	30.0	38.7	47.4	56.4	65.4

TRUMPET JET

- Trumpet Jet with single tall center column surrounded by arching sprays is wind stable
- Fresh water only; water level independent



ITEM	DESCRIPTION	INLET	FOR USE WITH	DIMENSIONS	REQUIRES	WARRANTY
50378	Trumpet Jet 30	3" G	Fresh water only	3½"W x 10½"H	51029 - G/ NPT Adapter	2-year

ITEM	SPRAY HEIGHT	16'-5"	19'-8"	23'	26'-3"	29'-6"	32'-10"
50378	GPM / GPH	96 / 5732	105 / 6268	113 / 6774	121 / 7247	128 / 7689	135 - 8100
	HEAD	33.4	40.0	46.7	56.0	61.7	68.4



PROFESSIONAL FOUNTAIN NOZZLES

FAN JET

- Fan Jet Nozzles create a thick veil of water useful for concealing unwanted views
- Three sizes create heavy fans of gushing water, ¼" and ⅝" thick respectively
- For fresh, pool and sea water; water level independent



ITEM	DESCRIPTION	INLET	FOR USE WITH	DIMENSIONS	REQUIRES	WARRANTY
53056	Fan Jet 10 - 6 E	1" G	Fresh, pool & sea water	2¾"L x 1¾"W x 4¾"H	51026 - G/NPT Adapter	2-year
53047	Fan Jet 15 - 8 E	1½" G	Fresh, pool & sea water	4"L x 2"W x 6"H	51027 - G/NPT Adapter	2-year

ITEM	SPRAY HEIGHT	10"	1'-8"	2'-6"	3'-3"	4'-1"	4'-11"	5'-9"	6'-7"
53056	GPM / GPH	18 / 1105	25 / 1484	31 / 1832	35 / 2116	40 / 2368	43 / 2605	47 / 2826	
	HEAD	1.3	2.0	3.7	4.3	5.3	6.3	7.7	
53047	GPM / GPH		38 / 2258	46 / 2747	53 / 3158	59 / 3521	64 / 3853	70 / 4168	74 / 4453
	HEAD		2.0	3.0	3.7	4.7	5.7	6.7	8.3

FINGER NOZZLE

- Finger Nozzles generate seven clear single stream jets that are resistant to wind deflection
- Stainless steel multi-jet nozzle achieves a maximum fountain height of 13'
- For fresh, pool and sea water; water level independent



ITEM	DESCRIPTION	INLET	FOR USE WITH	DIMENSIONS	REQUIRES	WARRANTY
51110	Finger Nozzle 7 - 15 E	1½" G	Fresh, pool & sea water	6½"L x 2"W x 6½"H	51027 - G/NPT Adapter	2-year

ITEM	SPRAY HEIGHT	3'-3"	6'-7"	9'-10"	13'-1"
51110	GPM / GPH	40 / 2368	53 / 3158	66 / 3947	79 / 4737
	HEAD	3.3	7.0	11.7	16



PROFESSIONAL FOUNTAIN NOZZLES

ROTATING NOZZLES

- Rotating Nozzles create gracefully dancing fountains of rotating screw-shaped water patterns
- 5 individual Comet Nozzles adjust for a wide variety of wind-stable water patterns
- Diagonally set nozzles rotate nozzle head on ball bearings
- Fresh water only; water level independent



ITEM	DESCRIPTION	INLET	FOR USE WITH	DIMENSIONS	REQUIRES	WARRANTY
50967	Rotating Nozzle 5 - 15 E	1½" G	Fresh water only	9¾"L x 5¾"W x 8"H	51027 - G/ NPT Adapter	2-year
50473	Rotating Nozzle 5 - 30 E	3" G	Fresh water only	15"L x 10"W x 13½"H	51029 - G/NPT Adapter	2-year

ITEM	SPRAY HEIGHT	3'-3"	6'-7"	9'-10"	13'-1"	16'-5"	19'-8"	23'	32'-10"
50967	GPM / GPH	37 / 2226	52 / 3142	64 / 3853	74 / 4453				
	HEAD	8.3	16.7	25.3	33.7				
50473	GPM / GPH	87 / 5211	131 / 7895	166 / 9947	195 / 11684	208 / 12474	230 / 13816	276 / 16579	308 / 18474
	HEAD	5.0	10.0	16.7	20.0	25.0	30.0	43.4	53.4

G/NPT ADAPTERS

- G/NPT Adapters convert BSPP/G (British Standard Pipe Parallel) to US standard NPT (National Pipe Thread)
- For use in fresh and pool water



ITEM	DESCRIPTION	INLET/OUTLET	DIMENSIONS	WARRANTY
51026	Adapter G 10 / NPT 10 Silver	1"	1¾"W x 1¾"H	2-year
51027	Adapter G 15 / NPT 15 Silver	1½"	2"W x 1¾"H	2-year
51028	Adapter G 20 / NPT 20 Silver	2"	2½"W x 2½"H	2-year
51029	Adapter G 30 / NPT 30 Silver	3"	3¾"W x 3"H	2-year

FS FORMAL SPILLWAY

Atlantic's Formal Spillway System makes easy work of adding the charm of running water to new or existing landscape or hardscape walls. Minimal noise and splash make this system ideal for indoor applications. Convenient Basin Kits include everything needed for installation, saving time and money. All components are matched for perfect performance every time.

- » Double filter mats keep debris out of the system, eliminating time consuming cleanouts
- » Basin Kits require no guesswork for installation and accommodate four spillway options
- » Dimensions of basins work well with all engineered stone systems
- » High efficiency pumps and top quality components keep cost of operation minimal
- » Water flow is adjustable to achieve the perfect effect regardless of location
- » The rigid basins are completely weatherproof and carry a lifetime warranty



- 1 Formal Spillway Basins are seamless, leak-proof and molded in sizes that complement most modular wall and paving systems, for easy installation and minimal cutting.
- 2 Built-in recesses route all the plumbing beneath the basin, including Auto Fill feed lines and low voltage wiring for accent lighting.
- 3 Basin Kits include all plumbing and fittings needed for installation, with a single union ball valve for easy pump removal and adjustment of water flow to the spillway.
- 4 All plumbing is contained inside the perimeter of the basin, allowing retaining wall blocks to surround the basin with no notching or cutting.



- 5 Internal Matala mat prevents any debris from entering the pump and spillway, filtering the water and diffusing turbulence for even water flow from the spillway.
- 6 Large pump chamber accommodates the appropriate TidalWave pump with room for the installation of an Auto Fill Valve.
- 7 Complete Basin Kits work interchangeably with all Atlantic Formal Spillway styles: Colorfalls, Color Changing Colorfalls and Spillways.



- 8 Atlantic Splash Rings keep stones in place and splash at bay as effectively as our Splash Mats, but with the appeal of steel and copper. Add an LED Ring Light under the mesh to illuminate the falls from below.





FORMAL SPILLWAY BASIN KITS



73849



73850



73851

- The heart of Atlantic Formal Spillway Systems, Basin Kits provide everything you need to install Colorfalls, WaterWalls and Spillways
- Three sizes of self-contained basins, complete with pumps and plumbing, accommodate 12, 24 and 36-inch Formal Spillways

- Seamless installation with four-inch garden block
- Basin Kits include basin, Splash Mat, pump, plumbing, PVC glue, adjustment valve and Auto Fill, all in one box

ITEM	73849	73850	73851
MODEL	CFBASINKIT12	CFBASINKIT24	CFBASINKIT36
DESCRIPTION	Complete Basin Kit for 12" Spillways	Complete Basin Kit for 24" Spillways	Complete Basin Kit for 24" Spillways
FOR USE WITH	All 6" & 12" Spillways	All 24" Spillways	All 36" Spillways
DIMENSIONS	20"W x 20"D x 16"H	44"W x 22"D x 16"H	56"W x 24"D x 16"H
PUMP	TT1500	TT3000	TT4000
WARRANTY	Basin - Lifetime / Pump - 3-year		

TECH TIP

Atlantic's Basin Kits come with everything needed to create a fully functioning water feature with any single Formal Spillway. Simply choose the appropriate width Basin Kit. For multiple Spillway installations, double or triple Wall Spout installations or Spillway and double Spout installations, you will need to add tees and valves and create a manifold to accommodate the additional water outlets. See page 157 for valved manifold examples.

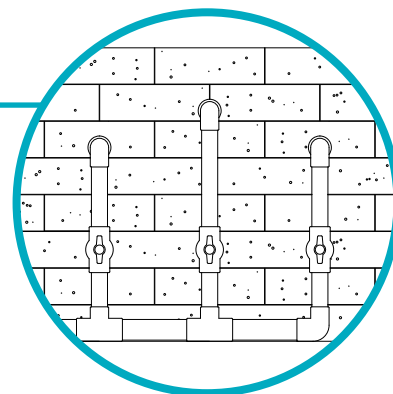

BASINS & ACCESSORIES



FORMAL SPILLWAY BASINS



73852



74232



74233

ITEM	73852	74232	74233
MODEL	CFBASIN12	CFBASIN24	CFBASIN36
DESCRIPTION	Formal Spillway Basin for 12" Spillways	Formal Spillway Basin for 24" Spillways	Formal Spillway Basin for 36" Spillways
DIMENSIONS	17"L x 17"W	41"L x 19"W	53"L x 21"W
CAPACITY	18 gallons	33 gallons	42 gallons
FILTERING	Matala Filter Mat		
FOR USE WITH	12" Spillways	24" Spillways	36" Spillways
WARRANTY	Lifetime		

ACCESSORIES



73845



74230



74231

ITEM	73845	74230	74231	73846
MODEL	CFSPMA12	CFSPMA24	CFSPMA36	CFSPMA2820
DESCRIPTION	Splash Mat for CFBASIN12	Splash Mat for CFBASIN24	Splash Mat for CFBASIN36	Splash Mat Roll
DIMENSIONS	17"L x 17"W	41"L x 19"W	53"L x 21"W	20'L x 28"W
FOR USE WITH	CFBASIN12	CFBASIN24	CFBASIN36	Custom Installations
WARRANTY	1-year			

FLEXIBLE HARDSCAPE BASINS & KIT

COPPER SPILLWAY BOWLS



73836
73839
73842

73837
73840
73843

73838
73841
73844



- For those applications that require an open basin, Atlantic's Flexible Basins are the easiest way to waterproof your block installation
- Reinforced 28mil PVC construction with fold out flaps and punched glue points anchor liner under capstones for security and durability
- Unlike improvised EPDM liner basins, welded corner construction eliminates folds and wrinkles for a neat professional appearance
- Basins are available in tan, grey and black to complement any surround up to eight-feet wide
- Includes backing plates and bulkheads for submersible or external pumps. Use Cord Seal Fittings to pass cords
- Perfect for use with Atlantic Spillways, WaterWalls and Wall Spouts, not recommended for Colorfalls installations without a FiltoClear, page 58

ITEM	73836	73837	73838	73839	73840	73841	73842	73843	73844
MODEL	FF4216B	FF4216G	FF4216T	FF6216B	FF6216G	FF6216T	FF8216B	FF8216G	FF8216T
DESCRIPTION	4' x 2' Flexible Hardscape Basin			6' x 2' Flexible Hardscape Basin			8' x 2' Flexible Hardscape Basin		
COLOR	Black	Grey	Tan	Black	Grey	Tan	Black	Grey	Tan
FOR USE WITH	Spillways, WaterWalls & Wall Spouts								
DIMENSIONS	4'W x 2'D x 16"H			6'W x 2'D x 16"H			8'W x 2'D x 16"H		
CAPACITY	80 gallons			120 gallons			160 gallons		
BULKHEAD	1½" w/ Backing Plate			(2) 1½" w/ Backing Plates					
WARRANTY	1-year								



73854



73853



73803

- Spillway Bowls complement any hardscape, landscape or poolscape with the elegance of copper
- Atlantic Copper Spillway Bowls are crafted out of solid copper in both round and square styles
- Copper Spillway Bowls are designed to form a natural patina over time
- All spillways are sized at 12" for maximum water flow and visual effect
- All Bowls feature dual 1½" FIPT inlets and solid copper standpipe for lighting and water supply
- Dual inlets allow water supply to be plumbed independently from lighting cords. Use Atlantic's Cord Seal Fitting to pass the light cord into the Bowl through the second inlet
- Solid Copper Pedestal accessory allows Bowls to be elevated 8"
- Copper Spillway Bowls are designed to work with the CFBASINKIT12
- Use a 12" Splash Ring on the 12" Formal Spillway Basin to control splash

ITEM	73854	73853	73803
MODEL	CB26S12	CB26R12	CB16P
DESCRIPTION	26" Square Copper Bowl w/ 12" Spillway	26" Round Copper Bowl w/ 12" Spillway	Copper Pedestal for Copper Bowls
FLOW RATE	1,200 gph		---
INLET	(2) 1½" FIPT		---
DIMENSIONS	26"W x 27½"D x 10"H		16"L x 16"W x 8"H
WARRANTY	3-year		



TECH TIP

Copper Bowls lend themselves to a number of lighting options. External Spotlights are a great way to accent water overflowing the 36" Copper Bowl or the concentrated flow from spillways. Inside the bowl, the submersible Ring Light creates rippling uplighting effects on overhanging trees or structures. Install Atlantic's unique Cord Seal Fitting to make lighting inside the Bowl possible without a visible cord coming over the edge. The rubber fitting installs in the off-center 1½" FIPT inlet and expands when tightened, sealing the cord and the inlet. Page 107

WALL SPOUTS



73867 (Copper)
73871 (Bronze)



73869 (Copper)
73873 (Bronze)



73870 (Copper)
73875 (Bronze)



73868 (Copper)
73872 (Bronze)

- Wall Spouts are an easy and elegant way to add the sight and sound of water to vertical surfaces
- Atlantic Wall Spouts complement larger spillways when paired; use alone to accent smaller spaces
- Solid brass fixtures add a captivating focal point to both traditional and contemporary walls and patios

- Choose from four architectural designs with oil rubbed bronze or antique copper finish to fit any style
- Integrated drip edge prevents water from backflowing down the wall
- Includes grounding lug for bonded systems

ITEM	73867	73871	73869	73873	73870	73875	73868	73872
MODEL	WSCM-S	WSM-S	WSCR-O	WSR-O	WSCV-S	WSV-S	WSCO-O	WSO-O
DESCRIPTION	Mantova Wall Spout		Ravenna Wall Spout		Verona Wall Spout		Olivett Wall Spout	
FINISH	Copper	Bronze	Copper	Bronze	Copper	Bronze	Copper	Bronze
FLOW RATE	600 gph							
PROJECTION*	14" - 16" at 18"H & 600 gph							
INLET	1½" FIPT							
DIMENSIONS	5"W x 4¼"D x 5"H		5"W x 5¼"D x 6"H		7"W x 4¾"D x 7"H		6"W x 4½"D x 5"H	
WARRANTY	3-year							

* Projection is measured from the face of the wall the Spout is mounted on

TECH TIP

Atlantic's unique Spout Lights illuminate the water from inside the plumbing. With 600 gallons per hour or more, the minimum flow required to submerge the light fixture in the plumbing, light is carried inside the laminar water flow.

Page 117

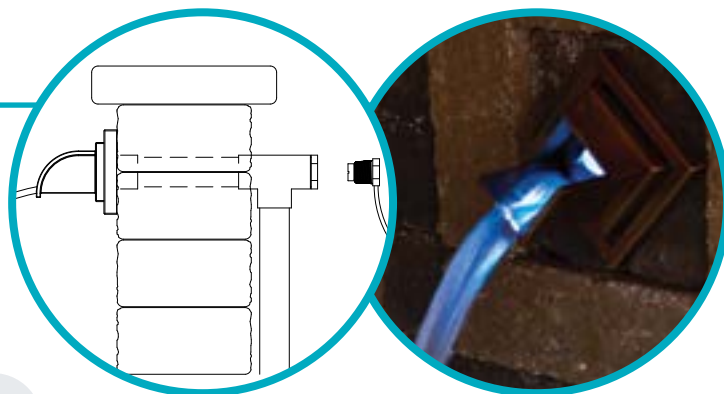

COLORFALLS



73883 (Ice Blue)
73885 (Crystal White)
73884 (SOL White)



73886 (Ice Blue)
73888 (Crystal White)
73887 (SOL White)



73889 (Ice Blue)
73891 (Crystal White)
73890 (SOL White)

- Colorfalls produce a sheer of lighted water emerging from a concealed source inside vertical walls
- Colorfalls adapt to any wall material – pavers, tile, brick, stone, wood – the only limit is your imagination
- Replaceable LED light bar available in three vibrant colors

- Colorfalls feature a 5" lip, 30' power cord and include a 12 volt outdoor transformer
- For use with Formal Spillway Basins and Basin Kits

ITEM	73883	73885	73884	73886	73888	73887	73889	73891	73890
MODEL	CF12B	CF12W	CF12SW	CF24B	CF24W	CF24SW	CF36B	CF36W	CF36SW
DESCRIPTION	12" Colorfalls			24" Colorfalls			36" Colorfalls		
COLOR	Blue	Crystal White	SOL White	Blue	Crystal White	SOL White	Blue	Crystal White	SOL White
FLOW RATE	1,000 gph			2,000 gph			3,000 gph		
PROJECTION*	13" - 15" at 18"H & 1,000 gph (Rec. Height: 20" max.)			13" - 15" at 18"H & 2,000 gph (Rec. Height: 30" max.)			13" - 15" at 18"H & 3,000 gph (Rec. Height: 40" max.)		
INPUT VOLTAGE	12 volt AC								
WATTS	3			6			9		
INLET	1½" FIPT								
DIMENSIONS	12"W x 8"D x 3½"H			24"W x 8"D x 3½"H			36"W x 8"D x 3½"H		
WARRANTY	1-year								

* Projection is measured from the face of the wall the Colorfalls is installed in

3 VIBRANT COLORS



WALL SPOUTS



73867 (Copper)
73871 (Bronze)

- Wall Spouts are an easy and elegant way to add the sight and sound of water to vertical surfaces
- Atlantic Wall Spouts complement larger spillways when paired; use alone to accent smaller spaces
- Solid brass fixtures add a captivating focal point to both traditional and contemporary walls and patios

ITEM	73867	73871	73869	73873	73870	73875	73868	73872
MODEL	WSCM-S	WSM-S	WSCR-O	WSR-O	WSCV-S	WSV-S	WSCO-O	WSO-O
DESCRIPTION	Mantova Wall Spout		Ravenna Wall Spout		Verona Wall Spout		Olivett Wall Spout	
FINISH	Copper	Bronze	Copper	Bronze	Copper	Bronze	Copper	Bronze
FLOW RATE	600 gph							
PROJECTION*	14" - 16" at 18"H & 600 gph							
INLET	1½" FIPT							
DIMENSIONS	5"W x 4¼"D x 5"H		5"W x 5¼"D x 6"H		7"W x 4¾"D x 7"H		6"W x 4½"D x 5"H	
WARRANTY	3-year							

* Projection is measured from the face of the wall the Spout is mounted on

TECH TIP

Atlantic's unique Spout Lights illuminate the water from inside the plumbing. With 600 gallons per hour or more, the minimum flow required to submerge the light fixture in the plumbing, light is carried inside the laminar water flow.

Page 117



COLOR CHANGING COLORFALLS

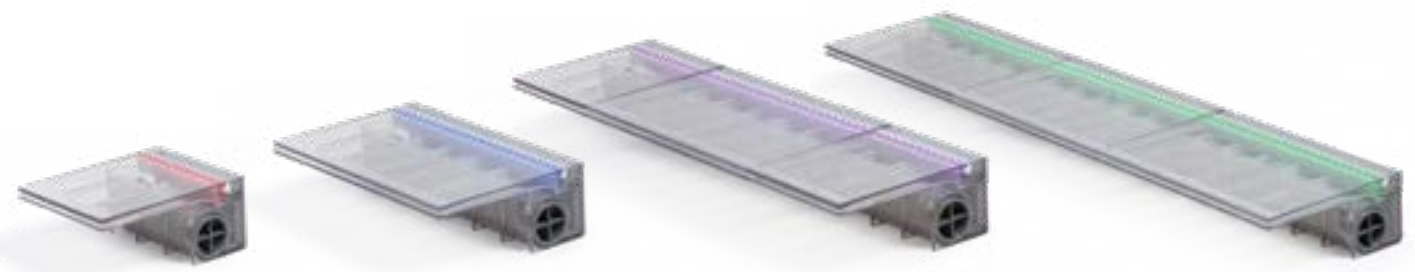

73878 **73879** **73880** **73881**

- Illuminated waterfalls are the most versatile way to add light and water to your landscape or hardscape
- Atlantic's Color Changing Colorfalls are the first modular sheer descent system with multiple light and configuration options
- Design custom colors, select transitions and create personalized sequences with the InfiColor Smart Module and Atlantic Control App
- Unlike other sheer descent waterfalls, Atlantic Color Changing Colorfalls may be linked together to create waterfalls of any width
- Synchronize multiple Colorfalls with InfiColor Smart Module (CCSM30X3) and a larger transformer
- Designed to install easily in any wall, indoors or out, whether stone, brick, block, stucco, tile or wood
- Atlantic's Color Changing Colorfalls' modular body style offers multiple inlets for maximum plumbing flexibility
- Generous weir openings resist clogging and create a thicker, fuller sheer for extra color and less wind deflection
- Colorfalls feature a 5" lip, 20' power cord and includes single outlet InfiColor Smart Module and 12V outdoor transformer
- For use with Formal Spillway Basins and Basin Kits

ITEM	73878	73879	73880	73881
MODEL	CC06	CC12	CC24	CC36
DESCRIPTION	6" Color Changing Colorfalls	12" Color Changing Colorfalls	24" Color Changing Colorfalls	36" Color Changing Colorfalls
FLOW RATE	600 gph	1,200 gph	2,400 gph	3,600 gph
PROJECTION*	8" - 10" at 18"H & 600 gph (Rec. Height: 20" max.)	8" - 10" at 18"H & 1,200 gph (Rec. Height: 20" max.)	8" - 10" at 18"H & 2,400 gph (Rec. Height: 30" max.)	8" - 10" at 18"H & 3,600 gph (Rec. Height: 40" max.)
INPUT VOLTAGE	InfiColor			
TRANSFORMER	10 watt (included)		20 watt (included)	
WATTS	3	5	10	15
INLET	1½" FIPT			
DIMENSIONS	6"W x 8"D x 3½"H	12"W x 8"D x 3½"H	24"W x 8"D x 3½"H	36"W x 8"D x 3½"H
WARRANTY	1-year			

* Projection is measured from the face of the wall the Colorfalls is installed in

COLOR CHANGING COLORFALLS FEATURES:

1. Large weir opening produces a thick sheer for less wind deflection, more color and less chance of clogging.
2. Internal lip supports eliminate splitting of the water sheer.
3. 1½" FIPT inlets on both sides and back for maximum plumbing options and versatility.
4. Includes (2) 1½" plugs for unused plumbing inlets.
5. Self-draining body for easy winterization.
6. Removable baffle for easy cleaning and servicing.
7. Color Changing LED light bar is accessible from the rear of the unit for servicing.
8. Removable back plate provides access to the interior and light bar for routine maintenance.
9. Threaded adapter with silicone O-rings to connect multiple Color Changing Colorfalls.

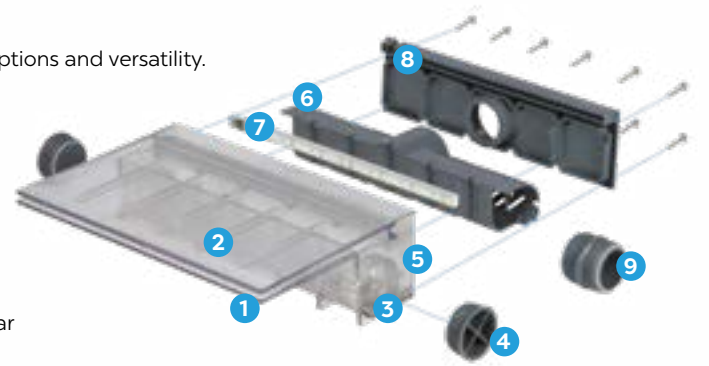

SINGLE-ZONE INFICOLOR SMART MODULE & ATLANTIC CONTROL APP



The InfiColor Smart Module and Atlantic Control mobile application, the heart of the new Color Changing Lighting System, allow users to program custom color sequences and transitions, set sequence timing and daily scheduling and unlock all RGB options on any Apple or Android mobile device.

- Every Color Changing Colorfalls includes Single-zone InfiColor Smart Module
- Smart Module is wirelessly controlled via Atlantic Control App to unlock the full potential of Color Changing Lights, no remote necessary



The Bluetooth® Atlantic Control App makes custom colors, sequences, transitions, timing and daily scheduling of your Atlantic Color Changing Lighting or Color Changing Colorfalls accessible on any Apple and Android mobile device, no remote necessary.

- Choose any color visually or create a custom color with RGB sliders
- Combine and save custom color sequences as Favorites
- Assign one of five transitions and adjust the speed of any Favorite
- Adjust brightness of sequences and solid colors if desired
- Built in timer function controls daily on and off times for LEDs
- Atlantic Control App available on all Apple and Android devices



DID YOU KNOW?

Thinking of adding a Color Changing Colorfalls to a new or existing hardscape? Check out our new Color Changing Colorfalls Project Bundle which includes everything needed to add the basin, plumbing, Colorfalls and even an Auto Fill! You choose the block, we provide the equipment! Page 43



316 STAINLESS STEEL SPILLWAYS



73859

73861

73863

- 316 Stainless Steel Spillways enhance any vertical wall in pools, hardscapes and wherever chlorine is used as a disinfecting agent
- Modular design and convenient 4-inch height make Spillways ideal for garden wall block construction
- Readily adaptable to any vertical wall installation without cutting

- Built of heavy-gauge 316 stainless steel for durability under the harshest conditions
- Structural enclosure supports 80 lbs. per linear foot, for incorporation into masonry walls without lintels
- Non-clogging weir reduces maintenance in open basin applications

ITEM	73859	73861	73863
MODEL	SS12-316	SS24-316	SS36-316
DESCRIPTION	12" 316 Stainless Steel Spillway	24" 316 Stainless Steel Spillway	36" 316 Stainless Steel Spillway
FLOW RATE	1,200 gph	2,400 gph	3,600 gph
PROJECTION*	9" - 10" at 18"H & 1,200 gph	9" - 10" at 18"H & 2,400 gph	9" - 10" at 18"H & 3,600 gph
INLET	1½" FIPT		
DIMENSIONS	12"W x 8½"D x 4"H	24"W x 8½"D x 4"H	36"W x 8½"D x 4"H
WARRANTY	3-year		

* Projection is measured from the face of the wall the Spillway is installed in

TECH TIP

316 Stainless Steel Spillways were specifically designed for use with chlorinated water. 316 stainless is much more resistant to corrosion than 304 stainless steel. Atlantic's 316 Stainless Steel Spillways feature an integrated grounding lug for use in bonded systems.



304 SPILLWAYS



73858

73860

73862



73855

73856

73857

- 304 Stainless Steel Spillways provide an enticing and durable focal point for fresh water applications in the hardscape
- Atlantic's copper finish and brushed stainless Spillways feature heavy-gauge construction for ageless durability
- Spillways replace 4-inch wall blocks for easy and convenient installation in standard wall block construction without cutting

- Lively, energetic water flow enhances any vertical wall installation
- Load bearing body design supports 80 lbs. per linear foot for trouble free installations
- Non-clogging weir reduces maintenance in open basin applications

ITEM	73858	73855	73860	73856	73862	73857
MODEL	SS12	CS12	SS24	CS24	SS36	CS36
DESCRIPTION	12" 304 Stainless Steel Spillway	12" 304 Copper Finish Spillway	24" 304 Stainless Steel Spillway	24" 304 Copper Finish Spillway	36" 304 Stainless Steel Spillway	36" 304 Copper Finish Spillway
FLOW RATE	1,200 gph		2,400 gph		3,600 gph	
PROJECTION*	9" - 10" at 18"H & 1,200 gph		9" - 10" at 18"H & 2,400 gph		9" - 10" at 18"H & 3,600 gph	
INLET	1½" FIPT					
DIMENSIONS	12"W x 8½"D x 4"H		24"W x 8½"D x 4"H		36"W x 8½"D x 4"H	
WARRANTY	3-year					

* Projection is measured from the face of the wall the Spillway is installed in



WATERWALL SPILLWAYS



73877

- Unique back-angled spout directs water downwards and onto wall below plumbing connection, to eliminate leaks, unwanted humidity and splash
- Revolutionary concept of spillway as a decorative focal point eliminates the need for valances
- Heavy-gauge 316 stainless steel construction ensures durability under even the harshest conditions



73876

- Bottom inlet accommodates wood-framed walls with masonry façades up to 1½" thick
- For masonry walls, cut channel in block below water wall to accommodate plumbing
- 1½" female threaded inlet and center rear bonding lug facilitate hidden in-wall plumbing connections

ITEM	73877	73876
MODEL	SWS24-316	CWS24-316
DESCRIPTION	24" Stainless Steel WaterWall Spillway	24" Copper Finish WaterWall Spillway
FINISH	Brushed Stainless	Antique Copper
FLOW RATE	Smooth Surfaces - 750-1500 gph / Rough Surfaces - 1500-3000 gph	
INLET	1½" FIPT	
DIMENSIONS	24"W x 5¼"D x 3½"H	
WARRANTY	3-year	

DID YOU KNOW?

A new concept in water wall design, Atlantic's WaterWall Spillways eliminate the need for valances with an attractive stainless steel or copper finish that can be left visible, simplifying installation. Modular vertical spillways create water walls and weeping walls of any width in 24-inch increments, with seamless water flow between units.



SPLASH RINGS



74973



74226



74974



73864



73865



73866

- Splash control is critical in small recirculating systems with little water volume
- Atlantic Splash Rings eliminate splash and reduce evaporation, prolonging time between fill ups
- Installed on the top of the basin, Splash Rings add a finished, architectural accent to Colorfalls, Wall Spout and Spillway displays

- Surround Splash Rings with decorative gravel for a finished look
- 304 stainless steel mesh and ¾" stainless banding deliver years of service

ITEM	74973	73864	74226	73865	74974	73866
MODEL	CFSR12	CFCR12	CFSR24	CFCR24	CFSR36	CFCR36
DESCRIPTION	Stainless Steel Splash Ring for 12" Spillways	Copper Finish Splash Ring for 12" Spillways	Stainless Steel Splash Ring for 24" Spillways	Copper Finish Splash Ring for 24" Spillways	Stainless Steel Splash Ring for 36" Spillways	Copper Finish Splash Ring for 36" Spillways
FINISH	Brushed Stainless	Antique Copper	Brushed Stainless	Antique Copper	Brushed Stainless	Antique Copper
FOR USE WITH	CFBASIN12		CFBASIN24		CFBASIN36	
DIMENSIONS	16"W x 8"D x 1½"H		28"W x 8"D x 1½"H		40"W x 8½"D x 1½"H	
WARRANTY	3-year					



PROJECT BUNDLES

You provide the hardscape materials, we provide the rest! Atlantic's Project Bundles include all the Atlantic components you need, ready to be assembled into the water feature of your dreams. Build a beautiful Formal Spillway using your choice of stone. Please note products that are included in Project Bundles may not necessarily come in the same box. Online videos make installation easy for contractors and first time builders alike.

COPPER SPILLWAY BOWL PROJECT BUNDLES



FLEX BASIN COLORS



- Project Bundles are an assembly of all Atlantic components needed to add a water feature to a new or existing hardscape
- Copper Spillway Bowl Project Bundles include 26" Copper Spillway Bowl, Flexible Hardscape Basin, pump, plumbing and glue
- Bundles install directly into 4" x 8" x 12" stone enclosures, but adapt to a variety of engineered stone sizes
- Two Copper Bowl styles, round or square, and three Flexible Hardscape Basin colors accommodate various architectural styles
- Project Bundle shows Copper Spillway Bowl at 22" above water level, but plumbing will accommodate varying heights

ITEM	MODEL	COPPER BOWL	BASIN	PUMP	TUBING
87767	BNDL CB26R12B	CB26R12 - 26" Round Copper Bowl w/12" Spillway	FF4216B - Black 4'W x 2'D x 16"H	TT1500	1½" x 9' Sch 40 Flexible PVC
87768	BNDL CB26R12G	CB26R12 - 26" Round Copper Bowl w/12" Spillway	FF4216G - Grey 4'W x 2'D x 16"H	TT1500	1½" x 9' Sch 40 Flexible PVC
87770	BNDL CB26R12T	CB26R12 - 26" Round Copper Bowl w/12" Spillway	FF4216T - Tan 4'W x 2'D x 16"H	TT1500	1½" x 9' Sch 40 Flexible PVC
87771	BNDL CB26S12B	CB26S12 - 26" Square Copper Bowl w/12" Spillway	FF4216B - Black 4'W x 2'D x 16"H	TT1500	1½" x 9' Sch 40 Flexible PVC
87772	BNDL CB26S12G	CB26S12 - 26" Square Copper Bowl w/12" Spillway	FF4216G - Grey 4'W x 2'D x 16"H	TT1500	1½" x 9' Sch 40 Flexible PVC
87773	BNDL CB26S12T	CB26S12 - 26" Square Copper Bowl w/12" Spillway	FF4216T - Tan 4'W x 2'D x 16"H	TT1500	1½" x 9' Sch 40 Flexible PVC

COLOR CHANGING COLORFALLS PROJECT BUNDLES



- Project Bundles are an assembly of all Atlantic components needed to add a water feature to a new or existing hardscape
- Color Changing Colorfalls Project Bundles include Color Changing Colorfalls, Formal Spillway Basin, pump, plumbing and glue
- Project Bundles shown with circle stone and 4" x 8" x 12" stone, but adapt to a variety of engineered stone sizes
- Choose from 3 different spillway widths and basin to fit any location
- Project Bundle shows Color Changing Colorfalls at 16" above basin level, but plumbing will accommodate varying heights

ITEM	MODEL	COLOR CHANGING COLORFALLS	BASIN	PUMP	TUBING
87755	BNDL CC12	12" Color Changing Colorfalls	CFBASINKIT12	TT1500	1½" x 9' Sch 40 Flexible PVC
87756	BNDL CC24	24" Color Changing Colorfalls	CFBASINKIT24	TT3000	1½" x 9' Sch 40 Flexible PVC
87757	BNDL CC36	36" Color Changing Colorfalls	CFBASINKIT36	TT4000	1½" x 9' Sch 40 Flexible PVC

STAINLESS STEEL SPILLWAY PROJECT BUNDLES



FLEX BASIN COLORS



- Project Bundles are an assembly of all Atlantic components needed to add a water feature to a new or existing hardscape
- Spillway Project Bundles include 304 Stainless Steel Spillway, Flexible Hardscape Basin, pump, plumbing and glue
- Bundles install directly into 4" x 8" x 12" stone enclosures, but adapt to a variety of engineered stone sizes
- Two Spillway options, brushed stainless or copper finish, and 3 Flexible Hardscape Basin colors adapt to any design scheme
- Project Bundle shows Spillway at 22" above water level, but plumbing will accommodate varying heights

ITEM	MODEL	SPILLWAY	BASIN	PUMP	TUBING
87762	BNDL SS24B	SS24 - 24" 304 Stainless Steel Spillway	FF4216B - Black 4'W x 2'D x 16"H	TT3000	1½" x 9' Sch 40 Flexible PVC
87763	BNDL SS24G	SS24 - 24" 304 Stainless Steel Spillway	FF4216G - Grey 4'W x 2'D x 16"H	TT3000	1½" x 9' Sch 40 Flexible PVC
87766	BNDL SS24T	SS24 - 24" 304 Stainless Steel Spillway	FF4216T - Tan 4'W x 2'D x 16"H	TT3000	1½" x 9' Sch 40 Flexible PVC
87758	BNDL CS24B	CS24 - 24" Copper Finish Spillway	FF4216B - Black 4'W x 2'D x 16"H	TT3000	1½" x 9' Sch 40 Flexible PVC
87759	BNDL CS24G	CS24 - 24" Copper Finish Spillway	FF4216G - Grey 4'W x 2'D x 16"H	TT3000	1½" x 9' Sch 40 Flexible PVC
87761	BNDL CS24T	CS24 - 24" Copper Finish Spillway	FF4216T - Tan 4'W x 2'D x 16"H	TT3000	1½" x 9' Sch 40 Flexible PVC

PF POND-FREE

Atlantic's Pond-free System makes below ground reservoir construction simpler, easier and more reliable. Sturdy Pump Vaults, Extensions and Eco-Blox create underground reservoirs that are stronger and safer than ever before. Above ground, FastFalls lead the industry with unmatched weight capacities and virtually leak-proof design. Innovative components make Atlantic's family of Pond-free products the best ever built.

- » Strongest water matrix blocks, vaults and spillways in the industry for longevity and peace of mind
- » Modular reservoir system creates water features of any size for the greatest versatility
- » Kits with pre-matched components take the guesswork out of specifying water features
- » FastFalls spillways with rear liner attachment eliminate leaks due to settling
- » Pump Vaults accommodate multiple pumps, plumbing sizes and accessories
- » Eco-Blox interlock to create stacked assemblies for easier installation and deeper reservoirs

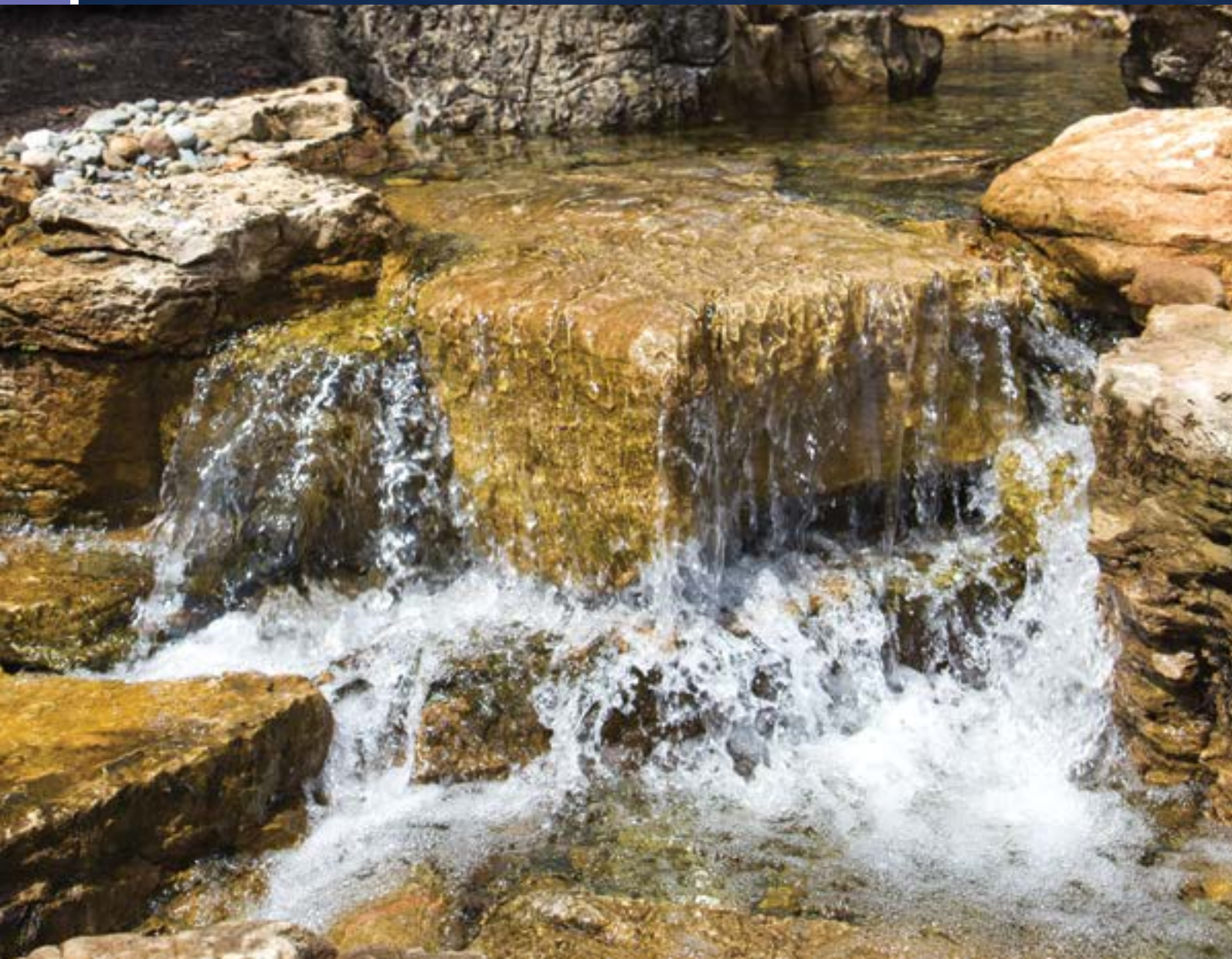

POND-FREE SYSTEM

- 1 FastFalls "inside the liner" design and reinforced spillway lip prevents leaks and retains rock, gravel, soil or mulch to help blend seamlessly with the surrounding landscape.
- 2 One-piece liner flange and molded inserts ensure a watertight liner attachment every time.
- 3 Molded support cones and internal baffles give the FastFalls incredible strength and diffuse the water, ensuring consistent flow across the spillway.
- 4 Heavy-duty, one-piece Pump Vaults offer all the strength and versatility you need, allow for large flow rates and will not bow, bend or break, even under the most extreme conditions.



- 5 Pump Vault Extensions add the height of one Eco-Blox for larger, deeper basins and carry the same strength and durability as Atlantic Pump Vaults.
- 6 Eco-Blox are modular, load-bearing blocks with over 95% void space to store large volumes of water easily and economically, in two sizes for maximum versatility.
- 7 Slide locks allow for quick, tool-free assembly of Eco-Blox that is also more secure and stable than peg-style connections used by the competition.
- 8 Eco-Blox are extremely strong, able to support 7.5 tons and are AASHTO HS-20 compliant for commercial applications.

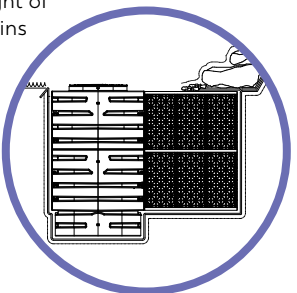

ECO-BLOX



89662

- Water matrix blocks installed in lined excavations create weight-bearing underground water storage reservoirs
- Atlantic's Eco-Blox are the strongest available, locking together to support up to seven tons of distributed load
- Small Eco-Blox, approximately half the size of Eco-Blox offer more design options with less excavation time and effort



74234

- Up to 96% void space, Eco-Blox hold more water in a smaller volume than gravel-filled basins, saving labor, time and money
- Arrange modular blocks in any configuration with any number of layers to accommodate almost any design
- Excellent for bog construction, to create settling chambers below natural plantings of active bog filters

ITEM	MODEL	DESCRIPTION	DIMENSIONS	CAPACITY	FOR USE WITH	APPLICATIONS	WARRANTY
89662	ECOBLOX-SMALL	Eco-Blox Small Water Matrix (Boxed)	27"W x 16"D x 9"H	15½ gallons	PV7500	Pond-free / Fountain	1-year
74234	ECOBLOX	Eco-Blox Water Matrix (Boxed)	27"L x 16"W x 17½"H	31½ gallons	PV15000	Pond-free / Fountain	1-year
74268	ECOBLOX-P	Full Pallet of Eco-Blox (60 - Unboxed)	---	---	---	Pond-free / Fountain	1-year
89664	ECOBLOX8X15	Eco-Blox Panels - 8" x 15" (Pack of 4 - unboxed)	8"L x 15"W x ¾"H	---	---	Pond-free / Fountain	1-year
89666	ECOBLOX8X27	Eco-Blox Panels - 8" x 27" (Pack of 4 - unboxed)	8" x 27" x ¾"H	---	---	Pond-free / Fountain	1-year
74270	ECOBLOX16X15	Eco-Blox Panels - 16" x 15" (Pack of 4 - unboxed)	16½"L x 15"W x ¾"H	---	---	Pond-free / Fountain	1-year
74269	ECOBLOX16X27	Eco-Blox Panels - 16" x 27" (Pack of 4 - unboxed)	27"L x 16"W x ¾"H	---	---	Pond-free / Fountain	1-year

DID YOU KNOW?

You can purchase Eco-Blox in bulk or loose panel configurations to further reduce costs.

For Eco-Blox Small you will need 1 pack #89666 ECOBLOX8X27, 2 packs of #89664 ECOBLOX8X15 and 1 pack of #74269 ECOBLOX16X27. This will build 2 Eco-Blox Small water matrix blocks.

For Eco-Blox you will need 1 pack of #74269 ECOBLOX16X27 and 1 pack #74270 ECOBLOX16X15 to create 1 Eco-Blox water matrix block.

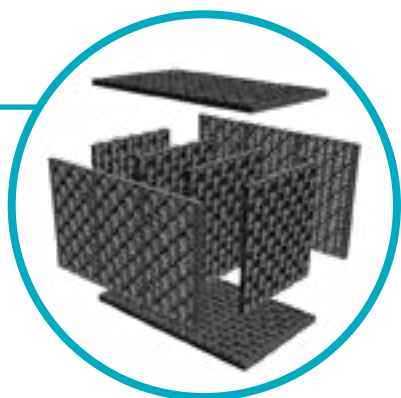

POND-FREE KITS



74250

- Kits come complete, right down to PVC glue, thread sealant and fittings, to eliminate guesswork and material runs, saving you time and money
- Included Warm White LED lighting in Medium & Large Pond-free Kits extend the enjoyment of the water feature into the evening
- Vaults and Spillways are matched to energy efficient pumps to keep operating costs low



92602

- Properly equipped for optimum streambed length and reservoir capacity to ensure your water feature works as designed
- Includes complete installation kit including fittings, thread sealant and PVC glue



92603

ITEM	74250	92602	92603
MODEL	PFK1716	PFK1519	PFK1526
DESCRIPTION	Small Pond-free Kit w/ 16" Spillway	Medium Pond-free Kit w/ 19" Spillway	Large Pond-free Kit w/ 26" Spillway
LINER SIZE	10' x 15'		10' x 20'
FASTFALLS	SP1600	SP1900	SP2600
PUMP VAULT	PV1700	PV15000	
ECO-BLOX	2	3	5
PUMP	TT3000	TT4000	TT5000
FALLSFOAM	LF1100	(2) LF1100	
LIGHTING	---	(2) WWCS2 Spotlights and WW30X4 Transformer & Splitter	
CHECK VALVE	TR215CV		
UNDERLAYMENT	12' x 12'		
AUTO FILL	---	AF1000	
TUBING	1½" x 25'	2" x 25'	
BASIN SIZE	48" x 30" x 18"	54" x 32" x 18"	54" x 48" x 18"
STREAMBED SIZE	16" - 24"W x 6'L	19" - 24"W x 6'L	26" - 32"W x 10'L



PUMP VAULTS



- Pump vaults house and protect the pumps and plumbing of underground water storage and circulation systems
- Atlantic's Pump Vaults occupy the same footprint as Eco-Blox for simplified installation within a rectangular basin
- Vaults are rotomolded of virtually indestructible polyethylene for long, worry-free service
- Extremely strong low profile vault lids fit all sizes, support gravel and foot traffic and can be removed without gravel falling in

- Flat panels accommodate up to 3" plumbing and auto fills
- Either slotted side of Vault handles double the rated flow so one side can be blocked by liner without effecting capacity
- Pump vault extensions increase the height of the vault in deeper, larger basins, with each extension the height of one Eco-Blox
- All Vaults accommodate two or more pumps for versatility
- Remote Pump Vault allows submersible pump location outside of lined reservoir

ITEM	74235	89583	89584	89585	90162
MODEL	PV1700	PV7500	PV15000	PVEXT	PVRI
DESCRIPTION	Pump Vault - 3900 gph	Pump Vault - 7500 gph	Pump Vault - 15000 gph	Pump Vault Extension	Pump Vault - Remote Inline
MAX PUMP FLOW	3,900 gph	7,500 gph	15,000 gph	---	
OPENING	10"	12¼" x 14¾"			
EXTENSION	---		17"		---
DISCHARGE	1½" & 2" step outlets	1½" & 2"	2" & 3"		
FOR USE WITH	#74234 - ECOBLOX	#89662 - ECOBLOX-SMALL	#74234 - ECOBLOX	#89583 - PV7500 & #89584 - PV15000	Remote Inline Pump Applications
DIMENSIONS	17"W x 12"D x 22½"H	27"L x 16"W x 20¾"H	27"L x 16"W x 27"H	27"L x 16"W x 18¾"H	27"L x 16"W x 18¾"H
WARRANTY	Lifetime				

ROCK LIDS



74005

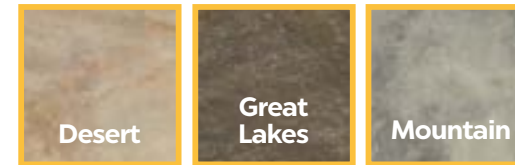

COLORS SHOWN MAY VARY FROM ACTUAL PRODUCT

ITEM	74005	74006	74007
MODEL	RL30D	RL30G	RL30M
DESCRIPTION	Small Rock Lid - Desert	Small Rock Lid - Great Lakes	Small Rock Lid - Mountain
DIMENSIONS	24"L x 24"W x 5"H		
MATCH TO PUMP VAULT	PV7500 / PV15000 / PVEXT / PVRI		
WARRANTY	1-year		

- Rock Lids conceal equipment under natural looking faux stones
- Atlantic's realistic Rock Lids are molded from real stones in three regional colors to complement every application perfectly
- Sturdy fiberglass construction, authentic textures and incredibly real finishes set these Rock Lids apart from plastic covers

PV7500 FEATURES:



1. Inset lid keeps gravel from falling into the vault.
2. Flat panels with drill points on two sides accommodate up to 3" bulkheads and Auto Fills.
3. Vault occupies same footprint as Eco-Blox for compact reservoirs.
4. Two recessed pockets accept up to two Eco-Rise Diverters to power up to six features in an Eco-Rise System. Page 11
5. Pump pocket extends below floor of Eco-Blox Small reservoirs to keep pumps submerged.

PV15000 FEATURES:



1. Large diameter housing provides better access to pump and plumbing.
2. Flat panels with drill points on all four sides accommodate up to 3" bulkheads and Auto Fills.
3. Pump pocket extends below floor of Eco-Blox reservoirs to keep pumps submerged.
4. Vault occupies same footprint as Eco-Blox for compact reservoirs.
5. Inset lid keeps gravel from falling into the vault.
6. Accommodates all 59 Atlantic and OASE pumps

TECH TIP

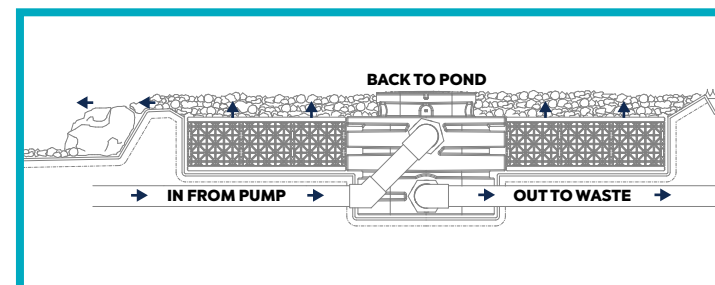

Atlantic's Eco-Blox and Pump Vaults make excellent, easy to maintain bog filters. The Pump Vault functions as both an inlet for incoming water and acts as a cleanout for upflow bogs of any size. Pond water pumped into the Pump Vault passes into the Eco-Blox reservoir, shedding velocity which causes sediment to settle out. Plants set in a thin layer of gravel on top of the Eco-Blox remove fine solids and nitrates. Simply flush the chamber to drain wastes from both Pump Vault and Eco-Blox.



FASTFALLS



74271

74227

74228

74229

- Spillway boxes diffuse incoming water flow to create the starting point of Pond-free streams and falls
- Atlantic FastFalls are designed to make plumbing the top of the waterfall as easy as possible
- Innovative rear liner attachment simplifies installation and eliminates leakage due to settling

- Crush-proof design with internal baffles stabilized by support cones carries the weight of the largest rock and stone
- Reinforced spillway lip retains rock, gravel, mulch or soil and can be planted to blend seamlessly into the surrounding landscape
- FastFalls includes installation kit, male thread adapter and one-piece liner flange

ITEM	74271	74227	74228	74229
MODEL	SP1600	SP1900	SP2600	SP3800
DESCRIPTION	16" FastFalls	19" FastFalls	26" FastFalls	38" FastFalls
WATERFALL WIDTH	16"	19"	26"	38"
INLET	1½" FIPT	2" FIPT		3" FIPT
MAX PUMP FLOW	3,000 gph	4,000 gph	6,000 gph	9,000 gph
DIMENSIONS	16½"W x 9½"D x 7¼"H	20½"W x 17"D x 10¼"H	27½"W x 17"D x 10¼"H	39½"W x 17"D x 10¼"H
WARRANTY	Lifetime			

DID YOU KNOW?

Did you know there is a FastFalls hiding in this photo? Although the FastFalls can support the heaviest rock and stone, it was also designed to retain soil, gravel and mulch perfectly. For the most natural looking camouflage possible, plant ground covers or low growing perennials directly into the pockets on top of the FastFalls to blend the FastFalls seamlessly with the surrounding landscape.



SP1600 FEATURES:



74271 Shown

1. Internal baffle diffuses the water for an even flow across the spillway.
2. Raised front radius retains natural camouflage.
3. One-piece design eliminates any chance of leaks due to 'over pumping'.
4. Pre-installed 1½" Spinweld® fitting simplifies plumbing connection.
5. One-piece liner flange and molded inserts ensure a secure liner attachment.

SP1900 / SP2600 / SP3800 FEATURES:

1. Molded support cones give the FastFalls incredible strength and help diffuse the water flow.
2. Two internal baffles slow down the water's velocity and ensure even water distribution across the spillway.
3. Raised front radius holds back any loose gravel, soil or mulch used to camouflage the top of the unit.
4. FastFalls are completely sealed except for the spillway opening. This design eliminates any chance of leakage due to 'over pumping'.
5. Molded gussets support the spillway lip.
6. FastFalls come with an installed 2" or 3" FIPT Spinweld® fitting.
7. One-piece liner flange and molded inserts ensure a watertight liner attachment every time.



74228 shown

DID YOU KNOW?

When we say you don't have to worry about crushing, cracking or breaking your FastFalls, we mean it! Set your large boulders right on top to camouflage these spillways without a second thought - we test them with a 33,000 lb. Caterpillar 928F Wheel Loader. Now, that's strong!



WATER GARDEN

Atlantic-Oase offers a complete solution for every pond builder. Full-featured Skimmers and FilterFalls remove floating debris and suspended solids with minimal maintenance. In-pond and pressure filters clear fish waste, toxins and particulates from small to medium ponds. Advanced ScreenMatic² and ProfiClear filters handle the heaviest fish loads and clean themselves. Select custom accessories or choose a Pond Kit that comes with all the equipment, liner and plumbing you'll need to complete any project.

- » Full range of Skimmers, FilterFalls and Filters for every size water garden
- » Crush-proof Skimmers and FilterFalls with lifetime warranties eliminate concerns of warping and deformation in the ground
- » Upflow, gravity flow and pressurized filtration options accommodate any fish stocking levels
- » Kits containing everything needed for a complete installation save you time and money
- » A complete line of accessories to complement and enhance your water garden allows for full customization



- 1 Skimmers feature Super Flow weir doors, stainless steel hardware and a heavy-duty rotomolded shell for the ultimate in durability backed by a lifetime warranty.
- 2 Large stainless steel-framed nets and stainless/nylon filter brush panels or Matala matting in Skimmers provide excellent pre-filtration and accept Matala cartridge upgrades.
- 3 Large pump chambers capable of housing multiple pumps provide the versatility to improve energy efficiency by using two smaller pumps instead of one large one.
- 4 Optional installation accessories such as the Triton Ionizer, Bottom Drain Kit and Auto Fill Kit allow you to keep your pond clean while reducing maintenance at the same time.

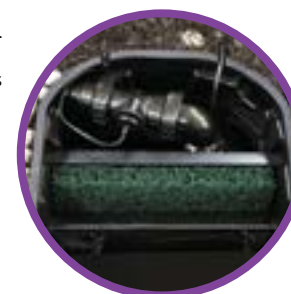
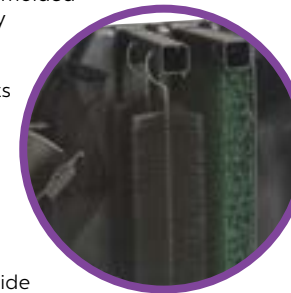

- 5 Atlantic's flexible PVC piping, geotextile underlayment and EPDM liner are all proudly made in the United States to the highest quality standards.
- 6 Heavy-duty rotomolded polyethylene FilterFalls feature stainless steel hardware, molded inserts and solid lips for watertight liner attachment and lifelong durability.
- 7 Sturdy support bars and top grates support the weight of natural rock camouflage and prevent crushing or warping from the surrounding soil.
- 8 Oversized interior volumes provide tremendous filtration capacity out of the box, expandable with any combination of Matala Mat Kits, Bio-Balls, Bio-Rocks and Bio-Tech media for custom filtration options.

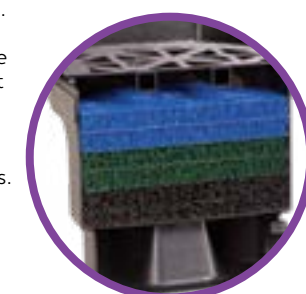

ANATOMY OF A RECREATIONAL POND

Recreational Ponds are nature-based engineered solutions that deliver safe, crystal clear water without chemicals. Safe 12-volt pumps pull water through multiple filtration modules set outside the pond, then to planted gravel Regeneration Zones that biologically filter the water in a natural way. Combine with low voltage lighting for the ultimate chemical-free experience!

1. SKIMMERS

Combination of liner-mounted and specialty Skimmers designed for regeneration zones pull water into filtration system from multiple areas to clear surface debris effectively.



ProfiSkim

Skimmers

2. FILTRATION

Gravity-fed filtration cleans and polishes water from skimmers and other inlets with a combination of mechanical, biological and UVC filtration. Filters are located below water level for easy concealment and are self cleaning for low maintenance.



ProfiClear Compact - Pump-fed & Gravity-fed

Bitron C

FiltoClear

Individual Module & Floating Bed Module

7. WATER FEATURES

Easily add the charm of falling water with FastFalls or an Aura Vase. Create captivating effects with modern and safe 12-volt Water Entertainment systems.



FastFalls



Water Entertainment



3. PUMPS

12-volt pumps located inside or outside the pond in a remote vault or Individual Module remove line voltage from direct contact with pond water to guarantee safety, perfect for use in recreational ponds



AquaMax Eco Expert 12V



AquaMax Eco Premium 12V

6. LIGHTING

Add color lighting effects above or below water safely with low voltage ProfiLux Lighting and easy-to-hide submersible transformer.



Hammered Brass Bowls & Aura Vases



ProfiLux Garden LED RGB Lights

5. CONTROL SYSTEM

The Oase Control System manages the pump, filter system and lighting in a recreational pond all from your smart device.



Garden Cloud Controller

4. REGENERATION ZONES

Regeneration zones return water through planting beds that provide natural biological filtration and even water distribution.



Eco-Blox Small



Pump Vault



FILTRAL UVC



- All-in-one in-pond filters integrate pump and filtration with a decorative element
- Oase Filtral UVC combines mechanical, biological and Ultraviolet filtration with multiple nozzles and aeration (800 & 1600 only) to keep small ponds clear
- Easy open clips allow quick access to filter foam, ceramic and bio-media that nurture beneficial bacteria, without dismantling the nozzle assembly
- Pivoting telescoping nozzle extends 5", while built-in flow control and diverter valve can run an optional small secondary water feature using the included stepped hose adapter
- Integrated grounding plate protects entire water feature with unparalleled safety while viewing port allows safe visual confirmation of proper UVC operation
- The aeration nozzle greatly increases gas diffusion and circulation (800 & 1600 only)

ITEM	76004	76005	76006
DESCRIPTION	Filtral UVC 400	Filtral UVC 800	Filtral UVC 1600
VOLTS		120	
WATTS	20	22	50
UVC	5W	9W	13W
MAX HEAD		4'	6'
MAX DEPTH	24" (for nozzle display)	25" (for nozzle display)	26" (for nozzle display)
CORD LENGTH		15'	
DIMENSIONS	8"L x 9"W x 5"H	10½"L x 9½"W x 5½"H	13½"L x 11"W x 6"H
HOSE SIZE		½", ¾", 1"	
POND VOLUME	up to 400 gal	up to 800 gal	up to 1,600 gal
WARRANTY		2-year	

CLEAR WATER GUARANTEE					
FISH LOAD			FILTER	UVC	PUMP
LIGHT	MEDIUM	HEAVY			
<400 gal	<200 gal	-	Filtral UVC 400	5W (included)	195 gph included
<800 gal	<400 gal	-	Filtral UVC 800	9W (included)	235 gph included
<1,600 gal	<800 gal	-	Filtral UVC 1600	13W (included)	410 gph included

NOZZLE PATTERNS				
ITEM	MAX FLOW (GPH)	LAVA	VULKAN	MAGMA
76004	195	8"W	24"W x 26"H	14"W x 14"H
76005	235	16"W	35"W x 43"H	39"W x 43"H
76006	410	16"W	40"W x 40"H	40"W x 40"H



BIOPRESS



45451

40348

45452

- In-line pressure filters offer biological and mechanical filtration that can be located remotely
- Oase BioPress filters combine mechanical and biological filtration with ultraviolet light to keep water features clear
- Monitor UVC, filter performance and pollutant level, even clean foams with cleaning handle without removing cover, simplifying maintenance
- Bury canister to the quick release clamps and use the Oase FiltoCap (not included, page 59) to completely conceal the filter
- Moving bed bio-media offers additional surface area for beneficial bacteria (1600 and 2400 only)

ITEM	45451	40348	45452
DESCRIPTION	BioPress 1000	BioPress 1600	BioPress 2400
UVC	7W	9W	
MAX FLOW	1,050 gph	2,000 gph	2,120 gph
MAX PRESSURE	2.9 psi / 7' of head		
MAX PUMP INPUT PRESSURE	7.25 psi / 17' of head (Max pump shut off 17')		
CORD LENGTH	10'		
DIMENSIONS	9"W x 13¼"H	14"W x 17¾"H	14"W x 22½"H
HOSE SIZE	¾" - 1½"		
POND VOLUME	up to 1,000 gal	up to 1,600 gal	up to 2,400 gal
INCLUDES	2 types of filter foams, bio-media (1600 & 2400), UVC, metric step fittings		
WARRANTY	2-year		

CLEAR WATER GUARANTEE					
FISH LOAD			FILTER	UVC	PUMP
LIGHT	MEDIUM	HEAVY			
<1,000 gal	<500 gal	<250 gal	BioPress 1000	7W (included)	AquaMax Eco Classic 1200
<1,600 gal	<800 gal	<400 gal	BioPress 1600	9W (included)	AquaMax Eco Classic 1900 AquaMax Eco Premium 2500
<2,400 gal	<1,200 gal	<600 gal	BioPress 2400	9W (included)	AquaMax Eco Classic 2700 AquaMax Eco Premium 3500



FILTOCLEAR



- In-line pressure filters offer biological and mechanical filtration that can be located remotely
- Oase 3rd generation FiltoClear provides mechanical and biological filtration with ultraviolet clarification (UVC)
- Compact, high-capacity filter is perfect for Fountain, Formal Spillway, Pond-free and Water Garden applications
- The high quality, impact resistant body can be buried to the clamping ring
- 3 densities of replaceable filter foams, new plates and extra supports improve cleaning function and ensure long service life

- Patented UVC Cleaning Rotor keeps quartz glass clean for better transmission of UV light (FiltoClear 5200 & 8200 only)
- 2-way valve backflushes filter and directs waste with Easy-Clean Technology, no need to open filter or remove the cover
- Monitor UVC, filter performance and pollutant level and change UV lamp all without opening filter
- Newly developed bypass technology ensures constant water flow and prevents the filter from becoming clogged.

ITEM	91669	91670	91671
DESCRIPTION	FiltoClear 3400	FiltoClear 5200	FiltoClear 8200
UVC	24W	42W	60W
MAX FLOW	2,400 gph	3,450 gph	4,500 gph
MAX PRESSURE	2.9 psi / 7' of head		
MAX PUMP INPUT PRESSURE	7.25 psi / 17' of head (Max pump shut off 17')		
CORD LENGTH	16'		
DIMENSIONS	15"W x 19¼"H	15"W x 24"H	15"W x 28¾"H
HOSE SIZE	1½", 2"		
POND VOLUME	up to 3,400 gal	up to 5,200 gal	up to 8,200 gal
INCLUDES	3 types of filter foams, UVC, metric step fittings, 1½" / 2" Sch40 adapter		
WARRANTY	2-year		

FILTOCLEAR FEATURES:

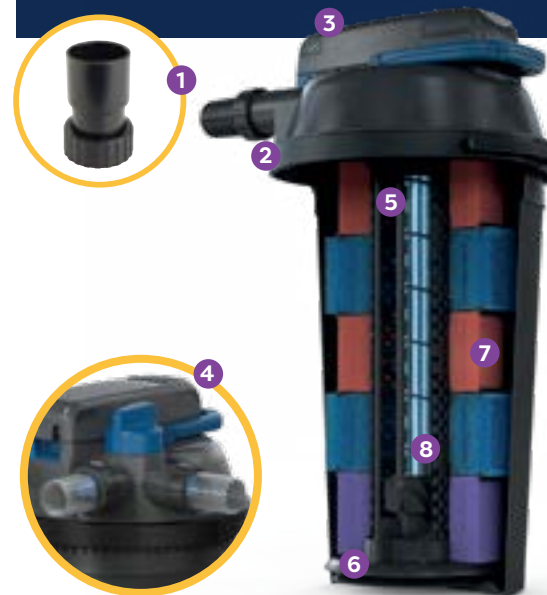

1. Metric step barbs and 1½" / 2" Sch 40 adapter fittings for both 1½" and 2" flexible and rigid PVC
2. Canister can be buried up to metal clamping ring with simple lever and safety lock
3. Sleek high powered ballast housing with high visibility power indicator
4. 2-way, quarter turn valve simplifies cleaning and backwash
5. High power UVC bulb is replaceable without turning off pump or removing quartz glass sleeve
6. Handle, foam plate and sponge supports work together for faster, more effective cleaning
7. Three foam densities, 10, 20 & 30 pores per inch (ppi), support removal of ammonium, nitrites and nitrates
8. Cleaning Rotor spins to minimize debris build up on UVC quartz sleeve (5200 & 8200 only)

CLEAR WATER GUARANTEE

FISH LOAD			FILTER	UVC	PUMP
LIGHT	MEDIUM	HEAVY			
<3400 gal	<1700 gal	<850 gal	FiltoClear 3400	24W (included)	AquaMax Eco Classic 1900 AquaMax Eco Premium 2500
<5200 gal	<2600 gal	<1300 gal	FiltoClear 5200	42W (included)	AquaMax Eco Classic 2700 AquaMax Eco Premium 3500
<8200 gal	<4100 gal	<2050 gal	FiltoClear 8200	60W (included)	AquaMax Eco Classic 3600 AquaMax Eco Premium 4500

FILTOCAP



ITEM	91645
DESCRIPTION	FiltoCap - Stone Grey
FOR USE WITH	3rd Gen FiltoClears & BioPress
WARRANTY	1-year

- Rock Lids are lightweight alternatives to natural rock for concealing equipment
- FiltoCap conceals all partially buried BioPress and FiltoClear filters
- Textured, molded urethane foam creates a lightweight, natural-looking rock cover
- Stone grey and neutral sand colors blend well into any landscape

DID YOU KNOW?



Oase pressure filters can be used with multiple Atlantic Systems! Add extra filtration to your Formal Spillway Hardscape Basin or your Pond-free waterfall. Just add a tee and ball valve to divert partial water flow to the FiltoClear and add a return line to your water feature.



SKIMMERS



74038



74039



74040



74041



74037



- Skimmers house and protect your pumps and plumbing while clearing surface debris from the pond
- Atlantic's Pond Skimmers offer more size and filtration options and greater strength and versatility
- All Skimmers excluding PS3000 accept two pumps for increased flow, lower operating costs and multiple spillway options
- Multiple filtration options including net, mats and brushes let you customize to fit every water garden

- Reinforced structures eliminate warping, deformation and callbacks
- Faceplate hardware is black anodized stainless steel for maximum concealment and longevity
- Multiple plumbing, check valve and ionizer options make these Skimmers the most versatile on the market
- PS3000 Satellite Skimmer plumbs to a larger Skimmer (PS7000/PS15000) to draw water from hard to reach areas, plumb directly to an AquaMax Eco Premium Pump, installed inside the liner

ITEM	74038	74039	74040	74041	74037
MODEL	PS3000	PS3900	PS4600	PS7000	PS15000
DESCRIPTION	Satellite Skimmer	Skimmer - 6" weir	Skimmer - 6" weir	Skimmer - 9" weir	Skimmer - 15" weir
WEIR WIDTH	6"			9"	14"
INTERNAL WATER DEPTH	21"	14½"	15½"	17½"	24½"
DIMENSIONS	13"W x 13"D x 25"H	17¼"W x 19½"D x 19½"H	19½"W x 26"D x 22"H	25"W x 30"D x 24"H	28"W x 33"D x 31"H
MAX PUMP FLOW	3,000 gph	3,900 gph	4,000 gph	7,000 gph	15,000 gph
SQ. FT. RATING	200	200	400	900	1400
FILTERING	Net	Net, Matala Mat	Net, Brush Panel		
MATCH TO	PS7000 / PS15000	BF1600	BF1900	BF2600	BF3800
WARRANTY	Lifetime (enclosure)				



PS3900 FEATURES:

1. Sturdy removable lid supports natural rock camouflage and foot traffic.
2. Support bar for added strength.
3. Stainless steel-framed trap net and Matala filter mat provide mechanical filtration.
4. Designed to enhance structural rigidity.
5. Rolled upper rim provides clean lines and incredible strength.
6. Cut-off step outlets for 1½" and 2" pipe provided on both sides of the skimmer.
7. Super Flow weir door to maximize skimming efficiency.
8. Labeled drill points for the installation of Auto Fill and overflow. (not shown)

PS4600 / PS7000 / PS15000 FEATURES:

1. Sturdy removable top lid supports natural rock camouflage and foot traffic.
2. Heavy-duty brush panel provides maximum surface area for mechanical filtration.
3. Heavy-duty stainless steel framed trap net for catching large debris.
4. Rolled upper rim provides clean lines and great strength.
5. Super Flow weir door to maximize skimming efficiency.
6. Ribbed design enhances structural rigidity and strength.



PS7000 shown

ROCK LIDS



74005 Desert (shown)
74006 Great Lakes
74007 Mountain



74009 Desert
74010 Great Lakes
74011 Mountain (shown)



74013 Desert
74014 Great Lakes (shown)
74015 Mountain

- Rock Lids cover Skimmers completely to attractively conceal them in the water garden
- Three sizes and three regional colors ensure the perfect fit for every application (color may vary on actual product)
- Molded from real stones, the sturdy fiberglass construction, authentic textures and incredibly real finishes set these Rock Lids apart
- Rock Lids can also be used to hide and protect Pump Vaults, FilterFalls and other equipment

ITEM	74005	74006	74007	74009	74010	74011	74013	74014	74015
MODEL	RL30D	RL30G	RL30M	RL40D	RL40G	RL40M	RL70D	RL70G	RL70M
DESCRIPTION	Small Rock Lid			Medium Rock Lid			Large Rock Lid		
COLOR	Desert	Great Lakes	Mountain	Desert	Great Lakes	Mountain	Desert	Great Lakes	Mountain
DIMENSIONS	24"L x 24"W x 5"H			34"L x 24"W x 5"H			40"L x 36"W x 10"H		
MATCH TO SKIMMER	PS3900			PS4600			PS7000 / PS15000		
WARRANTY	1-year								



SWIMSKIM

SWIMSKIM



ITEM	50040
DESCRIPTION	SwimSkim
WATTS	40
MAX FLOW	580 GPH
CORD LENGTH	15'
DIMENSIONS	13"L x 12"W x 10"H
SQ. FT. RATING	270
INCLUDES	2 high-density filter foams, integrated pump, and debris basket
WARRANTY	1-year

- In-pond skimmers remove surface debris before it can settle to the bottom of the pond
- Oase SwimSkim with integrated pump floats on the surface, drawing debris into removable basket using patented flap technology that increases surface tension
- Easy to use right out of the box, plug in and add to your pond

- Integrated aerator oxygenates your pond while skimming
- Versatile skimmer adapts to any pond or water feature at least 12" deep and skims up to 270 square feet



DID YOU KNOW?

SwimSkim, AquaSkim and ProfiSkim baskets can be easily reached for emptying up to eight feet away with the versatile telescoping Oase EasyPick premium pond pliers, page 137

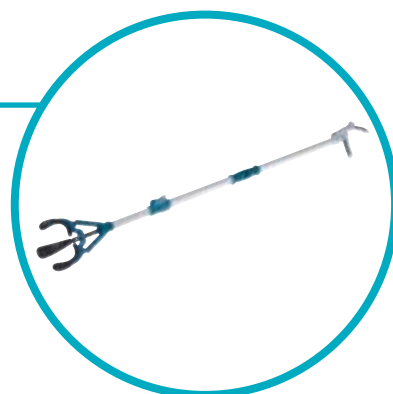

AQUASKIM40 & AQUASKIM GRAVITY



57395



- Floor mounted in-pond skimmers remove leaves and floating debris from water features
- Oase AquaSkim can be easily added to any new or existing water feature
- Telescopic design accommodates reservoir depths from 19" to 36" without modification, and as little as 11" by trimming support tube
- Float ring automatically adjusts to fluctuations in pond level up to 6"
- Easy to clean debris basket can be retrieved without entering pond
- Add stones to wide base to stabilize the unit
- Ideal for use with the adjustable secondary inlet of AquaMax Eco Premium pumps (see chart below)

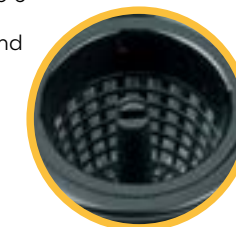

AQUAMAX PREMIUM PUMP MODEL	AQUAMAX PREMIUM SECONDARY INLET SETTING				
	0	1	2	3	4
2000	-	-	-	•	•
3000	-	-	•	•	•
4000	-	•	•	•	•



89198



- Skimmers pull debris off the surface of the pond before it can sink to the bottom
- Oase AquaSkim Gravity is designed to mount on the wall of recreational ponds
- AquaSkim Gravity connects directly to gravity-fed system intake
- Keeps up to 430 sq. ft. of water surface clear of debris
- Large, easy to clean basket with 48 oz. capacity and grip loop
- Maximum water level variation of 4¾"

ITEM	57395	89198
DESCRIPTION	AquaSkim40	AquaSkim Gravity
OUTLET	1" - 1½"	4" (DN 110)
MIN FLOW	1,600 gph	2,110 gph
MAX FLOW	4,200 gph	5,285 gph gravity-fed
DIMENSIONS	14"W x 32"H	30¾"L x 23"W x 13¾"H
BASKET VOLUME	38 oz.	48 oz.
INCLUDES	Sch40 adapter & metric kink-free hose adapter	DN 110 adapter (Sch35 4")
WARRANTY	2-year	5-year



PROFISKIM 100



ITEM	89197
DESCRIPTION	ProfiSkim 100
OUTLET	DN 110 - requires 4" rubber coupling (not included)
MIN FLOW	2,650 gph
MAX FLOW	3,170 gph gravity-fed / 5,300 gph pump-fed
DIMENSIONS	30 3/4"L x 23"W x 13 3/4"H
BASKET VOLUME	73 in ³ / 3 gal
INCLUDES	2" x 4" (DN 110) adapter
WARRANTY	5-year

- Skimmers pull debris off the surface of the pond before it can sink to the bottom
- Oase ProfiSkim low profile body is ideal for shallow water or regeneration zones from 14" to 21" in depth
- Can clean up to 860 sq. ft. of surface area

- Included adapter allows for use with pump-fed and gravity-fed systems
- Large, easy-to-clean stainless steel basket with 8mm mesh

DID YOU KNOW?

The ProfiSkim 100 is the perfect choice for the recreational pond because of its huge volume and low profile. Regeneration zones planted with aquatic plants are typically 18" deep or less and generate a surprising amount of floating surface debris, like leaves or flowers. The ProfiSkim effectively clears these areas before debris can sink and its huge 3 gallon capacity allows more time between cleanings without compromising flow.



BIOSMART



56929



- Flow through bio-mechanical filters clean and clear pond water which returns to the pond by gravity
- Oase BioSmart filters strip water of debris, ammonia and nitrites with three levels of foam filtration housing beneficial bacteria
- Cleaning indicator alerts when to pull up on the cleaning handles to squeeze debris from the foams, no need to remove or manually clean them
- Attach a hose to the Gardena-style fitting and open the sludge valve to finish cleaning and rinsing filter quickly and easily



56930



- With built-in thermometer, Venturi inlets for optional aeration and pre-drilled UVC attachment inlets to optimize water quality and clarity
- Add an optional Vitronic UVC to qualify for the Clear Water Guarantee

ITEM	56929	56930
DESCRIPTION	BioSmart 5000	BioSmart 10000
OUTLET	2 1/2" / 3" (adapter)	
MAX FLOW	1,450 gph	2,110 gph
DRAIN SIZE	2"	
DIMENSIONS	22"L x 22"W x 16"H	30"L x 22"W x 16"H
HOSE SIZE	3/4", 1", 1 1/4", 1 1/2"	
POND VOLUME	up to 5,000 gal	up to 10,000 gal
INCLUDES	Filter foams, 3" Sch40 outlet adapter, metric step fittings (3/4", 1", 1 1/2")	
WARRANTY	3-year	

CLEAR WATER GUARANTEE					
FISH LOAD			FILTER	UVC	PUMP
LIGHT	MEDIUM	HEAVY			
<5,000 gal	<2,500 gal	<1,250 gal	BioSmart 5000	Vitronic 18	AquaMax Eco Classic 1900 AquaMax Eco Premium 2500
<10,000 gal	<5,000 gal	<2,500 gal	BioSmart 10000	Vitronic 36	AquaMax Eco Classic 2700 AquaMax Eco Premium 3500 AquaMax Eco Premium 3000 12V





BIOTEC SCREENMATIC²



42975



44120



93036

- Flow through filters with biological and mechanical filtration clean and clear pond water which flows back down to the pond by gravity
- Oase BioTec ScreenMatic² automatically separates debris using the self-cleaning screen, depositing coarse debris into the removable tray
- Adjustable intelligent cleaning sensor mounted above screen detects buildup of debris and automatically empties screen into debris tray
- High efficiency filter system features 3 different densities of foam harboring a variety of beneficial bacteria that remove harmful ammonia and nitrites
- Double-sealed screen motor and reinforced screen material ensure an extended service life

- Foam distribution and optimized water level in the container to provide longer filter service life, improved filtration and reduced maintenance
- Filter foams clean directly inside the filter in pond water to preserve beneficial bacteria colonies and reduce water waste
- Slide valve on sludge drain removes sludge and dirty water with minimal mess
- Add an optional Bitron C UVC clarifier to any ScreenMatic² filter system for enhanced clarity and cleaner water, page 75

ITEM	42975	44120	93036
DESCRIPTION	BioTec ScreenMatic ² 18000	BioTec ScreenMatic ² 24000	BioTec ScreenMatic ² 39000
VOLTS	120		
WATTS	5		
OUTLET	3" adapter	DN 110 - requires 4" rubber coupling (not included)	
MIN FLOW	1,585 gph	2,110 gph	
MAX FLOW	2,900 gph	3,300 gph	4,620 gph
CORD LENGTH	6' + 16'		
DIMENSIONS	31"L x 23"W x 21½"H	31"L x 23"W x 25½"H	52½"L x 25"W x 33"H
HOSE SIZE	1", 1¼", 1½"		1", 1¼", 1½", 2"
POND VOLUME	up to 18,000 gal	up to 24,000 gal	up to 39,000 gal
INCLUDES	2 blue filter foams, 3 purple filter foams, 3 red filter foams, 3 phosless filters	4 blue filter foams, 6 purple filter foams, 6 red filter foams, 4 phosless filters	4 blue filter foams, 7 purple filter foams, 7 red filter foams, 12 phosless filters
WARRANTY	2-year + 1		

BIOTEC SCREENMATIC² FEATURES:



1. Intelligent cleaning sensor senses debris and activates cleaning screen
2. Manual belt run button for manual operation of cleaning screen
3. LED indicates status of cleaning bar and screen
4. Rubberized separator lip scrapes debris off screen and into tray
5. Removable sludge tray for easy maintenance
6. Built-in overflow holes keeps filter operational even when sludge tray is full
7. Sludge drain with integrated slide valve removes sludge and dirty water from system
8. Optimized water distributor evenly disperses water flow over screen
9. Three densities of foam harbor beneficial bacteria to remove ammonia and nitrite, while Phosless cartridges remove algae-stimulating phosphorus
10. Storm-safe fastening clips lock down filter lids (BioTecScreenMatic² 18000 and 24000 only)

CLEAR WATER GUARANTEE					
FISH LOAD			FILTER	UVC	PUMP
LIGHT	MEDIUM	HEAVY			
<18,000 gal	<9,000 gal	<4,500 gal	BioTec ScreenMatic ² 18000	Bitron C 55	AquaMax Eco Classic 3600 AquaMax Eco Premium 4500 AquaMax Eco Premium 3000 12V
<24,000 gal	<12,000 gal	<6,000 gal	BioTec ScreenMatic ² 24000	Bitron C 55 / Bitron C 110	AquaMax Eco Classic 3600 AquaMax Eco Premium 4500 AquaMax Eco Premium 3000 12V
<39,000 gal	<19,500 gal	<9,750 gal	BioTec ScreenMatic ² 39000	Bitron C 110	AquaMax Eco Premium 4500 / 5500 AquaMax Eco Expert 6800* AquaMax Eco Expert 5300 12V AquaMax Eco Expert 7100 12V*

*Must adjust flow down to max flow of filter



DID YOU KNOW?

Although flow through filtration has to be above water level, they are easier to hide than you might think. BioTec ScreenMatic² can be remotely located in sheds, behind walls, plantings or decorative screens wherever an electric source is easily accessible.



PROFICLEAR PREMIUM COMPACT PUMP-FED



72374



73379

- Drum filters utilize a rotating screen to remove debris and moving bed filtration to strip ammonia and nitrites from the water
- Oase ProfiClear Premium is a fully automatic pump-fed, flow-through self-cleaning drum filter that polishes water
- Moving Bed System with Hel-X Bio-media processes a minimum of 10 oz. of food waste per day and can be upgraded
- Micro control system offers a choice of manual cleaning, time interval cleaning or full automatic cleaning via sensor
- Digital temperature display provides accurate water temperatures for seasonal maintenance
- Connections for Bitron C UVC and AquaOxy 450 to enhance filtration and aeration (sold separately, page 75 & 132)
- Fully control your ProfiClear Compact with the Oase Control App from anywhere in the world (sold separately)

ITEM	72374	73379
DESCRIPTION	ProfiClear Premium Compact-M Pump-fed	ProfiClear Premium Compact-L Pump-fed
VOLTS	120	
WATTS	5 / 870 (cleaning)	5 / 1150 (cleaning)
INLET	2" & Bitron Dual Inlets	
OUTLET	DN 110 - requires 4" rubber coupling (not included)	(2) DN 110 - requires 4" rubber coupling (not included)
WASTE DISCHARGE OUTLET	4"	
MIN FLOW	2,000 gph	2,640 gph
MAX FLOW	4,000 gph	5,280 gph
COARSE DEBRIS EXTRACTION	80 microns	60 microns
CLEANING PUMP	58 psi	87 psi
CORD LENGTH	16' + 3'	
DIMENSIONS	35"L x 27"W x 32"H	53"L x 35½"W x 32½"H
POND VOLUME	up to 21,000 gal	up to 31,500 gal
INCLUDES	40 liters Hel-X Bio-media	60 liters Hel-X Bio-media
WARRANTY	2-year + 1	

PROFICLEAR PREMIUM PUMP-FED FEATURES:



1. Dual inlets accommodate optional Bitron C UVC Clarifier
2. Secondary inlet accommodates 2" pipe for non-UVC equipped installations
3. Microcontroller with digital thermometer automates cleaning functions and can be connected to an EGC system
4. Made from German engineered GFK Duroplast for enhanced structural integrity
5. Drain with integrated slide valve clears sludge as needed
6. Drum filter with removable micro sieve that can be upgraded to finer 60 micron screen and manually cleaned if needed
7. Spray bar removes fine particles from micro sieve
8. Hel-X floating bed Bio-media may be supplemented with 20 additional liters of Hel-X Bio-media
9. Discharge returns clean water to pond
10. Dirty water discharge 4" outlet

OASE CONTROL

Connect your ProfiClear Premium to the Oase Control System to fully control the filter from anywhere in the world on any Android or Apple Device with Oase Control mobile application. See page 124 for more information on the Garden Cloud Controller.

The Oase Control App can display and control a variety of functions including:

- Operational status
- Filtration cycles
- Water Temperature
- Cleaning time
- Interval time
- Manual cleaning
- Overall performance data
- Comparison charts with data collected over time



CLEAR WATER GUARANTEE					
FISH LOAD			FILTER	UVC	PUMP
LIGHT	MEDIUM	HEAVY			
<21,000 gal	<10,500 gal	<5,250 gal	ProfiClear Premium Compact-M Pump-fed	Bitron C 110	AquaMax Eco Classic 3600 AquaMax Eco Premium 4500 AquaMax Eco Expert 6800* AquaMax Eco Expert 5300 12V
<31,500 gal	<15,750 gal	<7,875 gal	ProfiClear Premium Compact-L Pump-fed	Bitron C 110	AquaMax Eco Premium 4500 / 5500 AquaMax Eco Expert 6800* AquaMax Eco Expert 5300 12V AquaMax Eco Expert 7100 12V*

*Must adjust flow down to max flow of filter



DID YOU KNOW?

The ProfiClear Premium filters use a high pressure pump to keep the tiny perforations in the sieve clean automatically. The powerful pump draws significant wattage during operation, but only operates a fraction of the time to keep total electrical usage minimal. When the pump is not running, the filter only uses 5 watts of electricity.



PROFICLEAR PREMIUM COMPACT GRAVITY-FED



ITEM	89194
DESCRIPTION	ProfiClear Premium Compact-L Gravity-fed
VOLTS	120
WATTS	5 / 1150 (cleaning)
INLET	(3) DN 110 - requires 4" rubber coupling (not included)
OUTLET	DN 110 - requires 4" rubber coupling (not included)
WASTE DISCHARGE OUTLET	4"
MIN FLOW	2,640 gph
MAX FLOW	6,600 gph
COARSE DEBRIS EXTRACTION	60 microns
CLEANING PUMP	87 psi
CORD LENGTH	16' + 16'
DIMENSIONS	53"L x 35½"W x 32½"H
POND VOLUME	up to 37,000 gal
REQUIRES	#89195 - Individual Module
INCLUDES	60 liters Hel-X Bio-media
WARRANTY	2-year + 1

- Gravity-fed filters install below pond level, take in dirty water and deliver clean water to a pump chamber that transfers it back to the pond
- Oase ProfiClear Premium is a fully automatic gravity-fed, flow through self-cleaning drum filter that polishes water
- Aligned plumbing connections simplify adding Individual Modules and Moving Bed Modules to increase capacity of filtration system
- For recreational ponds, gravity fed filters should be combined with 12 volt pumps and Individual Modules

- Moving Bed System with Hel-X Bio-media provides optimal biological filtration of up to 14 oz. of food waste per day
- Micro control system offers a choice of manual cleaning, time interval cleaning or full automatic cleaning via sensor
- Connections for AquaOxy 450 to enhance and aeration (sold separately, page 132)
- Fully control your ProfiClear Compact with the Oase Control App from anywhere in the world (sold separately)

PROFICLEAR PREMIUM GRAVITY-FED FEATURES:

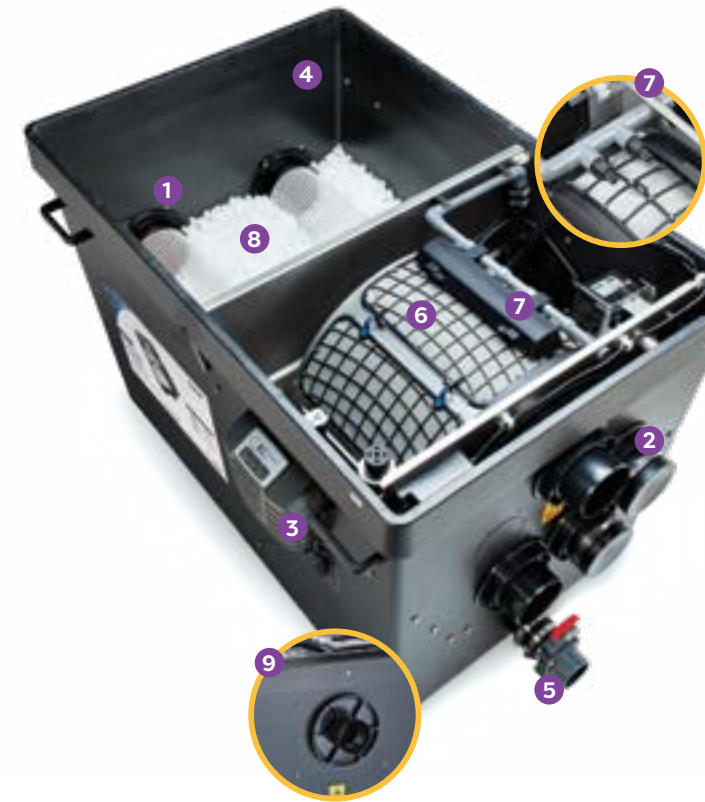

1. Dual outlets align with Moving Bed and Individual Modules
2. Three inlets allow for multiple intake locations throughout pond
3. Microcontroller with digital thermometer automates cleaning functions and can be connected to an EGC system
4. Made from German engineered GFK Duroplast for enhanced structural integrity
5. Drain with integrated slide valve clears sludge as needed
6. Drum filter with removable 60 micron screen
7. Spray bar removes fine particles from micro sieve
8. Hel-X floating bed Bio-media may be supplemented with 20 additional liters of Hel-X to process up to 19 oz. of daily waste
9. Dirty water discharge 4" outlet

OASE CONTROL

Connect your ProfiClear Premium to the Oase Control System to fully control the filter from anywhere in the world on any Android or Apple Device with Oase Control mobile application. See page 124 for more information on the Garden Cloud Controller.

The Oase Control App can display and control a variety of functions including:

- Operational status
- Filtration cycles
- Water Temperature
- Cleaning time
- Interval time
- Manual cleaning
- Overall performance data
- Comparison charts with data collected over time



Garden Cloud Controller

CLEAR WATER GUARANTEE					
FISH LOAD			FILTER	UVC	PUMP
LIGHT	MEDIUM	HEAVY			
<31,500 gal	<15,750 gal	<7,875 gal	ProfiClear Premium Compact-L Gravity-fed	Bitron C 110	AquaMax Eco Premium 4500 / 5500 AquaMax Eco Expert 6800 AquaMax Eco Expert 5300 12V AquaMax Eco Expert 7100 12V*

*Must adjust flow down to max flow of filter



INDIVIDUAL MODULE



ITEM	89195
DESCRIPTION	ProfiClear Premium Individual Module
INLET	(2) 180mm
OUTLET	(2) DN 110 - requires 4" rubber coupling & (2) 2"
WASTE DISCHARGE OUTLET	DN 75
MIN FLOW	2,640 gph
MAX FLOW	8,700 gph
DIMENSIONS	32¾"L x 26¾"W x 32¼"H
WARRANTY	2-year + 1

- Oase's Individual Module houses pump at the end of gravity-fed systems and provides space for additional filtration
- The two baskets in the flow area can be filled with up to 8 liters/488 cubic inches of Hel-X filter media for additional filtration capacity

- Modules allow easy adaptation of the filter system to meet any design requirement
- Integrated slide valve on the bottom allows filter to be easily drained for cleaning or winterization

TECH TIP

Gravity-fed systems must be installed at pond level, typically in an underground vault, and accept dirty pond water through bottom drains or skimmers. The modular systems can be expanded with multiple modules to accommodate any size pond but always end with an Individual Module housing the pump that returns clean water to the pond.

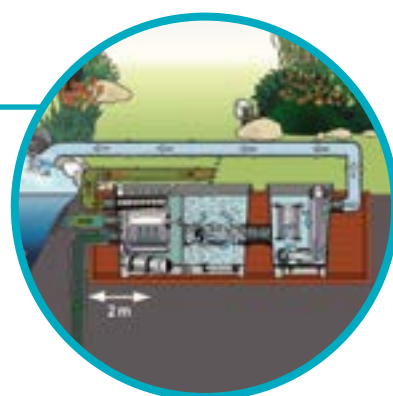

MOVING BED MODULE



ITEM	89196
DESCRIPTION	ProfiClear Premium Moving Bed Module
INLET	(2) 180mm
OUTLET	(2) DN 150
WASTE DISCHARGE OUTLET	DN 75
MIN FLOW	2,640 gph
MAX FLOW	8,700 gph
DIMENSIONS	32¾"L x 26¾"W x 32¼"H
MEDIA / SURFACE AREA	50 L Hel-X / 515 sq. ft.
WARRANTY	2-year + 1

- Oase's Moving Bed Module attaches to the ProfiClear Premium Compact-L Gravity-fed filter in series to provide additional biological filtration
- Innovative Hel-X bio-media provides tremendous protected surface area for colonizing beneficial bacteria (245 ft²/ft³)
- Included 50 liters of Hel-X decompose approximately 12 oz. of waste per day and can be increased to 75 L per module/18 oz. of waste per day
- Sludge drain flushes debris out and winterizes with the simple pull of a handle

- Pre-installed aerator bar provides optional oxygen enrichment and mixing to keep biofilm debris free and thriving by adding an AquaOxy 450 (sold separately, page 132)
- Module provides innovative bypass technology for optimal movement of the hel-x bio-media while keeping flow clear
- Hel-X media can be switched out for PondPads if additional waste removal is needed, page 176

DID YOU KNOW?

Combining aeration and agitation of bio-media is the most efficient way to maximize biofiltration and remove pollutants. Particles of bio-media in constant motion slough off dead bacteria, exposing new colonies to pollutants in the water. However, too much motion or collision of the particles can damage colonies on the outside of the floating media. Hel-X bio-media has a huge ratio of protected inner surface versus exposed outer surface so the agitation caused by the turbulent water does not damage the bacterial colonies inside the media. This keeps colonies clean and active without a loss of decomposition capacity.





VITRONIC



- Ultraviolet clarifiers clean and clear pond water with UVC band light
- Oase Vitronic UVC clarifiers offer powerful standalone clarification and integrate with Oase BioSmart filters
- Quick release ballast allows fast quartz sleeve maintenance and easy bulb changes
- Clear tubing adapters and indicator light show the clarifier is working
- Vitronic 18 and 36 watt units install easily on the housing of BioSmart filters (5000 & 10000 only)

ITEM	45427	56455	40350
DESCRIPTION	Vitronic 9	Vitronic 18	Vitronic 36
WATTS / UVC	9	18	36
MAX FLOW	500 gph	925 gph	1585 gph
MAX PRESSURE	7.25 psi / 17 ft. of head		
CORD LENGTH	10'	15'	
DIMENSIONS	13"L x 5"W x 4"H	21"L x 7"W x 5"H	21"L x 7"W x 5"H
HOSE SIZE	3/4", 1", 1 1/4", 1 1/2"	1", 1 1/4", 1 1/2"	
POND VOLUME	up to 2,500 gal	up to 5,000 gal	up to 10,000 gal
WARRANTY	2-year		

CLEAR WATER GUARANTEE		
UVC	FILTER	PUMP
Vitronic 18	BioSmart 5000	AquaMax Eco Premium 2500
Vitronic 36	BioSmart 10000	AquaMax Eco Premium 3500

TECH TIP

UVC bulbs have a service life of 9,000 hours, about a year of continuous use. At that point output drops to a level that is ineffective at controlling green water, so the bulb should be changed. Change the bulb early every spring, when nutrient levels accumulated over the winter are at their highest levels and plants other than algae are not yet actively growing. Replacement bulbs are available on page 176

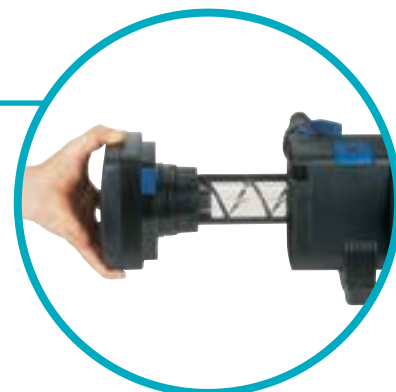

BITRON C



- Ultraviolet clarifiers clean and clear pond water with UVC light
- Oase Bitron C UVC clarifiers clean the green out of water in either standalone configurations or integrated with Oase filters
- Bitron C clarifiers mount directly to Oase BioTec Screenmatic² and ProfiClear Premium filters
- Quick-release fastener with safety switch provides fast, safe opening of bulb housing without fear of eye injury
- Inspection window allows visual inspection of the UVC bulb and self-cleaning feature
- Adjustable flow control optimizes water flow through the UVC chamber
- Automatic cleaning rotor powered by water flow, continuously glides around the quartz glass tube preventing debris from settling on quartz glass

ITEM	56936	57101
DESCRIPTION	Bitron C 55	Bitron C 110
WATTS / UVC	55	110
MAX FLOW	8,000 gph	11,000 gph
MAX PRESSURE	7.25 psi / 17 ft. of head	14.5 psi / 34 ft. of head
CORD LENGTH	15'	
DIMENSIONS	24"L x 7"W x 7"H	29"L x 9"W x 8"H
HOSE SIZE	3/4", 1", 1 1/4", 1 1/2", 2"	
POND VOLUME	up to 18,000 gal	up to 36,000 gal
WARRANTY	2-year	

CLEAR WATER GUARANTEE		
UVC	FILTER	PUMP
Bitron C 55	BioTec ScreenMatic ² 18000	AquaMax Eco Classic 3600 AquaMax Eco Premium 4500 AquaMax Eco Premium 3000 12V
Bitron C110	BioTec ScreenMatic ² 24000	AquaMax Eco Classic 3600 AquaMax Eco Premium 4500 AquaMax Eco Expert 6800* AquaMax Eco Expert 5300 12V
Bitron C 110	ProfiClear Premium Compact-M Pump-fed	AquaMax Eco Premium 4500
	BioTec ScreenMatic ² 24000	AquaMax Eco Premium 4500
	ProfiClear Premium Compact-L Pump-fed ProfiClear Premium Compact-L Gravity Fed BioTec ScreenMatic ² 39000	AquaMax Eco Premium 4500 / 5500 AquaMax Eco Expert 6800* AquaMax Eco Expert 5300 12V AquaMax Eco Expert 7100 12V*

*Must adjust flow down to max flow of filter



FILTERFALLS



73934



73935



73936



73937

- Biomechanical filters remove suspended solids, convert toxic ammonia and nitrites to harmless nitrates and aerate the pond
- Atlantic's FilterFalls are designed to be able to expand filter capacity as ponds age and fish grow
- Efficient removal of toxins and floating particles from the water column improves water quality and clarity
- Oversized chamber contains more media material to start with, upgrades with additional filtration when needed and offers more choices of optional filtration media
- Overhanging weir with drip edge eliminates leaking due to silicone seal failure
- Multiple bulkhead locations allow maximum versatility in plumbing FilterFalls
- Reinforced body prevents warping and deformation for years of worry-free service
- Support bars accommodate heavier stone and gravel for ease in camouflaging

ITEM	73934	73935	73936	73937
MODEL	BF1600	BF1900	BF2600	BF3800
DESCRIPTION	16" FilterFalls	19" FilterFalls	26" FilterFalls	38" FilterFalls
WATERFALL WIDTH	16"	19"	26"	38"
DIMENSIONS	21½"W x 19½"D x 17¼"H	28"W x 25"D x 21½"H	34½"W x 25"D x 23"H	46½"W x 30"D x 23"H
PUMP FLOW RANGE	1,000 - 3,900 gph	2,500 - 4,000 gph	4,000 - 6,000 gph	6,000 - 8,000 gph
BULKHEAD	1½"	2"		3"
POND VOLUME	up to 1,250 gal	up to 2,000 gal	up to 4,000 gal	up to 8,000 gal
MATCH TO	PS3900	PS4600	PS7000	PS15000
INCLUDES	installation kit, male thread adapter and one-piece liner flange			
WARRANTY	Lifetime (enclosure)			

BF1600 FEATURES:



BF1600 shown

1. Sturdy top grate and support bar allow natural rock camouflage.
2. Media Bag for Bio-Tech Media / Bio-Balls / Bio-Rocks (sold separately) provide maximum surface area for beneficial bacteria.
3. Dual Bio-Tech filter mats support both mechanical and biological filtration.
4. Sturdy bottom grate supports filter media.
5. Rolled upper rim provides clean lines with great strength.
6. One-piece liner attachment flange.
7. Heavy-duty 1½" FIPT bulkhead.

BF1900 / BF2600 / BF3800 FEATURES:

1. Heavy-duty removable top grate supports rock camouflage.
2. Support bars add stability and reinforce top grate.
3. Media Bag for use with Bio-Balls or Bio-Rocks (sold separately) provide maximum surface area for beneficial bacteria.
4. Dual Bio-Tech filter mats support both mechanical and biological filtration.
5. Sturdy bottom grate supports filter media.
6. Rolled upper rim provides clean lines with great strength.
7. 2" or 3" heavy-duty FIPT bulkhead for high flow rates.
8. Bottom chamber accepts bulkheads on all sides while bottom cones inside reduce surface area for back flushing.
9. One-piece liner flange allows easy, leak-free attachment of FilterFalls to pond liner.
10. Solid lip and molded inserts ensure a watertight liner attachment every time.



BF2600 shown



DID YOU KNOW?

Atlantic's custom cut Matala Filter Kits add tremendous surface area for biological activity, with 62 square feet of surface area available for bacterial colonization in every square foot of black mat, 96 square feet for the green and 124 square feet for the blue. Double up Matala Kits to add over 600 square feet of biological filtration to your pond! Page 175



CLEAR WATER SYSTEM KITS

A pond should be a little slice of paradise in your backyard. A place to enjoy coffee each morning gazing at the beautiful fish and plants while listening to the tranquil sounds of water cascading down a waterfall. At the end of the day, a place to unwind next to the pond as the light of the sun slowly fades and subtle submerged lighting takes over, revealing a totally new side to your personal paradise.

This paradise isn't beyond reach, but daily and yearly maintenance may lead to unmet expectations and disappointment. What if maintenance became weekly or monthly, with major cleanouts deferred for years, or eliminated altogether? Imagine a pond system that exceeds your expectations and delivers what you expect, without constant attention, guaranteed. That is the Clear Water System.



The current practice, with the pump in the skimmer and an upflow filter, works very well. It collects floating debris, traps suspended solids and removes toxins through the balance between fish, plants and beneficial bacteria. Your pond will look great and hum along for the season, but this system comes at a cost. The balance that keeps the pond beautiful can shift as waste accumulates on the bottom. It will need to be removed, usually by draining and "mucking out" the pond, typically once a year. This has become the industry standard here.

There is another way of pondkeeping that concentrates on continually removing heavy solids as they settle, instead of skimming the surface. This way depends on pumps that sit on the bottom and suck up the muck, sending it to sophisticated filters. The filters mechanically remove solids, biologically treat wastes then expose the water to ultraviolet light to inhibit the growth of algae. This standard expects pondkeepers to use nets or pond vacuums to remove leaves and floating debris, typically daily. Still not ideal.

What if we could almost eliminate maintenance and just let your pond and fish and plants keep doing their thing year after year?

That is what the Clear Water Pond System is all about.



The Clear Water Pond System doesn't depend on either standard; it combines the best of each. An Atlantic Skimmer removes floating debris before it can sink and keeps the waterfall pump flowing strong. An Oase pump at the bottom pulls in fish waste and sends it to a multistage filter. The EPA-certified filter screens out particulates mechanically, treats toxic ammonia, nitrite and nitrate biologically and clarifies water with ultraviolet light, delivering exquisite water clarity and quality.

Atlantic-Oase Clear Water System Kits are guaranteed to deliver clear water, even with fish loads that leave other ponds murky and dark. The pond you always wanted is as easy as picking a size – all components are expertly matched and everything is included. Routine maintenance is drastically reduced. AquaMax pumps are designed to go years in the bottom without clogging. Filters take minutes to clean, without getting yourself dirty. The UVC bulb takes five minutes to change, once every year or two. The System virtually ends major cleanouts.

This is the pond system you've been waiting for.

CLEAR WATER GUARANTEE

The Oase Clear Water Guarantee is your assurance of clear water down to three feet, a guarantee like no other.

Precisely engineered and matched components function in concert to remove not only suspended solids for excellent clarity, but toxic wastes as well, assuring high water quality. Filter pumps designed to pass solids pick up and deliver fish wastes to multistage filters. Filter foams of varying densities strip out solids and particulates. Beneficial bacterial colonies remove ammonia, nitrite and nitrate, eliminating nutrients in the water. Finally, water is bathed in ultraviolet light in an EPA-certified clarifier to further inhibit the growth of algae. You will be able to read the 1" mark on a measuring tape three feet below the surface, guaranteed.

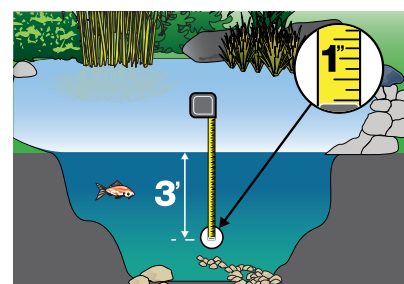

94629



94630



94631



94632

- Pond kits provide all the equipment needed - liner, pump, plumbing and filtration - to properly circulate and filter a pond
- Atlantic-Oase Clear Water System Kits provide the pond you always wanted but never had access to before
- Perfectly matched components remove leaves and debris off the surface, as well as heavy organics off the bottom, cleaning from the top down and the bottom up
- The complete solution to murky, dirty, green water, even with fish loads up to 10" per 100 gallons

- Clean, crystal clear water, guaranteed – see the Clear Water Guarantee for details
- Multi-stage complementary filtration reduces daily and yearly maintenance, so you can enjoy your pond more
- Add bacteria weekly to further reduce organic waste and control unwanted plant growth

ITEM	94629	94630	94631	94632
MODEL	PKCW161515	PKCW191520	PKCW262020	PKCW382025
DESCRIPTION	Small Clear Water System Kit	Medium Clear Water System Kit	Large Clear Water System Kit	Extra Large Clear Water System Kit
LINER SIZE	15' x 15'	15' x 20'	20' x 20'	20' X 25'
FASTFALLS	SP1600	SP1900	SP2600	SP3800
SKIMMER	PS3900	PS4600	PS7000	PS15000
FILTER	FiltoClear 3400	FiltoClear 5200	FiltoClear 8200	BioTec ScreenMatic ² 18000 & Bitron C 55
PUMP	TT2000 & AquaMax Eco Premium 2500	TT4000 & AquaMax Eco Premium 3500	TT6000 & AquaMax Eco Premium 4500	TT9000 & AquaMax Eco Premium 4500
FALLSFOAM	(2) LF1100			
LIGHTING	(2) WWCS2 Spotlights and WW30X4 Transformer & Splitter			
CHECK VALVE	TR215CV			AWGCV30
UNDERLAYMENT	12' x 12'	12' x 25'		(2) 12' x 25'
AUTO FILL	AF1000			
TUBING	1½" x 50' Flexible PVC	2" x 50' Flexible PVC		2" x 50' & 3" x 50' Flexible PVC
POND SIZE	11'L x 11'W	11'L x 16'W	16'L x 16'W	16'L x 21'W
INCLUDES	Installation Kit w/ PVC glue and thread sealant			



WATER GARDEN KITS



74238 / 74239



74240 / 74241



74242 / 74243



74244 / 74245

- Atlantic Pond Kits save you time and money by avoiding costly mismatching and multiple trips to the store
- Skimmer, FilterFalls, pump and accessories are designed to work together to eliminate any guesswork
- Energy efficient pumps keep operating costs under control

- Medium, Large and Extra Large Kits include LED lighting to extend the enjoyment of the water feature into the evening
- An additional two lights may be added with no additional hardware necessary
- Extra Large Pond Kits measure 42"W x 36"H x 48"D and are supplied on a pallet

ITEM	74238	74239	74240	74241	74242	74243	74244	74245
MODEL	PK161015	PK161515	PK191515	PK191520	PK261520	PK262020	PK382025	PK382530
DESCRIPTION	Small Water Garden Kit		Medium Water Garden Kit		Large Water Garden Kit		Extra Large Water Garden Kit	
LINER SIZE	10' x 15'	15' x 15'		15' x 20'		20' x 20'	20' x 25'	25' x 30'
FILTERFALLS	BF1600		BF1900		BF2600		BF3800	
SKIMMER	PS3900		PS4600		PS7000		PS15000	
PUMP	TT2000	TT3000	TT4000	TT5000		TT6000	TT9000	A-31
FALLSFOAM	LF1100		(2) LF1100					
LIGHTING	---		(2) WWCS2 Spotlights and WW30X4 Transformer & Splitter					
CHECK VALVE	TR215CV						AWGCV30	
UNDERLAYMENT	12' x 12'			12' x 25'			(2) 12' x 25'	
AUTO FILL	AF1000							
TUBING	1½" x 25'			2" x 25'			3" x 50'	
POND SIZE	6'L x 11'W	11'L x 11'W		11'L x 16'W		16'L x 16'W	16'L x 21'W	21'L x 26'W
INCLUDES	Installation Kit w/ PVC glue and thread sealant							

STREAMBED LINER

Don't forget streambed liner! When ordering your Pond Kit simply add liner, tubing and a coupling for a stream that will really accent your pond

- For your Small Pond Kit order an 8' x 10' boxed liner, 1½" x 25' roll of tubing and 1½" coupling to add a six- to eight-foot stream to your pond
- For Medium and Large Pond Kits add a 10' x 15' boxed liner, 2" x 25' roll of tubing and 2" coupling for streams up to 13 feet long
- For Extra Large Pond Kits, add a 15' x 20' boxed liner, 3" x 50' roll of tubing and 3" coupling for streams up to 18 feet long



ITEM	74193	74187	74189
MODEL	LI810-B	LI1015-B	LI1520-B
LINER SIZE	8' x 10'	10' x 15'	15' x 20'
TUBING NEEDED	#75251 / FH1525 - 1½" x 25' PVC Flex Pipe	#75253 / FH225 - 2" x 25' PVC Flex Pipe	#75255 / FH350 - 3" x 50' PVC Flex Pipe
FITTING NEEDED	#74241 / 429-015 - 1½" Coupling	#74215 / 429-020 - 2" Coupling	#74216 / 429-030 - 3" Coupling
STREAMBED LENGTH	up to 6'	up to 11'	up to 16'

P PUMP

Atlantic-Oase Pumps and accessories offer the perfect solution for all water features, large and small. Whether the application calls for Mag Drive or Direct Drive, Axial or Asynchronous, Synchronous or Brushless DC, line voltage or 12 volt, our pumps deliver the right flow at the right head for the right wattage. Advanced next generation design, top quality components and world class support ensure our pumps will provide years of trouble-free service.

- » Fountain pumps offer adjustable flows and multiple adapters for ease of installation and adjustment
- » Magnetic pumps make better flows at higher head heights and are the easiest to service in the industry
- » Asynchronous pumps have the most powerful, most efficient and smallest footprint on the market, offering tool-free maintenance and an optional Variable Speed Controller
- » Direct Drive pumps deliver high head and solids handling for the most demanding in-pond applications
- » Brushless DC fountain pumps offer up to 12 pre-programmed water displays, while Brushless DC filtration versions adjust from low to extremely high flows at very low wattages, both available in 12 volt



COMPREHENSIVE PUMP CHART

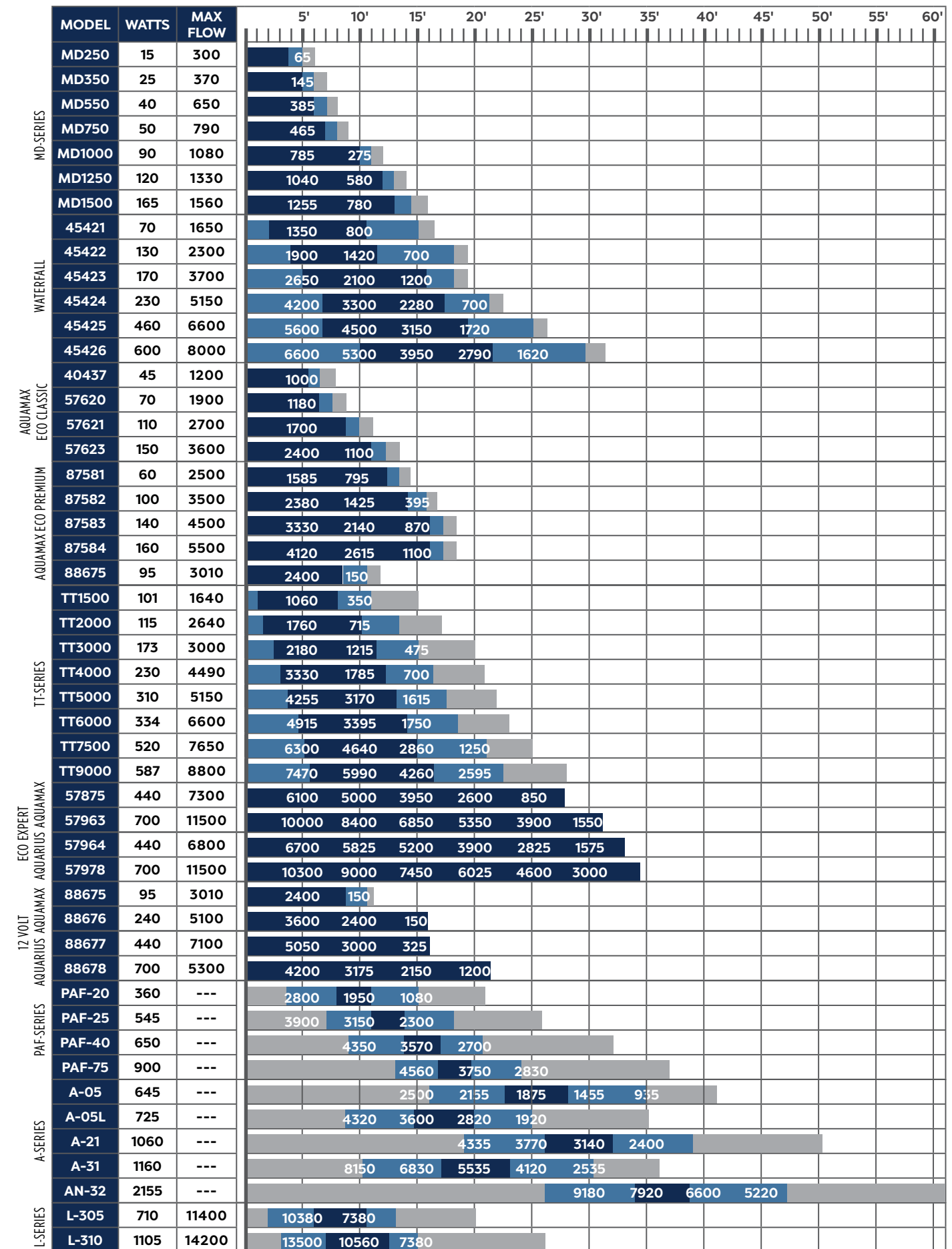

*All flows in gallons per hour (GPH)

Recommended Operating Range Best Efficiency Range Do Not Operate Range



TIDALWAVE FP-SERIES PUMPS



- Fountain Pumps offer Magnetic Induction performance and replaceable components in a tiny footprint for the smallest water features
- Atlantic FP-Series Pumps fit in the smallest spaces for reliable, adjustable performance in your wall and table top fountains
- Integrated valve allows flow adjustment in spaces where a separate valve wouldn't fit
- Removable washable foam filter protects internal components from wear
- Standard size fittings facilitate connection to various sizes and types of tubing
- Energy efficient motors keep operating costs to a minimum
- Impeller assemblies replace quickly, no tools needed for extended service life



ITEM	73816	73817	75472	73818	75474
MODEL	FP100	FP200	FP300	FP400	FP500
DESCRIPTION	FP-Series - 100 gph	FP-Series - 200 gph	FP-Series - 300 gph	FP-Series - 400 gph	FP-Series - 500 gph
VOLTS	115				
WATTS	7	9.5	16	24	33
INLET	Adjustable				
OUTLET	½" MIPT		½" FIPT		
CORD LENGTH	6'		16'		
DIMENSIONS	3½"L x 2¼"W x 2½"H		5"L x 3"W x 3¼"H		5¼"L x 3½"W x 4"H
OUTLET FITTING	½" - ¾" Insert				
WARRANTY	1-year				

MODEL	MAX FLOW (GPH)	2.5'	5'	7.5'
FP100	120			
FP200	175	100		
FP300	325	230	90	
FP400	370	290	180	
FP500	525	430	300	75



FOUNTAIN PUMPS



- Synchronous Magnetic Induction fountain pumps offer high efficiency and low power consumption in a small form factor
- Oase Fountain Pumps are ideal for small garden, wall and table top fountains
- With built-in adjustable flow control, suction cups for stabilization and grounding plate for an added measure of protection
- Removable filter foam protects rotor and impeller from wear
- Energy efficient motors keep operating costs to a minimum
- Includes fittings to accept Oase Kink-free hose
- Replaceable components assure a long service life
- Accessorize with Oase 4-pattern Nozzle Set for added visual interest page 21 (Fountain Pump 320 & 525 only)



ITEM	45417	45413	45414	45416
DESCRIPTION	Fountain Pump 90	Fountain Pump 150	Fountain Pump 320	Fountain Pump 525
VOLTS	120			
WATTS	4	7	23	42
CORD LENGTH	6'		16'	
DIMENSIONS	3"L x 1½"W x 2¼"H	3½"L x 1¼"W x 2½"H	4"L x 2"W x 3"H	4½"L x 2½"W x 3½"H
HOSE SIZE	⅜", ½"		½", ¾"	½", ⅝", ¾"
WARRANTY	2-year + 1			

ITEM	MAX FLOW (GPH)	2.5'	5'	7.5'
45417	90			
45413	135	30		
45414	320	220	60	
45416	525	370	260	70



AQUARIUS ECO-EXPERT



ITEM	57964	57978
DESCRIPTION	Aquarius Eco Expert 7300	Aquarius Eco Expert 11500
VOLTS	220 - 240 V / 50-60 Hz	
AMPS	2	3.5
WATTS	440	700
INLET	G2 (#85310 adapter available) / 2 1/2" Kink-free	
OUTLET	2"	
CORD	33'	
DIMENSIONS	19"L x 8 1/2"W x 8"H	21"L x 9 1/4"W x 8 3/4"H
OUTLET FITTING	Sch40 1 1/2" - 2" adapter / 1 1/2" & 2" Kink-free	
WARRANTY	3-year + 2	

- Brushless DC pumps are powerful, next generation pumps for demanding applications requiring powerful flows and economical water delivery
- Oase Aquarius Eco Expert are specifically designed for the most demanding fountain applications
- Robust stainless steel intake mesh screens out debris particles over 3/16", while integrated grounding plate offers unparalleled safety
- Unique patented frost protection safeguards pump from freeze damage down to -4°F so they can remain in place all winter long

- Integrated Environmental Function Control automatically shuts off the pump in run dry conditions to prevent motor damage
- Built in Dynamic Function Control (DFC) offers 1 pre-programmed scene, alternating fountain heights; connect pump to controller for 11 additional pre-programmed scenes, see page 166
- Eco Control and Garden Cloud Controller operate and monitor pump remotely (sold separately)
- Submersed or inline installation in a variety of water types, including chlorinated pool and salt water, see page 89

MODEL	MAX FLOW (GPH)	5'	10'	15'	20'	25'	30'	35'
57964	7300	6700	5825	5200	3900	2825	1575	
57978	11500	10300	9000	7450	6025	4600	3000	

TECH TIP

For inline applications, where the pump will be plumbed outside the body of water, such as shallow fountain applications, the threaded intake on the pump requires the #85310 - 3" Inlet Adapter to adapt the inlet to 3" Sch40. Any 3" female Sch40 slip fitting can then be glued in place.



AQUARIUS ECO EXPERT FEATURES:

1. Ergonomic handle aligns with the pump's center of gravity.
2. Integrated mounting holes in the base enable fixed installation.
3. Rotatable volute handles multiple configurations.
4. Robust stainless steel intake screen prevents debris entering.
5. Dynamic Function Control (DFC) switch enables 1 preprogrammed water pattern.
6. Grounding plate safeguards against short circuits anywhere in the water feature.
7. EGC connections provide input/output to an additional 9 devices, remotely from anywhere in the world.



ACCEPTABLE WATER QUALITY RANGE							
	pH VALUE	HARDNESS	FREE CHLORINE	CHLORIDE CONTENT	SALT CONTENT	OVERALL DRY RESIDUE	TEMPERATURE
FRESHWATER	6.8 - 8.5	142 - 267 ppm	<0.3 ppm	<250 ppm	<0.4%	<50 ppm	39° - 95°F
POOLWATER	7.2 - 8.3	142 - 267 ppm	<0.6 ppm	<250 ppm	<0.4%	<50 ppm	39° - 86°F
SALTWATER	7.2 - 8.5	256 - 534 ppm	<0.3 ppm	<22000 ppm	<4.0%	<50 ppm	39° - 82°F

CONTROLLERS

The Aquarius Eco Expert has two options to remotely control the pump.

ECO CONTROL*

Eco Control is an innovative controller that directly connects to the pump to regulate all functions, with an easy-to-read illuminated two-line display. See page 102 for more information.

The Eco Control standalone controller provides:

- Dynamic Function Control (DFC) of expanded library of 12 pre-programmed water patterns, see page 166
- Complete adjustment of output flow
- Power consumption read-out
- Pump status and malfunctions display
- Real time rotation speeds
- Total runtime data

*Not useable if the pump is connected to an OC network



Eco Control

OASE CONTROL (OC)

Connect your Aquarius Eco Expert to the Oase Control (OC) to operate the pump from anywhere in the world on any Android or Apple Device with Oase Control mobile application. See page 124 for more information.

Oase Control can display and/or control a variety of functions including:

- Dynamic Function Control (DFC) of expanded library of 12 pre-programmed water patterns, see page 166
- Complete adjustment of output flow
- Operation status
- Water temperature
- Power consumption
- Overall performance data
- Performance charts over time



Garden Cloud Controller



AQUARIUS ECO EXPERT 12 VOLT



ITEM	88678
DESCRIPTION	Aquarius Eco Expert 5300 - 12 V
VOLTS	100 - 120 V / 50-60 Hz
AMPS	2.2
WATTS	240
INLET	G2 (#85310 adapter available)
OUTLET	2"
MAX SOLIDS SIZE	3/16"
CORD	8' + 26'
DIMENSIONS	19 1/2"L x 9 1/2"W x 8 1/2"H
OUTLET FITTING	Sch40 1 1/2" - 2" adapter
WARRANTY	3-year + 2

- Brushless DC pumps are powerful, next generation pumps for demanding applications requiring extremely powerful flows and economical water delivery
- Aquarius Eco Expert 12 volt pumps were designed specifically for fountains where submersible line voltage pumps are prohibited
- Unique patented frost protection safeguards pump from freeze damage down to -4°F so they can remain in place all winter long
- Integrated Environmental Function Control prevents run dry damage and integrated grounding plate offers unparalleled safety

- Built in Dynamic Function Control (DFC) offers 1 pre-programmed scene, alternating fountain heights; connect pump to controller for 11 additional pre-programmed scenes, see page 166
- Eco Control and Garden Cloud Controller operate and monitor pump remotely (sold separately)
- Submersed or inline installation in a variety of water types, including chlorinated pool and salt water, see page 87
- 32' 12 volt extension cables available, see page 177

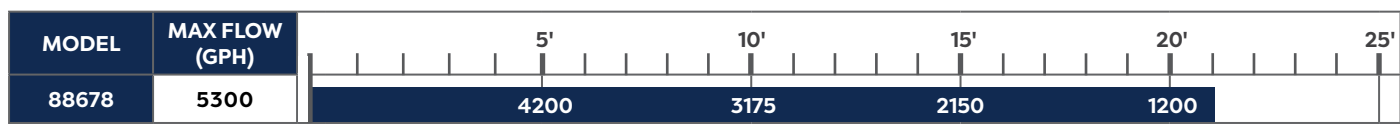

TIDALWAVE MD-SERIES PUMPS



- Magnetic Induction pumps provide years of service under the demanding conditions of smaller ponds, waterfalls and fountains
- Atlantic MD-Series pumps feature better flows at higher heads, a longer warranty and are easier to service
- Male threads on both inlet and outlet are less restrictive for higher flow
- Volute can be oriented in 4 ways for maximum versatility in placement
- A quarter-turn accesses replaceable impeller assembly for easy periodic cleaning to keep pump running for years
- Large, stable base for anchoring pump may be removed in tight applications
- Removable pre-filter and oversized ceramic shaft reduce internal wear and extend service life
- Included outlet fittings are tapered to fit a wide array of tubing types and sizes

ITEM	73822	73824	73825	73819	73820	73821
MODEL	MD250	MD550	MD750	MD1000	MD1250	MD1500
DESCRIPTION	MD-Series - 250 gph	MD-Series - 550 gph	MD-Series - 750 gph	MD-Series - 1000 gph	MD-Series - 1250 gph	MD-Series - 1500 gph
VOLTS	115					
WATTS	15	40	50	90	120	165
INLET	1" MIPT			1 1/2" MIPT		
OUTLET	3/4" MIPT			1" MIPT		
CORD LENGTH	20'					
DIMENSIONS	4 1/2"L x 3 1/2"W x 5"H			5 1/2"L x 4 1/4"W x 5 1/2"H		6"L x 4 3/4"W x 6"H
OUTLET FITTING	3/4" - 1" Step			1" - 1 1/2" Step / 1" FIPT x 1 1/2" FIPT adapter		
WARRANTY	5-year Limited					

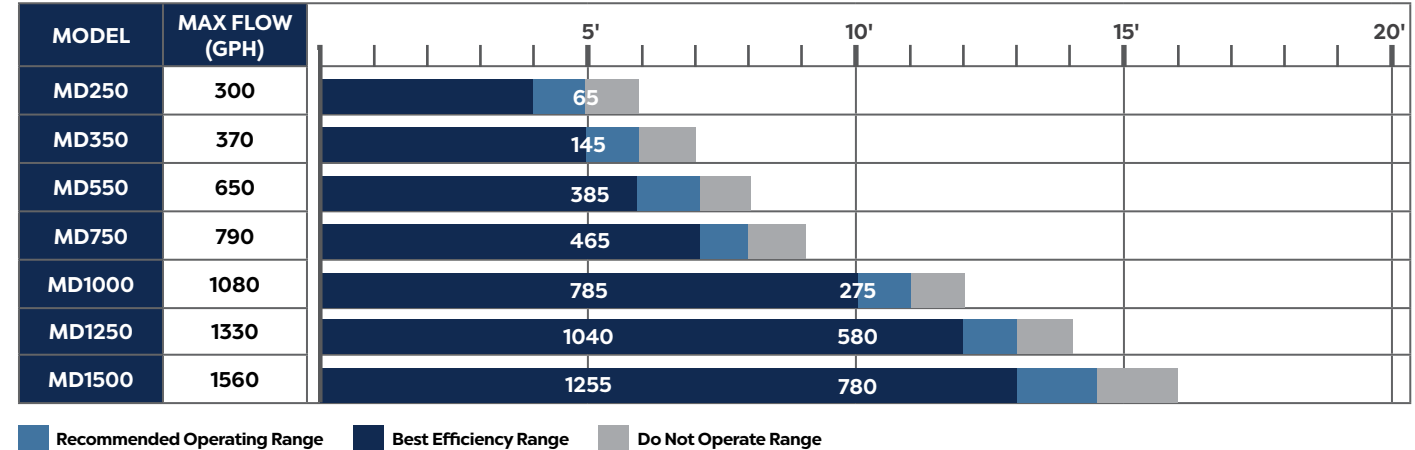



WATERFALL PUMPS



- Synchronous magnetic pumps are specifically designed to create falls in Water Garden and Pond-free applications
- Oase Waterfall Pumps are reliable, energy efficient pumps that excel in hard water conditions
- Grounding plate eliminates any chance of stray current entering water for unparalleled safety
- Replaceable coated magnetic rotors resist scale and poor water quality conditions (1650-5150)
- Tool-less volute removal makes maintenance fast and easy (1650-5150)
- Asynchronous 6600 and 8000 feature replaceable corrosion resistant rotors
- Self-cooling, debris flushing rotor chambers keep pumps from overheating in the most demanding applications
- Waterfall Pump 6600 and 8000 can be plumbed for inline applications

ITEM	45421	45422	45423	45424	45425	45426
DESCRIPTION	Waterfall Pump 1650	Waterfall Pump 2300	Waterfall Pump 3700	Waterfall Pump 5150	Waterfall Pump 6600	Waterfall Pump 8000
VOLTS	120					
AMPS	0.75	1.2	1.5	2.2	3.8	4.8
WATTS	70	130	170	230	460	600
OUTLET	1 1/4" MIPT		1 1/2" MIPT	2" MIPT		
CORD LENGTH	20'					
DIMENSIONS	8 1/2"L x 5"W x 6 1/4"H		9 1/2"L x 5 1/2"W x 6 1/2"H		12"L x 6 3/4"W x 8 1/2"H	
OUTLET FITTING	1" - 1 1/2" Step		1 1/2" - 2" Step			
WARRANTY	3-year					

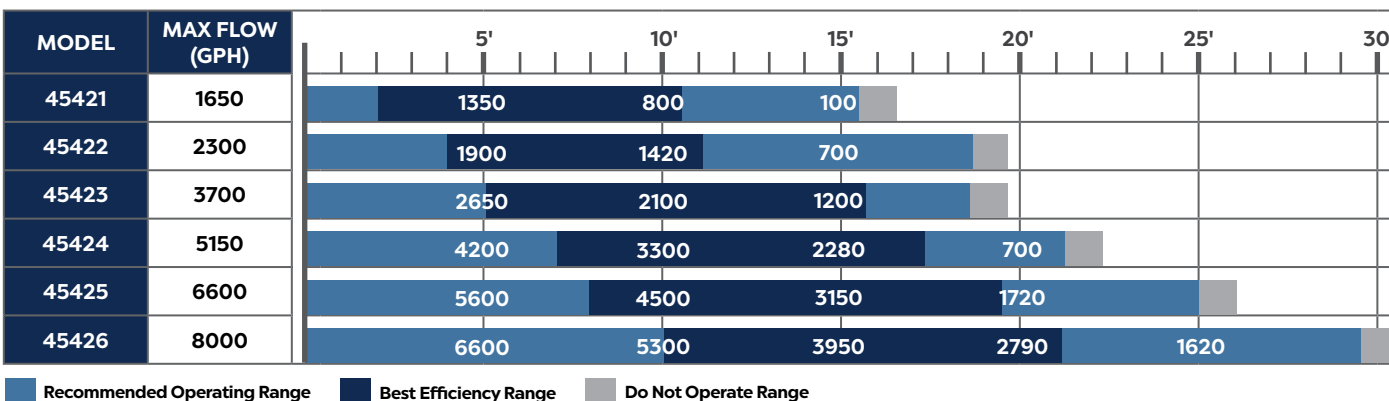

AQUAMAX ECO CLASSIC



- Synchronous electronic pumps are designed for in-pond applications where debris is delivered through the pump to a filtration system
- Oase AquaMax Eco Classic is an energy efficient, solids handling pump with a large intake pre-filter and Environmental Function Control
- Environmental Function Control (EFC) automatically shuts off the pump if dry run or clogged to prevent pump damage
- Large-surface, wrap-around pre-filter allows coarse debris particles up to 1/8" to pass through pump; may be removed for in-line use
- AquaMax Eco Classic features a coated magnetic rotor for adverse water conditions and proprietary grounding plate for unparalleled safety

ITEM	40347	57620	57621	57623
DESCRIPTION	AquaMax Eco Classic 1200	AquaMax Eco Classic 1900	AquaMax Eco Classic 2700	AquaMax Eco Classic 3600
VOLTS	120			
AMPS	1.2	1.3	1.4	1.7
WATTS	45	70	110	150
CORD LENGTH	20'			
DIMENSIONS	11"L x 9"W x 5 1/2"H			
HOSE SIZE	1" 1/4", 1 1/2", 2"			
OUTLET FITTING	metric pivoting step fitting (1" 1/4", 1 1/2"), Sch40 1 1/2" / 2" adapter			
WARRANTY	2-year + 1			

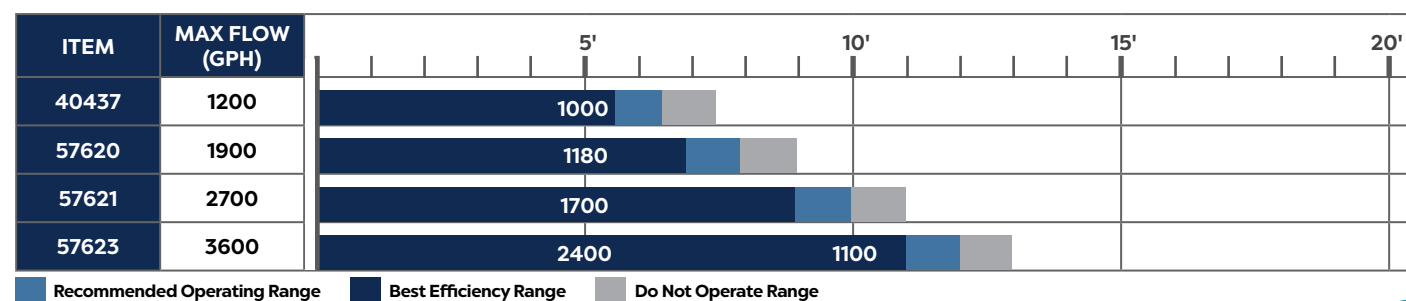

CLEAR WATER GUARANTEE		
PUMP	FILTER	UVC
AquaMax Eco Classic 1200	BioPres1000	Included w/Filter
AquaMax Eco Classic 1900	BioPress 1600 / FiltoClear 3400	Included w/Filter
	BioSmart 5000	Vitronic 18
AquaMax Eco Classic 2700	BioPress 2400 / FiltoClear 5200	Included w/Filter
	BioSmart 10000	Vitronic 36
AquaMax Eco Classic 3600	FiltoClear 8200	Included w/Filter
	BioTec ScreenMatic ² 18000 / 24000	Bitron C 55



AQUAMAX ECO PREMIUM



- Synchronous electronic pumps are designed for in-pond applications where debris is delivered through the pump to a filtration system
- Oase AquaMax Eco Premium is an energy efficient solids-handling pump with a second intake that can connect to an optional auxiliary intake or skimmer
- Motors with Pulse 6 technology with patented Seasonal Flow Control (SFC) can be regulated by manually or by optional Oase Eco Control or Garden Cloud Controller
- Patented Seasonal Flow Control (SFC) slows flow and reduces wattage up to 50% as water temperatures drop
- Environmental Function Control (EFC) automatically shuts off the pump if dry run or clogged to prevent pump damage
- Unique patented frost protection safeguards pump free from damage down to -4°F so they can remain in place all winter long
- Pump can be used in-line by removing large-surface, wrap-around pre-filter pre-filter and using mounting bracket to secure
- Pump features a grounding plate for unparalleled safety

ITEM	87581	87582	87583	87584
DESCRIPTION	AquaMax Eco Premium 2500	AquaMax Eco Premium 3500	AquaMax Eco Premium 4500	AquaMax Eco Premium 5500
VOLTS	120			
AMPS	1.0	1.6	2.2	2.4
WATTS	60	100	140	160
INLET	2"			
OUTLET	2"			
MAX SOLIDS SIZE	3/8"			
CORD	20'			
DIMENSIONS	13 1/2" L x 11" W x 6 1/2" H			
OUTLET FITTING	1", 1 1/4", 1 1/2", Sch40 1 1/2" - 2" adapter			
WARRANTY	3-year + 2			

ITEM	MAX FLOW (GPH)	5'	10'	15'	20'
87581	2500	1585	795		
87582	3500	2380	1425	395	
87583	4500	3330	2140	870	
87584	5500	4120	2615	1100	
88675	3010	2400	150		

Recommended Operating Range Best Efficiency Range Do Not Operate Range

AQUAMAX ECO PREMIUM 12 VOLT



ITEM	88675
DESCRIPTION	AquaMax Eco Premium 3000 - 12V
VOLTS	100 - 120V / 50-60 HZ
WATTS	95
INLET	2"
OUTLET	2"
MAX SOLIDS SIZE	3/8"
CORD	8' + 26'
DIMENSIONS	11" L x 6 1/2" W x 3 1/2" H
OUTLET FITTING	1" 1/4", 1 1/2", Sch40 1 1/2" - 2" adapter
WARRANTY	3-year + 2

- Synchronous electronic 12 volt pumps are designed for applications where submersible line voltage pumps are prohibited
- Oase AquaMax Eco Premium 12 volt is an energy efficient pump are perfect for use inline for recreational ponds or in submersible applications
- Patented Seasonal Flow Control (SFC) slows flow and reduces wattage up to 50% as water temperatures drop
- Environmental Function Control (EFC) automatically shuts off the pump if dry run or clogged to prevent pump damage
- Unique patented frost protection safeguards pump free from damage down to -4°F so they can remain in place all winter long
- Pump can be used in-line by removing large-surface, wrap-around pre-filter pre-filter and using mounting bracket to secure
- Pump features a grounding plate for unparalleled safety
- 32' 12 volt extension cables available, see page 177

ACCEPTABLE WATER QUALITY RANGE							
	pH VALUE	HARDNESS	FREE CHLORINE	CHLORIDE CONTENT	SALT CONTENT	OVERALL DRY RESIDUE	TEMPERATURE
FRESHWATER	6.8 - 8.5	0.45 - 0.84 ppm	<0.3 ppm	<250 ppm	<0.4%	<50 ppm	39° - 95°F
POOLWATER	7.2 - 8.3	0.45 - 0.84 ppm	<0.6 ppm	<250 ppm	<0.4%	<50 ppm	39° - 86°F
SALTWATER	7.2 - 8.5	1.12 - 1.68 ppm	<0.3 ppm	<22000 ppm	<4.0%	<50 ppm	39° - 82°F

CLEAR WATER GUARANTEE		
PUMP	FILTER	UVC
AquaMax Eco Premium 2500	BioPress 1600 / FiltoClear 3400	Included
	BioSmart 5000	Vitronic 18
AquaMax Eco Premium 3500	BioPress 2400 / FiltoClear 5200	Included
	BioSmart 10000	Vitronic 36
AquaMax Eco Premium 4500	FiltoClear 8200	Included
	BioTec ScreenMatic2 18000/24000/39000	Bitron C 55
	ProfiClear Premium Compact-M	Bitron C 55 / 110
AquaMax Eco Premium 5500	ProfiClear Premium Compact-L	Bitron C 110
	BioTec ScreenMatic2 39000	Bitron C 110
AquaMax Eco Premium 3000 12V	ProfiClear Premium Compact-L	Bitron C 110
	BioSmart 10000	Vitronic 36
	BioTec ScreenMatic2 18000	Bitron C 55
	BioTec ScreenMatic2 24000	Bitron C 110





TIDALWAVE TT-SERIES PUMPS



- Asynchronous Pumps combine the efficiency of Magnetic Induction with the power of Direct Drive geometry, keeping operating and ownership costs to a minimum
- Atlantic TT-Series pump more water for less watts, making them the ideal choice for water gardens and continuously operated water features
- Compact design fits the tightest pump chambers, perfect for vertical and multiple pump applications
- Excellent resistance to fouling in hard water environments and simple maintenance keeps pumps running in adverse conditions
- Ribs and large openings in pre-filter and handle provide tremendous surface area for greater clog resistance, decreasing upkeep and increasing pump life

ITEM	73924	73925	73926	73927	73928	73929	73930	73931
MODEL	TT1500	TT2000	TT3000	TT4000	TT5000	TT6000	TT7500	TT9000
DESCRIPTION	TT-Series - 1500 gph	TT-Series - 2000 gph	TT-Series - 3000 gph	TT-Series - 4000 gph	TT-Series - 5000 gph	TT-Series - 6000 gph	TT-Series - 7500 gph	TT-Series - 9000 gph
VOLTS	120							
AMPS	0.88	1.0	1.5	2.0	2.7	2.9	4.4	5.1
WATTS	101	115	173	230	310	334	520	587
INLET	1½" MIPT				2" MIPT			
OUTLET	1½" FIPT				2" FIPT		2" FIPT / 3" MIPT	
CORD LENGTH	20'							
DIMENSIONS	8"L x 5¼"W x 6¼"H			9¼"L x 6"W x 7"H			11"L x 7¼"W x 8"H	
OUTLET FITTING	1" - 1½" Step				2" Insert		---	
WARRANTY	3-year							

TT-SERIES PUMP FEATURES:

- Large threaded inlet and outlet for less restriction and greater flows.
- Quarter-turn volute provides access to impeller without the use of tools.
- Heavy-duty pre-filter locks in place. Large openings and increased surface area resist clogging.
- Three-vane hybrid impeller improves flows and passes solids easily.
- Additional perforations in handle provide greater surface area.
- Energy efficient asynchronous motor is up to 30% more efficient than the competition.
- All TT-Series models are compatible with the Variable Speed Controller.
- All models feature 20' power cord and three-year warranty.



Variable Speed Controller - Page 103

MODEL	MAX FLOW (GPH)	5'	10'	15'	20'	25'	30'
TT1500	1640	1060	350				
TT2000	2640	1760	715	150			
TT3000	3000	2180	1215	475			
TT4000	4490	3330	1785	700	90		
TT5000	5150	4255	3170	1615	395		
TT6000	6600	4915	3395	1750	265		
TT7500	7650	6300	4640	2860	1250		
TT9000	8800	7470	5990	4260	2595	1005	

■ Recommended Operating Range
 ■ Best Efficiency Range
 ■ Do Not Operate Range

TECH TIP

Servicing pumps has never been easier! With a rotor wrench built into the prefilter, TT-Series pumps can be cleaned and serviced without tools. Simply unlatch the prefilter, twist the volute a quarter turn to remove, and use the notch and two slots in the prefilter on the tabs to unlock the rotor.

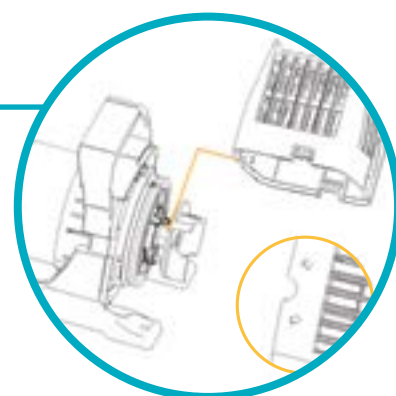



AQUAMAX ECO EXPERT



57875



88676

- Brushless DC pumps are powerful, energy efficient filtration pumps for demanding filter systems and large waterfalls
- Oase AquaMax Eco Expert are next generation pumps outstandingly suited for powerful and economical water delivery
- Oase AquaMax Eco Expert 12 Volt pumps are perfect for recreational ponds where line voltage pumps are prohibited
- Patented frost protection protects against freeze damage down to -4°F while grounding plate safeguards against stray current
- Integrated Environmental Function Control automatically shuts off the pump in run dry conditions to prevent motor damage
- Patented Seasonal Flow Control (SFC) slows flow and reduces wattage up to 50% as water temperatures drop
- Submersed or inline installation in a variety of water types, including chlorinated pool and salt water, see page 97
- Eco Control and Garden Cloud Controller operate and monitor pump remotely (sold separately)
- 32' 12 volt extension cables available, see page 177



ITEM	57875	57963	88676	88677
DESCRIPTION	AquaMax Eco Expert 6800	AquaMax Eco Expert 11500	AquaMax Eco Expert 5300 - 12V	AquaMax Eco Expert 7100 - 12V
VOLTS	220 - 240 V / 50-60 Hz		100 - 120V / 50-60 HZ	
AMPS	2	3.5	2.2	
WATTS	440	700	260	
INLET	G2 (#85310 adapter available)			
OUTLET	2"			
MAX SOLIDS SIZE	7/8"			
CORD	33'		8' + 26'	
DIMENSIONS	19"L x 8 1/2"W x 8"H	21"L x 9 3/4"W x 8 3/4"H	19 1/4"L x 9 1/2"W x 8 3/4"H	21 1/4"L x 9 3/4"W x 8 3/4"H
OUTLET FITTING	Sch40 1 1/2" - 2" adapter			
WARRANTY	3-year + 2			

ITEM	MAX FLOW (GPH)	5'	10'	15'	20'	25'	30'	35'
57875	6800	6100	5000	3950	2600	850		
57963	11500	10000	8400	6850	5350	3900	1550	
88676	5100	3600	2400	150				
88677	7100	5050	3000	325				

AQUAMAX ECO EXPERT FEATURES:

1. Ergonomic handle aligns with the pump's center of gravity.
2. Integrated mounting holes in the base enable fixed installation.
3. Rotatable volute handles multiple configurations.
4. Robust stainless steel intake screen prevents large debris entering pump.
5. Seasonal Flow Control (SFC) switch lowers flow and wattages as water cools to 40°F.
6. Grounding plate safeguards against short circuits.
7. EGC connections provide input/output to an additional 9 devices, remotely from anywhere in the world.



ACCEPTABLE WATER QUALITY RANGE

	pH VALUE	HARDNESS	FREE CHLORINE	CHLORIDE CONTENT	SALT CONTENT	OVERALL DRY RESIDUE	TEMPERATURE
FRESHWATER	6.8 - 8.5	142 - 267 ppm	<0.3 ppm	<250 ppm	<0.4%	<50 ppm	39° - 95°F
POOLWATER	7.2 - 8.3	142 - 267 ppm	<0.6 ppm	<250 ppm	<0.4%	<50 ppm	39° - 86°F
SALTWATER	7.2 - 8.5	256 - 534 ppm	<0.3 ppm	<22000 ppm	<4.0%	<50 ppm	39° - 82°F

CLEAR WATER GUARANTEE

PUMP	FILTER	UVC
AquaMax Eco Expert 6800*	ProfiClear Premium Compact-M	Bitron C 55 & Bitron C 110
	ProfiClear Premium Compact-L	Bitron C 110
AquaMax Eco Expert 11500*	BioTech ScreenMatic ² 39000	Bitron C 110
AquaMax Eco Expert 5300 12V AquaMax Eco Expert 7100 12V	ProfiClear Premium Compact-M Pump-fed ProfiClear Premium Compact-L Pump-fed ProfiClear Premium Compact-L Gravity-fed BioTec ScreenMatic ² 39000	Bitron C 110

*Must adjust flow down to Max flow of filter

CONTROLLERS

The AquaMax Eco Expert has two options to remotely control the pump

ECO CONTROL*

Eco Control is an innovative controller that directly connects to the pump to regulate all functions, with an easy-to-read illuminated two-line display. See page 102 for more information.

The Eco Control standalone controller provides:

- Seasonal Function Control (SFC)
- Complete adjustment of output flow
- Power consumption read-out
- Pump status and malfunctions display
- Real time rotation speeds
- Total runtime data



Eco Control

*Not useable if the pump is connected to an Oase Control network

OASE CONTROL (OC)

Connect your AquaMax Eco Expert to the Oase Control (OC) to operate the pump from anywhere in the world on any Android or Apple Device with Oase Control mobile application. See page 124 for more information.

Oase Control can display and/or control a variety of functions including:

- Seasonal Function Control (SFC)
- Complete adjustment of output flow
- Operation status
- Water temperature
- Power consumption
- Overall performance data
- Performance charts over time



Garden Cloud Controller



POOL CLEANOUT PUMP



ITEM	73903
MODEL	TUP2000
DESCRIPTION	Pool Cleanout Pump
MOTOR	1/5 HP
VOLTS	120
AMPS	2.9
WATTS	330
OUTLET	1 1/4" MPT
CORD	20'
DIMENSIONS	5 1/2"W x 12 1/2"H
OUTLET FITTING	Tapered 1 1/4" / 1 1/2" for standard pool hoses
WARRANTY	1-year Limited

- Pool cleanout pumps are designed to allow complete drainage of the water in a typical swimming pool or spa
- Atlantic's Pool Cleanout Pump features 316 stainless steel and composite construction resists chlorine, salt and acid
- Small diameter fits into most swimming pool drains, to drain pools dry
- High visibility low water level indicator band shows water level at a distance

- Shallow water bottom intake drains water down to as little as 1/2" of depth
- Flow-through internal cooling keeps pump from overheating even when not fully immersed
- Continuous duty motor features double mechanical seals and thermal overload protection
- Includes backwash hose adapter fitting, heavy duty top handle and strain relief to protect cord

MODEL	MAX FLOW	Distance (ft)				
		5'	10'	15'	20'	25'
TUP2000	GPM 34	29.5	23.8	17	4	
	GPH 2040	1770	1428	1020	240	

Recommended Operating Range Best Efficiency Range Do Not Operate Range

DID YOU KNOW?

Atlantic's Pool Cleanout Pump is designed to drain pools and spas down to the last 1/2" of water. And don't worry about burning the pump out as the water drops. Flow-through internal cooling and automatic thermal shut off protection keep the pump cool, making this the perfect pump for all of your maintenance needs.



TIDALWAVE PAF-SERIES PUMPS



- Direct Drive pumps are perfect for demanding medium head, high-volume applications
- Atlantic PAF-Series pumps feature energy efficient direct drive motors, double silicone carbide mechanical seals and fiber-reinforced vortex impellers to ensure dependable, long lasting continuous duty service
- Removable intake screen converts pump from clean water service in skimmers to 1/4" solids handling capacity in ponds
- Stainless steel and high impact FRP composite housings are rugged and lightweight, for easier servicing and long life
- Overload and thermal protection shut down pump before overheating can cause damage



ITEM	73899	73900	73901	73902
MODEL	PAF-20	PAF-25	PAF-40	PAF-75
DESCRIPTION	PAF-Series - 1/4 HP	PAF-Series - 1/3 HP	PAF-Series - 1/2 HP	PAF-Series - 1 HP
MOTOR	1/4 HP	1/3 HP	1/2 HP	1 HP
VOLTS	115			
AMPS	3.5	5	6	8.5
WATTS	360	545	650	900
OUTLET	2" FIPT			
CORD LENGTH	20'			
DIMENSIONS	9"L x 6"W x 14"H	9"L x 6"W x 14 1/2"H	9"L x 6"W x 15"H	
OUTLET FITTING	2" Insert			
WARRANTY	2-year			

MODEL	MAX FLOW (GPH)	Distance (ft)						
		5'	10'	15'	20'	25'	30'	35'
PAF-20	---	2800	1950	1080	180			
PAF-25	---	3900	3150	2300	1350	240		
PAF-40	---	4950	4350	3570	2700	1700	520	
PAF-75	---	5950	5270	4560	3750	2830	1770	550

Recommended Operating Range Best Efficiency Range Do Not Operate Range

TIDALWAVE A-SERIES PUMPS

87752

73892



- A-Series Direct Drive pumps are built for the highest head, high volume applications, to tackle the longest runs and tallest falls
- A-Series pumps feature heavy-duty cast iron and stainless steel housing for years of dependable service
- Continuous duty Direct Drive motors reduce maintenance to simply keeping the intake screen clean
- Double silicone carbide mechanical seals and dual drive bearings reduce friction and wear, prolonging motor life
- Thermal overload protection shuts down pump in low water conditions, to prevent serious damage due to overheating

ITEM	73892	73893	73894	73895	87752
MODEL	A-05	A-05L	A-21	A-31	AN-32
DESCRIPTION	A-Series - 1/2 HP	A-Series - 1/2 HP	A-Series - 1 HP	A-Series - 1 HP	A-Series - 2 HP / 230V
MOTOR	1/2 HP	1/2 HP	1 HP	1 HP	2 HP
VOLTS	115				230
AMPS	5.4	6.4	10		9.8
WATTS	645	725	1060	1160	2155
OUTLET	2" FIPT			3" FIPT	
WEIGHT	32 lbs.	40 lbs.	43 lbs.	48 lbs.	92 lbs.
CORD LENGTH	30'				
DIMENSIONS	9"L x 6 1/4"W x 15"H	10"L x 7"W x 17"H		11"L x 7"W x 18"H	15 1/2"L x 8 1/4"W x 23"H
WARRANTY	2-year				

MODEL	MAX FLOW (GPH)	5'	10'	15'	20'	25'	30'	35'	40'	45'	50'	55'	60'
A-05	---	3165	2840	2500	2155	1875	1455	935	320				
A-05L	---	5040	4320	3600	2820	1920	840						
A-21	---	5810	5325	4824	4335	3770	3140	2400	1530	540			
A-31	---	9300	8150	6830	5535	4120	2535	625					
AN-32	---	14100	13320	12300	11100	10200	9180	7920	6600	5220	3900	2520	1320

Recommended Operating Range Best Efficiency Range Do Not Operate Range

TIDALWAVE L-SERIES PUMPS



- L-Series Direct Drive Axial pumps economically deliver very high volumes of water at low head through large diameter plumbing for wide waterfalls or where massive flows are required
- L-Series Direct Drive Axial pumps feature 3-inch male threaded outlets for ease in plumbing large diameter tubing
- Heavy-duty cast iron and stainless steel housing ensures years of dependable service
- Dual drive bearings and double silicone carbide mechanical seals reduce friction and wear, prolonging motor life
- Thermal overload protection shuts down pump in low water conditions, to prevent serious damage due to overheating

ITEM	73897	73898
MODEL	L-305	L-310
DESCRIPTION	L-Series - 1/2 HP	L-Series - 1 HP
MOTOR	1/2 HP	1 HP
VOLTS	115	
AMPS	8.0	10
WATTS	710	1105
OUTLET	3" MPT	
WEIGHT	60 lbs.	65 lbs.
CORD LENGTH	30'	
DIMENSIONS	9"L x 9"W x 19 1/4"H	
WARRANTY	2-year	

MODEL	MAX FLOW (GPH)	5'	10'	15'	20'	25'	30'
L-305	---	10380	7380	3960			
L-310	---	13500	10560	7380	3240		

Recommended Operating Range Best Efficiency Range Do Not Operate Range

PUMP ACCESSORIES

AQUAMAX SATELLITE FILTER



ITEM	51074
DESCRIPTION	AquaMax Satellite Pre-Filter
DIMENSIONS	14½"L x 10¼"W x 4"H
FOR USE WITH	AquaMax Eco Premium Pumps
HOSE SIZE	1", 1¼", 1½"
WARRANTY	1-year

- Compatible with Oase AquaMax Eco Premium Pumps
- Use as a remote bottom drain for increased circulation and debris removal up to ¾" from an additional area on the pond floor
- Includes metric step fitting (1", 1¼", 1½")

PUMPSHIELD®



ITEM	45394
DESCRIPTION	PumpShield®
DIMENSIONS	15"L x 15"W
WARRANTY	1-year

- Extend the service life of your pump and ensure lasting high performance by keeping out large debris
- Simply drop the pump into the PumpShield and deploy
- Durable construction for long service life

ECO CONTROL



ITEM	72375
DESCRIPTION	Eco Control
CORD	33'
DIMENSIONS	3¼"L x 3½"W x 1½"H
FOR USE WITH	Aquarius Eco Expert & AquaMax Eco Expert Pumps
WARRANTY	1-year

- Innovative controller for smart regulation of Eco Expert Pumps
- Illuminated two-line display for easy read-out
- Displays power consumption, pump status and malfunctions, rotation speeds and total runtime
- Allows remote operation of Seasonal Function Control (SFC) and Dynamic Function Control (DFC)
- Standalone controller needs no external power supply, but cannot be used if the pump is connected to an Oase Control (OC) System

VARIABLE SPEED CONTROLLER



Weatherproof output port locks pump cord in place

ITEM	73933
MODEL	TWVSC
DESCRIPTION	TidalWave Variable Speed Controller
CORD LENGTH	6'
FOR USE WITH	TT-Series Pumps up to 800 watts
DIMENSIONS	6"H x 4"L x 2"W
REQUIRES	Atlantic Control App
WARRANTY	3-year

- Variable Speed Controllers change the speed of rotation of the rotor of asynchronous pumps to vary both the flow and the wattage draw
- Atlantic's TidalWave VSC allows you to vary the output of TidalWave TT-Series Asynchronous pumps wirelessly
- VSC varies pump output from maximum down to 30% in 10 levels of adjustment using required Atlantic Control Bluetooth® app
- Unlike built-in variable speed controlled pumps, where any failure of pump or controller renders both inoperable, our Variable Speed Controller operates separately from the pump
- Rugged weatherproof housing with covered plug nook allows mounting the box outdoors near your pump, while the cord lock eliminates inadvertent plug disconnection
- Indicator light turns blue when VSC is plugged into power and turns green when powering the pump
- In the event of power loss, the Variable Speed Controller will retain the last settings of flow level and programmed on/off times

ATLANTIC CONTROL APP

- Next generation Atlantic Control Bluetooth® application turns any TT-Series asynchronous pump into a variable speed pump
- Customize name and password to effortlessly switch between multiple VSCs to wirelessly control multiple water features
- Program up to 3 different time periods in 24 hours, each with its own custom flow
- Simplify routine maintenance and feeding with customizable pause button which automatically resumes last flow level after a preset time
- App is available on Google Play Store and Apple App Store and is required for operation of the Variable Speed Controller



I INSTALLATION

Atlantic offers the best of everything you need to install your water features, without ever compromising quality. From innovative products designed with you in mind, like the award-winning Triton Check Valve that works with any pump, skimmer or pump vault, to fittings, foam, tubing and liner all proudly manufactured in the USA, our installation accessories will stand the test of time.

- » Triton Check Valves custom fit every Atlantic application and adapt to all other manufacturers' equipment for the greatest versatility and convenience for the installer
- » Atlantic high density FallsFoam available in gun cartridge and single use cans resists ultraviolet light and weathering for years of dependable service
- » Compact, fully adjustable Automatic Fill Valves install easily to top water off automatically, saving time, trouble and pumps
- » American-made Kink-Free and flex PVC pipe sized for every application have greater flexibility for easier installation
- » Choice of liner includes Carlisle Aquatough EPDM with J-Tear technology or rolls of 40mil PVC



TRITON CHECK VALVE



ITEM	74222
MODEL	TR215CV
DESCRIPTION	Triton Check Valve
VALVE DIMENSIONS	5 5/8" L x 3 1/2" W x 10" H
INLET	1 1/2" or 2" MIPT
OUTLET	1 1/2" or 2" socket
WARRANTY	3-year

- Check Valves mount to the pump in the Skimmer to maintain water in biological filters and keep beneficial bacteria hydrated
- Atlantic's Triton TR215CV Check Valve is the first and only specifically designed for water feature use
- Included adapters accommodate multiple pump, skimmer, vault and plumbing options
- Single unions above and below the check valve speed removal of the valve and pump for servicing, maintenance and winterizing

TRITON CHECK VALVE FEATURES:

1. Full flow swing valve with inlet and outlet unions and a replaceable gasket.
2. Includes discharge fittings for 1 1/2" and 2" PVC pipe and 1" - 1 1/2" tapered insert fitting for metric and ASTM standard tubing.
3. Reversible discharge pipe works with all 1 1/2" and 2" discharge TidalWave pumps and Atlantic equipment.
4. Molded "perfect-cut" dimensions to identify proper lengths for Atlantic product and cut-to-fit 1/8" increments on the reverse side.
5. Discharge extension for use with taller Atlantic equipment.
6. Maximum assembled height of 23" from the pump discharge to the center of the outlet. Pipe can be extended to any length using 2" Sch 40 pipe and fittings.

AWGCV30



ITEM	74220
MODEL	AWGCV30
DESCRIPTION	3" Check Valve Assembly
VALVE DIMENSIONS	11 1/2" L x 5 1/2" W x 13 1/2" H
INLET	3" socket
OUTLET	3" rubber coupling
WARRANTY	3-year

- Asymmetrical valve body fits vertical pumps with little lateral clearance
- Rubber coupling simplifies pump and valve removal for servicing, maintenance and winterizing
- Can be extended to any height using 3" Sch 40 pipe and fittings
- Full flow flap design reduces friction losses and increases flow



INSTALLATION PRODUCTS

FALLSFOAM



- 74198**
 - FallsFoam fills voids and keeps water flowing on top of waterfall rocks instead of under them
 - Atlantic's high density closed cell FallsFoam resists foot traffic and waterlogging
- 74199**
 - Black for lower visibility, FallsFoam resists UV deterioration and lasts for years
- 74203**
 - Foam Cleaner quickly dissolves uncured foam to keep guns and surroundings clean

ITEM	74198	74199	74203
MODEL	LF1100	LF1300	LF1325
DESCRIPTION	DIY Black Waterfall Foam Can w/ applicator straw	Professional Black Waterfall Gun Foam	Foam Gun Cleaner Can w/ optional spray nozzle
FOR USE WITH	---	Foam Guns	
SIZE	12 oz.	24 oz.	12 oz.
WARRANTY / SHELF LIFE	1 year from Born on Date		1-year

FALLSFOAM GUNS

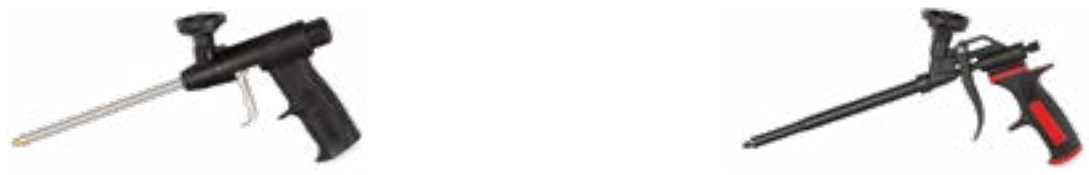

- 74201**
 - Foam Guns feature a 7" barrel length for hard to reach areas
 - Durable solvent resistant construction
- 74200**
 - Adjustable nozzle to control bead width
 - Professional Foam Gun features non-stick coated barrel

ITEM	74201	74200
MODEL	HT330	HT770
DESCRIPTION	Economy Foam Gun	Professional Foam Gun
FOR USE WITH	24 oz. cans	
WARRANTY	1-year	

AUTO FILL



ITEM	74246
MODEL	AF1000
DESCRIPTION	1/2" MIPT Auto Fill Kit
WARRANTY	1-year

- Automatic fill valves maintain a consistent water level in basins and reservoirs
- Atlantic's AF1000 Automatic Fill Valve works with all Atlantic Skimmers, Pump Vaults, Formal Spillway and Fountain Basins
- Includes fittings to connect to a water supply using standard garden hose, 1/2" irrigation line and 1/2" Sch 40 PVC
- Supplies 1.5 gallons per minute at up to 80 psi (60 psi or less is recommended)

RTV SILICONE SEALANT



ITEM	74247	74248
MODEL	SN2800	SN10300
DESCRIPTION	Black RTV Silicone Tube	Black RTV Silicone Cartridge
SIZE	2.8 oz.	10.3 oz.
SHELF LIFE	2 years from Born on Date	

- Black RTV Silicone Sealant is used to create a watertight seal where liner is attached to filtration components
- RTV Silicone used in conjunction with Atlantic's molded inserts, liner retention flanges and stainless steel hardware ensures a watertight connection every time
- Atlantic's Room Temperature Vulcanization formula cures quickly for a permanent flexible seal
- Available in both small tube and gun cartridge sizes

SPECIALTY FITTINGS



- Atlantic's polypropylene bulkhead fittings install in flexible and rigid reservoir walls to create secure plumbing connections with standard Schedule 40 PVC fittings
- Reverse threaded bulkhead fittings tighten as standard fittings are screwed into them
- Cord Seal Fitting with expanding rubber core fits inside 1/2" socket fittings to create a leak-proof seal around 1/8" - 3/8" cords
- Cord Seal Fitting is used to pass pump and lighting cords in underwater bulkhead or conduit connections through reservoir walls
- 1/2" Universal Union with multiple outlet options is perfect for almost all Fountain and Formal Spillway applications

ITEM	74223	74224	74225	74205	93453
MODEL	HA1550	HA2000	HA3000	CSEAL15	4SU-015-010G
DESCRIPTION	Bulkhead (1 1/2" FIPT x 1 1/2" FIPT)	Bulkhead (2" FIPT x 2" FIPT)	Bulkhead (3" FIPT x 3" FIPT)	Cord Seal Fitting	1 1/2" Universal Union (soc x soc / MPT)
DIMENSIONS	4 1/2"W x 2 3/4"H		5 1/2"W x 2 1/2"H	1 7/8"W x 1 7/8"H	4"L x 3 1/2"W x 3 1/2"H
HOLE SIZE	3"		4 1/2"	1 1/2" Sch 40 socket fitting	---
INCLUDES	---			1 1/2" male thread adapter	1 1/2" soc / 1 1/2" MPT / 1" soc outlet fittings

TUBING & FITTINGS

FLEXIBLE PVC PIPE

Atlantic's top quality, American made Schedule 40 PVC pipe is heavy-walled, extremely flexible and incredibly durable. Decrease labor and maximize pump flow with Flexible PVC Pipe.



ITEM	90158	93839	75251	75252	75253	75254	75255	75250
MODEL	FH125	FH150	FH1525	FH1550	FH225	FH250	FH350	KF.75100
DESCRIPTION	1" x 25' PVC Black Flex Pipe	1" x 50' PVC Black Flex Pipe	1½" x 25' PVC Black Flex Pipe	1½" x 50' PVC Black Flex Pipe	2" x 25' PVC Black Flex Pipe	2" x 50' PVC Black Flex Pipe	3" x 50' PVC Black Flex Pipe	¾" x 100' PVC Kink-Free Tubing
WEIGHT	8 lbs.	16 lbs.	13 lbs.	26 lbs.	18 lbs.	36 lbs.	70 lbs.	11 lbs.
WARRANTY	5-year							

METRIC KINK-FREE TUBING

UV resistant Oase Metric Kink-Free Tubing accommodates Oase fittings and outlets and can withstand up to 45 psi.



ITEM	45402	45399	45398	45400
DESCRIPTION	¾" x 20' Kink-Free Tubing	1" x 20' Kink-Free Tubing	1½" x 20' Kink-Free Tubing	2" x 100' Kink-Free Tubing
WARRANTY	1-year			

OASE VINYL TUBING

Oase Metric Vinyl Tubing handles up to 45 psi and accommodates ½" ID fittings and outlets.



ITEM	45405
DESCRIPTION	½" x 20' Vinyl Tubing
WARRANTY	1-year

MULTI WD 1"



- Oase Multi WD 1" distributes water flow to up to 3 outlets
- All three outlets feature integrated flow controls

ITEM	46980
DESCRIPTION	Multi WD 1"
INLET	¾", 1", 1¼", 1½"
OUTLET	1"
WARRANTY	1-year

- For use with only two outlets use the included cap to seal off the third outlet

TRADUX



- Oase Tradux is a bulkhead fitting assembly with accessories to pass tubing or cables through a reservoir wall
- Passes tubing or cords underwater through pond liner or pre-formed pond walls with included cord seal fitting

ITEM	42750
DESCRIPTION	Tradux Bulkhead Fitting
HOSE SIZE	¾", 1", 1¼", 1½", 2"
INCLUDES	(2) metric step fittings (¾", 1", 1¼", 1½", 2"), bulkhead fitting and cord seal fitting
WARRANTY	2-year

- Underwater connections keep water features aesthetically seamless and organic
- Easy installation with just a screwdriver

FLOW REGULATOR



- Oase Flow Regulator controls water flow to filters and water features

ITEM	51260
DESCRIPTION	Flow Regulator
OUTLET	1" - 1½"
HOSE SIZE	1", 1¼", 1½"
INCLUDES	Valve body, 2 metric step fittings (1", 1¼", 1½")
WARRANTY	1-year

- Use as a tubing connector for connecting kink-free tubing

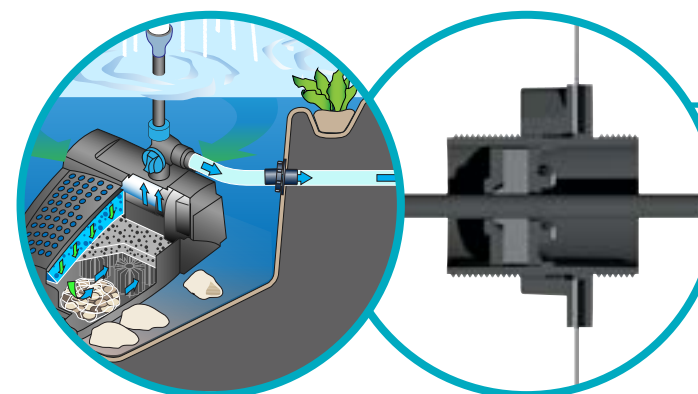

DID YOU KNOW?

The Tradux fitting can be used either to pass tubing through the liner of a pond or water feature or, with the included cord seal fitting to pass electrical cords, such as those of pumps or lights, through the liner.



LINER & ACCESSORIES

UNDERLAYMENT



- Non-woven polypropylene fabric underlayment is puncture and abrasion resistant while still allowing air and water to pass
- Use Atlantic's premium 6 oz. underlayment above and below liner to protect against cuts, roots and abrasion

ITEM	74147	74148	74146
MODEL	PU1212	PU1225	PU12100
DESCRIPTION	Pond Underlayment (single bag)		Pond Underlayment (full roll w/ 6' core)
SIZE	12' x 12'	12' x 25'	12' x 100'

EPDM PRIMER & SEAM TAPE



- Seam tapes and liner primer work together to create permanent bonds between two separate liners
- Seam tape has a sticky unvulcanized rubber side that bonds to cleaned liner prepared with Primer to create watertight seams and repairs of inadvertent rips and tears

*Primer sales restricted in certain states

ITEM	74184	74185	74196	74197	74194	74195
MODEL	LI SEAMTAPE3	LI SEAMTAPE6	LI PRIMERQT	LI PRIMERQT-L	LI PRIMERGAL	LI PRIMERGAL-L
DESCRIPTION	Double-Sided Seam Tape	Single-Sided Cover Tape	Multi-Purpose Primer*	Low VOC Multi-Purpose Primer	Multi-Purpose Primer*	Low VOC Multi-Purpose Primer
SIZE	3" x 100'	6" x 100'	1 quart	1 quart	1 gallon	1 gallon

EPDM LINER REPAIR KIT



ITEM	74183
MODEL	LI REPAIRKIT-SM
DESCRIPTION	Small Liner Repair Kit
INCLUDES	2 oz. of Multi-Purpose Primer*, (2) 6" x 6" Peel & Stick Patches, Patch Roller, Scrubber Pad & gloves

- Liner repair kits contain everything needed to create watertight seams and repair inadvertent rips and tears.
- Atlantic Small Liner Repair Kit is a convenient way to ensure you have everything on hand to make small repairs and seams instantly

PVC LINER GLUE



- PVC Liner adhesive is designed to create an ultra strong bond with 40 mil PVC liner and is safe for fish and plants after curing

ITEM	36861
DESCRIPTION	PVC Liner Adhesive 8.45oz / 250ml
SHELF LIFE	2-year

PVC LINER ROLLS

ITEM	DESCRIPTION	SIZE	CORE SIZE	PALLET QTY	WARRANTY
91258	13' x 82' 40 mil PVC Pond Liner	13'1" x 82' (4m x 25m)	6'-6"	12	20-year
91259	20' x 82' 40 mil PVC Pond Liner	20'8" x 82' (6m x 25m)	6'-6"	6	20-year
91260	26' x 82' 40 mil PVC Pond Liner	26'4" x 82' (8m x 25m)	6'-6"	6	20-year

CARLISLE EPDM BOXED LINER & LINER ROLLS

- Carlisle AquaTough 45mil EPDM liners are safe for use in water gardens, koi ponds, natural swim ponds and recreational ponds
- Exclusive J-Tear technology that turns on themselves to reduce the chance of ripping in the field
- Only Carlisle AquaTough liner includes a light surface dusting of the liner to improve handling and to reduce friction during panel install
- Available in boxed for convenience or in rolls for larger projects

ITEM	MODEL	SIZE	BOX DIMENSIONS / CORE SIZE	WEIGHT	WARRANTY
74193	LI810-B	8' x 10' Boxed Liner	12" x 12" x 13"	27 lbs.	Limited Lifetime
74186	LI1010-B	10' x 10' Boxed Liner	12" x 12" x 13"	33 lbs.	Limited Lifetime
74187	LI1015-B	10' x 15' Boxed Liner	12" x 12" x 13"	48 lbs.	Limited Lifetime
74188	LI1515-B	15' x 15' Boxed Liner	12" x 24" x 13"	71 lbs.	Limited Lifetime
74189	LI1520-B	15' x 20' Boxed Liner	12" x 24" x 13"	94 lbs.	Limited Lifetime
74190	LI1525-B	15' x 25' Boxed Liner	12" x 36" x 13"	117 lbs.	Limited Lifetime
74191	LI2020-B	20' x 20' Boxed Liner	12" x 36" x 13"	119 lbs.	Limited Lifetime
74192	LI2025-B	20' x 25' Boxed Liner	12" x 36" x 13"	150 lbs.	Limited Lifetime
74151	LI R1050	10' x 50' EPDM Liner Roll	6" Diameter - 6.5' Long	145 lbs.	Limited Lifetime
74154	LI R1550	15' x 50' EPDM Liner	6" Diameter - 6.5' Long	218 lbs.	Limited Lifetime
74159	LI R2050	20' x 50' EPDM Liner	6" Diameter - 6.5' Long	290 lbs.	Limited Lifetime
74164	LI R2550	25' x 50' EPDM Liner	6" Diameter - 6.5' Long	365 lbs.	Limited Lifetime
74168	LI R3050	30' x 50' EPDM Liner	6" Diameter - 6.5' Long	435 lbs.	Limited Lifetime
74171	LI R3550*	35' x 50' EPDM Liner	6" Diameter - 11' Long	508 lbs.	Limited Lifetime
77089	LI R4050*	40' x 50' EPDM Liner	6" Diameter - 11' Long	580 lbs.	Limited Lifetime
76033	LI R5050*	50' x 50' EPDM Liner	6" Diameter - 13.5' Long	725 lbs.	Limited Lifetime
74181	LI R5100	5' x 100' EPDM Liner	6" Diameter - 6.5' Long	145 lbs.	Limited Lifetime
74149	LI R10100	10' x 100' EPDM Liner	6" Diameter - 6.5' Long	290 lbs.	Limited Lifetime
74152	LI R15100	15' x 100' EPDM Liner	6" Diameter - 6.5' Long	435 lbs.	Limited Lifetime
74155	LI R20100	20' x 100' EPDM Liner	6" Diameter - 6.5' Long	580 lbs.	Limited Lifetime
74160	LI R25100	25' x 100' EPDM Liner	6" Diameter - 6.5' Long	725 lbs.	Limited Lifetime
74165	LI R30100	30' x 100' EPDM Liner	6" Diameter - 6.5' Long	870 lbs.	Limited Lifetime
76030	LI R35100*	35' x 100' EPDM Liner	6" Diameter - 11' Long	1015 lbs.	Limited Lifetime
76031	LI R40100*	40' x 100' EPDM Liner	6" Diameter - 11' Long	1160 lbs.	Limited Lifetime
77090	LI R45100*	45' x 100' EPDM Liner	6" Diameter - 13.5' Long	1320 lbs.	Limited Lifetime
76032	LI R50100*	50' x 100' EPDM Liner	6" Diameter - 13.5' Long	1450 lbs.	Limited Lifetime
74150	LI R10200*	10' x 200' EPDM Liner	6" Diameter - 13.5' Long	580 lbs.	Limited Lifetime
74153	LI R15200*	15' x 200' EPDM Liner	6" Diameter - 13.5' Long	870 lbs.	Limited Lifetime
74156	LI R20200*	20' x 200' EPDM Liner	6" Diameter - 13.5' Long	1160 lbs.	Limited Lifetime
74161	LI R25200*	25' x 200' EPDM Liner	6" Diameter - 13.5' Long	1440 lbs.	Limited Lifetime
74166	LI R30200*	30' x 200' EPDM Liner	6" Diameter - 13.5' Long	1730 lbs.	Limited Lifetime
74170	LI R35200*	35' x 200' EPDM Liner	6" Diameter - 13.5' Long	2000 lbs.	Limited Lifetime
74173	LI R40200*	40' x 200' EPDM Liner	6" Diameter - 13.5' Long	2280 lbs.	Limited Lifetime
74179	LI R50200*	50' x 200' EPDM Liner	6" Diameter - 13.5' Long	2850 lbs.	Limited Lifetime

Please note: All Liner is subject to availability

*Must be purchased on a full truckload, items are not stocked

L LIGHTING

Atlantic-Oase's innovative LED Lighting Systems feature the latest technology, fixtures, more color options and mobile applications to put complete control at your fingertips. Choose from a multitude of submersible and external fixtures, Warm White or Color Changing options.

- » Lighting products feature the highest quality light emitting diodes
- » Atlantic solid brass bodies dissipate heat, resist corrosion and provide long lasting, dependable service
- » Silicone gaskets and precision lenses guarantee weatherproof and waterproof performance
- » InfiColor Smart Module handles 80 watts, controls 3 independent illumination zones and is fully programmable via mobile application, controlling colors, timing, sequences, brightness and transitions
- » Oase ProfiLux RGB lights connect to the Oase Control System for individual cloud-based control from anywhere on the planet



ATLANTIC WARM WHITE LIGHTING SYSTEM

- Multiple fixtures cover a range of lighting options, in and out of the water
- Color temperature of 2800°K matches most legacy lighting including halogen
- Replaceable diodes ensure long service life
- Solid brass fixture construction resists corrosion and damage
- Standard flat 2-wire low voltage wiring easily integrates into existing systems



ATLANTIC COLOR CHANGING LIGHTING SYSTEM

- Multiple fixtures cover a range of lighting options, in and out of the water
- Replaceable diodes ensure long service life
- Solid brass fixture construction resists corrosion and damage
- InfiColor Smart Module controls lights via Bluetooth in Atlantic Control app
- Mix and match up to 80 watts over 3 independent zones



OASE PROFILUX RGB LIGHTING SYSTEM

- Highest quality German made components
- Oase Control System and App control each light individually
- Control lights via local Module over WiFi or connect to home router for Cloud control
- 24 volt system connects up to 4 lights at a time to underwater transformer
- Set lights up to 13' deep on adjustable base with nozzle mounting attachment



SPOTLIGHTS

- LED Spotlights create focal points in and around the water feature
- Atlantic's compact solid brass Spotlights with oil rubbed bronze finish blend into any landscape or water feature
- Small remote drivers 18" from light decrease heat and pull through 1" sweeps
- Submersible lights function equally well out of water and throughout the landscape
- LED units inside lights are easily replaceable
- Spotlights feature quick-connect plug for easy installation
- Flat 2-wire cord can be cut, stripped and tied into existing systems
- InfiColor Smart Module (sold separately) and Atlantic Control App (required) unlock the full potential of Color Changing Lights



74106
74096

74107
74097

ITEM	74106	74096	74107	74097
MODEL	WWCS2	CCCS2	WWCS4	CCCS4
DESCRIPTION	Warm White Compact Spotlight - 2 watt	Color Changing Compact Spotlight - 2 watt	Warm White Compact Spotlight - 4 watt	Color Changing Compact Spotlight - 4 watt
INPUT	12 volt AC	InfiColor	12 volt AC	InfiColor
WATTS	2		4	
BEAM ANGLE	45 Degrees			
LUMENS	100	Variable	300	Variable
COLOR TEMPERATURE	2800K	---	2800K	---
DIMENSIONS	2 5/8" L x 1 1/8" W		2 5/8" L x 1 1/4" W	
CORD LENGTH	20'			
INCLUDES	Base & ground stake			
REQUIRES	WW30X4 or 12 volt Transformer	InfiColor Smart Module, 12 volt Transformer & Atlantic Control App	WW30X4 or 12 volt Transformer	InfiColor Smart Module, 12 volt Transformer & Atlantic Control App
WARRANTY	5-year Limited			

DID YOU KNOW?

Atlantic has made major improvements to Color Changing lighting, redesigning plugs with large and small solid steel pins to eliminate any chance of misalignment, lengthening the driver housing to better dissipate heat and eliminate any chance of shorting between power leads.



HARDSCAPE LIGHTS

- Hardscape Lights brighten walls, columns or steps evenly, without hot spots
- Atlantic Hardscape Lights of solid brass and stainless steel feature a classic oil rubbed bronze finish to enhance any hardscape
- Hardscape Lights install under steps, caps and counters
- Cast brass epoxied diode assembly can be replaced without removing mounting plate
- Isolated drivers decrease size of fixture and optimize heat dissipation
- Hardscape Lights feature quick-connect plug for easy installation
- Flat 2-wire cord can be cut, stripped and tied into existing systems
- InfiColor Smart Module (sold separately) and Atlantic Control App (required) unlock the full potential of Color Changing Lights



ITEM	74141	74129
MODEL	WWHL6	CCHL6
DESCRIPTION	6" Warm White Hardscape Light	6" Color Changing Hardscape Light
INPUT	12 volt AC	InfiColor
WATTS	2	
BEAM ANGLE	120 Degrees	
LUMENS	20	Variable
COLOR TEMPERATURE	2800K	---
DIMENSIONS	6" L x 7/8" W x 7/8" H	
CORD LENGTH	20'	
INCLUDES	Mounting Plate	
REQUIRES	WW30X4 or 12 volt Transformer	InfiColor Smart Module, 12 volt Transformer & Atlantic Control App
WARRANTY	5-year Limited	

TECH TIP

Unlike many built-in fixtures, Atlantic's Hardscape Lights feature a removable LED diode assembly. The assembly attaches with two stainless steel screws, eliminating the need to remove the steel anchor plate to replace the light. Simply loosen the screws and unplug the assembly to remove the old light bar and replace with the new one. Use dielectric silicone grease on the plug to maintain water resistance.



FOUNTAIN LIGHTING



74143
74132

- Low profile Ring Light uplights and washes with an extremely wide 120° beam angle
- Atlantic's solid brass Ring Lights feature a classic oil rubbed bronze finish that complements any landscape or water feature
- Epoxy-encased, cast brass light fits over 1½" pipe and includes bushing for 1" applications
- Ring Lights feature quick-connect plug for easy installation
- Flat 2-wire cord can be cut, stripped and tied into existing systems
- InfiColor Smart Module (sold separately) and Atlantic Control App (required) unlock the full potential of Color Changing Lights



74137
74127

- Fountain lights illuminate water inside vases, basalt and bubbling boulders
- Atlantic's epoxy-encased Fountain Lights flood plumes of water with 120° beam angle
- PVC body with bottom mounted cord fits into ½" socket fittings and 2" bore holes
- Fountain Light accepts standard ¾" rigid PVC or Kink-free tubing
- Fountain Lights feature quick-connect plug for easy installation
- Flat 2-wire cord can be cut, stripped and tied into existing systems
- InfiColor Smart Module (sold separately) and Atlantic Control App (required) unlock the full potential of Color Changing Lights

ITEM	74143	74132	74137	74127
MODEL	WWRL5	CCRL5	WWFL2	CCFL2
DESCRIPTION	Warm White Ring Light	Color Changing Ring Light	Warm White Fountain Light	Color Changing Fountain Light
INPUT	12 volt AC	InfiColor	12 volt AC	InfiColor
WATTS	5		2	
BEAM ANGLE	120 Degrees			
LUMENS	500	Variable	150	Variable
COLOR TEMPERATURE	2800K	---	2800K	---
DIMENSIONS	3¼"OD x 2"ID x ¾"H		2"W x 1½"H	
CORD LENGTH	20'			
INCLUDES	1" Bushing		¾" insert fitting	
REQUIRES	WW30X4 or 12 volt Transformer	InfiColor Smart Module, 12 volt Transformer & Atlantic Control App	WW30X4 or 12 volt Transformer	InfiColor Smart Module, 12 volt Transformer & Atlantic Control App
WARRANTY	5-year Limited			

SPECIALTY LIGHTING



74145
74134

- Spout Lights illuminate water flowing from Wall Spouts and bubbling boulders
- Atlantic's Spout Light with 1" MIPT machined brass body mounts inside Sch 40 PVC FIPT fittings to light the stream of water from inside plumbing
- Small diameter drivers are isolated 18" from light for optimal heat dissipation and fit through 1" conduit
- LED units inside lights are easily replaceable
- Spout Lights feature quick-connect plug for easy installation
- Flat 2-wire cord can be cut, stripped and tied into existing systems
- InfiColor Smart Module (sold separately) and Atlantic Control App (required) unlock the full potential of Color Changing Lights



74136
74126

- Linear lights are designed to wash walls, falls and spillways with a wide 120° beam angle
- Atlantic's solid brass Bar Light includes dual bases and stainless steel L-brackets to mount to any hard surface
- Mounted light rotates 30° in either direction for versatility in directing illumination
- Bar Lights feature quick-connect plug for easy installation
- Flat 2-wire cord can be cut, stripped and tied into existing systems
- InfiColor Smart Module (sold separately) and Atlantic Control App (required) unlock the full potential of Color Changing Lights

ITEM	74145	74134	74136	74126
MODEL	WWSL2	CCSL2	WWBL5	CCBL5
DESCRIPTION	Warm White Spout Light	Color Changing Spout Light	Warm White Bar Light	Color Changing Bar Light
INPUT	12 volt AC	InfiColor	12 volt AC	InfiColor
WATTS	2		5	
BEAM ANGLE	45 Degrees		120 Degrees	
LUMENS	100	Variable	500	Variable
COLOR TEMPERATURE	2800K	---	2800K	---
DIMENSIONS	1½"L x 1½"W x 1¾"H		11½"L x ¾"W x ½"H	
CORD LENGTH	20'			
INCLUDES	---		(2) Bases, L-brackets	
REQUIRES	WW30X4 or 12 volt Transformer	InfiColor Smart Module, 12 volt Transformer & Atlantic Control App	WW30X4 or 12 volt Transformer	InfiColor Smart Module, 12 volt Transformer & Atlantic Control App
WARRANTY	5-year Limited			

POND LIGHTING

- Submersible pond lights extend enjoyment of ponds and water features beyond dusk
- Atlantic's Pond Light Kits come complete with everything needed to illuminate waterscapes and the surrounding landscape
- Durable high-impact housing and replaceable diode assembly for long service life
- Triple Light Kits includes 12' cord from transformer to junction plus 8' to each light
- Warm White Pond Lights feature removable photocell light sensor with built-in memory
- Light sensor turns lights on at dusk, off after 6 hours, even if photocell gets covered
- Color Changing Pond Lights include single-zone InfiColor Smart Module to unlock the full potential of Color Changing Lights with Atlantic Control App



ITEM	74102	74095
MODEL	SOLWPL3	CCPL3
DESCRIPTION	Warm White Triple Pond Light Kit	Color Changing Triple Pond Light Kit
INPUT	12 volt AC	InfiColor
WATTS	6	
BEAM ANGLE	30 Degrees	
LUMENS	120	Variable
COLOR TEMPERATURE	2800K	---
DIMENSIONS	(3) 2½"L x 2"W	
CORD LENGTH	12' cord from transformer to junction + 8' to each light	
INCLUDES	Light bases, removable photocell & 12 volt outdoor transformer	Light bases, InfiColor Single Zone Smart Module & 12 volt outdoor transformer
REQUIRES	---	Atlantic Control App
WARRANTY	1-year	

DID YOU KNOW?

Pond Light Kits come with everything needed to set up automatic operation. Warm White Sets include photocells with light sensors that turn on at dusk and off after 6 hours of operation. Photocells are designed with a built-in memory that records the last 24 hours and repeats that schedule indefinitely if the photocell gets covered by debris or overgrown plantings.



WIRING & TRANSFORMERS



- Atlantic quick-connect wiring makes connecting multiple fixtures fast and easy
- Compact inline 4-outlet Block Splitters simplify connections and mount on flat surfaces to neaten and organize wiring
- All Splitters feature removable weatherproof caps for unused outlets and include dielectric grease
- Warm White Splitter can be stripped and spliced into existing low voltage systems
- Color Changing Splitters feature one-way keyed connections to eliminate misalignment and water intrusion

ITEM	74123	74112
MODEL	WWBSX4	CCBSX4
DESCRIPTION	Warm White 4-outlet Block Splitter	Color Changing 4-outlet Block Splitter
INPUT	12 volt AC	InfiColor
DIMENSIONS	5"L x 1½"W x 1½"H w/ 4" cord	
INCLUDES	Weatherproof caps	
WARRANTY	5 year	



- Extension cords allow remote placement of lights where needed most in the landscape, waterscape and hardscape
- Atlantic's extensions feature silicone gaskets and dielectric grease for secure waterproof connections
- Warm White extension cord can be stripped and spliced into existing low voltage systems
- Color Changing Extension Cords feature one-way keyed connections to eliminate misalignment and water intrusion

ITEM	74124	74113
MODEL	WWEXT20	CCEXT20
DESCRIPTION	Warm White Extension Cord	Color Changing Extension Cord
INPUT	12 volt AC	InfiColor
CORD	20'	
INCLUDES	Weatherproof caps	
WARRANTY	5 year	



- Solid state transformers provide dependable low voltage AC current to Atlantic LED Lighting Systems and are fully weatherproof for worry-free outdoor installations
- TRANS60 connects to 2-pin Warm White quick-connect plugs
- TRANS88 and TRANS150 feature built-in photocell with light sensor and timer to turn on at dusk and off at dawn or after 4, 6 or 8 hours of operation
- Connect wiring directly to TRANS88 and TRANS150

ITEM	77031	74111	74110
MODEL	TRANS60	TRANS88	TRANS150
DESCRIPTION	60 Watt Transformer	88 Watt Transformer	150 Watt Transformer
INPUT	120 volt AC		
OUTPUT	12 volt AC		
WARRANTY	1 year		



INFICOLOR SMART MODULE

The InfiColor Smart Module and Atlantic Control mobile application at the heart of the Color Changing Lighting System allow users to program custom color sequences and transitions, set sequence timing and daily scheduling and unlock all RGB options on any Apple or Android mobile device. The InfiColor Smart Module controls three individual zones via Bluetooth® in the Atlantic Control app.



ITEM	97740
MODEL	CCSM30X3
DESCRIPTION	InfiColor Smart Module
INPUT	120 volt AC
OUTPUT	InfiColor
REQUIRES	Atlantic Control App
WARRANTY	1 year

- InfiColor Smart Module and Atlantic Control App unlock the full potential of Color Changing Lights
- Smart Module is wirelessly controlled via Atlantic Control App, no remote necessary
- The three outlets of the InfiColor Smart Module can be synced and linked as a single zone or three zones may be controlled individually
- Each outlet can control up to 30 watts of Color Changing Lighting with additional splitters
- A total of 80 watts of lighting can be controlled per InfiColor Smart Module
- Module includes removable weatherproof caps for unused outlets and dielectric grease

ATLANTIC CONTROL APP

The Bluetooth® Atlantic Control App makes custom colors, sequences, transitions, timing and daily scheduling of your Atlantic Color Changing Lighting or Color Changing Colorfalls accessible on any Apple or Android mobile device, no remote necessary.



- Select any or all of the three zones to control
- Choose any color visually or create a custom color with RGB sliders
- Combine and save custom color sequences as Favorites
- Assign one of five transitions and adjust the speed of any Favorite
- Adjust brightness of sequences and solid colors as desired
- The three zones can be independently named and scheduled
- Atlantic Control App is available on all Apple or Android devices



WIRING KITS

INFICOLOR WIRING KIT



ITEM	74125
MODEL	CC30X3
DESCRIPTION	InfiColor 3 Light Wiring Kit
INPUT	120 volt AC
OUTPUT	InfiColor
INCLUDES	InfiColor Smart Module & 30 Watt Transformer
WARRANTY	1 year

- InfiColor Wiring Kit powers and connects up to three Color Changing Lights
- Color Changing Lights can be synced and linked as a single zone or three zones may be controlled individually
- Module includes removable weatherproof caps for unused outlets and dielectric grease
- 30 watt solid state Transformer is fully weatherproof for worry-free outdoor installations
- Add additional splitters to control up to 30 watts of Color Changing lighting

WARM WHITE WIRING KIT



ITEM	74122
MODEL	WW30X4
DESCRIPTION	Warm White 4 Light Wiring Kit
INPUT	120 volt AC
OUTPUT	12 volt AC
INCLUDES	30 Watt Transformer & 4-outlet Block Splitter
WARRANTY	1 year

- Warm White Wiring Kit powers and connects up to four Warm White Lights
- Compact inline 4-outlet Block Splitter simplifies connections and mounts on flat surfaces to neaten and organize wiring
- 30 watt solid state Transformer is fully weatherproof for worry-free outdoor installations
- Add additional Splitters (not included) to power up to 30 watts of Warm White Lighting

PROFILUX GARDEN LED RGB



- RGB LED Lighting is a colorful way to extend your enjoyment of your landscape or waterscape into the evening
- Oase ProfiLux Garden LED RGB produces the full spectrum of LED light in conjunction with the Garden Cloud Controller unit
- Adjustable head with innovative integrated clamping system for flexible positioning in a variety of applications including onto OASE 1" Nozzle Extension (page 20, not included)
- Energy efficient LED with stainless steel adjustment screws and reflector
- Suitable for use in and out of the water to a water depth of 13'
- ProfiLux Garden LED Controller connects up to 4 spotlights; multiple ProfiLux Controllers may be connected to the Oase Control System



ITEM	72376	72377
DESCRIPTION	ProfiLux Garden LED RGB Set 3	ProfiLux Garden LED RGB
INPUT	24 volt DC	
WATTS	19	6
BEAM ANGLE	25 degrees	
LUMENS	213 (Red - 64 / Green - 114 / Blue - 35)	
DIMENSIONS	3"W x 4½"H	
CORD LENGTH	16'	
REQUIRES	Garden Cloud Controller (#72380)	ProfiLux Garden LED Controller (#72378) & Garden Cloud Controller (#72380)
INCLUDES	3 spotlights with 16' power cord, 24 volt underwater ProfiLux Garden LED controller, 3 bases and 3 ground stakes	1 spotlight with 16' power cable, base and ground stake
WARRANTY	2-year + 1	

OASE CONTROL



Connect your ProfiLux Lights to the Oase Control System (OC) to fully control each light, up to 40 lights*, from anywhere in the world on any Android or Apple device with Oase Control mobile application. See page 124 for more information on the Garden Cloud Controller.

Oase Control can display and control a variety of functions including:

- 9 preset color choices
- Color wheel for infinite color choices
- Brightness control
- Access 11 pre-programmed light shows
- Light show speed control
- All lights can be individually controlled

*Each ProfiLux Garden LED Controller is one device within the OC System



PROFILUX ACCESSORIES

PROFILUX GARDEN LED CABLE



- Extends the distance between ProfiLux Garden LED RGB Spotlights and LED Controller 24 feet

ITEM	72379
DESCRIPTION	24' ProfiLux Garden LED Cable
CORD LENGTH	24' / 7.5m
WARRANTY	2-year

- Only one extension cable can be used per light, suitable for use in and out of the water

PROFILUX GARDEN LED CONTROLLER



- Controller rated for underwater use is required for operation of ProfiLux Garden LED lights
- Connect to Garden Cloud Controller (sold separately) for wireless control of Spotlights

ITEM	72378
DESCRIPTION	ProfiLux Garden LED Controller
CORD LENGTH	16'
DIMENSIONS	8½"L x 4½"W x 2¼"H
WARRANTY	2-year + 1

- Powers up to 4 ProfiLux Spotlights with 30 watts of 24V current and only counts as one device within the Oase Control System

DID YOU KNOW?



ProfiLux Lights include a mounting attachment for Fountain Heads or any other shaft, pipe or object up to 1" in diameter. This allows for unique lighting opportunities in the landscape and underwater.



GARDEN CLOUD CONTROLLER



ITEM	72380
DESCRIPTION	Garden Cloud Controller
INPUT	12 volt AC
WATTS	2
CORD LENGTH	6'
DIMENSIONS	5¼"W x 3¼"D x 1½"H
INCLUDES	6' connection cable, End Resistor, OC Cable Connector and 110V outdoor transformer
WARRANTY	2-year + 1

- The Garden Cloud Controller operates and monitors Oase Control System devices via WiFi application, either locally or over the Internet
- OC-enabled filters, pumps and lights are directly linked to the Garden Cloud Controller with Connection Cables and controlled by the Oase Control App
- The free Oase Control App individually reads and regulates any combination of up to 10 OC pumps, filters or LED controllers on any Apple or Android platform
- For local control of the hardwired network within 260' of the Cloud Controller, the Oase Control App connects directly to the Controller via WiFi
- For world-wide control, link the Cloud Controller to a home router to enable the app to control the devices from anywhere on your mobile device

- Controller mounts conveniently on a wall or in the ground with included stake and mounting hardware
- The controller housing has an IP64 waterproof rating allowing for all-season outdoor use
- All compatible devices connect to each other by cables to in/out plugs on devices
- All components are individually controlled regardless of their location in the chain of devices

	COMPATIBLE DEVICES
FILTERS	ProfiClear Premium Compact-M Pump-fed (72374) ProfiClear Premium Compact-L Pump-fed (73379) ProfiClear Premium Compact-L Gravity-fed (89194)
LIGHTS	ProfiLux Garden LED RGB Set 3 (72376) ProfiLux Garden LED RGB (72377)
PUMPS	AquaMax Eco Premium 2500 (87581) AquaMax Eco Premium 3500 (87582) AquaMax Eco Premium 4500 (87583) AquaMax Eco Premium 5500 (87584) Aquamax Eco Expert 6800 (57875) Aquamax Eco Expert 11500 (58963) AquaMax Eco Expert 5300 - 12V (88676) AquaMax Eco Expert 7100 - 12V (88677) Aquarius Eco Expert 7300 (57964) Aquarius Eco Expert 11500 (57978) Aquarius Eco Expert 5300 - 12V (88678)



An End Resistor in the last device signals the end of the run to the Cloud Controller

All OC compatible devices feature In and Out ports to connect OC Connection Cables

OASE CONTROL SYSTEM

The Oase Control System has the ability to control the entire line of Oase Control Products - biOrb Earth, Aquariums and Water Feature products all within the same app.

OC compatible devices connect to each other directly with Connection Cables and Connectors, as required.

Start the beginning of the run with the Garden Cloud Controller.

It does not matter what order the devices are connected. Each device is individually addressable and controllable with 2-way communication.

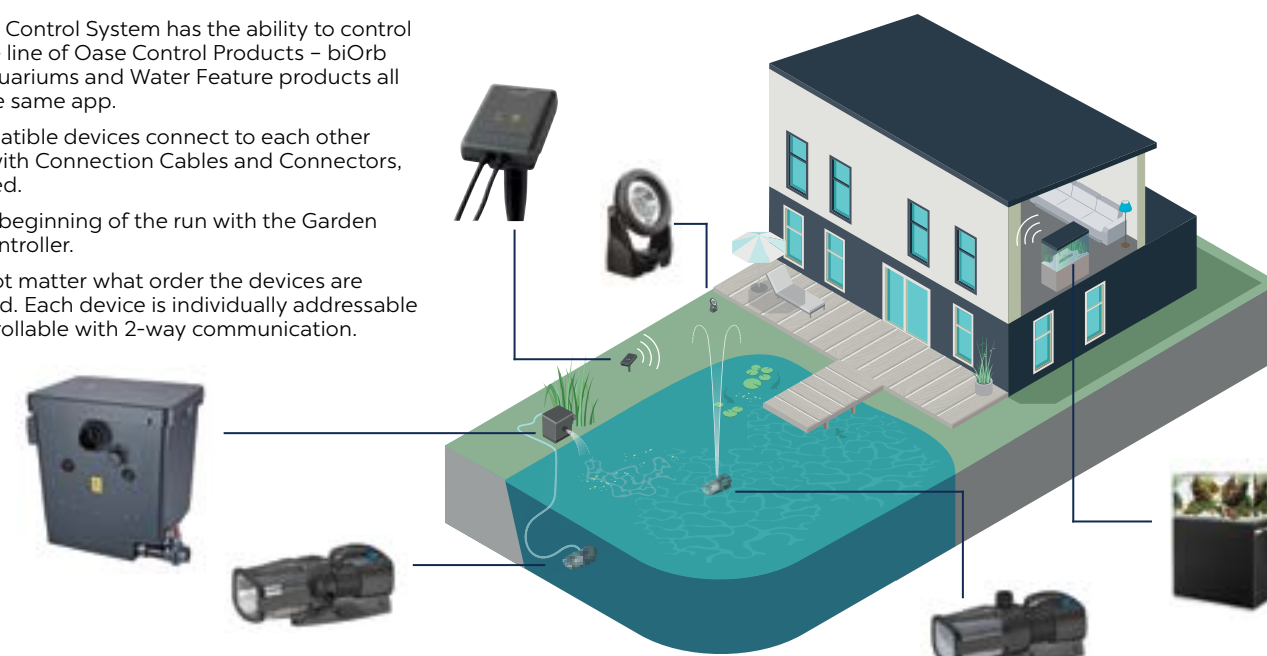

OASE CONTROL APP

Download Android or iOS "Oase Control" application and install to access Cloud Controller in one of two ways.

Select "Direct (Access Point)" on startup to connect to Cloud Controller's internal WiFi from anywhere within a 260' radius.

You may also connect the Cloud Controller directly to your home router for full cloud access. Once set up, you can access, monitor and control all enabled devices from anywhere in the world as long as you have an internet connection



ACCESSORIES

- Connection Cables are special cables for bi-directional communication between Oase Control devices
- Cable Connector with plug on one side and socket on the other allows watertight connect of 2 cables
- 4-wire shielded Cable and Connector plug-and-socket connections are completely waterproof for underwater use



ITEM	72381	72384	93534	72385
DESCRIPTION	Oase Control Connection Cable	Oase Control Connection Cable	Oase Control Connection Cable	Oase Control Cable Connector
CORD LENGTH	8' / 2.5m	32' / 10m	100' / 30m	---
WARRANTY	2-year			

Atlantic offers a full line of maintenance products that will keep your water feature healthy and beautiful for years to come. Triton Ionizer and treatments keep your pond crystal clear. Pond & Garden Protectors prevent accumulation of leaves and debris when the weather is less favorable. Winter or summer, Typhoon Air Pumps keep water moving and fish healthy. Oase PondoVacs keep ponds and fountains sparkling clean without draining.

- » The Triton Ionizer integrates seamlessly to the Triton Check Valve or directly to PVC or Kink-Free pipe for the easiest installation possible and the app provides control right from your smart device
- » PondoVac pond vacuums remove settled debris and wastes from the bottom and sides of ponds and fountains
- » Maintenance and treatment products offer a wide variety of solutions for all of your aquatic needs
- » Aeration products keep ponds aerated and breathing well year-round in the most economical manner possible
- » Pond & Garden Protectors, Pond Nets and tools make caring for ponds, water features and gardens faster and easier



TRITON IONIZER



ITEM	74055
MODEL	TRION3
DESCRIPTION	Electric Water Clarifier
INPUT	12 volt AC
WATTS	2
INLET/OUTLET	2" Sch 40 PVC
DIMENSIONS	4 3/4" L x 1 1/4" D x 3 1/2" H
INCLUDES	Transformer, test strips and insert fittings
WARRANTY	3-year

- Ionizers mineralize the water to keep water features clean and clear with minimal oversight
- Atlantic's TRION3 Ionizer integrates seamlessly with the TR215CV Check Valve
- Easily installed in any new or existing water feature, clears water without the use of harsh chemicals
- Electrodes are easily replaced without tools
- Level of mineralization is controlled by the LED panel or Mobile App via Bluetooth® connection
- Treats ponds up to 25,000 gallons, safe for fish and plants when used correctly
- Includes 1" to 1 1/2" tapered insert fittings for connection to metric and ASTM standard tubing

ATLANTIC CONTROL APP



- The Atlantic Control App allows you to adjust the level of ionization and turn the power on/off
- Conductivity alert will inform you if your water is not conductive enough for selected ionization level
- Effortlessly switch between multiple ionizers to control different water features with custom names and passwords for secure access
- Bluetooth® powered app available on the Apple App Store and Google Play Store

IONIZER ACCESSORIES



74054
• Replacement anode for TRION2 and TRION3 Ionizers



74057
• 50 Alkalinity/pH/Copper test strips in foil packets for long shelf life

ITEM	74054	74057
MODEL	TRION2-RA	TRION-TS
DESCRIPTION	Replacement Anode for TRION2 and TRION3 Ionizers	Alkalinity/pH/Copper Test Strips
SHELF LIFE	---	2-years from Born on Date



PONDOVACS

- Pond vacuums remove debris from ponds, fountains, waterfalls, spas and pools without needing to drain the feature
- All PondoVacs include a wastewater discharge, a debris collection bag and a transparent suction tube to visually monitor debris intake
- Oase PondoVacs feature powerful suction, portability and a variety of attachments to handle any maintenance task

PONDOVAC CLASSIC



57347

- Oase PondoVac Classic is perfect for cleaning small to medium sized water features, ponds and spas
- PondoVac Classic has a suction capacity of up to 800 gph
- Automatically empties tank when full through wastewater discharge hose
- Illuminated rocker switch signals power is on
- Compact design and built-in handle allow for easy movement and transportation

PONDOVAC 4



50409

- Oase PondoVac 4 features continuous suction and waste discharge
- Two chamber system fills and empties alternating chambers for continuous suction and gravity discharge
- PondoVac 4 has a suction capacity of up to 1,300 gph
- Wheeled chassis with suction tube sockets to conveniently carry attachments
- Adjustable handle for fast and convenient transportation

PONDOVAC 5



48080

- Oase PondoVac 5 features uninterrupted vacuuming with continuous waste discharge
- Two pump system simultaneously vacuums while integrated waste pump continuously empties tank
- PondoVac 5 has a suction capacity of up to 2,100 gph
- Wheeled chassis with 6" commercial wheels ensure stable movement through rough terrain
- Adjustable handle and suction tube sockets for fast and convenient transportation of attachments

ITEM	57347	50409	48080
DESCRIPTION	PondoVac Classic	PondoVac 4	PondoVac 5
WATTS	1400	1800	1800
MAX FLOW	800 gph	1,300 gph	2,100 gph
MAX SUCTION DEPTH	6'	8'	7'
CORD LENGTH	13'	14'	25'
DIMENSIONS	15"L x 15"W x 24"H	15 1/2"L x 16 1/4"W x 26 1/2"H	17 1/4"L x 16 1/4"W x 28 1/4"H
SUCTION HOSE	13'	16'	
DISCHARGE HOSE	7'	8'	26'
TANK VOLUME	7 gal	5 1/2 gal	8 1/4 gal
INCLUDES	3 suction tubes, 1 transparent suction tube, 4 tool attachments, debris collection bag	4 aluminum tubes, 1 transparent suction tube, 5 tool attachments, debris collection bag	4 aluminum tubes, 1 transparent suction tube, 5 tool attachments, debris collection bag, internal coarse debris collection bag
WARRANTY	2-year		2-year + 1

PONDOVAC TOOL ATTACHMENTS

	GRAVEL TOOL	LARGE GRAVEL TOOL	STRING ALGAE TOOL (BLACK)	STRING ALGAE TOOL (BLUE)	CREVICE TOOL	FLAT SURFACE BRUSH (BLACK)	FLAT SURFACE BRUSH (BLUE)	PREMIUM SURFACE BRUSH	SWIVEL BRUSH
PONDOVAC CLASSIC	•		•		•	•			
PONDOVAC 4		•		•			•	•	•
PONDOVAC 5		•		•			•	•	•



GRAVEL TOOLS



CREVICE TOOL



STRING ALGAE TOOLS



FLAT SURFACE BRUSHES



SWIVEL BRUSH



PREMIUM SURFACE BRUSH



DID YOU KNOW?

PondoVacs aren't just for ponds, these versatile vacuums are great for fountains, formal spillways and Pond-free fountains! Make spring openings a breeze and fall maintenance painless - put a PondoVac to work for you!



TYPHOON AIR PUMPS

Atlantic's Typhoon Air Pumps feature weatherproof, continuous duty diaphragm compressors specifically designed for year-round usage. Ideal for aeration and circulation in warm weather, these aerators are also excellent for de-icing and gas exchange in freezing weather. With diffuser options for ponds from 1,000 to 12,000 gallons, Typhoon Air Pumps adapt to most backyard ponds. Best of all Typhoon Air Pumps are easily rebuildable and exceptionally efficient!

DIAPHRAGM AIR PUMPS



73941

- Maintain maximum O₂ levels in summer, gas diffusion in winter
- Easy to clean air filter reduces particulates for motor longevity
- Most cost efficient way to keep an area free of ice in winter
- Aluminum housing radiates and reduces heat to extend diaphragm life



73942

- Replaceable diaphragms for extended service life
- Includes 3/8" insert fitting for most vinyl air tubing or use stainless steel band clamp (not included) with 1/2" tubing over outlet

ITEM	73941	73942
MODEL	TA1800	TA3600
DESCRIPTION	Typhoon Air Pump - 30 LPM	Typhoon Air Pump - 60 LPM
OUTLET	3/8" insert, 1/2" slip	3/8" insert, 5/8" slip
VOLTS	115	
WATTS	25	35
MAX PRESSURE	3 psi	5 psi
MAX DEPTH	7'	11'
CORDS	6'	
DIMENSIONS	6 3/4" L x 5" W x 5 1/4" H	7 1/4" L x 7" W x 6 1/2" H
WARRANTY	3-year Limited	

AIR PUMP OUTPUT											
MODEL		MAX	@ 1'	@ 2'	@ 3'	@ 4'	@ 5'	@ 6'	@ 8'	@ 10'	
TA400	LPM / CFM	6.5 / 0.23	6 / 0.21	5.1 / 0.18	4 / 0.14	2.5 / 0.09	1 / 0.04	---	---	---	
TA800	LPM / CFM	13 / 0.46	12 / 0.42	10.2 / 0.36	8 / 0.28	5 / 0.18	2 / 0.07	---	---	---	
TA1800	LPM / CFM	30 / 1.06	25 / 0.88	21 / 0.74	17 / 0.60	13 / 0.46	9 / 0.32	4 / 0.14	---	---	
TA3600	LPM / CFM	60 / 2.12	54 / 1.91	47 / 1.66	40 / 1.41	34 / 1.2	28 / 0.99	23 / 0.81	12 / 0.42	2 / 0.07	

MINI AERATION KITS



73943

- Dependable aeration for smaller ponds 5' deep or less
- Replaceable diaphragm cartridges extend pump service life



73944

- Weighted air stones with rim guards stand up to multi-season use

ITEM	73943	73944
MODEL	TAKIT0400	TAKIT0800
DESCRIPTION	Mini Aeration Kit - Single	Mini Aeration Kit - Dual
PUMP	TA400	TA800
TUBING SIZE	1/4" x 20'	(2) 1/4" x 20'
WATTS	4.5	9
MAX DEPTH	5'	
CORD LENGTH	6'	
POND VOLUME	1,000 gallons	2,000 gallons
DIMENSIONS	6 1/2" L x 4" W x 3 3/4" H	6 1/2" L x 6 1/4" W x 3 3/4" H
INCLUDES	4" air stone, in-line check valves and tubing	(2) 4" air stones, in-line check valves and tubing
WARRANTY	3-year Limited	

PROFESSIONAL AERATION KITS



73939

- High output for larger water gardens and koi ponds with greater oxygen demand
- High efficiency non-clogging diffuser tubing is less restrictive than stones or rubber diaphragms for greater flows and longer pump life



73940

- Circular diffuser design maximizes upwelling and water circulation and gas exchange
- Diffusers come unweighted to reduce shipping costs and will require filling with your choice of sand or gravel

ITEM	73939	73940
MODEL	TADKIT1800	TADKIT3600
DESCRIPTION	Professional Aeration Kit - Single	Professional Aeration Kit - Dual
PUMP	TA1800	TA3600
TUBING SIZE	3/8" x 20' weighted	3/8" x 40' weighted
WATTS	25	35
MAX DEPTH	7'	11'
CORD LENGTH	6'	
POND VOLUME	6,000 gallons	12,000 gallons
DIMENSIONS	6 3/4" L x 5" W x 5 1/4" H	7 1/4" L x 7" W x 6 1/2" H
INCLUDES	8" diffuser, fittings, in-line check valve and weighted tubing	(2) 8" diffusers, fittings, 2-way splitter, in-line check valves and weighted tubing
WARRANTY	3-year Limited	



AQUAOXY 450 & OXYTEX

AQUAOXY450



ITEM	50041
DESCRIPTIONS	AquaOxy 450
VOLTS	120
WATTS	25
MAX DEPTH	7'
MAX LPM	8.3
CORD LENGTH	15'
POND VOLUME	5,000 gal
DIMENSIONS	9"L x 9"W x 5"H
TUBING SIZE	(2) 3/16" x 16'
INCLUDES	(2) air stones, 16' silicone air hose, 120V outdoor transformer
WARRANTY	2-year

- Aeration systems maintain high oxygen levels in summer and aid in gas diffusion in winter
- Oase AquaOxy 450 is a safe 12V air compressor with dual valved outlets for versatile, energy efficient air delivery to dual locations in pond
- All-in-one aeration system includes silicone tubing and 2 weighted, high volume air stones
- Stainless steel regulating valves allow for easy air adjustment to air stones
- Durable, weatherproof UV stabilized housing dampens noise for quiet operation
- AquaOxy 450 is designed to supplement aeration in OASE ProfiClear Compact filters

OXYTEX



ITEM	51075
DESCRIPTION	OxyTex Underwater Air Difuser
MAX PRESSURE	5.8 psi
MAX DEPTH	14'
MAX LPM	16.6
DIMENSIONS	9"W x 12"H
TUBING SIZE	3/16" x 16'
INCLUDES	16' of 3/16" air hose, air hose adapter for larger diffuser tubing and diffuser plate
WARRANTY	2-year

- Aeration systems maintain high oxygen levels in summer and aid in gas diffusion in winter
- Oase OxyTex combines a high efficiency pond diffuser with high surface area filter medium
- Provides a unique combination of gas diffusion, water circulation and nutrient decomposition
- The ideal habitat for beneficial bacteria, the OxyTex improves filtration efficiency and contributes to a healthy pond environment
- Supplements ammonia and nitrite removal capability of the pond bacteria with replaceable air stone
- Designed for use with the Oase AquaOxy 450



POND DE-ICER



- Pond de-icers maintain a small area free of ice, allowing oxygen in and toxic gases like carbon dioxide and methane out of pond water in winter
- Atlantic's Pond De-Icer saves energy by cycling on and off, maintaining an internal temperature of 200° under the worst conditions
- Constructed of high strength and high temperature PPS polymer for maximum durability
- Internal thermostat turns heater on just above freezing and off as water warms for fully automatic operation

ITEM	73986
MODEL	PD300
DESCRIPTION	Pond De-Icer
VOLTS	120
WATTS	300*
CORD LENGTH	20'
DIMENSIONS	8"W x 4"H
WARRANTY	1-year

- Indicator light shines blue to show the De-Icer is in standby mode when plugged in with water temperature above freezing
- Indicator light shines green to show water temperature is below freezing and De-Icer is in operation
- *Efficient heating element only draws 300 watts when needed to keep a small area free of ice and operating costs low

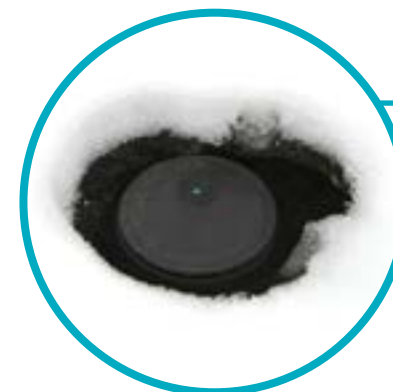

TECH TIP

Unlike typical de-icers that only indicate the heating cycle, Atlantic's De-Icer shines blue to show the unit is plugged in and operational even when the water temperature is above freezing. As the temperature drops the light changes to green, cycling on and off to indicate active heating. This not only saves money by only using electricity when heating, it also verifies the unit is ready for operation before icing even occurs.



WATER TREATMENTS

BIOMAX – WEEKLY BIOLOGICAL CONDITIONER



- Beneficial bacteria metabolize organic waste and neutralize odors
- Atlantic's BioMax contains potent strains with billions of bacteria
- Improved ecological balance lowers nitrates that promote unwanted plant growth
- Use weekly to reduce organics and keep water clear and healthy

BIOMAX+ – ENHANCED BIOLOGICAL CONDITIONER



- Liquid bacterial formula naturally removes organic debris, ammonia and nitrates
- Atlantic's BioMax+ balances pond ecosystem, enhances bacterial activity and seeds biological filters
- Specialized bacterial mix speeds up the natural cycle that maintains a healthy balanced ecosystem
- Use weekly to remove toxins and promote excellent water quality

ECOKLEAN – OXY POND CLEANER



- Oxy pond cleaners quickly remove attached organics and algae stains from rocks, waterfalls and streambeds
- Atlantic's EcoKlean fast dissolving granules lift debris to the surface with the power of pure oxygen
- Regularly use may eliminate the need for disruptive, expensive pond clean-outs
- Use as needed to keep hard surfaces clean and free of attached organics

ITEM	74058	74059	74060	74061	74063	74062	74082	74084	74083
MODEL	WTBM1	WTBM2	WTBM6	WTBM16	WTBM32	WTBM1G	WTEK1	WTEK2	WTEK10
DESCRIPTION	BioMax			BioMax+			EcoKlean		
SIZE	1 lb.	2 lbs.	6 lbs.	16 oz.	32 oz.	1 gal.	1 lb.	2 lbs.	10 lbs.
TREATS	16,000 gallons	32,000 gallons	96,000 gallons	6,000 gallons	12,000 gallons	48,000 gallons	400 ft ²	800 ft ²	4,000 ft ²

CLARITYBLAST – COMBINATION POND CLEANER



- Pond cleaners keep waterfalls, streams, ponds, plant pots and filters clean
- Atlantic's ClarityBlast is an all-natural proprietary treatment with bacteria and enzymes
- Keeps pond water and hard surfaces clean by removing attached organics
- Use as directed to remove algae stains and attached organics

RECLAIM – NATURAL SLUDGE REMOVER



- Sludge removers eliminate the build-up of dead algae, decomposing leaves and fish waste
- Atlantic's ReClaim ½ ounce tablets quickly go to work removing sludge on the bottom of ponds and streams
- Regular use reduces frequency of pond cleanouts and overall pond maintenance
- Apply tablets bi-weekly for best results

REVIVE – DECHLORINATOR WITH STRESS REDUCER



- Dechlorinators remove fish-toxic chlorine, chloramines, ammonia and heavy metals in tap water
- Atlantic's ReVive with stress reducer thickens the slime coat of Goldfish and Koi in times of stress
- Enhancing protective slime coat of fish helps fish recover from cuts and abrasions
- Use every time water is added or when moving fish

QUICKCLEAR – WATER CLARIFIER



- Water clarifiers temporarily flocculate, or clump together suspended particles, making them sink to the bottom
- Atlantic's QuickClear restores brilliant clarity to water clouded by sediment or organics
- Once out of suspension, debris can be easily filtered or vacuumed out
- Use to clear water after heavy rains or prolonged heat spells or before vacuuming

ALGAEICIDE – ALGAE REMOVER



- Algecide eliminates existing algae growth
- Pond Boss Algecide is fast acting for ponds and water features
- Safe for fish and plants when used as directed

ITEM	74064	74065	74066	74069	74070	74071	74075	74067	74068	54169
MODEL	WTCB1	WTCB2	WTCB6	WTRC24	WTRC48	WTRC72	WTRV32	WTQC16	WTQC32	
DESCRIPTION	ClarityBlast			ReClaim			ReVive	QuickClear		Algaeicide
SIZE	1 lb.	2 lbs.	6 lbs.	12 oz.	24 oz.	36 oz.	32 oz.	16 oz.	32 oz.	64 oz.
TREATS	8,000 gallons	16,000 gallons	48,000 gallons	1,200 ft ²	2,400 ft ²	3,600 ft ²	6,400 gallons	8,000 gallons	16,000 gallons	18,900 gallons

TOOLS & ACCESSORIES

POND GLOVES



- Neoprene pond gloves offer welcome protection against cold water
- Durable and elastic neoprene is a full 2mm thick for long lasting comfort
- Rubber coated palm for comfort and excellent grip
- Adjustable wrist strap keeps gloves from slipping
- Available in five sizes from small up to 2XL

ITEM	91657	91658	91659	91660	91661
DESCRIPTION	Neoprene Pond Gloves	Neoprene Pond Gloves	Neoprene Pond Gloves	Neoprene Pond Gloves	Neoprene Pond Gloves
SIZE	Small / 7	Medium / 8	Large / 9	X-Large / 10	XX-Large / 11

AQUATIC PLANT BASKET



ITEM	45386
DESCRIPTION	Aquatic Plant Basket
DIMENSIONS	10"L x 10"W x 6"H
WARRANTY	1-year

- Durable plastic mesh allows aquatic plant roots to more efficiently remove excess nutrients from the water column
- Strong construction keeps plants under control over multiple growing seasons
- Makes pruning, fertilizing and maintenance more convenient

EASYPICK



ITEM	42764
DESCRIPTION	EasyPick
DIMENSIONS	54"L x 3½"W
WARRANTY	2-year

- Oase EasyPick premium pond pliers facilitate the removal of cords, fixtures, plant baskets, debris large and small, even leaves
- Adjustable 78" telescoping handle reaches into the most inaccessible corners and depths, no need to get wet
- Rubberized triple gripper provides firm, secure hold of even slippery objects and debris

FLEXICUT 2-IN-1

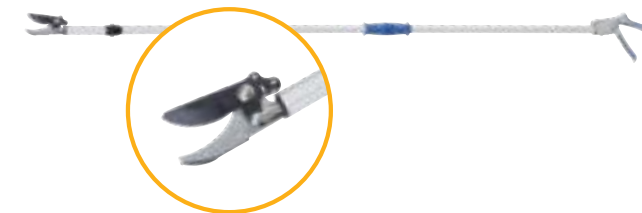

ITEM	46970
DESCRIPTION	FlexiCut 2-in-1
DIMENSIONS	65½"L x 2½"W
WARRANTY	2-year

- 2-in-1 pond scissors simultaneously cut and hold pruned aquatic material
- Adjustable head accommodates multiple working angles to protect the pond liner from cuts
- Also suitable for cutting terrestrial plants and thin branches

POND NET



ITEM	46934
DESCRIPTION	PondNet
DIMENSIONS	46"L x 15"W
WARRANTY	2-year

- Perfect for skimming, strong enough to remove wet leaves and muck
- Coated frame protects pond liner and fish
- Lightweight & durable 1" diameter handle telescopes from 46" to 63" for maximum versatility



NETTING



- Netting keeps out leaves and other wind-blown debris for a clean pond in the fall and spring
- Durable poly netting is UV-resistant for extended lifespan
- Physical barrier also protects fish from heron and other predators
- Netting your pond reduces organic wastes that can fuel algae growth and reduce oxygen levels
- 1/2" x 1/2" openings keep out smaller windblown debris
- 4 pre-cut and 3 roll sizes fit most water feature designs
- New stake design is longer with a larger diameter head for improved net retention
- Stakes available in 50 piece quantities for use with 100' rolled netting



ITEM	74047	74048	74050	74051	74046	74049	74052	74053
MODEL	PN1015	PN1520	PN2020	PN2030	PN10100	PN20100	PN30100	PNS50
DESCRIPTION	Pond Netting							Net Stakes
SIZE	10' x 15'	15' x 20'	20' x 20'	20' x 30'	10' x 100'	20' x 100'	30' x 100'	6"L x 1 1/2"W
HOLE SIZE	1/2" x 1/2"							---
INCLUDES	12 UV-Resistant Net Stakes				---	---	---	50 Net Stakes
WARRANTY	1-year							

TECH TIP

To prevent leaves from decomposing and fouling the water, stretch your nets as tightly as possible over the water feature just before the leaves begin to fall. This will keep the leaves from sinking to the bottom. For best results elevate the net with the Pond and Garden Protector to cover the pond completely. For larger ponds, the Protector can even be used to elevate the center of oversized nets.



POND & GARDEN PROTECTOR

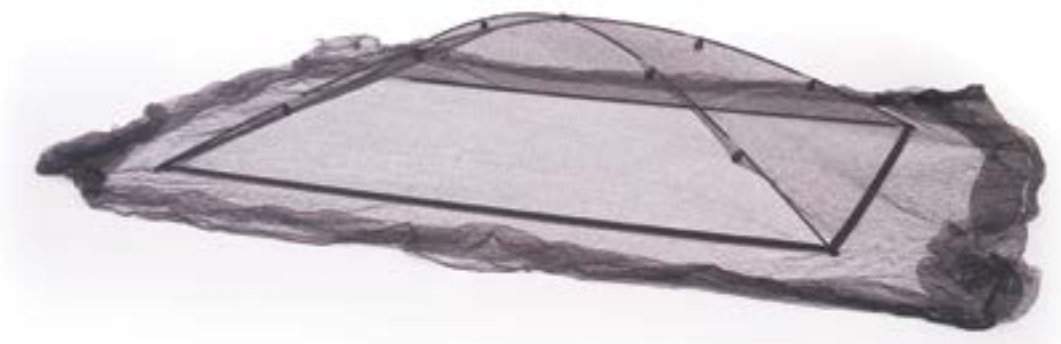

- The Pond and Garden Protector elevates the netting to keep leaves and other wind blown debris out of your pond or garden
- Domed design allows pond and garden plants to grow unobstructed under netting
- UV-resistant poly netting extends usable life
- 1/2" x 1/2" openings protects fish from heron and other predators
- Helps prevent algae growth by reducing organic waste that enters your pond
- Keeps out rabbits, deer and other herbivores to protect your garden during the growing season

ITEM	74045	74044
MODEL	PGPSM	PGPLG
DESCRIPTION	Pond & Garden Protector - Small	Pond & Garden Protector - Large
NET SIZE	15' x 20'	20' x 20'
ASSEMBLED SIZE	7"W x 9"L x 2"H	9"W x 12"L x 2 1/2"H
INCLUDES	Nylon Base, Center Receptor, (4) Fiberglass Poles, (4) 12' Tie-downs, (4) Ground Stakes, (12) Net Stakes, (8) Net Clips	Nylon Base, Center Receptor, (4) Fiberglass Poles, (4) 12' Tie-downs, (4) Ground Stakes, (12) Net Stakes, (8) Net Clips
WARRANTY	1-year	



POND FEATURES:

- Keeps out leaves and other windblown debris
- Protects fish from heron and other predators
- Helps prevent algae growth by reducing organic waste



GARDEN FEATURES:

- Protects fruiting plants and vegetables
- Allows for sunlight and optimum plant ventilation
- Can be covered with plastic to protect against frost

Atlantic's Aeration System offers everything you need for the health and maintenance of large ponds and lakes. The sophisticated suite of products includes powerful Air Compressors, sub-surface Diffusers and decorative floating Aerators optimized for every size and depth body of water. We took our time to develop the best system on the market today – efficient and economical, engineered for excellence!

- » Air Diffusers are economical to ship, easy to deploy and maintain and more efficient at circulation and gas diffusion
- » Robust Compressors are reliable, rebuildable and economical to run and service
- » Fully equipped Cabinets protect and soundproof equipment securely
- » Long lasting Direct Burial and Weighted Tubing simplifies sub-surface installation
- » Floating Fountain Aerators that excel in shallow water offer visual displays by day and night
- » Treatments provide solutions for almost every pond and lake problem
- » All Systems come complete with every component needed for your project



WHY AERATION?

Oxygen is essential to the biology of a healthy pond or lake, but it's often in short supply. When there isn't enough oxygen, fish and other aquatic animals can suffocate, wastes generate noxious gases and water may foul.

Subsurface aeration brings oxygen levels up, dissipates toxic gases and evens out temperature and saturation levels throughout the water feature. Aeration is also the most efficient way to circulate water, moving 10 times as much per watt as water pumps.

Finally, aeration greatly accelerates the decomposition of solid and dissolved wastes. Although smaller water features may respond to other strategies, aeration is the only way to effectively manage nutrient removal, algae, water quality and clarity in larger lakes, not to mention reducing pests and parasites.

WITHOUT AERATION

SIGNS OF IMBALANCE:

- Algae, opaque green water or excessive growth of string or blanket weed
- An excess of submerged vegetation and rampant marginal aquatic plant growth
- Foul odors, of the water or of the sediments at the bottom
- Dead fish, especially after a storm or a change to cooler weather
- Small, few or no live fish at all

CAUSES OF IMBALANCE:

- Excessive nutrients in the water and the sediment
- Insufficient total dissolved oxygen levels
- Stratification and thermoclines that cut off surface oxygen

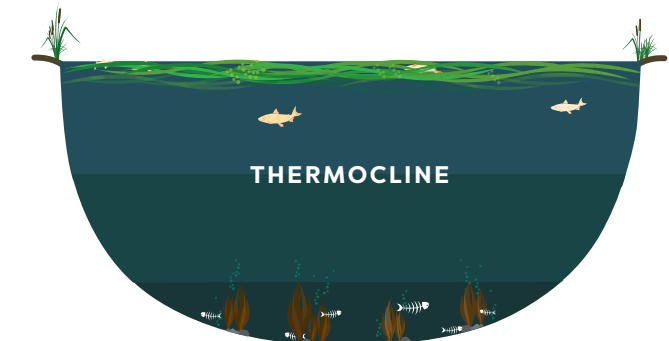

WITH AERATION

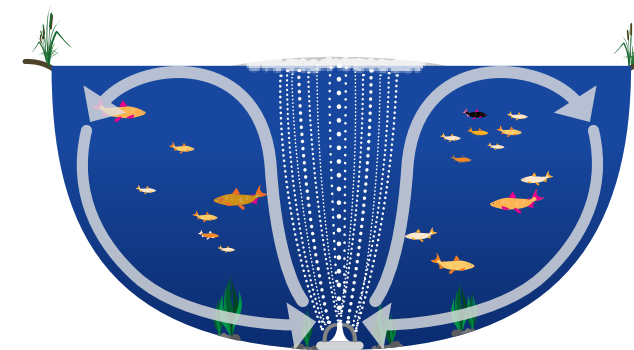

BENEFITS OF AERATION:

- Aeration creates bubbles that increase the surface area of air in contact with the water
- Millions of bubbles moving upwards pull huge volumes of water up from the bottom
- Oxygen-poor water rushes upwards, eliminating thermal layers, shedding toxic gases and picking up oxygen
- Oxygen-rich water circulates down to the bottom, promoting the growth of bacteria that digest organic sludge and eliminate excessive nutrients





DIFFUSERS & COMPRESSORS



73978

- Air Diffusers distribute compressed air to the bottom of the body of water where gas exchange and circulation are needed most
- Atlantic's Air Diffusers feature a streamlined body design and innovative diffuser tubing that circulates water more efficiently
- Extruded EPDM diffuser tubing proven in industrial applications offers tremendous longevity and resistance to fouling



73976

- Bubble sizes decrease as pressure rises; smaller bubbles maximize surface area for extremely efficient gas diffusion and circulation
- Easy to fill on-site with sand or gravel, Diffusers ship empty to save weight and freight
- Easily replaceable tubing and stainless steel hardware extends usable service life of Diffusers

ITEM	73978	73976
MODEL	TPSDIF	TPDDIF
DESCRIPTION	Shallow Water Diffuser	Deep Water Diffuser
FLOW RATE	15 - 75 LPM	25 - 150 LPM
DIMENSIONS	13½"L x 12"W x 8½"H	18"L x 16"W x 10½"H
WARRANTY	5-year	

TYPHOON DIFFUSER FEATURES:

1. Heavy-walled diffuser tubing produces ultra-fine bubbles with little back pressure.
2. Diffuser shape accelerates the rising water column.
3. Full flow manifold evenly distributes air to the diffuser tubing.
4. Push-lock manifold connection simplifies servicing.
5. Integrated strain relief for ½" and ¾" weighted tubing.
6. Includes ¾" check valve, ¾" insert fitting and stainless steel strain relief bracket.



To convert Atlantic Aeration Systems to ½" Weighted Tubing see page 144.



SHALLOW WATER AIR COMPRESSORS



73974



73975

- Compressors efficiently deliver pressurized air to specific depths
- Designed for the shallows, linear piston compressors combine the rugged reliability of a piston and cylinder system with the economy and simplicity of a magnetic motor
- Fully rebuildable linear piston compressors last longer and require less maintenance than cheaper linear diaphragm systems

ITEM	MODEL		MAX	@2'	@4'	@6'	@8'	@10'	@12'
73974	TPS200	LPM / CFM	110 / 3.9	85 / 3.0	65 / 2.3	50 / 1.8	35 / 1.2	15 / 0.5	---
73975	TPS400	LPM / CFM	240 / 8.5	190 / 6.7	150 / 5.3	115 / 4.1	85 / 3.0	55 / 1.9	25 / 0.9

DEEP WATER AIR COMPRESSORS



73973



73972

- Gast rocking piston Deep Water Air Compressors with high pressure output are the best choice for ponds from 7 to 35 feet deep
- Dual aluminum pistons, hard-coated cylinders and replaceable piston seals make these compact workhorses as long lasting as they are powerful
- Replaceable air filter keeps dust and abrasives out for longevity
- Rubber mounting feet help keep these compressors as quiet as they are dependable
- Quiet, damped operation for minimum noise and vibration
- Rebuildable, with components easily accessible for simple maintenance and servicing
- Deep Water Air Compressors have 6' power cords and intake filter

ITEM	MODEL		MAX	@10'	@15'	@20'	@25'	@30'	@35'
73973	TPD87R6	LPM / CFM	130 / 4.6	125 / 4.4	119 / 4.2	113 / 4	108 / 3.8	102 / 3.6	99 / 3.5
73972	TPD72R6	LPM / CFM	165 / 5.8	156 / 5.5	150 / 5.3	144 / 5.1	142 / 5	139 / 4.9	136 / 4.8

ITEM	73974	73975	73973	73972
MODEL	TPS200	TPS400	TPD87R6	TPD72R6
DESCRIPTION	Shallow Water Compressor for TPS200C	Shallow Water Compressor for TPS400C	Deep Water Compressor for TPD100C & TPD200C	Deep Water Compressor for TPD300C & TPD400C
VOLTS	115			
AMPS	0.9	1.4	4.4	5
WATTS	102	160	---	
INLET	---		¼" FIPT	
OUTLET	¾" FIPT		¼" FIPT	
MAX PRESSURE	5.1 psi	5.8 psi	30 psi	
MAX DEPTH	6'	7'	35'	
CORD LENGTH	6'			
DIMENSIONS	10"L x 5½"W x 7"H	11"L x 6"W x 8"H	10"L x 6½"W x 7"H	11"L x 7½"W x 7½"H
WARRANTY	2-year			



TUBING & TREATMENTS

WEIGHTED TUBING

- Atlantic's Tubing is made of the highest quality materials for long, trouble-free service life
- Thick-walled Weighted Tubing sinks without the inconvenience of adding weights to keep tubing from floating
- High density PVC formulation remains flexible in a wide range of temperatures
- Nickel-plated insert fittings, supplied with every roll, make connecting Weighted Tubing of different lengths simple and secure
- TPF12WT Fitting Kit available to convert Atlantic Diffusers and Aeration Cabinets to 1/2" weighted tubing for runs over 300 feet



ITEM	73983	73984	73985	73982	73977
MODEL	TPT38050	TPT38100	TPT38500	TPT12500	TPF12WT
DESCRIPTION	3/8" x 50' Weighted Tubing	3/8" x 100' Weighted Tubing	3/8" x 500' Weighted Tubing	1/2" x 500' Weighted Tubing	Fitting Kit for 1/2" Weighted Tubing Conversion
I.D.	3/8"		1/2"		---
O.D.	0.69"		0.97"		---
WEIGHT	10 lbs.	20 lbs.	100 lbs.	190 lbs.	---
INCLUDES	3/8" insert coupling		1/2" insert coupling		1/2" MPT x 1/2" Insert & 3/4" MPT x 1/2" Insert Adapters
WARRANTY	5-year				---

DIRECT BURIAL TUBING

- Low friction Direct Burial Tubing brings the air to the water's edge economically
- Tubing is made of UV-stabilized PVC for long life under the harshest conditions
- Push-lock fittings allow for quick, secure connection of Direct Burial Tubing between the Cabinet and the Weighted Tubing at the shoreline
- Tool-free connections simplify tubing installation



ITEM	MODEL	SIZE	I.D.	O.D.	WEIGHT	INCLUDES	WARRANTY
73979	TPB12100	1/2" x 100' Direct Burial Tubing	3/8"	---	10 lbs.	1/2" MPT / FPT Push-lock fittings	5-year

POND CLARIFIER

Custom bacterial strains clear pond water by consuming dissolved organics. Simply toss in appropriate number of 8 ounce water soluble packets each month for clear, clean water year round. Safe for fish, plants, livestock and pets.

ITEM	74076	74077
MODEL	TPWCP06	TPWCP24
DESCRIPTION	Pond Clarifier	
SIZE	12 packets - 6 lbs.	48 packets - 24 lbs.
DOSAGE	1 packet per 1/4 acre every two weeks	4 packets per acre every two weeks
TREATS	1/4 acre pond for 6 months	1 acre pond for 6 months



POND CLARIFIER +TM

Concentrated bacteria in 3 ounce slow release tablets with double the colony forming units (CFUs) per gram, Pond Clarifier Plus Trace Minerals accelerates organic removal and improves overall pond health. Safe for fish, plants, livestock and pets.

ITEM	74078	74079
MODEL	TPWPP06	TPWPP24
DESCRIPTION	Pond Clarifier +TM	
SIZE	32 tablets - 6 lbs.	128 tablets - 24 lbs.
DOSAGE	2 tablets per 1/4 acre every two weeks	8 tablets per acre every two weeks
TREATS	1/4 acre pond for 8 months	1 acre pond for 8 months



SLUDGE REMOVER

Easy to throw 1/2 ounce sludge eliminating tablets rapidly digest decomposing vegetation and fish waste. Plant and fish safe, perfect for wading and swimming areas. When regularly applied as directed to the shoreline, tablets can remove up to 5 inches of muck per year.

ITEM	74080
MODEL	TPWSR06
DESCRIPTION	Sludge Remover
SIZE	192 tablets - 6 lbs
DOSAGE	16 tablets per 1000 sq. ft. every 2 weeks
TREATS	1,000 sq. ft. for 6 months



POND DYE

Whether you prefer liquid dye or easy to apply dissolvable packets of powdered dye, Typhoon Pond Dye shades the water to eliminate plant growth below the surface. Available in both blue and black, concentrated dye can be mixed to create your own favorite shade. Safe for fish, plants, livestock and pets.

ITEM	74090	74088	74091	74089	74093	74092
MODEL	TPWDBLU2	TPWDBLK2	TPWDBLU4	TPWDBLK4	TPWDBLUG	TPWDBLKG
DESCRIPTION	Pond Dye					
SIZE	2 packets		4 packets		1 gallon	
DOSAGE	1 packet per acre-foot				1/4 gallon per acre-foot	
TREATS	1/2 acre 4' - 6' deep			1 acre 4' - 6' deep		





SHALLOW WATER AERATION

SHALLOW WATER AERATION CABINETS

- Includes Typhoon Linear Piston Shallow Water Compressor
- Easily adjusted locking manifold assemblies provide flow control to multiple Diffusers
- Heavy-duty Cabinets secure and protect components while muffling the sound of compressors
- Atlantic's Cabinets have a reinforced lockable lid and sturdy hinges with vandal resistant screws for secure installation
- Double walled for noise insulation and durability
- Integrated cooling fan keeps components from overheating under the harshest conditions
- Filtered air intake protects the compressor from dust and debris



73964 (shown)

ITEM	73964	73965
MODEL	TPS200C	TPS400C
DESCRIPTION	2-Outlet Shallow Water Assembly	4-Outlet Shallow Water Assembly
WEIGHT	55 lbs.	60 lbs.
DIMENSIONS	24"L x 22"W x 20"H	
POND DEPTH	Ponds up to 6' deep	Ponds up to 7' deep
INCLUDES	Cabinet with 2-outlet manifold and Linear Piston Compressor	Cabinet with 4-outlet manifold and Linear Piston Compressor
WARRANTY	2-year	

DID YOU KNOW?

Ventilation is crucial for proper functioning of components inside of the Cabinet. An inlet at the bottom rear of the Cabinet allows air to be drawn in directly over the Air Compressor as it is pulled out by the fan at the top of the Cabinet, cooling the motor and prolonging the time between servicing.



TYPHOON AERATION CABINET FEATURES:

1. Weatherproof, double walled Cabinet for strength and noise insulation.
2. Industrial hinges, rubber "T" hasp closures and stainless steel locking plates for maximum security and service life.
3. Aluminum manifold block with full flow 1/2" inlets and outlets, and flow adjusters.
4. High volume cooling fan in lid vents air through wall cavity for maximum cooling and minimum noise.
5. Large filtered air inlet at lower rear of cabinet for complete circulation.
6. PVC tubing with push lock quick release fittings.
7. Solid brass nickel plated fittings for maximum durability.



73965 (shown)

SHALLOW WATER AERATION SYSTEMS



73970

73971

- Shallow Water Aeration systems combine all of the components you need to aerate ponds and lakes up to 7' deep and a half acre in surface area
- Complete systems include Aeration Cabinet Assemblies with all subcomponents pre-installed, Shallow Water Diffusers, Weighted Tubing and all necessary fittings

ITEM	73970	73971
MODEL	TPS200S	TPS400S
DESCRIPTION	Shallow Water Aeration System with Two Diffusers	Shallow Water Aeration System with Four Diffusers
VOLTS	115	
AMPS	0.9	1.4
WATTS	112	170
MAX LPM	110	240
MAX CFM	3.9	8.5
COVERAGE AREA	Up to 1/4 surface acre	Up to 1/2 surface acre
COVERAGE AREA @ 2'	1/8 acre	1/4 acre
COVERAGE AREA @ 4'	1/8 acre	1/2 acre
COVERAGE AREA @ 6'	1/4 acre	1/2 acre
POND DEPTH	Ponds up to 6' deep	Ponds up to 7' deep
INCLUDES	Cabinet with 2-outlet manifold and Linear Piston Compressor, (2) TPT38100 Weighted Tubing and (2) TPSDIF Shallow Water Diffusers	Cabinet with 4-outlet manifold and Linear Piston Compressor, (4) TPT38100 Weighted Tubing and (4) TPSDIF Shallow Water Diffusers
WARRANTY	2-year	



DEEP WATER AERATION

DEEP WATER AERATION CABINETS

- Includes Gast rocking piston Deep Water Air Compressor
- Easily adjusted manifold assemblies provide flow control to multiple Diffuser systems
- Oil-filled pressure gauge and pressure relief valve monitor and protect compressor for enhanced reliability and longevity
- Heavy duty double-walled Cabinets secure and protect components while muffling the sound of compressors
- Atlantic's Cabinets have reinforced lockable lids and sturdy hinges with vandal-resistant screws for secure installation
- Integrated cooling fan keeps components from overheating under the harshest conditions
- Filtered air intake protects the compressor from dust and debris



73963 (shown)

ITEM	73960	73961	73962	73963
MODEL	TPD100C-87R6	TPD200C-87R6	TPD300C-72R6	TPD400C-72R6
DESCRIPTION	1-Outlet Deep Water Assembly	2-Outlet Deep Water Assembly	3-Outlet Deep Water Assembly	4-Outlet Deep Water Assembly
WEIGHT	60 lbs.		72 lbs.	
DIMENSIONS	24"L x 22"W x 20"H			
POND DEPTH	7' - 35' Deep			
INCLUDES	Cabinet with 1-outlet manifold and Rocking Piston Compressor	Cabinet with 2-outlet manifold and Rocking Piston Compressor	Cabinet with 3-outlet manifold and Rocking Piston Compressor	Cabinet with 4-outlet manifold and Rocking Piston Compressor
WARRANTY	2-year			

DID YOU KNOW?

Aeration is a powerful tool. There are times when full implementation without an acclimation period can lead to disaster. In warm weather it is best to start slowly to avoid a "turnover", where deoxygenated bottom water is mixed in so quickly that total dissolved oxygen levels plummet to lethal levels. To be safe it's best to run the system for only 15 minutes the first day, 30 minutes the second, 1 hour on the third day, doubling the running time each day for the first week. This will also allow toxic methane and hydrogen sulfide to dissipate slowly and safely.



DEEP WATER AERATION SYSTEMS



73966



73967



73968



73969

- Atlantic's Deep Water Aeration Systems offer complete solutions for lakes 7' to 35' in depth and 4 surface acres in area
- Complete systems come with Aeration Cabinet Assemblies with all subcomponents pre-installed, Deep Water Diffusers, Weighted Tubing and all necessary fittings

ITEM	73966	73967	73968	73969
MODEL	TPD100S-87R6	TPD200S-87R6	TPD300S-72R6	TPD400S-72R6
DESCRIPTION	Deep Water Aeration System with One Diffuser	Deep Water Aeration System with Two Diffusers	Deep Water Aeration System with Three Diffusers	Deep Water Aeration System with Four Diffusers
VOLTS	115			
AMPS	4.5		5.1	
MAX LPM	130		165	
MAX CFM	4.6		5.8	
COVERAGE AREA	Up to 1 surface acre	Up to 2 surface acres	Up to 3 surface acres	Up to 4 surface acres
COVERAGE AREA @ 8'	¼ acre	½ acre	¾ acre	1 acre
COVERAGE AREA @ 12'	½ acre	¾ acre	1 acre	2 acres
COVERAGE AREA @ 16'	¾ acre	1 acre	1½ acres	3 acres
COVERAGE AREA @ 20'	1 acre	2 acres	3 acres	4 acres
POND DEPTH	Ponds and lakes between 7' and 35' deep			
INCLUDES	TPD100C Cabinet Assembly, TPT38100 Weighted Tubing and TPDDIF Deep Water Diffuser	TPD200C Cabinet Assembly, (2) TPT38100 Weighted Tubing and (2) TPDDIF Deep Water Diffusers	TPD300C Cabinet Assembly, (3) TPT38100 Weighted Tubing and (3) TPDDIF Deep Water Diffusers	TPD400C Cabinet Assembly, (4) TPT38100 Weighted Tubing and (4) TPDDIF Deep Water Diffusers
WARRANTY	2-year			



FLOATING FOUNTAINS

PONDJET



ITEM	54019
DESCRIPTION	PondJet Floating Fountain
VOLTS	120
WATTS	260
MAX PRESSURE	10 psi
MAX FLOW	2400 gph
CORD	75'
DIMENSIONS	26"W x 21"H 6'
WARRANTY	2-year + 1

- Floating fountains offer economical shallow water aeration combined with an attractive visual display
- Oase PondJet features a powerful submersible pump and integrated nozzle for a complete drop in solution, ready to install and connect in minutes
- Tethered float accommodates ponds that vary in water level

- Will work with any 1" Oase or Atlantic Nozzle for maximum display versatility
- Includes pump, float and nozzle

TECH TIP

Accessorize your PondJet with any of our many 1" Nozzles for the widest variety of decorative displays. PondJet accepts 1" MIPT nozzles without modification. Use a 1" close nipple to adapt PondJet to any 1" FIPT Nozzle. See page 20-27 for full selections.



FLOATING FOUNTAIN WITH LIGHTS



45383

- Floating fountains offer economical shallow water aeration combined with an attractive visual display
- Oase Floating Fountains with Lights are compact, reliable and energy efficient
- Each Floating Fountain comes complete and ready to connect
- Designed for use in smaller water features with a minimum depth of 30"
- 3 LED spotlight illumination set brings the various water patterns to life after dark via optional photocell
- Choose from 3 ornamental nozzle attachments - Trumpet, Single Tier and 3-Tier

45393

- Grounding plate eliminates any chance of stray current entering water for unparalleled safety
- Coated magnetic rotors are impervious to adverse water conditions
- Self-cooling, debris flushing rotor chambers keep pumps from overheating in the most demanding applications
- Tool-less volute removal makes maintenance fast and easy
- Nylon jacket on power cord keeps line from tangling (1/2 HP only)
- Includes pump, float body, mooring lines, pump shield, stainless steel mooring anchors, lights and 3 nozzles

ITEM	45383	45393
DESCRIPTION	Floating Fountain with Lights 1/4 HP	Floating Fountain with Lights 1/2 HP
VOLTS	120	
WATTS	130	230
MAX HEIGHT	10'	14'
MAX FLOW	2300 gph	5150 gph
MOORING LINE	100'	150'
CORD LENGTH	50'	75'
DIMENSIONS	14½"W x 19"H	23"W x 16¾"H
WARRANTY	2-year + 1	

NOZZLE PATTERNS

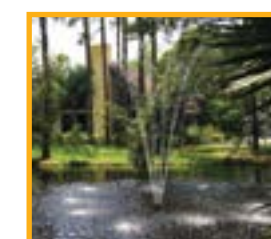
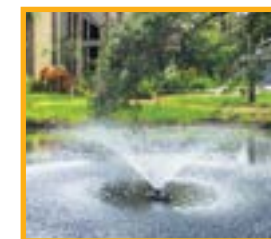

MODEL	TRUMPET		SINGLE TIER		3-TIER	
	SPREAD	HEIGHT	SPREAD	HEIGHT	SPREAD	HEIGHT
1/4 HP	16'	3'	16'	10'	6'	10'
1/2 HP	23'	5'	28'	12'	9'	12'

TECHNICAL DATA

FOUNTAIN

FOUNTAIN BASIN SYSTEM

For features up to 1,200 pounds per Basin

SIZING PUMPS FOR OVERFLOWING FOUNTAINS:

Provide 10-20 gph per inch of active edge (where water is actively overflowing) for bubbling rocks, overflowing vases and basins:

10 - 20 gph x diameter in inches x 3.14

For example:

400-800 gph for 12" fountain diameter, 600-1,200 gph for 18" diameter

800-1,600 for 24" diameter, 1,200-2,400 for 36" diameter

*Rougher surfaces require greater flows but may splash more

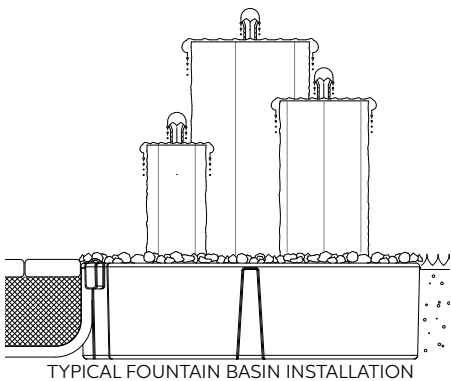

FOUNTAIN BASIN SPLASH CONTROL

- Typical splash zones extend from the source as far out as the feature is tall. A feature 3' tall may splash out 3' in every direction, a 6' diameter splash zone.
- For in-ground installations taller than 23" on an FB4700, or to capture splash from tall drops or excessively rough surfaces, consider creating a liner 'skirt' around the basin or reservoir.
- If splash is caused by water impacting the surface of the basin or reservoir, place a Splash Mat on the horizontal surface where water is falling to capture and suppress any splash. Splash Mat CFSMA2820 may be purchased in rolls of 28"W x 20'L. See page 31.
- With all Fountain Systems, the use of an Automatic Fill Valve AF1000 to compensate for splash and evaporation losses is strongly recommended. See page 107.

ECO-RISE SYSTEM

Accommodates multiple large or heavy decorative features, as many as six per PV7500 Pump Vault, fed by two TT4000 pumps through Eco-Rise Diverters. Eco-Rise weight distributors elevate the decorative elements over lined Eco-Blox reservoirs, allowing features to be plumbed, lit internally and moved with ease. Use multiple PV7500 Pump Vaults per reservoir for projects of greater than six pieces. Use multiple Eco-Rises to support massive elements in larger water features.

ECO-RISE SYSTEM CAPACITIES:

- Each 20" Eco-Rise supports up to 3,000 pounds, 1,200 pounds per 12" Eco-Rise
- Eco-Blox and Eco-Blox Small support 7 tons of distributed load on Eco-Rises
- For larger decorative elements, use multiple Eco-Rise units as needed

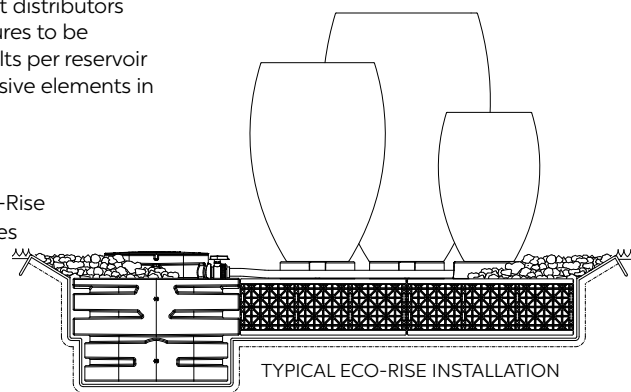

BASIC ECO-RISE INSTALLATION

A reservoir of five Eco-Blox Small with one PV7500 Pump Vault, 48" wide by 53" long is sufficient for single and tandem Vase or Bowl installations, and many stone and column installs. Excavate at least 12" wider and longer than blocks and Vault, 60" wide by 65" long, to allow ample space for backfilling. A depth of 15" measured from the lowest point along the perimeter will allow sufficient gravel to cover 9" tall Eco-Blox, Eco-Rises, Pump Vault and plumbing. Dig an additional depth of 7½" where the Pump Vault will be placed. An 8' x 8' liner is large enough for the reservoir. If your installation will splash outside the reservoir, a 10' x 15' liner will provide about two to three feet of liner "skirt" all around to capture splash. Set underlayment in the excavation to protect the liner, then set the liner with the excess distributed evenly all around. An inner layer of underlayment is recommended for added protection. Set the five Eco-Blox Small and the PV7500 Pump Vault in the excavation as shown. Pull underlayment and liner up snug and fold over the top of the Eco-Blox, then backfill in 6" lifts. Take care not to displace Eco-Blox as each layer is backfilled and stepped in. Grade the surrounding soil to capture any splash, then unfold the underlayment and liner and cover all with gravel.

FOR 3-6 FEATURES, UP TO 1,250 GPH EACH:

For up to three decorative features, install one TT4000 pump, Triton Check Valve and one Eco-Rise Diverter in the Pump Vault to supply and balance a total of 3,750 gallons per hour to up to three features through 1" Sch40 PVC flex tubing. Because each PV7500 Pump Vault will accommodate two TT4000 pumps, two Triton Check Valves and two Eco-Rise Diverters, you can distribute 7,500 gph to up to 6 individual pieces.

FOR LARGER FLOW FEATURES:

Install one or two TT3000 pumps per PV7500 Pump Vault to supply larger features with up to 2,000 gph each through 1½" tubing.

TECHNICAL DATA

LIGHTING:

- For Basalt Columns and cored boulders with 2" bore holes, use the Warm White Fountain Light WWFL2 to illuminate the water coming out of the top of the stone for a 'liquid torch' effect.
- For Brass Aura Vases, Hammered Brass and Copper Bowl installations, use a Warm White Ring Light WWRL5 and Cord Seal Fitting CSEAL15 on page 107 to illuminate the vessel from within the water. This will brightly light the inside of the feature and cast rippling light onto overhanging structures, while the Cord Seal allows the light cord to pass through the bowl invisibly. See detail at bottom of page 157.
- Install the Ring Light before plumbing the feature, beginning with the Cord Seal. Turn the Bowl or Vase over and install the included 1½" male thread x slip adapter (male adapter) in the offset threaded inlet.

BEST PRACTICE: Use sealant tape or silicone on all threaded connections.

- Set the Ring Light over the center standpipe and run the cord through the installed male adapter from the top down, then install the Cord Seal Fitting on the cord following the included instructions. Slide the Cord Seal into the male adapter, retaining nuts first, screws visible. Adjust the cord snug but not tight, then tighten the screws firmly to expand the Fitting in the adapter.
- The lights inside bowls or stones may be easily synchronized with external Spotlights and Hardscape Lights to extend the effects into the surrounding landscape or hardscape.

HAMMERED BRASS BOWL, COPPER SPILLWAY BOWL & AURA VASE INSTALLATIONS ON ECO-RISE SYSTEM

Set Aura Vase or Hammered Brass Bowl in the desired final location in the landscape or hardscape. Decide where the Pump Vault should be and mark out the reservoir location. Build the basic Eco-Rise reservoir outlined in the previous section, or to suit your installation. Pre-install the Ring Light, see above, before plumbing the fixture.

For a single Aura Vase, turn the vase over and install a 1½" male thread x slip adapter (male adapter) in the center inlet. Measure the distance from the male adapter to the bottom of the Bowl or Vase, then set the Vase in position and measure from the base of the fixture to the Pump Vault. Add the two plus another 12". Cut a piece of 1½" flexible PVC that combined length and glue it into the male adapter. Set assembly on Eco-Rise. Skip to CONNECTION TO PUMP, below.

For a single Bowl, install a 1½" male thread x slip elbow (threaded street 90) in the central inlet. Set the Bowl in position and measure from its base to the Pump Vault. Add 12", cut a piece of 1½" flexible PVC and glue into the male adapter. Set the Bowl with flex pipe on an Eco-Rise. Skip to CONNECTION TO PUMP, below.

CONNECTION TO PUMP - Install the TR215CV Triton Check Valve and optional TRION3 Ionizer on the TT pump called for in the specifications for your Vase or Bowl, using the provided 1½" bushing, and place assembly in the Vault. To adjust flow, either install a 1½" slip x slip ball valve or an electronic Atlantic Variable Speed Control TWVSC.

If using the TWVSC, cut the pipe from the Vase or Bowl to fit and glue through the pre-drilled 2" hole in the Vault into the Check Valve. Plug the pump into the TWVSC, then plug in the TWVSC and adjust the flow.

If using the ball valve, glue a 6" piece of 1½" flex pipe into the Check Valve through the pre-drilled 2" hole in the Vault, then glue a 1½" slip x slip ball valve to the 6" pipe. Cut the pipe from the Vase or Bowl to fit and glue into valve.

For multiple Aura Vases, turn the Vases over and install a 1½" male thread x slip adapter (male adapter) in the center inlet of each. Measure from the fitting to the bottom of each Vase, then set each Vase in position and measure from its base to the Pump Vault. Add the two plus another 12". Cut a piece of 1" flexible PVC for each Vase and glue a 1½" x 1" slip reducing bushing to the end of each length. Glue each reducer/flex pipe assembly into the male adapters and set each Vase on its own Eco-Rise. Skip to CONNECTION TO ECO-RISE DIVERTER, below.

For tandem Bowls with Pedestal, install a 1½" male thread by slip elbow (threaded street 90) in the center inlet of the larger, lower Bowl. Cut a 24" piece of 1½" flex PVC and glue into elbow. Glue a 1½" slip x slip x slip tee and 1½" street 90 onto the 24" pipe as shown. Glue 1½" x 1" slip reducing bushings into the tee and elbow as shown. Set assembly on Eco-Rise.

Install a 1½" male thread x slip adapter (male adapter) in the center inlet of the Spillway Bowl, then glue a 1½" x 1" slip reducing bushing into the male adapter. Set the Bowls and Pedestal in position. Measure the approximate distance from the center of the Spillway Bowl to the Pump Vault and add 12". Cut a piece of 1" flex pipe and glue into the reducing bushing. Skip to CONNECTION TO ECO-RISE DIVERTER, below.

CONNECTION TO ECO-RISE DIVERTER - Install the TR215CV Triton Check Valve and optional TRION3 Ionizer on the TT pump called for in the specifications for your Vases or Bowls, using the provided 2" bushing, and place assembly in the Vault. Glue the Eco-Rise Diverter into the Check Valve through the pre-drilled 2" hole in the Vault. Cut the 1" pipes from the Vases or Bowls to fit and glue into Eco-Rise Diverter.

For All Installations, slope the area around the reservoir so any splash will return to the reservoir, then cover the liner and reservoir with decorative stone or gravel. Fill the reservoir, turn on the pump and adjust the flow.

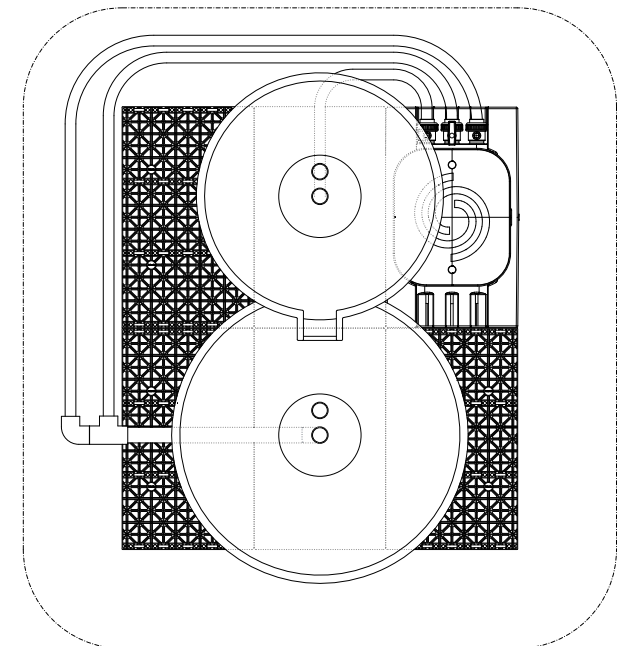

TECHNICAL DATA

WINTERIZING & REMOVAL FOR MAINTENANCE

To winterize any of the features in areas where hard freezes are expected, remove the standpipes in the Bowls or Vases to allow the water in them to drain down. Store the standpipes for winter. The small amount of water left the Bowls or Vases will not cause damage. Open the single union immediately inside the Pump Vault of the Check Valve (or Ionizer if so equipped) to allow the water in the plumbing to drain into the Vault. This will also provide a convenient handle for the removal of the pump assembly for end-of-season cleaning and maintenance. The pump assembly may be replaced in the Vault, disconnected, for the winter if the water in the Vault will not freeze solid, or it may be stored out of the weather for the season. If removal of the Bowls or Vases features is desired, disconnect the single unions of the Eco-Rise Diverter if so equipped, or install single unions as required to enable removal.

FLEX BASIN

INSTALLING A PUMP IN A FLEXIBLE FOUNTAIN BASIN:

Atlantic 4' x 4', 4' x 6', 4' x 8' rectangular and 4', 6' and 8' round Flexible Fountain Basins are equipped with integrated cord chases to hide pump and light cords. One runs across the bottom 2" from the vertical wall to 12" from the center of the reservoir. A second chase runs up the vertical wall from 2" above the bottom of the reservoir. This allows the pump to be set in the center of the reservoir with a pump nozzle attached directly to the outlet of the pump. The cord will exit the wall supporting the reservoir between the last vertical course of wall stone and the cap.

To pass the electrical cord of the pump through the wall instead, install a bulkhead fitting to the side of the vertical cord chase. Using an 1½" MIPT x slip male adapter, run a length of conduit through the wall. Installation may require notching the interior of the wallstone to accommodate the thickness of the bulkhead fitting so the liner will lay flat. Pass the cord through the horizontal cord chase, the bulkhead fitting and the conduit. Use a Cord Seal Fitting in the male adapter to seal around the cord and prevent any leakage. Construct wall as needed to hide conduit through wall.

FOUNTAIN NOZZLES

CALCULATING PUMP REQUIREMENTS FOR MULTIPLE NOZZLES

For multiple nozzles add up the volume that each nozzle requires. Determine which nozzle requires the highest pressure. The pump chosen will need to provide the total volume at that highest pressure. For example, if three nozzles require 1,200 gph at 4 psi, 2,400 gph at 6 psi and 3,600 gph at 2 psi respectively, you will need a pump that provides 7,200 gph at 6 psi.

The specification table for each Fountain Nozzle gives the recommended range of flow and pressure for each. Overdriving the volume or the pressure will not significantly increase the maximum height or width of the display but will cost more to operate and put more stress on the system. In order to avoid frequent nozzle clogging, the largest particles passing through the pump should be significantly smaller than the smallest orifice on the nozzle. Inlet screening and/or filtration may be required.

USING LIGHT RING TO ILLUMINATE DISPLAY FROM FOUNTAIN NOZZLES

To illuminate the display from an 1½" nozzle install an 1½" adapter at the appropriate height on an 1½" riser attached to the outlet of the pump. Slip the Ring Light over the male adapter before attaching the nozzle. To illuminate the display from a 1" nozzle, create a base for an Atlantic Ring Light by installing a 1" x 1½" reducing adapter on the 1½" riser attached to the outlet of the pump. Adapter should be set at the height appropriate for the nozzle. Install 1" bushing on Light Ring (included with light) and slip the Light Ring over the 1" adapter before attaching the nozzle.

LEVELING NOZZLES

The stainless steel Nozzle Adjustment Base is designed to level Fountain Nozzles that are up to 15 degrees off vertical. Adjustment is best done on a calm day when the wind will not throw off the procedure. Begin by adjusting all screws to leave a ¼" gap between the top and bottom plates. Install the Nozzle Adjustment Base on the pump or plumbing, then attach the nozzle to the Base. Set the pump or plumbing in position and ensure that it is stable and will not move when the pump is in operation. Turn on the pump and note the direction that the water "leans". Turn off the pump and back out the screw closest to the direction of 'lean', counterclockwise, noting the number of turns. Repeat as necessary to plumb the water column. If water column 'lean' is centered between two adjustment screws, adjust both as needed to correct.

WATER QUALITY GUIDE FOR PROFESSIONAL NOZZLES

TYPES	FRESH WATER	POOL WATER	SALT WATER
pH VALUE	7.2 - 7.6	7.2 - 7.6	8.0
HARDNESS	142 - 267 ppm CaCO ₃	142 - 267 ppm CaCO ₃	356 - 534 ppm CaCO ₃
FREE CHLORINE	< 0.3 ppm	0.3 - 0.6 ppm	< 0.3 ppm
CHLORIDE CONCENTRATION	< 250 ppm	< 250 ppm	22,000 ppm
SALINITY	-	-	< 4.0%
TOTAL SUSPENDED SOLIDS	< 50 ppm	< 50 ppm	< 50 ppm
TEMPERATURE	39° - 95° F	39° - 86° F	39° - 68° F

TECHNICAL DATA



FORMAL SPILLWAY

STAINLESS STEEL & COPPER FINISH SPILLWAY INSTALLATION

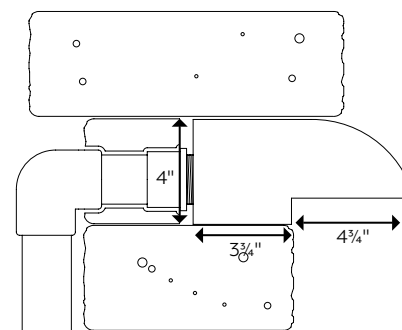

- Spillways are sized to exactly replace 4" tall block
- Load bearing capacity of Spillways is 80 lbs. per linear foot
- Heavier water sheer of Spillways allows taller waterfall height of up to four feet above basin level
- 304 Stainless Steel is not compatible with chlorinated or salt water pools
- 316 Stainless Steel Spillways are for use wherever chlorine is used as a disinfecting agent

LIGHTING OPTIONS:

- Because the water flow coming out of the Spillways is not laminar, they cannot be lit from within like Colorfalls and Wall Spouts
- To illuminate Spillways, either upright by placing a Ring Light or Bar Light directly below the falls or downlight by installing wall lights below the Spillway

WALL SPOUT INSTALLATION

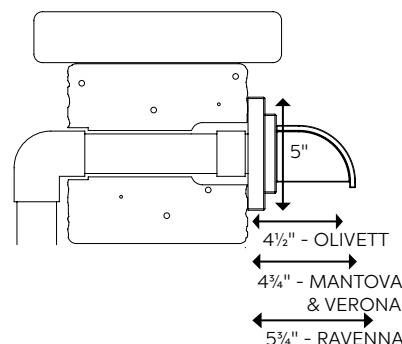

- Wall Spouts should protrude at least 2" over the catch basin
- Integrated drip edge ensures any drip falls straight down preventing water from running back, dampening retaining wall
- Allow for the plumbing to be adjusted backwards to snug the spout against the wall, or caulk small gap between Spout and wall
- Flows under 600 gph will not allow Spout Light to illuminate water flow if used

LIGHTING OPTIONS:

- To light the laminar flow of water coming out of a wall spout, install an 1½" tee fitting to supply water to the fixture fitted with a 1½" x 1" threaded bushing to accept a Warm White or Color Changing Spout Light
- With a minimum of 600 gallons per hour flow, the light will be fully encapsulated within the water illuminating the stream as it travels down to the basin

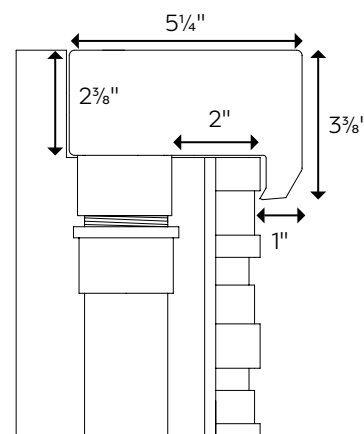
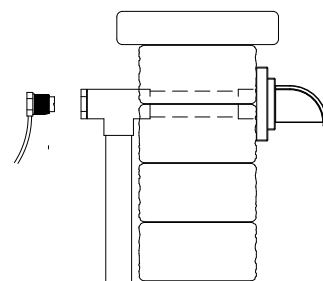

WATERWALL SPILLWAY INSTALLATION

- For framed wall installations, WaterWall Spillway installs on top of framed walls leaving 2" for concrete backer board and fascia
- Liner should cover framing and extend at least 18" to either side of WaterWall
- Bottom of liner must overlap edge of pump basin or reservoir
- Use ball valve on pump to adjust flow
- For masonry installations, a channel may be cut into the course of block below the WaterWall to accommodate 1½" pipe and fittings

LIGHTING OPTIONS:

- Two Spotlights submerged at either corner of reservoir will cast light on water cascading down wall enhancing the appearance of movement

TECHNICAL DATA

COPPER SPILLWAY BOWL INSTALLATION:

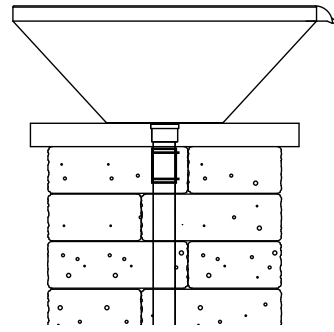

- Cap and one block in top course need to be removable to access rubber coupling
- Ensure that the spillway lip clears the column to avoid excessive splash and water loss
- For best results and the least amount of water loss, bowl height above reservoir should not exceed 3'

LIGHTING OPTIONS:

- Use Ring Light around included copper standpipe to illuminate interior of bowl
- Use Cord Seal Fitting in second inlet to pass light cord through bottom of bowl

COLOR CHANGING COLORFALLS INSTALLATION:

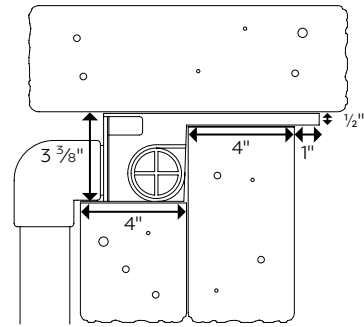

- Colorfalls must be supported evenly both above and below the lip as shown
- Lip overhang should not exceed 1" to avoid algae issues, warping and loss of support
- Load bearing capacity of Colorfalls is 40 lbs. per linear foot
- For best results and the least amount of water loss, falls should not exceed max heights listed on page 36

CONNECTING MULTIPLE COLOR CHANGING COLORFALLS

STEP 1.



Use included 1/2" threaded coupling to attach multiple Colorfalls together.

STEP 2.

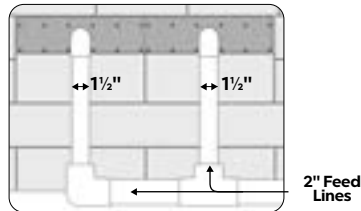

Plumb Colorfalls with 2" manifold or install valves to distribute water equally to all units.

STEP 3.

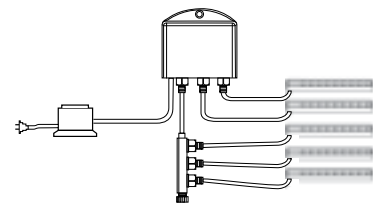

Use Splitters (CCBSX4) and InfiColor Smart Module (CCSM30X3) and larger Transformer to link and sync Color Changing Colorfalls.

Tip: Plumb directly into the back center of each unit. Plumbing multiple Colorfalls unevenly favoring one side will produce an uneven water sheer.

INFICOLOR SMART MODULE & ATLANTIC CONTROL APP:

See page 168 for more information on Atlantic Control App and connecting Color Changing products.

TECHNICAL DATA

FORMAL SPILLWAY AND FLEXIBLE BASIN INSTALLS & PLUMBING CONFIGURATIONS

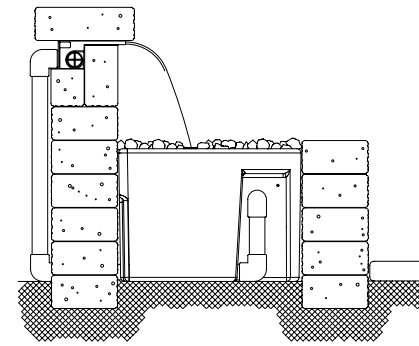

COLORFALLS WITH FORMAL SPILLWAY BASIN

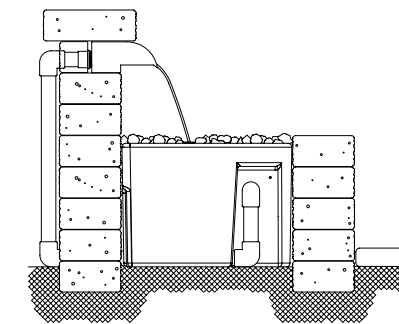

SPILLWAY WITH FORMAL SPILLWAY BASIN

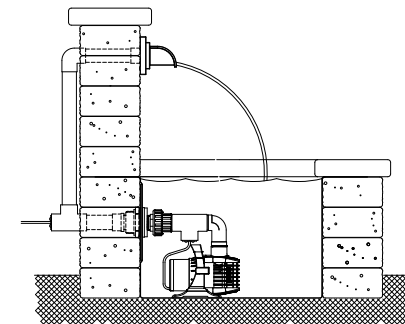

WALL SPOUT WITH FLEXIBLE HARDSCAPE BASIN

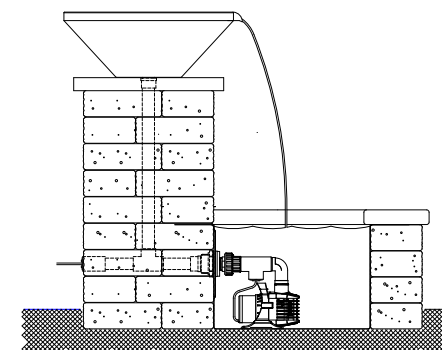

COPPER SPILLWAY BOWL WITH FLEXIBLE HARDSCAPE BASIN

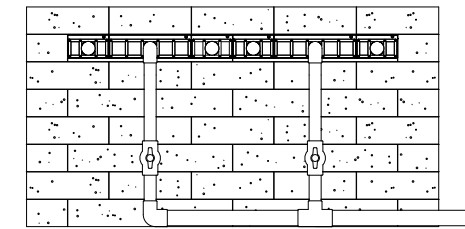

MULTIPLE COLORFALLS INSTALLATION IN CUSTOM BASIN

To feed multiple Colorfalls create a manifold of 2" pipe with 1/2" risers and valves to balance the flow to two or three Colorfalls. For total flows under 3000 gallons per hour, a single pump may be used; to feed multiple 24" or 36" Colorfalls install a pump at either end of the manifold.

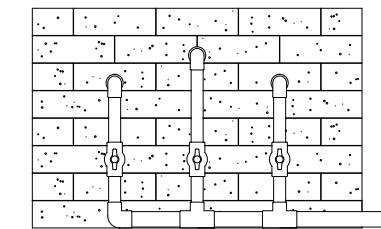

MULTIPLE SPILLWAYS WITH FORMAL SPILLWAY BASIN

To feed multiple spillways create a manifold of 2" pipe with 1/2" risers and valves to balance the flow to two or three spillways. For total flows under 3000 gallons per hour, a single pump may be used; to feed multiple spillways install a pump at either end of the manifold.

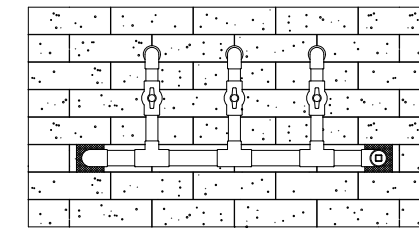

MULTIPLE SPOUT INSTALLATION IN FLEXIBLE HARDSCAPE BASIN

To feed multiple spouts create a manifold of 2" pipe with 1/2" risers and valves to balance the flow to two or three spouts. For total flows under 3000 gallons per hour, a single pump may be used; for flows over 3000 gallons per hour, install a pump at either end of the manifold.



CORD SEAL FITTING INSTALLATION

To install Copper Spillway Bowl run plumbing to center inlet and seal secondary inlet with included 1/2" Sch40 PVC plug using silicone or tape on threads. If lighting is desired, install 1/2" Sch40 PVC male adapter included with Cord Seal Fitting (CSEAL15) in secondary inlet as shown and use Cord Seal Fitting to seal around lighting cord.

TECHNICAL DATA

FLEXIBLE HARDSCAPE BASIN PLUMBING KIT (MODEL: FFKIT1 / ITEM: 87754)

Atlantic offers an easy way to plumb Flexible Hardscape Basins and simultaneously hide the pump cord, providing all the components needed to allow the pump cord to exit the basin invisibly. Two Cord Seal Fitting Kits, along with standard tees, allow the cord to pass from inside the basin to the exterior, inside the plumbing itself, without leakage. Once installed, the plumbing can be configured in any configuration desired, while the cord may be removed and replaced as needed.

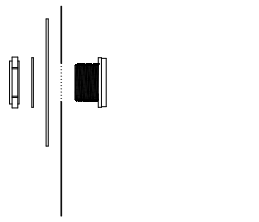
- 

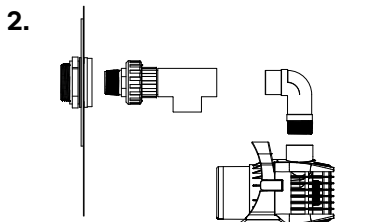
Place the bulkhead fitting and rubber gasket through the hole in the Flexible Basin, threads to the outside. Place the flange and slip washer over the threads, then the nut. Turn COUNTERCLOCKWISE to tighten.
- 

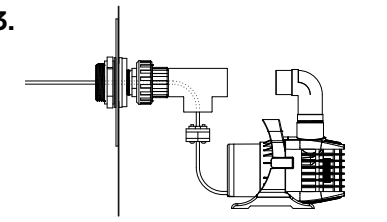
Attach the pump discharge elbow to the TT-Series pump. Hand tighten the assembly and orient the elbow so it is positioned over the pump body. Glue the included nipple into one of the long legs of the tee and glue the tee assembly into the union opposite the threaded end.
- 

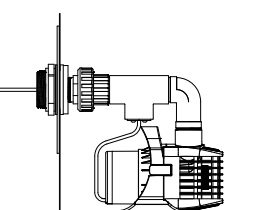
Pass the pump cord into the short leg of the tee and work the cord through the union and the bulkhead fitting. Screw the 1/2" male threaded end of the union into the bulkhead fitting. The Cord Seal Fitting will seal around the pump cord so it can pass through the plumbing without leaking. Disassemble the Cord Seal Fitting and slip the rubber gasket around the pump cord. Reassemble the Cord Seal Fitting ensuring the molded-in nuts are facing towards the tee. Be sure to align the inner and outer halves at 90° to each other and then start the screws.
- 

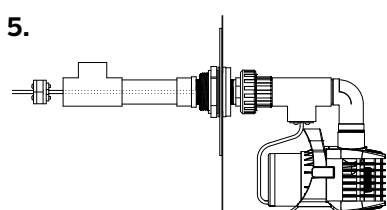
Loosen the union as needed to orient the tee to a convenient position then push the Cord Seal Fitting into the tee, leaving enough slack in the pump cord to allow for pump maintenance and servicing. Tighten the Cord Seal Fitting. Align the tee downwards and tighten the union, then glue the pump discharge elbow into the union assembly.
- 

Move to the back side of the wall to finish the remainder of the plumbing work. Slide a male thread adapter over the pump cord, apply silicone to the threads and install the adapter in the bulkhead fitting. Then, measure and cut a piece of pipe to extend from the male thread adapter to the back of the wall. Slide the section of cut pipe over the pump cord and glue into the male thread adapter. Next, slide a tee over the cord and glue that to the section of pipe, aligning the side-outlet of the tee towards the center of the back wall. Disassemble and reassemble a Cord Seal Fitting around the pump cord into the end of the tee.

FILTRATION OPTIONS

External pressure filters are particularly useful to keep open basins clean. They can be used with the pump set inside or outside the basin. Either way, first install the included bulkhead fitting through the liner following the included instructions. To mount the pump inside the basin, install a pair of tees on the output of the pump both inside and outside of the bulkhead fitting. This will allow the cord to pass through the wall inside the plumbing. Use a Cord Seal Fitting in each tee to seal around the pump cord. To install the pump outside the basin, remove the intake screen of the pump and connect a pipe directly from the bulkhead fitting to the pump intake. Connect the output of the pump to the filter and return the filtered water through the Spout(s) or Spillway to the basin.

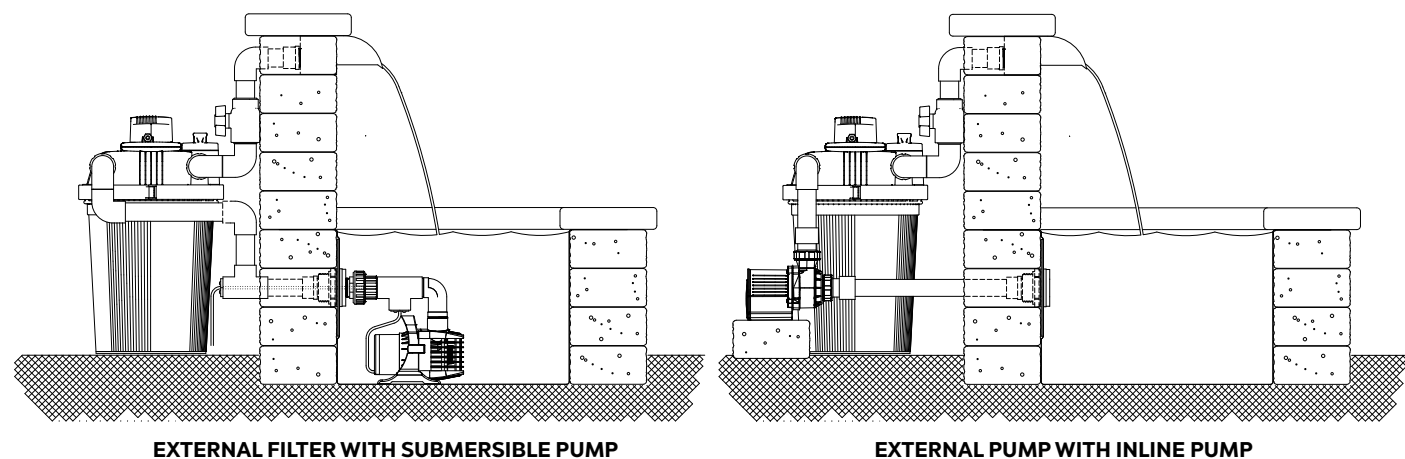

TECHNICAL DATA



POND-FREE

CALCULATING BASIN VOLUME

ECO-BLOX RESERVOIRS

Upon start-up, the pump draws water from the reservoir to fill the streambed, from top to bottom, until the water overflows back into the reservoir to complete the cycle. The amount of water needed to complete this cycle the 'transitional' water volume. If the reservoir is too small, or the streambed built improperly, the water level in the reservoir can drop below the top of the pump before cycling, leading to pump overheating and damage. Calculate the transitional water volume, then design the reservoir to hold at least three times as much, so the water level in the reservoir never drops by more than one-third when the pump is turned on, keeping the pump safely submerged at all times.

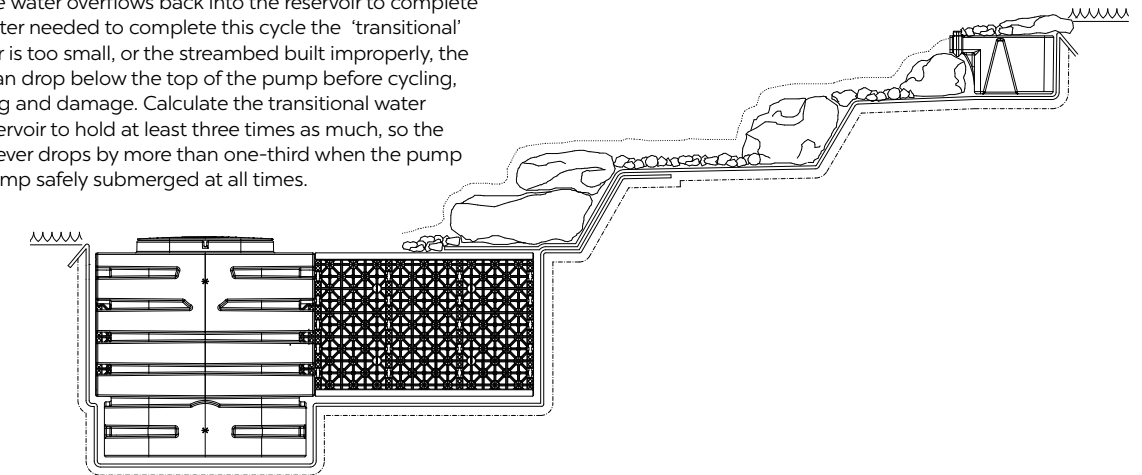

Assuming that it will take about 3" or 0.25 ft. of water to fill the stream and get the system recirculating, we can calculate the transitional volume, minimum reservoir volume and Eco-Blox quantity by using the formulas below:

$$\text{Avg. Depth (.25ft)} \times \text{Avg. Length (_____ ft)} \times \text{Avg. Width (_____ ft)} = \text{Transitional Volume}$$

$$\text{Transitional Volume} \times 3 = \text{Minimum Reservoir Volume}$$

$$\text{Minimum Reservoir Volume} \div 4.2 = \text{Number of Eco-Blox to fill Reservoir}$$

WATER DEPTH CONVERSIONS					
1" deep = 0.08'	2" deep = 0.16'	3" deep = 0.25'	4" deep = 0.33'	5" deep = 0.42'	6" deep = 0.50'

GRAVEL-FILLED RESERVOIRS

Because Eco-Blox are 96% void space, they allow the reservoir to be dug to just the size required for the water volume needed. Backfilling with gravel fills 65% of the reservoir with stone, leaving only the 35% that remains between the stones available for water storage. This means that a gravel-filled basin will need to be three times larger than an Eco-Blox basin to hold the same volume of water. That's a lot more time, excavation, additional soil removed, additional gravel to fill the hole, labor costs and cleanup.

$$\text{Transitional Volume} \times 9 = \text{Minimum Reservoir Volume (when filled with gravel)}$$

FOR LARGER BASIN VOLUMES

For installations where a larger basin volume or a deeper basin is required, Atlantic offers a Pump Vault Extension. Each additional layer of Eco-Blox increases the depth of your excavation by 17.5"; use one Extension for each additional layer.

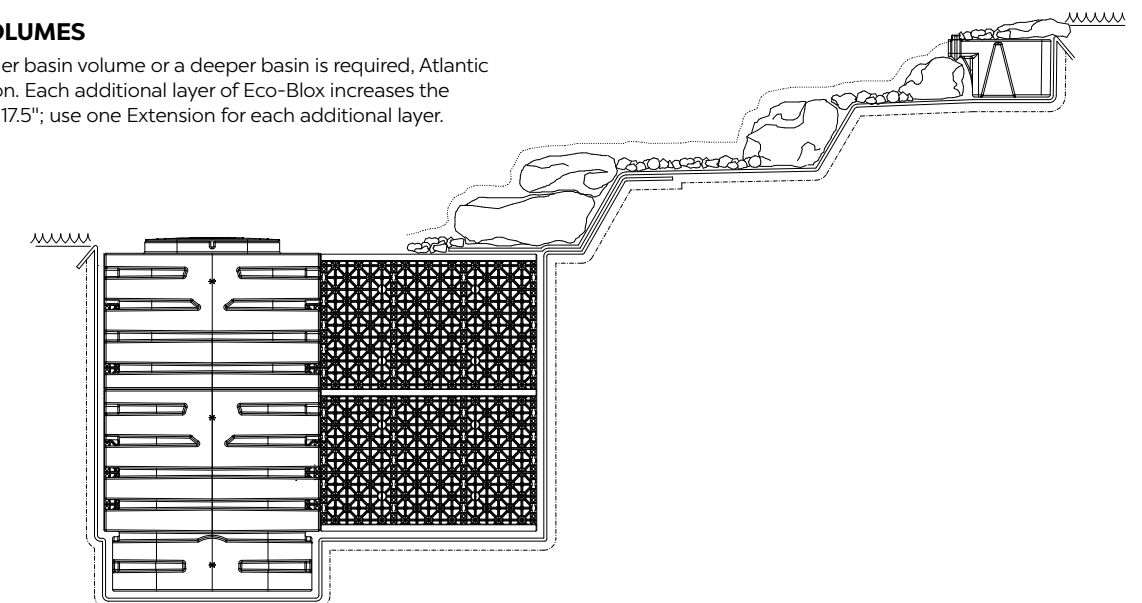

TECHNICAL DATA

ROCK & GRAVEL CALCULATIONS

QUANTITY OF BOULDERS AND GRAVEL FOR A STREAM:

Tons of Boulders = 1.5 tons for every 10' of stream
Tons of Gravel = Tons of Boulders ÷ 4

RATIO OF SIZES OF BOULDERS:

For every 1 ton of 6" - 12" boulders, get 2 tons of 12" - 18" boulders, 1 ton of 18" - 24" boulders

ECO-BLOX / PUMP VAULT LAYOUTS

1 LAYER ≈ 125 GALLONS
2 LAYERS ≈ 250 GALLONS



1 LAYER ≈ 285 GALLONS
2 LAYERS ≈ 570 GALLONS
3 LAYERS ≈ 855 GALLONS

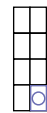

1 LAYER ≈ 500 GALLONS
2 LAYERS ≈ 1000 GALLONS
3 LAYERS ≈ 1500 GALLONS
4 LAYERS ≈ 2000 GALLONS

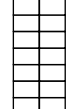

1 LAYER ≈ 190 GALLONS
2 LAYERS ≈ 380 GALLONS



STREAM BED CONSTRUCTION

The less the water level drops as the feature turns on and the stream fills, the better for proper function. Proper streambed construction can reduce the amount of water needed for this transition.

Since transitional volume is determined by the height that the weir rock extends above the liner at the spillways, minimizing that height reduces the amount of water necessary to fill the streambed. The drawings to the right display two examples of proper construction techniques for minimal transitional water.

IMPROPER STREAMBED CONSTRUCTION

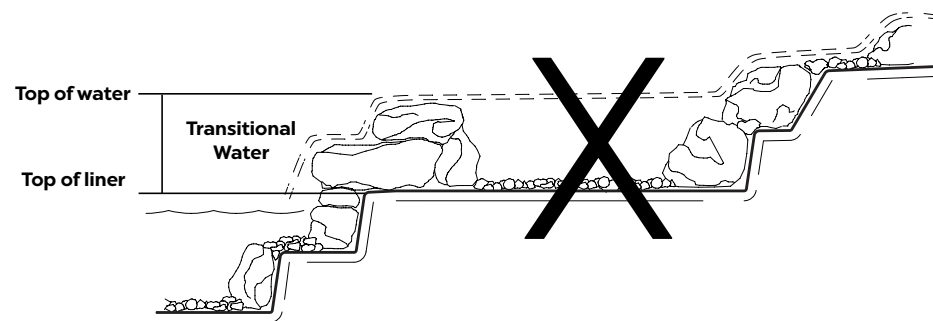

PROPER STREAMBED CONSTRUCTION

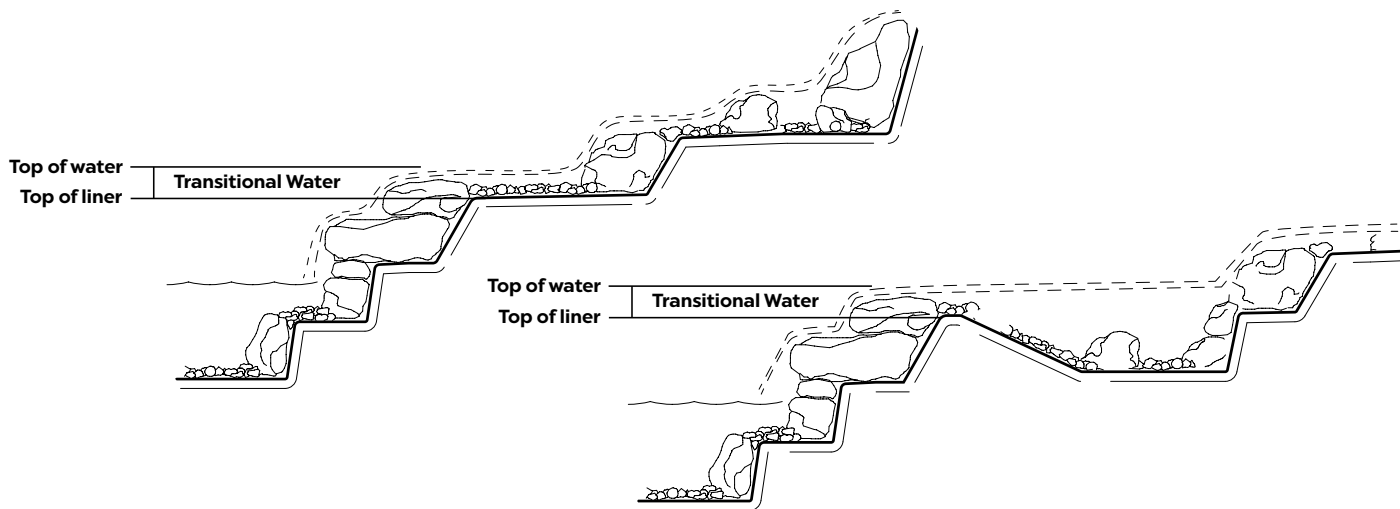

TECHNICAL DATA



WATER GARDEN

SURFACE AREA

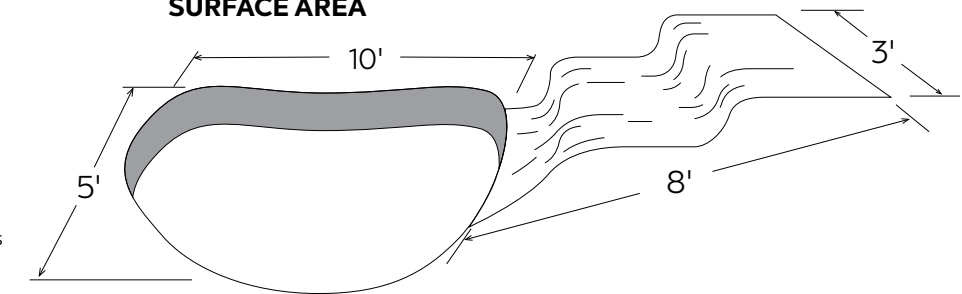

Upon start-up, the pump draws water from the pond to fill the streambed, from top to bottom, until the water overflows back into the pond to complete the cycle. We call the amount of water needed to complete this cycle the 'transitional' water volume. If the streambed is built improperly, or is built too big, the water level of the pond could drop below the opening in the skimmer before the water levels equalize. This would result in the pump starving for water and running dry.

This situation can be easily avoided by using the formula provided to calculate the surface area of your pond. With that number, you can then determine the maximum surface area of waterfalls and streambed that your pond can accommodate.

To limit the transitional volume of water needed get the system cycling, the stream surface area should be half of the pond surface area or less. Follow guidelines for proper Streambed Construction.

MAXIMUM AREA OF STREAM (IF YOU KNOW YOUR POND SIZE)
Average Length of Pond x Average Width of Pond ÷ 2 = Maximum Area of Stream

MINIMUM AREA OF POND (IF YOU KNOW YOUR STREAM SIZE)
Average Length of Stream x Average Width of Stream x 2 = Minimum Area of Pond

SIZING & CALCULATIONS

SIZING LINER (LENGTH, WIDTH AND DEPTH MEASURED IN FEET):
Pond Liner Length = Max. Length of Excavation + (2 x Maximum Depth) + 5'
Pond Liner Width = Max. Width of Excavation + (2 x Maximum Depth) + 5'
Stream Liner Length = Max. Length of Stream + 5'
Stream Liner Width = Max. Width of Stream + 5'

QUANTITY OF BOULDERS AND GRAVEL NEEDED FOR A FULLY ROCKED AND GRAVELED POND:
Tons of Boulders = Length x Width ÷ 40
Tons of Gravel = Tons of Boulders ÷ 4

APPROXIMATE VOLUME OF WATER IN POND IN GALLONS:
Average Length x Average Width x Average Depth x 7.5
= Total Gallons in Pond

QUANTITY OF BOULDERS AND GRAVEL FOR A STREAM:
Tons of Boulders = 2 tons for every 10' of stream
Tons of Gravel = Tons of Boulders ÷ 4

APPROXIMATE GALLONS OF WATER IN A STREAM:
Average Length x Average Width x Average Depth x 7.5
= Total Gallons in Stream

RATIO OF SIZES OF BOULDERS:
For every 1 ton of 6" - 12" boulders, get 2 tons of 12" - 18" boulders, 1 ton of 18" - 24" boulders

Note: Figure volume of fully rocked and graveled pond at approximately 80% of bare liner volume. Overestimating volume may throw off filtration calculations and could lead to overdoses of treatments.

FILTRATION OPTIONS

After figuring the size of the pond, the flow required for proper circulation and the width of the waterfall, next is the filtration system. One of the most popular systems, especially for ponds with lower fish loads, is the Atlantic Skimmer and Biological FilterFalls. The Skimmer houses the pump and removes surface debris at the end of the pond farthest from the FilterFalls. The FilterFalls starts the waterfall or stream and removes both suspended debris and toxins like ammonia. Setting the two components as far as possible from each other helps sweep the entire pond surface of debris into the Skimmer and ensures good circulation. Heavier, settled debris can be removed by vacuum or pond cleanup.

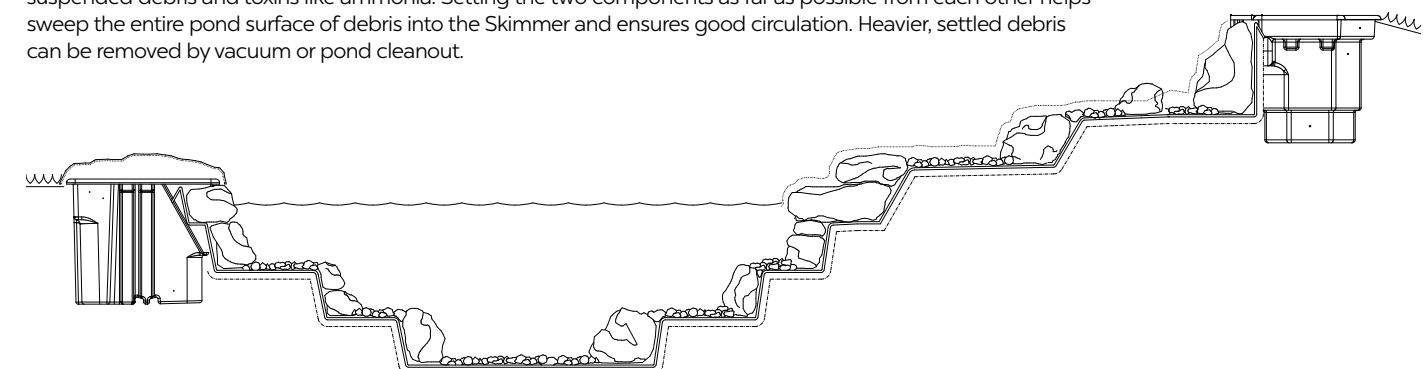

TECHNICAL DATA

Another filtration option for ponds with medium to high fish loads places a solids-handling pump on the bottom that pumps fish waste to a flow-through or pressure filter to remove solids and toxins, with an ultraviolet clarifier to control green water. In this system, pioneered by Oase, the pump is designed to pass wastes without clogging; filters can be cleaned by turning a valve and lifting a handle, lowering maintenance. Leaves can be removed by skimming or with a vacuum.

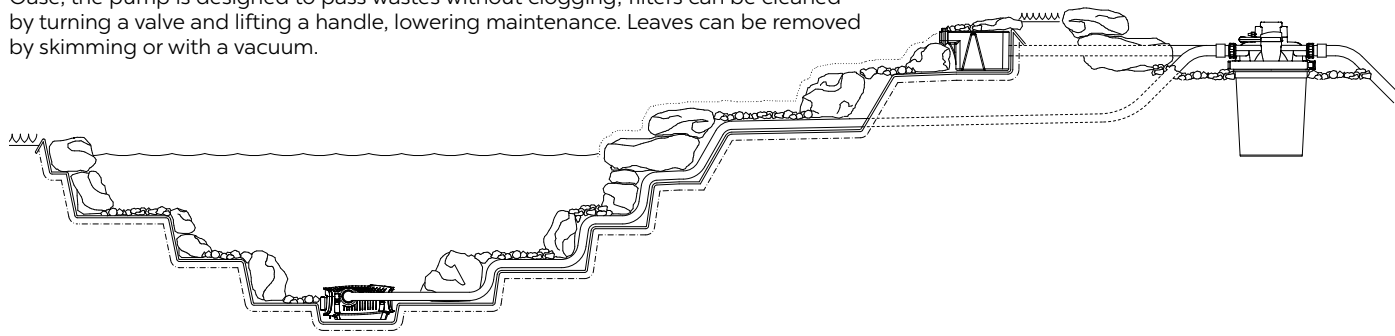

Adding an Oase pump, filter and UVC to a pond equipped with a Skimmer and FilterFalls is the perfect combination, especially for ponds that are at or exceeding maximum fish load. Floating debris is trapped by the Skimmer, heavier waste pumped into an external filter which can be quickly cleaned or even clean itself. Little waste accumulates in the Skimmer and FilterFalls, which need cleaning much less often. Total maintenance is minimized, while water clarity and quality are maximized, guaranteed.

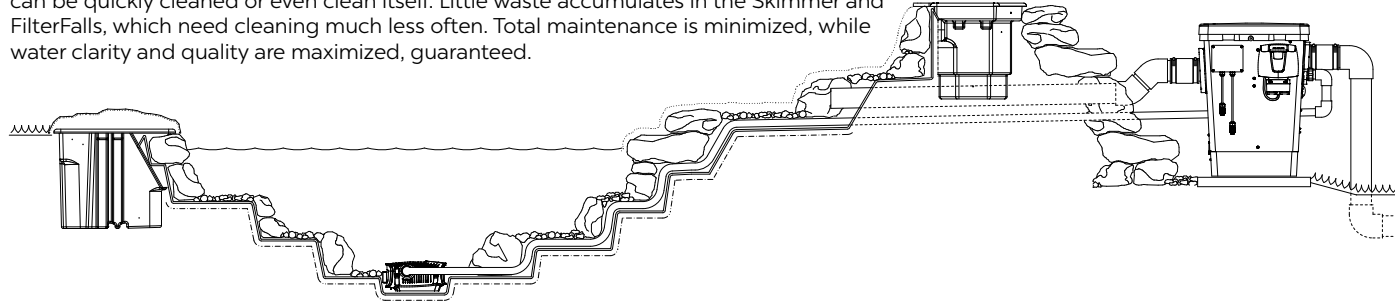

BOG CONSTRUCTION

Atlantic's Eco-Blox and Pump Vaults make excellent, easy to maintain upflow filters. The Pump Vaults act as distribution nodes and cleanouts. Eco-Blox, covered by a thin layer of planted gravel, create settling chambers that remove solids, nutrients and wastes. The void the blocks create under the gravel and plants removes and holds all the solids suspended in the water pumped into it. This avoids the problem of massive amounts of muck trapped in deep gravel beds that cannot be cleaned (which is where the term "bogs" came from.) To clean Eco-Blox upflow filters, simply install a drain so sediments can be drained out by opening a valve.

Conventional upflow filters pump water into the bottom of a gravel bed at or above pond level, that flows up and out through gravel and back into the pond. Upflow filters are typically located in a stream or along the perimeter of the pond. Because the debris ends up easily accessible near the surface, not trapped down in a deep gravel bed, upflow bogs are easy to keep clean. The thin layer of gravel stays highly oxygenated, so it's very effective at converting toxic ammonia and nitrite to nitrate, which can be removed by planting the gravel bed, giving rise to the name "veggie filter". Because the nitrates are delivered directly to the roots, plants in the beds grow prodigiously.

However, thin gravel beds are only effective at low flows, because solids only drop out of suspension as water velocity drops and there isn't much gravel to slow the water down. An Eco-Blox chamber under the gravel allows much higher flows to be filtered effectively. The partitions and large void spaces of the blocks quickly slow even high velocity flows, making the Eco-Blox upflow filter especially effective at removing suspended solids, even with minimal gravel thickness on top of only 4"-6". Bacteria in the highly oxygenated gravel on top of the Eco-Blox cycle ammonia at a very high rate. Plants in the gravel bed consume the nitrates produced and their roots help keep even the finest suspended solids from escaping the filter.

To simplify the plumbing, a Pump Vault acts as both the distribution node for incoming water, and the cleanout chamber for sediment. 3" bulkhead fittings top and bottom seal the liner to the wall of the Pump Vault, and a 3" valve allows wastes to be flushed out to grade at will.

SIZING UPFLOW BOGS:

- For water gardens with few fish and no food added, size the bog at **10%** of the surface area of the water garden
- For fish ponds with goldfish that are fed occasionally, size the bog at **20%** of the surface area of the fish pond
- For koi ponds with koi that are fed frequently, size the bog at **30%** of the surface area of the koi pond
- For recreational ponds where removal of all nutrients is critical, make the filter **40%** of the total area. Eco-Blox upflow filters are so efficient that the filtered area can be significantly reduced from typical 50% to 100% of additional area that 'regeneration zones' usually occupy.

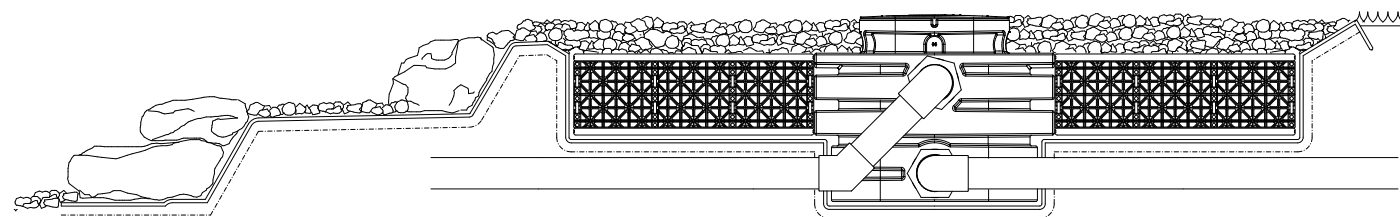

TECHNICAL DATA



PUMP

PUMP USAGE GUIDELINES

The water the pump will be moving determines which type of pump to use. "Clean water" pumps that handle small particles an eighth of an inch or less can be built to tight tolerances with high efficiency to move the most water per watt. Larger debris or abrasive sediments, like the wastes at the bottom of a pond, will require a solids-handling pump. Smaller impellers spinning in a large volute leave room for solids to pass without jamming, but this partial bypass design is inherently inefficient; solids-handling pumps draw more wattage than the same size clean water pump.

What's dissolved in the water also makes a difference. Salinity is corrosive to most metals, including mild stainless steel. Calcium salts readily bond to warm metal, causing scale that binds and overheats pumps. Metals in the water, especially iron, cause similar issues. Coating the rotor with plastic improves both salt- and scale resistance; special steel alloys resist salt and chlorine.

Finally, calculate the "Total Dynamic Head", the work a pump has to do, to specify the right size and type of pump. Find the Friction Head of the plumbing and add that to the Vertical Head for the TDH in feet of any application, p. 164.

MOTOR TYPES

Magnetic Induction pumps generate a magnetic field to spin an impeller. Best for low head, low volume applications because the field will slip under heavy load.

Mag Drive impellers are attached to a permanent magnet suspended inside a coil; when the coil is energized the magnet/impeller rotates.

Synchronous Mags rotate at the same speed as the frequency of the power supply.

Asynchronous pumps substitute a rotor with a coil in place of a permanent magnet; the rotor becomes a powerful electromagnet when the outer coil is energized.

Direct Drive impellers are directly attached to the motor via shaft, with shaft seals to keep the wet end isolated from the motor.

Direct Drive pumps handle solids, high volume/high head and restrictive plumbing but require significantly more power to run.

Axial Flow pumps push high volumes with an economical low-pressure impeller, but require large diameter plumbing to keep friction head to a minimum.

Brushless DC pumps are powerful and efficient, with built-in variable speed capability, but electronic control comes at a premium.

12 Volt pumps are specifically designed for applications where submersed line voltage pumps are prohibited, such as recreational ponds.

PUMP LINE	MOTOR TYPE	SOLIDS	WATER QUALITY			HEAD HEIGHTS		
			FRESH	CHLORINE	SALT	LOW <10'	MEDIUM 10'-20'	HIGH >20'
FP-SERIES	MAG DRIVE	Clean water only	•			•		
FOUNTAIN	SYNCHRONOUS MAG	≤ 3/32"	•			•		
MD-SERIES	MAG DRIVE	≤ 3/32"	•			•		
AQUARIUS ECO EXPERT	DC BRUSHLESS	≤ 1/16"	•	<0.6 ppm	<4.0%	•	•	•
AQUAMAX ECO CLASSIC	SYNCHRONOUS ELECTRONIC	≤ 1/8"	•			•		
AQUAMAX ECO PREMIUM	SYNCHRONOUS ELECTRONIC	≤ 3/16"	•			•		
TT-SERIES	ASYNCHRONOUS	≤ 3/32"	•			•	•	
WATERFALL	SYNCHRONOUS MAG & ASYNCHRONOUS (6600-8000)	≤ 1/16"	•			•	•	
AQUAMAX ECO EXPERT	DC BRUSHLESS	≤ 1/16"	•	<0.6 ppm	<4.0%	•	•	•
PAF-SERIES	DIRECT DRIVE	≤ 1/4"	•				•	
SH-SERIES	DIRECT DRIVE	≤ 1/2"	•			•	•	
A-SERIES	DIRECT DRIVE	A-05 ≤ 3/32" A-21-32 ≤ 1/32"	•				•	•
L-SERIES	AXIAL FLOW	≤ 1/32"	•			•		

PUMP APPLICATION GUIDELINES

- For very low head, very low volume, use Fountain Pumps (FP-Series and Fountain Pumps)
- For low head, low volume, use Magnetic Drive Pumps (MD-Series)
- For low head, very high volume, use Axial Pumps (L-Series) with 3" or larger tubing
- For medium head, medium volume, use Asynchronous and Synchronous Pumps (TT-Series, Waterfall, AquaMax Classic and Premium)
- For medium head, medium volume variable operation, use TidalWave Variable Speed Controller (TWVSC) with TT-Series Asynchronous Pumps
- For high head, high volume applications, use Direct Drive Pumps (A-Series)
- For solids and dirty water applications, use Direct Drive Solids Handling Pumps (PAF and SH-Series)
- For variable flow from low to high head and low to high volume, use DC Brushless Pumps (Aquarius and AquaMax Eco Expert)

TECHNICAL DATA

CALCULATING TOTAL DYNAMIC HEAD

1. PICK A LOOK & SPECIFY A FLOW:

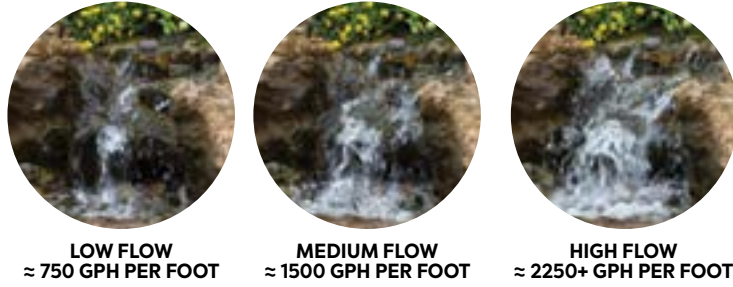

Choose the appearance you would like for your waterfall from the suggested choices to the left. Multiply the corresponding **GPH Per Foot** by the desired **Width of the Waterfall** to find the **Recommended Flow**.

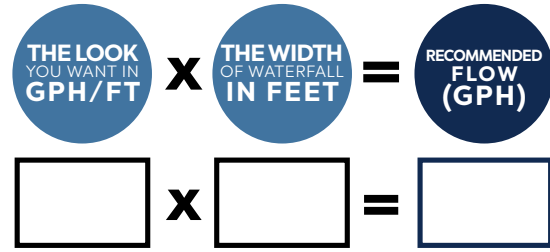

CHART A

FRICTION LOSS PER FOOT OF TUBING

FLOW (GPH)	TUBING SIZE						
	½"	¾"	1"	1¼"	1½"	2"	3"
100	0.10	0.01					
200	0.38	0.05	0.01				
300	0.83	0.10	0.02				
400	1.00	0.18	0.04	0.01			
500	2.23	0.27	0.06	0.02			
750		0.50	0.14	0.04	0.02		
1000		0.84	0.21	0.07	0.03		
1250		1.20	0.33	0.10	0.04	0.01	
1500			0.43	0.15	0.06	0.02	
2000			0.94	0.26	0.10	0.03	
3000			2.07	0.52	0.22	0.05	
4000				1.10	0.43	0.09	0.01
5000				1.80	0.67	0.15	0.02
6000					0.96	0.22	0.03
8000					1.77	0.38	0.05
10,000						0.59	0.07
12,000						0.84	0.10
15,000							0.15
18,000							0.25

Example: GPH: 3000 Friction Loss: 0.05 Tubing: 2"

** For flows over 20,000 GPH or lengths over 100 ft. please contact us.

CHART B

FRICTION IN EQUIVALENT FEET OF STRAIGHT PIPE

PVC FITTINGS	FITTING SIZE					
	¾"	1"	1¼"	1½"	2"	3"
Std Elbow, 90 degree	4.5	5.5	7.0	7.5	8.5	11.0
Std Elbow, 45 degree	1.0	1.5	2.0	2.5	3.0	4.0
Male / Female Adapter	1.5	2.0	3.0	3.5	4.5	6.5
Tee (Straight Thru)	2.5	3.0	5.0	6.0	8.0	12.0
Tee (Thru Branch)	5.5	7.0	9.0	10.0	12.0	17.0
Swing Check Valve	9.0	11.0	13.0	15.0	19.0	27.0

Example: 8.5 (90°) + 4.5 (M/FA) + 19.0 (Check Valve) = 32 (Fitting Length in Feet)

3. FIND THE TOTAL DYNAMIC HEAD

Add the Friction Head in Feet to the Vertical Head to find TDH. Vertical Head is the height in feet from the surface of the water the pump will be sitting in, to the highest point the water is pumped to.

4. CHOOSE YOUR PUMP

Locate the column representing the **Total Dynamic Head (TDH)** on the pump chart (opposite page). Find the pump that provides the required flow at that TDH. If the chart gives you a choice of more than one pump, check for the type that best fits your application, then check for the lowest wattage, to save on operating costs.

2. DETERMINE FRICTION LOSS:

2.1 FIND TUBING SIZE & FRICTION

Find the dark blue cell in the row that corresponds with the **Recommended Flow (GPH)** in CHART A. The column indicates the recommended tubing size and the number in the cell is the **Friction Loss** in every foot of tubing. Keep Friction Loss low for greatest flow.

To find the Friction Loss of existing systems, estimate the flow through the actual tubing size used.

2.2 ADD FRICTION IN FITTINGS

Add the equivalent lengths of all the fittings in the system, from CHART B, to the tubing length from pump to falls to find the **Equivalent Tubing Length**.

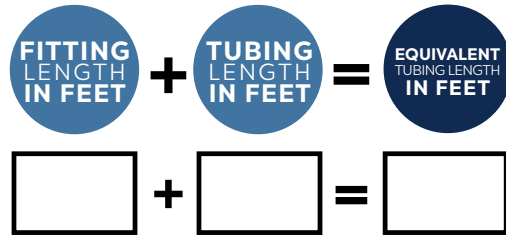

2.3 CALCULATE FRICTION HEAD

Multiply the **Equivalent Tubing Length** in feet by the **Friction Loss** in the dark blue cell from CHART A to find the **Friction Head** of the system.

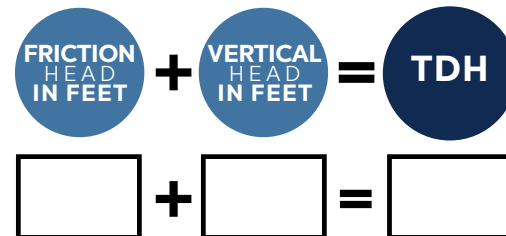
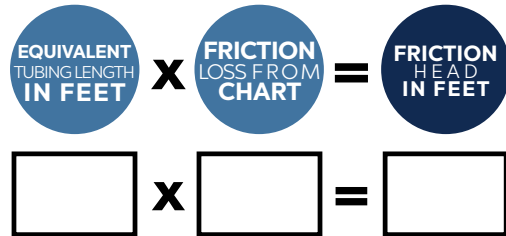

TECHNICAL DATA

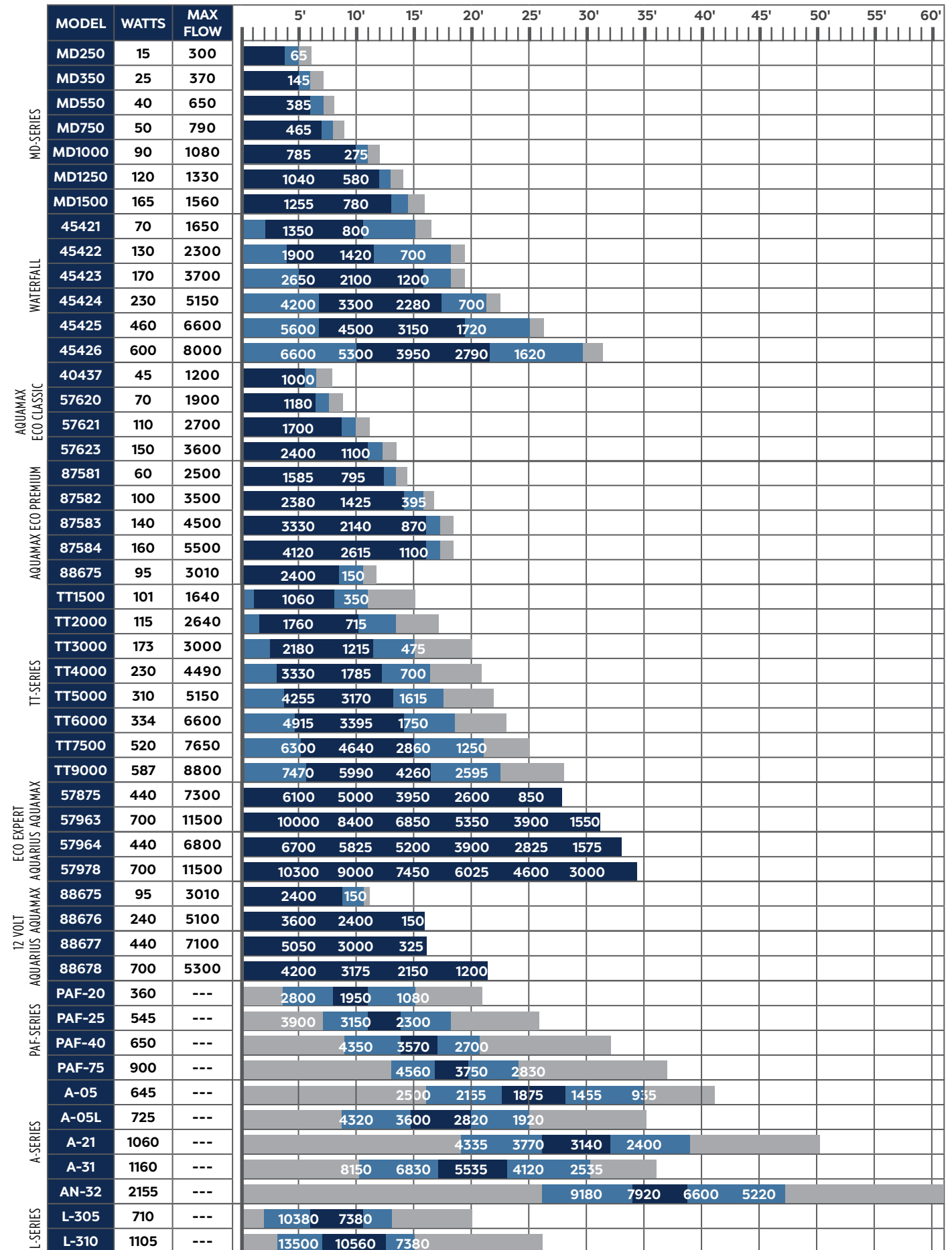

*All flows in GPH

Recommended Operating Range Best Efficiency Range Do Not Operate Range

TECHNICAL DATA

COST TO RUN A PUMP

Take the rate per kilowatt per hour, multiply that by the wattage of the pump and divide by 1000. For the monthly cost, multiply the hourly cost by 720 (24 hours per day times 30 days in a month). For more information, visit the College of Pumps in the Atlantic Water Gardens University, www.atlanticwatergardens.com/university.

$$\text{COST PER HOUR} = \frac{\text{\$/kW/hr} \times \text{Watts}}{1000} \times 720 = \text{COST PER MONTH}$$

Example: Electric costs \$0.10/kW/hr, the pump draws 100 Watts, so $\$0.10/\text{kW/hr} \times 100\text{W}/1000 = \$0.01/\text{hr}$ x 720hrs/mo = \$7.20/month

GROUNDING PLATE

This added measure of protection on Oase pumps exceeds all electrical safety standards. The grounding plate provides the path of least resistance, insuring that any electrical leakage, from any power source in your pond or fountain, harmlessly exits the pond or fountain through the grounding wire. With this feature, your pond or fountain will have unparalleled protection against electrical hazards.



AQUARIUS ECO EXPERT PUMP SEQUENCES

The Aquarius Eco Expert comes pre-programmed with "Scene 1", a sequence of varying pump outputs and times that creates a dancing fountain effect. Switch between eleven additional sequences using the Eco Control Module or Cloud Controller. The Cloud Controller offers the additional benefit of Cloud-based control via application through your home router, for access to the pump from anywhere there's an Internet signal.

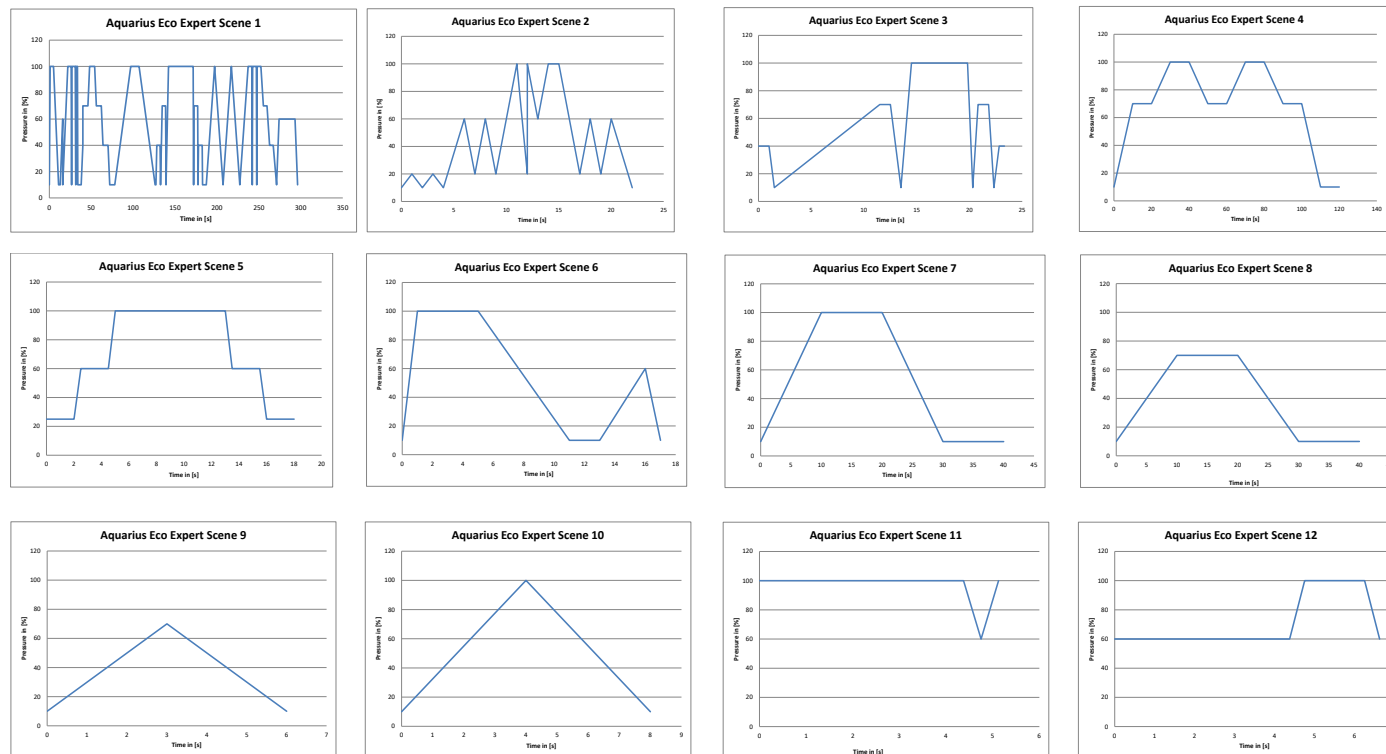

TECHNICAL DATA



LIGHTING

MAKING CONNECTIONS

The multistrand cord for Color Changing Lighting carries both AC and DC current that cannot be interchanged, so proper alignment of plugs is a must. **Dielectric grease must be used in all connections.** Any water intrusion into the quick-connect plugs will cause short circuiting and deterioration of the contacts. Make sure all connecting plugs are fully tightened. To fully tighten plugs, seat the nut as tightly as possible, then flex the connection two or three times and re-tighten the nut. Repeat until you can no longer tighten the nut. This assures the o-ring is fully seated and the connection is weather-tight. As a general rule, full or partial submersion of quick-connect plugs should be avoided.

REPLACING DIODES ASSEMBLIES

All the diode assemblies of the lights pictured can be replaced as needed. For the Hardscape Lights, remove the screws, unplug the light bar, plug in the new light bar, align the silicone gasket and retighten screws.

For the 2 and 4 watt Spotlights and the Spout Light, unscrew the bezel by hand, remove the diode assembly, replace and retighten bezel. In every case, make sure silicone gasket is properly seated to avoid leaks.

2 WATT SPOTLIGHT:

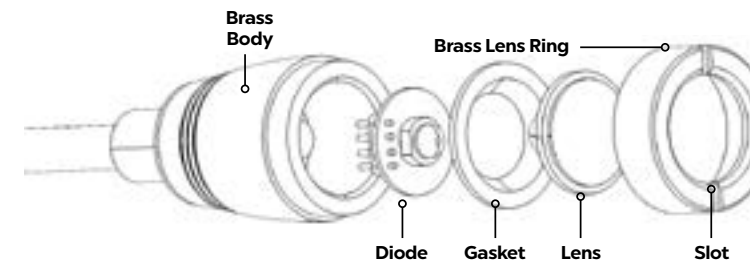

HARDSCAPE LIGHT:

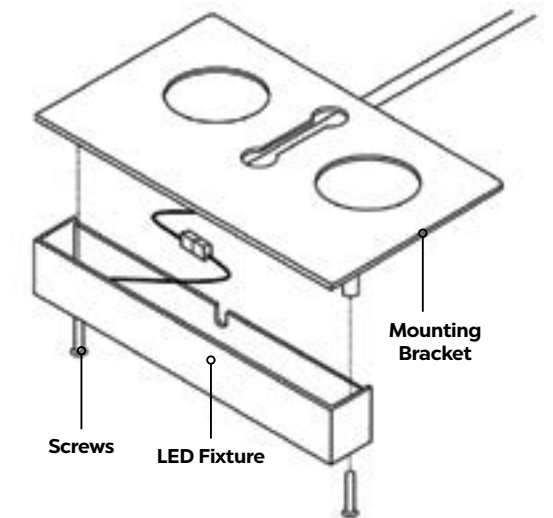

4 WATT SPOTLIGHT:

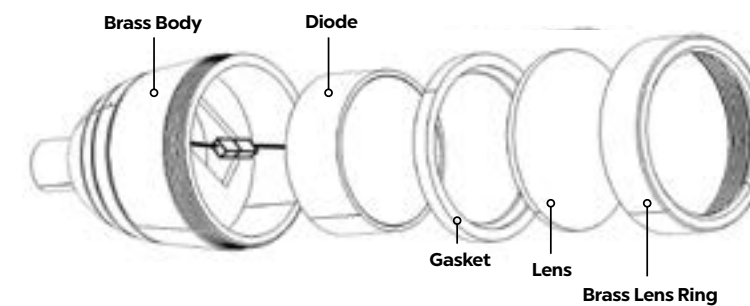

SPOUT LIGHT:

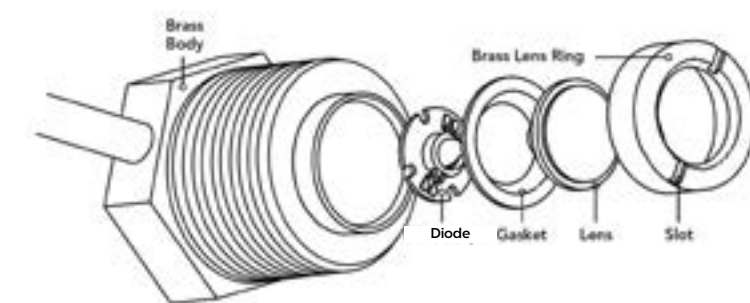

TECHNICAL DATA

HOW TO CALCULATE WATTAGES & MAKE CUSTOM SETUPS

HOW TO CALCULATE WATTAGES & MAKE CUSTOM SETUPS

The InfiColor Smart Module provides 30 watts to each of three zones, for a max of 80 watts per InfiColor Smart Module. The zones may be linked and synchronized as desired. Add up the wattage of each light, which can be found in the Catalog, the packaging, the instructions or the website, to find the total wattage of the group. The wattage shown is the highest wattage that the light will draw, rounded up to ensure Smart Module capacity is never exceeded (80 watts).

There is also a limit to the length of any lighting run. The number of extension cords you can use consecutively depends on the total wattage of the zone.

If your total wattage is:

- 0-7 watts - 4 extension cords max
- 7-15 watts - 3 extension cords max
- 15-22 watts - 2 extension cords max
- 22-30 watts - 1 extension cord max

INFICOLOR MOBILE APP

To Configure Zone Names and Timers

Click dropdown menu. Edit the names of the control module outlets or zones on the "Zone Settings" page. These zone names will be visible throughout the app. Each zone has an individual timer function to turn the zone on and off at set times. Click the "Save" button to save changes. A box will come up notifying the user the settings have been saved. Click the "Back" button once you have completed configuration.



Color Tab

Use the Color tab to choose colors for the different zones using either the color picker or the red, green and blue sliders at the bottom. Choose the brightness of the color by adjusting the slider. Select the color for each zone, or select multiple zones to change color at the same time.



Favorites Tab

The Favorites tab stores preset color changing sequences. Select one, two or all three zones. Choose a sequence of colors, then choose the transition between them, the speed of the sequence and the brightness. Swipe left on sequences to delete stored Favorites.



Custom tab

The Custom tab allows you to create and store a custom color changing sequence. Select the cell of the sequence to edit the color. Move the red, green and blue sliders to choose a color, or select it from the color picker. Repeat as desired. Add up to 10 colors to a sequence. Once the sequence has been created it can be named and saved. The saved sequence will be available on the Favorites page.

USING THE CORD SEAL FITTINGS TO PASS A LIGHT CORD THROUGH THE WATER SUPPLY LINE

There may be times when the only way to run a light cord into a reservoir is to pass the cord inside the water supply plumbing. Atlantic's Cord Sealing Fittings do just that, simply and easily. First, determine how to attach two Tee fittings to the supply plumbing, one on either side of the pass-through fitting that goes through the reservoir wall. Usually a Sch. 40 PVC 1 1/2" Tee is the preferred size, because the cord will not affect water flow in that large a supply line. Once the Tees are in place, pass the light cord through the Tees. Open the Cord Seal Fittings and insert the cord into each one, then tighten the fittings into the open legs of the Tees, snugging the cord between the fittings before fully tightening. Turn on water supply and check for leaks.



TECHNICAL DATA



MAINTENANCE

SMALL POND AERATION:

Aeration is critical for water clarity and quality, summer and winter.

In warm weather, aeration circulates and oxygenates water to the bottom, allowing for fast aerobic decomposition of wastes and eliminating hot spots at the surface where algae thrives.

In cold weather, move the aerator to the shallows to keep a section of the surface free of ice economically, allowing replenishment of oxygen and the degassing of carbon dioxide, without disturbing the pocket of warm water at the bottom of the pond.

SUMMER DIFFUSER PLACEMENT:

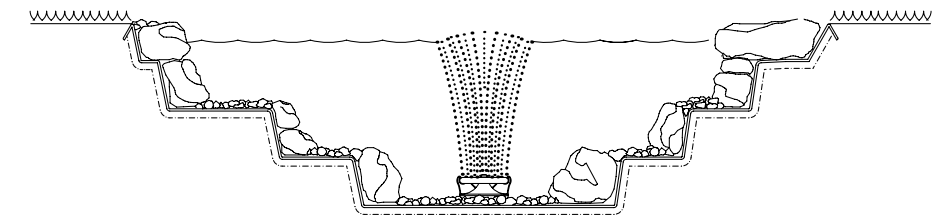

WINTER DIFFUSER PLACEMENT:

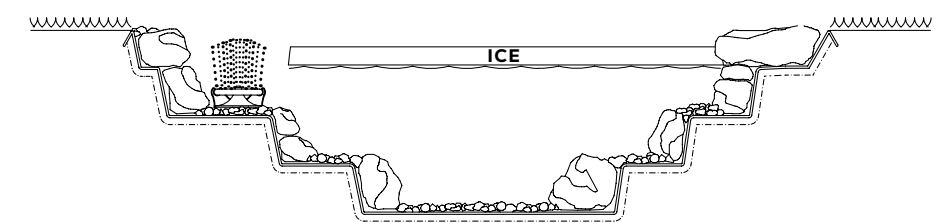

REPLACING DIAPHRAGMS IN AIR PUMPS

Rubber diaphragms are a wearable part that will need servicing over time. Moisture, heat and dust will all shorten the life of the diaphragms. Please follow the following steps when installing replacement diaphragms.

TA0400 & TA0800

- Remove the four screws on the bottom of air pump housing.
- Remove the top cover taking care not to damage/misplace the outer gasket and four O-rings that seal the housing at the screw connections.
- Remove the three screws and the bracket that hold the diaphragm cartridge in place.
- Unplug the outlet hose and remove the diaphragm cartridge.
- Discard and install the new cartridge.

TA1800 & TA3600

- Remove the top cover housing for the air pump. Loosen the air chamber screws (1) and remove the outer air chamber (2).
- Loosen the diaphragm nut (3) and remove the diaphragm depressor (4), electrostatic membrane (5) and the damaged diaphragm (6).
- Install the new diaphragm ensuring that the rubber tabs align properly with the notches on the inner air chamber.
- Once the diaphragm is seated properly, assemble the components by following the previous steps in reverse order.

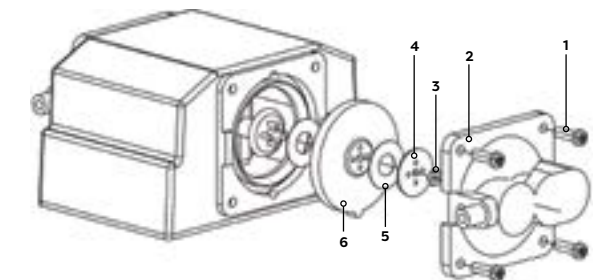
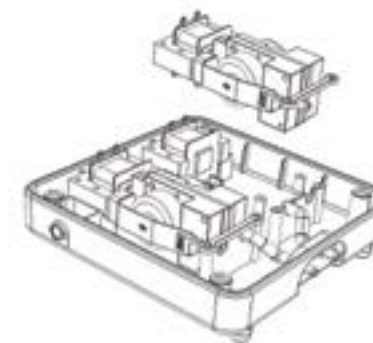

WATER TREATMENT GUIDE

CONDITION:	REVIVE	BIOMAX+	QUICKCLEAR	ECOKLEAN	CLARITYBLAST	RECLAIM	BIOMAX
NEW WATER GARDEN	•	•					
WATER CHANGE	•	•					
ADDING FISH	•	•					
ELEVATED AMMONIA	•	•					
MUDDY / CLOUDY WATER			•				
SUSPENDED ORGANICS		•	•		•		•
ATTACHED ORGANICS				•	•		
SLUDGE					•	•	
PLANT DEBRIS				•	•	•	•
FOUL ODOR					•	•	•

TECHNICAL DATA



POND & LAKE

Aeration and bacterial treatments are the best way to maintain ponds and lakes clear, clean and sediment free when properly sized and dosed. The three keys to sizing aeration are Depth, Shape and Profile.

DEPTH

Circulation is directly proportional to depth. The deeper the water, the longer the path to the surface for the rising bubbles and the more water each bubble can pull upwards with it. The rising water has to be replaced by water sweeping in towards the diffuser, so a relatively small amount of air rising from deep water can circulate a tremendous volume. Shallow water doesn't provide as much 'fetch', or time for the bubbles to act on the water column, so circulation is reduced and more air needed per given area. The water welling up from a deeply set diffuser has a great deal of inertia, which causes it to flow outward in all directions once it reaches the surface. The diameter of the circle of aerated water created is proportional to the depth. The same diffuser set in shallow water will aerate a smaller area.

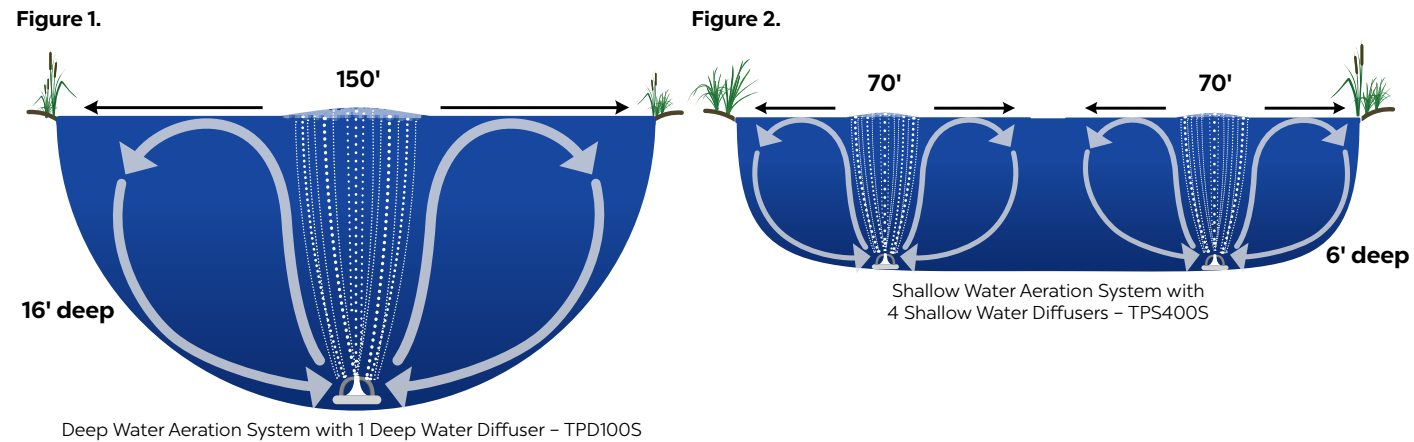

SHAPE

The shape of the water feature also affects circulation. A simple circle can typically be circulated with just one diffuser, while more complex shapes with coves and peninsulas that impede flow will require more diffusers, and more air. All four lakes below have the same area, but their different layouts require a different number of diffusers.

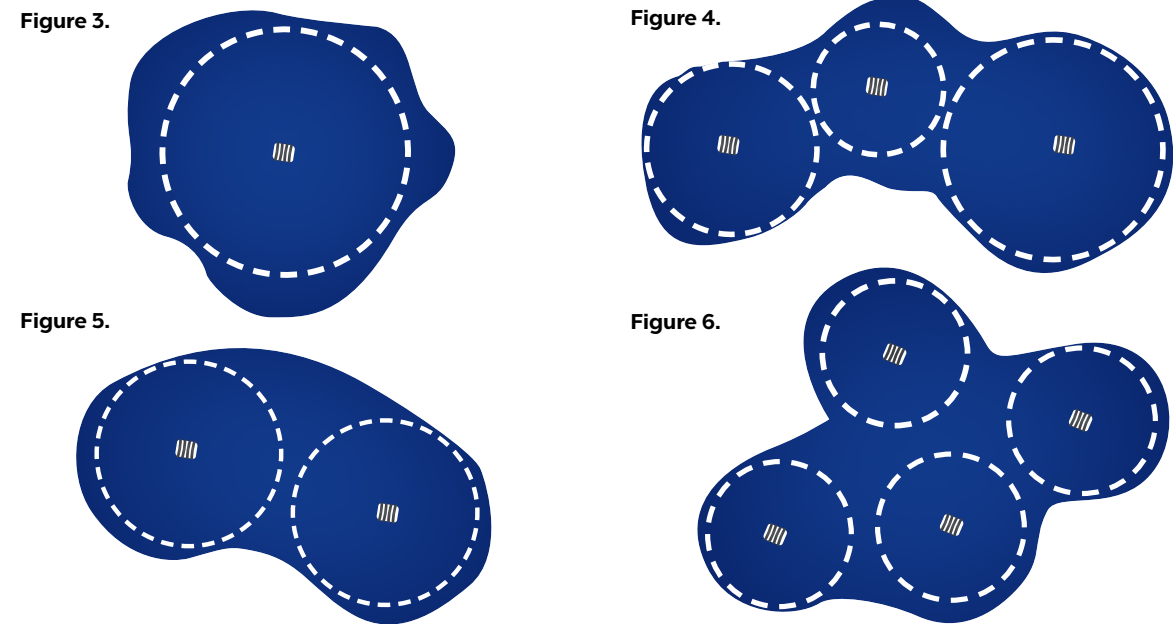

PROFILE

The quantity and placement of diffusers depends on the inner profile of the water feature as well, which will either enhance or impede flow. Rounded profiles with steep sides and few shelves or obstructions, like the bowl-shaped pond in Figure 1, can be aerated most easily. Wide, flat bottomed features like the pond in Figure 3, or shallow lakes with debris and vegetation everywhere will be more difficult to aerate and circulate effectively.

TECHNICAL DATA

SIZING YOUR SYSTEM: USE SURFACE AREA FOR LAKES WITH SIMPLE SHAPES AND SINGLE DEPTHS

Step 1. If your pond is roughly rectangular, square or circular, find the area of the pond and convert the square footage to acres by dividing by 43,560. (1 acre = 43,560ft²)

Step 2. Find the Acreage and Depth of your pond on the Chart to determine the correct system or number of systems.

EXAMPLE:

For the roughly square pond at the right, 150 feet on a side:
Multiply 150' x 150' to find the area and divide by 43,560 to convert to surface acres.

$$150' \times 150' = 22,500 \text{ ft}^2$$

$$22,500 \text{ ft}^2 \div 43,560 \text{ ft}^2/\text{acre} = .52, \text{ about } \frac{1}{2} \text{ surface acres}$$

Find the column corresponding to 16' and locate the matching surface area. In this case the correct system is a TPD100S-87R6. In the case of lakes larger than the surface areas listed, multiple systems will be required.

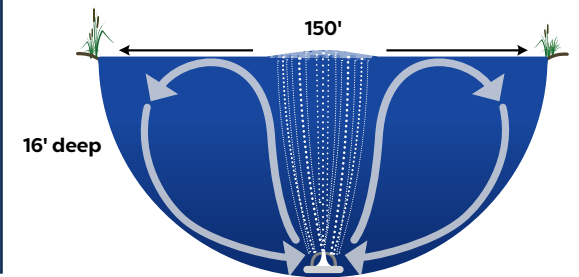

SYSTEM	No. of Diffusers	Coverage @2'	Coverage @4'	Coverage @6'	Coverage @8'	Coverage @12'	Coverage @16'	Coverage @20'
TPS200S	2	1/8 acre	1/8 acre	1/4 acre	---	---	---	---
TPS400S	4	1/4 acre	1/4 acre	1/2 acre	---	---	---	---
TPD100S-87R6	1	---	---	---	1/4 acre	1/2 acre	1/2 acre	1 acre
TPD200S-87R6	2	---	---	---	1/2 acre	3/4 acre	1 acre	2 acres
TPD300S-72R6	3	---	---	---	3/4 acre	1 acre	1 1/2 acres	3 acres
TPD400S-72R6	4	---	---	---	1 acre	1 1/2 acres	2 acres	4 acres

SIZING YOUR SYSTEM: USE DIAMETERS FOR LAKES WITH COMPLEX SHAPES AND MULTIPLE DEPTHS

Step 1. Draw the perimeter roughly to scale or download a satellite image.

Step 2. Determine the depth(s) and find the corresponding size circle from the tables below.

Step 3. Draw circles to scale, covering the surface without overlapping. Each circle equals one diffuser.

Step 4. Find the appropriate shallow or deep water system(s) with the correct number of diffusers.

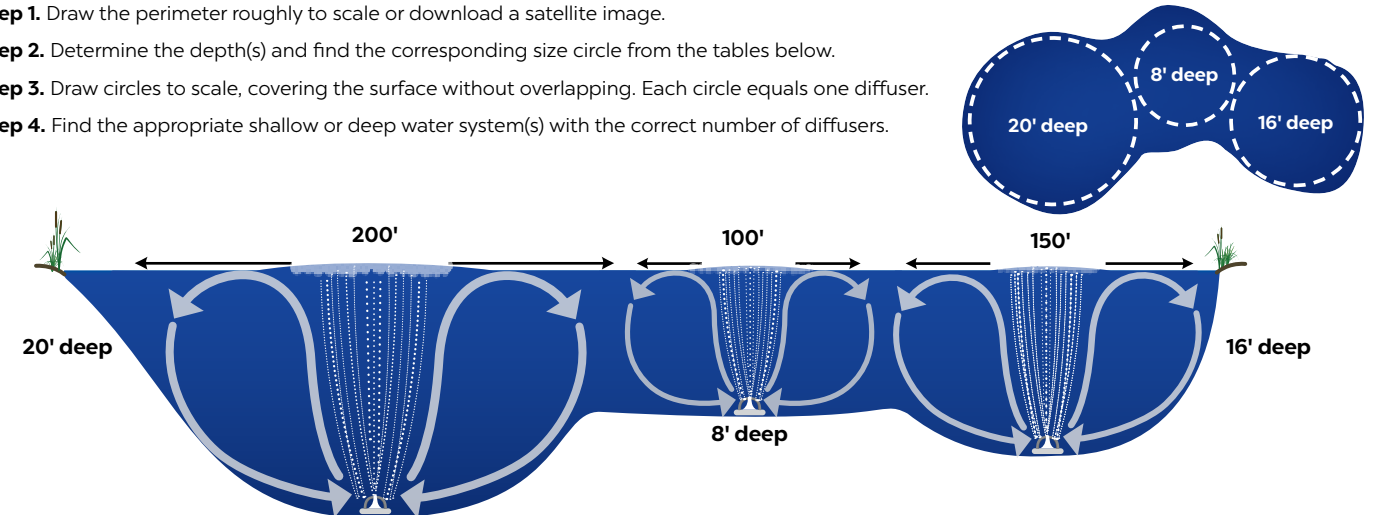

EXAMPLE:

The lake above is 200' wide and 20' deep at one end, 150' wide and 16' at the other, with a shallower 8' deep section 100' wide in the middle. From the depths on the chart below, draw three circles to scale on your sketch. In this example, three circles are sufficient, so you will need a deep water system with three diffusers. The second column of the chart above indicates the required system with three deep water diffusers is the TPD300S-72R6. In the case of larger lakes requiring more than four diffusers, use multiple systems to cover the entire surface area.

AREA COVERED BY SHALLOW WATER DIFFUSER			
DEPTH	@2'	@4'	@6'
Circle Diameter	40'	55'	70'
Diffusers per Surface Acre	16	12	8

AREA COVERED BY DEEP WATER DIFFUSER				
DEPTH	@8'	@12'	@16'	@20'
Circle Diameter	100'	120'	150'	200'
Diffusers per Surface Acre	4	3	2	1

TECHNICAL DATA



CLEAR WATER GUARANTEE

Oase has engineered specific filter systems to provide the Oase Clear Water Guarantee (CWG). Using a CWG filter system we guarantee you will be able to read the 1" marking on a tape measure when the tip is submerged to a depth of 3'.

A filter system consists of:

- A pump to feed the water into a filter
- A filter that ensures biological and mechanical cleaning
- A UVC clarifier to clean the green out of the water

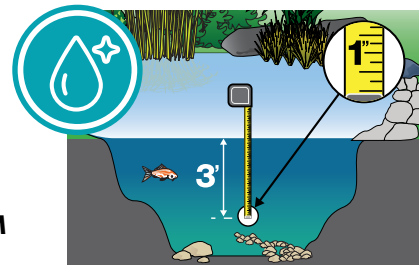

CLEAR WATER GUARANTEE PROGRAM

1. Determine your pond volume:

For circular ponds: Pond volume (gallons) = diameter (ft.) x diameter (ft.) x depth (ft.) x 7.5
For rectangular ponds: Pond volume (gallons) = length (ft.) x width (ft.) x depth (ft.) x 7.5

2. Determine the fish load: The more fish in the pond, the higher the nutrient load and the larger the filter system should be.

LIGHT - Planted ponds with few or no fish

MEDIUM - Planted ponds with 10 in. of fish per 100 gallons of water or less

HEAVY - Ponds with koi or 20+ in. of fish per 100 gallons of water

3. Choose the correct filter system: Choose the filter system that best suits your pond and use the chart below to determine the appropriate sized components for your application.

IN-POND FILTER SYSTEMS - for small ponds. In-pond filters include 3 nozzle choices for appeal and added aeration.

PRESSURE FILTER SYSTEMS - for small to medium ponds. Pressure filters can be remotely located, partially buried and feed waterfalls.

FLOW-THROUGH FILTER SYSTEMS - for medium to large ponds. Flow-through filters sit above water level and return water by gravity.

4. Install and maintain the filter system: Install the products per installation instructions. Clean the filter as needed and replace the UVC bulb annually.

FILTER SYSTEMS - SIZING CHARTS

FISH LOAD			FILTER	UVC	PUMP
LIGHT	MEDIUM	HEAVY			
IN-POND FILTER SYSTEMS					
<400 gal	<200 gal	-	Filtral UVC 400	5W (included)	195 gph included
<800 gal	<400 gal	-	Filtral UVC 800	9W (included)	235 gph included
<1,600 gal	<800 gal	-	Filtral UVC 1600	13W (included)	410 gph included
PRESSURE FILTER SYSTEMS					
<1,000 gal	<500 gal	<250 gal	BioPress 1000	7W (included)	AquaMax Eco Classic 1200
<1,600 gal	<800 gal	<400 gal	BioPress 1600	9W (included)	AquaMax Eco Premium 2500 / AquaMax Eco Classic 1900
<2,400 gal	<1,200 gal	<600 gal	BioPress 2400	9W (included)	AquaMax Eco Premium 3500 / AquaMax Eco Classic 2700
<3,400 gal	<1,700 gal	<850 gal	FiltoClear 3400	24W (included)	AquaMax Eco Premium 2500 / AquaMax Eco Classic 1900
<5,200 gal	<2,600 gal	<1,300 gal	FiltoClear 5200	42W (included)	AquaMax Eco Premium 3500 / AquaMax Eco Classic 2700
<8,200 gal	<4,100 gal	<2,050 gal	FiltoClear 8200	60W (included)	AquaMax Eco Premium 4500 / AquaMax Eco Classic 3600
FLOW-THROUGH FILTER SYSTEMS					
<5,000 gal	<2,500 gal	<1,250 gal	BioSmart 5000	Vitronic 18	AquaMax Eco Premium 2500 / AquaMax Eco Classic 1900
<10,000 gal	<5,000 gal	<2,500 gal	BioSmart 10000	Vitronic 36	AquaMax Eco Premium 3500 / AquaMax Eco Classic 2700 / AquaMax Eco Premium 3000 12V
<18,000 gal	<9,000 gal	<4,500 gal	BioTec ScreenMatic ² 18000	Bitron C 55	AquaMax Eco Premium 4500 / AquaMax Eco Classic 3600 / AquaMax Eco Premium 3000 12V
<21,000 gal	<10,500 gal	<5,250 gal	ProfiClear Premium Compact-M Pump-fed	Bitron C 110	AquaMax Eco Classic 3600 / AquaMax Eco Premium 4500 / AquaMax Eco Expert 6800* / AquaMax Eco Expert 5300 12V
<24,000 gal	<12,000 gal	<6,000 gal	BioTec ScreenMatic ² 24000	Bitron C 110	AquaMax Eco Premium 4500 / AquaMax Eco Classic 3600 / AquaMax Eco Premium 3000 12V
<31,500 gal	<15,750 gal	<7,875 gal	ProfiClear Premium Compact-L Pump-fed	Bitron C 110	AquaMax Eco Premium 4500 / AquaMax Eco Expert 6800* / AquaMax Eco Expert 5300 12V & 7100 12V*
<31,500 gal	<15,750 gal	<7,875 gal	ProfiClear Premium Compact-L Gravity-fed	Bitron C 110	AquaMax Eco Premium 4500 / AquaMax Eco Premium 5500 / AquaMax Eco Expert 6800* / AquaMax Eco Expert 5300 12V & 7100 12V*
<39,000 gal	<19,500 gal	<9,750 gal	BioTec ScreenMatic ² 39000	Bitron C 110	AquaMax Eco Premium 4500 & 5500 / AquaMax Eco Expert 6800* / AquaMax Eco Expert 5300 12V & 7100 12V*

*Must adjust flow down to max flow of filter

TECHNICAL DATA

BLUE = ACTION

Oase products have specific components that are designed to be adjusted, opened or maintained. These parts are colored blue to indicate exactly where to interact with the product, such as flow control adjustment, tubing connections, locking clips, manual cleaning handles and nozzle adjustment fittings.





ACCESSORIES & PARTS





FORMAL SPILLWAYS				
	ITEM	MODEL	DESCRIPTION	FOR USE WITH
	73847	CFMA12	CFBASIN12 Replacement Filter	CFBASIN12
	73848	CFMA24/36	CFBASIN24/36 Replacement Filter	CFBASIN24 / CFBASIN36

FILTRAL UVC				
	ITEM	DESCRIPTION	FOR USE WITH	INCLUDES
	76983	Replacement Foam Set Filtral UVC 400	Filtral UVC 400	1x - Blue 1x - Orange
	76984	Replacement Foam Set Filtral UVC 800	Filtral UVC 800	1x - Blue 1x - Orange
	76985	Replacement Foam Set Filtral UVC 1600	Filtral UVC 1600	1x - Blue 1x - Orange
	19503	Bio-Surface Element	Filtral UVC 400 / 800 / 1600	-
	72795	Replacement Ceramic Bag - Filtral Small	Filtral UVC 400	-
	72796	Replacement Ceramic Bag - Filtral Medium	Filtral UVC 800	-
	72797	Replacement Ceramic Bag - Filtral Large	Filtral UVC 1600	-

BIOPRESS				
	ITEM	DESCRIPTION	FOR USE WITH	INCLUDES
	46971	BioPress 1000 Filter Foam Set	BioPress 1000	2x - Blue 1x - Black
	40969	Biopress 1600-2400 Filter Foam Set	Biopress 1600 / BioPress 2400 (requires 2 sets)	2x - Blue 1x - Black

ACCESSORIES & PARTS

FILTOCLEAR				
	ITEM	DESCRIPTION	FOR USE WITH	INCLUDES
	91646	FiltoClear 3400 Filter Foam Set	FiltoClear 3400	1x - Orange 1x - Blue 1x - Purple
	91647	FiltoClear 5200 Filter Foam Set	FiltoClear 5200	1x - Orange 2x - Blue 1x - Purple
	91648	FiltoClear 8200 Filter Foam Set	FiltoClear 8200	2x - Orange 2x - Blue 1x - Purple









SKIMMER				
	ITEM	MODEL	DESCRIPTION	FOR USE WITH
	74019	BK4600	Skimmer Brush Kit	PS4600
	74020	BK7000	Skimmer Brush Kit	PS7000
	74018	BK15000	Skimmer Brush Kit	PS15000
	74022	GK600	Gate Keeper for 6" Weir Door	PS3900 / PS4600
	74023	GK900	Gate Keeper for 9" Weir Door	PS7000
	74021	GK1400	Gate Keeper for 14" Weir Door	PS15000
	74025	MK4600	Matala Mat Kit with support frame	PS4600
	74026	MK7000	Matala Mat Kit with support frame	PS7000
	74024	MK15000	Matala Mat Kit with support frame	PS15000
	74028	NT3000	PS3000 Replacement Net	PS3000
	74029	NT3900	PS3900 Replacement Net	PS3900
	74030	NT4600	PS4600 Replacement Net	PS4600
	74031	NT7000	PS7000 Replacement Net	PS7000
	74027	NT15000	PS15000 Replacement Net	PS15000
		74034	SM3900	PS3900 Replacement Mat
74035		SM4600	PS4600 Replacement Mat	PS4600
74036		SM7000	PS7000 Replacement Mat	PS7000
74033		SM15000	PS15000 Replacement Mat	PS15000
74017		BD2000	Bottom Drain Kit	PS4600/PS7000/PS15000





BIOSMART				
	ITEM	DESCRIPTION	FOR USE WITH	INCLUDES
	40974	BioSmart 5000-10000 Red Foam Set	BioSmart 5000 (requires 1 set) BioSmart 10000 (requires 4 sets)	1x - Red
	40975	BioSmart 5000-10000 Blue Foam Set	BioSmart 5000 (requires 2 sets) BioSmart 10000 (requires 4 sets)	1x - Blue
	40976	BioSmart 5000-10000 Green Foam Set	BioSmart 5000 (requires 1 set) BioSmart 10000 (requires 1 set)	1x - Green



ACCESSORIES & PARTS

FILTERFALLS				
	ITEM	MODEL	DESCRIPTION	FOR USE WITH
	73987	BB0500	Bio-Rocks Media - 0.5 cubic ft.	BG2234
	73988	BB1500	Bio-Balls - 150 pieces	BG2234
	73990	BG2234	18" x 22" Media Bag	BB0500 / BB1500
	74001	MA1600	Matala Filter Kit	BF1600
	74002	MA1900	Matala Filter Kit	BF1900
	74003	MA2600	Matala Filter Kit	BF2600
	74004	MA3800	Matala Filter Kit	BF3800
	73989	BFK100	Back Flush Kit for FilterFalls	BF1900 / BF2600 / BF3800
	73996	MT1600	BF1600 Replacement Filter	BF1600
	73997	MT1900	BF1900 Replacement Filter	BF1900
	73998	MT2600	BF2600 Replacement Filter	BF2600
	73999	MT3800	BF3800 Replacement Filter	BF3800
	73995	MA2820	Filter Material - 2" x 28" x 20' Roll	-
	73991	MA2439BLK	Matala Filter Sheet - Coarse - 24"L x 39"W	-
	73993	MA2439GRN	Matala Filter Sheet - Medium - 24"L x 39"W	-
	73992	MA2439BLU	Matala Filter Sheet - Fine - 24"L x 39"W	-
	73994	MA2439GRY	Matala Filter Sheet Super Fine - 24"L x 39"W	-





ACCESSORIES & PARTS



UVC BULBS			
	ITEM	DESCRIPTION	FOR USE WITH
	40963	7 Watt UVC Replacement Bulb	Filtral UVC 700 / BioPress 1000
	40964	9 Watt UVC Replacement Bulb	Vitronic 9 / Filtral UVC 1200 / Biopress 1600 / BioPress 2400
	40965	18 Watt UVC Replacement Bulb	Vitronic 18 / FiltoClear 3000
	41011	24 Watt UVC Replacement Bulb	FiltoClear 4000 / FiltoClear 3400
	40966	36 Watt UVC Replacement Bulb	Vitronic 36
	91649	42 Watt UVC Eco Replacement Bulb	FiltoClear 5200
	40967	55 Watt UVC Replacement Bulb	Bitron C 55 / Bitron C 110 (requires 2 bulbs) / FiltoClear 8000
	91650	60 Watt UVC Eco Replacement Bulb	FiltoClear 8200



BIOTEC SCREENMATIC ²				
	ITEM	DESCRIPTION	FOR USE WITH	INCLUDES
	48781	BioTec ScreenMatic ² 18000 & 38000 Blue Foam Set	Biotec ScreenMatic ² 18000 Biotec ScreenMatic ² 39000 (requires 2 sets)	2x - Blue
	48780	BioTec ScreenMatic ² 18000 & 38000 Red/Purple Foam Set	Biotec ScreenMatic ² 18000 (requires 3 sets) Biotec ScreenMatic ² 39000 (requires 7 sets)	1x - Red 1x - Purple
	89166	BioTec ScreenMatic ² 24000 Blue Foam Set	BioTec ScreenMatic ² 24000 (requires 2 sets)	2x - Blue
	89165	BioTec ScreenMatic ² 24000 Red/Purple Foam Set	BioTec ScreenMatic ² 24000 (requires 6 sets)	1x - Red 1x - Purple
	36981	Phosless Algae Reducer	Biotec ScreenMatic ² 18000 (requires 1½ sets) Biotec ScreenMatic ² 24000 (requires 2 sets) Biotec ScreenMatic ² 39000 (requires 6 sets)	2x

PROFICLEAR PREMIUM COMPACT				
	ITEM	DESCRIPTION	MEDIA SPECIFIC SURFACE AREA	FOR USE WITH
	72731	Hel-X 13mm Bio-Media - 20L Pack	245 ft ² /ft ³	ProfiClear Premium Compact-M ProfiClear Premium Compact-L ProfiClear Premium Individual Module ProfiClear Premium Moving Bed Module
	89205	PondPads 10L	1,665 ft ² /ft ³	ProfiClear Premium Moving Bed Module

ACCESSORIES & PARTS

INSTALLATION			
	MODEL	ITEM	DESCRIPTION
	406-015B	74211	1½" 90° (SOC X SOC)
	406-020B	74212	2" 90° (SOC X SOC)
	406-030	74213	3" 90° (SOC X SOC)
	429-015B	74214	1½" STRAIGHT COUPLING (SOC X SOC)
	429-020B	74215	2" STRAIGHT COUPLING (SOC X SOC)
	429-030	74216	3" STRAIGHT COUPLING (SOC X SOC)
	436-015B	74217	1½" MALE THREAD ADAPTER (MIPT X SOC)
	436-020B	74218	2" MALE THREAD ADAPTER (MIPT X SOC)
	436-030	74219	3" MALE THREAD ADAPTER (MIPT X SOC)
	SPSEAL	73815	Stand Pipe Sealant - Pack of 4 Strips
	CV30	74221	3" Swing Check Valve
		85310	3" Inline adapter for Eco Expert Pumps

PUMPS			
	ITEM	DESCRIPTION	FOR USE WITH
	84031	Extension Cable 12V Premium 32'/10m	#88675 AquaMax Eco Premium 3000 12V
	84032	Extension Cable 12V Eco Expert 32'/10m	AquaMax Eco Expert 5300 12V AquaMax Eco Expert 7100 12V Aquarius Eco Expert 5300 12V

POND & LAKE				
	ITEM	MODEL	DESCRIPTION	FOR USE WITH
	73959	TPD87R-645-REBUILD	Rebuild Kit for TPD87R6	TPD87R6
	73958	TPD72R-655-REBUILD	Rebuild Kit for TPD72R6	TPD72R6
	73957	REP TPDF INSERT	TPD Compressor Filter	TPD72R6 / TPD87R6

AO PRO CONTRACTOR PROGRAM



At Atlantic-Oase we pride ourselves on producing the best, most innovative and widest range of water feature products on the market, as you would expect from the world's largest manufacturer. If you share the same pride in your work as we do, you should consider joining the Atlantic-Oase Professional Network.

Atlantic-Oase Professionals Contractors are the best in the business, trained to install our products correctly the first time, every time. These experienced contractors bring more than just technical expertise to bear, they bring their artistry and passion to the network. As a member of that network, you'll be part of a friendly, helpful community of folks who share their time and their work with their peers. You'll have access to exclusive training opportunities, online and in-person, led by the best in the business.

CONTRACTOR REWARDS PROGRAM

Atlantic-Oase proudly presents the Contractor Rewards Program. This new promotion offers contractors a flat 10% rebate on all Atlantic and Oase products purchased during the calendar year (liner excluded). Simply sign up on our website at www.atlantic-oase.com/rewards, submit your receipts on our website, and receive a check at the end of the year!



Three easy steps to getting 10% back!

1. Sign up on our website: www.atlantic-oase.com/rewards
2. Submit your receipts to our website
3. Receive a check at the end of the year

*All liner purchases will be excluded from the 10% rebate

2025 CONTRACTOR TRAINING DATES

Are you looking for more experience installing water features? Want to add new revenue to your bottom line? Or broaden your understanding of the water feature business? We designed our Atlantic-Oase Contractor Training for you!



We are currently offering 3 training sessions that cover Fountains, Formal Spillways, Pond-free, Water Gardens, sizing, specifying, maintenance and more!

Visit www.atlantic-oase.com/training or scan the QR code for more information and our most up-to-date schedule.



WHAT'S PROVIDED:

- 2-day education on Atlantic-Oase product and installations
- Hotel - 2 nights
- Meals provided with key Atlantic-Oase personnel and some of our top industry contractors
- Travel between dinners, hotel & office
- Copies of presentation, helpful cheat sheets and estimating guides, swag bag and more

WHO SHOULD ATTEND?

Contractors who:

- Want to add additional profit streams to their business
- Want to learn how to install different water feature types
- Want to understand how to profit from water features
- Want to learn more about the global leader in water features
- Want to have fun while they learn

AWG UNIVERSITY

Atlantic-Oase University is your online home for water feature education. Start with the College of Construction then move on to Pumps, Filtration and Biology for solid, non-biased, valuable information from professionals that have years of experience in the field. When you finish each section, take the course exam to test your knowledge and earn your Atlantic-Oase University Certificate of Completion.



SOCIAL MEDIA

Follow us on all of our social media accounts to stay in the loop for all news Atlantic-Oase. We feature tech tips, inspirational photos, special announcements, behind-the-scenes and everything water features. Don't forget to use the @atlantic-oase to tag us in your posts.



POP MATERIAL

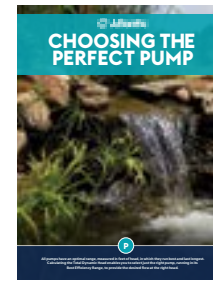

Item: 61900
Model: TMBP
Description: Choosing the Perfect Pump Bifold

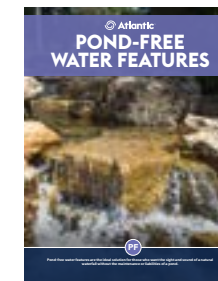

Item: 61901
Model: TMBPF
Description: Pond-free Bifold

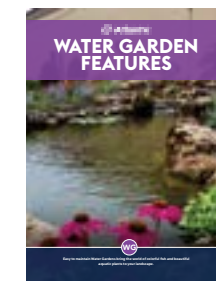

Item: 61903
Model: TMBWG
Description: Water Garden Bifold

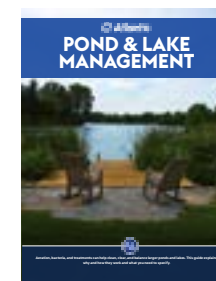

Item: 61902
Model: TMBPL
Description: Pond & Lake Management Booklet



Item: 74279
Model: SS DISPLAY
Description: 316 Stainless Steel Spillway Skeleton Display
Dimensions: 20"W x 24"D x 30"H



Item: 74278
Model: SC DISPLAY
Description: Copper Finish Spillway Skeleton Display
Dimensions: 20"W x 24"D x 30"H



Item: 74277
Model: CF DISPLAY
Description: Colorfalls Skeleton Display
Dimensions: 20"W x 24"D x 30"H



Item: 74280
Model: WS DISPLAY
Description: Wall Spout Skeleton Display
Dimensions: 20"W x 24"D x 30"H



Item: 62149
Model: TMAO-W
Description: Atlantic-Oase Wall Banner
Dimensions: 60"W x 36"H



Item: 61897
Model: TMATL-S
Description: Atlantic Standing Banner
Dimensions: 36"W x 83"H



Item: 63186
Model: RETHEADER46512
Description: Retail Header Card for 4' Shelving Displays
Dimensions: 46½"W x 12"H



Item: 63188
Model: RETSHFCHL241X12
Description: Shelf Channels for Retail Shelving (12-pack)
Dimensions: 24"W x 1¼"H

CUSTOMER LOGIN INFO

To access our high resolution product images and product data, please use our Customer Login. The Customer Login will give you access to product data, product images and resources for your company. You will be able to download our full catalog, product categories or individual products at your discretion. Please contact your Regional Sales Rep or the Marketing Department for login information.





 **Atlantic | Oase**

125 Lena Drive, Aurora, Ohio 44202

info@atlantic-oase.com

1.330.274.8317

www.ATLANTIC-OASE.com

