

SEATING STYLES & SUNDRIES CATALOGUE

Issue C



ATLAS
CONTRACT
FURNITURE





EXCEPTIONAL CONTRACT FURNITURE

Atlas Contract Furniture is one of the UK's most experienced manufacturers of contract furniture and banquette seating, providing an unmatched level of service.

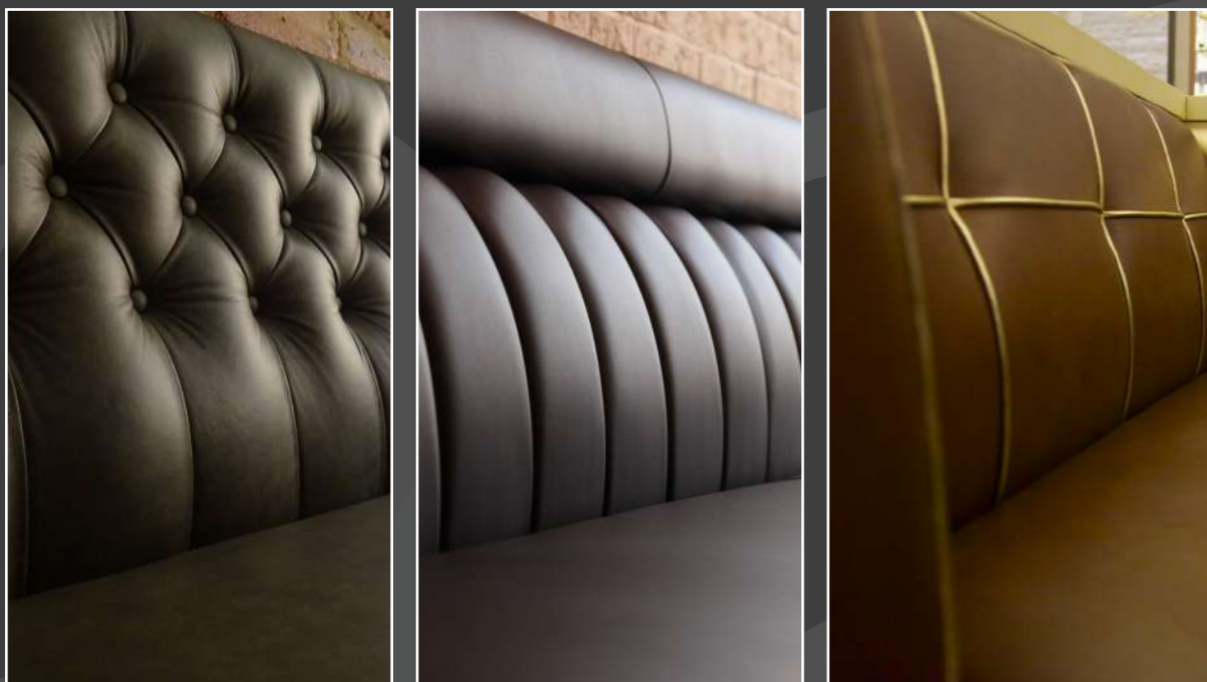

GETTING started

Catalogue Guide, Frame Constructions & Certification.

KEY READS

Catalogue Guide	
Section 1	4
Frame Constructions	
Section 2	5 - 7
Testing & Certification	
Section 3	49 - 50

SEATING styles

Portfolio of Atlas' Seating Styles Range.

PART A

Plain Back	
Section 1	10 - 11
Fluted Back	
Section 2	12 - 13
Deep Button Back	
Section 3	14 - 15
Two Horizontal Panel Back	
Section 4	16 - 17
Vertical Panel, Square Pleated Back	
Section 5	18 - 19
Plain & Roll, Flute & Roll Back	
Section 6	20 - 21
Half Diamond, Chester Button Back	
Section 7	22 - 23
Three & Four Horizontal Panel Back	
Section 8	24 - 25
Float Button Back	
Section 9	26
Additional Seating Styles	
Section 10	27

SEATING styles +

Assortment of Variations & Additions for Seating Styles.

PART B

Seating Variations	
Section 1	30 - 31
Seating Additions	
Section 2	32 - 33
Technical Seating Additions	
Section 3	34 - 35
Seating Styles Specification (CAD)	
Section 4	36 - 38

SUNDRY products

Additional Products to Further Customise Your Seating.

PART C

Legs - Metal & Wooden	
Section 1	41 - 44
Buttons, Nails and Glides	
Section 2	45 - 47

Disclaimer

Note that product information and availability are correct at the time of print. Atlas is not liable for changes to specification, nor the discontinuation of products implemented by the supplier.

These may be subject to change without prior notice.

Contact Us

- 🌐 www.atlascontractfurniture.com
- ✉ sales@atlascontractfurniture.com
- ☎ +44 1202 400999

CATALOGUE guide

Atlas Seating Styles & Sundries Catalogue Guide | ACF - Seating Styles & Sundries Catalogue - Key Reads, Section 1



Using the Seating Styles & Sundries Catalogue

FRAME CONSTRUCTIONS

We offer a range of frame constructions to suit every client. Our 'Standard Serpentine Sprung Construction' is the most popular, and comes with a 10-year frame warranty as standard. All our seating is completely bespoke and all elements are adaptable.

SEATING STYLES

Whether you are after a subtle design, something more decorative, or anything in between; we have the solution. For design inspiration, our portfolio of seating styles showcases how clients have developed our customisable styles into something unique.

SEATING OPTIONS

Explore our range of additional seating options for the finishing touches that will complete your design. From embroidery through to custom LED lighting and discrete storage solutions, these options aim to fulfil all practical and aesthetic requirements.

SEATING SUNDRIES

We offer an array of legs, buttons and decorative nails to further customise your seating style. Looking for something else? At Atlas, we are determined to find a solution that meets your exact needs.

Bespoke Sizes

- H** Banquette Height
- D** Banquette Depth
- SD** Seat Depth
- ST** Seat Thickness
- SH** Seat Height

Illustration of Customisable Dimensions

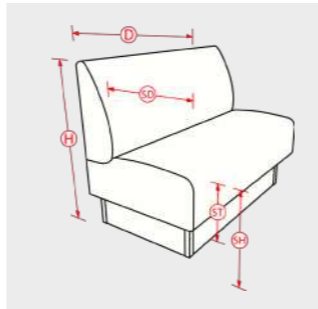

Warranties

Warranties for sundries are given on a product specific basis. Warranties for our seating and services are as per our full terms and conditions.

For further details and enquiries, please do not hesitate to contact a member of our friendly team to discuss your next project.

Experience

With decades of experience in the contract furniture industry, Atlas has a large portfolio of exceptional work and satisfied clients.

Our team are able to advise on technical queries whenever required, and ensure that projects are delivered successfully to strict deadlines. We are committed to producing the best possible results, with a remarkable level of quality that is unrivalled by competitor products.

FRAME constructions

Key Reads - Section 2

FRAME constructions

Our Quality Construction Methods | ACF - Seating Styles & Sundries Catalogue - Key Reads, Section 2

About Atlas Frame Constructions

We offer a range of frame constructions to suit the requirements of any project. All our seating is completely bespoke and all elements are customisable.

Whether you need seating that is ergonomically friendly, cosy and comfortable, or something a little firmer to speed up the flow of customers, we'll help you choose a solution best suited to your business.

Warranties Offered

Warranties offered on frame constructions are not inclusive of foams or fabrics. Please refer to our terms and conditions for full details on our warranties.

Require Further Information?

Our team of experts can advise the best construction solution for the project, based on the intended use of the project's seating.

STANDARD SERPENTINE SPRUNG CONSTRUCTION

Our Standard Serpentine Sprung Seating frame delivers uncompromising comfort through expertly crafted ergonomic design, and comes with a 10-year frame warranty as standard. The frame utilises serpentine type springs; robust, reliable, and built to last.

This frame has been successfully tested to: **EN 16139:2013** - Test Level 2



10 YEAR
Frame
Warranty

Please refer to terms and conditions for details.

PLATFORM BASE CONSTRUCTION

This frame construction utilises a rigid base in place of any springs or webbing. The platform base is covered in foam to suit, and then upholstered. Platform base units can often run at a more economical price, however some comfort will be compromised.

This frame has been successfully tested to: **EN 16139:2013** - Test Level 2



3 YEAR
Frame
Warranty

Please refer to terms and conditions for details.

HELICAL SPRUNG CONSTRUCTION

Our more luxurious 'Helical Sprung Seating' construction boasts the addition of a sprung back to provide extra comfort to the user. The helical springs in the base offer a natural fit that contours and supports the body effortlessly.

This frame has been successfully tested to: **EN 16139:2013** - Test Level 2



10 YEAR
Frame
Warranty

Please refer to terms and conditions for details.

POCKET SPRUNG CONSTRUCTION

Our latest 'Pocket Sprung Seating' construction features a base assembled using pocketed spring sections (similar to those found inside some mattresses). This provides great comfort with excellent ergonomic support and pressure relief.

This frame has been successfully tested to: **EN 16139:2013** - Test Level 2



7 YEAR
Frame
Warranty

Please refer to terms and conditions for details.

WEBBED CUSHION CONSTRUCTION

Our 'Webbed Cushion Seating' utilises a strong elasticated webbing in a lattice-like weave (as opposed to traditional springs), with foam, feather-filled or pocket sprung cushions. This produces a welcoming seat that is perfectly suited to relaxed environments.

This frame has been successfully tested to: **EN 16139:2013** - Test Level 2



5 YEAR
Frame
Warranty

Please refer to terms and conditions for details.

About Seating Profiles

It is also possible to tailor the seating profile to your requirements. This is achieved through selecting the appropriate foam densities and making adjustments to the springing rails. Please enquire for further details.

SEATING styles

Part A - Sections 1 to 10

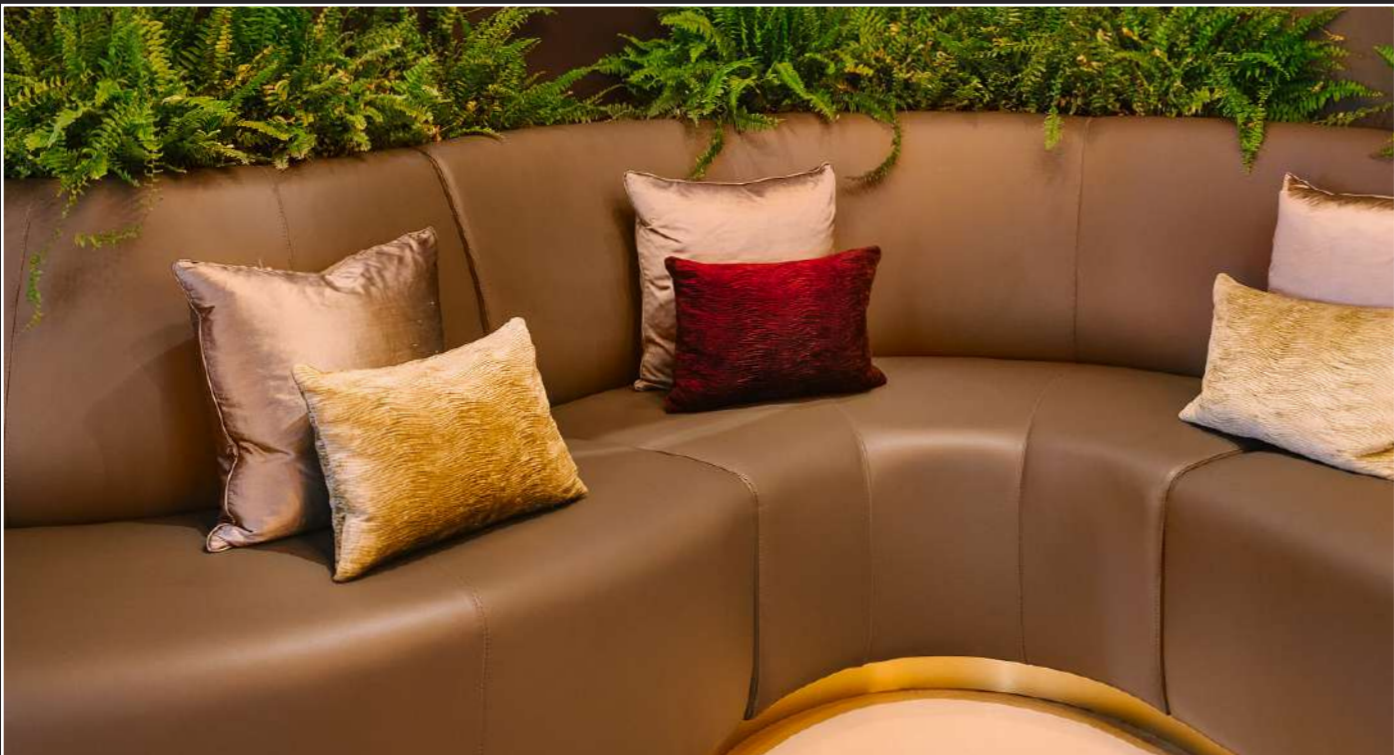

ATLAS
CONTRACT
FURNITURE

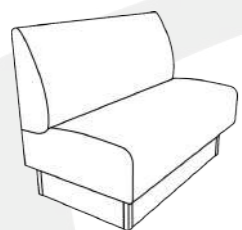

PLAIN BACK

Seating Style

About

Our classic Plain back seating style offers a clean and elegant look. A great way to showcase a single upholstery cover, or alternatively - why not mix seat and back upholstery covers for a stylish contrast. One of our most popular styles due to it's versatility and suitability for any project.

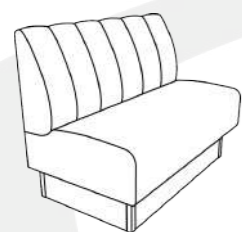

FLUTED BACK Seating Style

About

Our Fluted back seating style is available with any width of flute (*standard flutes are nominally 150 mm wide*). Aligned with precision and entirely customisable; flutes elegantly compliment plain upholstery covers. We offer a number of fluting styles to accommodate your exact requirements.

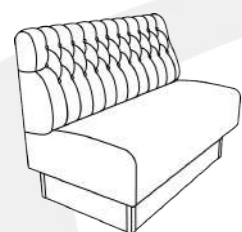

DEEP BUTTON BACK

Seating Style

About

Our Deep Button back seating style is traditional, classic and timeless. For a sophisticated and quality look, leathers go hand-in-hand with this style. Choose which buttons accent your piece, and really transform this design statement into something entirely unique with lots of character.

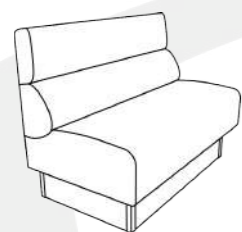

2 HORIZONTAL PANEL BACK Seating Style

About

Our Two Horizontal Panel back seating style features two individually upholstered, fully customisable panels. Panel sizes can be adjusted to suit your specifications, and different upholstery covers can also be chosen to create a striking contrast.

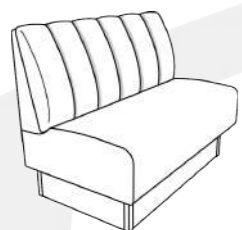
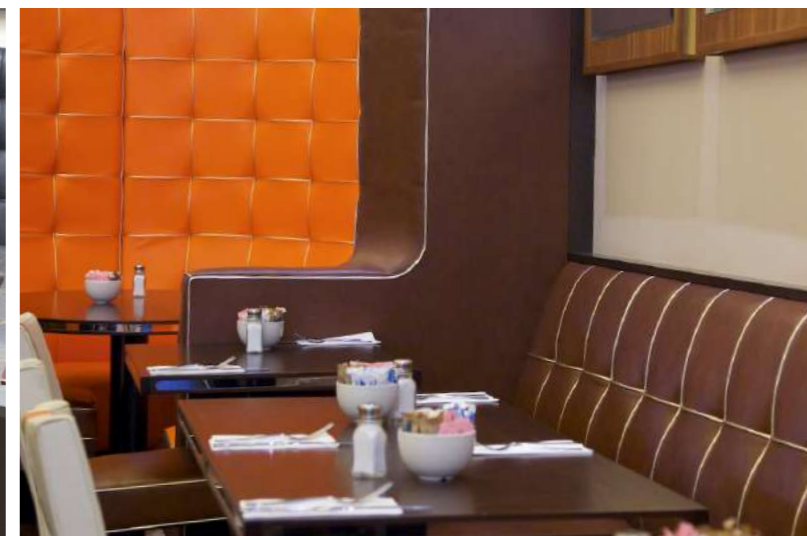

VERTICAL PANEL BACK

Seating Style

Our Vertical Panel back seating style is a popular choice for all types of seating due to its versatility. Similar in style to our Fluted back option, but utilising individually upholstered panels to create a deeper and more defined look.

SQUARE PLEATED BACK

Seating Style

Our Square Pleated back seating style is a great choice for high-backed seating; the padded, uniform squares can be customised to any size. Choose whether or not to add contrasting piped edges or buttons to complete the look.



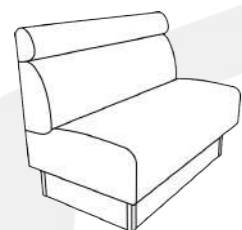
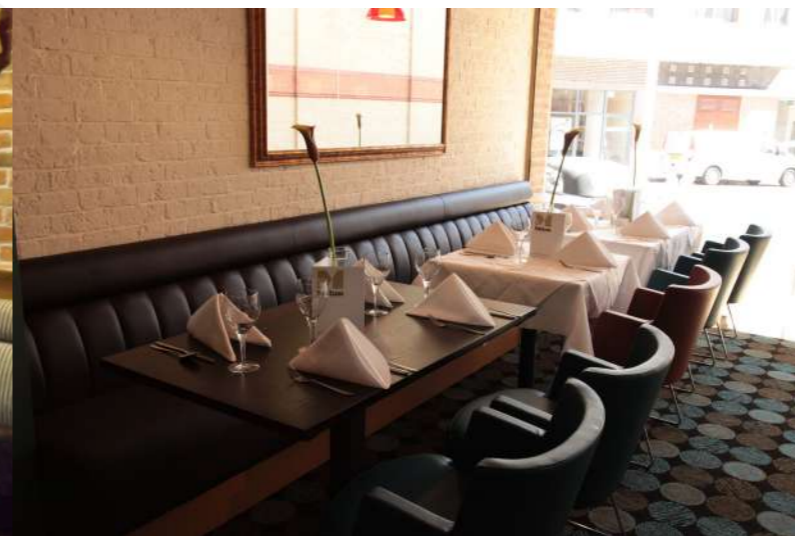

PLAIN & ROLL BACK

Seating Style

Our Plain & Roll back seating style offers a simplistic yet comfortable design. Its padded, cushioned back provides support to the lower back - and if you opt for a high-back seating arrangement, the cushioned roll supports the head and neck.

FLUTE & ROLL BACK

Seating Style

Our Flute & Roll back seating style is highly customisable. Opt for a single upholstery cover throughout for a classic look, or create a striking design by introducing contrasting colours and textures with different covers for the flutes and the roll.



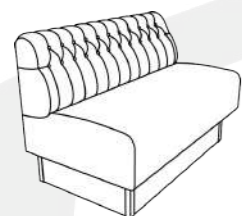

HALF DIAMOND BACK Seating Style

Our Half Diamond back seating style is a variation of the ever popular Deep Button back design. It's classic, luxurious, and looks stunning with both leathers and fabrics. All elements are customisable, right down to the buttons which accentuate your piece.

CHESTER BUTTON BACK Seating Style

Our Chester Button back seating style is a popular design for more traditional settings thanks to its vintage styling. This back style looks stunning in rich leathers, and partners well with the addition of an upholstered border and free standing legs.



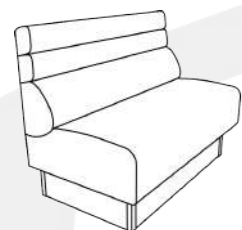

3 HORIZONTAL PANEL BACK Seating Style

Our Three Horizontal Panel back seating style is a contemporary design that features three customisable, individually upholstered panels. You can choose a single upholstery cover throughout, or mix cover designs for something truly unique.



4 HORIZONTAL PANEL BACK Seating Style

Our Four Horizontal Panel back features four individually upholstered panels that can be customised to your specification. Choose from our selection of upholstery covers to find the perfect colour and texture to complete your space.





ADDITIONAL SEATING STYLES

Seating Styles | ACF - Seating Styles & Sundries Catalogue - Part A, Section 10

OUR BESPOKE SERVICE

All Seating Styles Can Be Customised to Your Requirements



CUSHION Seating Style

Our Cushion seating style includes foam core cushions, with an optional upgrade to feather or pocket sprung cushions; perfect for a lounge area to create the right mood. Available for seating backs and/or the seats.



SETTEE Seating Style

Our Settee seating style is a variation on our Plain back. It features deeper, softer backs and/or seats, and is often paired with a deeper front border and legs in place of plinths. Settee arms can be added to complete the look.

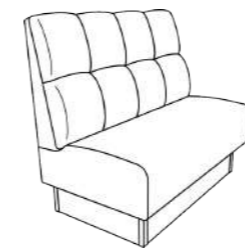

SQUARE PANEL BACK Seating Style

Our Square Panel back seating style is comprised of individually upholstered squares that can be customised to suit. Adjust the sizes, the layout (rows and columns), and even the shape (combination of rectangles and squares).

Looking for Something Else?

Every one of our seating styles is entirely customisable. We will work with you to create the bespoke banquette seating that meets your exact requirements.



FLOAT BUTTON BACK Seating Style

Our Float Button back seating style is similar to our Plain back, but with elegant surface floating buttons. These can be the same colour as the back, or contrasting to switch-up the design. Keep it simple with a single row, or add multiple rows.

SEATING styles +

Part B - Sections 1 to 4



ATLAS
CONTRACT
FURNITURE

SEATING variations

Seating Variations | ACF - Seating Styles & Sundries Catalogue - Part B, Section 1

OUR BESPOKE SERVICE

All Variations Can Be Customised to Your Requirements



HEIGHT Alterations

All of our seating backs can be customised to the required height. High-back styles can create partitions to form private dining areas and exclusive booths; breaking up larger spaces.



PROFILE Alterations

We can customise the profile of your seating to help create the desired environment. Our design experts have a wealth of knowledge in adapting seating profiles and ergonomic styles.



LEG Alterations

Depending on the design aesthetic you are trying to achieve, we offer a wide range of leg choices as an alternative to plinths. From classic and traditional legs to more modern and contemporary designs; you'll find the perfect fit to set your seating upon.



SEAT Alterations

All of our seat designs can be fully customised, so you can find a seat depth and thickness that compliments the aesthetics of your venue's interior.

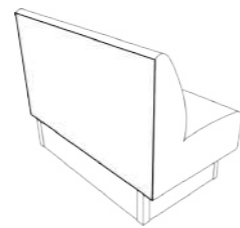

OUTSIDE Backs

Outside backs provide a design opportunity for free-standing units. From industrial sheet metal to veneered and upholstered backs, our team are on hand to help achieve your desired look.



CAPPINGS & Radiator Grilles

Cappings and radiator grilles can be incorporated to ensure there are no gaps between your seating and walls, and to help conceal radiators. They can even be used where seating is arranged back to back; providing a flat surface for accessories.



About Our Seating Variations

Whether you're after a stylish high-back design, or require a deeper seat for extra comfort; Atlas have you covered. From stunning upholstered or veneered outside backs through to sleek radiator grilles and cappings, our comprehensive service delivers the best possible results for your project.

SEATING additions

Seating Additions | ACF - Seating Styles & Sundries Catalogue - Part B, Section 2

OUR BESPOKE SERVICE

All Additions Can Be Customised to Your Requirements

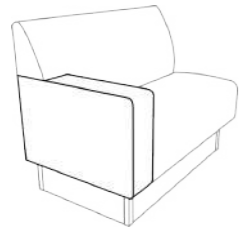

BOX Arms

Box arms can be added for both aesthetic and practical purposes, in any shape required.



POSEUR Height & Rail

Raised seating with options for foot rails or plinth steps; a perfect pairing for high stools.

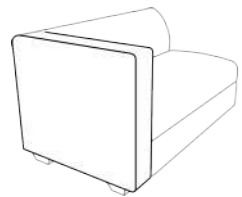

SETTEE Arms

Perfect for creating a relaxed and inviting environment with a 'home comfort' look.



RISE & FALL Backs

A creative way to add height and break long stretches of single-level seating.

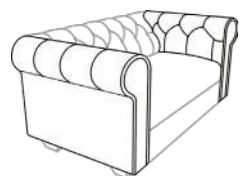

SCROLL Arms

A popular choice for traditional seating designs, offering a comfortable and luxurious feel.



LOGO Embroidery

Express your brand and add a memorable touch that is entirely personal to your business.

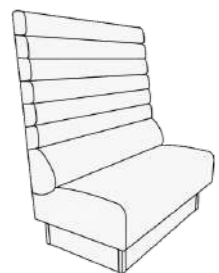

WALL Panelling

Extend your seating design or create an independent design feature. We can even incorporate recesses for TVs and electronics.



HINGED Storage Solution

Get the most from your space by incorporating easily accessible storage solutions. Our hinged storage systems are discreet and practical.



About Our Seating Additions

Customise the seating for your next project with some of our most popular seating additions. Why not consider poseur height banquette units to really set your project apart from the rest, or implement hinged and counterbalanced seats for a discrete and practical storage solution.

TECHNICAL seating additions

Technical Seating Additions | ACF - Seating Styles & Sundries Catalogue - Part B, Section 3

OUR BESPOKE SERVICE

All Technical Additions Can Be Customised to Your Requirements



HEATED Seat Pads

Add a little luxury to your outdoor seating areas by introducing heated seat pads. Even when we enter our colder seasons, you can make the most of your outdoor seating all year round.



LED Strip Lighting

Lighting is a fundamental component for shaping the ambience of a space. Providing a soft glow, our customisable LED strip lighting is discrete and inviting.



POWER Sockets for Plinths

Power sockets are a popular choice for pub and café seating as it provides a welcomed power source to customers on the go with phones and laptops. They're a really useful addition for cleaners too, as they can plug-in their appliances at various points around the room.



About Our Technical Seating Additions

Technical seating additions will bring your project right up to date. We can implement custom LED lighting, heated seat pads, and power sockets for the convenience of your customers. Don't quite see what you're looking for? Please get in touch to discuss your requirements.

SEATING styles specification

Seating Styles Specification (CAD) | ACF - Seating Styles & Sundries Catalogue - Part B, Section 4

CAD DRAWINGS

All Dimensions Are Customisable | Below Are Recommendations Only

PLAIN BACK

Overall Height	900 mm
Overall Depth	670 mm
Seat Height	470 mm
Seat Depth	470 mm
Seat Thickness	270 mm
Plinth Height	200 mm



FLUTED BACK

Overall Height	900 mm
Overall Depth	670 mm
Seat Height	470 mm
Seat Depth	470 mm
Seat Thickness	270 mm
Plinth Height	200 mm

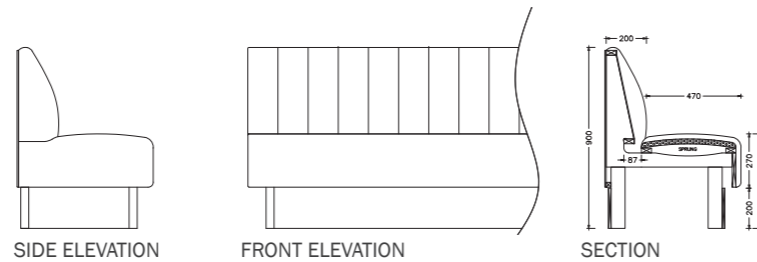

DEEP BUTTON BACK

Overall Height	900 mm
Overall Depth	670 mm
Seat Height	470 mm
Seat Depth	470 mm
Seat Thickness	270 mm
Plinth Height	200 mm

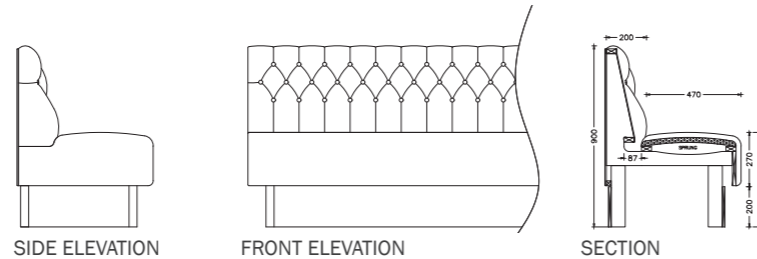

2 HORIZONTAL PANEL BACK

Overall Height	900 mm
Overall Depth	670 mm
Seat Height	470 mm
Seat Depth	470 mm
Seat Thickness	270 mm
Plinth Height	200 mm

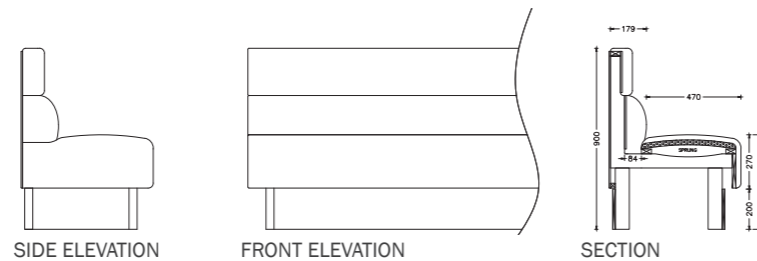

VERTICAL PANEL BACK

Overall Height	900 mm
Overall Depth	670 mm
Seat Height	470 mm
Seat Depth	470 mm
Seat Thickness	270 mm
Plinth Height	200 mm



CAD DRAWINGS

All Dimensions Are Customisable | Below Are Recommendations Only

SQUARE PLEATED BACK

Overall Height	900 mm
Overall Depth	670 mm
Seat Height	470 mm
Seat Depth	470 mm
Seat Thickness	270 mm
Plinth Height	200 mm

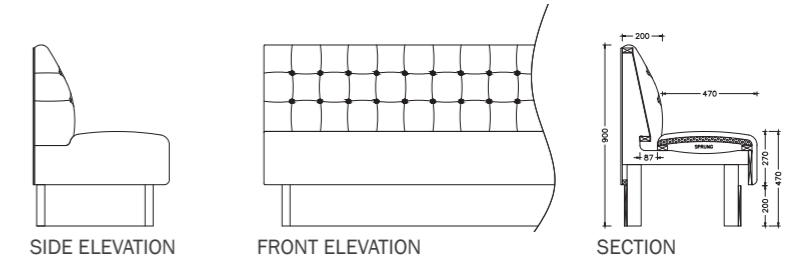

PLAIN & ROLL BACK

Overall Height	900 mm
Overall Depth	670 mm
Seat Height	470 mm
Seat Depth	470 mm
Seat Thickness	270 mm
Plinth Height	200 mm

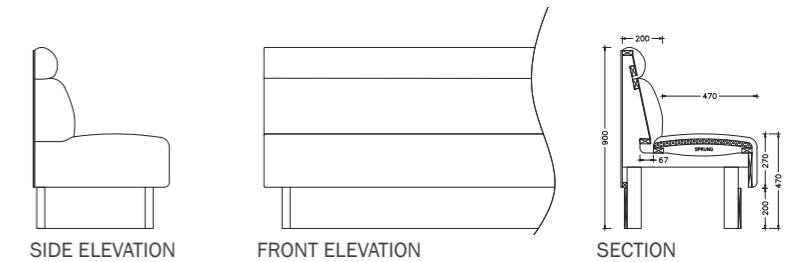

FLUTE & ROLL BACK

Overall Height	900 mm
Overall Depth	670 mm
Seat Height	470 mm
Seat Depth	470 mm
Seat Thickness	270 mm
Plinth Height	200 mm

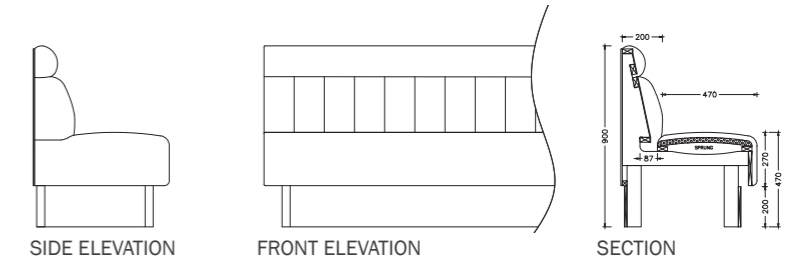

HALF DIAMOND BACK

Overall Height	840 mm
Overall Depth	670 mm
Seat Height	470 mm
Seat Depth	470 mm
Seat Thickness	270 mm
Plinth Height	200 mm

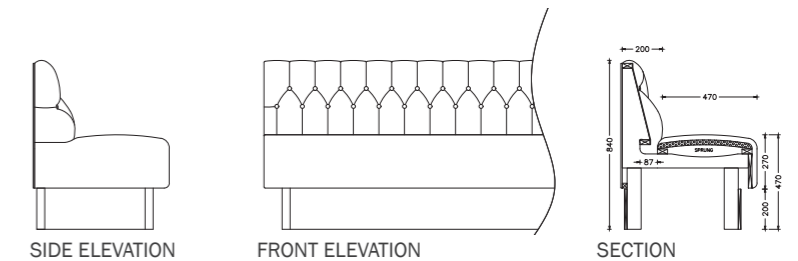

CHESTER BUTTON BACK

Overall Height	860 mm
Overall Depth	730 mm
Seat Height	470 mm
Seat Depth	470 mm
Seat Thickness	270 mm
Plinth Height	200 mm

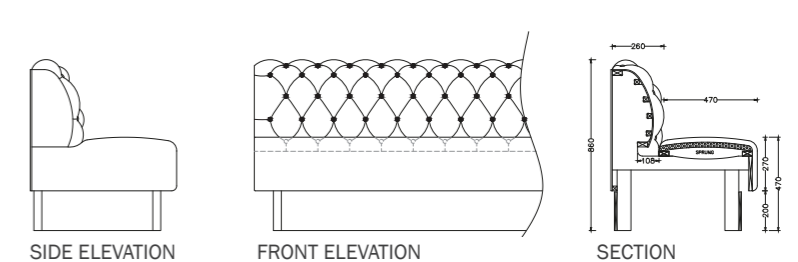

SEATING styles specification

Seating Styles Specification (CAD) | ACF - Seating Styles & Sundries Catalogue - Part B, Section 4

CAD DRAWINGS

All Dimensions Are Customisable | Below Are Recommendations Only

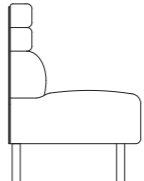
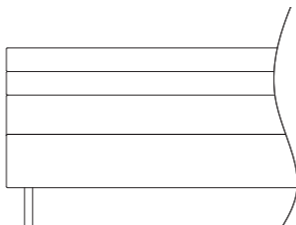
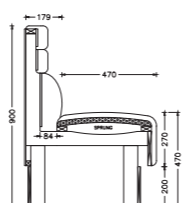
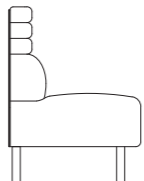
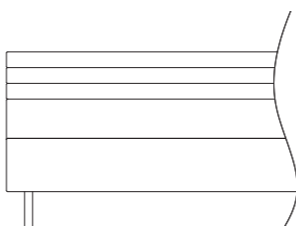
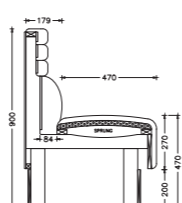
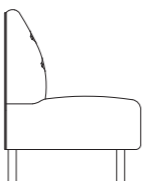
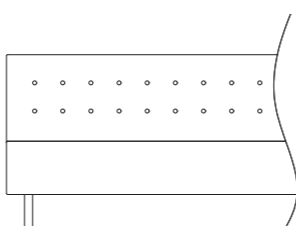
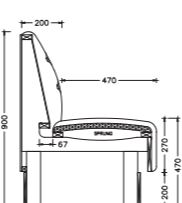
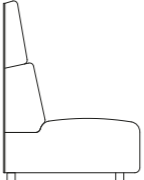
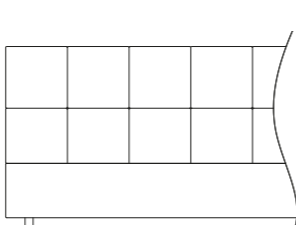
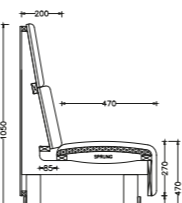
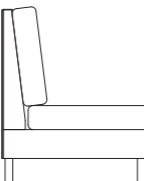
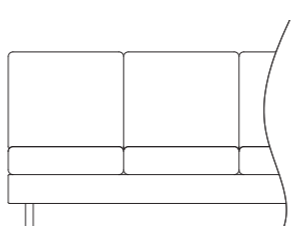
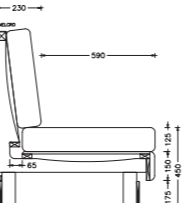
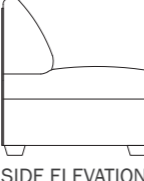
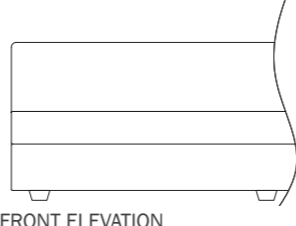
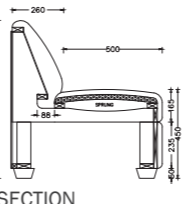
3 HORIZ. PANEL BACK	Overall Height	900 mm	 <p>SIDE ELEVATION</p>	 <p>FRONT ELEVATION</p>	 <p>SECTION</p>
	Overall Depth	670 mm			
	Seat Height	470 mm			
	Seat Depth	470 mm			
	Seat Thickness	270 mm			
	Plinth Height	200 mm			
4 HORIZ. PANEL BACK	Overall Height	900 mm	 <p>SIDE ELEVATION</p>	 <p>FRONT ELEVATION</p>	 <p>SECTION</p>
	Overall Depth	670 mm			
	Seat Height	470 mm			
	Seat Depth	470 mm			
	Seat Thickness	270 mm			
	Plinth Height	200 mm			
FLOAT BUTTON BACK	Overall Height	900 mm	 <p>SIDE ELEVATION</p>	 <p>FRONT ELEVATION</p>	 <p>SECTION</p>
	Overall Depth	670 mm			
	Seat Height	470 mm			
	Seat Depth	470 mm			
	Seat Thickness	270 mm			
	Plinth Height	200 mm			
SQUARE PANEL BACK	Overall Height	1050 mm	 <p>SIDE ELEVATION</p>	 <p>FRONT ELEVATION</p>	 <p>SECTION</p>
	Overall Depth	670 mm			
	Seat Height	470 mm			
	Seat Depth	470 mm			
	Seat Thickness	270 mm			
	Plinth Height	200 mm			
CUSHION	Overall Height	950 mm	 <p>SIDE ELEVATION</p>	 <p>FRONT ELEVATION</p>	 <p>SECTION</p>
	Overall Depth	820 mm			
	Seat Height	450 mm			
	Seat Depth	590 mm			
	Seat Thickness	275 mm			
	Plinth Height	175 mm			
SETTEE	Overall Height	800 mm	 <p>SIDE ELEVATION</p>	 <p>FRONT ELEVATION</p>	 <p>SECTION</p>
	Overall Depth	760 mm			
	Seat Height	450 mm			
	Seat Depth	500 mm			
	Seat Thickness	400 mm			
	Plinth Height	N/A mm			



LEGS metal & wooden

Part C - Section 1



ATLAS
CONTRACT
FURNITURE

WOODEN legs

Legs - Metal & Wooden | ACF - Seating Styles & Sundries Catalogue - Part C, Section 1

FSC2162
CRK-1



Leg Height 230 mm
Leg Width 65 mm
Fixing Type M10

FSC2163
CRK-2



Leg Height 150 mm
Leg Width 65 mm
Fixing Type M10

FSC2164
CRK-3



Leg Height 150 mm
Leg Width 65 mm
Fixing Type M10

FSC2165
CRK-4



Leg Height 130 mm
Leg Width 65 mm
Fixing Type M10

WF0005
CRK-5



Leg Height 128 mm
Leg Width 45 mm
Fixing Type M8

WF3076
CRK-21



Leg Height 125 mm
Leg Width 90 mm
Fixing Type M8

WF3322
CRK-22



Leg Height 150 mm
Leg Width 90 mm
Fixing Type M8

WF3340
CRK-23



Leg Height 150 mm
Leg Width 90 mm
Fixing Type M8

WF3621
CRK-24



Leg Height 127 mm
Leg Width 90 mm
Fixing Type M8

WF3721
CRK-25



Leg Height 150 mm
Leg Width 82 mm
Fixing Type M8

WF0025
CRK-6



Leg Height 120 mm
Leg Width 70 mm
Fixing Type M8

WF0031
CRK-7



Leg Height 70 mm
Leg Width 65 mm
Fixing Type M9

WF0045
CRK-8



Leg Height 120 mm
Leg Width 57 mm
Fixing Type M8

WF0119
CRK-9



Leg Height 125 mm
Leg Width 70 mm
Fixing Type M8

WF0234
CRK-10



Leg Height 90 mm
Leg Width 70 mm
Fixing Type M8

WF3798
CRK-26



Leg Height 135 mm
Leg Width 100 mm
Fixing Type M8

WF3975
CRK-27



Leg Height 140 mm
Leg Width 80 mm
Fixing Type M8

WF4120
CRK-28



Leg Height 200 mm
Leg Width 50 mm
Fixing Type M10

WF4150
CRK-29



Leg Height 160 mm
Leg Width 85 mm
Fixing Type M8

WF4325
CRK-30



Leg Height 132 mm
Leg Width 92 mm
Fixing Type M8

WF0418
CRK-11



Leg Height 150 mm
Leg Width 50 mm
Fixing Type M8

WF0721
CRK-12



Leg Height 120 mm
Leg Width 55 mm
Fixing Type M8

WF0811
CRK-13



Leg Height 155 mm
Leg Width 70 mm
Fixing Type M8

WF1051
CRK-14



Leg Height 128 mm
Leg Width 88 mm
Fixing Type M8

WF1211
CRK-15



Leg Height 125 mm
Leg Width 90 mm
Fixing Type M8

WF4477
CRK-31



Leg Height 160 mm
Leg Width 90 mm
Fixing Type M8

WF4486
CRK-32



Leg Height 150 mm
Leg Width 86 mm
Fixing Type M8

WF4536
CRK-33



Leg Height 145 mm
Leg Width 120 mm
Fixing Type M8

WF4576
CRK-34



Leg Height 145 mm
Leg Width 75 mm
Fixing Type M8

WF1415
CRK-16



Leg Height 200 mm
Leg Width 70 mm
Fixing Type M8

WF1573
CRK-17



Leg Height 128 mm
Leg Width 100 mm
Fixing Type M8

WF1749
CRK-18



Leg Height 150 mm
Leg Width 70 mm
Fixing Type M10

WF2172
CRK-19



Leg Height 160 mm
Leg Width 75 mm
Fixing Type M8

WF2302
CRK-20



Leg Height 115 mm
Leg Width 110 mm
Fixing Type M8

METAL legs

Legs - Metal & Wooden | ACF - Seating Styles & Sundries Catalogue - Part C, Section 1

AL0023
CRK-35



Leg Height 90 mm
Leg Width 57 mm
Fixing Type M8

AL0060
CRK-36



Leg Height 50 mm
Leg Width 45 mm
Fixing Type M8

AL0069
CRK-37



Leg Height 35 mm
Leg Width 65 mm
Fixing Type M10

AL0072
CRK-38



Leg Height 155 mm
Leg Width 135 mm
Fixing Type Screw Holes

AL0078
CRK-39



Leg Height 180 mm
Leg Width 175 mm
Fixing Type Screw Holes

AL2657P
CRK-40



Leg Height 100 mm
Leg Width 60 mm
Fixing Type M8

AL2894
CRK-41



Leg Height 155 mm
Leg Width 70 mm
Fixing Type M8

AL4093
CRK-42



Leg Height 150 mm
Leg Width 50 mm
Fixing Type M8

AL4329
CRK-43



Leg Height 100 mm
Leg Width 50 mm
Fixing Type M8

AL4604
CRK-44



Leg Height 100 mm
Leg Width 90 mm
Fixing Type M8

AL4666
CRK-45



Leg Height 120 mm
Leg Width 100 mm
Fixing Type Screw Holes

BUTTONS nails & glides

Part C - Section 2

BUTTONS nails & glides

Buttons, Nails & Glides | ACF - Seating Styles & Sundries Catalogue - Part C, Section 2

Finishing Nails



Upholstery Nails low dome

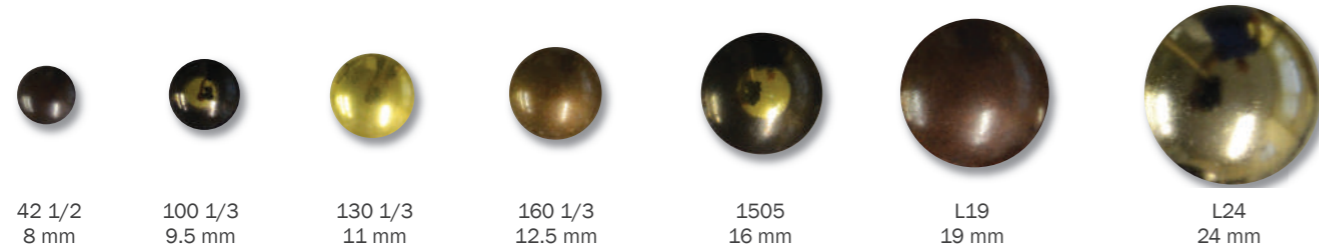

Upholstery Nails high dome



Upholstery Nails square head

Upholstery Nails solid brass head



Decorative Nails



Conical Heads



Blue Tacks



Decorative Nails

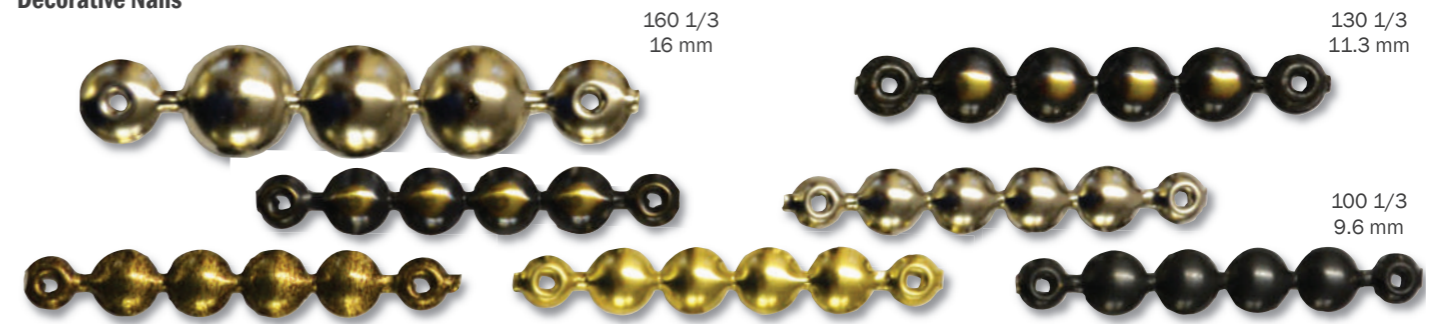

Decorative Nails



Crystal Buttons and Nails 11 mm and 16 mm nails, 18 mm buttons

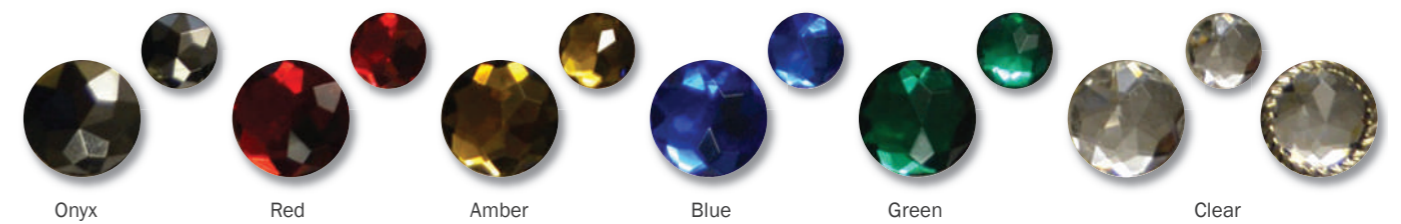

Glides



Cut Glass crystal buttons

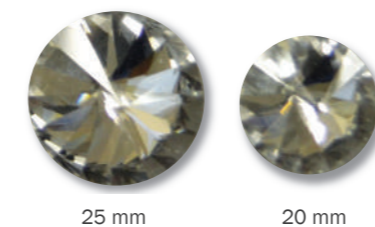

TESTING certification

Key Reads - Section 3



ATLAS
CONTRACT
FURNITURE

TESTING & certification

Testing Certification | ACF - Seating Styles & Sundries Catalogue - Key Reads, Section 3

About Our Testing & Certification

We take pride in ensuring that our seating is fit for contract use, and of the highest quality.

Our 5 standard frame constructions have been tested to:

BS EN 16139: 2013 - Test Level 2 - "Furniture - Strength, durability and safety - Requirements for non-domestic seating"

- ✔ Standard Serpentine Sprung Construction
- ✔ Platform Base Construction
- ✔ Helical Sprung Construction
- ✔ Pocket Sprung Construction
- ✔ Webbed Cushion Construction

Warranty Information

We offer an overview of our policies and warranty information within the O&M manuals.

Please note that the conditions outlined in the O&M manuals are not to be used as an independent guide in place of our full terms and conditions.

For a comprehensive guide to our policies (in addition to our terms of sale), please refer to our full terms and conditions for further details.



SATRA Test Certificate

ACF Standard Serpentine Sprung Seating Construction

Require Something Else?

We are here to assist should you have any queries or require anything further. Please get in touch with a member of our friendly team.



'The Bespoke Seating Manufacturers' from Christchurch, Dorset.

ASSOCIATED SERVICES



WEBSITE  www.atlassprayfinishes.co.uk

EMAIL  sales@atlassprayfinishes.co.uk

TELEPHONE  +44 1202 400999

We are 'Specialists in High Quality Finishing Services'.

Interior Finishes | Exterior Finishes | Deep Polyester Glosses | Lacquers | Staining | Antiquing | Distressing



CONTACT US

WEBSITE  www.atlascontractfurniture.com

EMAIL  sales@atlascontractfurniture.com

PHONE  +44 1202 400999

OUR PROMISE

Atlas are proud to offer comprehensive service & support, with free quotation & layout advice if required.

HEAD OFFICE

ADDRESS  Atlas Contract Furniture Ltd.
14A Airfield Road
Christchurch
BH23 3TG
United Kingdom

REGISTRATION DETAILS

Company Number: 6995494
Registered in England

WHY NOT GIVE US A FOLLOW...

