



Quality Access Doors- FAST!

INSTALLATION GUIDE

TELEPHONE:
1-800-483-0823
FAX:
1-888-828-6021

228 PARK AVE. S. #76520
NEW YORK, NY, 10003

WEBSITE:
www.BestAccessDoors.com
E-MAIL:
info@bestaccessdoors.com

SKU: BA-CF-2-DS

ACCESS DOOR INSTALLATION AND MAINTENANCE INSTRUCTIONS

These are recommended guidelines. Locally accepted and/or mandated practices and procedures should be followed to ensure the long-term durability and operation of the Milcor™ Access Doors installed into the various types of construction systems.

■ HANDLING AND UNPACKING

1. Handle with care during transport and installation to ensure against bending or racking of the access door.
2. Remove all packaging and inspect access door unit for damage.
3. Open and close door panel, operate latch and/or lock mechanism to confirm proper operation.

■ INSTALLATION IN ACOUSTICAL TILE SUSPENDED CEILING CONSTRUCTION

1. Cut an opening in the acoustical tile ceiling material that is 1/4" more than the nominal dimensions of the access door size. **Example: If installing a 12" x 12" access door, the opening dimensions in the ceiling material should measure 12 1/4" x 12 1/4"**. Install appropriate framing to support the suspended ceiling around the perimeter of the opening, and the access door unit. Framing shall be in accordance with local building and fire code regulations.
2. Open the access door by operating the cam latch(es) or using the provided key to unlock the door's cylinder lock.
3. Working through the opened door, insert the frame of the access door in the prepared opening and temporarily secure the unit to the structure above.
4. Verify that the unit is centered in the opening, plumb, level, and square prior to final fastening.
5. Permanently secure it to the structure above using appropriate fasteners.
6. The access door is now ready for post finishing.
7. Hold suspended grid tight to access frame, while ensuring access door operates properly. Secure the suspended grid to the structure above. Do not secure to the outer frame of the access door unit. Prepare ceiling tile finish material by drilling access holes for cam and keyed latches. (Quantity varies per unit size). Install plastic grommet(s) into holes using adhesive mastic. Acoustical ceiling tile shall be secured into recessed door panel using non-mechanical fasteners.

■ OPERATION

1. The basic components for door operation include; latching (cam latch), locking (keyed cylinder lock) and hinges.
2. Operate the cam latch(es).
3. Use a provided key to unlock the cylinder lock.

■ MAINTENANCE

This unit is an access door of corrosion-resistant construction and should be regularly inspected and maintained. Access doors should be manually operated annually to check performance.

1. Lubricate moving parts, hinges, latches with a silicone spray lubricant as required to maintain a smooth opening and closing of the door. Do not over grease. Do not use regular lubricating oil as it can attract dust and grit.
2. Clean non-moving parts with a mild soap and water solution. For access doors that have received a non-factory finish in the field, i.e. paint, refer to finish manufacturer's cleaning instructions.
3. Clean gaskets with a clean, damp, lint-free cloth. Do not apply mineral oils, vinyl dressings, or other lubricants to the gasket. This can cause the gasket to break down over time.
4. If any questions arise during the operation or maintenance of the products, please feel free to contact our technical support.



Quality Access Doors - FAST!

INSTALLATION GUIDE

TELEPHONE:
1-800-483-0823
FAX:
1-888-828-6021

228 PARK AVE. S. #76520
NEW YORK, NY, 10003

WEBSITE:
www.BestAccessDoors.com
E-MAIL:
info@bestaccessdoors.com

SKU: BA-CF-2-DS FLOOR & SIDEWALK DOORS INSTALLATION AND MAINTENANCE INSTRUCTIONS

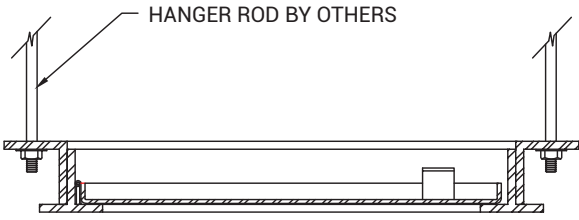

INSTALLATION DETAIL

OPTIONAL CYLINDER LOCK

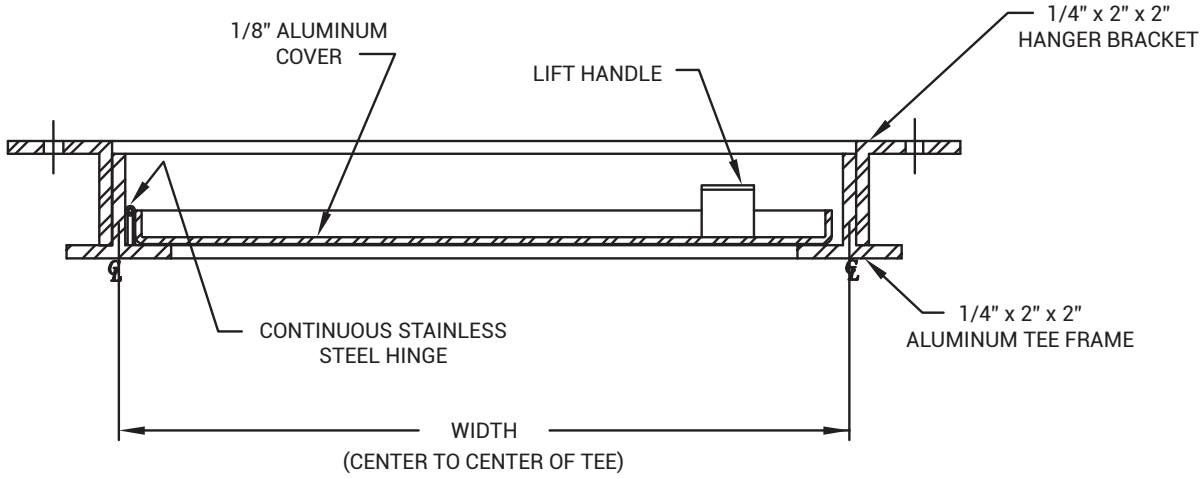
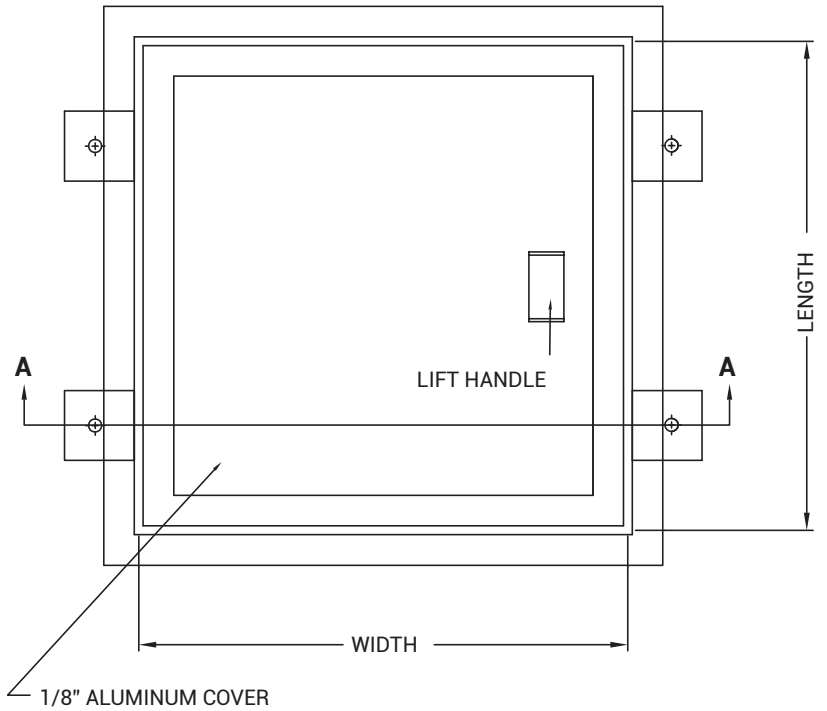
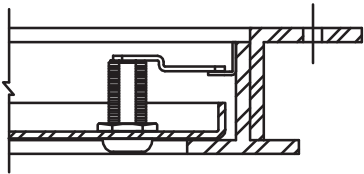

SECTION VIEW A-A