

# OWNER'S MANUAL

ALL TERRAIN VEHICLES  
LMATV-125HM

**STOP WARNING**

**UNDER 16**

Operating this ATV if you are under the age of 16 increases your chance of severe injury or death.

**NEVER** operate this ATV if you are under age 16.





## **WARNING**

Operation of this ATV by children under the age of 12 increase of the risk of severe injury or death.

An adult supervision required always.

Never permit children under age of 12 to operate this ATV.

### **ONLY FOR ADULT USE!**

Overloading can adversely affect vehicle handling.

This vehicle is designed and manufactured for OFF-ROAD use only.

Driving on public streets roads or highways is illegal.

Always wear helmet and other protective equipment.

Do not operate this vehicle after consuming Alcohol or Drugs.

Gasoline is flammable, when refueling, please shut off engine to avoid sparks and open flame.

Read owner's manual carefully before riding, keep owner's manual with vehicle.

Because after running and the exhaust muffler very hot, vehicles should be parked in child care and others not likely to encounter places.

## **FOREWORD**

Thank you choose this all terrain vehicles.

The all-terrain vehicle is based on market demand, production of a comprehensive survey. We hope that it will bring you driving pleasure.

Please read the manual before driving, because it will help you understand it all terrain vehicles on the structure, role, operation and maintenance of basic knowledge, while you keep off-road vehicles are in good condition and safe driving will be very useful.

NOTE: Manual illustrations are for demonstration purposes only. Illustrations may not reflect exact appearance of actual product. Specifications subject to change without notice.

# TABLE OF CONTENTS

<b>Pay attention to your security</b>	<b>1</b>
<b>Guidelines on safe driving</b>	<b>2</b>
<b>Warning</b>	<b>4</b>
<b>ATV recognition</b>	<b>6</b>
<b>Control functions</b>	<b>7</b>
<b>Other parts of the ATV</b>	<b>8</b>
<b>Inspection operation before use</b>	<b>10</b>
<b>Drivers must</b>	<b>12</b>
<b>Tires</b>	<b>12</b>
<b>Important elements operation and rides</b>	<b>13</b>
<b>Regular maintenance and minor repairs</b>	<b>15</b>
<b>Cleaning</b>	<b>22</b>
<b>Storage</b>	<b>23</b>
<b>Install process after packaging</b>	<b>24</b>
<b>Technical parameters</b>	<b>25</b>

# PAY ATTENTION TO YOUR SAFETY

ATV is not a toy, driving may cause danger. The operation of ATV is different from other motorcycles, automobiles and so on vehicles. If don't adopt right counter measures, even in right usage (such as turning, mountain roads, obstacles), can be easily roller over or collision. Please drive according to the operation rules, or it will bring serious damage or death.

1. Read carefully the instruction and all the labels, driving according to the procedure.
2. Contact with the local agency to search the training courses nearby, carry on training. Don't drive until have right guidance.
3. Children below 12 years old can not drive this ATV, as this ATV is not for children below 12 years old.
4. Can not carry passengers.
5. Do not drive on paved roads, including sidewalk, lane, packing and street.
6. Do not drive on public streets, roads, highway (even made of sand and stone).
7. When driving, please wear suitable certificated helmet, eye protection device (goggle or face cover), gloves, boots, long-sleeved shirt and long sleeve pants.
8. Do not drink wine or take medicine before or in driving.
9. Do not speeding. To the allowing scope of the terrain, visibility, operational experience, drive in uniform speed.
10. Do not use this vehicle for the balance of technology, jumping and other stunts.
11. Check ATV before using every time, make sure it is in safe situation, operate the inspection, maintenance method and time table in the instructions.
12. When driving, do not put one hand away with handle bar or one leg away with seat.
13. Slow down and pay more attention when driving in unfamiliar terrain, pay attention to the changes of terrain.
14. Do not drive on bumpy, wet, soft places, unless they have mastered driving skills and put into practice in such places, always alert in such terrain.
15. When turning, operate according to the relevant knowledge in manuals. Try high-speed turns, be sure to carry turning training in the low-speed. Do not speed when turning.
16. Do not drive in the slope which is too steep, exceeding the ATV and your allowed skills. First train in the flat slope.
17. In climbing, always use in proper procedures according to the requirements in instruction. Carefully observe the terrain before climbing, carefully climb in slippery or soft terrain. Driving on the way, keep the body center of gravity forward, do not suddenly full-throttle or shift. Do not speed when climbing the peak.
18. When brake in declivity and ramp, always use according to correct procedures required in instruction. Carefully observe terrain before downhill. Keep center of gravity backwards. Do not high-speed downhill. Avoid turning when downhill(ATV may lead to a sharp tilt to one side). Walk straight as much as possible.
19. When drive to the hillside, always use properly according to correct procedures required in instructions. Avoid over-smooth or soft terrain, in accordance with the rules mentioned in manuals. Center of gravity to the high side. With the slope driving, do not spin until master turning skills on flat roads described in the manuals.
20. During climbing, if want to turn off or reverse, pay attention to use the correct method. When climbing, avoid the engine stall, use correct gear and maintain a stable speed. If you want to turn off

or reverse, do as the brake programs required in the manuals. Get off from the higher side. Start and get on the vehicle according to the instructions.

21. When driving the unfamiliar areas, pay attention to obstacles. Do not try to climb over large obstacles, such as large rocks or fallen trees. When over obstacles, drive carefully according to the instructions.

22. Be careful when slide or brake. Learn to control braking or sliding safely when on flat roads in the low speed, such as ice surface, keeping in the slow speed, carefully driving, to prevent loss of control.

23. Do not drive in riptide or deep water. It is hard to brake when the plate is wet. Check the brake devices when away from water. Try to brake several times as much as possible.

24. When reverse , please ensure that no one or obstacles behind, slow reverse.

25. Using the specified type and size of the tires in the instructions, maintain the proper tire pressure specified in the operation manuals.

26. Do not reassemble the vehicle by increasing inappropriate equipment or accessories.

27. Do not overload. Max load: 120KGS

28. Do not touch the vent pipe, it is too hot after driving.

## GUIDELINES ON SAFE DRIVING

1. When approaching corners or bends, reduce speed. Upon the completion of turn, may gradually increase the speed.

2. When crossing the vehicles parked in front of you, to be very careful, because the driver of the vehicle may be invisible to you.

3. Brake lining may lose control when rising wetting, so when cleaning end before drive, should check all brake system.

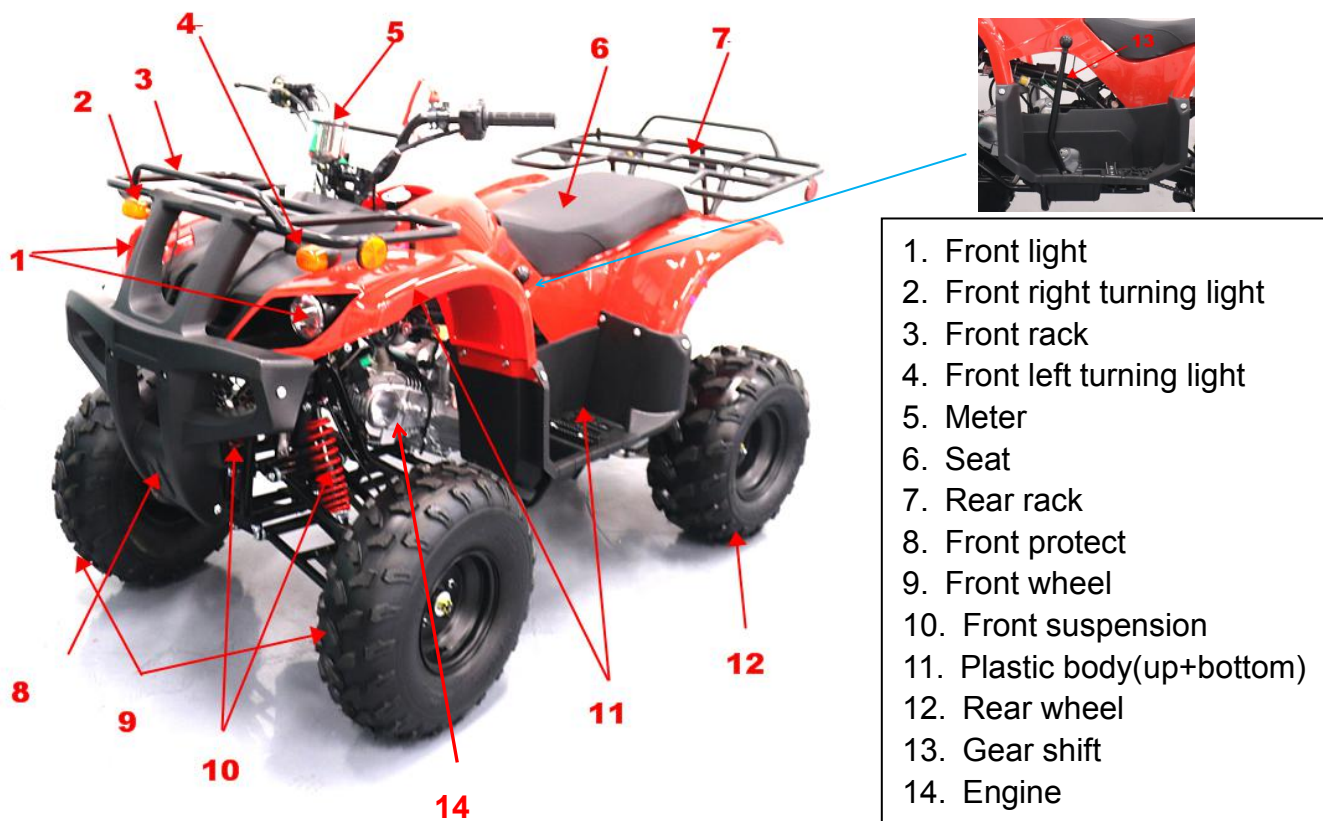



1. Rear left turning light
2. Rear right turning light
3. Hand grip
4. Rear light
5. Vent
6. Rear wheel
7. Rear suspension
8. Front wheel
9. Rear foot brake

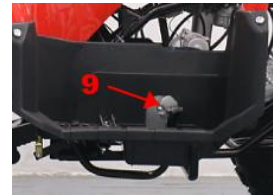

1. Left hand grip
2. Multi functional switch
3. Left mirror holder
4. Emergency stop
5. Right mirror holder
6. Hand brake
7. Right hand grip

# WARNING

ATV is not a toy, it may cause danger when driving. The operation of ATV is different from other motorcycles, cars and some other traffic tools. If do not take some certain protecting measures, even if in right usage, (for example turning, mountain road, or passing through the obstacles etc), it is easily lead to collision, or it may roll over.

Please drive properly as the following operation, or it may roll over.

1. Carefully read the instruction book (owner's manual) and all the labels, driving according to the procedure.

2. Contact with local sales agent, search for training classes nearby, and do some necessary training, you can also watch ATV safety Video for more security information, please do not drive this ATV until you get some appropriate guidance.

Training is very important, Unprofessional person may not understand the large information of this part. So "Training" will not explain in details .

How to get training : Learn from local professional institution or the retailer.

Operating and driving way in the first or second weeks may affect the vehicle future performance. Please pay more attention. During this period, do not turn the throttle into maximum, should alter the speed often.

After training period, maintain the vehicle according to maintenance form strictly. Keep the vehicle in good condition.

Training is necessary. Improper operation will result in the vehicle, and result in serious injuries and death. If the driver is without the safety awareness or driving experiences, please drive it under the supervision of the adults.

3. The warning signs with the word "WARNING" indicating the existence of the potential risks that may result in serious injury or death.

**STOP WARNING**

illegal operation **ATV** can result in **SEVERE INJURY** or **DEATH**.

ALWAYS USE AN APPROVED HELMET AND PROTECTIVE GEAR	NEVER USE ON PUBLIC ROADS	NEVER CARRY PASSENGERS	NEVER USE WITH DRUGS OR ALCOHOL

**NEVER** operate:

- without proper training or instruction.
- at speeds too fast for your skills or the conditions.
- on public roads-a collision can occur with another vehicle.
- with a passenger-passengers affect balance and steering and increase risk of losing control.

**ALWAYS :**

- use proper riding techniques to avoid vehicle overturns on hills and rough terrain and in turns.
- avoid paved surfaces-pavement may seriously affect handling and control.

**LOCATE AND READ OWNER'S MANUAL. FOLLOW ALL INSTRUCTIONS AND WARNINGS.**

**STOP WARNING**

**UNDER 16**

Operating this ATV if you are under the age of 16 increases your chance of severe injury or death.

**NEVER** operate this ATV if you are under age 16.

**STOP WARNING**

**It's dangerous to put the plastic film on head!**



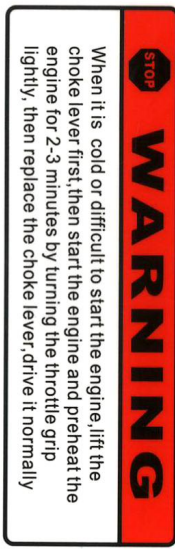
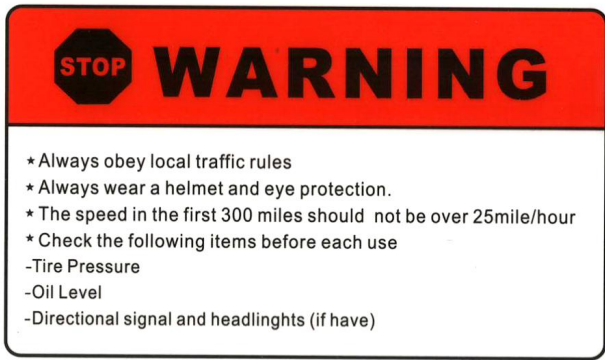

4. Improper tire pressure or overloading can cause loss of control. Loss of control can result in severe injury or death.  
Cold max tire pressure: Front: 24psi(165kpa) Rear: 24psi (165kpa)  
Maximum weight capacity: 264lbs (120kg)
5. Rear rack:  
Maximum weight capacity: 11lbs (5kg)
6. NEVER ride a passenger.  
Passengers can cause loss of control, resulting in SEVERE INJURY or DEATH.
7. Prohibit to run at max speed. Or jumping run.
8. Please read owner's manual before operate and follow instructions and warnings.
9. Operation of this ATV by children under the age of 12 increase of the risk of severe injury or death.
10. An adult supervision required always.
11. Never permit children UNDER AGE of 12 to operate this ATV.
12. Overloading can adversely affect vehicle handling.
13. Operator use only. Passengers are prohibited.
14. This vehicle is designed and manufactured for OFF-ROAD use only.
15. Driving on public streets, roads or highways is illegal.
16. Always wear helmet and other protective equipment.

- 17. Do not operate this vehicle after consuming Alcohol or Drugs.
- 18. Gasoline is flammable. When refueling, please shut off engine to avoid sparks and open flame.
- 19. Read owner’s manual carefully before riding. Keep owner’s manual with vehicle.
- 20. Please change your engine oil after the first 300 miles and each 1,000 miles thereafter. Use only type 15W - 40 oil. Capacity of engine oil tank: 0.9L

## ATV RECOGNITION

VIN plate number and product VIN (see below photo).  
 The VIN is on the right side of the front frame.

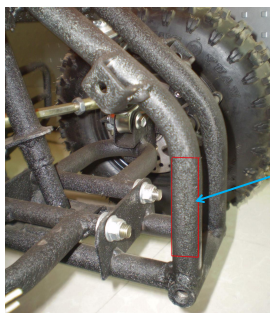
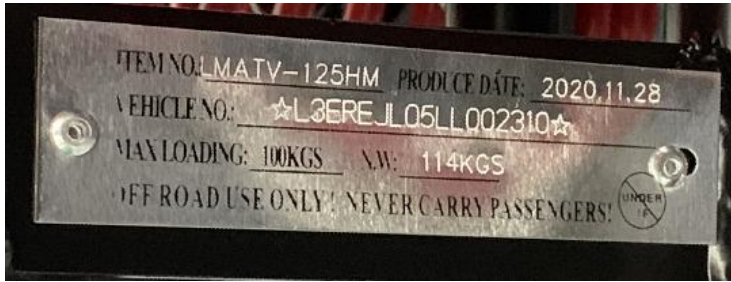

VIN number

Engine model and serial number (see below photo)

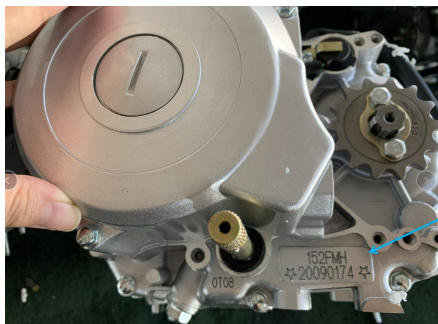

Engine number

Engine serial number and frame serial number (VIN number) are used to mark the motor vehicle, if some parts need special service, these marks can provide you some information for maintenance. Engine serial number is stamped on the topside of the engine transmission case.

Frame serial number (VIN bran) is located on the frame head pipe.

Please write down the engine serial number and frame serial number(VIN number) in the following blanks, in order to reference in the future.









Frame serial number (VIN number):	
Engine serial number:	

# CONTROL FUNCTIONS



## 1. The ignition switch

Location	Functions	Key state
	ON: All circuits was connected, ready for engine start.	Turn on power, the vehicle is started, the key could not be pulled out.
	OFF: All circuits were disconnected	Cut off the power, the vehicle could not be started, the key can be pulled out, pulling the key out can prevent non-owners from operating the vehicle.

## 2. Multi functional switch

Proximity switches	Location	Function
		Turn on high beam
		Turn on dipped headlight
		Start engine rotation switch
On switch		When press the on switch, engine ready to rotation
Off switch		When press the off switch, stop rotating engine
		Turn on left or right turning light
		horn

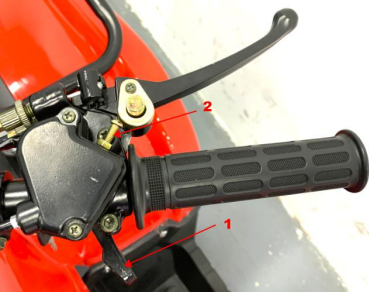
## 3. Accelerator controller

		When press this accelerator, the vehicle starts to move.
		Throttle limiter screw Prohibit to adjust it.

The throttle limiter screw can restrict maximum engine power by limiting throttle lever travel, then restrict the vehicle's maximum speed, do not adjust the throttle limiter screw unless skilled and experienced rider.

## OTHER PARTS OF THE ATV

### 1. The front wheel brake handle

The right handle brake : control the front both drum brakes

The foot brake: control the rear single disc brake



### 2. The fuel cover



### 3. Shift Gears

This model engine is automatic clutch with gears R+N+1+2+3, just push the gear shift forward or backward to control the speed.

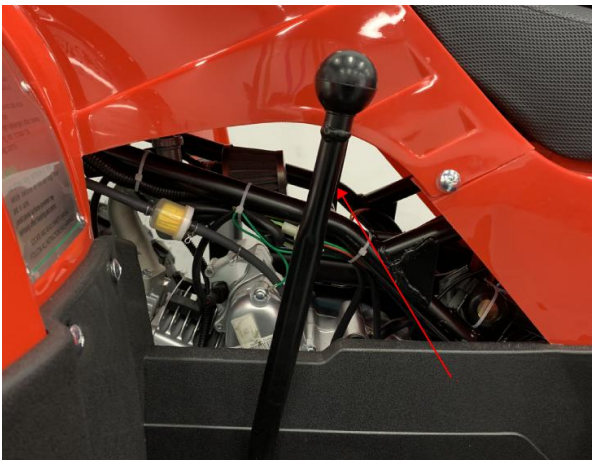

#### 4. Choke lever

Choke lever is located in the right side of the body. It is used to increase the fuel / air mixing ratio when the engine start in cold state. Pull the choke lever out a position to the max top when the engine is in start state. After start the vehicle, preheat the engine for 2-3 minutes, then push it back to the following position, it is in run this time.

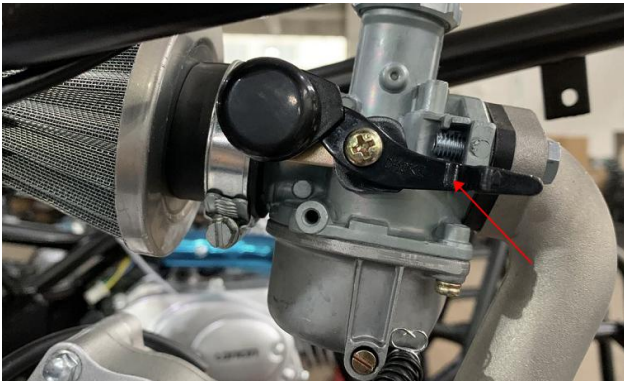

#### 5. The fuel valve (if having)

OFF: Disconnect the fuel supply from the tank to the carburetor when not in use.

ON: Connect the fuel supply from the tank to the carburetor when in use.



#### 6. Engine oil

When the engine oil is below empty line, should add more engine oil.

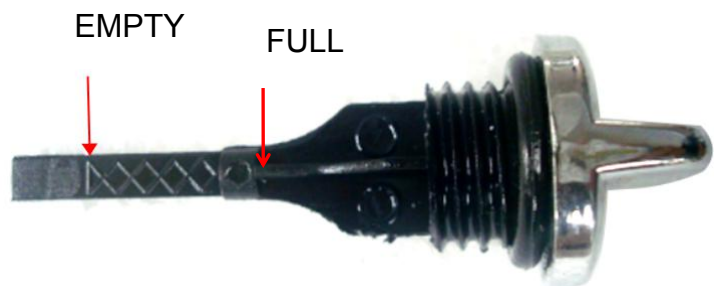

# INSPECTION OPERATION BEFORE USE

Prior to use the vehicle, should check the following.

Item	Normal checks
Brake	Inspection operation, status and freedom itinerary. If necessary, should be adjusted. Brake performance confirms whether the good work or not can be checked out at low speed.
Accelerator	Check whether the smooth operation of the accelerator. If necessary, should be conducted lubrication or adjusted.
Chain-driven	Chain of lax inspection and state. If necessary, should be adjusted.
Tire/Wheel	Checks tire pressure, wear, damage and the rate of take up the round.
Transmission and brake pedal shaft (if have) or handle shaft (if have)	Inspection operation is smooth or not, if necessary, should be conducted lubrication.
Brake and clutch manipulation of the handle shaft (if have) or pedal shaft (if have)	Operation of inspection, if necessary, should be conducted lubrication.
The stent and stent axis side	Check whether the smooth operation or not, if necessary, should be carried out tightening or adjustment.
Parts/fasteners	Inspection of all parts and fasteners, if necessary, should do tightening or adjustment.
Fuel tank	Inspection of the fuel, if necessary, should be filled with enough fuel.
Battery or water battery	Check the battery if work well or not, if necessary, should replace a new battery. Check liquid level, if necessary, distilled water should be filled for the water battery.
Engine oil	Inspection of the fuel oil, if necessary, should be filled with enough fuel.

Warning: If the item is in adverse conditions prior to use, it should be repaired prior to use.

## Idling inspection

1. Stabilize the vehicle, shake it up and down to inspect the swing arm and fork condition, to make sure it move normally and without interference.
2. Check whether the front and rear the shock absorber is deformed or leakage or not.
3. Check whether the front suspension and the rear flat fork is fastened in place.
4. Hold the vehicle when checking.
5. Repair and replace parts in time when finding that negative phenomena.
6. Contact with the dealer when the situation is out of control.

## Front brake inspection

Check whether the front brake installation is firm, the braking effect is valid.

1. Front brake handle is mounted on the right side.

2. The brake is working well if backward movement of the brake handle is in the top 20-30mm.
3. Check if the tire rotation is good after releasing the brake lever
4. Contact the dealer for the need of brake maintenance.
5. The front brake lever is with parking feature as well. Use it when parking.

### **Rear brake inspection**

Check whether the rear brake installation is firm, the braking effect is valid.

The rear brake is mounted on the left hand, or on the right foot.

The brake is working well if backward movement of the brake handle is in the top 20-30mm or downward movement of the top of the foot brake lever 20-30mm.

3. Put the brake lever or foot brake lever back into place quickly and check if the tire rotation is good when the force is removed.
4. Contact the dealer for the need of brake maintenance.
5. Inspect the brake shoe regularly, and replace if timely when it is worn out as the brake shoe is a worn pieces of block.
6. Do not open the brake casually as the brake fluid will damage people's skin. Clean the skin with water of go to the doctor when it happens.
7. The rear brake lever is with parking feature as well. Use it when parking.

### **Battery check (if available)**

If the battery of this vehicle is maintenance free, check below.

1. Check whether battery joint is tight. If there is some part broken ,please change it.
2. Do not throw off the battery which resulting in environment pollution.
3. Do not charge the battery until it is out of power.
4. When the vehicle placed for extended period of inactivity, check the electric quantity every 3 weeks. Charge it when below 12V.
5. When charging, using or placing the battery, do not put it upside down.

If use water battery: Check battery electrolyte level, if the electrolyte level low, add distilled water.

Check the battery if work well or not, if necessary, should replace a new battery.

### **Tool bag inspection**

Check whether tool bag is taken every time before riding.

The tool bag is equipped with some professional tools. You can use time when in need.

### **Self-protection inspection**

Self-protection inspection is the guarantee of pleased driving and life safety. Please wear the protective clothing correctly to ensure your safety.

Protective clothing consists of these parts below:



### Important!

Every check and inspection step above is necessary, there is danger existing when driving. Please conform the above process before driving, and operate in accordance with the standard strictly when driving will protect your and life safety. The warning sticker put on the surface of vehicle includes important safety information. User must comprehend fully and act strictly. It will cause the extreme injure and even death, if not carefully checking or executing.

## DRIVERS MUST

**Fuel:** Fuel compartment confirm the adequacy of fuel.

**Warning:**

Do not add fuel tank under drive. Otherwise, in the subsequent heating and fuel inflation, the fuel will overflow.

Fuel spillage should be avoided in the hot engine.

Recommended fuel: 90” Petrol

Total: 7.5L

**Oil:** Oil confirm whether oil at the designated place.

1. The maximum oil lever.
2. The lowest of oil.



## TIRES

1. Tires pressure

Before use the vehicle, should always check and adjust the pressure. (Tires Barometer)

2. Tires inspection

Before use the vehicle, should always check the tires, if excessive tire wear, to be replaced.

**Warning:**

Use of the tire wear is dangerous to travel.

	Size	Max Pressure
Front tire	19*7-8	24PSI
Rear tire	18*9.5-8	24PSI

Tires and Hub maintain: Check tire tread depth regularly. It must be noted that the shallower the tread pattern, the worse the tire's grip.

After the puncture, it is necessary to stop the car as soon as possible and remove the tire and check it.



Tire repairs should be carried out by professionals.

Deformed or damaged wheels should be replaced.

Change tire: Replacement tires and hubs must match the model specifications specified by the vehicle manufacturer.

Considering safety car performance and height from the ground, the model number should remain unchanged during tire replacement unless prior consent from the tire or vehicle manufacturer is obtained.

If do not know the previous use of old tires, you should not install old tires.

Tires Deterioration: Even if the tire has not been used or is used only occasionally, tire aging is inevitable. Tire aging is mainly reflected in the cracking of tread lines and sidewalls, sometimes accompanied by carcass deformation. Tire professionals should check old and worn tires to determine if they are suitable for continued use.

Tyres are the only link between vehicles and roads. The safety of various driving conditions depends on the relatively small area of contact with roads.

Tire gauge (optional): Manufacturer will provide to customers to measure tie pressure.

Tire gauge is put on the key ring of the key switch for users' convenience.

Measure method: Unscrew valve cap , then press it toward the valve cap with tire gauge. The measured value is tie pressure. Put back the valve cap and screw it after measuring. .

## IMPORTANT ELEMENTS OPERATION AND RIDES

### Cold Start and engine preheating

**Note:** This vehicle has been designed to control the operation with brake as motor starter switch. Only after pinch engine brake handle on, then to start. We had closed choke before delivery.

1. The ignition switch turns to the "ON" position.
2. The fuel valve turns to the "ON" position.
3. Pull the choke lever out a position to the max.
4. Hold on the handle brake or step on the rear brake pedal. (launched in order to prevent the vehicle forward)
5. Press the start switch.
6. Push the choke lever back to the original position.

**Note:** If the engine can not been started, should release starting switch, wait a few seconds, then try again. Each attempt, as far as possible in a short period of time in order to protect the battery. Each start, not to exceed 5 seconds when the engine can not been started.

**Note:** In order to achieve maximum engine life, before moving, engine should always be preheated. Not on a Cold-engine acceleration.

### Hot engine starter

When the engine has been preheated, then you do not need to pull the choke lever.

### Riding

Before driving, please review the safety driving way and its importance.

1. Pay attention to the brakes working condition always.
2. Driving with only one hand is dangerous and forbidden.
3. Turn the throttle slowly. Never turn it suddenly.
4. Release the throttle and use the brake, to make it slow down.

5. Make sure both the front brake and the rear brake work at the same time when braking. Never force too hard, that will reduce the working life of the brakes.
6. Do not make dangerous movement while driving to ensure safety.
7. Inspection the condition of the ATV make sure everything is ok for riding. When riding in a rugged or lean road, please must pay attention to the safely of the environment, you must ride it in a safely place which is under a professional person's supervise and the environment is made for riding the ATV. please slow down the speed, do not exceed 20km/h, do not turn over the ATV. this is important to wear all the protection equipment.

### **The acceleration engine**

Because the vehicle use Automatic clutch, so acceleration only needs to control the throttle on the right handle. Add the power on the right hand thumb, increase speed, deceleration is loosened.

The commissioning engine

0-1000km from the motorcycle mileage during your lift is very important for the period. Because the engine is new and in the mean time we must avoid prolonged Full Throttle or any situation that could be the super-engine overheating.

0-15km:

Operation and avoid prolonged refueling over 1/4 throttle position. An hour after the operation should cease engine to cool 5-10 minutes.

150-500km:

Operation and avoid prolonged refueling over 1/2 throttle position. At any time, should not be sued Full Throttle operation of this vehicle.

500-1000km:

Full throttle operation should be avoided. Avoid ultra-high-speed engine work.

Note: When traveling to 300-500km, the oil must be replaced, as the vehicle had not been installed Odometer to estimate mileage which can only be calculated.

### **Brakes**

When there are obstacles in the front (pedestrians, vehicles, goods), in order to break, security measures must be taken. Divided into braking deceleration, parking brake and emergency brake.

1. The braking deceleration

Release the throttle lever, and gently hold the rear brake lever with left hand, the rear brake is in action, the vehicle speed will decrease until the vehicle stops. You can hold both front and rear brakes to decrease the speed.

2. Parking brake

Hold the front brake lever firmly and turn off the engine. Parking brake plate is used to prevent from slipping of itself.

Method: Firstly hold right brake lever. Then press down parking brake plate to achieve parking brake.

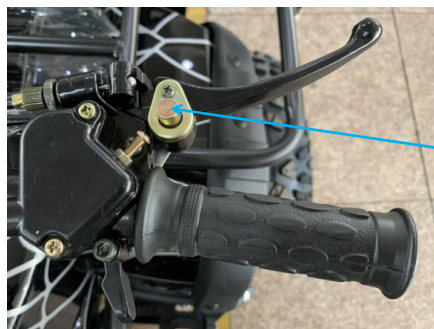

Parking brake plate

### 3. Emergency brake

Emergency braking is in the face of unexpected emergency situations, in order to avoid incidents taken braking, then minded response to fast and cool. Followed by throttle, the rear brake, and brake before the vehicle stopped and hit. These orders and spacing is necessary also to science. These moves are very short interval of time which are almost at the same time.

### Parking

1. Turn back the throttle and brake at the same time.
2. Turn the key to "OFF" position when the vehicle stops, then take out the key.
3. Parking brake function is recommended at this moment to avoid sliding.
4. The fuel valve turn to "OFF" position.

Warning: Because after running and exhaust muffler is very hot, vehicles should be parked in child care and other not likely to encounter places.

## REGULAR MAINTENANCE AND MINOR REPAIRS

Periodic inspection, emphasize peace and lubrication, the vehicle will be at the best and most effective work state.

Unprofessional person may not understand the large information of this part. So" Training "will not explain in details .For more details ,please contact local retailer.

Necessary maintenance is the important guarantee to keep the vehicle in good condition. Please maintain the vehicle according to time list.

Note: If you are not familiar with this vehicle maintenance services, the work should be operated in maintenance station.

Maintenance time list (Please do operate strictly according to maintenance list)

We propose that these items should be operated in repair station for maintenance services.

	First week	30days after driving	Each year
Fuel System	I		
Throttle		I	
Air filter		C	
spark plug		I	
carburetor	I	I&C	
chain	I&L	I&L	
Brake pads			
brake system	I	I	I
Nuts and bolts	I	I	
Tire	I	I	I
Steering system			I
suspension system		I	I
Battery (if available)		I	

When something wrong with the ATV, please inspection according to above maintenance list first. If not working please contact with local dealer to get help. If accident happen, please do not drive the ATV, please contact with local dealer or after sales department to get help or repair.

**Engine maintenance:**

**After every driving, please close the switch of carburetor and oil-way. Release the rest oil. This is very important. If not do it accordingly, the vehicle will not be easily started after it has been placed for a long time, or carburetor will leak.**

**Parts/Fasteners**

Prior to the use of the vehicle, should always check with the parts and fasteners tight degrees. We suggest that these projects should be carried out irregular inspections. After demolition of the self-locking nut, please replacement the self-locking nut as the use of safety request.

Correspondence tables fastening torque.

Screw size	Tightening torque N.M	Standard torque N.M	Screw size	Tightening torque N.M	Standard torque N.M
M5	4.5-6.0	5	M10	37-39	60
M6	8-12	9	M12	73-115	99
M8	16-26	23	M14	146-205	180

**Engine Oil**

**1. The measurement of oil.**

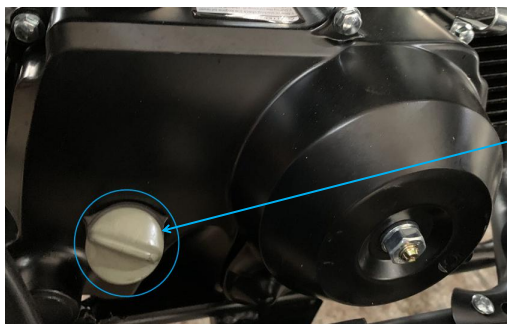

Oil measurement

1.1 Engine preheat minutes.

1.2 When the engine stopped operating, hold on a few minutes later, the oil Cyprits will be removed after the oil-observation.

1.3 The oil should be located at the highest and lowest among the oil-mark. If the oil level is low, should be enough oil to rise it into the oil-appropriate.

**2. Oil and oil filter replacement.**



Release oil bolt

2.1 Engine preheat minutes.

2.2 Engine stop operating.

2.3 Discard release oil bolts, release oil. Release oil may moderate sharking the impurities from the inside body of the engine.

2.4 Installed release oil bolts, and then full of engine oil.

- Starting engine and a few minutes to preheat. Preheat should check whether there are oil spills. If it appears oil spill, should immediately stop engine and check reasons.

- The replacement of oil in the second about 3 months or so to clean oil filters.

Warning: Do not join any chemical additives.

### Carburetor adjustment

Carburetor is a key part of the vehicle, the need for fine adjustment. Most adjustment should be entrusted with the expertise and experience repair shops.

### Idle adjustment

Engine Speed adjustment is through the idle screw on the carburetor, it is preset before sold out.

Warning: It is prohibit to adjust the idle screw. The adjustment should be entrusted with the expertise and experience repair shop if necessary.

### Air filters

Filters should carry out regular checks, cleaning if necessary, replaced.

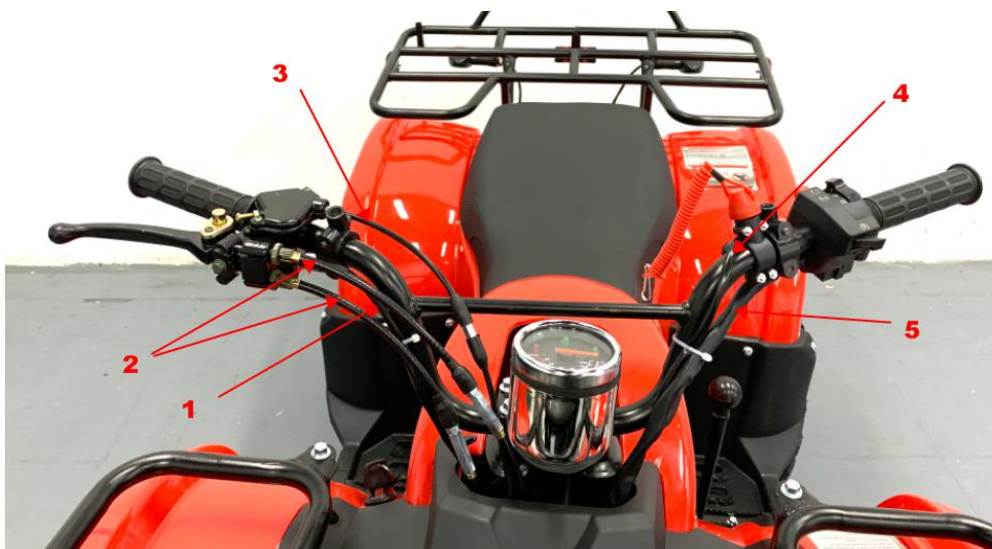

1. Power start protect cable
2. Front brake cable
3. Throttle cable
4. Emergency stop cable
5. Multi-function switch cable

### The throttle cable adjustment

Free trip: 3 to 7 mm

1. Loosen lock nut.

2. Through rotational regulator to adjust throttle cable, it can adjust throttle right hand free trip.

## The front wheel brake adjustment

Free trip: 10-15mm

1. Loosen lock nut
2. Rotation cable length regulator. Screw into the appropriate state.
3. Tighten the lock nut.

When the brake handle can not be used as appropriate requests, please commissioned repair shop to adjust brake cables.

## Spark plug inspection

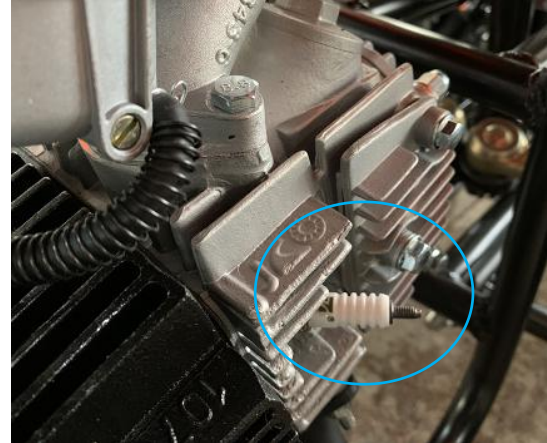

Clearance: 0.6~0.7mm

Torque: 12.5N.M

The spark plug is an important engine parts, if broken, replace a new one.

Do not attempt to self-diagnosis of any fault, and should send the ATV to repair shop.

## Throttle limited parking function

Please use parking button when you are parking.

1. Fasten front brake
2. Press parking button

Throttle limited nut: 1-Adjust screw 2-Lock nut 3-parking button

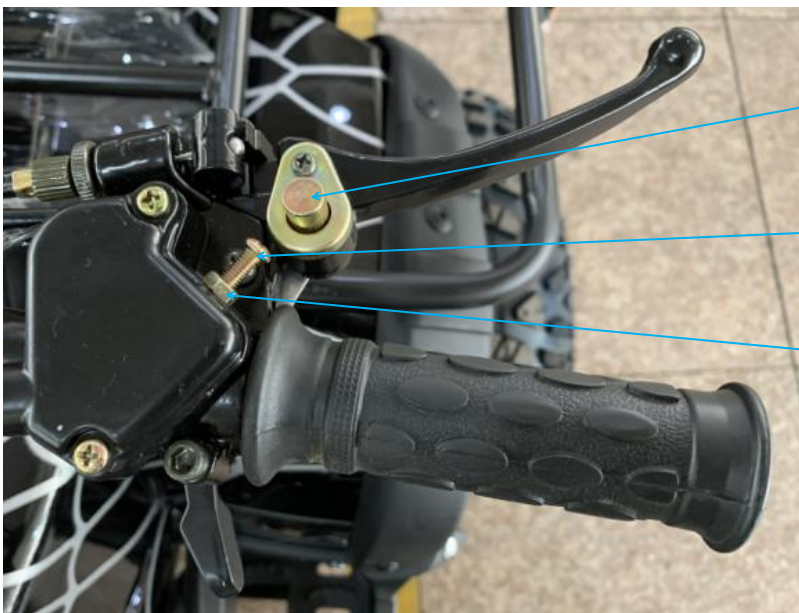

Parking button

Adjust screw

Lock nut

## Driving chain relaxation of inspection

Note: Rotation wheel several times to identify the most compact location of the chain. When the chain in the most compact position, check or adjust chain relaxation. The normal relaxation of 10 to 15mm. If relaxation beyond 20mm should be adjusted.

## The drive chain adjustment

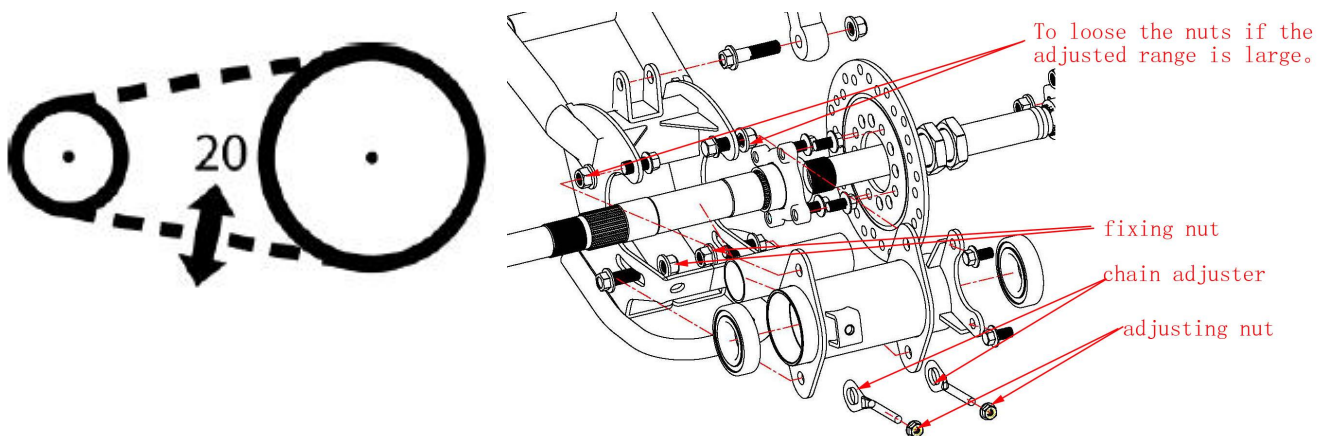

Use the index finger, to press lightly the middle position between power output sprocket and rear sprocket. The best condition should be pressed 10mm to 15mm. If it is not in this range, please adjust the chain adjuster. (Please note: The chain adjuster should be adjusted at the same time to ensure the balance of both side). To loosen the fasten nuts of chain adjuster first, and then unscrew or screw nuts to be best condition. Finally, make the nuts of chain adjuster screwed .

## The drive chain lubrication

The chain includes many mutual operation of the parts. If the chain would not carry out proper maintenance, the chain that will soon wear. Therefore, we must carry out regular maintenance of the chain. In this dusty region riding vehicle, the more maintenance is necessary.

1. May use any brands of spray-chain lubricant. First, the use of brush or cloth to remove all the dirt and mud masonry. Then two rows of siding between the center and all spraying lubricant on the roller.
2. For cleaning chain, will be removed from the board, the baptist in solution should be done as far as possible for the removal of masonry scale. The chain removed from the solution and make it dry. The chain lubrication will be carried out immediately to prevent corrosion.

## Battery

Check the batteries battery electrolyte level, and recognizing the terminal and the wiring of the battery casing is not leakage. If the electrolyte level low, add distilled water.

Note: The battery electrolyte checks at least once a month.

Warning:

Use batteries to be recharged in 30 minutes and cooled to room temperature to ensure the proper use of batteries. Battery electrolyte toxic and therefore dangerous, and so will cause serious burns. The electrolyte contains sulfuric acid. Avoid contact with skin, eyes or clothing.

Battery would have exploded gas, should stay away from sparks, flames, cigarettes, and so on, in or rechargeable battery scaled in a space, ventilation should be maintained. Near the battery should always work to protect your eyes.

Should be placed in child care could not get places.

If the battery of this vehicle is maintenance free, check below.

1. Check whether battery joint is tight. If there is some part broken ,please change it.
2. Do not throw off the battery which resulting in environment pollution.
3. Do not charge the battery until it is out of power.
4. When the vehicle placed for extended period of inactivity, check the electric quantity every 3 weeks. Charge it when below 12V.
5. When charging, using or placing the battery, do not put it upside down.

**The replacement fuse**



1. Fuse at the top of batteries
2. If the fuse comes break point fire switches and circuit switching problem. With the correct installation of the new ampere fuse. Connect the switch and watch the work of electrical installation of the new ampere fuse. Fusing immediately again if use new fuse, please contact repair shop.

Warning:

Do not use the fuse higher than the recommended ampere rating. Use not correct rating, the fuse will cause large-scale damage to electrical system and will cause the fire.

Provides fuse: 5amps

**WARNING:**

If you are not qualified ,it is better not to perform maintenance yourself , or you may damage your vehicle .The engine stop switch is usually on the “off” position unless the engine be running to perform the required maintenance . Keep ATV far away from children when you do maintenance to avoid injury.

**Common problem**

Problem instance	Reason		Solve way
	1. No mixed gas in Cylinder	A. Leaking for intake system	Screw down on sealed point
		B. Oil way plugged up	scatter
	2. Heap fuel in cylinder		Open spark plug. Clean fuel.
	3. Fuel has water or dirty		Clean fuel tank, carburetor, change fuel
	4. Cylinder compression low	A. Spark plug leaking	Screw down spark plug
		B. Leaking on the sealed point between	Clean it , install gaskets, screw down



Hard start or couldn't start		cylinder converse and cylinder body	nut
		C. Crank case leaking	Renew crank case or sealed glue of crank case
		D. Piston ring or cylinder body wear and tear heavy	Renew piston ring or cylinder body
		E. Piston ring broke off or block	Renew piston ring or clean it
	5. Exhaust block	Exhaust of cylinder or vent-pipe is dirty	Clean it
	6. Mixed gas is thick or thin		Adjust carburetor
	7. Spark plug problem	A. Spark plug is dirty	Clean it with gas
		B. Insulator of spark plug broke	Renew spark plug
		C. Space of spark plug is too big or small	Renew or adjust
	8. Magneto problem	A. Low-press wire is short circuit or turnoff	Find, repair or renew
		B. Ignition broke	Renew
		C. Ignition coil	Renew
	9. No enough battery (hard start)		
10. Foot start couldn't work		Repair or renew	
11. E-star	Rotor of E-starter couldn't work	Renew	
12. Other device couldn't work		Check and Repair	

Problem instance	Reason	Solve way
Engine couldn't work	1. Fuel couldn't feed (circuit block up)	Check oil switch, carburetor etc., repair it
	2. Break off	Check wire from spark plug to magneto
	3. Cylinder broken heavy, piston dead	Repair or renew
	4. Join bearing dead	Repair or renew
	5. Other device couldn't work	Check them, repair or renew
Engine power is not enough	1. Circuit block up	Scatter
	2. Ignition time is fast or slow	Adjust
	3. Spark is weak	Check it from spark plug to magneto
	4. Mixed gas is thick or thin	Adjust carburetor
	5. Engine leaking	Check, repair
	6. Vent-pipe block up	Scatter

	1. Spring of suspension break off	Renew
	2. Suspension bend	Renew
	3. Suspension leaking	Renew
	4. Bearing of wheel broke	Renew
	1. Parts of director handle is tight or loose	Check them
	2. Tire pressure is not enough	Check them
	3. Frame, suspension install is improper	Install again and adjust
	4. Axes is easy to move	Adjust
	1. Shoes of rear brake wear and tear heavy	Renew
	2. Brake cam wear and tear	Renew
	3. Front, rear brake pull cable broke	Renew
	4. Space of front, rear wheel is too much	Renew

## CLEANING

1. In order to keep the vehicle clean and protect the surface appearance of the painting, electroplating, should regularly or irregularly do its cleaning. When cleaning, use of external surface water irrigation, rush soil, use a soft cloth or sponge dip cleaning liquid bubble gently cleans the outer surface, to avoid residual gravel surface dip cleaning liquid bubble gently cleans the outer surface, to avoid residual gravel surface and paint scratches electroplating layer. Finally reuse water for irrigation.

2. After every riding, the driver should clean the vehicle. Then place it on flat ground to clean, and then check.

2.1 High pressure air or water will harm the vehicle.

2.2 Do not splash water on these parts: key switch, cables, below cushion, the exhaust pipe muffler exports, air filter inlet and battery.

2.3 Generally, to wash the vehicle with clean water..

2.4 Do not turn on the key switch immediately after cleaning.

2.5 Chain should be daubed with lubricating grease.

For less performance inspection, confirmed properties normal traffic could resume normal. After the vehicle wash thoroughly dry and then start engine, running for a few minutes. Finally repeatedly braking performance standards so far.

Special note: In the hot engine, the first will not wash engine room temperature with the same question again when cleaning. If water pressure caused the brake, the former damping seals and electrical parts loss.

# STORAGE

If the park does not need to use a long time, in order to maintain a good state of the vehicle, you please address the following methods.

1. Select the right parking place. The location should have security, ventilation, moisture-proof, anti-freezing conditions.
2. For engine lubricants.
3. In the fuel tank and the carburetor fuel release all net, oil stored properly. Note: Do not overlook the release carburetor net residual oil, otherwise, no need for a long time, the surface of the plastic fuel carburetor of holes to plug, re-use of the vehicle when trouble.

Warning: Volatile fuel in the fuel emissions, the engine must be stopped operating in the ventilation good place to prohibit smoking ban on the use of open flame and sparks objects.

4. In order to prevent cylinder rust, we should adopt the following measures:

Remove spark plugs. A spoonful (15-20ml) from the clean engine oil into the cylinder spark plug hole with a piece of cloth from top to bottom, so that the oil in the cylinder wall will on the cloth. Finally, install the spark plugs and spark plug cap.

5. Battery demolition down, stored in antifreeze, sunscreen, and other items collision difficult places. Every two weeks an additional charge.
6. Wash and dry your vehicle, paint waxing to all, to all chrome painted on the surface anti-rust oil.
7. To inflatable tires, tires pressure up to the required standard air pressure. After stooping the vehicle will be good, with shelves or pieces of wood and other wheels will be boosted so that the wheel does not contact with the ground.
8. Will cover the vehicle to prevent the dust down, do not use plastic sheeting to things such as gas-tight coverage, as these are for the mechanical vapor corrosion.

## Transport

1. Vehicles should be solidly fixed on the transporters, there should be effective rain preventing measures, without bumps and damaged phenomenon happen.
2. The packing carton shall not be tilted on the way of delivery.
3. Handling with care.

## After storage the re-use

1. Remove the guards cover the car, clean the body, if placed more than four months, the need for replacement of engine oil.
2. The battery will be sufficient to re-install on board
3. Add fuel to the fuel tank.
4. All of the pre-inspection lane.

Before traveling during the next regular session, a choice open, pedestrian areas.`

# INSTALL PROCESS AFTER UNPACKING

## Open the box and take out all the parts

Place packing box on the flat ground, then open it.(with the scissors or cutter)

Use 10# open-end wrench and 6# allen wrench to apart the packing metal.

## Assembling guide

1st step: Please install steering linkages, tighten nut with 25N.m force, and adjust the balance of the left and the right.

2nd step: Please install rear shock absorbers, and tighten nuts on both sides with 25N.m force.

3rd step: Please install the front tires (make the tread pattern and cycle valve outside),and tighten nuts with force between 35N.m ~ 45N.m.

4th step: Please install the rear tires (make the tread pattern and cycle valve outside),and tighten nuts with force between 50N.m ~ 60N.m.

5th step: Please install handlebar (adjust to proper angles), and tighten nuts with force between 15N.m ~ 25N.m.

6th step: Please install bumper and accessories, and tighten nuts with force between 15N.m ~ 25N.m. Connect battery cables. When you connect battery cables, electric lock is in the state of "OFF" . Positive first, then negative.

Disassemble is opposite.

## Tool kit

You are provided a tool kit for the convenience of inspection and maintenance as well as testing tire pressure . Included are some general tools ,such as spanner ,box wrench and tire pressure gauge . The tool kit is in a box packed together with ATV.

If you fail to understand the instruction, please contact with the local retailers and get professional confirmation after installation.

**Loading Adjustment** (This step should be checked regularly to ensure safety and convenience):

Check the toe-in of front tire, make sure the front center distance is 5-10mm shorter than the rear center distance.

Make sure the connection is ON, and no part is OFF. So vehicle can be started at anytime.

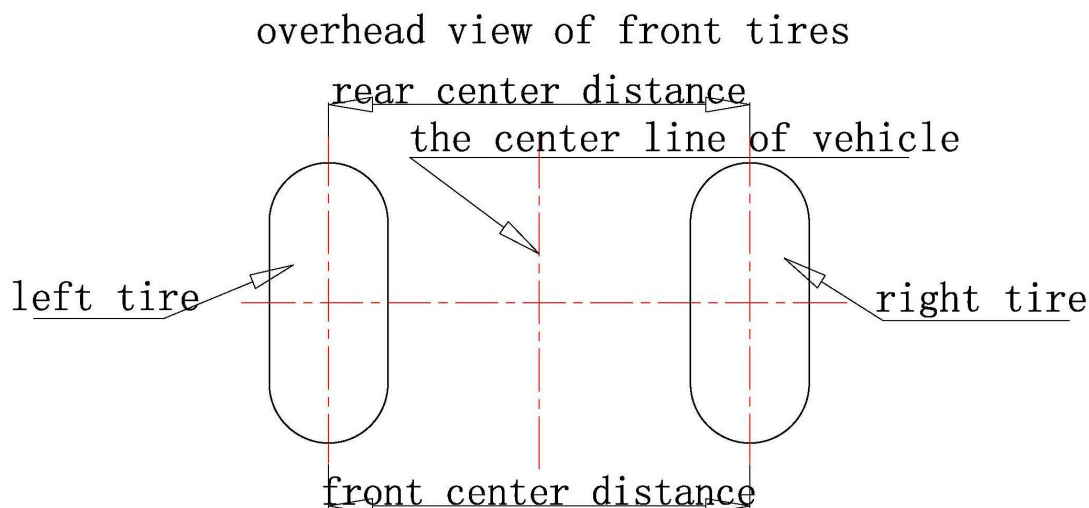

## VEHICLE MAIN SPECIFICATION

PRODUCT NAME	ATV	PRODUCT MODEL	LMATV-125HM
LENGTH X WIDTH X HEIGHT	177*100*106cm	BORE×STROKES	52.4*55.5mm
WHEEL BASE	111cm	GROUND CLEARANCE	12cm
FUEL TANK CAPACITY (L)	7.5L	RATED POWER Kw(r/min)	6.0KW/7500r/min
THE WEIGHT OF FULL FURNISHMENT (Kg)	114	MAXIMUM TORQUE N.m(r/min)	8.0 N.m/6000r/min+-500
RATED LOAD QUALITY (kg)	120	Max speed (Km/h)	55
FRONT/REAR SHOCK ABSORBER TYPE	DUAL/SINGLE SHOCK ABSORBER	SEAT HEIGHT	67cm
FRONT/REAR BRAKE OPERATE TYPE	F: DUAL DRUM BARKE R: SINGLE HYDRAULIC DISC	STARTING MODE	ELECTRIC START
FRONT/REAR BRAKE OPERATION MODE	F: BY HAND R: BY FOOT	IGNITION MODE	C.D.I
FRONT/REAR TIRE SPECIFICATION	F:19X7-8 rubber tire R: 18X9.5-8 rubber tire	DRIVE MODE	CHIAN DRIVE
MIXTURE RATIO OF FUEL OIL &LUBRICANT OIL	/	LUBRICATION MODE	PRESSURE & SPLASH LUBRICATION
FRONT/REAR TIRE RIM TYPE	F: STEEL WHEEL R: STEEL WHEEL	COOLING MODE	AIR-COOLED
FUEL BRAND	≥90#	BATTERY	12V 6.5Ah