





A subsidiary of CELLTREAT Scientific Products

You may have noticed a new logo on the front of this catalog. That's right, in early 2022 CELLTREAT® Scientific Products acquired VistaLab™ Technologies, Inc. By combining the strengths of the two companies, we have worked to establish a single, enhanced source for high-quality products with an expanded distribution network. What this means for you is access to even more unique and innovative products combined with the CELLTREAT service levels you have come to expect. Celebrate 15 years with us and experience the CELLTREAT difference!

www.celltreat.com - Visit us on the web and save time!

We make it easy for you to access all of the information you need in one central location:

- Expanded resources and product information
- Request a Quality Certificate (COC/COA)
- Request product samples
- Current CELLTREAT news and promotions
- Contact us
- Mobile & tablet optimized

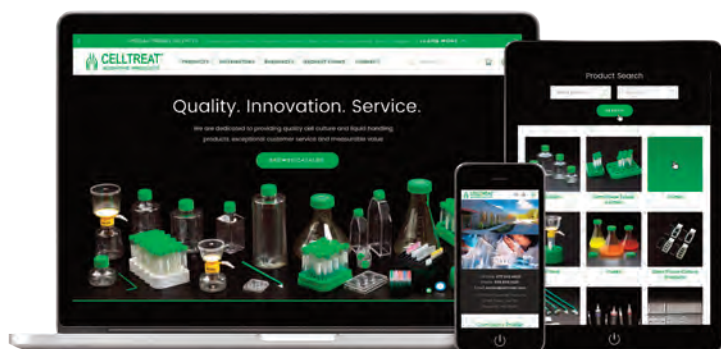

Product Certification & Material Indicator Symbols

For information about product sterility, material type, and certifications, please consult the reference table below and product tables on each page.

Symbol	Product Certification Indicator
AF	Product is Animal Free
S	Product is Sterile
N	Product is Non-sterile
R/D F	RNase/DNase Free
NP	Non-pyrogenic: Validated to have less than 0.1 to 0.5 EU/mL*
USP	Meets USP Class VI Certification Standards
A	Autoclavable**
Symbol	Product Material Indicator
ABS	Acrylonitrile butadiene styrene
GLS	Optical grade glass
HDPE	High Density Polyethylene
LDPE	Low Density Polyethylene
PC	Polycarbonate
PET	Polyethylene terephthalate
PETG	Polyethylene terephthalate, glycol modified
PP	Polypropylene
PS	Polystyrene
TPE	Thermoplastic elastomers

Product Certification and Material Indicator Symbols located in the black heading bar of each product table are included as a quick reference for ordering. Complete product and lot specific quality certificates are available through the CELLTREAT website - www.celltreat.com

Please refer to the table for the product specifications, primary materials and their indicator symbols.

* Limit varies by product. Please contact CELLTREAT for specific limits.

** Polypropylene Centrifuge Tubes are autoclavable. HDPE caps may be autoclaved at lower temperatures and should be inspected prior to use.



TREAT YOUR CELLS

Experience the CELLTREAT Difference



TREAT YOUR SHELF



CELLTREAT Unique & Exclusive Products



CELLTREAT has many products and features that are unique or exclusive to CELLTREAT Scientific Products and VistaLab Technologies. We have made it easier for you to find these items - look for this pink flask/check symbol throughout the catalog!



VistaPoint Program!

Look for this symbol on MLA & Ovation Pipette Tip pages for VistaPoint eligible products (see pages 12, 13, 16) See below for full details on the VistaPoint Program

VistaPoint Program



Cool swag coming soon!



EARN FREE CALIBRATION AND REPAIR SERVICES!

Collect VistaPoints on every case of VistaLab Pipette Tips

It's as easy as 1, 2, 3!

- 1 Buy VistaLab pipette tips and look for the sticker inside every box
- 2 Save stickers and login to My Account to register VistaPoints - they are automatically converted to credit for Calibration & Repair services
- 3 Redeem your points on any type of calibration and/or repair order during checkout



Visit www.celltreat.us/vistapoint for full program details or scan the QR code above

The CELLTREAT Difference

Treat Your Cells

Trust our oath to fuel your cell growth

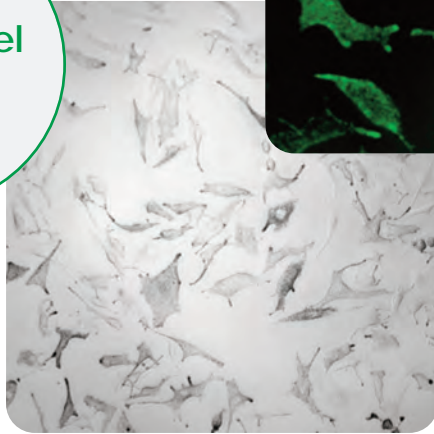

- ▶ Consistent performance and high quality ensures our products exceed your standards
- ▶ Request a free sample to experience it yourself

- ▶ Maximize your savings with CELLTREAT's lower list pricing
- ▶ Stack your savings with free cases when you redeem CELLTREAT promotions



Save on supplies no matter your size

Treat Yourself

Buy with ease from whom you please



- ▶ However you buy, we have a way that works for you
- ▶ No matter where you're located, our large distribution network has you covered

The CELLTREAT Difference

Products designed to save you time

Now even more options with VistaLab products!



- ▶ Work faster and easier
- ▶ Improved product and packaging designs



You get better service because mastering the details is JUST WHAT WE DO!



At your door when you need more

- ▶ Higher levels of stock
- ▶ Faster turnaround times
- ▶ Extensive shipping knowledge

Treat Your Shelf

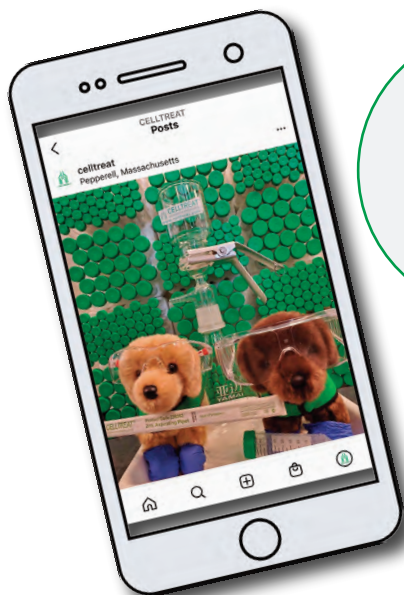

Your lab gets more, what a score!



- ▶ Expect the unexpected; feel delighted by choosing CELLTREAT
- ▶ Reward yourself with free cases, product samples, and bonus items

Pipette Tip Selection Guide



EASILY FIND YOUR PERFECT TIP!

Use the color coded bars on the sides of the pages

UNIVERSAL FIT PIPETTE TIPS



- Compatible with the major brands of universal fit pipettes
- Low retention surface treatment delivers high performance with exceptional value
- Available in a full range of volumes, both with and without filters
- Select from several packaging options; racks, reload systems, bulk bags
- See universal fit adjustable pipettes on page 17

LfTS FIT PIPETTE TIPS

- Compatible with popular Low-force Tip Solution (LfTS) pipettes
- Designed to provide a low-force tip solution for a more comfortable pipetting experience
- Available in 3 volumes (10 μ L, 200 μ L, 1000 μ L), all with or without filters
- Packaged in sterile racks with hinged lids

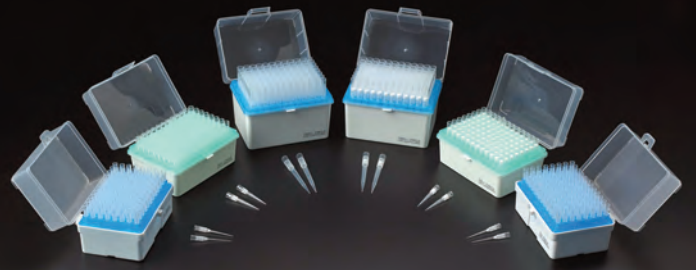

MLA & OVATION PIPETTE TIPS



- Compatible with VistaLab MLA and Ovation pipettes
- Perfect fit "click-tips" ensure performance and reliability every time
- Available in a full range of volumes for all MLA and Ovation pipettes, with and without filters
- Many packaging options and rack configurations to choose from
- See Ovation and MLA pipettes on pages 14-16, 18-19

PIPETTE TIP SELECTION GUIDE

	CELLTREAT Universal Fit Pipette Tips and Equipment
	LfTS Fit Pipette Tips
	VistaLab Perfect Fit Tips for use with VistaLab MLA and Ovation Equipment

Universal Pipette Tips

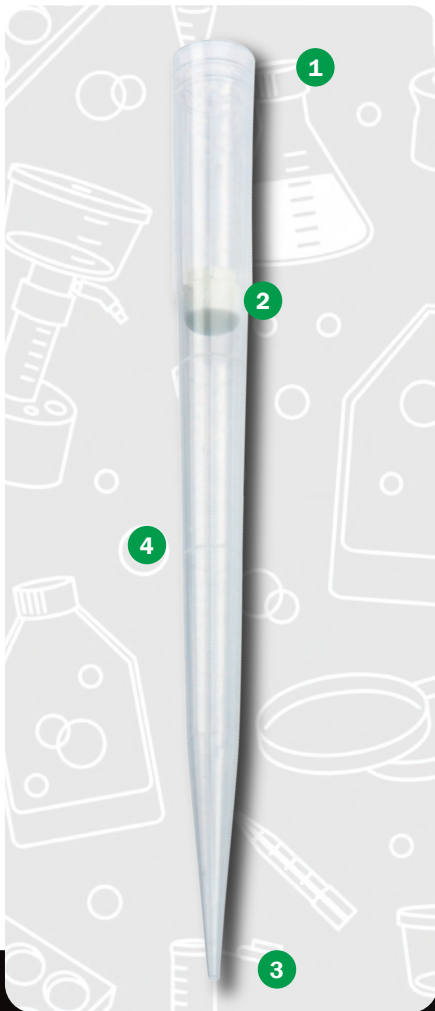

SUPERIOR LOW RETENTION & FINE TIP!

- CELLTREAT Scientific Products Pipette Tips deliver high performance with exceptional value. A perfected balance between raw materials and efficient manufacturing processes results in superior low retention
- Pipette Tips have smooth, hydrophobic surfaces to ensure accurate pipetting
- Multiple Pipette Tip sizes are available, including extended length tips (10 μ L and 1000 μ L) to allow better access to the bottom of test tubes, reagent bottles, flasks and other vessels
- 200 μ L filter tip is longer than standard tips for better access to vessels and increased headspace to filter
- Pipette Tip racks feature hinged lids that are designed for easy one-handed opening, making it easier to access repeatedly

- 1 Pipette Tips are universal fit and compatible with major pipettes
- 2 Filters reduce cross contamination and prevent aerosols from penetrating into the pipette, and are positioned to allow extra headspace when pipetting maximum volume
- 3 Fine tip for improved accuracy and precision
- 4 Molded volume reference markings offer a quick double check opportunity















UNIVERSAL FIT PIPETTE TIPS



Universal Pipette Tips

PIPETTE TIP SELECTION GUIDE

UNIVERSAL FIT PIPETTE TIPS

Tip Size	Low Retention	Low Retention, Filter
10µL	 229032	 229015
10µL Extended Length	 229033	 229016
20µL		 229017
100µL		 229018
200µL	 229034	 229019
300µL	 229035	 229020
1000µL	 229036	 229021
1000µL Extended Length	 229037	 229022

PIPETTE TIPS IN RACK - LOW RETENTION

AF, S, R/D F, NP, USP, A, PP

Part No.	Product Description	Low Retention (Y/N)	Filter (Y/N)	Pack Description	Qty/Case
229032	10µL Pipette Tips	Y	N	96 Tips/Rack	960
229033	10µL Extended Length Pipette Tips	Y	N	96 Tips/Rack	960
229034	200µL Pipette Tips	Y	N	96 Tips/Rack	960
229035	300µL Pipette Tips	Y	N	96 Tips/Rack	960
229036	1000µL Pipette Tips	Y	N	96 Tips/Rack	960
229037	1000µL Extended Length Pipette Tips	Y	N	96 Tips/Rack	960

PIPETTE TIPS IN RACK - LOW RETENTION, FILTER

AF, S, R/D F, NP, USP, PP

229015	10µL Pipette Tips	Y	Y	96 Tips/Rack	960
229016	10µL Extended Length Pipette Tips	Y	Y	96 Tips/Rack	960
229017	20µL Pipette Tips	Y	Y	96 Tips/Rack	960
229018	100µL Pipette Tips	Y	Y	96 Tips/Rack	960
229019	200µL Pipette Tips	Y	Y	96 Tips/Rack	960
229020	300µL Pipette Tips	Y	Y	96 Tips/Rack	960
229021	1000µL Pipette Tips	Y	Y	96 Tips/Rack	960
229022	1000µL Extended Length Pipette Tips	Y	Y	96 Tips/Rack	960

NEW 5mL & 10mL Universal Pipette Tips



UNIVERSAL FIT PIPETTE TIPS

- Sterile, accurate liquid transfer of larger volumes of media and solutions
- Universal fit is compatible with a range of popular pipettes
- More precise than serological pipets for volumes of 1 to 10mL
- 5mL tips have molded graduations, with 0.5mL increments

PIPETTE TIPS IN RACK - LOW RETENTION					AF, S, R/D F, NP, USP, A, PP	
Part No.	Product Description	Low Retention (Y/N)	Filter (Y/N)	Pack Description	Qty/Case	
229039	5mL Pipette Tips	Y	N	24 Tips/Rack	144	
229040	10mL Pipette Tips	Y	N	24 Tips/Rack	144	

Universal Pipette Tips - Bulk Packed

- Bulk, non-sterile pipette tips available in unique self-standing, resealable bags
- Tips are universal fit and compatible with major pipettes
- Pipette tips have smooth surfaces to ensure accurate pipetting
- Molded volume reference markings offer a quick double check opportunity
- Empty racks are available with a wafer to allow refill from bulk packed pipette tips (see page 10)

PIPETTE TIPS - BULK PACKED, NO FILTER			AF, N, R/D F, NP, USP, A, PP	
Part No.	Product Description	Pack Description	Qty/Case	
229042	10µL Pipette Tips	1000/Re-sealable Bag	5000	
229043	10µL Extended Length Pipette Tips	1000/Re-sealable Bag	5000	
229044	200µL Pipette Tips	1000/Re-sealable Bag	5000	
229047	1000µL Pipette Tips	1000/Re-sealable Bag	5000	
229049	1000µL Extended Length Pipette Tips	1000/Re-sealable Bag	5000	



Universal Pipette Tips - Reload System

UNIVERSAL FIT PIPETTE TIPS



- Reload System offers clear window for easy identification of color-coded wafers
- Support wafers have large grasping tabs for easy removal from Reload System and Rack
- Secure locking tab keeps reload system closed and prevents tumbling tips
- Reduce plastic waste and save time by refilling empty racks

PIPETTE TIPS - LOW RETENTION, RELOAD SYSTEM					AF, N, R/D F, NP, USP, A, PP	
Part No.	Product Description	Low Retention (Y/N)	Filter (Y/N)	Pack Description	Qty/Case	
229052	10µL Reload System	Y	N	960 Tips/Reload System	1920	
229054	200µL Reload System	Y	N	960 Tips/Reload System	1920	
229055	300µL Reload System	Y	N	960 Tips/Reload System	1920	
229056	1000µL Reload System	Y	N	480 Tips/Reload System	1920	
229057	1000µL Reload System, Extended Length	Y	N	480 Tips/Reload System	1920	

Universal Pipette Tips - Empty Racks

- Hinged lids are designed for easy one-handed opening, making it easier to access repeatedly
- Lids have a stacking feature for added stability and a secure locking tab
- Lightweight lid design prevents tipping when open
- Interior support ribs prevent racks from warping
- Empty racks available with or without a wafer; with a wafer allows refill from bulk packed pipette tips (see page 9), and without a wafer allows refill from pipette tip reload systems

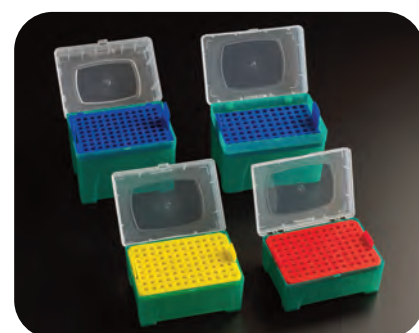

EMPTY PIPETTE TIP RACKS					AF, N, A, PP	
Tip Size	Color	Racks for Bulk Tips (Wafer Included)	Racks for Reload System (No Wafer Included)	Qty/Case		
10µL/10µL Extended Length	Red	229065	229060	20		
200µL/300µL	Yellow	229066	229061	20		
1000µL	Blue	229067	229062	20		
1000µL Extended Length	Blue	229068	229063	20		

NEW Low-force Tip Solution Pipette Tips (LfTS)



**COMPATIBLE WITH POPULAR
Low-force Tip Solution Pipettes**

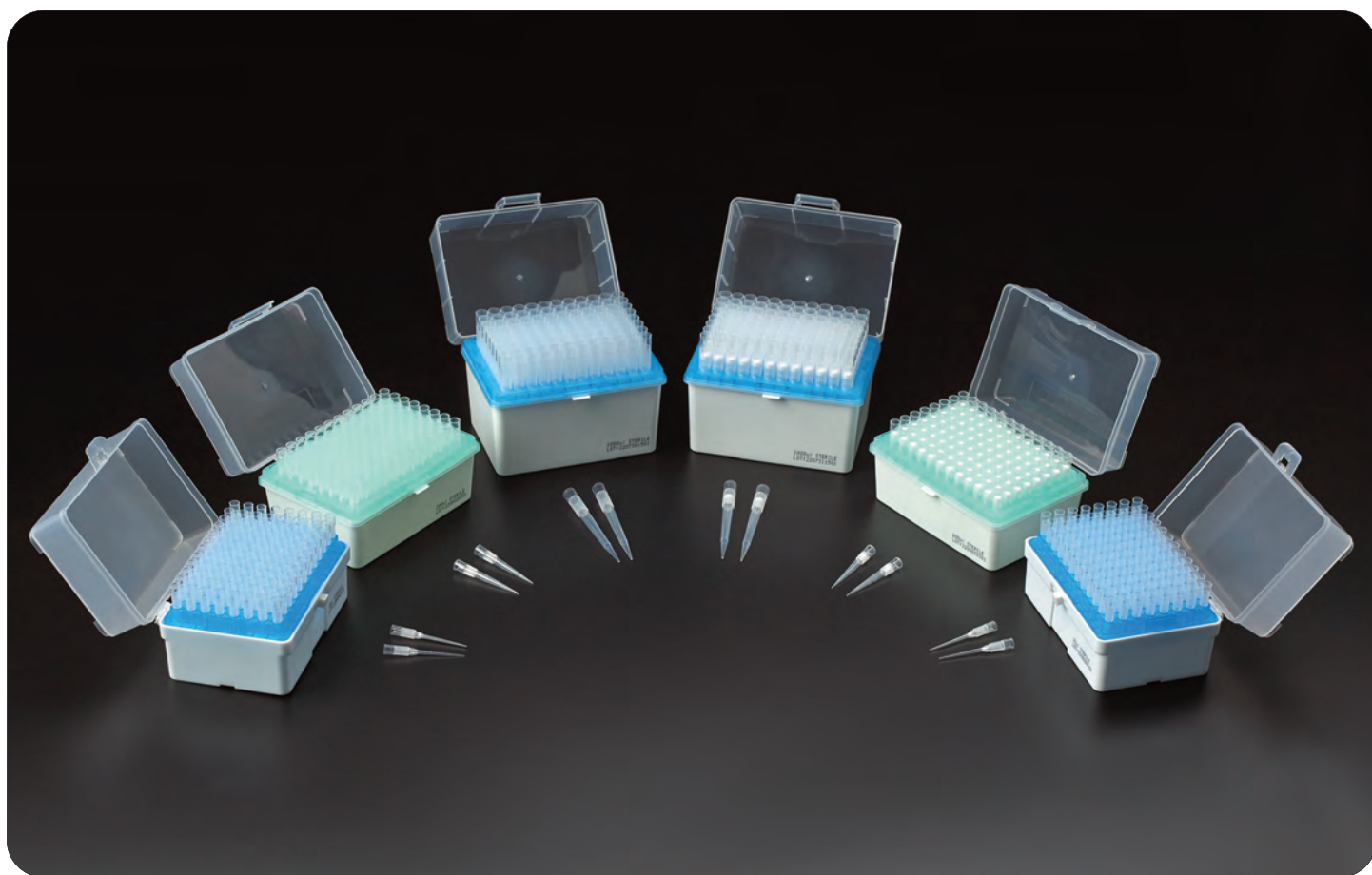

LfTS PIPETTE TIPS

- Designed to provide a low-force tip solution for a more comfortable pipetting experience; less force needed to acquire tips
- Pipette tips are packaged in racks with hinged lids designed for easy one-handed opening
- 10 μ L tips feature an extended length for easier access to the bottom of vessels
- Fine tip for improved accuracy and precision
- Filter tips are fitted with a polymer barrier to reduce the risk of contamination and prevent aerosols from penetrating into the pipette
- Lids feature stacking supports, and are removable to save bench space
- For universal fit pipette tips, please see pages 7-10

LfTS FIT PIPETTE TIPS - FILTER				AF, S, R/D F, NP, USP, PP		
Part No.	Product Description	Low Retention (Y/N)	Filter (Y/N)	Pack Description	Qty/Case	
229071	10 μ L Extended Length LfTS Fit Pipette Tips	Y	Y	96 Tips/Rack	960	
229072	200 μ L LfTS Fit Pipette Tips	Y	Y	96 Tips/Rack	960	
229073	1000 μ L LfTS Fit Pipette Tips	Y	Y	96 Tips/Rack	960	
LfTS FIT PIPETTE TIPS - NON-FILTER				AF, S, R/D F, NP, USP, A, PP		
229074	10 μ L Extended Length LfTS Fit Pipette Tips	Y	N	96 Tips/Rack	960	
229075	200 μ L LfTS Fit Pipette Tips	Y	N	96 Tips/Rack	960	
229076	1000 μ L LfTS Fit Pipette Tips	Y	N	96 Tips/Rack	960	



- Precision engineered to maximize the exceptional performance and benefits of Ovation and MLA pipettes for a superior, ergonomic pipetting experience
- All VistaLab pipettes are calibrated with VistaLab tips to provide a perfect fit and deliver accurate performance every time

Find the packaging option that works best for your application!

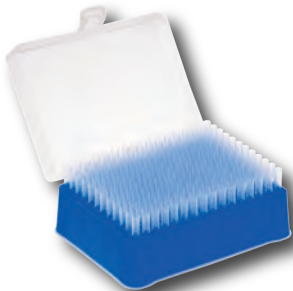

VistaRak™

Optimized design with
192/Rack



VistaStak™

Convenient layers save
bench and shelf space
192/Layer



Stacked Rack

Save space with
layered racks
200/Layer



Protectainer™

Stackable and reusable
plastic container
Small 1000/Container
Large 750/Container

MLA & OVATION PIPETTE TIPS

MLA & OVATION PIPETTE TIPS

AF, S, R/D F, NP, USP, PP

Tip Size	Non-Filter	Filter
Micro 2µL		
Micro 25µL		
Small 250µL		
Large 1250µL		

Earn VistaPoints with every pipette tip purchase! See page 3 for complete details!

MLA & Ovation Pipette Tips



Tip Size	Packaging	FILTER		Sterile Low Retention	Sterile	Non-Sterile	Non-Sterile Low Retention
		Sterile Low Retention	Sterile				
Micro 2µL	VistaRak™ 192 Tips/Rack 960/Case	4070-1333LR	4060-1333	-	-	-	-
Micro 25µL	VistaRak™ 192 Tips/Rack 960/Case	4070-1332LR	4060-1332	4070-1032LR	4060-1032	4060-1002	4070-1002LR
	VistaStak™ 192 Tips/Layer 576/Case	-	-	-	-	4060-9024	-
	VistaBulk™ 1000 Tips/Bag 1 Bag/Case	-	-	-	-	4058-1000	-
Small 250µL	VistaRak™ 192 Tips/Rack 960/Case	4070-2332LR	4060-2332	4070-2132LR	4060-2132	4060-2004	4070-2004LR
	VistaStak™ 192 Tips/Layer 960/Case	-	-	-	-	4060-9025	-
	Stacked Rack 200 Tips/Layer 5 Layers 1000/Case	-	-	-	-	9025 ¹	-
	VistaBulk™ 1000 Tips/Bag 1 Bag/Case	-	-	-	-	4058-2000	-
	Protectainer™ 1000 Tips/Container 1 Container/Case	-	-	-	-	4025	-
	VistaTip™ Individually Wrapped 200/Case	-	-	-	2027	-	-
Large 1250µL	VistaRak™ 192 Tips/Rack 960/Case	4070-3332LR	4060-3332	4070-3132LR	4060-3132	4060-3004	4070-3004LR
	VistaStak™ 192 Tips/Layer 576/Case	-	-	-	-	4060-9026	-
	Stacked Rack 200 Tips/Layer 3 Layers 600/Case	-	-	-	-	9026 ¹	-
	VistaBulk™ 1000 Tips/Bag 1 Bag/Case	-	-	-	-	4058-3000	-
	Protectainer™ 750 Tips/Container 1 Container/Case	-	-	-	-	4026	-
	VistaTip™ Individually Wrapped 200/Case	-	-	-	2028	-	-

MLA & OVATION PIPETTE TIPS

¹ Not for use with Ovation Multichannel pipettes

Ovation Pipettes - Mechanical



- 1 Low force plunger - less thumb strain
- 2 Spring loaded tip eject button - less thumb strain
- 3 Easy "click-on" tip acquisition - audible cue tip is secure
- 4 Accuracy & precision - superior performance
- 5 Built-in cap opener (M, QS & ESC only)
- 6 Stands on bench - reduce contamination
- 7 Contoured body shape color coded by volume
- 8 Adjustable hook for right and left handed use

You
DESERVE
a standing
Ovation!



- The first pipette designed with you in mind
- Ovation puts pipetting in the palm of your hand, allowing you to work in a comfortable, natural posture
- Reduce neck, back, shoulder and thumb strain caused by repetitive pipetting



OVATION QS - QUICK SET DIGITAL VOLUME

- Unique hybrid: two-stroke mechanical plunger with digital keypad volume adjustment
- 5 customizable volume presets
- Built-in cap opener
- Replaceable CR2 battery
- Shelf hanger included

MLA & OVATION PIPETTE TIPS

OVATION M - MECHANICAL ADJUSTABLE VOLUME			
Tip Size	Part Number	Volume	Color
	1070-0002*	0.2-2.0µL	Red
	1070-0010	1.0-10µL	Orange
	1070-0020	2.0-20µL	Yellow
	1070-0100	10-100µL	Green
	1070-0200	20-200µL	Blue
	1070-1000	100-1000µL	Purple
All	1070-0998	10µL, 100µL, 1000µL (3 Units)	Multi
	1070-0999	2µL, 20µL, 200µL, 1000µL (4 Units)	Multi

OVATION QS - QUICK SET DIGITAL VOLUME			
Tip Size	Part Number	Volume	Color
	1057-0002*	0.2-2µL	Red
	1057-0010	1-10µL	Orange
	1057-0020	2-20µL	Yellow
	1057-0100	10-100µL	Green
	1057-0200	20-200µL	Blue
	1057-1000	100-1000µL	Purple
All	1057-0999	20µL, 200µL, 1000µL (3 Units)	Multi

*Also compatible with Micro 2µL tips, see page 13

Ovation Pipettes - Electronic



PATENTED ERGONOMIC DESIGN!



EMC

OVATION EMC - ELECTRONIC MULTICHANNEL

- Fully electronic pipette
- Available with 8 or 12 channels
- Programmable functions: multi-dispensing, mixing, serial diluting, reverse pipetting, pipetting speed
- 3 customizable volume presets
- Power supply and shelf hanger included

OVATION EMC - ELECTRONIC MULTICHANNEL				
Tip Size	Part Number	Number of Channels	Volume	Color
	1160-0020	8	0.5-20µL	Yellow
	1160-0125	8	2-125µL	Green
	1160-0250	8	5-250µL	Blue
	1160-1250	8	25-1250µL	Purple
	1060-0020	12	0.5-20µL	Yellow
	1060-0125	12	2-125µL	Green
	1060-0250	12	5-250µL	Blue
	1060-0850	12	25-850µL	Gray

- 1 Electronically operated plunger
- 2 Spring loaded tip eject button - less thumb strain
- 3 Easy and secure "click-on" tip acquisition for all channels
- 4 Keypad and digital display - programmable
- 5 Stands on bench - reduce contamination
- 6 Rechargeable lithium-ion battery
- 7 Contoured body shape color coded by volume
- 8 Adjustable hook for right and left handed use

OVATION ESC - ELECTRONIC SINGLE CHANNEL

- Fully electronic pipette
- Programmable functions: multi-dispensing, mixing, serial diluting, reverse pipetting, pipetting speed
- 3 customizable volume presets
- Built-in cap opener
- Power supply and shelf hanger included

OVATION ESC - ELECTRONIC SINGLE CHANNEL			
Tip Size	Part Number	Volume	Color
	1065-0020	0.5-20µL	Yellow
	1065-0125	2-125µL	Green
	1065-0250	5-250µL	Blue
	1065-1250	25-1250µL	Purple

ESC



MLA & OVATION PIPETTE TIPS

Ovation Pipettes - Fixed Volume & Macro



F1



MACRO

OVATION F1 (ONE STROKE) - FIXED VOLUME			
Tip Size	Part Number	Volume	Color
Micro	1157-0005	5µL	Orange
	1157-0010	10µL	Orange
	1157-0020	20µL	Yellow
Small	1157-0025	25µL	Green
	1157-0050	50µL	Green
	1157-0100	100µL	Green
	1157-0200	200µL	Blue
Large	1157-0250	250µL	Purple
	1157-0300	300µL	Purple
	1157-0500	500µL	Purple
	1157-1000	1000µL	Purple
OVATION F2 (TWO STROKE) - FIXED VOLUME			
Tip Size	Part Number	Volume	Color
Micro 25µL	1257-0001*	1µL	Red
	1257-0002*	2µL	Red
	1257-0005	5µL	Orange
	1257-0010	10µL	Orange
	1257-0020	20µL	Yellow
Small	1257-0025	25µL	Green
	1257-0050	50µL	Green
	1257-0100	100µL	Green
	1257-0200	200µL	Blue
Large	1257-0250	250µL	Purple
	1257-0300	300µL	Purple
	1257-0500	500µL	Purple
	1257-1000	1000µL	Purple

OVATION - MACRO ESC			
Tip Size	Part Number	Volume	Color
	1065-05mL	100µL-5mL	Gray
	1065-10mL	200µL-10mL	Red

Tip Size	Packaging	Sterile Filter	Sterile	Non-Sterile
Macro5 - 5mL	Box 100 Tips/Box 1 Box/Case	-	-	9048
	VistaClear™ Box 60 Tips/Box 1 Box/Case	4058-5133	4058-5102	-
	VistaBulk™ 250 Tips/Bag 1 Bag/Case	-	-	4058-5000
	VistaTip™ Individually Wrapped 50/Case	4058-5332	-	-
Macro10 - 10mL	Box 35 Tips/Box 1 Box/Case	-	-	9050
	VistaClear™ Box 35 Tips/Box 1 Box/Case	4058-6133	4058-6102	4058-6100
	VistaBulk™ 100 Tips/Bag 1 Bag/Case	-	-	4058-6000
	VistaTip™ Individually Wrapped 50/Case	4058-6332	-	-

*Also compatible with Micro 2µL tips, see page 13

MLA & OVATION PIPETTE TIPS



Learn more!
See the video.
Discover the difference.

- All Ovation pipettes are covered by a two year warranty
- Repair and calibration services are available for all Ovation pipettes
- Maintain pipettes with spare parts, visit www.celltreat.us/spareparts for part number information
- Didn't find the best option for your application? Customization is available!

MLA & Ovation Pipette Stands



MLA STAND



OVATION STAND



**ORGANIZE AND DISPLAY
MLA & OVATION PIPETTES**

STANDS

Part No.	Product Description	Qty/Case
1700	MLA Pipette Stand	1
9057-4003	Ovation Pipette Stand	1

- Clear, acrylic stands designed to accommodate MLA and Ovation unique shapes
- Avoid contamination from lab bench surfaces and conserve space by suspending equipment
- Ovation stand has 4 places and is compatible with all models of Ovation pipettes, even multichannels
- Easily view all MLA pipette volume markings with off-set first and second row, which allows for racking up to 10 pipettes

Adjustable Pipettes - CELLTREAT

- Traditional design pipettes with easy-to-read volume display
- Continuously adjustable with locking ring to prevent volume changes while pipetting
- Lightweight design and easy operation with either hand
- Stainless steel, PTFE and PVDF components for long life
- Can be autoclaved up to 6 times
- Fits CELLTREAT brand Universal Pipette Tips for accurate pipetting, see pages 8-10



ADJUSTABLE PIPETTES

Part No.	Product Description	Pack Description	Qty/Case
230299	1-10 μ L Pipette, Adjustable Volume, Single Channel	1/Box	1
230300	2-20 μ L Pipette, Adjustable Volume, Single Channel	1/Box	1
230305	20-200 μ L Pipette, Adjustable Volume, Single Channel	1/Box	1
230306	30-300 μ L Pipette, Adjustable Volume, Single Channel	1/Box	1
230310	100-1000 μ L Pipette, Adjustable Volume, Single Channel	1/Box	1

MLA Pipettes



MLA & OVATION PIPETTE TIPS

Tip Size	MLA PRECISION		
	MLA Part #	Volume	Color
Small 250µL	1101	5µL	Silver
	1021	10µL	Orange
	1102	15µL	Silver
	1022	20µL	Black
	1023	25µL	White
	1103	30µL	Silver
	1104	40µL	Silver
	1024	50µL	Green
	1106	60µL	Silver
	1107	70µL	Silver
	1108	75µL	Silver
	1109	80µL	Silver
Large 1250µL	1110	90µL	Silver
	1025	100µL	Blue
	1111	120µL	Silver
	1112	150µL	Silver
	1026	200µL	Red
	1027	250µL	Purple
	1028	300µL	Brown
	1113	400µL	Silver
	1119	450µL	Silver
	1029	500µL	Yellow
1115	600µL	Silver	
1505	700µL	Silver	
1117	800µL	Silver	
1118	900µL	Silver	
1030	1000µL	Gray	



MLA PRECISION

- Fixed volumes from 5 – 1000µL
- Single-stroke "to deliver" operation



MLA MACRO

- Fixed volumes from 1 – 10mL
- Single-stroke "to deliver" operation



MLA MACRO SELECTABLE

- Select from set volumes: 2/3/4/5mL
- Single-stroke "to deliver" operation



MLA MACRO ADJUSTABLE

- Adjustable volumes from 1 – 5mL
- Single-stroke "to deliver" operation



A LABORATORY TRADITION FOR OVER FOUR DECADES!

- Made of precision engineered aluminum alloy and stainless steel, with a modern, sleek, anodized metal finish
- Dependable performance and durability designed for highly accurate delivery
- Color coded body for easy volume identification and individually serialized with Calibration Certificate included
- Limited Lifetime Warranty (covering parts)
- OEM/Customization available, please contact us for information

Tip Size	MLA MACRO		
	MLA Part #	Volume	Color
Macro 5	1065	1mL	Gray
	1066	2mL	Red
	1067	3mL	Green
	1068	4mL	White
	1069	5mL	Yellow
Macro 10	1076	6mL	Red
	1077	7mL	Red
	1078	8mL	Red
	1079	9mL	Red
	1070	10mL	Red
MLA MACRO - SELECTABLE			
	1134	2-5mL	Blue
MLA MACRO - ADJUSTABLE			
	1061	1-5mL	Blue

MLA Pipettes



MOST POPULAR!

MLA D-TIPPER



- Built-in tip ejector
- Fixed volumes from 5 – 1000µL
- Single-stroke “to deliver” operation
- Glove guard

MLA D-TIPPER SELECTABLE



- Built-in tip ejector
- Select from set volumes: 50/100/200µL
- Single-stroke “to deliver” operation
- Glove guard

MLA DIGITAL DIAL ADJUSTABLE



- Built-in tip ejector
- Dial-in adjustable volumes in 3 ranges
- Precise “click-stop” volume adjustment
- Single-stroke “to deliver” operation

MLA MICRO D-TIPPER



- Built-in tip ejector
- Fixed volumes from 2 – 10µL
- Two-stroke “to contain” operation

MLA D-TIPPER			
Tip Size	MLA Part #	Volume	Color
Small 250µL	1141C	5µL	Silver
	1051C	10µL	Orange
	1051PK	10µL	Pink
	1142C	15µL	Silver
	1052C	20µL	Black
	1052PK	20µL	Pink
	1053C	25µL	White
	1143C	30µL	Silver
	1144C	40µL	Silver
	1054C	50µL	Green
	1054PK	50µL	Pink
	1146C	60µL	Silver
	1147C	70µL	Silver
	1148C	75µL	Silver
	1149C	80µL	Silver
	1150C	90µL	Silver
	1055C	100µL	Blue
	1055PK	100µL	Pink
	1151C	120µL	Silver
	1152C	150µL	Silver
1056C	200µL	Red	
1056PK	200µL	Pink	
Large	1056CLT	200µL	Red
	1057C	250µL	Purple
	1057PK	250µL	Pink
MLA D-TIPPER SELECTABLE			
	1132	50/100/200µL	Silver

MLA D-TIPPER (Cont.)			
Tip Size	MLA Part #	Volume	Color
	1058C	300µL	Brown
	1153C	400µL	Silver
	1154C	450µL	Silver
	1059C	500µL	Yellow
	1059PK	500µL	Pink
	1159C	600µL	Silver
	1162C	700µL	Silver
	1157C	750µL	Silver
	1160C	800µL	Silver
	1163C	900µL	Silver
	1060C	1000µL	Gray
	1060PK	1000µL	Pink
MLA MICRO D-TIPPER			
	1802	2µL	Red
	1803	3µL	Gray
	1804	4µL	White
	1805	5µL	Silver
	1806	6µL	Green
	1807	7µL	Purple
	1808	8µL	Black
	1809	9µL	Blue
	1810	10µL	Orange
MLA DIGITAL - DIAL ADJUSTABLE			
	1136	10-50µL	Green
	1137	50-200µL	Red
	1138	200-1000µL	Gray

MLA & OVATION PIPETTE TIPS

Polystyrene Reagent Reservoirs - CELLTREAT

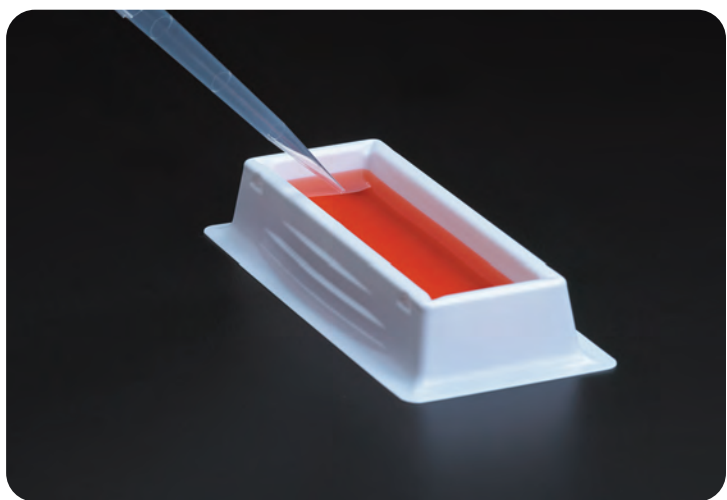

- Reagent reservoirs are designed to assist in repetitive liquid transfer
- White color enhances solution visibility
- Angled design promotes funneling of liquid to maximize retrieval, and works well with multiple-channel pipettes (sizes 50, 55 & 100mL only)
- 25, 55 & 100mL Reagent Reservoirs feature pour spouts on the corners, textured gripping areas on the sides, and a nesting design for easy stacking and storage

REAGENT RESERVOIRS - POLYSTYRENE

AF, S, R/D F, NP, USP, PS

Part No.	Product Description	Pack Description	Qty/Case
229294	25mL Reagent Reservoir	Individually Wrapped	80
229295	25mL Reagent Reservoir	5 Bulk Packed/Bag	200
229290	50mL Reagent Reservoir	Individually Wrapped	80
229291	50mL Reagent Reservoir	5 Bulk Packed/Bag	200
229296	55mL Reagent Reservoir	Individually Wrapped	80
229297	55mL Reagent Reservoir	5 Bulk Packed/Bag	200
229298	100mL Reagent Reservoir	Individually Wrapped	80
229299	100mL Reagent Reservoir	5 Bulk Packed/Bag	200



Polystyrene Reagent Reservoirs - VistaLab



SUPERIOR LOW RETENTION MAXIMIZES REAGENT RECOVERY
up to 67% better than comparable reservoirs!

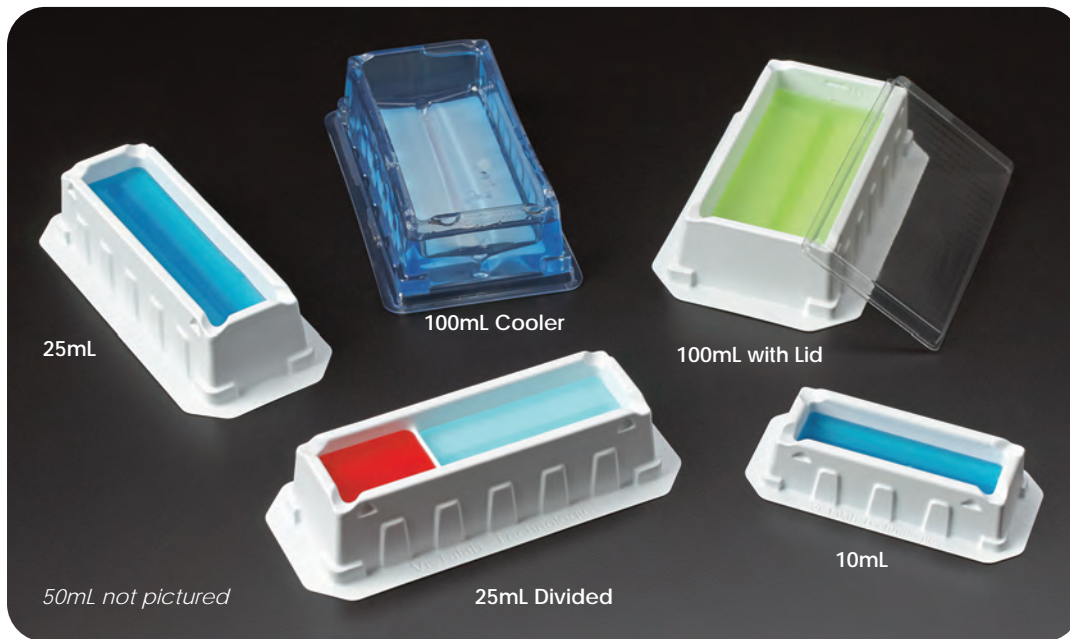

**AVAILABLE IN
5 SIZES!**
10mL, 25mL,
25mL Divided,
50mL & 100mL

- Proprietary high wettability, hydrophilic surface treatment
- Wider base for stability
- Bulk or Individually Wrapped packaging
- Clearly marked with PS6 for recycling

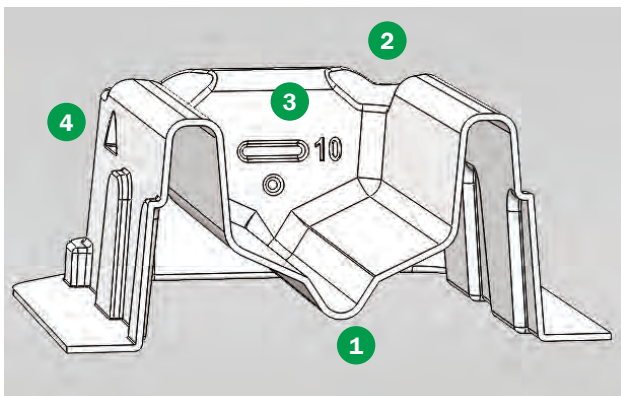

- 1 Trough-within-a-trough design to recover the "last few drops"
- 2 Pour-off spouts at every corner
- 3 Well-marked molded graduations on the inside wall (all sizes except 100mL)
- 4 Corner structures designed for easy bulk package unit separation

REAGENT RESERVOIRS - POLYSTYRENE							AF, R/D F, NP, USP, PS	
Packaging Description	Sterile (Y/N)	Qty/Case	10mL	25mL	25mL Divided	50mL	100mL	
Bulk	N	100	4054-1012	4054-1002	4054-1004	4054-1006	4054-1000	
Bulk	Y	100	3054-1012	3054-1002	3054-1004	3054-1006	3054-1000	
Bulk	Y	200	3054-2012	3054-2002	-	3054-2006	3054-2000	
Individually Wrapped	Y	50	3054-1013	3054-1003	3054-1005	3054-1007	3054-1001	
Individually Wrapped	Y	100	3054-2013	3054-2003	-	3054-2007	3054-2001	
Individually Wrapped with Lid	Y	50	-	-	-	-	3054-3001	
Bulk, Lid Only	Y	100	-	-	-	-	3054-3000	

REAGENT RESERVOIR COOLER				AF, R/D F, NP, USP, PET	
Part No.	Product Description	Pack Description	Qty/Case		
3054-5000	Reservoir Cooler for 100mL Reagent Reservoir	1 Cooler + 3 100mL reservoirs with lids	1		

Polypropylene Reagent Reservoirs



1 VistaLab 12 channel reagent reservoir facilitates manual multichannel pipetting.

This reservoir offers the ability to either save time by pipetting different reagents simultaneously, or conserve precious reagents by using only the number of channels needed.

- Reservoirs are designed to assist in repetitive or robotic liquid transfer
- Pyramid and Trough Bottom designs promote funneling of liquid to maximize reagent recovery by pipette tips
- 8 & 12 well reservoirs work well with multiple-channel pipettes and are available sterile or non-sterile
- Low profile is ideal for small volume robotic tips
- Can be stored at temperatures as low as -80°C
- Polypropylene offers a low binding surface to prevent samples from sticking to the side walls during elution, and is chemically inert for combinatorial chemistry applications



CELLTREAT REAGENT RESERVOIRS - POLYPROPYLENE

AF, R/D F, NP, USP, A, PP

Part No.	Product Description	Sterile	Pack Description	Qty/Case
229561	Multiple Cavity Reagent Reservoir, 8 Well, Trough Bottom	N	5/Bag	25
229565	Multiple Cavity Reagent Reservoir, 8 Well, Trough Bottom	Y	5/Bag	25
229562	Multiple Cavity Reagent Reservoir, 12 Well, Trough Bottom	N	5/Bag	25
229566	Multiple Cavity Reagent Reservoir, 12 Well, Trough Bottom	Y	5/Bag	25
229563	Single Cavity Reagent Reservoir, 96 Pyramid Bottom	N	5/Bag	25
229564	Single Cavity Reagent Reservoir, 384 Pyramid Bottom	N	5/Bag	25

VISTALAB REAGENT RESERVOIRS - POLYPROPYLENE

AF, R/D F, NP, USP, A, PP

3054-1010	12 Channel Reagent Reservoir with Lid	Y	Individual	10
3054-1011	12 Channel Reagent Reservoir with Lid	Y	Individual	25
4054-1010	12 Channel Reagent Reservoir with Lid	N	10/Bag	10
4054-1011	12 Channel Reagent Reservoir with Lid	N	25/Bag	25

NEW PCR Plates, Strips & Tubes

PCR PLATES

- Boldly printed, alphanumeric markings for easy identification of individual wells
- Universal design is compatible with the major brands of thermal cyclers
- Ultra-thin wells provide uniform and efficient heat transfer
- Certified RNase/DNase/DNA-free and non-pyrogenic to ensure reliable experimental results
- Available in skirted and non-skirted options
- Raised rim on 229516 reduces sample evaporation when sealed with film or foil
- See complimentary sealing films on page 68

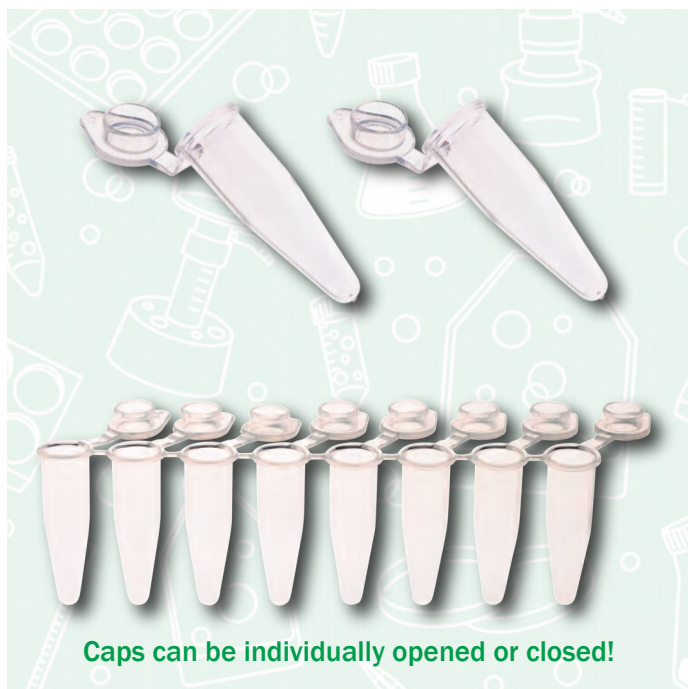
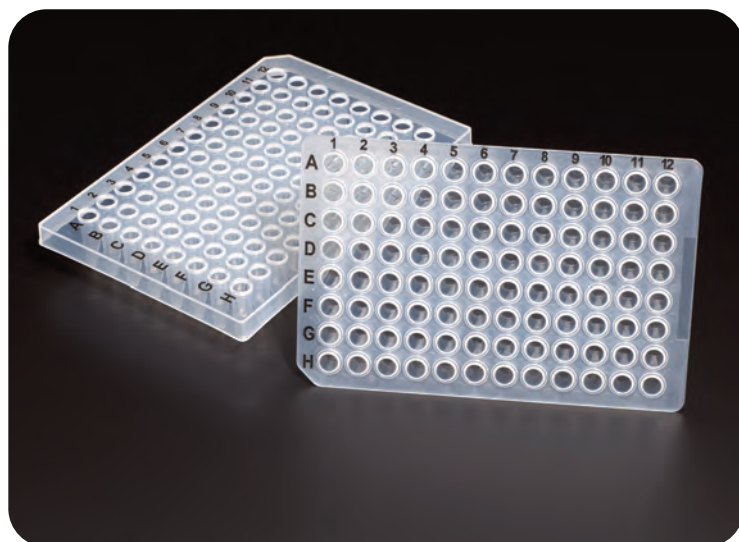

Caps can be individually opened or closed!

PCR TUBES & STRIPS

- Ultra-thin tube walls provide uniform and efficient heat transfer
- Avoid sample loss from evaporation with easy open and close lids
- Angularly-attached strip caps prevent lids and hinges from interfering with each other when several strips are racked simultaneously
- 230461 and 230462 strips feature easily separable tubes to customize strips
- 230463 strips feature robust inter-well linkages, increasing stability and preventing spills
- Individual tubes are available with either frosted flat caps for easier labeling, or optically clear flat caps for RT PCR applications
- Certified RNase/DNase/DNA-free and non-pyrogenic to ensure reliable experimental results
- Conveniently packaged in resealable bags to minimize risk of contamination

PCR PLATES		AF, N, R/D F, NP, USP, PP	
Part No.	Product Description	Pack Description	Qty/Case
229513	96 Well PCR Plate, Half Skirt, Clear, 0.2mL	10/Bag	50
229514	96 Well PCR Plate, No Skirt, Clear, 0.2mL	10/Bag	50
229515	96 Well PCR Plate, Full Skirt, Clear, 0.1mL	10/Bag	50
229516	96 Well PCR Plate, Raised Half Skirt, Clear, 0.2mL	10/Bag	50
PCR STRIP TUBES		AF, N, R/D F, NP, USP, PP	
230461	PCR 8-Strip Tubes, 0.2mL, Separable, Attached Flat Caps, Clear	120/Bag	120
230462	PCR 8-Strip Tubes, 0.2mL, Separable, Attached Dome Caps, Clear	120/Bag	120
230463	PCR 8-Strip Tubes, 0.2mL, Attached Flat Caps, Clear	120/Bag	120
PCR INDIVIDUAL TUBES		AF, N, R/D F, NP, USP, PP	
230455	PCR Tube, 0.2mL, Frosted Flat Cap, Clear	1000/Bag	1000
230456	PCR Tube, 0.2mL, Optically Clear Flat Cap, Clear	1000/Bag	1000

Centrifuge Tube Selection Guide



FLIP TOP CAP
P. 30

SNAP-POP LID
P. 31

BIO-REACTION
P. 34

PRINTED CAP
P. 27

**SELF
STANDING**
P. 31

After 15 years in the industry, CELLTREAT knows that each customer has unique needs when it comes to options and packaging. CELLTREAT offers high quality centrifuge tubes with a variety of special features and multiple packaging options. Refer to pages 26-36 for additional information.

15 & 50mL Conical Bottom Centrifuge Tube Features

- Graduations are printed in bold easy-to-read black ink and are accurate to $\pm 2\%$; Graduations molded into the conical bottom are ideal for pellet viewing and small volume quantification
- Large white marking area provides excellent contrast for identification
- Easy to write on flat surface polyethylene (HDPE) caps feature integrated leak-proof seal
- Temperature range of -80°C to 120°C (polypropylene only)
- See pages 26-27 for packaging options

30mL SELF-STANDING TUBES - P. 31



MICRO TUBES - P. 36



5mL MACRO TUBES - P. 36



SCREW TOP MICRO TUBES - P. 42-43



Centrifuge Tube Selection Guide

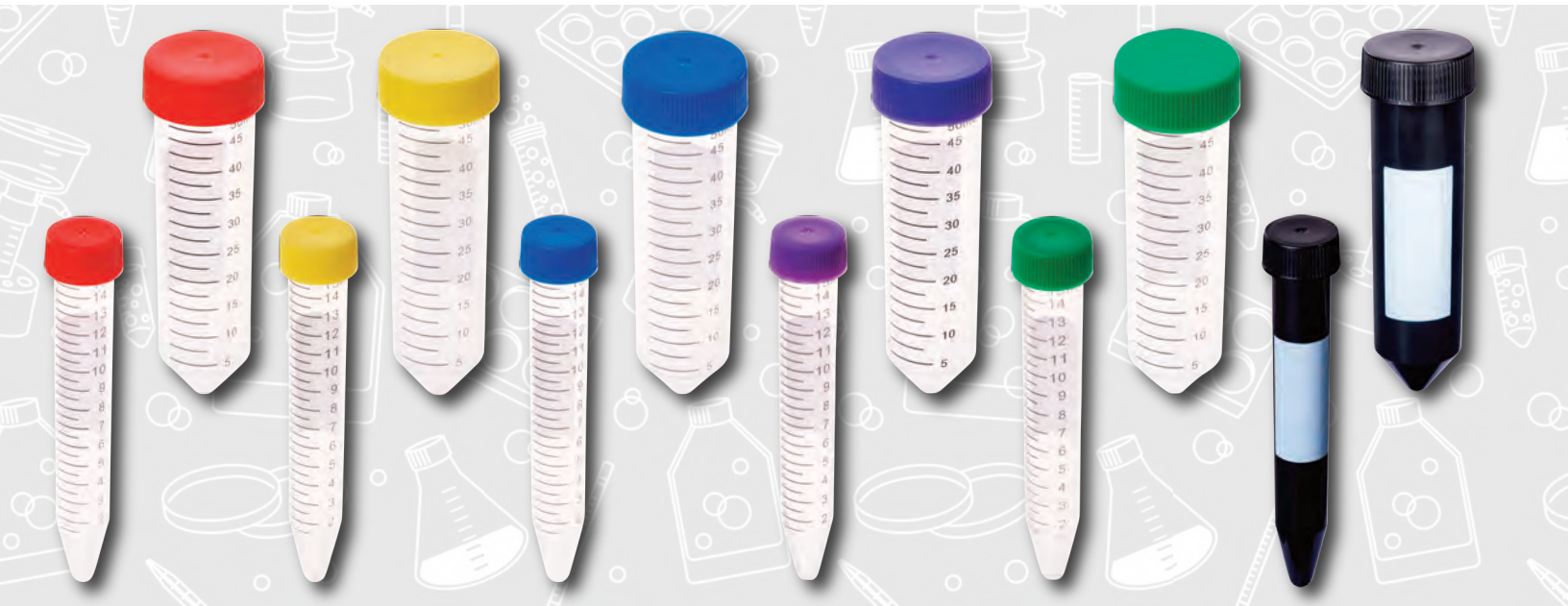

COLORED CAP
P. 29

STANDARD
P. 26-27

BLACK
P. 32

BEST VALUE CENTRIFUGE TUBES - P. 28



10mL CENTRIFUGE TUBES - P. 28



SURE CAP TUBES - P. 30



LARGE VOLUME TUBES - P. 33



OAK RIDGE STYLE TUBES - P. 32



CENTRIFUGE BOTTLES - P. 33



15 & 50mL Centrifuge Tubes - Bag



- Convenient zip-closure bag is a practical alternative to folding and taping opened bags
- Available in 15 & 50mL Conical Bottom, 50mL Self-Standing, 15 & 50mL Flip Top and 15 & 50mL Black tube options
- Easily refill reusable racks with tubes packed in bags
- See page 24 for complete information on Centrifuge Tubes

CENTRIFUGE TUBES - BAG			AF, S, R/D F, NP, USP, A, TUBE - PP, CAP - HDPE			
Part No.	Product Description	Max RCF	Sterile (Y/N)	Pack Description	Qty/Case	
229411	15mL Centrifuge Tube	12000 x g	Y	25/Re-sealable Bag	500	
229421	50mL Centrifuge Tube	16000 x g	Y	25/Re-sealable Bag	500	
229430	50mL Centrifuge Tube, Self-Standing	6000 x g	Y	25/Re-sealable Bag	500	
FLIP TOP CENTRIFUGE TUBES - BAG			AF, S, R/D F, NP, USP, A, TUBE - PP, CAP - HDPE			
229417	15mL Centrifuge Tube, Flip Top Cap	9400 x g	Y	25/Re-sealable Bag	500	
229427	50mL Centrifuge Tube, Flip Top Cap	9400 x g	Y	25/Re-sealable Bag	500	
229425	50mL Centrifuge Tube, Flip Top Cap Only	NA	Y	25/Re-sealable Bag	1000	
BLACK CENTRIFUGE TUBES - BAG			AF, S, R/D F, NP, USP, A, TUBE - PP, CAP - HDPE			
229431	15mL Centrifuge Tube, Black	12000 x g	Y	25/Re-sealable Bag	100	
229432	15mL Centrifuge Tube, Black	12000 x g	Y	25/Re-sealable Bag	500	
229433	50mL Centrifuge Tube, Black	16000 x g	Y	25/Re-sealable Bag	100	
229434	50mL Centrifuge Tube, Black	16000 x g	Y	25/Re-sealable Bag	500	
CAP OR TUBE ONLY CENTRIFUGE TUBES - BAG			AF, N, R/D F, NP, USP, A, TUBE - PP, CAP - HDPE			
229450	TUBE ONLY, 15mL Centrifuge Tube	12000 x g	N	500/Bag	500	
229451	CAP ONLY, 15mL Centrifuge Tube	NA	N	500/Bag	500	
NEW	229457	CAP ONLY, 15mL Centrifuge Tube	NA	Y	25/Re-sealable Bag	500
229452	TUBE & CAP, 15mL Centrifuge Tube & Cap	12000 x g	N	Tubes 500/Bag & Caps 500/Bag	500	
229454	TUBE ONLY, 50mL Centrifuge Tube	16000 x g	N	500/Bag	500	
229453	CAP ONLY, 50mL Centrifuge Tube	NA	N	500/Bag	500	
NEW	229458	CAP ONLY, 50mL Centrifuge Tube	NA	Y	25/Re-sealable Bag	500
229456	TUBE & CAP, 50mL Centrifuge Tube & Cap	16000 x g	N	Tubes 500/Bag & Caps 500/Bag	500	
229459	TUBE & CAP, 50mL Centrifuge Tube & Cap, Self-Standing	6000 x g	N	Tubes 500/Bag & Caps 500/Bag	500	

15 & 50mL Centrifuge Tubes - Paperboard Rack

- Economical, recyclable alternative to disposable foam rack
- Available in 15 & 50mL Screw Cap and 15 & 50mL Flip Top Cap tube options
- Folds flat for recycling or disposal
- See page 24 for complete information on Centrifuge Tubes



CENTRIFUGE TUBES - PAPERBOARD RACK			AF, R/D F, NP, USP, A, TUBE - PP, CAP - HDPE			
Part No.	Product Description	Max RCF	Sterile (Y/N)	Pack Description	Qty/Case	
229410	15mL Centrifuge Tube	12000 x g	Y	25/Paperboard Rack with 2 Racks/Bag	500	
229420	50mL Centrifuge Tube	16000 x g	Y	25/Paperboard Rack	500	
229455	50mL Centrifuge Tube	16000 x g	N	25/Paperboard Rack	500	
FLIP TOP CENTRIFUGE TUBES - PAPERBOARD RACK			AF, S, R/D F, NP, USP, A, TUBE - PP, CAP - HDPE			
229416	15mL Centrifuge Tube, Flip Top Cap	9400 x g	Y	25/Paperboard Rack with 2 Racks/Bag	500	
229426	50mL Centrifuge Tube, Flip Top Cap	9400 x g	Y	25/Paperboard Rack	500	

15 & 50mL Centrifuge Tubes - Plastic Rack



▲ Reusable/Recyclable Racks also available for purchase separately (Part No. 229419 & 229429)

- Plastic Racks are manufactured from polypropylene and are chemically resistant and autoclavable
- Durable racks are reusable and recyclable
- Design of the tray prevents racks from sticking/freezing to surfaces
- Widely spaced design catches drips and allows tubes to be easily retrieved

CENTRIFUGE TUBES - PLASTIC RACK

AF, R/D F, NP, USP, A, TUBE - PP, CAP - HDPE

Part No.	Product Description	Max RCF	Sterile (Y/N)	Pack Description	Qty/ Case
229418	15mL Centrifuge Tube	12000 x g	Y	25/Plastic Rack with 2 Racks/Bag	300
229428	50mL Centrifuge Tube	16000 x g	Y	25/Plastic Rack	300
229419	PLASTIC RACK ONLY, 15mL Centrifuge Tube	NA	N	5/Bag	5
229429	PLASTIC RACK ONLY, 50mL Centrifuge Tube	NA	N	5/Bag	5

15 & 50mL Centrifuge Tubes - Foam Rack

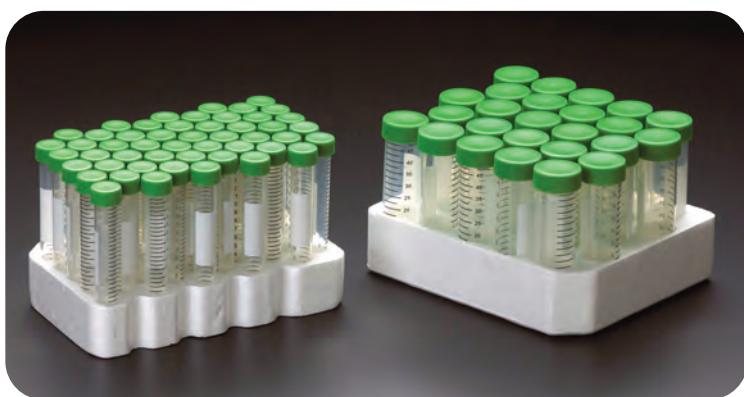

- Sturdy alternative to disposable paperboard racks
- See page 24 for complete information on Centrifuge Tubes
- Also available with printed marking spot and pre-numbered caps

CENTRIFUGE TUBES - FOAM RACK

AF, S, R/D F, NP, USP, A, TUBE - PP, CAP - HDPE

Part No.	Product Description	Max RCF	Sterile (Y/N)	Pack Description	Qty/ Case
229412	15mL Centrifuge Tube	12000 x g	Y	50/Foam Rack	300
229422	50mL Centrifuge Tube	16000 x g	Y	25/Foam Rack	300
229423	50mL Centrifuge Tube, Marking Spot Cap	16000 x g	Y	25/Foam Rack	300
229424	50mL Centrifuge Tube, Numbered Cap	16000 x g	Y	25/Foam Rack	300

10mL Centrifuge Tubes



10mL vs. 15mL Centrifuge Tube



THE TUBE SIZE THAT'S JUST RIGHT!

The perfect size for volumes between 5 - 10mL

- Offers the convenience of a micro centrifuge tube with the ability to process sample volumes up to 10mL
- Contains less plastic than 15mL tube to minimize shipping, storage and waste; saves over one pound of plastic per case!
- Easily access cell pellets and reduce contamination risk with shorter tube
- Graduations are printed in bold, easy-to-read black ink and are accurate to +/-2%
- Large white marking area provides excellent contrast for identification
- Easy to write on flat surface polyethylene (HDPE) caps feature integrated leak-proof seal
- Tubes include graduations molded into the conical bottom, ideal for pellet viewing and small volume quantification
- Convenient zip-closure bag is a practical alternative to folding and taping opened bags

CENTRIFUGE TUBES - BAG

AF, S, R/D F, NP, USP, A, TUBE - PP, CAP - HDPE

Part No.	Product Description	Max RCF	Sterile (Y/N)	Pack Description	Qty/Case
229493	10mL Centrifuge Tube	12000 x g	Y	25/Re-sealable Bag	500

NEW 15 & 50mL Best Value Centrifuge Tubes

- Best Value 15 & 50mL centrifuge tubes are manufactured using an improved production process, offering a savings advantage
- Graduations are printed in bold, easy-to-read black ink and are accurate to +/-2%
- Large white marking area provides excellent contrast for identification
- Easy to write on flat surface polyethylene (HDPE) caps feature integrated leak-proof seal
- Tubes include graduations molded into the conical bottom, ideal for pellet viewing and small volume quantification
- Convenient zip-closure bag is a practical alternative to folding and taping opened bags
- Easily refill reusable racks with tubes packed in bags



CENTRIFUGE TUBES - BAG

AF, S, R/D F, NP, USP, A, TUBE - PP, CAP - HDPE

Part No.	Product Description	Max RCF	Sterile (Y/N)	Pack Description	Qty/Case
229413	15mL Centrifuge Tube	12000 x g	Y	25/Re-sealable Bag	500
229435	50mL Centrifuge Tube	16000 x g	Y	25/Re-sealable Bag	500

15 & 50mL Colored Cap Centrifuge Tubes

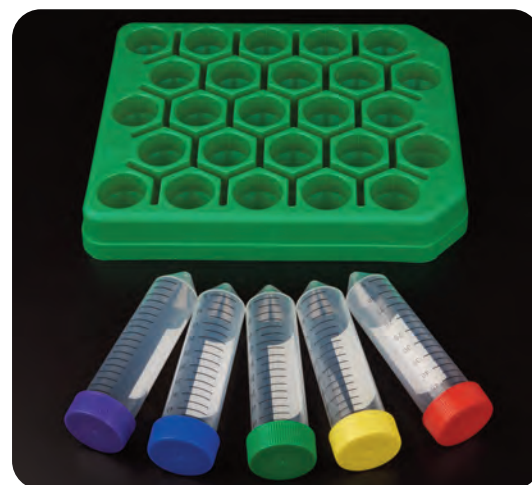

Assorted color cases (PN 230411A & 230421A) include a free reusable plastic rack (PN 229419 & 229429)

- Easily color code samples for quick identification, customization and to increase productivity
- Tubes available packed with a single color per case or assorted cases containing 4 bags of each individual color (red, yellow, green, blue, purple)
- Same great features as standard centrifuge tubes, see page 24

COLORED CAP CENTRIFUGE TUBES			AF, S, R/D F, NP, USP, A, TUBE - PP, CAP - HDPE			
Part No.	Product Description	Cap Color	Max RCF	Sterile (Y/N)	Pack Description	Qty/Case
230411A	15mL Centrifuge Tube	Assorted	12000 x g	Y	25/Re-sealable Bag	500
229411	15mL Centrifuge Tube	Green	12000 x g	Y	25/Re-sealable Bag	500
230411B	15mL Centrifuge Tube	Blue	12000 x g	Y	25/Re-sealable Bag	500
230411P	15mL Centrifuge Tube	Purple	12000 x g	Y	25/Re-sealable Bag	500
230411R	15mL Centrifuge Tube	Red	12000 x g	Y	25/Re-sealable Bag	500
230411Y	15mL Centrifuge Tube	Yellow	12000 x g	Y	25/Re-sealable Bag	500
230421A	50mL Centrifuge Tube	Assorted	16000 x g	Y	25/Re-sealable Bag	500
229421	50mL Centrifuge Tube	Green	16000 x g	Y	25/Re-sealable Bag	500
230421B	50mL Centrifuge Tube	Blue	16000 x g	Y	25/Re-sealable Bag	500
230421P	50mL Centrifuge Tube	Purple	16000 x g	Y	25/Re-sealable Bag	500
230421R	50mL Centrifuge Tube	Red	16000 x g	Y	25/Re-sealable Bag	500
230421Y	50mL Centrifuge Tube	Yellow	16000 x g	Y	25/Re-sealable Bag	500

Markers



- Fast drying, smudge resistant, fine point marker
- Ideal for permanently marking all plastic labware, especially centrifuge tubes; even works with frozen tubes!

MARKERS		
Part No.	Product Description	Qty/Case
229405	Green Tube Marker, Fast Drying Ink	5
229406	Blue Tube Marker, Fast Drying Ink	5
229407	Black Tube Marker, Fast Drying Ink	5
229408	Red Tube Marker, Fast Drying Ink	5

15 & 50mL Sure Cap Centrifuge Tubes

SURE CAP - POLYPROPYLENE & POLYSTYRENE TUBES

- Sure Cap with compressible liner creates a stable seal
- Available in 15 & 50mL **polypropylene** and 15mL **polystyrene** tube options
- Polypropylene tubes have same great features as standard tube offering (see page 24)

SURE CAP - POLYSTYRENE TUBES

- Polystyrene tube is optically clear for easy viewing of sample
- Includes molded 15mL graduation line plus 0.5 and 1mL graduations molded into conical bottom allowing for small volume quantification

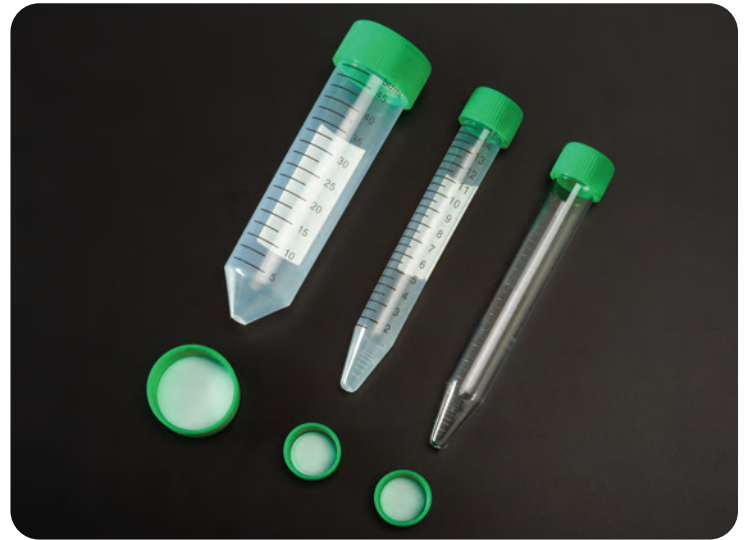

SURE CAP CENTRIFUGE TUBES - POLYPROPYLENE				AF, S, R/D F, NP, A, TUBE - PP, CAP - HDPE		
Part No.	Product Description	Max RCF	Sterile (Y/N)	Pack Description	Qty/Case	
229401	15mL Centrifuge Tube, Sure Cap	12000 x g	Y	25/Re-sealable Bag	500	
229402	50mL Centrifuge Tube, Sure Cap	16000 x g	Y	25/Re-sealable Bag	300	
SURE CAP CENTRIFUGE TUBES - POLYSTYRENE				AF, S, R/D F, NP, TUBE - PS, CAP - HDPE		
229491	15mL Centrifuge Tube, Sure Cap	3000 x g	Y	25/Re-sealable Bag	500	

15 & 50mL Flip Top Cap Centrifuge Tubes



- Ergonomic flip top screw cap is designed for single handed operation
- Easily flip cap open or screw on/off as a standard cap
- Graduations are printed in bold, easy-to-read black ink and are accurate to $\pm 2\%$
- Large white marking area provides excellent contrast for identification
- Easy to write on flat surface polyethylene (HDPE) caps
- Tubes include graduations molded into the conical bottom, ideal for pellet viewing and small volume quantification
- Convenient zip-closure bag is a practical alternative to folding and taping opened bags
- Paperboard rack is a recyclable, fold-flat alternative to bulky foam racks

15ML CENTRIFUGE TUBES - FLIP TOP CAP				AF, S, R/D F, NP, USP, A, TUBE - PP, CAP - HDPE		
Part No.	Product Description	Max RCF	Sterile (Y/N)	Pack Description	Qty/Case	
229416	15mL Centrifuge Tube, Flip Top Cap	9400 x g	Y	25/Paperboard Rack with 2 Racks/Bag	500	
229417	15mL Centrifuge Tube, Flip Top Cap	9400 x g	Y	25/Re-sealable Bag	500	
50ML CENTRIFUGE TUBES - FLIP TOP CAP				AF, S, R/D F, NP, USP, A, TUBE - PP, CAP - HDPE		
229426	50mL Centrifuge Tube, Flip Top Cap	9400 x g	Y	25/Paperboard Rack	500	
229427	50mL Centrifuge Tube, Flip Top Cap	9400 x g	Y	25/Re-sealable Bag	500	
229425	50mL Centrifuge Tube, Flip Top Cap Only	NA	Y	25/Re-sealable Bag	1000	

15 & 50mL Snap-Pop Lid Centrifuge Tubes



AUDIBLE 'SNAP!' GIVES YOU CONFIDENCE THAT THE TUBE IS COMPLETELY CLOSED

- Easily open or seal the tube with one hand; same hinged cap style as micro centrifuge tubes
- Elongated lip on attached cap prevents finger contact with tube, reducing cross contamination
- Ideal for sample storage, collection and experimental procedures
- Single-piece design is easy to use in the lab or the field
- Offers savings advantage versus traditional flip-top screw cap
- Available in conical and self-standing bottoms



CONICAL BOTTOM			AF, S, R/D F, NP, A, PP	
Part No.	Product Description	Max RCF	Pack Description	Qty/Case
229496	15mL Centrifuge Tube	5500 x g	50/Re-sealable Bag	500
229498	50mL Centrifuge Tube	9000 x g	25/Re-sealable Bag	500
SELF-STANDING			AF, S, R/D F, NP, A, PP	
229497	15mL Centrifuge Tube	1000 x g	50/Re-sealable Bag	500
229499	50mL Centrifuge Tube	1000 x g	25/Re-sealable Bag	500

30 & 50mL Self-Standing Centrifuge Tubes

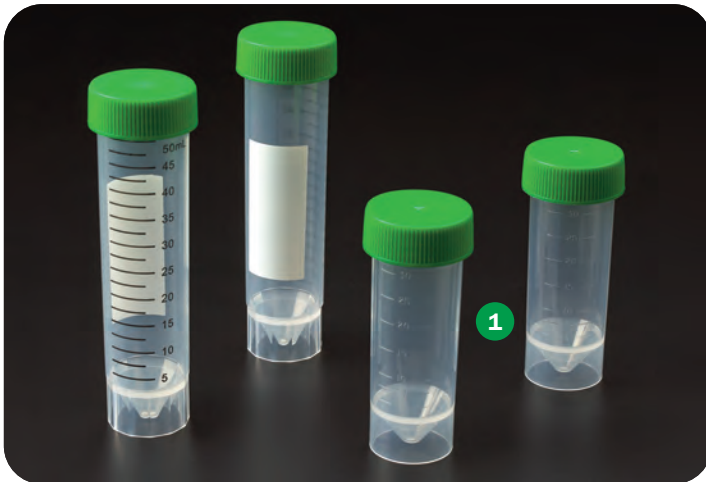

- Self-Standing base for use without a rack
- Graduations are printed in bold, easy-to-read black ink and are accurate to +/-2% (50mL only)
- Large white marking area provides excellent contrast for identification (50mL only)
- Ink-free 30mL tubes feature molded graduations
- Easy to write on flat surface polyethylene (HDPE) caps feature integrated leak-proof seal

1 Ink-free 30mL tubes feature molded graduation

CENTRIFUGE TUBES - 30mL SELF-STANDING			AF, S, R/D F, NP, USP, A, TUBE - PP, CAP - HDPE			
Part No.	Product Description	Max RCF	Sterile (Y/N)	Pack Description	Qty/Case	
NEW 229492	30mL Centrifuge Tube, Self-Standing	7500 x g	N	50/Re-sealable Bag	500	
NEW 229494	30mL Centrifuge Tube, Self-Standing	7500 x g	Y	50/Re-sealable Bag	500	
NEW 229495	TUBE & CAP, 30mL Centrifuge Tube & Cap, Self-Standing	7500 x g	N	Tubes 500/Bag & Caps 500/Bag	500	
CENTRIFUGE TUBES - 50mL SELF-STANDING			AF, S, R/D F, NP, USP, A, TUBE - PP, CAP - HDPE			
229430	50mL Centrifuge Tube, Self-Standing	6000 x g	Y	25/Re-sealable Bag	500	
229459	TUBE & CAP, 50mL Centrifuge Tube & Cap, Self-Standing	6000 x g	N	Tubes 500/Bag & Caps 500/Bag	500	

15 & 50mL Black Centrifuge Tubes



PROTECT LIGHT SENSITIVE COMPOUNDS!

- Eliminate the need to wrap tubes with aluminum foil
- Large white marking area provides excellent contrast for identification
- Flat surface polyethylene (HDPE) caps feature integrated leak-proof seal
- Convenient zip-closure bag is a practical alternative to folding and taping opened bags
- Available in smaller case quantity of 100 tubes per case or standard 500 tubes per case

BLACK CENTRIFUGE TUBES - BAG

AF, S, R/D F, NP, USP, A, TUBE - PP, CAP - HDPE

Part No.	Product Description	Max RCF	Sterile (Y/N)	Pack Description	Qty/Case
229431	15mL Centrifuge Tube, Black	12000 x g	Y	25/Re-sealable Bag	100
229432	15mL Centrifuge Tube, Black	12000 x g	Y	25/Re-sealable Bag	500
229433	50mL Centrifuge Tube, Black	16000 x g	Y	25/Re-sealable Bag	100
229434	50mL Centrifuge Tube, Black	16000 x g	Y	25/Re-sealable Bag	500

10, 30 & 50mL Oak Ridge Style Centrifuge Tubes

- High speed tubes feature a round bottom and uniform wall thickness
- Tubes are economical and leak-proof for refrigerated or standard centrifugation
- Tube should be filled 80% of total capacity to obtain maximum results



OAK RIDGE STYLE CENTRIFUGE TUBES

AF, N, USP, A, PP

Part No.	Product Description	Max RCF	Sterile (Y/N)	Qty/Case
229460	10mL Oak Ridge Style Centrifuge Tube, Round Bottom	50000 x g	N	12
229461	30mL Oak Ridge Style Centrifuge Tube, Round Bottom	50000 x g	N	12
229462	50mL Oak Ridge Style Centrifuge Tube, Round Bottom	50000 x g	N	12

225, 250 & 500mL Large Volume Centrifuge Tubes

- For applications requiring large volume centrifugation
- Tubes include molded graduation lines
- Polyethylene (HDPE) cap with integrated plug seal provides a secure closure
- Temperature range of -80°C to 120°C
- Use of a rotor cushion is advised to support tubes during centrifugation



LARGE VOLUME CENTRIFUGE TUBES		AF, S, R/D F, NP, USP, A, TUBE - PP, CAP - HDPE			
Part No.	Product Description	Max RCF	Sterile (Y/N)	Pack Description	Qty/Case
229465	225mL Conical Bottom Centrifuge Tube	7500 x g	Y	6/Re-sealable Bag	48
229466	250mL Conical Bottom Centrifuge Tube	7500 x g	Y	6/Re-sealable Bag	48
229463	500mL Conical Bottom Centrifuge Tube	6000 x g	Y	6/Re-sealable Bag	36

250 & 500mL Centrifuge Bottles

- Centrifuge Bottles have a rigid body for low to moderate speed centrifugation of biological and chemical samples
- High quality polycarbonate and polypropylene have excellent chemical resistance
- Reusable and autoclavable
- Use of a rotor cushion is advised to support bottles during centrifugation
- Packaged non-sterile in re-sealable bags



POLYCARBONATE

- Optically clear for high visibility
- Seal cap features integrated silicone gasket for leak-proof seal
- Cap has extended lip to facilitate removal from rotor, and gripping ridges for easy opening and closing
- Bottles include molded graduation lines
- Bottle should be filled 80% of total capacity to obtain maximum results

POLYPROPYLENE

- Translucent and provides chemical resistivity needed for many applications
- Bottle should be filled 80% of total capacity to obtain maximum results

CENTRIFUGE BOTTLES - POLYCARBONATE		AF, N, USP, A, BOTTLE - PC, CAP - PP			
Part No.	Product Description	Max RCF	Sterile (Y/N)	Qty/Case	
229464	250mL Centrifuge Bottle - Polycarbonate	13700 x g	N	4	
229469	500mL Centrifuge Bottle - Polycarbonate	13850 x g	N	4	
CENTRIFUGE BOTTLES - POLYPROPYLENE		AF, N, USP, A, PP			
229467	250mL Centrifuge Bottle - Polypropylene	27500 x g	N	2	
229468	500mL Centrifuge Bottle - Polypropylene	13500 x g	N	2	

15 & 50mL Bio-Reaction Tubes

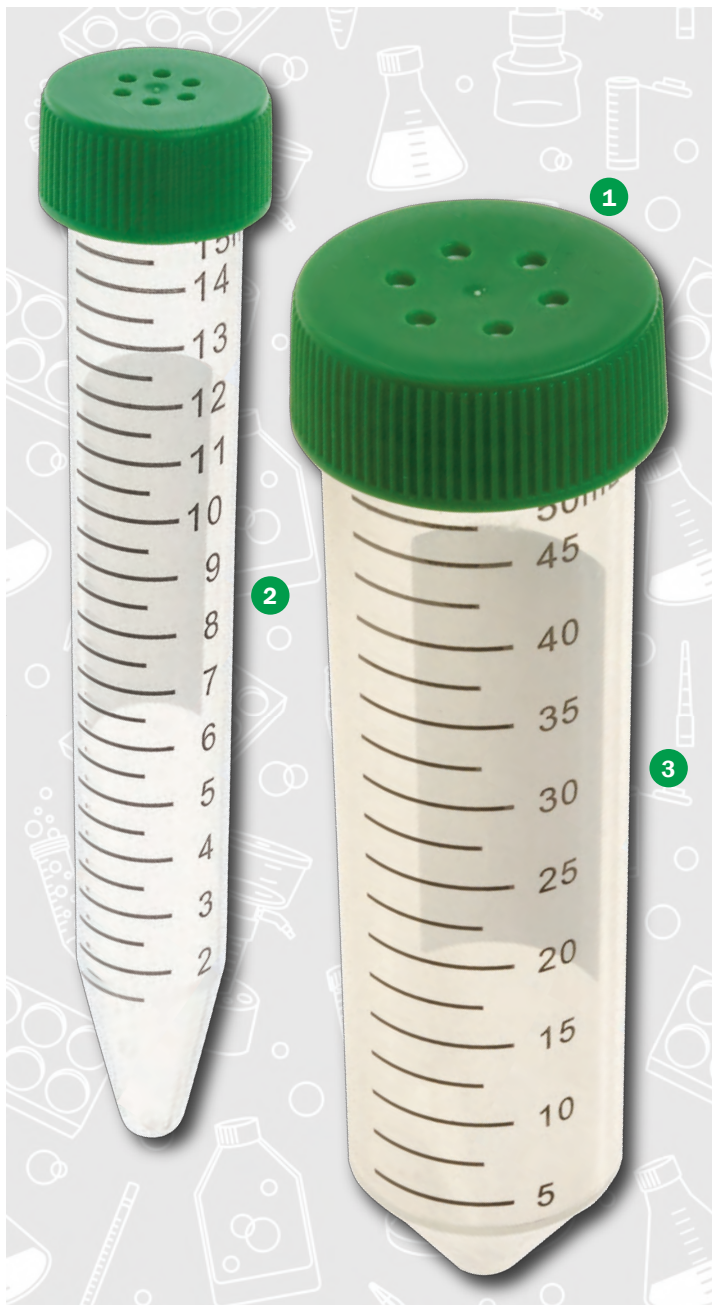

- Bio-reaction tubes offer a convenient and economical option for small scale, high density suspension cell culture
- Ideal for biological reaction applications that require sterile conditions and free gas exchange
- Aseptic conditions are maintained through 0.22µm hydrophobic vented membrane
- Useful in the screening and optimization processes of suspension cells
- Reaction parameters can be optimized using small amounts of materials, maximizing the number of parallel experiments that can be performed simultaneously
- Ideal for suspension cell culture, bacterial growth, seeding larger bioreactors and supporting start-up testing procedures for larger bioreactors
- Can be used for lyophilization

- 1 Feature a 0.22µm hydrophobic membrane in the vent cap
- 2 Easy-to-read black graduations
- 3 Large white marking area



Vent control labels for 50mL Bio-Reaction Tube Caps cover 1 to 5 of the cap vent openings to control the amount of gas exchanged (Part No. 229478)

BIO-REACTION TUBES

AF, S, R/D F, NP, USP, A, TUBE - PP, CAP - HDPE

Part No.	Product Description	Max RCF	Sterile (Y/N)	Pack Description	Qty/Case
229471	15mL Bio-Reaction Tube	12000 x g	Y	10/Re-sealable Bag	100
229472	15mL Bio-Reaction Tube	12000 x g	Y	50/Foam Rack	300
229475	50mL Bio-Reaction Tube	16000 x g	Y	10/Re-sealable Bag	100
229476	50mL Bio-Reaction Tube	16000 x g	Y	25/Foam Rack	300
229479	50mL Self-Standing Bio-Reaction Tube	6000 x g	Y	10/Re-sealable Bag	100

BIO-REACTION TUBE CAPS

AF, S, R/D F, NP, USP, HDPE

229473	CAP ONLY, Vented, Fits 15mL Bio-Reaction Tube	NA	Y	25/Re-sealable Bag	100
229477	CAP ONLY, Vented, Fits 50mL Bio-Reaction Tube	NA	Y	25/Re-sealable Bag	100

BIO-REACTION TUBE VENT CONTROL LABELS

AF, N

229478	Vent Control Label, 50mL Bio-Reaction Tube, Sheet	NA	N	10 Sets/Page	500
--------	---	----	---	--------------	-----

NEW Culture Tubes - Round Bottom



- Dual caps allow for either vented or sealed positions
- 14mL tubes feature molded graduations
- Suitable for Fluorescence-Activated Cell Sorting (FACS) and flow cytometry applications
- Polystyrene tubes are optically clear to visualize cultures
- Polypropylene tubes offer better chemical resistance
- Used for bacterial & suspension cell culture

- 1 2 position dual cap
- 2 Molded graduations (14mL only)
- 3 USP Class VI virgin plastic resins
- 4 Rounded bottom for sample collection



CULTURE TUBES - POLYPROPYLENE			AF, R/D F, NP, USP, A, TUBE - PP, CAP - LDPE			
Part No.	Product Description	Max RCF	Sterile (Y/N)	Pack Description	Qty/Case	
230433	5mL Culture Tube and Dual Cap	3000 x g	Y	25/Re-Sealable Bag	500	
230439	14mL Culture Tube and Dual Cap	3000 x g	Y	25/Re-Sealable Bag	500	
230431	TUBE ONLY, 5mL Culture Tube	3000 x g	N	1000/Re-Sealable Bag	1000	
230437	TUBE ONLY, 14mL Culture Tube	3000 x g	N	1000/Re-Sealable Bag	1000	
CULTURE TUBES - POLYSTYRENE			AF, R/D F, NP, USP, A, TUBE - PS, CAP - LDPE			
230434	5mL Culture Tube and Dual Cap	1400 x g	Y	25/Re-Sealable Bag	500	
230440	14mL Culture Tube and Dual Cap	1400 x g	Y	25/Re-Sealable Bag	500	
230432	TUBE ONLY, 5mL Culture Tube	1400 x g	N	1000/Re-Sealable Bag	1000	
230438	TUBE ONLY, 14mL Culture Tube	1400 x g	N	1000/Re-Sealable Bag	1000	
CULTURE TUBES - DUAL CAP ONLY			AF, R/D F, NP, USP, A, LDPE			
230443	CAP ONLY, 5mL Culture Tube Dual Cap	NA	N	1000/Re-Sealable Bag	1000	
230444	CAP ONLY, 14mL Culture Tube Dual Cap	NA	N	1000/Re-Sealable Bag	1000	

5mL Macro Centrifuge Tubes

- Offers the convenience of a micro centrifuge tube with the ability to process sample volumes up to 5mL
- Tube diameter is the same as a standard 15mL conical bottom centrifuge tube enabling use with existing equipment
- All tubes have frosted marking spot and engraved graduations
- Attached flat top cap is easy to open and close with one hand
- Center of the cap includes a thin “membrane” area designed for easy puncture and access by a syringe/needle
- Opaque black tube protects light sensitive compounds



5ML MACRO CENTRIFUGE TUBES

AF, R/D F, USP, A, PP

Part No.	Product Description	Max RCF	Sterile (Y/N)	Pack Description	Qty/Case
229439	5mL Macro Centrifuge Tube, Black	25000 x g	N	50/Re-sealable Bag	100
229449	5mL Macro Centrifuge Tube	25000 x g	Y	20/Re-sealable Bag	100

0.5, 1.5 & 2.0mL Micro Centrifuge Tubes



- All tubes have a frosted marking spot and engraved graduations
- Attached flat top cap is easy to open and close with one hand
- 1.5mL opaque black tube protects light sensitive compounds

MICRO CENTRIFUGE TUBES

AF, R/D F, NP, USP, A, PP

Part No.	Product Description	Max RCF	Sterile (Y/N)	Pack Description	Qty/Case
230400	0.5mL Micro Centrifuge Tube	25000 x g	Y	500/Re-sealable Bag	1000
230401	0.5mL Micro Centrifuge Tube	25000 x g	N	500/Re-sealable Bag	1000
229440	0.5mL Micro Centrifuge Tube	25000 x g	Y	1000/Re-sealable Bag	5000
229441	1.5mL Micro Centrifuge Tube	25000 x g	N	500/Re-sealable Bag	1000
229442	1.5mL Micro Centrifuge Tube	25000 x g	Y	500/Re-sealable Bag	1000
229443	1.5mL Micro Centrifuge Tube	25000 x g	Y	1000/Re-sealable Bag	5000
229437	1.5mL Micro Centrifuge Tube, Black	25000 x g	Y	500/Re-sealable Bag	1000
230402	2.0mL Micro Centrifuge Tube	25000 x g	Y	500/Re-sealable Bag	1000
230403	2.0mL Micro Centrifuge Tube	25000 x g	N	500/Re-sealable Bag	1000
229446	2.0mL Micro Centrifuge Tube	25000 x g	Y	1000/Re-sealable Bag	5000
229448	2.0mL Micro Centrifuge Tube, Self-Standing	15000 x g	N	500/Re-sealable Bag	5000

Cell Strainers



EXCLUSIVE PESTLE IS AN INEXPENSIVE AND CONVENIENT TOOL FOR USE WITH CELL STRAINERS!

- Can be used for many applications including isolating cells and removing clumps or debris
- Hydrophilic treatment increases flow and reduces the effects of surface tension
- Designed to universally fit most brands of 50mL conical tubes
- The CELLTREAT exclusive pestle design improves manipulation of material in the strainer during use

- 1** Polypropylene housing with nylon mesh filter eliminates the need to fabricate filters from gauze, paper, nylon mesh, or other materials
- 2** Extended lip on housing enables aseptic handling with forceps
- 3** Elongated gripping tab on housing for easy handling
- 4** 5.5 inch pestle length for convenient hand manipulation
- 5** Convex pestle head includes molded textured surface



▲ Cell Strainers are also available bulk packed in re-sealable bags



CELL STRAINERS				AF, S, R/D F, NP, USP, PP	
Part No.	Product Description	Pore Size	Color	Pack Description	Qty/ Case
229481	Cell Strainer	40µm	Blue	Individually Wrapped	50
229482	Cell Strainer	40µm	Blue	10 Bulk Packed/Bag	50
229483	Cell Strainer	70µm	White	Individually Wrapped	50
229484	Cell Strainer	70µm	White	10 Bulk Packed/Bag	50
229485	Cell Strainer	100µm	Yellow	Individually Wrapped	50
229486	Cell Strainer	100µm	Yellow	10 Bulk Packed/Bag	50
229480	Pestle	NA	Green	Individually Wrapped	50

CELLTREAT Freeze Cryogenic Vials

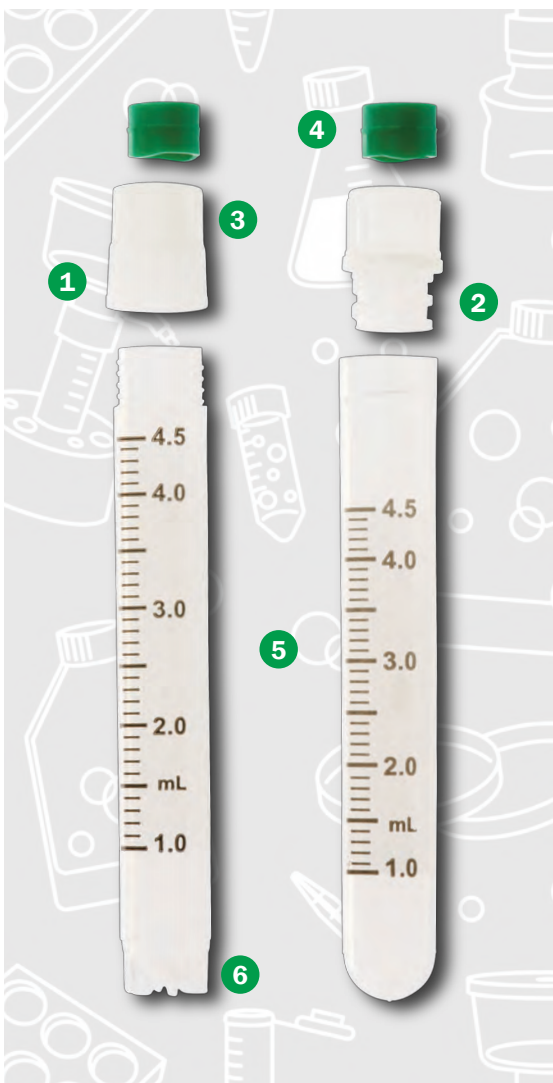

- CELLTREAT Freeze Cryogenic Vials are designed for storing biological material at temperatures as low as -196°C , in the gas phase of liquid nitrogen
- Available in round bottom or self-standing options
- Large white marking area for writing provides backdrop to enhance black graduations

Accessory items also available

- Easily color-code samples with colored cap inserts (see page 40)
- Easy-Grip Workstation Rack and Storage Boxes available to hold and store CELLTREAT Freeze Cryogenic Vials (see page 39)

- 1 External thread cap features integrated leak-proof seal, a long skirt for easy one hand aseptic methods, and a thread design allowing it to be removed or sealed with a mere $1\frac{1}{4}$ turn. External threads also reduce contamination.
- 2 Internal thread cap uses O-ring silicone seal to ensure positive seal at any temperature
- 3 Caps have textured ridges to improve grip when wearing gloves
- 4 Cap Inserts available in 10 different colors to easily color-code samples
- 5 Contrasting black graduations are large and easy to view
- 6 Self-standing bottoms interlock with Easy-Grip Workstation Rack (Part No. 229941) enabling easy one-handed opening

CELLTREAT Freeze Cryogenic Vials

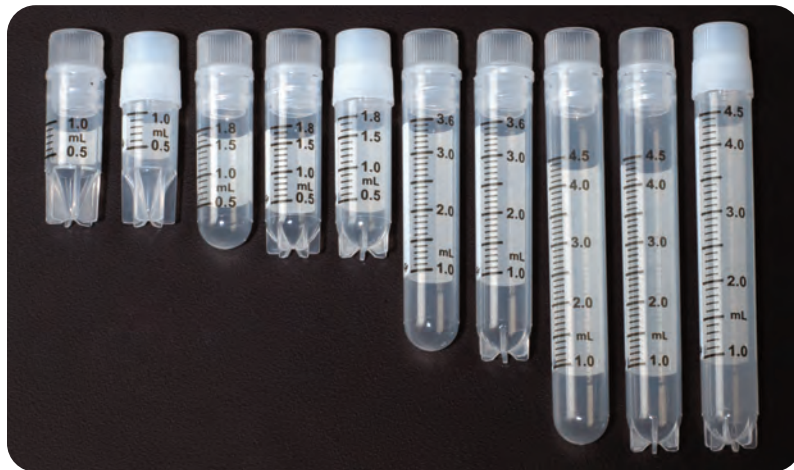

! CELLTREAT product descriptions are based on the highest graduation mark on the vial. Other brands may name vials based on actual liquid capacity which is listed in the table below.

CELLTREAT DESCRIPTION	EQUIVALENT VALUE
1.0mL	1.2mL
1.8mL	2.0mL
3.6mL	4.0mL
4.5mL	5.0mL

CELLTREAT FREEZE CRYOGENIC VIALS - INTERNAL THREAD							AF, S, R/D F, NP, USP, A, PP
Part No.	Product Description	Liquid Capacity	Threading	Base	Pack Description	Qty/Case	
229913	1.0mL CF Cryogenic Vial	1.2mL	Internal	Self-Standing	100/Re-sealable Bag	100	
NEW 229913B	1.0mL CF Cryogenic Vial	1.2mL	Internal	Self-Standing	100/Re-sealable Bag	500	
229914	1.8mL CF Cryogenic Vial	2.0mL	Internal	Round-Bottom	100/Re-sealable Bag	100	
229915	1.8mL CF Cryogenic Vial	2.0mL	Internal	Self-Standing	100/Re-sealable Bag	100	
NEW 229915B	1.8mL CF Cryogenic Vial	2.0mL	Internal	Self-Standing	100/Re-sealable Bag	500	
229916	3.6mL CF Cryogenic Vial	4.0mL	Internal	Round-Bottom	100/Re-sealable Bag	100	
229917	3.6mL CF Cryogenic Vial	4.0mL	Internal	Self-Standing	100/Re-sealable Bag	100	
NEW 229917B	3.6mL CF Cryogenic Vial	4.0mL	Internal	Self-Standing	100/Re-sealable Bag	500	
229918	4.5mL CF Cryogenic Vial	5.0mL	Internal	Round-Bottom	100/Re-sealable Bag	100	
229919	4.5mL CF Cryogenic Vial	5.0mL	Internal	Self-Standing	100/Re-sealable Bag	100	
NEW 229919B	4.5mL CF Cryogenic Vial	5.0mL	Internal	Self-Standing	100/Re-sealable Bag	500	
CELLTREAT FREEZE CRYOGENIC VIALS - EXTERNAL THREAD							AF, S, R/D F, NP, USP, A, PP
229923	1.0mL CF Cryogenic Vial	1.2mL	External	Self-Standing	100/Re-sealable Bag	100	
NEW 229923B	1.0mL CF Cryogenic Vial	1.2mL	External	Self-Standing	100/Re-sealable Bag	500	
229925	1.8mL CF Cryogenic Vial	2.0mL	External	Self-Standing	100/Re-sealable Bag	100	
NEW 229925B	1.8mL CF Cryogenic Vial	2.0mL	External	Self-Standing	100/Re-sealable Bag	500	
229929	4.5mL CF Cryogenic Vial	5.0mL	External	Self-Standing	100/Re-sealable Bag	100	
NEW 229929B	4.5mL CF Cryogenic Vial	5.0mL	External	Self-Standing	100/Re-sealable Bag	500	

CELLTREAT Freeze Cryogenic Vial Workstation Rack

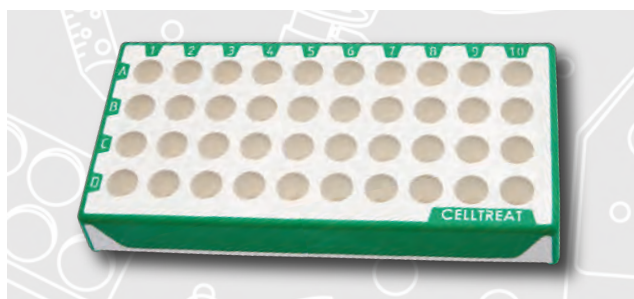

- Individual positions feature ribs which interlock with CELLTREAT Freeze Self Standing Cryogenic Vials for easy one-handed opening and closing
- Features four gripping feet for increased stability and reduced slipping during use
- Low-profile design for maximum storage efficiency
- Labeled with alpha-numeric markings for easy identification of individual positions

CELLTREAT FREEZE CRYOGENIC VIAL WORKSTATION RACK			AF, N, A, PP
Part No.	Product Description	Qty/Case	
229941	Easy-Grip Workstation Rack, CF Cryogenic Vial, 40 Place	2/Re-sealable Bag	

CELLTREAT Freeze Cryogenic Vial Storage Boxes

- Durable polycarbonate material designed to withstand a wide temperature range and is a reusable, autoclavable alternative to disposable boxes
- Ventilation holes in the lids and bases prevent vacuum sealing in freezer
- Storage Boxes are labeled with numeric markings for easy identification of individual positions
- Safe to use at ultra-low temperatures
- 100 place box features ridges along the sides to improve handling

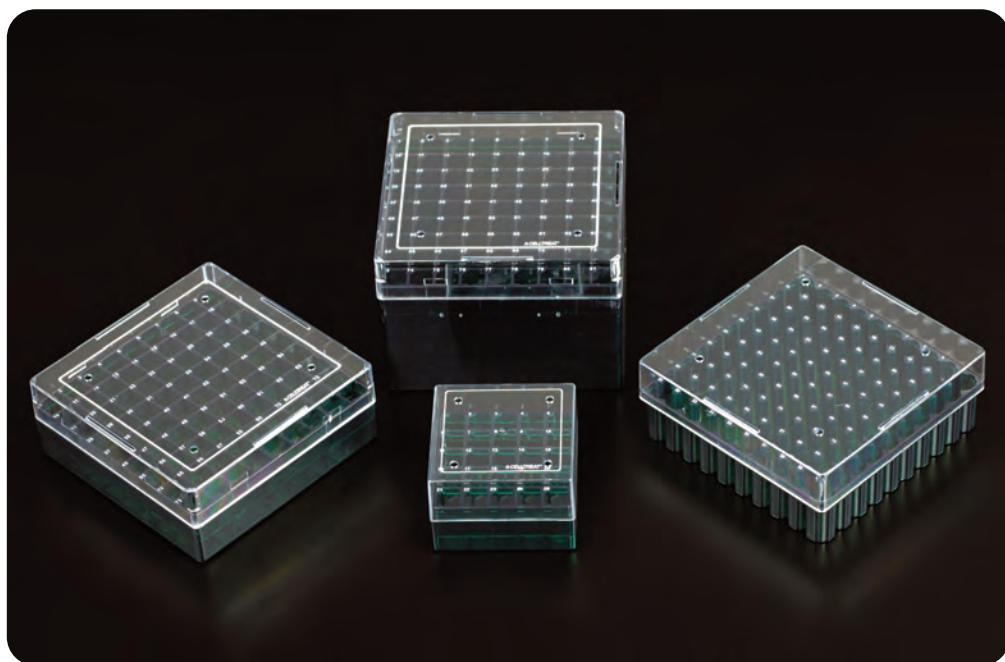

CELLTREAT FREEZE CRYOGENIC VIAL STORAGE BOXES

AF, N, R/D F, NP, USP, A, PC

Part No.	Product Description	Compatible With	Qty/Case
229942	Storage Box, CF Cryogenic Vial, 25 Place	Fits 1mL-1.8mL vials	5
229943	Storage Box, CF Cryogenic Vial, 81 Place	Fits 1mL-1.8mL vials	5
229945	Storage Box, CF Cryogenic Vial, 100 Place	Fits 1mL-1.8mL vials	5
229944	Deep Storage Box, CF Cryogenic Vial, 81 Place	Fits 4.5mL vials	5

CELLTREAT Freeze Cryogenic Vial Cap Inserts



- Easily color-code samples with colored cap inserts
- CELLTREAT Freeze Cap Inserts are compatible with all CELLTREAT Freeze Cryogenic Vials

CELLTREAT FREEZE CRYOGENIC VIALS - CAP INSERTS

AF, N, R/D F, NP, USP, PP

Part No.	Product Description	Color	Pack Description	Qty/Case
229930	Cap Insert for CF Cryogenic Vials	Red	500 Bulk Packed/Re-sealable Bag	500
229931	Cap Insert for CF Cryogenic Vials	Orange	500 Bulk Packed/Re-sealable Bag	500
229932	Cap Insert for CF Cryogenic Vials	Yellow	500 Bulk Packed/Re-sealable Bag	500
229933	Cap Insert for CF Cryogenic Vials	Green	500 Bulk Packed/Re-sealable Bag	500
229934	Cap Insert for CF Cryogenic Vials	Blue	500 Bulk Packed/Re-sealable Bag	500
229935	Cap Insert for CF Cryogenic Vials	Purple	500 Bulk Packed/Re-sealable Bag	500
229936	Cap Insert for CF Cryogenic Vials	Pink	500 Bulk Packed/Re-sealable Bag	500
229937	Cap Insert for CF Cryogenic Vials	Brown	500 Bulk Packed/Re-sealable Bag	500
229938	Cap Insert for CF Cryogenic Vials	Gray	500 Bulk Packed/Re-sealable Bag	500
229939	Cap Insert for CF Cryogenic Vials	White	500 Bulk Packed/Re-sealable Bag	500
229940	Cap Insert for CF Cryogenic Vials	Assorted	500 Bulk Packed/Re-sealable Bag	500

Transport Tubes



- Transport tubes offer advanced seal and extended HDPE deep cap to prevent leaking when shipping samples
- Compliant with 95kPa IATA Packaging Instruction 650
- Cap is designed to accommodate swab for transport, and is easily sealed or removed with a single turn
- Self-standing base allows use without racks
- Round bottom maximizes liquid retrieval and will not pinch swabs
- High-quality, medical grade virgin polypropylene is transparent for viewing samples, shatterproof and resistant to heat and cold
- Convenient zip-closure bag is a practical alternative to folding and taping opened bags
- **NEW** - Now available in red cap option

TRANSPORT TUBES

AF, S, R/D F, NP, A, TUBE - PP, CAP - HDPE

Part No.	Product Description	Cap Color	Pack Description	Qty/Case
230417	12mL Transport Tube	Green	100/Re-sealable Bag	500
230418	12mL Transport Tube - Tubes & Caps Separate	Green	Tubes 100/Bag & Caps 100/Bag	500
230419	12mL Transport Tube - Tubes & Caps Separate	Green	Tubes 100/Bag & Caps 100/Bag	1000
NEW 230419R	12mL Transport Tube - Tubes & Caps Separate	Red	Tubes 100/Bag & Caps 100/Bag	1000

0.5, 1.5 & 2.0mL Screw Top Micro Tubes



Product Family Categories:

- Sterile Assemblies (Tube with Green Grip Cap)
- Cap Only (Grip Cap, Opaque Cap, Translucent Cap)
- Tube Only (Conical Bottom & Self-Standing)

- High temperature resistivity range – shatter/crack resistant and ideal for boiling
- Temperature range of -196°C to 121°C
- Max RCF = 20000 x g
- Easy ¾ turn to open and close
- Sterile Assemblies packed in self-standing re-sealable bags offer a unique storage solution
- Translucent and Opaque Cap O-rings ensure leak-proof seal
- Translucent and Opaque Cap O-rings are a highly visible contrasting color
- Caps are available in various colors for easy identification and color-coding
- Caps are compatible with all CELLTREAT brand Screw Top Micro Tubes
- Autoclavable



- 1 Grip band tubes feature ribs that provide exceptional gripping surface and lessen movement during centrifugation
- 2 Graduated tubes have markings every 100µL for easy volume identification
- 3 Premium Grip Cap features molded TPE sealing rings which ensure O-ring will never slip out of place; striped TPE grips on cap edge enable secure handling under all conditions

SCREW TOP MICRO TUBES - STERILE ASSEMBLIES

AF, S, R/D F, NP, USP, A, TUBE - PP, CAP - PP & TPE





















Part No.	Product Description	Tube Feature	Cap Feature	Base	Pack Description	Qty/ Case
230810	0.5mL Sterile Assemblies	Grip Band	Green Grip Cap	Self-Standing	50/Re-sealable Bag	500
230820	1.5mL Sterile Assemblies	Grip Band	Green Grip Cap	Self-Standing	50/Re-sealable Bag	500
230830	2.0mL Sterile Assemblies	Grip Band	Green Grip Cap	Self-Standing	50/Re-sealable Bag	500

0.5, 1.5 & 2.0mL Screw Top Micro Tubes

SCREW TOP MICRO TUBES - TUBE ONLY						AF, N, R/D F, NP, USP, A, PP	
Part No.	Product Description	Tube Feature	Base	Sterile (Y/N)	Pack Description	Qty/Case	
230811	0.5mL Tube Only	Grip Band	Self-Standing	N	500/Re-sealable Bag	1000	
NEW 230811S	0.5mL Tube Only	Grip Band	Self-Standing	Y	500/Re-sealable Bag	1000	
230823	1.5mL Tube Only	Graduated	Conical	N	500/Re-sealable Bag	1000	
230821	1.5mL Tube Only	Grip Band	Self-Standing	N	500/Re-sealable Bag	1000	
NEW 230821S	1.5mL Tube Only	Grip Band	Self-Standing	Y	500/Re-sealable Bag	1000	
230833	2.0mL Tube Only	Graduated	Conical	N	500/Re-sealable Bag	1000	
230831	2.0mL Tube Only	Grip Band	Self-Standing	N	500/Re-sealable Bag	1000	
NEW 230831S	2.0mL Tube Only	Grip Band	Self-Standing	Y	500/Re-sealable Bag	1000	

SCREW TOP MICRO TUBES - CAP ONLY

Screw Top Micro Tube Caps are packed non-sterile, 500/Re-sealable Bag, 1000/Case

CAP COLOR		Grip Cap		Opaque Cap		Translucent Cap
Assorted		230840A		230841A		230842A 230842AS - Sterile
Blue		230840B		230841B		230842B
Clear		230840C		NA		230842C 230842CS - Sterile
Green		230840G		230841G		230842G
Orange		230840N		230841N		230842N
Purple		230840P		230841P		230842P
Red		230840R		230841R		230842R
Yellow		230840Y		230841Y		230842Y

Lab Grab Multi-Use Extension Grabber



- Allows hands-free and easy grasping of small items, as well as hot or cold samples
- Large extension radius to pick up small to mid-sized objects including cryogenic vials, screw top micro tubes, micro centrifuge tubes and cell strainers
- Retraction feature aids in stability and strength of grip
- Textured handle prevents slipping when wearing gloves
- All-metal construction allows autoclaving

LAB GRAB MULTI-USE EXTENSION GRABBER				AF, N, A
Part No.	Product Description	Pack Description	Qty/Case	
230110	Lab Grab Multi-Use Extension Grabber	2/Bag	2	

ali-Q™ 2 - Pipet Controller

 **ali-Q™ 2**
aliquoting pipet controller



REPEAT PIPETTING IS FASTER & EASIER WITH ALI-Q 2
You'll be impressed how light it is!

Turn the dial to set your exact aliquot volume

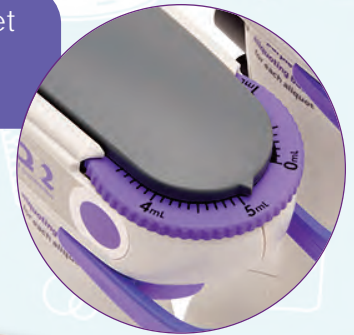

Set your ideal speed for any solution or application (VS model only)



4

5

6

7

8

3

1

2

Press and hold purple aliquoting button for each aliquot

No need to watch the lines!
Take the guesswork out of repeat pipetting

Press and hold aliquot button for accurate dispensing



ali-Q™ 2 - Pipet Controller



THE NEW POWER COUPLE
ali-Q 2 & Wobble-not Serological Pipets
(see pages 52-53)



- 1 Aliquot button allows for accurate repeat pipetting
- 2 Aspirate & dispense like a traditional pipet controller
- 3 Universal nosepiece accepts any size serological pipet
- 4 Variable speed dial (VS model only)
- 5 LED charging status indicator
- 6 Aliquot volume dial
- 7 Lithium-ion battery charges with included USB-C 40 hour battery life
- 8 Removable kickstand prevents contact with surfaces when resting



Learn more!

See the video.

Discover the difference.



All ali-Q 2 models operate as both a regular and repeat pipet controller.
2 pieces of equipment in 1 unit!

Part Number 2100-1005

MOST POPULAR! ALI-Q 2 VS - Variable Speed

- VS (Variable Speed) model has additional dial on top for aliquoting speed adjustments
- Versatile tool is suitable for a wide array of solutions and applications
- Volume range of 0.5 to 5.0mL

Part Number 2100-0005

ALI-Q 2 - High Speed

- Handles like a traditional pipet controller, with additional aliquoting function
- Volume range of 0.5 to 5.0mL

Part Number 2100-0003

ALI-Q 2 LS - Low Speed

- Aliquoting speed is approximately 50% slower with the LS (Low Speed) model than the ali-Q 2, allowing for gentle dispensing every time
- LS model features white numbers on the dial to easily differentiate from the other ali-Q models
- Volume range of 0.3 to 3.0mL



Pipet Controller - Automatic

- Lightweight (6.3oz/170g) and designed to fit comfortably in either hand
- Long-life rechargeable lithium battery provides up to 8 hours of use on a two hour charge

- 1 Adjustable dial for powered or gravimetric speed setting
- 2 Attached kickstand prevents contact with surfaces when resting the Pipet Controller
- 3 Low pressure fingertip control buttons
- 4 Easy fit adapter accepts pipet sizes from 1 to 100mL



PIPET CONTROLLER			
Part No.	Product Description	Pack Description	Qty/Case
230200	Pipet Controller, 120V	Individual	1
230202	AC Adapter, Replacement, 120V	Individual	1
230204	Battery, Replacement	Individual	1
230205	Rubber Grommet, Replacement	Individual	1
230206	Filter, Replacement, 0.45µm	2/Bag	2

Pipet Controller - Manual



- Lightweight manual pipet controller does not require batteries
- Compatible with 1-100mL serological pipets
- Economical backup option for automatic pipet controller

- 1 Squeeze bulb creates pressure to draw fluid up into pipets; up to 50mL per squeeze
- 2 Ergonomic thumb lever controls speed of aspirating and dispensing
- 3 Press button blows out remaining drops in pipet

PIPET CONTROLLER			
Part No.	Product Description	Pack Description	Qty/Case
230210	Pipet Controller, Manual	Individual	1
230211	Replacement Filter, 3µm	2/Bag	2

Pipet Storage Rack

- Durable ABS plastic rack can stand on flat surfaces or attach to the metal sides of lab cabinets and appliances

- 1 Strong magnets are included on both sides for increased versatility
- 2 Angled shelves provide secure yet easy access to pipets
- 3 Pipet sizes, colors and types can be viewed from the side windows and front
- 4 Side bracket can hold pipet controllers, bulbs and pumps

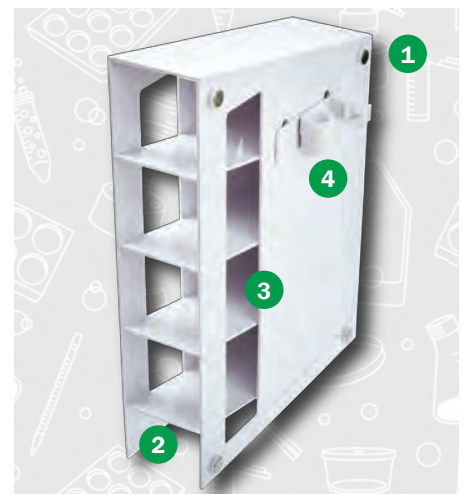

PIPET STORAGE RACK			ABS
Part No.	Product Description	Qty/Case	
230295	Pipet Storage Rack	1	

Aspirating Pipets



- Ideal for aspiration of media and sample waste removal without needing to measure the volume
- Aspirating Pipets are supplied without graduations or plugs
- Available individually wrapped in paper/plastic wrappers or bulk packed in bags
- 2mL Aspirating Pipet (Part No. 229262A) also available in plastic/plastic wrap, the ideal option for eliminating particulate; proven benefit over traditional paper/plastic wrapper

ASPIRATING PIPETS - PAPER/PLASTIC WRAP

AF, S, R/D F, NP, USP, PS

Part No.	Product Description	Pack Description	Qty/ Case
229251	1mL Aspirating Pipet	25 Bulk Packed/Bag	400
229252	2mL Aspirating Pipet	25 Bulk Packed/Bag	400
229255	5mL Aspirating Pipet	25 Bulk Packed/Bag	200
229261	1mL Aspirating Pipet	100 Individually Wrapped/Bag	400
229262	2mL Aspirating Pipet	100 Individually Wrapped/Bag	400
229265	5mL Aspirating Pipet	50 Individually Wrapped/Bag	200
229247	10mL Aspirating Pipet	50 Individually Wrapped/Bag	200
229248	25mL Aspirating Pipet	50 Individually Wrapped/Bag	200
229249	50mL Aspirating Pipet	25 Individually Wrapped/Bag	100

ASPIRATING PIPETS - PLASTIC/PLASTIC WRAP

AF, S, R/D F, NP, USP, PS

229262A	2mL Aspirating Pipet	100 Individually Wrapped/Bag	400
---------	----------------------	------------------------------	-----

Polystyrene Plasteur® Pipets



- The Plasteur Plastic Pasteur Pipet offers the aspirating precision of a glass pipet and the safety benefits of plastic
- Available in 5.75 and 9 inch lengths for easier handling and longer reach when working with larger vessels
- Sterile

Plasteur Pipet Selection Guide

Not sure which Plasteur Pipet to choose? Use the selection guide below to select whether Polystyrene or Polypropylene is the best option for you.

	POLYSTYRENE	POLYPROPYLENE
Autoclavable		X
Chemically Compatible		X
Precision Tip	X	
Flexible		X
High Clarity	X	



PLASTEUR PLASTIC PASTEUR PIPETS - POLYSTYRENE

AF, S, R/D F, NP, USP, PS

Part No.	Product Description	Length	Sterile (Y/N)	Pack Description	Qty/Case
229270	Plasteur Pipet - Polystyrene	5.75 inch	Y	50 Individually Wrapped/Bag	200
229275	Plasteur Pipet - Polystyrene	5.75 inch	Y	25 Bulk Packed/Re-sealable Bag	500
229280	Plasteur Pipet - Polystyrene	9 inch	Y	50 Individually Wrapped/Bag	200
229285	Plasteur Pipet - Polystyrene	9 inch	Y	25 Bulk Packed/Re-sealable Bag	500
229279	Aspirating Bulb	NA	N	12/Re-sealable Bag	12

Polypropylene Plasteur® Pipets

Don't let a pain in the glass ruin your day!



- CELLTREAT brand Plasteur Plastic Pasteur Pipets offer the aspirating precision of a glass pipet and the safety benefits of plastic
- Polypropylene provides the chemical resistivity needed for many applications; a chemical compatibility guide is available at www.celltreat.com

SAFETY

- No more broken glass - more durable than standard glass pipets
- Flexible plastic helps prevent glove or skin punctures

CONVENIENCE

- Available packaged sterile individually wrapped or bulk packed
- Also available packaged non-sterile in re-sealable bags or tab lock boxes

EFFICIENCY

- Will not shatter, eliminating losses due to broken glass
- Polypropylene is chemical resistant and autoclavable

VALUE

- No damage during shipping and handling unlike traditional glass pipets
- Eliminate "sharps" disposal cost
- Polypropylene material can be autoclaved

PLASTEUR PLASTIC PASTEUR PIPETS - POLYPROPYLENE

AF, USP, A, PP

Part No.	Product Description	Length	Sterile (Y/N)	Pack Description	Qty/Case
229271	Plasteur Pipet - Polypropylene	5.75 Inch	Y	50 Individually Wrapped/Bag	200
229276	Plasteur Pipet - Polypropylene	5.75 Inch	Y	25 Bulk Packed/Re-sealable Bag	500
229277	Plasteur Pipet - Polypropylene	5.75 Inch	N	100 Bulk Packed/Re-sealable Bag	500
229274	Plasteur Pipet - Polypropylene	5.75 Inch	N	200 Bulk Packed/Tab Lock Box	1000
229281	Plasteur Pipet - Polypropylene	9 Inch	Y	50 Individually Wrapped/Bag	200
229286	Plasteur Pipet - Polypropylene	9 Inch	Y	25 Bulk Packed/Re-sealable Bag	500
229287	Plasteur Pipet - Polypropylene	9 Inch	N	100 Bulk Packed/Re-sealable Bag	500
229284	Plasteur Pipet - Polypropylene	9 Inch	N	200 Bulk Packed/Tab Lock Box	1000

Pipet Selection Guide



STANDARD SEROLOGICAL PIPETS - P. 52-57

All serological pipets are manufactured to the ASTM Standard Specification for Serological Pipets E-934; Accuracy is $\pm 2\%$.

CELLTREAT brand Serological Pipets are available in a wide range of sizes from 1-100mL, with a variety of unique packaging options including:

- individually wrapped paper/plastic
- Individually wrapped plastic/plastic
- bulk packed
- dispenser carton

Please refer to pages 52-58 for additional information on pipet options.



WOBBLE-NOT™ SEROLOGICAL PIPETS HAVE A PATENTED, INNOVATIVE 2-TIER STEP DESIGN AT THE PLUG END!

(see pages 52 & 53) ▼

Premium polymer fiber barrier plug outperforms cotton plugs



Pipet Selection Guide

SHORT SEROLOGICAL PIPETS - P. 53 & 58

- Compact design provides ergonomic benefit and reduces storage space

OPEN END PIPETS - P. 58

- Wide, open end is ideal for slurries, gels, viscous and high particulate solutions

BACTERIOLOGICAL/MILK PIPETS - P. 58

- Used primarily in the examination of dairy products, milk or bacteria

ASPIRATING PIPETS - P. 47

- Ideal for aspiration of media and sample waste removal

PLASTEUR® PIPETS - P. 48 & 49

- Offers the aspirating precision of a glass pipet and the safety benefits of plastic



NEW Serological Pipets - Wobble-not™



PATENTED, INNOVATIVE 2-TIER STEP DESIGN AT THE PLUG END!

Wobble-not™
No Wobble. No Drip.

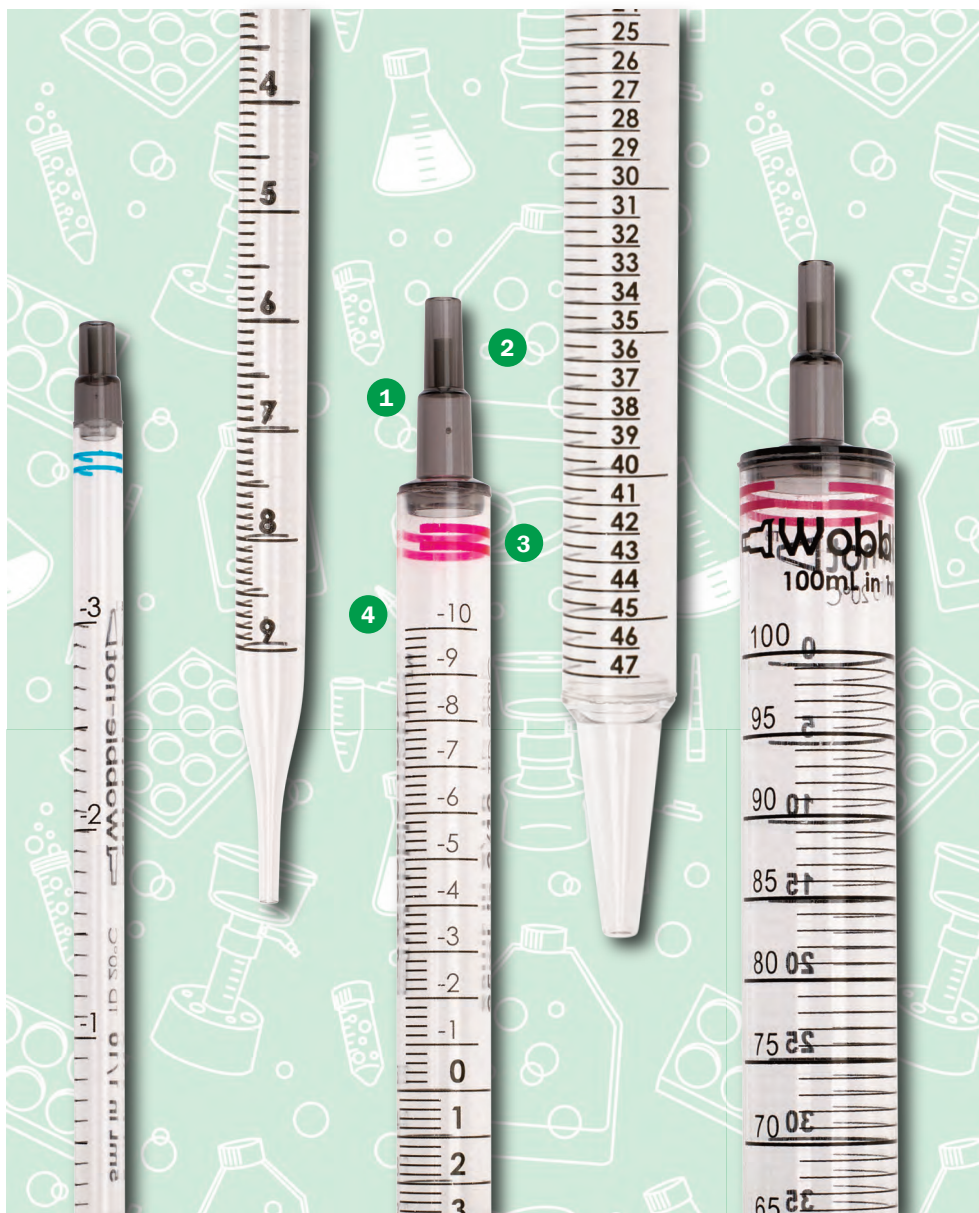

Patented design is compatible with any pipet controller

- 1** Two-tier step design increases stability
No Wobble. No Drip.
- 2** Premium polymer fiber barrier plug
- 3** Color-coded stripes for quick volume identification
- 4** CELLTREAT branded 25 & 50mL pipets feature negative graduations to -10mL

Wobble-not Serological pipets are available in both CELLTREAT and VistaLab brand packaging to make it easier for customers around the world to have access to this differentiated product.

CELLTREAT

WOBBLE-NOT - INDIVIDUALLY WRAPPED (PAPER/PLASTIC) IN BAGS

AF, S, R/D F, NP, USP, PS

Part No.	Product Description	Negative Graduations	Pack Description	Qty/Case
229091B	5mL Wobble-not Serological Pipet	-3mL	50 Individually Wrapped/Bag	200
229092B	10mL Wobble-not Serological Pipet	-3mL	50 Individually Wrapped/Bag	200
229093B	25mL Wobble-not Serological Pipet	-10mL	25 Individually Wrapped/Bag	200
229094B	50mL Wobble-not Serological Pipet	-10mL	25 Individually Wrapped/Bag	100
229095B	100mL Wobble-not Serological Pipet	NA	10 Individually Wrapped/Bag	50

SEROLOGICAL PIPETS REIMAGINED

Your serological pipet just graduated to the next level

- Wobble-not serological pipets require less insertion force due to the patented, innovative 2-tier step design
- Wobble-nots are the only serological pipets that will give you two zones of contact in your pipet controller's nozzle, to increase stability and reduce dripping
- Ultra-clear markings and color-coded stripes for quick volume identification
- Accuracy \pm 2% at full volume
- Ideal liquid handling partner when paired with ali-Q™ 2 Pipet Controller, see pages 44-45

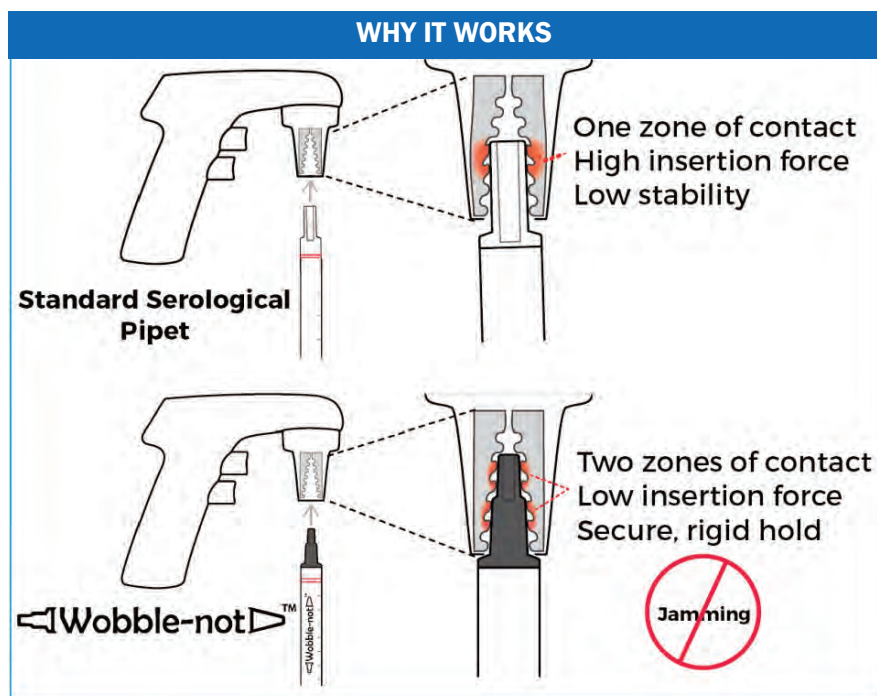

VISTALAB

WOBBLE-NOT - INDIVIDUALLY WRAPPED (PAPER/PLASTIC) IN BAGS

AF, S, R/D F, NP, USP, PS

Part No.	Product Description	Negative Graduations	Pack Description	Qty/ Case
4090-0005	5mL Wobble-not Serological Pipet	-3mL	50 Individually Wrapped/Bag	200
4090-0010	10mL Wobble-not Serological Pipet	-3mL	50 Individually Wrapped/Bag	200
4090-0025	25mL Wobble-not Serological Pipet	-8mL	25 Individually Wrapped/Bag	200
4090-0050	50mL Wobble-not Serological Pipet	-8mL	25 Individually Wrapped/Bag	100
4090-0100	100mL Wobble-not Serological Pipet	NA	10 Individually Wrapped/Bag	50

WOBBLE-NOT - INDIVIDUALLY WRAPPED (PLASTIC/PLASTIC) IN BAGS

AF, S, R/D F, NP, USP, PS

4190-0005	5mL Wobble-not Serological Pipet	-3mL	50 Individually Wrapped/Bag	200
4190-0010	10mL Wobble-not Serological Pipet	-3mL	50 Individually Wrapped/Bag	200
4190-0025	25mL Wobble-not Serological Pipet	-8mL	25 Individually Wrapped/Bag	200
4190-0050	50mL Wobble-not Serological Pipet	-8mL	25 Individually Wrapped/Bag	100
4190-0100	100mL Wobble-not Serological Pipet	NA	10 Individually Wrapped/Bag	50

WOBBLE-NOT - BULK PACKED IN BAGS

AF, S, R/D F, NP, USP, PS

4290-0005	5mL Wobble-not Serological Pipet	-3mL	25 Bulk Packed/Bag	500
4290-0010	10mL Wobble-not Serological Pipet	-3mL	25 Bulk Packed/Bag	400
4290-0025	25mL Wobble-not Serological Pipet	-8mL	10 Bulk Packed/Bag	150
4290-0050	50mL Wobble-not Serological Pipet	-8mL	10 Bulk Packed/Bag	100
4290-0100	100mL Wobble-not Serological Pipet	NA	10 Bulk Packed/Bag	60

SHORTY WOBBLE-NOT - INDIVIDUALLY WRAPPED (PAPER/PLASTIC) IN BAGS

AF, S, R/D F, NP, USP, PS

5090-0010	10mL Wobble-not Serological Pipet, Short	-10mL	25 Individually Wrapped/Bag	200
5090-0025	25mL Wobble-not Serological Pipet, Short	-10mL	25 Individually Wrapped/Bag	100

Best Value Serological Pipets



SEROLOGICAL PIPETS - INDIVIDUALLY WRAPPED (PAPER/PLASTIC) IN BAGS

AF, S, R/D F, NP, USP, PS

Part No.	Product Description	Negative Graduations	Pack Description	Qty/ Case
229001B	1mL Serological Pipet	-0.3mL	100 Individually Wrapped/Bag	500
229002B	2mL Serological Pipet	-0.5mL	100 Individually Wrapped/Bag	500
229005B	5mL Serological Pipet	-3mL	50 Individually Wrapped/Bag	200
229010B	10mL Serological Pipet	-3mL	50 Individually Wrapped/Bag	200
229212B	10mL Serological Pipet, Wide Tip	-3mL	50 Individually Wrapped/Bag	200
229025B	25mL Serological Pipet	-10mL	50 Individually Wrapped/Bag	200
229030B	50mL Serological Pipet	-10mL	25 Individually Wrapped/Bag	100
229220B	100mL Serological Pipet	NA	10 Individually Wrapped/Bag	50

SEROLOGICAL PIPETS - BULK PACKED IN BAGS

AF, S, R/D F, NP, USP, PS

Part No.	Product Description	Negative Graduations	Pack Description	Qty/ Case
229231	1mL Serological Pipet	-0.3mL	25 Bulk Packed/Re-sealable Bag	1000
229232	2mL Serological Pipet	-0.5mL	25 Bulk Packed/Re-sealable Bag	800
229235	5mL Serological Pipet	-3mL	25 Bulk Packed/Re-sealable Bag	500
229240	10mL Serological Pipet	-3mL	25 Bulk Packed/Re-sealable Bag	500
229245	25mL Serological Pipet	-10mL	25 Bulk Packed/Re-sealable Bag	200
229250	50mL Serological Pipet	-10mL	25 Bulk Packed/Re-sealable Bag	200

Best Value Serological Pipets



1, 2, 5 & 10mL Serological Pipets



10mL Standard vs. 10mL Wide Tip Pipet

All serological pipets are manufactured to the ASTM Standard Specification for Serological Pipets E-934; Accuracy is $\pm 2\%$

- 1 Bi-directional (ascending & descending) graduations are printed in bold easy-to-read black ink
- 2 10mL Wide Tip Serological Pipet for viscous solutions - Wide Tip opening is 4x larger than standard 10mL pipet
- 3 25 & 50mL pipets feature an anti-drip tip for accurate delivery
- 4 Premium polymer fiber barrier plug outperforms cotton plugs
- 5 Color coded stripes and packaging enable quick volume identification
- 6 Printed indicator arrow for quickly locating negative graduations when using a pipet controller



Serological Pipets - Double Case



**SAVE UP TO 65%
ON SHIPPING COSTS**

- Your favorite serological pipets, now available in double case quantities
- Same great features as standard pipets (see page 55) with a cost savings over buying 2 individual cases
- Reduce your order frequency and cardboard waste



SEROLOGICAL PIPETS - INDIVIDUALLY WRAPPED IN BAGS			AF, S, R/D F, NP, USP, PS
Part No.	Product Description	Pack Description	Qty/Case
229006B	5mL Serological Pipet	50 Individually Wrapped/Bag	400
229011B	10mL Serological Pipet	50 Individually Wrapped/Bag	400
229026B	25mL Serological Pipet	50 Individually Wrapped/Bag	400
229031B	50mL Serological Pipet	25 Individually Wrapped/Bag	200

Serological Pipets - Plastic/Plastic Wrap

- Peel-to-open plastic/plastic wrappers are the ideal option for eliminating particulate; proven benefit over traditional paper/plastic wrapper
- The all-plastic wrapper can be wiped with alcohol without smearing ink or penetrating wrapper
- Wrappers have reduced static cling compared to other brands of plastic wrap pipets
- Same great features as standard pipets (see page 55)
- 100mL pipet is ideal for large volume pipetting
- Also available in 2mL Aspirating Pipet



**WOBBLE-NOT PIPETS ALSO AVAILABLE
IN PLASTIC/PLASTIC WRAP!**

(see page 53)

SEROLOGICAL PIPETS - PLASTIC/PLASTIC WRAP			AF, S, R/D F, NP, USP, PS
Part No.	Product Description	Pack Description	Qty/Case
229201A	1mL Serological Pipet	100 Individually Wrapped/Bag	800
229202A	2mL Serological Pipet	100 Individually Wrapped/Bag	600
229205A	5mL Serological Pipet	50 Individually Wrapped/Bag	200
229210A	10mL Serological Pipet	50 Individually Wrapped/Bag	200
229225A	25mL Serological Pipet	50 Individually Wrapped/Bag	200
229230A	50mL Serological Pipet	30 Individually Wrapped/Bag	90
229220A	100mL Serological Pipet	10 Individually Wrapped/Bag	50

ASPIRATING PIPETS - PLASTIC/PLASTIC WRAP			AF, S, R/D F, NP, USP, PS
229262A	2mL Aspirating Pipet	100 Individually Wrapped/Bag	400

Classic Serological Pipets

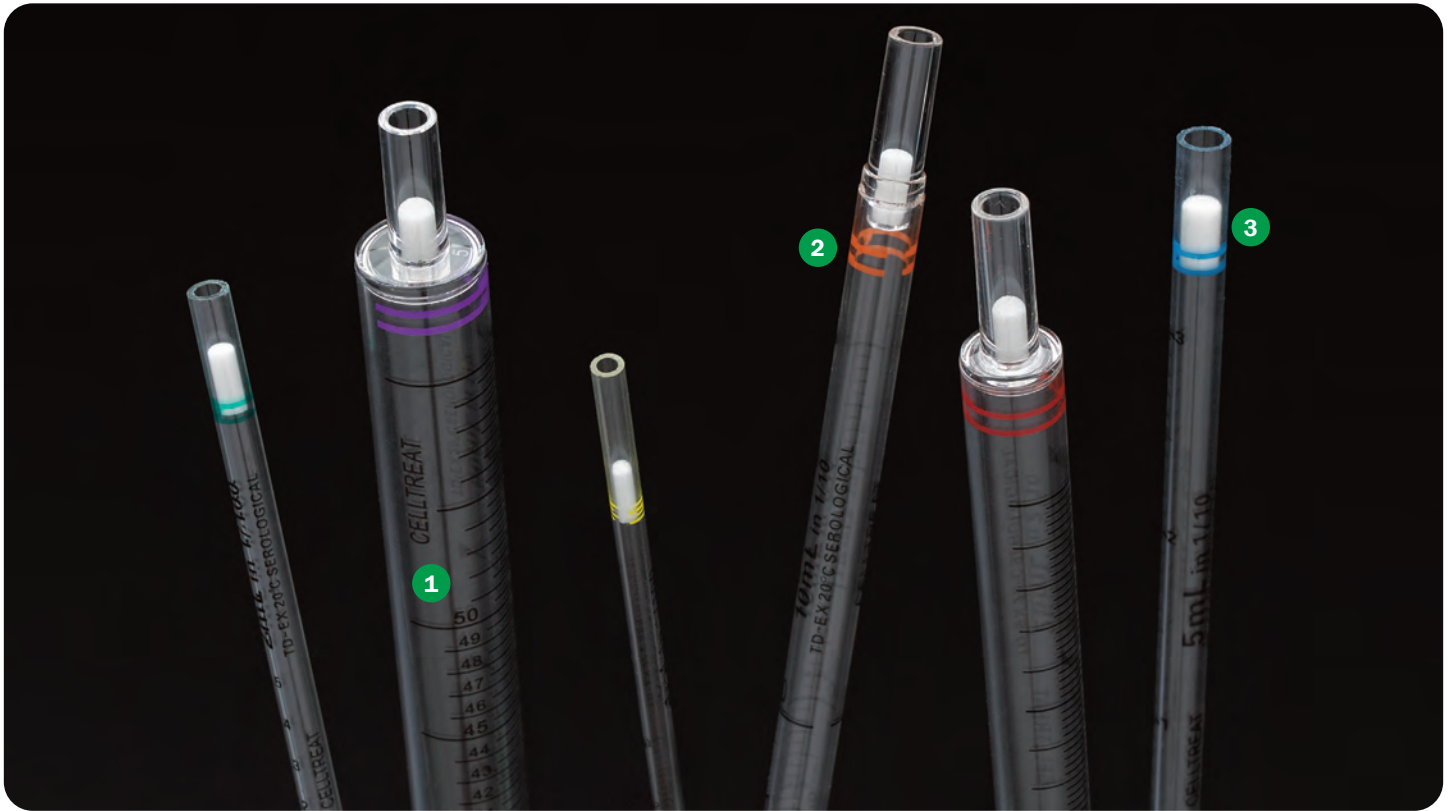

- 1 Bi-directional graduations are printed in bold easy-to-read black ink
- 2 Color coded stripes and packaging enable quick volume identification
- 3 Premium polymer fiber barrier plug outperforms cotton plugs

Assorted packaging options:

- 4 Individually wrapped and packed in bags
- 5 Individually wrapped in convenient shelf carton
- Also available individually wrapped in plastic/plastic wrapper (see page 56 for details)



SEROLOGICAL PIPETS - INDIVIDUALLY WRAPPED IN BAGS **AF, S, R/D F, NP, USP, PS**

Part No.	Product Description	Pack Description	Qty/Case
229201B	1mL Serological Pipet	100 Individually Wrapped/Bag	800
229202B	2mL Serological Pipet	100 Individually Wrapped/Bag	600
229205B	5mL Serological Pipet	50 Individually Wrapped/Bag	200
229210B	10mL Serological Pipet	50 Individually Wrapped/Bag	200
229225B	25mL Serological Pipet	50 Individually Wrapped/Bag	200
229230B	50mL Serological Pipet	30 Individually Wrapped/Bag	90



SEROLOGICAL PIPETS - INDIVIDUALLY WRAPPED IN DISPENSER CARTON **AF, S, R/D F, NP, USP, PS**

Part No.	Product Description	Pack Description	Qty/Case
229201	1mL Serological Pipet	200 Individually Wrapped/Dispenser Carton	800
229202	2mL Serological Pipet	150 Individually Wrapped/Dispenser Carton	600
229205	5mL Serological Pipet	100 Individually Wrapped/Dispenser Carton	200
229210	10mL Serological Pipet	100 Individually Wrapped/Dispenser Carton	200
229225	25mL Serological Pipet	50 Individually Wrapped/Dispenser Carton	200
229230	50mL Serological Pipet	45 Individually Wrapped/Dispenser Carton	90

Serological Pipets - Open End



- Ideal for viscous and high particulate solutions
- Wide, open end is ideal for slurries and gels
- Same great features as standard pipets (see page 57)

SEROLOGICAL PIPETS - OPEN END			AF, S, R/D F, NP, USP, PS
Part No.	Product Description	Pack Description	Qty/Case
229243	5mL Open End Pipet	25 Bulk Packed/Bag	500
229244	10mL Open End Pipet	25 Bulk Packed/Bag	500
229221B	1mL Open End Pipet	100 Individually Wrapped/Bag	500
229222B	2mL Open End Pipet	100 Individually Wrapped/Bag	500
229223B	5mL Open End Pipet	50 Individually Wrapped/Bag	200
229224B	10mL Open End Pipet	50 Individually Wrapped/Bag	200

Serological Pipets - Short

- Compact design of short serological pipet provides ergonomic benefit and reduces storage space
- Shorter length helps prevent pipet tip touching surfaces in the hood
- Ideal for students and those new to pipetting; improved stability while pipetting
- Same great features as standard length pipets (see page 55)
- Short Wobble-not™ Serological Pipets also available (see page 53)



Short Wobble-not pipets



Short vs. standard length pipets

SEROLOGICAL PIPETS - SHORT AF, S, R/D F, NP, USP, PS

Part No.	Size	Pack Description	Qty/Case
229206B	5mL, Short	50 Individually Wrapped/Bag	200
229211B	10mL, Short	50 Individually Wrapped/Bag	200
229226B	25mL, Short	25 Individually Wrapped/Bag	100

Serological Pipets - Bacteriological/Milk

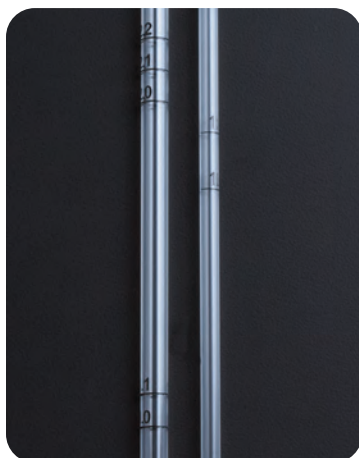

- Bacteriological/Milk pipets are manufactured to meet APHA requirements shown in Standard Methods for Examination of Dairy Products and ASTM E1043-00(2010) Standard Specification for Pipets, Milk and Cream Examination
- Specialized graduations allow quick volume identification
- Same great features as standard pipets (see page 55)

SEROLOGICAL PIPETS - BACTERIOLOGICAL/MILK AF, S, R/D F, NP, USP, PS

Part No.	Product Description	Pack Description	Qty/Case
229257	1.1mL Bacteriological/Milk Pipet	50 Bulk Packed/Bag	500
229258	2.2mL Bacteriological/Milk Pipet	50 Bulk Packed/Bag	400
229267	1.1mL Bacteriological/Milk Pipet	50 Individually Wrapped/Bag	250
229268	2.2mL Bacteriological/Milk Pipet	50 Individually Wrapped/Bag	250

Roller Bottles



DOUBLE YOUR CELL GROWTH AREA WITH EXPANDED SURFACE ROLLER BOTTLE

- Five options for growth area from 490cm² to 4250cm² to fit all your needs
- Tissue Culture Treated Roller Bottles have uniform hydrophilic surface ideal for consistent cell attachment
- Vented or non-vented cap for open or closed systems
- Easy-to-read black printed graduations
- Working volumes are recommendations only; optimize as required for individual protocols
- Part Number 229385B features alternate packaging of bulk sterile bottles within multiple protective dust bags

- 1 Large knurled HDPE cap for easy grip
- 2 Ribbed surface of ESRB increases surface area and horizontal ribs bathe cells with media more evenly than bottles with vertical ribs

ROLLER BOTTLES - TISSUE CULTURE TREATED AF, S, R/D F, NP, USP, PS

Part No.	Size	Cap Style	Working Volume	Pack Description	Qty/Case
229382	490cm ²	Non-Vented	100-150mL	1/Bag	24
229383	490cm ²	Vented	100-150mL	1/Bag	24
229384	850cm ²	Non-Vented	170-255mL	1/Bag	12
229385	850cm ²	Vented	170-255mL	1/Bag	12
NEW 229385B	850cm ²	Vented	170-255mL	20/Bag	40
229375	1700cm ²	Vented	340-510mL	1/Bag	12

ROLLER BOTTLES - TCT, EXPANDED SURFACE AF, S, R/D F, NP, USP, PS

229386	1900cm ²	Non-Vented	170-255mL	1/Bag	12
229387	1900cm ²	Vented	170-255mL	1/Bag	12
229377	4250cm ²	Vented	340-510mL	1/Bag	12

ROLLER BOTTLES - NON-TREATED AF, S, R/D F, NP, USP, PS

229582	1000mL	Non-Vented	100-150mL	1/Bag	24
229584	2000mL	Non-Vented	170-255mL	1/Bag	12

ROLLER BOTTLES - CAP ONLY AF, S, R/D F, NP, USP, HDPE

229391	Cap Only	Vented		1/Bag	24
--------	----------	--------	--	-------	----



Cell Culture Flasks



- Tissue Culture Treated Flasks have uniform hydrophilic surface ideal for consistent cell attachment
- Stable base enables filling the flask while standing upright
- 182cm² flask offers more growth area than standard 175cm² flasks
- 300cm² flask offers a large culture area with the convenience of a single layer flask
- Convenient zip-closure bag is a practical alternative to folding and taping opened bags
- Working volumes are recommendations only; optimize as required for individual protocols

- 1** Vent caps feature 0.22µm hydrophobic membrane
- 2** Large opening, canted neck design and moderate angles allow easy access to entire flask surface; ideal for cell scrapers (see page 62)
- 3** Molded, interlocking T design for improved stacking - included on 75, 182 & 300cm² and 250, 600 & 850mL size flasks only
- 4** Flask is printed with lot number and expiration date for easy identification and tracking
- 5** Angled design is easier to access than square or U-shaped flasks

FLASKS - TISSUE CULTURE TREATED

AF, S, R/D F, NP, USP, FLASK - PS, CAP - HDPE

Part No.	Product Description	Cap Style	Working Volume	Pack Description	Qty/Case
229321	12.5cm ² Tissue Culture Flask	Vent	2-4mL	10/Re-sealable Bag	200
229331	25cm ² Tissue Culture Flask	Vent	3-7mL	10/Re-sealable Bag	200
229341	75cm ² Tissue Culture Flask	Vent	8-20mL	5/Re-sealable Bag	100
229351	182cm ² Tissue Culture Flask	Vent	40-55mL	5/Re-sealable Bag	40
229381	182cm ² Tissue Culture Flask - Deep Volume	Vent	40-80mL	5/Re-sealable Bag	40
229371	225cm ² Tissue Culture Flask	Vent	45-70mL	5/Re-sealable Bag	25
229361	300cm ² Tissue Culture Flask	Vent	60-85mL	3/Re-sealable Bag	18
229320	12.5cm ² Tissue Culture Flask	Plug Seal	2-4mL	10/Re-sealable Bag	200
229330	25cm ² Tissue Culture Flask	Plug Seal	3-7mL	10/Re-sealable Bag	200
229340	75cm ² Tissue Culture Flask	Plug Seal	8-20mL	5/Re-sealable Bag	100
229350	182cm ² Tissue Culture Flask	Plug Seal	40-55mL	5/Re-sealable Bag	40
229370	225cm ² Tissue Culture Flask	Plug Seal	45-70mL	5/Re-sealable Bag	25
229360	300cm ² Tissue Culture Flask	Plug Seal	60-85mL	3/Re-sealable Bag	18

Cell Culture Flasks



Standard 182cm² Tissue Culture Flask (Top) vs. Deep Volume 182cm² Tissue Culture Flask (Bottom)

- 182cm² Deep Volume Flask (Weekend Flask) has extra depth that allows for more media volume; cell cultures can be left to grow for longer without running out of nutrients; confidently maintain cell cultures over the weekend!

Flasks - Non-Treated Suspension Culture

FLASKS - NON-TREATED SUSPENSION CULTURE				AF, S, R/D F, NP, USP, FLASK - PS, CAP - HDPE		
Part No.	Product Description	Cap Style	Working Volume	Pack Description	Qty/Case	
229500	25mL Suspension Culture Flask	Vent	2-4mL	10/Re-sealable Bag	200	
229510	50mL Suspension Culture Flask	Vent	3-7mL	10/Re-sealable Bag	200	
229520	250mL Suspension Culture Flask	Vent	8-20mL	5/Re-sealable Bag	100	
229530	600mL Suspension Culture Flask	Vent	40-55mL	5/Re-sealable Bag	40	
229540	850mL Suspension Culture Flask	Vent	60-85mL	3/Re-sealable Bag	18	

Flask Caps



FLASK CAPS				AF, S, R/D F, NP, USP, HDPE	
Part No.	Product Description	Cap Style	Fits Flask Size	Qty/Case	
229392	Flask Cap	Plug Seal	12.5cm ² & 25mL	5	
229389	Flask Cap	Plug Seal	25cm ² & 50mL	5	
229396	Flask Cap	Plug Seal	75cm ² & 250mL	5	
229398	Flask Cap	Plug Seal	182 & 300cm ² & 600 & 850mL	5	
229393	Flask Cap	Vent	12.5cm ² & 25mL	5	
229390	Flask Cap	Vent	25cm ² & 50mL	5	
229397	Flask Cap	Vent	75cm ² & 250mL	5	
229399	Flask Cap	Vent	182 & 300cm ² & 600 & 850mL	5	

Cell Scrapers

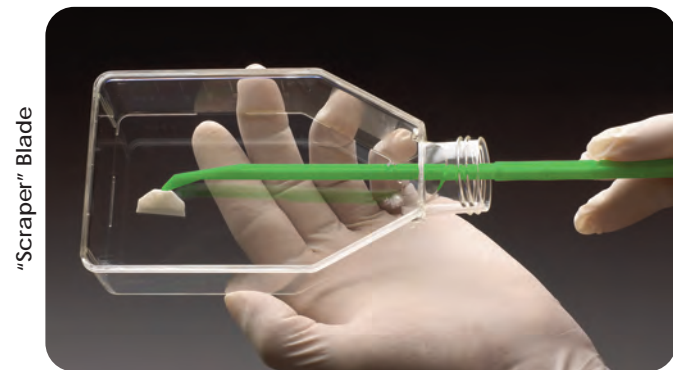

SOFT, PLIABLE BLADE IS GENTLE ON CELLS!

- Cell Scrapers are designed to gently harvest cells from tissue culture flasks, dishes or bottles
- Soft, pliable blade won't damage cells or scratch surfaces; outperforms hard plastic blade of other brands

- 1 "Scraper" Blade is positioned parallel to the handle for windshield wiper like scraping (PN 229310 & 229315)
- 2 "Lifter" Blade is positioned perpendicular to the handle for use with a raking motion (PN 229311 & 229316)
- 3 Pivoting Blade Cell Scraper features free rotating blade that adjusts to the desired position, providing access to all corners of the flask or tissue culture vessel (PN 229312)

CELL SCRAPERS

AF, S, R/D F, NP, USP, ABS & TPE

Part No.	Product Description	Handle Length	Blade Length	Blade Orientation	Pack Description	Qty/Case
229310*	Cell Scraper	25cm	20mm	Scraper (parallel)	Individually Wrapped	100
229311	Cell Scraper	25cm	20mm	Lifter (perpendicular)	Individually Wrapped	100
229312	Cell Scraper	30cm	20mm	Pivoting	Individually Wrapped	100
229315	Cell Scraper	39cm	30mm	Scraper (parallel)	Individually Wrapped	100
229316	Cell Scraper	39cm	30mm	Lifter (perpendicular)	Individually Wrapped	100

*Most popular option

Double Ended Cell Lifters

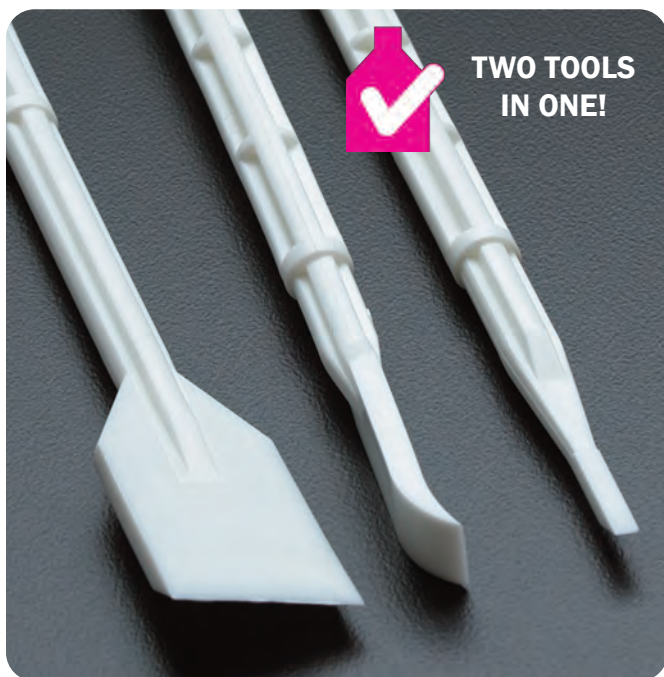

- 1** Unique double end design features 19mm beveled edge flat blade on one end and J-Hook or Narrow Blade on the other
- 2** Narrow blade is tapered to fit into 96 well plates or micro centrifuge tubes and can be used to re-suspend stubborn pellets
- 3** J-Hook is curved on the end to vertically lift cells from 4, 6, 12, 24 and 48 well plates
- 4** 19mm beveled edge flat blade ensures even contact with growth surface of flasks and dishes



DOUBLE ENDED CELL LIFTERS			AF, S, R/D F, NP, USP, PP	
Part No.	Product Description	Pack Description	Qty/	Case
229305	Cell Lifter, Double End, Flat Blade & Narrow Blade	100 Individually Wrapped/Bag	100	
229306	Cell Lifter, Double End, Flat Blade & J-Hook	100 Individually Wrapped/Bag	100	

Multiple Well Plates



1 Each well has a raised rim which nests into the rings on the single direction lid to reduce evaporation and limit the risk of cross contamination

2 Plates are labeled with alpha-numeric markings for easy identification of individual wells

3 Lids have a stacking feature for added stability when handling tall stacks of plates

1 Well Plates

- Useful for high volume and robotic screening of DNA libraries as well as manual plating
- Same footprint as standard multiple well plates
- Suitable for dot-blotting bacterial clones on 11.4 x 7.3cm (4.5 x 2.875in) nylon membranes

4 Well Plates

- Expanded spacing of wells helps reduce cross contamination
- Well diameter similar to 24 well plate
- Smaller footprint than standard multiple well plates

384 Well Plates

- Smaller size wells use less volume, reducing costs
- Increase the number of drug screening targets within the standard footprint
- Ideal for automated applications, colorimetric assays, compound storage or small volume applications

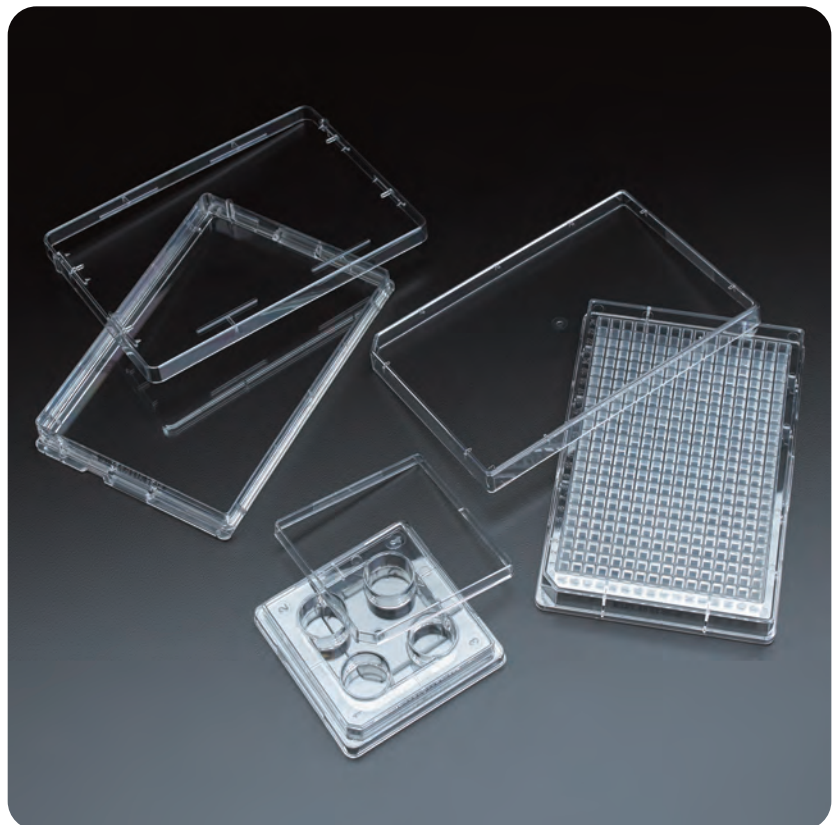

Multiple Well Plates



- Cell culture treatment process provides consistent and even hydrophilic surface for improved cell attachment
- Polystyrene is optically clear for easy cell viewing and imaging
- Round bottom option maximizes sample retrieval and allows mixing (PN 229190)
- Plate is printed with lot number and expiration date for easy identification and tracking
- Sturdy individual blister pack prevents damage when handling or shipping
- Bulk packaging option (5/sleeve) increases efficiency for high volume users (PN 229197)

MULTIPLE WELL PLATES - TISSUE CULTURE TREATED*

AF, S, R/D F, NP, USP, PS

Part No.	Product Description	Bottom Shape	Cell Growth Area	Pack Description	Qty/Case
229101	1 Well Tissue Culture Plate	Flat	97.4cm ²	Individual	50
229103	4 Well Tissue Culture Plate	Flat	1.96cm ²	Individual	50
229105	6 Well Tissue Culture Plate	Flat	9.60cm ²	Individual	50
229106	6 Well Tissue Culture Plate	Flat	9.60cm ²	Individual	100
229111	12 Well Tissue Culture Plate	Flat	3.85cm ²	Individual	50
229112	12 Well Tissue Culture Plate	Flat	3.85cm ²	Individual	100
229123	24 Well Tissue Culture Plate	Flat	1.93cm ²	Individual	50
229124	24 Well Tissue Culture Plate	Flat	1.93cm ²	Individual	100
229147	48 Well Tissue Culture Plate	Flat	0.84cm ²	Individual	50
229148	48 Well Tissue Culture Plate	Flat	0.84cm ²	Individual	100
229195	96 Well Tissue Culture Plate	Flat	0.33cm ²	Individual	50
229196	96 Well Tissue Culture Plate	Flat	0.33cm ²	Individual	100
229197	96 Well Tissue Culture Plate	Flat	0.33cm ²	5/Bag	100
229190	96 Well Tissue Culture Plate	Round	0.58cm ²	Individual	100
229138	384 Well Tissue Culture Plate	Flat	0.1135cm ²	Individual	50

*See page 68 for Non-Treated Multiple Well Plates

Glass Bottom Cell Culture Dishes & Plates

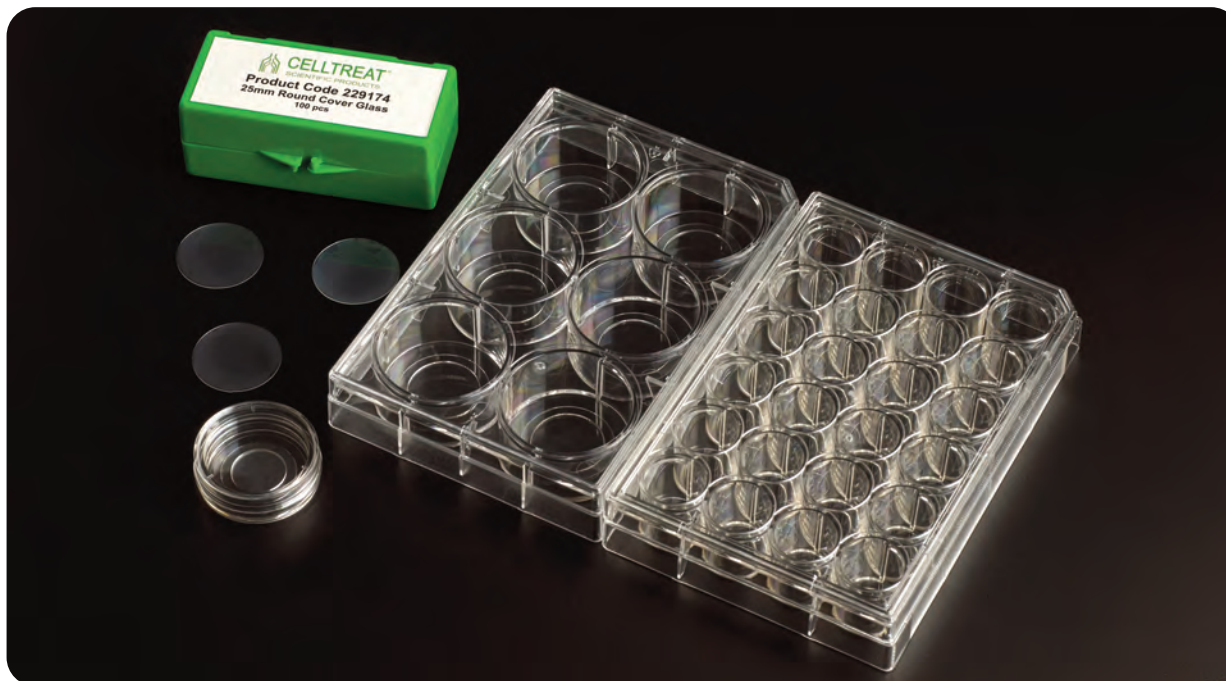

- Conveniently view live cells without needing to transfer
- Optically clear borosilicate glass bottom is #1.5 thickness
- Applications include: cell culture and imaging, live cell observation and specialty microscopy such as confocal high resolution and contrast
- Traditional footprints cause minimal disruption in cell culture techniques
- Constructed with non-cytotoxic medical adhesive
- Round cover glass also available for use with glass bottom plates and dishes (see below)

DISHES - GLASS BOTTOM TISSUE CULTURE

AF, S, R/D F, NP, USP, PS, GLS

Part No.	Product Description	Pack Description	Qty/Case
229632	30mm x 10mm Tissue Culture Dish, 15mm Glass Bottom	10/Re-sealable Bag	50

PLATES - GLASS BOTTOM TISSUE CULTURE

AF, S, R/D F, NP, USP, PS, GLS

229107	6 Well Tissue Culture Plate with Lid, 20mm Glass Bottom	Individual	5
229125	24 Well Tissue Culture Plate with Lid, 10mm Glass Bottom	Individual	5

Round Cover Glass

- High-quality, optically clear borosilicate glass cover slips are ideal for specialty microscopy and imaging with Dishes, Multiple Well Plates or anywhere a square cover glass is unsuitable
- Consistent flatness and scratch-free
- Resistant to organic solvents
- Packaged in a hinged plastic storage case
- Cover Glass is #1.5 thickness

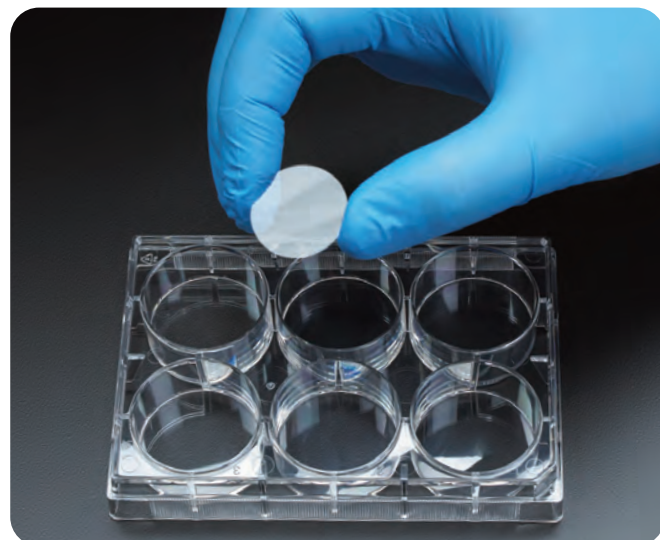

ROUND COVER GLASS

AF, S, R/D F, NP, A, GLS

Part No.	Size	Fits	Qty/Case
229172	15mm	24 Well Plate	100/Pack
229173	20mm	12 Well Plate or 35mm Dish	100/Pack
229174	25mm	6 Well Plate	100/Pack

Permeable Cell Culture Inserts



TRANSFORM YOUR RESEARCH
Easily mimic *in vivo* conditions!

- Mimic a variety of *in vivo* conditions with 2 membrane materials and 3 porosities
- Inserts center in wells, which allows pipette access to lower chamber, and prevents wicking between insert and side wall
- Inserts hang above tissue culture-treated wells, allowing co-culture: grow cells on both the insert membrane and the well bottom (non-treated plates sold separately, see page 68)
- PC membrane is best for cell attachment; PET is best for imaging and microscopy
- 0.4µm PET inserts feature clear membranes for improved cell viewing
- 0.4µm pore size is ideal for cell-cell interaction and drug transport studies
- 3.0µm and 8.0µm pore sizes are ideal for angiogenesis, migration, and chemotaxis experiments

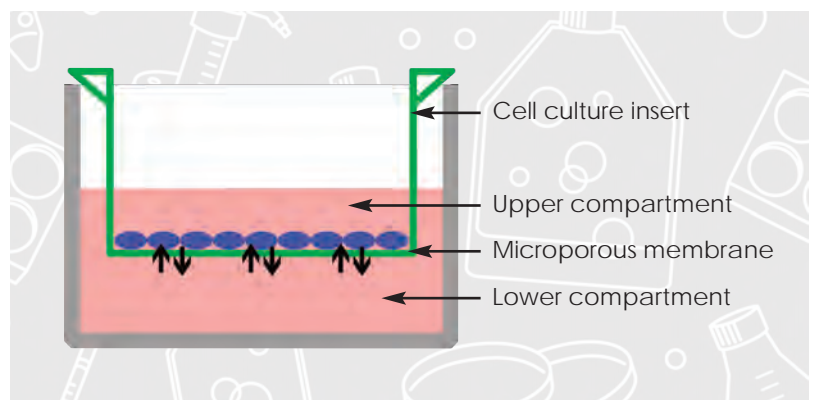

PERMEABLE CELL CULTURE INSERTS

AF, S, R/D F, NP, USP, PS

Part No.	Product Description	Membrane Material	Membrane Pore Size	Pack Description	Qty/Case
230601	Inserts Packed in 6 Well Plate	PC	0.4µm	6 Inserts/Plate, 2 Plates/Case	12
230603	Inserts Packed in 6 Well Plate	PC	3.0µm	6 Inserts/Plate, 2 Plates/Case	12
230605	Inserts Packed in 6 Well Plate	PC	8.0µm	6 Inserts/Plate, 2 Plates/Case	12
230607	Inserts Packed in 6 Well Plate	PET	0.4µm	6 Inserts/Plate, 2 Plates/Case	12
230609	Inserts Packed in 6 Well Plate	PET	3.0µm	6 Inserts/Plate, 2 Plates/Case	12
230611	Inserts Packed in 6 Well Plate	PET	8.0µm	6 Inserts/Plate, 2 Plates/Case	12
NEW 230615	Inserts Packed in 12 Well Plate	PC	0.4µm	12 Inserts/Plate, 2 Plates/Case	24
NEW 230617	Inserts Packed in 12 Well Plate	PC	3.0µm	12 Inserts/Plate, 2 Plates/Case	24
NEW 230619	Inserts Packed in 12 Well Plate	PC	8.0µm	12 Inserts/Plate, 2 Plates/Case	24
NEW 230621	Inserts Packed in 12 Well Plate	PET	0.4µm	12 Inserts/Plate, 2 Plates/Case	24
NEW 230623	Inserts Packed in 12 Well Plate	PET	3.0µm	12 Inserts/Plate, 2 Plates/Case	24
NEW 230625	Inserts Packed in 12 Well Plate	PET	8.0µm	12 Inserts/Plate, 2 Plates/Case	24
230629	Inserts Packed in 24 Well Plate	PC	0.4µm	12 Inserts/Plate, 2 Plates/Case	24
230631	Inserts Packed in 24 Well Plate	PC	3.0µm	12 Inserts/Plate, 2 Plates/Case	24
230633	Inserts Packed in 24 Well Plate	PC	8.0µm	12 Inserts/Plate, 2 Plates/Case	24
230635	Inserts Packed in 24 Well Plate	PET	0.4µm	12 Inserts/Plate, 2 Plates/Case	24
230637	Inserts Packed in 24 Well Plate	PET	3.0µm	12 Inserts/Plate, 2 Plates/Case	24
230639	Inserts Packed in 24 Well Plate	PET	8.0µm	12 Inserts/Plate, 2 Plates/Case	24

Non-Treated Multiple Well Plates



- Polystyrene is optically clear for easy cell viewing and imaging
- Round bottom option maximizes sample retrieval and allows mixing (PN 229590 & 229591)
- Plate is printed with lot number and expiration date for easy identification and tracking
- Sturdy individual blister pack prevents damage when handling or shipping
- Bulk packaging option (5/sleeve) increases efficiency for high volume users (PN 229597)
- Same low evaporation, marking, and stacking design features as Multiple Well Plates, see pages 64-65

MULTIPLE WELL PLATES - NON-TREATED

AF, S, R/D F, NP, USP, PS

Part No.	Product Description	Bottom Shape	Working Volume	Pack Description	Qty/ Case
229501	1 Well Non-treated Plate	Flat	19.5 - 48.7mL	Individual	50
229503	4 Well Non-treated Plate	Flat	500 - 800µL	Individual	50
229506	6 Well Non-treated Plate	Flat	2 - 8mL	Individual	100
229512	12 Well Non-treated Plate	Flat	2 - 4mL	Individual	100
229524	24 Well Non-treated Plate	Flat	0.5 - 1.5mL	Individual	100
229548	48 Well Non-treated Plate	Flat	0.3 - 1.0mL	Individual	100
229590	96 Well Non-treated Plate	Round	50 - 300µL	Individual	100
229591	96 Well Non-treated Plate without Lid	Round	50 - 300µL	Individual	100
229592	96 Well Non-treated Plate without Lid	Flat	50 - 300µL	Individual	100
229596	96 Well Non-treated Plate	Flat	50 - 300µL	Individual	100
229597	96 Well Non-treated Plate	Flat	50 - 300µL	5/Bag	100
229538	384 Well Non-treated Plate	Flat	15 - 110µL	Individual	50

*See page 65 for Tissue Culture Treated Multiple Well Plates

Sealing Films

BREATHABLE SEALING FILM

- Breathable Sealing Film promotes uniform gas exchange and can be pierced easily with pipette tips
- Constructed with non-cytotoxic medical grade adhesive

FOIL SEALING FILM

- Foil Sealing Film (50µm thickness) reduces sample evaporation, can be pierced easily with pipette tips, and is heat and cold resistant

CLEAR SEALING FILM

- Clear Sealing Film is optically clear, ideal for qPCR applications
- Superior adhesive minimizes evaporation

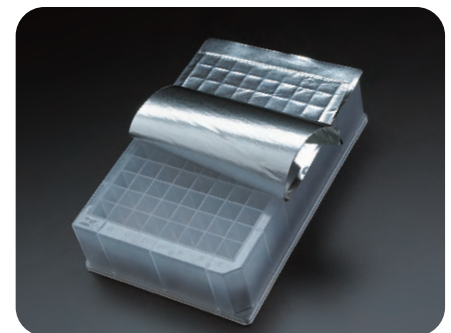

SEALING FILMS

Part No.	Product Description	Sterile (Y/N)	Temperature Range	Pack Description	Qty/ Case
229130	Breathable Sealing Film	Y	-20°C to 80°C	50/Re-sealable Bag	50
229132	Foil Sealing Film	Y	-80°C to 120°C	50/Re-sealable Bag	50
229133	Foil Sealing Film	N	-80°C to 120°C	100/Re-sealable Bag	100
NEW 229135	Clear Sealing Film	N	-80°C to 105°C	100/Re-sealable Bag	100

Polypropylene Plates

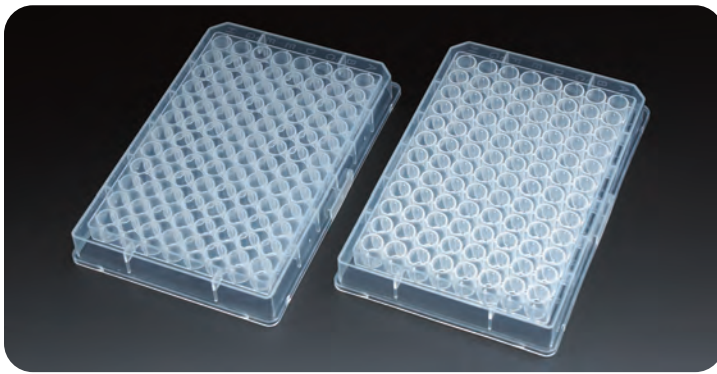

- 96 Well Polypropylene Plates can be used for the growth of bacterial cultures or storage of compounds
- Round Bottom with round wells enables use with magnetic beads
- V-Bottom maximizes sample retrieval
- Polypropylene offers a low binding surface to prevent samples from sticking to the side walls during elution, and is chemically inert for combinatorial chemistry applications
- Low profile design for easy sample retrieval

96 DEEP WELL STORAGE PLATES

N, R/D F, NP, USP, A, PP

Part No.	Product Description	Well Volume	Well Shape	Bottom Shape	Pack Description	Qty/ Case
229576	96 Well Plate	0.4mL	Round	Round	5/Bag	50
229577	96 Well Plate	0.36mL	Round	V-Bottom	5/Bag	50

Deep Well Storage Plates

- 96 Deep Well Storage Plates can be used for the growth of bacterial cultures or storage of compounds
- 48 Well Deep Storage Plate features larger, rectangular well for increased well volume
- Square to round transition of V-Bottom maximizes working volume
- Pyramid Bottom eases sample retrieval and improves mixing by creating a sloshing effect rather than a vortex when agitated
- Round Bottom with round wells enable use with magnetic beads
- Polypropylene offers a low binding surface to prevent samples from sticking to the side walls during elution, and is chemically inert for combinatorial chemistry applications
- **NEW** - Two sterile options now available (Part No. 229570S & 229574S)

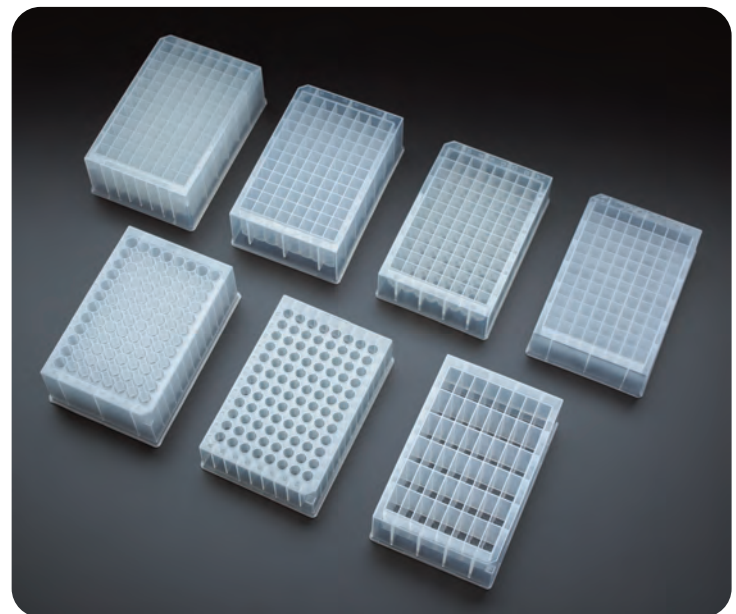

96 DEEP WELL STORAGE PLATES

AF, N, R/D F, NP, USP, A, PP

Part No.	Product Description	Max RCF	Well Volume	Well Shape	Bottom Shape	Sterile (Y/N)	Pack Description	Qty/ Case
229578	48 Deep Well Storage Plate	4000 x g	4.6mL	Rectangle	U-Bottom	N	5/Bag	25
229570	96 Deep Well Storage Plate	4000 x g	1.0mL	Round	V-Bottom	N	5/Bag	25
NEW 229570S	96 Deep Well Storage Plate	4000 x g	1.0mL	Round	V-Bottom	Y	5/Bag	25
229571	96 Deep Well Storage Plate	4000 x g	1.1mL	Square	V-Bottom	N	5/Bag	25
229573	96 Deep Well Storage Plate	4000 x g	1.5mL	Square	Round Bottom	N	5/Bag	25
229572	96 Deep Well Storage Plate	4000 x g	2.0mL	Square	Pyramid Bottom	N	5/Bag	25
229574	96 Deep Well Storage Plate	4000 x g	2.0mL	Square	V-Bottom	N	5/Bag	25
NEW 229574S	96 Deep Well Storage Plate	4000 x g	2.0mL	Square	V-Bottom	Y	5/Bag	25
229575	96 Deep Well Storage Plate	4000 x g	2.0mL	Round	Round Bottom	N	5/Bag	25

Treated Cell Culture Dishes



**GRIP IT,
DON'T DROP IT!**
Gripping feature
available

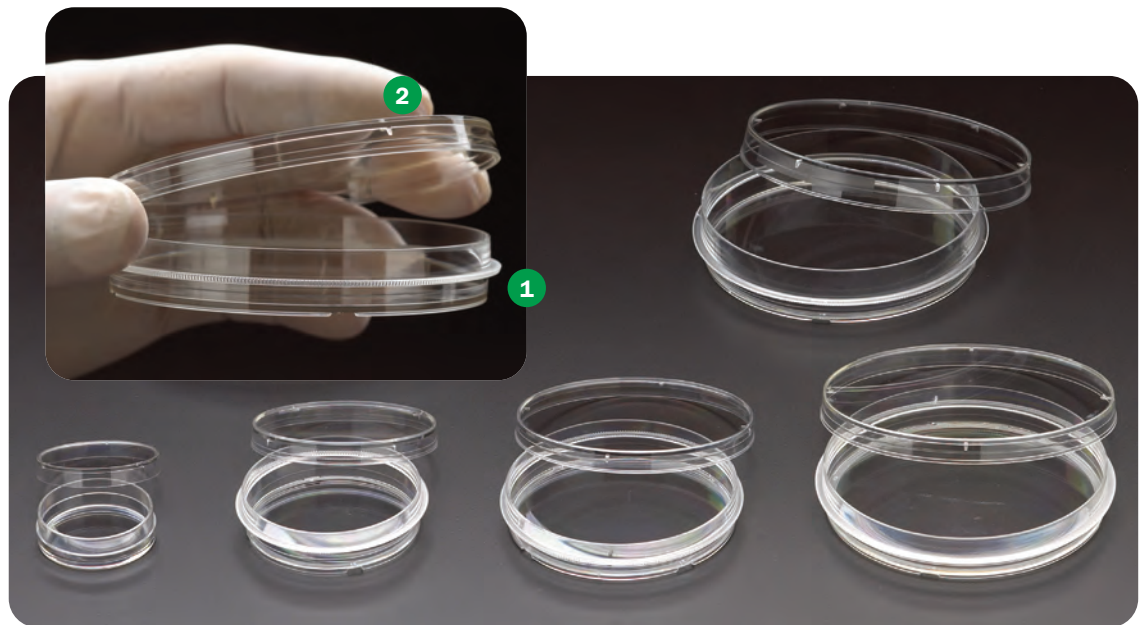

- Cell culture treatment process provides consistent and even hydrophilic surface for improved cell attachment
 - Manufactured from medical grade virgin polystyrene
- 1 35, 60, 70 and 100mm dishes available with a gripping feature for secure handling of dish bottom
 - 2 Vented lids contain molded spacers to allow gas exchange, and stacking rings for increased stability

DISHES - TREATED CELL CULTURE WITH GRIPPING FEATURE

AF, S, R/D F, NP, USP, PS

Part No.	Product Description	Working Volume	Growth Area	Pack Description	Qty/ Case
229635	35mm x 10mm Tissue Culture Treated Dish	5mL	8.5cm ²	10/Re-sealable Bag	500
229660	60mm x 15mm Tissue Culture Treated Dish	7 - 8mL	21cm ²	10/Re-sealable Bag	500
229670	70mm x 15mm Tissue Culture Treated Dish	7 - 8mL	36.3cm ²	10/Re-sealable Bag	500
229690	100mm x 15mm Tissue Culture Treated Dish	15 - 16mL	55cm ²	10/Re-sealable Bag	500
229620	100mm x 20mm Tissue Culture Treated Dish	15 - 16mL	60.5cm ²	10/Re-sealable Bag	300

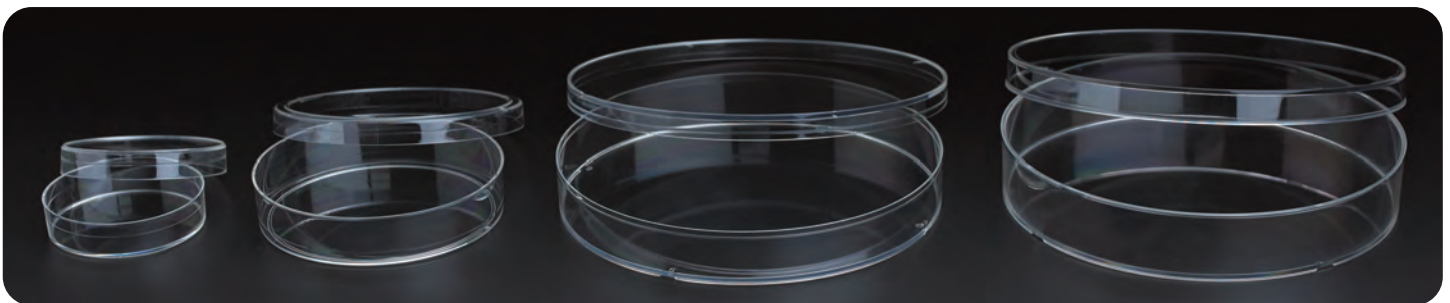

DISHES - TREATED CELL CULTURE WITHOUT GRIPPING FEATURE

AF, S, R/D F, NP, USP, PS

Part No.	Product Description	Working Volume	Growth Area	Pack Description	Qty/ Case
229661	60mm x 15mm Tissue Culture Treated Dish	7 - 8mL	21cm ²	20/Re-sealable Bag	500
229621	100mm x 20mm Tissue Culture Treated Dish	15 - 16mL	60.5cm ²	10/Re-sealable Bag	300
229650	150mm x 20mm Tissue Culture Treated Dish	25 - 28mL	143cm ²	1/Bag	60
229651	150mm x 20mm Tissue Culture Treated Dish	25 - 28mL	143cm ²	5/Re-sealable Bag	100
229652	150mm x 25mm Tissue Culture Treated Dish	52 - 132mL	154cm ²	5/Bag	60

Non-Treated Cell Culture Dishes

- Non-Treated Cell Culture Dishes have thicker and more durable plastic than standard Petri Dishes - both can be used for the same applications
- 35, 60, 70 and 100mm dishes available with a gripping feature for improved handling
- Vented lids contain molded spacers to allow gas exchange, and stacking rings for increased stability
- Manufactured from medical grade virgin polystyrene

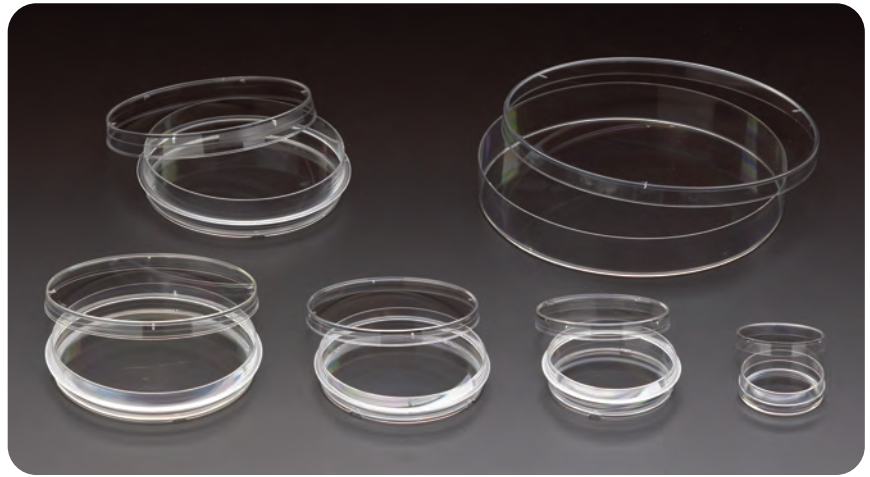

DISHES - NON-TREATED CELL CULTURE WITH GRIPPING FEATURE					AF, S, R/D F, NP, USP, PS	
Part No.	Product Description	Working Volume	Growth Area	Pack Description	Qty/Case	
229638	35mm x 10mm Petri Dish	5mL	8.5cm ²	10/Bag	960	
229663	60mm x 15mm Petri Dish	7 - 8mL	21cm ²	10/Bag	500	
229692	100mm x 15mm Petri Dish	15 - 16mL	55cm ²	10/Bag	300	
229693	100mm x 15mm Petri Dish	15 - 16mL	55cm ²	10/Bag	500	
229623	100mm x 20mm Petri Dish	15 - 16mL	60.5cm ²	10/Bag	300	
DISHES - NON-TREATED CELL CULTURE WITHOUT GRIPPING FEATURE					AF, S, R/D F, NP, USP, PS	
229656	150mm x 15mm Petri Dish	25 - 28mL	153cm ²	10/Bag	100	
229653	150mm x 20mm Petri Dish	25 - 28mL	143cm ²	5/Bag	100	

Timer & Bag Cutter



TIMER

- Multiple functions include timer, clock and alarm
- Includes easel stand, mounting magnet and retractable hook for hanging
- Uses 1 standard AAA Battery (not included)

ACCESSORIES

Part No.	Product Description	Qty/Case
230123	Multi-Function Timer	1

BAG CUTTER

- Safely and easily cuts plastic bags and pouches
- Features unique contoured design, sharp non-removable stainless steel blade and lanyard hang hole for convenience
- Includes integrated tape splitter for easy box opening



ACCESSORIES		
Part No.	Product Description	Qty/Case
230100	Bag Cutter	5

Compartment Petri Dishes



- Designed for simultaneous studies of organisms in a common environment
- Molded dividers create completely separate compartments while allowing airflow
- Ridge on bottom of dish allows easy handling and stacking
- Lids contain 3 molded spacers to allow gas exchange
- Working volume and growth area listed in table below are per compartment

DISHES - COMPARTMENT PETRI

AF, S, R/D F, NP, USP, PS

Part No.	Product Description	Working Volume	Growth Area	Stackable (Y/N)	Pack Description	Qty/Case
229682	100mm x 15mm Petri Dish, 2 Compartments	7-8mL	28.3cm ²	Y	20/Bag	500
229683	100mm x 15mm Petri Dish, 3 Compartments	5mL	18.9cm ²	Y	20/Bag	500
229684	100mm x 15mm Petri Dish, 4 Compartments	4mL	14.1cm ²	Y	20/Bag	500

Loops, Needles and Spreaders

- Flexible design provides easy access to tubes and dishes
- Color coded for easy identification
- Flexible design is gentle on delicate agar or other surfaces
- L-Shaped Cell Spreader is ideal for evenly spreading bacterial cultures
- Loops and L-Shaped Cell Spreader available individually wrapped in peel-to-open paper/plastic wrappers

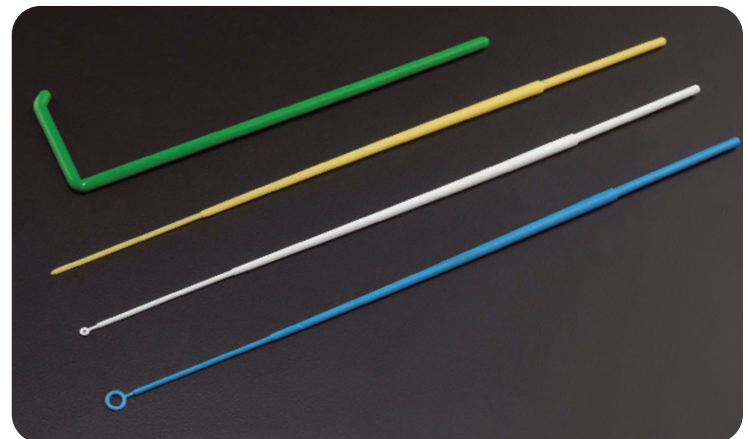

L-SHAPED CELL SPREADERS

AF, S, R/D F, NP, USP, PP

Part No.	Product Description	Color	Length	Pack Description	Qty/Case
229617	L-Shaped Spreader	Green	145mm	10/Pack	500
229616	L-Shaped Spreader	Green	145mm	100 Individually Wrapped/Bag	100

INOCULATING LOOPS AND NEEDLES

AF, S, R/D F, NP, USP, PP

229601	1uL Inoculating Loop	White	218mm	20/Pack	2000
229602	1uL Inoculating Loop	White	218mm	100 Individually Wrapped/Bag	600
229610	10uL Inoculating Loop	Blue	221mm	20/Pack	2000
229612	10uL Inoculating Loop	Blue	221mm	100 Individually Wrapped/Bag	600
229615	Inoculating Needle	Yellow	221mm	20/Pack	2000

Petri Dishes



CELLTREAT ADVANTAGE FEATURE:
Durable packaging offers greater protection from shipping damage



Part No. 229695

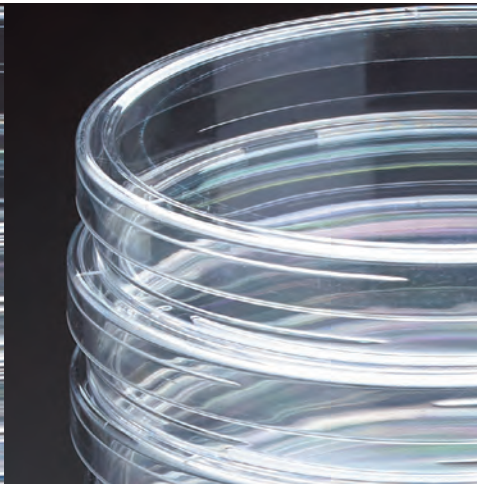

Part No. 229694

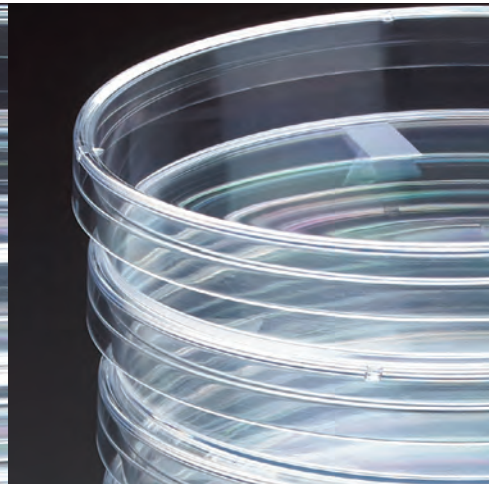

Part No. 229697

STACKABLE	STACKABLE/SLIDEABLE	SLIPPABLE
Lids contain stacking rings for increased stability	Features partial edge ring on base which allows a single dish to be slid from a large stack and enhances stability when stacked	Designed for automated filling and streaking systems, features side arrows and ISO Mark Target for automation

- CELLTREAT Petri Dishes are manufactured in high capacity automated production lines resulting in high quality, value priced products
- Ventilation ribs reduce condensation and allow air circulation
- Consistent flatness allows for even media distribution
- Durable packaging helps reduce shipping damage

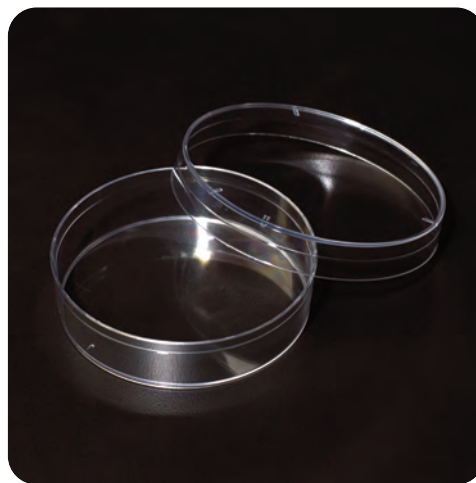

60mm x 15mm - Part No. 229665

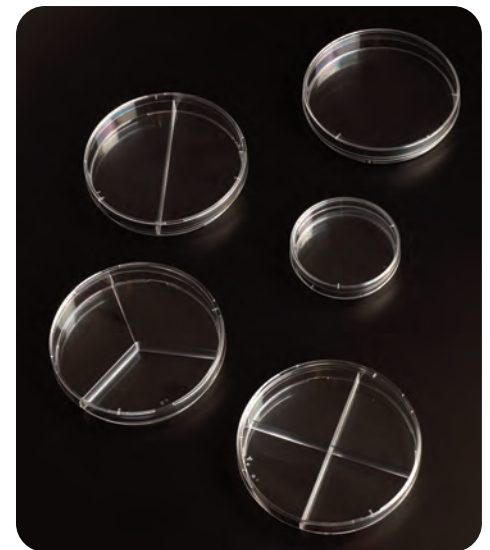

Compartment Dishes page 72

DISHES - PETRI				AF, S, R/D F, NP, USP, PS		
Part No.	Product Description	Dish Style	Working Volume	Growth Area	Pack Description	Qty/ Case
229665	60mm x 15mm Petri Dish	Stackable	7 - 8 mL	21cm ²	20/Bag	500
229694	100mm x 15mm Petri Dish	Stackable/Slideable	15 - 16mL	55cm ²	20/Bag	500
229695	100mm x 15mm Petri Dish	Stackable	15 - 16mL	55cm ²	20/Bag	500
229697	100mm x 15mm Petri Dish	Slippable	15 - 16mL	55cm ²	20/Bag	500

Erlenmeyer Flasks

Erlenmeyer Flask Selection Guide

	PC	PETG
Vented Caps	X	X
Solid Caps		X
Plain Bottom	X	X
Baffled Bottom	X	



- Lightweight plastic material is easier and safer to handle than glass
- Designed for mammalian suspension culture applications as well as bacterial and yeast culture
- Vent caps with 0.22µm hydrophobic membrane for improved gas exchange without contamination
- All flasks include molded graduation lines
- Baffled bottom improves mixing and aeration
- Baffled flasks feature a molded 1/3 fill line to help ensure optimal working volumes
- Individually bagged for easy storage and handling
- Medical grade virgin Polycarbonate is autoclavable (temperature range of -80°C - 121°C)
- Medical grade virgin PETG reduces gas permeability (temperature range of -80°C - 60°C)

PC Erlenmeyer Flasks - Vent Cap/Plain Bottom				AF, S, R/D F, NP, A, FLASK - PC, CAP - HDPE				
Part No.	Product Description	Flask Material	Cap Type	Bottom Type	Working Volume	Pack Description	Qty/Case	
229821	125mL Erlenmeyer Flask	Polycarbonate	Vent	Plain	30mL	1/Bag	12	
229825	250mL Erlenmeyer Flask	Polycarbonate	Vent	Plain	60mL	1/Bag	12	
229829	500mL Erlenmeyer Flask	Polycarbonate	Vent	Plain	150mL	1/Bag	12	
NEW 229833	1000mL Erlenmeyer Flask	Polycarbonate	Vent	Plain	350mL	1/Bag	6	
PC Erlenmeyer Flasks - Vent Cap/Baffled Bottom				AF, S, R/D F, NP, A, FLASK - PC, CAP - HDPE				
NEW 229823	125mL Erlenmeyer Flask	Polycarbonate	Vent	Baffled	30mL	1/Bag	12	
NEW 229827	250mL Erlenmeyer Flask	Polycarbonate	Vent	Baffled	60mL	1/Bag	12	
NEW 229831	500mL Erlenmeyer Flask	Polycarbonate	Vent	Baffled	150mL	1/Bag	12	
NEW 229835	1000mL Erlenmeyer Flask	Polycarbonate	Vent	Baffled	350mL	1/Bag	6	
PETG Erlenmeyer Flasks - Solid Cap/Plain Bottom				AF, S, R/D F, NP, FLASK - PETG, CAP - HDPE				
229800	125mL Erlenmeyer Flask	PETG	Solid	Plain	30mL	1/Bag	12	
229804	250mL Erlenmeyer Flask	PETG	Solid	Plain	60mL	1/Bag	12	
229808	500mL Erlenmeyer Flask	PETG	Solid	Plain	150mL	1/Bag	12	
229812	1000mL Erlenmeyer Flask	PETG	Solid	Plain	350mL	1/Bag	6	
PETG Erlenmeyer Flasks - Vent Cap/Plain Bottom				AF, S, R/D F, NP, FLASK - PETG, CAP - HDPE				
229801	125mL Erlenmeyer Flask	PETG	Vent	Plain	30mL	1/Bag	12	
229805	250mL Erlenmeyer Flask	PETG	Vent	Plain	60mL	1/Bag	12	
229809	500mL Erlenmeyer Flask	PETG	Vent	Plain	150mL	1/Bag	12	
229813	1000mL Erlenmeyer Flask	PETG	Vent	Plain	350mL	1/Bag	6	

Erlenmeyer & Fernbach Flasks - Large Volume



- 1 70mm opening for easy filling and dispensing
 - 2 Over-sized vent area in cap for improved gas exchange
 - 3 Fernbach flask shape increases surface area to volume ratio
 - 4 Baffled bottom improves mixing and aeration
- Designed for mammalian suspension culture applications as well as bacterial and yeast culture
 - Conveniently pre-sterilized
 - Autoclaving of the flasks may be limited due to application and autoclave techniques
 - Available with plain or baffled bottom

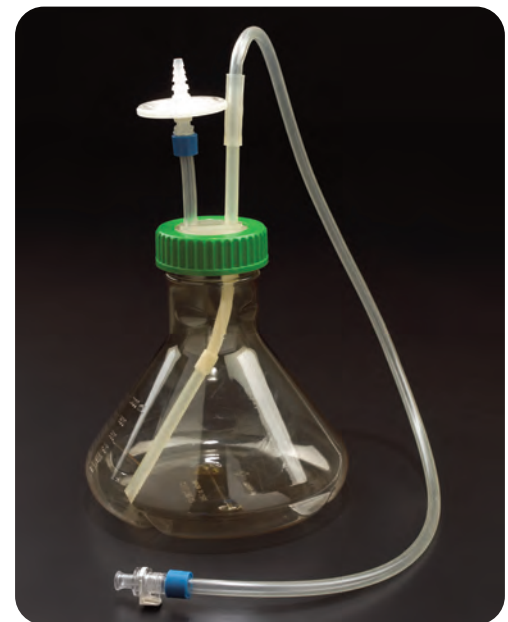

Part No. 229896 - Transfer Assembly
 Other custom transfer assembly options available. Please contact us for information.

ERLENMEYER & FERNBACH FLASKS		AF, S, NP, USP, A, FLASK - PC, CAP - HDPE					
Part No.	Product Description	Cap Type	Bottom Type	Working Volume	Pack Description	Qty/Case	
229850	2L Erlenmeyer Flask	Vent	Plain	400mL	1/Bag	6	
229855	2L Erlenmeyer Flask	Vent	Baffled	400mL	1/Bag	6	
229860	2L Fernbach Flask	Vent	Plain	400mL	1/Bag	6	
229865	2L Fernbach Flask	Vent	Baffled	400mL	1/Bag	6	
229870	3L Fernbach Flask	Vent	Plain	800mL	1/Bag	4	
229875	3L Fernbach Flask	Vent	Baffled	800mL	1/Bag	4	
ERLENMEYER & FERNBACH FLASK CAPS		AF, S, R/D F, NP, USP, HDPE					
229894	CAP ONLY, 70mm, Erlenmeyer/Fernbach	Solid	NA	NA	1/Bag	24	
229895	CAP ONLY, 70mm, Erlenmeyer/Fernbach	Vent	NA	NA	1/Bag	24	
TRANSFER ASSEMBLY		AF, S, NP, HDPE					
229896	Transfer Assembly for 3L Fernbach Flask	NA	NA	NA	1/Bag	1	

Chambered Cell Culture Slides

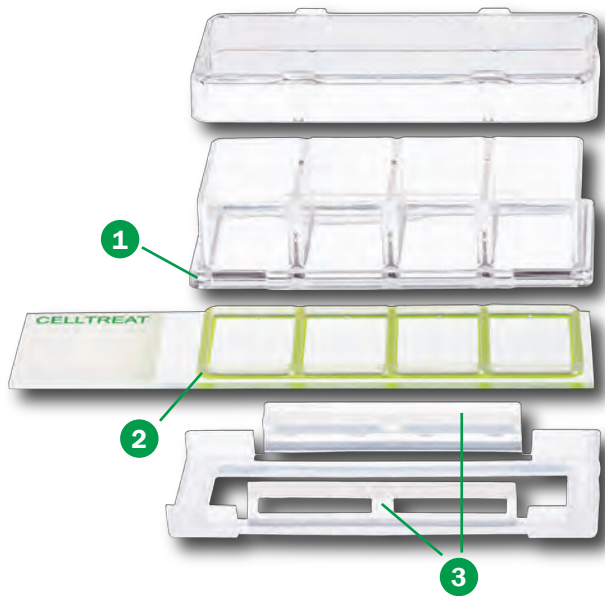
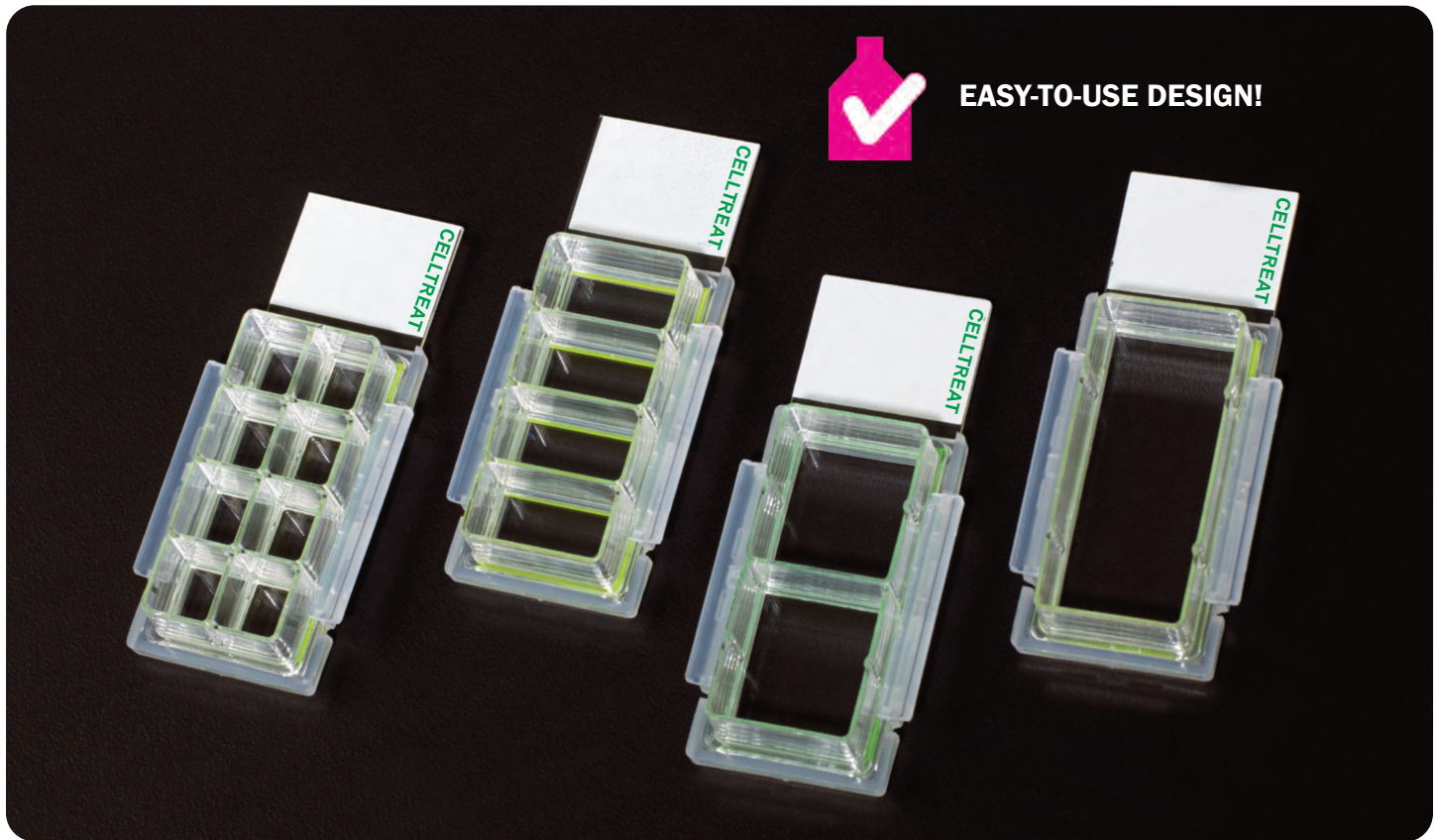

- Grow cells directly on the slide without any need for future transfer; ideal for growing and viewing cells under a microscope on a standard 25mm x 75mm slide
- Uniform hydrophilic surface ideal for consistent cell attachment
- Slides are labeled with numeric markings
- Packing trays can be used as incubation racks in CO₂ incubators
- Adhesive free
- Reusable slide tray available, see page 77

- 1 Integrated gasket prevents cross-contamination between chambers
- 2 Inert hydrophobic green border printed on slide to define cell culture area
- 3 Chamber holder features easy flip locks assembly and disassembly; no separation tool required

CHAMBERED CELL CULTURE SLIDES

AF, S, R/D F, NP, USP, PS, PP, GLS

Part No.	Product Description	Pack Description	Qty/Case
229161	1 Chamber Cell Culture Slide, Glass	6/Tray with 2 Trays/Box	12
229162	2 Chamber Cell Culture Slide, Glass	6/Tray with 2 Trays/Box	12
229164	4 Chamber Cell Culture Slide, Glass	6/Tray with 2 Trays/Box	12
229168	8 Chamber Cell Culture Slide, Glass	6/Tray with 2 Trays/Box	12

Slide Tray



EASILY STACK & STORE YOUR SLIDES!

- Slide tray provides a sturdy and durable method to handle slides
- Depth of tray is designed to fit CELLTREAT Chamber Slides
- Side of the tray has a large area for writing on or labeling contents
- Trays feature recessed spaces to make it easier to access slides
- The tray design enables them to be stacked, and when stacked, the top tray is fully supported by the tray below
- Stacking design of tray isolates and protects slides



SLIDE TRAY		AF, N, A, PP
Part No.	Product Description	Qty/Case
229167	Slide Tray, White, 8 Place	6

Beakers



GREAT VALUE COMPARED TO COMPETITIVE BRANDS!

- Molded pouring spouts and rolled lip for dripless work environment
- Angled walls for easier handling and sample retrieval
- Nesting design for easy stacking and storage
- Assorted Beaker Set contains 10 beakers each of 30, 50, 100, 150, 250, 400 and 600mL sizes
- Smaller case quantities are easier to store and are ideal for small scale users
- Polypropylene material is resistant to a variety of strong acids, bases and solvents

BEAKERS		AF, N, A, PP	
Part No.	Product Description	Pack Description	Qty/Case
230511	30mL Graduated Beaker	100/Bag	100
230512	50mL Graduated Beaker	100/Bag	100
230513	100mL Graduated Beaker	100/Bag	100
230514	150mL Graduated Beaker	100/Bag	100
230515	250mL Graduated Beaker	50/Bag	50
230516	400mL Graduated Beaker	50/Bag	50
230517	600mL Graduated Beaker	25/Bag	25
230509	Assorted Set Graduated Beaker	10/Bag	70

500mL Square Media Bottle



OPEN ONLY ONE BAG AT A TIME!
Individually Bagged packaging

- Ideal for media prep and storage of laboratory reagents and biological buffers
- Square design saves valuable shelf space
- High clarity for easy viewing of contents
- Shatterproof alternative to glass media bottles
- PETG material reduces gas permeability
- Both PET and PETG media bottles have equivalent performance and share key material properties, such as operating temperature range (-80°C to 60°C) and chemical compatibility

- 1 Molded graduations on two sides
- 2 Flat surface polyethylene (HDPE) caps are ideal for marking



SQUARE MEDIA BOTTLE **AF, S, R/D F, NP, USP, PETG**

Part No.	Product Description	Pack Description	Qty/Case
229788	500mL Media Bottle, Square	1/Bag	24

Wide Mouth Bottles



- Round shape and easy-pour wide mouth design
- Excellent chemical resistance and durable, rigid walls
- Ideal for specimen and chemical storage
- Linerless leak-proof screw top closure
- Bottle and cap supplied assembled
- Non-sterile; autoclavable

WIDE MOUTH BOTTLES **AF, N, A, PP**

Part No.	Product Description	Pack Description	Qty/Case
229793	30mL Wide Mouth Bottle	12/Bag	48
229794	60mL Wide Mouth Bottle	12/Bag	48
229795	125mL Wide Mouth Bottle	12/Bag	48
229796	250mL Wide Mouth Bottle	6/Bag	24
229797	500mL Wide Mouth Bottle	6/Bag	24

NEW PET Square Media Bottles



- Lightweight plastic material is easier and safer to handle than glass
- Square bottle shape conserves space in refrigerated storage areas
- Wide mouth design minimizes contamination risk when pipetting media and solutions
- Clearly printed graduations for quick volume reference
- Defined marking area is easy to write on
- Bottles are sterile, available individually wrapped or tray packed with 12 bottles per tray
- PET material reduces gas permeability and improves solution stability compared to polystyrene
- Both PET and PETG media bottles have equivalent performance and share key material properties, such as operating temperature range (-80°C to 60°C) and chemical compatibility

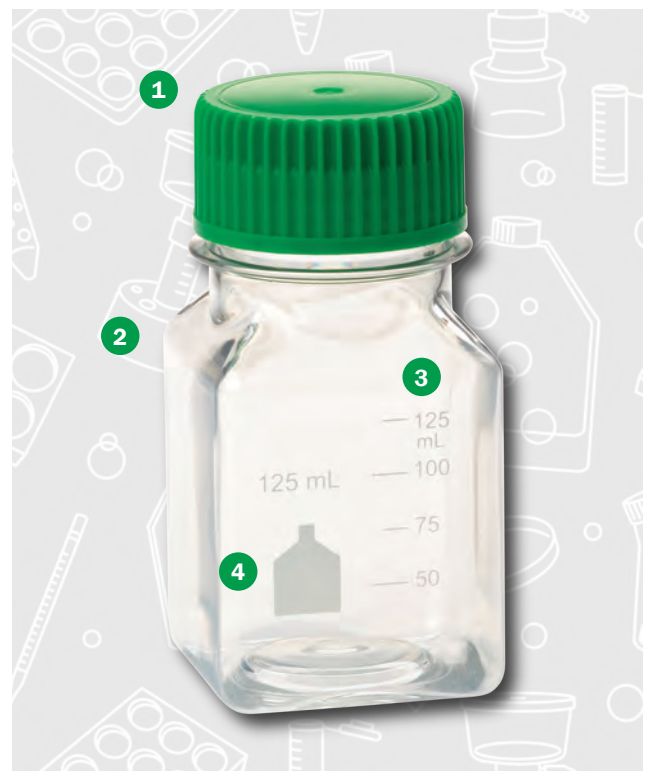

SQUARE MEDIA BOTTLE AF, S, R/D F, NP, USP, PET

Part No.	Product Description	Pack Description	Qty/Case
229786	125mL Media Bottle, Square	1/Bag	24
229789	250mL Media Bottle, Square	1/Bag	24
229791	500mL Media Bottle, Square	1/Bag	24
229798	1000mL Media Bottle, Square	1/Bag	24
229787	125mL Media Bottle, Square	12/Tray	24
229790	250mL Media Bottle, Square	12/Tray	24
229792	500mL Media Bottle, Square	12/Tray	24
229799	1000mL Media Bottle, Square	12/Tray	24

- 1 Wide mouth design with flat surface polyethylene (HDPE) caps ideal for marking
- 2 Square shape saves storage space
- 3 Clearly printed graduations and volumes
- 4 Easy-to-write on marking area

Syringe Filters

SYRINGE FILTERS							AF, R/D F, NP, USP, PP
Part No.	Membrane Material	Membrane Pore Size	Membrane Diameter	Sterile	Packaging	Qty/ Case	
229739	PES	0.10µm	30mm	Y	Individual	30	
229746	PES	0.22µm	13mm	Y	Individual	75	
229747	PES	0.22µm	30mm	Y	Individual	30	
229748	PES	0.45µm	13mm	Y	Individual	75	
229749	PES	0.45µm	30mm	Y	Individual	30	
229771	PES	0.45µm	30mm	N	Bulk	100	
229740	PVDF	0.10µm	13mm	Y	Individual	75	
229741	PVDF	0.10µm	30mm	Y	Individual	30	
229742	PVDF	0.22µm	13mm	Y	Individual	75	
229743	PVDF	0.22µm	30mm	Y	Individual	30	
229744	PVDF	0.45µm	13mm	Y	Individual	75	
229745	PVDF	0.45µm	30mm	Y	Individual	30	
229774	PVDF	0.45µm	30mm	N	Bulk	100	
229760	Nylon	0.22µm	13mm	Y	Individual	75	
229761	Nylon	0.22µm	30mm	Y	Individual	30	
229754	Nylon	0.45µm	13mm	Y	Individual	75	
229755	Nylon	0.45µm	30mm	Y	Individual	30	
229775	Nylon	0.22µm	30mm	N	Bulk	100	
229776	Nylon	0.45µm	30mm	N	Bulk	100	
229756	PTFE	0.22µm	13mm	Y	Individual	75	
229757	PTFE	0.22µm	30mm	Y	Individual	30	
229758	PTFE	0.45µm	13mm	Y	Individual	75	
229759	PTFE	0.45µm	30mm	Y	Individual	30	
229777	PTFE	0.22µm	13mm	N	Bulk	100	
229778	PTFE	0.22µm	30mm	N	Bulk	100	
229779	PTFE	0.45µm	13mm	N	Bulk	100	
229780	PTFE	0.45µm	30mm	N	Bulk	100	
229750	MCE	0.22µm	13mm	Y	Individual	75	
229751	MCE	0.22µm	30mm	Y	Individual	30	
229752	MCE	0.45µm	13mm	Y	Individual	75	
229753	MCE	0.45µm	30mm	Y	Individual	30	
229768	Glass Fiber (GF)	1.1µm	30mm	Y	Individual	30	
229762	CA	0.22µm	30mm	Y	Individual	30	
229763	CA	0.45µm	30mm	Y	Individual	30	
229764	CA	0.80µm	30mm	Y	Individual	30	
229769	CA w/ GF Prefilter	0.22µm	30mm	Y	Individual	30	
229765	SFCA	0.22µm	30mm	Y	Individual	30	
229766	SFCA	0.45µm	30mm	Y	Individual	30	

Syringe Filters



MOST POPULAR!

PES (Polyethersulfone) - Low affinity for proteins and extractables

- Faster flow rate than PVDF
- Pre-filtration and filtration of buffers and culture media
- Available in three pore sizes including 0.10µm for mycoplasma removal



PVDF (Polyvinylidene fluoride) -

Low protein-binding for filtration of non-aggressive aqueous and mild organic solutions

- Maximizes protein recovery
- High temperature filtration



NYLON - Universal application for analytical procedures

- Chemical filtration
- Beverage filtration



PTFE (Polytetrafluorethylene) -

Hydrophobic membrane has great temperature resistance

- Degassing/clarifying aqueous samples
- Strong acid solvent filtration
- Alkali solvent filtration



MCE (Mixed Cellulose Ester) - Filtration of aqueous solutions

- Effectively binds trace proteins
- Oil particulates and bacteria filtration



GF (Glass Fiber) - Preliminary filtering step to avoid clogging

- Coarse particulate removal
- Pre-filtration



CA (Cellulose Acetate) - Low protein binding, reduced extractables and low hold-up volume

- Filtration of aqueous solutions such as buffers, media and reagents



SFCA (Surfactant Free Cellulose Acetate)

Similar uses to CA but contains no pre-wetting agents; lower extractables

COLOR CODED FOR EASY IDENTIFICATION!

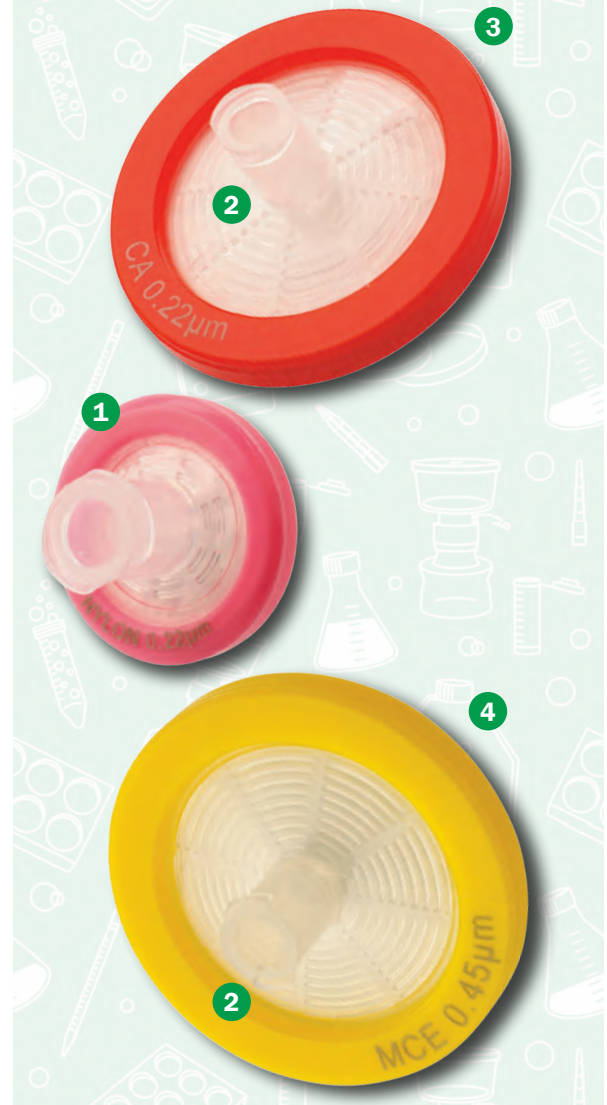

- Individually packed, sterile, in peel-to-open paper/plastic blister packs
- Also available bulk packed, non-sterile, in PVDF, PES, PTFE and Nylon membranes

- 1 Color coded syringe filters are laser printed with membrane material and pore size
- 2 Female luer-lock inlet and male luer slip outlet
- 3 0.22µm CA Syringe Filter with integrated GF prefilter (PN 229769) is ideal for one-step filtration of viscous solutions and particulate removal
- 4 Filters are molded into the polypropylene housings, providing a reliable seal without the use of adhesives

Filter Systems & Bottle Top Filters



500mL Filter System, 0.22µm

Filter Systems

- Improved filter support provides faster flow rates
 - Easy-to-read molded graduation marks on bottle top filter
 - Curved bottle design for easy handling
- 1** Larger membrane diameter for 250 & 500mL filters increases flow and reduces clogs for faster filtration
 - 90mm diameter of 500mL membrane has 44% more filtration area than standard 75mm
 - Larger area, same price
 - 2** Angled hose barb adapter fits three size hose diameters and prevents the filter from tipping
 - 3** Printed lot number and expiration date on every bottle top
 - 4** Bold easy-to-read printed membrane and pore size for easy identification
- Bottle Top Filters fit on CELLTREAT brand solution bottles or other standard 45mm storage bottles
 - Bottle Top Filters do not include solution bottles, sold separately, see page 84

50mL Centrifuge Tube Filter Systems

- Eliminate a transfer step by filtering directly into a 50mL tube
 - One Centrifuge Tube Stand included with each case of 50mL Centrifuge Tube Filter Systems
 - Centrifuge Tube Stands are manufactured from polypropylene and are autoclavable, reusable and recyclable
 - Centrifuge Tube Stand will hold one 50mL tube, three 15mL tubes and three microcentrifuge tubes (1.5mL)
- 1** Multi-purpose Centrifuge Tube Stand available for purchase separately Part No. 229409



50mL Centrifuge Tube Filter System, 0.45µm

Filter Systems & Bottle Top Filters



0.1µm AVAILABLE FOR MYCOPLASMA REMOVAL!

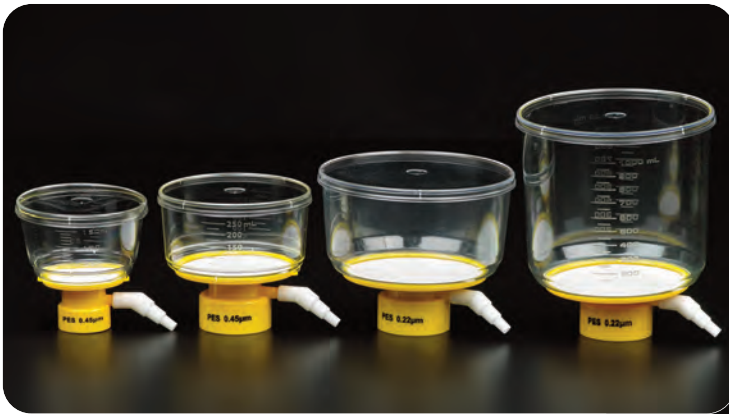

- Polyethersulfone (PES) membrane is useful for high flow and low binding
- Nylon (PA) membrane has excellent chemical compatibility and does not require pre-wetting
- 0.22µm PES membrane is the first choice for sterile filtration of cell culture media
- 0.10µm PES membrane ideal for mycoplasma removal
- 0.45µm PES membrane ideal for solution clarification



FILTER SYSTEMS (Bottle Top Filter + Solution Bottle)

AF, S, R/D F, NP, USP, PS

Part No.	Product Description	Membrane Material	Membrane Diameter	Membrane Pore Size	Sterile	Pack Description	Qty/Case
229701	150mL Filter System	PES	50mm	0.45µm	Y	1/Bag	12
229702	250mL Filter System	PES	75mm	0.45µm	Y	1/Bag	12
229703	500mL Filter System	PES	90mm	0.45µm	Y	1/Bag	12
229704	1000mL Filter System	PES	90mm	0.45µm	Y	1/Bag	12
229705	150mL Filter System	PES	50mm	0.22µm	Y	1/Bag	12
229706	250mL Filter System	PES	75mm	0.22µm	Y	1/Bag	12
229707	500mL Filter System	PES	90mm	0.22µm	Y	1/Bag	12
229708	1000mL Filter System	PES	90mm	0.22µm	Y	1/Bag	12
229721	150mL Filter System	PES	50mm	0.10µm	Y	1/Bag	12
229722	250mL Filter System	PES	75mm	0.10µm	Y	1/Bag	12
229723	500mL Filter System	PES	90mm	0.10µm	Y	1/Bag	12
229724	1000mL Filter System	PES	90mm	0.10µm	Y	1/Bag	12

BOTTLE TOP FILTERS (No Solution Bottle)

AF, S, R/D F, NP, USP, PS

229711	150mL Bottle Top	PES	50mm	0.45µm	Y	1/Bag	24
229712	250mL Bottle Top	PES	75mm	0.45µm	Y	1/Bag	24
229713	500mL Bottle Top	PES	90mm	0.45µm	Y	1/Bag	24
229714	1000mL Bottle Top	PES	90mm	0.45µm	Y	1/Bag	24
229715	150mL Bottle Top	PES	50mm	0.22µm	Y	1/Bag	24
229716	250mL Bottle Top	PES	75mm	0.22µm	Y	1/Bag	24
229717	500mL Bottle Top	PES	90mm	0.22µm	Y	1/Bag	24
229718	1000mL Bottle Top	PES	90mm	0.22µm	Y	1/Bag	24
229732	250mL Bottle Top	Nylon (PA)	75mm	0.45µm	Y	1/Bag	24
229733	500mL Bottle Top	Nylon (PA)	90mm	0.45µm	Y	1/Bag	24

CENTRIFUGE TUBE FILTER SYSTEMS (Tube Filter, Centrifuge Tube, Cap + Stand)

AF, R/D F, NP, USP, PS

229709	50mL Centrifuge Tube Filter	PES	50mm	0.45µm	Y	1/Bag	12
229710	50mL Centrifuge Tube Filter	PES	50mm	0.22µm	Y	1/Bag	12
229409	Multi-Purpose Stand	NA	NA	NA	N	5/Bag	5

Solution Bottles



- Compatible with bottle top filters or for use as solution storage containers (Bottle Top Filters sold separately, see page 83)

- 1 Solution bottle neck size is 45mm with GL45 HDPE cap
- 2 Curved bottle design for easy handling

SOLUTION BOTTLES		AF, S, R/D F, NP, USP, PS		
Part No.	Product Description	Working volume	Pack Description	Qty/ Case
229781	150mL Solution Bottle	150mL	1/Bag	24
229782	250mL Solution Bottle	250mL	1/Bag	24
229784	500mL Solution Bottle	500mL	1/Bag	24
229785	1000mL Solution Bottle	1000mL	1/Bag	24

Glass Fiber Filter Disks

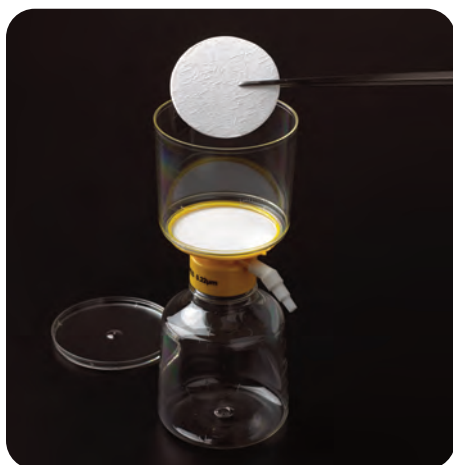

- Glass Fiber Filter Disks are an ideal prefilter to prevent clogging when filtering viscous or particulate-laden solutions with CELLTREAT Scientific Products Filter Systems and Bottle Top Filters (see page 82-83)
- Increase filtration speed by removing larger particles prior to sterilizing filtration
- Packaged sterile, individually wrapped



GLASS FIBER FILTER DISKS		AF, S, R/D F, NP, GLS			
Part No.	Product Description	Filter Diameter	Filter Pore Size	Pack Description	Qty/ Case
230730	Glass Fiber Filter Disk, Prefilter, Binder Free	50mm	1.0µm	Individually Wrapped	50
230732	Glass Fiber Filter Disk, Prefilter, Binder Free	70mm	1.0µm	Individually Wrapped	50
230734	Glass Fiber Filter Disk, Prefilter, Binder Free	90mm	1.0µm	Individually Wrapped	50

Accessories		Cap Inserts	40
Markers	29	Dishes	
Vent Control Labels	34	Glass Bottom Dishes & Plates	66
Lab Grab Multi-Use Extension Grabber	43	Tissue Culture Treated	70
Pipet Storage Rack	46	Non-Treated	71
Aspirating Bulb.....	48	Compartment Petri	72
Timer	71	Petri	73
Bag Cutter.....	71	Filtration	
Beakers	77	Syringe Filters	80-81
Bio-reaction Tubes	34	Filter Systems & Bottle Top Filters	82-83
Bottles		Centrifuge Tube Filter Systems	82-83
250 & 500mL Centrifuge	33	Glass Fiber Filter Disks	84
Roller	59	Flasks	
500mL Square Media	78	Cell Culture	60-61
Wide Mouth	78	Non-Treated Suspension Culture	61
PET Square Media	79	Flask Caps	61
Solution	84	Erlenmeyer	74
Cell Lifters	63	Erlenmeyer & Fernbach - Large Volume	75
Cell Scrapers	62	Loops, Needles & Spreaders	72
Cell Strainers	37	PCR Plates, Strips & Tubes	23
Pestle	37	Pipet Controllers	
Centrifuge Tubes		ali-Q 2™ Pipet Controller	44-45
Centrifuge Tube Selection Guide	24-25	Manual	46
15 & 50mL Bag	26	Automatic	46
15 & 50mL Paperboard Rack	26	Pipets	
15 & 50mL Plastic Rack	27	Pipet Selection Guide	50-51
15 & 50mL Foam Rack	27	Aspirating	47
10mL Bag	28	Polystyrene Plasteur®	48
15 & 50mL Best Value Bag	28	Polypropylene Plasteur®	49
15 & 50mL Colored Cap Bag	29	Serological Pipets - Wobble-not	52-53
15 & 50mL Sure Cap Bag	30	Serological Pipets - Best Value	54-55
15 & 50mL Flip Top Cap Bag or Rack	30	Serological Pipets - Double Case	56
15 & 50mL Snap-Pop Lid Bag	31	Serological Pipets - Plastic/Plastic Wrap	56
30 & 50mL Self-Standing Bag	31	Serological Pipets - Classic	57
15 & 50mL Black Bag	32	Serological Pipets - Open End	58
10, 30 & 50mL Oak Ridge Style Bag	32	Serological Pipets - Short	58
225, 250 & 500mL Large Volume Bag	33	Serological Pipets - Bacteriological/Milk	58
5mL Macro Bag	36	Pipette Tips	
0.5, 1.5 & 2.0mL Micro Bag	36	Pipette Tip Selection Guide	6-7
0.5, 1.5 & 2.0mL Screw Top Micro Tubes Bag ..	42-43	Universal Pipette Tips	7-8
Chambered Cell Culture Slides	76	Universal Pipette Tips - 5mL & 10mL	9
Slide Tray	77	Universal Pipette Tips - Bulk Packed	9
Cover Glass, Round	46	Universal Pipette Tips - Reload System	10
Cryogenic Vials		Universal Pipette Tips - Empty Racks	10
CELLTREAT Freeze Cryogenic Vials	38-39	Low-force Tip Solution Pipette Tips (LFTS).....	11
Workstation Rack	39	MLA & Ovation Pipette Tips	12-13, 16
Storage Boxes	40		

Index continued on next page

Pipettes	Non-Treated Multiple Well	68
Ovation Pipettes - Mechanical	Polypropylene	69
Ovation Pipettes - Electronic	Deep Well Storage	69
Ovation Pipettes - Fixed Volume & Macro	Reagent Reservoirs	
Adjustable Pipettes - CELLTREAT	Polystyrene - CELLTREAT	20
MLA Pipettes	Polystyrene - VistaLab	21
Plates	Polypropylene	22
Cover Glass, Round	Sealing Films	68
Tissue Culture Treated Multiple Well	Tubes	
Glass Bottom Dishes & Plates	Culture Tubes - Round Bottom	35
Permeable Cell Culture Inserts	Transport Tubes	41

Product Certification & Material Indicator Symbols

For information about product sterility, material type, and certifications, please consult the reference table below and product tables on each page.

Symbol	Product Certification Indicator
AF	Product is Animal Free
S	Product is Sterile
N	Product is Non-sterile
R/D F	RNase/DNase Free
NP	Non-pyrogenic: Validated to have less than 0.1 to 0.5 EU/mL*
USP	Meets USP Class VI Certification Standards
A	Autoclavable**
Symbol	Product Material Indicator
ABS	Acrylonitrile butadiene styrene
GLS	Optical grade glass
HDPE	High Density Polyethylene
LDPE	Low Density Polyethylene
PC	Polycarbonate
PET	Polyethylene terephthalate
PETG	Polyethylene terephthalate, glycol modified
PP	Polypropylene
PS	Polystyrene
TPE	Thermoplastic elastomers

Product Certification and Material Indicator Symbols located in the black heading bar of each product table are included as a quick reference for ordering. Complete product and lot specific quality certificates are available through the CELLTREAT website - www.celltreat.com

Please refer to the table for the product specifications, primary materials and their indicator symbols.

* Limit varies by product. Please contact CELLTREAT for specific limits.

** Polypropylene Centrifuge Tubes are autoclavable. HDPE caps may be autoclaved at lower temperatures and should be inspected prior to use.

Trademarks & Certifications

CELLTREAT® and Plasteur® are registered trademarks of CELLTREAT® Scientific Products

VistaLab™, ali-Q™ 2, MLA™, Protectainer™, VistaBulk™, VistaClear™, VistaRak™, VistaStak™, and VistaTip™ are trademarks of VistaLab™ Technologies, Inc. Ovation® is a registered trademark of VistaLab™ Technologies, Inc.

CELLTREAT® Scientific Products has a Quality Management System certified by PRI Registrar to ISO 9001:2015. See www.celltreat.com for certificate.

VistaLab™ Technologies, Inc. has a Quality Management System certified by TUV USA to ISO 9001:2015. VistaLab Technologies, Inc. also has a metrology lab that is accredited to ISO/IEC 17025:2017. See www.celltreat.com for certificates.

Calibration & Repair



ISO/IEC 17025-2017 ACCREDITED METROLOGY LAB WITH NIST TRACEABILITY

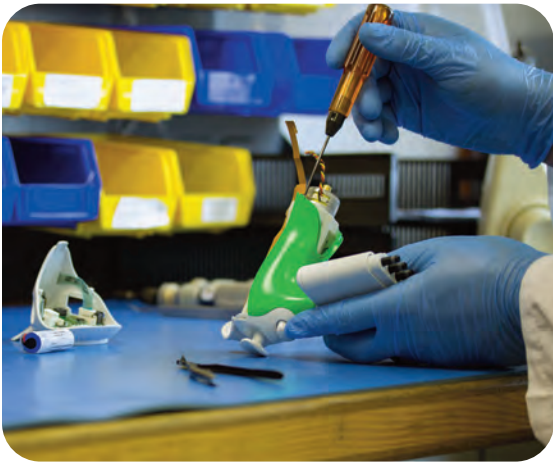

VISTALAB CALIBRATION

- Ensure optimum performance and meet all regulatory requirements for your MLA & Ovation pipettes with VistaLab calibration services
- Over 40+ years of calibration experience
- Calibration is performed in compliance with ISO 8655 in a state-of-the-art, ISO/IEC 17025:2017 accredited metrology lab with NIST traceability
- A variety of calibration service levels are available to meet the unique needs of every lab, visit www.celltreat.us/vlservices or scan QR code for detailed information



VISTALAB REPAIR & WARRANTY

- Repair service can be added to any calibration service
- All repairs are performed using original manufacturer's parts
- 90 day warranty on all services performed on MLA and Ovation pipettes, and a 1 year warranty on parts

Calibration & Repair Address

VistaLab Technologies, Inc.
2 Geneva Road
Brewster, NY 10509
Phone: 888.652.6520

MLA & Ovation Customization

- MLA and Ovation pipettes can be made to order with custom colors, volumes, and etchings
- See www.celltreat.us/custom or scan QR code for full details



Need to request a Sample or Quality Certificate?

Samples

Simply send an email to samples@celltreat.com or complete the online sample request form at www.celltreat.us/samples, or scan the QR code below. Include your name and complete address along with the part number of the product you are requesting. You will receive an email with tracking information after it has shipped. **It's that easy!**



Quality Certificate (COC/COA)

Multi-level quality process ensures that all products meet our high standards. Lot-specific Quality Certificates are available, verifying that products have been manufactured and inspected to rigorous specifications.

To request a Quality Certificate, please complete the online form at www.celltreat.us/quality, or scan the QR code below.



CELEBRATE WITH US! 15 YEARS

Experience the CELLTREAT difference

CELLTREAT Scientific Products

Toll Free: 877.345.4620

Phone: 978.650.1320

Fax: 978.650.1316

Email: service@celltreat.com

Web: www.celltreat.com

