

Proud To Be The UK's
Leading Supplier of
Roofing Sheets

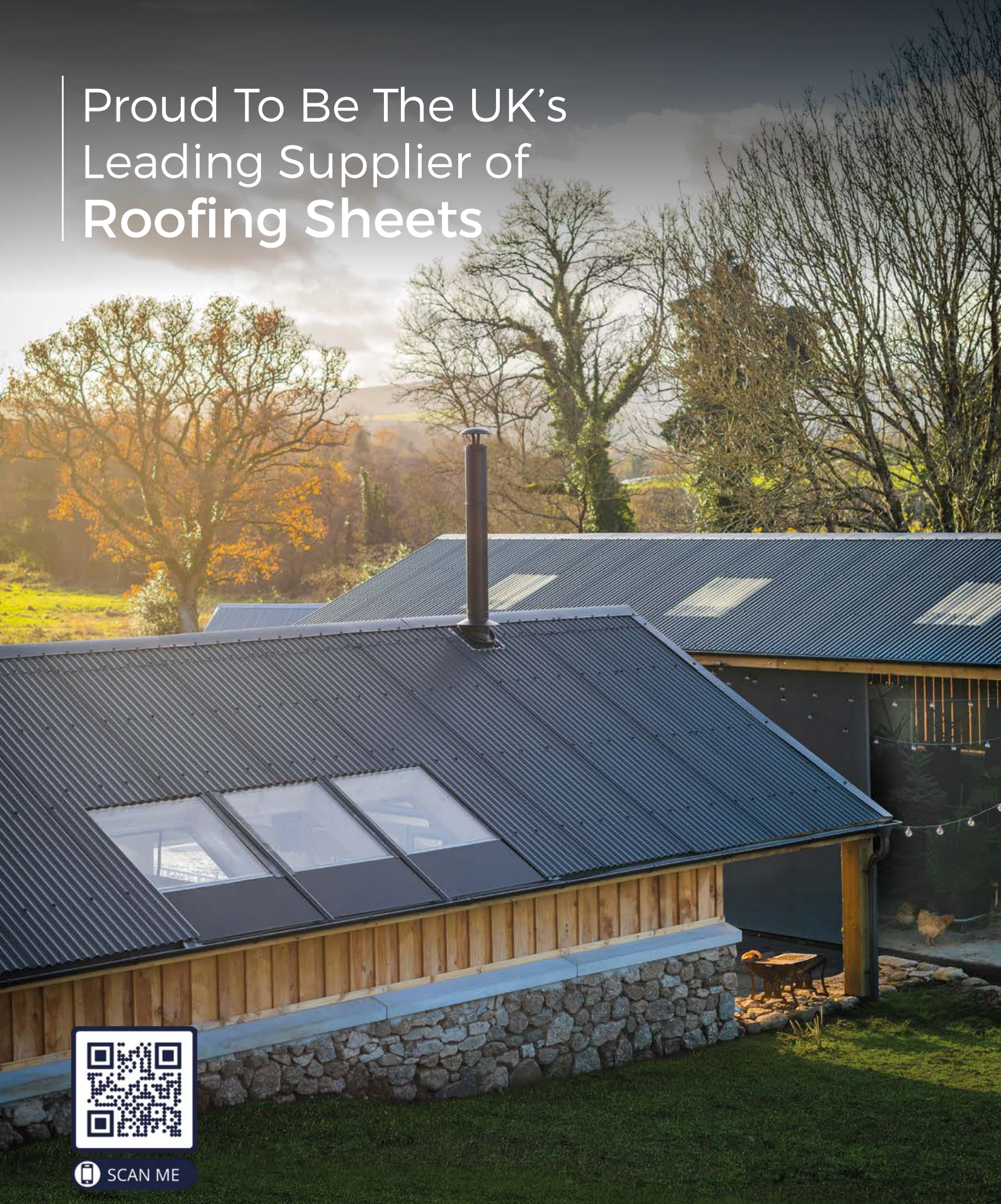

SCAN ME

ORDER ONLINE
www.cladco.co.uk
or call **01837 659901**

CLADCO
PROFILES

ROOFING CLADDING & SHEETING



Contents

- 4 **Cladco Profiles**
- 6 **Overview Of Coatings**
- 8 **Overview Of Profiles**
- 10 **Dripstop Condensation Control**
- 12 **32/1000 Box Profile**
- 14 **34/1000 Box Profile**
- 16 **13/3 Corrugated Profile**
- 18 **41/1000 Tile Form Profile**
- 20 **30/500 Standing Seam Profile**
- 24 **Insulated Panels**
- 25 **Flat Sheets**
- 26 **Installation Guides**
- 30 **GRP Roof Lights**
- 32 **Z Purlins**
- 33 **Trims And Flashings**
- 34 **Custom-Made Trims And Flashings**
- 36 **Tarpaulin Range**
- 38 **Fixings And Accessories**
- 40 **Case Studies**

At Cladco Profiles, we believe in supplying high-quality custom-made Roofing and Cladding products at highly competitive prices, alongside excellent customer service.

We work closely with our customers to provide advice on the best solution for a project. Our investment in manufacturing and product development has increased to meet our customers' demands. We have installed the latest sheet metal production machinery, giving us the ability to manufacture Sheeting, Purlins, Trims and Flashings to meet our customers' requirements.

We hold large stocks of coated Sheeting, GRP Roof Lights, Fixings and Accessories, enabling us to supply at short notice.

Our products are available to order online or over the phone.

Pictured - Black Corrugated Cladding



Cladco Profiles

About Us

Established in 1972, Cladco Profiles is a family-run business based on the edge of Dartmoor in Okehampton, Devon. We supply the UK with high-quality Steel Roofing Sheets and custom-made Flashings, available in a range of colours, coatings and Profiles to suit your needs.

We are proud to celebrate our 50th Anniversary, marking five decades of supplying high-quality products across the country. Our commitment to product innovation and customer service has enabled us to become the UK's Leading Supplier of Roofing Sheets. As a business, we are constantly adapting to our customers' requirements and have a team of highly trained experts to help with your project, from quoting materials through to installation advice.



ISO Certified



ISO 9001 is the world's most recognised Quality Management System Standard. ISO 9001 is designed to ensure organisations

meet the needs of customers and other stakeholders, by having a framework in place that helps ensure consistent quality in the provision of goods and services. Cladco is accredited with ISO 9001 after achieving Management Excellence Status from ISO.



ISO 45001 - Cladco has achieved Occupational Health and Safety Management Performance accredited by ISO. ISO 45001

Standard reduces workplace risks to improve employee safety. This Standard surpasses many existing health and safety standards because it has been developed by a committee of occupational health and safety experts.



ISO 14001 is the International Standard for Environmental Management Systems (EMS). This Standard was designed by

the International Organisation for Standardisation (ISO) to help businesses and other organisations reduce their environmental impact.

Customer Service

At Cladco Profiles, our staff are highly trained to perform outstanding customer service at any opportunity, ensuring no problem is left unsolved. We believe in the quality of our products and offer a Sample service so you can see the products before committing to purchase.

Call 01837 659901

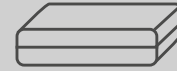

Sample Swatches

Want to see the quality, colours and finish of our Roofing products before purchasing? Order Samples from our website with a wide choice of colours available.



Installation Guides

Easy-to-follow Installation Guides can be found on our website for all Roofing Sheet Profiles, as well as Installation Videos on YouTube.

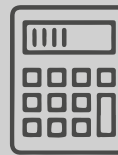

Roofing Calculator

Unsure of the quantity of Roofing Sheets you may need? Our Roofing Calculator on our website will be able to work out how many Sheets, Flashings and Accessories you require, and provide you with a quote.



Cladco Decking® Also Available

We are also the UK's Leading Supplier of Composite Decking, providing a range of Wall Cladding, Fencing, Balustrades and Accessories for any outdoor project. Please visit our other website to find out more.



www.cladcodecking.co.uk



We are constantly reviewing the way we work and setting new targets to ensure that, as a business, we are being as environmentally friendly as we can. One example is, since 2019, 50% of our forklifts are electric, charged using energy produced from the solar panels on our warehouse roof.

For more information on our environmental journey please visit our website: www.cladcodecking.co.uk/cladco-environmental



SCAN ME

Overview Of Coatings

Our products are custom-made to order and manufactured in our Devon-based warehouse.

The coated steel strip we make into our products is produced in accordance with a strict series of quality standards by leading suppliers, giving us traceability and quality control. All of our Profiled Sheeting and Purlin products have been independently tested to current CE EN 14782 requirements.

The durability of this material is dependant on the galvanised and protective coatings directly applied to the steel substrate. As a material, steel has long been used in construction and has the added benefit of being recyclable.

To produce high-quality, pre-coated Sheeting, a system of multi-layered coatings is applied to zinc coated, high-tensile steel strips and oven-cured to ensure optimum adhesion. This gives each of our Sheets excellent resistance and climatic protection, together with abrasion resistance and high strength.

Our Sheeting is available in 0.5mm, 0.6mm and 0.7mm thicknesses, and in 200 micron PVC Plastisol, 25 micron Polyester Paint, GreenCoat® Mica BT and Pural BT or plain Galvanised coatings, suitable for all types of agricultural, industrial and commercial buildings.

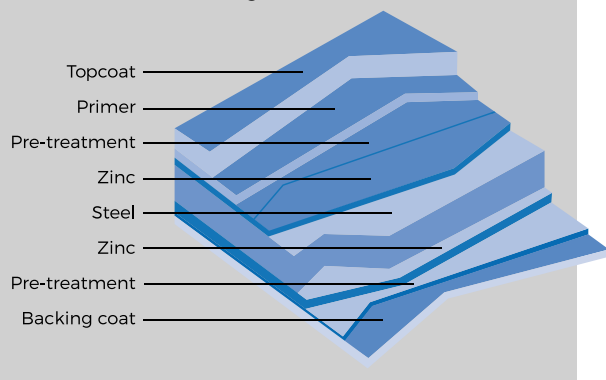

PVC Plastisol Coated

Pre-finished Steel Sheeting with a 200 micron thick coating of high-quality PVC Plastisol with an embossed leather grain finish. This gives long life, typically 15 to 25 years to first maintenance or repaint, with a life in excess of 40 years in normal environments and with a high resistance to scratching and damage.

Polyester Paint Coated

A 25 micron thick, smooth enamel coating that is economic to use and gives excellent weather resistance. Typically 8 to 12 years to first maintenance or repaint, with a life in excess of 20 years in normal environments, with a moderate resistance to scratching.

Both coatings are available in an extensive range of colours, where choice and aesthetic appeal can be matched to environmental and performance requirements. Both types use a light grey enamel coating on the reverse side.

GreenCoat® Mica BT and Pural BT Coated

GreenCoat® colour coated Sheeting is manufactured according to the BT patent (bio-based technology), holding a high environmental position. In BT coated steel, a substantial portion of the traditional fossil oil is replaced by Swedish rapeseed oil, which is unique on the market. SSAB holds a worldwide patent for this coating technology.

GreenCoat® Mica BT and Pural BT coatings are optimised for wear resistance with a low resource consumption. GreenCoat® Mica BT and Pural BT have excellent colour retention and also provide good protection against corrosion.

Dripstop Condensation Control

Dripstop is available with all our Roofing Sheet Profiles (except Standing Seam) and is applied to the reverse of the Sheet during manufacturing.

Dripstop is a condensation control membrane which is proven to prevent drips forming in conditions of high humidity.





We always insist on Cladco PVC Plastisol Sheeting because we only use the best possible materials in the construction of our garden buildings. The quality and service we receive from Cladco is excellent."

John, Customer

Polyester Paint Chart



PVC Plastisol Chart

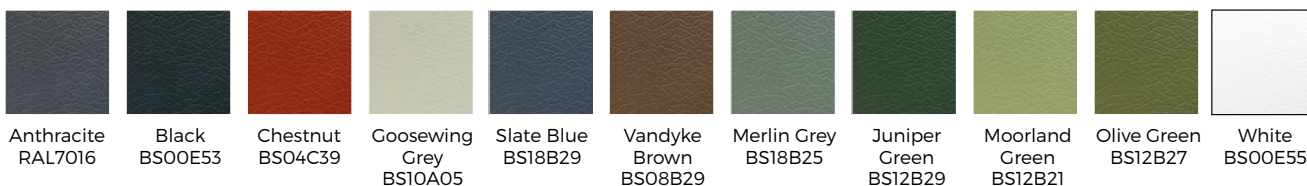

GreenCoat® Mica BT

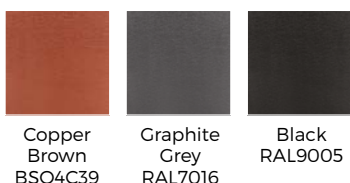

GreenCoat® Pural BT







Please note: colours are for guidance purposes only. The actual colour may vary from image supplied. Numbers represent nearest BS/ RAL or SS/RR reference. If you would like to see the actual colour before purchasing, we recommend ordering a swatch sample. Not all colour variations are available on all thicknesses. Please contact us to find out more.

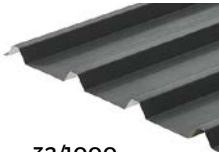

Further information can be obtained by calling our Customer Service Team on **01837 659901**

Overview Of Profiles

We can manufacture and supply Roofing Sheets in five different Profiles: 32/1000 Box Profile, 34/1000 Box Profile, 13/3 Corrugated, 30/500 Standing Seam and 41/1000 Tile Form. Our Roofing Sheets are available in 0.5mm, 0.6mm and 0.7mm thicknesses for use as wall cladding or roofing. We can cut Sheets to custom lengths, with necessary fixtures including Roof Lights, Flashings and Fillers.

 32/1000 BOX PROFILE	Available Thickness	Minimum Pitch	Available Finish	Standard Width (When Lapped)	Minimum Length	Maximum Length	Weight	Application
	0.5mm or 0.7mm	4 Degrees	Polyester Paint, PVC Plastisol, Galvanised	1000mm	500mm	7m or 9m	From 4.9kg/m ²	Side Clad or Roof
 34/1000 BOX PROFILE	Available Thickness	Minimum Pitch	Available Finish	Standard Width (When Lapped)	Minimum Length	Maximum Length	Weight	Application
	0.5mm or 0.7mm	4 Degrees	Polyester Paint, PVC Plastisol, Galvanised	1000mm	500mm	7m or 9m	From 4.9kg/m ²	Side Clad or Roof
 13/3 CORRUGATED	Available Thickness	Minimum Pitch	Available Finish	Standard Width (When Lapped)	Minimum Length	Maximum Length	Weight	Application
	0.5mm or 0.7mm	10 Degrees	Polyester Paint, PVC Plastisol, Galvanised	990mm	500mm	5m or 7m	From 4.9kg/m ²	Side Clad or Roof
 41/1000 TILE FORM	Available Thickness	Minimum Pitch	Available Finish	Standard Width (When Lapped)	Minimum Length	Maximum Length	Weight	Application
	0.6mm	12 Degrees	Mica BT	1000mm	500mm	6m	From 6.6kg/m ²	Roof
 STANDING SEAM	Available Thickness	Minimum Pitch	Available Finish	Standard Width (When Lapped)	Minimum Length	Maximum Length	Weight	Application
	0.7mm	6 Degrees	Pural BT	500mm	1.2m	8m	From 5.11kg/m ²	Side Clad or Roof

Roofing Types

Popular roof styles include an apex, hip, lean-to and valley.



Apex

An apex roof is a roof with two slopes, which meet at the highest point in the middle.



Hip

A hip roof has no vertical ends. It is sloped on all sides, with the slopes meeting in a peak.



Lean-To

A lean-to roof is a single sloped roof, with one edge attached or supported by an adjoining wall or building.



Valley

A valley roof has junctures in the roof, marking a change in the angle or direction of the roof.

Please note, for roofing applications outside of these examples, please contact us.

Measuring A Roof

When planning your project, we need to know the number of Sheets and the length of Sheeting required. To work this out, start by measuring the ridge length of your roof and the Sheet length.

Simply divide this measurement by 1m for Box Profile and Tile Form Sheeting, or by 500mm for Standing Seam and 990mm for Corrugated Sheeting. Next up, measure the Sheet length of your roof, allowing for adequate overhang, to work out the maximum length of Sheeting.

If your Sheet length measurement is over the maximum length of the Profile (see table), then a two-Sheet run is required. These measurements will then give you how many Sheets you will need and at what lengths. For two-Sheet runs, ensure you have calculated the overlap, usually a minimum of 250mm, depending on pitch angle.

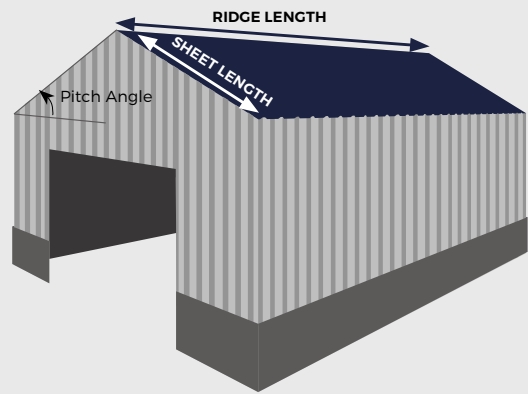

Sheets As Side Cladding

Steel Roof Sheets can also be installed as wall cladding and offer a range of beneficial properties over traditional alternatives. The hard-wearing properties of 0.5mm thick steel, or 0.7mm for Standing Seam, make for an ideal cladding material, as the load bearing weight is less when compared to a roof.

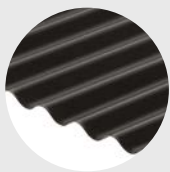

13/3 Corrugated
Thickness: 0.5mm
Max Length: 5m



34/1000 Box Profile
Thickness: 0.5mm
Max Length: 7m



32/1000 Box Profile
Thickness: 0.5mm
Max Length: 7m



30/500 Standing Seam
Thickness: 0.7mm
Max Length: 8m

Dripstop Condensation Control

Anti-Condensation Membrane

We can supply our Profiled Sheets with Dripstop anti-condensation membrane applied on the reverse, as a proven way of stopping Sheets dripping with condensation in conditions of high humidity.

Dripstop membrane works by providing a medium for trapping moisture in the fibre pockets formed in the polyester felt membrane. Dripstop holds the moisture until conditions go back below the dew point, when moisture is then released back into the air as humidity.

Dripstop is self-adhesive and applied to Steel Sheeting in the profiling process. The membrane is resistant to ageing and provides an additional layer of protection for your roof.



Reduces damage from dripping or running condensation



Applied directly to the Sheet during manufacturing



Provides an additional layer of protection for your roof



Easy to clean and low-maintenance



Dripstop is available on all Profiles (except Standing Seam)

Condensation

Condensation can occur when warm, moist air inside a building comes into contact with cold surfaces. This occurs on the underside of the roof in un-insulated, single-skin metal buildings during the winter, and on clear nights when the temperature of the roof's surface is lowered due to night sky radiation. Condensation can run down the roof and collect on, or within, the interior of a building where it can cause rust or rot damage and may also drip from the roof.

Dripstop Condensation Control

Dripstop is a membrane designed to reduce damage from dripping or running condensation on metal roofs in buildings with moderate to high levels of humidity and poor ventilation.

Dripstop controls levels of condensation in an environment where cyclical condensation may occur. Dripstop does not prevent condensation and feels damp to the touch when working correctly. **For Dripstop to work effectively, the building must be adequately ventilated to allow the material to dry out between each cycle.**

Anti-condensation membrane absorbs and holds condensation until it can evaporate. The membrane insulates the Sheeting and prevents drips falling from the underside of the roof, further reducing the formation of condensation.

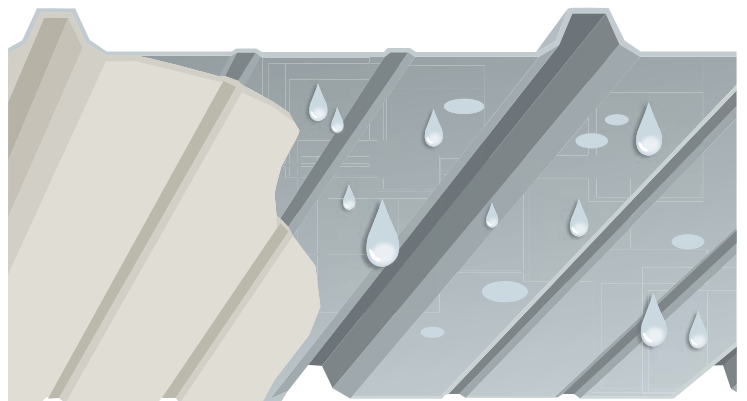

DRIPSTOP

“

Cladco has been so helpful from start to finish with my recent project, even down to helping me choose the colour of the Roofing Sheet. Thank you, Cladco.”

Katie, Customer

Benefits Of Dripstop

- Holds condensation safely until it evaporates.
- Prevents condensate dripping from the underside of the roof.
- Formation of condensation is slowed by insulating the Sheeting.
- Dripstop offers resistance to acids, hydroxides and sulphides and does not support the growth of mould or bacteria.

“For best results when using Dripstop, we recommend the roof pitch is a minimum of 10°.”



SCAN ME

32/1000 Box Profile Sheets

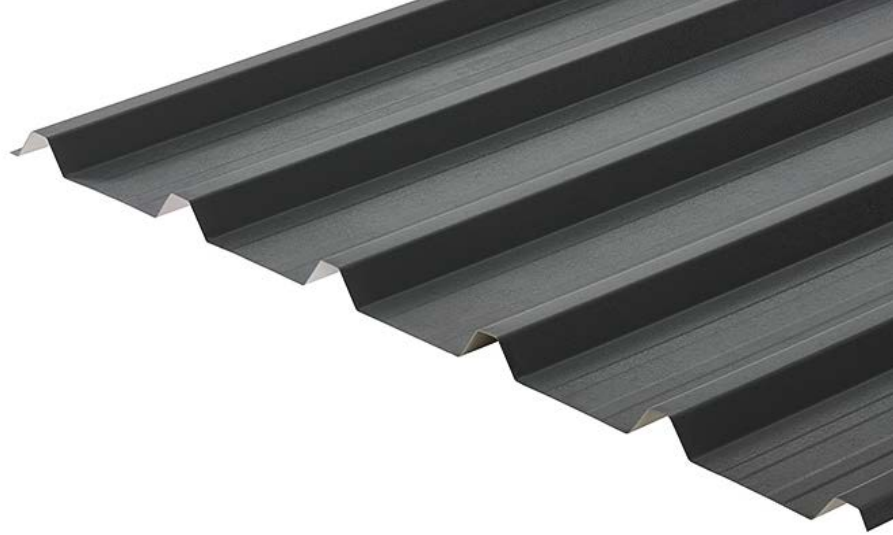

Lightweight, Low Profile Design

Our 32/1000 Box Profile single-skin Sheeting gives robust strength, with six profiles spaced 200mm apart and 32mm in height across the width of the Sheet.

Some users prefer the appearance of this Box Profile due to having lower and fewer profiles. Made from 1220mm coated steel strips, 32/1000 Box Profile gives 1000mm actual width coverage when lapped.

Available in 0.7mm and 0.5mm Sheet thicknesses, with PVC Plastisol, Polyester Paint and plain Galvanised coatings.

Applications

Industrial, agricultural, commercial, domestic roofing and cladding.

Can be used as single-skin roofing and cladding, over cladding an existing roof, or as part of a built-up insulated system.

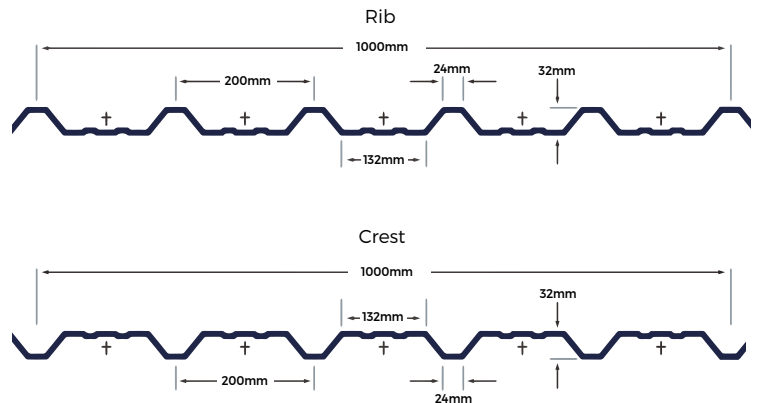

Permissible downward (imposed) loads in kN/m²

Sheet thickness	Weight kg/m ²	Span Condition	Span mm									
			1200	1400	1600	1800	2000	2200	2400	2600	2800	3000
0.50mm	4.78	Single	3.49	2.52	1.91	1.37	0.99	-	-	-	-	-
		Double	2.58	2	1.6	1.3	1.09	0.92	0.79	-	-	-
		Multi	3.15	2.45	1.96	1.6	1.34	1.13	0.86	-	-	-
0.70mm	6.22	Single	5.77	4.17	2.74	1.9	1.37	1.02	0.78	-	-	-
		Double	4.12	3.18	2.53	2.06	1.72	1.45	1.2	0.94	0.75	-
		Multi	5.04	3.9	3.11	2.54	2.11	1.57	1.2	0.94	0.75	-

Permissible wind uplifts (negative) loads in kN/m²

Sheet thickness	Weight kg/m ²	Span Condition	Span mm									
			1200	1400	1600	1800	2000	2200	2400	2600	2800	3000
0.50mm	4.78	Single	3.62	2.62	1.98	1.52	1.1	0.82	-	-	-	-
		Double	2.52	1.95	1.56	1.27	1.06	0.89	0.77	-	-	-
		Multi	3.09	2.39	1.91	1.56	1.3	1.1	0.94	0.82	-	-
0.70mm	6.22	Single	5.58	4.03	3.05	2.14	1.54	1.15	0.88	-	-	-
		Double	4.2	3.24	2.59	2.11	1.76	1.48	1.27	1.1	0.96	0.8
		Multi	5.13	3.98	3.18	2.6	2.16	1.83	1.57	1.25	0.99	0.8



Colour swatch samples are available on our website



Specifications

Application	Wall or Roof
External Finish	PVC Plastisol, Polyester Paint, or Galvanised
Internal Finish	Light Grey Polyester or Galvanised
External Face	32mm profile height, 200mm pitch centres
Standard Width	1000mm when lapped
Max Length	9m in 0.7mm thickness - 7m in 0.5mm thickness
Minimum Pitch	4 degrees
Gauge Thickness	0.7mm and 0.5mm
Weight	From 4.9kg/m ²

When used in roof applications, construction can be safely undertaken down to a 4 degree pitch using conventional self-drilling fasteners through lower parts of the profile. Roof Lights, Fixings, Trims and Flashings complete the system, offering robust, cost-effective Sheeting.



Cut To Custom Lengths



Easy To Install And Handle



Cladco staff were very helpful when ordering our Roofing Sheets. We were able to have colour swatch samples sent, which made choosing the colour easy."

Sheila, Customer



Benefits Of 32/1000 Box Profile Sheeting

- A strong industrial Profile.
- Can be manufactured to specific lengths.
- Available in a range of colours to suit.
- Lightweight and easy to fit.
- Independently tested to current CE EN 14782 requirements.
- Complementary Flashings are available.

AVAILABLE WITH



SCAN ME

34/1000 Box Profile Sheets

A Strong And Modern Profile

Our 34/1000 Box Profile single-skin Sheets give maximum strength with seven rigid profiles spaced 166mm apart and 34mm in height across the width of the Sheet. This Profile is made from wider coated steel strips to give a secure weatherproof lap and gives 1000mm actual width cover when lapped.

Available in 0.7mm and 0.5mm Sheet thicknesses, with PVC Plastisol, Polyester Paint and Galvanised coatings. Also available with Dripstop anti-condensation membrane on the reverse.

Applications

Industrial, agricultural, commercial, domestic roofing and cladding.

Can be used as single-skin roofing and cladding, over cladding an existing roof, or as part of a built-up insulated system.



Colour swatch samples are available on our website

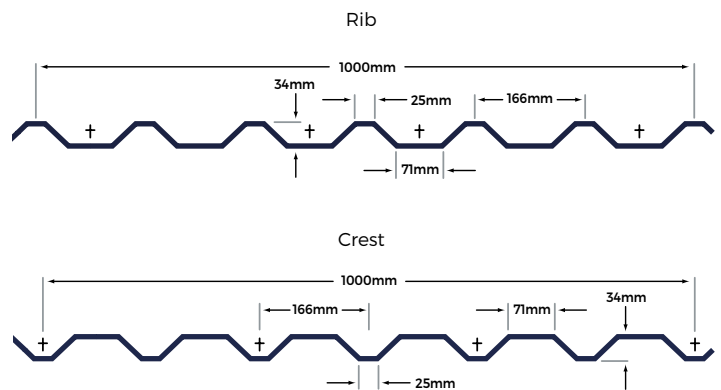

Permissible downward (imposed) loads in kN/m²

Sheet thickness	Weight kg/m ²	Span Condition	Span mm									
			1200	1400	1600	1800	2000	2200	2400	2600	2800	3000
0.50mm	4.78	Single	3.49	2.52	1.91	1.37	0.99	-	-	-	-	-
		Double	2.58	2	1.6	1.3	1.09	0.92	0.79	-	-	-
		Multi	3.15	2.45	1.96	1.6	1.34	1.13	0.86	-	-	-
0.70mm	6.22	Single	5.77	4.17	2.74	1.9	1.37	1.02	0.78	-	-	-
		Double	4.12	3.18	2.53	2.06	1.72	1.45	1.2	0.94	0.75	-
		Multi	5.04	3.9	3.11	2.54	2.11	1.57	1.2	0.94	0.75	-

Permissible wind uplifts (negative) loads in kN/m²

Sheet thickness	Weight kg/m ²	Span Condition	Span mm									
			1200	1400	1600	1800	2000	2200	2400	2600	2800	3000
0.50mm	4.78	Single	3.62	2.62	1.98	1.52	1.1	0.82	-	-	-	-
		Double	2.52	1.95	1.56	1.27	1.06	0.89	0.77	-	-	-
		Multi	3.09	2.39	1.91	1.56	1.3	1.1	0.94	0.82	-	-
0.70mm	6.22	Single	5.58	4.03	3.05	2.14	1.54	1.15	0.88	-	-	-
		Double	4.2	3.24	2.59	2.11	1.76	1.48	1.27	1.1	0.96	0.8
		Multi	5.13	3.98	3.18	2.6	2.16	1.83	1.57	1.25	0.99	0.8

Specifications

Application	Wall or Roof
External Finish	PVC Plastisol, Polyester Paint, or Galvanised
Internal Finish	Light Grey Polyester or Galvanised
External Face	34mm profile height, 166mm pitch centres
Standard Width	1000mm when lapped
Max Length	9m in 0.7mm thickness - 7m in 0.5mm thickness
Minimum Pitch	4 degrees
Gauge Thickness	0.5mm and 0.7mm
Weight	From 4.9kg/m ²

When used in roof applications, construction can be safely undertaken down to a 4 degree pitch using conventional self-drilling fasteners through lower parts of the profile. Roof Lights, Fixings, Trims and Flashings complete the system, offering robust, cost-effective Sheeting.



Cut To Custom Lengths



Easy To Install And Handle

“

My order was dispatched and delivered very quickly. The delivery driver was very kind and drove to where we wanted the items delivered. The roof was easy to install and looks great! Thanks so much.”

Dave, Customer



Benefits Of 34/1000 Box Profile Sheeting

- Economic Sheeting in a robust, rigid Profile that offers high strength.
- Manufactured to custom lengths.
- Lightweight profile.
- Fast and easy to fit.
- Available in a range of traditional colours.
- Independently tested to current CE EN 14782 requirements.

AVAILABLE WITH



SCAN ME

13/3 Corrugated Profile Sheets

A Traditional Sheet Profile

Our traditional 13/3 Corrugated Sheets feature 13 round corrugations of 76mm per corrugation, giving 990mm width coverage when lapped.

Available in 0.7mm and 0.5mm Sheet thicknesses, in PVC Plastisol, Polyester Paint and Galvanised coatings, Corrugated Sheeting is also available with Dripstop anti-condensation membrane on the reverse.

This traditional Corrugated Profile has been used in construction for over a century.

Applications

Industrial, agricultural, commercial, domestic roofing and cladding.

Can be used as single-skin roofing and cladding, over cladding an existing roof, or as part of a built-up insulated system.



Colour swatch samples are available on our website

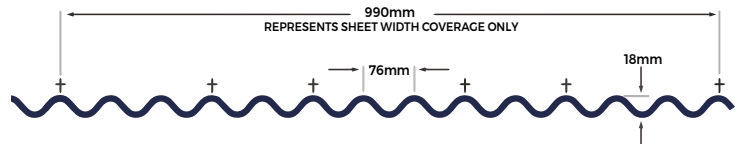

Permissible downward (imposed) loads in kN/m²

Sheet thickness	Weight kg/m ²	Span Condition	Span mm						
			600	800	1000	1200	1400	1600	1800
0.50mm	4.78	Single	9.32	4.51	2.19	1.22	0.75	-	-
		Double	5.93	3.66	2.49	1.81	1.25	0.82	-
		Multi	7.33	4.54	3.09	2.04	1.25	0.82	-
0.70mm	6.22	Single	12.3	5.91	2.87	1.6	0.99	-	-
		Double	8.36	5.1	3.44	2.48	1.64	1.08	0.75
		Multi	10.4	6.36	4.29	2.67	1.64	1.08	0.75

Permissible wind uplifts (negative) loads in kN/m²

Sheet thickness	Weight kg/m ²	Span Condition	Span mm						
			600	800	1000	1200	1400	1600	1800
0.50mm	4.78	Single	9.32	4.94	2.92	1.63	1	-	-
		Double	5.93	3.66	2.49	1.81	1.37	1.08	0.76
		Multi	7.33	4.54	3.09	2.24	1.67	1.1	0.76
0.70mm	6.22	Single	5.58	4.03	3.05	2.14	1.54	1.15	-
		Double	8.36	5.1	3.44	2.48	1.87	1.44	1
		Multi	10.4	6.36	4.29	3.1	2.19	1.44	1



Specifications

Application	Wall or Roof
External Finish	PVC Plastisol, Polyester Paint, or Galvanised
Internal Finish	Grey Polyester or Galvanised
External Face	18mm profile height, 76mm pitch centres
Standard Width	990mm when lapped
Max Length	7m in 0.7mm thickness - 5m in 0.5mm thickness
Minimum Pitch	10 degrees
Gauge Thickness	0.5mm and 0.7mm
Weight	From 4.9kg/m ²

When used in roof applications, construction can be safely undertaken down to a 10 degree pitch using conventional nail or self-drilling screw fixings through the top of the profile. Roof Lights, Fixings, Trims and Flashings complete the system, offering cost-effective, traditional Corrugated Sheeting.



Cut To Custom Lengths



Easy To Install And Handle



We used Cladco Corrugated Sheets on our garden shed and were so pleased with the quality. The Sheets were made to length and in just a few days. Really impressed!"

Angela, Customer



Benefits Of 13/3 Corrugated Profile

- Robust, cost-effective Sheeting giving a traditional look.
- Lightweight Profile.
- Fast and easy to fit.
- Available in a range of traditional colours.
- Independently tested to current CE EN 14782 requirements.

AVAILABLE WITH



41/1000 Tile Form Profile Sheets

Elegant Pantile Appeal

Tile Form Profile is the classic pantile metal Sheeting that gives the appearance of traditional clay tiles. Our Tile Form Sheets give a standard 1000mm width coverage when lapped and are available in custom lengths of up to six metres.

Single Sheet thickness of 0.6mm and a GreenCoat® Mica BT coating available for the external face, with three colours available: Black, Copper Brown and Graphite Grey.

Applications

Industrial, agricultural, commercial and domestic roofs.

Can be used as single-skin roofing, over cladding an existing roof, or as part of a built-up insulated system.



Colour swatch samples are available on our website

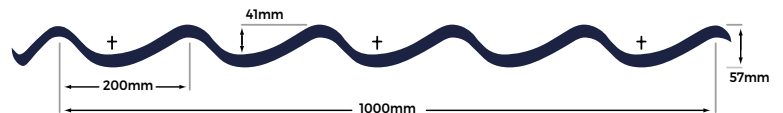

Black

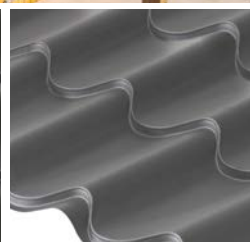

Graphite Grey



Copper Brown

Specifications

Application	Roof
External Finish	GreenCoat® Mica BT
Internal Finish	Grey Polyester
External Face	41mm profile height, 200mm pitch
Standard Width	1000mm when lapped
Max Length	6m
Minimum Pitch	12 degrees
Gauge Thickness	0.6mm
Weight	From 6.6kg/m ²
Purlin spacing	600mm

When used in roof applications, construction can be safely undertaken down to a 12 degree pitch using conventional self-drilling TEK screw fasteners at lower points of the profile into purlin supports. Fixings, Trims and Flashings complete the system, offering cost-effective, traditional Sheeting with a roof tile appearance.



Cut To Custom Lengths



Easy To Install And Handle



I ordered Cladco Roofing Sheets online and the customer service was brilliant. I had ordered the wrong screws but Cladco picked up on this and rectified this immediately for me. Really impressed with the Sheet quality and delivery service. Spot on!"

Daniel, Customer



Benefits Of 41/1000 Tile Form Profile

- Strong Sheeting that requires little maintenance, providing an efficient way to create a traditional pantile appearance with the benefits of modern coated steel.
- Stylish appearance and blends beautifully into older, architecturally sensitive areas.
- Lightweight and simple to install, with a choice of three colours for a solid, attractive and long-lasting roof.
- Independently tested to current CE EN 14782 requirements.

Our Tile Form Sheeting uses GreenCoat® colour coated steel, which is an eco-friendly, long-lasting material superior to other materials, meaning your new roof will last longer. For more information on GreenCoat® materials, please see their website www.ssab.com/en/brands-and-products/greencoat.

AVAILABLE WITH



SCAN ME

30/500 Standing Seam Sheets

A Tough, Stylish Profile

Our Standing Seam Sheeting recreates the look of traditional zinc panels with the benefits of steel. Standing Seam is manufactured from sustainable Swedish steel and protected by a durable and environmentally-friendly GreenCoat® Pural BT coating. Available in lengths up to 8 metres, Sheets provide a 500mm width coverage once installed.

Standing Seam Sheeting is profiled from 0.7mm thick Swedish steel, with a GreenCoat® Pural BT coating on the external face. Four colours are available: Nordic Night Black, Slate Grey, Tile Red and Silver Fir Green.

Applications

Industrial, commercial and domestic roofs. Can be used as roofing or cladding for dual and single pitch roofs and lean-to roofs, over OSB or plywood boards.



Colour swatch samples are available on our website

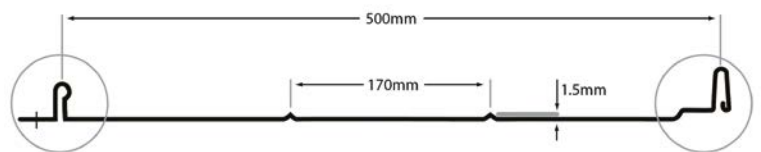
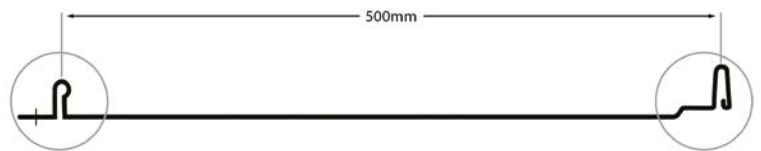

Nordic Night

Slate Grey

Tile Red

Silver Fir Green

Specifications

Application	Wall or Roof
External Finish	GreenCoat® Pural BT
Internal Finish	Grey Polyester
External Face	30mm profile height, 1.5mm ribs (optional)
Standard Width	500mm when lapped
Max Length	8m
Minimum Pitch	6 degrees
Gauge Thickness	0.7mm
Weight	From 5.11kg/m ²

When used in roof applications, construction can be safely undertaken down to a 6 degree pitch using Annular Ring Nails through fixing holes into OSB board or plywood. Fixings, Trims and Flashings complete the system, offering cost-effective, modern and discreet Sheeting.



Cut To Custom Lengths



Easy To Install And Handle



I ordered Cladco Roofing Sheets online and the customer service was brilliant. I had ordered the wrong screws but Cladco picked up on this and rectified this immediately for me. Really impressed with the Sheet quality and delivery service. Spot on!"

Daniel, Customer



Our Standing Seam Sheeting uses GreenCoat® colour coated steel, which is an eco-friendly, long-lasting material superior to other materials, meaning your new roof will last longer. For more information on GreenCoat® materials, please see their website www.ssab.com/en/brands-and-products/greencoat.

Benefits Of 30/500 Standing Seam Profile

- The installation of Standing Seam Sheets allows the fixings to be concealed, giving a sleek appearance.
- Simple to fit in place with a quick-snap lapping system, complemented by Flashings.
- Standing Seam Sheeting is scratch and corrosion resistant for a long-lasting roof.
- Independently tested to current CE EN 14782 requirements.



SCAN ME

Standing Seam Flashings



STANDING SEAM FLASHINGS FOR WALL CLADDING

We manufacture a range of Flashings for use with Standing Seam Roofing or Wall Cladding projects. Made from the same eco-friendly Swedish steel, and available in a choice of four colours, Flashings for Standing Seam create a sealed, fixing-free finish that will last.

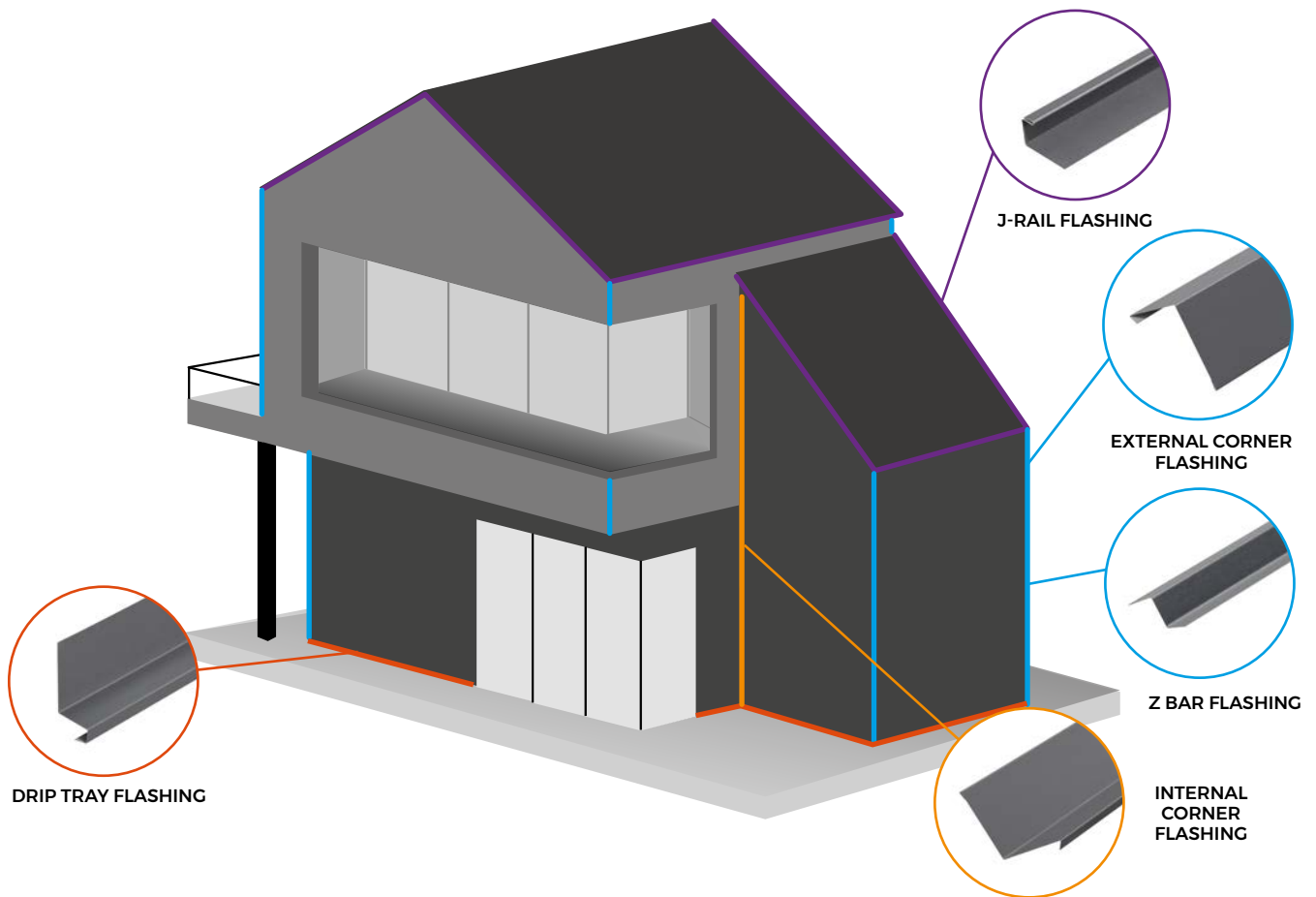

Please refer to our Standing Seam Installation Guide on how to install Flashings.

Flashings For Wall Cladding

Flashings are available in all colours: Nordic Night Black, Slate Grey, Tile Red, Silver Fir Green

Product	External Finish	Size	Length	Angles
J-Rail Flashing	GreenCoat® Pural BT	60mm x 30mm x 15mm	3m	2 x 90°
External Corner	GreenCoat® Pural BT	120mm x 120mm	3m	90°
Z Bar	GreenCoat® Pural BT	25mm x 29mm x 36mm	3m	2 x 90°
Internal Corner	GreenCoat® Pural BT	120mm x 120mm	3m	90°
Drip Tray Flashing	GreenCoat® Pural BT	100mm x 40mm x 20mm x 10mm	3m	2 x 105°, 1 x 90°

STANDING SEAM FLASHINGS FOR ROOFING

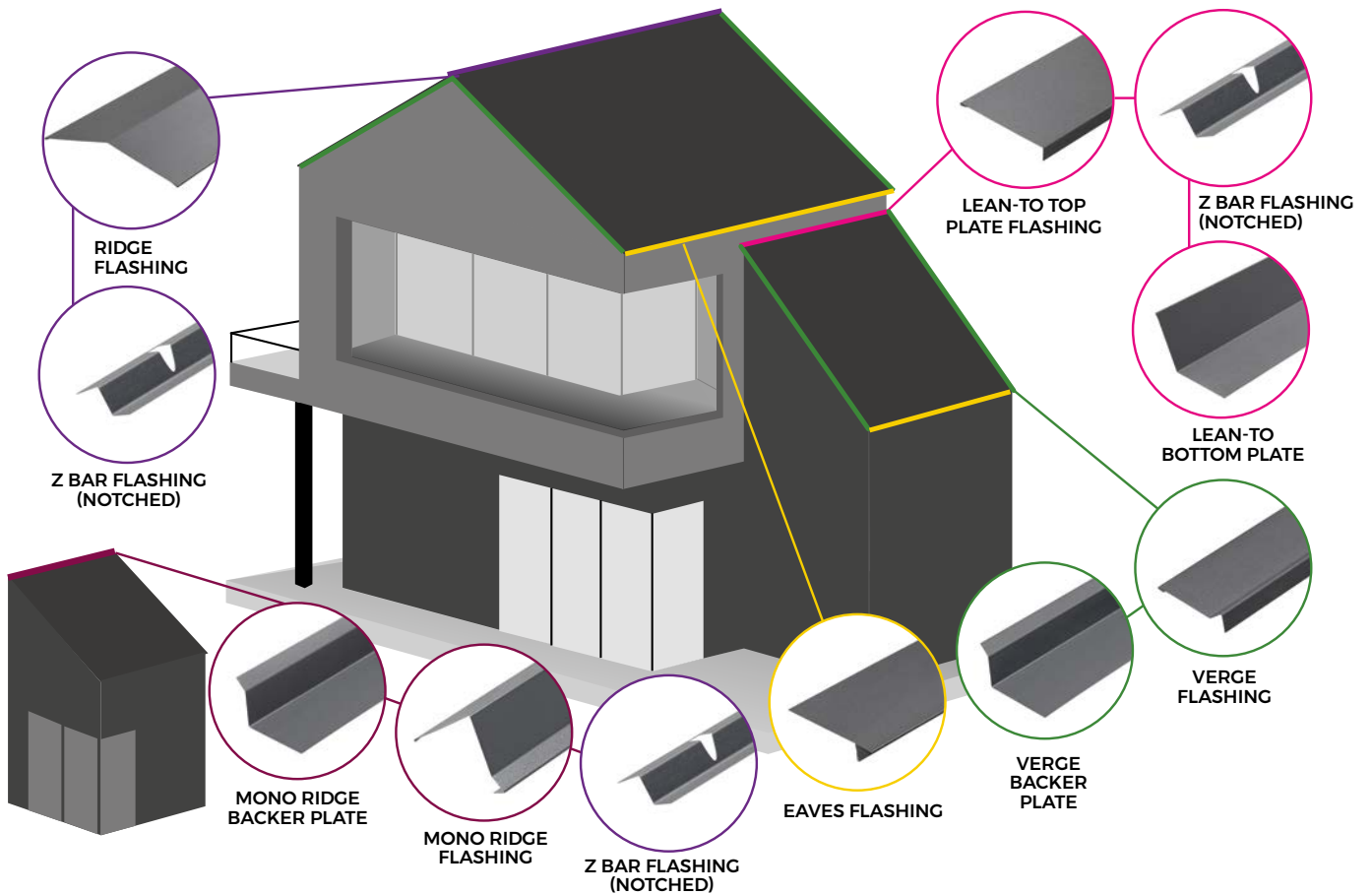

Please refer to our Standing Seam Installation Guide on how to install Flashings.

Flashings For Roofing

Flashings are available in all colours: Nordic Night Black, Slate Grey, Tile Red, Silver Fir Green

Product	External Finish	Size	Length	Angles
Lean-To Top Plate	GreenCoat® Pural BT	150mm x 15mm	3m	90°
Z Bar (Notched)	GreenCoat® Pural BT	25mm x 29mm x 36mm	3m	2 x 90°
Lean-To Bottom Plate	GreenCoat® Pural BT	150mm x 150mm	3m	110°
Verge Flashing	GreenCoat® Pural BT	85mm x 25mm x 25mm	3m	-
Verge Backer Plate	GreenCoat® Pural BT	90mm x 60mm x 23mm	3m	90°
Eaves Flashing	GreenCoat® Pural BT	200mm x 40mm x 30mm x 15mm	3m	-
Ridge Flashing	GreenCoat® Pural BT	185mm x 185mm	3m	130°
Mono Ridge Backer Plate	GreenCoat® Pural BT	90mm x 60mm x 23mm	3m	1 x 75°, 1 x 135°
Mono Ridge Flashing	GreenCoat® Pural BT	150mm x 93mm x 25mm x 25mm	3m	1 x 75°, 1 x 135°



Custom-Made Flashings

Our range of Standing Seam Flashings for Roofing and Wall Cladding applications offer a professional way to finish your project with hidden fixings. We can customise Flashings to suit your project and needs. Please contact us to find out more about our products.

Insulated Panels

Our Insulated Panels are suitable for both roofing and cladding projects. Designed with a composite core and a wide-spaced trapezoidal steel construction, Insulated Panels offer optimal water drainage performance and strength.

Manufactured with a high-quality, pre-finished steel top sheet and available with a PVC Plastisol coating. Panels are available in various lengths, from 2.5 metres up to 5 metres to suit your project.

Insulated Panels boast a highly consistent insulation performance, with outstanding colour retention and corrosion resistance for longevity.

Each Panel can be installed down to a 4-degree pitch and provides a 1000mm standard width coverage when lapped. Insulated Panels can be carefully cut at ground level using a jigsaw for small cutouts and a circular saw with a fine-tooth blade for long straight cuts.



SCAN ME

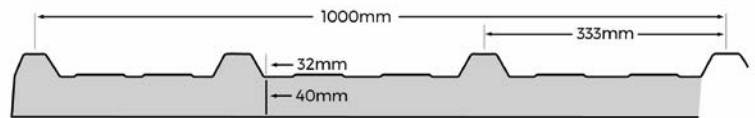

32/1000 Profiled Sheet

Suitable for roofing or cladding (32mm height, 25mm cut-back giving 1000mm actual width coverage when lapped).
Pre-finished PVC Plastisol coating in Goosewing Grey colour.

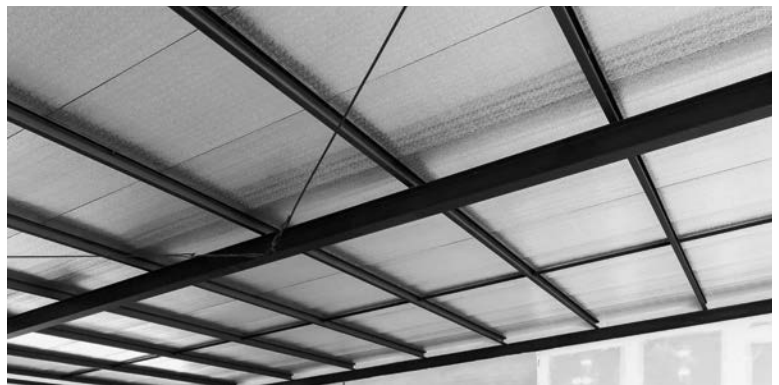

Fire-resistance of 4hrs integrity (when using 32/1000 sheets)



Withstand heavy loads such as solar panels, sheeting and tiles



Reduced risk of water penetration



Heat regulation

Specifications

32/1000 Insulated Panel Panel

Application	Wall or Roof
External Finish	Goosewing Grey PVC Plastisol
External Face	32mm profile height, 333mm pitch centres
Standard Width	1000mm when lapped
Available Length	2.5m, 3m, 3.5m, 4m, 5m
Minimum Pitch	4 degrees
Thickness	40mm
Cutback	25mm
Weight per Panel	24.75kg, 29.70kg, 34.65kg, 39.6kg, 49.5kg

When used in roof applications, construction can be safely undertaken down to a 4-degree pitch, using stainless steel self-drilling screws with a thread free zone and 19mm sealing washers. All cutting should be performed safely on a flat and level surface.

Flat Sheets

Flat Sheets can be used in a variety of ways, from lining the bottom of a trailer bed to making your own custom flashings. Made from high-quality steel roofing materials and incorporating multi-layer coatings to provide excellent corrosion and climatic protection.

Galvanised steel is the ideal material for Roofing Sheets, thanks to its excellent resistant properties against wind, heat, rain and snow, as well as rust and staining. Galvanised steel should not corrode due to its reactive, protective elements, guarding itself against natural breakdown by forming a passive corrosion layer.

Find out more about Flat Sheets and how they could benefit your project by contacting us directly.

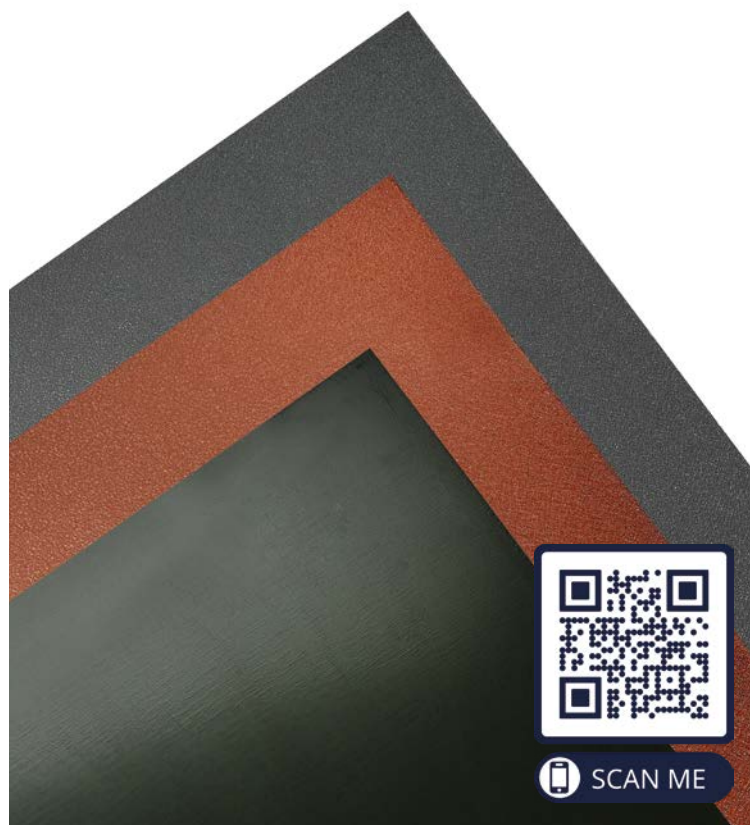

Colour swatch samples are available on our website



Suitable to be made into Flashings



Easy to install and handle



0.6mm and 0.7mm thicknesses



Various finishes available

Specifications

Application	Various
External Finish	PVC Plastisol, Polyester Paint, Mica BT, Pural BT or Galvanised
Standard Width	1240mm
Length	3m
Thickness	0.6mm and 0.7mm

Flat Sheets can be fastened with self-drilling screw fixings and offer a cost-effective, versatile material for flashings, cladding, roofs and more.

Installation Guides

Box Profile Sheets



SCAN ME

Before You Get Started

Working out the Sheets, Flashings, Fixings and Fillers that are needed for a project can be difficult. If you let us know the details of your roof we can help you figure out what you need and ensure that you place your order correctly. Remember that Sheets and Flashings are often manufactured to order and it could be one to two weeks before you receive your order. Make sure your plans allow for a suitable lead time prior to delivery.

UK law requires employers and self-employed contractors to formally assess the risks associated with each roofing job and, before starting their work, to plan and organise their work so that it is carried out in a safe manner. Further information on working at heights and other applicable legislative requirements can be found by visiting the Health and Safety Executive's website www.hse.gov.uk. Receipt of goods, such as Sheets and Flashings, are bundled together and shipped in packs that are heavy and awkward to handle, making delivery worth the extra expense. Upon receipt of your order, check that your goods are correct and consistent with the accompanying delivery note. Any issues should be reported to us immediately by phoning our **Customer Service Team** on **01837 659901**. Two people may be able to lift a single Sheet at a time off a delivery truck, depending on their own physical ability and weather conditions. This will also depend on the length and weight of the Sheets, which are given on our website. Extra care should be taken in windy or exposed areas. The edges of Sheets and Flashings can be sharp so remember to wear protective gloves with rubber palms for grip.

For other Installation Guides visit www.cladco.co.uk

For your safety 

Roofing work can be hazardous. Caution should be exercised and appropriate safety precautions taken including the wearing of suitable protective gloves, clothing, footwear and hard hat.

Care should be taken when handling Sheets to prevent damage or injury during installation. If possible, mechanical handling equipment should be used. Dragging a Sheet's edge across another when unloading may cause scratching of the Sheet, so make sure the Sheet is lifted clear and not dragged. Any packaging should be removed before lifting Sheets onto a roof.

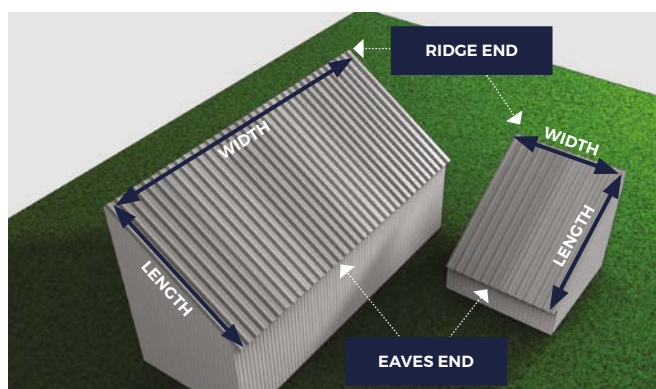

1 A single slope roof is sometimes referred to as mono pitch or lean-to roof. When working out your Sheeting requirements, we require the length and width as shown in the diagram for us to be able to help you with a quotation. A width measurement is used to calculate the number of Sheets required. The length measurement is used to calculate the length of Sheets required.

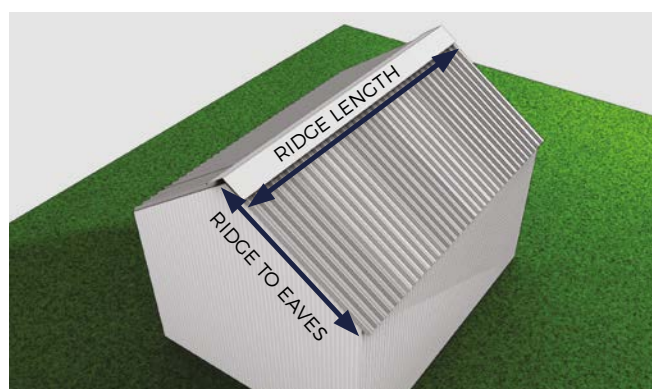

2 Apex roofs are separated by a central ridge. As per the diagram we require the length of Sheet from ridge to eaves and the ridge length to calculate your requirements. You will need to measure both sides of the roof as the building/roof can vary in size from side to side. If the apex is uneven, ridge to eaves will need to be measured on both sides.

TOP TIP When measuring your roof always measure in more than one place to ensure your roof is square. If you find you have different measurements, always order your Sheets to the longest length.



3 The minimum pitch needed for Box Profile Sheets is four degrees. If in doubt consult an engineer. The purlin spaces on average should be a maximum of 1.2m apart, however if using 0.5mm for the roof (which is normally used for side cladding) you would need to reduce purlin spaces to no more than 1m apart. Please note, these are recommended spacings and always seek advice from a structural engineer before installing.



4 When installing Box Profile Sheets you may need to lay the Sheets on the roof before fixing to ensure the overlap is sufficient. Sheets should be overlapped by a minimum of one profile when laid side by side. Colour Caps can be used to cover the silver screw head and matched to the Roofing Sheet colour.



5 When fixing your Box Profile Sheets, it's imperative they are fixed at the valley point. We recommend using our TF32-S19 Screws which are self-drilling and self-sealing. Please see image above.

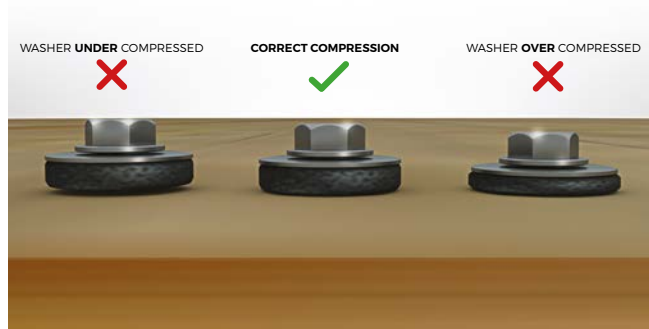

6 TOP TIP Do not over-tighten or under-tighten your screws as this can affect the performance of the washer and prevent it from sealing correctly. See diagram above.

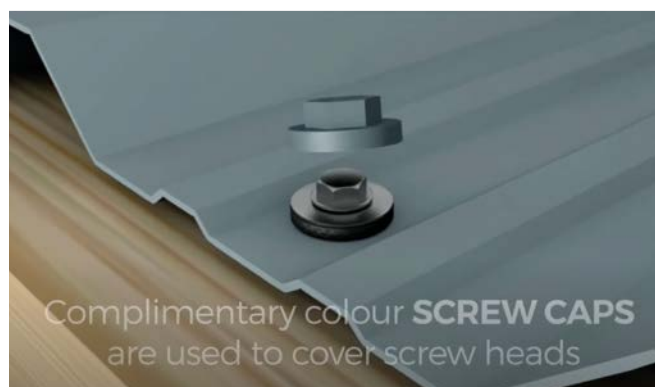

7 Colour Caps can be used to match or contrast with the colour of the Sheeting you are using. They provide an effective way of concealing the steel Screws and washers from view.



8 Once you have installed the final Sheet you can use Cladco Flashings for the sides and apex. Barges are used on the edges to help seal the building and provide an aesthetically pleasing effect. Please note, when joining or laying Flashings, there needs to be a minimum overlap of 200mm on Barges. Our 22mm Stitcher Screws are advised for securing Flashings in place.

ALL OUR BARGES CAN BE MADE TO SUIT YOUR SPECIFICATIONS

Minimum overlap on Ridges / Barges of 200mm



Finish off your build with CLADCO colour matched TRIMS & FLASHINGS



SUPER STYLISH & VERY STRONG ✓

9 Ridge Flashings are used for the ridge on an apex roof, whereas for a single slope roof you may need to use a Custom Flashing. To fit the Ridge, use Stitcher Screws through the Flashing and into the Sheets. Lay Ridge Flashings from the opposite end of the roof to the direction of the prevailing wind. Each Ridge should be overlapped by a minimum of 200mm.

10 We recommend Ridge Flashings are fixed using self-drilling TEK Type Stitcher Screws through the highest point of each profile and through the appropriate Ridge Filler, if being used. This helps ensure a weather resistant seal to prevent birds and vermin, as well as water, from entering the building. Ridge and Barge Flashings can be made to match your Roofing Sheets.

Commercial Buildings And Two-Sheet Runs



1 The minimum pitch needed for Box Profile Sheets is four degrees. On a two-Sheet run remember to have a purlin under the overlap, as shown. These are guides and it depends on your roof construction and pitch. If in doubt, consult an engineer. Purlin spaces using 0.7mm thick Sheets should be approximately 1.2m apart. Purlin spaces using 0.5mm thick Sheets should be approximately 1m apart.



2 For a two-Sheet run, Sheets should be laid in a particular order to the prevailing wind. Start at the eaves and in the corner away from the direction of the prevailing wind (this will help to prevent side laps facing into the wind and water ingress). If the first Sheet is not laid perpendicular to the eaves and ridge, adjustments will have to be regularly made when laying other Sheets and a 'saw tooth' effect at the eaves will occur.



3 Custom Flashings can be made for projects to match the Steel Sheeting we offer. Flashings can provide weatherproofing to the building particularly at the ridge where two Sheets meet.



4 Sheets must be overlapped by a minimum of 250mm where the two Sheets meet. Roof Lights can be installed between the Sheets, but must have Sheets either side for support. Sheets should overlap side by side by at least one profile.



5 Sheets should be overlapped by the next Sheet in the run by at least one profile ('side laps'). Adjacent runs of Sheets should overlap each other by at least 250mm ('end laps'). Please note, we can only supply a maximum of nine metres. If you require a longer length, it's recommended to do a two Sheet run.



6 Barge Flashings can be used to seal and finish off the ends of your roofing project. Flashings can ensure the building is watertight and prevent birds and water from entering the building. It is good practice to use Mastic Lapping Tape and Stitcher Screws to ensure a robust weather-resistant join on side laps.



7 Stitcher Screws are recommended to secure Flashings. Screws should be no more than 400mm apart when securing the Flashing. Colour Caps can be used to conceal the top of each Screw.



8 Fillers can help ensure a robust weather resistant seal to prevent birds and vermin, as well as water, from entering the building. An eaves Foam Filler is designed to go under a Sheet, while an opposite Ridge Foam Filler is designed to go over a Sheet. All Foam Fillers should be bonded to the Sheeting with a flexible, waterproof silicone sealant and should be continuous over the entire width of the Sheeting.



9 Roof Lights can be added to a project to increase the natural light coming into a building. Roof Lights have a translucent rate of 80% and can be used between Roofing Sheets. Please note, Roof Lights must be supported either with steel Sheets and appropriate purlin supports.



10 Finish your project by installing the Ridge Flashing along the centre where two Sheets meet. You can then install guttering, or fascia, as required.

TOP TIP Clean the roof of any debris whilst fixing the Sheets down. This will prevent it from penetrating the coating of the Sheet.

GRP Roof Lights



To let natural daylight into a building you can replace some of the Steel Sheeting with Roof Lights. These are translucent Sheets made of GRP (glass reinforced plastic) to match our Sheeting detailed on the previous pages.

Translucent Roof Lights are made from high-grade GRP glass fibre and are 1.5mm thick offering extremely high impact resistance, minimising the risk of breakage. Roof Lights let in diffused daylight at a transmission rate of over 80% and give excellent flexibility and light stability.

The protective polyester film bonded to both surfaces prevents moss and lichen growth and discolouration, as well as offering protection against the degrading effects of ultra-violet rays in natural sunlight.

GRP Roof Lights are also suitable for carports, canopies, walkways and screens. Lengths from 2.5 metres to 5 metres are available, and independently drop tested and fire tested.

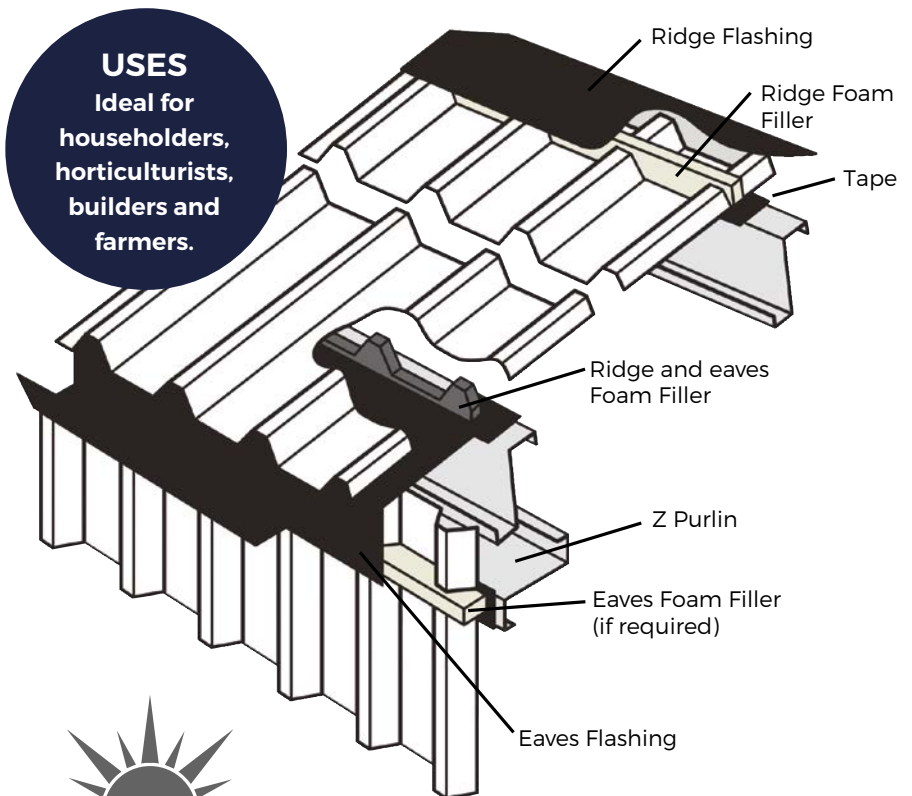

USES
Ideal for
householders,
horticulturists,
builders and
farmers.

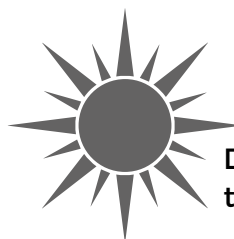

Diffused daylight at a
transmission rate of over 80%



34/1000 Profile Glass Reinforced Plastic (Fibreglass) Roof Lights



13/3 Corrugated Profile Glass Reinforced Plastic (Fibreglass) Roof Lights



32/1000 Profile Glass Reinforced Plastic (Fibreglass) Roof Lights

Translucent, lightweight GRP Roof Lights let in diffused daylight at an 80% transmission rate. Width and profiles are matched to that of 34/1000, 32/1000 and 13/3 Corrugated Sheeting, and are available in a range of lengths. The resin-enriched gel coat finish protects the Sheets against the effects of UV radiation and gives them a long lifespan in excess of 15 years.



Lightweight Construction



Set Lengths Of 2.5m, 3m, 3.5m, 4m, 4.5m & 5m



80% Transmission Rate



Available In Box Profile And Corrugated



1.5mm Thickness

Benefits Of Our Roof Lights And Translucent Sheets

- Natural daylight with weather protection offering a long, maintenance-free life.
- Economic sheeting in a robust profile will withstand high winds and hailstones.
- Lightweight construction.
- Fast and easy to fit, can be fixed and cut with simple tools, no specialised equipment required.
- Offers protection against damaging ultra violet rays.
- Independently tested to current CE EN 14782 requirements.
- Gel coat protects the Sheets to give a long life.
- Ideal for plant growing.



Z Purlins

We manufacture metal Z Purlins for supporting either Roofing Sheets or vertical wall cladding. Z Purlins have a depth of 175mm and our production system enables the accurate manufacturing of metal Z Purlins to lengths of up to nine metres. This traditional well-proven system of Sheet support offers a high degree of strength, flexibility, and weight-saving over timber or hot rolled steel sections, with ease of handling on-site and during installation.

The 175mm Z Purlin profiles are made from 1.8mm thick, Z39 structural grade steel. Purlins are made from high tensile steel with a Galvanised coating for long life so no additional finish is required.

Sections are designed to BS EN 1993-1-3:2006 using analysis and testing and satisfy the requirements of BS5950: Part 5 (1998). We supply Sleeves for joining Purlins together and Cleats for securing Purlins to rafters. Z Purlins can be produced for sleeved, double span sleeved, butted and over-lapped Purlin systems.



Benefits Of Our Metal Z Purlins

- Manufactured to exact lengths up to 9m.
- Made from structural grade Z39 steel, measuring 1.8mm in thickness for maximum strength.
- Lighter, stronger and cheaper than equivalent timber purlins.
- Independently tested to current CE EN 14782 requirements, loading tables available on request.



Purlin Cleats

Our Purlin Cleats are designed to be bolted to 175mm Z Purlins to enable you to join the Purlins to the rafters.

Manufactured from high-grade steel with a natural finish, they come pre-drilled with 18mm holes for use with M16 bolts.



Purlin Sleeves

Purlin Sleeves used alongside Z Purlins will give you a lighter, stronger and cheaper way to support your Sheets with ease of handling for on-site installations.

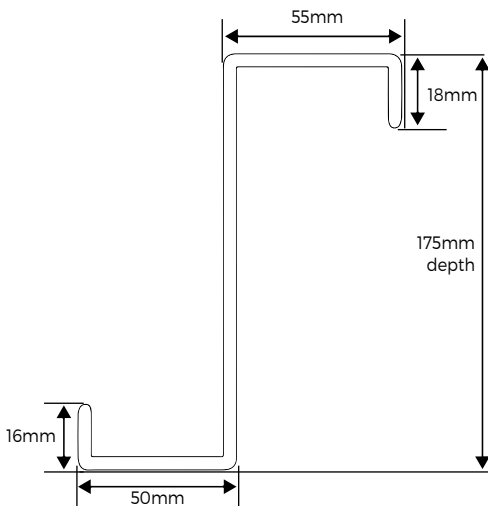

Trims And Flashings



Trims and Flashings are used to finish the ends and corners of a run of Roofing Sheets, helping to protect your building against water intrusion. As well as being an integral component for the performance of your Box Profile, Tile Form or Corrugated roof, Flashings are

also a good opportunity to enhance the aesthetics of your building. We manufacture and supply high-quality Flashings made from galvanised steel, with a variety of coatings and a great choice of colour options available.



Nordic Ridge Flashings

Used at the apex to cover the join of two Roofing Sheets, Nordic Ridge Flashings are a necessary part of any profiled roof. Flashings can be made using the same range of colours and finishes as our Sheeting, meaning they can finish off your building to the highest standard.

Standard stock size is 195mm x 195mm and come in 3-metres lengths and 130-degree internal angle, and will flex 10-15 degrees either way, depending on the angle of your roof.



Barge Flashings / Corner Trims

Used at the end of a run of Sheets to trim and seal off the edges of a roof. We aim to accommodate wherever possible; simply provide the dimensions or drawings of the trim you need.

Flashings come with a safety welt to increase the strength of the material. Stock Flashings have a 90 degree angle and measure 200mm x 200mm in 3-metre lengths.



Standard Ridge Flashings

Used at the apex of the roof, Ridge Flashings are a necessary part of any profiled roof, with a range of colours available to enhance the aesthetics of any structure. Ridges include a safety welt to increase the strength of the material.

Standard stock size is 200mm x 200mm in 3-metre lengths with a 130-degree internal angle. Ridge Flashings are available in various finishes to suit the Sheeting.



Drip Tray Flashings

Installed at the base of a run of Sheets when used as side cladding. Drip Tray Flashings provide an efficient way to redirect water run-off externally on a building, or above windows and doors.

Drip Tray Flashings are available in a range of colours and coatings to match your existing choice of Roofing Sheets.

Custom-Made Trims And Flashings

Trims and Flashings can be made bespoke to specifications and dimensions, available in 3-metre lengths using 0.7mm thick Flat Sheets throughout the entire colour range. Available in Polyester Paint, PVC Plastisol, GreenCoat® Mica BT, GreenCoat® Pural BT, or Galvanised coatings and complete with safety edges, if required. Trims can also be tapered to fit custom valley and guttering systems.

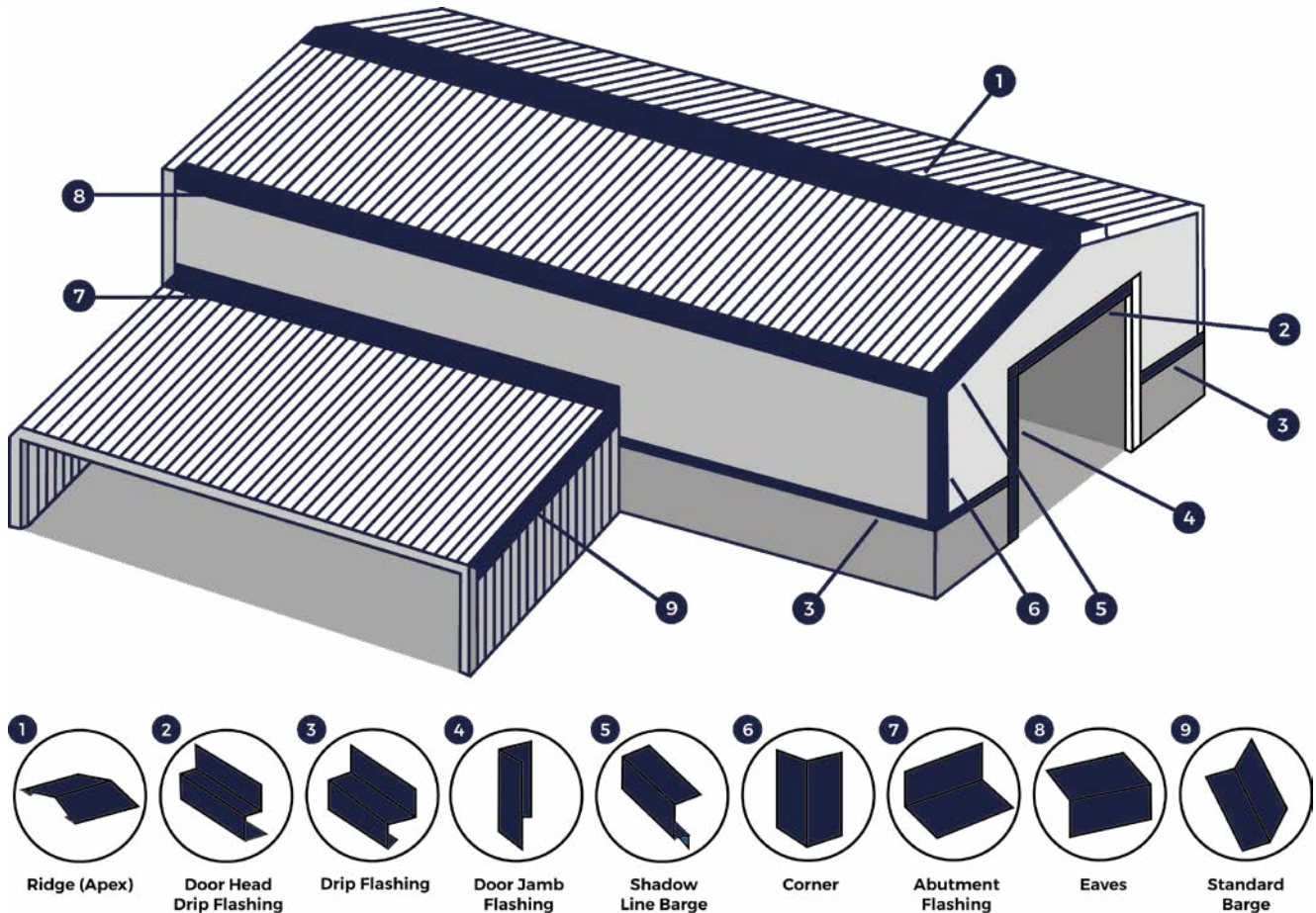

Typical Flashings:

- Ridge Flashings used at the apex join of two sides of a roof.
- Barge Flashings, or corner trims, used at the end of a run of Sheets to trim and seal off the edge of a roof.
- Abutment Flashings for sealing the join where the Sheets come off a vertical wall.
- Drip Trays, or sill Flashings, to trim the bottom edge of vertical side cladding, window and door reveals.

Custom Flashings can be made to most requirements. Please call our Sales team, or visit our website, to find out more.





Custom Flashings

We can design and manufacture Custom Flashings to suit your project, available in the same colours and finishes as our Sheeting.

Choice Of Coatings

The coated steel strip profiled into Sheets and Flashings is produced by leading suppliers, giving control over quality and traceability of the material.

The maximum width Custom Flashings can be made is up to 1200mm, due to the size of the Flat Sheet they are manufactured from. Trims and Flashings can be made to specification from our range of colours and coatings to suit your project.

These diagrams (right) are examples of the types of Flashings that can be produced. Contact us with your requirements and include any measurements you have for our Sales Team to provide an accurate quotation.

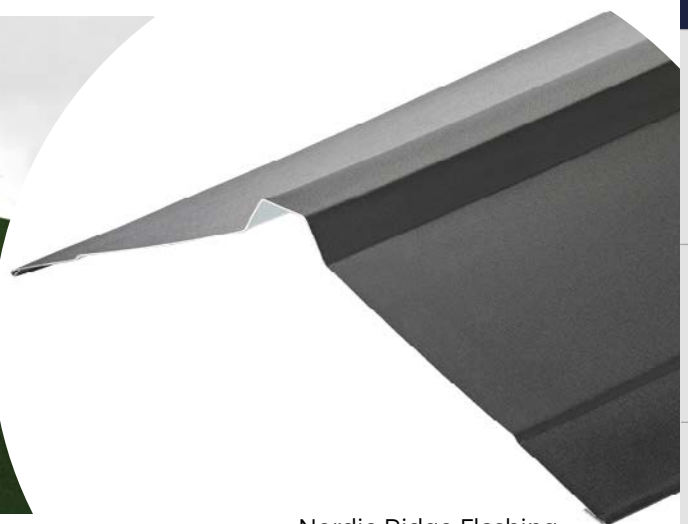
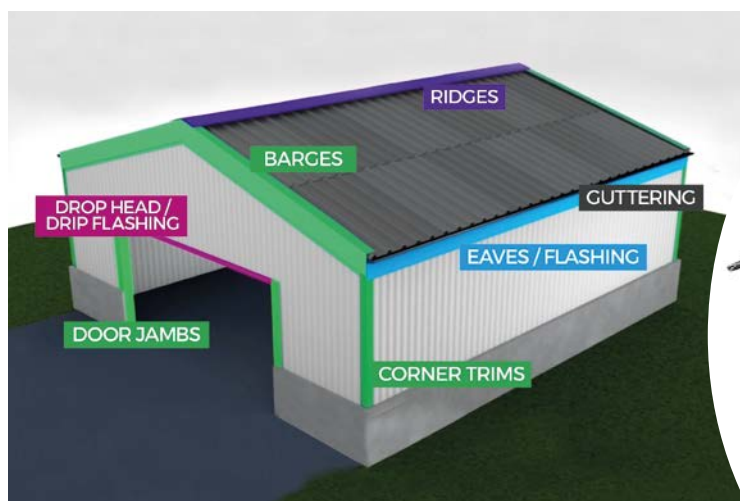
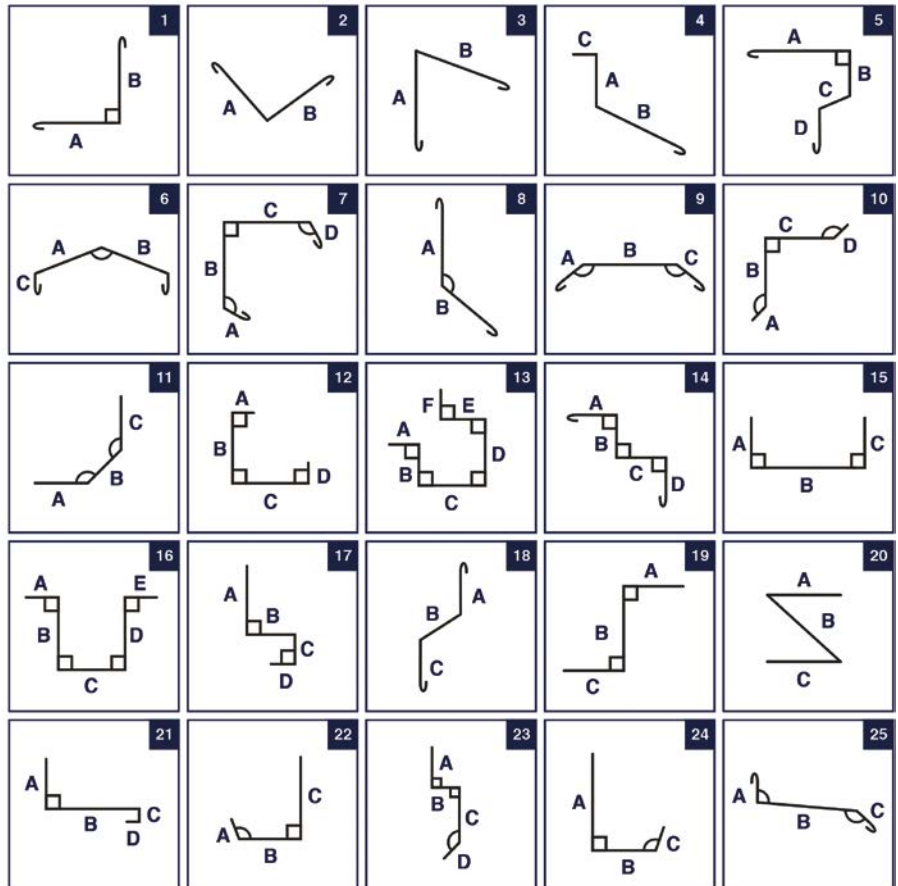

Nordic Ridge Flashing

Tarpaulin Range



A Temporary Covering for Construction Projects

Our range of waterproof Tarpaulins are available in a variety of sizes and weights and can be used as a temporary covering for any outside project.

Available in Lightweight (80gsm), Standard (170gsm) and Heavy Duty (270gsm) weights, our Tarpaulins are ideal for temporarily covering outdoor furniture, tools and materials as well as being used as a short-term roofing cover.

Applications

Industrial, agricultural, commercial, and domestic.

Can be used as a temporary covering for ongoing construction projects, keeping goods and buildings protected and dry.



Lightweight Tarpaulin



Specifications - Lightweight Tarpaulin

Application	Covering furniture, wood stacks, building materials or as a ground sheet
Material	Polyethylene (8x8 weave count)
Thickness	80gsm
Dimensions	1.2m x 1.8m, 3.5m x 5.4m, 5.4m x 7m, 7m x 11m, 9m x 14m
Weight	175g (1.2m x 1.8m), 1.5kg (3.5m x 5.4m), 3kg (5.4m x 7m), 6.2kg (7m x 11m), 10kg (9m x 14m)
Coverage	2.16m ² (1.2m x 1.8m), 18.9m ² (3.5m x 5.4m), 37.8m ² (5.4m x 7m), 77m ² (7m x 11m), 126m ² (9m x 14m)
Colour	Green, Blue
Eyelets	12mm aluminium eyelets spaced at 1m intervals



Mediumweight Tarpaulin



Heavy Duty Tarpaulin

Specifications - Mediumweight Tarpaulin

Application	Covering materials, tools and unfinished ground-level building projects
Material	Polyethylene (3x3 multifilament grid)
Thickness	140gsm, 170gsm
Dimensions	4m x 6m, 4m x 10m, 8m x 10m, 10m x 17m
Weight	175g (1.2m x 1.8m), 1.5kg (3.5m x 5.4m), 3kg (5.4m x 7m), 6.2kg (7m x 11m), 10kg (9m x 14m)
Coverage	2.16m ² (1.2m x 1.8m), 18.9m ² (3.5m x 5.4m), 37.8m ² (5.4m x 7m), 77m ² (7m x 11m), 126m ² (9m x 14m)
Colour	Green
Eyelets	12mm aluminium eyelets spaced at 1m intervals

Specifications - Heavy Duty Tarpaulin

Application	As a temporary Roof Covering
Material	Dense polyethylene (16x16 weave count)
Thickness	250gsm, 270gsm
Dimensions	3m x 6m, 4m x 5m, 4m x 10m, 8m x 8m and 7m x 10m
Weights	4.9kg (3m x 6m), 5.4kg (4m x 5m), 10.8kg (4m x 10m), 7.3kg (8m x 8m) 19kg (7m x 10m)
Coverage	19m ² (3m x 6m), 20m ² (4m x 5m), 40m ² (4m x 10m), 64m ² (8m x 8m) 70m ² (7m x 10m)
Colour	Green/Brown, Black/Silver
Eyelets	12mm aluminium eyelets spaced at 50cm intervals

All our Tarpaulin sheets are cut sizes, which is industry standard terminology for the size of the material before it is formed into a tarpaulin. This means that when seams and hems are taken into consideration, the final size can be up to 30-45cm shorter.



Tarpaulin Poly Rope

Multi-purpose, 6mm thick Poly Rope is available in 30m, 220m and 500m lengths.



Tarpaulin Ball Bungees

20cm Ball Bungees will keep Tarpaulin sheets fixed in place while providing flexibility.

Fixings And Accessories



Self-drilling TEK Type Screws feature a 5/16th hexagonal head with a stainless steel washer and neoprene bonded pad. Screws are used to either fix Sheet-to-Sheet overlaps or the Sheet to either wood or metal Purlins. Longer Screws up to 175mm in length are available for fixing through insulation materials or composite panels.

Self-drilling Stitcher TEK Screws are available for fixing Flashings to Sheets, or overlapping Sheets. Colour Caps are used to cover Screw heads.



Timber Frame Screws

Timber Fixings available in sizes: 32mm, 45mm, 65mm, 80mm, 105mm, 125mm & 150mm.

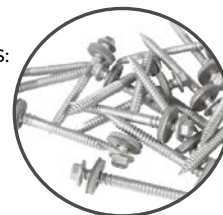

Light Steel Screws

Fixings for Light Steel available in sizes: 25mm, 57mm, 85mm, 115mm & 135mm.



Heavy Steel Screws

Fixings for Heavy Steel available in sizes: 38mm, 55mm, 75mm, 105mm & 125mm.



BAZ TEK Screws

Fixing Corrugated Sheets to wood: 65mm & 130mm with BAZ washer.



Stitcher Screws

22mm Screws for stitching Flashings or Sheet-to-Sheet.



Colour Caps

Available in a range of colours to complement Roofing Sheets.



Select The Screw Most Suitable For Your Application

SHEETING TYPE	TEK SCREW TYPE (WOOD)
34/1000 Box Profile	TF32-S19
32/1000 Box Profile	TF32-S19
13/3 Corrugated Profile	TF65-BAZ
41/1000 Tile Form Profile	TF32-S19
Sheets with insulation (40mm)	TF80-S19
Sheets with insulation (60mm)	TF105-S19
Sheets with insulation (80mm)	TF125-S19
Big 6 Roofing Sheets	TF130-BAZ
Sheets with insulation (100mm)	TF150-S19

Please note, this is a guide only.



C24 Sawn Green Treated Timber Support

47mm x 100mm
Timber supports for Cladco Roofing Sheets, available in 4.2m and 4.8m lengths.



C24 Sawn Green Treated Timber Support

47mm x 150mm
Timber supports for domestic and commercial applications, available in 4.2m and 4.8m lengths.



Roofing Membrane

Breathable, durable membrane providing excellent weather protection. Available in 50m rolls.



Foam Fillers

Profiled Supaseal 25mm thick Fillers available for all Cladco Roofing Sheets.



Safety Gloves

Suitable for handling metal Sheets and Flashings to protect your hands. Available in three sizes.

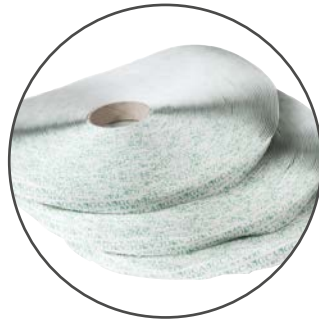

Mastic Lapping Tape

Lapping Tape for joining side laps or end laps. Supplied in 30m rolls.



TEK Screw Socket Driver

TEK Socket Driver tool will ensure you have got the right fitting for TEK Screws.



Soudafoam Gap Filler

Self-expanding gap filler. Easy to apply around windows and doors.



Silicone Sealant and Gun

Clear silicone sealant supplied in 300ml cartridges and Sealant Gun (items sold separately).



Fibre Cement Construction Backer Board

A1 fire-rated Fibre Cement Backer Board is available in 1.2m and 2.4m lengths and in 6mm, 9mm, 12mm and 18mm thicknesses.



Aviation Tin Snips

A safe way to cut Roofing Sheets and Flashings. Made from drop-forged, high-carbon steel.



Retractable Tape Measure

An accurate way to measure roofing projects. Featuring a nylon-coated blade with both imperial and metric measurements.

Case Study

Renovations by @jamiewarebuilding began in May 2021, when he and the team skilfully transformed this property from a small, three-bed bungalow to what it is today - a vast two-storey dwelling featuring six bedrooms with four ensuite bathrooms, two reception rooms, a large open plan kitchen-diner with a built-in wine cellar and a sizeable balcony overlooking the remote area known as "The Spinney".

This cutting-edge design has used Cladco 32/1000 Box Profile Sheets as a cladding material for the sides of this grand design, creating a high-spec and quality finish to the build, whilst Cladco 34/1000 Box Profile Sheets have been used as a roofing material. On top of this, Cladco Woodgrain Composite Wall Cladding Boards in Charcoal have also been used as a cladding solution for the rest of the property.



Cladco Sheets bring a modern aesthetic to The Spinney - complementing the industrial feel of the project. Steel Sheets have low-maintenance and high-strength benefits, protecting any building from harsh weather conditions and side winds, whilst still being lightweight and easy to cut, install and handle.



SCAN ME



The Box Profile Sheets used to clad and roof one-half of The Spinney's exterior have been manufactured using Galvanised Steel Coils, that are pre-coated in Black PVC Plastisol. This finish has a 200-micron-thick coating that adds a high-quality, scratch-resistant surface to the Steel Sheets.



- ABOUT
- QUALITY
- D RIPSTOP
- PROFILES
- INSTALLATION
- ROOF LIGHTS
- FLASHINGS
- TARPAULIN
- FIXINGS
- CASE STUDY



A selection of Custom-Made Cladco Flashings has been used to suit the unique shape and angles of The Spinney.

The other half of The Spinney's exterior has been beautifully finished using Cladco Woodgrain Composite Wall Cladding Boards in Charcoal. They have been installed vertically - elongating the building whilst stylishly coinciding with the rest of the cladding where Cladco Steel Sheets have been used.

Case Study

This phenomenal life-size treehouse, designed and built by @LifeSpaceCabins is aptly named "Two Pines" and is set within a 90-acre nature reserve at @TheWildingAirfield - formerly a WW2 Airfield, now a woodland holiday retreat. Cladco Corrugated Metal Roof Sheets in Black have been used to both roof and clad the additional exterior sides of the treehouse, blending industrial design with an otherwise arboreal aesthetic - steering away from the typical look of generic glamping pods or cabins.

The Corrugated Sheets used on Two Pines have been coated with PVC Plastisol. PVC Plastisol is a 25-micron thick, smooth coating, that is economic to apply and provides excellent weather and scratch resistance. PVC Plastisol can also be applied to other Cladco Box Profiles such as our 34/1000 and 32/1000 Sheets, extending the lifespan of the material by up to 40 years.

One of the numerous unique features included at Two Pines treehouse is the luxury outside copper bath and accompanying wood burner, allowing guests to unwind among nature after a long day adventuring within the vast acres of The Wilding Airfield.



SCAN ME



The lightweight profile of Cladco Corrugated Sheets makes for an easy-to-install, yet robust and cost-effective material to build this stunning design with, and Life Space Cabins have certainly done the project justice with the brief they were given. Our 13/3 Corrugated Profile Sheets are available in a range of coatings and colours to suit any project, and our Black PVC Plastisol Coating (as used on Two Pines) makes the perfect choice when it comes to style, longevity and quality.



As well as Black, an extensive selection of alternative colours are available within our range of Profiled Sheets, allowing the desired aesthetic of your project to blend in with the surrounding environment. These colours include Juniper Green, Merlin Grey, Moorland Green, Chestnut, Slate Blue, Anthracite and many more.

Have a project you would like to share?

We are always looking for projects to share with our customers. If you would like to feature, please send your images to images@cladco.co.uk

Thank you @out.of.the.valley on Instagram for this image.

Please note: not all images submitted may be used.

Cladco Profiles is a family owned company offering quality products at competitive prices.

Established in 1972, Cladco has steadily grown to become a Leading Supplier of Roofing, Cladding and outdoor materials to businesses and households throughout Britain.

Head Office

Cladco Profiles, Beardown Road, Exeter Road Industrial Estate, Okehampton, Devon EX20 1UA

T: 01837 659901 E: info@cladco.co.uk

Andover Branch

Cladco Profiles Andover, 55 Reith Way, Andover, Hampshire SP10 3TY

T: 01264 598231 E: info@cladco.co.uk

Brochure printed October 2024

www.cladco.co.uk



All information is correct at time of print. Please note that prices may be subject to change and Cladco reserves the right to change prices without notice. All measurements given are approximate and due to the manufacturing process may vary slightly. Images are used for illustration purposes only, actual item may vary slightly from the image shown.

CLADCO
PROFILES

