



# QUICK REFERENCE CATALOGUE 2022



## AIR REGULATION DAMPER HARDWARE

## FLEXIBLE DUCT CONNECTOR



## DYNA-TITE CABLE LOCKS, CABLES AND ACCESSORIES



## DYN-O-VENT GRILLES, REGISTERS AND DIFFUSERS



## INDEX

PRODUCT	ITEM CODES	PAGE
Access Door Handles, Hardware	(SP, SL, A1SF,)	B-11
Access Doors Insulated & Self Stick	(DAD, DADC, NHSAD, NCSAD)	B-13 to B-14
Adhesives, Stripper, Spray Products	(WIT, SRPG, CCASAWFT, DCEC, DTWAC)	C-2
Ball Joints	(DCS, SRP)	B-1, B-5
BANGERS - Standard & Tripod	(BG, TBG)	C-5
Blade Kits & Parts	(BDK, BDP, BK, BKO, BKP)	B-1 to B-3
BRAK-IT Galvanized Steel Fixture	(BRAK-IT)	B-18
Brushes for Glue	(BB-1, BB-1.5, BB-2, BB-3, BB-4)	C-1
Caulking Gun	(SG-2)	C-1
Chucks & Drivers	(DCL, DCR)	D-1 to D-2
CLIP PINS Gold Seal, Rib, Econo, Diamond Point	(SSPB, CP, FTC, DDP)	C-6
Connector Fabric Only	(DFN, DFDU, DFX, DCT)	A-2
Connector, Flexible	(SMF, MF, IDC, EF, JR)	A-1 to A-2
Dampers, Jiffy	(JDS, JD)	B-7
Drill Bits	(TD, TED)	D-4
DUROZONE Zone Panels, Dampers & Accessories		DZ
DYNA-CLAMP - Stainless	(DT)	B-19
DYNASTICK Hangers and FLIPSTIX	(SAH, FSG, FSA, FSS)	C-7
DYNA-TITE Locks, Cables and Accessories	(CL, KV, WC, LC)	B-15 to B-18
DYN-O-MATE TDC/TDF Flanges, Corners, Cleats, Vanes & Rails		B-20 to B-22
DYN-O-TIES & Tool	(DDN, DIT-3)	B-19
DYN-O-WRAP Blue Self Adhesive Film	(DW, PRW)	B-20
Flexible Connector Selection Guide		1
Fusible links	(FBL, ML)	B-4
Gasketing Material	(GN, GU, BTL, BN)	B-11, B-20
Grilles, Registers and Diffusers (Dyn-O-Vent)		DV
Hand Tools	(DDPR, DTP, 323W, POT, HM, DDTH, DDHC WMET)	D-5 to D-6
Hanger Strap	(VDS200C, Handy Strap, GS241)	B-10, B-20
Hinges	(HB, HP, HPH, HPB, HPX)	B-12
Instrument Test Port	(IP)	B-8
Insulation Cutting Machine	(LSU, PLSU2)	C-8
Insulation Fasteners	(LN, BDEP, PN, SSPB, CP, FTC, SAH, TBG, BG)	C-4 to C-7, C-9
KLENK Tools - Aviation Snips, Shears	(KJS, KDC, KTS, KDC, K, KRB, KDS, KDST)	D-7 to D-8
Nail Plates, Hangers, Z&L Brackets, Stud Guard	(BOCA, ZB, MDB, NPFHA, SGF)	B-22
Pinspotters & Parts	(FG MACH, FPP, RH MACH, PBF, MF)	C-8 to C-9
Regulators, Damper, RAPIT	(AL, MSRO, SK, KR, RS, RB, KS, KSR, K)	B-5 to B-9
Rivets & Riveter	(SS, AS, AA, CS, DDPR)	D-3, D-5
Screws	(ZD, DX, SDU, SDX)	D-1 to D-2
Sealer - Water Base	(DWN)	C-1
Shop Aprons	(SA-1)	D-5
SIDE SEAL	(BKSS)	B-2
SPECLINE Regulators and Parts	(SR, SRH, SRC, SB, AD-38, SRHS, SRST)	B-6
SPEC SEAL Regulators	(AL, MSRO, SK, KR)	B-5
Splitter Damper Parts	(SRP)	B-5
Spotter Pins and Clips	(PN, PC)	C-5
Stainless and Aluminum Product List		D-9
Standoff Regulators - Universal	(UESO)	B-23
Stapler (Rapit) & Staples	(DS, DSP)	A-2
SUPER SPRAYFAST Spray System for Water Base Adhesives	(SSFU)	C-3
VANE RAIL, Vanes & Rails	(VR, JVR, HTV, DHVR)	B-10, B-20

# FLEXIBLE CONNECTOR SELECTION GUIDE

## Industrial/Commercial Applications

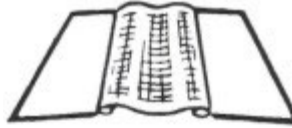

### Metal Fab

**Metal Fab** meets the requirements of most commercial and industrial applications, allowing for absorption of normal equipment-created vibration and preventing it from being transmitted through the duct system. Also available with Aluminium or Stainless Steel.

*Gauge: 24*  
*Dimensions: 3" metal, 3" fabric, 3" metal*  
*Fabric: Neoprene, Durolon, Canflex, Teflon*

**For heavy Commercial Systems**  
 3" metal - 3" fabric - 3" metal  
**"GRIP LOC"**



### Super Metal Fab

**Super Metal Fab** provides additional fabric width for use with larger equipment and ducts where more than 3" deflection is likely to occur.

*Gauge: 24*  
*Dimensions: 3" metal, 6" fabric, 3" metal*  
*Fabric: Neoprene, Durolon, Teflon*

**For special Commercial Systems (where wide fabric is specified)**  
 3" metal - 6" fabric - 3" metal

### TDC/TDF Connector

**TDC/TDF Connector** is specially manufactured for use by shops producing duct with Lockformer TDC or Engel TDF flange-forming machines.

*Gauge: 24*  
*Dimensions: 4" metal, 4" fabric, 4" metal*  
*Tissus: Neoprene, Durolon, Black Excelon*

**For use with TDC or TDF Machines**  
 4" metal - 4" fabric - 4" metal

## Residential/Light Commercial Applications



**"GUARD LOC"**

### Econo Fab

*Gauge: 28*  
*Dimensions: 3" metal - 3" fabric - 3" metal*  
*Fabric: Neoprene, Light Canflex, Teflon*  
*Grip Loc Seam*

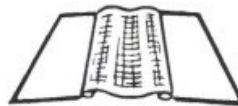

### Junior Connector

*Gauge: 28*  
*Dimensions: 1-3/4" metal, 3" fabric, 1-3/4" metal*  
*Fabric: Canflex, Durolon, Teflon*  
*Neoprene.*  
*Guard Loc Seam*



## FABRIC QUICK COMPARISON CHART

Fabric Description	Mass	Thickness	Tensile Strength	Burst Strength	Temp. Range
<b>NEOPRENE</b> - industry standard for high velocity systems. A Fiberglass fabric, double coated with polychloroprene. Strong, airtight, waterproof and moisture resistant. Resistant to most acids, alkalis, oil and gasoline.	1017 g/m <sup>2</sup> (30 oz/sq.yd)	0,68 mm (.027")	2000x1550N (450x350 lb)	4137 kPa (600 psi)	-40° to 93°C
<b>DUROLON</b> – convenient for inside and outside flexible connector, for medium or high velocity applications, industrial and commercial applications. Durolon is made of Fiberglass fabric double coated with a special synthetic rubber. Has broad service temperature range and resist sunlight, weathering, ozone and abrasion. Ideal for outdoor applications.	814 g/m <sup>2</sup> (24 oz/sq.yd)	0,61 mm (.030")	2000x1780N (450x400 lb)	3450 kPa (500 psi)	-40° to 120°C
<b>CANFLEX</b> - general purpose H.V.A.C. material. Replaces Canvas. A polyvinyl chloride, (P.V.C.), coated woven polyester fabric with properties surpassing canvas at comparable cost. Considering it's great microbiologic resistance, sunlight and ozone, canflex is well indicated in humid, outside or underground areas.	750 g/m <sup>2</sup> (22 oz/sq.yd)	0,66 mm (.026")	1290x1290N (290x290 lb)	2100 kPa (300 psi)	-35°C to 95°C
<b>TEFLON</b> - for higher temperature use, (to 260°C), or with a high risk of fire. A fluorocarbon-impregnated coated fiberglass fabric. Broad temperature range and superior resistance to weathering, aging, sunlight and many chemicals.	561 g/m <sup>2</sup> (16.5 oz/sq.yd)	0,381 mm (.016")	1779 x 1334N (400x300 lb)	4481 kPa (650 psi)	-101°C to 260°C

## CONNECTOR DISPENSER

No.	Code	Description
43023	FDC-AB4	Connector Dispenser Cradle with Shear
43022	FDCS-10-4	Connector Shear Only



## FLEXIBLE DUCT CONNECTORS

### SUPER METAL FAB

Grade: Commercial Dimensions: 3" Metal, 6" Fabric, 3" Metal Construction: "Grip-Loc" - Gauge: 24

No.	Code	Description	Ft / Roll
10188	SMFN-50	Neoprene	50'
10012	SMFN-100	Neoprene	100'
10189	SMFDU-50	Durolon	50'
10011	SMFDU-100	Durolon	100'
10291	SMCT-50	Teflon	50'

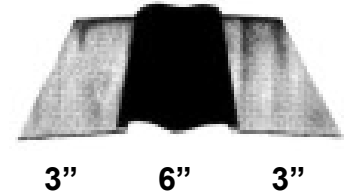

### METAL FAB

Grade: Commercial - Dimensions: 3" Metal, 3" Fabric, 3" Metal - Construction: "Grip-Loc" - Gauge: 24

No.	Code	Description	Ft / Roll
10062	MFN-50	Neoprene	50'
10003	MFN-100	Neoprene	100'
10316	MFN-700	Neoprene	700'
10061	MFDU-50	Durolon	50'
10002	MFDU-100	Durolon	100'
10193	MFX-50	Canflex	50'
10140	MFX-100	Canflex	100'
10274	MCT-50	Teflon	50'
10278	MCT-100	Teflon	100'

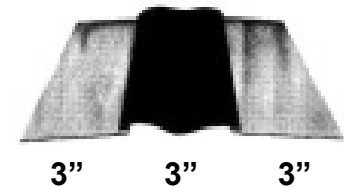

## ALUMINUM FLEXIBLE CONNECTORS

Aluminum 0.033" thick - Dimensions: 3" Metal, 3" Fabric, 3" Metal - "Grip Loc"

10097	MFDAL-100	Durolon	100'
10098	MFNAL-100	Neoprene	100'

## STAINLESS STEEL CONNECTORS

Series 300 Stainless, 0.015" thick, Dimensions: 3" Metal - - 3" Fabric - 3" Metal - "Grip-Loc"

10232	MFN-100XX	Neoprene	100'
10234	MFDU-100XX	Durolon "A"	100'
10293	MCT-SS 4x4x4	Teflon	100'

## TDC/TDF CONNECTOR

For use with Lockformer (TDC) or Engel (TDF) flange-forming machines

Dimensions: 4" Metal, 4" Fabric, 4" Metal - Construction: "Grip-Loc", Gauge: 24

10211	MFN 4x4x4	Neoprene	100'
10315	MFN700 4x4x4	Neoprene	700'
10237	MBDU 4x4x4	Durolon "A"	100'
10210	MBX 4x4x4	Excelon	100'

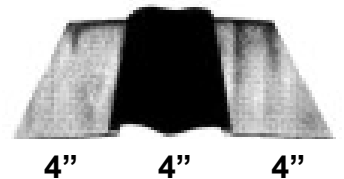

## INSULFLEX Insulated Flexible Connector

Dimensions: 3" Metal, 4" Fabric, 3" Metal - Construction: Guard Loc - Gauge: 28

10173	IDC 343	Insulflex	100'
-------	---------	-----------	------



## ECON-O-FAB

Grade: Light Commercial & Residential - Dimensions: 3" Metal, 3" Fabric, 3" Metal  
Construction: "Grip-Loc" Gauge: 28

No.	Code	Description	Ft / Roll
10078	EFN-50	Neoprene	50'
10035	EFN-100	Neoprene	100'
10317	EFN-700	Neoprene	700'
10311	EFN-150	Neoprene	150'
10194	EFX-50	Canflex	50'
10142	EFX-100	Canflex	100'
10284	ECT-50	Teflon	50'
10071	ECT-100	Teflon	100'

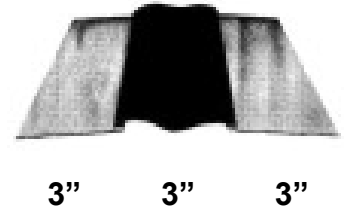

3" 3" 3"

## JUNIOR CONNECTOR

Grade: Residential - Dimensions: 1-3/4" Metal, 3" Fabric, 1-3/4" Metal  
Construction: Guard-Loc - Gauge: 28

10120	JRX-50	Canflex	50'
10141	JRX-100	Canflex	100'
10073	JRT-50	Thermafab	50'
10070	JCT-100	Teflon	100'
10123	JRN-100	Neoprene	100'
10313	JRDU-100	Durolon	100'

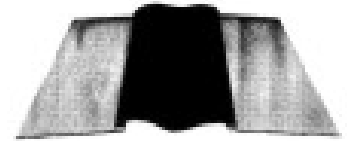

1-3/4" 3" 1-3/4"

## DUCT FABRIC ONLY

(Widths other than listed below are available on application).

10195	DFN-5	Neoprene	100'
10043	DFN-6	Neoprene	100'
10089	DFN-8	Neoprene	100'
10051	DFN-10	Neoprene	100'
10090	DFN-12	Neoprene	100'
10196	DFDU-5	Durolon	100'
10091	DFDU-8	Durolon	100'
10050	DFDU-10	Durolon	100'
10197	DFX-5	Canflex	100'
10295	DCT-5	Teflon	100'
10297	DCT-8	Teflon	100'



## DURO STAPLER & STAPLES

No.	Code	Description
10065	DS-31	Rapit 31 Stapler
10059	DSP-1	Staples for Neva Clog Stapler Box of 5,000



## STAINLESS STEEL SCRIBER

10015	SSSES	Stainless Edge Scriber
-------	-------	------------------------



# AIR REGULATING CONTROL EQUIPMENT

## PARTS FOR BACK-DRAFT DAMPERS

No.	Code	Description	Qty / Box
2303	BDK-51	Kit for Back-Draft Dampers, consist of 100 ea BDP-52 Bracket & Pivot 200 ea BDP-518, 1/8" I.D. Bushings 200 ea AA-42D 1/8" x 1/8" Alum. Pin Rivets	100
2304	BDP-52	Aluminium Linkage Bracket and Nylon Pivot	100
2305	BDP-53	Nylon Pivot only	100
2306	BDP-518	1/8" I.D. Nylon Bushing	200
2307	BDP-536	3/16" I.D. Nylon Bushing	200

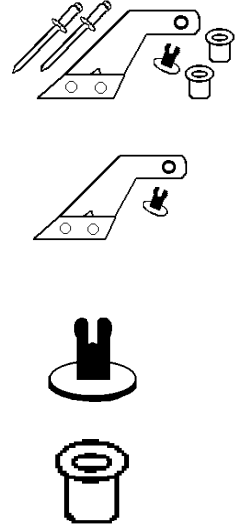

### INSTRUCTIONS:

Connecting bar between blades may be L-formed or flat aluminum strip .040" to .060" thick. Holes for nylon pivots should be drilled (No. 11 size bit), or punched (13/64") on appropriate centres.

## CONTROL SWIVEL AND DAMPER CRANK ARM

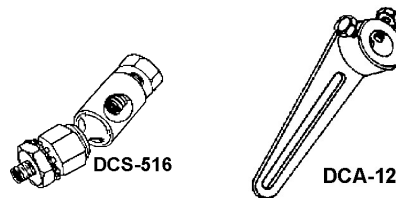

No.	Code	Description	Qty / Box
2309	DCS-516	Control Swivel to accept 5/16" or 1/4" connecting rod	25
2320	DCA-12	Crank arm for 1/2" shaft, 5-1/2" overall length	10

## NEVA-BIND™ DURO BLADE KIT

Contains hardware for 1 complete blade of a Parallel Multiblade Damper.

No.	Code	Description	Bearing Size
2001	BK-1	7/16" I.D. Neva-Bind Blade Kit	7/16"
2002	BK-2	1/2" I.D. Neva-Bind Blade Kit	1/2"

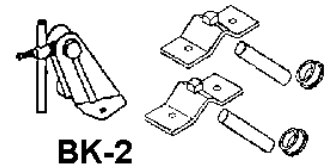

## "OPAX" BLADE KIT

Contains hardware for 2 complete blades for an Opposed Action Damper.

No.	Code	Description	Bearing Size
2003	BKO-3	7/16" I.D. Opax Blade Kit	7/16"
2004	BKO-4	1/2" I.D. Opax Blade Kit	1/2"

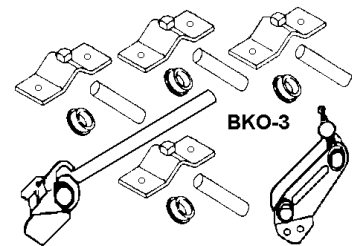

## SIDE-SEAL (Type 301 stainless)

Stainless Spring Steel Insert

Minimizes air leakage between damper blades and frame.

No.	Code	Description	Thickness	Feet / Box
2077	BKSS	Stainless Side Seal	0.015"	100
2250	BKSS	Stainless Side Seal	0.015"	2000

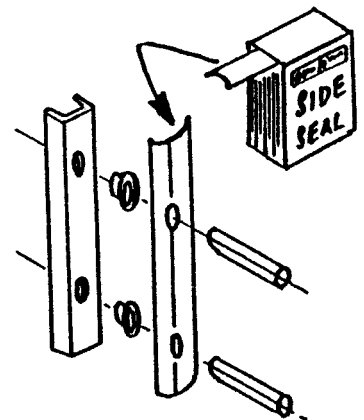

## DAMPER BLADE EDGINGS

No.	Code	Description	Feet / Box
2151	BKDBE-2	White Vinyl	600
2156	BKDBE-3	Grey Vinyl	600
2153	BKDBE-SS	.015" Stainless	600

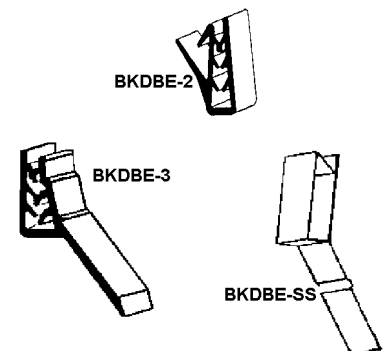

# BLADE KIT PARTS

## LINKAGE BRACKETS

Packed 100 per box.

No.	Code	Description
2005	BKP-814	Neva-Bind Bracket for 1/4" Rod
2257	BKP-814WB	Neva-Bind Bracket for 1/4" Rod with Brass Bushing
2006	BKP-856	Neva-Bind Bracket for 5/16" Rod
2060	BKP-20	Opax Linkage Set, (BKP-22 + BKP-23)
2008	BKP-22	Opax Hi Bracket for 1/4" Rod
2300	BKP-225	Opax Hi Bracket for 5/16" Rod
2009	BKP-23	Opax Lo Bracket & Linkage Rod
2010	BKP-24	Lo Bracket, Pivot & Set Screw for 1/4" Rod
2301	BKP-245	Lo Bracket, Pivot & Set Screw for 5/16" Rod
2011	BKP-25	Hi Bracket, Pivot & Set Screw for 1/4" Rod

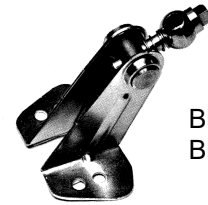

BKP-814  
BKP-856

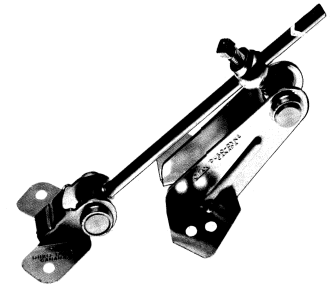

BKP-22

BKP-23

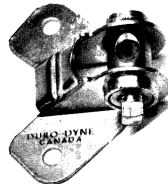

BKP-24



BKP-25

## BUSHINGS

Packed 100 per box

No.	Code	Description
2012	BKP-9	Bronze Bushing 7/16" I.D.
2013	BKP-10	Bronze Bushing 1/2" I.D.
2053	BKP-10-D	Delrin Bushing 1/2" I.D.
2240	BKP-80	Plastic Blade Kit Bushing 1/4" Round
2241	BKP-81	Plastic Blade Kit Bushing 1/4" Square
2242	BKP-82	Plastic Blade Kit Bushing 3/8" Round
2266	BKPRB80	Rubber Blade Kit Bushing 1/4" Round
2267	BKPRB81	Rubber Blade Kit Bushing 1/4" Square
2269	BKPRB83	Rubber Bushing 3/8" Square



BKP-10

## STRAPS AND PINS

All Items Packed 100/box, except \* packed 50/box

No.	Code	Description
2016	BKP-13	Strap & Set Screw
2017	BKP-1	7/16" x 2-1/2" Bearing Pin
2018	*BKP-2	7/16" x 6" Bearing Pin
2019	BKP-5	1/2" x 2-1/2" Bearing Pin
2020	*BKP-6	1/2" x 6" Bearing Pin
2024	*BKP-70	7/16" dia. to 3/8" sq. x 6" Pin
2063	BKP-8	1/2" dia. to 3/8" sq. x 4" Pin
2023	*BKP-7	1/2" dia. to 1/2" sq. x 6" Pin
2041	BK-11	Set Screw Only for BKP-13

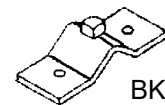

BKP-13



BKP-1



BKP-9



# FIRE DAMPER HARDWARE

## FUSIBLE LINKS — U.L. LISTED

No.	Code	Temp. Rating	Load Rating	Between Center of Holes	Bearing Length	Qty / Box
2033	FBL-165	165°F	1-30 lbs.	1-3/4"	2-9/16"	25
2034	FBL-212	212°F	1-30 lbs.	1-3/4"	2-9/16"	25
2035	FBL-286	286°F	1-30 lbs.	1-3/4"	2-9/16"	25
2032	ML-165	165°F	1-10 lbs.	1"	1-1/2"	25
2321	ML-212	212°F	1-10 lbs.	1"	1-1/2"	25
2322	ML-286	286°F	1-10 lbs.	1"	1-1/2"	25



## STAINLESS STEEL PARTS

No.	Code	Description
2049	BKP-22XX	Opax Hi-Bracket
2047	BKP-25XX	Hi-Bracket with Pivot and Set Screw for 1/4" Rod
2058	BKP-24XX	Lo-Bracket with Pivot and Set Screw for 1/4" Rod
2052	BKP-13XX	Bearing Strap & Set Screw
2051	BKP-5XX	1/2" x 2-1/2" Bearing Pin
2068	BKP-6XX	1/2" x 6" Bearing Pin
2085	BKP-10XX	Flanged Bushing 1/2" I.D.
7396	KP-7L-SS	3/8" x 3-3/4" Stainless Spring Loc Bearing
7393	KP-9XL-SS	3/8" Square Stainless End Bearing Long (2-7/8")
7394	KP-10R-SS	1/2" Round Stainless End Bearing
7395	KP-10S-SS	1/2" Square Stainless End Bearing



BKP-13XX



BKP-22XX

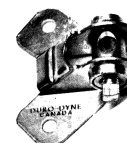

BKP-24S  
BKP-24XX

## BLADE PINS

No.	Code	Description	Qty / Box
2094	DBP-1	Slip-in Blade Pin	100
2089	DBP-1	Slip-in Blade Pin Only	1000
2215	SDBP-100A	3/8" Square Pin 1" Long	100
2216	SDBP-150A	3/8" Square Pin 1-1/2" Long	100
2217	SDBP-200A	3/8" Square Pin 2" Long	100
2221	RDBP-100A	1/2" Round Pin 1" Long	100
2222	RDBP-150A	1/2" Round Pin 1-1/2" Long	100
2223	RDBP-200A	1/2" Round Pin 2" Long	100

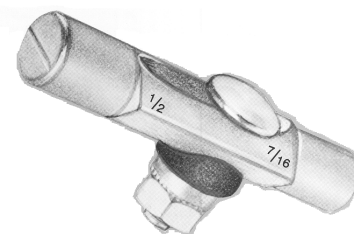

DBP-1

# SPEC-SEAL™

## AIR TIGHT, RATTLE PROOF, REGULATOR SETS

Each set consists of: regulator, 2 seals and washers, end bearing support and 2 end bearings

No.	Code	Description
8153	AL-38	3/8" Square Bearing
8154	AL-38R	3/8" Round Bearing
8158	AL-38L	3/8" Square Long Bearing
8152	AL-12R	1/2" Round Bearing



### REGULATOR ONLY (No end bearings, seals, washers)

No.	Code	Description
8279	RO-12R-N	1/2" Round (Old Style) <b>SEE ALSO ITEM #8270</b>

### UNIVERSAL REGULATOR

No.	Code	Description	Qty / Box
8270	MSRO3812	Universal Regulator for 3/8" and 1/2" round or square bearings	10
8155	SK38	MSRO 3/8 in. Seal Kit	10
8156	SK12	MSRO 1/2 in. Seal Kit	10



MSRO3812

### STAINLESS STEEL REGULATOR SET

Regulator: 400 Series SS      Parts & Bolts: 300 Series SS

No.	Code	Description
8301	AL-12SS	1/2" Square

### STAINLESS STEEL REGULATOR ONLY

No.	Code	Description
8302	RO-12SS-N	1/2" Square. <b>See Item 8328</b>
8328	MSRO3812-SS	3/8" and 1/2" SQ or RND Bearing c/w Red Vinyl Handle
8272	KR-3SS	3/8" Square Dial Regulator

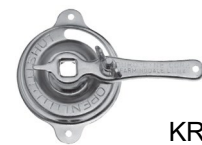

KR-3SS

### BALL JOINTS & SPLITTER DAMPER BRACKETS

No.	Code	Shaft Size	Description	Qty / Box
8032	SRP-14	1/4"	Ball Joint for Duct	25
8033	SRP-516	5/16"	Ball Joint for Duct	25
8034	SRP-40	1/4"	Bracket for Damper	25
8035	SRP-50	5/16"	Bracket for Damper	25



SRP-14  
SRP-516

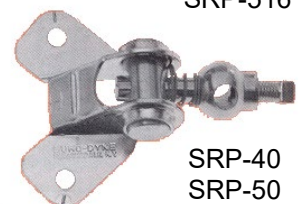

SRP-40  
SRP-50

# SPECLINE™ REGULATOR

No.	Code	Shaft Size	Type	Qty / Box
8002	SR-148	1/4"	Handle	10
8003	SR-380	3/8"	Indicator	10
8004	SR-388	3/8"	Handle	10
8005	SR-120	1/2"	Indicator	10
8006	SR-128	1/2"	Handle	10
<b>As above but with open hex lock nut</b>				
8011	SRH-248	1/4"	Handle	10
8012	SRH-280	3/8"	Indicator	10
8013	SRH-288	3/8"	Handle	10
8014	SRH-220	1/2"	Indicator	10
8015	SRH-228	1/2"	Handle	10
8007	SRC-140	1/4"	Concealed	5
8008	SRC-380	3/8"	Concealed	5
8009	SRC-120	1/2"	Concealed	5
8135	AD-38	3/8"	Right Angle Drive	5

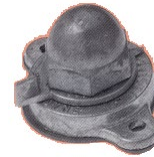

SR-380  
SR-120



SR-148  
SR-388  
SR-128



SRH-280  
SRH-220



SRH-248  
SRH-288  
SRH-228



SRC-140  
SRC-380  
SRC-120



AD-38

## SPECLINE™ REGULATOR PARTS END BEARINGS

No.	Code	Shaft Size	Type	Qty / Box
8025	SB-114	1/4"	Open End	25
8026	SB-314	1/4"	Closed End	25
8027	SB-138	3/8"	Open End	25
8028	SB-338	3/8"	Closed End	25
8029	SB-112	1/2"	Open End	25
8030	SB-312	1/2"	Closed End	25
8031	SRP-10	3/8"	Bearing Conn.	12

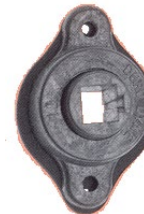

SB-114  
SB-138  
SB-112



SB-314  
SB-338  
SB-312

## DIAL REGULATORS STAMPED FRAME, CAST CORE

No.	Code	Shaft Size	Type	Qty / Box
8016	SRHS-148	1/4"	Open Nut	10
8017	SRHS-388	3/8"	Open Nut	10
8018	SRHS-128	1/2"	Open Nut	10
8022	SRS-148	1/4"	Closed Nut	10
8023	SRS-388	3/8"	Closed Nut	10
8024	SRS-128	1/2"	Closed Nut	10



SRHS-148  
SRHS-388  
SRHS-128



SRS-148  
SRS-388  
SRS-128

## ELEVATED FOR INSULATED DUCT

8019	SRST-1	3/8"	1" Stand-Off	10
8020	SRST-1-1/2	3/8"	1-1/2" Stand Off	10
8021	SRST-2	3/8"	2" Stand-Off	10

SRST-1  
SRST-1-1/2  
SRST-2

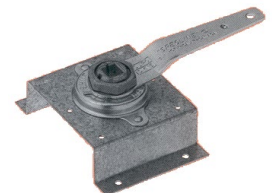

# RAPIT™ DAMPER REGULATORS

No.	Code	Description	Quantity per Ctn	Pricing Units
8085	RS-256	2 "Rapit" Bearings 1 Washer, 1 Handle and 1 Wing Nut	10 sets	Box of 10
8086	RS-156	1 "Rapit" Bearing 1 Washer, 1 Handle and 1 Wing Nut	100 sets	Per Set
8088	RB-50	"Rapit" Bearing Only	100	Each
8201	RB-25T	Solid Bearing Threaded – replaces RB-51	100	Each
<b>ACCESSORIES</b>				
8089	RP-1	Handle	100	Box of 100
8090	RP-2	Wing Nut	100	Box of 100
8091	RP-3	Washer	100	Box of 100
8198	RP-1T	Special Handle for RB-25T	100	Box of 100
7190	RP3-50 NEO	Rapit Neo/Steel Washer	100	Box of 100
7191	RP3-25 NEO	Rapit Neo/Steel Washer	100	Box of 100
7378	SRE1	Slide Rapit Extension	100	Box of 100

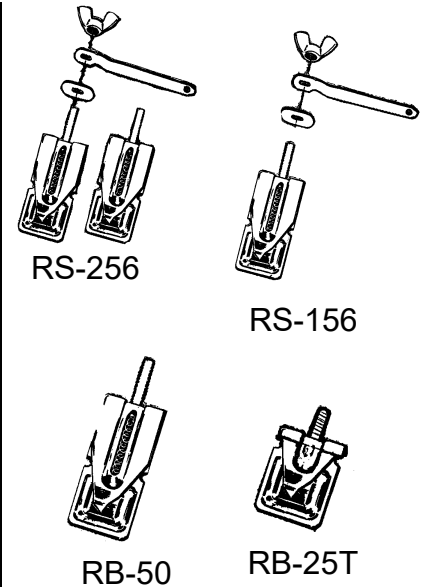

We will be pleased to quote on large quantities or special requirements

## PRE-FAB ROUND DAMPERS

No.	Code	Description	Pricing Units
8092	JDS-4	Round damper includes rapit spring bearing handle and wing nut with solid bearing on opposite side	Box of 10
8093	JDS-5		Box of 10
8094	JDS-6		Box of 10
8095	JDS-7		Box of 10
8096	JDS-8		Box of 10
8097	JDS-9		Box of 10
8137	JDS-10		Box of 10
8098	JD-4	Round damper includes rapit spring bearing handle and wing nut	Box of 10
8099	JD-5		Box of 10
8100	JD-6		Box of 10
8101	JD-7		Box of 10
8146	JD-8		Box of 10
JDS and JD dampers may be combined in full carton quantities for best prices.			



# DAMPER REGULATOR & QUADRANT SETS

## DAMPER REGULATOR SETS

No.	Code	Shaft Size	For Dampers	Sets Consists of: *
8039	KS-7	1/4"	10"	JB-1 + KP-6
8040	KS-14	1/4"	10"	K-2 + KP-8S + KP-8R
8041	KS-145	1/4"	10"	K-2 + KP-8S + KP-6
8042	KS-19	3/8"	20"	K-3 + KP-9S + KP9R
8043	KS-195	3/8"	20"	K-3 + KP-9S + KP-7
8044	KSR-19	3/8"	20"	KR-3 + KP-9S + KP-9R
8045	KSR-195	3/8"	20"	KR-3 + KP-9S + KP-7

\* See page B-9 for bearing descriptions

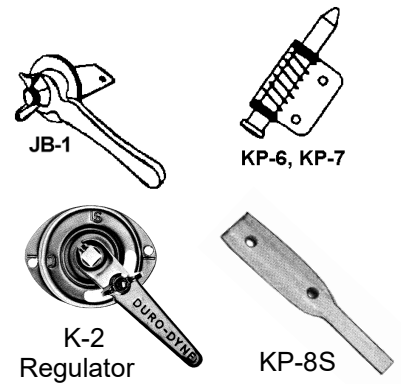

## REGULATOR SETS For Insulated Ducts - Long Bearings

No.	Code	Shaft Size	For Dampers	Sets Consists of: *
8046	KS-7L	1/4"	10"	JB-1L + KP-6
8047	KS-145L	1/4"	10"	K-2 + KP-8L + KP-6
8048	KS-195L	3/8"	20"	K-3 + KP9L + KP-7
8139	KSR-195L	3/8"	20"	KR-3 + KP-9L + KP-7
8049	KS-385L	3/8"	20"	K-4 + KP-9L + KP-7
8312	KS-12L	1/2"	30"	K-5 + KP-10L + KP-10R

\* See page B-9 for bearing descriptions

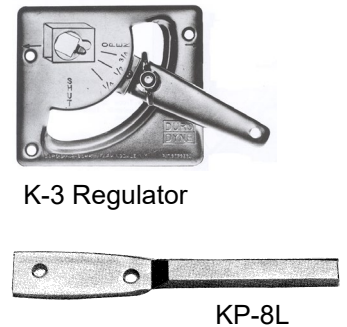

## DAMPER QUADRANT SETS

No.	Code	Shaft Size	For Dampers	Sets Consists of: *
8050	KS-38	3/8"	20"	K-4 + KP-9S + KP-9R
8051	KS-385	3/8"	20"	K-4 + KP-9S + KP-7
8052	KS-12	1/2"	30"	K-5 + KP10S + KP-10R

\* See page B-9 for bearing descriptions

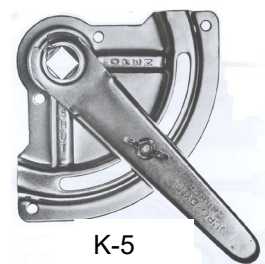

## INSTRUMENT TEST PORT

No	Code	Insulation up to	Description	Qty / Box
8296	IP-1	1"	Inst. Test Port	10
8298	IP-2	2"	Inst. Test Port	10
8308	IP-4	1"	Inst. Test Port (Economy Model)	25

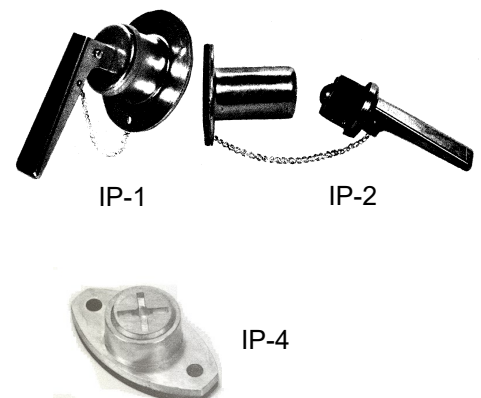

## REGULATORS AND QUADRANTS

No.	Code	Shaft Size	Description	Qty / Box
8102	JB-1	1/4"	Jiffy Bearing/Handle	100
8056	K-2	1/4"	Dial Regulator	100
8057	K-3	3/8"	Wedge Loc Regulator	100
8058	KR-3 *	3/8"	Dial Regulator	100
8059	K-4	3/8"	Quadrant	100
8060	K-5	1/2"	Quadrant	100
8064	K-8	1/2"	Clamp Quad-Round Rod	25
8063	K-9	1/2"	Clamp Quad-Square Rod	25

\* Also available in Stainless. See Page B-5

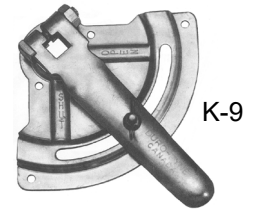
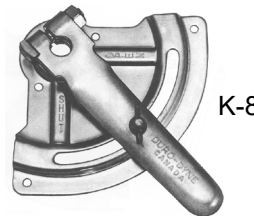
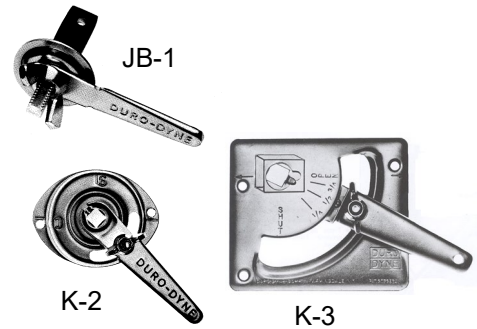

## END BEARINGS (Packed 100 per box)

No.	Code	Shaft Size	Description
8065	KP-6	1/4"	Spring Loc Bearing
8241	KP-6L	1/4"	Long Spring Loc
8066	KP-7	3/8"	Spring Loc Bearing
8242	KP-7L	3/8"	Long Spring Loc
8067	KP-8R	1/4"	Round End Bearing
8068	KP-8S	1/4"	Square End Bearing
8069	KP-8L	1/4"	Long Square Bearing
8077	KP-8XL	1/4"	Extra Long Square End Bearing
8070	KP-9R	3/8"	Round End Bearing
8071	KP-9S	3/8"	Square End Bearing
8072	KP-9L	3/8"	Long Square Bearing
8247	KP-9XL	3/8"	Extra Long Square Bearing
8073	KP-10R	1/2"	Round End Bearing
8074	KP-10S	1/2"	Square End Bearing
8303	KP-10L	1/2"	Long Square Bearing
7370	KP-8S-T	1/4"	Threaded Square End Bearing
8986	KP-8L-T	1/4"	Long Square Threaded Bearing



KP-8S, KP-8R  
KP-9S, KP-9R  
KP-10S, KP-10R

KP-8L  
KP-9L  
KP-10L

## DURO VANE RAIL

For Single or Hollow Air Turning Vanes

No.	Code	Description	Feet per Carton
4002	VR-2	Continuous coil 4-1/2" wide	100

## ALUMINUM VANE RAIL (.033" Aluminum)

No.	Code	Description	Feet per Carton
4008	VR-2AL	Continuous coil Aluminum 4-1/2" wide	100

## STAINLESS VANE RAIL (Series 300, .015" thick)

No.	Code	Description	Feet per Carton
4007	VR-2SS	Continuous coil Stainless 4-1/2" wide	100

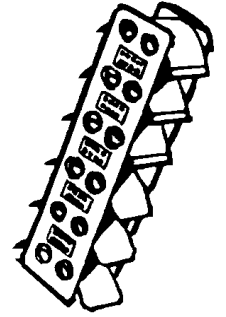

VR-2  
VR-2AL  
VR-2SS

## PUSH RAIL

For 2" Hollow Vanes

No.	Code	Description	Feet per Carton
36050	QR-2	Push Rail	100

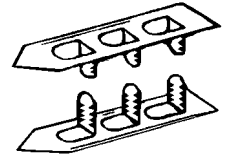

QR-2

## JUNIOR VANE RAIL

For Smaller Duct Vane Assemblies (Single or Hollow Vanes)

No.	Code	Description	Feet per Carton
4003	JVR-2	Twin Coils 2-1/4" wide	200

## VINYL DURO STRAP

For Hanging Duct

Reinforced Vinyl Strap, 1-1/2" Wide. Packed 200 Ft. in Dispenser Carton

No.	Code	Description	Feet per Carton
-----	------	-------------	-----------------



Vinyl Duro Strap

10181	VDS200C	Vinyl Duro Strap (Packed 10 Rolls/Case)	200
-------	---------	--	-----

## HANDY STRAP

For Hanging Duct

No.	Description	Feet per Carton
10202	Handy Strap	100

24 Gauge, perforated galvanized steel strap, 3/4" wide.



Handy Strap

## ACCESS DOOR HANDLES, HARDWARE

No.	Code	Shaft Size	Description	Qty / Box
8105	SP-5	5/16"	Latch Assembly	25
8106	SP-10	3/8"	Latch Assembly	10
8107	SP-20	1/2"	Latch Assembly	10
8309	SP-21	1/2"	Latch Assembly	10
8108	SL-1		Sash Lock	50
8138	SL-2		Cam-Lock	100



## SNAP FASTENER

No.	Code	Description	Qty / Box
8182	A1SF	Snap Fastener	100

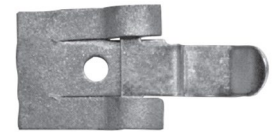

A1SF

## REDDI-STIK GASKETING FOR ACCES DOORS AND DAMPERS

No.	Code	Thickness	Width	Feet/Roll	Rolls/Case
<b>NEOPRENE</b>					
8129	GN-22	1/8"	1/2"	50	24
8310	GN-23	1/8"	3/4"	50	16
8130	GN-43	1/4"	3/4"	25	16
8131	GN-63	3/8"	3/4"	20	16
<b>URETHANE</b>					
8126	GU-32	3/16"	1/2"	50	24
8127	GU-43	1/4"	3/4"	40	16
8128	GU-63	3/8"	3/4"	25	16





**BUTT HINGES** Packed – 1 dozen pairs per carton

No.	Code	Size	Description
8113	HB-2	2" x 1-1/2"	Light narrow butt hinge, solid brass pin, without screw holes. Steel, zinc plated finish.
8114	HB-3	3" x 2"	

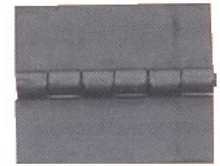

HB-2, HB-3

**PIANO HINGES** Packed – 26 per carton

No.	Code	Total Width	Thick	Length
<b>UNPLATED STEEL – STEEL PIN – NO HOLES</b>				
8117	HP-116	1-1/16"	.040"	3'
8119	HP-23	2"	.060"	3'
8313	HP-616	1-1/16"	.040"	6'
8315	HP-623	2"	.060"	6'



HP-116  
HP-23

No.	Code	Total Width	Thick	Length
<b>PLATED STEEL – STEEL PIN – WITH HOLES</b>				
8121	HPH-112	1-1/2"	.040"	3'
8317	HPH-612	1-1/2"	.040"	6'



HPH-112

No.	Code	Total Width	Thick	Length
<b>PLATED STEEL – BRASS PIN – NO HOLES</b>				
8320	HPB-23	2"	.060"	3'
8323	HPB-623	2"	.060"	6'

No.	Code	Total Width	Thick	Length
<b>STAINLESS STEEL (type 300) – STAINLESS PIN (type 300) – NO HOLES</b>				
8325	HPX-112	1-1/2"	.037"	3'
8327	HPX-612	1-1/2"	.037"	6'

# ACCESS DOORS

## INSULATED ACCESS DOORS – HINGED – TAB STYLE

No.	Code/Size	Description	Qty / Box
6100	DAD 4X4	Insulated Access Door-Hinged-Cam	10
6101	DAD 6X6	Insulated Access Door-Hinged-Cam	10
6102	DAD 8X8	Insulated Access Door-Hinged-Cam	10
6103	DAD 10X10	Insulated Access Door-Hinged-Cam	10
6104	DAD 12X12	Insulated Access Door-Hinged-Cam	10
6105	DAD 14X14	Insulated Access Door-Hinged-Cam	10
6106	DAD 16X16	Insulated Access Door-Hinged-Cam	5
6107	DAD 18X18	Insulated Access Door-Hinged-Cam	5
6108	DAD 20X20	Insulated Access Door-Hinged-Cam	5
6109	DAD 24X24	Insulated Access Door-Hinged-Cam	5



## INSULATED ACCESS DOORS – CAM ONLY – TAB STYLE

No.	Code/Size	Description	Qty / Box
6130	DADC 4X4	Insulated Access Door-Cam Only	10
6131	DADC 6X6	Insulated Access Door-Cam Only	10
6132	DADC 8X8	Insulated Access Door-Cam Only	10
6133	DADC 10X10	Insulated Access Door-Cam Only	10
6134	DADC 12X12	Insulated Access Door-Cam Only	10
6135	DADC 14X14	Insulated Access Door-Cam Only	10
6136	DADC 16X16	Insulated Access Door-Cam Only	5
6137	DADC 18X18	Insulated Access Door-Cam Only	5
6138	DADC 20X20	Insulated Access Door-Cam Only	5
6139	DADC 24X24	Insulated Access Door-Cam Only	5



# ACCESS DOORS

## INSULATED ACCESS DOORS – HINGED – SELF STICK

No.	Code/Size	Description	Qty / Box
7046	NHSAD 6X6	Insulated Access Door-Hinged-Self Stick	10
7047	NHSAD 8X8	Insulated Access Door-Hinged-Self Stick	10
7048	NHSAD 10X10	Insulated Access Door-Hinged-Self Stick	10
7049	NHSAD 12X12	Insulated Access Door-Hinged-Self Stick	10
7050	NHSAD 14X14	Insulated Access Door-Hinged-Self Stick	10
7051	NHSAD 16X16	Insulated Access Door-Hinged-Self Stick	5
7052	NHSAD 18X12	Insulated Access Door-Hinged-Self Stick	5
7053	NHSAD 18X18	Insulated Access Door-Hinged-Self Stick	5
7054	NHSAD 20X20	Insulated Access Door-Hinged-Self Stick	5
7055	NHSAD 24X24	Insulated Access Door-Hinged-Self Stick	5

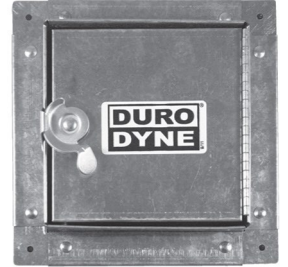

## INSULATED ACCESS DOORS – CAM ONLY – SELF STICK

No.	Code/Size	Description	Qty / Box
7056	NCSAD 6X6	Insulated Access Door-Cam-Self Stick	10
7057	NCSAD 8X8	Insulated Access Door-Cam-Self Stick	10
7058	NCSAD 10X10	Insulated Access Door-Cam-Self Stick	10
7059	NCSAD 12X12	Insulated Access Door-Cam-Self Stick	10
7060	NCSAD 14X14	Insulated Access Door-Cam-Self Stick	10
7061	NCSAD 16X16	Insulated Access Door-Cam-Self Stick	5
7062	NCSAD 18X12	Insulated Access Door-Cam-Self Stick	5
7063	NCSAD 18X18	Insulated Access Door-Cam-Self Stick	5
7064	NCSAD 20X20	Insulated Access Door-Cam-Self Stick	5
7065	NCSAD 24X24	Insulated Access Door-Cam-Self Stick	5



## INSULATED DUCT BOARD ACCESS DOORS

No.	Code/Size	Description	Qty / Box
36066	DBD 8X8	Insulated Duct Board Access Door	10
36067	DBD 10X10	Insulated Duct Board Access Door	10





**The Hanging Solution  
For HVAC Installations**

**CL23-WC6 Cable Lock for use with WC6 Wire Rope**

*Safe working load with WC6 (3/16") wire rope 50-640 lbs*

No.	Code	Description	Qty
30350	CL23-WC6	Cable Lock for WC6 (3/16")	100



**CL18-WC4 Cable Lock for use with WC4 Wire Rope**

*Safe working load with WC4 (1/8") wire rope 25-250 lbs*

30354	CL18-WC4	Cable Lock for WC4 (1/8")	100
-------	----------	---------------------------	-----



**CL12-WC3 Cable Lock for use with WC3 Wire Rope**

*Safe working load with WC3 (3/32") wire rope 25-150 lbs*

30351	CL12-WC3	Cable Lock for WC3 (3/32")	100
30361	KV12-WC3	Bracket c/w CL12-WC3	100

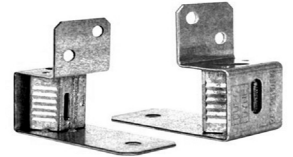

**CL6-WC2 Cable Lock for use with WC2 (1/16") Wire Rope**

*Safe working load with WC2 (1/16") wire rope 10-75 lbs*

30348	CL6-WC2	Cable Lock for WC (1/16")	100
-------	---------	---------------------------	-----



**Locking Cable Locks for use with Duro Dyne WC Cable only**

30369	CL12L-WC3	Locking Cable Lock for WC3	100
30370	CL18L-WC4	Locking Cable Lock for WC4	100
30371	CL23L-WC6	Locking Cable Lock for WC6	100
30372	CL25L-WC8	Locking Cable Lock for WC8	50



**Strut Lock Assemblies**

31080	DSL3Z	Strut Lock Assembly for WC3	10
31081	DSL4Z	Strut Lock Assembly for WC4	10



**Zip-Clip Lock**

30040	ZCL	Zip-Clip Lock	100
-------	-----	---------------	-----



**Cable Lock Wire Rope – For use with Duro Dyne CL Cable Locks**

30200	WC2-CL6	(1/16") Wire Rope for CL6 Lock	500
30202	WC3-CL12	(3/32") Wire Rope for CL12 Lock	500
30204	WC4-CL18	(1/8") Wire Rope for CL18 Lock	500
30206	WC6-CL23	(3/16") Wire Rope for CL23 Lock	500
30208	WC8-CL25	(1/4") Wire Rope for CL25 Lock	250



**Dyna-Tite Looped Cable**

30228	LC5-332	3/32"x5' Looped Cable	100
30229	LC10-332	3/32"x10' Looped Cable	100
30230	LC15-332	3/32"x15' Looped Cable	100
30232	LC25-332	3/32"x25' Looped Cable	50
30233	LC5-18	1/8"x5' Looped Cable	100
30234	LC10-18	1/8"x10' Looped Cable	100
30235	LC15-18	1/8"x15' Looped Cable	100
30237	LC25-18	1/8"x25' Looped Cable	50





**The Hanging Solution  
For HVAC Installations**

**ZIP-CLIP LOCK WITH LOOPED CABLE KIT**

No.	Code	Description	Qty / Box
30041	ZCWR5	Zip Clip Lock with Looped Cable 5ft	100
30042	ZCWR10	Zip Clip Lock with Looped Cable 10ft	100
30043	ZCWR15	Zip Clip Lock with Looped Cable 15ft	100
30044	ZCWR25	Zip Clip Lock with Looped Cable 25ft	50



**SWAGED DYNA-STUD**

1/4", 3/8" Swaged Threaded Stud with 5', 10', 15', 25' – WC3CL12 or WC4CL18 Cable

No.	Code	Description	Qty / Box
30052	SDSA1405WC3	1/4" Stud x 5'-3/32" Cable	100
30053	SDSA1410WC3	1/4" Stud x 10'-3/32" Cable	100
30054	SDSA1415WC3	1/4" Stud x 15'-3/32" Cable	100
30055	SDSA1425WC3	1/4" Stud x 25'-3/32" Cable	50
30056	SDSA3805WC4	3/8" Stud x 5'-1/8" Cable	100
30057	SDSA3810WC4	3/8" Stud x 10'-1/8" Cable	100
30058	SDSA3815WC4	3/8" Stud x 15'-1/8" Cable	100
30059	SDSA3825WC4	3/8" Stud x 25'-1/8" Cable	50



**90° 1/4" EYELETS WITH CABLE**

No.	Code	Description	Qty / Box
30144	9014-05WC3	90° 1/4" Eyelet 5'x3/32" Cable	100
30145	9014-10WC3	90° 1/4" Eyelet 10'x3/32" Cable	100
30146	9014-15WC3	90° 1/4" Eyelet 15'x3/32" Cable	100
30147	9014-25WC3	90° 1/4" Eyelet 25'x3/32" Cable	50
30148	9014-05WC4	90° 1/4" Eyelet 5'x1/8" Cable	100
30149	9014-10WC4	90° 1/4" Eyelet 10'x1/8" Cable	100
30150	9014-15WC4	90° 1/4" Eyelet 15'x1/8" Cable	100
30151	9014-25WC4	90° 1/4" Eyelet 25'x1/8" Cable	50



**90° 3/8" EYELETS WITH CABLE**

30152	9038-05WC3	90° 3/8" Eyelet 5'x3/32" Cable	100
30153	9038-10WC3	90° 3/8" Eyelet 10'x3/32" Cable	100
30154	9038-15WC3	90° 3/8" Eyelet 15'x3/32" Cable	100
30155	9038-25WC3	90° 3/8" Eyelet 25'x3/32" Cable	50
30157	9038-05WC4	90° 3/8" Eyelet 5'x1/8" Cable	100
30158	9038-10WC4	90° 3/8" Eyelet 10'x1/8" Cable	100
30159	9038-15WC4	90° 3/8" Eyelet 15'x1/8" Cable	100
30160	9038-25WC4	90° 3/8" Eyelet 25'x1/8" Cable	50



**The Hanging Solution  
For HVAC Installations**

**45° 1/4" EYELETS WITH CABLE**

No.	Code	Description	Qty / Box
30161	4514-05WC2	45° 1/4" Eyelet 5'x1/16" Cable	100
30162	4514-10WC2	45° 1/4" Eyelet 10'x1/16" Cable	100
30163	4514-15WC2	45° 1/4" Eyelet 15'x1/16" Cable	100
30164	4514-25WC2	45° 1/4" Eyelet 25'x1/16" Cable	50
30165	4514-05WC3	45° 1/4" Eyelet 5'x3/32" Cable	100
30166	4514-10WC3	45° 1/4" Eyelet 10'x3/32" Cable	100
30167	4514-15WC3	45° 1/4" Eyelet 15'x3/32" Cable	100
30168	4514-25WC3	45° 1/4" Eyelet 25'x3/32" Cable	50
30169	4514-05WC4	45° 1/4" Eyelet 5'x1/8" Cable	100
30170	4514-10WC4	45° 1/4" Eyelet 10'x1/8" Cable	100
30171	4514-15WC4	45° 1/4" Eyelet 15'x1/8" Cable	100
30172	4514-25WC4	45° 1/4" Eyelet 25'x1/8" Cable	50



**45° 3/8" EYELETS WITH CABLE**

30173	4538-05WC3	45° 3/8" Eyelet 5'x3/32" Cable	100
30174	4538-10WC3	45° 3/8" Eyelet 10'x3/32" Cable	100
30175	4538-15WC3	45° 3/8" Eyelet 15'x3/32" Cable	100
30176	4538-25WC3	45° 3/8" Eyelet 25'x3/32" Cable	50
30177	4538-05WC4	45° 3/8" Eyelet 5'x1/8" Cable	100
30178	4538-10WC4	45° 3/8" Eyelet 10'x1/8" Cable	100
30179	4538-15WC4	45° 3/8" Eyelet 15'x1/8" Cable	100
30180	4538-25WC4	45° 3/8" Eyelet 25'x1/8" Cable	50

**STRAIGHT 1/4" EYELETS WITH WC2 CABLE**

30110	S14-05WC2	Straight 1/4" Eyelet 5' x1/16" Cable	100
30111	S14-10WC2	Straight 1/4" Eyelet 10' x1/16" Cable	100
30116	S14-15WC2	Straight 1/4" Eyelet 15' x1/16" Cable	100



**STRAIGHT 1/4" EYELETS WITH WC3 CABLE**

30122	S14-05WC3	Straight 1/4" Eyelet 5' x3/32" Cable	100
30123	S14-10WC3	Straight 1/4" Eyelet 10' x3/32" Cable	100
30128	S14-15WC3	Straight 1/4" Eyelet 15' x3/32" Cable	100

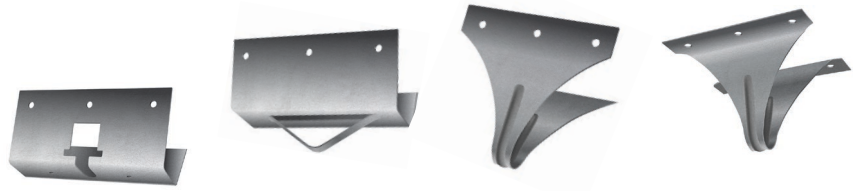

**BRAK-IT Galvanized Steel Fixture**

No.	Code	Description	Qty / Box
30373	BRAK-IT 100	Hook	50
30374	BRAK-IT 200	Rod	50
30375	BRAK-IT 300	Rod	50
30376	BRAK-IT 125	Hook	50
30377	BRAK-IT 225	Rod	50
30378	BRAK-IT 325	Rod	50
30379	BRAK-IT 150	Hook	50
30380	BRAK-IT 250	Rod	50
30381	BRAK-IT 350	Rod	50
30382	BRAK-IT 185	Hook	50
30383	BRAK-IT 185-P	Hook	50
30384	BRAK-IT 185-CM	Hook	50

**SEISMIC KITS**

30311	4H Seismic Bracket, CL18 Lock & 45° 3/8x15' Eyelet Kit	2 Per Bag
30325	4H Seismic Bracket, CL18 Lock & 1/8x15' Looped Cable Kit	2 Per Bag
30326	45HK Seismic Bracket, CL18 Lock & 1/8x10' Looped Cable Kit	2 Per Bag



**JUNIOR STARTER KITS INCLUDE:**

- 1 Roll of 500 feet Wire Cable
- 100 Cable Locks
- 1 Cable Cutter
- Bucket with Lid and Handle



**DDG3W**



**DSB1**



**DTWRLC**



**CL12WC3SK**

**DYNA-TITE ACCESSORIES**

No.	Code	Description	Qty / Box
30390	CCC1	Custom Cable Counter	1
30220	DDG3W	Eye Bolt and Nut	100
30340	DSB1	Dyna-Tite Spiral Buckle	50
818263	DTWRLC	Cable Cutter	1
30344	DTRWC14	Cable Cutter for WC-8	1
30394	CL12WC3SK	Starter Kit	1
30395	CL18WC4SK	Starter Kit	1
30397	CL12WC3SKJ	“Junior” Starter Kit	1
30398	CL18WC4SKJ	“Junior” Starter Kit	1

## DYN-O-TIES

Self-extinguishing, mildew resistant, high tensile nylon with tab release.  
Service Temperature range -40°C to 85°C



No.	Code	Maximum Diameter	Description	Qty / Pack
6298	DDN-36	11"	Nylon Dyn-O-Ties	50
6299	DDN-48	15"	Nylon Dyn-O-Ties	50

### HEAVY DUTY NYLON DYN-O-TIES (TITANIUM GREY COLOR)

Maximum Operating Temperature 85°C, Tensile Rating 175 lbs (779 N)

No.	Code	Maximum Diameter	Description	Qty / Pack
7116	DN-36HDG	11"	Nylon Dyn-O-Ties	50

## INSTALLATION TOOL FOR DYN-O-TIES

No.	Code	Description
7343	DIT-3	DYN-O-TIE Installation Tool



## STAINLESS STEEL DYNA-CLAMP™

No.	Code	Description	Qty / Box
7012	DT7WD	7 Inch Stainless Steel Dyna-Clamp	100
7007	DT8WD	8 Inch Stainless Steel Dyna-Clamp	100
7008	DT10WD	10 Inch Stainless Steel Dyna-Clamp	100
7009	DT12WD	12 Inch Stainless Steel Dyna-Clamp	100
7010	DT15WD	15 Inch Stainless Steel Dyna-Clamp	100
7011	DT16WD	16 Inch Stainless Steel Dyna-Clamp	100
7013	DT18WD	18 Inch Stainless Steel Dyna-Clamp	100

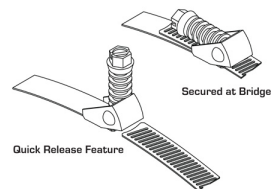



# TDC & TDF

## FLANGE, CORNERS, EZ BOLTS & CLEATS

No.	Code	Description	Packaging	Wgt.
21230	DOMJ20	J Flange 50-20'	1000'/Bndl	740 lbs
21233	DOMJ-10	J Flange 50-10'	500'/Bndl	370 lbs
21234	DOMJ12	J Flange 100-12'	1200'/Bndl	890 lbs
21235	DOMH12	H Flange 100-12'	1200'/Bndl	640 lbs
21270	DDEJ	J Quad Corner	250/Box	33 lbs
21254	DOMC	TDC Corner	250/Box	46 lbs
21255	DOMF	TDF Corner	250/Box	46 lbs
21020	TDCS	TDC Stackable Corner	250/Box	35 lbs
21021	TDFS	TDF Stackable Corner	250/Box	35 lbs
13078	EZCS	TDC EZ Stackable Corner	250/Box	35 lbs
13079	EZFS	TDF EZ Stackable Corner	250/Box	35 lbs
13082	EZQC	EZ Quad Corner	250/Box	33 lbs
13070	EZB100B	EZ Bolt 1in Bulk	1000/Box	
13071	EZB100	EZ Bolt 1in	125/Bag	
13073	EZB112B	EZ Bolt 1-1/2in Bulk	500/Box	
13074	EZB112	EZ Bolt 1-1/2in	125/Bag	
13077	EZS2	EZ Swivel Impact Nut Driver	1 Each	
13100	QXCLT20-125	6" Quad Cleat 20ga	125' (250Ea/Bx)	35 lbs
13096	DOMQCLT6	6" Quad Cleat 22ga	125' (250Ea/Bx)	31 lbs
13175	HDQC-PLUS125	6" Heavy Duty Quad Clt.22ga	125' (250Ea/Bx)	29 lbs
13230	TDC-2230	TDC Cleat Breakaway	60 x 30" 150'	33 lbs
13231	TDF-2230	TDF Cleat Breakaway	60 x 30" 150'	33 lbs
13108	PQCLT	6" PVC Quad Cleat	250' (500Ea/Bx)	19 lbs

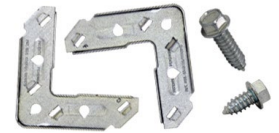
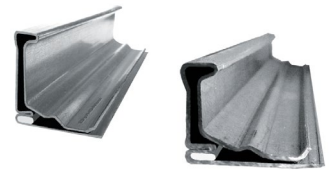

## HOLLOW VANES AND RAILS

No.	Code	Description	/Bndl	Packaging	Weight
13203	HTV2-2610	26 ga. 2" Vane 10'	5x10'	7200'/skid	3456 lbs
13300	DHVR2-2210	22 ga. 2" Rail 10'	10x10'	4000'/skid	1840 lbs
13207	HTV4-2410	24 ga. 4" Vanes 10'	5x10'	2500'/skid	2750 lbs
13302	DHVR4-2210	22 ga. 4" Rail 10'	10x10'	2000'/skid	1420 lbs



## GASKETING

No.	Code	Description	Packaging	Weight
21042	BTL-500	Butyl Gasket	500'/Box	46 lbs/Box
8151	BN516-34	5/16"x3/4" Neoprene Gasket	1000'/Box	20 lbs/Box



## GALVANIZED DURO STRAP

No.	Code	Description	Packaging	Weight
13253	GS241-200	Galvanized Strap 1" 24 Ga	200'/Roll	20 lbs



## DYN-O-WRAP

### BLUE SELF-ADHESIVE FILM

Item No.	Code	Description	Packaging	Weight
13380	DW24-200	Dyn-O-Wrap Roll 24" x 200'	6 rolls/Box	6.3 lbs
13384	DW36-200	Dyn-O-Wrap Roll 36" x 200'	1 roll/Box	10 lbs
13388	DW48-200	Dyn-O-Wrap Roll 48" x 200'	1 roll/Box	14 lbs
<b>PUNCTURE RESISTANT WRAP 2 mm thickness</b>				
13382	PRW24-200	Puncture Resist. Wrap 24" x 200'	1 roll/Box	6.3 lbs
13386	PRW36-200	Puncture Resist. Wrap 36" x 200'	1 roll/Box	10 lbs
13389	PRW48-200	Puncture Resist. Wrap 48" x 200'	1 roll/Box	14 lbs



# DYN-O-MATE™

## DYN-O-LOC & D-STUD

No.	Code	Description	Packaging
21097	DOMRL12	Rod Lock 1/2"	250/Box
21098	DOMRL34	Rod Lock 3/4"	250/Box
21208	DOMRL12-100	1/2" Dyn-O-Loc Assembly	100/Box
21209	DOMRL34-100	3/4" Dyn-O-Loc Assembly	100/Box
21008	SN12	1/2" Dyn-O-Loc Spring Nut	250/Box
21009	SN34	3/4" Dyn-O-Loc Spring Nut	250/Box
13021	DS12K-250	1/2" Dyn-O-Loc Stud Kit	250/Box
13023	DS34K-250	3/4" Dyn-O-Loc Stud Kit	250/Box
13025	DS12-250	1/2" Dyn-O-Loc D-Stud	250/Box
13027	DS34-250	3/4" Dyn-O-Loc D-Stud	250/Box
13029	DSGW-250	Dyn-O-Loc D-Stud Gasket Washer	250/Box
13031	DSFN-250	Dyn-O-Loc D-Stud Flange Nut	250/Box
21286	SWW1420	1/4-20 Dyn-O-Loc Bolt with Washer	250/Box
21298	DOMOC1234	1/2", 3/4" Dual Dyn-O-Claw	250/Box



## DYN-O-MATE AIR GUN & ACCESSORY TOOLS

No.	Code	Description	Packaging
13113	DAG	Duro Air Gun	1 Each
13116	PT	Pittsburgh Locking Tool for DAG	1 Each
13117	VL	Vane Locking Tool for DAG	1 Each
13118	DST	D-Stud Insertion Tool for DAG	1 Each
13119	DLT	Dyn-O-Loc Insertion Tool for DAG	1 Each



## DYN-O-MATE TOOLS

No.	Code	Description	Packaging
13063	PDH	Dyna-Hammer for Pittsburgh Lock	1 Each
13263	SPDH	Super Dyna-Hammer for Pittsburgh Lock	1 Each
13289	MDPR916	9" Magnetic Drift Pin Ratchet Tool	1 Each
13107	MWI916	Magnetic Wrench Insert 9/16"	1 Each
21062	DOM6	Dimpler Tool	1 Each
10069	MPOTSA	Magnetic Pittsburgh Lock Opening Tool	1 Each
13124	UMCT2	Universal Cleat Tool	1 Each
21072	DOMCRMP	TDC/TDF Crimping Tool	1 Each
13120	MRLT	Rod Lock Insertion Tool	1 Each
21060	DOMNB38	3/8" Nuts & Bolts	125/Pack



## DYN-O-RINGS

### 90° 18ga Galvanized 1-1/2" x 1-1/2"

Available in sizes from 8" to 59" – non welded.

### TDC 18ga Galvanized 1-1/2" x 1-1/2"

Available in sizes from 14" to 59" – non welded



# DYN-O-MATE™

## BOCA NAIL PLATES

No.	Code	Description	Pkg
70046	BOCA1658	BOCA Safety Plate 5"x8"	50
70047	SNBOCA1658	Self-Nailing BOCA Safety Plate 5"x8"	50



## EASY BREAK GAS PIPE HANGERS

No.	Code	Description	Pkg.
70021	GPH1615-2	Gas Pipe Hanger 15"x1" with 7/8 double holes	250
70022	GPH167.5-1	Gas Pipe Hanger 7.5"x1" with 7/8 single hole	250

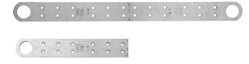

## Z BRACKET

No.	Code	Description	Pkg.
70008	ZB8	8" Z Bracket	100
70009	ZBL9	9" Z Bracket	100
70010	ZBXL10	10" Z Bracket	100
70011	ZBXXL11	11" Z Bracket	100
70012	ZBXXXL12	12" Z Bracket	100



## MULTI-DUCT L BRACKET

No.	Code	Description	Pkg.
70027	MDB12	1/2" Wide Multi-Duct L Bracket	100
70028	MDB12Q	1/2" Wide Multi-Duct L Bracket	250
70029	MDB12F	1/2" Wide Multi-Duct L Bracket	500
70030	MDB12B	1/2" Wide Multi-Duct L Bracket-Bulk	1000



## NAIL PLATE 1.5" X 24"

No.	Code	Description	Pkg.
70079	NPFHA161.5124-8W	Nail Plate 1.5"x24", 16ga 8 Hole Z pattern	50



## NAIL PLATE 5" X 18"

No.	Code	Description	Pkg.
70054	NPFHA16518-6U	Nail Plate 5x18, 6 Holes Straight	25
70055	NPFHA16518-6WU	Nail Plate 5x18, 6 Holes Wavy	25
70056	NPFHA16518-8	Nail Plate 5x18, 8 Holes Straight	25
70057	NPFHA16518-8U	Nail Plate 5x18, 8 Holes Straight	25
70058	NPFHA16518-8VU	Nail Plate 5x18, 8 Holes Vertical Upper	25
70059	NPFHA16518-8W	Nail Plate 5x18, 8 Holes Wavy	25
70060	NPFHA16518-8WU	Nail Plate 5x18, 8 Holes Wavy Upper	25

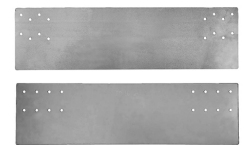

## NAIL PLATE 3" X 18"

No.	Code	Description	Pkg.
70063	NPFHA16318-8W	Nail Plate 3x18, 8 Holes Wavy	25
70064	NPFHA16318-8	Nail Plate 3x18, 8 Holes	25
70065	NPFHA16318-4	Nail Plate 3x18, 4 Holes	25



## STUD GUARD WITH FANGS

No.	Code	Description	Pkg.
70294	SGF161.53	Stud Guard 1-1/2"x3", 16ga with Fangs	100
70300	SGF161.55	Stud Guard 1-1/2"x5", 16ga with Fangs	100
70303	SGF161.56	Stud Guard 1-1/2"x6", 16ga with Fangs	100



# UNIVERSAL ECONOMY STANDOFF REGULATOR

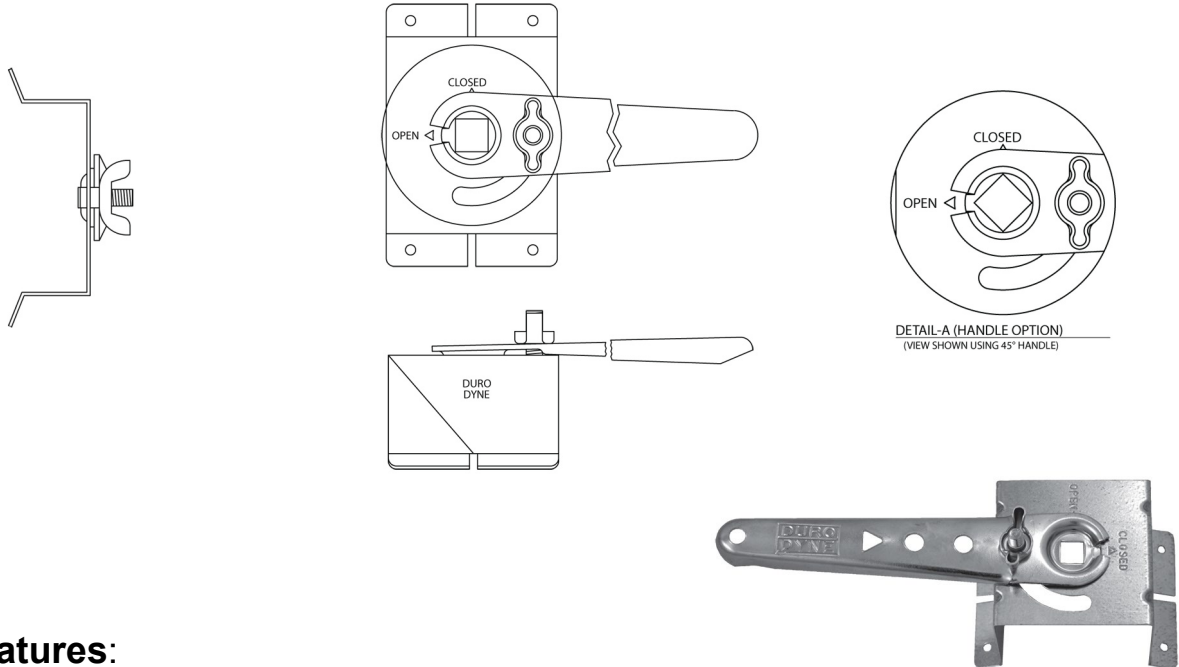

## Features:

- Base available with 10° degree foot for square or round duct
- Same regulator for square or round duct
- Standoff heights available in 1", 1.5", 2" and 3" height
- Handle available for 1/4", 3/8" or 1/2" square rod
- Heavy duty ergonomic rolled handle

No.	Code	Handle Size	Standoff Height	Qty / Box
<b>FOR SQUARE OR ROUND DUCT</b>				
6369	UESO14-100	1/4"	1"	10
6370	UESO14-150	1/4"	1-1/2"	10
6371	UESO14-200	1/4"	2"	10
6372	UESO14-300	1/4"	3"	10
6373	UESO38-100	3/8"	1"	10
6374	UESO38-150	3/8"	1-1/2"	10
6375	UESO38-200	3/8"	2"	10
6376	UESO38-300	3/8"	3"	10
6377	UES012-100	1/2"	1"	10
6378	UES012-150	1/2"	1-1/2"	10
6379	UES012-200	1/2"	2"	10
6380	UES012-300	1/2"	3"	10

# SEALER, ADHESIVES, INSULATION FASTENERS

## DUCT SEALER

### DWN – WATER BASE DUCT SEALER

No.	Code	Quantity	Qty / Box
5050	DWN-C	11 oz. Cartridge	24
5043	DWN-1	1 U.S. Gal.	4



### EDS-RS – SMOOTH WATER BASE SEALER (DUROSEAL)

Slate Grey

No.	Code	Quantity	Qty / Box
5233	EDS-RSC	Cartridge	24
5231	EDS-RS1	1 U.S. Gal.	2



### WEDS-RF – FIBER REINFORCES WATER BASE DUCT SEALER

White

No.	Code	Quantity	Qty / Box
5235	WEDS-RFC	Cartridge	24
5234	WEDS-RF1	1 U.S. Gal.	2

### GLUE BRUSH – Natural Bristle Priced per box

No.	Code	Description	Qty / Box
5008	BB-1	1" Wide Glue Brush	36
5014	BB-15	1-1/2" Wide Glue Brush	24
5022	BB-2	2" Wide Glue Brush	24
5029	BB-3	3" Wide Glue Brush	12
5039	BB-4	4" Wide Glue Brush	12



### CAULKING GUN

No.	Code	Description	Qty / Box
5125	SG-2	Caulking Gun Model for 11 oz. Cartridges	1



# INSULATION ADHESIVES

## WIT-LVAS WATER BASE ADHESIVE

Fast Tacking for Roller, Spray or Brush Application (White)

No.	Code	Quantity per Can	Cans per Shipping Unit
5106	WITLVAS-5	5 US gallons	1
5107	WITLVAS-50	50 US gallons	1



## WIT-M WATER BASE INSULATION ADHESIVE

For Roller, Spray or Brush Application (White)

No.	Code	Quantity per Can	Cans per Shipping Unit
5160	WIT1M	1 US gallon	4
5161	WIT5M	5 US gallons	1



## WIT-HS WATER BASE DUCT LINER INSUL. ADHESIVE

No.	Code	Quantity per Can	Cans per Shipping Unit
5169	WIT5HS	5 US gallon	1
5168	WIT50HS	50 US gallons	1

## SRPG-LVOC SOLVENT TYPE ADHESIVE – LOW VOC

For Spray, Brush or Roller Application

No.	Code	Quantity per Can	Cans per Shipping Unit
5148	SRPG-1LVOC	1 US gallon	4
5149	SRPG-5LVOC	5 US gallons	1



## “STRIPPER”

### Cleanser and Lubricating Spray

Removes galvanizing build-up

Lubricates moving parts

Effective preventive maintenance spray

No.	Code	Quantity per Case
27147	Stripper	12 cans



## OTHER SPRAY PRODUCTS

No.	Code	Description	Qty per Case
5164	CCASAWFT	Spray Adhesive	12 cans
5165	DCEC	Dynocoat Edge Coat	12 cans
5166	DTWAC	Dyn-O-Tac Web Adhesive	12 cans

# SUPER SPRAYFAST UNIVERSAL

## Insulation Adhesive Application System for Water-Based Adhesive

No.	Code	Description
5151	SSFU	Super Sprayfast Universal

**Sprayfast Unit Includes:** Stainless Steel & Aluminum Gun, 25 feet of gun hose, acetal/Teflon diaphragm pump, circulating system, surge tank and a flush kit assembly.

Specifically designed for use with Duro Dyne Water Base Adhesive. For use with a 5 gallon pail or a 45 or 50 gallon drum. A flush kit assembly makes clean up and maintenance procedure easier than before.

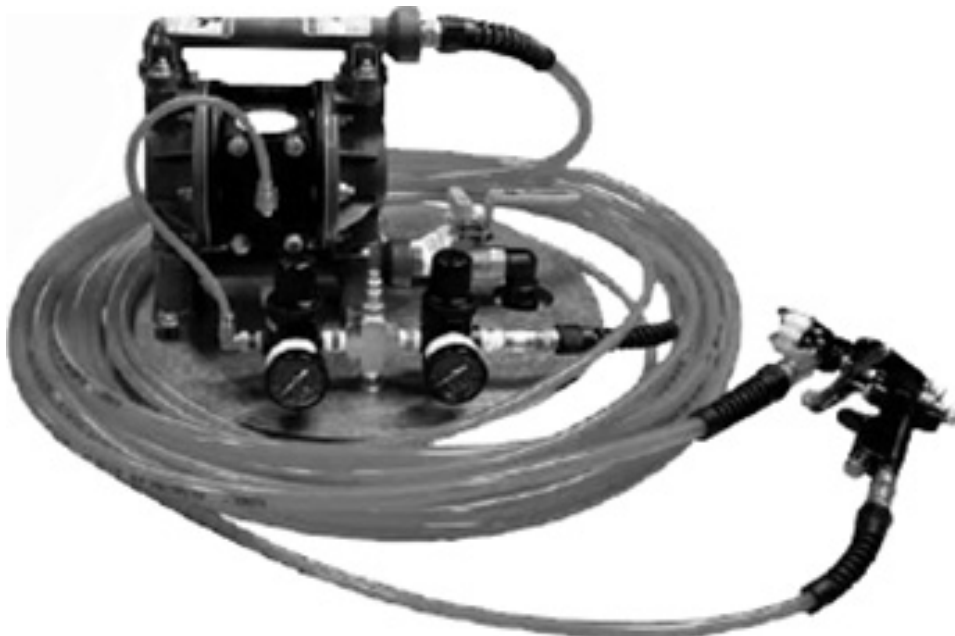

# DYN-O-LITE™

“LN” PINS – 16 Gauge

For use with LF-1000LN Pinspotter and TPL-2 Tip

Thousand Pack

No.	Code	Length
26149	LN-34	3/4”
26147	LN-250	2-1/2”



# DYN-O-LITE™ CLIPS

For use with LN Dyn-O-Lite Pins up to 2-1/2”.

Thousand Pack

No.	Code	Description
26145	LC-1	Dyn-O-Lite Washer

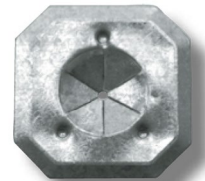

# AERODYNAMIC WASHER TARGET PINS

For use with Duro Dyne FG, RH, PBF and MF pinspotters.

Bulk Pack in plastic pail only

No.	Code	Length	Qty / Box
26220	BDEP-12	1/2”	5M
26221	BDEP-34	3/4”	5M
26222	BDEP-100	1”	5M
26217	BDEP-118	1-1/8”	3M
26218	BDEP-150	1-1/2”	3M
26219	BDEP-200	2”	3M





# INSULATION FASTENING MATERIALS AND EQUIPMENT

**SPOTTER-PINS** – Packed in cardboard containers.

Thousand Pack

No.	Code	Length
26001	PNT-34	3/4"
26002	PNT-114	1-1/4"
26003	PNT-200	2"
26004	PNT-250	2-1/2"



Bulk Pack

No.	Code	Length	Qty / Box
26005	PNB-34	3/4"	10M
26006	PNB-114	1-1/4"	10M
26007	PNB-200	2"	5M
26008	PNB-250	2-1/2"	5M

**SPOTTER-CLIPS** – Packed in cardboard containers.  
For use with PNT, PNB Pins up to 2-1/2"

Thousand Pack

No.	Code	Material
26017	PCT-1	Steel



Bulk Pack

No.	Code	Material	Qty / Box
26019	PCB-1	Steel	10M

**BANGERS™**  
(IMPACT DRIVEN INSULATION FASTENERS)

**STANDARD BANGERS** – Thousand Pack

No.	Code	Insulation Thickness
26033	BGT-12	1/2" (2 lb.)
26044	BGT-100	1" (1-1/2 lb.)

Bulk Pack

No.	Code	Insulation Thickness	Qty / Box
26095	BGB-12	1/2" (2 lb.)	5 M
26096	BGB-100	1" (1-1/2 lb.)	5 M



**TRIPOD BANGERS** – Thousand Pack

No.	Code	Insulation Thickness
26130	TBG-100	1" (1-1/2 lb.)

Bulk Pack

No.	Code	Insulation Thickness	Qty / Box
26134	TBGB-100	1" (1-1/2 lb.)	5M

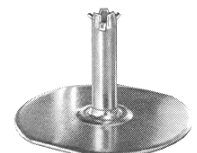

**DOUBLE HEADER HAMMER**

No.	Code	
27064	RBH2	Double Head Banger Hammer



*Specify the gold!*

**GOLD SEAL™ PINS**  
Self Sealing Pins

Bulk Pack

No.	Code	Length	Qty / Box
26297	SSPB-12	1/2"	5M
26294	SSPB-34	3/4"	5M
26295	SSPB-100	1"	5M
26296	SSPB-200	2"	3M
26303	SSP-300	3"	1M
26304	SSP-400	4"	1M

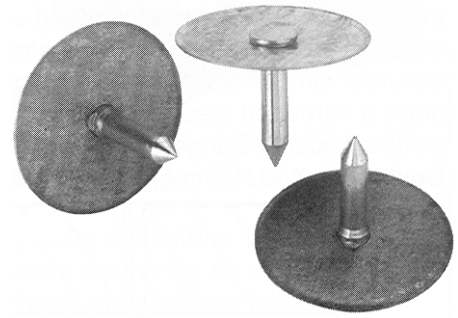

SSP

**CLIP PINS (RIB PINS)**

For use with Duro Dyne "Through-Insulation" Pinspotters

Thousand Pack

No.	Code	Length
26023	CPT-50	1/2"
26024	CPT-75	3/4"
26025	CPT-100	1"
26032	CPT-118	1-1/8"
26026	CPT-150	1-1/2"
26027	CPT-200	2"

Bulk Pack

No.	Code	Length	Qty / Box
26028	CPB-50	1/2"	5M
26029	CPB-75	3/4"	5M
26030	CPB-100	1"	5M
26035	CPB-118	1-1/8"	3M
26031	CPB-150	1-1/2"	3M
26038	CPB-200	2"	3M

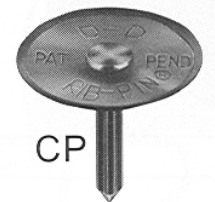

CP

**FTC**

Econo-Point Through-Insulation Fasteners

Sold in Bulk Cartons Only

No.	Code	Length	Qty / Box
26072	FTC-12	1/2"	5M
26073	FTC-34	3/4"	5M
26074	FTC-100	1"	5M
26131	FTC-118	1-1/8"	3M
26226	FTC-150	1-1/2"	3M
26227	FTC-200	2"	3M

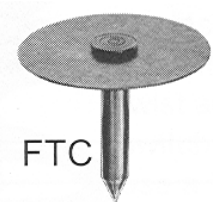

FTC

**DDP Diamond Point**

No.	Code	Length	Qty / Box
26200	DDP-12	1/2"	5M
26201	DDP-34	3/4"	5M
26202	DDP-100	1"	5M



DDP

**DYNASTICK™**  
**SELF ADHESIVE HANGERS – All pricing includes washers.**

Hundred Pack

No.	Code	Length	Qty / Box
26067	SAH-34	3/4"	100
26068	SAH-114	1-1/4"	100
26069	SAH-134	1-3/4"	100
26070	SAH-200	2"	100
26071	SAH-212	2-1/2"	100

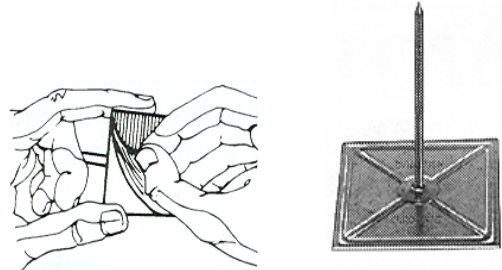

Bulk Pack

No.	Code	Length	Qty / Box
26036	SAHB-34	3/4"	500
26037	SAHB-114	1-1/4"	500
26040	SAHB-134	1-3/4"	500
26041	SAHB-200	2"	500
26047	SAHB-212	2-1/2"	500
26126	SAHB-350	3-1/2"	500
26127	SAHB-450	4-1/2"	500

**FLIP Stix!™**

No.	Code	Description	Qty / Box
26055	FSG-250	Galvanized Steel	100
26056	FSA-250	Aluminum	100
26057	FSS-250	Stainless (type 300)	100



Price includes retaining washers

**FLIP Stix!™**  
**EXTENSIONS For use with 3" - 5" insulation**

No.	Code	Description	Qty / Box
26061	FSG-E	Galvanized Steel	100
26054	FSA-E	Aluminum	100
26063	FSS-E	Stainless (type 300)	100

**DYNASTICK™**  
**Perforated Base Adhesive Type Hangers.**

All hangers include washers.  
 Sizes 3/4" to 2-1/2"

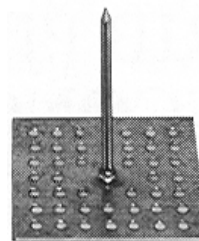

**DYNASTICK™ ADHESIVE**

For use with Perforated Base Adhesive Type Hangers. Cartridges Only

No.	Code	Description	Qty / Box
5143	PBACZVOC	Dynastick Adhesive Cartridge	24 x 10oz

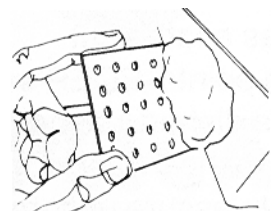

# BULK FEED PINSPOTTERS

Use BDEP, Gold Seal, CP or FTC Fasteners (See Pages C-4 and C-6)

## FG MACH70 AUTOMATIC BULK FEED PINSPOTTER

No.	Code	Description
27184	FG MACH70	Automatic Bulk Feed Pinspotter

## FPP70 CONVERSION PLATFORM PINSPOTTER

For use with MF70 Compact Pinspotter

No.	Code	Description
27181	FPP70	Conversion Platform Pinspotter

## RH MACH70 ROLLING HEAD AUTOMATIC PINSPOTTER

No.	Code	Description
27182	RH MACH70	Rolling Head Pinspotter

## PBF70 PINSPOTTER

No.	Code	Description
27187	PBF70	Heavy Duty Portable Pinspotter

## MF70 COMPACT PINSPOTTER

No.	Code	Description
27180	MF70	Compact Pinspotter

## CCD110N COMPACT PINSPOTTER (110V)

No.	Code	Description
27122	CCD110N	Compact Pinspotter 110V



## ADHESIVE APPLICATION MACHINES

No.	Code	Description
39171	GBA-C	Roto Bonder L-R Flow with circulating system. Approx. 750 lbs.
39250	GBA-C	Roto Bonder R-L Flow with circulating system. Approx. 750 lbs.

Flow direction is determined with operator standing at the control side facing machine.



## MANUAL INSULATION CUTTING MACHINE

No.	Code	Description
28076	LSU	Advanced Liner Sizer (285 lbs)



## AUTOMATIC INSULATION CUTTING MACHINE

No.	Code	Description
39021	PLSU2	Automatic Insulation Cutter L-R & R-L Flow. For use with 1/2" – 2" Liner.



# MACHINERY PARTS

## REPLACEMENT TIPS FOR LF, MF PINSPOTTERS

No.	Code	Description
27005	TP-2	Replacement Tip for <b>PN</b> Pins
27159	TPL-2	Replacement Tip for <b>LN</b> Pins



27005

## REPLACEMENT MAGNETIC TIP FOR MF, PBF PINSPOTTER

No.	Code	Replaces	Description
18035	NPTP9	27230	Nickel Plated Weld Tip Kit



18033

## REPLACEMENT WELDING TIPS & PLATES "NICKEL PLATED"

No.	Replaces	Description
18033	17191	Upper Weld Tip Assembly
18031	17189	Upper Tip Replacement Plates <b>5/Pk</b>
18034	17192	Lower Weld Tip Assembly
18032	17190	Lower Tip Replacement Plates <b>5/Pk</b>

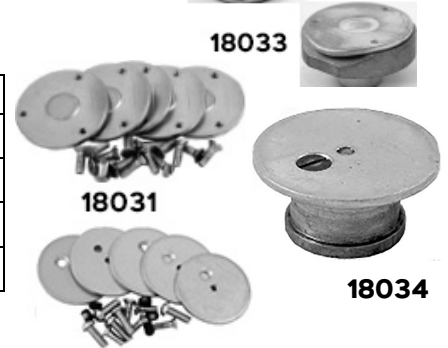

18031

18034

18032

## WELD GUNS FOR MF, PBF PINSPOTTERS

No.	Description
27275	Universal Weld Gun & 10' Cable for MF, PBF
27276	Universal Weld Gun & 16' Cable for MF, PBF
27008	PGC Ground Clamp & 5' Cable for old model PBFS



27275

**BALL TRANSFERS** – For constructing feed tables for your insulation centre

No.	Code	Description	Qty/Bx
27025	BT-100	Ball Transfer	10



## REPLACEMENT BLADE FOR PLS, LS & LSU

No.	Description
28009	Replacement Blade for PLS, LS
28080	Replacement Blade for LSU

## LS, LSU SLITTING ASSEMBLY

No.	Description
28015	LS Slitting Assembly with Blade Roller
28078	LSU Slitting Assembly with Blade Roller

## PLS SLITTING ASSEMBLY

No.	Description
39087	PLS Slitting Assembly with Blade Roller

# SCREWS, FASTENERS AND TOOLS

## Drill-X™ FOR HEAVIEST GAUGES (#8-1/4" hex head, #10 + #12-5/16" hex head)

Thousand Pack (In Plastic Screw Top Containers)				Bulk Pack			
No.	Code	Size	Qty	No.	Code	Size	Qty/Box
14100	DXT-812	8-18 x 1/2"	1M	15100	DXB-812	8-18 x 1/2"	10M
14102	DXT-834	8-18 x 3/4"	1M	15102	DXB-834	8-18 x 3/4"	10M
14103	DXT-1012	10-16 x 1/2"	1M	15103	DXB-1012	10-16 x 1/2"	8M
14105	DXT-1034	10-16 x 3/4"	1M	15105	DXB-1034	10-16 x 3/4"	5M
14106	DXT-1011	10-16 x 1"	1M	15106	DXB-1011	10-16 x 1"	5M
14107	DXT-1234	12-14 x 3/4"	1M	15107	DXB-1234	12-14 x 3/4"	5M



DXT  
DXB

Sizes may be mixed for quantity price.

## DRILL SCREW CHUCKS

No.	Code	Length Overall	Hex Socket Size	Description
16008	DCL-14	2-3/4"	1/4"	Hex Shank
16009	DCL-516	2-3/4"	5/16"	Hex Shank – for #10 & #12 Drill-X Screws



DCL-14 and DCL-516

## SUPER SABER POINT Duz-Drill SELF DRILLING SCREWS

(#8-1/4" hex head, #10- 5/16" hex head)

Thousand Pack (In Plastic Screw Top Containers)			Bulk Pack		
No.	Code and Screw Size	Qty/Box	No.	Code and Screw Size	Qty/Box
14160	ZDT 8 x 1/2	1M	15110	ZDB 8 x 1/2	14M
14161	ZDT 8 x 3/4	1M	15111	ZDB 8 x 3/4	10M
14174	ZDT 8 x 1	1M	15124	ZDB 8 x 1	7M
14175	ZDT 8 x 1-1/2	1M	15125	ZDB 8 x 1-1/2	4M
14176	*ZDT 8 x 2	1M	15126	ZDB -8 x 2	3M
14162	ZDT 10 x 1/2	1M	15112	ZDB -10 x 1/2	10M
14163	ZDT 10 x 3/4	1M	15113	ZDB 10 x 3/4	7M



ZDT  
ZDB

\*Available in Cardboard Box Only.

Sizes may be mixed for quantity price.

Note: Screws over 3/4" long require pre-drilled hole.

# PAN, SOCKET HEAD SHEET METAL SCREWS

## “SUPER SABER” POINT TOP QUALITY, ZINC CHROMATE PLATED

**Thousand Pack** – (In Plastic Screw Top Containers)

No.	Code	Qty / Box
11032	SDUT – 8 x 1/2	1M
11034	SDUT - 10 x 1/2	1M
11035	SDUT - 10 x 3/4	1M

**Bulk Pack** – (Cardboard Container)

No.	Code	Qty / Box
12043	SDUB - 8 x 1/2	14M
12045	SDUB - 10 x 1/2	10M
12046	SDUB - 10 x 3/4	7M

Orders must be in multiples of carton quantity.



SDUT  
SDUB

## DRIVER FOR SOCKET HEAD SCREWS

Packed 25 per box

No.	Code	Description
16011	DCR-2	1/4" Full Hex Shank 2" Long, Twin Head

## PAN, SOCKET HEAD “Drill-X” SCREWS

**Thousand Pack** – (In Plastic Screw Top Containers)

No.	Code	Qty / Box
14214	SDXT - 812	1M





**Bulk Pack** – Cardboard Container

No.	Code	Qty / Box
15176	SDXB - 812	10 M



SDXT  
SDXB

# PIN RIVETS

					Drill Size No.	<b>THOUSAND PACK</b>	
Rivet Head	Rivet Mat.	Pin Mat.	Rivet Dia.	Max Grip.		No.	Code
<b>STEEL RIVET • STEEL MANDREL</b>							
D	S	S	5/32	.125	20	23006	SS-52-D-T
D	S	S	5/32	.250	20	23007	SS-54-D-T
D	S	S	5/32	.375	20	23008	SS-56-D-T
D	S	S	3/16	.625	11	23111	SS-610-D-T
<b>ALUMINUM RIVET • STEEL MANDREL</b>							
D	A	S	1/8	.063	30	23029	AS-41-D-T
D	A	S	1/8	.375	30	23034	AS-46-D-T
D	A	S	1/8	.500	30	23112	AS-48-D-T
D	A	S	5/32	.125	20	23035	AS-52-D-T
D	A	S	5/32	.375	20	23038	AS-56-D-T
D	A	S	3/16	.125	11	23039	AS-62-D-T
D	A	S	3/16	.375	11	23042	AS-66-D-T
D	A	S	3/16	.500	11	23043	AS-68-D-T
D	A	S	3/16	.625	11	23044	AS-610-D-T
<b>ALUMINUM RIVET • ALUMINUM MANDREL</b>							
D	A	A	1/8	.063	30	23059	AA-41-D-T
D	A	A	1/8	.250	30	23062	AA-44-D-T
D	A	A	5/32	.125	20	23065	AA-52-D-T
D	A	A	5/32	.250	20	23067	AA-54-D-T
D	A	A	5/32	.375	20	23068	AA-56-D-T
D	A	A	3/16	.125	11	23069	AA-62-D-T
D	A	A	3/16	.250	11	23071	AA-64-D-T
D	A	A	.375	.375	11	23072	AA-66-D-T
D	A	A	3/16	.625	11	23074	AA-610-D-T
<b>COPPER RIVET • STEEL MANDREL</b>							
D	C	S	1/8	.250	30	23051	CS-44-S-T





# DRILL BITS

## SUPER-T-DRILL BITS™

Hot roll forged specially hardened High Vanadium Steel 135° Split Point; Heavier Web, packaged 10 per size.

No.	Code & Size	Diameter mm	Diameter Inch.
24001	TD-41 *	2.438	0.0960
24002	TD-7/64	2.778	0.1093
24004	TD-1/8	3.175	0.1250
24005	TD-30 *	3.264	0.1285
24006	TD-9/64	3.572	0.1405
24008	TD-20 *	4.089	0.1610
24009	TD-11/64	4.366	0.1719
24010	TD-3/16	4.762	0.1875
24012	TD-7/32	5.556	0.2187
24013	TD-1/4	6.350	0.2500
24014	TD-9/32	7.144	0.2811

\* When drilling holes for Blind Rivets, use no. 41 for 30 series, no. 30 for 40 series, no. 20 for 50 series.



## TWIN END DRILL BITS

No.	Code & Size	Diameter in mm	Diameter in inch.
24015	TED-1/8	3.175	0.1250
24016	TED-30	3.264	0.1285



# HAND TOOLS

## PIN RIVETER

No.	Code	Description	For Rivet Diameter
22110	DDPR-6	Pin Riveter	3/32", 1/8", 5/32" and 3/16"



DDPR-6

## REPLACEMENT POINTS FOR DIVIDER & TRAMMEL

No.	Code	Description
818023	DDRP1R	Replacement Points (nail type) (pairs) for DDIV-24
818008	DDRP-1	Screw-In Replacement Point (ea) for DTP-18



323W Circular Steel Gauge

## STEEL GAUGE

No.	Code	Description
818015	323W	Circular Steel Gauge

## SCRIBE, AWL AND CHISEL

No.	Code	Description
10015	SSES	Stainless Scribe
10014	3-3/8"	Plastic Handle Scratch Awl
10019	TVC	Turning Vane Setting Chisel



Stainless Scribe



TVC



Scratch Awl

## PITTSBURGH LOCK OPENING TOOL

No.	Code	Description
10069	MPOTSA	Pittsburgh Lock Opening Tool



## WOODEN MALLET

No.	Code	Description
818262	DM16	Wooden Mallet

## SHOP APRON

No.	Code	Description
20003	SA-1	Sturdy <b>black</b> fabric—waist style with pocket



# DURO DYNE TOOL LINE

## STEEL TINNER'S HAMMER

No.	Code	Description
838396	DDTH-18	18 oz. Tinner's Hammer



## HOLE CUTTER & REPLACEMENT BIT

No.	Code	Description
818269	THC-12	12" Hole Cutter
818264	THC-12RB	Replacement Bit for DDHC-12



## HEX KEY SETS

No.	Code	Description
818100	FKS9	9 pc Fold-Up Key Set
818102	BLX12	12 Piece L-Wrench Key Set



FKS9



BLX12

## METAL EDGE TURNER 3/8" and 1"

No.	Code	Description
818137	WMET-12138	12" Metal Edge Turner
818134	WMET-18138	18" Metal Edge Turner
818135	WMET-24138	24" Metal Edge Turner



## GLOVES

No.	Code	Description	Qty / Box
10063	NDG	Yellow Dipped Latex White Cotton Gloves	12
10068	YLC	Nitrile Dipped Gloves	12
10066	HCR4	Hi-Cut Resistant Black Gloves	12



KLENK

DURO DYNE TOOL LINE

# Tools for Professionals

## AVIATION SNIPS

*Often imitated – Never equalled*

### 9-1/2" MODELS

No.	Code	Description	Klenk No.	Length	Cut
820011	KJS-1	RH Model, Cuts left	MA70000	9-1/2" 24.1cm	1-1/4" 3.2cm
820021	KJS-2	LH Model, Cuts right	MA70010	9-1/2" 24.1cm	1-1/4" 3.2cm
820031	KJS-3	Straight cut	MA70020	9-1/2" 24.1cm	1-1/4" 3.2cm
820095	KBD	Bulldog Snip	MA74500	9-1/2" 24.1cm	3/4" 1.4cm

KJS-1 #820011



### 10-1/2" MODELS

No.	Code	Description	Klenk No.	Length	Cut
820070	KDC-1G	RH Model, Cuts left	MA70560	10-1/2" 26.7cm	1-1/2" 3.8cm
820080	KDC-2G	LH Model, Cuts right	MA70570	10-1/2" 26.7cm	1-1/2" 3.8cm
820090	KDC-3G	Straight cut	MA70580	10-1/2" 26.7cm	1-1/2" 3.8cm

KDC-1G #820070



## OFFSET SNIPS AND TINNER'S SHEARS

No.	Code	Description	Klenk No.
820122	KTS-7	7" Tinner's Shear	DA70010
820123	KTS-10	10" Tinner's Shear	DA70020
820120	KTS-12	12" Tinner's Shear	DA70030
820121	KTS-14	14" Tinner's Shear	DA70040
820124	KTB-16	16" Bulldog Shear	DA70050



KTS-12 #820120

## PIPE/SLOT OR DOUBLE CUT

No.	Code	Description	Klenk No.	Length	Cut
820100	KDC 5	Pipe/Slot Double Cut	MA71500	10-1/2" 26.7cm	1-1/2" 3.8cm

KDC-5 #820100



## CRIMPER

No.	Code	Description	Klenk No.	Length	Cut
820110	K-6	Crimper 5 Blade	MA71260	9-3/4" 24.8cm	1-1/4" 3.2cm

K-6 #820110



# Tools for Professionals

## REPLACEABLE BLADE SNIPS

No.	Code	Description	Klenk No.
820143	KRBK-12	Replaceable Blade Set for KRB-12	DA74510
820144	KRB-14	Klenk Replaceable Blades Snip	DA70060
820145	KRBK-14	Replaceable Blade Set for KRB-14	DA74520



KRBK-12 #820143



KRB-14 #820144

## SPECIALTY ITEMS

No.	Code	Description	Klenk No.
820117	KDS-3000	Duct Slicer	MA73010
820130	KDST	Offset Duct Stretcher	MA77530
820103	KHT	3" Tong	DA73000
820104	KHT 3G	3" Tong with Grips	MA73500
820108	KNHR	Notcher	MA77000



KDS-3000 #820117



KDST #820130



KHT #820103



KNHR #820108

## REPLACEMENT SPRINGS

No.	Code	Description
820211	RH Spring	Right Hand Spring, cuts left and straight cut for Red/Yellow Handle Snips (KJS-1, KJS-3, KJ-1, KJ-3, KDC-1S, KDC-3S, KDC-1G, KDC-3G, KBD and KDC-5).
820221	LH Spring	Left Hand Spring, cuts right for Green Handle Snips (KJS-2, KJ-2 and KDC-2G).
820331	K-6 Spring	Replacement Spring for K-6 Crimper

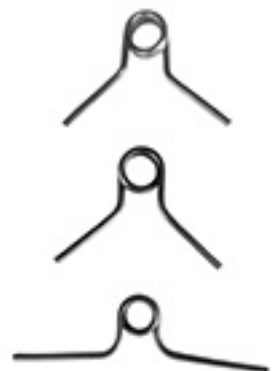

# ALUMINUM AND STAINLESS STEEL PRODUCTS

## FLEXIBLE CONNECTOR

**Stainless Steel** (series 300, .015" Thick, 3" metal, 3" fabric, 3" metal)

10232 – MFN-100XX Neoprene

10234 – MFDU-100XX Durolon

10293 – MCT-SS 4x4x4 Teflon (4" metal, 4" fabric, 4" metal)

## ALUMINUM (100 foot rolls)

10097 - MFDAL Durolon (3" metal, 3" fabric, 3" metal) with .033" aluminum edge

10098 - MFNAL Neoprene (3" metal, 3" fabric, 3" metal) with .033" aluminum edge

## REGULATORS

8272 - KR-3SS Round Dial Type Stainless Regulator Only, for 3/8" square bearings.

8328 - MSRO3812-SS Stainless Universal Regulator for 3/8" and 1/2" round or square bearings.

8301 - AL-12SS Stainless Spec-Seal Regulator for 1/2" square bearings with accessories:  
2 special rubber seals for applications up to 500°F constant temperature,  
2 stainless washers, stainless end bearing support and 2 stainless end bearings.

## VANE RAIL

4008 VR-2AL: .033" Aluminum vane rail

4007 VR-2SS: Stainless Steel vane rail (series 300, .015" thick)

## DYNA-CLAMP

7008 – 7013 Worm Drive Stainless Dyna-Clamp. Available in 7,8,10,12,15,16 & 18 inch diameters.

## INSULATION FASTENERS

### Self adhesive Flip-Stix

26056 FSA-250 Aluminum, self adhesive insulation fastener for up to 2.5" insulation.  
Extensions available for up to 5" insulation.

26057 FSS-250 Stainless Steel, self adhesive insulation fastener for up to 2.5" insulation.  
Extensions available for up to 5" insulation. (type 300)

## DAMPER HARDWARE

2049 BKP-22XX Damper blade Neva Bind Opax Hi bracket (type 300)

2047 BKP-25XX Damper blade Hi bracket with pivot and set screw for 1/4" rod  
(Bracket type 400, Pivot and Set Screw type 300)

2058 BKP-24XX Damper blade Lo bracket with pivot and set screw for 1/4" rod  
(Bracket type 400, Pivot and Set Screw type 300)

2052 BKP-13XX Damper blade bearing strap with set screw (type 400, Set Screw type 300)

2051 BKP-5XX 1/2" x 2-1/2" bearing pin (type 300)

2068 BKP-6XX 1/2" x 6" bearing pin (type 300)

2085 BKP-10XX Flanged bushing 1/2" I.D. (type 300)

2077 BKSS Stainless Steel Damper Side-Seal, (type 301) (minimizes air leakage between damper blades and frame)

7393 KP-9XL-SS 3/8" Square Stainless End Bearing Long (2-7/8") (type 300)

7394 KP-10R-SS 1/2" Round Stainless End Bearing (type 300)

7395 KP-10S-SS 1/2" Square Stainless End Bearing (type 300)

7396 KP-7L-SS 3/8" x 3.75" Spring Loc Bearing (type 300)

## PIANO HINGES (Type 300 Stainless Steel, no holes)

8325 HPX-112 1-1/2" x .037" x 3 feet

8327 HPX-612 1-1/2" x .037" x 6 feet

# **WARRANTY**

All **Duro Dyne** products are manufactured by skilled labour, operating under comprehensive quality control procedures. **Duro Dyne** warrants its products to be free of any defects in material or workmanship for a period not less than 30 days and no more than 5 years, depending upon the particular products. Specific products and their warranty are outlined below.

Expendable parts, such as welding tips, cutting blades, etc. are excluded from warranty claims.

Defective material and machinery repairs should be sent to **Duro Dyne Canada Inc.**, through a local distributor, for credit or replacement consideration.

Machinery and Materials are to be sent to:

**Duro Dyne Canada Inc. 2365 46<sup>e</sup> Avenue, Lachine, Quebec H8T 3C9**

All shipments to **Duro Dyne** are to be freight prepaid or material will be refused.

**Duro Dyne's** liability under this warranty shall be limited to replacement of defective material. Claims for any consequential damage or labour will not be allowed.

---

## **30 DAYS**

DDPR-6, DS-31 and all supply items

## **90 DAYS**

All repairs/parts replaced under warranty, LSU,  
Super Sprayfast Universal

## **ONE YEAR**

MF12A, MF70, PBF520, PBF70, CCD110N

## **TWO YEARS**

FG MACH III, FG MACH70, FPP70, RH MACH IV, RH MACH70  
GBA-C, PLSU2, FGMH

## **FIVE YEARS**

All DuroZone dampers and equipment from date of installation





**DURO DYNE CANADA ALSO CARRIES A WIDE VARIETY OF RESIDENTIAL, ALUMINUM & COMMERCIAL GRILLES, REGISTERS AND DIFFUSERS.**



**FG Floor Grille - Plastic  
Brown & Tan**



**FGDC Floor Grille-Decorative  
Antique Brass, Oil Rubbed Bronze  
& Satin Nickel.**



**FP Face Plate (Toe Kick)  
Brown or White**



**FRAG Floor Return  
Air Grille Brown or White**



**BBD15W, BBD18W  
Baseboard Diffuser**



**BBD24W, BBD48W  
Baseboard Diffuser**



**BBRA 14x6W Baseboard  
Triangle Return Air Grille**



**FBBRA Baseboard  
Flat Return Air Grille**

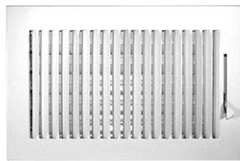

**SW1W Sidewall**



**SW2W Sidewall**

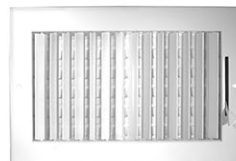

**110M Adjustable  
V/H Steel Register**



**RAG, RAG13, RAGF  
Return Air Grille**



**RCD Ceiling Diffuser**



**FG Floor Grille  
Brown or White**



**ARAG Aluminum  
Return Air Grille**



**ASWHDD Aluminum  
Sidewall, Horizontal,  
Double Deflection**



**FPR Flat Panel**



**FPA Star Panel**

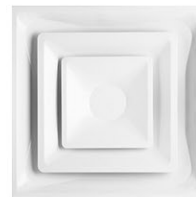

**2CDR Diffuser**



**3CDR Diffuser**

**CONTACT DURO DYNE CANADA FOR MORE DETAILS  
ABOUT OUR DYN-O-VENT PRODUCT LINE!**





# DuroZone

## Zone Control Panels, Dampers & Accessories

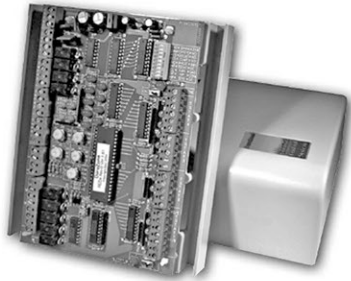

RED-4 4-Zone Panel

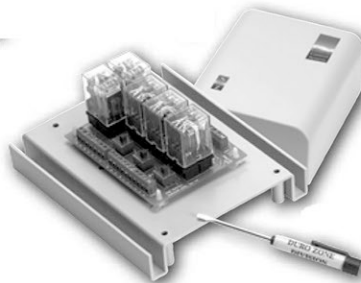

SMZ-3 Zone Panel

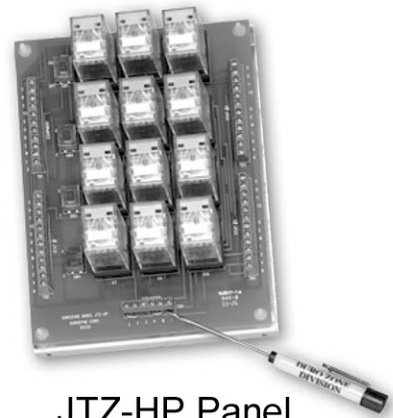

JTZ-HP Panel



RD Round Dampers



PMB Dampers



Spring Return Round Dampers



Replacement Damper Motors



Cable Operated Round and Rectangular Dampers

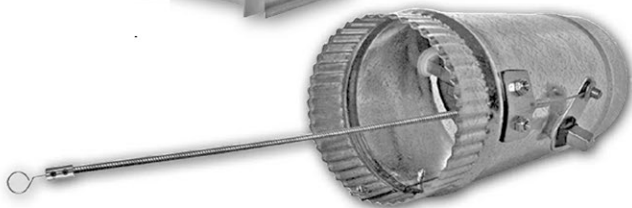

Thermostats

and other zoning accessories available at Duro Dyne Canada Inc.



DURO DYNE CANADA INC.  
2365 46e AVENUE  
LACHINE QUEBEC H8T 3C9  
TEL: (514) 422-9760  
www.durodyneCanada.com  
durodyneCanada@durodyne.com



### FASTENERS AND MACHINERY

### DYNO-MATE 4 BOLT CONNECTORS AND ACCESSORIES



### HAND TOOLS



### DUROZONE ZONE PANELS, DAMPERS AND ACCESSORIES

*Serving the Greatest Products in  
Sheet Metal Necessities Since 1952.*

