

# Glendale

PARADESTORE.COM

**NEW!** Raider and Ranger Gear

See page 52

**NEW!** AGSU Uniforms

See pages 56-57

**Big Savings on  
Swords & Sabers**

See pages 18-21

**FMAA**  
Our Flags are  
certified made in  
the USA!  
See pages  
91-95

**GSA** Contract GS-03F-048BA  
*Advantage!*

Contract 670-22  
**BuyBoard**

Contract SP47W121D0005  
**FEDMALL**

**All the Gear Your Cadet Program Needs**

**First Responders' Gear**  
is online. Look for our new  
First Responder catalog in 2025.

## Quick Index

AGSU	56-57
Arc Pins	67
Ascots	43
Belts	34-36
Berets	44
Bib Scarves • Leader Loops	43
Books	16
Cheater Bars	39
Custom Flags/Banners/Patches	90-91
DrillAmerica® Rifles	6-15
Flag Carriers	80-81
Flag Covers and Cases	83
Flag Pole Floor Stands	84-85
Flag Pole Ornaments	86-87
Flag Poles	88-89
Flags	94-99
Garment & Gear Bags	46-47
Gloves	23-25
Hat Carriers	62, 64
MarchOn® Tee Shirts	online
Medals and Drapes	70-76
Memorial	92-93
Nameplates	42
Ordering Information	78-79
Parade Helmets	45
Parade Rifles	6-12, 16
Pins: Hat • Collar • Lapel	48, 50-51, 66-67
Raider Gear	52
Ribbon Attachments	48, 53, 68
Ribbon Mounts	67-69
Ribbon Slides	48, 53, 70-71
Rifle and Pistol Accessories	14-17
ROTC & JROTC	48-55
Saber & Sword Accessories	21
Sabers & Swords	18-19
Shoe & Boot Accessories	38-39
Shoes	39-41
Shoulder Cords	26-33
Uniform Accessories	37-42
U.S. Air Force	62-64
U.S. Army	56-61
U.S. Marine Corps	65

## Made in USA with pride



Glendale proudly carries a huge selection of products made right here, stateside. We strive to source our products from manufacturers within the USA. Look for the logo identifying made in America products.

## Our Quality Pledge

Glendale fully guarantees all merchandise against defects in material and workmanship.

Glendale assumes no liability for any loss, damage, injury or expense of any kind arising out of the use or abuse of products in this catalog. This catalog may not be reproduced in whole or in part without our written consent.

© Copyright 2024 Glendale Parade Store, LLC..

Cover Photo: AJROTC 5th Brigade 2024 Raider Challenge, San Antonio, TX



# 2024 Championship Memories



## Meet Glendale's CEO, Jose Barreto

Welcome to the fall, 2024 Glendale catalog. My name is Jose Barreto and I am the new owner of this exceptional company. I am a 17 year (and counting) member of the Armed Forces who, like many of you, began purchasing products from Glendale as a young recruit.

When the opportunity to purchase Glendale came along, I was thrilled. There are not too many companies that have been around for nearly one hundred years anymore, and certainly none with the proud military affiliation of Glendale.

### But who will carry the flag forward?

In a world where the significance of national symbols seems to be fading and recruitment faces unprecedented challenges, Glendale Parade Store and our sister company, The Drill Dojo, are committed to restoring pride in America's military and first responder symbols.

### New Products

Our team is focused on providing best-in-class products for JROTC, ROTC, first responders, and military color guards. We are constantly evaluating and adding new items to meet your needs and expectations. We are creating separate catalogs for ROTC/JROTC, First Responders and Military. As always, you'll find our full assortment at Glendale.com.

### Free Training

Glendale offers the largest free drill program in the world through our sister company, The Drill Dojo. This innovative one-on-one online program inspires personal growth and helps instill a sense of tradition, legacy, and valor in today's youth. (See p. 5)

### Unrivaled Support

Have product questions or suggestions? The Glendale team has your back. Placing a large order? We're ready to help. We'll even send an expert to measure your team for uniforms where you practice and/or create money saving product bundles.

We also attend hundreds of events every year. If you see us at one of yours, please stop by and introduce yourself.

Thank you for being a Glendale customer.

Sincerely,  

Jose Alejandro Barreto Martinez  
Owner, Glendale Parade Store and The Drill Dojo



# Here's What's New!

### Two New Swords! See pages 18 - 22.



There's lots going on at Glendale—a new CEO, a new service team, a new website, dozens of new products and new catalogs that are tailored to you and your needs—all designed to improve our service and your experience. We're excited about the changes and hope you are, too. Please let us know how we're doing. We'd love to hear from you.



### JROTC Wallets **GLENDALE EXCLUSIVE**

A useful gift and a treasured memory in one. See page 41.



### Raider Gear

Glendale is proud to introduce a new line of gear designed for the rigors of Raider training. See page 52.



### Thoughtful Gifts

Glendale makes it easier than ever to celebrate life's milestones with gifts drillers will love. From Swords to Graduation Stoles, to cufflinks, you'll find just what you're looking for on page 77.



### Rocky® Lightweight Commercial Military Boots

The comfort of an athletic shoe meets the performance of a tactical boot. See page 40.



### AGSU Uniforms

Better fabrics, better fit. See page 56-57.

# The Drill Dojo Story

In 2009, young Adam Jeup competed in the World Drill Championships for the first time. There, he joined a community that was invested in sharing their collective knowledge and growing the art of rifle exhibition drill. Motivated by their message, Adam began cataloging tricks through an online training resource he created called Independent Drill. Less than one year later, the military drill world had a new standard in online education.

But as the channel grew, so too did Adam's skills. This led to the release of more advanced tricks on his website. But he realized that while posting videos was an ideal way to showcase technique, it wasn't effective at all for providing feedback. The advanced nature of these moves created a gap where many drillers attempted tricks outside their skillset, highlighting the need for a more comprehensive drill training program.

To address this, Adam enlisted fellow champion drillers Justin Delaurier, Justin Ghan, Andres Ryan, and Neriah Guerin to reimagine program's platform. The new project created a curriculum that helped guide drillers from their first spin all the way to septuple aerials. It soon became known as the Drill Dojo.

Drill Dojo qualified the first drillers in September, 2020. Over the years, the Drill Dojo has certified thousands of military members, veterans, JROTC instructors, first responders, cadets, academy students, service team members, honor guard members, and civilians alike. It has become an integral part of JROTC's exhibition drill phase and a core training component of world champion drillers. In short, there is no finer place to learn exhibition drill anywhere in the world.



## The World's Best Rifle Exhibition Drill Training Tool is Free!

Are you worried about trying dangerous tricks way outside of your skillset? Not sure when it's time to move on to the next level? Want to be sure you're doing a trick right? The Drill Dojo has your back!

The Drill Dojo, the world's best rifle exhibition drill training tool, gives you immediate online access to over a hundred training materials and our custom martial arts style training curriculum. To participate in the program, just learn the tricks in our online videos, film yourself performing them, and submit your video. Our team of World Champion drillers will review your certification videos and check for details like rifle control, body precision, and hand pins. Each month, you'll get detailed feedback on a livestream that will help you grow as a driller and stay safe as your progress.

After you've earned your certification, you can celebrate by purchasing one of our new certified slings (shown on page 4). Invented by us, these Velcro-adhesive slings have been optimized for exhibition drill with a limited-metal design that will reduce injuries to your hands. They are a great way to show off your accomplishments to the world.

There are no sign ups, no expenses, and no hassles. And it's free to use! Just visit [www.drilldojo.com](http://www.drilldojo.com) to get started.



# Come to Drill Dojo for:

## 1. Unrivaled online content

View dozens of videos detailing the best drill skills and techniques

## 2. Critiques of your drill routine

Upload videos of your drill and have them reviewed and critiqued by world class instructors

## 3. Drill Dojo Certification

As your skill improves, The Drill Dojo helps you mark your achievements

Take your drill routine to the next level. Just visit [www.drilldojo.com](http://www.drilldojo.com) or use the QR code below.

## Meet Your Instructor

World Drill Champion and National High School Drill Team Championship winning coach Adam Jeup is the founder of the Drill Dojo. He'll be your personal guide through the Dojo's curriculum. When you upload a video of your drill routine, Adam provides actionable, training tips that will help you reach new levels of rifle exhibition drill and achieve certification in each.



Adam Jeup Drill Dojo Founder



Use this QR code to visit the Drill Dojo and get started on your journey to drill excellence!

To get expert feedback on your drilling, upload your video to [www.DrillDojo.com](http://www.DrillDojo.com).



## Drill Dojo Slings

Available with, and without, Drill Dojo certification.



### Drill Dojo Velcro Slings **NEW!**

We worked with Drill Dojo to create a sling with Velcro® hook and loop fasteners that secure the sling to the rifle, yet help prevent injuries during Exhibition. Each sling also includes optional metal hardware. Available in 14 colors. Drill Dojo certification is required for slings with the Drill Dojo Emblem, see below.

#DJ200

\$15.00 each

## At Drill Dojo Certification is earned!

The Drill Dojo drill training method marks each level of achievement with a different color (similar to karate and other disciplines that require agility, skill, and commitment). As you progress through the ranks, you can purchase a special Drill Dojo branded sling that is only available to drillers who have been certified. Earning a Drill Dojo sling acknowledges that you have the dedication and desire to achieve excellence for yourself and for your drill team.



# DrillAmerica® 1903 Springfield Replica Rifle

## Beauty, balance, and authentic tone.

With the look, the feel and even the sound of the revered 1903 Springfield rifle, this highly detailed replica will take your drill team, honor guard or color guard to the next level. Known for both its beauty and balance, the 1903 Springfield is the functional equivalent of the drill rifles issued to each service, but with better balance, durability, and quality! Our DrillAmerica® 1903 Springfield is 43.3" long, weighs in at 8.5-8.6 lbs., and is made of the same tough, scratch-resistant high-impact resin as our DrillAmerica® M1 Garand.

### What sets our DrillAmerica® 1903 Springfield Replica Rifle apart:

- Better balance: Bolt and 24" barrel are one continuous piece, distributing weight across the rifle for exceptional balance.
- Exceptional sound: The multi-component rifle has a bit of a tone when you slap or spin it and just enough give when you catch it. You'll appreciate its moving bolt for Inspection Arms.
- Superior durability: We went back to the 1903 original to capture the untouchable strength and toughness of its rear end swivel.
- More authentic look: The beautifully detailed appearance, the serialized bolt, and the black metal parts (also available in chrome) mirror the look of the 1903 original.
- Additional options: Vulcanized butt plate and sling sold separately (accepts any Glendale sling except the MK1 Parade Rifle Strap)

Introduce your team to the 1903 Springfield today and experience for yourself its precise center balance and outstanding sound.

### DrillAmerica® 1903 Springfield Replica Rifle

#### Wood Grain Rifle Stock

DrillAmerica® 1903 Springfield Replica Rifle black metal	#DA1903	<b>\$279.95</b> each
DrillAmerica® 1903 Springfield Replica Rifle chrome metal	#DA1903C	<b>\$324.95</b> each

#### Black Rifle Stock

DrillAmerica® 1903 Springfield Replica Rifle black metal	#DA1903BK	<b>\$274.95</b> each
DrillAmerica® 1903 Springfield Replica Rifle chrome metal	#DA1903BKC	<b>\$319.95</b> each
NGA 1903 Springfield Replica Rifle gold metal	#NGA1903BKGO	<b>\$319.95</b> each

#### White Rifle Stock

DrillAmerica® 1903 Springfield Replica Rifle chrome metal	#DA1903WHC	<b>\$324.95</b> each
---	------------	----------------------

### DrillAmerica® 1903 Springfield Butt Plate

To protect floors during indoor drills, replace the existing plate of your DA1903 with this metal plate covered with 1 cm of molded rubber.

Black Butt Plate	#DAS25	<b>\$14.95</b> each
------------------	--------	---------------------

### Brown Touch-up Marker

Cover up minor dings to keep your wood grain rifle looking presentable.

Touch-up Marker	#9130	<b>\$2.95</b> each
-----------------	-------	--------------------

**Need parts?  
See page 15**



2024 JROTC Nationals - Blackhawks team



*Moving bolt*

*Classic rear end swivel is strong and built to last*

### Engrave Your Bolt and Trigger Guard **NEW!**

We can now engrave the Bolt or Trigger Guard Plate on your DA1903 rifles to show your team spirit, your school name, unit name, or even to recognize an instructor or donor! Up to 25 Characters upper case and lower case. Please add 5 days for delivery.

Engrave the Bolt	#ENG-BOLT	<b>\$15.00</b> each
Engrave the Trigger Guard	#ENG-TRIG	<b>\$15.00</b> each
Engrave Bolt and Trigger Guard	#ENG1903	<b>\$25.00</b> each



# DrillAmerica® Makes the Best Drill Rifles You Can Buy!



DrillAmerica 1903  
Springfield Rifle®  
Black with Black Metal  
#DA1903BK

*Authentic tone*

*High-impact resin*

*8.6 pounds*

**5 MODELS!**

Wood Grain  
with Chrome  
Metal  
#DA1903C

Wood Grain  
with Black  
Metal  
#DA1903

Black with  
Chrome Metal  
#DA1903BKC

White with Chrome  
Metal  
#DA1903WHC

Black with Black  
Metal  
#DA1903BK

**NEW!**

Black with Gold Metal  
#NGA1903BKGO

*This NGA 1903  
model is reinforced  
to stand up to  
mastering even the  
most complicated  
moves.*

# DrillAmerica® M1 Garand Replica Rifle

## Exceptional balance and quality

The overwhelming choice of drill teams, honor guards and color guards. The M1 Garand features a solid barrel which provides balance and durability. The front and rear swivels are reinforced and more durable than ordinary drill rifles so the M1 Garands can take anything you throw, (or spin) at them. Weighs 9 lbs. Features include a moving bolt to enable Inspection Arms, a trigger that "clicks" for effect, a reversible black rubber butt pad and a metal butt plate. Made of high-impact plastic with a wood-grain appearance, exterior chromed metal parts and a solid barrel. Approved for all JROTC competitions as a demilitarized weapon. Does not have bayonet lug. Length 43". Accepts any Glendale web or leather sling (not included).

All bolts can be engraved on one line, 24 characters maximum. We present the DrillAmerica® M1 Garand with pride. Use it wisely and well!

## DrillAmerica® M1 Garand Rifle

Rifle with Moving Bolt	#M1000	\$199.95 each
Rifle engraved Moving Bolt	#M1000E	\$214.95 each

**FREE shipping on orders over \$600**

*“This rifle continues to amaze me. I would not let my cadets use any other rifle except this one.”*

*CSM Randall Woods, Smith Cotton HS*

### It's Your Rifle, Put Your Name On It!

It's easy to make your rifle stand out from the crowd. The bolt of the M1 Garand can be engraved with up to 25 letters for just \$15. Please add 5 days for delivery.



*Includes moving bolt*

*Each rifle has a reversible black butt pad and a metal butt plate*

*Trigger that "clicks" for effect*

*Reinforced Swivels*

**Our best selling Heavy Web Rifle Slings are sold on page 13**





# Exceptional in Every Respect

*First regulation weight,  
center balanced, drill rifle in  
the United States*

*Solid Barrel*

DrillAmerica Rifle®  
#M1000

*High-impact plastic  
with a wood-grain  
appearance*

*9 pounds*

Rifle Stock only #1000S

Moving Bolt #1000MB

Safety Bolt #1000SB



Kirkwood Highschool, Clarksville, TN

## DrillAmerica® M1 Garand Rifle Stock

Suitable for practice drill or as a replacement stock for previous model #1000 (screw holes included). Measures 36". Weight 8.5 lbs.

Rifle Stock #1000S **\$74.95** each

## DrillAmerica® M1 Garand Rifle Accessories:

Bolts can be engraved, 24 characters maximum.

Submit customized engraving in writing.

## DrillAmerica® M1 Garand Moving Bolt

Moving Bolt #1000MB **\$40.95** each

Moving Bolt with engraving #1000MBE **\$55.95** each

## DrillAmerica® M1 Garand Safety Bolt without Handle

Completely interchangeable with Moving Bolt.

Safety Bolt #1000SB **\$31.95** each

Safety Bolt with engraving #1000SBE **\$46.95** each

## Brown Touch-up Marker

Cover up minor dings to keep your rifle looking presentable.

Touch-up Marker #9130 **\$2.95** each

**Replacement parts for the DrillAmerica® Rifle are available online at [www.paradestore.com](http://www.paradestore.com)**

## Please Note:

### Rifles are NOT RETURNABLE.

Before ordering a quantity of rifles, we suggest ordering a single piece for your examination to be certain it meets your requirements.

### Rifles Cannot Be Guaranteed Against Breakage.

You will spin them, throw them, pound them and drop them. Our DrillAmerica® Rifles are built really tough, and while we can't guarantee you won't break them, it won't be easy.



“My cadets love their MK1 rifles more than any we’ve used in the past. From their durability and showmanship, they are the perfect style and weight for my cadets.”

Miriam Gaytan, Instructor,  
TC Marsh Middle School LCC

*Solid front band*

Black MK1  
#MK1BK

## DrillAmerica® MK1 Replica Rifle

**DrillAmerica® makes the best drill rifle you can buy. Period!**

When you’re competing, you need enough mass to spin and enough sass to win. The MK1 rifle is weightier, sturdier, and, frankly, classier than other Mark 1’s—and easy on the wallet! Molded from high-impact resin for greater durability, the MK1 uses chrome-plated, non-moving parts and borrows its sturdy, durable metal front band and hardware from our most expensive rifles. 39” Long and roughly 4.3 pounds, which makes it a superior drill rifle for spinning. Can be fitted with any of our leather or cotton web slings.

### DrillAmerica® MK1 Replica Rifle

Black Rifle	#MK1BK	\$87.95 each
Brown Rifle	#MK1BW	\$87.95 each
White Rifle	#MK1WH	\$87.95 each
White Practice Stock	#1001S	\$38.95 each

**FREE shipping on orders over \$600**

*Cast metal front band and hardware*

*4.3 pounds—  
lightweight and sturdy*

*Non-moving plastic bolt and trigger*

Brown MK1  
#MK1BW

White MK1  
#MK1WH

White Practice Stock  
#1001S

### MK1 Parade Rifle Strap

Designed for show, this Parade Rifle Strap is a shorter version of our Leather Rifle Slings (page 13).

Can be used as a replacement strap for MK1 and MK1 Masters Level replica rifles only.

Black leather	#1008BK	\$24.95 each
White leather	#1008WH	\$24.95 each



**Scan this QR code with your phone or mobile device to shop, and see this rifle in action, or visit <https://glendale.com/drillamerica-mk1-replica-rifle/>.**  
(Despite concerted effort, no rifles were harmed making this video.)



# DrillAmerica® MK1 and Masters Level MK1 Replica Rifles

## MK1 Masters Level Replica Rifle

MK1 Masters Level Replica Rifle

An emerging legend in precision performance

"Back in the day", explained Michael M. Anderson, 1SG, USA (Ret.) and leader of the perennial champion Heights High School "Rough Riders" from Houston, Texas, "the Mark 1 Drill Rifle we had been using suffered from a number of deficiencies. They were underweighted, fragile and the quality was inconsistent. Our drill team went through stacks of them every year. That all changed when we met Joe Rivas from the Glendale Parade Store."

1SG Anderson told Joe that the MK1 needed some upgrades to earn the loyalty of people who spin heavy weapons. Joe listened and went to work with a respected drill rifle manufacturer. Here's what they did.

### Heavier, more durable construction -

The MK1 Masters Level weighs 5.5 lbs. (a full pound heavier than our standard MK1). The stock is made from high impact resin to add weight and be nearly indestructible.

**Full heavyweight barrel -** The addition of a full-length metal barrel adds heft and improves the rifle's balance, so it makes spinning effortless.

The result? "We were so impressed with these rifles that we entered competitions using the prototypes that Joe sent us. The fact that we did says all you need to know about how great these rifles are. I placed an order for our whole team as soon as they were available."

*Non-functioning  
all metal bolt  
assembly*

*Solid front  
band*

Black MK1  
#MAS1BK

*Solid steel  
hardware*

*5.5 pounds, with  
more heft and better  
balance*

Brown MK1  
#MAS1BW

White MK1  
#MAS1WH

## DrillAmerica® Masters Level MK1 Replica Rifle

### DrillAmerica® MK1 Masters Level Replica Rifle

Spin circles around the competition! Our Masters Level MK1 was designed to meet the needs of championship drillers. A solid longer barrel, metal receiver, and bolt assembly add a pound of heft that makes the balance exceptional and spinning effortless. You'll feel the difference the first time you put it through its paces. Accepts any of our leather or cotton web slings. 5.5 lbs, 41". Colors: Black. Brown. White.

### DrillAmerica® MK1 Replica Rifle

Black MK1 Masters	#MAS1BK	\$106.95 each
Brown MK1 Masters	#MAS1BW	\$106.95 each
White MK1 Masters	#MAS1WH	\$106.95 each

**FREE shipping on orders over \$600**

# Full Size, Half the Weight 100% DrillAmerica®!

## Building a Reliable Parade Rifle, One Test at a Time

Drill America® is more than a name, it is your guarantee that each rifle is the best you can buy. When we developed the Drill America DA30 Parade Rifle we made sure that it would deliver the consistency of weight and appearance that alternative arms drillers need to train effectively. Our high-impact resin parade rifle passed all of our quality tests—but we knew who the real experts were. We sent our rifles out to schools to be field-tested by numerous drill teams. Reports from the field helped us make a good rifle even better. Drillers told us to eliminate the front-stacking swivel and lower the screw-head profile to reduce risk of cuts. They asked us to improve the stiffness of the bolt spring so it wears better. Our testers told us what they wanted. We listened. And together we created a reliable drill-tested rifle perfect for practice and parades.

4.2 pounds—  
our lightest rifle

DrillAmerica DA30  
Parade Rifle®  
#DA30BK

Durable  
Resin Stock

**\$56.95**  
includes Sling!

Includes web  
rifle sling

Includes  
moving bolt

Trigger that  
“clicks” for effect

Rubber  
Butt Plate

Sturdy  
rear end  
swivel

### Please Note:

**Rifles are NOT RETURNABLE.** Before ordering a quantity of rifles, we suggest ordering a single piece for your examination to be certain it meets your requirements. **Rifles Cannot Be Guaranteed Against Breakage.** You will spin them, throw them, pound them and drop them. Our DrillAmerica Rifles are built really tough, and while we can't guarantee you won't break them, it won't be easy.

### Drill America® DA30 Parade Rifle

Just a few ounces either way can change the feel and performance of a drill rifle, something drillers quickly learn as they train. Wooden parade rifles can vary in weight by almost half a pound. The Drill America® Parade Rifle, a replica of the 1903 Springfield, lets drillers train with a full-size (42") high impact resin rifle that, at 4.2 lbs., is exactly half the weight of our other Drill America® rifles. Great for parade use and Alternative Arms Drillers. Built to last, these rifles won't fade, crack or discolor over time. Field-tested by school teams, who helped us make this parade rifle a winner. With nickel-plated barrel and bolt, rubber butt plate, operating bolt action and clicking trigger. Includes a black nylon web rifle sling with nickel hardware. No bayonet lug.

- DrillAmerica® DA30 Parade Rifle, black #DA30BK \$56.95 each
- DrillAmerica® DA30 Parade Rifle, white #DA30WH \$56.95 each
- DrillAmerica® DA30 Parade Rifle, brown #DA30BW \$56.95 each



Includes a black nylon web rifle sling!



The Drill Dojo's martial-arts style training program offers free, one-on-one training feedback for drill enthusiasts of all levels. Led by drill champion Adam Jeup, it's an invaluable free resource for mastering and refining skills. To learn more, see pages page 4-5.

### Drill Dojo Velcro Slings **NEW!**

We worked with Drill Dojo to create a sling with Velcro® hook and loop fasteners that secure the sling to the rifle, yet help prevent injuries during Exhibition. Each sling also includes optional metal hardware. Available in 14 colors. Drill Dojo certification is required to purchase slings with the Drill Dojo logo. See below.

#DJ200 **\$15.00** each



### At Drill Dojo Certification is earned!

The Drill Dojo drill training method marks each level of achievement with a different color (similar to karate and other disciplines that require agility, skill, and commitment). As you progress through the ranks, you can purchase a special Drill Dojo branded sling that is only available to drillers who have been certified. Earning a Drill Dojo sling acknowledges that you have the dedication and desire to achieve excellence for yourself and for your drill team.



**CUSTOMER FAVORITE!**

### Heavy Web Rifle Slings

Traditional 1¼" wide double hook adjustable slings that fit all Glendale rifles, as well as rifles with a swivel opening of 1¼" or larger. Sling is 44" long.

#### White

Brass hardware #200AB **\$12.50** each  
 Nickel hardware #200AN **\$12.50** each

#### AF Blue

Brass hardware #200CB **\$12.50** each  
 Nickel hardware #200CN **\$12.50** each

#### Black

Brass hardware #200BB **\$12.50** each  
 Nickel hardware #200BN **\$12.50** each

#### Olive Drab

Brass hardware #200DB **\$12.50** each  
 Nickel hardware #200DN **\$12.50** each



### Leather Rifle Slings

Made from premium quality top grain leather with rich finishes that endure. Double hook, used on U.S. military rifles, is adjustable. Fits all Glendale rifles and all rifles with a swivel opening of 1¼" or larger. Available in four colors including high-gloss black Clarino, 1¼".



#### White

Brass hardware #201B **\$54.95** each  
 Nickel hardware #201N **\$54.95** each

#### Brown

Brass hardware #203B **\$54.95** each  
 Nickel hardware #203N **\$54.95** each

#### Black

Brass hardware #202B **\$44.95** each  
 Nickel hardware #202N **\$44.95** each

#### Black Clarino (high gloss)

Brass hardware #202CB **\$61.95** each  
 Nickel hardware #202CN **\$61.95** each

Universal Rifle Sling #206



### Universal Rifle Sling

Our most affordable sling. Made of durable 1" Polypro webbing with adjustable buckles. Fits all Glendale rifles. Color: Black.

Universal Rifle Sling #206 **\$8.50** each

# Conversion Kits for NGA Stocks

## New Guard America High Impact Drill Stock for Demilitarized 1903A3 & 1903 Rifles

Glendale Parade Store is proud to introduce the NGA High Impact Drill Stock, designed to take a beating and keep on drilling. Created in partnership with New Guard America, this stock provides a replacement for demilitarized U.S. Models 1903A3 and 1903. Its super-high-impact resin can withstand even the most drop-prone drillers, making it the perfect stock for the up-and-coming competitor.

Note: This is a stock only, not a complete rifle.

### Black

Hand Guard #NGA12BK **\$24.95** each  
Base Stock #NGA1BK **\$99.95** each

### Brown

Hand Guard #NGA12BW **\$24.95** each  
Base Stock #NGA1BW **\$99.95** each

### White

Hand Guard #NGA12WH **\$24.95** each  
Base Stock #NGA1WH **\$99.95** each

## Parts Kits for NGA stocks

### Large Parts Kit for NGA

Everything you need to turn your NGA High Impact stock into a competition ready chrome metal drill rifle. Includes all parts shown, plus weight kit and instructions. Stock and hand guard sold separately.

### Gold **NEW!**

#NGALGKITGO Complete Conversion Kit **\$219.95** each

### Chrome

#NGALGKIT Complete Conversion Kit **\$219.95** each

### Black

#NGALGKITBK Complete Conversion Kit **\$189.95** each

### Small Parts Kit for NGA

Now you can retrofit your existing barrel assembly and receiver into an NGA stock. Our kit includes butt plate, trigger guard plate, bolts and screws to fit your NGA stock. Stock and hand guard sold separately.

### Chrome

#NGASMKIT Small NGA Kit **\$79.95** each

### Black

#NGASMKITBK Small NGA Kit **\$59.95** each

### NGA Rubber Butt Plate

To protect floors during indoor drills, replace the existing plate of your NGA rifle with this metal plate covered with 1 cm of molded rubber.

Black Butt Plate #NGA25 **\$13.95** each

### Weight Pack

Adds an extra half pound of weight to an NGA stock to meet the 8.5 lb. regulation weight required for competition. Can be placed behind trigger plate, at rear of stock or toward barrel end to create a perfectly balanced rifle.

#NGAWT Weights Only **\$12.95** each



New Guard America High Impact Hand Guard #NGA12BK

New Guard America High Impact Base Stock #NGA1BK

Connector Front Pin

Spring

Barrel

Bolt Assembly

Trigger Guard Plate and screws

White #NGA1WH

Brown #NGA1BW

Rear Swivel Plate  
Rear Swivel Screws

Front Band with Bayonet Lug  
Pin

Stacking Swivel Band

Mid Band and Swivel

- Large Parts Kit for NGA**  
Includes Small Kit parts plus:  
Barrel  
Connector Front Pin  
Spring  
Front Band with Bayonet Lug  
Front Band Pin  
Receiver Ring  
Connector/Receiver  
Bolt Assembly  
Bolt Stop Screw  
NGA Weight Pack

- Small Parts Kit for NGA**  
Butt Plate  
Butt Plate Screw (2 sizes)  
Trigger Guard Plate  
Trigger Guard Plate Front Screw  
Trigger Guard Plate Rear Screw  
Mid Swivel  
Mid Swivel Band  
Stacking Swivel Band  
Band Screws (2)  
Rear Swivel Plate  
Rear Swivel Screws (2)

Scan this QR code with your phone or mobile device to shop or see how easy it is to replace a 1903A3 stock. Shop online at <https://glendale.com/chrome-parts-kit-for-nga-stock-large/>



# Parts for the DrillAmerica® 1903 Springfield Replica Rifle

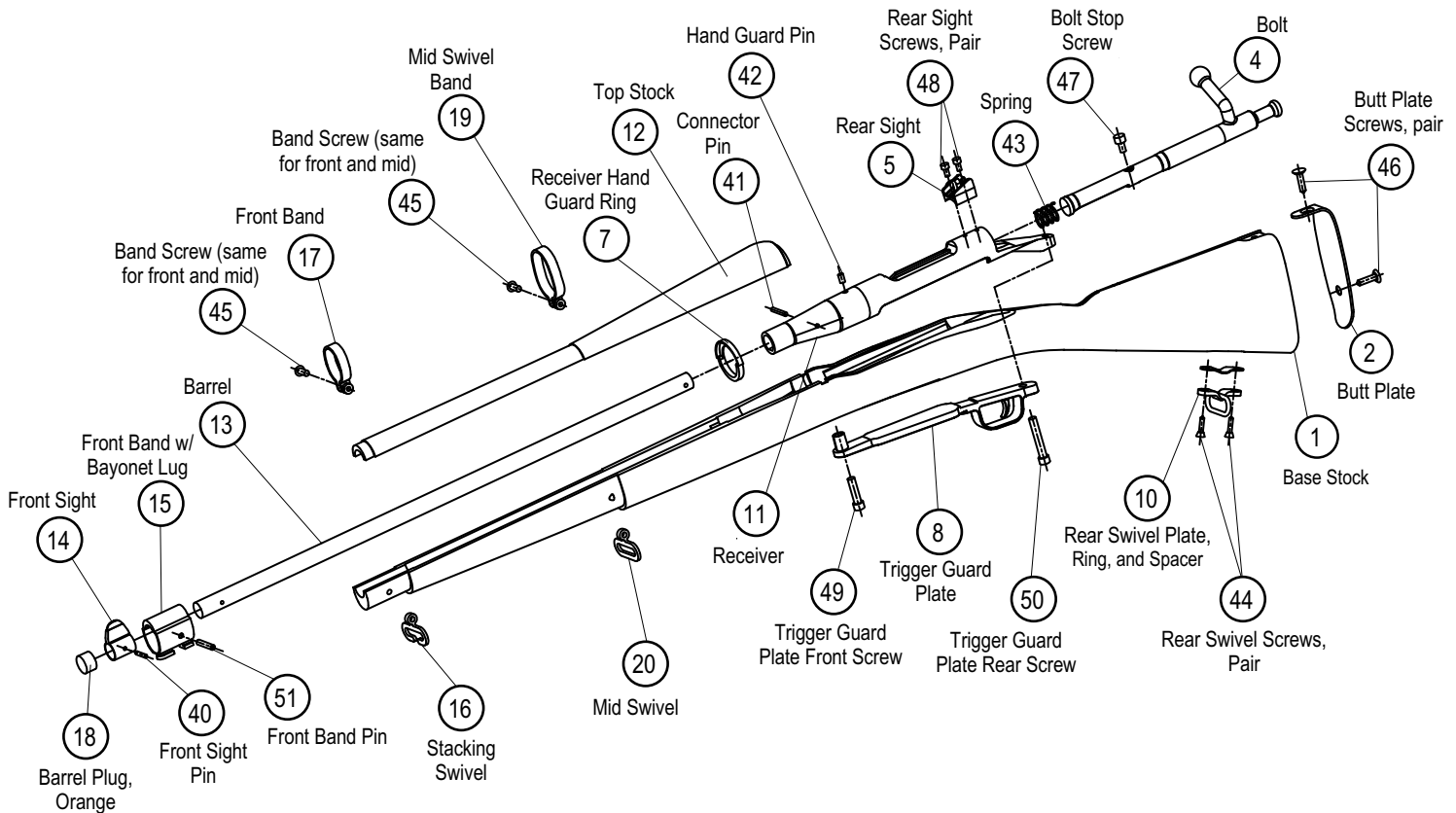

**It's Your Rifle, Put Your Name On It!**

It's easy to make your rifle stand out from the crowd. The bolt and Trigger Guard Plate of the DA1903 can each be engraved with up to 25 letters for \$15 each or \$25 for both. Please add 5 days for delivery.

DA1903 Parts							
No.	Description	Chrome		Black		Stock and Misc.	
		SKU	Price	SKU	Price	SKU	Price
2	DA1903 Butt Plate	DASC2	\$13.75	DAS2	\$9.25		
4	DA1903 Bolt Assembly	DASC4	\$36.75	DAS4	\$27.50		
5	DA1903 Rear Sight	DASC5	\$8.50	DAS5	\$6.75		
8	DA1903 Trigger Guard Plate	DASC8	\$30.95	DAS8	\$23.75		
10	DA1903 Rear Swivel Plate, Ring and Spacer	DASC10A	\$9.95	DAS10A	\$8.50		
11,42,7	DA1903 Receiver, Handguard Pin and Ring	DASC311A	\$74.25	DAS311A	\$63.75		
13	DA1903 Barrel	DASC13	\$33.95	DAS13	\$25.25		
14	DA1903 Front Sight	DASC14	\$8.50	DAS14	\$6.75		
15	DA1903 Front Band W/ Bayonet Lug	DASC15	\$9.95	DAS15	\$7.75		
16	DA1903 Stacking Swivel Ring	DASC16	\$7.25	DAS16	\$5.25		
17	DA1903 Front Swivel Band	DASC17	\$7.25	DAS17	\$5.75		
19	DA1903 Mid Swivel Band	DASC19	\$7.25	DAS19	\$5.25		
20	DA1903 Mid Swivel	DASC20	\$7.25	DAS20	\$5.25		
40	DA1903 Front Sight Pin	DASC40	\$1.10	DAS40	\$0.70		
44	DA1903 Rear Swivel Screws, Pair	DASC44	\$1.90	DAS44	\$1.40		
45	DA1903 Band Screw	DASC45	\$0.95	DAS45	\$0.70		
46	DA1903 Butt Plate Screws, Pair	DASC46	\$1.90	DAS46	\$1.40		
47	DA1903 5mm Bolt Stop Screw	DASC47	\$2.25	DAS47	\$1.40		
48	DA1903 Rear Sight Screw, Pair	DASC48	\$1.50	DAS48	\$0.95		
49	DA1903 Trigger Guard Plate Front Screw,	DASC49	\$2.25	DAS49	\$1.70		
50	DA1903 5mm Trigger Guard Rear Screw,	DASC50	\$2.25	DAS50	\$1.70		
1	DA1903 Base Stock Wood Grain, Black (BK) White (WH)					DAS1	\$49.75
12	DA1903 Top Stock Wood Grain, Black (BK) White (WH)					DAS12	\$13.75
18	DA1903 Barrel Cover, Orange					DAS18	\$0.70
	DA1903 Rubber Coated Butt Plate					DAS25	\$14.95
41	DA1903 Connector Front Pin					DAS41	\$0.70
43	DA1903 Bolt Spring					DAS43	\$3.50
44	DA1903 Rear Swivel Screws, Pr					DAS44	\$1.40
51	DA1903 Front Band Pin					DAS51	\$1.40



Wood grain rifle #M30

**Wood Replica Springfield Parade Rifles**

This detailed version of the 1903 Springfield rifle is designed for parade use only. Made from lightweight wood with nickel-plated barrel and bolt (with operating bolt action and clicking trigger), rubber butt plate and stacking swivel. No bayonet lug. Weights may vary slightly.

Wood grain rifle with adjustable OD web sling. 42" L. 2.3 lbs. #M30 **\$59.95** each  
 Butt Pad 4" H; 1" thick slip-on rubber pad protects floors. #31 **\$9.75** each



For Replica Springfield Parade Rifles #31



For M14 and Springfield #38

**Rifle Butt Pads**

This 6 oz. slip-on rubber butt pad will unbalance a rifle, but protect floors during training sessions. A great value! For all MK1, MAS1, DA30, and M30 models. For DA1903 models, use DAS25 rubble butt plate. page 15

For Replica Springfield Parade Rifles M30 and WH30. 4" H; 1" thick. #31 **\$9.75** each  
 For M14 and Springfield Drill rifles. 2 1/2" - 3 3/4" #38 **\$36.95** each

**TSA Rifle Case Locks *NEW!***

These tough locks exceed TSA standards to provide extra security whenever you travel. Automatically relocks in the event of TSA inspection. Easy-set combination. Made of rugged zinc alloy and backed by an unconditional lifetime guarantee. Small Works great with carry on and other standard zipper bags. Large has a longer shackle for use with hard sided luggage and cases.

- #1719 Small **\$7.50** each
- #1720 Small set of 3 **\$22.00** set
- #1767 Large. **14.95** each
- #1768 Large. set of 3 **35.95** set



Small TSA lock #1719

**GET 10% OFF** when you buy a Rifle, Case and three locks!



Large TSA Lock #1767

**Drill Anywhere**



**DrillAmerica® 9-Pound Weighted Training Rod**

Train anywhere anytime with our 9 pound training bar. Weighted like your DA1903, it's an excellent choice for team or individual practice drills. Great for practicing in places where rifles would not be appropriate. Covered in a foam sleeve with molded plastic end caps for added safety.

9 lb. Training Rod #DRILLBAR8 **39.95** each\*

\*Add \$7 additional shipping if shipped to the lower continental US. Outside the continental US, higher surcharges apply. See page 77 for more information.

**Please Note:**

**Rifles are NOT RETURNABLE.**

Before ordering a quantity of rifles, we suggest ordering a single piece for your examination to be certain it meets your requirements.

**Rifles Cannot Be Guaranteed Against Breakage.**

You will spin them, throw them, pound them and drop them. Wooden rifles are prone to breakage. For a more durable option consider our DrillAmerica Rifles. They are built really tough, and while we can't guarantee you won't break them, it won't be easy.



**Magnetic 22 Gun Rotary Gun Rack**



Keep drill rifles tidy and easy to reach. This magnetic gun rack rotates around a 30" pedestal, and securely holds up to 22 rifles in only 30" of floor space. Reduces unnecessary damage and teaches respect for the rifles. Turn any corner into a showcase.

Magnetic gun rack #GUNRACK-22 **\$574.95** each\*  
 (\*\$25 additional shipping. See page 77 for complete shipping information.)

*"Nice speedy delivery. Keep up the good work!"*  
 S. Terry, TN

**Books**

*More Books, DVD's and Music @ [paradestore.com](http://paradestore.com)*



**The Honor Guard Manual Second Edition**

Updated and expanded, this manual based on the American military standard clearly lays out all ceremonial facets for police, firefighter, EMS, veteran, cadet, fraternal and military honor guard units. Extensive explanations and detailed pictures provide a complete understanding of all aspects. Spiral-bound for easy teaching and learning. Written by John Marshal, 413-page paperback.



The Honor Guard Manual Second Edition #2359 **\$59.95** each







Airline-approved Single Rifle Case #23



Airline-approved Double Rifle Case #24



Inside Case

**Airline-approved Rifle Cases**

Designed to withstand the rough and tumble of frequent flying, these tough cases will protect any rifle up to 52" long. Made of high-impact, injection-molded plastic with thick wall construction and high-density egg crate foam inserts. Durable hinges, heavy-duty latches, and oversized, comfortable molded handles. Lockable and airline-approved. Color: Black.

- Single rifle case. 48<sup>3</sup>/<sub>8</sub>"L x 3<sup>3</sup>/<sub>8</sub>"W x 11"H #23 \$42.95 each\*
- Double rifle case. 52<sup>1</sup>/<sub>8</sub>"L x 3<sup>3</sup>/<sub>8</sub>"W x 17"H #24 \$72.95 each\*

\*Add \$7 additional shipping if shipped to the lower continental US. Outside the continental US, higher surcharges apply. See page 77 for more information.

# “Fantastic service!”

**All-Purpose Carrying Case with Large Pocket**

We designed this special 46<sup>1</sup>/<sub>2</sub>" x 8<sup>3</sup>/<sub>4</sub>" All-Purpose Carrying Case to hold one or two of any of our drill and parade rifles, swords or sabers. The sides and top are padded, and the end flap is secured with a full-width hook and loop strip. The case boasts a large pocket to hold accessories. Another of its great features—the Navy, exterior polyester duck fabric is waterproof! Sling it over your shoulder with the adjustable shoulder strap or carry it with the durable poly web handle. Personalization available, see below.

- All-Purpose Carrying Case #25 \$59.95 each



All-Purpose Carrying Case with Large Pocket #25

**Padded Weather-Resistant Carrying Case**

Black padded weather-resistant nylon rifle or shotgun case with strong nylon handles and heavy-duty zipper. 48" inside length. A good choice for carrying the full line of DrillAmerica® rifles. Personalization available, see below.

- Padded Case #33 \$39.95 each



Case can be personalized

Padded weather-resistant nylon rifle case #33

Personalization available for the #25 and #33 rifle cases on one line with 1" letters in white, gold, or red. Submit imprinted orders in writing.

- Case with Imprinting # 25I or #33I
- A: 1–6 characters/spaces add \$8.00 each
- B: 7–12 characters/spaces add \$12.00 each
- C: 13–22 characters/spaces add \$16.00 each
- Example: to order an imprinted rifle case with 5 gold letters: #33IGOA @ \$47.95.



**Rifle Case with Pocket**

Made of weather-resistant nylon material with a carrying handle and a loop at the muzzle end of the bag. This fully padded case also has a zippered accessory pocket. 5<sup>1</sup>/<sub>2</sub>" x 9<sup>1</sup>/<sub>2</sub>". 48" inside length. Suitable for carrying the full line of DrillAmerica® rifles.

- Rifle Case with Pocket #36 \$46.95 each



Rifle Case with Pocket #36

**Protective Sleeve**

Black nylon sleeve, 44", with drawstring closure to protect second rifle or saber inside our All-Purpose Carrying Case or separately.

- Protective Sleeve #25S \$17.25 each



Protective Sleeve for second rifle or sword #25S



Since 1883, Weyersberg, Kirschbaum & Co. (WKC) has manufactured swords and cutlery of impeccable quality in Solingen, Germany, a city famous since the middle ages for its metal-working and craftsmanship in sword making. Today, as the oldest and largest sword manufacturer in Germany, this family-owned business is the leading supplier to military schools and services worldwide. The WKC sword and scabbard are still handmade by skilled sword assemblers and weapon polishers. Even the detailed damascened ornaments of the blades are still etched by hand! No wonder WKC ceremonial swords are worn with pride by U.S. military academies, heads of state, kings and princes, ministers of defense and chiefs of police. Glendale is proud to offer these precision swords and sabers to our customers. Returns for other than defects will be subject to a 15% restocking charge. Engraved Swords can not be returned.

## Sabers & Swords

Sizes available on sabers and swords: 28", 30" and 32" blades. All sabers and swords are handcrafted and include scabbards. The Army Saber is carbon steel, nickel plated. All others are premium stainless steel.

West Point Military Style Sword **GLENDALE EXCLUSIVE!**  
#671 **\$439.99** each

Regulation Army Officer Saber  
#670 was ~~\$437.95~~ NOW **\$407.99** each

Regulation Army Officer Saber  
in Premium Stainless Steel **NEW GLENDALE EXCLUSIVE!**  
#670S **\$427.99** each

Coast Guard Officer Sword  
#691 was ~~\$457.95~~ NOW **\$427.99** each

Marine Corps Officer Sword **NEW!**  
#695 **\$597.99** each

Navy Officer Sword  
#681 was ~~\$465.95~~ NOW **\$467.99** each

Air Force Honor Guard Sword,  
#698C was ~~\$421.95~~ NOW **\$347.99** each

# West Point Army



West Point Military Style Sword #671



Regulation Army Officer Saber #670

### Sword/Saber Size Chart

Height of user	Sword size
5'6" to 5'7"	28"
5'8" to 5'11"	30"
6'0" to 6'3"	32"



### Sword Engraving

Now you can personalize swords purchased from Glendale! We can engrave up to 20 characters, including spaces. Engraving is only available on new purchases. Engraved Swords cannot be returned.

Choose your sword and add an "E" to the item number (ex: #689CE)  
**\$29.00** each

Scan this QR code with your phone or mobile device learn how to wear a sword, or visit <https://glendale.com/how-to-wear-a-saber-or-sword/>



# Coast Guard



Coast Guard Officer Sword #691

# Marines



Marine Corps Officer Sword #695

# Navy



Navy Officer Sword #681

# Air Force



Air Force Honor Guard Sword #698C

# Army NCO Marines NCO



Army NCO Sword #672

Marine Corps NCO Sword #694

Since 1883, Weyersberg, Kirschbaum & Co. (WKC) has manufactured swords and cutlery of impeccable quality in Solingen, Germany, a city famous since the middle ages for its metal-working and craftsmanship in sword making. Today, as the oldest and largest sword manufacturer in Germany, this family-owned business is the leading supplier to military schools and services worldwide. The WKC sword and scabbard are still handmade by skilled sword assemblers and weapon polishers. Even the detailed damascened ornaments of the blades are still etched by hand! No wonder WKC ceremonial swords are worn with pride by U.S. military academies, heads of state, kings and princes, ministers of defense and chiefs of police. Glendale is proud to offer these precision swords and sabers to our customers. Returns for other than defects will be subject to a 15% restocking charge. Engraved Swords can not be returned.

### NCO Swords

Sizes available on swords: 28", 30" and 32" blades. All NCO swords are handcrafted in premium stainless steel, and include scabbards.

### GLENDALE EXCLUSIVE!

Army NCO Sword **NEW!**

#672 **\$407.99** each

Marine Corps NCO Sword

#694 **\$467.99** each

### Foam-padded Carrying Case

Foam-padded, weather-resistant nylon with reinforced nylon web handles and heavy duty zipper. Will hold one sword/saber. 44" L.

Foam-padded Case #646 **\$37.95** each

**Personalize the #646 case** on one line with 1" letters in white, gold, or red.

**A:** 1-6 characters/spaces add **\$8.00** each **B:** 7-12 add **\$12.00** each; **C:**

13-18 add **\$16.00** each

For example, to order an imprinted sword case with 8 white letters: #646IWHB. Submit imprinted orders in writing.



Foam-padded Carrying Case #646

## The History of the Mameluke Sword

Though now designated for ceremonial duty, the swords Marine Officers carry are the oldest weapons still in service in the United States Armed Forces and represent the Marine Corps' rich legacy of fighting by those who our Nation trusts to win.

The "Mameluke," as the sword is now called, is cross-hilted, curved, and developed from the sabers of the Mamluk warriors of the Ottoman Empire in the seventeenth century. During the Napoleonic Wars, the French conquest of Egypt brought these beautiful and functional swords to the attention of Europeans, and the style became very popular for light cavalry officers in both France and Britain. In 1831, the Mameluke became a regulation pattern for British general officers; the 1831 pattern is still in use today. The American victory over the rebellious forces in the citadel of Tripoli in 1805 during the First Barbary War led to the presentation of a bejeweled example of this sword as a sign of respect and praise to U.S. Marine Lieutenant Presley O'Bannon. Lt O'Bannon and his Marines had marched across 600 miles of North African desert to rid the "shores of Tripoli" of pirates and rescue the kidnapped crew of the USS Philadelphia.

By 1825, all Marine Officers carried the Mameluke Sword in recognition of this historic battle—the Marine Corps' first on foreign soil. Today's swords closely resemble those first worn nearly 100 years ago.

# Sword and Saber Accessories



Web Sword Sling with Leather Sword Throg, white #101

**Web Sword Slings with Leather Sword Throgs** 

White #101 **\$59.95** each  
 Black (not shown) #106 **\$59.95** each



Throg for Sword Belt, White #679WH

USAF Sword Throg, Black #680BK

USMC Sword Throg, Black #683BK



#676BK #676WH

**Saber Guards for Sword Belt** 

Black #676BK **\$19.95** each  
 White #676WH **\$24.25** each  
 Black Clarino #676BKC **\$32.50** each



**USMC Sword Mourning Knot** 

#8142 **\$17.50** each

Figure 8 link #673



**Saber Chain**  
 Figure 8 link #673  
**\$39.25** each

**Throgs for Sword Belt** 

Black #679BK **\$24.25** each  
 White #679WH **\$31.75** each

**USAF Sword Throgs** 

Made with a special safety loop to hold the scabbard in place.

Black #680BK **\$27.50** each  
 White #680WH **\$35.50** each  
 Black Clarino (high gloss) #680BKC **\$39.50** each

**USMC Sword Throgs** 

Black #683BK **\$26.75** each  
 White #683WH **\$34.95** each  
 Black Clarino (high gloss) #683BKC **\$39.25** each



Web Saber Sling and Guard, white #105

**Web Saber Slings and Guards** 

White web sling with white leather Saber Guard. #105 **\$59.95** each  
 Black web sling with black leather Saber Guard (Not Shown). #107 **\$59.95** each

“Exceptional service, we look forward to growing our business relations with Glendale Parade Store.”  
 TSgt. A. R., USAF

## Letter Openers



**Sword/Saber Letter Openers *BEST SELLER***

Exact replicas of the U.S. military swords sold on page 18. Weyersberg, Kirschbaum & Co. (WKC) has manufactured swords and cutlery of impeccable quality in Solingen, Germany, a city famous since the middle ages for its metal-working and craftsmanship in sword making. Today, as the oldest and largest sword manufacturer in Germany, this family-owned business is the leading supplier to military schools and services worldwide. These detailed, attractive and useful letter openers make excellent special gifts and awards. Each comes in a scabbard. Average length is 11”.

USAF Officer #698WLO **\$53.99** each  
 US Army Officer #670WLO **\$53.99** each  
 US Navy Officer #681WLO **\$53.99** each  
 USMC Officer #693WLO **\$53.99** each  
 USMC NCO #694WLO **\$53.99** each



**The perfect gift!**

*Our letter openers are beautifully detailed.*

USAF Officer #698WLO

A drone made for learning



## Drones Essential to Battlefield (and Trainee) Readiness

Drones have transformed modern warfare and drone pilots will have a leg up on other recruits.

According to a report by the Modern War Institute at West Point, the Army has taken steps to train drone pilots, such as setting up a drone warfare school, but “not enough attention has been given to how soldiers can go on the offensive with small drones at the unit level” and that “the service should consider outfitting formations with affordable commercial drones so units can try using the devices in new ways.” (Source - Stars and Stripes online, March 7, 2024.)

There’s no better way to gain that training experience than with our Co-Drone packages that are easy to fly, 889 compliant, and ready for training and competition.



## Help Their Skills Soar!

### JROTC Drones **NEW!**

Skilled drone pilots are coveted by the military, and the uses for drones are literally just taking off. Glendale has proudly partnered with CoDrone to offer this best-in-class drone to help you teach your JROTC students piloting, programming and communication skills and/or prepare them for JROTC drone flying competitions. Includes quick-start guide, extra propellers, 8 landing pads, smart controller, rechargeable batteries and charger. American Security Drone Act (Section 889) compliant and ready to fly.

Single Drone #DR100 \$314.99 each

### Competition CoDrone EDU JROTC Edition Classroom Package **NEW!**

20 drones, 20 power packs, 2 frames, 2 controllers, 2 motors, 4 hr PD and two year extended warrantee.

Set of 20 #DR200 \$7,999.99 set



*Drones come with everything you need including extra landing pads and replacement propellers.*

*Drones teach kids piloting, programming and communication skills.*





Enloe HS, AJROTC 2019 Nationals.

Two-Color Stretch Poly Gloves



**Two-color Stretch Poly Gloves**

Add a splash of style! Parade gloves with white backs have colorful palm colors to show off your team spirit. Easy-care, comfy stretch polyester. With white back, available palm colors are: orange, purple, maroon, gold, royal blue, red, kelly green, black, and navy.

**Regular 9" slip on.** One size fits most.  
Poly Gloves #6401FP **\$6.50** pair



Solid Color Stretch Poly Gloves

**Solid Stretch Poly Gloves**

Show your colors with pride and in comfort with these easy-care stretch poly gloves. Available in navy, orange, purple, maroon, gold, royal blue, red, kelly green and black.

**Regular 9" slip on.** One size fits most.  
Solid Stretch Poly Gloves  
#6401SCP **\$5.95** pair

Men's Stretch Poly Gloves



**Men's Stretch Poly Gloves**

Sized for larger hands. Cozy stretch polyester fabric is also easy care. Colors: black, gold, kelly green, royal blue and red. Black snaps on black; white snaps on gold, kelly green, royal, and red.

**Regular 9" slip on.** One size fits most.  
Men's Poly #6400SCMP **\$6.50** pair



**Wrist Wraps**

Adapted from the same accessory used by the 3rd United States Infantry (The Old Guard) and the Sentinels at the Tomb of the Unknowns in Arlington National Cemetery. Prevent the showing of any skin around the wrist/forearm area when handling rifles or saluting—a small but important detail to look your finest when properly presenting honors!



White #1087 **\$13.25** pair  
Black #1085 **\$13.25** pair



**Formal Stretch Nylon Gloves**

Stretch nylon is a popular choice for gloves that need to withstand repeated use and still look great. Full-fashioned for form-fitting comfort and control. 3-row stitching on back. (Not available with Sure-Grip.)

**Regular 9" slip on** one size fits most  
Slip-on #6400PR **\$4.25** pair  
Snap Wrist #6400SP **\$4.95** pair

**Men's Stretch Nylon Gloves**

Heavier weight nylon, snap wrist. Large only

**Regular 9" #6402S \$5.50** pair



Snap wrist

Formal Nylon Gloves



Slip-on #6400



Calcasieu Parish, LA 2012 Honor Guard Competition Silver Medalists.  
The catch was perfect!

# When Every Catch Needs to Be Perfect

When a secure hold is a matter of honor, when each slip means a demerit, it's time to graduate to our sure-grip gloves (page 25). While we offer a wide assortment of gloves for every need, our Sure-Grip Flag Bearer Gloves are a clear customer favorite for top competitors.

And for good reason. First and foremost, the patented dots spread over the palms and between the thumb and index fingers and the small and ring fingers secure your grip. Because the gloves are breathable 100% cotton, they stay cool and comfortable even on the hottest of parade grounds. Wrist grips keep them precisely in place. Double reinforcement makes them tough.

To be a top competitor, you need the right equipment. Don't overlook the importance of the right gloves!

## SURE-GRIP

*Sure Grip Gloves feature patented patterns of rubber-like dots on the fingers and palms to give you the extra grip needed to perform exacting maneuvers with confidence and precision.*



### No Frills and Extended Sizes

Basic Gloves  
Regular 9"



Slip-on Military Gloves  
Regular 9"



Black  
Long  
10½" - 12"

#### Basic Glove

Our most affordable glove. White, interlock cotton with rolled hem. (Not available with Sure-Grip.) **Regular 9"** S, M, L, XL

White #1065 **\$2.95** pair

#### Slip-on Military Gloves

A full-fashioned cotton glove at a very affordable price. 3-row stitching on back of hand, and shirring at wrist. (Not available with Sure-Grip.)

<b>Regular 9"</b> XS (white only), M, L, XL, XXL - XXXL (white only)	<b>Long 10½" - 12"</b> (to cover the wrist): S M L XL
White #1050 XS - XL <b>\$3.50</b> pair	White #1066 <b>\$3.95</b> pair
White #1050 XXL-XXXL <b>\$3.95</b> pair	Black #1067 <b>\$4.95</b> pair
Black #1063 S M L XL <b>\$4.25</b> pair	

### Find your Size

Measure the circumference around the palm at the knuckle area, and convert the numeric measurement to determine size.

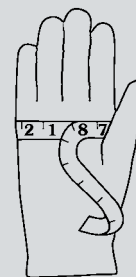

6½"	.....	XS
7"	.....	S
8"	.....	M
9"	.....	L
10"	.....	XL
10½"	.....	XXL
11"	.....	XXXL

*Washing instructions for cotton and nylon gloves:  
DO NOT USE HOT WATER OR BLEACH!  
Hand wash: Soak gloves for 5 minutes in warm water and soap or detergent. Rub gloves together on or off hands. Rinse and dry away from heat.  
Machine wash: Cold water, gentle cycle. Dry away from heat.*



**Honor Guard Gloves**

Best quality cotton with a touch of Lycra® stretch for extra comfort.  
**Long** 10½ - 11" (to cover the wrist:) S-M, L-X, XXL-XXXL L.

**Sure-Grip**

White	S-M	#1078SP	<b>\$8.95</b> pair
White	L-XL	#1078LP	<b>\$8.95</b> pair
White	XXL-XXXL	#1078XXP	<b>\$8.95</b> pair

**Plain**

White	#1070	<b>\$8.25</b> pair
-------	-------	--------------------



**SURE-GRIP**  
Honor Guard  
Gloves

Long  
10½" - 11"

**Sure-Grip Flag Bearer Gloves** *CUSTOMER FAVORITE!*

When one slip can spoil the show, you can depend on the Sure-Grip palm and fingers of our best-selling cotton gloves. Flag-bearers, drill corps, and baton twirlers will appreciate the added control and the durability of double reinforced material between thumb and index finger and between small and ring fingers. Velcro® strap at wrist. **Regular** 9" XS, S, M, L, XL

**Sure-Grip**

White	#1068	<b>\$6.25</b> pair
Black	#1069	<b>\$7.25</b> pair



**SURE-GRIP**  
Sure-Grip Flag  
Bearer Gloves

Snug fit Velcro®  
wrist grips

Black

# No Slip with Sure-Grip

**Fleece Lined Gloves**



Regular 9"

**SURE-GRIP**

Long  
10½"

**Snap Military Gloves**  
available with  
Sure-Grip



**SURE-GRIP**

**Sure-Grip Parade Gloves**



Regular 9"

Black  
**SURE-GRIP**

**Warm Fleece-Lined Gloves**

In blustery weather, you'll appreciate the warmth of the light fleece lining inside these breathable, comfortable top quality gloves. Regular is pure cotton. 3-row stitching on back of hand. Long version is cotton/Lycra®. Plain Palm style has shirring at wrist.

**Regular 9"** S-M or L-XL

Plain palm	#1075	<b>\$4.75</b> pair
------------	-------	--------------------

**Long 10½-12"** (to cover the wrist:)

S-M or L-XL

Plain palm	#1076	<b>\$11.50</b> pair
------------	-------	---------------------

<b>Sure-Grip</b>	#1077	<b>\$12.25</b> pair
------------------	-------	---------------------

**Snap Military Gloves**

These all cotton military style gloves have become standard issue for special events. Full-fashioned for exceptional comfort and control, with 3-row stitching on back and snap wrist. **Regular** 9" S, M, L, XL; XS, XXL (plain only)

**Sure-Grip**

White	#1057	<b>\$4.95</b> pair
-------	-------	--------------------

**Plain**

White XS - XL	#1051	<b>\$3.95</b> pair
---------------	-------	--------------------

White XXL	#1051	<b>\$4.25</b> pair
-----------	-------	--------------------

**Sure-Grip Parade Gloves**

These all cotton gloves provide added dexterity, thanks to the Sure-grip dots on the palm. 3-row stitching on back of hand. Slip-on; wrist length. **Regular** 9" (shown). S, M, L, XL, White only for 2XL. **Long** 10½-12" (to cover the wrist:) M (Ladies) and XL (Mens) only.

**Sure-Grip**

White Regular	#1055	<b>\$3.95</b> pair
---------------	-------	--------------------

Black Regular	#1056	<b>\$4.50</b> pair
---------------	-------	--------------------

White Long	#1058	<b>\$4.75</b> pair
------------	-------	--------------------

# 5 Infantry Style Cord Options all made in America!



Button Loop  
Cord  
#452



Shoulder Top  
Cord  
#454



Epaulet Cord  
#456



Shoulder  
Cord with Pin  
#485



Shoulder Cord  
with Pin  
#454P

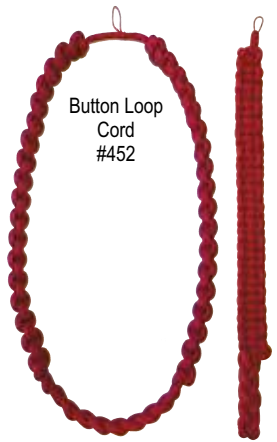

Button Loop  
Cord  
#452



Shoulder Top  
Cord  
#454



Epaulet Cord  
#456

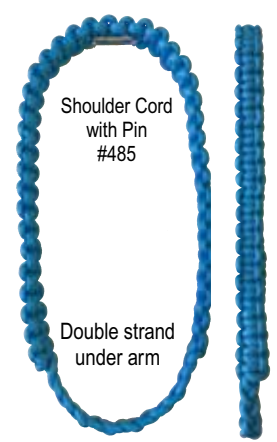

Shoulder Cord  
with Pin  
#485

Double strand  
under arm

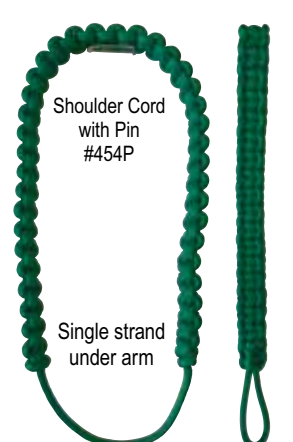

Shoulder Cord  
with Pin  
#454P

Single strand  
under arm

## Poly Cord

	White WH
	Black BK
	Jay Blue JB
	Infantry Blue IB
	Medium Blue MB
	Royal Blue RY
	Teal TL
	Navy Blue NV
	Gold GO

	Dark Gold DG
	Old Gold OG
	Kelly Green KG
	Pine Green PG
	Dark Green GR
	Scarlet SC
	Dark Red DR
	Cardinal CD
	Maroon MR

	Gray GY
	Orange OR
	Purple PR
	Buff BU
	Brown BW

## METALLIC CORD

	Metallic Silver (MS)
	Metallic Gold (MG)
	Silver Luminette (SL) (For Shaker Knot Honor Cord 484, Shoulder Cord with Pin 486, USAF Dress 622 and USAF Honor Guard Cord 638 only.)

## MADE-TO-ORDER CORDS

Longer Lengths: Styles #452, #454 and #456 can be custom-made in two longer lengths. Add \$5 to the prices for an additional 5" and \$8 for an additional 10". Then, add the length to the number — for example, #452X5, #454X10, #452C2X10

• Pin Attachment: Any cord with a button loop can be custom-made with a pin attachment to wear on uniforms without buttons or epaulets. Add \$3 to the price of each cord and a "P" (for pin) to the product number — for example, #452P.

Allow 4 weeks for delivery.



## Special Color Orders

All 2-color and 3-color cords are made to customer specifications and are not returnable. Special color orders and combinations may require 4 weeks for delivery.



Not sure about what color you need or what will match something else you already have?

# Infantry Style Shoulder Cords

For color brilliance, thickness, smoothness, strength, and weight, we really do have the finest cords made in the United States! Each cord — braided, knotted, and sewn by hand — is a true testament to quality and craftsmanship. Because the same U.S. factory both creates the braid and makes the finished cord, our customers are assured of consistent top quality year after year.

The button loop-style is designed to be worn with an epaulet that unbuttons. The open-end style with hook-and-eye closure is designed for epaulets that do not open. The wrapped pin attachment style can be worn on uniforms or shirts without epaulets or with epaulets that unbutton.

## Think Pink Shoulder Cord **CUSTOMER FAVORITE!**

Wear a pink cord and show you care! Use our button-loop bright pink shoulder cord for fundraising and to reward your cadets for community service in the fight against breast cancer. We're proud to donate a portion of the proceeds for every sale of this cord to the Susan G. Komen Foundation.

- Breast Cancer Awareness cord with button loop #452PK **\$13.95** each
- Breast Cancer Awareness shoulder top cord with pin #485PK **\$18.25** each

## Button Loop Cord **CUSTOMER FAVORITE!**

- Button Loop Cord in any one poly color. #452 **\$13.50** each
- Button Loop Cord in two poly colors. #452C2 **\$14.95** each
- Button Loop Cord in metallic gold or silver. #453 **\$16.75** each
- Button Loop Cord in metallic gold or silver, plus any one poly cord. #453C2 **\$18.50** each

## Shoulder Top Cord

Bright poly cord with full shoulder braid, wide loop, hole underneath for epaulet to pass through, and single underarm cord.

- Shoulder Top Cord in one color. #454 **\$15.75** each
- Shoulder Top Cord in two colors. #454C2 **\$18.25** each
- Shoulder Top Cord in metallic gold or silver. #455 **\$19.95** each
- Shoulder Top Cord in metallic gold or silver, plus any one poly cord. #455C2 **\$21.50** each

## Epaulet Cord

Bright poly cord with open ends and hook-and-eye closure. These are suitable for uniforms with permanently affixed epaulets.

- Epaulet Cord in one color. #456 **\$17.95** each
- Epaulet Cord in two colors. #456C2 **\$19.95** each
- Epaulet Cord in metallic gold or silver. #457 **\$22.50** each
- Epaulet Cord in metallic gold or silver, plus any one poly cord. #457C2 **\$24.95** each

## Shoulder Cords with Pins Double Strand Under Arm

- Shoulder Cord with Pin in one poly color. #485 **\$18.25** each
- Shoulder Cord with Pin in any two poly colors. #485C2 **\$20.75** each
- Shoulder Cord with Pin in metallic gold or silver. #486 **\$23.95** each
- Shoulder Cord with Pin in metallic gold or silver, plus any one poly cord. #486C2 **\$25.75** each
- Shoulder Cord with Pin in silver luminette. #486SL **\$39.95** each

## Shoulder Cords with Pins Single Strand Under Arm

- Shoulder Cord with Pin in one poly color. #454P **\$18.75** each
- Shoulder Cord with Pin in any two poly colors. #454C2P **\$21.25** each
- Shoulder Cord with Pin in metallic gold or silver. #455P **\$22.95** each
- Shoulder Cord with Pin in metallic gold or silver, plus any one poly cord. #455C2P **\$24.50** each

### MADE-TO-ORDER CORDS

Cords are 28' in length and can be custom made in two longer lengths. Add \$5 to the prices for an additional 5" and \$8 for an additional 10". Then, add the length to the number – for example, #454X5, #450C2X10

*“You are the Best in the business. I try to spread the word about your company. None Better!!”*

J.B., Powell WY

## Two color cords

When ordering two colors in any infantry style cord, the first color you list will be on outer edges.

Photos of two-color cords are shown to indicate placement of color choices. **All 2-color and 3-color cords are made to customer specifications and are not returnable.**

Special color orders and combinations may require 4 weeks for delivery.



Two-color Cords  
Gold & Navy  
#452C2

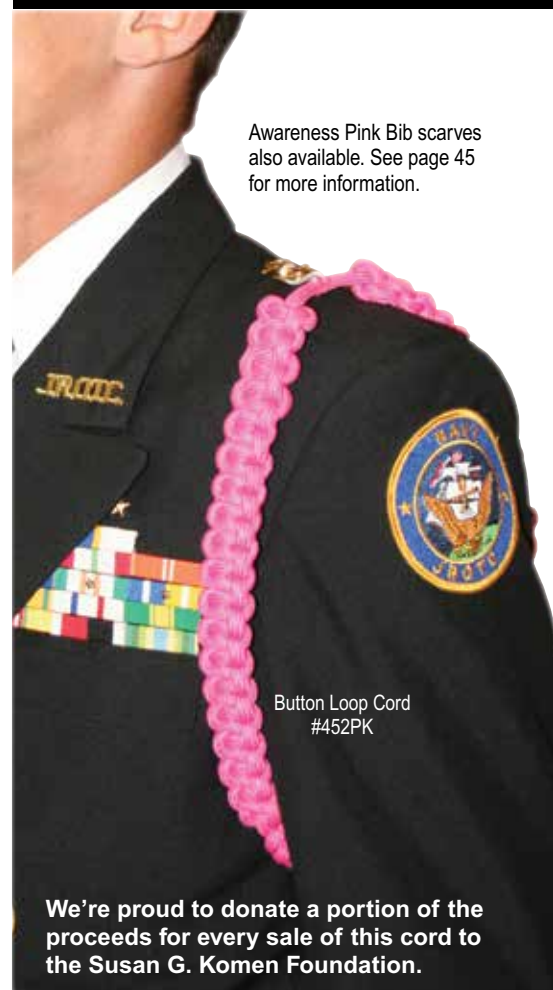

Awareness Pink Bib scarves also available. See page 45 for more information.

Button Loop Cord  
#452PK

**We're proud to donate a portion of the proceeds for every sale of this cord to the Susan G. Komen Foundation.**

## Glendale's Color Compatibility Chart

If you're trying to match scarves, berets and shoulder cords in the same color, the most compatible matches (barring any changes in manufacturers' colors or dye lots) are indicated in the following chart. Color swatches are available for scarves, berets and cords.

BIB SCARVES	BERETS	CORDS
White 011, 014, 015, 020	—	White
—	White 4024, 4051	White
Scarlet 011, 014, 015, 020	Scarlet 4024, 4051, 4062, 4063 Dark Red 4062, 4063	Scarlet
Dark Orange 014	Orange 4062, 4063	Orange
Maroon 014, 015	Maroon 4024, 4051, 4062, 4063	Maroon
Purple 015	Purple 4024, 4051	Purple
Navy Blue 011, 014, 015, 020	Navy Blue 4062, 4063	—
Light Navy Blue 015	Navy Blue 4024, 4051	Navy Blue
Infantry Blue 015	—	Infantry Blue
Royal Blue 011, 014	Royal Blue 4024, 4051	Royal Blue
Royal Blue 011, 015, 020	Royal Blue 4062, 4063	—
Academy Royal Blue 015	Academy Royal Blue 4062, 4063	—
Teal 015	—	Teal
Dark Green 015	—	Dark Green
Kelly 015, 020	—	Kelly
Dark Gold 011, 015, 020	Gold 4024, 4051	Dark Gold
Gold 014	Gold 4024, 4051	Dark Gold
Buff 015	—	Buff
Black 011, 014, 015, 020	Black, all styles	Black
Charcoal Gray 015	Gray 4062, 4063	—
	Kelly 4024, 4051, 4062, 4063	Pine Green

# Cord Add-Ons

## Cord Add-Ons **BEST SELLER!**

Details, details – it's all in the details! Change a cord, enhance a cord, add flair. Anything's possible with our exclusive line of Add-Ons. Pin them on to any cord to create your own distinctive look!



### Hang Cord

Bright polycord in any one color, brass or nickel tip with pin and safety catch attachment. #056 **\$9.95** each  
 Above cord in metallic gold or silver, brass or nickel tip. #057 **\$10.95** each

### Knotted Loop Cords

These pin-on cords are available in any one poly or metallic cord color — in a single 8" or 9" length or in a double combination cord with both an 8" and 9" loop.

Single Loop, 8" in any one poly color. #062 **\$7.95** each  
 Single Loop, 8" in any one metallic color. #063 **\$8.95** each  
 Single Loop, 9" in any one poly color. #064 **\$7.95** each  
 Single Loop, 9" in any one metallic color. #065 **\$8.95** each  
 Double Loop, 8" & 9" in any one poly color. #066 **\$10.95** each  
 Double Loop, 8" & 9" in any one metallic color. #067 **\$14.25** each



### Cord Tips

Army or Air Force tips may be added to any hang cord on any citation cord or aiguillette at an additional charge of **\$15.50** per tip. When ordering, add A or AF to cord number. These cords are made to customer's specifications, so please allow extra time for the manufacturing process. If ordering tips alone to be sewn on at your location:

Army tip and barrel with eagle and starburst, brass #4612 **\$14.95** each  
 Air Force Hap Arnold tip and barrel, nickel #4613 **\$14.95** each  
 Plain brass tip and barrel #4614 **\$4.95** each  
 Plain nickel tip and barrel #4615 **\$4.95** each

# Cap Cords & Lanyards

### Double-knotted Cap Cord

Standard length is 12"; cords are not adjustable. Remove buttons and measure from button screw hole to button screw hole. If other lengths are required, call for customization.

Any one poly cord #780 **\$9.95** each  
 Metallic gold or silver cord #781 **\$11.50** each



### Army Band Cap Cord

Wear on any cap with two buttons. Be sure to add color code after item number. eg #790KG for Kelly Green. See chart at left for color codes.

Any one poly cord #790 **\$13.50** each  
 Metallic gold or silver cord #791 **\$16.75** each



Not sure about what color you need or what will match something else you already have?

### Pistol/Whistle Lanyards

Fully braided lanyard in any one poly color. #400 **\$21.75** each  
 Partially braided lanyard in any one poly color. #403 **\$11.25** each  
 Bright poly cord lanyard, no braid, in any one color. #405 **\$12.50** each



## Poly Cord

White WH	Gold GO	Cardinal CD
Black BK	Dark Gold DG	Maroon MR
Jay Blue JB	Old Gold OG	Gray GY
Infantry Blue IB	Kelly Green KG	Orange OR
Medium Blue MB	Pine Green PG	Purple PR
Royal Blue RY	Dark Green GR	Buff BU
Teal TL	Scarlet SC	Brown BW
Navy Blue NV	Dark Red DR	

### METALLIC CORD

Add \$8 for silver or gold metallic cord.

Silver Luminette (SL) (For Shaker Knot Honor Cord 484, Shoulder Cord with Pin 486, USAF Dress 622 and USAF Honor Guard Cord 638 only)

Metallic Silver (MS)  
 Metallic Gold (MG)

See page 27 for Glendale's Color Compatibility Chart

# Add Cords the Easy Way with Pins

Glendale was the first to introduce pin-on cords and still has the best selection. Pins are the easy way to add cords to any uniform. In fact if you want to create custom cords, you can add pins to any of our Shoulder Cords for \$3.

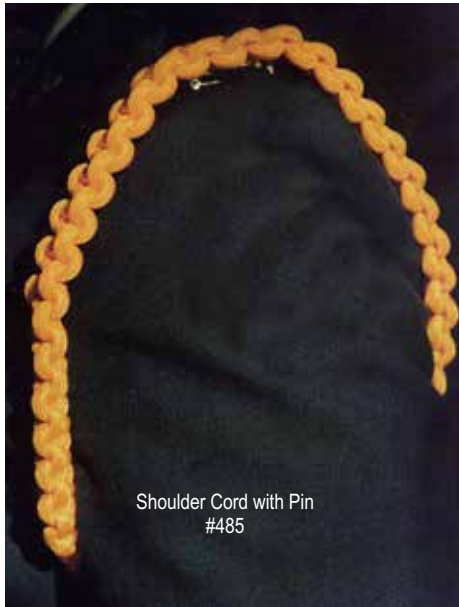

2019 National Drill championships

## Infantry Style Shoulder Cords with Pins Double Strand Under Arm

Shoulder Cord with Pin in one poly color.	#485	\$18.25 each
Shoulder Cord with Pin in any two poly colors.	#485C2	\$20.75 each
Shoulder Cord with Pin in metallic gold or silver.	#486	\$23.95 each
Shoulder Cord with Pin in metallic gold or silver, plus any one poly cord.	#486C2	\$25.75 each
Breast Cancer Awareness shoulder top cord with pin	#485PK	\$18.25 each

## Infantry Style Shoulder Cords with Pins Single Strand Under Arm

Shoulder Cord with Pin in one poly color.	#454P	\$18.75 each
Shoulder Cord with Pin in any two poly colors.	#454C2P	\$21.25 each
Shoulder Cord with Pin in metallic gold or silver.	#455P	\$22.95 each
Shoulder Cord with Pin in metallic gold or silver, plus any one poly cord.	#455C2P	\$24.50 each



**MADE-TO-ORDER CORDS**  
Cords can be custom made in two longer lengths. Add \$5 to the prices for an additional 5" and \$8 for an additional 10". Then, add the length to the number – for example, #485X5, #466C2X10.

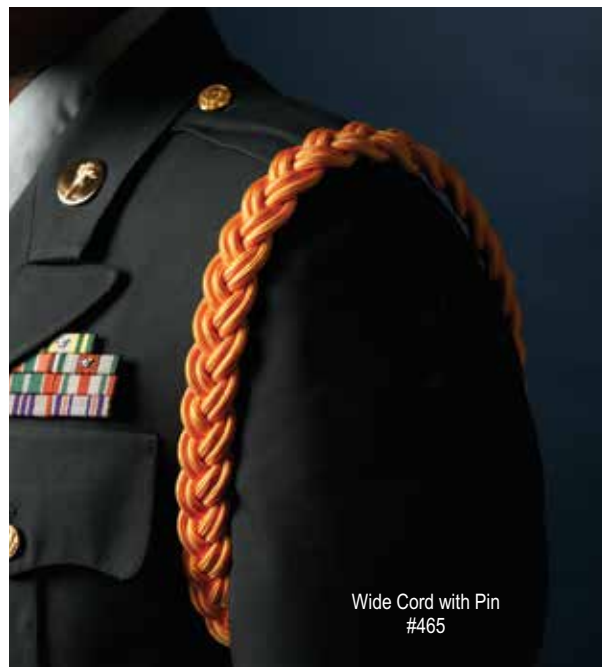

## Wide Braid Cords with Pins

In any one poly color with pin.	#465	\$22.75 each
Above cord in any two poly colors.	#465C2	\$26.75 each
Above cord in metallic gold or silver.	#466	\$29.95 each
Above cord in metallic gold or silver, plus any one non-metallic cord.	#466C2	\$31.50 each

**When ordering two colors in this cord, no color will be dominant.**



# Shoulder Cords



Double Knot Loop Cords  
#482



Navy & Gold  
#482C2



Double Circle Braided Cord  
#480



Royal Blue & White  
#480C2

## Double Knot Loop Cords

- Any one poly color. #482 **\$18.25** each
- Above cord in two poly colors. #482C2 **\$21.95** each
- Above cord in metallic gold or silver. #483 **\$23.25** each
- Above cord in metallic gold or silver, plus any one non-metallic cord. #483C2 **\$26.95** each

*When ordering two colors in this cord, the second color you list will be the color of the double knot loops*



## Double Circle Braided Cords

- Any one poly color. #480 **\$21.50** each
- Above cord in two poly colors. #480C2 **\$24.75** each
- Above cord in metallic gold or silver. #481 **\$27.25** each
- Above cord in metallic gold or silver, plus anyone non-metallic cord. #481C2 **\$29.25** each

*When ordering two colors in this cord, the first color you list will be dominant in both braided cords.*



# The Easiest, Fastest Way to Get Custom Cords in 26 Colors!



Single Strand Shoulder Cord  
#460

glendale  
exclusive

### MADE-TO-ORDER CORDS

Standard length is 28 inches  
**LONGER LENGTHS:** Styles on this page can be custom-made in two longer lengths. Add \$5 to the prices for an additional 5" and \$8 for an additional 10". Then, add the length to the number — for example, #480X5, #458X5, #482C2X10.

**PIN ATTACHMENT:** Any shoulder cord with a button loop can be custom-made with a pin attachment to wear on uniforms without buttons or epaulets. Add \$3 to the price of each cord and a "P" (for pin) to the product number — for example, #458P.

Allow 4 weeks for delivery.



Single Underarm Loop Cord  
#458



Kelly Green and White  
#458C2

## Single Strand Shoulder Cord

This single cord with a button loop will add a simple, clean line of color to a uniform or shirt. It's 28" round.

- Single Strand Shoulder Cord #460 **\$8.25** each



## Single Underarm Loop Cords

- Any one poly color. #458 **\$12.25** each
- Above cord in two poly colors. #458C2 **\$15.25** each
- Above cord in metallic gold or silver. #459 **\$15.75** each
- Above cord in metallic gold or silver, plus any one non-metallic cord. #459C2 **\$18.25** each

*When ordering two colors in this cord, the second color you list will be the color of the underarm loop cord.*



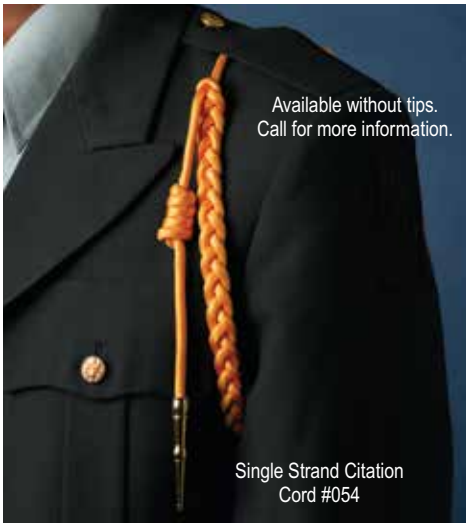

Available without tips.  
Call for more information.

Single Strand Citation  
Cord #054



Navy & Gold  
#054C2

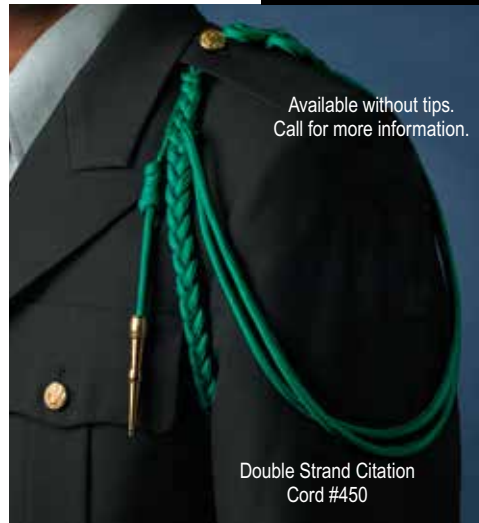

Available without tips.  
Call for more information.

Double Strand Citation  
Cord #450



Royal Blue, White, Scarlet  
#450C3

**Single Strand Citation Cords**

- Bright cord in any one color, brass or nickel tip, button loop. #054 **\$17.75** each
- Above cord in two poly colors, brass or nickel tip. #054C2 **\$20.75** each
- Above cord in metallic gold or silver, brass or nickel tip. #055 **\$21.75** each
- Above cord in metallic gold or silver, plus any one poly cord, brass or nickel tip. #055C2 **\$23.75** each



**Double Strand Citation Cords**

- Bright poly cord double strand, brass or nickel tip, button loop. #450 **\$18.25** each
- Above cord in one color, brass or nickel tip. #450C2 **\$23.25** each
- Above cord in two colors, brass or nickel tip. #450C3 **\$27.75** each
- Above cord in three colors, brass or nickel tip. #450C3 **\$27.75** each
- Above cord in metallic gold or silver, brass or nickel tip. #451 **\$20.95** each
- Above cord in metallic gold or silver, plus one non-metallic cord, brass or nickel tip. #451C2 **\$25.75** each
- Above cord in metallic gold or silver, plus two other non-metallic cords, brass or nickel tip. #451C3 **\$29.95** each



**Ordering Cord Tips**

All Citation cords on this page come with your choice of brass or nickel tips. Order by placing B (for brass) or N (for nickel) after the number and before the color code. For example, #450C3NNVWHSC or #054C2BNVGO.

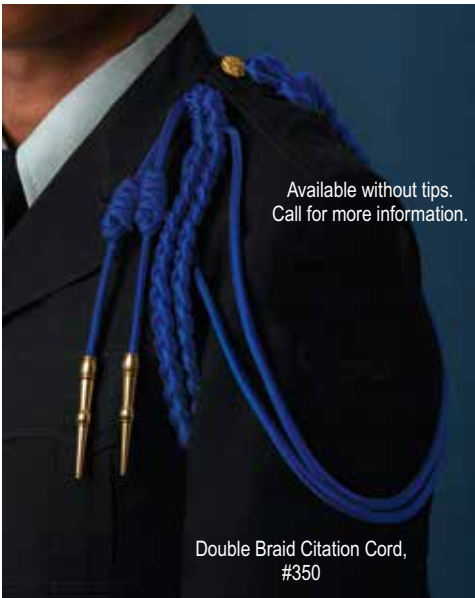

Available without tips.  
Call for more information.

Double Braid Citation Cord,  
#350



Maroon & Gold  
#350C2

**Special Color Orders**

When ordering two colors in the cords on this page, the first color you list will be on the hang cord. Photos of each two-color cord are shown to indicate placement of color choices. All 2-color and 3-color cords are made to customer specifications and are not returnable. Special color orders and combinations may require 4 weeks for delivery.



#450C2

**Double Braid Citation Cords**

- Bright poly cord in any one color, brass or nickel tips, button loop. #350 **\$33.95** each
- Cord in two poly colors, brass or nickel tips. #350C2 **\$39.95** each
- Cord in metallic gold or silver, brass or nickel tips. #351 **\$46.25** each
- Cord in metallic gold or silver, plus any one poly cord, brass or nickel tips. #351C2 **\$48.25** each



Not sure about what color you need or what will match something else you already have?



**Poly Cord**

	White WH		Dark Gold DG		Gray GY
	Black BK		Old Gold OG		Orange OR
	Jay Blue JB		Kelly Green KG		Purple PR
	Infantry Blue IB		Pine Green PG		Buff BU
	Medium Blue MB		Dark Green GR		Brown BW
	Royal Blue RY		Scarlet SC		
	Teal TL		Dark Red DR		
	Navy Blue NV		Cardinal CD		
	Gold GO		Maroon MR		

**METALLIC CORD**

- Metallic Silver (MS)
- Add \$8 for silver or gold metallic cord.**
- Metallic Gold (MG)
- Silver Luminette (SL) (For Shaker Knot Honor Cord 484, Shoulder Cord with Pin 486, USAF Dress 622 and USAF Honor Guard Cord 638 only.)

See page 27 for Glendale's Color Compatibility Chart

# Aiguilletes Handmade with Pride in the USA



#630 (US Army Dress)



#636 (US Army Service)

## US Army Dress Aiguilletes

Two-piece cord with two button loops and pin attachments.   
 Any one poly color, brass or nickel tip, #630 **\$53.95** each  
 Above cord in two poly colors, brass or nickel tip. #630C2 **\$66.95** each  
*When ordering two colors in this cord, the first color you list will be on hang cord.*



Gold & Maroon #630C2



Not sure about what color you need or what will match something else you already have?

## Ordering Aiguilletes Tips

All Aiguilletes come with your choice of brass or nickel tips. Order by placing B (for brass) or N (for nickel) after the number and before the color code. For example, #630C2BGOMR.

## Also available:

Aiguilletes to wear on the right shoulder may be custom ordered.

Add \$8 for silver or gold metallic cord. Add \$3 to change from button loop to pin attachment (add P to the product number).

See page 27 or the chart of the best color matches for bib scarves, berets, shoulder cords, and gloves.

## Cord Tips

Add Army (with eagle and starburst) or Air Force Hap Arnold tips as shown to any Aiguillette for just \$14.95 per tip. See page 28 for ordering details.



## Special Color Orders

Photos of each two-color cord are shown to indicate placement of color choices. All 2-color and 3-color cords are made to customer specifications and are not returnable. Special color orders and combinations may require 4 weeks for delivery.

### Custom Lengths

Cords can be custom made in two longer lengths. Add \$5 to the prices for an additional 5" and \$8 for an additional 10". Then, add the length to the number – for example, #630X5, #636C2X10

## US Army Service Aiguilletes

Open ends with two pin attachments.   
 Any one poly color, brass or nickel tip. #636 **\$27.95** each  
 Above cord in two poly colors, brass or nickel tip. #636C2 **\$30.75** each  
*When ordering two colors in this cord, the first color you list will be on hang cord.*



Black & Gold #636C2

## Poly Cord

	White WH		Dark Gold DG		Gray GY
	Black BK		Old Gold OG		Orange OR
	Jay Blue JB		Kelly Green KG		Purple PR
	Infantry Blue IB		Pine Green PG		Buff BU
	Medium Blue MB		Dark Green GR		Brown BW
	Royal Blue RY		Scarlet SC	<b>METALLIC CORD</b>	
	Teal TL		Dark Red DR		Metallic Silver (MS)
	Navy Blue NV		Cardinal CD	Add \$8 for silver or gold metallic cord.	
	Gold GO		Maroon MR		Metallic Gold (MG)
					Silver Luminette (SL) (For Shaker Knot Honor Cord 484, Shoulder Cord with Pin 486, USAF Dress 622 and USAF Honor Guard Cord 638 only.)

See page 27 for Glendale's Color Compatibility Chart to match Bib Scarves, Berets, and Cords





Black & Cardinal  
#622C2

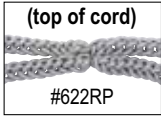

Longer cords are available call 800-653-5515 for more information



Royal Blue & Gold  
#638C2

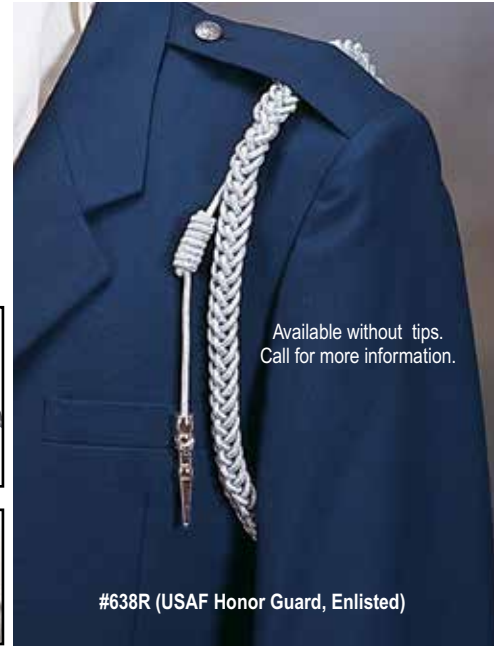

**USAF Dress**

- Bright poly cord, any one color, brass or nickel tips, with button loop. #622 **\$69.95** each
  - Above cord in two poly colors, brass or nickel tips. #622C2 **\$74.95** each
  - Above cord in silver luminette with Hap Arnold tips and barrels. #622R **\$153.75** each
  - USAF Dress Aiguillette in silver luminette with Hap Arnold tips and barrels, pin attachment. #622RP **\$155.75** each
- When ordering two colors in this cord, the first color you list will be in the larger braid.*



**USAF Service**

- Any one poly color, brass or nickel tip, with pin attachment. #638 **\$46.25** each
  - Above cord in two poly colors, brass or nickel tip. #638C2 **\$49.25** each
  - USAF Honor Guard Cord in silver luminette with Hap Arnold tip and barrel and pin attachment, Enlisted. #638R **\$83.25** each
  - USAF Honor Guard Cord in silver luminette with Hap Arnold tip and barrels, Officer. #638RO **\$76.25** each
- When ordering two colors in this cord, the first color you list will be on hang cord.*
- Shaker Knot Honor Cord with Pin, Silver luminette only (see page 29)  
#484SL **\$56.95** each



Purple & White  
#628C2

**US Army Bandsman**

- Any one poly color, brass or nickel tips, with button loop. #628 **\$72.95** each
  - Above cord in two poly colors, brass or nickel tips. #628C2 **\$79.95** each
- When ordering two colors in this cord, the first color you list will be on hang cord.*



Gold & Dark Green  
#632C2

**USAF Bandsman**

- Any one poly color, brass or nickel tips, with button loop. #632 **\$67.50** each
  - Above cord in two poly colors, brass or nickel tip. #632C2 **\$73.50** each
- When ordering two colors in this cord, the first color you list will be in the larger braid.*



Dark Red & Royal Blue  
#626C2

**Single Braid/ Double Knot Aiguillettes**

- Any one poly color, brass or nickel tips, with button loop. #626 **\$47.95** each
  - Above cord in two poly colors, brass or nickel tips. #626C2 **\$53.50** each
- When ordering two colors in this cord, the first color you list will be on hang cord.*



*Wide shaker knot cords on this page cannot be interwoven in two colors.*

# Belts

Heavy Weight, Black #174

**CUSTOMER FAVORITE!**



Heavy Weight, AF Blue #173



Heavy Weight, White #170



2" Heavyweight canvas webbing

Heavy Weight, OD #176



## Parade Belts

2 1/4" heavyweight cotton webbing – with or without eyelets – with large waist buckle and four keepers, adjustable to 44" and 52" length. Made in U.S.A. to military specifications.



Parade Belts				
Color	Hardware	Eyelets	Adjustable to 44"	Adjustable to 52"
#159 AF Blue	Brass	Eyelets	#158 <b>\$56.75</b>	#158X <b>\$58.95</b>
		No eyelets	#159 <b>\$56.75</b>	#159X <b>\$58.95</b>
	Nickel	Eyelets	#160 <b>\$56.75</b>	#160X <b>\$58.95</b>
		No eyelets	#161 <b>\$56.75</b>	#161X <b>\$58.95</b>
#150 White	Brass	Eyelets	#150 <b>\$56.75</b>	#150X <b>\$58.95</b>
		No eyelets	#151 <b>\$56.75</b>	#151X <b>\$58.95</b>
	Nickel	Eyelets	#152 <b>\$56.75</b>	#152X <b>\$58.95</b>
		No eyelets	#153 <b>\$56.75</b>	#153X <b>\$58.95</b>
#156 Black	Brass	Eyelets	#154 <b>\$56.75</b>	#154X <b>\$58.95</b>
		No eyelets	#155 <b>\$56.75</b>	#155X <b>\$58.95</b>
	Nickel	Eyelets	#156 <b>\$56.75</b>	#156X <b>\$58.95</b>
		No eyelets	#157 <b>\$56.75</b>	#157X <b>\$58.95</b>
#162 Olive Drab	Brass	Eyelets	#162 <b>\$56.75</b>	#162X <b>\$58.95</b>
		No eyelets	#163 <b>\$56.75</b>	#163X <b>\$58.95</b>
	Nickel	Eyelets	#164 <b>\$56.75</b>	#164X <b>\$58.95</b>
		No eyelets	#165 <b>\$56.75</b>	#165X <b>\$58.95</b>

### Parade Buckle only 2 1/2" x 3 1/2"

Brass	#166 <b>\$24.95 each</b>
Nickel	#167 <b>\$24.95 each</b>

### Keepers only 2 1/4" x 3/4"

Brass	#168 <b>\$11.95 pair</b>
Nickel	#169 <b>\$11.95 pair</b>

## Heavy Weight Pistol Belts

Sturdy 2" heavy weight canvas pistol belts adjust for a perfect fit and will last until the final reveille. Choose from 2 sizes, 4 colors and 2 metals — brass or nickel — for hardware.

Heavy Weight Pistol Belts			
Color	Hardware	Adjustable to 44"	Adjustable to 52"
Black	Brass	#174 <b>\$21.25</b>	#174X <b>\$24.50</b>
	Nickel	#175 <b>\$21.25</b>	#175X <b>\$24.50</b>
AF Blue	Brass	#146 <b>\$21.25</b>	#146X <b>\$24.50</b>
	Nickel	#173 <b>\$21.25</b>	#173X <b>\$24.50</b>
White	Brass	#170 <b>\$21.25</b>	#170X <b>\$24.50</b>
	Nickel	#172 <b>\$21.25</b>	#172X <b>\$24.50</b>
Olive Drab	Brass	#176 <b>\$21.25</b>	#176X <b>\$24.50</b>
	Nickel	#177 <b>\$21.25</b>	#177X <b>\$24.50</b>

## Medium Weight Pistol Belts

2" Medium weight canvas webbing, black hardware, adjustable to 38".

Black	#4219 <b>\$7.95 each</b>
White	#4226 <b>\$7.95 each</b>
OD	#4227 <b>\$7.95 each</b>



## Military Police Belts

Heavy-duty military police belts in 2" heavyweight canvas webbing adjust to fit, come in 2 sizes, 4 colors, and with your choice of brass or nickel hardware.

Military Police Belts			
Color	Hardware	Adjustable to 44"	Adjustable to 52"
Black	Brass	#183 <b>\$19.95</b>	#183X <b>\$23.25</b>
	Nickel	#184 <b>\$19.95</b>	#184X <b>\$23.25</b>
White	Brass	#180 <b>\$19.95</b>	#180X <b>\$23.25</b>
	Nickel	#181 <b>\$19.95</b>	#181X <b>\$23.25</b>
AF Blue	Brass	#148 <b>\$19.95</b>	#148X <b>\$23.25</b>
	Nickel	#182 <b>\$19.95</b>	#182X <b>\$23.25</b>
Olive Drab	Brass	#185 <b>\$19.95</b>	#185X <b>\$23.25</b>
	Nickel	#186 <b>\$19.95</b>	#186X <b>\$23.25</b>

**HIGHLY RECOMMENDED!**





Solid Color Cotton Web Waist Belt, White with Brass Plated Roller Buckle #78L44WH



Large Waist Buckle, Brass #178 (Front View)



Large Waist Buckle, Brass #178 (Side View)

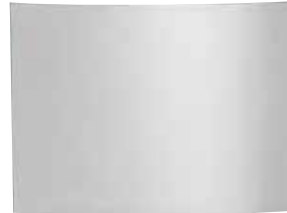

Large Waist Buckle, Nickel #179 (Front View)



Large Waist Buckle #179 (Rear View)

**Group A:**

Sold individually

Black BK
White WH
Navy NV
Royal Blue RY
Red RD
Buff/Khaki BU

**Solid Color Cotton Web Waist Belts**

Military Style: 1 1/4" width comes with roller buckle and metal tip.

To order, please include color abbreviation for clarification: e.g. #77L50NV (navy belt with brass buckle adjustable to size 50").



**Cotton Web Waist Belts:**

Roller Buckles available in Brass and Nickel

Quantity	Adjustable to 44"	Adjustable to 50"	Adjustable to 54"	Adjustable to 60"
----------	-------------------	-------------------	-------------------	-------------------

**Brass Plated with Roller Buckle and Tip**

Each (Group A only)	#77L44 <b>\$4.25</b>	#77L50 <b>\$4.50</b>	#77L54 <b>\$4.75</b>	#77L60 <b>\$4.95</b>
Dozen (Group B only)	#77L44 <b>\$51.00</b>	#77L50 <b>\$54.00</b>	#77L54 <b>\$57.00</b>	#77L60 <b>\$59.40</b>

**Belt with Nickel Roller Buckle and Tip:**

Each (Group A only)	#79L44 <b>\$4.25</b>	#79L50 <b>\$4.50</b>	#79L54 <b>\$4.75</b>	#79L60 <b>\$4.95</b>
Dozen (Group B only)	#79L44 <b>\$51.00</b>	#79L50 <b>\$54.00</b>	#79L54 <b>\$57.00</b>	#79L60 <b>\$59.40</b>

**Black Belt with Black Open Face Buckle and Tip:**

Dozen (Group B only)	#90L44DZ <b>\$45.50</b>	#90L50DZ <b>\$47.75</b>	#90L54DZ <b>\$49.50</b>	#90L60DZ <b>\$52.50</b>
----------------------	----------------------------	----------------------------	----------------------------	----------------------------



Black Belt with Black Open Face Buckle and Tip #90L see chart for sizes.

**Large Waist Buckles**

Fit easily on the vertical pieces of Pistol Belts and MP Belts with hook-and-eye closures as shown.

**Not engraved**

Brass, 2 1/2" x 3 1/2"	#178	<b>\$23.75</b> each
Nickel, 2 1/2" x 3 1/2"	#179	<b>\$23.75</b> each

**Engraved** (Submit customized engraving in writing. Two lines. 12 characters total.)

Brass, 2 1/2" x 3 1/2"	#178E	<b>\$33.75</b> each
Nickel, 2 1/2" x 3 1/2"	#179E	<b>\$33.75</b> each



Large Waist Buckle, Brass #178E (Engrave with up to 12 characters)



Roller Buckle, Brass plated #19



Open Face Buckle, Anodized Brass #8169



Roller Buckle, Nickel plated #18



Roller Buckle, Black #20



Open Face Buckle, Black #39

**Buckles for 1 1/4" Web Waist Belts**

**Roller Buckle 1 3/8" wide (regulation type):**

Brass-plated	#19	<b>\$1.95</b> each
Nickel-plated	#18	<b>\$2.75</b> each
Black	#20	<b>\$2.75</b> each

**Open Face Buckle 1 1/8" wide:**

Brass plain	#8167	<b>\$9.25</b> each
Brass anodized	#8169	<b>\$17.95</b> each
Black	#39	<b>\$3.25</b> each

**Belt tips to match above buckles:**

Brass-plated	#40B	<b>\$1.50</b> each
Nickel	#40N	<b>\$1.50</b> each
Black	#40BK	<b>\$1.50</b> each



= PERMANENT SHINE. No polish! Gently wipe with clean, soft cloth.

**Buckle Bag**

Soft gray buckle bag with drawstring protects your buckle's polished finish. 4" x 5 1/2"

Bag #199 **\$1.95** each



# Personalized Service for Teams!

Glendale's new service team's sole mission is to help prepare your team for competition. Whether you need expert product advice or help with large orders, we'll answer the call. We can even meet your team in person to measure everyone to ensure everyone gets the best possible fit the first time.

To learn more, call **1-800-653-5515** between 8 a.m. and 5 p.m. Monday through Friday, or leave a message at the same extension any time. You can also send an email to Bill or Isaac at the email addresses below.



**Bill Johnson**  
West/Mid-West Sales Manager.

Bill joined Glendale last year. He brings over 20 years experience to the Glendale team.

[bjohnson@glendale.com](mailto:bjohnson@glendale.com)



**Isaac Rodriguez**  
Central/Eastern US Sales Manager

Isaac joined the Glendale team in 2019. He has over ten years of experience of working with JROTC Programs.

[isaac@glendale.com](mailto:isaac@glendale.com)

## USAF Honor Guard Ceremonial Belt, Officer

Complete belt with Coat of Arms emblem on nickel buckle, plus catch and nickel keepers. Adjustable to 50".

USAF Belt, Officer #8157 **\$109.75** each



## USAF Honor Guard Ceremonial Belt, Enlisted

Complete belt with Hap Arnold emblem on nickel buckle, plus catch and nickel keepers. Adjustable to 50".

USAF Belt, Enlisted #8172 **\$109.75** each



## Army Ceremonial Belt

Complete belt with Coat of Arms emblem on gold-plated buckle, plus catch and lace keepers. Adjustable to 50".

Army Belt #8151 **\$89.95** each



USAF Honor Guard Belt, Officer #8157



USAF Honor Guard Ceremonial Belt, Enlisted #8172

Army Ceremonial Belt #8151



= **PERMANENT SHINE**. No polish! Gently wipe with clean, soft cloth.

USMC Dress Buckle gilt emblem #8164



USMC Cotton Web Khaki Belt #8168

## USMC Belts & Buckles

USMC Dress Buckle only, no emblem, 2" x 3". #8163 **\$49.95** each

USMC Dress Buckle only, gilt emblem, 2" x 3". #8164 **\$53.95** each

USMC cotton web khaki belt — 1 1/4" wide, 44" long with open, solid brass, gold-plated and hand-polished buckle. Government spec. #8168 **\$19.95** each



Buttons to shirt to keep ties straight



Designed to break away if grabbed by a suspect.

Clip-on Black, 18" #3045

Velcro Dark Navy, 20" #3050

**Quick Release Uniform Ties**

Stay safe while looking sharp! Designed to break away if grabbed by a suspect, these ties also have a buttonhole feature to keep them straight. Simply slide the narrow end of the tie through the loop and button to the shirt. Each is 3" wide with a permanent knot. Available in 18" or 20" length in dark navy or black. Made of polyester in the U.S.

**Clip-on**

Dark Navy, 18"	#3044	\$9.95 each
Dark Navy, 20"	#3046	\$9.95 each
Black, 18"	#3045	\$9.95 each
Black, 20"	#3047	\$9.95 each

**Velcro® closure**

Dark Navy, 18"	#3048	\$12.95 each
Dark Navy, 20"	#3050	\$12.95 each
Black, 18"	#3049	\$12.95 each
Black, 20"	#3051	\$12.95 each



**Female Neck Tab**

Velcro closure, poly-cotton blend. Black. Made in the USA

Black	#3053	\$13.95 each
Navy	#3054	\$12.50 each

Rain cover with visor sold on page 48.



**Uniform Poncho**

Heavy duty, opaque vinyl poncho — foul weather gear for parades and competitions — keeps your uniform dry and protected. Electronically sealed seams, double snaps on sides, permanent hood; individually packed in snap pouch. 50" x 80".

Poncho (Not Shown)	#490	\$5.50 each
--------------------	------	-------------

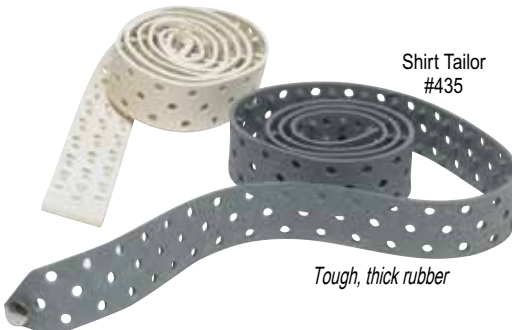

Shirt Tailor #435

Tough, thick rubber

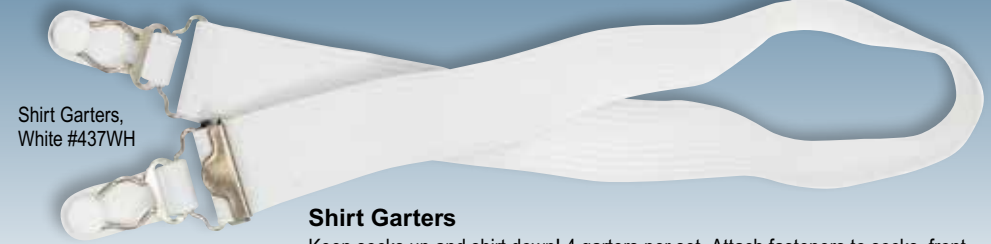

Shirt Garters, White #437WH

**Shirt Garters**

Keep socks up and shirt down! 4 garters per set. Attach fasteners to socks, front and back, and front and back of shirt tail. No metal touches body. Slide adjustment for comfortable tension. One size fits all.

Black	#437BK	\$12.50 set
White	#437WH	\$12.50 set

Super Shirt Stay Garters, #443BK



**Super Shirt Stay Garters**

Our Super Shirt Stay Garters ensure you always look parade-sharp. What's super? The No-Slip Clip, which attaches firmly to shirt while elastic stirrup strap slips under foot. Black only.

#443BK	Black	\$24.95 pair.
--------	-------	---------------

Stirrup Shirt Stays, #440BK



**Stirrup Shirt Stays**

Make sure your shirt stays tucked in smartly with stirrups. The elastic strap encircles your foot; the adjustable garters attach to your shirt. Black only.

Stirrup Shirt Stays	#440BK	\$13.75 pair
---------------------	--------	--------------

Military Y-Style Shirt Stay #441BK



**Military Y-Style Shirt Stay**

The single clip attaches to sock; the double clip attaches to shirt tail. 3/4" black elastic with black metal adjusters.

#441BK Black	\$11.50 pair
--------------	--------------

**Shirt Tailor**

Look professional and parade-ready every time with our Shirt Tailor. Wear it over your shirttail and inside your trousers just below the waistband to keep your shirt neatly tucked in and you looking sharp no matter the drill. Thick rubber and a reinforced end offer improved durability; light weight (6 oz) makes it day-long comfortable under uniform or casual clothes. 1 1/4" wide. One size fits most. 44" stretches to 46"; trim excess to fit. Gray or white.

Shirt Tailor, gray	#435	\$14.25 each
Shirt Tailor, white	#436	\$14.25 each



**Non-slip Shirt Holders 4pc set**

Non-slip locking clamps help avoid those awkward moments caused by clasps coming loose. Attach the clamps to your shirt and sock (front and back); use the adjustable clips to find the most comfortable fit. All four straps should be used to maintain a professional, dry-cleaned appearance.

Wash with warm, soapy water, air dry.

Black	#438BK	\$16.95 set
-------	--------	-------------



Non-slip locking clamps provide a secure grip on socks and shirt.

Shirt Lock is a great alternative to stays or suspenders!

Shirt Lock™ 1" #445



Shirt Lock™ 1 1/2" #446



**Shirt Lock™**

This undergarment belt was designed for uniformed officers in police, fire, military, and homeland security services. It's a reliable alternative to shirt stays, rubber and flex belts, and even suspenders. Made of high quality lightweight nylon hook-on-hook material that grips both the fabric of your shirt and your pants. Wear it around your waist just below the belt line of your pants — it won't roll — to hold uniform, dress or sport shirts. Includes a decorative anodized copper tin that helps maintain the Shirt Lock's shape and keep it lint free between uses.

1" width to 38"	#445	\$19.95 each
1" width to 48"	#445X	\$20.95 each
1 1/2" width to 38"	#446	\$21.95 each
1 1/2" width to 48"	#446X	\$22.95 each
1 1/2" width to 58"	#446XX	\$25.25 each

## Spats and Leggings



Snap Leggings  
#200E

M: Men's shoe sizes  
up to 7½  
L: Men's shoe sizes  
8 and above



Vinyl Spats  
#110E

### Vinyl Snap Leggings

Top-quality 9" leggings in a wipe-clean off-white vinyl with a fabric lining for comfort. White metal snaps on elastic ensure a proper fit.

S/M or L/XL #200E **\$34.95** pair

### Vinyl Spats

Top-quality 6" spats in a wipe-clean off-white vinyl have a fabric lining for comfort. White metal snaps on elastic ensure proper fit. S/M: Men's shoe sizes up to 7½; L/XL: Men's shoe sizes 8 and above.

S/M or L/XL #110E **\$19.95** pair

## Heel and Edge Color

### Angelus Roll Call Military Grade Edge Dressing

Used by the Old Guard for soles and edges! Black. 4 oz. Use it with the Honor Guard High Gloss Instant "Spit-Shine," sold above.

Military Grade Edge Dressing  
#3441 **\$10.75** each



Honor Guard  
Heel & Sole  
Edge Color  
Renew #3413



### Honor Guard Heel & Sole Edge Color Renew

Kiwi's® updated version of the black edge dressing previously available — but without the high gloss shine. Water resistant, it renews the factory finish of heels and soles. Plastic bottle and sponge applicator. 2.5 fl.oz.

Color Renew #3413 **\$7.95** each



Roll Call  
Edge  
Dressing  
#3441



## Blousers

Olive Drab  
#110D



Foliage Green  
#11FG



Black  
#11BK



Desert Tan  
#11DS



### Blousing Garters

Hook-on fastener.

Olive Drab	#110D	<b>\$2.25</b> pair	Tan	#11DS	<b>\$2.25</b> pair
Black	#11BK	<b>\$2.25</b> pair	Foliage Green	#11FG	<b>\$2.25</b> pair

### T.A.B.S.® Boot Blousers

A sturdy 2"-wide woven elastic band with hook and loop closure end tabs for military personnel or sportsmen. Wear them inside or outside your boots.

Black	#16BK	<b>\$4.95</b> pair	Olive Drab	#16OD	<b>\$4.95</b> pair
Desert Tan	#16DS	<b>\$4.95</b> pair	ACU Foliage Green	#16FG	<b>\$4.95</b> pair

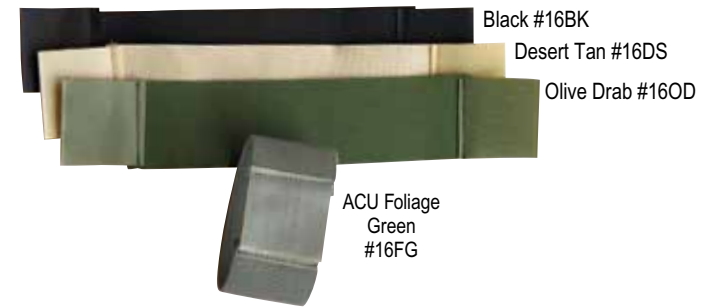

Black #16BK

Desert Tan #16DS

Olive Drab #16OD

ACU Foliage  
Green  
#16FG

## Leather Polish and Color

### Honor Guard High Gloss Instant "Spit-Shine"

When a real high gloss shine is what you want, this is the product you need! Made by Kiwi. Black. 2.5 oz. Use this along with the Angelus Roll Call Military Grade Edge Dressing.

Instant "Spit-Shine" #3412 **\$7.95** each

Honor Guard  
Instant "Spit Shine"  
#3412



### Parade Gloss Wax

Kiwi® Parade Gloss paste wax guarantees a brilliant, long-lasting and water-repellent shine. 1 1/8 oz.

Parade Gloss Wax  
#3414 **\$7.95** each



Parade Gloss Wax  
#3414

## Laces

### Nylon Boot Laces

No-fray nylon laces in 4 colors, 72".

Gold	#603G	<b>\$2.95</b> pair
Black	#603B	<b>\$2.95</b> pair
White	#603W	<b>\$2.95</b> pair
Red	#603R	<b>\$2.95</b> pair



### Military Boot Laces

For use with desert or mojave military boots. Tan nylon laces meet government specifications, 72".

Boot laces, tan #7441 **\$2.95** pair



## Leather Cleaner and Conditioner

### Leather Luster™

A liquid polish used by law enforcement, fire and rescue, military, sports officials, and medical personnel to give leather boots, shoes, gun belts, and other leather articles a brilliant, high gloss shine. It will not crack, peel or harm leather in any way. 4 oz. can.

Leather Luster™ #3443 **\$17.95** each



Leather Luster #3443

### Rough-Out Leather Cleaner & Conditioner



Keep rough-out leather looking clean and cared for, and prevent cracking and breaking. Built-in scrub topper; wipe clean. For best results, follow by protecting with Rough-Out Leather Color Renew & Protector #3435 or #3436 (available at paradestore.com).

4 oz. plastic bottle #3434 **\$8.95** each



Rough-Out Leather Cleaner & Conditioner #3434



### Rocky High-Gloss Dress Leather Oxford

At last, a stylish dress oxford that you'll look forward to wearing. Built with a premium on cushioning, it has a patented air flow insole that keeps your feet dry and comfortable all day. Made with Goodyear® welt construction and full-grain water-resistant leather, with a 1.5" heel and classic rounded toe. Oil-resistant rubber outsole. Color: Black. Standard Width Sizes: Whole and half sizes: 6-12, 13, 14, 15. Wide Width Sizes: Whole and half sizes: 4-13, 14, 15.

Medium Width #RK51S **\$106.00** pair  
Wide Width #RK51W **\$106.00** pair

### High Gloss Uniform Oxford

Mirror-finish black Oxfords spiff up your step and won't break your wallet. The tough, slip-resistant polyurethane outer sole ensures years of drilling; lightweight lining and removable cushion insole promise comfort. Manmade materials; steel shank. Cheater Bars and Heel Taps not recommended for these shoes. Men's Sizes: Whole: 3-15; Half: 4.5-12.5; Wide in Whole: 6-15, Half: 7.5-11.5. Women order two sizes down.

Standard Width #3455S **\$63.75** pair  
Wide Width #3455W **\$63.75** pair

Women order  
2 sizes down.

## Heel Taps and Cheaters

Civilian Guard  
Cheater Bars #3426



### Civilian Guard Cheater Bars

These new and improved cheaters — in size, position of the screw holes, and the screws themselves — are designed to be more compatible with the men's and women's shoes worn by civilian honor guards. The black oxidized finish is rust resistant inside and out. 4" x 7/8". Two bars and four screws per set.

Civilian Guard Cheater Bars #3426 **\$13.50** set



Old Guard Cheater  
Bars #3423



### Old Guard Cheater Bars



Worn on the inside of shoe heels to emphasize the "click" of the heels. Silver finish, 3 1/2" x 1". Two bars and four screws per set.

Old Guard Cheaters #3423

**\$13.50** set

### Honor Guard Horseshoe Heel Taps

These metal taps are sized for the shoe heel. Two in a set with extra nails. Please measure shoe heel, as there is no standardization in shoe size and heel size.

2 7/8" W x 3 1/8" H #3421S **\$10.95** set  
2 7/8" W x 3 1/4" H #3421M **\$10.95** set  
3 1/8" W x 3 3/8" H #3421L **\$10.95** set  
3 1/4" W x 3 9/16" H #3421XL **\$10.95** set



**COMFORTABLE AND AFFORDABLE!**



High Gloss Uniform Oxford #3455S

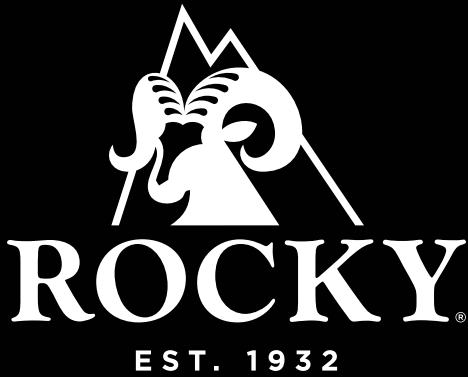

**LIGHTWEIGHT & DURABLE**

**NEW! Rocky® Lightweight Commercial Military Boots**

The comfort of an athletic shoe meets the performance of a tactical boot. These AR 670-1 and GSA-compliant boots weigh only 18 ounces per boot, thanks to the breathable, fast-drying leather and Cordura® nylon uppers. Removable Rocky Airport comfort sole, rubber midsole and aggressive multi-directional rubber outsole provide exceptional cushioning. 8" high with speed lace eyelets and NATO hooks for quick on and off. Padded collar. Color: Coyote Brown. Whole and half sizes 4-14, 15.

Medium #RKC042S \$160.00 pair  
 Wide #RKC042W \$160.00 pair



**NEW! Rocky® C7 CXT Tactical Boots**

Light on weight, heavy on performance. Designed by soldiers to deliver comfort and durability, they feature super breathable, triple-stitched uppers, supportive nylon shanks and a field-proven lightweight Vibram™ soles, yet weigh only 15 ounces per boot. Uniform and GSA/TAA compliant. Ultra-cushioning Ortholite memory foam footbed. Speed lace eyelets and NATO hooks. AR670-1 compliant flesh-out cattle hide leather construction. Color: Coyote Brown. Whole and half sizes 4-14, 15.

Medium #RK65S \$129.99 pair  
 Wide #RK65W \$129.99 pair







See page 67 for our complete selection of Arc Pins.

**JROTC Wallets** *GLENDALE EXCLUSIVE* 

We teamed with PerfectFit, the USA company that makes the most popular badge holders and wallets for police officers and first responders to create these highly customizable wallets for JROTC cadets. Crafted with care and backed by a lifetime leather warranty, each wallet includes your choice of coin and is available in two Arc Pin styles.

Colors: Black. Brown.

Arch Pin Styles: Raider. Rifle Team. Exhibition. Drill Team. Color Guard.

Coin styles: Army. Navy. Air Force. USMC. Space Force. Coast Guard.

#0833 Single Arc Wallet with Coin and Arc Pin **\$35.99** each

#0834 Double Arc Wallet with Coin and Two Arc Pins **\$39.99** each

Our JROTC Wallet makes a great commemorative gift for graduation or other special milestones!



# Show Your Team Spirit with Drill Socks!

## Drill Socks

Made exclusively for Glendale, these super comfortable socks featuring cushioned arch support and seamless toes really stand up to the rigors of drill practice and repeated washings. Knit in USA from a blend of 60% American grown cotton/35% Nylon/5% Spandex for breathable comfort and shape retention. Sock sizes: 9-11 or 10-13.

- #17501 Drill Team Socks. Color: Black **\$12.95/pr.**
- #17502 Drill Team Socks. Color: White **\$12.95/pr.**
- #17503 Crossed Rifle Socks. Color: Black **\$12.95/pr.**
- #17504 Crossed Rifle Socks. Color: White **\$12.95/pr.**

### Want Custom Socks for Your Team?

We can put your team's design on orders 60 pairs or more. Call for details.

## 9" Tactical Boots

The cushioning of a running shoe and the traditional support of military boot combine to set a new all-day comfort standard. The suede leather and nylon mesh uppers are backed by a moisture-wicking lining to help keep your feet dry. Easy on/off non-rusting YKK® side zipper has a hook-n-loop zipper strap that secures and silences the zipper fob. D-Ring top laces for a snug fit. EVA midsoles for cushioning. Steel shank for added support. Padded leather collar. Removable comfort cushion footbed Slip-resistant dura-grip outsoles. Note: Some sizes are subject to availability. Color: Desert Tan. 8" height. Whole and half sizes 7-11, 12 Medium.

Standard Width #3475S **\$109.95** pair



Glendale has your feet covered. We carry everything from high-performance, merino wool boot socks, to super comfortable cotton blend running socks. Visit us at [glendale.com](http://glendale.com) for the complete selection.

## Whistles



American Classic™ Whistle, Brass #817

Bosun's Whistle #812

American Classic™ Whistle, Nickel #818 shown with Cushion Cover #819

### Whistles



#### American Classic™ Whistle:

Brass #817 **\$8.75** each  
 Nickel #818 **\$8.75** each

#### Cushion/Cover for American Classic™ Whistle,

Black #819 **\$2.50** each

#### Bosun's Whistle

Brass-plated boating and sailing whistle is a replica of those still in use by boatswains on Royal Navy ships. Comes with chain as shown. (This whistle not made in the U.S.)

Bosun's Whistle #812 **\$12.50** each

## Chains and Holder



### Chains

#### Snake Chain with button hook:

Gold plated, 20" #813 **\$9.95** each  
 Nickel plated, 20" #814 **\$9.95** each

#### Police Whistle Chain

Spring clip at each end.  
 Chrome #126 **\$8.95** each



Bar and Hook Whistle Holder #820

#### Bar and Hook Whistle Holder

Gold plated #820 **\$5.95** each  
 Nickel plated #821 **\$5.95** each

## Toggles and Extenders



Button Toggle (Actual Size) #3430

**CUSTOMER FAVORITE!**

#### Button Toggle

Holds shank of button firmly in place. Nickel 3/4" long  
 Button Toggle #3430 **\$.50** each

#### Collar Extender

Add up to one-half size to your shirt collar! Loop extender over your collar button — it stays hidden behind your tie. Rust-proof.



Collar Extender #432

Collar Extender #432 **\$4.75** each

## Cleaning & Polishing



Giant Lint Roller #9276

#### Giant Lint Pick-Up Roller

Handy oversize roller makes a spotless appearance easy. Use before each competition or performance. 10" tall; 60 extra-large sheets—more than 36 feet of roller material!

Giant Lint Roller #9276 **\$9.95** each

**Tip:** Dust, lint and dandruff can make a crisp uniform look shabby. Keep your uniform in tip top condition with a lint roller.

**Call our Sales team for large or custom orders**  
**1-800-555-9269**



**Bill Johnson**  
 West/Mid-West Sales Manager.  
**bjohnson@glendale.com**



**Isaac Rodriguez**  
 Central/Eastern US Sales Manager  
**isaac@glendale.com**

## Nameplates

U.S. Army #251AE



AGSU #259AGE



U.S. Air Force #251AFE



U.S. Navy #251NE



U.S. Marine Corps #251MCE



### Military Plastic Nameplates



Made of a shatterproof and mar-resistant plastic with a non-glare smooth matte finish, nameplates have two military clutches on the reverse side. Plastic, rotary engraved. 15 letters max. Submit customized engraving in writing. Nameplates will be engraved with last name only in upper case.

#### Army nameplate: 1" x 3"

White letters on black, #251AE **\$3.25** each

#### AGSU nameplate: 1" x 3"

Tan letters on brown, #259AGE **\$5.25** each

#### Air Force nameplate: 5/8" x 3 3/16"

White letters on blue, #251AFE **\$3.25** each

#### Navy nameplate: 3/4" x 3"

White letters on black, #251NE **\$3.25** each

#### Marine nameplate: 5/8" x 3"

White letters on black, #251MCE **\$3.25** each

**Any of the above except AGSU, Please note branch of service.**

Regular Service Blank, #251B **\$2.75** each

AGSU Blank, #259B **\$3.00** each



U.S. Air Force Metal #252E

### USAF Metal Nameplate

Dress Uniform engraved metal nameplate, 3/4" x 3". Nameplates will be engraved with last name only in upper case.

USAF Metal Nameplate #252E **\$10.95** each



2024 National Drill championships



### Military Bib Scarves

Made to military specifications in the traditional tropical weave polyester, this scarf can be laundered or dry cleaned. Hook and loop closure. 19" neck measurement. Bib is 8 3/4" x 17". White, scarlet, brick red, maroon, purple, light navy, navy blue, infantry blue, teal, royal blue, academy royal, powder blue, dark green, kelly green, Glendale gold, dark gold, buff, orange, silver gray, black, and charcoal. The scarf extender can be used with this scarf.

Solid or Military Bib Scarf #015	\$9.25 each
Digital Military Bib Scarf #015DC	\$9.25 each

White WH	Purple PR	Teal TL	Dark Green GR	Buff BU	Black BK
Scarlet SC	Light Navy LN	Royal Blue RY	Kelly Green KG	Orange OR	
Brick Red BR	Navy Blue NV	Academy Royal AR	Glendale Gold GG	Silver Gray GY	
Maroon MR	Infantry Blue IB	Powder Blue PB	Dark Gold DG	Charcoal Gray CH	

### Pleated Bib Scarves

Smart pleats at the neckline distinguish this scarf, made in the traditional military tropical weave fabric that can be laundered or dry cleaned. 19" neck measurement with a hook and loop closure. Bib is 14" x 15". Available in white, scarlet, royal, navy, dark gold, Glendale gold, kelly green, and black. The scarf extender can be used with this pleated scarf.

Pleated Bib Scarves #020 \$10.50 each

White WH	Navy Blue NV	Kelly Green KG
Scarlet SC	Dark Gold DG	Black BK
Royal Blue RY	Glendale Gold GG	



See page 45 for Glendale's Color Compatibility Chart to match Bib Scarves, Berets and Cords

Call for a Free Swatch



### Smooth-as-Silk Bib Scarves

Soft polyester feels great against skin and can be laundered or dry cleaned. Scarves are already turned over once at the neckline and tacked down at the sides. Hook and loop closure. 19" neck measurement. Bib is 8 1/4" x 15". Available in awareness pink, white, scarlet, royal blue, navy blue, powder blue, dark orange, gold, maroon, and black.

Smooth-as-Silk Bib Scarves #014 \$9.95 each

White WH	Scarlet SC	Dark Orange DO
Maroon MR	Royal Blue RY	Navy Blue NV
Powder Blue PB	Gold GO	Black BK

Awareness Pink PK

Cold Weather Fleece Bib Scarf #011



### Winter Weight Fleece Bib Scarves

When the temperature starts dropping but honor duty calls, switch to this fleece scarf. The design is similar to a military bib scarf – but so much warmer! This machine washable fleece won't pill. Bib is 9 1/2" x 19". Available in black, dark gold, navy, royal blue, scarlet and white.

Fleece Bib Scarves #011 \$11.25 each

White WH	Scarlet SC	Dark Gold DG
Royal Blue RY	Navy Blue NV	Black BK

### Military Bib Scarf Extenders

For extra comfort, extend your neck band up to 4". Scarf Extenders can be used on all Glendale bib scarves, but fabric is the same as the #015 and #020 scarves. Colors shown above. Specify color code after order number. 3/4" wide by 4" with hook and loop closures at both ends.

Military Bib Scarf Extenders #018 \$2.95 each



### Leader Loops

A new style loop with a hook and loop closure that allows each loop to lie flat and secure under an epaulet. In the same tropical weave polyester as the #015 and #020 Bib Scarves. Available in Glendale gold, dark green, kelly green, navy, royal, scarlet, white, orange, and black.

Leader Loops #1015 \$5.95 pair

White WH	Scarlet SC	Orange OR	Glendale Gold GG	Navy Blue NV	Royal Blue RY
Dark Green GR	Kelly Green KG	Black BK			

glendale exclusive



Armed Forces Beret #4063

**Armed Forces Berets**

Military wool beret without the "pip" on top. Available with or without polyester lining. Adjustable drawstring fit with left badge stay and leather sweatband. XS S M L XL or give hat size. See chart below for color choices.

Fully lined	#4062	\$19.95 each
White only		\$19.95 each
Unlined	#4063	\$17.95 each
White only		\$17.95 each



2024 JROTC Nationals - Blackhawks team

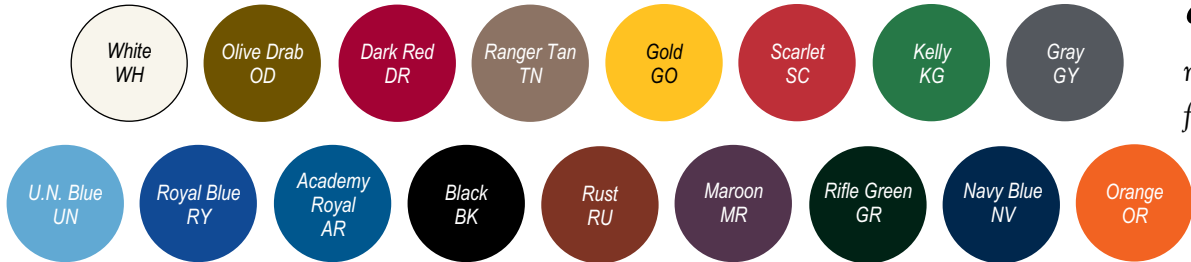

“Buying all my berets here from now on!”  
A.C., TX

See page 45 for Glendale’s Color Compatibility Chart to match Bib Scarves, Berets and Cords

# Glendale Makes it Easy to Coordinate Berets, Bib Scarves and Cords

**Special Forces Beret Flashes**

The Special Forces flashes shown at left are available with no minimum order. All flashes are 1 3/4" x 2". Order any flash at left by writing order number #4081 + number shown on flash.

#4081 \$3.95 each



**Patch Attach**

Here’s a quick and easy way to bond patches onto berets, jackets, and most fabrics without sewing! A hot iron makes it permanent and washable or dry cleanable. It’s also non-toxic. Use it for beret flashes, military and police patches, varsity letters, and school patches. Patch Attach is not recommended for satins, nylon, leather, or fabrics that are thin, sheer, padded, insulated, or so delicate they cannot withstand heat. 1 oz. #3410 \$7.95 each



# Comfort Meets Salute-Worthy Style



White Plastic Helmet  
#761

Chrome-plated Plastic Helmet  
#762

“Amazing delivery, faster than anything else. Will recommend to my fellow LAPD cadets and let them know about Glendale.”

J.N., CA

### Parade Helmets

White molded plastic helmet liner has an adjustable headband and 3/4" white web nylon adjustable chin strap. Shiny finish.

- White Plastic Helmet #761 **\$33.95** each
- Brilliant and reflective chrome-plated molded plastic helmet with adjustable headband and 3/4" white web nylon adjustable chin strap.
- Chrome-plated Plastic Helmet #762 **\$56.95** each

### Glendale's Color Compatibility Chart

If you're trying to compare scarves, berets and shoulder cords in the same color, the most compatible matches (barring any changes in manufacturers' colors or dye lots) are indicated in the following chart. Color swatches are available for scarves, berets and cords.

BIB SCARVES	BERETS	CORDS
White 011, 014, 015, 020	—	White
—	White 4024, 4051	White
Scarlet 011, 014, 015, 020	Scarlet 4024, 4051, 4062, 4063 Dark Red 4062, 4063	Scarlet
Dark Orange 014	Orange 4062, 4063	Orange
Maroon 014, 015	Maroon 4024, 4051, 4062, 4063	Maroon
Purple 015	Purple 4024, 4051	Purple
Navy Blue 011, 014, 015, 020	Navy Blue 4062, 4063	—
Light Navy Blue 015	Navy Blue 4024, 4051	Navy Blue
Infantry Blue 015	—	Infantry Blue
Royal Blue 011, 014	Royal Blue 4024, 4051	Royal Blue
Royal Blue 011, 015, 020	Royal Blue 4062, 4063	—
Academy Royal Blue 015	Academy Royal Blue 4062, 4063	—
Teal 015	—	Teal
Dark Green 015	—	Dark Green
Kelly 015, 020	—	Kelly
Dark Gold 011, 015, 020	Gold 4024, 4051	Dark Gold
Gold 014	Gold 4024, 4051	Dark Gold
Buff 015	—	Buff
Black 011, 014, 015, 020	Black, all styles	Black
Charcoal Gray 015	Gray 4062, 4063	—
—	Kelly 4024, 4051, 4062, 4063	Pine Green



Black Strap and Cup #86

White Strap and Cup #85

glendale  
exclusive

### Elastic Chin Straps and Cups

This may be the most comfortable chin strap and cup you'll ever wear! It's a soft white or black elastic with a soft plastic cup for use with our #761/#762 helmets. Will fit any size chin!

- White Strap and Cup #85 **\$9.95** each
- Black Strap and Cup #86 **\$9.95** each

glendale  
exclusive

*P.S. Customers tell us it's good for service caps, and shoes, as well!*



Flannel Helmet Bag  
#765

### Flannel Helmet Bag

Protect the white helmet or the highly polished surface of your chrome helmet from scratching with this soft green flannel storage bag, created especially for Glendale. Color may vary.

- Flannel Helmet Bag #765 **\$9.95** each





Uniform Carrying Case #1190

**CUSTOMER FAVORITE!**

## Code Alpha™

Designed for extreme use in adverse conditions, Code Alpha™ brand gear bags were developed for the Navy SEALs and military Special Operations Forces. They are constructed from the most durable materials available, packed with innovative features, and guaranteed to last.

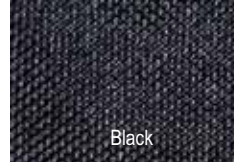

Black

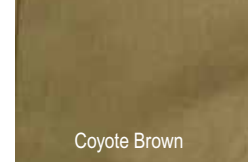

Coyote Brown

*“Made in USA—Excellent!”*

J.M., PA

*Don't forget to pack an extra set of gloves! See page 25.*



### Uniform Carrying Case

A Code Alpha™ carry-all in one durable organizer! Constructed of 600 denier water-resistant polyester, this two-level bag has movable dividers. The bottom level has a ventilated mesh front door; the top lid organizer has a large mesh section for assorted gear. There are large self-healing locking zippers (lock not included). Another easy feature is the address card window and hook-and-loop strip for name tapes. When not in use, it collapses in height from 12" to 2" for easy storage. Ease of handling and stability are assured with two end carry handles and non-slip rubberized feet. Black only. 12"H x 27"L x 14"D.

Black #1190 **\$119.95 each**



### Buckle Bag

Soft gray buckle bag with drawstring protects your buckle's polished finish. 4" x 5½"

Bag #199 \$1.95 each

### TSA Rifle Case Locks **NEW!**

These tough locks exceed TSA standards to provide extra security whenever you travel. Automatically relocks in the event of TSA inspection. Easy-set combination. Made of rugged zinc alloy and backed by an unconditional lifetime guarantee. Small Works great with carry on and other standard zipper bags. Large has a longer shackle for use with hard sided luggage and cases.

#1719 Small **\$7.50 each**  
 #1720 Small set of 3 **\$22.00 set**  
 #1767 Large. **14.95 each**  
 #1768 Large. set of 3 **35.95 set**



Small TSA lock #1719

**GET 10% OFF** when you buy a Rifle, Case and three locks!



Large TSA Lock #1767

### Garment Covers

Step up to a travel worthy solution. These tough travelers are infinitely better than plastic garment covers. Made of 600 denier polyester with a double vinyl backing for waterproof protection. Full length zipper and a hanging loop handle. 38½"L x 24"W x 3¼"D.

Black #1142 **\$29.95 each**  
 Coyote Brown #1141 **\$29.95 each**



Coyote Brown Garment Cover #1141



**WallyBags® Garment Bags**

WallyBags® offers a wide selection of high quality garment bags, featuring the exclusive WallyLock® hanger clamping system. Your clothes won't fall to the bottom of the bag with the innovative Wally® clamp that can accept any type of hanger. No folding, rolling, or special packing skills required. Pack straight from closet to garment bag – ready for travel! Clothes stay neat and wrinkle-free.

Durable, water repellent, polyester material provides all weather protection, and is designed to withstand the wear and tear of frequent travel. Conveniently fits in the overhead bin for most airlines. Made in China. Colors: Navy, Black.

**40" Garment Bags**

WallyLock® clamping system holds up to 6 hangers. Soft carrying handles wrap around the trolley system of rolling luggage for effortless travel. Full length center zipper, and 3" gusset. 40"L x 22"W x 3"D

- Black #1031BK \$49.95 each
- Black, Embroidered \* #1031BKE \$64.95 each

**40" 2-Pocket Garment Bags**

WallyLock® clamping system holds up to 6 hangers. Two pockets for packing shoes, a toiletry bag, and more. Full length center zipper, and 3" gusset. 40"L x 22"W x 3"D

- Black #1032BK \$69.95 each
- Black Embroidered\* #1032BKE \$84.95 each
- Navy #1032NV \$69.95 each
- Navy Embroidered\* #1032NVE \$84.95 each

**45" Extra Capacity 2-Pocket Garment Bag**

Larger WallyLock® clamping system holds up to 8 hangers. Two pockets for packing shoes, a toiletry bag, and more! Double side zippers open like a book for easy packing. 4" gusset. 45"L x 22"W x 4"D

- Black #1035BK \$89.95 each
- Black Embroidered\* #1035BKE \$104.95 each

\*40" and 45" WallyBags® can be embroidered with a personal ID of name and/or unit. Indicate one or two lines of embroidery and 25 letters per line. Embroidery colors: White, Red or Gold. Submit embroidery instructions in writing. Allow three weeks extra for embroidery.

Request a quote to add a logo to your bags.

40" Garment Bag, Navy #1031BK



#1031 Garment Bag Closed



#1032 Garment Bag Closed



Patented hanger clamping system prevents hangers and clothes from falling to the bottom of the bag. Clamping system design mark is registered in the U.S. Patent and Trademark Office.

40" 2-Pocket Garment Bag #1032BK



**45" Slim-Fit Garment Bag NEW!**

The WallyLock® clamping system holds up to 6 hangers. One pocket for packing shoes or toiletry bag. Perfect for a weekend trip. Full length center zipper. Colors: Black. 45"L x 24"W.

- Black #1030BK \$39.95 each

Black Lightweight Garment Cover #1030BK



45" Extra Capacity WallyBag® #1035BK

**Add your name or logo!**

Add an embroidered personal ID, and name to your bag for easy identification.



Add logos and emblems to your bags. No minimum quantities required. Call 1-800-653-5515 or email orders@glendale.com for a quote.

# Competition Color Guard Checklist

For the color guard unit looking to be highly proficient in competitions, Glendale Parade Store enlisted the help of professional drill team trainers to determine the best gear for competition color guards!

After more than a decade of National Championship-winning excellence, this gear comes recommended by the top color guard instructor in the country, Edford Luckey, MSG, USA (Ret.) formerly of Alamo Heights High School in San Antonio, TX.

NOTE: This gear checklist does NOT apply to MCJROTC units who must drill in strict accordance with their service guidance.

## Start with Poles and Toppers

Traditional Fit Two-Piece Aluminum Poles: see page 87

For male/mixed teams, select 8'x1 1/4".

#84S (Silver) or #84G (Gold)

For all-female teams, select 8'x1".

#81S (Silver) or #81G (Gold)

Aluminum poles add snap and pop to all your standing manual, ensuring your unit catches the judge's eye!

Round Spears are the BEST choice for uncasing/casing of the colors in competition due to their rounded edges!

Styrene Traditional Fit Round Spears see page 85

#85SC (Silver) or #85SG (Gold)

Traditional Fit 7" Army Spades see page 85

#22C (Chrome) or #22B (Brass)

Suitable for both National and Organizational/State colors!

## You'll want the best carriers...

Leather Flag Carrier, Double-Harness with Plastic Cup

#1802BK (Black) or #1802WH (White) see page 80

The larger diameter and material of the cup ensures no misses and amazing audio to "WOW" the judges! Also available in Clarino high-gloss finishes!

## Don't forget casings to protect the colors...

Canvas Flag Covers

#68 (Choose Your Color/Imprinting) see page 81

Choose from our wide variety of colors and imprint with lettering of your choice for a sharp look! These can be pressed and starched for crisp performance!

## Each member will need a belt...

Military Police Belt #180 (Choose Your Color/Finish) see page 35

Easy to maintain and classy, these belts will compliment each of your color guard cadets! Make sure to get one for each member of your color guard!

## Last but not least...

3x4 Un-Fringed American flag #0223 see page 95

and State Colors call for custom quote on state flags!

The 3x4 size ensures that flags do not hang in cadets' faces helping vision/alignment and displaying their amazing bearing to the judges! The shorter length means fewer cranks while uncasing/casing the colors! We recommend NO fringe for competition units, especially those uncasing/casing the colors!

## Do you need rifles?

Check out our selection of competition-ready drill rifles on pages 4-14! While any of these rifles are suitable for competition, we recommend the DrillAmerica 1903 Springfield replica rifle for its sharp appearance and exceptional balance!

# Army JROTC and ROTC Ribbons



Ribbon mounts are on page 67.

## Superior Cadet Award Set

Set includes boxed medal, ribbon and pin.

### JROTC

Set #9026 **\$29.95** each

Ribbon Only

#R9026 **\$1.95** each

### ROTC

Set #9027 **\$29.95** each

Ribbon Only

#R9027 **\$1.95** each

Superior Cadet Award Set #9026



## JROTC and ROTC Ribbons

Regulation JROTC and ROTC Ribbon Slides. Order by ribbon number.

N Series - Army JROTC #N **\$1.35** each

R Series - Army ROTC #R **\$1.35** each

## JROTC and ROTC Ribbon Drapes

Regulation JROTC and ROTC Ribbon Drape with pin and safety catch and gold ring.

ND Series - Army JROTC #NDG **\$3.50** each

RD Series - Army ROTC #RDG **\$5.75** each

For a complete listing of all our ribbons, with photos, visit us online at [www.Glendale.com](http://www.Glendale.com)

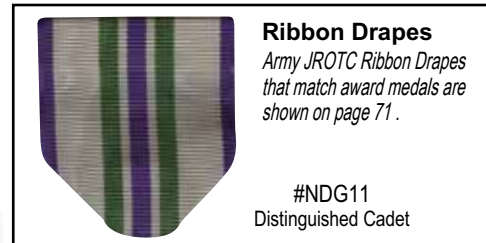

### Ribbon Drapes

Army JROTC Ribbon Drapes that match award medals are shown on page 71.

#NDG11  
Distinguished Cadet



## Ribbon Attachments

Torch measures: 1/4" high. Lamp measures: 1/4" wide.

Torch Awards, Senior-bronze, silver, gold (2nd, 3rd, 4th).

Torch Award #2085 **\$1.95** each

Lamp of Knowledge Awards, Junior-bronze, silver, gold.

Lamp of Knowledge Award #2086 **\$1.70** each

# Army ROTC Pins and Patches



Academic Achievement

Honor Unit

Meritorious Unit

Honor Unit with Distinction

## ROTC Honor Insignia

Academic Achievement, gold. #775 **\$6.75** each

Honor Unit, blue enamel star. #776 **\$3.75** each

Honor Unit w/ Distinction, gold enamel star. #777 **\$4.95** each

Meritorious Unit, white enamel star. #779 **\$4.75** each

Felt Pads for Achievement insignia sold above:  
red, gray, gold. #778 **\$1.30** each



## Army ROTC Distinguished Cadet Badge

Silver finish, clutch back. #903 **\$12.50** each



## ROTC Rifle Badges

Each 2 3/8" with nickel finish.

Rifle, plain #9020 **\$8.95** each

Rifle, 1 star #9021 **\$10.50** each

Rifle, 2 star #9022 **\$10.50** each



## Physical Fitness Excellence Patch

Patch, full color, 2 1/2".

Full color #832

**\$4.95** each



## Raider and Ranger



#829OCP

### Raider Tabs

Gold on Black

- Gold on black #829C11 \$2.50 each
- OCP with Velcro™ #829OCP \$4.25 each



Gold on Black

### Raider Challenge Tabs

Army JROTC Competition

- Gold on black #836C11 \$2.50 each
- OCP with Velcro™ #836OCP \$4.50 each



Gold on Royal Blue

### Ranger Tabs

- Gold on royal blue #828C10 \$2.50 each
- Gold on black #828C11 \$2.50 each
- White on black #828C17 \$2.50 each
- OCP with Velcro™ #828OCP \$4.50 each



Gold on Black

### Ranger Challenge Tabs

Army SR ROTC Competition

- Gold on black #830C11 \$2.50 each
- OCP with Velcro™ #830OCP \$3.25 each



Regulation

Dress Mini

### Ranger Pins

- Regulation: gold plated, clutch back, 1 1/4" #828PR \$6.25 each
- Dress Mini: gold plated, clutch back, 3/4" #828PM \$5.75 each



### Army ROTC Ranger Beret Flash

- Gold and black #831 \$3.50 each



Ranger Beret Flash

See page 43 for more Beret Flashes.

## JROTC Challenge Coin

Army JROTC Front



Design on back



glendale  
exclusives

Actual Size

### JROTC Challenge Coin

By popular request, here's another Glendale exclusive! These JROTC Challenge Coins are available for all units. All have the eagle and sunburst on the reverse side in matching finish. Each coin is 1 1/2" in diameter.



Army JROTC Challenge Coin, antique gold finish #CCAJR \$11.50 each

## Shoulder Tabs and Patches

### Army Cadet Command Patches



- Full color #842 \$4.75 each
- Hook backing for OCP #842OCP \$6.95 each

### Army JROTC Patches



- Full color #840 \$5.25 each
- Hook backing for OCP #840OCP \$7.95 each

### Shoulder Tabs



Standard Shoulder Tabs are 2 3/4" across; OCP Digital Shoulder Tabs are 3 3/4" across. Hook backing. Not shown to size.

#### OCP Digital Camo

- Honor Guard #821OCP \$3.50 each
- Drill Team #823OCP \$3.50 each
- Rifle Team #824OCP \$3.50 each
- Color Guard #825OCP \$3.50 each

#### ACU Digital Camo

- Honor Guard #821ABU \$4.25 each
- Drill Team #823ABU \$4.25 each
- Rifle Team #824ABU \$4.25 each
- Color Guard #825ABU \$4.25 each

#### Colored Tabs See Color Chart below

- Honor Guard #821 \$2.50 each
- Drill Team #823 \$2.50 each
- Rifle Team #824 \$2.50 each
- Color Guard #825 \$2.50 each

### How to order Shoulder Tabs

To order shoulder tabs, indicate # of shoulder tab + # of color - for example, the Honor Guard tab in white on royal, should be ordered as #821C16.

Lettering	Background	Border
C10	Gold	Royal Blue
C11	Gold	Black
C13	Gold	Red
C15	White	Red
C16	White	Royal Blue
C17	White	Black
C19	White	Brown
C20	White	Kelly Green
C23	Royal Blue	White
C24	White	Maroon
C26	Red	White
C27	Royal Blue	White
CS	Black	OD



#842OCP



Full color



#840OCP



#821OCP



#821  
C23



#823OCP



#823  
C15



#824OCP



#824  
C10



#825ABU



#825  
C27

## Qualification Badges

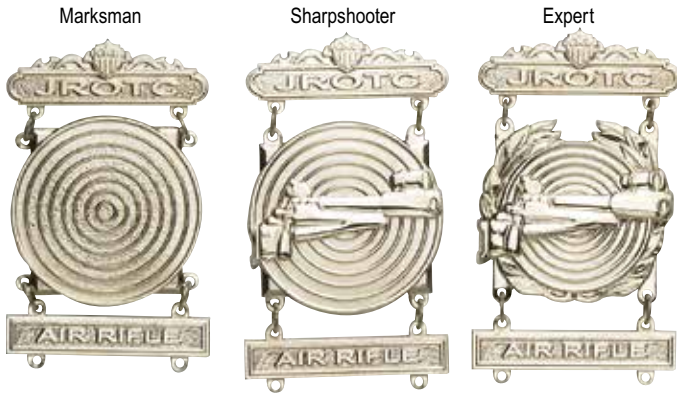

All Three Different Badges available in either Bright Nickel (shown above) or Silver Oxide (shown below)



### Army JROTC Qualification Badges

Choose from six badge styles, all available in Bright Nickel or Silver Oxide finish. 2½" H x 1½" W.

	Silver Oxide	Bright Nickel
Marksman, Air Rifle	#3010 <b>\$12.95</b>	#3110 <b>\$12.95</b>
Sharpshooter, Air Rifle	#3012 <b>\$13.95</b>	#3112 <b>\$13.95</b>
Expert, Air Rifle	#3014 <b>\$14.75</b>	#3114 <b>\$14.75</b>

## Cap Devices



### Cadet Officer Cap Device

Army Service Cap Device  
Male, screw back  
#9002 **\$12.95** each  
Female, clutch back  
#9003 **\$11.95** each



### Regulation ROTC Cap Device

with letters in panel: gold plate, screw back or clutch back.  
Screw back  
#9001SB **\$7.95** each  
Clutch back  
#9001CB **\$5.95** each

= PERMANENT SHINE. No polish! Gently wipe with clean, soft cloth.

## Flags



Cadet Double Guidon  
Available with up to 2 letters or numbers

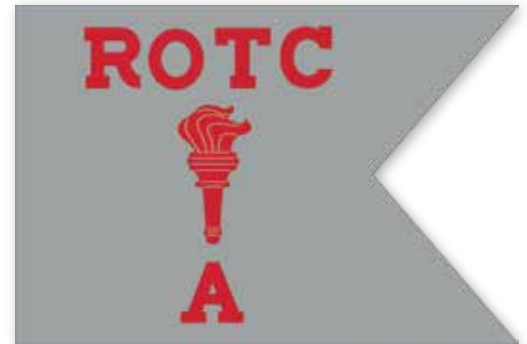

Army Guidon

### Cadet Command Double Guidon

This flag with Leadership Excellence emblem is made to customer specifications with a pole hem — 20" x 27¾" Allow 3–5 weeks for delivery.

Emblem only	#7703	<b>\$99.95</b> each
Emblem and 1 number/letter	#7703C1	<b>\$109.95</b> each
Emblem and 2 numbers/letters	#7703C2	<b>\$119.95</b> each



### Army Guidon

20" x 27¾" Allow 3–5 weeks for delivery - Bottom Line can change.  
Army Guidon #ARMYGUIDON **\$335.95** each



### Customizable JROTC Unit Flag

Double Lined construction.  
Pole hem with Velcro Tabs

### For Outdoor Use

Appliqued/Embroidered Design on nylon  
#AJROTCFLAG  
3' x 4' **\$899.00**

For more custom flags turn to page 88



### Custom Guidon

Let Glendale help you design your unit's custom guidon. See page 88 for options and pricing. Contact customwork@glendale.com to have a guidon made for your unit.



# Insignia

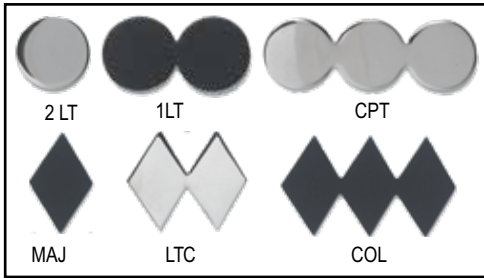

## ROTC Rank Insignia

Smooth metal, all have military clutch backs.

2nd Lt: Single disc			
Silver-plated	#2801	\$6.50	pair
Black metal (Subdued)	#2807	\$6.25	pair
1st Lt: Double disc			
Silver-plated	#2811	\$7.95	pair
Black metal (Subdued)	#2815	\$6.95	pair
Capt: Triple disc			
Silver-plated	#2819	\$9.95	pair
Black metal (Subdued)	#2823	\$8.50	pair
Maj: Single diamond			
Silver-plated	#2802	\$6.95	pair
Black metal (Subdued)	#2808	\$5.95	pair
Lt Col: Double diamond			
Silver-plated	#2812	\$7.95	pair
Black metal (Subdued)	#2816	\$6.95	pair
Col: Triple diamond			
Silver-plated	#2820	\$9.95	pair
Black metal (Subdued)	#2824	\$8.50	pair

## Scorpion OCP Cadet Rank

Hook backing, specify rank.

Scorpion OCP #9050 All \$4.50 each

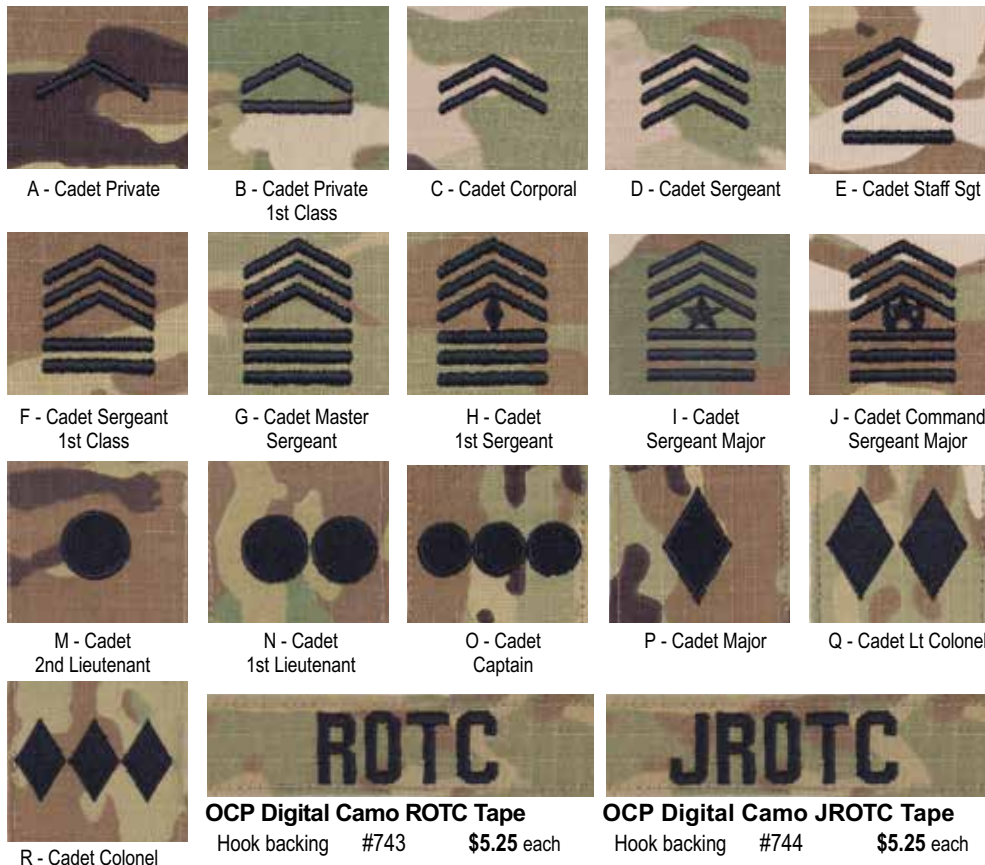

### OCP Digital Camo ROTC Tape

Hook backing #743 \$5.25 each

### OCP Digital Camo JROTC Tape

Hook backing #744 \$5.25 each

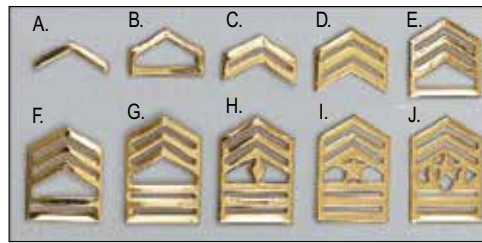

## Army ROTC Metal Chevrons

Senior division choose	Plated, pair	Black, pair
Gold-plated or Black (Subdued).	#9010	#9011
A- Private	\$4.95	\$4.75
B- Private First Class	\$5.95	\$4.95
C- Corporal	\$7.25	\$5.25
D- Sergeant	\$7.50	\$5.50
E- Staff Sergeant	\$7.75	\$5.75
F- Sergeant First Class	\$7.95	\$5.95
G- Master Sergeant	\$8.25	\$6.25
H- First Sergeant	\$8.50	\$6.50
I- Sergeant Major	\$8.75	\$6.75
J- Command Sergeant Major	\$8.95	\$6.95



## Command Crest

Army Cadet  
Command Crest  
#842C \$8.75 each



## ROTC Collar Insignia

Gold plate, clutch back.	#910	\$6.25	pair
Nickel plate, clutch back.	#911	\$5.75	pair
Subdued, clutch back.	#912	\$5.25	pair

## JROTC Collar Insignia

Gold plate, clutch back.	#914	\$6.25	pair
Nickel plate, clutch back.	#915	\$5.95	pair
Subdued, clutch back.	#916	\$5.50	pair



## Torch on Disc

Brass, clutch back.  
#913 \$9.25 pair

Large chevrons-  
male

Small chevrons-  
female

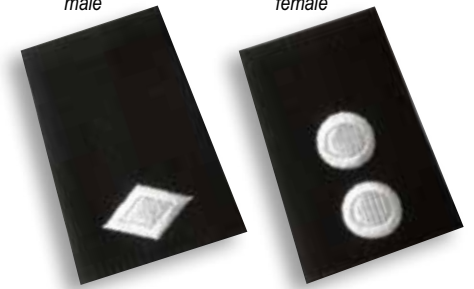

## Army ROTC Cadet Epaulets

#9013 Large chevrons: male, pair.  
#9014 Small chevrons: female, pair.

A - Private	\$7.95
B - Private First Class	\$8.75
C - Corporal	\$8.75
D - Sergeant	\$9.25
E - Staff Sergeant	\$9.95
F - Sergeant First Class	\$10.25
G - Master Sergeant	\$10.95
H - First Sergeant	\$11.95
I - Sergeant Major	\$12.50
J - Command Sergeant Major	\$12.50
M - Second Lieutenant	\$8.75
N - First Lieutenant	\$10.25
O - Captain	\$11.95
P - Major	\$9.25
Q - Lieutenant Colonel	\$10.95
R - Colonel	\$12.50



## Scorpion OCP Custom Camo Tape

Letters are black on digital camo background with hook backing. 15 letters max. Submit names in writing. Please allow 10 business days for customizing.

#ACUTAPE Custom	\$5.50	each
#OCPTAPE-ARMY Custom	\$4.95	each

= PERMANENT SHINE. No polish! Gently wipe with clean, soft cloth.



**Glendale Carabiners *NEW!***

Classic D-style climbing carabiners favored by climbers and adventurers worldwide. All styles are capable of supporting over 5,000 lbs..

**Aluminum**

Bright blue color helps set your team apart.

#120 Locking, 2.8 oz. \$18.00 each

**Steel**

#313 Standard Weight: 5.5 oz. \$12.00 each

#121 Locking Weight: 5.7 oz. \$15.00 each

**Raider Climbing Rope *NEW!***

These high-performance ropes feature a tough outer sheath that minimizes stretch, withstands hard use, and makes rappelling a breeze. Color: Olive Drab. Length: 150', Diameter: 7/16".

#SR150 \$200.00 each



**Raider Platoon Guidon Flag**

Represent your unit with pride. Two styles: Black with gold letters, single reverse (20" x 30"). Black with gold letters, single reverse, and pole hem (20" x 27 3/4").

# 2225 \$119.95 each

**Merino Wool Blend Interceptor Boot Sock *NEW!***

Our highest ranking boot sock is knit from a supremely comfortable, long wearing blend of 53% Merino wool/38% nylon/9% Spandex for all-day performance. Made in USA. Colors: Black. Coyote. Olive.

#270 Black (Sock sizes 9-11) \$16.95/pair

#271 Coyote (Sock sizes 10-13) \$16.95/pair

#273 Olive (Sock sizes 10-13) \$16.95/pair



**Two *NEW* styles of Rocky Boots!**

Turn to page 40 to learn more



**Socks that Make a Statement**

Land of the Free Socks 17300

Alamance Socks 17301

Crossed Rifle Drill Socks White 17504, Black 17503

Solid Color Drill Socks White 17502, Black 17501

Freedom Isn't Free Socks 16110

Don't Mess with Texas Socks 17601

**Drill Team Socks**

Made exclusively for Glendale, these super comfortable socks really stand up to the rigors of drill practice and repeated washings. Knit in USA from a blend of 60% American grown cotton/35% Nylon/5% Spandex for breathable comfort and shape retention. Size 10-13

- 17502 White Drill Socks. \$12.95 pair
- 17501 Black Drill Socks. \$12.95 pair
- 17504 White Crossed Rifle Drill Socks. \$12.95 pair
- 17503 Black Crossed Rifle Drill Socks. \$12.95 pair
- 17505 Raider Drill Socks. Color: Black. \$12.95 pair
- 16110 Freedom Isn't Free Socks. \$12.95 pair.
- 17300 Land of the Free Socks. \$12.95 pair
- 17601 Don't Mess with Texas Socks. \$12.95 pair.
- 17301 Alamance Socks. \$12.95 pair.

**Want Custom Socks for Your Team?**

We can put your team's design on orders 60 pairs or more. Call for details.



# Insignia

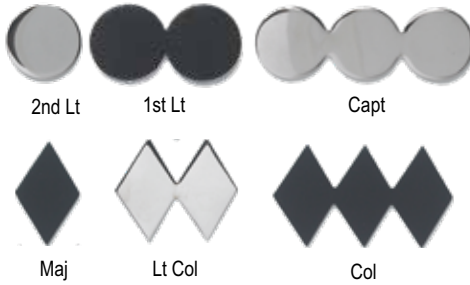
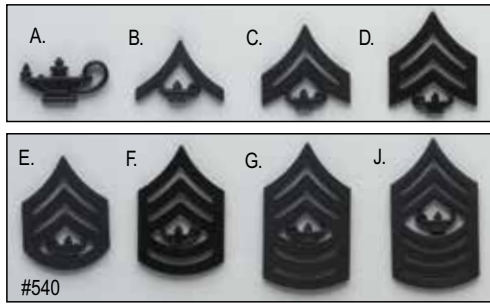

## MCJROTC Metal Chevrons



All have military clutch backs. Indicate rank

	Black, #540	Gold, #541
A- Private First Class	\$5.95 pair	\$8.50 pair
B- Lance Corporal	\$7.50 pair	\$8.50 pair
C- Corporal	\$7.75 pair	\$9.25 pair
D- Sergeant	\$7.95 pair	\$9.75 pair
E- Staff Sergeant	\$7.95 pair	\$9.75 pair
F- Gunnery Sergeant	\$8.25 pair	\$10.25 pair
G-1st Sergeant	\$9.25 pair	\$10.50 pair
J-Sergeant Major	\$9.95 pair	\$10.95 pair

## ROTC Mini Rank Insignia



Smooth metal all have military clutch backs.

2nd Lt: Single disc		
Silver-plated	#2831	\$8.50 pair
1st Lt: Double disc		
Silver-plated	#2833	\$8.50 pair
Capt: Triple disc		
Silver-plated	#2835	\$8.50 pair
Maj: Single diamond		
Silver-plated	#2832	\$8.50 pair
Lt Col: Double diamond		
Silver-plated	#2834	\$8.50 pair
Col: Triple diamond		
Silver-plated	#2836	\$8.50 pair

## ROTC Rank Insignia

Smooth metal, all have military clutch backs.

2nd Lt: Single disc		
Silver-plated	#2801	\$6.50 pair
Black metal (Subdued)	#2807	\$6.25 pair
1st Lt: Double disc		
Silver-plated	#2811	\$7.95 pair
Black metal (Subdued)	#2815	\$6.95 pair
Capt: Triple disc		
Silver-plated	#2819	\$9.95 pair
Black metal (Subdued)	#2823	\$8.50 pair
Maj: Single diamond		
Silver-plated	#2802	\$6.95 pair
Black metal (Subdued)	#2808	\$5.95 pair
Lt Col: Double diamond		
Silver-plated	#2812	\$7.95 pair
Black metal (Subdued)	#2816	\$6.95 pair
Col: Triple diamond		
Silver-plated	#2820	\$9.95 pair
Black metal (Subdued)	#2824	\$8.50 pair

## Navy JROTC Cap Devices



Small Fouled Anchor for Garrison Cap, clutch back	#642	\$6.95 each
Large Fouled Anchor for Combination Cap, screw back	#643	\$11.95 each

# Awards



## Navy JROTC Award Ribbons

Slide only. Please order by name.

Award Ribbons	#2082	\$1.35 each
---------------	-------	-------------

## Marine Corps JROTC Award Ribbons

Slide only. Please order by name.

Award Ribbons	#2083	\$1.35 each
---------------	-------	-------------



There's an extensive list of ribbon mounts and ribbon attachments on page 67.

A complete listing with pictures of all our ribbons can be seen on our web site at [www.paradestore.com](http://www.paradestore.com).

# JROTC Challenge Coins

## JROTC Challenge Coins glendale exclusives



By popular request, here's another Glendale exclusive! These JROTC Challenge Coins are available for all units. All have the eagle and sunburst on the reverse side in matching finish. Each coin is 1 1/2" in diameter.

Navy JROTC Challenge Coin, Antique gold finish	#CCNJR	\$11.50 each
Marine Corps JROTC Challenge Coin, Antique gold finish	#CCMJR	\$11.50 each

Navy JROTC Front



Marines JROTC Front



Design on back of both



# Insignia

## AFJROTC Cadet Officer Insignia



## Cadet Airman Insignia



## AFJROTC Cadet Officer Insignia

Silver and enamel with clutch back fastener, 5/8" W x 1 1/8" H. Specify Rank

- #9011 **\$14.95** pair
  - M- 2nd Lieutenant
  - N- 1st Lieutenant
  - O- Captain
  - P- Major
  - Q- Lieutenant Colonel
  - R- Colonel
- (For Senior Program:  
#9011M = 4th Class;  
#9011N = 3rd Class)

## Cadet Airman Insignia

Silver and enamel chevrons with clutch back fastener. (These all match current regulations.) Specify Rank #9009

- A- Airman **\$14.25** pair
- B- Airman 1st Class **\$15.25** pair
- C- Senior Airman **\$16.25** pair
- D- Staff Sergeant **\$16.50** pair
- E- Tech Sergeant **\$16.75** pair
- F- Master Sergeant **\$19.95** pair
- G- Senior Master Sergeant **\$20.95** pair
- I- Chief Master Sergeant **\$21.95** pair

## AFROTC Cadet Officer Insignia

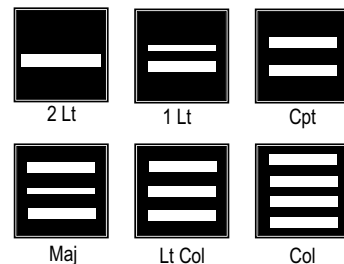

## AFROTC Cadet Officer Insignia

Cadet Officer Insignia, black and silver, clutch back, Specify Rank #9015 **\$11.50** pair

- M- 2nd Lieutenant
- N- 1st Lieutenant
- O- Captain
- P- Major
- Q- Lieutenant Colonel
- R- Colonel

# Cap Devices



AFROTC POC Service Cap, #9004



AFROTC POC Flight AFJROTC Cadet Officer Service #9005, #9006, #9007



GMC and JROTC Cadet Airman #901, #902, #908

## Cadet Officer Cap Devices

- AFROTC POC Service Cap Device: screw back. #9004 **\$13.95** each
- AFROTC POC Flight Cap Device: clutch back. #9005 **\$10.95** each
- AFJROTC Cadet Officer Service Cap Device: screw back. #9006 **\$19.95** each
- AFJROTC Cadet Officer Service Cap Device: clutch back. #9007 **\$19.95** each

## AFROTC GMC & JROTC Cadet Airman Cap Devices

- AFROTC Service Cap Device: screw back. #901 **\$26.95** each
- AFROTC Flight Cap Device: clutch back. #902 **\$9.95** each
- AFROTC Service Cap Device: clutch back. #908 **\$24.95** each

# Flags



## Air Force JROTC Flags

All AFJROTC flags are Indoor/Parade only. They have a royal blue background with the shield emblem in the center.

- Single with fringe, 3' x 5' #7700AF5 **\$99.95** each
- Single without fringe, 3' x 5' #7700AF6 **\$74.95** each
- Double with fringe, 3' x 5' #7700AF7 **\$139.95** each

*"You went above and beyond to make sure that we were taken care of and received our items in plenty of time. Thank you so much!!"*

Ron King, IN



## AFROTC and AFJROTC Soft Epaulets

Specify size: male (LG) female (SM)

- |                              |                              |
|------------------------------|------------------------------|
| AFJROTC, POC grade. #9017    | AFROTC, POC grade. #9018     |
| M- 2Lt <b>\$11.50</b> pair   | M- 2Lt <b>\$13.25</b> pair   |
| N- 1Lt <b>\$12.50</b> pair   | N- 1Lt <b>\$13.75</b> pair   |
| O- Capt <b>\$13.25</b> pair  | O- Capt <b>\$14.25</b> pair  |
| P- Maj <b>\$14.75</b> pair   | P- Maj <b>\$14.75</b> pair   |
| Q- LtCol <b>\$15.25</b> pair | Q- LtCol <b>\$15.50</b> pair |
| R- Col <b>\$16.50</b> pair   | R- Col <b>\$16.50</b> pair   |

# Badges



AFJROTC Flight Solo #906  
AFROTC Flight Pilot #9031



AFJROTC Ground School #905  
AFROTC Navigator #9030



AFJROTC Flight Certificate #907



AFROTC Senior Navigator Instructor #9032

## AFJROTC Badges

- Ground School #905 **\$10.95** each
- Flight Solo #906 **\$10.95** each
- Flight Certificate #907 **\$10.95** each

## AFROTC Badges

- Navigator #9030 **\$10.95** each
- Flight Pilot #9031 **\$10.95** each
- Senior Navigator Instructor Wings #9032 **\$14.75** each

= PERMANENT SHINE. No polish! Gently wipe with clean, soft cloth.

# Awards



Missile Badge #9024



Model Rocketry Badge #9023

### Missile Badge

Bright Nickel #9024 **\$12.95** each

### Model Rocketry Badge

Bright Nickel #9023 **\$10.95** each



Wings and Prop, Bright Nickel

### AF Wings and Prop Collar Devices

Solid Bright Nickel #909 **\$13.95** pair  
 Nickel propeller/ gold-plated wings. #917 **\$15.95** pair



### AFROTC Cadet Training Officer Badge & AFJROTC Distinguished Cadet Badge

Blue enamel, clutch back #904 **\$11.50** each



### Hap Arnold Beret Device

Solid Bright Nickel #709S **\$9.95** each



### AFJROTC & AFROTC Ribbon Awards

Slide only. Please order by name.

AFROTC #2081 **\$1.35** each  
 AFJROTC #2080 **\$1.35** each



A complete listing with photos of all our ribbons can be seen on our website at [www.ParadeStore.com](http://www.ParadeStore.com).

# Shoulder Patches

AFJROTC Presentation Badge Full color #845

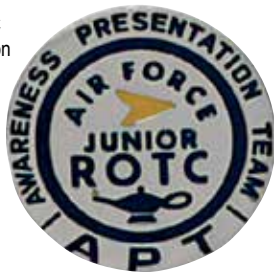

AFJROTC Patch Full color #844



### Cadet Airman Patches & Badge

AFJROTC Awareness Presentation Team Badge Full color 1 1/2". #845 **\$5.95** each  
 AFJROTC Patch: Full color #844 **\$4.25** each  
 Full color Velcro #844V **\$5.50** each  
 OCP #844OCP **\$6.50** each



Visit [paradestore.com](http://paradestore.com) to see the complete selection of Air Force OCP insignia and patches.



AFJROTC #741ABU



AFJROTC #741OCP

### ABU Digital Camo and OCP AFJROTC Tape

Letters are dark blue on digital camo background.

#741 AFJROTC ABU Tape, Sew-on **\$4.95** each  
 #747 AFJROTC ABU Tape, Hook backing **\$5.25** each  
 #741OCP AFJROTC OCP Tape, Sew-on **\$4.95** each  
 #747OCP AFJROTC OCP Tape, Hook backing **\$5.95** each



Custom Tape #ABUTAPE



Custom Tape #OCPTAPE

### ABU Custom Digital and OCP Camo Tape

Letters are dark blue on digital camo background with hook backing. 15 letters max. Submit names in writing. Please allow 10 business days for customizing.

#ABUTAPE Custom **\$4.95** each  
 #OCPTAPE-AIR FORCE Custom **\$4.75** each

# JROTC Challenge Coin



Air Force JROTC Front



Design on back

### JROTC Challenge Coin

By popular request, here's another Glendale exclusive! These JROTC Challenge Coins are available for all units. All have the eagle and sunburst on the reverse side in matching finish. Each coin is 1 1/2" in diameter.



Air Force JROTC Challenge Coin, antique nickel finish #CCAFJR **\$11.50** each

Call for OCP Shoulder Patches and Insignia

1-800-653-5515



**Male AGSU Coat**

Our Army Green Service Uniform Jacket is made to government specifications and features a 55% polyester/45% gabardine wool weave that's wrinkle resistant and a pleasure to wear in all seasons. Bi-swing (gusseted) construction and moisture-wicking lining provide ease of movement and all-day comfort when on the go. Diamond quilted chest lining. Front placket has removable buttons for easy cleaning. Imported. Choose Classic or Athletic Cut.

Sizes: Small, Regular, and Long. Available from 38 to 58XL. Visit Glendale.com for detailed sizing information.

**Classic Cut**

Has a traditional fit, providing more room through the trunk of the body and a looser chest fit.

#AGSU2 Jacket **\$379** each

**Athletic Cut**

Has a tailored fit that accommodates a larger chest and a slimmer waist.

#AGSU1 Jacket **\$379** each



**AGSU Service Belt**

U.S. Army AGSU spec cotton belt with metal buckle and tip. 1.25" width. Unisex style. Choose 44", 49" or 55" length.

#AGSU8

**\$23.75** each



**Male Brown Leather Dress Shoe**

Designed for comfort right out of the box. Full-grain leather uppers with a moisture-wicking lining for all-day comfort. Removable cushioned insole. Slip-resistant, non-marking outsole. Color: Brown. Whole and half sizes: 6 to 15. Choose Regular or Wide width.

#AGSU12

**\$139.00** each

**Male AGSU Shirt**

Our Army Green Service Uniform Shirts are made to government specifications from a special 55% polyester/45% wool blend that is wrinkle-resistant, exceptionally comfortable, and never needs ironing. Button chest pockets. Officer shirts have shoulder epaulettes. Long Sleeve sizes 14 x 30/31 to 21½ x 38/39. Short Sleeve neck sizes 14 to 21½. Visit Glendale.com for detailed sizing information.

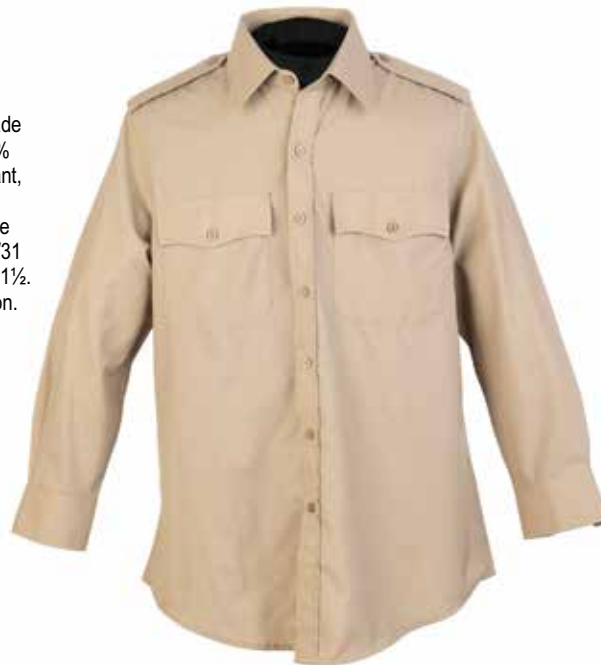

**Athletic Cut Long Sleeve**

Enlisted #AGSU7 **\$69.00** each  
Officer #AGSU5 **\$69.00** each

**Athletic Cut Short Sleeve**

Enlisted #AGSU19 **\$65.00** each  
Officer #AGSU17 **\$65.00** each

**Classic Cut Long Sleeve**

Enlisted #AGSU8 **\$69.00** each  
Officer #AGSU6 **\$69.00** each

**Classic Cut Short Sleeve**

Enlisted #AGSU20 **\$65.00** each  
Officer #AGSU18 **\$65.00** each

**Male AGSU Trousers**

Our Army Green Service Uniform Trousers are made to government specifications and are made from a 55% polyester/45% wool gabardine weave that's the perfect blend of durability, style, and wrinkle-resistance. Satin lined to the knee for extra comfort when sitting. Permanent silicone front crease. Satin pocket linings. Button wallet pocket. Choose Classic or Athletic Cut.

Sizes: Small, Regular, and Long. Available from 28 to 48. Visit Glendale.com for detailed sizing information.

**Classic Cut**

Classic pants have traditional fit that is slimmer through the seat and thighs.

#AGSU3 Trousers **\$135.00** each

**Athletic Cut**

Athletic Cut pants are slimmer at the waist and more generous through the seat and thighs.

#AGSU4 Trousers **\$135.00** each



**AGSU Eisenhower (Ike) Jacket**

Styled after the original "Ike" Jacket, which General Dwight Eisenhower conceived to be "very short, very comfortable, and very natty looking" and would become standard issue in 1944. Made from a 55% polyester/45% wool blend and fully lined to provide warmth in a variety of weather conditions. Adjustable waist tabs and cuffs for a custom fit. Hidden snap chest pockets with an extra snap under the upper corner the keeps flaps snug for a polished appearance. Produced in accordance with PD S-06-21 standards to ensure compliance and quality. Visit Glendale.com for detailed sizing information.

Male Sizes: Small, Regular, and Long. Available from 34 to 54.

#AGSU10

**\$325.00** each



**Female Neck Tab**

An alternate choice for those who prefer not to wear a neck tie. For wear with the AGSU dress shirt. Color: Heritage Green.

#FAGSU7 Neck Tab  
\$13.95 each



**Female AGSU Coat**

Designed by female service members to optimize initial fit and lasting comfort. Made from a 55% polyester/45% wool gabardine weave for wrinkle resistant performance and easy care. Bi-swing (gusseted) back panel promotes ease of movement. Full-length moisture-wicking lining. Quilted chest lining. Button strip with removable buttons for easy cleaning. Choose Misses or Women's style.

Sizes: Petite, Regular, and Tall. Available from 6 to 24. Visit Glendale.com for detailed sizing information.  
#FAGSU1 \$379.00 each



# Glendale's AGSU— Better Fit, Better Fabric!

Visit [Glendale.com](http://Glendale.com) to see the complete selection



Pump



Oxford

**Female Dress Shoes**

Made from full-grain leather with a polyester lining that wicks away moisture to keep feet dry and comfortable. Removable cushioned insole. Color: Brown.

**Oxford:** Whole and half sizes: 4 to 13. Choose Regular or Wide width.

#FAGSU8 \$139.00 each

**Pump:** 1" heel. Whole and half sizes: 3 plus 4 to 14.5. Choose Regular or Wide width.

#FAGSU9 Pump \$119.00 each



**Female AGSU Tuck-in Blouse**

These Army Green Service Uniform Shirts are made from an exceptionally comfortable 55% polyester/45% blend that's wrinkle resistant and never needs ironing. Officer styles have shoulder epaulettes. Choose Short Sleeve or Long Sleeve style.

Sizes: Petite, Regular, and Tall. Available from 4 to 26. Visit [Glendale.com](http://Glendale.com) for detailed sizing information.

**Enlisted**

Long sleeve #FAGSU15 \$69.00 each  
Short Sleeve #FAGSU13 \$65.00 each

**Officer**

Long sleeve #FAGSU14 \$69.00 each  
Short sleeve #FAGSU12 \$65.00 each

**Female AGSU Overblouse**

Designed to be worn untucked, this overblouse has princess seams in front and back for a flattering, tailored fit. Made from a wrinkle-resistant 55% polyester/45% wool blend for year-round comfort. Officer styles have shoulder epaulettes. Choose Short Sleeve or Long Sleeve style.

Sizes: Petite, Regular, and Tall. Available from 8 to 24. Visit [Glendale.com](http://Glendale.com) for detailed sizing information.

**Enlisted**

Long sleeve #FAGSU5 \$69.00 each  
Short Sleeve #FAGSU11 \$65.00 each

**Officer**

Long sleeve #FAGSU4 \$69.00 each  
Short sleeve #FAGSU10 \$65.00 each

**Female AGSU Pants**

Knit from comfortable, wrinkle resistant 55% polyester/45% wool gabardine weave that never needs ironing. Satin lined to the knee for extra comfort when seated. Permanent silicone crease in front. Satin pocket linings.

Sizes: Misses and Women's Petite, Regular, and Tall 4 to 24.

#FAGSU2 \$135.00 each

**Female AGSU Skirt**

Designed in strict adherence to patterns provided by the Army, Combat Capabilities and Development Command and knit from 6.9 oz. 55% polyester/45% wool fabric that's both easy-care and wrinkle resistant. Completely lined with breathable, moisture wicking fabric for comfort in all seasons. Color: Heritage Taupe 565.

Sizes: Misses and Women's Petite, Regular, and Tall. Available from 4 to 26.

Visit [Glendale.com](http://Glendale.com) for detailed sizing information.

#FAGSU3 \$135.00 each



## FREE In-person Fitting

Glendale offers FREE in-person, professional fitting for groups of at least 10 -15 people. Call 1-800-653-5515 to schedule your group's fitting.

Sam Browne belts are also available with and without shoulder straps



Thumb break Holster Clarino #511

Thumb break Holster Basket Weave #511BW

Holster (back view)

### Thumb Break Holster

Since its invention in 1979, the Thumb Break has become a favorite of law enforcement. Honor Guards like the Thumb Break for its clean lines and have made it a favorite on parade routes as well. Made from the same top grain leather as our Sam Browne gear. Available in both Clarino and Basket Weave.

- Clarino (High Gloss) #511 \$169.95 each
- Basket Weave #511BW \$169.95 each

*Ceremonial loop-style holsters without eyelets and prongs are available as a custom order for all large frame automatics and 4" revolvers. Specify type of pistol, whether belt prongs or loop is required and if you prefer brass or nickel snaps.*

### Basket Weave Pattern



Thumb break Holster Basket Weave #511BW

Round Bottom Cuff Case

Complete Basket Weave Belt with right Shoulder Strap #204RBW (Individual accessories may be purchased separately)



Half-lined Sam Browne Waist Belt Plain Black #204BK.

### Sam Browne Belt Buckles

Brass or nickel finish in solid brass.

- Brass #210B \$20.95 each
- Nickel #210N \$20.95 each



Brass

Nickel

### Break-Away Clips for Sam Browne Belts

Stay safe! These two black metal clips attach to each end of a Sam Browne strap and the D-rings, so the strap breaks away if grabbed by an assailant.

- Break-Away Clips #211BAC \$23.25 each

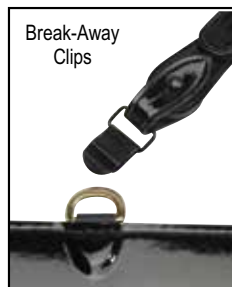

Round Bottom Cuff Case



Double Magazine Pouch



Holster (back view)



Holster fits most automatics

Sam Browne Accessories					
	Color Hardware	Round Bottom Cuff Case	Double Magazine Pouch		Honor Guard Holster
			9mm	.40/.45 Cal	
Plain Black	Brass	#231BBK \$28.75	#232BBK \$49.95	#332BBK40 \$53.25	NA
	Nickel	#231NBK \$28.75	#232NBK \$49.95	#332NBK40 \$53.25	NA
Clarino (High Gloss), Black	Brass	#231BC \$45.25	#232BC \$56.75	#332BC40 \$62.50	#501 \$109.95
	Nickel	#231NC \$45.25	#232NC \$56.75	#332NC40 \$62.50	#503 \$109.95
Basket Weave Black	Brass	#231BBW \$37.75	#232BBW \$51.95	NA	#501BW \$109.95
	Nickel	#231NBW \$37.75	#232NBW \$51.95	NA	#503BW \$109.95

Complete Plain Black Belt with right Shoulder Strap #604RBK  
(Individual accessories may be purchased separately)

Order Left Shoulder Strap for right hand pistol draw.

Right shoulder strap for left hand pistol draw or right hand saber draw.

Sliding "D" Rings

Leather Keepers

Belt Buckle



Dan Foley  
Wyandotte (MI)  
Police  
Honor Guard

**Sam Browne Belts and Accessories**



So how did this classic duty belt get its name? British General Sir Samuel Browne (1824-1901) designed it after his left arm was severed during battle in India; the strap helped stabilize the belt for the one-handed drawing of a saber. Our Sam Brownes are made of top grain leather, 2 1/4" wide with panel stitching for beauty and durability. Plain black waist belts and shoulder straps are available half-lined, and fully lined with top and bottom stitching. Clarino (high gloss) belts and straps are fully lined with top and bottom stitching. The "D" rings on shoulder straps are sewn into belt when ordered together; if you buy the belt only, then later decide to add a shoulder strap, sliding "D" rings will be required to attach strap to belt. When selecting your size, remember to add at least 2" if the belt will be worn over a jacket. **Shoulder straps are made in proportion to belt size. When ordering shoulder straps separately, order by length.** If you need assistance in belt or strap measurements, please call, or visit [www.paradestore.com/SamBrowne](http://www.paradestore.com/SamBrowne). Belts and straps are custom-made. Returns will be subject to a 15% restocking charge.

Sam Browne Belts												
Color	Hardware	Complete Half-lined Belt w/ Right Shoulder Strap	Complete Half-lined Belt w/ Left Shoulder Strap	Complete Fully-lined Belt w/ Right Shoulder Strap	Complete Fully-lined Belt w/ Left Shoulder Strap	Sliding "D" Rings	Half-lined Waist Belt 28"-44"	Fully-lined Waist Belt 28"-44"	Shoulder Strap 33"-50"	1/2" Leather Keeper (each)	1" Leather Keeper (each)	1 1/4" Leather Keeper (each)
Plain Black	Brass	#204RBK \$93.75	#204LBK \$93.75	#604RBK \$114.75	#604LBK \$114.75	#209BBK \$18.50 pair	#204BK \$72.75	#604BK \$81.95	#211BBK \$48.75	#212BBK \$5.50	#213BBK \$7.95	#214BBK \$9.95
	Nickel	#205RBK \$93.75	#205LBK \$93.75	#605RBK \$114.75	#605LBK \$114.75	#209NBK \$18.50 pair	#205BK \$72.75	#605BK \$81.95	#211NBK \$48.75	#212NBK \$5.50	#213NBK \$7.95	#214NBK \$9.95
Clarino (High Gloss), Black	Brass	NA	NA	#204RC \$126.25	#204LC \$126.25	#209BC \$22.95 pair	NA	#204C \$88.75	#211BC \$54.25	#212BC \$7.95	#213BC \$12.95	#214BC \$14.95
	Nickel	NA	NA	#205RC \$126.25	#205LC \$126.25	#209NC \$22.95 pair	NA	#205C \$88.75	#211NC \$54.25	#212NC \$7.95	#213NC \$12.95	#214NC \$14.95
Basket Weave Black	Brass	NA	NA	#204RBW \$119.95	#204LBW \$119.95	#209BBW \$20.95 pair	NA	#204BW \$84.95	#211BBW \$51.95	#212BBW \$6.95	#213BBW \$8.95	#214BBW \$11.95
	Nickel	NA	NA	#205RBW \$119.95	#205LBW \$119.95	#209NBW \$20.95 pair	NA	#205BW \$84.95	#211NBW \$51.95	#212NBW \$6.95	#213NBW \$8.95	#214NBW \$11.95

Prices shown are for even waist sizes 28-44; for sizes 46 and above, please call for pricing or order online. Add belt size when ordering.

Email [customerservice@glendale.com](mailto:customerservice@glendale.com) • Order online at [www.paradestore.com](http://www.paradestore.com)



**SMITH & WARREN**  
Built With Care. Worn With Pride.

# Custom Badges and Parade Insignia

Smith & Warren® products available at Glendale Parade Store

Smith & Warren® partners with **Glendale Parade Store** to enhance ceremonial uniforms with the finest quality badges and uniform insignia. A seamless one-stop shop for customized badges, nameplates and tie bars for work uniforms and special occasion days. Glendale Parade Store, your total uniform badge and insignia source.

Glendale uses this symbol to indicate products that are made in the USA.

## Made with Pride, to be Worn with Pride

Glendale makes Made in America a top priority whenever we add new products. We know what a difference working with American companies makes to our communities and our customers.

Our Made in America products range from wallets and badge holders to badges, buttons, socks, and flags, but they share a single thread — they are all crafted by people dedicated to supporting you and your team with products you can rely on when it really counts.

When you see the Made in America logo in our catalog, it means we carry that product with an extra measure of pride, so that you can, too.

Here are just a few of the companies we are proud to work with:

### Smith & Warren

Maker of badges, insignia, and uniform accessories of the absolute highest quality standards since 1925.

### Perfect Fit

Hand-tooled wallets, badge holders, and accessories made in Maine one piece of leather at a time.

### Wilson Brown Sock Company

From day one, on a mission to supply the US Military with performance socks.

### Waterbury Button Company

Founded in 1812 to supply American soldiers with buttons for their uniforms.

### Flags

All of our American flags are FMAA certified as made in the U.S.A. with domestic resources and labor.

Start Designing Today!



Custom Badges



Hat Badges & Coat Discs



Cut-Out Insignia



Nameplates & Tie Bars



Service Award Bars



Medals



Smith & Warren Badges are Made in the USA in White Plains, NY.

Smith & Warren Badges are Built to Last and are covered by a Full Warranty.

Army Guidon #ARMYGUIDON

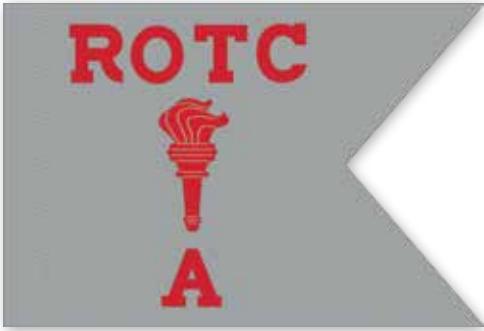

**Army Guidon**

20" x 27 3/4" Allow 3-5 weeks for delivery - Bottom Line can change.

Army Guidon #ARMYGUIDON \$335.95 each

*“Just keep doing what you already do so well. Thanks.”*

R.B., IN



Army Ceremonial Belt #8151

**Army Ceremonial Belt**

Complete belt with Coat of Arms emblem on gold-plated buckle, plus catch and lace keepers. Adjustable to 50".

Army Belt #8151 \$89.95 each

U.S. Army #251AE



AGSU #259AGE



**Military Plastic Nameplates**

Made of a shatterproof and mar-resistant plastic with a non-glare smooth matte finish, nameplates have two military clutches on the reverse side. Plastic, rotary engraved. 1" x 3". 15 letters max. Submit customized engraving in writing. Nameplates will be engraved with last name only in upper case.

US Army #251AE \$3.25 each  
AGSU #251AE \$5.25 each

**Army Officer Swords and Sabers**

We carry world-famous Weyersberg, Kirschbaum & Co. (WKC) Swords and Sabers. Turn to page 18 to learn more about these extraordinary weapons.

- Regulation Army Enlisted Sword
- Regulation Army Officer Saber
- West Point Military Style Sword

[Learn more on page 18](#)

**Cap Devices**



Army Officer Regulation Cap Device #751



Warrant Officer Cap Device #752



Army Enlisted Cap Device #705

**Army Officer Cap Insignia**

Army Officer Regulation Cap Device: Gold plate, screw back. #751 \$13.50 each

Warrant Officer Cap Device: Gold plate, screw back. #752 \$11.50 each



**Army Enlisted Cap Insignia**

Gold plate, tarnish resistant, high luster, screw back.

Army Enlisted Cap Device: #705 \$12.50 each



= PERMANENT SHINE. No polish! Gently wipe with clean, soft cloth.



West Point Military Style Sword #671



Regulation Army Officer Saber #670



Regulation Army Enlisted Sword #672



## New Air Force Warrant Officer Program Creates Cyber Security Experts

For the first time in 65 years, the U.S. Air Force has created a new warrant officer program. The new Warrant Officer Training School is currently an eight-week program that gives existing Air Force IT and cyber security specialists the enhanced training they need to become the link between war fighters and their leaders serving on the front lines.

The new training school creates "a way service members can progress their careers without having to broaden and generalize their skills to rise up the ranks of NCO leaders," said Maj. Nathaniel Roesler in a recent issue of Air and Space Force Magazine.

In addition, the Air Force is developing a 10-14 day "on ramp" designed to recruit civilians with specialist skills directly into the warrant officer program. This is an exciting development for potential recruits who are interested in serving our country in a technical capacity, especially when those skills are so highly valued.

Did you like this story? For more history, insight, and coupons, sign up for our newsletter, the Bugler, today at [www.paradestore.com/aboutus](http://www.paradestore.com/aboutus)

### Air Force Cap Devices

Screw back Cap Devices for honor guard, officers and enlisted men and women. Bright nickel that never needs polishing, just wipe clean with soft cloth.



Honor Guard Hap Arnold #709 **\$11.95** each



**Hap Arnold Beret Device**  
Bright Nickel #709S **\$9.95** each



Officer #710AFB **\$13.50** each



Enlisted #712AFB **\$12.25** each



**= PERMANENT SHINE.**  
No polish! Gently wipe with clean, soft cloth.

### USAF Cap Straps

Wear leather cap straps down as chinstraps to keep in place during ceremonies, continuous drill movements, or in adverse conditions. Service Cap Straps, Plain (or flat) black



Honor Guard Cap Strap, silver #3032 **\$14.95** each



Service Cap Strap, plain black #3033 **\$7.95** each



Honor Guard Cap Back Strap, black gloss patent leather #3034 **\$9.50** each

### USAF Silver Braid, 3/4" (shown actual size)



Order in multiples of 36 yards. Allow 3-4 weeks for delivery.

Silver Braid #71418 **\$449.00** for each 36-yard roll



### Dress Cap Protective Cover

Protect your military dress cap with a lightweight and compact black nylon cover that is easy to transport and a cinch to store. Updated with an easy access ID plate. For military, police, and fire service personnel worldwide. Round male cover is 6.7 oz., 12" diameter. Oval female cover is 7.3 oz., 12 1/2" x 10 1/2". Black. Hand wash; air dry.

Dress Cap Protective Cover,  
Male #517 **\$34.95** each  
Female #518 **\$34.95** each



Dress Cap Protective Cover, #517



# Aim High: Top Quality in Every Detail



USAF Regulation Honor Guard Ceremonial Belt, Officer #8157



### USAF Regulation Honor Guard Ceremonial Belt, Officer



Complete with nickel buckle with Coat of Arms, catch, and keepers. Adjustable to 50".

USAF Belt, Officer #8157 **\$109.75** each

### USAF Honor Guard Ceremonial Belt, Enlisted



Complete belt with Hap Arnold emblem on nickel buckle, plus catch and nickel keepers. Adjustable to 50".

USAF Belt, Enlisted #8172 **\$109.75** each



USAF Honor Guard Ceremonial Belt, Enlisted #8172

### Air Force Collar Insignia



Both insignia are never-polish, wipe-clean bright nickel.

Officer's "U.S." letters

#714AF **\$11.50** pair

Enlisted "U.S." letters in ring (not shown)

#713AF **\$11.95** pair

Officer Pin #714AF



#71417



Hap Arnold Buttons #3029



### Hap Arnold Buttons

HG Jacket Buttons #3029 **\$18.50** set of 3

HG Epaulet Buttons #3029EP **\$9.25** pair

Service Jacket Buttons #3019 **\$8.95** set of 3



Turn to page 88 for more custom flags and banners.

### Customizable Air Force Guidon

Customizable Regulation Air Force Guidon.

Single Reverse construction. Pole hem with leather tabs.

Appliqued/Embroidered Design on nylon

#AFGUIDON 20" x 27 3/4" **\$339.00**



#638R

### USAF Regulation Honor Guard Cord

Silver luminette with Hap Arnold tip and barrel and pin attachment.

Honor Guard Cord, Enlisted #638R **\$83.25** each

Honor Guard Cord, Officer #638RO **\$76.25** each



Base Honor Guard Arc Tab #71412 **\$5.25** each



USAF Honor Guard Arc Tab #71411 **\$5.25** each



### Base Honor Guard Breast Badge



White #71417 **\$18.50** each

#71415



### Base Honor Guard Patches

Full Color #71415 **\$6.95** each

*"Had to call to return an item I ordered by mistake. Excellent customer service. Thank you"*

A.C., HI



USAF Honor Guard Cap #3027

Cap Button #3027B



**USAF Honor Guard Cap**

Regulation Service Cap with silver-edged visor. Enlisted and Company Grade.

Sizes: 6 1/2, 6 5/8, 6 3/4, 6 7/8, 7, 7 1/8, 7 1/4, 7 3/8, 7 1/2, 7 5/8, 7 3/4, 7 7/8 #3027 **\$109.95** each  
 Size: 8 #30278 **\$109.95** each  
 Replacement Honor Guard Cap Button and Screw #3027B **\$6.50** each



USAF Service Cap #3028

Cap Button #3028B



**USAF Service Cap**

Regulation Service Cap with plain visor.



Sizes: 6 1/2, 6 5/8, 6 3/4, 6 7/8, 7, 7 1/8, 7 1/4, 7 3/8, 7 1/2, 7 5/8, 7 3/4, 7 7/8 #3028 **\$84.95** each  
 Size: 8 #30288 **\$84.95** each  
 Replacement Service Cap Button and Screw #3028B **\$6.50** each

Bernard Cap Company — the only headwear company to be awarded the Department of Defense Quality Excellence Award — represents quality and craftsmanship. We're proud to offer their Air Force Caps.

**Military Plastic Nameplates**



Made of a shatterproof and mar-resistant plastic with a non-glare smooth matte finish, nameplates have two military clutches on the reverse side. Plastic, rotary engraved. 15 letters max. Submit customized engraving in writing. Nameplates will be engraved with last name only in upper case.

**Air Force nameplate:** 5/8" x 3 3/16"

White letters on blue, #251AFE **\$3.25** each



**USAF Cap Sizes and Equivalents**

TO DETERMINE CAP SIZE: With a cloth measuring tape, measure completely around the head. Position the tape above the ears where you wish to wear the cap. Find your measurement below and the corresponding hat size.

6 1/2 — 20 1/2"	6 7/8 — 21 5/8"	7 1/4 — 22 3/4"	7 5/8 — 23 1/8"
6 5/8 — 20 7/8"	7 — 22"	7 3/8 — 23 1/8"	7 3/4 — 24 1/4"
6 3/4 — 21 1/4"	7 1/8 — 22 3/8"	7 1/2 — 23 1/2"	8 — 25"

# We Share Your Commitment to Excellence



#513

**Service Cap Carrier**

Finally, a hard service cap carrier that protects and preserves any style service cap in any size—another product customers asked for that we were pleased to develop with the manufacturer! Inside this hard plastic carrier, an adjustable mount and a soft foam block to hold cap in place when case is closed. With two lockable latches, the case can be flown as checked baggage or taken on board as a carry-on. 14"W x 15"H x 7 7/8"D. Black only. For another way to protect Service Caps, see our Flannel Helmet Bag on page 46.

Cap Carrier #513 **\$74.95** each\*

\*Add \$7 additional shipping if shipped to the lower continental US. Add \$15 each outside the lower continental US. See page 77 for complete shipping information.



#505

#506

**The CoverBag**

Protect your service cap or Bell Crown Cap (Choose the larger, Male CoverBag for a Bell Crown cap) with this water-resistant nylon carrying case that's convenient, comfortable and easy to transport. It has reinforced walls, a leather handle and a strap that fits over a roller case handle. Interior and exterior pockets will hold gloves and keys or phone. When not in use, it's fully collapsible. Available in two styles, black only: either as a plain bag or one with two black loop panels to hold patches with a hook backing. One 2 3/4"-square loop fastener is sewn on the front panel to accommodate a 4" patch. There is also a 2 3/4" x 2" loop fastener on the side pocket. The larger male size is 11" W x 12" H x 6" D. The smaller female size is 10" W x 10 1/2" H x 6" D.

Male, plain #504 **\$49.95** each  
 Female, plain #505 **\$49.95** each  
 Male, with loop panel #506 **\$59.95** each



**For Garment and Gear Bags, see pages 46-47**





USMC Cotton Web Khaki Belt #8168

**USMC Belts & Buckles**

- USMC Dress Buckle only, no emblem, 2" x 3". #8163 \$41.95 each
- USMC Dress Buckle only, gilt emblem, 2" x 3". #8164 \$41.95 each
- USMC cotton web khaki belt — 1 1/4" wide, 44" long with open, solid brass, gold-plated and hand-polished buckle. Government spec. #8168 \$17.50 each

USMC Dress Buckle only, gilt emblem #8164



= **PERMANENT SHINE.** No polish! Gently wipe with clean, soft cloth.

“You got it right!  
“Semper Paratus”  
Cpl. C. Frey, PA

**PARKER**

U.S. Marine Corps #251MCE

**Military Plastic Nameplates**

Made of a shatterproof and mar-resistant plastic with a non-glare smooth matte finish, nameplates have two military clutches on the reverse side. Plastic, rotary engraved. 15 letters max. Submit customized engraving in writing. Nameplates will be engraved with last name only in upper case.

**Marine nameplate:** 5/8" x 3"

White letters on black, #251MCE \$3.25 each

**USMC Collar Insignia**



USMC Enlisted Collar Device #722

**USMC Officer Service Collar Device**

Black, screw back. #721 **\$19.95** pair

**USMC Enlisted Collar Device**

Gold plate, screw back. #722 **\$11.50** pair

**USMC Enlisted Collar Device**

Black, screw back. #723 **\$9.95** pair

= **PERMANENT SHINE.** No polish! Gently wipe with clean, soft cloth.

**USMC Cap Insignia**



USMC Officer Dress Cap Device #715



USMC Enlisted Dress Cap Device #717

**USMC Officer Dress Cap Device**

Gold/silver, screw back. #715 **\$41.50** each

**USMC Officer Service Cap Device**

Black, screw back. #716 **\$14.75** each

**USMC Enlisted Dress Cap Device**

Gold plate, screw back. #717 **\$8.75** each

**USMC Enlisted Service Cap Device**

Black, screw back. #718 **\$6.75** each

**Band Insignia**



Lyre in Wreath #658G



Lyre Collar Insignia #659G

**Band Cap Devices**

Lyre in wreath: gold plate, screw back.

#658G **\$8.75** each

Same as above, nickel plate.

#658N **\$7.95** each

Lyre Collar Insignia: gold plate, clutch back. #659G **\$13.95** pair



Marine Corps Officer Sword #695

Marine Corps NCO Sword #694

WKC ceremonial swords are worn with pride by U.S. military academies, heads of state, kings and princes, ministers of defense and chiefs of police. Glendale is proud to offer these precision swords and sabers to our customers. Returns for other than defects will be subject to a 15% restocking charge. Engraved Swords can not be returned.

**USMC Swords NEW!**

Sizes available on sabers and swords: 28", 30" and 32" blades. All sabers and swords are handcrafted and include scabbards. The Swords and Sabers are nickel-plated carbon steel.

Marine Corps Officer Sword #695 **\$437.95** each

Marine Corps NCO Sword #694 **\$465.95** each

Marine Corps Flag #7714 see page 96 for sizes and prices.



Turn to page 96 for Marine and Armed Forces flags.



**Waterbury Cufflinks**

Made by the legendary company that's been making military buttons since 1812, these classic cufflinks are made from premium materials with the highest level of detail. Choose branch: Airforce, Army, Navy, Marines, Coast Guard

#330 All Branches \$65.95 each

# Lost a Button?

Glendale has partnered with Waterbury Buttons, the oldest button manufacture in the United States. We can replace any button of any military garment. Just give us a call. We'll track one down and provide a price and shipping estimate.



*“Well done! Thanks you very much for your efficient service.”*

R.S., Glen Mills, PA



Saber Team #960



Rifle Team #961



Rifle Team #989

**Hat/Collar/Lapel Pins for Drill Units**

Pins above are double clutch back. **\$3.95** each

- Saber Team Crossed Sabers in goldtone finish, 1". #960
- Rifle Team Crossed Rifles in goldtone finish, 1 1/2". #961
- Rifle Team Crossed Rifles in black finish, 1 1/2". #989



U.S. Army #132A



U.S. Air Force #132AF



U.S. Navy #132N



U.S. Marine Corps #132MC

**Armed Forces Pins with Flags**

Armed Forces emblems with U.S. flags. Etched enameled pins, epoxy coated, clutch back, 7/8" W x 1 1/8" H. All **\$4.95** each

**Military Hat/Lapel Pins**

1 1/2" diameter. All pins are clutch back. **\$4.95** each



Navy #7793



Coast Guard #7797



Marine Corps #7795 (actual size)



Army #7790



Army National Guard #7791



Air Force #7792

**Veterans' Organization Lapel Pins**

All pins are clutch back. **\$3.95** each



Commander 1 1/4" x 3/8" #139A



District Commander 1 1/4" x 1/2" #139C



Senior Vice Commander 1 1/4" x 3/8" #139E



Quartermaster 1 1/2" x 3/8" #139G



Sergeant at Arms 1 1/4" x 3/8" #139I



Life Member 1 1/4" x 3/8" #139K



Past Commander 1 1/4" x 3/8" #139B



Past District Commander 1 1/4" x 1/2" #139D



Junior Vice Commander 1 1/4" x 1/2" #139F



Finance Officer 1 1/8" x 5/8" #139H



Adjutant 1 1/4" x 1/2" #139J



Chaplain 1 1/8" x 3/8" #139L (actual size)



**Metal Arc Pins**

All pins are a shiny gold metal with bright, colorful enamel and double clutch back. Shown actual size: 1 1/8" x 7/16". **\$5.95** each



Leadership — black  
#868



Honor Roll — royal  
#856



JCLC — brown  
#874



Drill Team — scarlet  
#851



L.O.T.C. — royal  
#876



Academics — yellow  
#857



Sabre Team — white  
#862



Color Guard — white  
#853



Rifle Team — olive  
#852



Orienteering — kelly green  
#858



Sabre Guard — gold  
#865



Staff — lt. blue  
#869



Cadet Challenge — white  
#870



Regulation — burgundy  
#859



Rappelling — black  
#863



Honor Guard — cream  
#850



Recondo — white  
#871



P.T. Team — black  
#860



Flag Detail — royal  
#864



Honor Guard — orange  
#873



Sail Team — royal  
#872

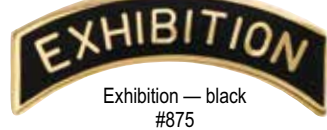

Exhibition — black  
#875



Drum & Bugle — royal  
#866



Raider — black  
#855



Band — royal  
#854



Summer Camp — brown  
#861

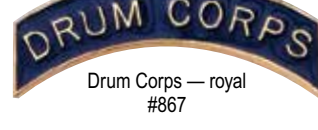

Drum Corps — royal  
#867



PT Excellence — black  
#881



Archery — yellow  
#879



**JROTC Wallets *GLENDALE EXCLUSIVE***

We teamed with PerfectFit, the USA company that makes the most popular badge holders and wallets for police officers and first responders to create these highly customizable wallets for JROTC cadets. Crafted with care and backed by a lifetime leather warranty, each wallet includes your choice of coin and is available in two Arc Pin styles.

Colors: Black. Brown.

Arch Pin Styles: Raider. Rifle Team. Exhibition. Drill Team. Color Guard.

Coin styles: Army. Navy. Air Force. USMC. Space Force. Coast Guard.

#0833 Single Arc Wallet with Coin and Arc Pin **\$35.99** each

#0834 Double Arc Wallet with Coin and Two Arc Pins **\$39.99** each



Our JROTC Wallet makes a great commemorative gift for graduation or other special milestone!



**Color Guard Pin**

Words only in red/white/blue  
1 1/2" W x 5/8"H

#940 **\$4.25** each



**Honor Guard Pin**

Words only in red/white/blue  
1 1/2" W x 5/8"H

#941 **\$4.25** each

**We have more Honor and Color Guard Pins on page 51.**

# Ribbon Attachments

Shown actual size.  
Most are 1/8" x 3/4".



#2061



#2062



#2063



#2064



#2065



#2066

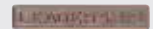

#2067



#2068



#2069



#2070 #2071



#2072



#2073



#2074 #2078

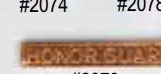

#2079



#2080



#2056 #2081 #2082 #2057



To add attachments, push the attachment through the ribbon then fold over the prongs to secure.

## Ribbon Attachments

Available in bronze, silver or gold finish. Please order by combining item number and desired finish (for example: #2061BRNZ, #2061SILV or #2061GOLD).

Academic	#2061	\$3.50	each
Band	#2062	\$3.50	each
Color Guard	#2063	\$3.50	each
Drill Team	#2064	\$3.50	each
Honor	#2065	\$3.50	each
Honor Student	#2066	\$3.50	each
Leadership	#2067	\$3.50	each
Rifle Team	#2068	\$3.50	each
Saber Team-bronze only	#2069	\$3.50	each
Anchor	#2070	\$3.50	each
Crossed Rifles	#2071	\$3.50	each
Crossed Pistols	#2072	\$3.50	each
Rifle	#2073	\$3.50	each
Crossed Sabers	#2074	\$3.50	each
Maltese Cross	#2078	\$3.50	each
Honor Guard	#2079	\$3.50	each
Pilot Wings	#2080	\$3.50	each
"M": bronze	#2056	\$3.50	each
"W" silver	#2081	\$3.50	each
Eagle, globe & anchor	#2082	\$3.50	each
"E" gold or silver	#2057	\$3.50	each

## Ribbon Attachments

Glendale goes the extra mile to offer ribbon mounts that are well crafted down to the final detail.

### Stars: bronze, silver, gold

single	#2040R	\$1.35	each
double	#2041R	\$1.95	each
triple	#2042R	\$2.95	each
quad	#2043R	\$3.25	each

### Arrowhead:

bronze	#2044R	\$2.95	each
--------	--------	--------	------

### Oak Leaf Clusters: bronze, silver, gold

single	#2045R	\$1.35	each
double	#2046R	\$1.95	each
triple	#2047R	\$2.95	each
quad	#2048R	\$3.25	each

### Numerals 0-9: bronze or gold finish

	#2055	\$2.95	each
--	-------	--------	------

Please order by complete number: for example, #2040RBRNZ or #2046RSILV or #20559GOLD instead of 2055GOLD to indicate numeral ordered.



Army Frame, #A25



Air Force Frame, #AF25

## Unit Citation Frames

Army frame: gold plate	#A25GILT	\$3.50	each
Air Force frame: gold plate	#AF25GILT	\$3.50	each



Klench Fasteners, brass #2162



Klench Fasteners, brass with protective clear back #2163

## Klench Fasteners

Both fasteners have the same strong holding capability—the magic is in the urethane membrane. The fasteners with a clear back have a flexible protective back and will accept a longer pin backing on insignia, name tags and ribbon bars and hold them flush to the surface of the uniform. Neither will cause skin abrasion. Sold in a packaged set of 6.

Brass	#2162	\$6.50	per set of 6
Brass with protective clear back	#2163	\$6.50	per set of 6



Military Clutches, Brass #2060



## Hold-Tight Pin Keepers

As the name implies, you'll never lose another pin with these trusty metal keepers. Each bag includes 10 keepers and an Allen wrench. Pins not included.

Hold-Tight Pin Keepers	#2090	\$7.25	per bag
------------------------	-------	--------	---------

## Military Clutches, Brass

Set of 10 Clutches	#2060	\$1.35	per set
--------------------	-------	--------	---------



## Mil-Enforcer Ribbon Support Kit

Helps reinforce and safeguard ribbon awards, badges, and insignia from drooping, sagging, and catching to achieve a professional appearance in any uniform.

3 Piece Kit	#RIBKIT	\$9.75	each
-------------	---------	--------	------



## Mega Ribbon Kits

Mount 4-32 ribbons, 4 across, with this easily-assembled DIY ribbon kit. The mount is clear plastic and is packaged complete with ten prongs and military clutches, a red plastic anvil to support the mount when attaching the prongs, a cutting blade and instruction booklet. Available with no spacing or 1/8" spacing.

No spacing	#GKIT	\$11.50	each
1/8" spacing	#HKIT	\$11.50	each

# Ribbon Mounts

## Metal Ribbon Mounts

These contoured Uni-mounts are for standard metal ribbon mounts and right staggered ribbon mounts for the left collar. Single, Double and Triple mounts are made of brass, all other mounts are made of durable but lightweight stainless steel.

## Standard Metal Ribbon Mounts **BEST SELLER!**

All ribbon holders are center mount and include clutches.

## Right Staggered Metal Ribbon Mounts

These multiple ribbon mounts are staggered to fit around a lapel, so all ribbon awards will show. Includes clutches.

## Standard Plastic Ribbon Mounts

Unlike metal mounts, these flexible mounts contour to the shape of the body. In fact, they will bend to 90° and still revert back to original shape. All ribbon holders are center mount and include clutches.

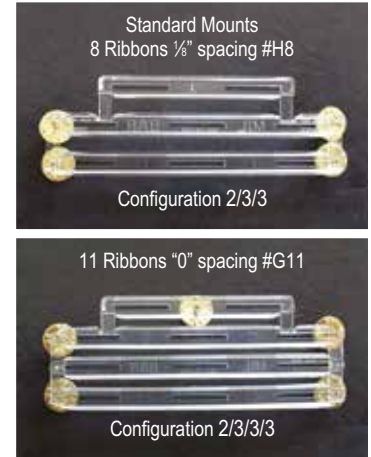
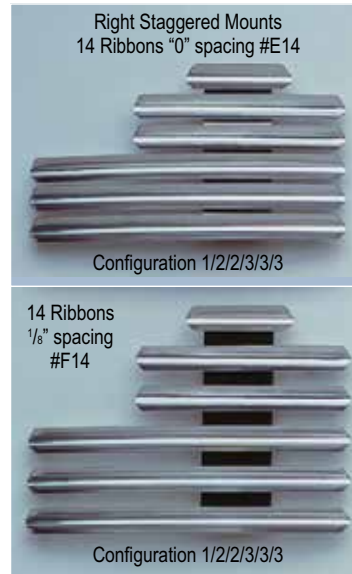
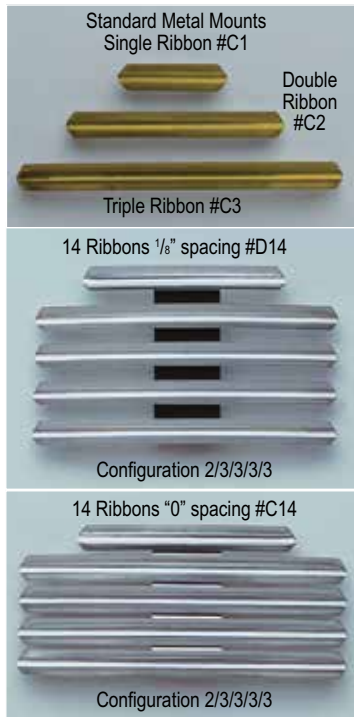

Air Force and Navy Ribbon Mounts - "0" spacing  
 Army Ribbon Mounts - 1/8" spacing  
 Marine Corps Ribbon Mounts - either "0" or 1/8" spacing

Ribbon Mounts		Standard Metal <b>BEST SELLER!</b>		Right Staggered Metal		Standard Plastic	
Number of Ribbons displayed	Ribbons/Bar Configuration for standard mounts	C: "0" spacing	D: 1/8" spacing	E: "0" spacing	F: 1/8" spacing	G: "0" spacing	H: 1/8" spacing
1	1	#C1 \$0.95					
2	2	#C2 \$1.10					
3	3	#C3 \$1.25				#G3 \$1.95	
4	1/3	#C4 \$3.75	#D4 \$3.75			#G4 \$3.50	#H4 \$3.50
5	2/3	#C5 \$3.75	#D5 \$4.50			#G5 \$3.50	#H5 \$3.75
6	3/3	#C6 \$3.75	#D6 \$4.50			#G6 \$3.75	#H6 \$3.75
7	1/3/3	#C7 \$4.50	#D7 \$4.50			#G7 \$3.75	#H7 \$3.95
8	2/3/3	#C8 \$4.50	#D8 \$4.75			#G8 \$3.75	#H8 \$4.25
9	3/3/3	#C9 \$4.50	#D9 \$4.75	#E9 \$4.25	#F9 \$4.75	#G9 \$3.75	#H9 \$4.25
10	1/3/3/3	#C10 \$4.50	#D10 \$4.95	#E10 \$4.50	#F10 \$4.95	#G10 \$4.25	#H10 \$4.50
11	2/3/3/3	#C11 \$4.75	#D11 \$4.95	#E11 \$5.95	#F11 \$5.50	#G11 \$4.50	#H11 \$4.75
12	3/3/3/3	#C12 \$4.95	#D12 \$5.25	#E12 \$5.95	#F12 \$5.50	#G12 \$4.50	#H12 \$4.75
13	1/3/3/3/3	#C13 \$5.25	#D13 \$5.25	#E13 \$6.25	#F13 \$5.50	#G13 \$4.75	#H13 \$5.25
14	2/3/3/3/3	#C14 \$5.50	#D14 \$5.75	#E14 \$6.25	#F14 \$5.50	#G14 \$4.95	#H14 \$5.75
15	3/3/3/3/3	#C15 \$5.50	#D15 \$5.95	#E15 \$6.25	#F15 \$5.75	#G15 \$5.25	#H15 \$5.75
16	1/3/3/3/3/3	#C16 \$5.75	#D16 \$6.50	#E16 \$6.25	#F16 \$6.25	#G16 \$5.50	#H16 \$5.75
17	2/3/3/3/3/3	#C17 \$6.25	#D17 \$6.50	#E17 \$7.25	#F17 \$6.25	#G17 \$5.50	#H17 \$5.95
18	3/3/3/3/3/3	#C18 \$6.50	#D18 \$6.50	#E18 \$7.25	#F18 \$6.50	#G18 \$5.75	#H18 \$6.25
19	1/3/3/3/3/3/3	#C19 \$6.50	#D19 \$6.75	#E19 \$7.25	#F19 \$6.75	#G19 \$5.75	#H19 \$6.50
20	2/3/3/3/3/3/3	#C20 \$6.75	#D20 \$7.25	#E20 \$7.50	#F20 \$6.75	#G20 \$6.25	#H20 \$6.75
21	3/3/3/3/3/3/3	#C21 \$6.95	#D21 \$7.25	#E21 \$7.50	#F21 \$6.75	#G21 \$6.50	#H21 \$6.75
22	1/3/3/3/3/3/3/3	#C22 \$7.25	#D22 \$9.75	#E22 \$7.50	#F22 \$9.75	#G22 \$6.50	#H22 \$8.50
23	2/3/3/3/3/3/3/3	#C23 \$7.50	#D23 \$10.25	#E23 \$9.95	#F23 \$9.75	#G23 \$6.75	#H23 \$8.75
24	3/3/3/3/3/3/3/3	#C24 \$7.50	#D24 \$10.25	#E24 \$10.25	#F24 \$9.75	#G24 \$6.75	#H24 \$9.75
25	1/3/3/3/3/3/3/3/3	#C25 \$8.25	#D25 \$10.25	#E25 \$10.25	#F25 \$10.25	#G25 \$7.25	#H25 \$10.25
26	2/3/3/3/3/3/3/3/3	#C26 \$8.75	#D26 \$10.75	#E26 \$10.75	#F26 \$10.75	#G26 \$7.50	#H26 \$10.25
27	3/3/3/3/3/3/3/3/3	#C27 \$9.25	#D27 \$10.75	#E27 \$11.50	#F27 \$10.75	#G27 \$9.50	#H27 \$10.75
28	1/3/3/3/3/3/3/3/3/3	#C28 \$9.95	#D28 \$11.25	#E28 \$11.95	#F28 \$11.25	#G28 \$10.50	#H28 \$11.25
29	2/3/3/3/3/3/3/3/3/3	#C29 \$10.25	#D29 \$11.75	#E29 \$11.95	#F29 \$11.50	#G29 \$11.50	#H29 \$11.50
30	3/3/3/3/3/3/3/3/3/3	#C30 \$10.75	#D30 \$11.95	#E30 \$11.95	#F30 \$11.95	#G30 \$12.95	#H30 \$11.95
31	1/3/3/3/3/3/3/3/3/3/3	#C31 \$10.75	#D31 \$12.25	#E31 \$11.95	#F31 \$12.25	#G31 \$13.50	#H31 \$12.25
32	2/3/3/3/3/3/3/3/3/3/3	#C32 \$10.75	#D32 \$12.50	#E32 \$11.95	#F32 \$12.50	#G32 \$13.50	#H32 \$12.50

4-32 See page page 68 for our Do-It-Yourself Mega Ribbon Kits.

# Air Force and Space Force JROTC Ribbon Chart



Coat of arms of the United States Army Institute of Heraldry

## Who Designs Military Ribbons?

In 1918, the President directed the War Department to establish an office that could organize military insignia such as metal badges, ribbons, patches, and flags. Accordingly, the U.S. Army Institute of Heraldry was created one year later. Its original purpose was to take responsibility for the coordination and approval of coats of arms and other insignia for Army organizations. By the end of World War II, its role expanded to include the other military services.





























“Our Nation’s premier team of heraldic experts...

The guardians of our National symbolic heritage.”

The Institute of Heraldry’s work encompasses all elements of National symbolism associated with research, design, development, standardization, quality control, and other services which are fundamental to the creation and custody of official coats of arms, decorations, medals, flags, streamers, agency seals, badges, and other types of official insignia. TIOH also provides the general public with limited research and information services.

In addition to ensuring the quality and consistency of design, TIOH honors the centuries old function of making sure emblems, insignia and ribbons provide clear visual communication and identification on the battlefield and wherever else they are worn or displayed.

Did you like this story? For more history, insight and coupons, sign up for our newsletter, the *Bugler*, today at [www.paradestore.com/aboutus](http://www.paradestore.com/aboutus)

			
Gold Valor Award 20801140	Silver Valor Award 20801149	Cadet Humanitarian Award 2080CHA	Community Service with Excellence Award 2080CSEA
			
Distinguished Unit with Merit Award 2080DUWM	Distinguished Unit Award 20801340	Outstanding Organization Award 2080OOA	Outstanding Flight Ribbon 20801106
			
Top Performer Award 20801338	Outstanding Cadet Ribbon 2080OUTC	Leadership Ribbon 2080LEAD	Superior Performance Ribbon 2080SUPP
			
Achievement Ribbon 2080ACHV	Academic Ribbon 2080ACAD	Cadet Leadership Course Ribbon 20801487	Special Teams Placement Ribbon 20801553
			
All Service National Competition Ribbon 2080ASNC	Air Force Nationals Competition Ribbon 2080ADNC	Orienteering Ribbon 20801225	Leadership Development Requirement Ribbon 2080COAL
			
Drill Team Ribbon 2080DRTM	Color Guard Ribbon 2080COLG	Sabre Team Ribbon 2080SABR	Marksmanship Ribbon 2080MARK
			
JLAB Ribbon 2080JLAB	Cyber Patriot Ribbon 2080CYBER	StellarXplorers Ribbon 2080EXP	Raiders Team Ribbon 2080RAIDER
			
Military Model Building Ribbon 2080MODL	Unmanned Aircraft Systems Ribbon 2080UAS	Robotics Ribbon 2080ROBO	Good Conduct Ribbon 20801110
			
Service Ribbon 20802054	Health and Wellness Ribbon 20801557	Recruiting Ribbon 20801552	Activities Ribbon 20801213
			
Attendance Ribbon 20801121	Dress and Appearance Ribbon 20801505	Longevity Ribbon 20804059	Bataan Death March Memorial Hike Ribbon 2080BDMM
		<b>Air Force and Space Force JROTC Ribbon Slides</b> Regulation ribbon awards, slide only, made in USA. See list of all ROTC and JROTC awards on our web site at <a href="http://www.paradestore.com">www.paradestore.com</a> . Order by name of award, adding to end of product number. Ribbon Slides <b>\$1.35</b> each.	
Patriotic Flag Ribbon 2080PATR	Resiliency Ribbon 2080COVD		

# Visit ParadeStore.com for our complete selection

## Ribbon Slides



Ribbon slides with stock ribbon in solid colors or combinations to match drapes on page 72. 1 1/2" x 3/8". To order, add color abbreviation to RBN15 or RBN16 (for example RBN15RAIN for Rainbow).

Ribbon slide posts and clutches.  
#RBN15 \$1.45 each



Ribbon back, slide, posts, and clutches

Ribbon slide only.

#RBN16 \$1.35 each



Ribbon back, slide only (shown actual size)













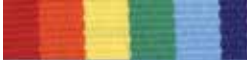



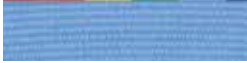





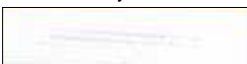

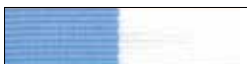



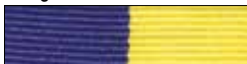
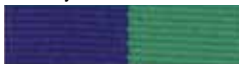

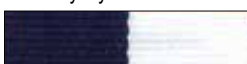
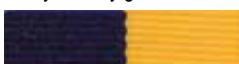
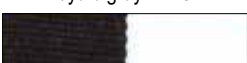

## JROTC, ROTC Ribbon Slides

Regulation ribbon awards, slide only, made in USA. See list of all ROTC and JROTC awards on our web site at [www.paradestore.com](http://www.paradestore.com). Order by name of award, adding to end of product number.

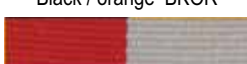
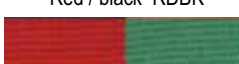
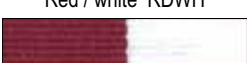
Ribbon Slides \$1.35 each.  
AFROTC #2081; AFJROTC #2080;  
MCJROTC #2083; NJROTC #2082  
(For Army ROTC and JROTC ribbons, see page 48. For Air Force and Space Force, see page 70. For Navy and Marine Corps, see page 54.)

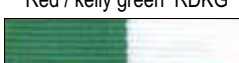
*“Thank you so much for your phenomenal professional customer service and congeniality. Your excellence in helping our organization at a critical time; is heartwarming and positively overwhelming! Our crisis was averted by your expert service. As a result of your efforts; I will recommend this company to all those I know, that may need the services you all provide. We’ve been very pleased!”*

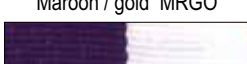
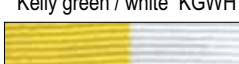
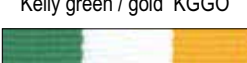
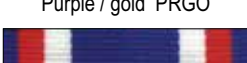
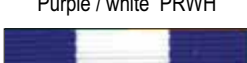
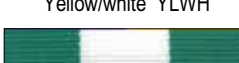
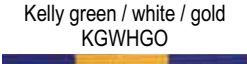
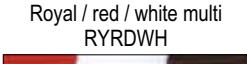
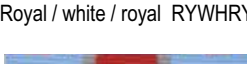
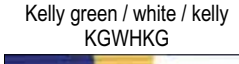
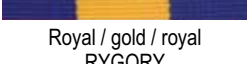
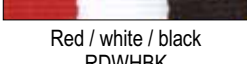
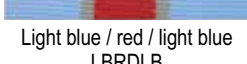
*Reginald Washington,  
CMSgt (Ret), USAF FL*

 Rainbow RAIN	 Stars & Stripes SS	 Royal RY	 Red RD
 Maroon MR	 Light blue LB	 Navy blue NV	 Gold GO
 Gray GY	 Orange OR	 Black BK	 Purple PR
 White WH	 Kelly green KG	 Light blue / white LBWH	 Royal / white RYWH
 Royal / red RYRD	 Royal / gold RYGO	 Royal / yellow RYYL	 Royal / kelly green RYKG
 Royal / gray RYGY	 Royal / orange RYOR	 Navy / white NVWH	 Navy / gold NVGO
 Black / white BKWH	 Black / gold BKGO	 Black / orange BKOR	 Red / black RDBK
 Red / white RDWH	 Red / gold RDGO	 Red / gray RDGY	 Red / kelly green RDKG
 Maroon / white MRWH	 Maroon / gray MRGY	 Maroon / gold MRGO	 Kelly green / white KGWH
 Kelly green / gold KGGO	 Purple / gold PRGO	 Purple / white PRWH	 Yellow / white YLWH
 Kelly green / white / gold KGWHGO	 Royal / red / white multi RYRDWH	 Royal / white / royal RYWHRY	 Kelly green / white / kelly KGWHKG
 Royal / gold / royal RYGORY	 Red / white / black RDWHBK	 Light blue / red / light blue LBRDLB	 Royal / gold / white RYGOWH
 Royal / white / red multi RYWHRD	 Red / white / royal blue RDWHRY	 Red / white / royal / metallic gold trim MGRDWHRY	 Pink for Breast Cancer Awareness PK



Stars and Stripes Ribbon #RBN15SS

**The Stars and Stripes Medal**  
The drape with pin fastener holds an antique finish gold starburst medal, 1 1/2", with eagle.  
Medal #SS1 \$12.75 each

**Stars 'n Stripes Ribbon**  
Clutch back.  
Ribbon #RBN15SS \$1.60 each



Stars and Stripes Medal #SS1



Stars and Stripes Pin #SS4

**Stars 'n Stripes Pin**  
Enameled pin, 1 1/4".  
Clutch back.  
Enameled Pin #SS4 \$5.25 each

# Ribbon Drapes

## Ribbon Drapes



Pin back ribbon drapes – size 1½" x 1⅜". Specify gold, silver, or bronze ring for RL1, RL5 and RL9 drapes.

All RL ribbon Drapes **\$3.50** each  
All drapes have an attached ring.



### Ribbon Drape Bar Holder

Available in antique finish goldtone, silvertone, or bronzetone with two clutch backs. Measures 1½" x ½".

#### Plain

Goldtone	#1049G	\$8.75 each
Silvertone	#1049S	\$8.75 each
Bronzetone	#1049B	\$8.75 each

#### Engraved

Goldtone	#1049GE	\$13.75 each
Silvertone	#1049SE	\$13.75 each
Bronzetone	#1049BE	\$13.75 each



Maximum number of characters for Engrave Bar Holder is 12. Submit customized engraving in writing.



### Presentation Neck Ribbons

All drape colors shown above are available in 1½" x 30" neck ribbons, except for colors RL233 (Red/black) and RL235 (Red/kelly) and all ribbons in bottom row.

RP + number above	\$3.25 each
RP17 with gold trim	\$3.95 each





### JROTC Ribbon Drapes (ND Series)

Regulation JROTC Ribbon Drape with pin and safety catch and gold ring. Order by number – for example, #NDG13 for N-1-3, Academic Achievement. There are 37 N-Series drapes. The ones shown here match the N-Series medals below. All others are shown online at [www.ParadeStore.com](http://www.ParadeStore.com)

ND Series – Army JROTC **\$3.50** each.

					
#NDG11 Distinguished Cadet	#NDG12 Academic Excellence	#NDG13 Academic Achievement	#NDG14 Perfect Attendance		
					
#NDG15 Student Government	#NDG16 Leadership Development	#NDG21 Varsity Athletic	#NDG22 Physical Fitness	#NDG23 Athletic	#NDG31 Instructor Leadership
					
#NDG32 Personal Appearance	#NDG33 Proficiency	#NDG34 Drill Team	#NDG35 Orienteering	#NDG36 Color Guard / Honor Guard	#NDG37 Rifle Team
					
#NDG38 Adventure Training	#NDG39 Commendation	#NDG310 Good Conduct	#NDG311 Summer Camp	#NDG41 Parade	#NDG42 Recruiting

### N-Series Awards Medals

The N-Series Awards Medals, 1 1/2" diameter, are available in an antique gold finish with a gold ring to attach a drape. Some are designed to match the JROTC N-series ribbon drapes above, but all can be used on any drape of your choice – shown opposite. The N-Series Awards Medals are **\$6.95** each without engraving. For 2 - 3 initials engraved on the reverse side, add **\$5.00** for each medal. Submit engraving in writing.

					
#N0011 Distinguished Cadet	#N0012 Academic Excellence	#N0013 Academic Achievement	#N0014 Perfect Attendance	#N0015 Student Government	#N0016 Leadership Development Service
					
#N0021 Varsity Athletic	#N0022 Physical Fitness	#N0023 ROTC Athletic	#N0031 Sr. Army Instructor Leadership	#N0032 Personal Appearance	#N0033 Proficiency
					
#N0034 Drill Team	#N0035 Orienteering	#N0036CG Color Guard	#N0036HG Honor Guard	#N0037 Rifle Team	#N0038 Adventure Training
					
#N0039 Commendation	#N0310 Good Conduct	#N0311 Summer Camp	#N0041 Parade	#N0042 Recruiting	BACK OF ALL MEDALS

# Unique Medals Are a Snap



Medal shown actual size

## Step 1

Choose a Ribbon Drape or a JROTC Ribbon Drape.



#NDG11 Distinguished Cadet

## Step 2

Choose a medal or award from pages 73-76.



#N0011 Distinguished Cadet

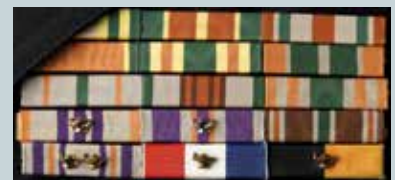

### AROTC and AJROTC Ribbons

Regulation AROTC awards (R Series) and AJROTC awards (N Series). Order by number; for example, N11 for N-1-1, Distinguished Cadet. See full listing with pictures on our web site: [www.paradestore.com](http://www.paradestore.com).

#R Series **\$1.35** each  
 #N Series **\$1.35** each

## A-Series Achievement Medals

Recognize citizenship and excellence with the A-Series Achievement Medals, 1 1/2" diameter, available in an antique gold finish. **\$6.50** each without engraving. For 2 - 3 initials engraved on the reverse side, add **\$5.00** for each medal. Submit engraving in writing.

*All Glendale medals can be worn with any ribbon drape. Solid colors, two- and three-color combinations, and some Army JROTC drapes are shown on page 72 and page 73.*



*“One of the best customer service I have received. Speed of delivery exceptional.”*

*D.L., Colorado springs, CO.*

*Reverse side of all medals*



#A0001  
Citizenship Award



#A0002  
Perfect Attendance



#A0003  
Leadership Camp



#A0004  
Drum & Bugle Corps



#A0005  
Band Excellence



#A0006  
Flag Detail



#A0007  
Sabre Team



#A0008  
Raider Team



#A0009  
Regulation Drill



#A0010  
Best Squad Drill



#A0011  
Best Company Drill



#A0012  
Leadership Award



#A0013  
Achievement Award



#A0014  
Cadet NCO of the Quarter



#A0015  
Cadet NCO of the Semester



#A0016  
Cadet NCO of the Month



#A0017  
Cadet NCO of the Year



#A0018  
Outstanding Cadet NCO



#A0019  
Cadet Officer of the Year



#A0020  
Cadet Officer of the Month



#A0021  
Cadet Officer of the Quarter



#A0022  
Cadet Officer of the Semester



#A0023  
Outstanding Cadet Officer



#A0024  
Cadet of the Month



#A0025  
Cadet of the Quarter



#A0026  
Cadet of the Semester



#A0027  
Cadet of the Year



#A0028  
Most Improved Cadet



#A0029  
Best First Year Cadet



#A0030  
Cadet Commander



#A0031  
Honor Roll



#A0032  
National Honor Society



#A0033  
Second Mile Award



#A0034  
Military Merit



#A0035  
Pathfinder



#A0036  
Ranger



#A0037  
Ranger Challenge



#A0038  
Raider Challenge



#A0039  
Cadet Challenge



#A0040  
Efficiency Award



#A0041  
Community Service Award



#A0042  
Principal's Award



#A0043  
Commandant's Award



**E-Series Medals**

For achievements that deserve high recognition, present an E-Series Medal. All medals are available in a gold (G), silver (S), or bronze (B) finish unless otherwise noted. Each is 1 1/4" diameter with an area for engraving on the back of 3/4". **\$5.25** each without engraving.

To add value and meaning to the award, each of these medals can be engraved on the reverse side for **\$5.00** per medal. Submit engraving in writing.

All Glendale medals can be worn with any ribbon drape. To see the complete selection of Army JROTC drapes visit us online at [www.paradestore.com](http://www.paradestore.com).



Medal shown actual size

Reverse side of all medals



#E9141G  
In Honor of Academic Excellence



#E9004B  
Scholastic Achievement



#E9231G  
Star Performer (gold only)



#E9039G  
Track, General



#E9041G  
Female Track Runner



#E9043G  
Male Track Runner



#E9070B  
Rifle Shooter



#E9075G  
Eagle with Torch



#E9133G  
Eagle (gold and silver only)



#E9140G  
Scholastic Achievement, (gold only)



#E9003G  
Achievement



#E9152G  
Achievement Recognition



#E9196G  
Succeeding with Teamwork (gold only)



#E9208G  
Leadership, (gold & silver only)



#E9255G  
Outstanding Citizen



#E9301G  
Distinguished Service Award, (gold only)



#E9428S  
Crossed Rifles (silver and gold only)



#E9871G  
First Place (gold only)



#E9882S  
Second Place (silver only)



#E9893B  
Third Place (bronze only)



#E4791G  
Lamp of Learning



#E9951G  
Outstanding Student (gold only)



#E9073G  
Track Female Field Events



#E9163G  
In Honor of Excellence (gold only)

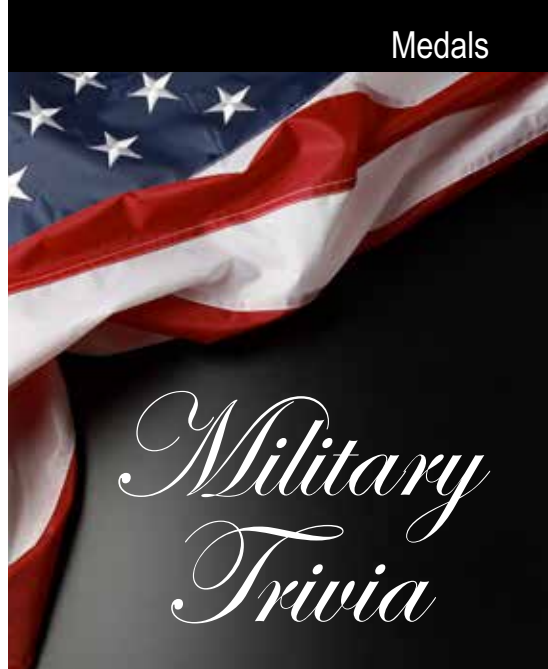

*Military Trivia*

**Test yourself!**

We've compiled eight trivia questions about the U.S. military. Can you get a perfect score?

1. Who was the only US president to have earned the rank of Eagle Scout?
2. In what state is Military installation Area 51 located?
3. The F-22 Raptor stealth fighter jet is operated by which brand of the military?
4. True or False — The U.S. Marines are the oldest branch of the United States military?
5. Which is the only branch of service that does not have an ROTC program?
6. What does the acronym SEAL mean (as in U.S. Navy SEAL team)?
7. What are the minimum and maximum ages to enlist in the U.S. Army?
8. How much does the ROTC program cover for college tuition?

Do you enjoy military history, insight, and coupons? Sign up for our newsletter, the *Bugler*, today at [www.paradestore.com/aboutus](http://www.paradestore.com/aboutus)

1. President Gerald Ford 2. Nevada 3. U.S. Air Force 4. False (by a few months). The Army was founded on June 14, 1775, the Navy on October 13, 1775, and the Marines on November 10, 1775. 5. U.S. Coast Guard. 6. Sea, Air, and Land. 7. Ages 17 and 35. 8. Up to 100%.

# Create Your Own Medals!

## School and Organization Medals

All medals below are available in gold(G), silver (S), or bronze (B) tone. Inserts sold below.



Octagon, 1 1/16"  
#S006  
\$3.95 each  
with insert \$6.45



"V" w/ flame,  
1 3/4" #S007  
\$6.25 each  
with insert \$8.75  
w/ 2 inserts \$11.25



Victory, 1 3/4"  
#S423  
\$5.50 each  
with insert \$7.50



Victory, 1 5/8"  
#S127  
\$3.95 each  
with insert \$6.45



Scholastic, 1 5/8"  
#S117  
\$3.95 each  
with insert \$6.45



Honor Roll, 1 1/2"  
#S195  
\$4.25 each  
with insert \$6.75



Citizenship, 1 1/2"  
#S194  
\$4.25 each  
with insert \$6.75

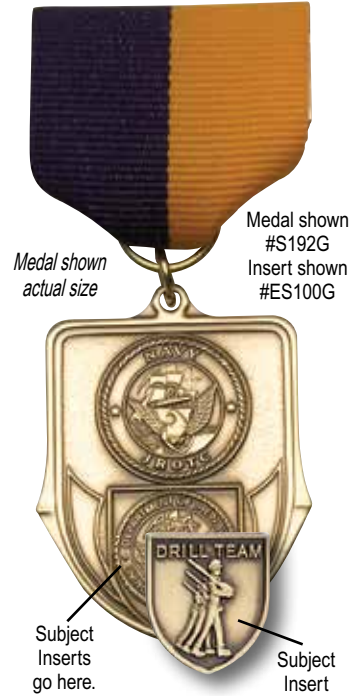

Target, 1 1/2"  
#S181  
\$3.95 each  
with insert \$6.45



Crossed Rifles,  
1 1/2"  
#S1200  
\$4.25 each  
with insert \$6.75



Excellence, 1 1/2"  
#S133  
\$3.95 each  
with insert \$6.45



Plain Laurel, 1 1/2"  
#S187  
\$3.95 each  
with insert \$6.45



Track, 1 1/2"  
#S160  
\$4.25 each  
with insert \$6.75



Archery, 1 1/2"  
#S142  
\$4.75 each  
with insert \$7.25

### An honor that will last

Metals and inserts you can be proud to give, these are produced from top quality materials carefully selected for their metal integrity. To display a more specific message, place an insert into the shield where the "V" or laurel leaf symbol is located. Unless noted, all are available in gold, silver, or bronze tone. Because these medals do not require additional inserts, prices for medals and inserts are separate.

Engrave medals on the reverse side for \$5.00 per medal. Submit customized engraving in writing.



## JROTC Medals

All JROTC medals below are 1 3/8" W x 1 5/8" H. Available in gold, silver, or bronze tone. JROTC top seal; BOS on bottom shield. Inserts sold below are placed over shield, if desired.



Army JROTC  
#S190  
\$4.50 each  
with insert \$7.00



AFJROTC  
#S191  
\$4.50 each  
with insert \$7.00



Navy JROTC  
#S192  
\$4.50 each  
with insert \$7.00



MCJROTC  
#S193  
\$4.50 each  
with insert \$7.00

For ribbon drapes for each medal — in solid colors, two- and three-color combinations, and Army JROTC drapes — see pages 75-76.

## Glendale Exclusive Inserts glendale exclusive

Subject inserts for medals on this page are available in gold, silver, or bronze tone. \$2.50



#ES100  
Armed Drill Team



#ES101  
Honor Guard



#ES102  
Color Guard



#ES103  
Sabre Team



#ES104  
JROTC



#ES105  
PT Team



#ES106  
Rifle Team



#ES107  
Orienteering



#ES108  
Unarmed Drill Team



#ES109  
Excellence/  
Torch



#ES110  
Leadership

## Subject Inserts

Subject inserts for medals on this page are available in gold, silver, or bronze tone. \$2.50



#ES735  
Honor Student



#ES746  
Service



#ES698  
Rifle



ES682  
Fire Dept.



#ES762  
Band



#ES743  
Excellence



1st Place, gold  
2nd Place, gold or silver  
3rd Place, gold or bronze  
4th Place, gold or bronze  
5th Place, gold or bronze  
6th Place, gold or bronze



#ES736



#ES738

#ES737

#ES739

#ES740

#ES741

 This symbol indicates Made in America



Available for all branches of service!

**Armed Forces Medallion Desktop Box *NEW!***

Give a gift of true distinction! These elegant, handcrafted dark cherry wood boxes make an attractive and distinctive home or office desktop accessory. Each box features a die-cast, gold-plated Armed Forces medallion on the lid, a quality brass lock and double hinges. Lined with black velvet. Felt bottom adds protection. Size: 8" x 8" x 4". Choose Army, Air Force, Navy, Marine Corps or Coast Guard medallion.

#8090 All Branches **\$79.95** each



**Armed Forces Medallion Picture Frames *NEW!***

A thoughtful gift for service members, these rich, mahogany-colored solid wood frames accompanied by a die-cast gold-plated U.S. Armed Services medallion create a place of honor on a wall or desktop. Choose Army, Air Force, Navy, Marine Corps or Coast Guard medallion. Two frame styles. each holds a 4"x6" photo.

#8070 Horizontal All Branches **\$39.95** each  
 #8080 Vertical All Branches (not shown) **\$54.95** each

# Thoughtful Gifts that Make Special Memories

**JROTC Graduation Stoles *NEW!***

Commemorate the big day with our new graduation stoles. Available in white, blue, grey, and red with the patches of the corresponding JROTC (Army, USAF, Navy, USMC) on the side. Each Stole comes with a bottle of Fabric-Tac adhesive.

Customize Your Stole!

- Graduate's name or Branch
- Sewn in Patch
- Arch and/or Ribbons

Please call us to discuss the full range of options and prices.

#150 All Branches **\$28.75** each



**Waterbury Cufflinks**

Made by the legendary company that's been making military buttons since 1812, these classic cufflinks are made from premium materials with the highest level of detail. Choose branch: Airforce, Army, Navy, Marines, Coast Guard

#330 All Branches **\$65.95** each



**Sword Engraving**

Now you can personalize swords purchased from Glendale! We can engrave up to 20 characters, including spaces. Engraving is only available on new purchases. Engraved Swords cannot be returned.

Choose your sword on pages 18-20 and add an "E" to the item number (ex: #689CE) **\$25.00** each

**Call our Sales team for large or custom orders  
 1-800-555-9269**



# Call between 8:00AM and 5PM CST and you will always reach a customer service representative. No answering machine or phone tree!

## Glendale Makes Ordering Easy

- By Phone: 800-653-5515 or 201-767-0233  
Mon-Fri 8 AM - 5 PM Central Time
- By Fax: 800-555-9269 or 201-767-3323  
7 days a week, 24 hours a day.
- Online: [www.ParadeStore.com](http://www.ParadeStore.com) (Also a great way to learn more about us, subscribe to the "Bugler" newsletter or send us an e-mail.
- By Mail: 12754 O'Connor Road San Antonio, TX 78233.  
(If a mailed order confirms a phone, fax, e-mail, or Web order, please mark it "CONFIRMATION" to avoid duplication.) Within TX, add 8.25% sales tax. If tax-exempt, notification must be included at time of order. Please make a note of your customer account number that appears above your name on the address label. Using it for each order or inquiry speeds response time! Order Processing: Most orders are processed and available items are shipped within 5 business days. (Refer to the UPS Ground Service map for time in transit.)

## Back Orders:

Unforeseen demand or manufacturer's delays occasionally result in items that are out of stock. Nevertheless, it is our policy to ship all available merchandise and back order the balance unless customer specifies otherwise. There are no additional delivery charges for multiple shipments within the contiguous U.S.

Custom Orders: Please plan accordingly. Custom work may take 4 - 10 weeks for delivery. Submit specifications for custom work, including imprinting, embroidery and engraving in writing. Credit cards will be charged and items cannot be canceled once production has begun.

## Prices:

Prices in this catalog are FOB San Antonio, TX effective August 1, 2024, and supersede all previously published prices. **We reserve the right to correct and change prices due to errors or frequent manufacturer increases.**

Payment Terms: Credit will be extended on authorized purchase orders of U.S. schools, military, police and fire units, and government agencies. Terms are Net 30 days. Visa, MasterCard, Discover, American Express and Impac/GPC/Smart Pay Visa orders are accepted. All other orders prior to shipment must be paid in full by check or money order to Glendale. Orders with declined credit cards will be canceled and are subject to a \$5 charge on reorders. When authorized, we will make partial shipments to meet customer deadlines; but partial invoices must be paid within our payment terms.

## Colors:

We try to accurately reproduce all colors shown in this catalog, but some variation may occur due to the printing process. Reorders are best handled by sending a sample for us to match colors. We aim for consistency, but variation in dye lots may occur. Small fabric swatches are available for cords, berets and bib scarves.

## Shortages or Damaged Goods:

Despite our quality assurance efforts, damages can occur in production or transit and order processing errors can be made. Please inspect all merchandise carefully. Call Customer Service at 1-800-653-5515 to report damages and claims. If a shipment is damaged in transit, it may be necessary for the carrier to inspect the shipment. Hold all cartons and packaging materials until you speak to us. We cannot accept responsibility for shortages or damages reported more than 48 hours after delivery.

## Glendale Exclusives:

Glendale has created and developed many unique and exclusive items. We are the only source for these products and reserve the right not to sell them for resale. Retail sales only.

## Suggestions:

We appreciate any suggestions, comments, criticisms, or questions you may have about our catalog, website, products, or service.

## Guarantee:

We fully guarantee all merchandise against defects in material and workmanship.

## Returns and Exchanges:

If there are any problems, please notify us immediately upon receipt of order. Merchandise must be returned only with prior authorization within 30 days of receipt in "as shipped" condition, including all original and retail packaging. We cannot accept returns of rifles, two-color cords, three-color cords, personalized items, DVDs or CDs, books, medals with inserts, custom orders or used or altered merchandise. A 15% restocking charge will apply to all Sabers & Swords as well as Sam Browne belts and straps.

Return items to: Glendale, Attn: Returns, 12754 O'Connor Road San Antonio, TX 78233.

- We will refund the purchase price for returned items.
- Original shipping charges are not refundable nor can they be credited unless shipment is Glendale's error. Only then will we pay return and/or replacement shipping charges.

## Shipping Information:

All packages will ship UPS Ground or US Postal Service (USPS), whichever is more expedient. APO/FPO will be sent USPS Priority, and a receiver's signature will be required. UPS fees incurred for change-of-delivery address or address errors after package has shipped will be charged to customers.

## Please Note:

For UPS Ground delivery, include a street address in shipping instructions. For all orders shipped by ground service within the contiguous United States, shipping charges are determined by the MERCHANDISE VALUE + any additional shipping surcharges for flag pole floor stands, rifle cases and drill bars.

## ADDITIONAL SHIPPING SURCHARGES

For Flagpoles, Floor Stands, Weighted Training Bars and Rifle Cases, add the following weight surcharges to regular shipping fees.

### Flag Pole Floor Stands

AAA \$10 each	L8 \$7 each	LG20 \$15 each
AMG \$10 each	L15 \$10 each	MFS \$15 each
C \$8 each	L20 \$15 each	MFS1 \$15 each
EN \$6 each	LG8 \$7 each	3W \$20 each
F \$7 each	LG15 \$10 each	

### Weighted Training Bar

DRILLBAR8: \$7 each if shipped in the lower continental US\*

### Rifle Cases

23, 24: \$7 each if shipped in the lower continental US\*

### Flag Carrying Cases

61, 65: \$10 each if shipped in the lower continental US\*

### Hat Carriers

512, 513, 516, 29: \$7 each if shipped in the lower continental US\*

### Gun Rack

GUNRACK-22: \$35 each if shipped in the lower continental US\*

### Flagpoles and Guidon Poles

\$5 each if shipped in the lower continental US\*

\* The lower continental US consists of all the states except AK and HI. Higher surcharges apply if shipped outside the lower continental US depending on region- Call for Quote

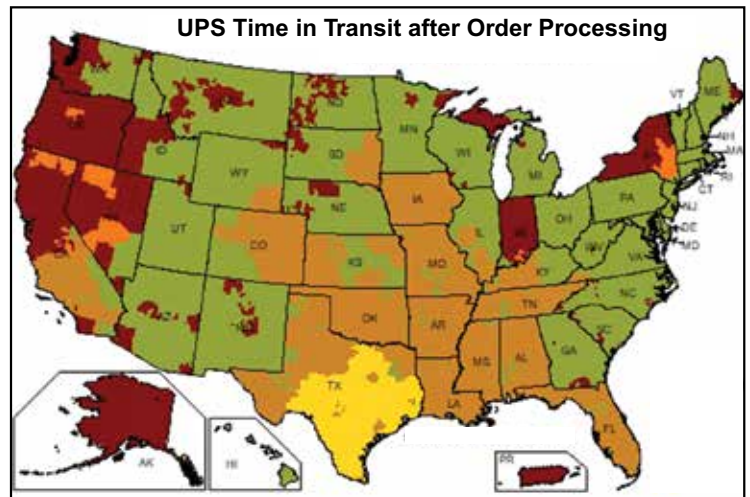

1 day 2 days 3 days 4 days 5 days 6 days

Most orders are processed and available items are shipped within 5 business days. For delivery estimate, add the UPS ground transit time from TX to your location shown on this UPS map.

Glendale assumes no liability for any loss, damage, injury, or expense of any kind arising out of the use or abuse of products in this catalog. This catalog may not be reproduced in whole or in part without the written consent of Glendale.

Copyright © 2024 Glendale Parade Store, LLC.



2024 JROTC Nationals - Regan Highschool



Black Clarino with nickel, #897BKC

**Honor Guard Leather Flag Carriers**

The standard of quality. This double harness is made from skillfully stitched top quality leather with premium polished metal flag cups to serve proudly for years to come. Double adjustable 1 3/4" straps. Hole at bottom of cup accommodates guidon pole.

Black with brass	#896BK	\$247.95 each
Extra Large Black with brass	#896BKXL	\$262.95 each
Black with nickel	#897BK	\$239.95 each
Extra Large Black with nickel	#897BKXL	\$254.95 each
Black Clarino with brass	#896BKC	\$259.95 each
Black Clarino with nickel	#897BKC	\$249.95 each
White with brass	#896WH	\$281.95 each
White with nickel	#897WH	\$269.95 each

glendale exclusive



**Flag Cup Insert, Leather**

This black leather insert fits inside the metal flag cups of all Glendale flag carriers to hold any 1" - diameter pole more securely. Will not be visible in any of the polished cups. 1 3/4" H.

Leather Flag Cup Insert #2281 \$8.95 each

**How to clean Clarino**

Clarino is a synthetic leather known for its durability and high-gloss finish. To keep Clarino clean and supple, use a spray-on furniture polish. Lightly spray the polish onto a soft cloth, apply to the belt or flag carrier, then buff dry. (You can also use a furniture polish wipe to attain similar results.)

**Mounted Guard Leather Flag Carriers**

Reinforced black leather Flag Carrier for mounted color guard. 10" high to securely hold a flag pole while riding. Two buckles and two 1/2" straps allow adjustment on a stirrup.

Brass buckles #1705 \$52.95 each  
Nickel buckles #1706 \$52.95 each

Slide-on Flag Carrier #131BK



Belt Mount Flag Carrier #132BK



Leather Flag Carrier with Belt #130BK

**Belt Mount Flag Carriers**

This slides over any belt up to 2 1/4" wide to seat flag securely at waist level. Leather shield. Heavy plastic flag cup.

Black	#132BK	\$42.50 each
White	#132WH	\$50.50 each
Black Clarino	#132BKC	\$71.75 each

**Slide-on Flag Carriers**

Two loops slip over belts up to 2 1/4" wide. Reinforced leather shield. Heavy plastic flag cup.

Black	#131BK	\$42.50 each
White	#131WH	\$50.50 each
Black Clarino	#131BKC	\$71.75 each

**Leather Flag Carriers with Belt**

Leather waist carrier with reinforced leather shield and heavy plastic flag cup. Nickel buckle. 1 3/4" belt. Please state waist size up to 44". (Larger sizes available. Please call for prices.)

Black	#130BK	\$59.95 each
White	#130WH	\$75.95 each





Double Harness, front view #1902



Double Harness, back view #1902



Single Harness, white, #1901

**Web Single Harness Flag Carriers**

Single harness with 2" webbing, reinforced leather shield, adjustable strap, heavy plastic flag cup and vinyl buckle.

- White webbing, flag cup, and buckle #1901 **\$39.95** each
- Same as above with an added 5" #1901XL **\$51.50** each
- Black webbing, flag cup, and buckle #1903 **\$39.95** each
- Same as above with an added 5" #1903XL **\$51.50** each

**Web Double Harness Flag Carriers**

Double harness with 2" webbing, reinforced leather shield, adjustable straps, heavy plastic flag cup and vinyl buckle.

- White webbing, flag cup, and buckle #1902 **\$55.25** each
- Same as above with an added 5" #1902XL **\$65.25** each
- Black webbing, flag cup, and buckle #1904 **\$55.25** each
- Same as above with an added 5" #1904XL **\$65.25** each

**Custom Web Flag Carriers**

Substitute a polished metal flag cup (as shown below) to any #1901 or #1902 flag carrier.

**Custom Single Web Flag Carriers**

- White with polished brass cup #1901PB **\$129.95** each
- White with polished brass cup, XL #1901PBXL **\$139.95** each
- White with polished nickel cup #1901PN **\$119.95** each
- White with polished nickel cup, XL #1901PNXL **\$129.95** each
- Black with polished brass cup #1903PB **\$129.95** each
- Black with polished brass cup, XL #1903PBXL **\$139.95** each
- Black with polished nickel cup #1903PN **\$117.95** each
- Black with polished nickel cup, XL #1903PNXL **\$127.95** each

**Custom Double Web Flag Carriers**

- White with polished brass cup #1902PB **\$139.95** each
- White with polished brass cup, XL #1902PBXL **\$149.95** each
- White with polished nickel cup #1902PN **\$129.95** each
- White with polished nickel cup, XL #1902PNXL **\$139.95** each
- Black with polished brass cup #1904PB **\$139.95** each
- Black with polished brass cup, XL #1904PBXL **\$149.95** each
- Black with polished nickel cup #1904PN **\$129.95** each
- Black with polished nickel cup, XL #1904PNXL **\$139.95** each



Nickel flag cup, # 1902PN



Brass flag cup, #1902PB



White Double Harness with Brass Flag Cup, #900WH

**Best Quality Web Double Harness Flag Carriers — with Guidon Pole Cup**

Double harness with 2" heavyweight pistol belt webbing and double adjustable shoulder straps. Reinforced leather shield and polished brass or nickel flag cup. Hole at bottom of cup accommodates guidon pole.

- Black/Brass #900BK **\$149.95** each
- Black/Nickel #899BK **\$139.95** each
- AF Blue/Brass #900AFB **\$149.95** each
- AF Blue/Nickel #899AFB **\$139.95** each
- White/Brass #900WH **\$149.95** each
- White/Nickel #899WH **\$139.95** each
- OD/Brass #900OD **\$149.95** each
- OD/Nickel #899OD **\$139.95** each



AF Blue Double Harness with Nickel Flag Cup, #899AFB



Black Harness with Brass Flag Cup, #900BK



**Airliner Flag Carrying Case**

Designed for frequent travel, this rugged case is called the "Airliner" for a reason! The innovative three-piece telescoping design extends from 48" to 88" and has a diameter of 5 1/2" to accommodate a mounted flag. This tough molded tube is lockable for secure travel and has a comfortable molded handle for easy carrying. Because it nests to only 48", it can easily be shipped by US Mail to overseas customers. Airline approved!

- #65 **\$89.95** each (\*\$10)

\* There is a shipping surcharge for heavy items. The surcharge is in parentheses following the price. See page 79 for complete shipping information.



**Flag Carrying Case**

The perfect case for carrying or storing two poles up to 8 1/2" long or one mounted flag set with spear ornament. 4 1/4"-diameter tube telescopes from 60" - 102" and has protective foam padding at the top. Easy-to-load hinged door with padlock eyes. Please note: This case is oversized and can only be shipped by UPS Ground or Parcel Select.

- #61 **\$94.95** each (\*\$10)



Call us at **800-653-5515** for fit questions and sizing information.

**Guidon Flag Carriers**

What makes this Guidon Carrier unique is its leather flag cup, narrowed to hold a guidon pole, with a hole at the bottom to allow for the ferrule to pass through as shown. Harness has 2" white webbing, adjustable strap, reinforced leather shield and white vinyl buckles.

- Single #1701 **\$46.75** each
- Double #1702 **\$61.75** each



Single Guidon Flag Carrier, #1701

*“Customer service is extremely professional. The merchandise is very reasonable.”*

C.C., FL



#1801BK



#1802WH

## Double Harness Leather Flag Carriers



Comfortable, sturdy, all-leather harness with large shield, adjustable straps, heavy plastic flag cup and nickel buckles. 1 1/4" W.

Black	#1802BK	\$56.95 each
Black: +5"	#1802BKXL	\$69.95 each
Same as above, in Black Clarino or White.		
Black Clarino	#1802BKC	\$108.95 each
Black Clarino: +5"	#1802BKCXL	\$119.95 each
White	#1802WH	\$69.95 each
White: +5"	#1802WHXL	\$88.75 each

The 1802 flag carrier can be special-ordered in smaller sizes. Send measurements required. (For instance, 12" less on the long straps and 4" less on the short straps.)

Black	#1802BKXS	\$67.95 each
White	#1802WHXS	\$76.75 each



Call us at  
**800-653-5515**  
for fit questions  
and sizing  
information.

Back view of Double  
Leather Flag Carrier in  
white  
#1802WH

## Single Harness Leather Flag Carriers



A well made leather carrier at an attractive price. 1 1/4"-wide leather single harness with leather shield, reinforced adjustable straps, heavy plastic flag cup and nickel buckle.

Black	#1801BK	\$49.95 each
White	#1801WH	\$59.95 each
Black Clarino	#1801BKC	\$93.75 each



### Pole Insert

Avoid frustration and demerits. This simple tapered insert makes guiding the flag pole into the cup a smooth and easy endeavor. The permanent, press fit attachment is made of cold rolled steel for durability. #2217 works with our line of 1 1/8" diameter Perfect-Fit Parade Poles, #2217S works with 1" Perfect-Fit Parade Poles. (See page 89). 4" long with taper starting 2.5" from the end.

Pole insert	#2217	\$24.95 each
Pole insert	#2217S	\$22.25 each



# All of Our Flag Carriers Are Proudly Made in the U.S.A

## Add a Polished Metal Cup to a Single or Double Harness Leather Flag Carriers

Substitute a polished metal flag cup to any Single Harness (#1801) or Double Harness (#1802) Leather Flag Carrier. Also available in Nickel (not shown).



### Single Leather Flag Carriers with Polished Metal Cup

Black with polished brass cup	#1801BKPB	\$131.75 each
Black with polished nickel cup	#1801BKPN	\$124.95 each
Black Clarino with polished brass cup	#1801BKCPB	\$164.95 each
Black Clarino with polished nickel cup	#1801BKCPN	\$145.75 each
White with polished brass cup	#1801WHPB	\$144.95 each
White with polished nickel cup	#1801WHPN	\$134.95 each



Black Clarino with polished brass cup  
#1802BKCPB

### Double Leather Flag Carriers with Polished Metal Cup

Black with polished brass cup	#1802BKPB	\$139.95 each
Black with polished brass cup, XL: +5"	#1802BKPBXL	\$149.95 each
Black with polished nickel cup	#1802BKPN	\$129.95 each
Black with polished nickel cup, XL: +5"	#1802BKPNXL	\$139.95 each
Black Clarino with polished brass cup	#1802BKCPB	\$174.95 each
Black Clarino with polished brass cup, XL: +5"	#1802BKCPBXL	\$188.75 each
Black Clarino with polished nickel cup	#1802BKCPN	\$169.95 each
Black Clarino with polished nickel cup, XL: +5"	#1802BKCPNXL	\$179.95 each
White with polished brass cup	#1802WHPB	\$149.95 each
White with polished brass cup, XL: +5"	#1802WHPBXL	\$159.95 each
White with polished nickel cup	#1802WHPN	\$139.95 each
White with polished nickel cup, XL: +5"	#1802WHPNXL	\$149.95 each



**Airliner Flag Carrying Case**

Designed for frequent travel, this rugged case is called the "Airliner" for a reason! The innovative three-piece telescoping design extends from 48" to 88" and has a diameter of 5 1/2" to accommodate a mounted flag. This tough molded tube is lockable for secure travel and has a comfortable molded handle for easy carrying. Because it nests to only 48", it can easily be shipped by US Mail to overseas customers. Airline approved!

#65 **\$89.95** each (\*\$10)

\* There is a shipping surcharge for heavy items. The surcharge is in parentheses following the price. See page 77 for complete shipping information.



**Flag Carrying Case**

The perfect case for carrying or storing two poles up to 8 1/2' long or one mounted flag set with spear ornament. 4 1/4"-diameter tube telescopes from 60" - 102" and has protective foam padding at the top. Easy-to-load hinged door with padlock eyes. Please note: This case is oversized and can only be shipped by UPS Ground or Parcel Select.

#61 **\$94.95** each (\*\$10)

Display Pole Case #49

**Display Pole Carrying Case with Handle**

Holds any two-piece pole, up to 8 feet, except 94TG & 98TGE telescoping poles. Multiple interior pockets for accessories and ornaments. Handle carrying strap. Made from heavy, water-resistant woven nylon material. Full perimeter length zipper makes it easy to load. 8 1/4" x 60". Black.

Display Pole Case #49 **\$49.50** each



Parade Case #67

**Parade Flag Pole Carrying Case**

This heavyweight vinyl case has snap closures, a shoulder strap and handle. At 10" x 59", it will hold any two-piece Glendale parade pole, including the 8' pole, except 94TG and 98TGE telescoping poles. Internal compartment separates the pole halves for added protection. This case will fit a mounted flag and a 7" eagle ornament.

Parade Case #67 **\$69.50** each

**Canvas Flag Covers**



These durable water-resistant flag covers are sized to fit over any fully-mounted assembled pole with a spear ornament and 3' x 5' flag. Designed by Glendale for parade and competition use and made exclusively for us. The 8" x 56" - 58" cover has a pierce-resistant spear compartment at the top and a slip-cord and lock closure at the bottom. We can personalize these covers (see below). Canvas cover weighs 9 oz.

Navy, royal, black, red, dark green.  
Canvas Flag Cover #68 **\$37.95** each

*"Thank you. I really appreciate the effort that you've made on our behalf. This is exactly why I recommend you all to those I work with."*

Paul

Flag covers will protect flags from weather conditions and minimize damage while traveling to and from parade and display sites.

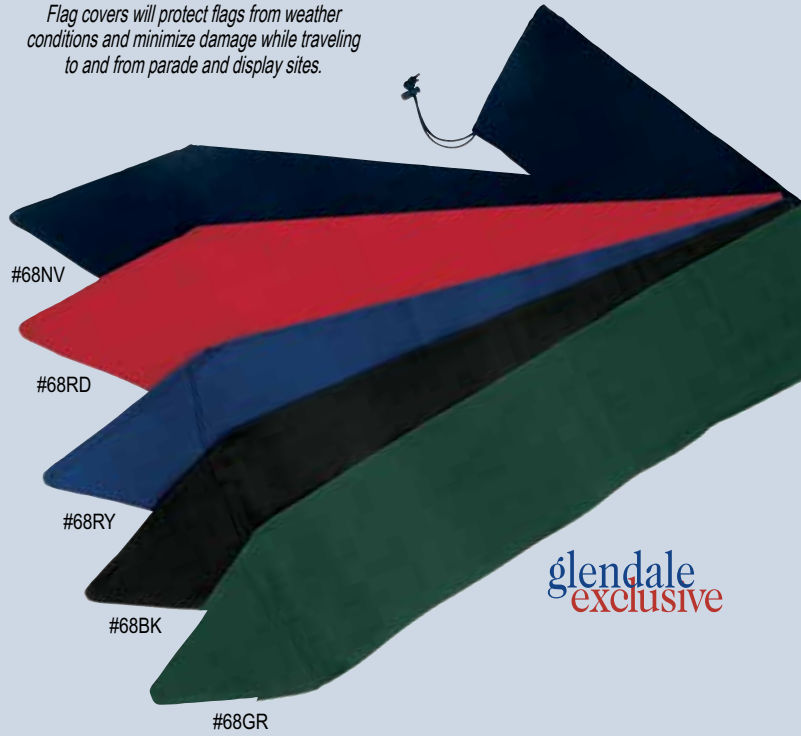

glendale exclusive

**Dust Cover**

Protects mounted flag sets while on display. Clear, heavy-gauge polyethylene. 12" x 108". (not shown)

Dust Cover #60 **\$7.50** each



Rain Cover #59

**Rain Cover**

Carry or store a mounted flag set. Durable and waterproof, soft tan vinyl, lined with protective material. Tie tape closure. 8" x 70". Color: Tan.

Rain Cover #59 **\$30.25** each



#68I



Nylon Flag Cover #48

glendale exclusive

**Nylon Flag Cover**

This 8" x 56" cover has a pierce-resistant spear compartment at the top and a slip cord and lock closure at the bottom. Wt. 6 oz. Color: Black.



Nylon Flag Cover #48 **\$35.95** each

**Imprinted Canvas Flag Covers**

Letters available in 2", upper case only. All orders for imprinting must be submitted in writing to avoid misprints. Email us at customerservice@glendale.com. Cover will be printed horizontally (as shown) with up to 25 characters/spaces. If a vertical design is needed, only 20 spaces are available. No punctuation marks.

**Step One**—choose cover color :

Navy - #68NV, Red - #68RD, Royal - #68RY, Black - #68BK, Green - #68GR

**Step Two**—choose direction of printing:

Horizontal - HI, Vertical - VI

**Step Three**—choose the color for the lettering:

White - WH, Gold - GO, Red - RD, Black - BK

**Step Four**—choose the number of letters

A: 1-6 (vertical or horizontal) **\$45.95** each

B: 7-13 (vertical or horizontal) **\$49.25** each

C: 14-25 (Horizontal only) **\$63.25** each

**Step Five**—put it all together. The code for a navy flag cover, with horizontal printing, white lettering, and 15 letters would be #68NV HI WH C.

Call if you need assistance, we're happy to help. 1-800-653-5515



Original Military Floor Stand #MFS



Single Military Floor Stand (without adapter) #MFS1

## Military Floor Stands

As beautiful as they are functional. These highly polished, reflective chrome stands will accommodate any pole up to 1 1/4" diameter, as well as the bottom ferrule of any military guidon staff. Tip-resistant flat base has a diameter of 13" and weighs 30 pounds without adapter. Two styles: Original (includes adapter that accommodates one, two or three guidon staffs or 1" poles). Single (holds one flag with pole up to 1 1/4" diameter). Shaft height of both styles is 11 1/2".

- |   |        |                       |
|---|--------|-----------------------|
| Original Military Floor Stand (with adapter)  | #MFS   | \$579.00 each (\$15*) |
| Single Military Floor Stand (without adapter) | #MFS1  | \$459.00 each (\$15*) |
| MFS Carrying Case, holds up to 30 lbs.        | #35MFS | \$46.95 each          |

*Note: Guidon poles with pointed bottom ferrules will only fit in MFS stands. To use Guidon poles with other Glendale stands, order our exclusive Floor Stand Adapters see below.*

“Glendale Parade Store had exactly what was needed and items shipped fast.”  
C.C., USAF

# Show off your colors!



Three-Way Stand #3W

## Three-Way® Floor Stand

Create a dramatic display with this versatile stand designed to accommodate one, two, or three 1-1/4" diameter poles. Cast iron 12" base with gold aluminum cover.

- |                           |     |                       |
|---------------------------|-----|-----------------------|
| Three-Way Stand (45 lbs.) | #3W | \$379.00 each (\$20*) |
|---------------------------|-----|-----------------------|

*Makes Guidon Poles fit regular floor stands!*

## Floor Stand Adapters

A simple and inexpensive solution to the problem of how to use a guidon pole with a regular flag pole floor stand. Just place the 12" adapter into the stand, then slide the pole into the adapter. The pole will be held upright and securely. Available with brass or chrome finish to match the metal on the guidon poles and/or similarly finished floor stands.

- |               |       |              |
|---------------|-------|--------------|
| Brass finish  | #1101 | \$25.95 each |
| Chrome finish | #1102 | \$25.95 each |



Brass adapter #1101



Chrome adapter #1102

**glendale**  
exclusive



Commodore Stand #C

## Commodore® Floor Stands

The Commodore stand is made of durable ABS plastic with a rich, permanent matte gilt finish. Includes an adapter sleeve to allow use with a 1-1/4" diameter pole. Base measures 11 1/2".

- |                              |     |                     |
|------------------------------|-----|---------------------|
| 10 lbs. (Weighted with sand) | #C  | \$52.95 each (\$8*) |
| 2 lbs. (Not weighted)        | #CE | \$49.95 each        |

## Admiral® Floor Stands

Extremely stable 18-pound cast iron stand with gold aluminum anodized matte cover (similar in appearance to Commodore Floor Stand). Includes an adapter sleeve that allows use with a 1" diameter pole. Base measures 11 1/2". (Not shown.)

- |                           |      |                       |
|---------------------------|------|-----------------------|
| For a 1-1/4" pole         | #AMG | \$179.95 each (\$10*) |
| For a 1 1/4 - 1 3/8" pole | #AAA | \$169.95 each (\$10*) |

Ensign Stand #EN



## Ensign® Floor Stand

An attractive, economical stand designed for smaller flags and pole sets that require less weight and base size. Made of tough ABS plastic with a matte gilt finish. Includes an adapter sleeve to allow use with a pole of 3/4-1" diameter. Base measures 9 1/2".

- |                             |     |                     |
|-----------------------------|-----|---------------------|
| 5 lbs. (Weighted with sand) | #EN | \$44.95 each (\$6*) |
|-----------------------------|-----|---------------------|

**Liberty® Floor Stands**

Made of strong ABS plastic with a bright metalized finish. Includes an adapter sleeve to allow use with a pole of 1-1/4" diameter. The base of each stand measures 11 1/2". (The 2-lb. stand is not weighted; the 8-lb. stands are weighted with sand; 15- and 20-lb. stands, with sand and Dura-steel shot.)

- Chrome 2 lbs. #LE \$57.95 each
- Chrome 8 lbs. #L8 \$59.95 each (\$7\*)
- Chrome 15 lbs. #L15 \$79.95 each (\$10\*)
- Chrome 20 lbs. #L20 \$97.95 each (\$15\*)
- Gold 2 lbs. #LGE \$57.95 each
- Gold 8 lbs. #LG8 \$59.95 each (\$7\*)
- Gold 15 lbs. #LG15 \$79.95 each (\$10\*)
- Gold 20 lbs. #LG20 \$97.95 each (\$15\*)



Liberty Stand  
Chrome  
#L8

**Our Best Seller!**  
Liberty Stand  
Gold  
#LG8



Freedom Stand  
#F

**Freedom® Floor Stands**

Made of strong ABS plastic with a gilt matte finish. Includes an adapter sleeve to allow use with a pole of 1-1/4" diameter. The base of each stand measures 11 1/2".

- 8 lbs. (Weighted with sand) #F \$52.95 each (\$7\*)
- 2 lbs. (Not weighted) #FE \$49.95 each



glendale  
exclusive

Carrying  
Case  
#35

**Floor Stand Carrying Case**

Protect your stand while making transport easier. Made of a weather-resistant black nylon with a reinforced carrying handle and heavy duty zipper. Strong vinyl bottom. Suitable for any Glendale flag stand weighing. MFS case comes with 2" X 12" draw string bag to house chrome sleeve or adapter.

Carrying Case holds up to 25 pounds. Base measures 12" across. #35 \$39.95 each

MFS Carrying Case holds up to 30 pounds. Base measures 13" across. #35MFS \$46.95 each

\* Due to increased shipping charges for the heavyweight stands, there is a shipping surcharge for all weighted floor stands (those over 2 lbs.). The surcharge is shown in parentheses following the prices of items requiring the additional shipping fee.



Save when you buy a Mounted Flag Set. Turn to page 95 for more information.

# Make Your Flag a Statement

**Tassels and Cords**

**GOLD**

- 3" Tassels with 5' Cord for 2' x 3' flag #117 \$24.95 each
- 5" Tassels with 9' Cord for 3' x 5' flag #118 \$29.95 each
- 6" Tassels with 9' Cord for 4' x 6' flag #119 \$31.95 each

**SILVER**

- 4 1/2" Tassels with 9' Cord for 3' x 5' flag #124SV \$34.95 each

**WHITE**

- 6" Tassels with 9' Cord for 4' x 6' flag #124WH \$39.95 each

**Red White and Blue**

- 7" Tassels with 9' Cord for 3' x 5' flag #124RWB \$122.95 each



3" #117

5" #118

6" #119

4 1/2" #124SV

6" #124WH

7" #124RWB

# Perfect Fit Ornaments

**P** **Perfect-Fit Ornaments**  Threaded to fit precisely atop our Perfect Fit Aluminum Flag Poles (see page 89), our brass Perfect-Fit metal ornaments are also compatible with all of our Two-Piece Polished Wood Flag Poles (see page 88) except 24GE and 24SE.

### Army Spear

The appropriate ornament for Army and Marine Corps flags is the gold Army spear; for the Air Force flag, the silver Army spear. For Perfect-Fit poles only.

- Gold, 8" 22GE **\$69.95** each
- Silver, 8" 22SE **\$69.95** each

For Perfect Fit poles and wood poles.

- Gold, 8" 24GE **\$84.75** each
- Silver, 8" 24SE **\$84.75** each

### Eagle Ornament

Our country's symbol soars in bright metal. 7" tall with 7" wingspan.

- Gold, 7" 7GE **\$54.95** each

### Flat Spear

- Gold metal, 7½" 32GE **\$59.95** each
- Silver metal, 7½" 32SE **\$59.95** each

### 3" Parade Balls

- Gold #87BE **\$54.95** each
- Silver #87CE **\$54.95** each

### Star of David

- Gold metal, 6 ¾" 34GE **\$64.95** each

### Passion Cross

- Hammered Surface, 6½" #26GE **\$54.95** each



**Don't see the Perfect-Fit ornament you want? No problem!**  
**Traditional-Fit to Perfect Adaptor**  
 Our solid brass adaptor lets you install Traditional Fit ornaments (page 87) onto any Perfect Fit Pole.  
 2222E Perfect Fit Adapter **\$20.75** each



**P** **Perfect-Fit Ornaments**  
 Are threaded to fit precisely atop our Perfect-Fit Aluminum Parade Poles, each Perfect-Fit ornament is also compatible with all of our Two-Piece Polished Wood Flag Poles. (See pages page 88 Perfect-Fit to Traditional-Fit adaptor. See page 89.

**T** **Traditional-Fit Ornaments**  
 Are made to slip over the top of poles. They are compatible with our Traditional Fit Aluminum Parade Poles and all of our Two-Piece Polished Wood Flag Poles. (See pages 88-89.) (Please note a fibroid sleeve #2228 is necessary for a tighter fit with the aluminum poles)

# Flag Pole Accessories

### Flag Accessories

- Tangle-free Flag Mounting Swivels with carabiner for 1"-1.25" diameter poles
  - Black, set of 2 #2276B **\$19.95** set
  - Aluminium set of 2 #2276A **\$18.95** set
- 5" Tapered Bottom Ferrules. For 1" wood poles only. (To fit, it will be necessary to undercut the pole.) Available with Brass or Chrome finish.
  - Brass #2218 **\$69.95** each
  - Chrome #2219 **\$74.95** each
- Nylon Snap Hook for second flag on halyard. #2210 **\$3.50** each
- Pole screw joint, brass, 1" diameter. #2204 **\$34.95** each
- Pole screw joint, brass, 1¼" diameter. #2205 **\$34.95** each
- Pole screw joint, brass, 1⅜" diameter. #2206 **\$49.95** each
- Ornament Ferrule, 2" x 1" for #5A, #7A, #11A and #31G ornaments. #2207 **\$12.95** each
- Black Plastic Sleeve Insert for Commodore, Liberty or Freedom Floor Stands. #2209 **\$3.95** each
- Adjustable aluminum ring with screw eye, 1". #2220 **\$6.50** each
- Adjustable aluminum ring with screw eye, 1¼". #2221 **\$9.95** each
- Perfect Fit Adapter #2222E **\$22.95** each
- Rubber stopper for bottom of 1" aluminum pole. #2223 **\$1.95** each (Items # 2222 and 2223 not for use on telescoping or wood-grained steel poles.)
- Rubber stopper for bottom of 1¼" aluminum pole. (Not for use on telescoping pole.) #2224 **\$2.50** each
- E-Z Mount plastic flag rings to attach a flag with grommets to an indoor pole. 1" pole #2277 **\$1.95** each
- 1½"-1⅜" pole #2278 **\$4.95** each
- Nylon flag ties. #2226 **\$.95** each



## Brass Ornaments

### T Solid Brass Ornaments

Fit High quality and built to last for years. Will fit our Traditional Fit Aluminum Pole all of our Two-Piece Polished Wood Flag Poles (see page 88).

#### Army Spears

The appropriate ornament for Army and Marine Corps flags is the gold Army spear; for the Air Force flag, the silver Army spear.

Brass, 7"	#22B	\$64.95 each
Brass, 8 1/4"	#22LB	\$79.95 each
Chrome, 7"	#22C	\$74.95 each
Chrome, 8 1/4"	#22LC	\$89.95 each



*"Thanks a million for the excellent quality and service."  
D.T., Las Vegas, NV*

#### Round Spears

Brass, 8"	#85G	\$59.95 each
Chrome, 8"	#85C	\$69.95 each

#### Spears and Lances

Fancy Spear Brass, 8"	#31G	\$59.95 each
Battalion Lance Brass, 9 1/2"	#13B	\$69.95 each

#### Brass Cross

Plain Church Cross brass, 9 1/4"	#56	\$79.95 each
Botonee Cross brass, 7 3/4"	#83B	\$109.95 each

#### Maple Leaf

Brass, 8 1/4"	#10A	\$99.95 each
---------------	------	--------------

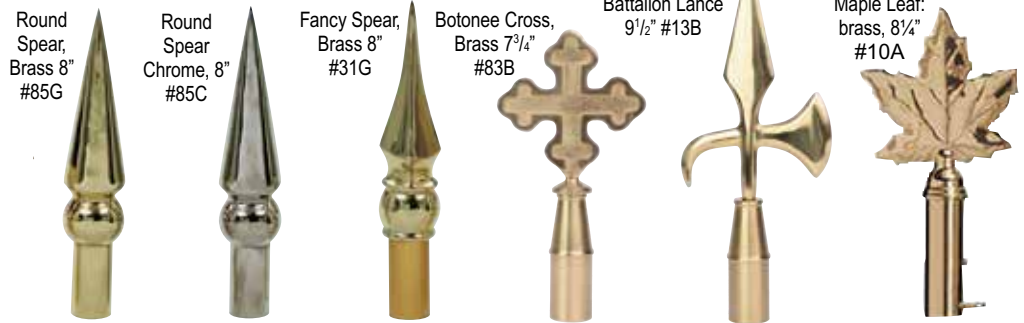

## High Impact Styrene Ornaments

### T Styrene Ornaments

Fit The look of metal but at significant savings. Will fit our Traditional Fit Aluminum Pole all of our Two-Piece Polished Wood Flag Poles (see page 88).

#### Round Styrene Spears

Round Gold styrene, 8 1/4"	#85SG	\$27.95 each
Round Silver styrene, 8 1/4"	#85SC	\$27.95 each

#### Fancy Styrene Spears

Fancy Gold styrene, 7 3/4"	#31SG	\$27.95 each
----------------------------	-------	--------------

#### Classic Eagle Styrene Ornament

Perched eagle made of high-impact styrene plastic with bright silver or gold finish. Has removable ferrule and includes adapter for use with 1 1/4" poles. 8 1/2" wing span.

#6SC Silver	\$29.95 each
#6SG Gold	\$29.95 each

#### Perched Eagle Styrene Ornament

Lightweight and extremely durable. Made of high-impact styrene plastic with an antique gold-plated finish. 7" wing-span

#7S	\$29.95 each
-----	--------------



## Brass Plated Aluminum Ornaments

### T Brass Plated Aluminum Ornaments

Fit Sturdy yet light weight, with brass plating that looks sharp and wears well. Will fit our Traditional Fit Aluminum Pole all of our Two-Piece Polished Wood Flag Poles (see pages 90-91).

#### Gold Eagle Flag Pole Ornaments

Perched eagles in bright, brass-plated aluminum casting. Sizes are based on wing spread.

5" (same perch as 7" Eagle)	#5A	\$39.95 each
7"	#7A	\$47.95 each
11"	#11A	\$94.95 each



# Flag, Guidon and Lead Banner Poles



8' x 1" Wood Pole  
Brass #81W

8' x 1 1/4" Wood Pole  
Brass #84W

7' x 1" Wood Pole  
Chrome #71WC

## Two-Piece Polished Wood Poles



The natural beauty of a wood pole makes it an enduring choice for displaying colors with distinction. These carefully selected hardwood poles have a handsome metal screw joint and a rich polished oak finish on brass and dark oak on chrome. Wood poles should always be stored horizontally.

### Brass Joint

Pole Size	Weight		
6' x 1"	1.75 lbs	#61W	\$62.95 each (\$5*)
7' x 1"	2.25 lbs	#71W	\$69.95 each (\$5*)
7' x 1 1/4"	2.50 lbs	#74W	\$74.95 each (\$5*)
8' x 1"	2.75 lbs	#81W	\$72.95 each (\$5*)
8' x 1 1/4"	3.50 lbs	#84W	\$82.95 each (\$5*)
9' x 1 1/4"	4.25 lbs	#94W	\$94.95 each (\$5*)
9' x 1 3/8"	5.00 lbs	#95W	\$105.95 each (\$5*)

### Chrome Joint

Pole Size	Weight		
7'x1"	1.6 lb	71WC	\$102.95 each (\$5*)
7'x1 1/4"	3.1 lb	74WC	\$119.95 each (\$5*)
8'x1"	2.1 lb	81WC	\$107.95 each (\$5*)
8'x1 1/4"	3.5 lb	84WC	\$124.95 each (\$5*)
9'x1 1/4"	3.8 lb	94WC	\$136.95 each (\$5*)

## Guidon Floor Saver

This black 1/2" rubber stopper saves gym and hardwood floors. Can be taped for added security.

#G1TIP Guidon Floor Saver  
\$3.50 each



Military 7' Guidon Pole  
#G77C

Military 8' Guidon Pole  
#G87B

Military 9' Guidon Pole  
#G98C

## Two-Piece Guidon Poles **BEST SELLER!**

Two-piece light ash pole with Army spear and bottom-tapered ferrule is a standard guidon staff made to military specifications. The sizes given are the total assembled height from top to bottom. These tapered poles measure 1-1/4" in diameter at widest point. The 7' pole is not a regulation size.

Fits in Military Floor Stands (page 84) or floor stand adapter (page 84). Wood poles should always be stored horizontally.

Military 7' Pole with Chrome Spear and ferrule. (7' is not regulation.)	#G77C	\$194.95 each (\$5*)
Military 8' Pole with Brass Spear and ferrule.	#G87B	\$194.95 each (\$5*)
Military 8' Pole with Chrome Spear and ferrule.	#G87C	\$194.95 each (\$5*)
Military 9' 6" Pole with Chrome Spear and ferrule.	#G98C	\$216.95 each (\$5*)
Military 9' 6" Pole with Brass Spear and ferrule.	#G98B	\$216.95 each (\$5*)

## Assembling Two-Piece Poles

Before assembling two-piece poles, use a lubricant spray or gel on threads to avoid cross-threading precision screw joints.



Quality Mounting Pole Gold  
Aluminum #2216

Deluxe Mounting Pole Silver  
Aluminum #2238

## Aluminum Lead Banner Poles

Each mounting is a two-piece aluminum crossbar. Poles have a solid brass precision-machined screw joint. Poles have either a shiny silver mil or bright gold finish.

### For 6' Banners:

Quality Mounting Pole, Gold 7' x 1", with golden acorn ends.	#2215	\$99.95 each (\$5*)
Deluxe Mounting Pole, Gold 7' x 1 1/8", with golden spear ends.	#2233	\$193.75 each (\$5*)

### For 8' Banners:

Quality Mounting Pole, Gold, 9' x 1 1/4", with golden acorn ends.	#2216	\$107.95 each (\$5*)
Deluxe Mounting Pole, Gold, 9' x 1 1/8", with golden spear ends.	#2237	\$225.95 each (\$5*)

\* Due to increased shipping charges on all poles and banners, there is a shipping surcharge of \$5.00 each. The surcharge is shown in parentheses following the prices of items requiring the additional shipping fee.





7' x 1" Gold Parade Pole #71GE

8' x 1" Silver Parade Pole #81SE

Telescoping Gold Parade Pole #98TGE

**Perfect-Fit Aluminum Poles**

Two-Piece and Telescoping Styles

Precision-engineered to be incredibly lightweight and easy to handle, these beautiful poles are the choice of America's leading color guards and marching bands. Made from strong aluminum tubing with a rich gold anodized or bright silver mill finish, each two-piece pole has a base plug, a ring for attaching cord with tassels, and two adjustable rings to hold a flag tautly in place. The Telescoping Pole has an internal sleeve joint that forms a secure lock.



Gold	7'x1"	1.2 lb	71GE	\$84.95 each (\$5*)
Gold	7'x1 1/8"	1.7 lb	78GE	\$99.95 each (\$5*)
Gold	8'x1"	1.3 lb	81GE	\$87.95 each (\$5*)
Gold	8'x1 1/8"	1.9 lb	88GE	\$103.95 each (\$5*)
Gold	9'x1 1/8"	2.1 lb	98GE	\$105.95 each (\$5*)
Silver	7'x1"	1.2 lb	71SE	\$83.95 each (\$5*)
Silver	7'x1 1/8"	1.7 lb	78SE	\$99.95 each (\$5*)
Silver	8'x1"	1.3 lb	81SE	\$86.95 each (\$5*)
Silver	8'x1 1/8"	1.9 lb	88SE	\$103.95 each (\$5*)
Silver	9'x1 1/8"	2.1 lb	98SE	\$105.95 each (\$5*)
Telescoping Pole:				
Gold only	6' to 10' x 1 1/8"	1.4 lbs	98TGE	\$79.95 each (\$5*)

**P Perfect-Fit Poles**  
Are threaded to precisely fit our Perfect-Fit Ornaments (see page 86).

\* Due to increased shipping charges on all poles and banners, there is a shipping surcharge of \$5.00 each. The surcharge is shown in parentheses following the prices of items requiring the additional shipping fee.



**Compact 6' Flag Pole with Spear**

These durable aluminum poles are a great option when a shorter pole design is needed. Includes plastic base cap and short 3 1/2" spear. Bright gold finish.



Gold 6' Flag Pole #61G

Gold	6' x 1"	1.50 lbs	#61G	\$104.95 each
------	---------	----------	------	---------------

# Quality Poles Let You Parade with Pride



9' x 1 1/4" Gold Parade Pole #94G

9' x 1 1/4" Silver Parade Pole #94S

Telescoping Gold Parade Pole #94TG

**Traditional-Fit Aluminum Poles**

Two-Piece Style Poles

Engineered for maximum performance and beauty, these poles are the choice of America's leading color guards and marching bands. Made from strong aluminum tubing with a rich gold or silver anodized finish. Each style has a shock absorbing rubber base plug and an adjustable band for attaching flag, cord and tassels.



	Pole Size	Weight		
Gold	7' x 1"	2.25 lbs	#71G	\$84.95 each (\$5*)
Gold	8' x 1"	2.75 lbs	#81G	\$93.95 each (\$5*)
Gold	8' x 1 1/4"	3.25 lbs	#84G	\$99.95 each (\$5*)
Gold	9' x 1 1/4"	3.75 lbs	#94G	\$112.95 each (\$5*)
Silver	7' x 1"	2.25 lbs	#71S	\$89.95 each (\$5*)
Silver	8' x 1"	2.75 lbs	#81S	\$96.95 each (\$5*)
Silver	8' x 1 1/4"	3.25 lbs	#84S	\$99.95 each (\$5*)
Silver	9' x 1 1/4"	3.75 lbs	#94S	\$112.95 each (\$5*)
Telescoping Pole:				
Gold Only	5' - 9' x 1 1/4"	2.00 lbs	#94TG	\$71.95 each (\$5*)

**T Traditional-Fit Poles**  
Will fit our Traditional-Fit Ornaments. (see page 87).

**Attaching cords and tassels**

1. Insert folded end of cord and tassel up through bottom of screw eye.
2. Pass loose ends of cord and tassel through and over loop above screw eye.
3. Pull down gently until cord and tassel are snug against pole, then drape over the front of the flag.

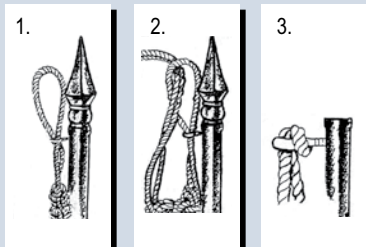

**Perfect to Traditional Fit Adaptor**



Our solid brass adaptor lets you install Traditional Fit ornaments (page 87) onto all sizes and styles of our Perfect Fit Poles.

2222E Perfect Fit Adaptor  
\$22.95 each



See page 85 to see our Tassels and Cords

# How to Order Custom Flags and Banners

Make an impression with beautiful custom flags and banners from Glendale. Flags and banners are easy to order and most can be created in 3-4 weeks time. To receive a firm quote on a custom flag or banner, please email the following specifications to: [customwork@glendale.com](mailto:customwork@glendale.com) along with a drawing or reference of your design.

1. What Item style are you looking for? (flag, banner, guidon, etc.)
2. Quantity of flags and banners you need.
3. Size: Both height and length.
4. Construction (single, single/reverse or double see below for more information)
5. Finish (pole sleeve or heading & grommet holes to attach to pole or guidon)
6. Method of manufacture (digitally printed or appliqued)
7. Background color(s) We can match most Pantone, hex or RGB colors.
8. Lettering that goes on the flag or banner (proper spelling, please!)
9. Lettering color(s) and Style (block or stylized)
10. Your emblem (Please provide artwork)
11. Emblem colors (if not depicted in artwork)
12. Fringe color(s) if you are adding fringe.

If you need help just call 1-800-653-5515 and ask for Custom Work.

**IMPORTANT:** If artwork must be redrawn (from a drawing, photograph, JPEG or other non-vector graphic), a \$50 per hour charge will apply.

Artwork can be emailed to: [customwork@glendale.com](mailto:customwork@glendale.com)



3' x 5' flag with digital print, grommets, and gold fringe.



20' x 27 3/4' guidon, digitally printed, pole sleeve.



This 8' x 3' banner can be appliqued or digitally printed.

## Flag Terms to Know

Reverse Construction: Printing Front and Back

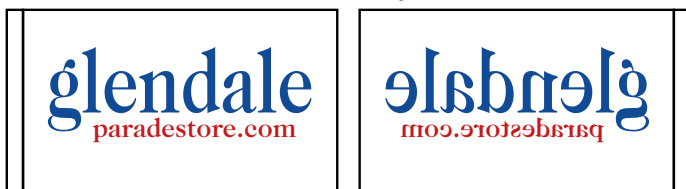

Single Construction: Printing Front only



Double Construction: Printing Front and Back

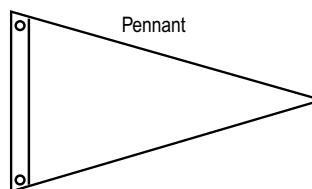

Pennant

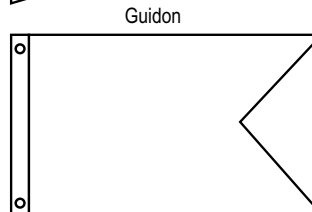

Guidon

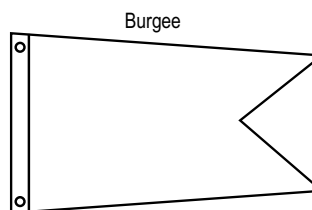

Burgee

Finish: Pole Sleeve

Finish: Heading and Grommet Holes



Fringe



Lead Poles available for both 6" and 8" banners. See page 86





*This 8' x 3' banner can be appliqued or digitally printed.*



**Customizable Air Force Guidon**

Customizable Regulation Air Force Guidon. Single Reverse construction. Pole hem with leather tabs. Appliqued/ Embroidered Design on nylon  
#AFGUIDON 20" x 27 3/4" \$339.00



**Army Guidon**

20" x 27 3/4" Allow 3-5 weeks for delivery - Bottom Line can change.  
Army Guidon  
#ARMYGUIDON \$335.95 each

## Custom Patches and Flashes

**Custom Patches**

Embroidered patches with 100% or partial embroidery on a twill fabric can be made to your specifications. Price is determined by quantity, size, shape, amount of embroidery (number of stitches) number of colors, type of thread, and backing – PVC (sew on), glue (iron on), or hook and loop. Please send a detailed sketch (you can use a copying machine to blow the image to the desired 200%). Price quotation will be sent on inquiry. Allow 5-7 weeks for delivery after confirmation of order. Minimum order is 50 pieces; price break is at 200 and over. Designs may be emailed to [customwork@glendale.com](mailto:customwork@glendale.com) or faxed to 1-800-555-9269.



*Glendale has a complete line of Special Forces Flashes. Turn to page 44 for more information.*





**CUSTOMER FAVORITE!**



## Armed Forces Flag Display Cases

These attractive cases are made of rich mahogany-colored hardwood and a thick glass for enduring service. A die-cast, gold-plated U.S. Armed Forces medallion is centered on the bevel-cut double mat. Felt lined with an easy-open back panel to insert the flag. Scratch-resistant bottom. Holds up to a 5' x 9½" cotton flag. Outside dimensions are 26"L x 13"H x 3½"D.

Army	#8025	<b>\$84.95</b> each
Air Force	#8026	<b>\$84.95</b> each
Navy	#8027	<b>\$84.95</b> each
Marine Corps	#8028	<b>\$84.95</b> each
Coast Guard	#8029	<b>\$84.95</b> each



Casket Band  
#27602

## Casket Bands



Assure peace of mind during casket movement — when safety, protocol, and respect to our National Colors is of the highest concern — by securing the flag with this elastic band, which holds and blows a 5' x 9½" flag on a casket during ceremonies. Designed by a police officer with more than 22 years of experience as an honor guard member, team leader, and instructor. Available in black or white, 1" or 2" wide.

Black 1"	#27601	<b>\$32.95</b> each
Black 2"	#27602	<b>\$36.95</b> each
White 1"	#27611	<b>\$32.95</b> each
White 2"	#27612	<b>\$36.95</b> each

Turn to page 55  
see our selection of  
American flags.

## Memorial Flag Cases

Display and protect your treasured memorial flag in a beautiful wooden case with a glass front and removable back panel for easy insertion. Can be either free-standing or wall-mounted. (Flags not included.)

Capitol Case  
in Oak Finish  
#70130



Memorial Case  
in Cherry Finish  
#7011C



Veteran Case in  
Oak Finish  
#70140



## Capitol Flag Case – for 3' x 5' flag.

Cherry Finish	#7013C	<b>\$114.95</b> each
Oak Finish	#70130	<b>\$114.95</b> each

## Memorial Flag Case – for 5' x 9½' flag.

Cherry Finish	#7011C	<b>\$96.95</b> each
---------------	--------	---------------------

## Veteran Flag Case – for 5' x 9½' flag

Cherry Finish	#7014C	<b>\$149.95</b> each
Oak Finish	#70140	<b>\$149.95</b> each

## Memorial Flag Hat/Lapel Pins/Patch

To be in an honor guard is a special privilege, one you can proudly declare with a hat and/or lapel pin or patch. All pins are clutch back.

Folded Flag Pin	#967	<b>\$3.95</b> each
Folded Flag In Honor Pin	#980	<b>\$3.95</b> each
Folded Flag In Memoriam Pin	#977	<b>\$3.95</b> each
Patch	#1042	<b>\$3.75</b> each



Folded Flag Pin,  
Enameled finish,  
7/8" W x 1/2" H  
#967



Folded Flag – In Memoriam Pin  
1" W x 3/4" H  
#977



Folded Flag – In Honor Pin  
1" W x 3/4" H  
#980



Folded Flag — In  
Memoriam Patch  
Embroidered patch  
is 3"H x 4 1/4"W.  
#1042

Vinyl & Fabric  
Flag Bag  
#66



## Vinyl & Fabric Flag Bag

Fabric back with zipper closure and clear vinyl front, 23" x 12". Holds up to a 5' x 9½" flag.

Vinyl Flag Bag	#66	<b>\$12.95</b> each
----------------	-----	---------------------



Turn to page  
55 to see our  
selection of flags.

## Flag Protectors

Safeguard your cherished flag, shielding it from dust and dirt so that it can be passed down to the next generation.

## Flag Box

Sturdy white storage carton protects any flag up to 5' x 9½". (Flag not included.) Ships FedEx Ground or Parcel Post only.

Flag Box	#50	<b>\$7.95</b> each
----------	-----	--------------------



Flag Box  
#50

**Firefighter, Police & EMT Mourning Cords**



This shoulder cord started a new tradition for funeral honor guards. Designed by a member of a police honor guard and, like all Glendale shoulder cords, handcrafted in the U.S. The button loop-style (shown here) is worn with an epaulet that unbuttons. The open-end style with hook-and-eye closure is worn with epaulets that do not open. The wrapped pin attachment style can be worn on uniforms or shirts without epaulets or with epaulets that unbutton. The funeral honor guard stands at attention – a mourning band covers each member's badge — and each uniform displays a unique mourning shoulder cord. It's a look that is both distinctive and respectful. **These cords generally have a 28" circumference.** They can be custom-made in two longer lengths. Add \$5 to the price for an additional 5" and \$8 for an additional 10". Then, add the length to the number -- for example, #4521106X5 or #4561107X10.

Fire, red line #4521107

EMS, green line #4521108

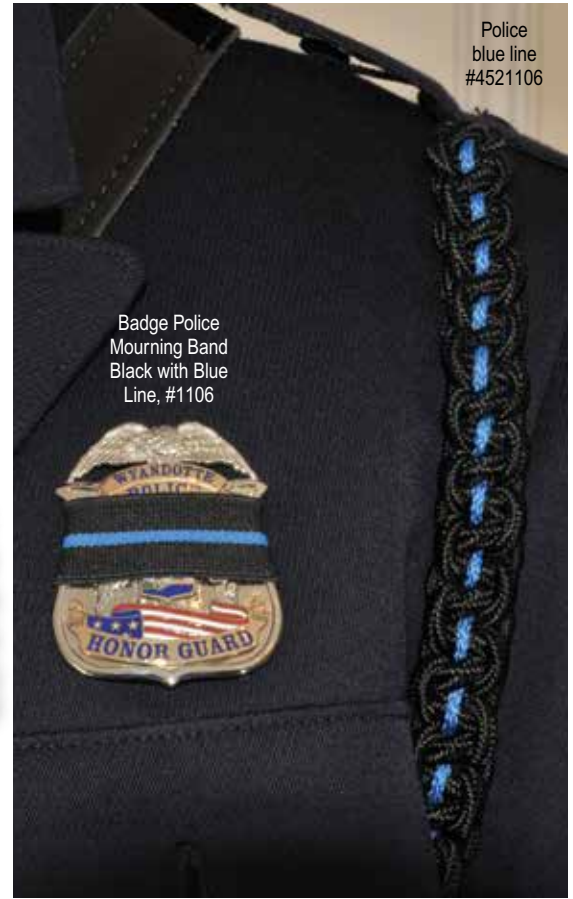

Police blue line #4521106

Badge Police Mourning Band Black with Blue Line, #1106

**Police (Blue)**

- Police, button loop. #4521106 **\$24.75** each
- Police, pin attachment #4521106P **\$24.75** each
- Police, open ends, hook and eye closure. #4561106 **\$27.95** each

**Firefighter (Red)**

- Firefighter, button loop. #4521107 **\$24.75** each
- Firefighter, pin attachment #4521107P **\$27.75** each
- Firefighter, open ends, hook and eye closure. #4561107 **\$27.95** each

**EMS (Green)**

- EMS, button loop. #4521108 **\$24.75** each
- EMS, pin attachment #4521108P **\$27.75** each
- EMS, open ends, hook and eye closure. #4561108 **\$27.95** each

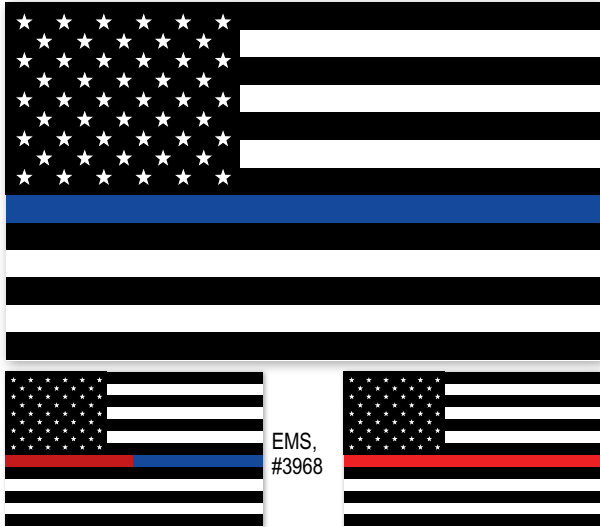

Police, #1107

EMS, #3968

Firefighter, #3969

**Support Flags *NEW!***

Our Support Flags commemorate the fallen and their relationship with the community they serve. These flags are made from Nyl-Glo fabric with pole hem for parade use. 3' x 5'.

- Police #FLAG1106 **\$39.95** each
- Firefighter #4330 **\$39.95** each
- EMS #4329 **\$39.95** each

**Memorial Flags**

Sturdy nylon flags to display indoors or out to honor and remember. All are 3' x 5'. Outdoor flags have canvas heading and grommets; indoor flags have pole hem and no fringe.

- Firefighter Mourning Flag (outdoor display). #7780 **\$59.95** each
- Firefighter Remembrance Flag (outdoor display) #7725 **\$63.50** each
- Firefighter Remembrance Flag (indoor display) #7758 **\$73.50** each
- Police Mourning Flag (outdoor display). #7781 **\$59.95** each
- Police Remembrance (outdoor display).. #7726 **\$62.25** each
- Police Remembrance Flag (indoor display). #7759 **\$69.95** each
- EMS Mourning Flag (outdoor display). #7851 **\$99.75** each



Firefighter, #1107



Black, #1105



EMS, #1108



Nemo Me Impune Lacessit, #1110

**Police/Firefighter/EMS Badge Mourning Bands**

Elastic bands to cover a badge, shield, or star as a sign of respect and honor when a fellow police officer, firefighter, or EMT dies in the line of duty. Each is 3/4" wide and stretches to 3".

**General Mourning**

Black #1105 **\$2.75** each

**Police**

Black with Blue Line #1106 **\$2.75** each

**Nemo Me Impune Lacessit**

Black with purple lines and gold letters #1110 **\$4.25** each

**Firefighter**

Black with Red Line #1107 **\$2.75** each

**EMS**

Black with Green Line #1108 **\$2.75** each

Firefighter Remembrance, #7725 / 7758

EMS Mourning, #7851



Police Mourning, #7781

## U.S. Flag Patches

Fully embroidered U.S. flag patches, 2" x 3" (within government specifications). All styles are sew-on unless noted otherwise with a Velcro® hook backing.

The reverse-star-field U.S. flag patch is worn on the right sleeve with the blue union (or star field) in the forward position of honor as if the flag were passing in review.



#1828

Red, white, blue with dark gold border.

#1828

\$1.95 each

#1828R

Red, white, blue with dark gold border, reverse star field. #1828R

\$1.95 each



#1829

Red, white, blue with white border.

#1829

\$1.95 each

#1829R

Red, white, blue with white border, reverse star field. #1829R

\$1.95 each



#1856

Red, white, blue with light gold border.

#1856

\$1.70 each

Red, white, blue with light gold border, Velcro®.

#1856V

\$2.95 each

Red, white, blue with light gold border, reverse star field.

#1856R

\$1.80 each

#1856R

Red, white, blue with light gold border, reverse star field, Velcro®.

#1856RV

\$3.50 each

### ACU - Army Flag Patches

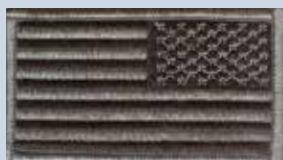

#1858RV

Red, white, blue with gold border, reverse star field.

#1857R

\$2.95 each

Red, white, blue with gold border, reverse star field, Velcro®.

#1857RV

\$3.95 each

Foliage green/black, reverse star field, Velcro®.

#1858RV

\$4.50 each



# Don't Forget These Flag Essentials!

## Airliner Flag Carrying Case

Designed for frequent travel, this rugged case is called the "Airliner" for a reason! The innovative three-piece telescoping design extends from 48" to 88" and has a diameter of 5 1/2" to accommodate a mounted flag. This tough molded tube is lockable for secure travel and has a comfortable molded handle for easy carrying. Because it nests to only 48", it can easily be shipped by US Mail to overseas customers. Airline approved!

#65

\$89.95 each (\*\$10)

\* There is a shipping surcharge for heavy items. The surcharge is in parentheses following the price. See page 79 for complete shipping information.



## Liberty® Floor Stands

Made of strong ABS plastic with a bright metalized finish. Includes an adapter sleeve to allow use with a pole of 1-1/4" diameter. The base of each stand measures 11 1/2". (The 2-lb. stand is not weighted; the 8-lb. stands are weighted with sand; 15- and 20-lb. stands, with sand and Dura-steel shot.)

Chrome 2 lbs.	#LE	\$57.95 each
Chrome 8 lbs.	#L8	\$59.95 each (\$7*)
Chrome 15 lbs.	#L15	\$79.95 each (\$10*)
Chrome 20 lbs.	#L20	\$97.95 each (\$15*)
Gold 2 lbs.	#LGE	\$57.95 each
Gold 8 lbs.	#LG8	\$59.95 each (\$7*)
Gold 15 lbs.	#LG15	\$79.95 each (\$10*)
Gold 20 lbs.	#LG20	\$97.95 each (\$15*)



Our Best Seller!

Liberty Stand  
Gold  
#LG8

Liberty Stand  
Chrome  
#L8

## Flag Carrying Case

The perfect case for carrying or storing two poles up to 8 1/2' long or one mounted flag set with spear ornament. 4 1/4"-diameter tube telescopes from 60" - 102" and has protective foam padding at the top. Easy-to-load hinged door with padlock eyes. Please note: This case is oversized and can only be shipped by UPS Ground or Parcel Select.

#61

\$94.95 each (\*\$10)



glendale  
exclusive

Carrying  
Case  
#35

## Floor Stand Carrying Case

Protect your stand while making transport easier. Made of a weather-resistant black nylon with a reinforced carrying handle and heavy duty zipper. Strong vinyl bottom. Suitable for any Glendale flag stand weighing. MFS case comes with 2" X 12" draw string bag to house chrome sleeve or adapter.

Carrying Case holds up to 25 pounds. Base measures 12" across.	#35	\$39.95 each
MFS Carrying Case holds up to 30 pounds. Base measures 13" across.	#35MFS	\$46.95 each

**State & Territorial Flags** (See page 94-99 for U.S. Flags) 

Unexcelled in beauty and craftsmanship and made to exacting specifications. Seals and designs are authentic and always in correct proportion to flag size. Emblems are dyed in fast, brilliant colors. (We cannot guarantee against fading or weathering.) **Indoor and Parade use flags** are made of lustrous 100% nylon. Finished with a flannel-lined pole hem with Velcro® tabs and golden yellow fringe. **Indoor flags** may also be ordered without fringe, if desired. **Outdoor display flags** are made of 100% heavyweight SolarMax nylon bunting (specially treated to minimize sun and chemical deterioration) and finished with strong canvas headings and large brass grommets. To order, indicate the flag number + state abbreviation. (For example #22035TX, for a Texas indoor flag size 3' x 5' or #22035UTX for the same without fringe.)

**For Flags of the World Visit us online at [www.paradestore.com](http://www.paradestore.com)**

		OUTDOOR					INDOOR/PARADE			
		2' x 3'	3' x 5'	4' x 6'	5' x 8'	6' x 10'	—with fringe—		—without fringe—	
							3' x 5'	4' x 6'	3' x 5'	4' x 6'
AL	Alabama	#22123	#22135	#22146	#22158	#221610	#22035	#22046	#22035U	#22046U
AZ	Arizona	\$29.95	\$39.95	\$59.95	\$89.95	\$169.95	\$89.95	\$119.95	\$69.95	\$99.95
AR	Arkansas	\$29.95	\$39.95	\$59.95	\$89.95	\$169.95	\$89.95	\$119.95	\$69.95	\$99.95
CA	California	\$29.95	\$39.95	\$59.95	\$89.95	\$169.95	\$89.95	\$119.95	\$69.95	\$99.95
CO	Colorado	\$29.95	\$39.95	\$59.95	\$89.95	\$169.95	\$89.95	\$119.95	\$69.95	\$99.95
CT	Connecticut	\$29.95	\$39.95	\$59.95	\$89.95	\$169.95	\$89.95	\$119.95	\$69.95	\$99.95
DE	Delaware	\$29.95	\$39.95	\$59.95	\$89.95	\$169.95	\$89.95	\$119.95	\$69.95	\$99.95
FL	Florida	\$29.95	\$39.95	\$59.95	\$89.95	\$169.95	\$89.95	\$119.95	\$69.95	\$99.95
GA	Georgia	\$29.95	\$39.95	\$59.95	\$89.95	\$169.95	\$89.95	\$119.95	\$69.95	\$99.95
HI	Hawaii	\$29.95	\$39.95	\$59.95	\$89.95	\$169.95	\$89.95	\$119.95	\$69.95	\$99.95
ID	Idaho	\$29.95	\$39.95	\$59.95	\$89.95	\$169.95	\$89.95	\$119.95	\$69.95	\$99.95
IL	Illinois	\$29.95	\$39.95	\$59.95	\$89.95	\$169.95	\$89.95	\$119.95	\$69.95	\$99.95
IN	Indiana	\$29.95	\$39.95	\$59.95	\$89.95	\$169.95	\$89.95	\$119.95	\$69.95	\$99.95
IA	Iowa	\$29.95	\$39.95	\$59.95	\$89.95	\$169.95	\$89.95	\$119.95	\$69.95	\$99.95
KS	Kansas	\$29.95	\$39.95	\$59.95	\$89.95	\$169.95	\$89.95	\$99.95	\$69.95	\$119.95
KY	Kentucky	\$29.95	\$39.95	\$59.95	\$89.95	\$169.95	\$89.95	\$119.95	\$69.95	\$99.95
LA	Louisiana	\$29.95	\$39.95	\$59.95	\$89.95	\$169.95	\$89.95	\$119.95	\$69.95	\$99.95
ME	Maine	\$29.95	\$39.95	\$59.95	\$89.95	\$169.95	\$89.95	\$119.95	\$69.95	\$99.95
MD	Maryland	\$29.95	\$39.95	\$59.95	\$89.95	\$169.95	\$89.95	\$119.95	\$69.95	\$99.95
MA	Massachusetts	\$29.95	\$39.95	\$59.95	\$89.95	\$169.95	\$89.95	\$119.95	\$69.95	\$99.95
MI	Michigan	\$29.95	\$39.95	\$59.95	\$89.95	\$169.95	\$89.95	\$119.95	\$69.95	\$99.95
MN	Minnesota	\$29.95	\$39.95	\$59.95	\$89.95	\$169.95	\$89.95	\$119.95	\$69.95	\$99.95
MS	Mississippi	\$29.95	\$39.95	\$59.95	\$89.95	\$169.95	\$89.95	\$119.95	\$69.95	\$99.95
MO	Missouri	\$29.95	\$39.95	\$59.95	\$89.95	\$169.95	\$89.95	\$119.95	\$69.95	\$99.95
MT	Montana	\$29.95	\$39.95	\$59.95	\$89.95	\$169.95	\$89.95	\$119.95	\$69.95	\$99.95
NE	Nebraska	\$29.95	\$39.95	\$59.95	\$89.95	\$169.95	\$89.95	\$119.95	\$69.95	\$99.95
NV	Nevada	\$29.95	\$39.95	\$59.95	\$89.95	\$169.95	\$89.95	\$119.95	\$69.95	\$99.95
NH	New Hampshire	\$29.95	\$39.95	\$59.95	\$89.95	\$169.95	\$89.95	\$119.95	\$69.95	\$99.95
NJ	New Jersey	\$29.95	\$39.95	\$59.95	\$89.95	\$169.95	\$89.95	\$119.95	\$69.95	\$99.95
NM	New Mexico	\$29.95	\$39.95	\$59.95	\$89.95	\$169.95	\$89.95	\$119.95	\$69.95	\$99.95
NY	New York	\$29.95	\$39.95	\$59.95	\$89.95	\$169.95	\$89.95	\$119.95	\$69.95	\$99.95
NC	North Carolina	\$29.95	\$39.95	\$59.95	\$89.95	\$169.95	\$89.95	\$119.95	\$69.95	\$99.95
ND	North Dakota	\$29.95	\$39.95	\$59.95	\$89.95	\$169.95	\$89.95	\$119.95	\$69.95	\$99.95
OH	Ohio	\$29.95	\$39.95	\$59.95	\$89.95	\$169.95	\$89.95	\$119.95	\$69.95	\$99.95
OK	Oklahoma	\$29.95	\$39.95	\$59.95	\$89.95	\$169.95	\$89.95	\$119.95	\$69.95	\$99.95
OR	Oregon	\$44.95	\$89.95	\$129.95	\$149.95	\$239.95	\$139.95	\$189.95	\$119.95	\$159.95
PA	Pennsylvania	\$29.95	\$39.95	\$59.95	\$89.95	\$169.95	\$89.95	\$119.95	\$69.95	\$99.95
RI	Rhode Island	\$29.95	\$39.95	\$59.95	\$89.95	\$169.95	\$89.95	\$119.95	\$69.95	\$99.95
SC	South Carolina	\$29.95	\$39.95	\$59.95	\$89.95	\$169.95	\$89.95	\$119.95	\$69.95	\$99.95
SD	South Dakota	\$29.95	\$39.95	\$59.95	\$89.95	\$169.95	\$89.95	\$119.95	\$69.95	\$99.95
TN	Tennessee	\$29.95	\$39.95	\$59.95	\$89.95	\$169.95	\$89.95	\$119.95	\$69.95	\$99.95
TX	Texas	\$19.95	\$34.95	\$39.95	\$59.95	\$159.95	\$79.95	\$99.25	\$59.95	\$99.95
UT	Utah	\$29.95	\$39.95	\$59.95	\$89.95	\$169.95	\$89.95	\$119.95	\$69.95	\$99.95
VT	Vermont	\$29.95	\$39.95	\$59.95	\$89.95	\$169.95	\$89.95	\$119.95	\$69.95	\$99.95
VA	Virginia	\$29.95	\$39.95	\$59.95	\$89.95	\$169.95	\$89.95	\$119.95	\$69.95	\$99.95
WA	Washington	\$44.95	\$89.95	\$129.95	\$149.95	\$239.95	\$139.95	\$189.95	\$119.95	\$159.95
WV	West Virginia	\$29.95	\$39.95	\$59.95	\$89.95	\$169.95	\$89.95	\$119.95	\$69.95	\$99.95
WI	Wisconsin	\$29.95	\$39.95	\$59.95	\$89.95	\$169.95	\$89.95	\$119.95	\$69.95	\$99.95
WY	Wyoming	\$29.95	\$39.95	\$59.95	\$89.95	\$169.95	\$89.95	\$119.95	\$69.95	\$99.95
DC	Dist. of Columbia	\$29.95	\$39.95	\$59.95	\$89.95	\$169.95	\$89.95	\$119.95	\$69.95	\$99.95
GU	Guam	\$29.95	\$39.95	\$59.95	\$89.95	\$169.95	\$89.95	\$119.95	\$69.95	\$99.95
PR	Puerto Rico	\$29.95	\$39.95	\$59.95	\$89.95	\$169.95	\$89.95	\$119.95	\$69.95	\$99.95
VI	Virgin Islands	\$29.95	\$39.95	\$59.95	\$89.95	\$169.95	\$89.95	\$119.95	\$69.95	\$99.95
AS	American Samoa	\$29.95	\$39.95	\$59.95	\$89.95	\$169.95	\$89.95	\$119.95	\$69.95	\$99.95
SET	Complete Set	\$1,399.00	\$1,799.00	\$2,799.00	\$4,299.00	\$7,699.00	\$3,999.00	\$5,299.00	\$2,999.00	\$4,599.00

Complete sets include 50 state flags only.

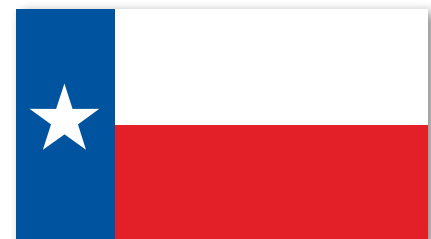
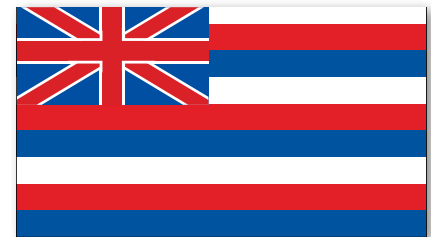
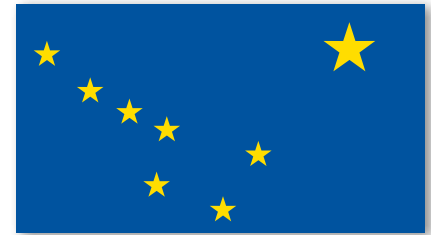



Marine Corps Flag #7714



Army Flag, #7711



Air Force Flag, #7712



Air Force Departmental Flag, #7712AFD



Coast Guard Flag, #7715



Navy Flag, #7713



Space Force Flag, #7716SD

**Armed Forces Flags** 

**Nylon:** This high-quality fabric exceeds stringent U.S. Government specifications. It is the most popular flag material and offers both durability and beauty. Outdoor flags have strong canvas headings and brass grommets. Indoor flags are

finished with flannel-lined pole hems, Velcro® tabs, and golden yellow rayon fringe. A single seal flag is correct on one side; reverse on the other. A double seal flag reads correctly on both sides. Double seal flags 4 1/2" x 5 1/2" and

larger will have the branch of service seal appliquéd onto the larger background. The lining of double sided flags is heat sensitive. Do not press.

	Army	Air Force	Navy	Marine Corps	Coast Guard	Space Force
<b>Outdoor Nylon with canvas heading and grommets</b>						
3' x 5', Single seal	#7711A3 <b>\$49.95</b>	#7712AF3 <b>\$44.95</b>	#7713N3 <b>\$49.95</b>	#7714M3 <b>\$49.95</b>	#7715C3 <b>\$49.95</b>	#7716SD3 <b>\$54.95</b>
4' x 6', Single seal	#7711A4 <b>\$59.95</b>	#7712AF4 <b>\$64.95</b>	#7713N4 <b>\$69.95</b>	#7714M4 <b>\$74.95</b>	#7715C4 <b>\$59.95</b>	#7716SD4 <b>\$87.95</b>

Outdoor polyester single seal flags available for all branches (except Space Force). Visit [Glendale.com](http://Glendale.com) for pricing

<b>Indoor &amp; Parade Nylon w/ pole hem</b>						
3' x 5', Single seal w/ fringe	#7711A5 <b>\$92.25</b>	#7712AF5 <b>\$92.25</b>	#7713N5 <b>\$92.25</b>	#7714M5 <b>\$92.25</b>	#7715C5 <b>\$92.25</b>	#7716SD5 <b>\$92.25</b>
3' x 5', Single seal w/o fringe	#7711A6 <b>\$79.95</b>	#7712AF6 <b>\$79.95</b>	#7713N6 <b>\$74.95</b>	#7714M6 <b>\$74.95</b>	#7715C6 <b>\$83.95</b>	#7716SD6 <b>\$89.95</b>
3' x 5', Double seal w/ fringe	#7711A7 <b>\$199.95</b>	#7712AF7 <b>\$199.95</b>	#7713N7 <b>\$199.95</b>	#7714M7 <b>\$199.95</b>	#7715C7 <b>\$199.95</b>	#7716SD7 <b>\$199.95</b>
4' x 6', Single seal w/ fringe	#7711A10 <b>\$159.50</b>	#7712AF10 <b>\$154.50</b>	#7713N10 <b>\$154.50</b>	#7714M10 <b>\$154.50</b>	#7715C10 <b>\$159.50</b>	#7716SD10 <b>\$154.50</b>
4' x 6', Single seal w/o fringe	#7711A11 <b>\$133.95</b>	#7712AF11 <b>\$133.95</b>	#7713N11 <b>\$133.95</b>	#7714M11 <b>\$133.95</b>	#7715C11 <b>\$133.95</b>	#7716SD11 <b>\$144.95</b>
4' x 6' Double seal w/ fringe	#7711A12 <b>\$285.95</b>	#7712AF12 <b>\$285.95</b>	#7713N12 <b>\$285.95</b>	#7714M12 <b>\$285.95</b>	#7715C12 <b>\$285.95</b>	#7716SD12 <b>\$299.95</b>

Indoor and Parade Armed Forces flags are sold in 4 1/2' X 5 1/2' size - Visit [www.paradestore.com](http://www.paradestore.com) for current pricing.



**POW-MIA Flags, Patches and Pins are available at [www.ParadeStore.com](http://www.ParadeStore.com)**

**Guarantee:** We fully guarantee all merchandise against defects in material and workmanship.





**Army National Guard Flag**

3' x 5' Outdoor. Nylon with canvas heading and grommets. #7788 **\$56.95** each  
 3' x 5' Indoor/Parade. Nylon with pole hem and fringe. #7789 **\$89.85** each



**Air National Guard Flag**

3' x 5' Outdoor. Nylon with canvas heading and grommets. #7786 **\$64.95** each  
 3' x 5', Indoor/Parade. Nylon with pole hem and fringe. #7787 **\$99.95** each



**Merchant Marine Flag**

3' x 5' Outdoor. Nylon with canvas heading and grommets. #7800 **\$64.95** each

# Custom Streamers: Honor and Award



Honor Unit #2305



Matching Date Streamer #2305D



Honor Unit with Distinction #2306



Matching Date Streamer #2306D



Distinguished Unit Date Streamer #2307

**JROTC Honor Streamers**



Honor Unit: 2 3/4" x 3', regulation, red and gold.	#2305	<b>\$74.95</b> each
Matching Date Streamer (Specify dates.)	#2305D	<b>\$74.95</b> each
Honor Unit with Distinction: 2 3/4" x 3', regulation, blue and gold.	#2306	<b>\$74.95</b> each
Matching Date Streamer (Specify dates.)	#2306D	<b>\$74.95</b> each
Distinguished Unit Date Streamer: 2 3/4" x 3', regulation, blue and gold. (Specify school year.)	#2307	<b>\$74.95</b> each



15 Ring Holder #9330

**Holders For Campaign Streamers**

Silver-plated ring attachment for campaign streamers. (Designed to fit Army spear ornaments only, except 22GE and 22SE.)

15 rings - inside hole diameter is 1/2", outside diameter is 2 3/8". #9330 **\$59.95** each  
 18 rings (Army) - inside hole diameter is 5/8", outside diameter is 3 3/8". #9331 **\$66.75** each



**Custom Award Streamers**

These streamers can be individually customized on a stock solid color ribbon – either 1 3/8" or 2 3/4" width – with a contrasting embroidery color, as specified by customer. Streamers are one sided only and each is finished with a metal grommet and stitched swallowtail. Made of Nylon material. Please submit text to be embroidered to customwork@glendale.com.

**1 3/8" width:** Available in black, brown, gray, white, kelly green, hunter green, light blue, navy blue, royal blue, red, orange, gold, yellow, maroon, and purple; stitch color of your choice:

1 3/8" x 24" (maximum 18 characters/spaces) #ST13824 **\$49.95** each  
 1 3/8" x 36" (maximum 30 characters/spaces) #ST13836 **\$59.95** each

**2 3/4" width:** available in black, gold, navy blue, royal blue, purple, red, silver gray, and white; stitch color of your choice:

2 3/4" x 36" (maximum 30 characters/spaces) #ST23436 **\$79.95** each



Goldtone Award Ribbon Ring #9360G

**Award Ribbon Ring**

This metal ring fits on top of wood poles or 1" aluminum poles. Place disk under ornament. 6 rings: inside hole diameter is 7/8", outside diameter is 3 1/2". Available in two finishes.

Silvertone #9360S **\$52.95** each  
 Goldtone #9360G **\$66.95** each

### Choosing Outdoor U.S. flags:

Glendale is proud to present a selection of outdoor flags designed to stand up to the varying weather conditions in which they fly. All styles are made with strong canvas heading and grommets for display on outdoor flag poles:

#### Polyester

The most durable flag fabric you can buy. Engineered for industrial, commercial and institutional use. (As with all flags, improper flag care, high winds, high temperatures and other environmental conditions that vary due to climate and location can reduce the fabric life.)

#### Nylon

Nylon is the most popular flag material. It is lightweight, holds dye well and can stand up to extreme conditions. Nylon flags can be recycled.

#### Cotton

An excellent quality flag made of extra-strength cotton weave bunting with rich colors that are resistant to sun and rain, making it suitable for a wide range of applications.

#### How long will a flag last?

The U.S. government generally expects a nylon or cotton bunting flag to last approximately 90 days, based on daily usage from sunrise to sunset — but not during periods of inclement weather. Tests have shown that in some cases a flag flown 24 hours a day will last only one-fourth as long as one flown during the daylight hours only. Regardless of how well it is constructed, a flag is, after all, only a piece of cloth and will sooner or later succumb to the elements. However, it has been well documented that reasonably good care can contribute greatly to longer life.



Government Spec U.S. Flag #4322

### Government-Spec Outdoor Display U.S. Flags

Made to U.S. government specifications in accordance with U.S. Code, Title 4, in the official government size (1:1.9) hoist fly ratio. Choose from high-tenacity, industrial strength-70 denier lightweight nylon or 2-ply mercerized cotton bunting. Heavy canvas duck heading is constructed to government specs. Lock-stitched seams, material and color-matched thread. Stars are 3/4".



#### Nylon

2'4 <sup>7</sup> / <sub>16</sub> " x 4'6"	#4320	\$94.95 each
3'6" x 6'7 <sup>3</sup> / <sub>4</sub> "	#4322	\$99.95 each
5' x 9'6"	#4323	\$149.95 each

#### Cotton

5' x 9'6"	#4328	\$164.95 each
-----------	-------	---------------

### Polyester Outdoor Display U.S. Flags

3' x 5'	#2710	\$39.95 each	10' x 19'	#2765	\$397.95 each
4' x 6'	#2720	\$77.95 each	12' x 18'	#2770	\$379.95 each
5' x 8'	#2730	\$84.95 each	15' x 25'	#2780	\$729.95 each
5' x 9 <sup>1</sup> / <sub>2</sub> ' casket size			20' x 30'	#2790	\$999.95 each
	#2735	\$129.95 each	20' x 38'	#2800	\$1399.00 each
6' x 10'	#2740	\$122.95 each	30' x 50'	#2827	\$2699.00 each
8' x 12'	#2750	\$309.95 each	30' x 60'	#2830	\$2999.00 each
10' x 15'	#2751	\$321.95 each			



### Nylon Outdoor Display U.S. Flags

2' x 3'	#0242	\$39.95 each	8' x 12'	#0232	\$239.95 each
2 <sup>1</sup> / <sub>2</sub> ' x 4'	#0244	\$47.95 each	10' x 15'	#0234	\$226.95 each
3' x 5'	#0246	\$25.95 each	10' x 19'	#0235	\$377.95 each
4' x 6'	#0222	\$51.95 each	12' x 18'	#0236	\$324.95 each
4 <sup>1</sup> / <sub>3</sub> ' x 5 <sup>1</sup> / <sub>2</sub> '	#0224	\$84.95 each	15' x 25'	#0238	\$609.95 each
5' x 8'	#0227	\$75.95 each	20' x 30'	#0240	\$869.95 each
5' x 9 <sup>1</sup> / <sub>2</sub> ' casket size			20' x 38'	#0241	\$1199.00 each
	#0228	\$119.95 each	30' x 50'	#0243	\$1799.00 each
6' x 10'	#0230	\$135.95 each	30' x 60'	#0245	\$2499.00 each



### Cotton Outdoor Display U.S. Flags

2' x 3'	#2754	\$41.25 each	5' x 9 <sup>1</sup> / <sub>2</sub> ' casket size		
3' x 5'	#2755	\$49.95 each		#2759	\$141.95 each
4' x 6'	#2756	\$69.95 each	6' x 10'	#2758	\$169.95 each
5' x 8'	#2757	\$109.95 each	8' x 12'	#2762	\$349.95 each



### Appropriate flag sizes for outdoor poles:

Length of flag should be approximately 1/4 of the height of the flagpole:

20' pole - 3' x 5' flag.

25' pole - 4' x 6' flag.

40' pole - 6' x 10' flag.

A second flag flown under the U.S. flag should be one size smaller than the U.S. flag.

Our Solar Lighted Flag needs no plugs, cords or power to shine bright!



Solar Lighted US Flag Unit #0417

### Solar Lighted US Flag Unit

Add beauty and patriotic spirit to walkways, gardens, decks, and gravesites. Solar light charges itself during the day and shines on the flag at night. Flag made in USA. Light imported from China. 12"x18" Flag on a 30" wooden staff.

Solar Lighted US Flag Unit #0417 \$6.95 each



### Armed Forces Flag Display Cases

These attractive cases are made of rich mahogany-colored hardwood and a thick glass to honorably display a cotton flag. Die-cast, gold-plated U.S. Armed Forces medallion is centered on a bevel-cut double mat. Case is felt lined with an easy-open back panel to insert a cotton flag up to 5' x 9-1/2" in size. Outside dimensions 26"L x 13"H x 3-1/2"D. Choose Army, Air Force, Navy, Marine Corps or Coast Guard medallion..

#8025 \$84.95 each



## Choosing Indoor & Parade U.S. flags

### Nylon

Very durable. Made of high quality nylon that exceeds stringent U.S. Government specifications. High-gloss, densely embroidered stars. Lock-stitched, hand-sewn stripes and hems. Finished with flannel-lined pole hems, Velcro® tabs and, if requested, golden yellow rayon fringe.

### Bemberg Rayon

The finest, most luxurious flag fabric available. Woven of heavy Bemberg rayon, this flag combines a beautiful appearance with superior form retention. A particular favorite of the federal government. Features large embroidered rayon stars. Finished with a flannel-lined pole hem and Velcro® tab. Available with golden yellow rayon fringe. Note: this fabric may stain if it gets wet.

### Recommended sizes

Flag Size	Pole Size	Tassels & Cord
2' x 3'	7'	3" & 5'
3' x 5'	8'	5" & 9'
4' x 6'	9'	5" & 9" or 6" & 9'

### Flag Spreader

The center part of this spreader snaps around an indoor pole, and the ends clip to the sides or to both corners at the bottom edge of the flag – holding an indoor flag open, so more of it can be seen when it's draped.

Flag Spreader #2227 **\$23.75** each



Save when you buy a Mounted US Flag Set!

# American Made with Pride

## U.S. Flags: Indoor & Parade Use, Nylon



2' x 3' fringed	#0210	<b>\$79.75</b> each
2' x 3' unfringed	#0219	<b>\$64.95</b> each
3' x 4' fringed	#0229	<b>\$144.25</b> each
3' x 4' unfringed	#0223	<b>\$129.95</b> each
3' x 5' fringed	#0215	<b>\$88.75</b> each
3' x 5' unfringed	#0211	<b>\$75.25</b> each
4' x 6' fringed	#0216	<b>\$133.95</b> each
4' x 6' unfringed	#0212	<b>\$119.95</b> each
4 1/3' x 5 1/2' fringed	#0217	<b>\$217.95</b> each
4 1/3' x 5 1/2' unfringed	#0213	<b>\$179.95</b> each
5' x 8' fringed	#0218	<b>\$207.95</b> each
5' x 8' unfringed	#0214	<b>\$179.95</b> each



No Fringe



Our flags are FMAA certified, made from US materials, crafted in US facilities by US labor.



Beautifully embroidered stars that shine brightly against the rich blue background.

## U.S. Flags: Indoor & Parade Use, Rayon

3' x 5' fringed	#2270	<b>\$349.95</b> each
3' x 5' unfringed	#2230	<b>\$331.95</b> each
4' x 6' fringed	#2280	<b>\$461.95</b> each
4' x 6' unfringed	#2240	<b>\$439.95</b> each
4 1/3' x 5 1/2' fringed	#2290	<b>\$475.95</b> each
4 1/3' x 5 1/2' unfringed	#2250	<b>\$465.95</b> each

## Mounted U.S. Flag Sets (includes stand)

This pre-assembled set includes everything you need to proudly fly America's colors, right out of the box. You save and pay no weight surcharge. The 3' x 5' set is shipped in one oversized carton; the 4' x 6' set, in two. (UPS Ground or Parcel Post delivery only). Sorry, no substitutions or partial returns.

**3' x 5' mounted flag set.** Includes: 3' x 5' fringed nylon flag (#0215), 8' x 1 1/4" wood pole with dark oak finish (#84W), brass-plated eagle with 7" wing span (#7A), 5" golden tassels with 9' cord (#118) and 8 lb. gold Liberty Floor Stand (#LG8) **\$299.95** each

**4' x 6' mounted flag set.** Includes 4' x 6' fringed nylon flag (#0216), 9' x 1 1/4" wood pole with dark oak finish (#94W), brass-plated eagle with 7" wing span (#7A), 6" golden tassels with 9' cord (#119) and 8 lb. gold Liberty Floor Stand (#LG8) **\$379.95** each

## How to mount an indoor flag:

**On aluminum poles** – Pull out the Velcro® tabs inside the top and bottom of the pole hem. Loosen the set and eye screws of the aluminum ring, slide it down the pole, and position it where it will hold the bottom tab of the flag. Carefully slide top of pole up through the flag's pole hem. Attach the ornament to the top of the pole. Slip tab button holes over the eye screws of both the ornament and ring. Adjust aluminum ring so that pole hem is taut and tighten screws against pole. Instead of attaching tabs to the eye screws, Velcro® tabs can be more permanently fixed directly to the pole. Remove the adhesive backings, position the flag and press the sticky sides of the tabs to the flag pole.

**On wood poles** – No bottom ring is required. Top Velcro® tab may be attached to the eye screw of the ornament or the adhesive side may be affixed directly to the flag pole.



Mounted U.S. Flag Set

**First Responders' Gear**  
is online. Look for our new  
First Responder catalog in 2025.

**Quick Index**

AGSU	56-57
Arc Pins	67
Ascots	43
Belts	34-36
Berets	44
Bib Scarves • Leader Loops	43
Books	16
Cheater Bars	39
Commemorative Items & Gifts	21, 77
Custom Flags/Banners/Patches	90-91
DrillAmerica® Rifles	6-15
Flag Carriers	80-81
Flag Covers and Cases	83
Flag Pole Floor Stands	84-85
Flag Pole Ornaments	86-87
Flag Poles	88-89
Flags	94-99
Garment & Gear Bags	46-47
Gloves	23-25
Hat Carriers	62, 64
MarchOn® Tee Shirts	online
Medals and Drapes	70-76
Memorial	92-93
Nameplates	42
Ordering Information	78-79
Parade Helmets	45
Parade Rifles	6-12, 16
Pins: Hat • Collar • Lapel	48, 50-51, 66-67
Raider Gear	52
Ribbon Attachments	48, 53, 68
Ribbon Mounts	67-69
Ribbon Slides	48, 53, 70-71
Rifle and Pistol Accessories	14-17
ROTC & JROTC	48-55
Saber & Sword Accessories	21
Sabers & Swords	18-19
Shoe & Boot Accessories	38-39
Shoes	39-41
Shoulder Cords	26-33
Uniform Accessories	37-42
U.S. Air Force	62-64
U.S. Army	56-61
U.S. Marine Corps	65

**Swords and Sabers**

We carry world-famous Weyersberg, Kirschbaum & Co. (WKC) Swords and Sabers. Turn to page 18 to learn more about these extraordinary weapons.



- Air Force Honor Guard Sword,
- Regulation Army Officer Saber
- West Point Military Style Sword

- Navy Officer Sword
- Coast Guard Officer Sword
- Marine Corps NCO Sword

Engrave your sword for just \$25,  
see page 18 for details.



**DrillAmerica®**  
makes the finest drill  
rifles you can buy.  
Designed for precision  
and balance to the  
exacting specification  
of world class drillers.

Turn to pages 4-10  
to see all 5 models.

DrillAmerica 1903  
Springfield Rifle®  
Black with Chrome  
Metal #DA1903BKC  
Available in 4 additional  
color options. Turn to  
page 6 to learn more



Our flags are FMAA certified,  
made from US materials, crafted  
in US facilities by US labor.

**Be Kind to your Feet!**  
**NEW!** boots and shoes from  
Rocky. See pages 39 - 40.



**Better Fabric,  
Better Fit**

**NEW! Glendale introduces Our  
AGSU Collection.**

Look and feel your professional best in styles and  
fabrics to suit every body. We have a variety of  
fits from athletic to classic and a wide range of  
sizes so you're sure to find the perfect uniform.  
Turn to pages 56-57 to see all the options for  
men and women.