

NOTICE: This document contains references to Varian. Please note that Varian, Inc. is now part of Agilent Technologies. For more information, go to www.agilent.com/chem.



Turbo-V Pumps

Turbo-V Pumps
Features and Benefits
2-3

Turbo-V SEM
Features and Benefits
4-5

Typical Applications
6-11

Pump Models
12-31

Pump Controllers
32-38

Accessories
40-41

Technical Notes
42-49

Service and Support Plan
50-53

Turbo-V Pumps Features and Benefits

The Varian Advantage

- Varian turbopumps are designed for optimum performance in real world applications.
- As a consequence we offer several families of pumps matching the requirements of most applications.
- This includes integration of pumping systems and multi-flow pumps.
- We have the technology and the tools to perfectly match the requirements of virtually any application.

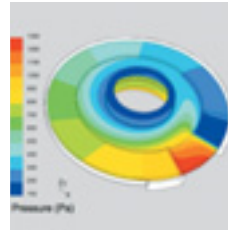

Turbopump Performance Targeting & Design

- Varian Turbo-V solutions are designed using state of the art proprietary numerical modelling.
- Optimized solutions for:
 - high compression ratio (low base pressure)
 - high pressure differential (high throughput)
 - high foreline pressure.



Application Specific Solutions for SEM:

a complete line of turbo pumps dedicated to Electron Microscopy. (See page 4)

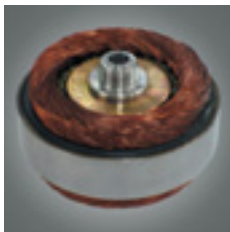

Induction Motor

- All Varian pumps are equipped with the most rugged, simple and efficient existing motor.
- High efficiency is combined with very low stray magnetic field.



Ceramic Ball Bearings

- Varian was the first to introduce ceramic ball bearings in turbomolecular pumps in 1992.
- From there, bearings' quality and reliability have dramatically improved.
- Now typical MTTF well exceeds 250,000 hours.



Oil Free – Permanent Lubrication

- Permanent lubrication is possible thanks to the extremely low vapour pressure of the solid lubricant used in all our pumps.
- Operation in any position.
- No maintenance, no oil, no refill and finally no contamination.



Controllers

- Various configurations available to match each application's requirements.
- Rack controllers, to fit your existing system architecture.
- Low voltage - PCB units, to fully integrate turbopump electronics into your system's electronics.
- Navigator on board controllers, for plug-and-pump operation driven by the computer of your system.
- Truly integrated electronics, completely embedded in the pump body.



Controller and T-plus SW

- T-plus Software is an effective trouble shooting tool.
- It can enable complete remote control of the pump.
- It is available for all controllers, when equipped with serial port, for data logging and displaying.

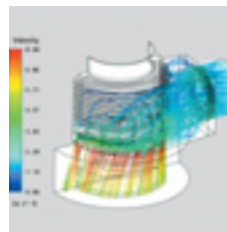
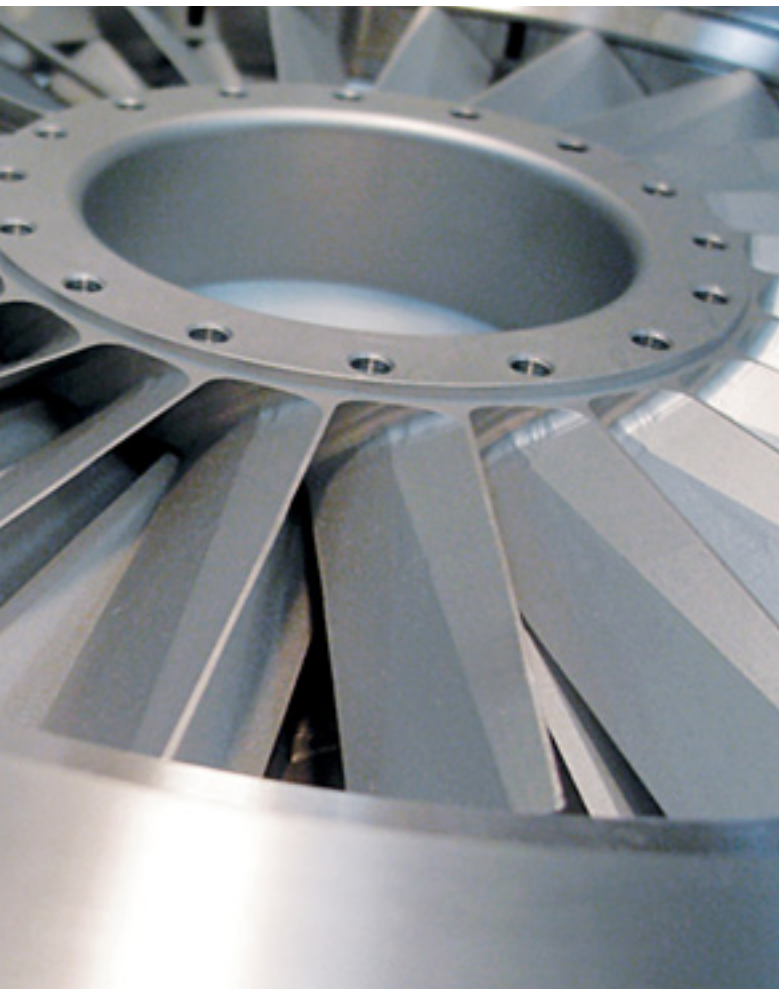

Thermal Efficiency

- The design of pumping stages, motor and electronics allows low heat dissipation and low power consumption.
- Efficient air and water cooling system.
- No matter what the application is, these are also key factors for reliability.

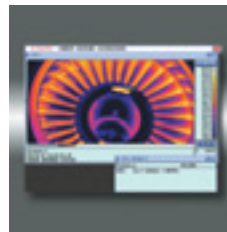

Temperature Distribution Control

- Temperature control within the pump is important for reliable long- term operation.
- All our pumps are equipped with at least one temperature sensor: the temperature control is important for reliable, long- term operation.
- Controllers manage temperature information and the other operational parameters, for an even distribution of temperature within the pump.



Global Support

- **Advanced Exchange:** in case of failure we immediately (within 24 hours) ship to you from our closer distribution centre a replacement unit.
- **Upgrade Program:** older models can be upgraded to an equivalent pump of most recent design and technology.
- **Factory Repair:** we get the failed unit back to our factory for failure analysis and corrective actions (whenever applicable).

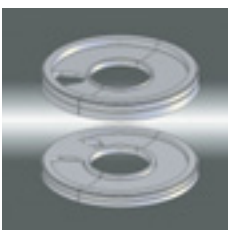

Molecular Drag Technology & Pumping Efficiency

- MacroTorr technology allows higher foreline pressure, higher efficiency and smaller backing pump, in a very compact design.
- Varian R&D Team has the capability to optimize the pump performances for different applications.

Turbo-V SEM Features and Benefits

The Varian Advantage: Dedicated Solutions for SEM Applications

As the leading Ultra-High Vacuum products supplier, Varian has long been working with all SEM and TEM manufacturers, providing application specific solutions. Today Varian is the only company able to offer a complete and dedicated range of SEM products, including primary pumps, turbomolecular pumps, ion getter pumps, and vacuum measurement, that meet the most stringent requirements of the industry. Turbo-V SEM versions are available on request; please ask Varian for technical details.



Supply Chain Partner
Carl Zeiss SMT AG

Carl Zeiss SMT, global leader in light, electron and ion-optical technologies for industry and R&D, has designated Varian Vacuum Technologies as a Carl Zeiss SMT Supply Chain Partner.

Vacuum for SEM: basic requirements

- *Vacuum in the gun and sample chamber must be particle-free and oil-free*
- **No Vibrations**
- **No Resonances**
- **No Magnetic stray fields from both IGP and TMPs**
- **No Electric noise from power supplies**
- **Fastest Pumpdown cycles**
- *Pressure levels stable and controlled*
- *Maximum Uptime*
- *Fast, worldwide Service Support*



Dry Lubrication

- Oil free, no need for refill.
- Contamination free.
- Mountable in any position.
- No preventive maintenance.



Wide, Dedicated Range

Sizes: 80, 300, 400, 550, 700, 1000 l/s,
from NW63 to ISO 250 flanges:
the right size for each application,
at the right cost.

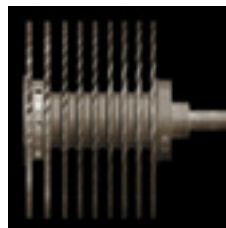

Monolithic Rotor

- Mounting in any position, with no limitations.
- Rugged design.
 - Light weight.
 - Air inrush proof.
 - Earthquake proof.

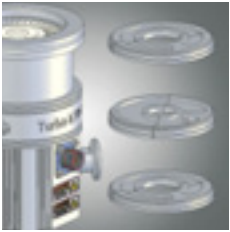

MacroTorr Stages

- Fastest pump down.
- Ideal for load-lock pumping.
- Works with very small primary pumps like the Varian IDP-3 Dry Scroll Pump.

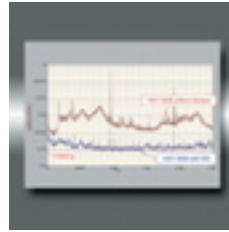

Superior Vibration Isolation System

- Lower vibrations than Mag-Lev!
- Certified Computer Aided Balancing, thanks to suspended benches with special high sensitivity accelerometers.

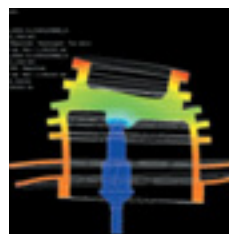

Improved Roto Dynamics

- Designed to avoid internal mechanical resonances.
- Varian SEM turbopumps are designed to minimize vibration sources, and have a very stable vibration profile.



Integrated Double Dampers

- Varian developed special Integrated Double Dampers for the most demanding SEM applications.
- Damping factor up to 1400X (Radial, at unbalance level, with IDD100 ISOK): better than Mag-Lev!
- Best SEM image resolution.



Enhanced Electronic Controllers

- Universal voltages.
- Integrated Vent valve command, adjustable valve delay and opening time.
- Pressure gauge reading.
- Integrated Profibus.



Magnets Free Design

- Lowest Magnetic Signature in the industry.
- Best to work very close to ebeams.
- No need for magnetic shields.



Foreline Pressure up to 15 mbar

- Ideal to minimize forepump size (i.e. IDP-2 and IDP-3 Dry Scroll Pumps), resulting in the lowest cost of ownership.

Turbo Pumps

Turbo-V Pump Typical Applications

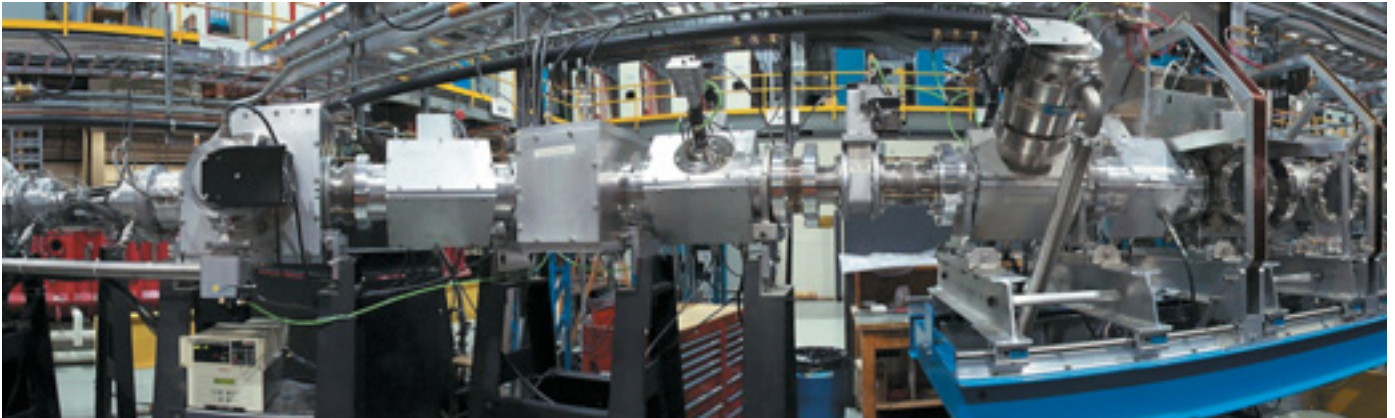

Courtesy TRIUMF-ISAC.

High Energy Physics and Research Laboratories

- Turbomolecular pumps are widely used in High Energy Physics, Fusion Technology and general UHV research. Synchrotron Light Sources, Particle Accelerator Rings, UHV Laboratory research, and Fusion reactors need extremely clean, reliable and cost effective HV and UHV. Maintenance-free pumps are specifically required, because most pumps are not easily accessible.
- Varian Turbo-V pumps are designed to offer unmatched reliability, performance and cleanliness for these applications.

Ceramic bearing pumps, thanks to their reduced rolling friction, low stress and high thermal stability compared to conventional bearings, deliver longer operating life. Ultra low vapor pressure solid lubricant eliminates the need for maintenance and assures clean operation under any operating conditions.

- Furthermore, in contrast to most of the other pumps, all Varian Turbo-V pumps have both the upper and the lower bearing in the rough vacuum side and not exposed to UHV, further reducing the possibility of contamination - even in case of misuse.

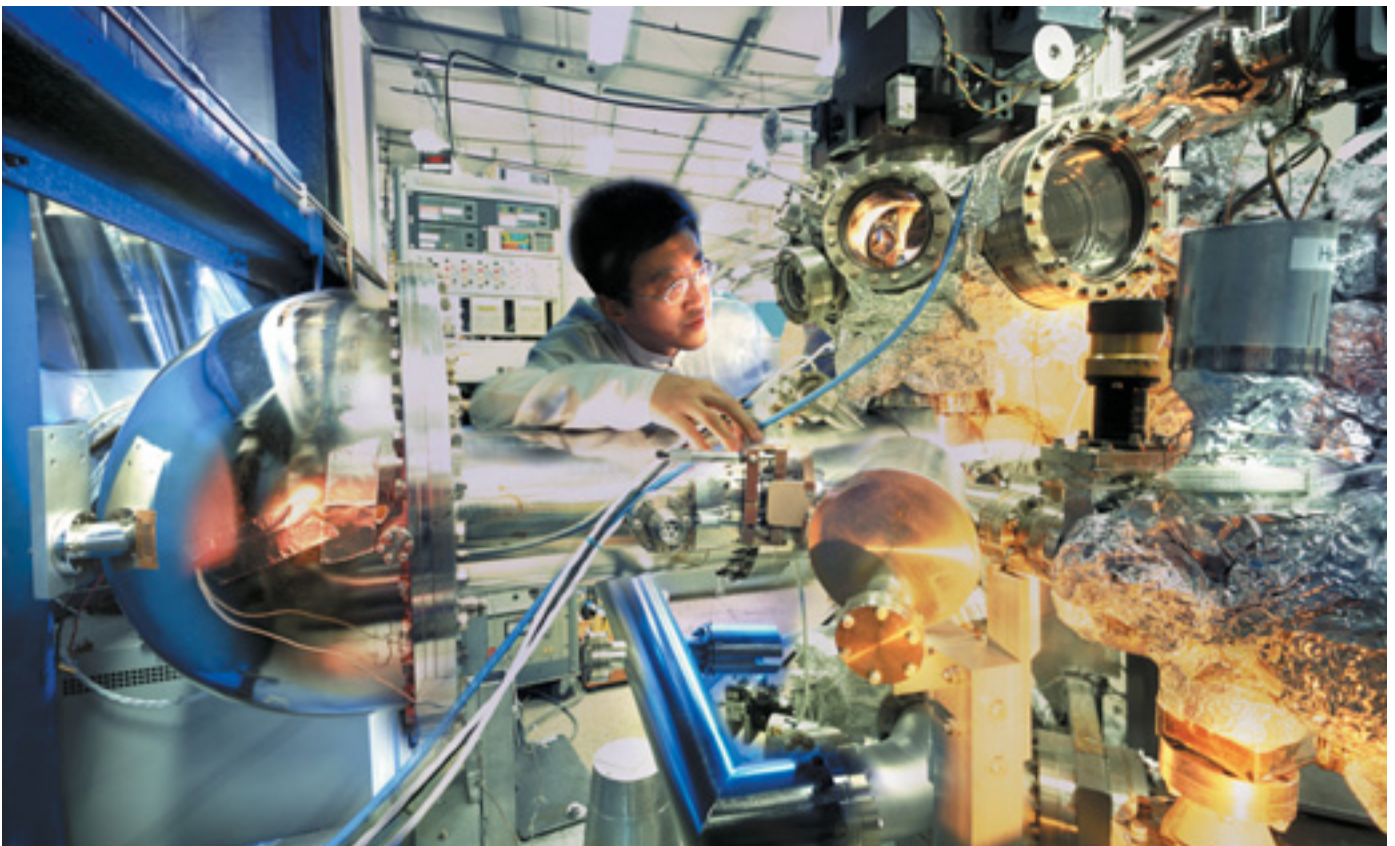

Courtesy SLAC / Peter Ginter.

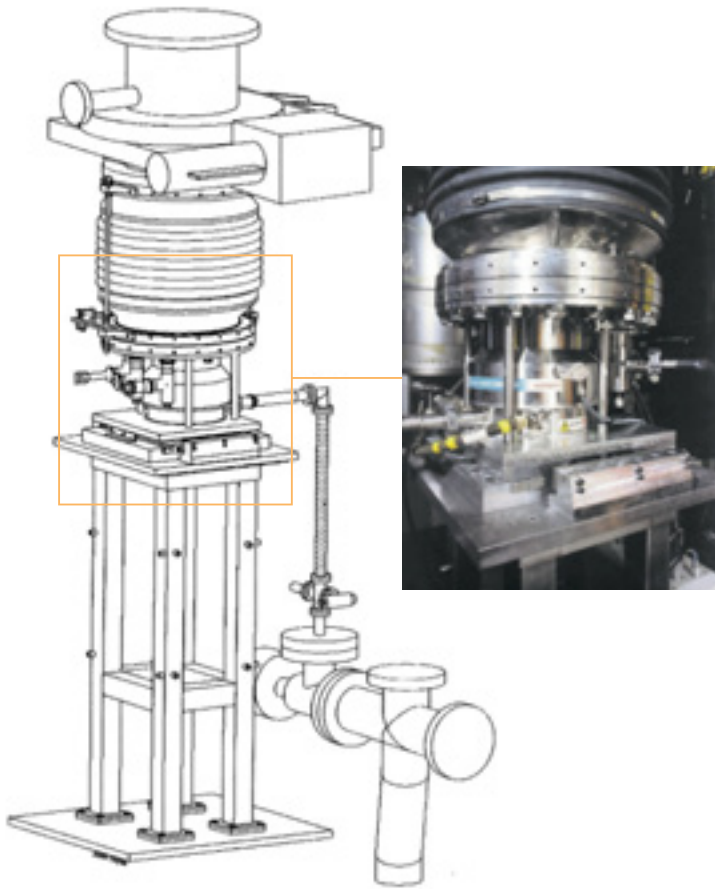

Courtesy JET

- The patented MacroTorr® stages provide the highest speed and compression ratio in the smallest footprint; furthermore all the Turbo-V pumps can truly be mounted in any orientation, from vertical to horizontal to upside down, aiding system design in the most stringent space requirements. MacroTorr® Turbo Pumps can operate at higher foreline pressures, allowing the use of diaphragm roughing pumps, thus providing a completely clean, oil-free compact and cost effective pumping package.
- Whenever a large amount of gas has to be pumped and higher throughput is needed, the combination of Turbo-V pumps and TriScroll® dry pumps is the state-of-the-art solution.

All the Turbo-V Navigator pumps have the option of an on board controller, allowing easy plug and pump operation, or a rack-mounted controller for applications where the electronics need to be remotely placed (i.e. radioactive environments).

Nanotechnologies

Electron Microscopy (SEM, TEM), Focused Ion-beam Systems (FIB) and Surface Analysis

- Modern focused-beam systems such as SEM's, TEM's and FIB's utilize columns that project electrons or ions onto microscopic samples for detailed analysis. End users analyze all types of substances from organic compounds to semiconductor wafers. In the Semiconductor industry, in particular, they require more sensitivity for better sample resolution. Another key requirement is high sample throughput in order to lower the cost of ownership of these instruments.
- Based on these requirements, the demand for high performance vacuum pumps is greater than ever. Varian offers a full range of high and ultra-high vacuum pumps designed especially for the demanding requirements of SEM's, TEM's and surface analysis systems (Varian has a full range of ion pumps, which are key products for this application; please see ion pump section).
- Turbo molecular pumps are also a key component in modern focused-beam systems because they offer fast, oil-free air evacuation of large sample chambers (oil-free operation is a key requirement of many modern analysis applications such as semiconductor manufacturing). From Varian's full range of turbo pumps, the focused-beam system designer can choose a pump size that offers the best chamber evacuation time with the best cost of ownership and compact size for use in limited space situations.
- Varian has a full line of customized, low vibration turbo pumps for the most sensitive microscopy applications. Finally, Varian has a full range of integrated pump controllers that offer the highest control flexibility with near zero electromagnetic noise generation.
- **Varian offers a full range of application specific designed SEM turbo pumps including 80 l/s, 300 l/s, 550 l/s, 700 l/s and 1000 l/s speeds (see page 4).** All of Varian's SEM turbo pumps designs can be verified in Varian's application lab. Finally, each SEM turbo pump is tested in production before being shipped to the customer.



Varian, Inc. Vacuum Technologies

Turbo-V Pump Typical Applications

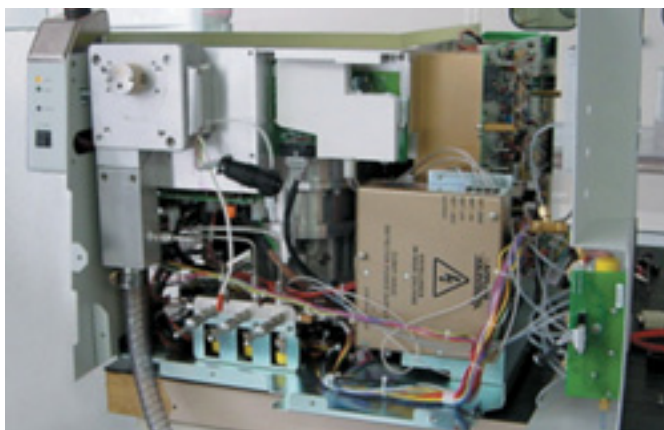

Courtesy Varian Scientific Instruments.

Mass Spectrometry

Mass Spectrometry has become an important analytical tool in many industries including pharmaceuticals. Thanks to advances in electronics, instrument designers can implement cost-effective, high-performance analytical power in a cost-effective, easy-to-use system.

These developments require advanced vacuum systems that are characterized by multi-chamber, high throughput designs on the high quality instruments.

These requirements, in turn, demand cost-effective, high performance vacuum pumps.

Varian offers a full line of pumps and controllers that meet the most challenging vacuum requirements and are optimized for the specific requirements of modern mass spectrometry systems.



Varian can further customize its pumps by providing multi-inlet pumping systems that are compact and reliable. A few common application examples for mass spectrometry are listed below:

- **GC-MS**

Gas Chromatograph Mass Spectrometers typically use one vacuum chamber in relatively low gas load environments and an intermediate vacuum interface to analyze inorganic samples.

The Varian Turbo-V 81 with printed circuit board controller (PCB) is a very cost-effective solution for this common analytical technique. The V 301 Navigator offers a compact, cost-effective solution for larger instrument designs.



Courtesy Centorr.

- **LC-MS**

Liquid Chromatograph Mass Spectrometers typically include multi-chamber, high throughput vacuum systems. Varian's Turbo-V301 and V 551 pumps are designed for high throughput operation with air cooling – an important benefit for maintaining a compact system. The V 301 and V 551 pumps are also available in several split flow versions to increase their utility and performance in this application. The integrated Navigator control system provides a high level of control function in a small package.

- **ICP-MS**

Inductively Coupled Plasma-MS systems have a wide range of vacuum requirements. Many systems can use heavy carrier gases such as argon, while collision cell designs use helium. The Turbo-V 301 Navigator has a high efficiency motor and MacroTorr® drag stages to reduce heat production under gas load. These features allow the V 301 to pump high levels of argon. The Navigator controller provides high controller function in a compact package.

- **TOF**

Time Of Flight systems are becoming very important analytical tools in drug discovery and proteomics. Vacuum requirements vary, although small size is often an important consideration. The Turbo V 301 Navigator pump and controller package provides the TOF designer with a high degree of flexibility with regard to high throughput, efficient heat dissipation and compact size.



Courtesy Optovac Vacuum Coating Systems.

Industrial Vacuum Processing

- In a wide range of industries, from glass coating to medical equipment, manufacturers share a need for robust, reliable, production-friendly vacuum technologies.
- Focusing on the total cost of ownership, Varian continues to deliver innovative vacuum solutions that maximize throughput, tolerate varying operating conditions, and simplify maintenance, helping to assure maximum uptime and efficiency.
- Turbo-V pumps, designed to withstand heavy industrial use, can handle high gas loads and will recover quickly from accidental air in-rushes.
- Varian offers a comprehensive range of vacuum pumps and systems for industrial uses, including the new Turbo-V K-G Series, with truly integrated electronics embedded in the pump body.



Thin Film Deposition application.

Thin Film Deposition

- Glass coating equipment (architectural glass, automotive glass, flat panel display substrates)
- Thin film solar cells production (photo-voltaic)
- Optical data media (Compact Discs, Digital Versatile Discs, Magneto Optical Discs)
- Magnetic storage media (hard discs, read heads)
- Surface treatments used for Tribological and Wear coatings
- Functional and Decorative coatings, including Metallization
- Optical coating (ophthalmic, precision opto-electronics)
- Roll/Web coating on films or foils
- PVD and other Plasma Process systems requiring high gas load.

Device Processing:

- TV & Monitor picture tube manufacture
- Evacuation of lamps (motorway lighting, beamers)
- X-Ray tubes & electron devices
- Medical accelerator tubes
- Lasers

General Industrial Processes:

- Vacuum furnaces / Brazing
- Electron beam welding

Turbo-V Pump Typical Applications

Dedicated Solutions for Thin Film Deposition

- In single chamber batch systems, multiple chamber systems, with load locks, or large inline continuous systems, Varian has the right turbo pump for your process requirements. What really differentiates Varian is the expertise of its applications, support and custom system design staff to integrate vacuum pumps into optimized vacuum solutions.



The Turbo-V K-G Series Systems

- Application-specific pumping solutions designed for thin film deposition equipment: the first fully integrated approach for maximum system productivity and uptime.
 - high pumping speed and high gas throughput
 - truly integrated power supply (Protection Class IP 54), resulting in compact size and ease of system integration
 - capability to create differentiated partial pressures where needed
 - maximum throughput capacity at stable operation pressure
 - ceramic ball bearings, oil-free, contamination-free, no preventive maintenance, make the pump mountable in any position
 - extremely low vibration and noise for sensitive applications
 - water cooling (water compatibility up to 35 °C) allows long service life of electronic components
 - permanent monitoring system integrated in the electronic device, and built-in self-diagnostics capability, in combination with our tailored service & support plans offers a unique solution for TFD applications.



Thin Film Deposition application.

Semiconductors

The turbo pump is the critical element in the creation of an appropriate environment in the world of semiconductor manufacturing. In fact, as semiconductor chip geometries continue to shrink, the reliance on turbo pump technology is the highest it has been in the history of semiconductor manufacturing. Varian's turbo pumps provide unique and critical advantages in the creation of vacuum for the manufacture of semiconductor devices. Varian's rich history of innovations includes the pioneering of thermally stable ceramic bearings in place of stainless steel bearings, and the development of MacroTorr® turbo stages, among others.

The use of ceramic bearing technology allows Varian to run its turbo pumps at one of the highest rotational speeds in the industry, providing high pumping speed for light gases like helium and hydrogen, which are frequently liberated in the production of semiconductors. Since pumping speed is directly related to rotational speed, our turbo pumps provide improved pumping speed in a more compact package.

Another critical innovation by Varian in the world of turbo pumps has been the introduction of the monolithic rotor in conjunction with MacroTorr® turbo stages. These two additions provide the turbo pump with the ability to meet demanding rapid cycle applications, such as vacuum load locks, in which high gas-load cycling and

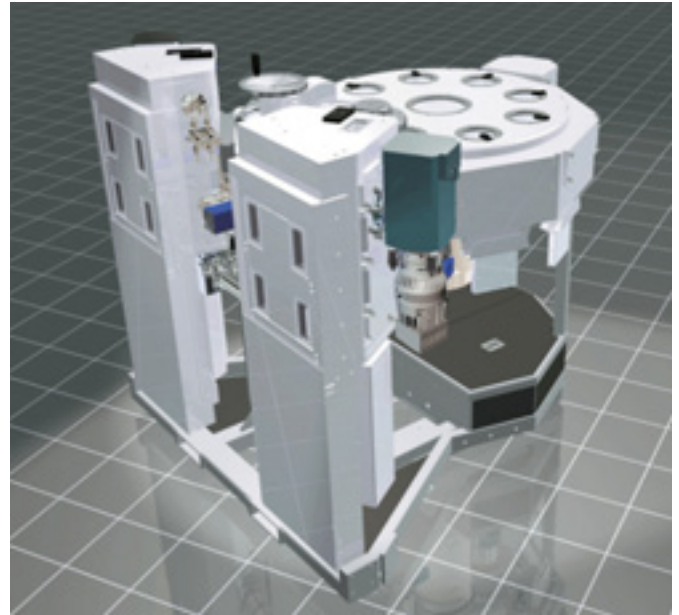

high tolerable foreline pressures are critical to the success of the process. Varian's turbo pump capabilities are unique, and the most advanced in the industry, allowing the user to share a single roughing pump across multiple turbo pumps, thus reducing costs and improving tool reliability by reducing the number of dynamic systems within the process tool.



Courtesy Brooks Automation.

Pump Models

Pump Specification	Turbo-V 81 M		Turbo-V 81 T		Turbo-V 301 Navigator	
	DN 40	DN 63	DN 40	DN 63	DN 100	DN 160
Pumping Speed, l/s						
Nitrogen	50	77	50	77	250	280
Helium	56	65	56	65	220	230
Hydrogen	46	50	46	50	200	210
Compression Ratio						
Nitrogen	3×10^8	7×10^6	7×10^8	7×10^8	7×10^8	7×10^8
Helium	8×10^4	8×10^4	3×10^3	3×10^3	1×10^5	1×10^5
Hydrogen	7×10^3	7×10^3	3×10^2	3×10^2	1×10^4	1×10^4
Base pressure, mbar						
with recommended mechanical pump	5×10^{-10}	5×10^{-10}	5×10^{-9}	5×10^{-9}	$< 5 \times 10^{-10}$	$< 5 \times 10^{-10}$
with recommended dry pump	5×10^{-9}	5×10^{-9}	5×10^{-8}	5×10^{-8}	$< 5 \times 10^{-9}$	$< 5 \times 10^{-9}$
Startup Time, min						
	< 1	< 1	< 1	< 1	2.5	2.5
Rotational Speed, rpm						
	80,000	80,000	80,000	80,000	56,000	56,000
Recommended Forepump						
Two-stage mechanical pump	DS 42 - DS 102	DS 42 - DS 102	DS 42 - DS 102	DS 42 - DS 102	DS 102	DS 102
Dry pump	SH-110	SH-110	SH-110	SH-110	SH-110	SH-110
Inlet Flange, nominal diameter						
Klamp Flange, mm	40	-	40	-	-	-
ConFlat®, mm (inches OD)	35 (2.75)	63 (4.5)	35 (2.75)	63 (4.5)	100 (6)	160 (8)
ISO clamp style, mm	-	63	-	63	100	160
ISO-F bolted, mm	-	-	-	-	-	-
Foreline Flange, nominal diameter						
Klamp Flange	NW16	NW16	NW16	NW16	NW16	NW16
SEM Version Available on Request						
	-	-	-	-	•	•
Controllers						
Rack Controller	•	•	•	•	•	•
Navigator on board Controller	•	•	•	•	•	•
Integrated Electronics	-	-	-	-	-	-
PCB Controller	•	•	•	•	•	•



Turbo-V 551 Navigator		Turbo-V 701 Navigator		Turbo-V 1001 Navigator			Turbo-V 2K-G System	Turbo-V 3K-G System
DN 100	DN 160	DN 200		DN 160	DN 200	DN 250	DN 250	DN 250
350	550	690		790	950	1,050	1,600	2,200
450	600	620		820	870	900		
450	510	510		860	900	920		
$> 1 \times 10^9$	$> 1 \times 10^9$	1×10^9		1×10^9	1×10^9	1×10^9	3×10^5	$> 1 \times 10^7$
1×10^7	1×10^7	1×10^7		1×10^7	1×10^7	1×10^7		
1×10^6	1×10^6	1×10^6		1×10^6	1×10^6	1×10^6		
$< 1 \times 10^{-10}$	$< 1 \times 10^{-10}$	$< 1 \times 10^{-10}$		$< 1 \times 10^{-10}$	$< 1 \times 10^{-10}$	$< 1 \times 10^{-10}$	$< 1 \times 10^{-8}$	$< 1 \times 10^{-9}$
$< 1 \times 10^{-10}$	$< 1 \times 10^{-10}$	$< 1 \times 10^{-10}$		$< 1 \times 10^{-10}$	$< 1 \times 10^{-10}$	$< 1 \times 10^{-10}$	$< 1 \times 10^{-8}$	$< 1 \times 10^{-9}$
< 5	< 5	< 5		< 4	< 4	< 4	< 7	< 6
42,000	42,000	42,000		38,000	38,000	38,000	33,000	31,800
DS 302 TS300	DS 302 TS300	DS 402 TS300		DS 402 TS300	DS 402 TS300	DS 402 TS300	$> 40 \text{ m}^3/\text{h}$	$> 60 \text{ m}^3/\text{h}$
-	-	-		-	-	-	-	-
100 (6)	160 (8)	200 (10)		-	200 (10)	-	-	-
-	160	200		160	200	250	-	-
-	160-F bolted	200-F bolted		-	200-F bolted	250-F bolted	250-F bolted	250-F bolted
NW25	NW25	NW25		NW40	NW40	NW40	NW40	NW40
•	•	•		•	•	•	-	-
•	•	•		•	•	•	-	-
•	•	•		•	•	•	•	•
-	-	-		-	-	-	-	-
-	-	-		-	-	-	-	-

Turbo
Pumps



Turbo-V 6000 available on request (see page 26)

Turbo-V 81-M

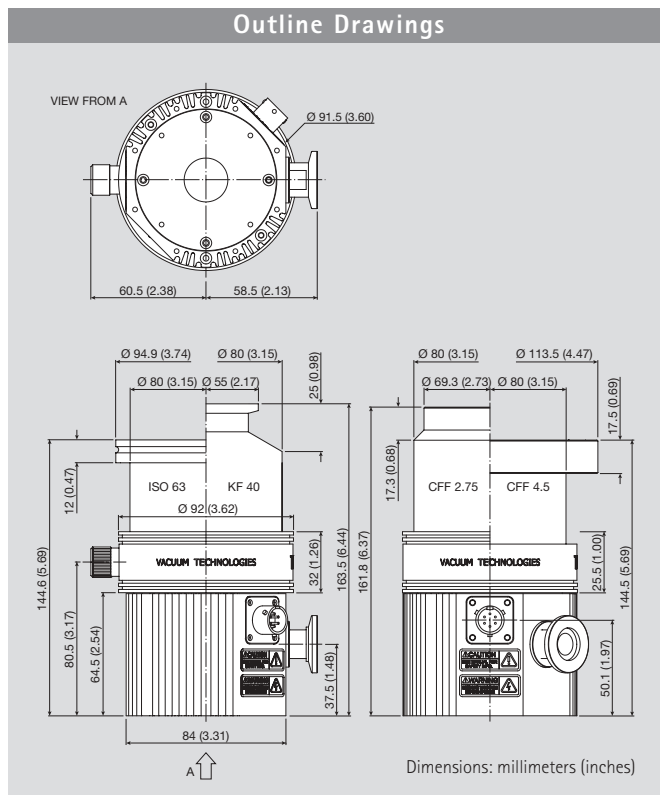

Technical Specifications

Pumping speed (l/s)			
With CF 4 1/2" or ISO 63:	N ₂ : 77 l/s	He: 65 l/s	H ₂ : 50 l/s
With CF 2 3/4" or KF 40:	N ₂ : 50 l/s	He: 56 l/s	H ₂ : 46 l/s
Compression ratio	N ₂ : 5 x 10 ⁸	He: 8 x 10 ⁴	H ₂ : 7 x 10 ³
Base pressure* (with recommended forepump)	5 x 10 ⁻¹⁰ mbar (3.8 x 10 ⁻¹⁰ Torr)		
Inlet flange	CF 4 1/2" O.D. CF 2 3/4" O.D.	ISO 63 KF 40	
Foreline flange		KF 16 NW	
Rotational speed		1350 Hz (max)	
Start-up time		< 60 seconds	
Recommended forepump		Mechanical: Varian DS 42 – DS 102 Dry pump: Varian IDP-2, IDP-3, SH 110	
Operating position		Any	
Cooling requirements		Natural air convection Forced air or water optional	
Bakeout temperature		120 °C at inlet flange max. (CF flange) 80 °C at inlet flange max. (ISO flange)	
Vibration level (displacement)		<0.01 µm at inlet flange	
Weight kg (lbs)		ISO 63: 2 (4.4) CF 4 1/2": 2,98 (6.57)	

* According to standard DIN 28 428.

NOTE • The pump is available with On-board Navigator Controller, 1/4 Rack Controller or PCB Controller; for information on controllers see also pages 32-33.

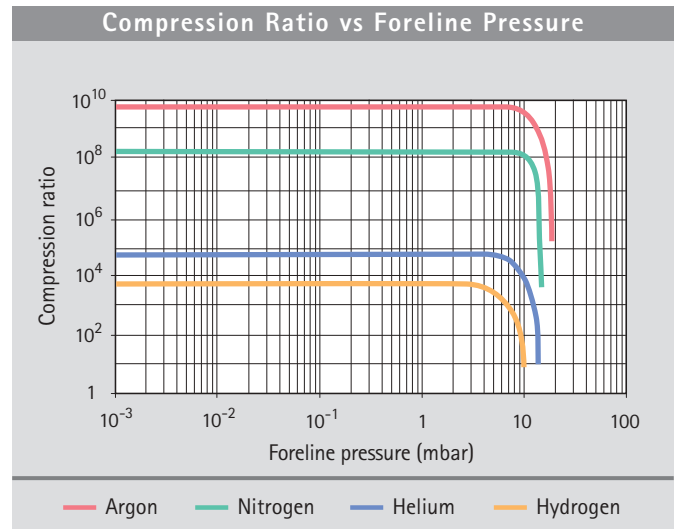
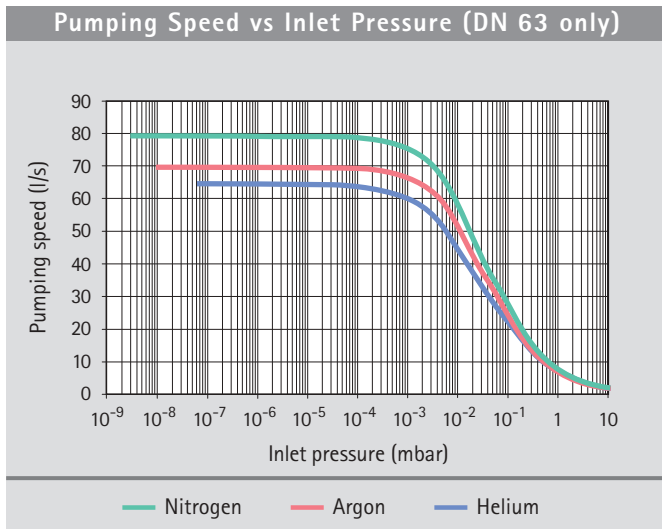

Ordering Information

Description	Weight kg (lbs)	Part Number
Pumps		
Turbo-V 81-M pump with ISO 63 inlet flange	2.0 (4.4)	9698901
Turbo-V 81-M pump with CF 4 1/2" inlet flange	2.98 (6.57)	9698903
Turbo-V 81-M pump with KF 40 inlet flange	2.0 (4.4)	9698902
Turbo-V 81-M pump with CF 2 3/4" inlet flange	2.98 (6.57)	9698904
Controllers		
Turbo-V 81-AG Navigator controller 100-240 Vac	0.3 (0.66)	9698996
Turbo-V 81-AG Navigator controller 24 Vdc	0.3 (0.66)	9698995
Turbo-V 81-AG Rack controller base	1.7 (3.2)	9698988
Turbo-V 81-AG Rack controller RS232/485	1.7 (3.2)	9698989
Turbo-V 81-AG Rack controller Profibus	1.7 (3.2)	9698990
Turbo-V 81 PCB controller 24 Vdc	1.0 (2.2)	9699538
Pump Accessories		
Mains cable NEMA plug, 3 m long	0.5 (1.0)	9699958
Mains cable European plug, 3 m long	0.5 (1.0)	9699957
Serial cable and T-Plus Software	0.5 (1.0)	9699883
Inlet screen, KF 40	0.5 (1.0)	9699309
Inlet screen, CF 4 1/2" - ISO 63	0.5 (1.0)	9699300
Inlet screen, CF 2 3/4"	0.5 (1.0)	9699328
Heater band 220 V	1.0 (2.2)	9699801
Heater band 120 V	1.0 (2.2)	9699802
Metallic water cooling kit	0.5 (1.0)	9699823
Plastic water cooling kit	0.5 (1.0)	9699824
Air cooling kit (0.5 m cable)	2.2 (5.0)	9699290
Air cooling kit extension cable (5 m)	2.2 (5.0)	9699940
Pump extension cable	2.2 (5.0)	9699942
Vibration damper DN 63	0.5 (1.0)	9699375
Vibration damper CFF 4.5"	0.5 (1.0)	9699376
Vent flange KF 10	0.5 (1.0)	9699108
Active Gauges	Ask Varian for details	
Recommended Forepump		
Mechanical pump DS 42	11.0 (24.0)	9499309
Mechanical pump DS 102	22.0 (48.0)	9499315
Dry scroll SH 110	19.0 (43.0)	SH01101 UNIV

Turbo Pumps

Turbo-V 81-T

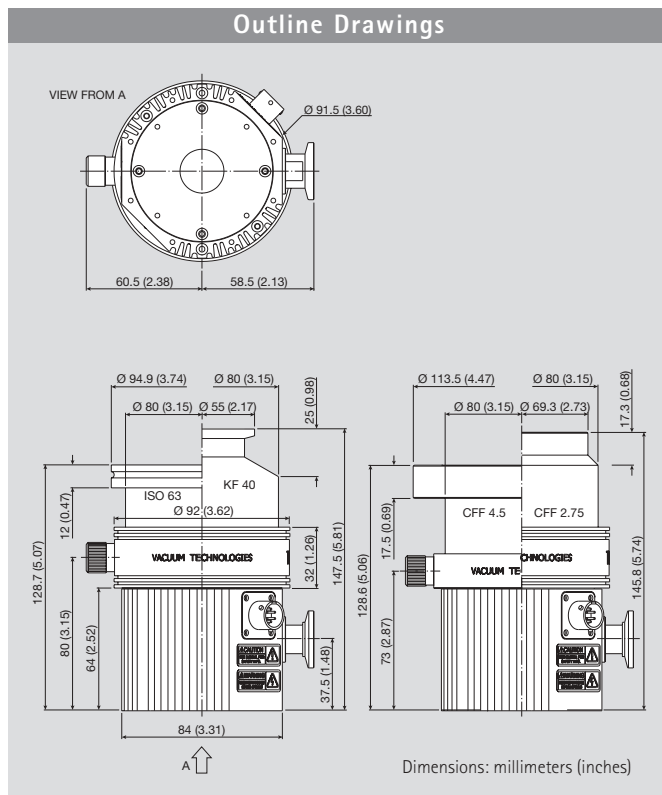

Technical Specifications

Pumping speed (l/s)			
With CF 4 1/2" or ISO 63:	N ₂ : 77 l/s	He: 65 l/s	H ₂ : 50 l/s
With CF 2 3/4" or KF 40:	N ₂ : 50 l/s	He: 56 l/s	H ₂ : 46 l/s
Compression ratio	N ₂ : >7 x 10 ⁶	He: 3 x 10 ³	H ₂ : 3 x 10 ²
Base pressure* (with recommended forepump)	5 x 10 ⁻⁹ mbar (3.8 x 10 ⁻⁹ Torr)		
Inlet flange	CF 4 1/2" O.D. CF 2 3/4" O.D.	ISO 63 KF 40	
Foreline flange	KF 16 NW		
Rotational speed	1350 Hz (max)		
Start-up time	< 60 seconds		
Recommended forepump	Mechanical: Varian DS 42 – DS 102 Dry pump: Varian IDP-2, IDP-3, SH 110		
Operating position	Any		
Cooling requirements	Natural air convection Forced air or water optional		
Bakeout temperature	120 °C at inlet flange max. (CF flange) 80 °C at inlet flange max. (ISO flange)		
Vibration level (displacement)	<0.01 µm at inlet flange		
Weight kg (lbs)	ISO 63: 1,82 (4) CF 4 1/2": 2,68 (5.90)		

* According to standard DIN 28 428.

NOTE • The pump is available with On-board Navigator Controller, 1/4 Rack Controller or PCB Controller; for information on controllers see also pages 32-33.

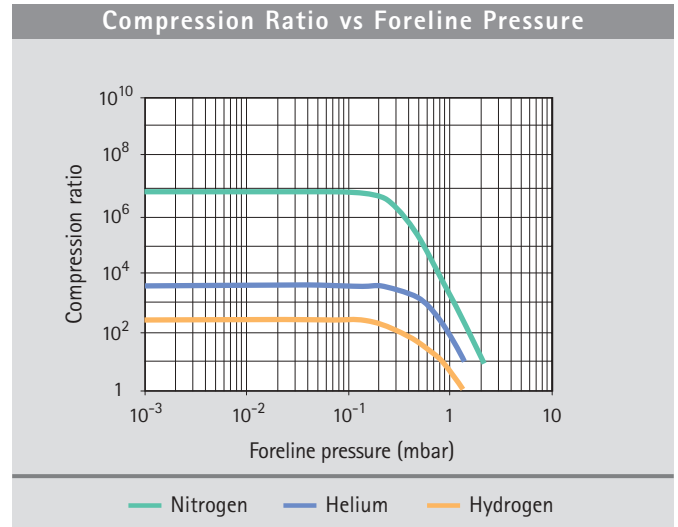
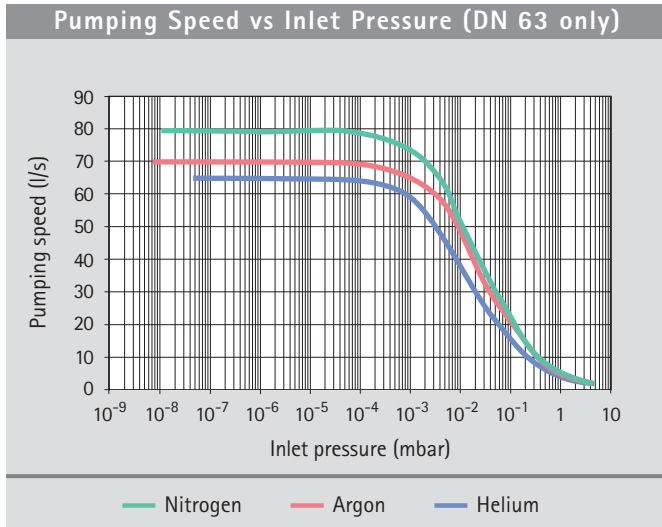

Ordering Information

Description	Weight kg (lbs)	Part Number
Pumps		
Turbo-V 81-T pump with ISO 63 inlet flange	1.82 (4.0)	9698905
Turbo-V 81-T pump with CF 4 1/2" inlet flange	2.68 (5.9)	9698907
Turbo-V 81-T pump with KF 40 inlet flange	1.82 (4.0)	9698906
Turbo-V 81-T pump with CF 2 3/4" inlet flange	2.68 (5.9)	9698908
Controllers		
Turbo-V 81-AG Navigator controller 100-240 Vac	0.3 (0.66)	9698996
Turbo-V 81-AG Navigator controller 24 Vdc	0.3 (0.66)	9698995
Turbo-V 81-AG Rack controller base	1.7 (3.2)	9698988
Turbo-V 81-AG Rack controller RS232/485	1.7 (3.2)	9698989
Turbo-V 81-AG Rack controller Profibus	1.7 (3.2)	9698990
Turbo-V 81 PCB controller 24 Vdc	1.0 (2.2)	9699538
Pump Accessories		
Mains cable NEMA plug, 3 m long	0.5 (1.0)	9699958
Mains cable European plug, 3 m long	0.5 (1.0)	9699957
Serial cable and T-Plus Software	0.5 (1.0)	9699883
Inlet screen, KF 40	0.5 (1.0)	9699309
Inlet screen, CF 4 1/2" - ISO 63	0.5 (1.0)	9699300
Inlet screen, CF 2 3/4"	0.5 (1.0)	9699328
Heater band 220 V	1.0 (2.2)	9699801
Heater band 120 V	1.0 (2.2)	9699802
Metallic water cooling kit	0.5 (1.0)	9699823
Plastic water cooling kit	0.5 (1.0)	9699824
Air cooling kit (0.5 m cable)	2.2 (5.0)	9699290
Air cooling kit extension cable (5 m)	2.2 (5.0)	9699940
Pump extension cable	2.2 (5.0)	9699942
Vibration damper DN 63	0.5 (1.0)	9699375
Vibration damper CFF 4.5"	0.5 (1.0)	9699376
Vent flange KF 10	0.5 (1.0)	9699108
Active Gauges	Ask Varian for details	
Recommended Forepump		
Mechanical pump DS 42	11.0 (24.0)	9499309
Mechanical pump DS 102	22.0 (48.0)	9499315
Dry scroll SH 110	19.0 (43.0)	SH01101 UNIV



Turbo-V 301 Navigator

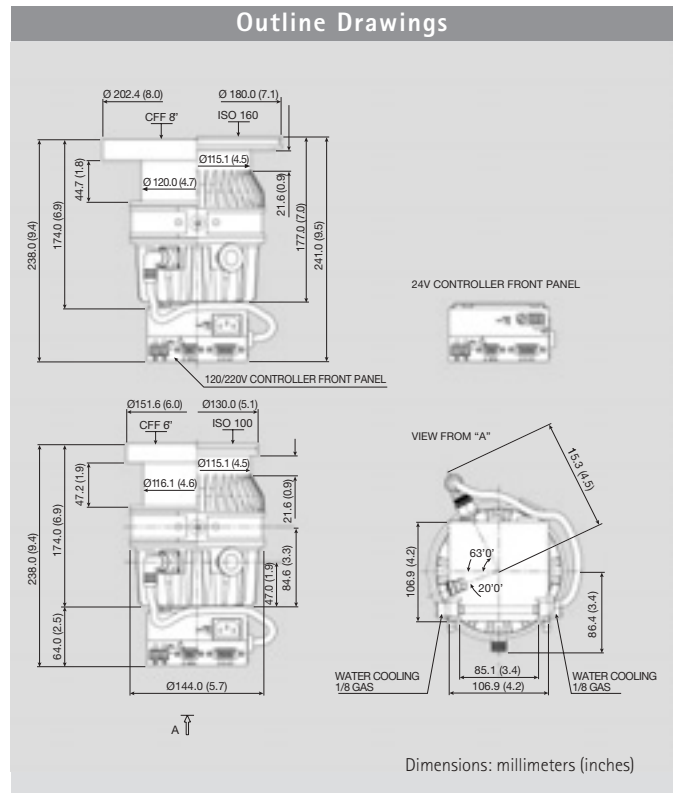

Technical Specifications

Pumping speed			
With CF 8" or ISO 160:	N ₂ : 280 l/s	He: 230 l/s	H ₂ : 210 l/s
With CF 6" or ISO 100:	N ₂ : 250 l/s	He: 220 l/s	H ₂ : 200 l/s
Compression ratio	N ₂ : 7 x 10 ⁸	He: 1 x 10 ⁵	H ₂ : 1 x 10 ⁴
Base pressure * (with recommended forepump)	mechanical: < 5 x 10 ⁻¹⁰ mbar (< 3.75 x 10 ⁻¹⁰ Torr) dry: < 5 x 10 ⁻⁹ mbar (< 3.75 x 10 ⁻⁹ Torr)		
Inlet flange	CF 8" O.D.	ISO 160	
	CF 6" O.D.	ISO 100	
Foreline flange	KF16 (KF25 optional)		
Rotational speed	56,000 rpm		
Start-up time	< 3 minutes		
Recommended forepump	Mechanical: Varian DS 102 Dry scroll: Varian SH-110		
Operating position	Any		
Cooling requirements	Natural air convection Forced air or water optional		
Bakeout temperature	120 °C at inlet flange max. (CF flange) 80 °C at inlet flange max. (ISO flange)		
Vibration level (displacement)	<0.01 μm at inlet flange		
Weight kg (lbs)			
Kit: (Pump + Navigator controller)	ISO 100 and 160: 4.5 (10) CF 6" and 8": 8 (17.6) 1 (2.2)		
Navigator controller	4,5 (10)		
1/4 Rack controller			

* According to standard DIN 28 428.

SEM version available on request

Pumping Speed vs Inlet Pressure (DN 160 only)

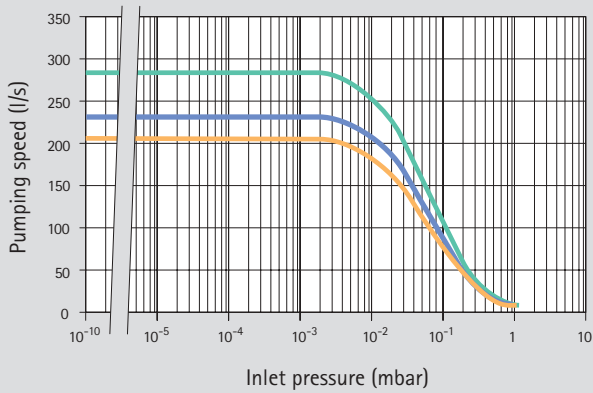

— Nitrogen — Helium — Hydrogen

Compression Ratio vs Foreline Pressure

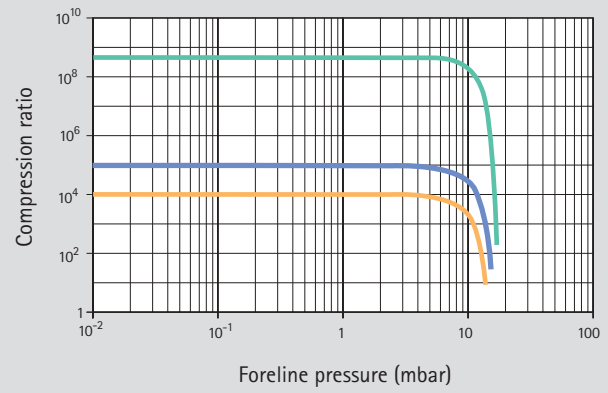

— Nitrogen — Helium — Hydrogen

Ordering Information

Description	Weight kg (lbs)	Part Number
-------------	-----------------	-------------

Complete Systems

(Pump + Navigator Controller)

Turbo-V 301 Navigator complete system, ISO 100, 24 Vdc	4.5 (10.0)	9698824
Turbo-V 301 Navigator complete system, CF 6", 24 Vdc	8.0 (17.6)	9698825
Turbo-V 301 Navigator complete system, ISO 160, 24 Vdc	4.5 (10.0)	9698826
Turbo-V 301 Navigator complete system, CF 8", 24 Vdc	8.0 (17.6)	9698827
Turbo-V 301 Navigator complete system, ISO 100, 120/220 Vac	4.5 (10.0)	9698828
Turbo-V 301 Navigator complete system, CF 6", 120/220 Vac	8.0 (17.6)	9698829
Turbo-V 301 Navigator complete system, ISO 160, 120/220 Vac	4.5 (10.0)	9698830
Turbo-V 301 Navigator complete system, CF 8", 120/220 Vac	8.0 (17.6)	9698831

Complete system includes: Pump, Inlet screen, Navigator controller, 2 Mains cables (NEMA plug and European plug)

Pumps

Turbo-V 301 Navigator pump, ISO 100	4.2 (9.2)	9698918
Turbo-V 301 Navigator pump, CF 6"	7.7 (16.8)	9698919
Turbo-V 301 Navigator pump, ISO 160	4.2 (9.2)	9698920
Turbo-V 301 Navigator pump, CF 8"	7.7 (16.8)	9698921

Controllers*

Turbo-V 301 Navigator controller, 24 Vdc	1.0 (2.2)	9698972
Turbo-V 301 Navigator controller, 120/220 Vac	1.0 (2.2)	9698973
Turbo-V 301-AG rack controller	1.7 (3.2)	9698991
Turbo-V 301-AG rack controller with RS-232/485	1.7 (3.2)	9698992
Turbo-V 301-AG rack controller with Profibus	1.7 (3.2)	9698993

* Power cord to be ordered separately (please see pump accessories)

Description	Weight kg (lbs)	Part Number
-------------	-----------------	-------------

Pump Accessories

Mains cable NEMA plug, 3m long	0.5 (1.0)	9699958
Mains cable European plug, 3m long	0.5 (1.0)	9699957
Serial cable and T-plus Software	0.5 (1.0)	9699883
<i>(previous release Navigator 2.2 included in the CD)</i>		
Inlet Screen DN100	0.5 (1.0)	9699302
Inlet Screen DN160	0.5 (1.0)	9699304
Heater band 120 Vac	1.0 (2.0)	9699804
Heater band 220 Vac	1.0 (2.0)	9699803
Water cooling kit	0.5 (1.0)	9699337
Plastic water cooling kit	0.5 (1.0)	9699347
Air cooling kit for Navigator controller	4.5 (10.0)	9699299
Fan extension cable for Navigator controller	0.5 (1.0)	9699949
Air cooling kit for rack AG controller	3.0 (7.0)	9699291
Fan extension cable for rack AG controller	0.5 (1.0)	9699940
Bracket for Navigator controller side mouting	2.0 (4.0)	9699970
Vibration damper ISO 100	3.0 (7.0)	9699344
Vibration damper CF 6"	3.0 (7.0)	9699334
Vibration damper ISO 160	4.0 (9.0)	9699345
Vibration damper CF 8"	4.0 (9.0)	9699335
Vent flange, NW 10 KF / M8	0.5 (1.0)	9699108
Vent device with adjustable delay time for standard rack controller	2.0 (4.0)	9699831
Vent valve N.O. for 301-AG rack controller	2.0 (4.0)	9699844
Vent valve N.C. for 301-AG rack controller	2.0 (4.0)	9699847
Vent valve for Navigator controller	2.0 (4.0)	9699834
Purge valve 10 SCCM NW16KF - M12	0.2 (0.5)	9699239
Purge valve 10 SCCM 1/4 Swagelok - M12	0.2 (0.5)	9699240
Purge valve 20 SCCM NW16KF - M12	0.2 (0.5)	9699241
Purge valve 20 SCCM 1/4 Swagelok - M12	0.2 (0.5)	9699242
Purge valve 10 SCCM 1/4 Swagelok - 1/4 Swagelok	0.2 (0.5)	9699232
Purge valve 20 SCCM 1/4 Swagelok - 1/4 Swagelok	0.2 (0.5)	9699236
Foreline flange KF25 1/4 gas	0.2 (0.5)	9699130
Active Gauges	Ask Varian for details	

Turbo-V 551 Navigator

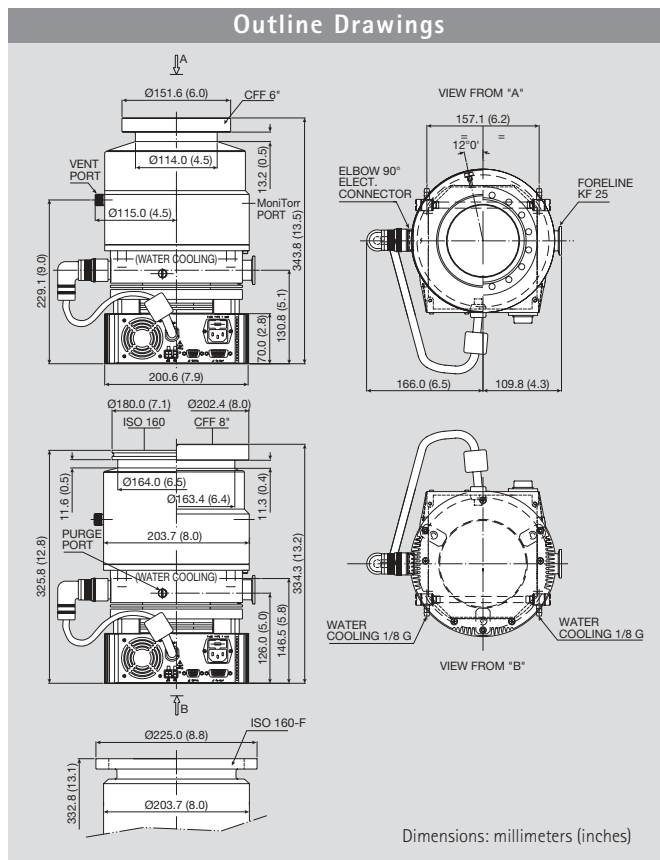

Technical Specifications

Pumping speed			
CF 6":	N ₂ : 350 l/s	He: 450 l/s	H ₂ : 450 l/s
CF 8" or ISO 160:	N ₂ : 550 l/s	He: 600 l/s	H ₂ : 510 l/s
Compression ratio	N ₂ : 1 x 10 ⁹	He: 1 x 10 ⁷	H ₂ : 1 x 10 ⁶
Base pressure *(with minimum recommended forepump)	< 1 x 10 ⁻¹⁰ mbar (< 1 x 10 ⁻¹⁰ Torr)		
Inlet flange	CF 6"	ISO 160	
	CF 8"	ISO 160-F bolted	
Foreline flange	KF 25		
Rotational speed	42,000 rpm		
Start-up time	< 5 minutes		
Recommended forepump	Mechanical: Varian DS 302 Dry scroll: Varian TS300		
Operating position	Any		
Cooling requirements	Natural air convection Water optional (use water with electrical conductivity ≤ 500 μS/cm)		
Bakeout temperature	120 °C at inlet flange max. (CF flange) 80 °C at inlet flange max. (ISO flange)		
Vibration level (displacement)	< 0.01 μm at inlet flange		
Weight kg (lbs)	ISO flange 19.4 (43.0) CF flange 23.4 (51.6) CF and ISO bolted flange 23.4 (51.6)		

* According to standard DIN 28 428.

SEM version available on request

Pumping Speed vs Inlet Pressure (DN 160 only)

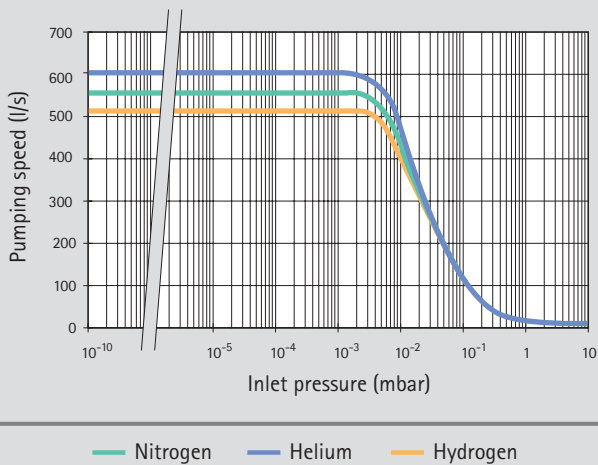

Compression Ratio vs Foreline Pressure

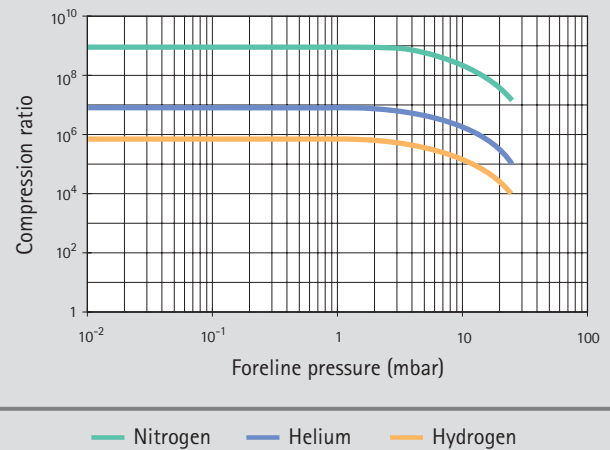

Ordering Information

Description	Weight kg (lbs)	Part Number
Complete Systems		
Turbo-V 551 Navigator complete system, ISO 160 flange	19.4 (43.0)	9698832
Turbo-V 551 Navigator complete system, ISO 160-F bolted flange	23.4 (51.6)	9698842
Turbo-V 551 Navigator complete system, 6" CF flange	23.4 (51.6)	9698835
Turbo-V 551 Navigator complete system, 8" CF flange	23.4 (51.6)	9698833
<i>Complete system includes: Pump, Inlet screen, Controller mounted on the bottom, 2 Mains cables (NEMA plug and European plug).</i>		
Pumps		
Turbo-V 551 Navigator pump, ISO 160 flange	16.0 (35.0)	9698922
Turbo-V 551 Navigator pump, ISO 160-F bolted flange	22.0 (49.0)	9698944
Turbo-V 551 Navigator pump, 6" CF flange	22.0 (49.0)	9698925
Turbo-V 551 Navigator pump, 8" CF flange	22.0 (49.0)	9698923
Controllers		
Turbo-V 551 Navigator controller 120/220 V - 50/60 Hz	3.0 (6.0)	9698976
Turbo-V 550 Rack controller, 220 V	15.7 (35.0)	9699444
Turbo-V 550 Rack controller, 110 V	15.7 (35.0)	9699544

Description	Weight kg (lbs)	Part Number
Pump Accessories		
Mains cable NEMA plug, 3 m long	0.5 (1.0)	9699958
Mains cable European plug, 3 m long	0.5 (1.0)	9699957
Serial cable and T-plus Software <i>(previous release Navigator 2.2 included in the CD)</i>	0.5 (1.0)	9699883
Inlet screen DN 100	0.5 (1.0)	9699302
Inlet screen DN 160	0.5 (1.0)	9699304
Heater band, 220 V	1.0 (2.0)	9699807
Heater band, 120 V	1.0 (2.0)	9699808
Water cooling kit	0.5 (1.0)	9699337
Plastic water cooling kit	0.5 (1.0)	9699347
Air cooling kit for use with Navigator controller	4.5 (10.0)	9699339
Air cooling kit for use with standard rack controller	3.0 (7.0)	9699314
Bracket for Navigator controller side mouting	2.0 (4.0)	9699349
Vibration damper CF 6"	3.0 (7.0)	9699334
Vibration damper ISO 160	4.0 (9.0)	9699345
Vibration damper CF 8"	4.0 (9.0)	9699335
Vent flange, NW 10 KF / M8	0.5 (1.0)	9699108
Vent device with adjustable delay time for standard rack controller	2.0 (4.0)	9699831
Vent valve for standard rack controller	2.0 (4.0)	9699843
Vent valve for Navigator controller	2.0 (4.0)	9699834
Purge valve 10 SCCM NW16KF - M12	0.2 (0.5)	9699239
Purge valve 10 SCCM 1/4 Swagelok - M12	0.2 (0.5)	9699240

Turbo Pumps

Turbo-V 701 Navigator

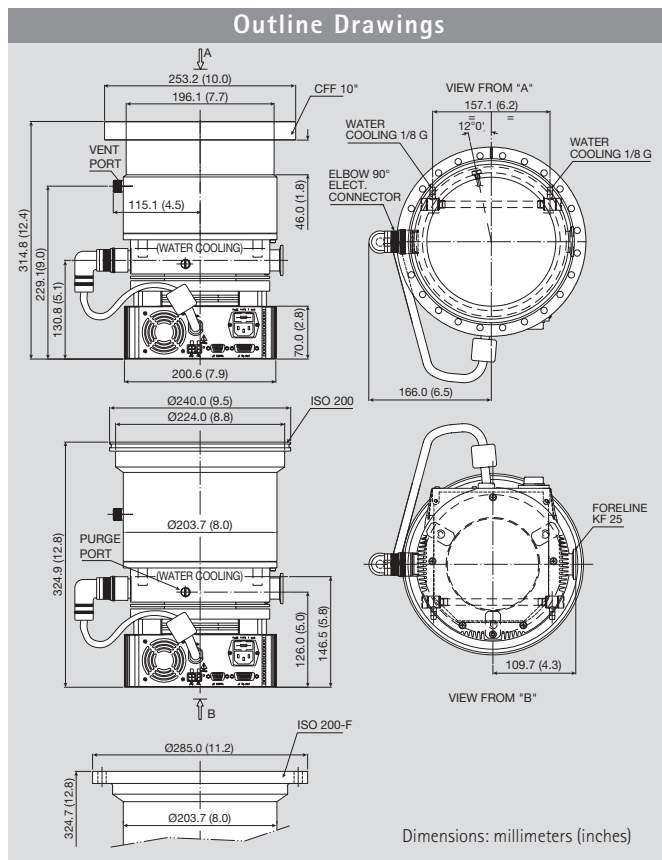

Technical Specifications

Pumping speed			
CF 10" or ISO 200:	N ₂ : 690 l/s	He: 620 l/s	H ₂ : 510 l/s
Compression ratio	N ₂ : 1 x 10 ⁹	He: 1 x 10 ⁷	H ₂ : 1 x 10 ⁶
Base pressure *(with minimum recommended forepump)	$< 1 \times 10^{-10}$ mbar ($< 1 \times 10^{-10}$ Torr)		
Inlet flange	CF 10"	ISO 200	ISO 200-F bolted
Foreline flange		KF 25	
Rotational speed	42,000 rpm		
Start-up time	<5 minutes		
Recommended forepump	Mechanical: Varian DS 402 Dry scroll: Varian TS300		
Operating position	Any		
Cooling requirements	Natural air convection Water optional (use water with electrical conductivity $\leq 500 \mu\text{S/cm}$)		
Bakeout temperature	120 °C at inlet flange max. (CF flange) 80 °C at inlet flange max. (ISO flange)		
Vibration level (displacement)	$< 0.01 \mu\text{m}$ at inlet flange		
Weight kg (lbs)	ISO flange 19.4 (43.0) CF flange 25.5 (54.2) CF and ISO bolted flange 25.5 (54.2)		

* According to standard DIN 28 428.

SEM version available on request

Pumping Speed vs Inlet Pressure (DN 200 only)

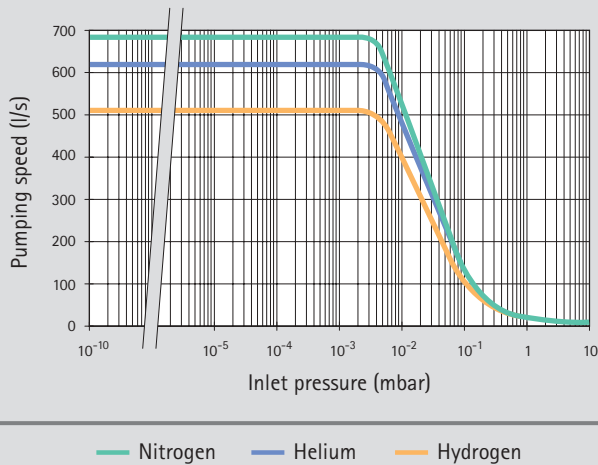

Compression Ratio vs Foreline Pressure

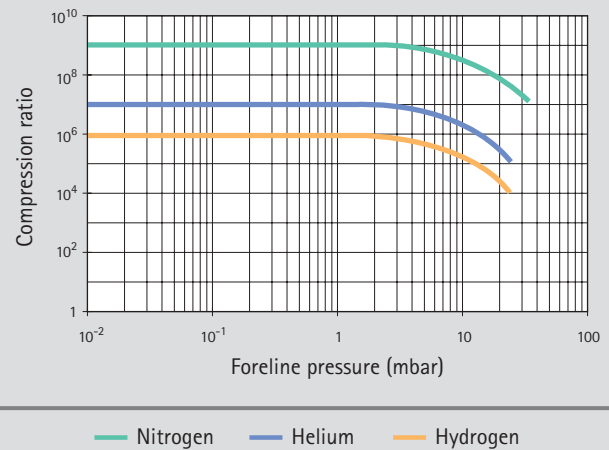

Ordering Information

Description	Weight kg (lbs)	Part Number
Complete Systems		
Turbo-V 701 Navigator complete system, ISO 200 flange	19.0 (43.0)	9698836
Turbo-V 701 Navigator complete system, ISO 200-F bolted flange	25.0 (56.0)	9698843
Turbo-V 701 Navigator complete system, 10" CF flange	25.0 (56.0)	9698837
<i>Complete system includes: Pump, Inlet screen, Controller mounted on the bottom, 2 Mains cables (NEMA plug and European plug).</i>		
Pumps		
Turbo-V 701 Navigator pump, ISO 200	16.0 (35.0)	9698926
Turbo-V 701 Navigator pump, ISO 200-F bolted	22.0 (49.0)	9698945
Turbo-V 701 Navigator pump, 10" CF	22.0 (49.0)	9698927
Controllers		
Turbo-V 701 Navigator controller 120/220 V - 50/60 Hz	3.0 (6.0)	9698977
Turbo-V 700HT Rack controller, 220 V	16.0 (35.0)	9699445
Turbo-V 700HT Rack controller, 110 V	16.0 (35.0)	9699545
Pump Accessories		
Mains cable NEMA plug, 3 m long	0.5 (1.0)	9699958
Mains cable European plug, 3 m long	0.5 (1.0)	9699957
Serial cable and T-plus Software <i>(previous release Navigator 2.2 included in the CD)</i>	0.5 (1.0)	9699883
Inlet screen DN 200	0.5 (1.0)	9699316
Heater band, 220 V	1.0 (2.0)	9699807
Heater band, 120 V	1.0 (2.0)	9699808
Water cooling kit	0.5 (1.0)	9699337
Plastic water cooling kit	0.5 (1.0)	9699347
Air cooling kit for use with Navigator controller	5.0 (10.0)	9699339
Air cooling kit for use with standard rack controller	3.0 (7.0)	9699314
Bracket for Navigator controller side mounting	2.0 (4.0)	9699349
Vibration damper, ISO 200	5.0 (10.0)	9699346
Vibration damper, CF 10"	5.0 (10.0)	9699336
Vent flange, NW 10 KF / M8	0.5 (1.0)	9699108
Vent device with adjustable delay time for standard rack controller	2.0 (4.0)	9699831
Vent valve for standard rack controller	2.0 (4.0)	9699843
Vent valve for Navigator controller	2.0 (4.0)	9699834
Purge valve 10 SCCM NW16KF - M12	0.2 (0.5)	9699239
Purge valve 10 SCCM 1/4 Swagelok - M12	0.2 (0.5)	9699240

Turbo Pumps

Turbo-V 1001 Navigator

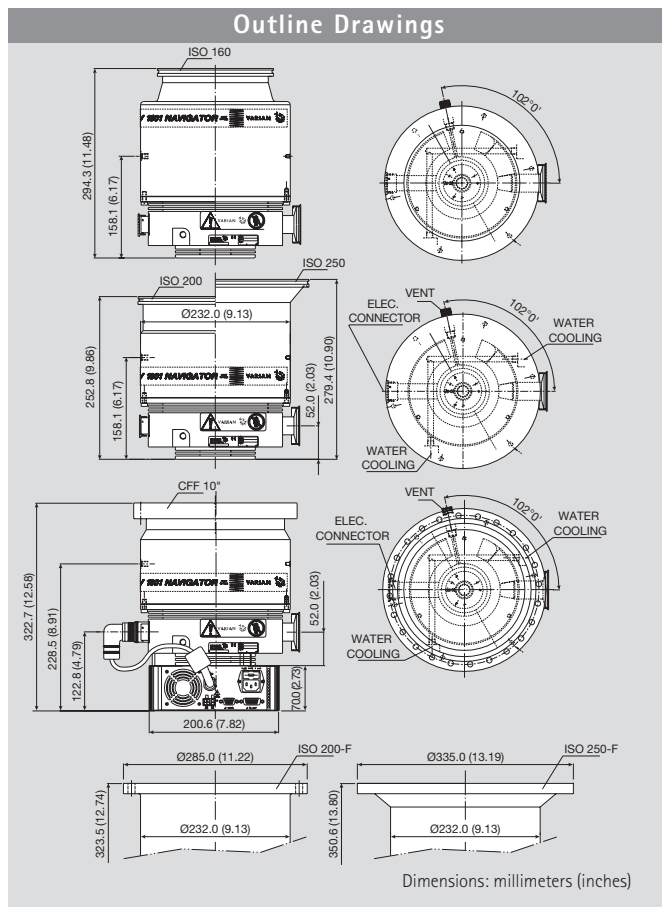

Technical Specifications

Pumping speed:	ISO 160:	N ₂ : 790 l/s	He: 820 l/s	H ₂ : 860 l/s		
	CFF 10" or ISO 200:	N ₂ : 950 l/s	He: 870 l/s	H ₂ : 900 l/s		
	ISO 250:	N ₂ : 1,050 l/s	He: 900 l/s	H ₂ : 920 l/s		
Compression ratio:	ISO 160	N ₂ : 1 x 10 ⁹	He: 1 x 10 ⁷	H ₂ : 1 x 10 ⁶		
	CF 10"/ISO 200 - ISO 250	N ₂ : 1 x 10 ⁹	He: 1 x 10 ⁷	H ₂ : 1 x 10 ⁶		
Base pressure* (with recommended forepump)		$< 1 \times 10^{-10}$ mbar ($< 1 \times 10^{-10}$ Torr)				
Inlet flange	ISO 160	ISO 200	ISO 200-F bolted	CF 10"	ISO 250	ISO 250-F bolted
Foreline flange	KF 40					
Rotational speed	38,000 rpm					
Start-up time	<4 minutes					
Recommended forepump	Mechanical: Varian DS 402 Dry scroll: Varian TS300					
Operating position	Any					
Cooling requirements	Forced air or water					
Bakeout temperature	120 °C at inlet flange max. (CF flange) 80 °C at inlet flange max. (ISO flange)					
Vibration level (displacement)	$< 0.01 \mu\text{m}$ at inlet flange					
Weight kg (lbs):	ISO 160 flange					19 (41.8)
	ISO 200 flange					19.4 (43.0)
	CF 10" flange					25.5 (54.2)
	ISO 250 flange					21.2 (46.6)
	ISO 200-F and 250-F bolted flange, CF 10" flange					25.5 (54.2)

* According to standard DIN 28 428.

NOTE • The pump is available with On-board Navigator Controller, 1/4 Rack Controller or PCB Controller; for information on controllers see also pages 36-37.

SEM version available on request

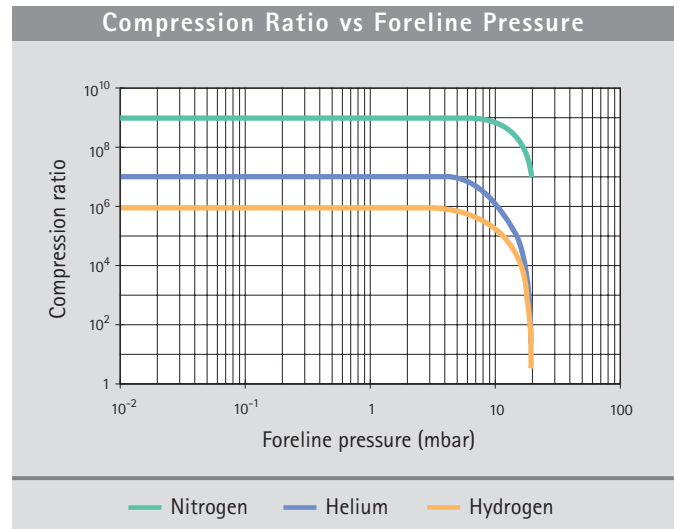
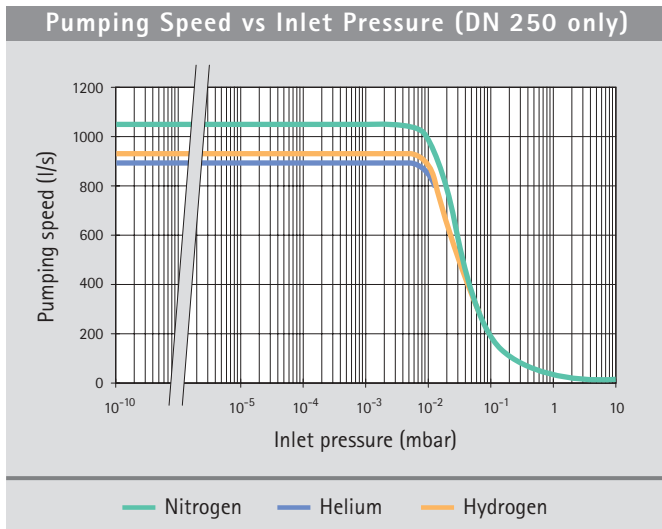

Ordering Information

Description	Weight kg (lbs)	Part Number
Complete Systems		
Turbo-V 1001 Navigator complete system, ISO 160 flange	24.4 (53.8)	9698840
Turbo-V 1001 Navigator complete system, ISO 200 flange	24.8 (55.0)	9698838
Turbo-V 1001 Navigator complete system, ISO 200-F bolted flange	30.9 (66.2)	9698844
Turbo-V 1001 Navigator complete system, 10" CF flange	30.9 (66.2)	9698839
Turbo-V 1001 Navigator complete system, ISO 250 flange	26.6 (58.6)	9698841
Turbo-V 1001 Navigator complete system, ISO 250-F bolted flange	30.9 (66.2)	9698845
<i>Complete system includes: Pump, Inlet screen, Controller mounted on the bottom, 2 Mains cables (NEMA plug and European plug).</i>		
Pumps		
Turbo-V 1001 Navigator pump, ISO 160 flange	19.0 (41.8)	9698933
Turbo-V 1001 Navigator pump, ISO 200 flange	19.4 (43.0)	9698931
Turbo-V 1001 Navigator pump, ISO 200-F bolted flange	25.5 (54.2)	9698946
Turbo-V 1001 Navigator pump, 10" CF flange	25.5 (54.2)	9698932
Turbo-V 1001 Navigator pump, ISO 250 flange	21.2 (46.6)	9698934
Turbo-V 1001 Navigator pump, ISO 250-F bolted flange	25.5 (54.2)	9698947
Controllers		
Turbo-V 1001 Navigator controller 120/220 V - 50/60 Hz	5.4 (12.0)	9698978
Turbo-V 1000HT Rack controller, 220 V	15.7 (35.0)	9699454
Turbo-V 1000HT Rack controller, 110 V	15.7 (35.0)	9699554

Description	Weight kg (lbs)	Part Number
Pump Accessories		
Mains cable NEMA plug, 3 m long	0.5 (1.0)	9699958
Mains cable European plug, 3 m long	0.5 (1.0)	9699957
Serial cable and T-plus Software (previous release Navigator 2.2 included in the CD)	0.5 (1.0)	9699883
Inlet screen DN 160	0.5 (1.0)	9699304
Inlet screen DN 200	0.5 (1.0)	9699316
Inlet screen DN 250	0.5 (1.0)	9699350
Heater band, 220 V	1.0 (2.0)	9699327
Heater band, 120 V	1.0 (2.0)	9699317
Water cooling kit	0.5 (1.0)	9699337
Plastic water cooling kit	0.5 (1.0)	9699347
Air cooling kit for use with Navigator controller	4.5 (10.0)	9699297
Air cooling kit for use with standard rack controller	3.0 (7.0)	9699315
Bracket for Navigator controller side mouting	2.0 (4.0)	9699298
Vibration damper ISO 160	4.0 (9.0)	9699345
Vibration damper, ISO 200	5.0 (10.0)	9699346
Vibration damper, CF 10"	5.0 (10.0)	9699336
Vent flange, NW 10 KF / M8	0.5 (1.0)	9699108
Vent device with adjustable delay time for standard rack controller	2.0 (4.0)	9699831
Vent valve for standard rack controller	2.0 (4.0)	9699843
Vent valve for Navigator controller	2.0 (4.0)	9699834
Purge valve 10 SCCM NW16KF - M12	0.2 (0.5)	9699239
Purge valve 10 SCCM 1/4 Swagelok - M12	0.2 (0.5)	9699240
Purge valve 20 SCCM NW16KF - M12	0.2 (0.5)	9699241
Purge valve 20 SCCM 1/4 Swagelok - M12	0.2 (0.5)	9699242
Purge valve 10 SCCM 1/4 Swagelok 1/4 Swagelok	0.2 (0.5)	9699232
Purge Valve 20 SCCM 1/4 Swagelok 1/4 Swagelok	0.2 (0.5)	9699236



Turbo-V 6000

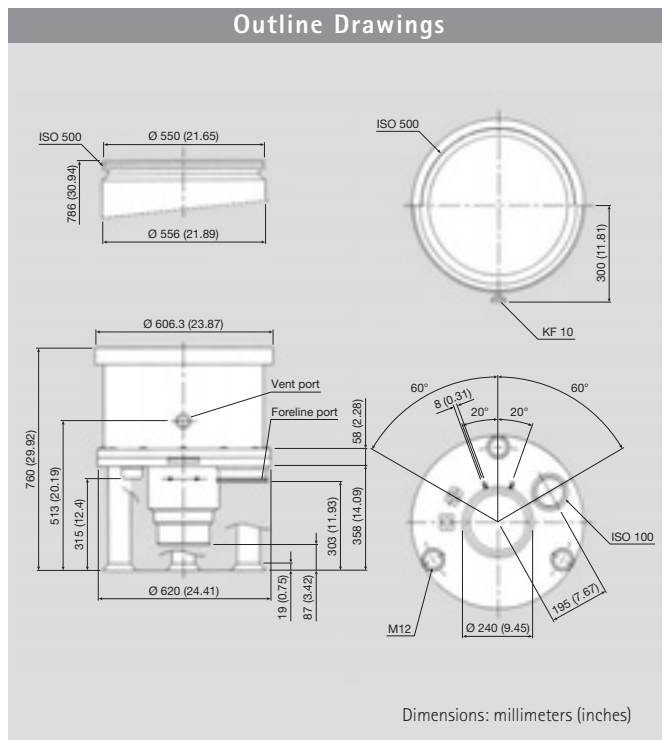

Technical Specifications

Pumping speed l/s	N ₂ : 6,000	He: 7,000	H ₂ : 6,500
Compression ratio	N ₂ : > 1 x 10 ¹⁰	He: 2.3 x 10 ⁵	H ₂ : 8 x 10 ³
Base pressure with recommended mechanical pump:	< 1 x 10 ⁻¹⁰ mbar (< 1 x 10 ⁻¹⁰ Torr)		
Inlet flange	ISO 500		
Foreline flange	ISO 100		
Rotational speed	14,000 rpm		
Startup time	30 minutes		
Recommended forepump	80 m ³ /h		
Operating position	Vertical ±10°		
Cooling requirements	Water		
Bakeout temperature	80 °C at inlet flange (ISO version)		
Vibration level (displacement)	≤ 0.05 μm at inlet flange		
Weight kg (lbs)	250 (550)		
Lubricant	Varian T.A. oil (charge 1,000 cm ³)		

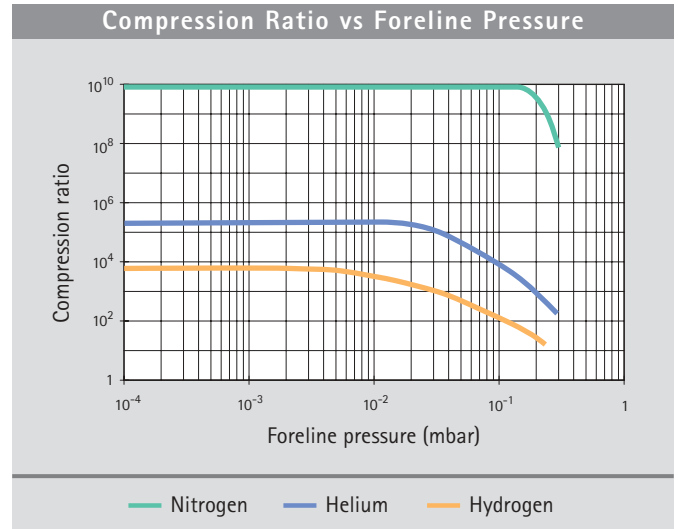
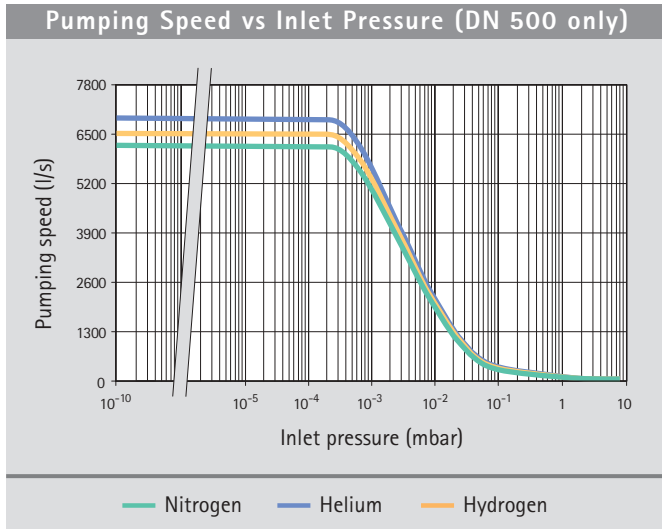

Ordering Information

Description	Weight kg (lbs)	Part Number
Pump		
Turbo-V 6000 pump with ISO 500 inlet flange	282.0 (620.0)	On request
Controllers		
Turbo-V 6000 controller, 120 V	50.0 (110.0)	On request
Turbo-V 6000 controller, 220 V	50.0 (110.0)	On request
Accessories		
Inlet screen, DN 500	10.0 (22.0)	On request
Vent valve with fixed delay time	2.0 (4.0)	On request
Vent device with adjustable delay time	2.2 (5.0)	On request
Replacement Parts		
Varian T.A. oil, 100 cm ³	0.5 (1.0)	On request
Varian T.A. oil, 1000 cm ³	1.4 (3.0)	On request

Please contact Varian for ordering information.

Turbo Pumps

Turbo-V 2K-G System

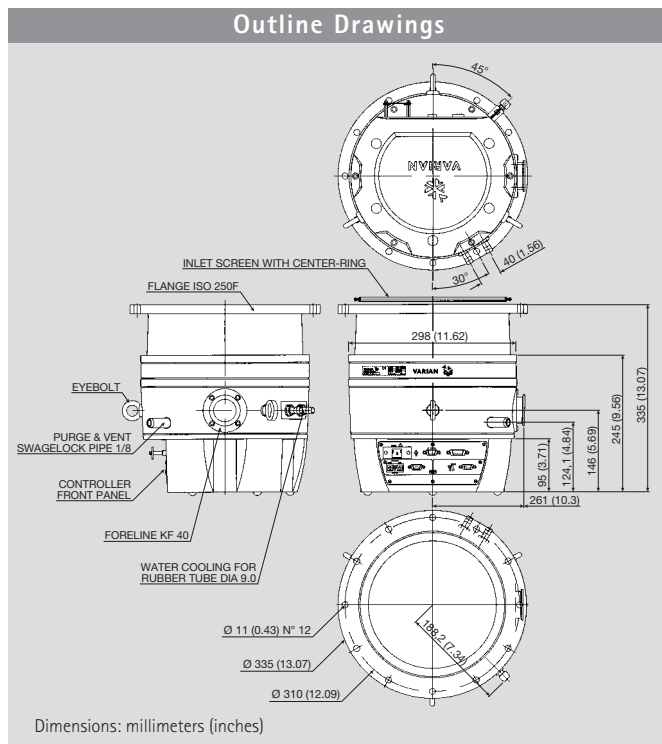

Turbo-V 2K-G System

- The first application-specific pumping solution designed for thin film deposition equipment
- The highest performing, most compact unit available
- The first fully integrated approach for maximum system productivity and uptime

The System Interface

- Integrated package includes Turbo Molecular Pump, Drive Electronics, Power Supply, MoniTorr, Purge Gas and Communication
- Versatile electronics interface with easy to use control Software
- Analog I/O signals and RS232 / RS485 interface as standard
- Varian Profibus® interface as option

Technical Specifications

Pumping speed		N ₂ : 1600 l/s
Compression ratio		N ₂ : 3 x 10 ⁵
Base pressure* with recommended forepump		< 1 x 10 ⁻⁸ mbar
Inlet flange		ISO 250 F
Foreline flange		KF 40 NW
Nominal rotational speed		33,000 rpm
Start-up time		<7 minutes
Recommended forepump		> 40 m ³ /h
Operating position		Any
Operating ambient temperature		+5 °C to +40 °C
Power supply	Input voltage	100 - 240 Vac
	Input freq.	50 - 60 Hz
Communication Interface	Analogue I/O	Standard
	RS232 / RS485	Standard
	Profibus	Optional
Dimensions	Height	335 mm
	Diameter	335 mm
	Weight	35 kg

* According to standard DIN 28 428.

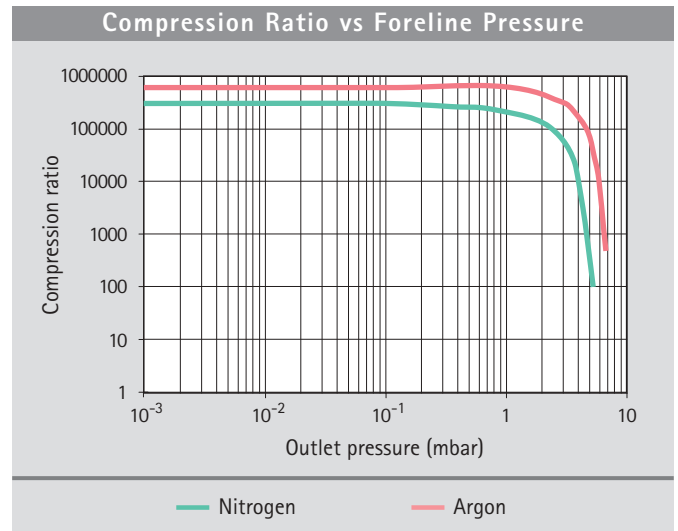
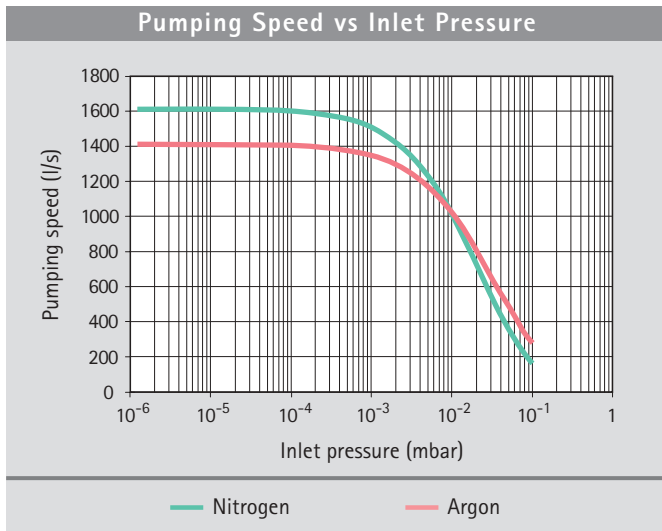

Ordering Information

Description	Part Number
Turbo-V 2K-G system with MoniTorr	9698871
Turbo-V 2K-G system with Profibus and MoniTorr	9698873
Mains cable NEMA Plug, 3m long	9699958
Mains cable European Plug, 3m long	9699957
Serial cable and Navigator Software 3.0	9699883
MoniTorr connectivity kit	9699260
Remote Assist Support program 12 Months	RASS2KG_1YR
Remote Assist Support program 24 Months	RASS2KG_2YR
Inlet screen ISO 250 with center ring	9699138
Water cooling kit for 6x8 (IDxOD) flexible tube	9699348
Water cooling kit for 3/8 in. ID flexible tube	9699338
Water hoses	9699825

Turbo Pumps

Turbo-V 3K-G System

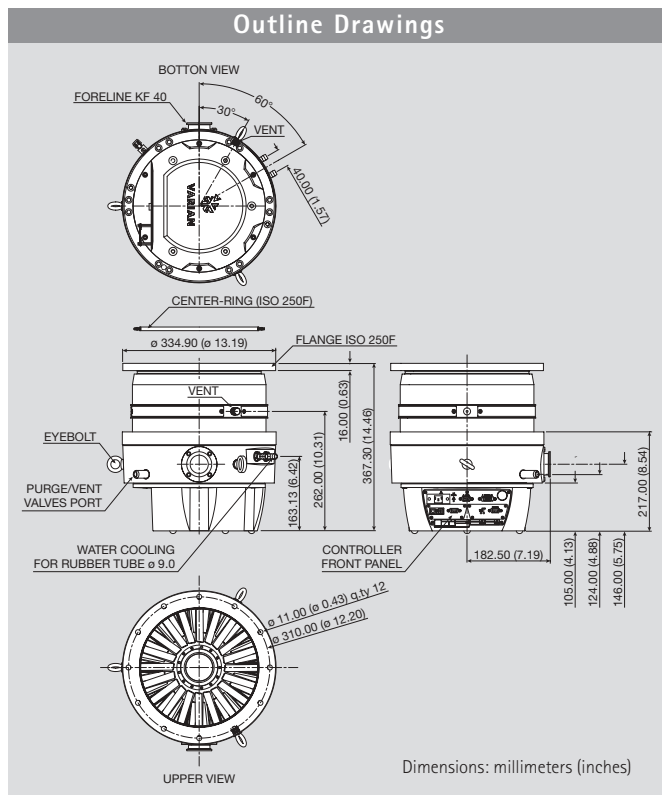

The Only Truly "Integrated" System in the Market

The Turbo-V 3K-G: an advanced solution for Thin Film applications

- Fully integrated system with on board waterproof power supply
- Vent/purge valves control capability
- Integrated diagnostics
- Multiple interfaced capability
- Lowest power absorption

Best Footprint to Performance Ratio

- The highest Argon pumping speed (2050 l/s) for its size allows uniform deposition rates at high substrate throughput
- Highest pumping speed in its class: 2200 l/s for Nitrogen
- Throughput: over 1400 sccm for Nitrogen
- The all-turbo, more compact rotor design delivers highest performance with the smallest footprint

Technical Specifications

Pumping speed	N ₂ : 2200 l/s	He: 1900 l/s	Ar: 2050 l/s
Compression ratio	N ₂ : > 1 x 10 ⁷	He: 6 x 10 ³	Ar: > 1 x 10 ⁸
Base pressure* with recommended forepump	< 1 x 10 ⁻⁸ mbar		
Inlet flange	ISO 250 F		
Foreline flange	KF 40 NW		
Nominal rotational speed	31,800 rpm		
Start-up time without gas load and with the recommended forepump	< 6 minutes		
Foreline pressure	< 0.5 mbar		
Minimum recommended forepump	> 60 m ³ /h (depending on gasflow requirements)		
Operating position	Any		
Cooling requirements	Water		
Weight (ISO 250)	52 (114.63) kg (lbs)		

* According to standard DIN 28 428.

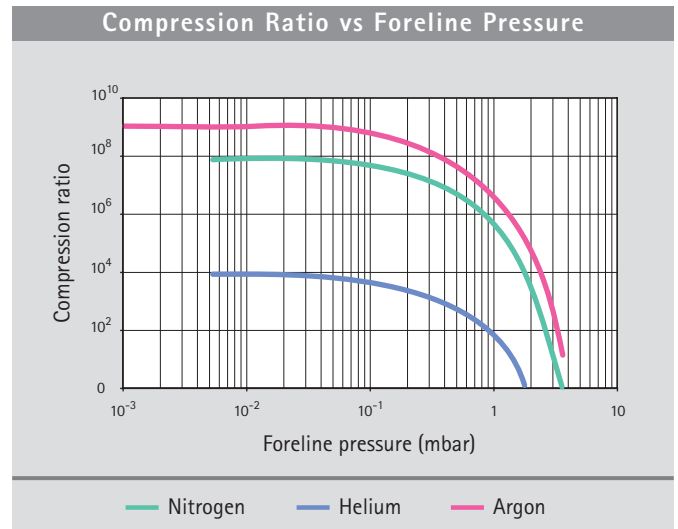
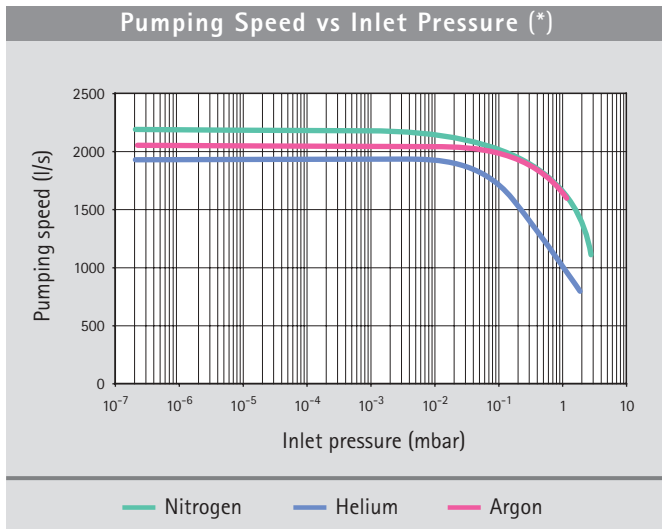

(*) Measured with a 60 m³/h forepump.

Ordering Information

Description	Part Number
Pumping Systems (*)	
Turbo-V 3K-G ISO 250 F System with integrated purge/vent device	9698888
Turbo-V 3K-G ISO 250 F System with Profibus and integrated purge/vent device	9698889
<i>(*) Pumping Systems include Pump with 230V Integrated Electronics, Inlet Screen installed on the pump, separate center-ring and pre-installed IP54 Mating Connectors. Both standard models can be equipped with Varian's MoniTorr device on request. Also 120Vac units available on request.</i>	
Accessories	
Mains cable NEMA Plug, 3m long	9699958
Mains cable European Plug, 3m long	9699957
T-Plus Software and serial cable	9699883
Water cooling kit for 6x8 (IDxOD) flexible tube	9699348
Water cooling kit for 3/8 in.ID flexible tube	9699338
Spare Parts	
IP54 proof mating connectors	9699958
Inlet screen ISO 250	9699350
O-ring and center ring ISO250	9699144

Turbo Pumps

Turbo-V 81-AG Navigator Controller



The Turbo-V 81-AG Navigator controller is a solid-state frequency converter with the following features:

- Drives the pumps of the Turbo-V 81 family.
- Powers the pump cooling fan.
- Drives the vent valve.
- Provides and acquires the pressure of the wide range gauge.
- Remote I/Os compatible with the previous version.
- Navigator default serial compatible with the previous RS 232 and 485 version.
- Able to operate with Active Gauges (IM-500, Full Range Gauge FRG-700 and FRG-702).

Technical Specifications

Input voltages:	
Navigator controller, 24 Vdc	24 Vdc $\pm 10\%$
Navigator controller, 100/240 Vac	100 ÷ 240 Vac $\pm 10\%$
Input power:	
Navigator controller, 24 Vdc	80W
Navigator controller, 100/240 Vac	180 VA
Input frequency:	
Navigator controller, 100/240 Vac	50 to 60 Hz $\pm 5\%$
Fuse	2 x T4 A 250V
Output voltage	60 Vac
Output frequency	1350 Hz
Output power:	
Navigator controller, 24 Vdc	50W
Navigator controller, 100/240 Vac	70 W (ramp), 50 W (Normal and Autotuning)
Operating temperature	+5 ÷ +45 °C 0 - 90% (Not condensing)
Storage temperature	-20 °C to +70 °C 0 - 95%

Outline Drawings

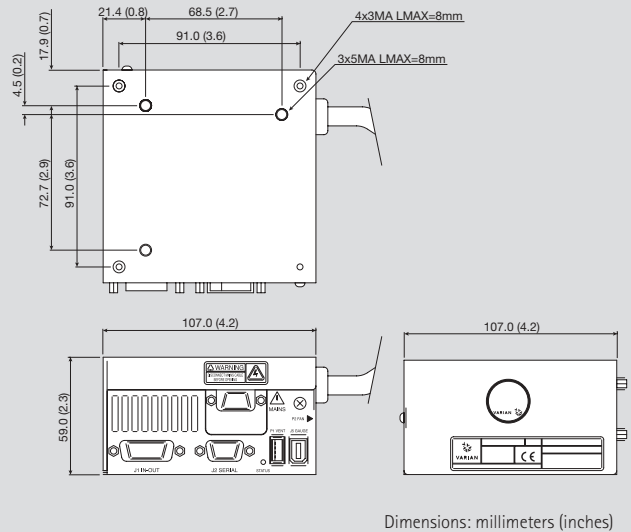

The dedicated controller is a solid-state frequency converter which is driven by a single chip microcomputer and consists of two PCBs which include power supply and 3-phase output, analog and input/output section, microprocessor and digital section. The power supply, together with the 3-phase output, converts the single phase AC mains supply or 24Vdc supply into a 3-phase, low voltage, medium frequency output which is required to power the pump. The controller can be operated by a remote host computer via the serial connection. A Windows-based software is available (optional). The Turbo-V 81-AG Navigator controller can be mounted on board, on the bottom of the Turbo-V 81 Series pumps.

Ordering Information

Description	Weight kg (lbs)	Part Number
Controllers		
Turbo-V 81-AG Navigator controller*, 24 Vdc	0.3 (0.66)	9698995
Turbo-V 301 Navigator controller*, 100/240 Vac	0.3 (0.66)	9698996
* Order power cable separately		
Accessories		
Mains cable NEMA Plug, 3m long		9699958
Mains cable European Plug, 3m long		9699957
Serial cable and T-Plus Software		9699883
Air cooling kit (0,5m)		9699290
Air cooling kit, extension cable (5m)		9699940
Vent Valve N.O. 0.5mm orifice (0.7 m cable)		9699844
Vent valve Extension Cable (5m, USB Type A - USB Type A)		9699941
Active Gauges	Ask Varian for details	
Active Gauges cables	Ask Varian for details	

Turbo-V 81-AG Rack Controller

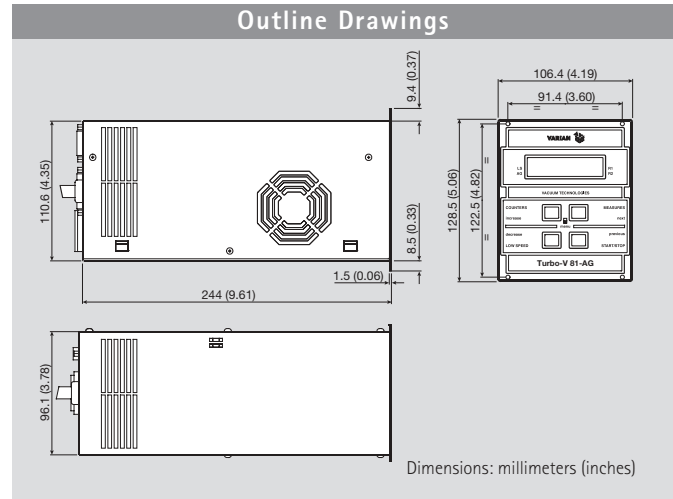

The Turbo-V 81-AG Rack controller is a microprocessor-controlled frequency converter with new, enhanced features that allow greater control and communication capabilities. This compact, 1/4 rack unit is designed for full worldwide compatibility, for vent valve control, active gauge pressure reading and pump operation parameters control, as well as for self diagnostic and protection features.

- **Universal Voltage**
Controller able to auto set according to the input voltage, providing flexibility for easy installation worldwide.
- **RS-232/485 Communication Protocols and Profibus (Options)**
 - Allows the pump to be interfaced with the system controls.
 - Enables the pump to be operated via PC with T-Plus software.
 - Helps development of own customer software.

- **Stop Speed Reading (SSR)**
 - Continues pump speed reading after the stop command.
 - Allows monitoring the pump in slow down ramp and shut down time.
- **N.O. and N.C. Vent Valve Drive**
 - Valve delay and opening time adjustable.
 - Vent valve driven by controller automatically or by serial line.
 - Opening time control through SSR function.
- **Active Gauge Pressure Reading Capability**
 - Able to operate with Active Gauges (IM-500, Full Range Gauge FRG-700 and FRG-702).
 - Provides accurate pressure measurements from atm down to 10⁻⁹ mbar.
 - Rack mounted control electronics no longer necessary, with simple +24 Vdc power connector.
 - Proven inverted magnetron design.
 - Rapid start even in high-vacuum conditions.

Technical Specifications

Input	100, 240 Vac 50/60 Hz
Maximum input power	210 VA
Output voltage	76 Vac
Output frequency	1,350 Hz
Nominal output power	100 W
Operating temperature	+5 °C to +45 °C
Storage temperature	-20 °C to +70 °C

Ordering Information

Description	Weight kg (lbs)	Part Number
Controller		
Turbo-V 81-AG rack controller*	1.7 (3.2)	9698988
* Order power cable separately		
Accessories		
Air cooling kit (0.5 m cable)		9699290
Air cooling kit extension cable (5 m)		9699940
Vent valve N.C. 0.5 orifice (0.5 m cable)		9699847
Vent valve N.O. 0.5 orifice (0.5 m cable)		9699844
Vent valve extension cable (5 m)		9699941
Mains cable NEMA plug (3 m)		9699958
Mains cable european plug (3 m)		9699957
Pump extension cable (3 m)		9699942
Active Gauges	Ask Varian for details	
Active Gauges cables	Ask Varian for details	
Options		
Turbo-V 81-AG with RS-232/485		9698989
Turbo-V 81-AG with Profibus		9698990



Turbo-V 301 Navigator Controller



The Turbo-V 301 Navigator controllers are microprocessor-controlled frequency converters, fully controllable through PC software, with self-diagnostic and protection features that ensure the highest degree of reliability.

Technical Specifications

Input voltages:	
Navigator controller, 24 Vdc	24 Vdc \pm 10%
Navigator controller, 120/220 Vac	100/120/220/240 Volt, 1 phase, 50/60Hz
Maximum input power:	
Navigator controller, 24 Vdc	200 W
Navigator controller, 120/220 Vac	300 VA
Output voltage	75 Vac, 3 phase
Output frequency	963 Hz
Nominal power	150 W
Start-up power	150 W
Operating temperature	0°C to +40°C
Storage temperature	20°C to +70°C

Outline Drawings

120/220 V controller front panel

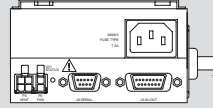

24 V controller front panel

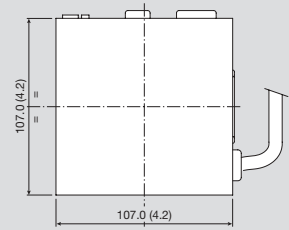
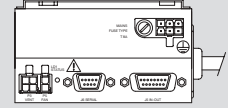

Dimensions: millimeters (inches)

They can be mounted on board, either on the bottom or on the side of the pump, offering outstanding flexibility and simplicity.

Ordering Information

Description	Weight kg (lbs)	Part Number
Controllers		
Turbo-V 301 Navigator controller*, 24 Vdc	1.0 (2.2)	9698972
Turbo-V 301 Navigator controller*, 120/220 Vac	1.0 (2.2)	9698973
* Order power cable separately		
Accessories		
Mains cable NEMA plug, 3m long	0.5 (1.0)	9699958
Mains cable European plug, 3m long	0.5 (1.0)	9699957
Serial cable and T-plus Software <i>(previous release Navigator 2.2 included in the CD)</i>	0.5 (1.0)	9699883
Air cooling kit	1.0 (2.0)	9699299
External "TMP Profibus gateway"	0.4 (0.8)	9699261

Turbo-V 301-AG Rack Controller

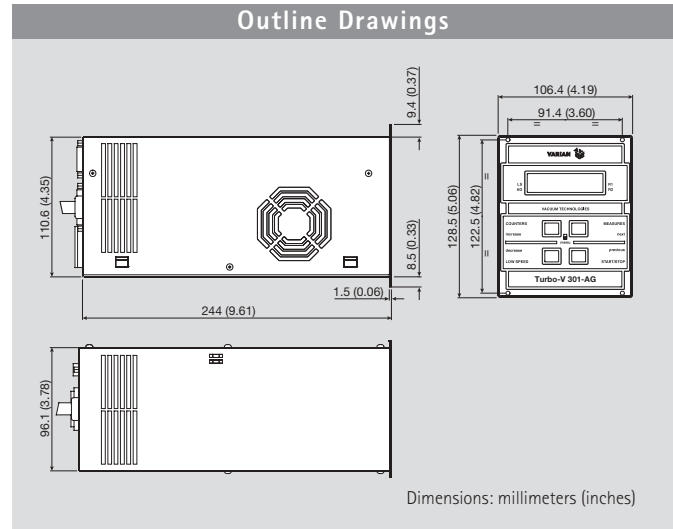

The Turbo-V 301-AG Rack controller is a microprocessor-controlled frequency converter with new, enhanced features that allow greater control and communication capabilities. This compact, 1/4 rack unit is designed for full worldwide compatibility, for vent valve control, active gauge pressure reading and pump operation parameters control, as well as for self diagnostic and protection features.

- **Universal Voltage**
Controller able to auto set according to the input voltage, providing flexibility for easy installation worldwide.
- **RS-232/485 Communication Protocols and Profibus (Options)**
 - Allows the pump to be interfaced with the system controls.
 - Enables the pump to be operated via PC with T-Plus software.
 - Helps development of own customer software.

- **Stop Speed Reading (SSR)**
 - Continues pump speed reading after the stop command.
 - Allows monitoring the pump in slow down ramp and shut down time.
- **N.O. and N.C. Vent Valve Drive**
 - Valve delay and opening time adjustable.
 - Vent valve driven by controller automatically or by serial line.
 - Opening time control through SSR function.
- **Active Gauge Pressure Reading Capability**
 - Able to operate with Active Gauges (IM-500, Full Range Gauge FRG-700 and FRG 702).
 - Provides accurate pressure measurements from atm down to 10⁻⁹ mbar.
 - Rack mounted control electronics no longer necessary, with simple +24 Vdc power connector.
 - Proven inverted magnetron design.
 - Rapid start even in high-vacuum conditions.

Technical Specifications

Input	100, 240 Vac 50/60 Hz
Maximum input power	300 VA
Output voltage	75 Vac
Output frequency	963 Hz
Nominal output power	150 W
Operating temperature	+5 °C to +45 °C
Storage temperature	-20 °C to +70 °C

Ordering Information

Description	Weight kg (lbs)	Part Number
Controller		
Turbo-V 301-AG rack controller*	1.7 (3.2)	9698991
* Order power cable separately		
Accessories		
Air cooling kit (0.5 m cable)		9699291
Air cooling kit extension cable (5 m)		9699940
Vent valve N.C. 0.5 orifice (0.5 m cable)		9699847
Vent valve N.O. 0.5 orifice (0.5 m cable)		9699844
Vent valve extension cable (5 m)		9699941
Mains cable NEMA plug (3 m)		9699958
Mains cable european plug (3 m)		9699957
Pump extension cable (3 m)		9699942
Active Gauges	Ask Varian for details	
Active Gauges cables	Ask Varian for details	
Options		
Turbo-V 301-AG Rack controller with RS-232/485		9698992
Turbo-V 301-AG Rack controller with Profibus		9698993

Turbo-V 551, 701 and 1001 Navigator Controllers



The Turbo-V 551, 701 and 1001 Navigator controllers are microprocessor-controlled frequency converters, fully controllable through PC software, with self-diagnostic and protection features that ensure the highest degree of reliability. They can be mounted on board, either on the bottom or on the side of the pump, offering outstanding flexibility and simplicity.

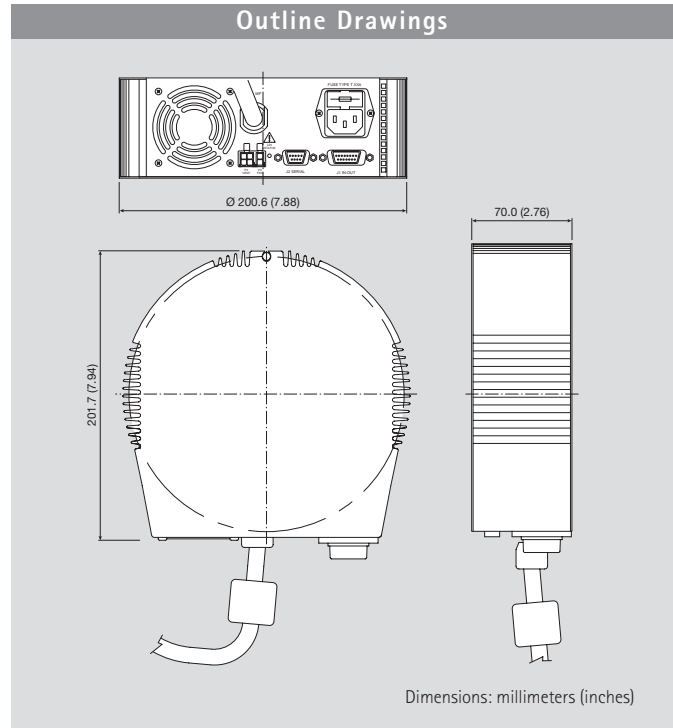

Technical Specifications

	Turbo-V 551, 701	Turbo-V 1001
Input voltages	100/120/220/240 VAC 50/60 Hz, 1 ph	100/120/220/240 VAC 50/60 Hz, 1 ph
Maximum input power	640 VA	850 VA
Output voltage	54 VAC, 3 ph	54 VAC, 3 ph
Output frequency	714 Hz	640 Hz
Operating temperature	0 °C to +40 °C	0 °C to +40 °C
Storage temperature	-20 °C to +70 °C	-20 °C to +70 °C

Ordering Information

Description	Weight kg (lbs)	Part Number
Controllers		
Turbo-V551 Navigator controller 120/220 V - 50/60 Hz	3.0 (6.0)	9698976
Turbo-V701 Navigator controller 120/220 V - 50/60 Hz	3.0 (6.0)	9698977
Turbo-V1001 Navigator controller 120/220 V - 50/60 Hz	3.0 (6.0)	9698978
Accessories		
Mains cable NEMA plug, 3 m long	0.5 (1.0)	9699958
Mains cable European plug, 3 m long	0.5 (1.0)	9699957
Serial cable and T-plus Software <i>(previous release Navigator 2.2 included in the CD)</i>	0.5 (1.0)	9699883
External "TMP Profibus gateway"	0.4 (0.8)	9699261

Turbo-V 550, 700HT and 1000HT Rack Controllers



These controllers are microprocessor-controlled frequency converters with self diagnostic and protection features that ensure the highest degree of reliability. The compact, 1/2 rack unit has a multifunction alphanumeric display for pump status and error code diagnostics. The front panel has a two-line dot matrix LCD display with back lighting. It displays rotational speed as the pump starts up and indicates when full speed is reached. At any time during the operation of the pump, the speed, current, power, and bearing temperature can be displayed. Additionally, the microprocessor acts as a pump cycle

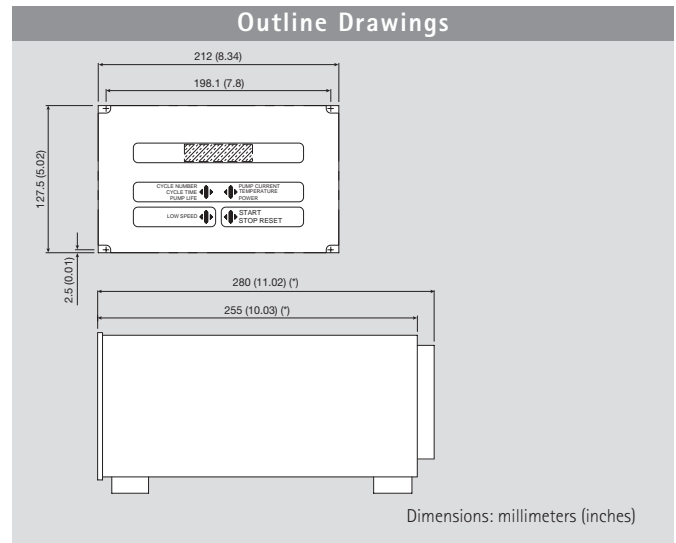

log, and can display the number of vacuum cycles, the cycle time for the current cycle, and the total operating hours on the pump. Remote operation can be accomplished with logic level contact closures and with optional computer interfaces. PCB controllers are available. Please contact Varian for details.

Technical Specifications

	V 550	V 700 HT	V 1000 HT
Input voltages	100/120/220/240 V 1 ph, 50/60 Hz	100/120/220/240 V 1 ph, 50/60 Hz	100/120/220/240 V 1 ph, 50/60 Hz
Maximum input power	600 VA	600 VA	700 VA
Output voltage	56 VAC, 3 ph	56 VAC, 3 ph	56 VAC, 3 ph
Output frequency	700 Hz	700 Hz	633 Hz
Maximum output power*	325 W	350 W	450 W
Startup power	420 W	420 W	430 W
Operating temperature	0 °C to +40 °C	0 °C to +40 °C	0 °C to +40 °C
Storage temperature	-20 °C to +70 °C	-20 °C to +70 °C	-20 °C to +70 °C

* Data valid for nitrogen.

Ordering Information

Description	Weight kg (lbs)	Part Number
Controllers		
Turbo-V550 Rack controller, 120 V	15.7 (35.0)	9699544
Turbo-V550 Rack controller, 220 V	15.7 (35.0)	9699444
Turbo-V700HT Rack controller, 120 V	15.7 (35.0)	9699545
Turbo-V700HT Rack controller, 220 V	15.7 (35.0)	9699445
Turbo-V1000HT Rack controller, 120 V	15.7 (35.0)	9699554
Turbo-V1000HT Rack controller, 220 V	15.7 (35.0)	9699454
Accessories		
J1 input mating connector	0.5 (1.0)	9699853
P6 and P7 mating plug	0.5 (1.0)	9699854
Mains cable (European plug, 3 m long)	1.0 (2.0)	9699957
Mains cable (American plug, 120 V, 3 m long)	1.0 (2.0)	9699958

Description	Weight kg (lbs)	Part Number
Options		
RS485 Computer communication kit	5.0 (1.0)	9699856
RS232 Computer communication kit	5.0 (1.0)	9699857
RS422 Computer communication kit	5.0 (1.0)	9699858
P2 output mating connector	5.0 (1.0)	9699852
Rack adapter for controller	2.0 (4.0)	9699191
Controller to pump extension cable (5 m extension) for Turbo-V 550, 700HT, 1000HT	1.0 (2.0)	9699951L0500
Controller to pump extension cable (10 m extension) for Turbo-V 550, 700HT, 1000HT	2.0 (4.0)	9699951L1000
External "TMP Profibus gateway" (usable only with RS-485 option installed)	0.4 (0.8)	9699261

Turbo-V 6000 Rack Controller



The Turbo-V 6000 controller is a 19" rack mountable unit. This controller provides the following features:

Remote Operation with System Controller

The Turbo-V controller can accept remote commands with either TTL-compatible logic level signals or with permanent contact closures.

A signal (logic level) indicates that the pump is operating and has achieved normal speed. Also available is the indication of overload due to high-temperature or high-current levels.

System Diagnostics

Front panel LED bar graph displays the controller output frequency and the power drawn by the pump. An overload condition is also indicated and an hour counter monitors the operating hours on the pump to help adhere to the recommended maintenance intervals.

Control of other System Components

The Turbo-V controller can power the mechanical pump contactor to provide a one-switch control of both Turbo-V and mechanical pump startup. Simultaneous starting of the Turbo-V and mechanical pump is recommended for most applications where no high-vacuum valve is required.

Technical Specifications

Input voltage	120/220 V, 1 ph, 50/60 Hz
Maximum input power	3,000 VA
Output voltage	100 VAC, 3 ph
Output frequency	233 Hz
Maximum output power*	1,500 W
Startup power	2,200 W
Operating temperature	0 °C to +40 °C
Storage temperature	-20 °C to +70 °C

* Data valid for nitrogen

Outline Drawings

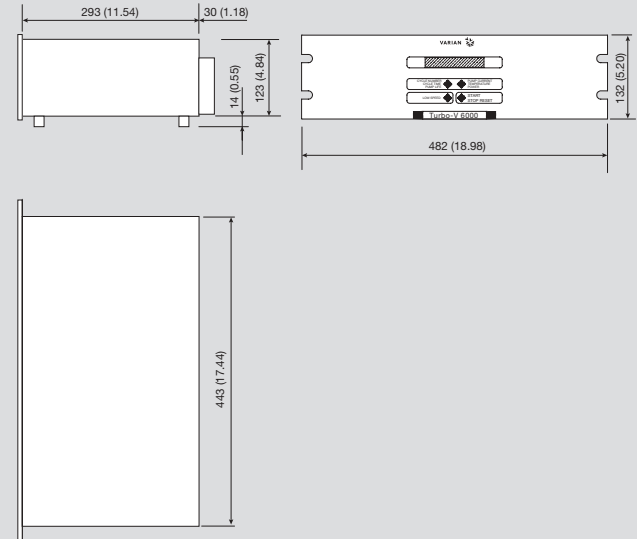

Dimensions: millimeters (inches)

The Turbo-V controller provides power to a turbo vent valve, if used.

A starting interlock is available that can be used for delayed starting of the Turbo-V with a contact closure from a vacuum gauge set point. The interlock could also be integrated to a water-flow switch to provide an early warning of interrupted cooling of the pump.

High-pressure Operation

The controller's ability to adjust the Turbo-V pump's rotational speed under high gas load conditions extends the operating range of the Turbo-V pumps into the 10^{-1} mbar range.

RPM Display

Digital display of nominal pump speed.

Ordering Information

Description	Weight kg (lbs)	Part Number
Controllers		
Turbo-V6000 Rack controller, 220 V	50.0 (110.0)	On request
Turbo-V6000 Rack controller, 120 V	50.0 (110.0)	On request

Please contact Varian for ordering information.

Turbo-V Accessories

Inlet Screens

To prevent any possible damage to the pump blades caused by particles falling into the pump, an inlet screen is available as an accessory. The inlet screen is a curved stainless steel mesh. It provides protection against debris larger than 0.7 to 3 mm (depending on the model), while reducing the pumping speed by only about 10%.

For ordering information, see individual pumps.

Heater Bands

To improve the attainable ultimate pressure in a vacuum system as well as to shorten the pump down time, bakeout of the chamber and the turbopump is recommended. To bake out the Turbo-V pumps, heater bands are provided as an option. The heaters are shaped to fit the upper part of the pump envelope and automatically heat up to a temperature of about 80 °C. The required bakeout time is a function of the degree of contamination of the system and the desired base pressure. For ordering information, see individual pumps.

Air Cooling Kits

A fan is provided as an option for applications requiring forced air flow. The fan is easily installed using the included installation kit. The air cooling kit for the Turbo-V81's can be mounted beside or underneath the pump body. The fans for all the other pump models can be installed in a side location only. The maximum allowable ambient temperature for an effective cooling action is 30 °C. To meet the air flow rate specifications, care must be taken not to restrict or cover the space around the fan so that air can flow freely. The operation of the cooling fan is controlled by the Turbo-V controller.

For ordering information, see individual controllers.

Water Cooling Kits

A water cooling kit is provided to cool the pump when operating at high inlet or high exhaust pressures. The kit is available for the Turbo-V301, 551, 701 and 1001 Navigator, and 3K-T pumps. The cooling water can be supplied by an open circuit with drainage or a closed-loop refrigerated system. Care must be taken to secure the tubes to ensure that they do not detach during operation. Four different kits with various tube sizes are available (refer to the following table).

Tube Size	Material	Screw Thread	Part Number
4 x 6 mm (ID x OD)	Plastic	1/8 BSP	9699347
6 x 8 mm (ID x OD)	Plastic	1/4 BSP	9699348
1/4" ID	SST	1/8 BSP	9699337
3/8" ID	SST	1/4 BSP	9699338

For ordering information, see individual pumps.

Vibration Dampers

Highly sensitive equipment such as an electron microscope and certain analytical instruments require extremely low vibration amplitudes. The dampers reduce turbopump vibration amplitude by at least a factor of 10 at their main frequencies.

They are available up to a size of 200 mm (ISO 200 or CF 10" O.D.). To effectively decouple the equipment from the pump, the vibration damper must be installed between the connecting flanges.

For ordering information, see individual pumps.

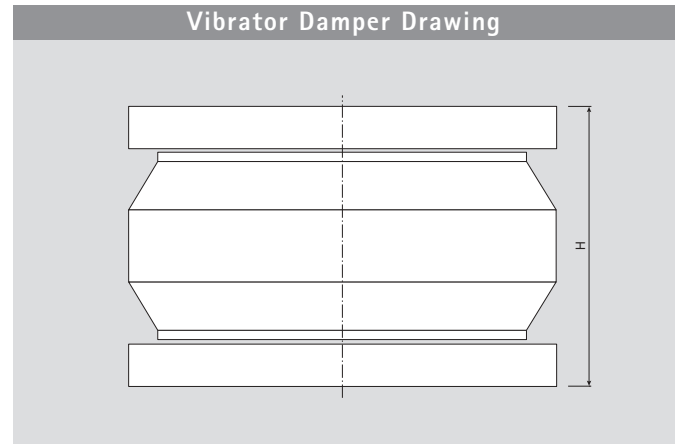

	H (mm)	H (inches)
Vibration Damper 4 1/2" CF	96.5	3.80
Vibration Damper 6" CF	101	3.97
Vibration Damper 8" CF	110	4.33
Vibration Damper 10" CF	113	4.45
Vibration Damper 63 ISO	84	3.31
Vibration Damper 100 ISO	84	3.31
Vibration Damper 160 ISO	88	3.46
Vibration Damper 200 ISO	88	3.46

Turbo-V Vent Valve

The Turbo-V Vent Valve, consisting of a control unit and a valve, is a complete unit for automatic venting of the Turbo-V pump when it is switched off or during a power failure. The valve is a normally open, electromagnetically-actuated valve with a filter on the air inlet. The control unit is powered by the Turbo-V controller and is provided with a fixed delay time of about 5 seconds to avoid undesired venting during a temporary power failure and to allow closure of the system valves before venting.

For ordering information, see individual controllers.

Turbo-V Vent Device

To control the venting of the Turbo-V pumps when they are switched off or during a power failure, a vent device is offered. The Turbo-V vent device consists of a normally closed valve and a control unit. The valve is electromagnetically-actuated and has a filter on the air-inlet. The control unit is powered by the Turbo-V controller and has a built-in battery backup. Delay and venting times are adjustable up to 36 minutes to optimize the venting conditions for each application.

For ordering information, see individual controllers.

Handheld Terminal

The handheld terminal is a remote control display for use with V 81 series Turbo-V pumps when connected to a controller without a front panel. It consists of an LCD alphanumeric display and keyboard which provide useful real time indications of the operating conditions and parameters of the turbopump.

Moreover, it allows the reprogramming of the controller parameters and troubleshooting of the pump and controller. The handheld terminal is connected to and powered from the

Turbo-V controller through a 1.5 meter cable.

For ordering information, please call your local Varian Office.

Purge Valve

To protect the bearings of a turbomolecular pump used with aggressive process gases, a measured supply of inert gas (N₂, Ar) must flow into the pump body around the upper bearing toward the fore-vacuum line. The Varian fixed orifice purge valve is calibrated for nitrogen to provide the correct gas flow to safely operate Turbo-V pumps. See Fixed Orifice Purge Valve Selection Guide below.

Fixed Orifice Purge Valve Selection Guide

Ordering Information				
Pump model	N ₂ Flowrate	Gas Line Connection	Weight kg (lbs)	Part Number
V301/V551/V701/1001 Navigator, and 3K-T models without integrated purge/vent				
	10 SCCM	NW16KF	0.2 (0.5)	9699239
	10 SCCM	1/4 Swagelok	0.2 (0.5)	9699240
	20 SCCM	NW16KF	0.2 (0.5)	9699241
	20 SCCM	1/4 Swagelok	0.2 (0.5)	9699242
	10 SCCM	1/4 Swagelok – 1/4 Swagelok*	0.2 (0.5)	9699232
	20 SCCM	1/4 Swagelok – 1/4 Swagelok*	0.2 (0.5)	9699236

* For remote installation

The Varian Turbo-V Pumps

Enjoying the Varian Turbo Experience...

Just imagine 1,333 turns in one second: this is the extraordinary rotational speed of our 80 l/s turbomolecular pump. Isn't it amazing? Consider that when you are driving on an open highway, the wheels of your car make about 15 turns every second. The turbo rotor spins almost 100 times faster!

This is the typical rotational speed of our turbomolecular pumps, designed to meet the most demanding vacuum applications: in the Analytical Instrumentation business, the Semiconductor Market, the Industrial market and the High Energy Physics research facilities.

All of these varied applications require ultimate vacuum performance, reliability, and cleanliness, as well as a service organization that provides rapid response 24 hours a day, 7 days a week. Meeting all of these requirements is our everyday goal.

With more than 50 years of experience in Vacuum Science, Varian leads the market in developing unique design solutions. Examples of our technological achievements include:

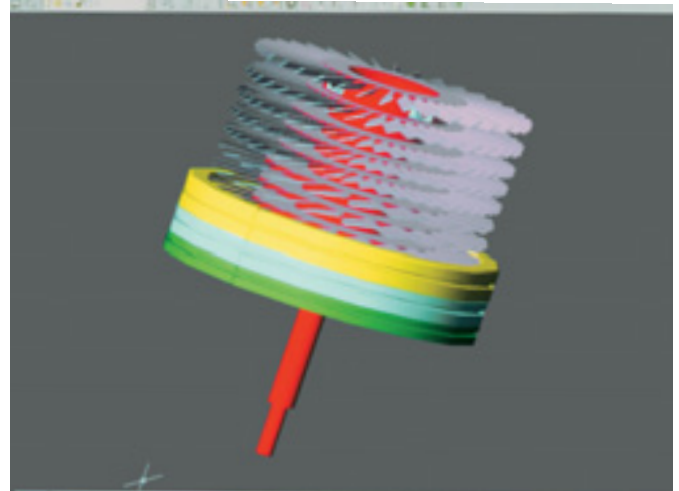

In Vacuum

The award winning and unique MacroTorr® pumping stage, with exhaust pressures up to 18 mbar, minimizes the size and cost of your primary pumps. Thanks to a complete set of proprietary numerical modeling tools, the MacroTorr® stages have been optimized for maximum vacuum performances at the minimal energy consumption.

In Mechanics

The dry ceramic ball bearing technology, along with our computer aided balancing system, provide ultimate turbopump reliability with minimal intervention. No oil in the pump, no oil in the vacuum system, no oil to refill.

In Electronics

Our microprocessor based pump control units, allow integration onto the pump and direct pump-to-laptop RS232 serial communications in a user-friendly Windows™ based environment. Please check our special T-plus Software available with any of our on board control units.

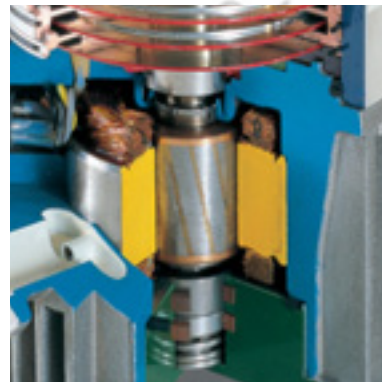

$$\tau_{ij} = \mu \left(\frac{\partial u_i}{\partial x_j} + \frac{\partial u_j}{\partial x_i} \right)$$

Last but not least, the MoniTorr System, our intelligent turbopump autodiagnostic system, that continuously monitors the pump's operating parameters and informs the service personnel about the state of the pump, ensuring maximum vacuum system uptime.

Part of our success is due to our Applications based structure. Everything in our organization reflects the will to meet customer needs. Today our R&D Engineers work side by side with the customer's system engineers, linked by the Varian worldwide structure of Application Engineers, designing the vacuum pumping systems that meet customer expectations.

With our complete range of turbo pumps from 80 to 6,000 l/s and a wide selection of pumping groups, Varian has the best solution to meet your needs.

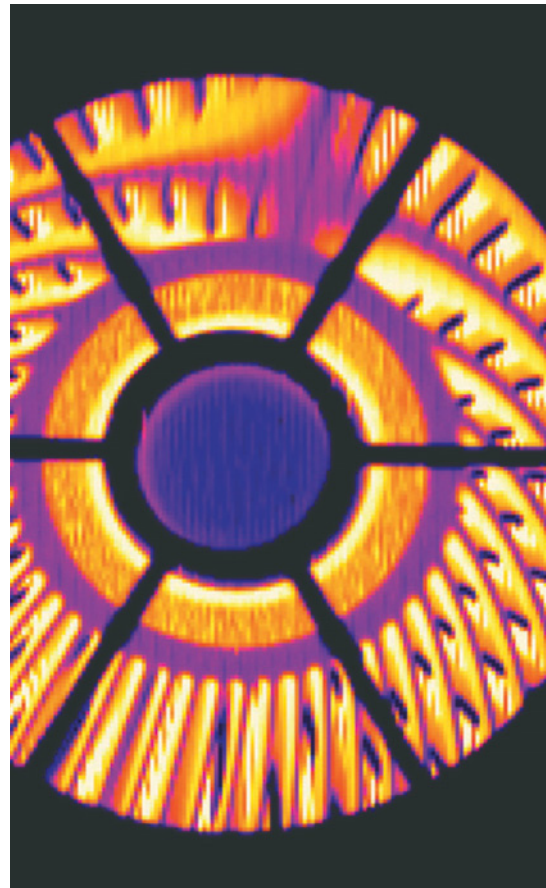

Turbo Pumps

Turbo-V Pump Technical Notes

Turbopump Operating Principles

Turbomolecular pumps consist of a series of bladed impellers rotating at high speed and fixed bladed stators. These impellers and stators are alternately spaced and are inclined in opposite directions.

The pumping action is based on momentum transfer from the fast moving impeller surface to the gas molecules.

The speed of the moving surface must be as high as possible to achieve optimum pumping efficiency in terms of pumping speed and compression ratio.

When this mechanism takes place several times in a pump a pumping action is created. The sequence of alternating rotors and stators typical of a conventional turbomolecular pump develops the compression ratio.

Turbomolecular drag pumps operate according to the same principle, but with a different geometry in the pumping stages. Gas molecules collide against a fast moving wall and are dragged into a channel toward the high pressure region.

Conventional turbomolecular pumps have high pumping speed but low compression ratio at foreline pressures higher than 10^{-1} mbar. Molecular drag pumps have low pumping speed but high compression ratios up to foreline pressures of more than 20 mbar.

When the two types of stages are combined together in one pump, as in the Varian MacroTorr® pumps, extended operational pressure ranges can be achieved. (See page 25 for further description of the MacroTorr® principle).

Pump Selection

How to Select a Turbo-V Pump

The right choice of a turbomolecular pump depends on the application; as a general rule we can reduce the choice to two types of use:

UHV (no gas flow) operations and Process Gas flow operations.

– UHV (no gas flow) operations.

The former case includes most cases in which the turbomolecular pump is employed to create vacuum in systems where the gas load is mainly produced by outgassing. In this application the choice is typically based on the desired base pressure within a desired time as a function of the foreseen outgassing rate, i.e.

$$S_{\text{eff}} = Q / p$$

where:

p is the desired base pressure (mbar)
 Q is the total outgassing rate at the desired time (mbar l/s)
 S_{eff} is the effective pumping speed

– Process Gas flow operations.

The second case relates to all operations where process gases must be used. The main parameters are therefore the desired operation pressure and the process gas flow

$$S_{\text{eff}} = Q' / p'$$

where Q' is the total gas flow and p' is the operating pressure.

How to Select the Backing Pump of a Turbomolecular Pump

The selection of a backing pump should be based analyzing two requirements of the vacuum system:

- a. the roughing time
 - b. the minimum recommended backing pump of the turbo
- a. Roughing: once the desired roughing time is established, the size of the forepump can be determined through the following formula:

$$S_{\text{foreline}} = (V / t) \ln (p_0 / p_1)$$

where

S_{foreline} is the pumping speed of the roughing pump (l/min)
 V is the volume of the chamber to be evacuated (l)
 t is the desired roughing time (min)
 p_0 is the starting pressure (mbar)
 p_1 is the end pressure (mbar)

When using a foreline pump much larger than the recommended size, a by-pass line might be necessary to achieve calculated roughing time.

- b. Backing: the backing pump must be big enough to achieve an effective pumping speed as close as possible to the nominal speed.

$$p_{\text{foreline}} = Q / S_{\text{foreline}}$$

where

S_{foreline} is the pumping speed of the foreline pump
 Q is the gas load
 p is the operating foreline pressure

It should be noted that Q is the total gas load on the pump and includes process gases and turbo purge gases when used.

The size of the backing pump can be calculated according to the following rule:

$$S_{\text{foreline}} \geq 20S / K$$

where

S is the pumping speed of the turbopump
 S_{foreline} is the pumping speed of the backing pump
 K is the maximum compression ratio of the turbopump for a given gas (i.e.: process gas) at the operating foreline pressure.

The pumping speed of the backing pump should be the higher of the two values calculated as above (roughing and backing).

Finally, it is possible to use a dry pump (scroll or diaphragm) for hydrocarbon-free operation when pumps of the MacroTorr® type are used.

Turbomolecular Pump Parameters and Definitions

Throughput

"Throughput" is the flow rate of pumped gas through the turbomolecular pump (and foreline pump).

Throughput (Q) is measured in mbar l/s \approx 1/60 standard cm³/min. The maximum throughput a pumping system can handle is, in general, dependent upon the size of its foreline pump rather than the turbomolecular pump.

Pumping Speed

"Pumping speed" (S) (volumetric flow rate) of a turbomolecular pump is the ratio between throughput and inlet pressure (foreline pump size must be the recommended one as a minimum).

$$S = Q / p$$

The pumping speed of a turbomolecular pump is constant over a wide pressure range and depends upon geometric factors such as diameter and rotational speed. For most turbomolecular pumps, pumping speed is nearly independent from gas species (molecular weight).

Compression Ratio

"Compression Ratio" is the ratio between foreline (partial) pressure and inlet (partial) pressure for a given process gas, measured in "zero flow" conditions (performed by injecting the process gas in the pump foreline while the high vacuum port is blanked off).

Compression ratio is generally indicated with the letter "K".

In technical specifications of turbomolecular pumps, it is the maximum attainable value of K (at low foreline pressure).

Compression ratio is, in fact, a function of the foreline pressure as shown in Figure 1.

Compression ratio decays at high pressure depending on turbomolecular pump configuration (the number of molecular stages) and/or power limitations that slow down the rotor (gas friction increases with pressure).

The maximum compression ratio is strongly influenced by gas species: it is an exponential function of the molecular weight of the pumped gas (compression ratio is considerably lower for light gases).

Pumping Speed and Pressure Ratio

The pressure ratio between foreline and inlet pressures in each operational situation is indicated by "R_p". This is, in general, equal to pumping speed ratio

$$R_p = p_{\text{foreline}} / p_{\text{inlet}} = S_{\text{eff}} / S_{\text{foreline}}$$

where S_{eff} is the effective pumping speed, and S_{foreline} is the pumping speed of the foreline pump.

In fact

$$Q = S_{\text{eff}} p_{\text{inlet}} = S_{\text{foreline}} p_{\text{foreline}}$$

therefore

$$S_{\text{eff}} / S_{\text{foreline}} = p_{\text{foreline}} / p_{\text{inlet}}$$

The pumping speed of a turbomolecular pump is minimally affected by pressure ratio (and foreline pump size) in most common operational conditions (when pressure ratio is much smaller than K).

Generally, however, the effective pumping speed "S_{eff}" is a linear function of the pressure ratio "R_p" as shown in Figure 2 (and therefore is also dependent upon the size of the backing pump).

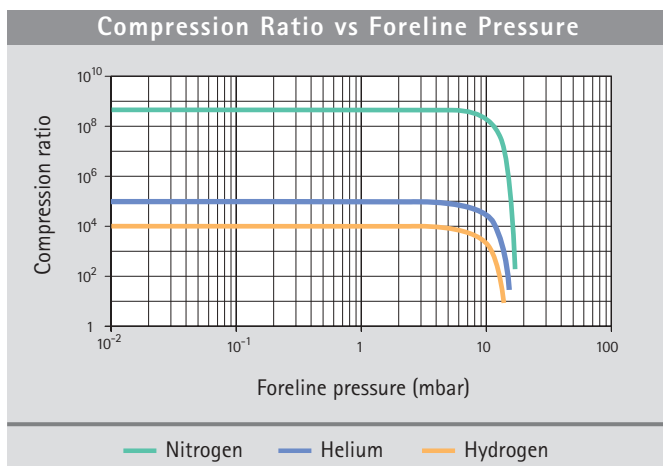

Figure 1

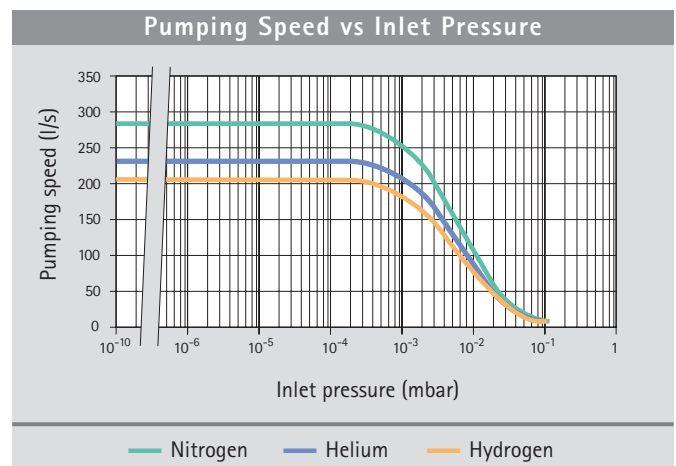

Figure 2

Turbo-V Pump Technical Notes

S_{eff} reaches its maximum value "S" (nominal pumping speed) when " R_p " equals unity, and it is zero when the pressure ratio R_p has reached its maximum value "K".

This linear dependence can be expressed by the following relationship:

$$S_{eff} = S / (1 - 1 / K + S / S_{foreline}K) \quad (1)$$

As it can be seen:

when

$$K \gg S / S_{foreline}$$

and

$$K \gg 1$$

then

$$S_{eff} \cong S$$

when

$$K \cong 1$$

then

$$S_{eff} = S_{foreline}$$

The above formula (1) must be used to evaluate pumping speed when operating at high pressure, especially with light gases (low K).

Base Pressure

The base pressure of a turbomolecular pump is the equilibrium pressure between outgassing of pump surfaces exposed to high vacuum, including test dome, and the pumping speed of the pump.

$$p_{base} = Q_{outgas} / S_{eff}$$

In the case of ultimate operational pressure, as specified by norms, the pressure is measured after 48 hours bakeout of pump and dome (provided with metal gasket); therefore the prevailing outgassing product is H_2 and equilibrium is reached with hydrogen pumping speed.

$$p_{base} = Q_{H_2} / S_{effH_2}$$

When foreline pumps with relatively high base pressures are used, base pressure is sometimes limited by the compression ratio for H_2O (or N_2).

$$p_{base} = p_{forelineH_2O} / K_{H_2O}$$

Vibration Level

Thanks to low vibration, focused design, and computer assisted balancing tools, today turbomolecular pumps generate very low levels of mechanical vibration. This is mainly a result of the numerical modeling of the pump rotodynamics (see Figure 3) and a specific vibration damping system already built into the pump structure. Thanks to

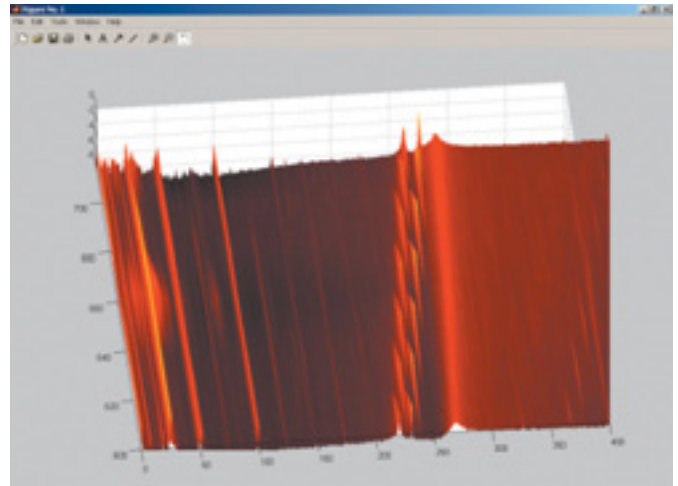

Figure 3

both design features, today ceramic ball bearings pumps are standard even in very high vibration applications like SEM and Metrology Tools.

A typical vibration spectrum of a turbomolecular pump can be seen in Figure 4:

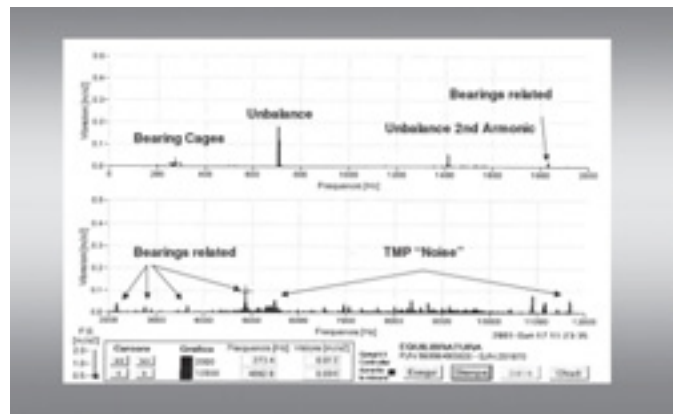

Figure 4

Possible sources of vibration in a turbomolecular pump are unbalanced rotor, high frequency motor or bearings. Rotor unbalance can be reduced to a very low level through dynamic balancing, which minimizes forces caused by a nonsymmetric distribution of masses in relation to the rotational axis. As an order of magnitude, the radial displacement on the pump HV flange after balancing can be as low as $0.001 \mu m$.

The vibrations from a high frequency motor are caused by electromagnetic interactions between the motor stator and rotor: their characteristic frequencies are multiples of the motor driving frequency. Also, the rotor supports generate both white noise and vibrations at specific frequencies of the bearings' moving parts (cage, balls and rotating ring, usually the inner one).

In general, the vibrations caused by an electric motor or bearing are even lower than those caused by unbalance. They may be relevant in the case of bearing damage or because of excitation of a natural resonant frequency of the system connected to the pump. In the second case, the system structure should be modified by adding mass, changing the stiffness and/or inserting a vibration damper between pump and system.

Operation in Presence of Magnetic Fields

Magnetic fields induce eddy currents in the turbomolecular pump rotor that tend to oppose its rotation. As a consequence the power delivered to the electrical motor is increased. Since the pump rotor is not in contact with the stator, all the heat generated by the eddy currents must be dissipated by radiation, so the rotor can be overheated even if the static parts remain cool.

According to our tests, the maximum magnetic field that our pumps can tolerate is:

- 50 Gauss in the transversal direction
- 100 Gauss in the axial direction

In these cases, a power increase to the motor can be expected.

If the magnetic field is greater than the above values a shield must be used in order to have a residual magnetic field around the pump below the value specified.

Please contact Varian for more details.

Electrical Interfacing

The input/output of our controllers have been designed to give maximum flexibility to operate the pump remotely. Two types of interface are offered for the following two controller families:

- Rack controllers (including V 81, V 301, V 550, V 700HT, V 1000HT)
- Navigator controllers (including V 301, V 551, V 701, V 1001)

Please contact Varian for more details.

Turbomolecular Pump Bearings and Lubrication System

The Turbo-V pumps incorporate Varian's innovative ceramic bearing design with a proprietary ultra-low vapor pressure solid lubricant, which enables these pumps to provide a long service life and a high degree of cleanliness under most operating conditions. This lubrication system is a superior feature of Varian Technology and guarantees no contamination of the vacuum system, especially when compared to other oil-lubricated turbomolecular pumps (See figures 5–6).

The ceramic bearings utilize balls made of silicon nitride, a polycrystalline material with an amorphous intergranular binder base that offers the following advantages:

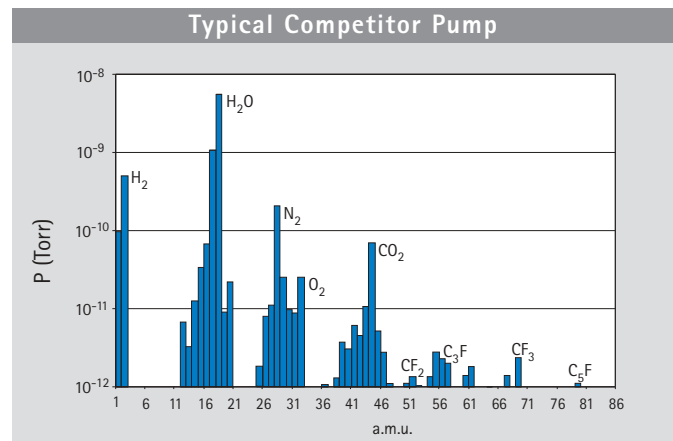

Figure 5

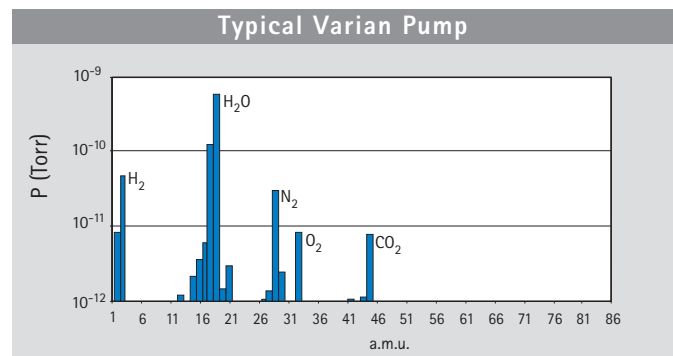

Figure 6

Hardness

This is a critical aspect of bearing design, and it closely relates to bearing performance and reliability. The silicon nitride material used in Varian's Turbo-V bearing system is twice as hard as conventional steel providing dramatic improvement in wear resistance while minimizing the effects of surface contact and stress.

Weight

Silicon nitride is 40% less dense than conventional steels, which helps to reduce centrifugal loading and stress levels at high rotational speeds, especially in the bearing race area.

Friction

Silicon nitride's low coefficient of friction enhances wear resistance and adds to the bearing's operational life.

Thermal Stability

With its low thermal expansion coefficient, the silicon nitride bearing material ensures that tight tolerances and mating component fit will be maintained over an extremely wide temperature range. In addition, silicon nitride has an outstanding resistance to fracture by thermal shock.

Chemical Stability

Silicon nitride is virtually inert.

Turbo-V Pump Technical Notes

Another feature of the Turbo-V bearing system is its proprietary lubricant which has an extremely low vapor pressure and is virtually hydrocarbon free. The use of this lubricant in the permanently sealed bearing system ensures clean, reliable operation without the need for any maintenance whatsoever.

Varian T-plus

Varian T-plus (Turbo Pumps Linked User Software) is the new communication, control and monitoring software for Varian Turbomolecular Pumps and all other Varian products featuring the Varian Window Serial Protocol.

With T-plus, you can simultaneously drive and control one or more Turbo Pumps, connected to a PC through an RS232 or an RS485 serial communication.

Automatic identification of the connected Pumps, description of each command always on screen, and User Interface adaptable to the Pump Status are only some of the new features developed to make the approach to pump settings easy and to reduce the number of steps during pump configuration.

Moreover, special care is given to the GUI (Graphical User Interface), to reproduce the environment of well-known User Interfaces (such as Microsoft® Windows® applications), to obtain a real User Friendly tool, and to reduce the user learning time.

T-plus software features several options like Data Logging, Chart Representation and Network Configuration, to help you configure your Vacuum devices quickly, and to check your vacuum system status at any time.

Exhaustive online Help is also included, providing the user with a complete, easy to learn system, tailored to customer requirements.

The previous software release Navigator 2.2 is included in the T-plus CD.

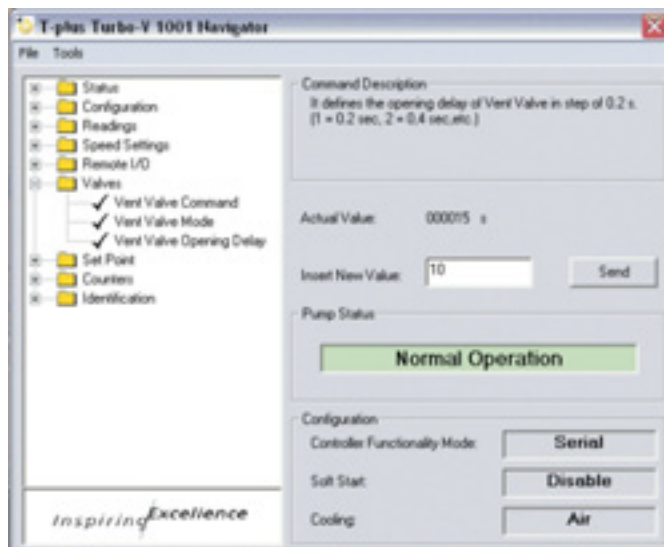

CE/CSA, EMC Electrical Specifications Compliance

Compliance to these norms guarantees that there are no limits on the use of the controllers and turbopumps in every type of ambient, and that their use doesn't create any kind of disturbance to electronic units connected to the same line. Varian's new generation of Turbo controllers comply with the limits given by the following norms:

- EN 55011 Class A group 1
- EN 61000/3/2
- EN 61000/3/3
- EN 61000/4/2
- EN 61000/4/3
- EN 61000/4/4
- EN 61010-1
- UNI EN 291-1
- UNI EN 292-2
- EN 1012-2

The MacroTorr® Concept

The Varian award winning, patented MacroTorr® design, which was developed in 1991, is the result of the improvement of the original design of the Gaede molecular pump.

It is based on the idea of replacing (rather than adding) molecular impeller disks to some turbo bladed stages. The molecular impellers consist of a disk rotating in a channel in which the inlet and outlet are divided by a wall.

The cross section of the channels decreases from the top to the bottom of the pump (from high vacuum to low vacuum or from the low pressure to the high pressure zone).

Gas molecules gain momentum after each collision with the moving surface of the impeller.

The gas is then forced to pass through a hole to the next stage due to the wall.

The result is a product that, with the same dimensions as a conventional turbopump, provides: high compression ratios for light gases and high compression ratios at high foreline pressure. This allows the use of a very small mechanical pump while maintaining a low inlet pressure, or the use of a dry pump, for an oil free environment, and high throughput capacity at inlet pressures greater than 10^{-3} mbar.

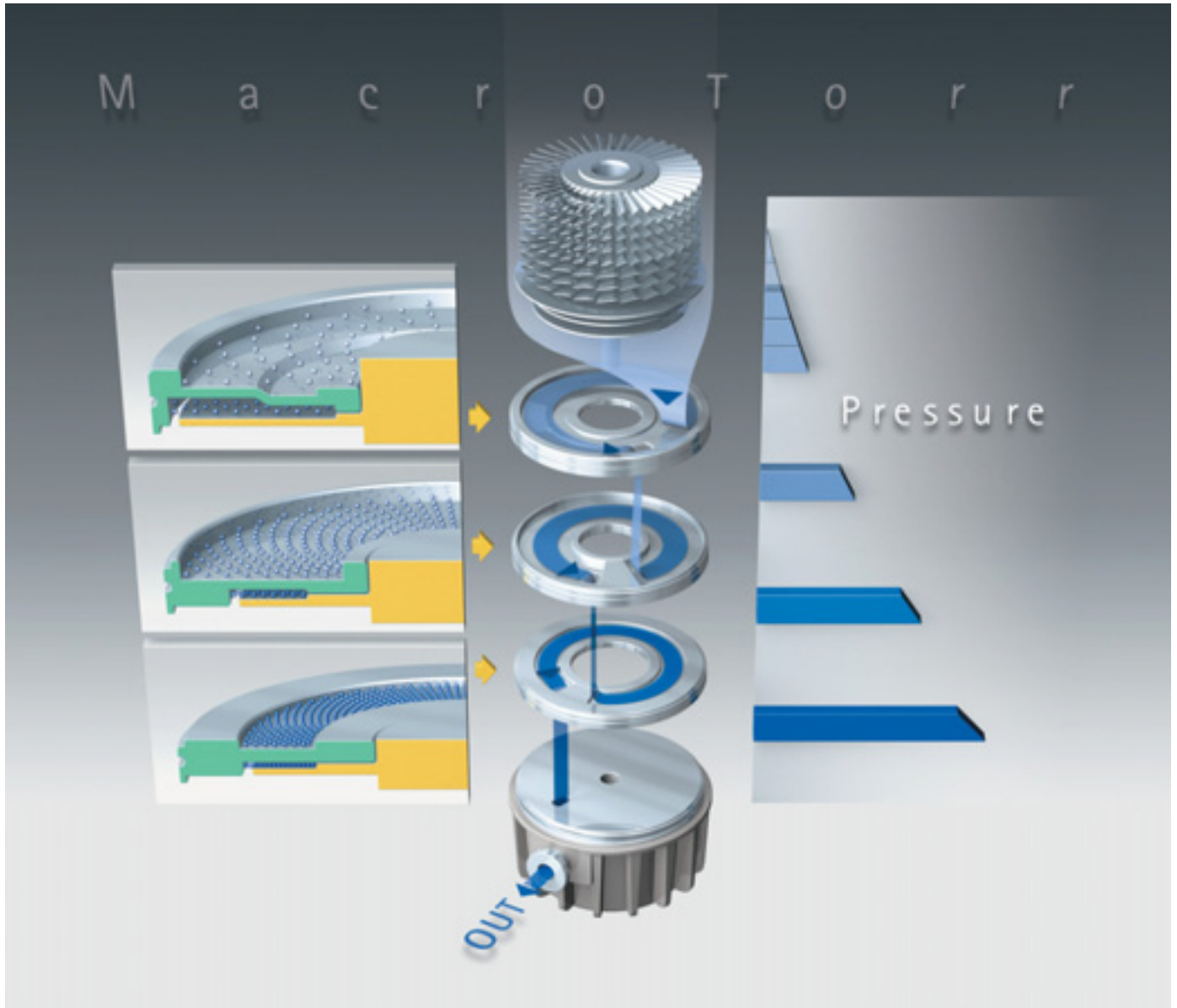

Turbo
Pumps

Turbo Pump Service and Support Plans

Varian Vacuum Technologies offers one of the most comprehensive service and support plans in the industry. As a worldwide, first class company we strive to offer added value to our Customers wherever they may be located. Excellence in Service and Support is a key factor in added value. Support can be accomplished with qualified Engineers and an appropriate logistic infrastructure. Technical skills and infrastructure are two areas where we are continuously making medium and long-term investments. Our daily customer support philosophy is focused on two important factors: fast response and no hassle. This philosophy translates to the following sections of our Turbo Pump Service and Support Plan:

- **Worldwide Parts Sourcing Plan:**
Three Progressive Levels of Support
- **Technical Assistance:** Customer Support, Application Support, Application Training
- **Uptime Services:** Remote Diagnostics

Varian Vacuum Technologies is committed to providing our Customers with the most comprehensive service plans possible. The following pages detail the standard sections of our Turbo Pump Service and Support Plan. For more information, or if you have a need for customized solutions, please contact your Varian representative. Often, excellent products are not enough: Varian's constant presence with Customer Service as a responsive partner is what really makes a difference.

Worldwide Parts Sourcing Plan

- **Repair Program**
Varian products offer unmatched reliability, performance and cleanliness. Production requirements, however, inevitably create, over time, the need for maintenance and repair. Timely repair at Varian will keep your products performing at an outstanding level all the time.

- **Advanced Exchange Program**
To maximize uptime, and for those occasions where time is essential, Varian offers exchange units for advance shipment. Exchange units are fully remanufactured to the same strict standards as new products. They are kept in stock in North America, Europe, China, Japan, Korea, Singapore and Taiwan. As soon as requested, your Exchange unit can be shipped for overnight delivery. This efficiency is due to our logistic infrastructure and is the result of excellent teamwork among our Service and Customer Service Teams! The Exchange and Repair Programs are available worldwide and allow global OEMs and End-Users consistent delivery time, value pricing, consistent part numbers, and simple order processing procedures.

Ordering Information for Varian's Exchange Program

To order an Exchange unit, add the letters "EX" before the product part number you need to exchange. After receipt of the exchange unit, you have 20 days to ship the original unit back to Varian. To place your request, contact the closest Varian location.

- **Upgrade Program**
The Upgrade Program is designed for customers who need to replace a Varian product at the end of its life, or of old technology, with a newest technology product. For example, a customer may wish to replace a Turbo-V250 with our Turbo-V301 Navigator. The Upgrade Program includes proactive technical installation support, by telephone and full 12-month warranty.

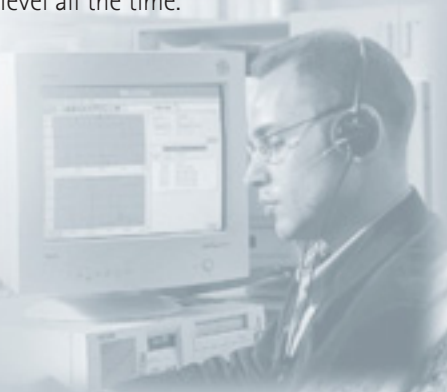

Varian's Turbo pump Upgrade Program provides a customer with the same outstanding support delivered with our service programs, including:

- RMA# tracking
- Replacement with remanufactured pump of the newest technology
- Advance replacement
- 24-hour expedited order management
- WEB on-line order status & shipment tracking

• **End User Extended Warranty**

The End User Extended Warranty is a Service Agreement that provides coverage extension beyond the standard 12 months warranty of a product. It extends for additional 12 months the coverage from failures due to defects in material and workmanship.

By extending the warranty of purchased products, post-sales satisfaction is guaranteed. This is the result of the relevant cost decrease while cost predictability is increased.

The End User Extended Warranty has been designed to cover the needs of the End User Market:

- General Purpose Vacuum applications.
- High Energy Physics Ultra High Vacuum applications.

Ordering Information for End User Extended Warranty

General Purpose Vacuum Applications

General Purpose Vacuum Applications	Part Number
Extd. Warranty 12M Turbo 80 l/s class	EW81
Extd. Warranty 12M Turbo 300 l/s class	EW300
Extd. Warranty 12M Turbo 550 l/s class	EW550
Extd. Warranty 12M Turbo 700 l/s class	EW700
Extd. Warranty 12M Turbo 1000 l/s class	EW1000
Extd. Warranty 12M Turbo TV1KG	EWTV1KG
Extd. Warranty 12M Turbo TV2KG	EWTV2KG
Extd. Warranty 12M Turbo TV3KG	EWTV3KG
Extd. Warranty 12M Turbo (other config.)	EW969TMP

High Energy Physics UHV Applications

High Energy Physics UHV Applications	Part Number
Extd. Warranty HEP 12M Turbo 80 l/s class	EW969TV81
Extd. Warranty HEP 12M Turbo 300 l/s class	EW969TV301
Extd. Warranty HEP 12M Turbo 550 l/s class	EW969TV551
Extd. Warranty HEP 12M Turbo 700 l/s class	EW969TV701
Extd. Warranty HEP 12M Turbo 1000 l/s class	EW969TV1001
Extd. Warranty 12M Turbo TV3KT	EW969TV3KT
Extd. Warranty 12M Turbo (other config.)	EW969TMP

• **Cleaning Service**

Varian offers a cleaning service in cases where a turbo pump may have been exposed to chemically hazardous materials.

This service is available worldwide and allows global OEMs and End-Users consistent delivery time, pricing, part numbers, and order processing procedures.

Ordering Information for Varian's Cleaning Service

Turbo-V Pump Size

Turbo-V Pump Size	Part Number
From V 60 to V 301 Navigator	TURBOCLEAN1
From V 450 to V 701 Navigator	TURBOCLEAN2
From V 1000 to TV 3K-T	TURBOCLEAN3



Turbo Pump Service and Support Plans

Uptime Services

Varian's Remote Assist Agreements

- Designed to provide first class support in monitoring your Varian Turbo Pumps to avoid unexpected failures and allow preventive maintenance, and is based on Varian's MoniTorr product.
- The MoniTorr is a preventive maintenance device that continuously monitors the Turbo Pump's operating parameters, including vibration spectra.
- The information acquired is automatically stored and sent for analysis to Varian's Technical Support Center via Internet or e-mail.
- SPC (Statistical Pump Control) is regularly performed to compare the present pump behavior against the collected data and finally point out if a preventive Turbo pump replacement is required.
- Remote Assist is provided through dedicated service agreements: please contact your local Varian office to select the appropriate program that covers your installed base needs.



Technical Assistance

As a Varian Customer, you can rely on an attentive and professional support staff, dedicated to providing you with the easiest and most personalized service solution possible.

Customer Support

- Our toll-free lines, with mother tongue Technical Support Engineers at worldwide locations, allow us to provide you with quick responses to your needs.
- All issues are entered into our data-base, and become available to all Varian's Technical Support Centers and to our R&D Departments for possible product improvements.

Americas

North America: Tel. 1.800.882.7426 (toll-free)
Tel. 1.800.8VARIAN (toll-free)
Fax (1) 781.860.5437

Central and South America: Tel. (1) 781.861.7200
Fax (1) 781.860.5437

Asia

Japan: Tel. 0120-655-040 (toll-free)
Fax (81) 3.5232.1710 (dedicated line)

Korea: Tel. 080.222.2452 (toll-free)
Fax (82) 2.3452.2451 (dedicated line)

Taiwan: Tel. 0800-051342 (toll-free)
Fax (886) 2.2698.9678 (dedicated line)

China: Tel. 800.820.6556 (toll-free)
Fax (86) 21.6375.6848 (dedicated line)

Europe and Israel

Austria, Belgium, Finland, France, Germany, Holland, Ireland, Israel (*), Italy, Portugal, Spain, Switzerland, UK:

Tel. 00.800.234.234.00 (toll-free)
Fax 00.800.345.345.00 (fax free)

(* From Israel dial 012 instead of initial 00)

Other Countries

Tel. (39) 011.9979.369 (dedicated line)
Fax (39) 011.9979.330 (dedicated line)

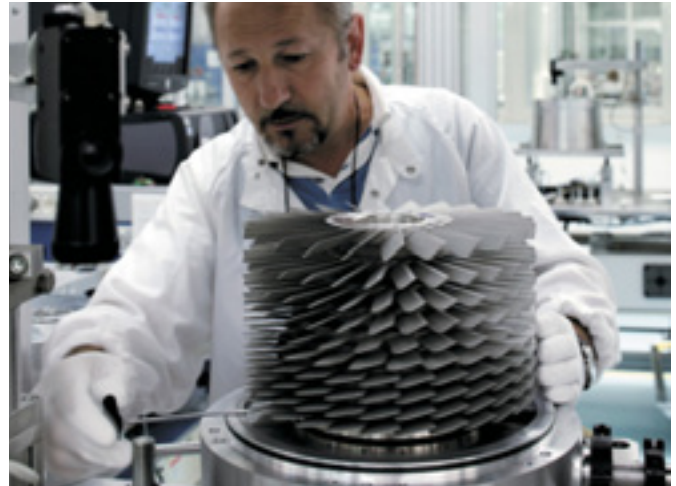

Application Support – Application Training

- Our Application Engineers can bring Varian's expertise in vacuum technology to our customers.
- Application Support is a project-based activity where our experts assist you solving the application issues that might arise pre-sales or post-sales.
- By designing solutions that meet customer needs, Varian aims at creating a positive and synergetic relationship with customers.
- Our experts keep you up-to-date on industrial and scientific vacuum applications with the goal of optimizing the use of our products on your system.