

# SMALL DRY PUMPS

## THE ULTIMATE DRY CHOICE

---

nXDS Dry Scroll Pump	62
XDS Scroll Vacuum Pump	68
XDD1 Diaphragm Vacuum Pump	72
D-LAB Diaphragm Vacuum Pump	75

# nXDS DRY SCROLL PUMP

## THE ULTIMATE DRY CHOICE

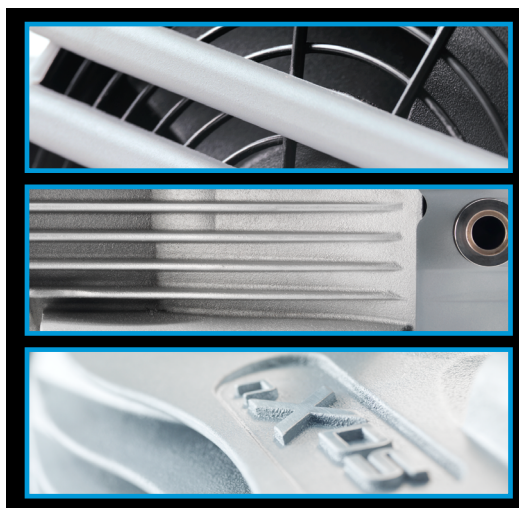

With exceptional pumping capability, ultimate vacuum performance and state-of-the-art design features, the nXDS dry scroll pump is the best performing pump in its class. nXDS improves on the original XDS pump technology by offering increased pumping speeds, combined with lower ultimate pressures, low power consumption and reduced noise. The gas ballast allows for pumping of condensable vapours, including water, solvents, dilute acids and bases. nXDS pumps feature the very latest in tip seal technology, giving a significantly longer life between tip seal changes. nXDS-C has been modified so that it is more suitable for use on vapour handling processes and may be used in some applications involving corrosive substances. This chemically resistant version is fitted with Chemraz® internal valve pads and stainless steel fittings. nXDS-R has the gas ballast blanked off so it cannot be accidentally opened. This is useful for applications such as rare gas recirculation or gas recovery.



### Features and Benefits

- **Lubricant-free** within the vacuum envelope and hermetically sealed means a totally clean and dry vacuum to prevent cross contamination.
- **Advanced scroll-form and tip-seal technologies** deliver best-in-class vacuum performance and unrivalled ultimate vacuum levels.
- **Unique tip seal design** significantly reduces wear to minimise maintenance and extend service life.
- **Quiet operation** with typical noise during operation < 52 dB(A) for minimal environmental impact.
- **Advanced interface** providing a variety of traditional and analogue and digital control methods enabling remote control/monitoring via RS232 or RS485.
- **Integrated inverter drive** with auto sensing input delivers optimised pumping performance globally.
- **Pump range** includes 6, 10, 15 and 20 m<sup>3</sup>h<sup>-1</sup>.

### Applications

- Backing turbomolecular pumps.
- Chamber evacuation.
- Chemical applications including gel dryers and solvent recovery.
- Electron microscopy.
- High energy physics.
- Mass spectrometry.

### Pump Range

<b>nXDS6i</b>	<b>nXDS15i</b>
- nXDS6i	- nXDS15i
- nXDS6iC	- nXDS15iC
- nXDS6iR	- nXDS15iR
<b>nXDS10i</b>	<b>nXDS20i</b>
- nXDS10i	- nXDS20i
- nXDS10iC	- nXDS20iC
- nXDS10iR	- nXDS20iR

Chemraz® is a registered trademark of Greene Tweed

# Performance Curves

## nXDS6i Dry Scroll pump

### nXDS6i



#### Peak pumping speed

6.2 m<sup>3</sup>h<sup>-1</sup>  
(3.6 ft<sup>3</sup>min<sup>-1</sup>)

#### Ultimate Pressure

0.020 mbar  
(0.015 Torr)

### Ordering information

Product description	Order no:
nXDS6i 100-127 V, 200-240 V, 1ph 50-60 Hz	A73501983
nXDS6iC 100-127 V, 200-240 V, 1ph 50-60 Hz	A73502983
nXDS6iR 100-127 V, 200-240 V, 1ph 50-60 Hz	A73503983

### nXDS6i Performance Curve

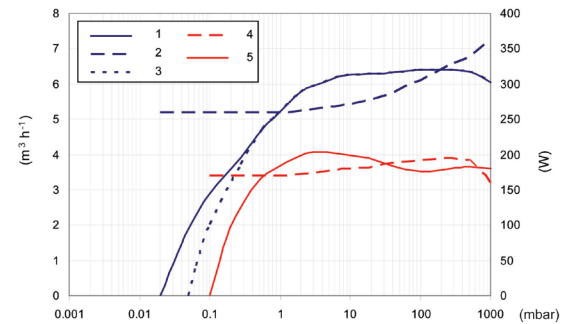

- |                        |                     |
|------------------------|---------------------|
| 1 Normal Pumping Speed | 4 min Standby Power |
| 2 Normal Full Power    | 5 min Standby Speed |
| 3 Normal GB speed      |                     |

## nXDS10i Dry Scroll pump

### nXDS10i



#### Peak pumping speed

11.4 m<sup>3</sup>h<sup>-1</sup>  
(6.7 ft<sup>3</sup>min<sup>-1</sup>)

#### Ultimate Pressure

0.007 mbar  
(0.005 Torr)

### Ordering information

Product description	Order no:
nXDS10i 100-127 V, 200-240 V, 1ph 50-60 Hz	A73601983
nXDS10iC 100-127 V, 200-240 V, 1ph 50-60 Hz	A73602983
nXDS10iR 100-127 V, 200-240 V, 1ph 50-60 Hz	A73603983

### nXDS10i Performance Curve

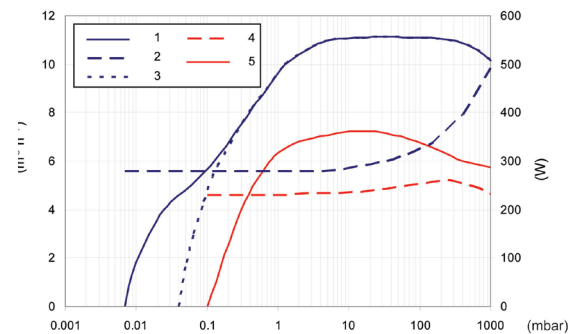

- |                        |                     |
|------------------------|---------------------|
| 1 Normal Pumping Speed | 4 min Standby Power |
| 2 Normal Full Power    | 5 min Standby Speed |
| 3 Normal GB speed      |                     |

## nXDS15i Dry Scroll pump

### nXDS15i Performance Curve

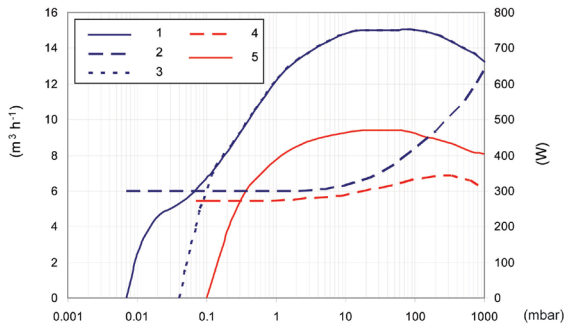

1	Normal Pumping Speed	4	min Standby Power
2	Normal Full Power	5	min Standby Speed
3	Normal GB speed		

#### Peak pumping speed

15.1 m<sup>3</sup>h<sup>-1</sup>  
(8.9 ft<sup>3</sup>min<sup>-1</sup>)

#### Ultimate Pressure

0.007 mbar  
(0.005 Torr)



### nXDS15i

#### Product description

nXDS15i 100-127 V, 200-240 V, 1ph 50-60 Hz  
nXDS15iC 100-127 V, 200-240 V, 1ph 50-60 Hz  
nXDS15iR 100-127 V, 200-240 V, 1ph 50-60 Hz

#### Order no:

A73701983  
A73702983  
A73703983

## nXDS20i Dry Scroll pump

### nXDS20i Performance Curve

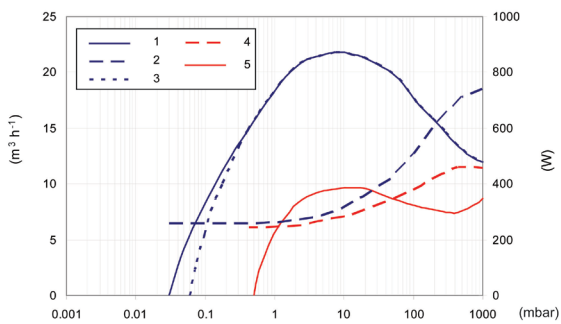

1	Normal Pumping Speed	4	min Standby Power
2	Normal Full Power	5	min Standby Speed
3	Normal GB speed		

#### Peak pumping speed

22.0 m<sup>3</sup>h<sup>-1</sup>  
(13.0 ft<sup>3</sup>min<sup>-1</sup>)

#### Ultimate Pressure

0.030 mbar  
(0.022 Torr)



### nXDS20i

#### Product description

nXDS20i 100-127 V, 200-240 V, 1ph 50-60 Hz  
nXDS20iC 100-127 V, 200-240 V, 1ph 50-60 Hz  
nXDS20iR 100-127 V, 200-240 V, 1ph 50-60 Hz

#### Order no:

A73801983  
A73802983  
A73803983

# Dimensions

## nXDS dimensions

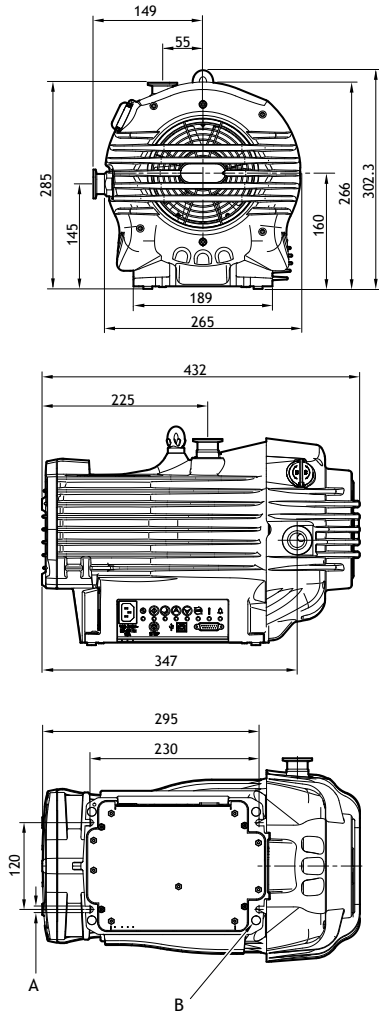

## Pump views



A 9 mm wide slots 4 off

B Rubber feet 4 off

All nXDS variants are of the same dimensions.  
Dimensions in mm (inch).

## Technical Data



	Units	nXDS6i	nXDS10i	nXDS15i	nXDS20i
Nominal rotational speed	rpm			1800	
Displacement	m <sup>3</sup> h <sup>-1</sup> / ft <sup>3</sup> min <sup>-1</sup>	6.8 / 4.0	12.7 / 7.5	17.1 / 10.1	28.0 / 16.5
Peak pumping speed	m <sup>3</sup> h <sup>-1</sup> / ft <sup>3</sup> min <sup>-1</sup>	6.2 / 3.6	11.4 / 6.7	15.1 / 8.9	22.0 / 13.0
Ultimate vacuum (total pressure)	mbar / Torr	0.020 / 0.015		0.007 / 0.005	0.030 / 0.022
Minimum standby rotational speed	rpm			1200	
Speed control resolution (percentage of full rotation speed)				1%	
Max water vapour pumping rate	gh <sup>-1</sup>	110	145	145	220
Maximum continuous inlet pressure	mbar		200		50
Voltage input	V		100-127, 200-240 (+/-10%)		
Voltage frequency	Hz		50/60		
Motor power 1-ph*	W	260	280	300	260
Power connector 1-ph			IEC EN60320 C13		
Weight	kg / lb	26.2 / 58	25.8 / 57	25.2 / 56	25.6 / 56
Inlet flange			NW25		
Exhaust flange			NW25		
Noise level**	dB(A)		52		
Vibration at inlet flange	mms <sup>-1</sup> (rms)		< 4.5		
Leak tightness (static)	mbar ls <sup>-1</sup>		< 1 x 10 <sup>-6</sup>		
Operating temperature range	°C / F		10 to 40 / 41 to 104		

\* Typical.

\*\* For low fan speed, typical at ultimate end when load/ambient conditions allow.

## Service, Spares and Accessories

The control cable is used to connect the nXDS pump directly to the RS485 or RS232 serial input on your control equipment or a PC, or alternatively, to an Edwards controller such as a TIC (Turbo Instrument Controller) or TAG (Turbo & Active Gauge controller).

### Pump to TIC/TAG Controller Cable

Product description	Order no:	Product description	Order no:
Interface cable 1.0 m	D39700835	2 m electrical supply cable for 1-ph pumps, UK, three-pin plug	A50505000
Interface cable 2.0 m	D39700836	2 m electrical supply cable for 1-ph pumps, North European plug	A50506000
Interface cable 5.0 m	D39700837	2 m electrical supply cable for 1-ph pumps, North America/Japan plug	A50507000
		2 m electrical supply cable for 1-ph pumps, no plug	A50508000

### Gas Ballast Adaptor

Product description	Order no:
Gas Ballast adaptor blank	A73501806
Gas Ballast Adaptor 0.25mm restrictor	A73501809
Gas Ballast Adaptor no restrictor	A73501811

### Exhaust

Product description	Order no:
Exhaust silencer	A50597000
Silencer spares kit	A50597800
Exhaust nozzle kit 3/8" to 15 mm	A50509000
NW25 inlet/outlet filter 5 micron	A50597805
XDS Filter 5 micron element kit	A50597802
XDS Filter 1 micron element kit	A50597803

### Vibration Isolator

Product description	Order no:
nXDS Vibration isolator (0.45 kg)	A24701441

### Chemical Resistance Conversion Unit

Product description	Order no:
nXDS6i, 10i & 15i Chemical resistance conversion unit	A73501807
nXDS20i Chemical resistance conversion unit	A73501808

### nXDS Service kits

Product description	Order no:
nXDS Exhaust and gas ballast kit	A73501803
nXDS Tip seal service kit	A73501801
nXDS Bearing replacement kit	A73501802

### Service

Edwards products, spares and accessories are available from Edwards companies in Belgium, Brazil, China, France, Germany, Israel, Italy, Japan, Korea, Singapore, United Kingdom, U.S.A. and a worldwide network of distributors. The majority of these centres employ Service Engineers who have undergone comprehensive Edwards training courses. Order spare parts and accessories from your nearest Edwards company or distributor.

When you order, please state for each part required:

- Model and item number of your equipment.
- Serial number (if any).
- Item number and description of the part.



# XDS SCROLL VACUUM PUMP

## THE ULTIMATE DRY CHOICE



XDS scroll pumps have become industry standard when dry pumping is essential, proving to be a robust and clean vacuum pump solution in a range of applications and processes.

The XDS35i pump has an innovative bearing shield that isolates the vacuum environment from all forms of lubricant, making it not only lubricant-free but hermetically sealed. XDS35iNGB variant has had the gas ballast feature removed for applications such as rare gas recirculation and gas recovery.

The XDS46i shares many of the same features of the XDS35i but with a peak speed of  $40 \text{ m}^3\text{h}^{-1}$ . The pump has been optimised for maximum pumping speed at inlet pressures between 1 mbar and 10 mbar, making it ideally suited for LCMS and ICPMS applications requiring higher pumping speeds.

The C variant has been modified so that it is more suitable for use on vapour handling processes and may be used in some applications using corrosive substances. The C version is fitted with Chemraz<sup>®</sup> internal valve pads and stainless steel exhaust port.

Chemraz<sup>®</sup> is a registered trademark of Greene Tweed



### Features and Benefits

- **Lubricant-free** within the vacuum envelope and hermetically sealed means a totally clean and dry vacuum to prevent cross contamination.
- **No atmosphere to vacuum shaft seals** means bearings are completely isolated, this prevents process attack and enable the bearings to run cooler and last longer.
- **No oil to change eliminating cost** of contaminated oil disposal.
- **Simple single sided scroll design** allows maintenance to be done in minutes for low cost of ownership and maximum up-time.
- **Inverter drive** for consistent pumping speeds worldwide.
- **Pump range** includes 35 and  $40 \text{ m}^3\text{h}^{-1}$ .

### Applications

- Automotive; brake line and air conditioning evacuation.
- Backing turbomolecular pumps.
- Chemical applications including gel dryers and solvent recovery.
- Coating systems.
- High energy physics.
- Mass spectrometry.

### Pump Range

#### XDS

- XDS35i
- XDS35iNGB
- XDS35iC
- XDS46i
- XDS46iC



# Performance Curves

## XDS35i Scroll vacuum pump

### XDS35i



#### Peak pumping speed

35 m<sup>3</sup>h<sup>-1</sup>

(21 ft<sup>3</sup>min<sup>-1</sup>)

#### Ultimate Pressure

1 x 10<sup>-2</sup> mbar

(8 x 10<sup>-3</sup> Torr)

### XDS35i Performance Curve

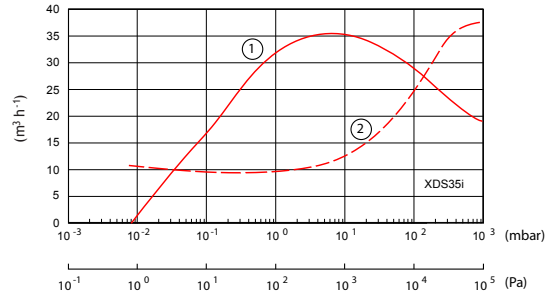

### Ordering information

Product description	Order no:
XDS35i 100-120/200-230V 1 ph 50/60 Hz set to 230V	A73001983
XDS35i NGB 100-120/200-230V 1 ph 50/60 Hz set to 230V	A73005983
XDS35iC 100-120/200-230V 1 ph 50/60 Hz set to 230V	A73006983

1	Speed
2	Power

Note: Mains leads must be ordered separately, please see accessories and spares at the end of this section for the relevant standard XDS pump for the correct mains lead.

## XDS46i Scroll vacuum pump

### XDS46i



#### Peak pumping speed

40 m<sup>3</sup>h<sup>-1</sup>

(23.5 ft<sup>3</sup>min<sup>-1</sup>)

#### Ultimate Pressure

5 x 10<sup>-2</sup> mbar

(4 x 10<sup>-2</sup> Torr)

### XDS46i Performance Curve

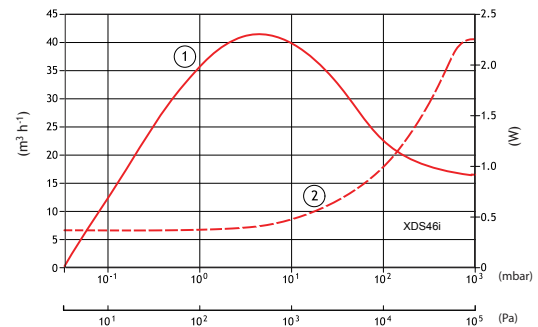

### Ordering information

Product description	Order no:
XDS46i 100-120/200-230V 1 ph 50/60 Hz set to 230V	A73101983
XDS46iC 100-120/200-230V 1 ph 50/60 Hz set to 230V	A73106983

1	Speed
2	Power

Note: Mains leads must be ordered separately, please see accessories and spares at the end of this section for the relevant standard XDS pump for the correct mains lead.

# Dimensions

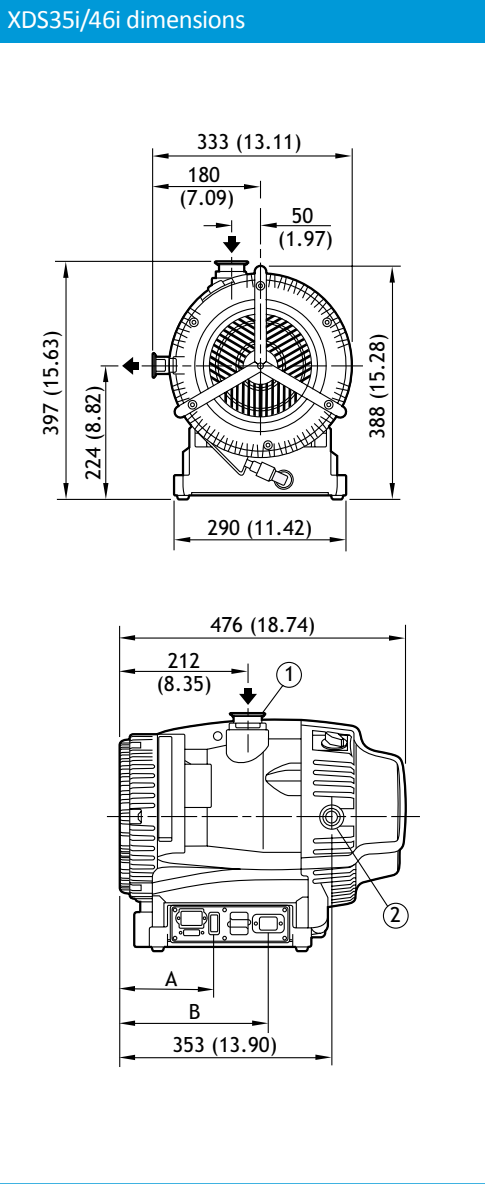

XDS35i / 46i	
A	150 (5.91)
B	247.5 (9.74)
1	NW40
2	NW25

Dimensions in mm (inch).

## Technical Data



	Units	XDS35i	XDS46i
Displacement 50 or 60 Hz	m <sup>3</sup> h <sup>-1</sup> / ft <sup>3</sup> min <sup>-1</sup>	43 / 25	60 / 35
Peak pumping speed 50 or 60 Hz	m <sup>3</sup> h <sup>-1</sup> / ft <sup>3</sup> min <sup>-1</sup>	35 / 21	40 / 23.5
Ultimate vacuum (Total pressure)	mbar / Torr	1 x 10 <sup>-2</sup> / 8 x 10 <sup>-3</sup>	5 x 10 <sup>-2</sup> / 4 x 10 <sup>-2</sup>
Max inlet pressure for water vapour	mbar / Torr	35 / 23	40 / 30
Max water vapour pumping rate – GB I	gh <sup>-1</sup>	70	-
Max water vapour pumping rate – GB II	gh <sup>-1</sup>	240	-
Max allowed outlet pressure	bar gauge / psig*	0.2 / 2.9	
Max allowed inlet and GB pressure	bar gauge / psig*	0.5 / 7	
Motor power	kW	0.52	
Power connector		IEC EN60320 C19	
Nominal rotation speed	rpm	1750	
Weight	kg / lb	48 / 105	
Inlet flange		NW40	
Exhaust flange		NW25	
Noise level	dB(A)	57	55.4
Vibration	mms <sup>-1</sup> (rms)	< 4.5	
Leak tightness (static)	mbar ls <sup>-1</sup>	< 1 x 10 <sup>-6</sup>	
Operating temperature range	°C / F	10 to 40 / 50 to 104	

\*1 bar gauge / 14 psig for short period of time only

## Service, Spares and Accessories

### XDS Accessories

Product description	Order no:
Exhaust silencer XDS35i	A50597001
Gas Ballast Adapter with 0.25 mm hole	A50626801
XDS NW25 Inlet Outlet filter	A50597805
XDS NW40 Inlet Outlet Filter	A50597806
XDS Filter 5 micron Element kit	A50597802
XDS Filter 1 micron Element kit	A50597803
Vibration Isolator	A24801408

### XDS kits

Product description	Order no:
Tip seal kit XDS35i	A73001801
Tip seal kit XDS46i	A73101801
Silencer spares kit	A50597801

### Electrical Supply Cable

Product description	Order no:
2 m Electrical supply cable, no plug	A50508003
2 m Electrical supply cable, North America/ Japan plug	A50507003
2 m Electrical supply cable, North European plug	A50506003
2 m Electrical supply cable, UK, three-pin plug	A50505003

## Service

Edwards products, spares and accessories are available from Edwards companies in Belgium, Brazil, China, France, Germany, Israel, Italy, Japan, Korea, Singapore, United Kingdom, U.S.A. and a worldwide network of distributors. The majority of these centres employ Service Engineers who have undergone comprehensive Edwards training courses. Order spare parts and accessories from your nearest Edwards company or distributor.

When you order, please state for each part required:

- Model and item number of your equipment.
- Serial number (if any).
- Item number and description of the part.

# XDD1 DIAPHRAGM VACUUM PUMP

## THE ULTIMATE DRY CHOICE



XDD1 diaphragm pumps are used for backing small compound turbomolecular pumps in clean, high vacuum applications, and also designed to be free standing bench top units. A typical ultimate pressure of better than  $5 \times 10^{-8}$  mbar can be achieved when using an XDD1 to back a  $70 \text{ ls}^{-1}$  turbomolecular pump.

The 24 V version is designed to provide a complete pumping package using the Edwards Turbo and Instrument Controller (TIC). The d.c. voltage motor runs on 24 V via a 15 pin DIN connector. By selecting the appropriate mode the pump speed can be controlled by the user to provide variable pumping speed. This version is suited to the customer who is building their own a system. The pump is a compact and efficient. Under normal conditions the XDD1 is virtually maintenance free, the lifetime of the diaphragms and valves is typically  $> 10,000$  operating hours, depending on the application.



### Features and Benefits

- **Dry pumping, lubricant free technology** eliminating the need for costly oil changes and disposal.
- **Lightweight and compact** with a small footprint allowing flexibility of use.
- **Ideal backing pump** for small turbomolecular pumps.
- **Complies** with EN61010, EN1012, CSA/UL standards.
- **Worldwide** 115/230 V or 24 V options.
- **IEC 60320 C14 connector** on a.c. pumps.

### Applications

- Residual gas analysis.
- Mass spectrometers.
- Cryostat and Dewar evacuation.
- Ion pump evacuation.
- Surface science.

### Pump Range

#### XDD1

- XDD1 115/230 V AC
- XDD1 24 V DC

# Performance Curves

## XDD1 Diaphragm vacuum pump

### XDD1



#### Pumping speed

a.c.	1.2 m <sup>3</sup> h <sup>-1</sup> 50Hz
	1.4 m <sup>3</sup> h <sup>-1</sup> 60 Hz
d.c.	0.6 m <sup>3</sup> h <sup>-1</sup> 600 rpm
	1.4 m <sup>3</sup> h <sup>-1</sup> 1700 rpm (factory setting)
	1.7 m <sup>3</sup> h <sup>-1</sup> 2200 rpm

#### Ultimate vacuum (typical)

< 2 mbar

### Ordering information

Product description	Order no:
XDD1 Diaphragm pump 100-115 V/200-230 V 50/60 Hz	A74602983
XDD1 Diaphragm pump 24 V d.c.	A74602991

Pumps are not supplied with connection cables. A suitable cable should be ordered with the pump.

### XDD1 Performance Curve

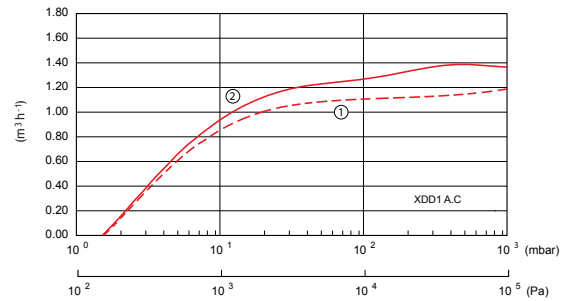

1 50 Hz                      2 60 Hz

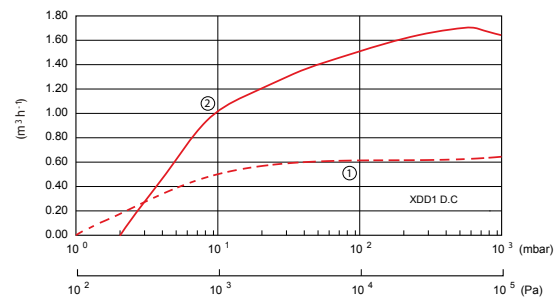

1 600 rpm                      2 2200 rpm

## Dimensions

### XDD1 a.c. dimensions

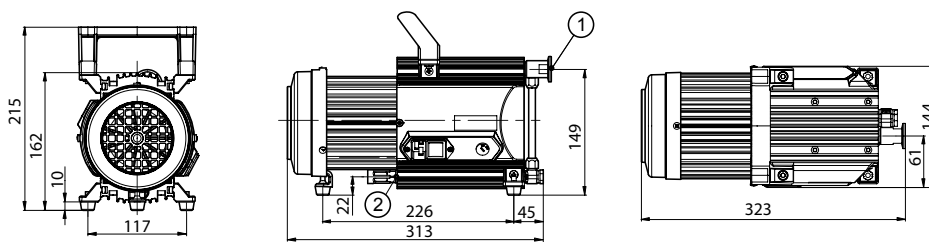

### XDD1 d.c. dimensions

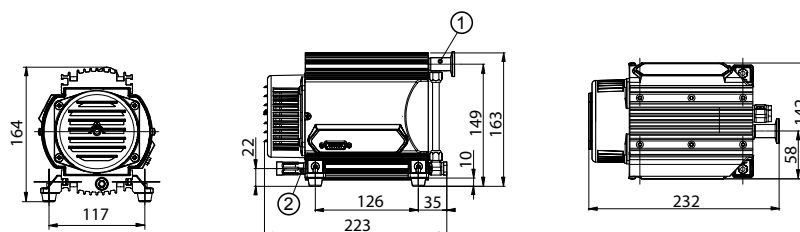

1 Inlet

2 Outlet

Dimensions in mm (inch).

## Technical data

	Units	XDD1
Pumping speed		
a.c.		
50 Hz	m <sup>3</sup> h <sup>-1</sup>	1.2
60 Hz	m <sup>3</sup> h <sup>-1</sup>	1.4
d.c.		
600 rpm (factory settings)	m <sup>3</sup> h <sup>-1</sup>	0.6
1700 rpm (factory settings)	m <sup>3</sup> h <sup>-1</sup>	1.4
2200 rpm	m <sup>3</sup> h <sup>-1</sup>	1.7
Ultimate vacuum (typical)	mbar	< 2
Ambient temperature limit	°C	10 to 40
Inlet connection		NW16
Exhaust connection	The pump is fitted with a silencer which can be removed and an exhaust line connected with a 1/8" BSP fitting	
Max allowed inlet pressure	bar (abs)	1
Power connector		IEC EN60320 C13

	Units	XDD1
Motor power		
a.c.	W	80
d.c.	W	64
Weight		
a.c.	kg	6.5
d.c.	kg	4.1



## Service, Spares and Accessories

### Service kit

Product description	Order no:
XDD1 diaphragm service kit	A74601800

### 2 m Electrical Supply Cable

Product description	Order no:
2 m electrical supply cable for 1-ph pumps, UK plug 3A	A50516000
2 m electrical supply cable for 1-ph pumps, North European plug	A50506000
2 m electrical supply cable for 1-ph pumps, North America/Japan plug	A50507000
2 m electrical supply cable for 1-ph pumps, no plug	A50508000

### Extension cable

Product description	Order no:
XDD/DX/EXDC Extension cable 1 m	D39700835
XDD/DX/EXDC Extension cable 2 m	D39700836
XDD/DX/EXDC Extension cable 5 m	D39700837

### Service

Edwards products, spares and accessories are available from Edwards companies in Belgium, Brazil, China, France, Germany, Israel, Italy, Japan, Korea, Singapore, United Kingdom, U.S.A. and a worldwide network of distributors. The majority of these centres employ Service Engineers who have undergone comprehensive Edwards training courses. Order spare parts and accessories from your nearest Edwards company or distributor.

When you order, please state for each part required:

- Model and item number of your equipment.
- Serial number (if any).
- Item number and description of the part.

# D-LAB DIAPHRAGM VACUUM PUMP

## PERFORMANCE YOU CAN RELY ON

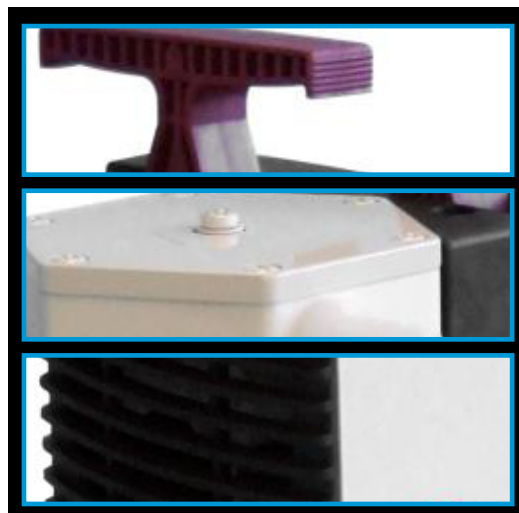

D-LAB membrane pumps with their chemically resistant Teflon® heads, diaphragms and Kalrez® valves, offer the chemical or pharmaceutical laboratory user a wide range of choice.

The one head, 100 mbar ultimate vacuum pumps are suitable for use with drying equipment or for replacing water-jet pumps, whilst the two head, 8 mbar ultimate vacuum pumps are suitable for rotary evaporation, gas transfer and a wide range of medium vacuum applications.



### Features and Benefits

- **100% lubricant free**, maintenance free and quiet.
- **Six different pumping capacities** and modular expansion – the D-LAB can be optimised for any application.
- All parts of the pump head in contact with gases being pumped are **resistant against aggressive substances** (PTFE, FFKM, PVDF).

### Applications

- Rotary evaporation.
- Gel drying.
- Vacuum desiccation.
- Vacuum filtration.
- Vacuum degassing.

### Pump Range

#### D-LAB

- D-LAB 10-100
- D-LAB 20-100
- D-LAB 34-100
- D-LAB 10-8
- D-LAB 20-8
- D-LAB 34-8





# Performance Curves

## D-LAB Diaphragm vacuum pump

### D-LAB



Pumping speed (air)	
10-100, 10-8	0.6 m <sup>3</sup> h <sup>-1</sup> , 10 lmin <sup>-1</sup>
20-100, 20-8	1.2 m <sup>3</sup> h <sup>-1</sup> , 20 lmin <sup>-1</sup>
34-100, 34-8	2.0 m <sup>3</sup> h <sup>-1</sup> , 34 lmin <sup>-1</sup>
Ultimate vacuum, 50 Hz (60 Hz)	
10-100, 20-100, 34-100	100 mbar (75 mbar)
10-8, 20-8, 34-8	8 mbar (6 mbar)

110 V pumps are supplied with USA plug; 220-240 V pumps are supplied with an IEC connector but mains cable with correct plug must be ordered separately.

### Ordering information

Product description	Order no:
D-LAB 10-100, diaphragm pump, 110 V, 60 Hz, 1-ph	A48015941
D-LAB 10-100, diaphragm pump, 220-240 V, 50 Hz, 1-ph	A48015960
D-LAB 20-100, diaphragm pump, 110 V, 60 Hz, 1-ph	A48017941
D-LAB 20-100, diaphragm pump, 220-240 V, 50 Hz, 1-ph	A48017960
D-LAB 34-100, diaphragm pump, 110 V, 60 Hz, 1-ph	A48021941
D-LAB 34-100, diaphragm pump, 220-240 V, 50 Hz, 1-ph	A48021960
D-LAB 10-8, diaphragm pump, 110 V, 60 Hz, 1-ph	A48016941
D-LAB 10-8, diaphragm pump, 220-240 V, 50 Hz, 1-ph	A48016960
D-Lab 20-8, diaphragm pump, 110 V, 60 Hz, 1-ph	A48018941
D-Lab 20-8, diaphragm pump, 220-240 V, 50 Hz, 1-ph	A48018960
D-LAB 34-8, diaphragm pump, 110 V, 60 Hz, 1-ph	A48022941
D-LAB 34-8, diaphragm pump, 220-240 V, 50 Hz, 1-ph	A48022960

### D-LAB Performance Curve

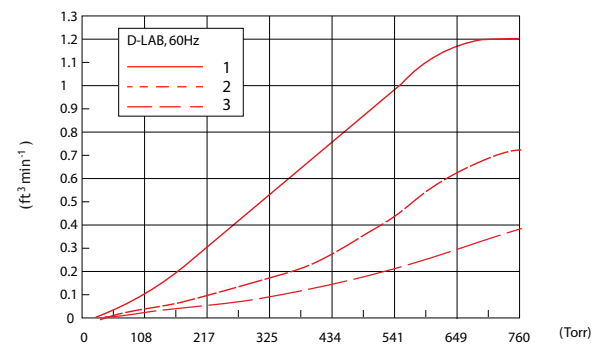
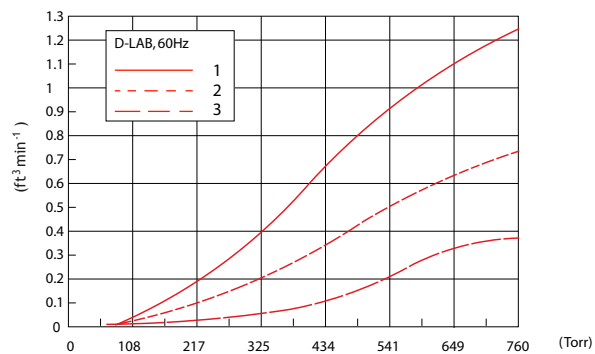
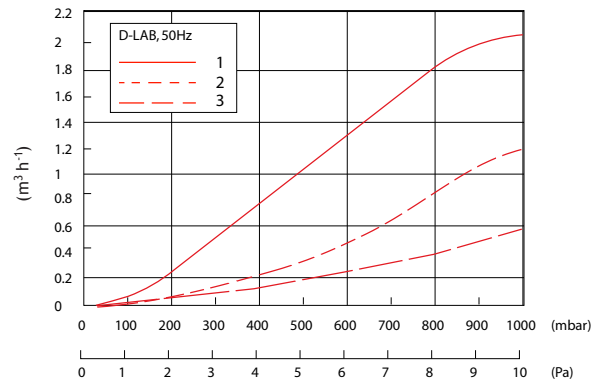
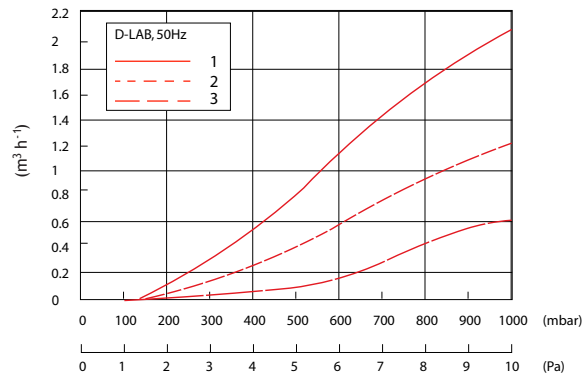

- 1 D-LAB 34-100
- 2 D-LAB 20-100
- 3 D-LAB 10-100

- 1 D-LAB 34-8
- 2 D-LAB 20-8
- 3 D-LAB 10-8

# Dimensions

## DLAB dimensions

One head pump

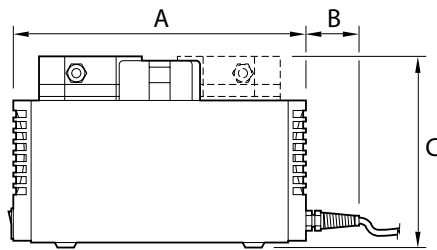
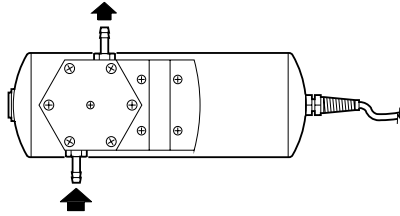
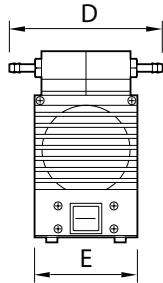

Two head pump

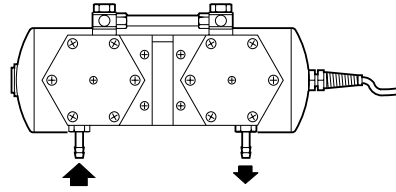
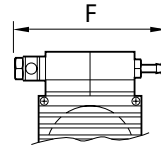

	A	B	C	D	E	F
10-100	255	50	182	144	98	-
20-100	268	60	204	157	110	-
34-100	296	60	222	172	122	-
10-8	288	53	184	-	98	140
20-8	312	59	204	-	110	153
34-8	341	62	222	-	122	169



# Technical Data



	Units	D-LAB
<b>Pumping speed (air)</b>		
10-100, 10-8	m <sup>3</sup> h <sup>-1</sup> / lmin <sup>-1</sup>	0.6 / 10
20-100, 20-8	m <sup>3</sup> h <sup>-1</sup> / lmin <sup>-1</sup>	1.2 / 20
34-100, 34-8	m <sup>3</sup> h <sup>-1</sup> / lmin <sup>-1</sup>	2 / 34
<b>Ultimate vacuum</b>		
10-100, 20-100, 34-100	mbar, Hz / mbar, Hz	100, 50 / 75, 60
10-8, 20-8, 34-8	mbar, Hz / mbar, Hz	8, 50 / 6, 60
<b>Inlet and outlet connection</b>		Riffled nozzle, suitable for 9 mm i.d. hose
<b>Maximum inlet pressure</b>	bar	1
<b>Motor power and current</b>		
10-100, 110 V 60 Hz	W / A	110 / 1.3
10-100, 220-240 V 50Hz	W / A	100 / 0.6
20-100, 110 V 60 Hz	W / A	145 / 1.9
20-100, 220-240 V 50Hz	W / A	130 / 0.9
34-100, 110 V 60 Hz	W / A	220 / 3.2
34-100, 220-240 V 50Hz	W / A	180 / 1.4
10-8, 100 V 60 Hz	W / A	110 / 1.3
10-8, 220-240 V 50Hz	W / A	90 / 0.6
20-8, 110 V 60 Hz	W / A	130 / 1.2
20-8, 220-240 V 50Hz	W / A	120 / 0.9
34-8, 110 V 60 Hz	W / A	250 / 3.2
34-8, 220-240 V 50 Hz	W / A	200 / 1.5
<b>Enclosure rating</b>		IP44
<b>Operating temperature</b>	°C	5-40
<b>Weight</b>		
10-100	kg / lbs	5.8 / 12.8
20-100	kg / lbs	7.1 / 15.6
34-100	kg / lbs	10.3 / 22.7
10-8	kg / lbs	6.9 / 15.2
20-8	kg / lbs	9.3 / 20.5
34-8	kg / lbs	12.6 / 27.7

# Service, Spares and Accessories

## D-LAB Accessories

Product description	Order no:
D-LAB Controller 230 V	A48015138
D-LAB Controller 100/110 V	A48015139
D-LAB Baseplate 10+20-x	A48015134
Baseplate for D-LAB pumps 34-100, 34-8	A48021134
D-LAB Separator	A48015136
D-LAB Condenser	A48015137
Gas Ballast for D-LAB pumps 10-100, 10-8	A48015135
Gas Ballast for D-LAB pumps 20+34-8	A48017135

## Electrical Supply Cable

Product description	Order no:
2 m electrical supply cable for 1-ph pumps, UK, three-pin plug	A50505000
2 m electrical supply cable for 1-ph pumps, North European plug	A50506000
2 m electrical supply cable for 1-ph pumps, no plug	A50508000

## Service kits

Product description	Order no:
Service kit for D-LAB 10-100	A48015815
Service kit for D-LAB 20-100	A48017815
Service kit for D-LAB 34-100	A48021815
Service kit for D-LAB 10-8	A48016815
Service kit for D-LAB 20-8	A48018815
Service kit for D-LAB 34-8	A48022815

## Service

Edwards products, spares and accessories are available from Edwards companies in Belgium, Brazil, China, France, Germany, Israel, Italy, Japan, Korea, Singapore, United Kingdom, U.S.A. and a worldwide network of distributors. The majority of these centres employ Service Engineers who have undergone comprehensive Edwards training courses. Order spare parts and accessories from your nearest Edwards company or distributor.

When you order, please state for each part required:

- Model and item number of your equipment.
- Serial number (if any).
- Item number and description of the part.

