

Spray Dryer

Contents

Spray Dryer Overview	Page 96
Compact & Economical	
ADL311SA	Page 97
Versatile Mini-spray	
GB210A	Page 99
Versatile Granulation	
GB210B	Page 101
Large Capacity	
DL410	Page 103
Inert N₂ Gas Sealed System	
GAS410	Page 105
Spray Dryer Reference Application Data	Page 107
Sprary Dryer Accessories	Page 109



Spray Dryer

Suitable for water soluble samples

Inert N₂ Gas Sealed System

Required for organic solvent samples

Economical System

ADL311SA
With GF300 Glassware set



Versatile System

GB210
Without glassware



GF300
For Spray Drying



GB210A
For Spray Drying



Selectable Glassware



GF200
For Granulating



GB210B
For Granulating

Large Capacity System

DL410



GAS410



Safe N₂ gas sealed circulation system

Spray Dryer

Compact & Economical

ADL311SA

Water evaporation rate Max. 1,300mL/h

Temp. control range 40~220°C

Sample flow Max. 26mL/min.

Spray nozzle (selectable) Nozzle for liquid Nozzle for gas

Customer benefit Low cost & economical

Easily micronize liquid samples with a spray dryer.



ADL311SA: For aqueous soluble samples
(When organic solvent is used, a GAS410 organic solvent recovery unit is required.)

- Easy setup, easy operation
- Suitable for heat sensitive samples. High heat is not directly applied to dry, fine powder
- Obtain contaminant free fine powder which is not oxidized and contains minimal moisture
- Direct drying of solution or solution liquid into fine powder. No pre- or post processes such as filtration, separation, or pulverization required
- Safe and explosion free working is guaranteed in combination with GAS410 due to oxygen & pressure control
- Organic solvents are recovered in a closed loop to protect the environment to enable minimized pollution
- Easy operation with one-touch detachable mechanism for drying chamber and cyclone
- An arm jack is equipped as standard for easy installation and removal of glassware attachments
- A service outlet (max.2A) and a sample stand are equipped as standard for connecting a magnetic mixer for stirring suspended liquid samples
- Unique peristaltic pump, nozzle cooling mechanism, pulse jet mechanism and a nozzle knocker for stable spray drying
- ADL311SA is highly mobile on wheels, or usable with shorter height as a bench top unit by removing the movable caster

Specifications

Model	ADL311SA
Supported samples	Water soluble samples
Evaporated water amount	Max. 1300mL/h
Spraying system	Two-way nozzle, Nozzle No. 1A as standard (0.4mm)
Temp. adjusting unit setting range	40 to 220°C (inlet temperature), 0 to 98°C (outlet temperature)
Temperature adjusting accuracy	Inlet temperature ±1°C
Drying air amount adjusting range	0 to 0.7m³/min
Spray air pressure adjusting range	0 to 0.3MPa
Liquid sending pump flow rate range	0 to 26 mL/min
Spray air line washing function	Spraying at the nozzle tip, manual pulse jet system
External output	Inlet temperature, outlet temperature, temperature outlet (4-20 mA)
Temperature adjusting device	PID digital temperature adjusting device
Touch panel	Blower, heater, liquid sending pump, pulse jet switch, error display
Control select switch	Inlet temperature, outlet temperature control switch (outlet temperature control is conditional)
Temperature sensor	K-thermocouple
Heater	2.0kW(at200V) to 2.88kW(at240V)
Liquid sending pump	Fixed amount peristaltic pump
Spraying air pump	For water soluble samples air compressor is used (sold separately). For organic solvent samples the integrated compressor in GAS410 is used (no separate air compressor required).
Service outlet	For stirrer: AC115V, MAX2A
Suction blower	Bypass blower
Filter	Suction filter, exhaust filter
Recovery of solvent	Solvent recovery unit GAS410 (sold separately) is used
Spray nozzle cooling mechanism	Connector: nipple x 2, O.D.: ø10.5mm
Spray air connection diameter	Nipple diameter: ø7mm
Spray air pressure	Bourdon tube: 0.3 MPa
Exhaust connecting diameter	ø50mm
Safety function	Inlet/outlet temperature overheat, sample feed reverse rotation mechanism, over current electric leakage breaker, nozzle connection error
External size	W580 x D420 x H1,125 mm
Weight	80kg
Power supply (50/60 Hz) rated current	AC220V 17A, AC240V 18A switching of terminals necessary
Accessories	Silicon tubes (with a stopper) x 3, exhaust duct (with one hose band) x 1, outlet temperature sensor, spray air tube, sample box, static electricity removal earth, "Tetron" braided tube hose 5m (with two hose bands)



Example of installation: ADL311SA + GAS410

Control Panel



Diagram

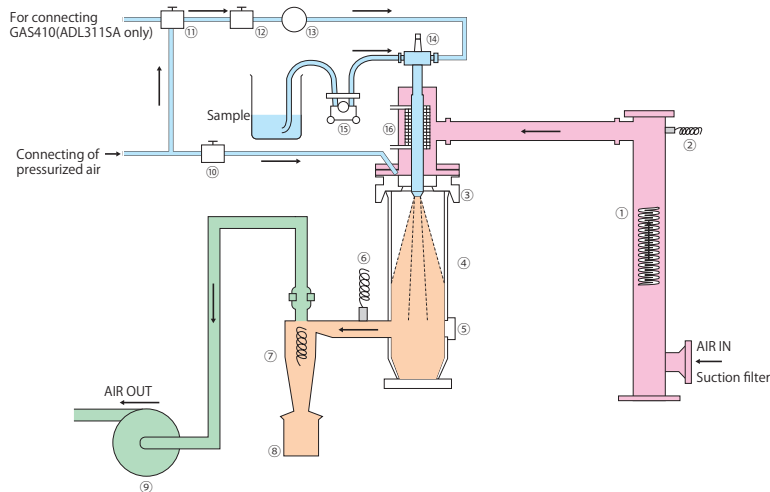

No.	Part name	No.	Part name
(1)	Heater	(9)	Blower
(2)	Inlet temperature sensor	(10)	Solenoid valve
(3)	Distributor	(11)	3-way solenoid valve (ADL311SA only)
(4)	Drying chamber	(12)	Needle valve
(5)	Cap	(13)	Pressure meter
(6)	Outlet temperature sensor	(14)	Spray nozzle
(7)	Cyclone	(15)	Liquid sending pump
(8)	Product collecting container	(16)	Nozzle cooling mechanism connecting port

Spraying Nozzle



The tip of the nozzle comprises of a nozzle for liquid and a nozzle for gas.

Two-way nozzle system



Easy to take apart for cleaning to prevent contamination

Nozzle for liquid(F)

Nozzle for gas(A)

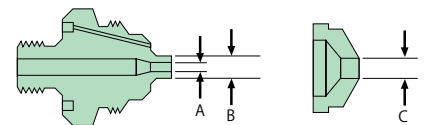

Model	Nozzle No.	Size (μm)	Particle size
1A (Standard)	(F)1650	A 406 B 1270	1~40μm
	(A)64	C 1626	
1	(F)2050	A 508 B 1270	5~40μm
	(A)64	C 1626	
2A	(F)2050	A 508 B 1270	5~50μm
	(A)70	C 1778	
2	(F)2850	A 711 B 1270	10~40μm
	(A)70	C 1778	
3	(F)2850	A 711 B 1270	10~50μm
	(A)64	C 1626	

Particle sizes may vary on samples used and parameter settings.

Piping



ADL311SA+GAS410

Optional items

Product Name	Product Code
Fine powder recovery cyclone	212780
Safety cover	212784
Static removal brush set	212788
Viton packing for cyclone inlet/outlet (1 set of 2 types)	212781
Teflon packing for cyclone inlet/outlet (1 set of 2 types)	212782
Airfilter + Mist separator + Regulator set	212789
Supply air filter box (for 0.3 micro meter collection)	212790
Air compressor	SL100-8

Example of implementation (spray dryer ADL311SA)

Sample name	Composition (%)	Inlet temp. (°C)	Outlet temp. (°C)	Dry air amount (m ³ /min)	Spray air pressure (MPa)	Sent amount of sample liquid (g/min)	Sample recovery rate (%)
Dextrin (solution)	10	150	80	0.4	0.1	6.1	66
Dextrin (emulsion)	40	150	80	0.4	0.1	5.1	63
Oxidized titanium (suspended liquid)	10	150	85	0.42	0.1	5.3	50
Soy sauce	50	130	75	0.36	0.1	5.1	60
Salt	10	145	85	0.38	0.1	5.3	52

Repeatability of spray drying test (spray dryer ADL311SA)

Test No.	Sample name	Sample density (%)	Drying conditions				Test sample amount (g/min)	Sent amount of sample liquid (g/min)	Test time (min)	Yield (g)	Recovery rate (%)
			Inlet temp. (°C)	Outlet temp. (°C)	Dry air amount (m ³ /min)	Spray air pressure (MPa)					
1	Coffee solution	5.00	150	75	0.45	0.15	93.1	3.1	30	4.3	92.4
2	Coffee solution	5.00	150	75	0.45	0.15	93	3.1	30	4	86
3	Coffee solution	5.00	150	75	0.45	0.15	91.4	2	30	4	87.5
4	Coffee solution	5.00	150	75	0.45	0.15	84.9	2.8	30	3.7	87.2
5	Coffee solution	5.00	150	75	0.45	0.15	83.8	2.8	30	3.7	88.3

Applications

- Food and medicinal products
Powdered milk, egg yolks, soy sauce, coffee, starches, proteins, hormones, serums, antibiotics, enzymes, fragrances, essences, etc.
- Organic chemistry
Waxes, dyes, cleaning agents, surface acting agents, agricultural chemicals, antiseptic agents, synthesized resins, pigments, etc.
- Inorganic chemistry
Ferrites, ceramics, photocopy toners, magnetic tapes materials, photosensitive materials, various industrial chemicals, waste fluid samples, etc.

Spray Dryer Pulvis Mini Spray

Supports spray drying of fine powder of 1µm

GB-210A

Evaporated water Max.1,300ml/h

Temp. control range 40 to 220°C

Sample flow Variable up to 26ml/min

Spray nozzle (selectable) Nozzle for liquid Nozzle for gas

Capable of drying ultra small samples as low as 0.5g of solid content.
Can spray dry into fine powder 1µm in size when optional mini cyclone is used.



Compact spray dryer that can produce powder easily on a laboratory scale. It is capable of variety of applications from preliminary experiments in a pilot plant to drying work in general laboratories.

- Samples unstable at high temperatures can be reliably processed into fine powder. The heat is applied instantly and indirectly to the powder itself
- Prepared fine powder will not be oxidized, contains minimal moisture and is contaminant-free
- Direct drying from solution/suspension liquid to fine powder with a reduced risk of contamination. No pre or post processes such as filtration, separation, or pulverization are required
- Processing of samples containing organic solvents is made possible by connecting the Solvent Recovery Unit GAS410
- This unit can also be used as a fluid bed drying granulator by installing a separate mini bed attachment GF200 instead of GF300 spray drying attachment
- An automatic lift is equipped as standard to enable easy installation or removal of glass drying chamber attachment
- A service outlet (max. 2A) and a sample stand are equipped as standard for connecting a magnetic mixer for stirring suspended liquid sample
- Stable spray drying using a unique peristaltic pump, nozzle cooling mechanism, pulse jet mechanism and a nozzle knocker enable stable spray drying

Specifications

Model	GB-210A
Temp. adjusting unit setting range	40 to 220deg.C (inlet temperature), 0 to 60deg.C (outlet temperature)
Temperature adjusting accuracy	Inlet temperature±1deg.C
Spraying system	Two-way nozzle, Nozzle No. 1A as standard
Drying air amount adjusting range	0 to 0.7m ³ /min
Spray air pressure adjusting range	0 to 0.3MPa
Liquid sending pump flow rate range	0 to 26 ml/min
Spray air line washing function	Spraying at the nozzle tip, manual pulse jet system
External output	Inlet temperature, outlet temperature, temperature outlet (4-20 mA)
Automatic lift	Moving up/down of glass chamber automatic lift
Temperature adjusting device	PID digital temperature adjusting device
Touch panel	Blower, heater, liquid sending pump, pulse jet switch, error display
Control select switch	Inlet temperature, output temperature control switch (outlet temp. control is conditional)
Temperature sensor	K-thermocouple
Heater	2.0 kW (at 200V) to 2.88 kW (at 240V)
Liquid sending pump	Fixed amount peristaltic pump
Spraying air pump	Spraying air compressor (sold separately) is used.
Service outlet	For stirrer: AC100V, Max. 2A
Suction blower	Bypass blower, brushless DC motor
Filter	Suction filter, exhaust filter
Recovery of solvent	Solvent recovery unit GAS410 (sold separately) is used.
Spray nozzle cooling mechanism	Connector: nipple x 2, O.D.:φ10.5 mm
Spray air connection diameter	Nipple diameter:φ7 mm
Exhaust connecting diameter	φ50mm
Safety function	Inlet/outlet temperature overheat, sample feed reverse rotation mechanism, over current electric leakage breaker, nozzle connection error
External size	W760 x D420 x H1,350 mm
Weight	110kg
Power supply (50/60Hz) rated current	AC220V 17A, AC240V 18A, Switching of terminals necessary
Accessories	Silicon tube (with a stopper) x 3, tiron tube (with a stopper) x 2 exhaust duct (with one hose band) x 1, outlet temperature sensor, spray air tube, sample box, static electricity removal earth, Teflon braided hose 5m (with two hose bands), a container table

Control Panel

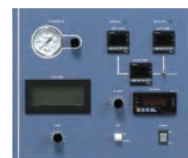

Inlet temperature, outlet temperature, and drying air amount are digitally displayed. Setting is made on the touch panel that allows operation settings, operation status display

as well as error display, and settings of various operation conditions.

Mini spray attachment	GF300
Evaporated water amount	MAX1300mL/h
Sample for drying	Suspended solution, emulsion
Ultra hard glass	Cyclone, drying chamber, product container

Diagram

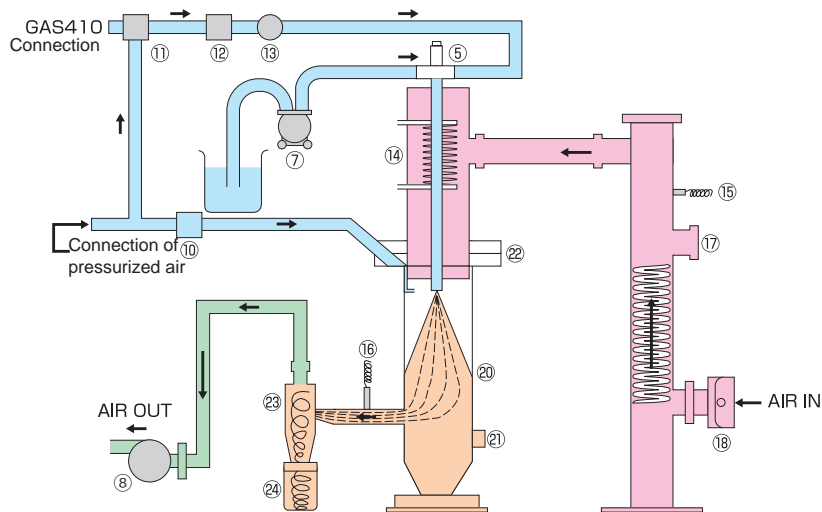

No.	Part name	No.	Part name
(1)	Heater	(16)	Outlet temperature sensor
(5)	Spray nozzle	(17)	Blind
(7)	Liquid sending pump	(18)	Suction port, suction filter
(8)	Blower, exhaust filter	(19)	Nozzle cooling connection port
(10)	Solenoid valve	(20)	Drying chamber
(11)	3-way solenoid valve	(21)	Cap
(12)	Needle valve	(22)	Distributor
(13)	Pressure meter	(23)	Cyclone
(14)	Nozzle cooling port	(24)	Product collecting container
(15)	Inlet temperature sensor		

Spraying Nozzle



The tip of the nozzle comprises of a nozzle for liquid and a nozzle for gas.

Two-way nozzle system



Easy to take apart for cleaning to prevent contamination

Nozzle for liquid(F)

Nozzle for gas(A)

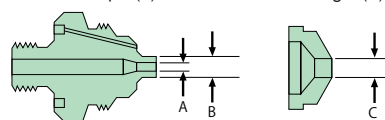

Model	Nozzle No.	Size (µm)	Particle size
1A (Standard)	(F)1650	A 406 B 1270	1~40µm
	(A)64	C 1626	
1	(F)2050	A 508 B 1270	5~40µm
	(A)64	C 1626	
2A	(F)2050	A 508 B 1270	5~50µm
	(A)70	C 1778	
2	(F)2850	A 711 B 1270	10~40µm
	(A)70	C 1778	
3	(F)2850	A 711 B 1270	10~50µm
	(A)64	C 1626	

Particle sizes may vary on samples used and parameter settings.

Applications



- Food and medicinal products: Powdered milk, egg yolks, soy sauce, coffee, starches, proteins, hormones, serums, antibiotics, enzymes, fragrant materials, essences, etc.
- Organic chemistry: Waxes, dyes, cleaning agents, surface acting agents, agricultural chemicals, antiseptic agents, synthesized resins, pigments, etc.
- Inorganic chemistry: Ferrites, ceramics, photocopy toners, magnetic tape materials, photosensitive materials, various industrial chemicals, waste fluid of samples, etc.

Optional items

Product name	Product code
Fine grain sample collecting cyclone	212780
Safety cover	212784
Static removal brush set	212788
Air filter + Mist separator + Regulator set	212789
Supply air filter box (for 0.3 µm collection)	212791

Handling



The one touch removal system has made the removal and cleaning of the drying chamber, the cyclone, and the product container much easier.



Solvent Recovery Unit GAS410

Repeatability of spray drying test

Test No.	Sample name	Sample density (%)	Drying conditions				Test sample amount (g)	Sent amount of sample liquid (g/min)	Test time (min)	Yield (g)	Recovery rate (%)
			Inlet temp. (°C)	Outlet temp. (°C)	Dry air amount (m ³ /min)	Spray air pressure kPa(kg/cm ²)					
1	Coffee solution	5	150	80	0.45	147(1.5)	198	6.6	30	8.1	81.8
2	Coffee solution	5	150	80	0.45	147(1.5)	198.7	6.6	30	8.1	81.5
3	Coffee solution	5	150	80	0.45	147(1.5)	200.6	6.7	30	8	79.8
4	Coffee solution	5	150	80	0.45	147(1.5)	198.1	6.6	30	8.2	82.8
5	Coffee solution	5	150	80	0.45	147(1.5)	199.3	6.6	30	8.4	84.3

Spray Dryer Pulvis Mini Bed

Spray Dryer (For Granulating, Drying, Mixing)

GB-210B

Processing capacity

50g to 300g

Temp. control range

40 to 220°C

Sample flow

Variable up to 26ml/min

Spray nozzle (selectable)

Nozzle for liquid
Nozzle for gas

Spray dryer capable of granulating and drying wet powder.



Designed to granulate powder and dry wet powder using a fluid bed. This is a fluid bed drying granulator used in combination with the basic unit GB210 and Mini-bed attachment GF200.

- Conditions such as hot air temperature, air amount, binder liquid flow amount can be set easily with the setting dial on the front of the unit
- The chamber is made of ultra hard glass and the user can observe status of the fluid bed or spraying status. Also, the flowage meter, the spraying pressure meter, the chamber inlet/outlet temperature indicator are useful for evaluation of data
- The unit can also be used as a spraying dryer by installing the mini spray attachment GF300 (optional)
- The unit has an automatic lift as a standard to enable convenient installation or removal of the glass chamber attachment

Control Panel

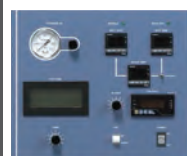

Inlet temperature, outlet temperature, and drying air amount are digitally displayed. Setting is made on the touch panel that

allows operation settings, operation status display as well as error display, and settings of various operation conditions.

Specifications

Model	GB-210B
Temp. adjusting unit setting range	40 to 220°C (inlet temperature), 0 to 98°C (outlet temperature)
Temperature adjusting accuracy	Inlet temperature $\pm 1^\circ\text{C}$
Spraying system	Two-way nozzle, Nozzle No. 1A as standard
Drying air amount adjusting range	0 to 0.7m ³ /min
Spray air pressure adjusting range	0 to 0.3MPa
Liquid sending pump flow rate range	0 to 26mL/min
External output	Inlet temperature, outlet temperature, temperature outlet (4-20 mA)
Automatic lift	Moving up/down of glass chamber automatic lift
Temperature adjusting device	PID digital temperature adjusting device
Touch panel	Blower, heater, liquid sending pump, pulse jet switch, error display
Control select switch	Inlet temperature, output temperature control switch (outlet temp. control is conditional)
Temperature sensor	K-thermocouple
Heater	2.0 kW (at 200V) to 2.88 kW (at 240V)
Liquid sending pump	Fixed amount peristaltic pump
Spraying air pump	Spraying air compressor (sold separately) is used
Service outlet	For stirrer: AC100V, Max. 2A
Suction blower	Bypass blower, brushless DC motor
Filter	Suction filter, exhaust filter
Spray nozzle cooling mechanism	Connector: nipple x 2, O.D.: $\phi 10.5\text{mm}$
Spray air connection diameter	Nipple diameter: $\phi 7\text{mm}$
Exhaust connecting diameter	$\phi 50\text{mm}$
Safety device	Inlet/outlet temperature overheat, sample feed reverse rotation mechanism, over current electric leakage breaker, nozzle connection error
External dimensions	W760 x D420 x H1,350 mm
Weight	~110 kg
Power supply (50/60Hz) rated current	AC220V 17A, AC240V 18A, Switching of terminals necessary
Accessories	Silicon tube (with a stopper) x 3, iron tube (with a stopper) x 2, exhaust duct (with one hose band) x 1, outlet temperature sensor, spray air tube, sample box, static electricity removal earth, Teflon braided hose 5m (with two hose bands), container table

Mini bed attachment	GF200
Processing capacity	50 to 300g (It differs depending on whether the unit is of the batch type or specific samples used.)
Flow layer chamber capacity	3L
Spray nozzle	Dual fluid nozzle: 1A standard
Stirring blades	Integrated inside the flow layer chamber
Filter	Polyester (Carbon fiber mixed PTFE membrane laminate)
Filter cleaning mechanism	Pulse jet system
Glass parts	Ultra hard glass
Weight	~13 kg

Diagram

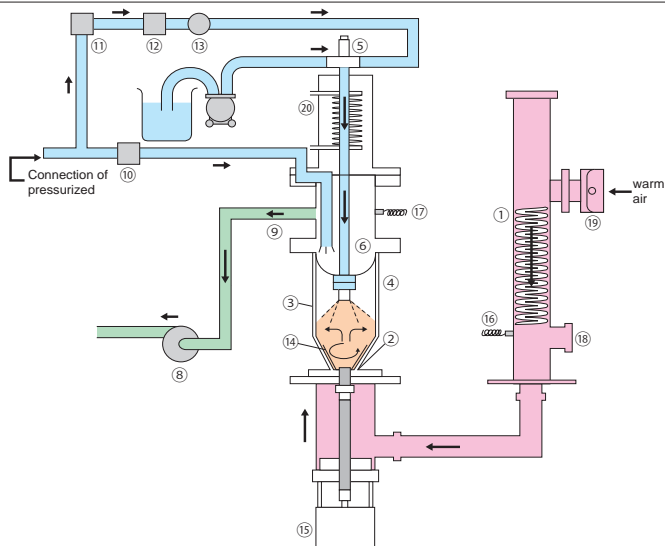

No.	Part name	No.	Part name
(1)	Heater	(11)	3-way solenoid valve
(2)	Micro porous plate	(12)	Needle valve
(3)	Flow layer chamber	(13)	Pressure meter
(4)	Filter chamber	(14)	Stirring blades
(5)	Nozzle	(15)	Stirring motor
(6)	Filter	(16)	Inlet temperature sensor
(7)	Liquid sending pump	(17)	Outlet temperature sensor
(8)	Blower	(18)	Blind
(9)	Interim pipe	(19)	Suction port, suction filter
(10)	Solenoid valve	(20)	Nozzle cooling connection port

Spraying Nozzle



The tip of the nozzle comprises of a nozzle for liquid and a nozzle for gas.

Two-way nozzle system



Easy to take apart for cleaning to prevent contamination

Nozzle for liquid(F)

Nozzle for gas(A)

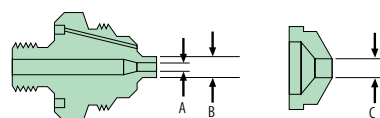

Model	Nozzle No.	Size (μm)	Particle size
1A (Standard)	(F)1650	A 406 B 1270	1~40μm
	(A)64	C 1626	
1	(F)2050	A 508 B 1270	5~40μm
	(A)64	C 1626	
2A	(F)2050	A 508 B 1270	5~50μm
	(A)70	C 1778	
2	(F)2850	A 711 B 1270	10~40μm
	(A)70	C 1778	
3	(F)2850	A 711 B 1270	10~50μm
	(A)64	C 1626	

Particle sizes may vary on samples used and parameter settings.

Applications



- Granulation, drying, mixing of powder
- Applications:
Medicines, food, catalyst, die, detergent, ceramics, etc.

The unit accepts sample weight as less as 50 to 300g and is suitable for experiments of expensive samples or those of a laboratory level.

Handling



Use of the one touch removal system has made removal or cleaning of the drying chamber, cyclone or the product container much easier.

Optional items

Product name	Product code
Safety cover	212784
Viton packing for cyclone inlet/outlet (1 set of 2 types)	212781
Teflon packing for cyclone inlet/outlet (1 set of 2 types)	212782
Air filter + Mist separator + Regulator set	212789
Supply air filter box (for 0.3 μm collection)	212791

Example of implementation

Sample Name	Weight (min)	Binder		Spray amount (min)	Test conditions					Results	
		Name	Density (%)		Inlet temp. (°C)	Liquid sending rate (g/min)	Spray pressure kPa (kg/cm ²)	Spray times (times)	Nozzle height (cm)	Average dia. (μm)	12~115 mesh recovery rate(%)
Silicon	200	PVA	5.0	77	125	15	59 (0.6)	4	27	339	58
Oxidized iron	160	PVA	2.5	50	120	15	98 (1.0)	4	21	205	62
Ceramics	200	PVA	3.0	106	120	15	78 (0.8)	3	22	404	82
Alumina	160	PVA	3.0	60	110	15	59 (0.6)	4	22	311	88
Silica	150	CMC	1.0	100	120	15	78 (0.8)	4	22	306	60
Lactose	200	Sorbitol	70.0	10	100	14	98 (1.0)	4	25	390	80
Black tea essence	250	Guar gum	0.5	24	85	6	59 (0.6)	10	28	333	77
Grease containing powder	200	Glucose	30.0	11	85	4	59 (0.6)	7	22	236	82

*The average granule diameter is a geometric average.

Spray Dryer

Fine powder: 40 to 100µm with larger capacity

DL410

Evaporated water	Max. 3,000mL/h	Temp. control range	40 to 300°C	Sample flow	Variable up to 70ml/min.	Spray nozzle (selectable)	Two-way nozzle	Operation	Easy operation
------------------	----------------	---------------------	-------------	-------------	--------------------------	---------------------------	----------------	-----------	----------------

Spray drying of fine powder as small as 100µm with a high recovery rate.



This spray dryer can produce fine particles from 40 to 100µm which are considered to be extremely difficult to produce in laboratories. It is useful for preliminary tests for pilot plant or expensive samples, micro capture spray drying research, substitute for general laboratory drying method etc.

The DL410 is a larger capacity spray dryer that also does not require the liquid sample or solution to undergo any pre or post-processes such as filtration, separation, or pulverization. The use of organic solvents is fully supported with the attachment of our GAS410 organic solvent recovery unit. Small, expensive and/or heat sensitive samples can be dried quickly and efficiently with this easy to operate system.

- Processes samples as small as 0.5 g of solid matter
- Safe for heat-sensitive samples, such as food or medical products
- No risk of contamination
- Digital display of inlet/outlet temperature and drying air volume
- Detachable drying chamber, cyclone and product vessel
- Fast and easy clean up
- Universal power supply and multilingual touch screen controller

Easy operation and maintenance

- The hot air inlet and drying chamber cover automatically move up and down, and since the cyclone and product vessel can easily be removed, cleaning and maintenance after your experiment is easy
- Control functions are conveniently arranged on the control panel for various conditions
- The temperature recorder, air flow meter, pressure gauge and other measurements allow easy control of experiment conditions

Specifications

Model	DL410
Water evaporation rate	Max. approx. 3,000 ml/h
Temperature control range	40°C - 300°C at inlet
Temperature control accuracy	± 1°C at inlet
Dry air flow rate	Max. 1.2 m³/min
Air spray pressure control range	0 - 600 k Pa (0-6 kg/cm²)
Spraying system	Two-way nozzle (Dia. of orifice: 0.7mm) Nozzle No.3 standard supply
Spray/hot air contact system	Downward spray parallel flow system
Temperature controller	PID digital temperature controller
Temperature sensor	K thermocouple
Stainless pipe heater	2kW x 2 at 240V
Sample liquid feeding pump	Quantitative peristaltic pump, flow rate variable up to 70ml/min.
Solvent recovering capability (optional)	Organic solvent recovery unit GAS410 must be used
Spray line cleaning	Needle inside the nozzle to clean the mesh automatically
Safety device	Self-diagnostic functions (e.g. temperature aberration); Sample feed reversal
Air spray pressure gauge	Bourdon tube: 600k Pa (6 kg/cm²)
External dimensions (W x D x H)	1750 x 1060 x 880 mm or 69 x 42 x 35 in
Weight	180 kg or 397 lbs
Power source	AC 200V - 240V, single-phase 24 A
Included Accessories	
Sample liquid tube	Silicone tube - 2 pcs
Safety Cover	Yes
Static removal brush	1pc
Air hose	1 pc
Exhaust Duct	1 pc
Optional Accessories	
Organic Solvent Recovery Unit	GAS410
Inlet/outlet temperature recorder	212792 - factory installed
Viton/Tiron Feeding Tube	Please inquire
Nozzle	4, 5 (options), 3 standard
Compressed air	28 L/min air volume and 8 kgf/cm² compressed air is required
Type of gas	N. gas (99.99% purity, medical grade) is required when using GAS410

Dimensions (Unit:mm)

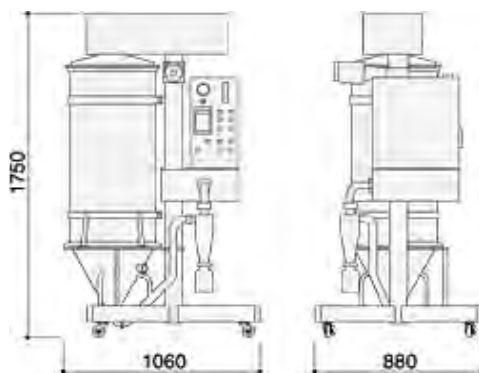

Diagram

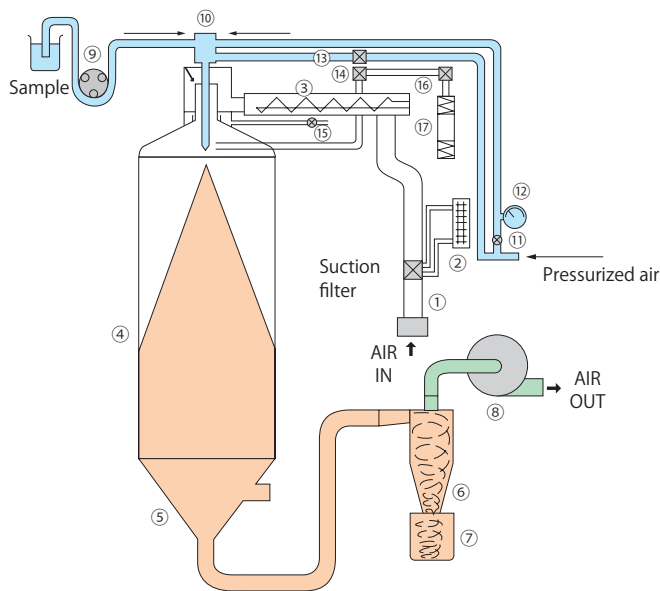

- | | |
|-------------------------------|---------------------------------------|
| (1) Orifice tube | (10) Atomizing nozzle |
| (2) Drying air flow meter | (11) Atomizing pressure control valve |
| (3) Heater | (12) Atomizing pressure gauge |
| (4) Drying chamber | (13) Needle knock Solenoid valve |
| (5) Drying chamber lower half | (14) Nozzle blower Solenoid valve |
| (6) Cyclone | (15) Cool air control valve |
| (7) Product vessel | (16) Head elevation control valve |
| (8) Aspirator | (17) Air cylinder for head elevation |
| (9) Sample feed pump | |

Spraying Nozzle

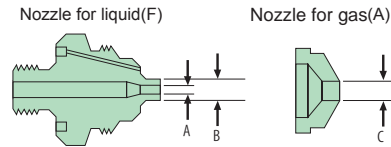

Spraying Nozzle size (μm)

Model	Nozzle No.	Size (μm)	Particle size
3 (Standard)	(F)2850	A 711 B 1270	up to 50μm
	(A)64.5	C 1638	
	(F)60100	A 1530 B 2550	
4	(A)120	C 3060	40~100μm
	(F)100150	A 2550 B 3825	
5	(A)130	C 4530	40~200μm

Particle sizes may vary on samples used and parameter settings.

Control Panel



Multilingual touch screen controller

Application

(1) Spray granulation

With the process of granulation and spheronization, powder liquidity is significantly improved and the pressure is uniform. Applications: aluminum, zirconia, ceramics, heavy metals, cemented carbide fields etc.

(2) Micro capture

In spray drying, the combination of core and coating material is a source solution to obtain encapsulated powder.

Applications:

- Ink for pressure-sensitive paper
- Adjustment of pharmaceutical products flavouring and lyolysis.
- Encapsulation of fragrances used in food and hygiene related products
- Encapsulation of dyes, fertilizers, oils, adhesives etc.

(3) Spray cooling granulation

Difficult to get dry powder, such as wax, oils and fats, fatty acids, etc.

(4) Special applications

Spray concentrated, spray reaction, powder sizing, etc.

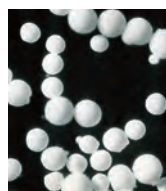

0 50 100μm
Powder generated by DL410

Equipment



Static removal brush

Burn prevention safety cover

Burn prevention safety cover and the static removal brush are standard equipment.

Time

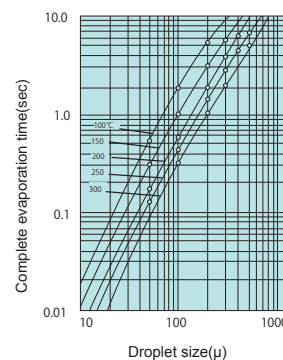

Drying time until the liquid droplets are completely evaporated with hot air.

Inert N₂ Gas Sealed System

Highly safe N₂ gas sealed circulation system

GAS410

Circulation flow 0.12 to 0.65m³/min

Recovery capacity 1,300ml/h or more

Cost savings With integrated freezer
With integrated compressor

Inert N₂ Gas Sealed System used in conjunction with Spray Dryers



The Inert N₂ Gas Sealed System is used to prevent external discharge when combined with a spray dryer (ADL311SA or GB-210A) when using an organic solvent.

- Dehumidifier (Freezer) integrated in GAS410. No extra Freezer/dehumidifier equipment needed
- Compressor included, no need for a separate compressor to operate the spray dryer ADL311SA when using organic solvent samples
- Flammable or toxic solvents can be processed by combining a N₂ gas sealed circulation system and a solvent recovery system (with freezer and capacitor)
- Explosion safety with closed loop N₂ inert gas system
- Recovery of solvent to protect the environment and enable minimized pollution.
- Drying of easily oxidized materials is possible
- Supports low temperature drying of materials that easily deform with heat
- No freezing risk due to organic solvent with aqueous solution mixtures which could cause damage to the closed loop GAS410 system
- Spray drying and recovery of products and solvents are performed with meticulously devised safety measures



Example of installation: ADL311SA + GAS410

Specifications

Model	GAS410
Solvent recovery system	Capacitor + freezer
Circulating gas	N ₂ gas (sealed circulation when connected to ADL311SA or GB-210A)
Circulating volume flow	0.12 to 0.65m ³ /min
Compressor (for spraying)	Linear compressor integrated
Circulation blower	Roots blower
Solvent recovery container	2L flask
Freezer	Air-cooled condensation full-sealed type: 400W R404A
Solvent recovery mechanism	Capacitor cooling mechanism
Filter	Cartridge filter
Instruments	Cooling trap temperature display monitor Filter differential pressure meter (monitor for clogging of filter) O ₂ density display monitor Blower wind amount adjusting volume
O ₂ Sensor	Solid electrolyte (Zirconium) limit current type
Pump	For circulation to measure Oxygen
Safety device	O ₂ density meter, flammable gas alarm, electric leakage breaker, N ₂ gas forced introduction (when removing nozzles)
External dimensions	W700 x D950 x H1,500 mm
Weight	~130 kg
Power source (50/60 Hz) rated current	AC200 to 240V 5A (15A)
Required N ₂ amount	15 L/h at 0.1 MPa
Accessories	Set of connection parts, anti-seismic clamps, interface cable, sample gas for gas alarm inspection, 2L flask

Diagram

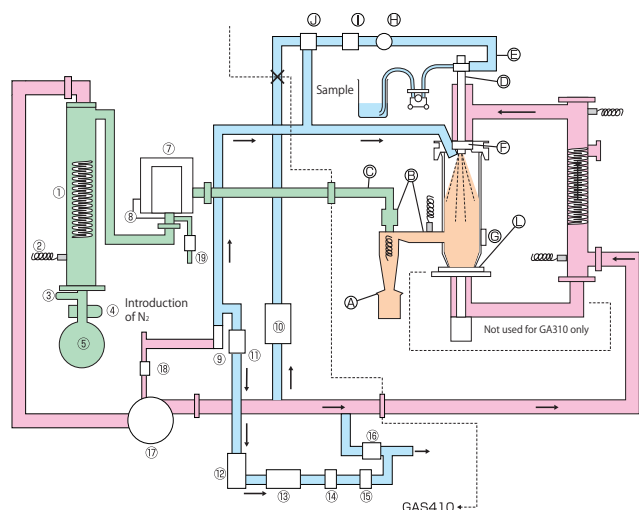

No.	Part name	No.	Part name
(1)	Capacitor	A	O ring
(2)	Sensor	B	Packing
(3)	Ball valve	C	Hose
(4)	Clamp	D	Spray nozzle
(5)	Recovery flask	E	Tube
(6)	Filter element	F	Aluminum honeycomb
(7)	Filter case	G	Cap
(8)	Differential pressure meter	H	Pressure meter
(9)	Flow meter (for introduction of N ₂)	I	Needle valve
(10)	Compressor	J	3-way valve
(11)	Solenoid valve (for N ₂ control)	K	Solenoid valve
(12)	Flow meter (for measuring O ₂ density)	L	Packing
(13)	Filter		
(14)	Pump		
(15)	O ₂ Sensor		
(16)	Solenoid valve (for exhaust)		
(17)	Blower		
(18)	Solenoid valve (for introduction of N ₂)		
(19)	Solenoid valve (for air supply)		

Control Panel



Major control functions and detection function

- Closed system (N₂ gas sealed circulation type)
- O₂ density control function
- Flammable gas detection function
- Inlet temperature overheat detection function
- Outlet temperature overheat detection function
- In case of an abnormality, the alarm sounds and liquid flow stops
- Other self diagnostics functions
 - Detection of temp. sensor disconnection
 - Overheat prevention
 - Detection of absence of spray nozzle

Fields



- Non-oxide ceramics
- Polymer material
- Super conductivity materials
- Medicinal products
- Food products
- Material research

Connection



Rear of GAS410



ADL311SA + GAS410 + stand with caster wheels

Optional items

Product name	Product code
Filter element 0.1μ	212785
Viton packing for cyclone inlet/outlet (1 set of 2 types)	212781
Teflon packing for cyclone inlet/outlet (1 set of 2 types)	212782
Dry air flow meter (differential pressure type)*	212786

* The item marked "*" shall be ordered together with the main unit.

Reference Spray Dryer, Model Supporting Organic Solvent

Repeatability of granulation test

Mesh	#1	#2	#3	#4
12 and up	5.6	0.8	1.2	1.3
12~16	0.5	0.9	1	1.2
16~24	0.6	0.8	1.2	1.4
24~32	0.7	0.8	0.9	1.1
32~42	1.6	1.7	1.9	1.8
42~60	5.9	4.3	4.8	3.5
60~80	9.6	8.5	8.5	6.6
80~115	13.2	15.6	13.4	12.8
115 and under	66.8	66.6	67	70.6
Average particle size*	135.6	135.7	138.3	136.9

*Average particle diameter of the geometric mean

(Conditions)

Raw material	Sintered alumina (average particle size 40) 400g
Binder	5% PVA solution (#500) 25g
Inlet temperature	100°C
Binder liquid feed rate	12.4g/min
Binder spray times	6 times
Binder spray pressure	78kPa(0.8kg/cm ²)
Nozzle height	25cm from microporous plate

The granulation process has many operation factors, the reproducibility depends on the skill level of the operation. The flow state of the granules has a significant impact on the test results. By adjusting the amount of hot air consistent flow conditions are achievable.

Change of particle diameter

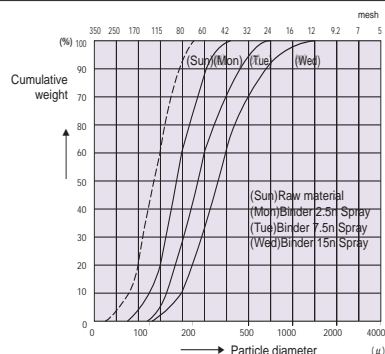

(Conditions)

Raw material	Lactose(100 mesh under) 200g
Binder	70% Sorbitol solution
Inlet temperature	90°C
Binder liquid feed rate	12g/min
Binder spray pressure	98kPa (1.0kg/cm ²)
Nozzle height	25cm from microporous plate

The factors that influence the particle diameter are the binder liquid feed rate and the spray pressure, the former being the most influential. A higher binder amount will result in larger diameter particles.

Repeatability of granulation test

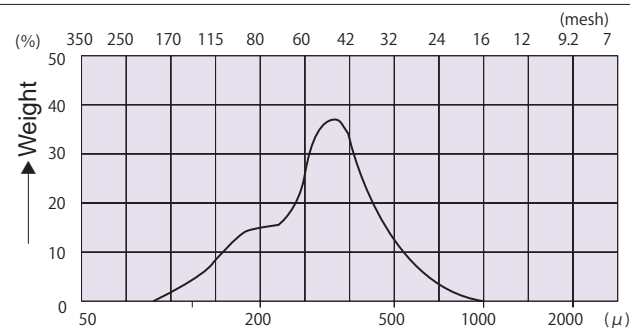

Particles generated by the pulvis mini bed are usually in the range of 0.1~1.5μ. The particle size uniformity is lower than extrusion granulation and compression granulation methods.

The granularity consistency may be regulated by test conditions.

(Conditions)

Raw material	Lactose (100 mesh under) 200g
Binder	70% Sorbitol solution 7.3g
Inlet temperature	90°C
Binder liquid feed rate	12g/min
Binder spray times	7 times
Binder spray pressure	98kPa(1.0kg/cm ²)
Nozzle height	22.5cm from microporous plate

Example of implementation (Spray dryer ADL311SA)

Sample name	Composition (%)	Inlet temp. (°C)	Outlet temp. (°C)	Dry air amount (m ³ /min)	Spray air pressure kPa (kg/cm ²)	Sent amount of sample liquid (g/min)	Sample recovery rate (%)
Dextrin (solution)	10	150	80	0.4	98 (1.0)	6.1	66
Dextrin (emulsion)	40	150	80	0.4	98 (1.0)	5.1	63
Oxidized titanium (suspended liquid)	10	150	85	0.42	98 (1.0)	5.3	50
Soy sauce	50	130	75	0.36	98 (1.0)	5.1	60
Salt	10	145	85	0.38	98 (1.0)	5.3	52

Repeatability of spray drying test (spray dryer ADL311SA)

Test No.	Sample name	Sample density (%)	Drying conditions				Test sample amount (g/min)	Sent amount of sample liquid (g/min)	Test time (min)	Yield (g)	Recovery rate (%)
			Inlet temp. (°C)	Outlet temp. (°C)	Dry air amount (m ³ /min)	Spray air pressure kPa(kg/cm ²)					
1	Coffee solution	5.00	150	75	0.45	147(1.5)	93.1	3.1	30	4.3	92.4
2	Coffee solution	5.00	150	75	0.45	147(1.5)	93	3.1	30	4	86
3	Coffee solution	5.00	150	75	0.45	147(1.5)	91.4	2.0	30	4	87.5
4	Coffee solution	5.00	150	75	0.45	147(1.5)	84.9	2.8	30	3.7	87.2
5	Coffee solution	5.00	150	75	0.45	147(1.5)	83.8	2.8	30	3.7	88.3

Example of implementation (Pulvis mini spray GB-210A)

Sample name	Sample density	Inlet temp. (°C)	Outlet temp. (°C)	Dry air amount (m ³ /min)	Spray air pressure kPa(kg/cm ²)	Sent amount of sample liquid (g/min)	Recovery rate (%)
Dextrin (solution)	20% solution	140	85	0.48	147(1.5)	8.8	66
Drug suspension	10% suspension	145	80	0.42	196(2.0)	8.2	82
Black tea extract	20% solution	155	100	0.4	147(1.5)	7.8	72
Silica gel	20% solution	150	75	0.48	147(1.5)	12.6	70
Iron oxide	3% suspension	175	90	0.4	127(1.3)	9.5	75

Example of implementation (Pulvis mini bed GB-210B)

Sample		Binder			Test conditions					Results	
Name	Weight (min)	Name	Concentration (%)	Spray amount (min)	Inlet temp. (°C)	Liquid sending rate (g/min)	Spray pressure kPa (kg/cm ²)	Spray times (times)	Nozzle height (cm)	Average dia. (µm)	12-115 mesh recovery rate(%)
Silicon	200	PVA	5.0	77	125	15	59 (0.6)	4	27	339	58
Oxidized iron	160	PVA	2.5	50	120	15	98 (1.0)	4	21	205	62
Ceramics	200	PVA	3.0	106	120	15	78 (0.8)	3	22	404	82
Alumina	160	PVA	3.0	60	110	15	59 (0.6)	4	22	311	88
Silica	150	CMC	1.0	100	120	15	78 (0.8)	4	22	306	60
Lactose	200	Sorbitol	70.0	10	100	14	98 (1.0)	4	25	390	80
Black tea essence	250	Guar gum	0.5	24	85	6	59 (0.6)	10	28	333	77
Grease containing powder	200	Glucose	30.0	11	85	4	59 (0.6)	7	22	236	82

Binder category and features

Category	Features
Gelatin	Gelatin Low density and weak bonding strength. No need to heat.
Dextrin	While it has excellent disintegrating and formability, the binding strength is weak.
Potato starch	Good granulation properties and inexpensive. Used in the pharmaceutical and food sector.
Arsinic acid soda	Suitable as a binder for the high viscosity samples. Used primarily in the food sector.
Gum arabic	Warm and spray. Need large amount of binder.
CMC (Carboxymethyl cellulose)	High viscosity at low temperatures. High amount of powder remains.
HPC (hydroxypropyl cellulose)	Good cohesion and is suitable for hydrophilic material.
MC (methyl cellulose)	Strong binding strength, is suitable for rough particles.
PVA (Polyvinyl alcohol)	Excellent in granulation properties but somewhat difficult to disintegrate granulated products.
PVP (Polyvinylpyrrolidone)	High molecular weight and strong binding strength, is suitable for hydrophobic material.

Repeatability of spray drying test (Pulvis mini spray GB-210A)

Test No.	Sample name	Sample density (%)	Drying conditions				Test sample amount (g/min)	Sent amount of sample liquid (g/min)	Test time (min)	Yield (g)	Recovery rate (%)
			Inlet temp. (°C)	Outlet temp. (°C)	Dry air amount (m ³ /min)	Spray air pressure kPa(kg/cm ²)					
1	Coffee solution	5.00	150	80	0.45	147(1.5)	198.0	6.6	30	8.1	81.8
2	Coffee solution	5.00	150	80	0.45	147(1.5)	198.7	6.6	30	8.1	81.5
3	Coffee solution	5.00	150	80	0.45	147(1.5)	200.6	6.7	30	8.0	79.8
4	Coffee solution	5.00	150	80	0.45	147(1.5)	198.1	6.6	30	8.2	82.8
5	Coffee solution	5.00	150	80	0.45	147(1.5)	199.3	6.6	30	8.4	84.3

Example of implementation Pulvis mini spray GB-210A, organic solvent recovery unit GAS410

Sample	Sample density (%)	Inlet temp. (°C)	Outlet temp. (°C)	Drying nitrogen (m ³ /min)	Spray pressure (kg/cm ²)	Sent rate of sample liquid (g/min)	Dispersion medium or solution	Results			Others
								Powdered	Recovery rate (%)	Solution recovery rate (%)	
Hydroxypropyl methylcellulose	10	90	55	0.5	1.0	9.9	*	G	65.3	92.5	*Chloroform1: Ethanol1
Cellulose polymer	5.0	70	47	0.5	1.0	8.3	Methylene chloride	G	72.3		
Polymer	2.0	100	64	0.5	1.0	8.4	*	G	77.8	80.7	*Ethanol95: Water5
Resin	23.5	80	55	0.5	1.0	4.2	*	G	81.9	96.7	*(Methanol4:Water1) Distributed
Carbon + resin	5.8	100	70	0.5	1.0	5.3	IPA	G	85.1	94.1	
Polymer + inorganic salt	10.2	140	98	0.5	1.0	3.8	*	G	97.6	97.4	*Dimethylacetamide
Polyvinylpyrrolidone (K30)	10.0	80	55	0.5	1.0	7.7	Ethanol	G	79.4	95.0	
Polyvinyl pyrrolidone + drug	10.0	80	55	0.5	1.0	7.7	Ethanol	G	75.9	95.4	
Botanical extract	3.0	130	71	0.5	1.0	9.1	*	G	96.5	91.9	*Ethanol6: Water4
Silicon carbide	38.5	150	84	0.5	1.0	12.1	Ethanol	G	89.9	99.9	*Use nozzle 3S
Aluminum nitride	13.2	150	99	0.5	1.0	12.9	Butyl acetate	G	92.2	86.7	*Use nozzle 3S
Nitride ceramic	60.5	120	83	0.5	1.0	11.3	MEK	G	74.7	88.7	
Superconducting material	33.3	80	60	0.5	1.0	15.7	Acetone	G	66.6	99.6	
Drug	3.61	100	68	0.6	1.0	10.0	*	Yes	73.6	87.2	*Ethanol+Methylene chloride
Drug	13.2	60	45	0.32	1.25	6.0	*	Yes	87.6	94.7	*Methylene chloride+Ethanol
W-Cu	50.0	100	62	0.5	0.5	20.7	Ethanol	Yes	60.3	91.9	
Metamorphic polystyrene	48.7	140	60	0.45	1.0	22.3	Water	Yes	67.6	91.7	
Polymer	0.5	150	88	0.5	1.0	8.5	*	Yes	83.1	97.6	*Methanol3+Water1
Organic matter	50.0	150	88	0.4	1.0	8.3	Methanol	Yes			
Silica dispersion	10.0	100	88	0.5	1.0	4.8	*	Yes	96.2	99.5	*Ethanol+Water(little)

Spray Dryer Recommended Accessories

Air Compressor & Air Combination

Air Compressor SL100-8

For Spray Dryer ADL311SA, GB-210A, GB-210B, DL-410

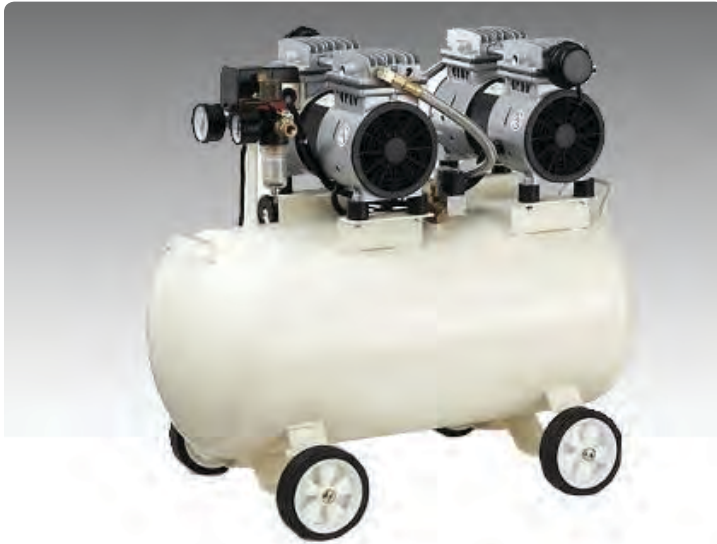

- Provides a stable source of oil free air
- Noiseless and oil free
- High flow, low noise, low vibration and low maintenance
- Automatic control and smooth operation

Specifications

Brand	SMTmax
Model	SL100-8
Horsepower	2 x 3/4 HP
Voltage	110 V
Power	2X 550 W
Starting Pressure (Mpa)	0.5
Max Pressure (Mpa)	0.8
Noise dB(A)	55
Speed (r/min.)	1680
Capacity (L/min)	220
Cu. Ft. Delivered @ 115 PSI	7.8 CFM
Tank	50 L (13.3 GAL)
Dimensions (L x W x H)	69 x 30 x 63 cm 27.2 x 11.8 x 24.8 in
Weight	47 kg (104 lbs)

Air Combination 212789

For Spray Dryer ADL311SA, GB-210A, GB-210B

- To guarantee moisture-free, oil-free and clean air spray drying
- Element and bowl in one-piece for easy replacement (AF)
- Energy saving regulator (AR)
- Transparent bowl guard provides 360° visibility

Specifications

Product name	Product code	
Air combination	212789	
Components	Air Filter [AF]	AF20
	Mist Separator [AFM]	AFM20
	Regulator [AR]	AR20

Model	AF20+AFM20+AR20
Ambient and fluid temperature	-5~60°C (with no freezing)
Max. operating pressure	145psi (1.0MPa)
Min. operating pressure	7.3psi (0.05MPa)
Set pressure range	7.3-102psi (0.05-0.7MPa)
Nominal filtration rating [AF/AFM]	AF: 5µm, AFM: 0.3µm (99.9 filtered particle size)
Outlet side oil mist concentration[AFM]	Max 1.0mg/m ³ (ANR) (≈0.8ppm)*
Bowl material [AF/AFM]	Polycarbonate
Bowl guard [AF/AFM]	Semi-standard (steel)
Weight	~0.39kg

*When the compressor oil mist discharge concentration is 30mg/m³ (ANR). Bowl seal and other o-rings are slightly lubricated.



Dimension (mm)

