

VT 4.10
VT 4.16

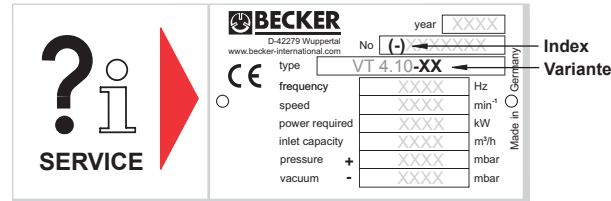
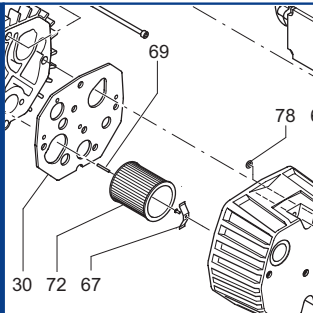

Ersatzteilliste
Spare parts list
Liste de pièces de rechange
Listino pezzi di ricambio
Lista de piezas de recambio
Lista de peças sobresselentes
Reserveonderdelenlijst
Atsarginių dalių sąrašas
Varuosad nimekirja
Rezerves daļu saraksts

Reservdeliste
Reservdelista
Varaosuettelolo
Reservdeliste
Wykaz części zamiennych
Tartalékalkatrész lista
Seznam náhradních dílů
Seznam nadomestnih delov
Zoznam náhradných dielov
Rezervni dijelovi popis

Lista pieselor de schimb
Páirteanna spártha liosta
Κατάλογος ανταλλακτικών
Yedek parça listesi
Списък на резервните части
Перечень запасных частей
スベアパーツリスト
예비 부품 목록
备用零件目录



Sales and service network

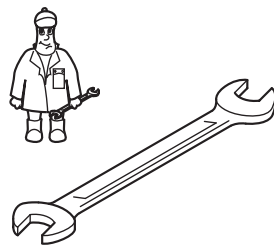

Wartung
Maintenance
Entretien
Manutenzione
Mantenimiento



Pos.	Menge ²⁾ Quantity Quantité Quantità Cantidad	Bestell-Nr. Ident No. No. Identification No. Identificazione No. de pedido	Bezeichnung Description Designation Designazione Descripción
VT 4.10			
24	SATZ/KIT	901327 00007	Schieber, Rotor Vane, Palette, Empujador
72	1	909518 00000	Filterpatrone, Filter cartridge, Cartouche Filtrante, Cartuccia filtro, Cartucho de filtro
VT 4.16			
24	SATZ/KIT	901347 00007	Schieber, Rotor Vane, Palette, Empujador
72	1	909519 00000	Filterpatrone, Filter cartridge, Cartouche Filtrante, Cartuccia filtro, Cartucho de filtro

²⁾ erforderliche Bestellmenge / necessary order quantity / quantité nécessaire / quantità di ordinazione necessari / cantidad necesario

VT 4.10
 VT 4.16

Standard



Variante



VT 4.10/XX

①

- 1~ Einphasenwechselstrom
- 1~ single-phase AC
- 1~ AC monophasé
- 1~ AC monofase
- 1~ AC monofásica

VT 4.16/XX

②

- 1~ Einphasenwechselstrom
- 1~ single-phase AC
- 1~ AC monophasé
- 1~ AC monofase
- 1~ AC monofásica

③

- /O-34
- 1~ mit erhöhter Volumenstrom
- 1~ with increased volume flow rate
- 1~ avec débit volume augmentée
- 1~ con flusso in volume aumentata

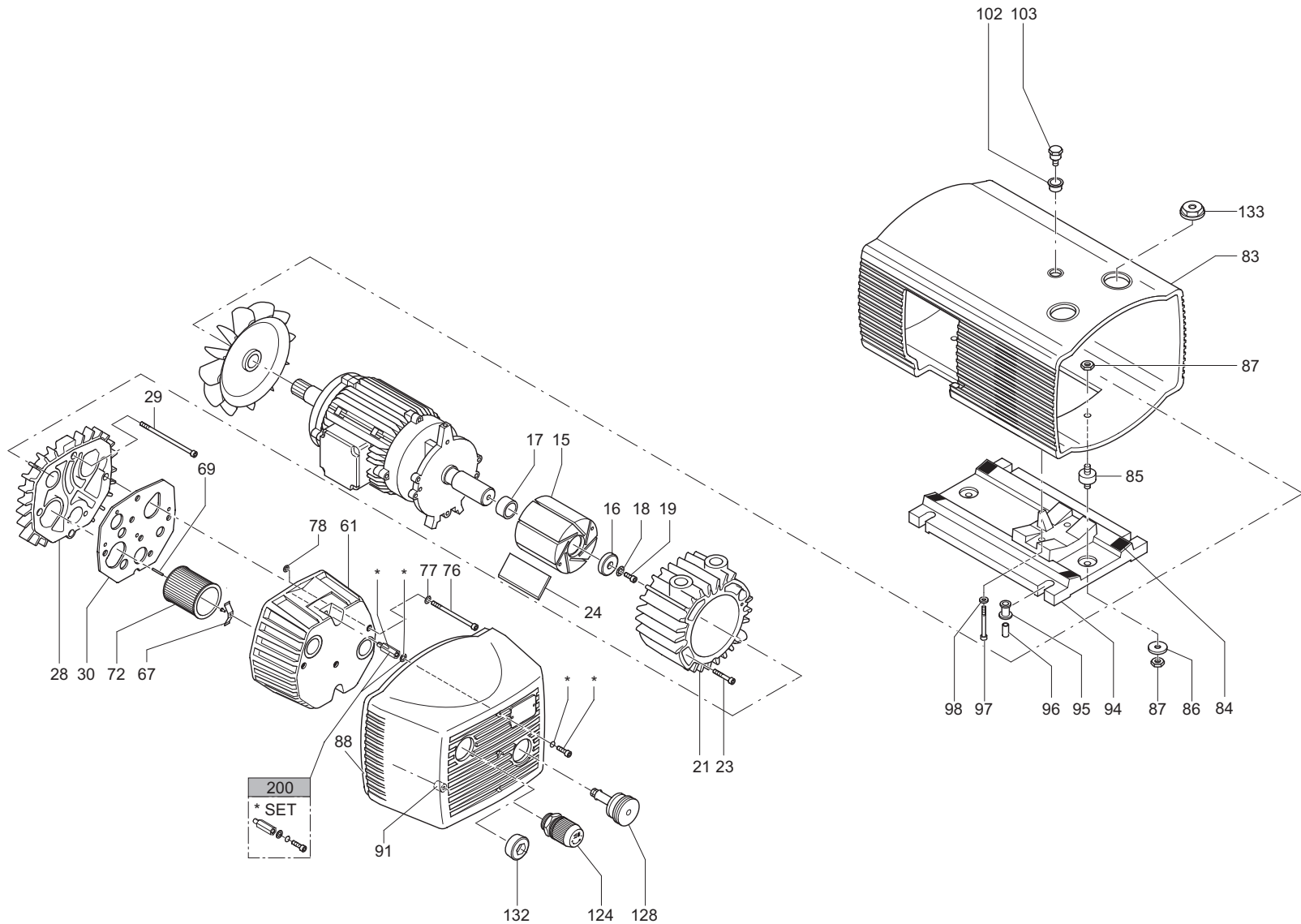

SERVICE ?

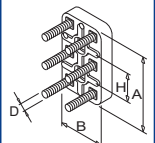
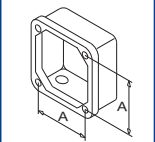
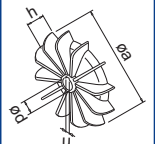
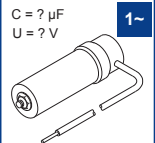
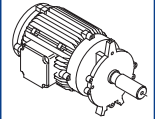

- INDEX	Pos.	Bestell Nr.	Beschreibung	
VT 4.10	15	020000 16200	KOLBEN	
	16	016800 05000	SPANNSCHEIBE	
	17	911001 00000	STAR-TOLERANZRING	
	18	949203 00000	ZAHNSCHEIBE	
	19	945320 00000	INNENSECHSKANTSCHRAUBE	
	21	000100 16200	GEHÄUSE	
	23	945319 00000	INNENSECHSKANTSCHRAUBE	
	24	901327 00007	SCHIEBER-KOHL E (SATZ)	
	28	000700 16200	SEITENDECKEL	
	29	945364 00000	INNENSECHSKANTSCHRAUBE	
	30	008901 16200	DICHTUNG	
	61	004800 27300	FILTERDECKEL	
	67	009000 16300	ANPRESSFEDER	
	69	952009 00000	SPANNHÜLSE	
	72	909518 00000	FILTERPATRONE (1x) ¹⁾	
	76	945364 00000	INNENSECHSKANTSCHRAUBE	
	77	948021 00000	DICHTRING	
	78	913161 00000	O-RING	
	83	006800 27300	GERÄTEHAUBE	
	84	060901 16300	DÄMPFUNGSSTREIFEN	
85	741310 50000	GUMMIPUFFER		
86	949402 00000	UNTERLEGSCHLEIBE		
87	947001 00000	SECHSKANTMUTTER		
88	006801 27300	FRONTHAUBE		
91	951922 00000	GUMMIFORMTEIL		
94	015100 27300	MOTORFUSS		
95	951921 00000	GUMMIFORMTEIL		
96	068000 27600	DISTANZSTÜCK		
97	945363 00000	INNENSECHSKANTSCHRAUBE		
98	949451 00000	UNTERLEGSCHLEIBE		
102	968104 00000	GUMMI-DISTANZSTÜCK		
103	029600 16300	BOLZEN		
124	736001 99613	VAKUUMREGULIERVENTIL		
128	727502 06000	ABBLASEVENTIL		
132	951232 00000	VERSCHLUSS-SCHRAUBE		
133	951224 00000	VERSCHLUSS-SCHRAUBE		
	200	568000 27300	FRONTHAUBENBEFESTIGUNG (SATZ)	

¹⁾ erforderliche Bestellmenge / Wartung

- INDEX	Pos.	Bestell Nr.	Beschreibung	
VT 4.16	15	020000 16300	KOLBEN	
	16	016800 16300	SPANNSCHEIBE	
	17	911009 00000	STAR-TOLERANZRING	
	18	949203 00000	ZAHNSCHEIBE	
	19	945320 00000	INNENSECHSKANTSCHRAUBE	
	21	000105 16300	GEHÄUSE	
	23	945321 00000	INNENSECHSKANTSCHRAUBE	
	24	901347 00007	SCHIEBER-KOHL E (SATZ)	
	28	000705 16300	SEITENDECKEL	
	29	945372 00000	INNENSECHSKANTSCHRAUBE	
	30	008901 16300	DICHTUNG	
	61	004800 27400	FILTERDECKEL	
	67	009000 16300	ANPRESSFEDER	
	69	952009 00000	SPANNHÜLSE	
	72	909519 00000	FILTERPATRONE (1x) ¹⁾	
	76	945325 00000	INNENSECHSKANTSCHRAUBE	
	77	948021 00000	DICHTRING	
	78	913161 00000	O-RING	
	83	006800 27400	GERÄTEHAUBE	
	84	060901 16300	DÄMPFUNGSSTREIFEN	
85	741310 50000	GUMMIPUFFER		
86	949402 00000	UNTERLEGSCHLEIBE		
87	947001 00000	SECHSKANTMUTTER		
88	006801 27400	FRONTHAUBE		
91	951922 00000	GUMMIFORMTEIL		
94	015100 27400	MOTORFUSS		
95	951921 00000	GUMMIFORMTEIL		
96	068000 27600	DISTANZSTÜCK		
97	945323 00000	INNENSECHSKANTSCHRAUBE		
98	949451 00000	UNTERLEGSCHLEIBE		
102	968104 00000	GUMMI-DISTANZSTÜCK		
103	029600 16300	BOLZEN		
124	736001 99613	VAKUUMREGULIERVENTIL		
128	727502 06000	ABBLASEVENTIL		
132	951232 00000	VERSCHLUSS-SCHRAUBE		
133	951224 00000	VERSCHLUSS-SCHRAUBE		
	200	568000 27300	FRONTHAUBENBEFESTIGUNG (SATZ)	

¹⁾ erforderliche Bestellmenge / Wartung

INDEX	Pos.	Ident No.	Description	
VT 4.10	15	020000 16200	ROTOR	
	16	016800 05000	CLAMPING DISC	
	17	911001 00000	STAR-TOLERANCE-RING	
	18	949203 00000	TOOTHED SPRING WASHER	
	19	945320 00000	SOCKET HEAD SCREW	
	21	000100 16200	PUMP BODY	
	23	945319 00000	SOCKET HEAD SCREW	
	24	901327 00007	CARBON VANES (KIT)	
	28	000700 16200	LID	
	29	945364 00000	SOCKET HEAD SCREW	
	30	008901 16200	GASKET	
	61	004800 27300	FILTER COVER	
	67	009000 16300	BLADE SPRING	
	69	952009 00000	LOCATING PIN	
	72	909518 00000	FILTER CARTRIDGE (1x)¹⁾	
	76	945364 00000	SOCKET HEAD SCREW	
	77	948021 00000	SEALING RING	
	78	913161 00000	O-RING	
	83	006800 27300	PROTECTIVE HOOD	
	84	060901 16300	ELASTIC PAD	
85	741310 50000	RUBBER BUFFER		
86	949402 00000	WASHER		
87	947001 00000	HEX.NUT		
88	006801 27300	FRONT HOOD		
91	951922 00000	RUBBER ELEMENT		
94	015100 27300	FOOT		
95	951921 00000	RUBBER ELEMENT		
96	068000 27600	SPACING COLLAR		
97	945363 00000	SOCKET HEAD SCREW		
98	949451 00000	WASHER		
102	968104 00000	RUBBER SLEEVE		
103	029600 16300	BOLT		
124	736001 99613	VACUUM REGULATING VALVE		
128	727502 06000	BLOW-OFF VALVE		
132	951232 00000	SCREW PLUG		
133	951224 00000	SCREW PLUG		
200	568000 27300	FRONT HOOD ATTACHMENT (KIT)		

¹⁾ necessary order quantity / maintenance

INDEX	Pos.	Ident No.	Description	
VT 4.16	15	020000 16300	ROTOR	
	16	016800 16300	CLAMPING DISC	
	17	911009 00000	STAR-TOLERANCE-RING	
	18	949203 00000	TOOTHED SPRING WASHER	
	19	945320 00000	SOCKET HEAD SCREW	
	21	000105 16300	PUMP BODY	
	23	945321 00000	SOCKET HEAD SCREW	
	24	901347 00007	CARBON VANES (KIT)	
	28	000705 16300	LID	
	29	945372 00000	SOCKET HEAD SCREW	
	30	008901 16300	GASKET	
	61	004800 27400	FILTER COVER	
	67	009000 16300	BLADE SPRING	
	69	952009 00000	LOCATING PIN	
	72	909519 00000	FILTER CARTRIDGE (1x)¹⁾	
	76	945325 00000	SOCKET HEAD SCREW	
	77	948021 00000	SEALING RING	
	78	913161 00000	O-RING	
	83	006800 27400	PROTECTIVE HOOD	
	84	060901 16300	ELASTIC PAD	
85	741310 50000	RUBBER BUFFER		
86	949402 00000	WASHER		
87	947001 00000	HEX.NUT		
88	006801 27400	FRONT HOOD		
91	951922 00000	RUBBER ELEMENT		
94	015100 27400	FOOT		
95	951921 00000	RUBBER ELEMENT		
96	068000 27600	SPACING COLLAR		
97	945323 00000	SOCKET HEAD SCREW		
98	949451 00000	WASHER		
102	968104 00000	RUBBER SLEEVE		
103	029600 16300	BOLT		
124	736001 99613	VACUUM REGULATING VALVE		
128	727502 06000	BLOW-OFF VALVE		
132	951232 00000	SCREW PLUG		
133	951224 00000	SCREW PLUG		
200	568000 27300	FRONT HOOD ATTACHMENT (KIT)		

¹⁾ necessary order quantity / maintenance

- INDICE	Pos.	No. Identification	Designation
VT 4.10	15	020000 16200	PISTON
	16	016800 05000	DISQUE DE SERRAGE
	17	911001 00000	BAGUE STAR
	18	949203 00000	DENT DISQUE
	19	945320 00000	VIS HEXAGONALE INTERNE
	21	000100 16200	CORP DE POMPE
	23	945319 00000	VIS HEXAGONALE INTERNE
	24	901327 00007	PALETTE DE CHARBON (KIT)
	28	000700 16200	COUVERCLE
	29	945364 00000	VIS HEXAGONALE INTERNE
	30	008901 16200	JOINT
	61	004800 27300	COUVERCLE DU FILTRE
	67	009000 16300	RESSORT-JAME
	69	952009 00000	DOVILLE DE ETRAGE
	72	909518 00000	CARTOUCHE FILTRANTE (1x)¹⁾
	76	945364 00000	VIS HEXAGONALE INTERNE
	77	948021 00000	JOINT
	78	913161 00000	ANNEAU-O
	83	006800 27300	CAPOT DE PROTECTION
	84	060901 16300	AMORTISSEUR
85	741310 50000	AMORTISSEUR EN CAOUTCHOUC	
86	949402 00000	RONDELLE	
87	947001 00000	ECROU A 6PANS	
88	006801 27300	CAPOT AVANT	
91	951922 00000	ELEMENT EN CAOUTCHOUC	
94	015100 27300	PIED	
95	951921 00000	ELEMENT EN CAOUTCHOUC	
96	068000 27600	DONILLE D'ECARMENT	
97	945363 00000	VIS HEXAGONALE INTERNE	
98	949451 00000	RONDELLE	
102	968104 00000	PIECE D'ECARTEMENT CAOUTCHOUC	
103	029600 16300	BOULON	
124	736001 99613	SOUPAPE REGLAGE VIDE	
128	727502 06000	SILENCIEUX	
132	951232 00000	BOUCHON	
133	951224 00000	BOUCHON	
200	568000 27300	PIÈCES DE FIXATION DU CAPOT AVANT (KIT)	

¹⁾ quantité nécessaire / entretien

- INDICE	Pos.	No. Identification	Designation
VT 4.16	15	020000 16300	PISTON
	16	016800 16300	DISQUE DE SERRAGE
	17	911009 00000	BAGUE STAR
	18	949203 00000	DENT DISQUE
	19	945320 00000	VIS HEXAGONALE INTERNE
	21	000105 16300	CORP DE POMPE
	23	945321 00000	VIS HEXAGONALE INTERNE
	24	901347 00007	PALETTE DE CHARBON (KIT)
	28	000705 16300	COUVERCLE
	29	945372 00000	VIS HEXAGONALE INTERNE
	30	008901 16300	JOINT
	61	004800 27400	COUVERCLE DU FILTRE
	67	009000 16300	RESSORT-JAME
	69	952009 00000	DOVILLE DE ETRAGE
	72	909519 00000	CARTOUCHE FILTRANTE (1x)¹⁾
	76	945325 00000	VIS HEXAGONALE INTERNE
	77	948021 00000	JOINT
	78	913161 00000	ANNEAU-O
	83	006800 27400	CAPOT DE PROTECTION
	84	060901 16300	AMORTISSEUR
85	741310 50000	AMORTISSEUR EN CAOUTCHOUC	
86	949402 00000	RONDELLE	
87	947001 00000	ECROU A 6PANS	
88	006801 27400	CAPOT AVANT	
91	951922 00000	ELEMENT EN CAOUTCHOUC	
94	015100 27400	PIED	
95	951921 00000	ELEMENT EN CAOUTCHOUC	
96	068000 27600	DONILLE D'ECARMENT	
97	945323 00000	VIS HEXAGONALE INTERNE	
98	949451 00000	RONDELLE	
102	968104 00000	PIECE D'ECARTEMENT CAOUTCHOUC	
103	029600 16300	BOULON	
124	736001 99613	SOUPAPE REGLAGE VIDE	
128	727502 06000	SILENCIEUX	
132	951232 00000	BOUCHON	
133	951224 00000	BOUCHON	
200	568000 27300	PIÈCES DE FIXATION DU CAPOT AVANT (KIT)	

¹⁾ quantité nécessaire / entretien

I INDICE	Pos.	No. Identificazione	Designazione
VT 4.10	15	020000 16200	ROTORE
	16	016800 05000	DISCO DI FISSAGGIO
	17	911001 00000	STAR-ANELLO TOLLERANZA
	18	949203 00000	DISCO A DENTE
	19	945320 00000	VITE ESAGONALE INTERNA
	21	000100 16200	CARCASSA
	23	945319 00000	VITE ESAGONALE INTERNA
	24	901327 00007	PALETTE DI CHARBONE (KIT)
	28	000700 16200	COPERCHIO
	29	945364 00000	VITE ESAGONALE INTERNA
	30	008901 16200	GUARNIZIONE
	61	004800 27300	COPERCHIO FILTRO
	67	009000 16300	MOLLA
	69	952009 00000	SPINE DI RISCONTRO
	72	909518 00000	CARTUCCIA FILTRO (1x)¹⁾
	76	945364 00000	VITE ESAGONALE INTERNA
	77	948021 00000	ANELLO GUARNIZIONE
	78	913161 00000	ANELLO-O
	83	006800 27300	COPERCHIO DI PROTEZIONE
	84	060901 16300	AMORTIZZATORE
85	741310 50000	AMMORTIZZATORE IN GOMMA	
86	949402 00000	RONDELLA	
87	947001 00000	DADO ESAGONALE	
88	006801 27300	COFANO	
91	951922 00000	ELEMENTO IN GOMMA	
94	015100 27300	PIEDE	
95	951921 00000	ELEMENTO IN GOMMA	
96	068000 27600	BOCCOLA DISTANZIATRICE	
97	945363 00000	VITE ESAGONALE INTERNA	
98	949451 00000	RONDELLA	
102	968104 00000	PEZZO DI SCOSTAM. IN GOMMA	
103	029600 16300	BULLONE	
124	736001 99613	VALVOLA REGOLAZIONE VUOTO	
128	727502 06000	SILENZIATORE	
132	951232 00000	VITE DI CHIUSURA	
133	951224 00000	VITE DI CHIUSURA	
200	568000 27300	PARTI DI FISSAGGIO DEL COFANO (KIT)	

¹⁾ quantità di ordinazione necessari / manutenzione

I INDICE	Pos.	No. Identificazione	Designazione
VT 4.16	15	020000 16300	ROTORE
	16	016800 16300	DISCO DI FISSAGGIO
	17	911009 00000	STAR-ANELLO TOLLERANZA
	18	949203 00000	DISCO A DENTE
	19	945320 00000	VITE ESAGONALE INTERNA
	21	000105 16300	CARCASSA
	23	945321 00000	VITE ESAGONALE INTERNA
	24	901347 00007	PALETTE DI CHARBONE (KIT)
	28	000705 16300	COPERCHIO
	29	945372 00000	VITE ESAGONALE INTERNA
	30	008901 16300	GUARNIZIONE
	61	004800 27400	COPERCHIO FILTRO
	67	009000 16300	MOLLA
	69	952009 00000	SPINE DI RISCONTRO
	72	909519 00000	CARTUCCIA FILTRO (1x)¹⁾
	76	945325 00000	VITE ESAGONALE INTERNA
	77	948021 00000	ANELLO GUARNIZIONE
	78	913161 00000	ANELLO-O
	83	006800 27400	COPERCHIO DI PROTEZIONE
	84	060901 16300	AMORTIZZATORE
85	741310 50000	AMMORTIZZATORE IN GOMMA	
86	949402 00000	RONDELLA	
87	947001 00000	DADO ESAGONALE	
88	006801 27400	COFANO	
91	951922 00000	ELEMENTO IN GOMMA	
94	015100 27400	PIEDE	
95	951921 00000	ELEMENTO IN GOMMA	
96	068000 27600	BOCCOLA DISTANZIATRICE	
97	945323 00000	VITE ESAGONALE INTERNA	
98	949451 00000	RONDELLA	
102	968104 00000	PEZZO DI SCOSTAM. IN GOMMA	
103	029600 16300	BULLONE	
124	736001 99613	VALVOLA REGOLAZIONE VUOTO	
128	727502 06000	SILENZIATORE	
132	951232 00000	VITE DI CHIUSURA	
133	951224 00000	VITE DI CHIUSURA	
200	568000 27300	PARTI DI FISSAGGIO DEL COFANO (KIT)	







¹⁾ quantità di ordinazione necessari / manutenzione

- ÍNDICE	Pos.	No. De pedido	Descripción	
VT 4.10	15	020000 16200	ÉMBOLO	
	16	016800 05000	ARANDELA TENSORA	
	17	911001 00000	ANILLO DE TOLERANCIA STAR	
	18	949203 00000	POLEA DENTADA	
	19	945320 00000	TORNILLO HEXAGONAL INTERIOR	
	21	000100 16200	CARCASA	
	23	945319 00000	TORNILLO HEXAGONAL INTERIOR	
	24	901327 00007	EMPUJADOR DE CARBÓN (KIT)	
	28	000700 16200	TAPA LATERAL	
	29	945364 00000	TORNILLO HEXAGONAL INTERIOR	
	30	008901 16200	JUNTA	
	61	004800 27300	TAPA DE FILTRO	
	67	009000 16300	MUELLE DE PRESIÓN	
	69	952009 00000	CASQUILLO TENSOR	
	72	909518 00000	CARTUCHO DE FILTRO (1x)¹⁾	
	76	945364 00000	TORNILLO HEXAGONAL INTERIOR	
	77	948021 00000	ANILLO DE JUNTA	
	78	913161 00000	JUNTA TÓRICA	
	83	006800 27300	CUBIERTA DEL APARATO	
	84	060901 16300	TIRAS DE AMORTIGUACIÓN	
85	741310 50000	AMORTIGUADOR DE GOMA		
86	949402 00000	ARANDELA		
87	947001 00000	TUERCA HEXAGONAL		
88	006801 27300	CUBIERTA FRONTAL		
91	951922 00000	PIEZA DE ORMA DE GOMA		
94	015100 27300	PIE DE MOTOR		
95	951921 00000	PIEZA DE ORMA DE GOMA		
96	068000 27600	PIEZA DISTANCIADORA		
97	945363 00000	TORNILLO HEXAGONAL INTERIOR		
98	949451 00000	ARANDELA		
102	968104 00000	PIEZA DE GOMA DISTANCIADORA		
103	029600 16300	BULÓN		
124	736001 99613	VÁLVULA REGULADORA DE VACÍO		
128	727502 06000	VÁLVULA DE BARRIDO		
132	951232 00000	TORNILLO DE CIERRE		
133	951224 00000	TORNILLO DE CIERRE		
200	568000 27300	PIEZAS DE FIJACIÓN DE LA CUBIERTA FRONTAL (KIT)		

¹⁾ cantidad necesario / mantenimiento

- ÍNDICE	Pos.	No. De pedido	Descripción	
VT 4.16	15	020000 16300	ÉMBOLO	
	16	016800 16300	ARANDELA TENSORA	
	17	911009 00000	ANILLO DE TOLERANCIA STAR	
	18	949203 00000	POLEA DENTADA	
	19	945320 00000	TORNILLO HEXAGONAL INTERIOR	
	21	000105 16300	CARCASA	
	23	945321 00000	TORNILLO HEXAGONAL INTERIOR	
	24	901347 00007	EMPUJADOR DE CARBÓN (KIT)	
	28	000705 16300	TAPA LATERAL	
	29	945372 00000	TORNILLO HEXAGONAL INTERIOR	
	30	008901 16300	JUNTA	
	61	004800 27400	TAPA DE FILTRO	
	67	009000 16300	MUELLE DE PRESIÓN	
	69	952009 00000	CASQUILLO TENSOR	
	72	909519 00000	CARTUCHO DE FILTRO (1x)¹⁾	
	76	945325 00000	TORNILLO HEXAGONAL INTERIOR	
	77	948021 00000	ANILLO DE JUNTA	
	78	913161 00000	JUNTA TÓRICA	
	83	006800 27400	CUBIERTA DEL APARATO	
	84	060901 16300	TIRAS DE AMORTIGUACIÓN	
85	741310 50000	AMORTIGUADOR DE GOMA		
86	949402 00000	ARANDELA		
87	947001 00000	TUERCA HEXAGONAL		
88	006801 27400	CUBIERTA FRONTAL		
91	951922 00000	PIEZA DE ORMA DE GOMA		
94	015100 27400	PIE DE MOTOR		
95	951921 00000	PIEZA DE ORMA DE GOMA		
96	068000 27600	PIEZA DISTANCIADORA		
97	945323 00000	TORNILLO HEXAGONAL INTERIOR		
98	949451 00000	ARANDELA		
102	968104 00000	PIEZA DE GOMA DISTANCIADORA		
103	029600 16300	BULÓN		
124	736001 99613	VÁLVULA REGULADORA DE VACÍO		
128	727502 06000	VÁLVULA DE BARRIDO		
132	951232 00000	TORNILLO DE CIERRE		
133	951224 00000	TORNILLO DE CIERRE		
200	568000 27300	PIEZAS DE FIJACIÓN DE LA CUBIERTA FRONTAL (KIT)		

¹⁾ cantidad necesario / mantenimiento

VT 4.10/XX VT 4.16/XX	Variante 	Pos. ²⁾	Bestell Nr. / Ident No. / No. Identification / No. Identificazione / No. De pedido		Beschreibung / Description / Designation / Designazione / Desripcion
			  	  	
VT 4.10					
① 1~ Einphasenwechselstrom 1~ single-phase AC 1~ AC monophasé 1~ AC monofase 1~ AC monofásica		5	964233 00000		WINKEL / BRACKET / SUPPORT / SUPPORTO / SOPORTE
		6	945204 00000		SECHSKANTSCHRAUBE / HEX-HEAD SCREW / VIS HEXAGONALE / VITE ESAGONALE / TORNILLO DE CABEZA HEXAGONAL
		7	947102 00000		MUTTER / NUT / ECROU / DADO / TUERCA
		8	742002 40000		KABEL / CABLE / CABLE / CAVO / CABLE
		82	006802 27300		HAUBE / PROTECTING HOOD / CARTER PROTECTEUR / CARTER DI PROTEZIONE / CAPERUZA
		83		006800 27300	HAUBE / PROTECTING HOOD / CARTER PROTECTEUR / CARTER DI PROTEZIONE / CAPERUZA
VT 4.16					
② 1~ Einphasenwechselstrom 1~ single-phase AC 1~ AC monophasé 1~ AC monofase 1~ AC monofásica		5	964233 00000		WINKEL / BRACKET / SUPPORT / SUPPORTO / SOPORTE
		6	945204 00000		SECHSKANTSCHRAUBE / HEX-HEAD SCREW / VIS HEXAGONALE / VITE ESAGONALE / TORNILLO DE CABEZA HEXAGONAL
		7	947102 00000		MUTTER / NUT / ECROU / DADO / TUERCA
		8	742002 40000		KABEL / CABLE / CABLE / CAVO / CABLE
		82	006802 27400		HAUBE / PROTECTING HOOD / CARTER PROTECTEUR / CARTER DI PROTEZIONE / CAPERUZA
		83		006800 27400	HAUBE / PROTECTING HOOD / CARTER PROTECTEUR / CARTER DI PROTEZIONE / CAPERUZA
③ /0-34 1~ mit erhöhter Volumenstrom 1~ with increased volume flow rate 1~ avec débit volume augmentée 1~ con flusso in volume aumentata 1~ con flusso in volume aumentata		5	964233 00000		WINKEL / BRACKET / SUPPORT / SUPPORTO / SOPORTE
		6	945204 00000		SECHSKANTSCHRAUBE / HEX-HEAD SCREW / VIS HEXAGONALE / VITE ESAGONALE / TORNILLO DE CABEZA HEXAGONAL
		7	947102 00000		MUTTER / NUT / ECROU / DADO / TUERCA
		8	742002 40000		KABEL / CABLE / CABLE / CAVO / CABLE
		21	000107 16300		GEHÄUSE / PUMP BODY / CORP DE POMPE / CARCASSA / CARCASA
		82	006802 27400		HAUBE / PROTECTING HOOD / CARTER PROTECTEUR / CARTER DI PROTEZIONE / CAPERUZA
		83		006800 27400	HAUBE / PROTECTING HOOD / CARTER PROTECTEUR / CARTER DI PROTEZIONE / CAPERUZA

²⁾ variantenabhängige Bauteile / variant-dependent components / composants variante-dependantes / componenti variante-dispendenti / componentes variante-dependientes