

livinggreen design



www.livingreendesign.com

exclusive planters for professionals 2012/2013

livinggreen
design



livinggreen Intro

At Livinggreen Design we take pride in taking a different approach. Instead of outsourcing our production to the far east with the inherent supply problems that result, we decided to concentrate on producing all our products ourselves, here in the UK. In this catalogue EVERY planter featured is handmade to order by our own highly experienced and skilled labour force, giving us control over every stage of the production process and allowing us to offer reliable lead times, full quality control and a simply huge range of finishing options.

Our range is all designed in house or in collaboration with professional designers who see the endless possibilities our methods and material provide. Rather than focus on one aspect of the market we have products at every price range and style from classical to cutting edge modern design. All Livinggreen planters are suitable for both interior and exterior use being both waterproof and frostproof, while our finishes are UV resistant and durable. In this catalogue we are introducing both silver and gold leaf as well our new Dapple and Vintage paint finishes

A material for the modern world, we work only with our own formulation of fibreglass (GRP) which we describe as Advanced Composite, in reference to the additions and alterations we make to the raw material in order to achieve the strength, quality and finishing that is the hallmark of our work. Very similar to the composites now used to manufacture race cars, airliners and wind turbines, AC is lightweight, super strong and capable of being formed into almost any shape – the perfect material for planter manufacture. See separate sections for more details, along with our excellent environmental credentials.

A large part of our business is the creation of bespoke planters to our clients' specification. We work with top European architects, landscape architects and garden & interior designers to achieve their vision on projects of every size. Some of these are illustrated in the bespoke section of this catalogue. We have full product design capability including CAD drawings & 3D modelling and regularly advise on the specification of planters suitable for use on roof gardens and with green roofs.

You can find this catalogue and our full range on our websites where it is now possible to order online and sign up for our newsletters which will keep you fully up to date with our new products as they are launched. If based outside the UK, you can order through one of our professional Agents who provide excellent service and now cover the whole of Europe and the Middle East. For regular customers we also provide a free customised web brochure and other marketing tools. Please telephone our fully trained Product Advisors for further details or if you want to discuss a potential bespoke project. And please don't hesitate to contact us direct – we love to talk planters!

Tony and Karen Sawyer
Directors, Livinggreen Design Ltd

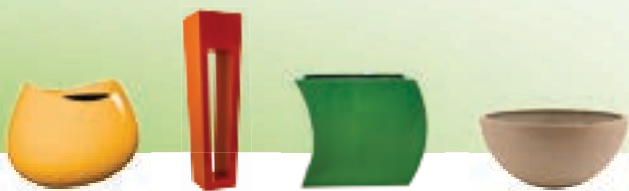

livinggreen Intro

Chez Livinggreen Design nous sommes fiers de prendre une approche différente. Au lieu de sous-traiter notre production à l'Extrême-Orient avec les problèmes d'approvisionnement qui en découlent, nous avons décidé de se concentrer sur la production de tous nos produits nous-mêmes, ici au Royaume-Uni. Dans ce catalogue CHAQUE bac est fait main sur commande par notre équipe de techniciens hautement qualifié et expérimenté, nous contrôlons chaque étape du processus de fabrication, ce qui nous permet d'offrir des délais fiables, de contrôler la qualité et de proposer une gamme complète, avec des possibilités et des options de finition tout simplement énorme.

Toutes nos références sont conçues en interne ou en collaboration avec des designers professionnels qui voient les possibilités infinies de nos méthodes et les matériaux. Plutôt que de se concentrer sur un seul aspect du marché, nous avons des produits à tous les niveaux de prix et de style, du classique au design modern. Tous les pots Livinggreen conviennent à la fois pour un usage à l'intérieur et à l'extérieur, étant à la fois imperméable et résistant au gel, tandis que nos finitions sont résistantes aux UV et durables. Dans ce catalogue nous présentons des nouveautés en finitions : de feuille d'argent et feuille d'or, ainsi que nos nouvelles finitions peintures - Moucheté et Vintage.

Un matériau pour le monde moderne, nous travaillons uniquement avec notre propre formulation de fibre de verre (GRP) que nous décrivons comme Advanced Composite, en référence aux ajouts et modifications que nous apportons à la matière première afin de parvenir à la force, la qualité et la finition qui est la marque de notre travail. Très semblable aux composites désormais utilisées pour fabriquer des voitures de course, les avions et les turbines éoliennes, AC est léger, super robuste et capable d'être moulé en presque n'importe quelle forme - le matériau idéal pour la fabrication de bac. Voir les autres chapitres pour plus de détails, ainsi que nos excellentes qualités environnementales.

Une grande partie de notre activité est la création de bacs sur mesure selon les spécifications de nos clients. Nous travaillons avec les plus grands architectes européens, des architectes paysagistes et concepteurs de jardins et d'aménagement intérieur pour réaliser leur vision sur des projets de toutes tailles. Certains d'entre eux sont illustrés dans la section sur mesure de ce catalogue. Nous avons la capacité de maîtriser depuis la conception des produits jusqu'à la livraison, y compris des dessins CAO et des modélisations 3D. Nous donnons régulièrement des conseils techniques sur la spécification des bacs pour les toit terrasses et les toitures plantées.

Vous pouvez trouver ce catalogue et notre gamme complète sur nos sites Web où il est maintenant possible de commander en ligne et vous inscrire à nos newsletters qui vous garderont complètement à jour avec nos nouveaux produits quand ils sont lancés. Si vous êtes en dehors du Royaume-Uni, vous pouvez contacter un de nos agents professionnels qui offrent un excellent service et couvrent désormais l'ensemble de l'Europe et le Moyen Orient. Pour nos clients habituels nous fournissons également une brochure web gratuite personnalisée et d'autres outils de marketing. Merci de téléphoner nos conseillers parfaitement formés, pour plus de détails ou si vous voulez discuter d'un projet potentiel sur mesure. N'hésitez pas à nous contacter directement, nous aimons parler pots!

Tony and Karen Sawyer
Directors, Livinggreen Design Ltd



livinggreen design

Our planters represent the best in UK design and manufacture. Although reflecting influences from Europe, Asia and the Americas we are proud to be innovators, developing ideas and themes and bringing them to life at our factories throughout Britain. Each planter is genuinely handcrafted and with literally hundreds of colours and finishes possible, our customers get bespoke products, made individually for their unique requirements.

In a world of mass produced identikit plastics, it's reassuring to know that through the use of our unique Advanced Composite (AC) formulation, we can manufacture striking designs of outstanding quality without compromise to availability or price. Indeed many of our Spirit ranges are less expensive than injection moulded equivalents and all are better value. The secret? Simply taking fibreglass as a base and adding modern materials and manufacturing techniques to create AC planters that are the perfect solution to every situation. Just look at these advantages:

- **All planters are suitable for both interior and exterior use**
- **Outstanding environmental credentials (see page 6)**
- **Ultra lightweight but as strong as steel**
- **Fully frostproof and UV stable**
- **Completely watertight but can be easily drilled for exterior use**
- **Every RAL and BS colour available in textured, polished and matt finishes**
- **Unique range of special 'Natural' finishes – metal, stone, terracotta, rust and ceramic finishes that look, feel and weather just like the real thing**
- **Can be specified as Class 0/Class 1 fire retardant**
- **Design your own! – AC is ideal for bespoke project work with any size or shaped planter possible (see page 222)**
- **Tree planters designs available off the shelf up to 2m square**

All our products are made by hand to the highest standards. We operate a rigid quality control policy to ensure that proper standards are maintained. Small variances can occur such as weight, the level of lustre in the finish and the flatness of the surface. Slight differences can happen when for example, the same model of planter is produced from two separate moulds, or the paint and texturing materials used, comes from a different batch. Such differences are rare and very small and are only the result of the hand made manufacturing process. Our technicians are highly trained and aim to produce a product with tolerances that are within the guidelines set out by our designers.

With water conservation ever more important we have spent the past 28 years developing and refining our own solution for planters, beds and fine turf, which has been independently tested and verified by Reading University's Horticultural Technology Unit. The result, "Tanker Irrigation" can cut water usage by a minimum of 35% and much more outdoors, while prolonging the period required between watering by 100%. Easy to fit and use Tanker is a natural choice for any new planting and is specified in the catalogue for each of our planters.





livinggreen design

Nos contenants constituent ce qui se fait de mieux en matière de conception et de fabrication entièrement britannique. Ils sont inspirés par de nombreuses influences tant européennes, asiatiques et américaines. Chaque contenant est véritablement fait à la main et peut être décliné en une multitude de couleurs et finitions possibles. Nos clients obtiennent ainsi un produit fait sur mesure parfaitement adapté à leurs projets.

Dans un monde dominé par l'usage des matières plastiques nous nous démarquons avec notre formule de AC – les composites avancés. Elle nous permet de concevoir des produits remarquables, de qualité exceptionnelle sans concession en termes de prix et de disponibilité. Nos contenants AC offre ainsi des solutions d'usages multiples et présentent de nombreux avantages:

- **Tous les bacs conviennent pour l'usage à l'intérieur à l'extérieur**
- **Ils présentent des qualités environnementales exceptionnelles (voir la page 7)**
- **Ils sont ultralégers mais plus robustes que l'acier**
- **Entièrement résistant au gel, aux UV et aux intempéries**
- **Complètement étanche mais pouvant être percés pour un usage à l'extérieur**
- **Chaque couleur RAL et BS disponibles dans des finitions texturées, polie et matte**
- **La gamme unique de finitions réalistes 'Naturel' – le métal, la pierre, la terre cuite, la rouille, les finitions qui ressemblent à la vraie matière**
- **Peut-être classé en incombustible MO et non-inflammable M1**
- **Concevez le votre! – le AC est idéal pour les projets sur mesure décliné en taille, en forme et en finition (voir la page 222)**
- **Les bacs à arbres de grandes tailles sont disponibles en stock jusqu'à 2 mètres**

Tous nos produits sont fabriqués à la main aux normes les plus exigeantes. Nous exigeons une qualité contrôlée stricte afin de maintenir ces normes.

Néanmoins des petites variations peuvent survenir telles que le poids, le niveau de brillance dans la finition et la planéité de la surface. Ces légères différences peuvent se produire lorsque, par exemple, le même modèle de bac est fabriqué à partir de deux moules séparés, ou la peinture utilisée provient d'un lot différent.

Ces différences sont rares et très petites et ne sont que le résultat du processus de fabrication à la main. Nos techniciens sont hautement formés et visent à produire un produit avec des tolérances qui sont dans les lignes directrices énoncées par nos designers.

Avec la nécessité croissante d'économiser l'eau, nous avons développé depuis 25 ans une solution pour les bacs, jardins et gazon, validée par l'unité horticole de l'université de Reading en Angleterre. La réserve d'eau, 'Tanker', permet d'économiser au moins 35% de l'eau d'arrosage voire plus en extérieur, tout en nécessitant deux fois moins d'arrosage. D'une adaptation et d'un usage facile, la réserve d'eau est un choix naturel pour les nouvelles plantations et nous la prescrivons dans notre catalogue pour chacun de nos pots.



environment and ethics

In choosing Livinggreen Design planters you are making a sound environmental and ethical choice.

In comparison to other planter materials such as plastic, ceramics, metals and wood, AC offers many environmental advantages, not least because many of these products are manufactured in Asia and imported with the resulting larger Carbon Footprint and ethical uncertainty this brings.

Manufacturing

AC planters are based on fibreglass, a composite of plastic resins and glass fibres. Glass is of course made from silica, the most common mineral on Earth. Typically, an AC planter is only 2 - 3mm thick, with the plastic element only one third of this. Compare this to an injection moulded plastic product which needs to be double walled and you realise that AC planters contain at most a tenth of the plastic of these. AC planters are made by hand at room temperature using a chemical process and the only machinery required are hand tools for the finishing process. Compare this to plastics and metals where massive inputs of heat and machinery are required and you quickly see the energy inputs into AC planter production are miserly. Even ceramics require machinery to extract the clay and huge furnaces to power the kilns – so it's no surprise in Asia to find these placed nearby forests as a plentiful source of wood.

Ethical Production

Our AC planters are manufactured in the UK under European Health and Safety Legislation. Our craftsmen are necessarily well paid and subject to regular health checks. All waste is disposed of under environmental legislation. By contrast, most other planters sold in Europe to professional landscapers have been sourced in Vietnam, the Philippines, Malaysia, India and China. Can we be sure equivalent standards are in place?

Carbon Footprint

Made in the UK and ultra lightweight, AC planters travel far fewer miles and require less energy per mile than much heavier clay and metal imports. As detailed above, the energy used in production is also minimal.

Recycling

Firstly, all our AC planters can be returned to us for repair and refinishing to an as new condition. The only reason to ever throw one of these planters away is if the design has become so obsolete it is unusable. Should disposal be the only option then full recycling is now possible thanks to processes developed for the automotive industry. Glass fibres can be reclaimed chemically from the waste and reused in insulation products. Also the product can be ground down and is commercially used both as an element of new road construction and in industrial roofing products.

It's worth pointing out that much of the glass fibre matting used in production of AC planters is itself made from recycled glass!



environnement et éthique

En choisissant les contenants 'Livinggreen Design' vous faites un choix environnemental et éthique. Contrairement à d'autres matériaux pouvant constituer un bac comme le plastique, la céramique, les métaux et le bois, généralement fabriqué en Asie, AC offre des avantages environnementaux: Les produits sont recyclables, durables, réparables, légers et fabriqués au Royaume-Uni, donc ils possèdent une empreinte de carbone réduite par rapport aux produits importés d'Asie.

Fabrication

Des bacs AC sont basés sur l'utilisation d'un composite de fibre de verre, obtenu à partir de la Silice, que l'on trouve abondamment sur terre. L'épaisseur d'un bac AC est généralement de 2 à 3 mm. Les bacs AC sont faits à la main à la température ambiante, les seules machines nécessaires sont des outils à main pour réaliser les finitions.

Production éthique

Nos contenants AC sont fabriqués au Royaume Uni dans le cadre de la législation européenne en termes de santé et de sécurité. Nos artisans sont correctement payés et sont régulièrement contrôlés par des inspections sanitaires. Les pertes et les chutes sont traitées selon la législation environnementale.

Empreinte de pas de carbone

Fabriqués au Royaume-Uni et ultralégers, les bacs AC voyagent moins et consomment moins d'énergie par KM que des pots importés fabriqués avec des matériaux plus lourds en céramique ou en métal.

Recyclage

Tous nos bacs AC peuvent être renvoyés afin d'être réparés, ils retrouvent alors leur aspect neuf. Au cas où la suppression d'un bac serait toutefois nécessaire, il est maintenant possible de le recycler entièrement. La fibre de verre broyée peut entrer dans la composition des structures de voiries, des éléments d'isolation ou de toiture préfabriquées. D'ailleurs, une part importante des plaques de fibres de verre utilisées dans la production des bacs AC est déjà elle-même fabriquée à partir de verre recyclé.



Credits

We would like to thank everyone who helped to make this brochure possible. Without the help of our friends, colleagues and customers it would not be feasible to produce a catalogue in this form, particularly in relation to the onsite photography. We have made every attempt to ensure that everyone who supplied photographs or gave help of any sort is credited below but if we have forgotten someone or made a mistake we apologise and would ask for corrections which will be posted on the website.

Please note that all photographs and designs are the copyright of Livinggreen Design unless detailed otherwise below and may not be reproduced in any form without the permission of the copyright holder. Please contact our sales office for clarification if required.

Planter Designs

All planters in the Livinggreen Design range were designed in house by our own design team of Dorian Hope, Karen Sawyer and Tony Sawyer with help from Francesca Attala except for the following.

Wave Attala Creations
Easter Island Attala Creations
U.N.C Attala Creations

Contact: www.22-degres.com email: fran@22-degres.com.
Tel: +33 (0) 6 62 76 55 41

Terraces Derek Hodgson Associates
Contact: Derek Hodgson. Tel: +44 (0) 131 343 1919

Please note the Design Rights for the planters belong to Livinggreen Design or the Designers above as appropriate. Copying of any of the designs may be a criminal offence.

Picture Credits

Livinggreen Design is the copyright owner of all the photographs in the catalogue with the exception of those on the following pages which were kindly supplied by our Customers as detailed below:

p12 Floratec,	p38 22 DEGRES,	p136 AMBIUS France,
p12 SAVI,	p39 JARDINS DE GALLY,	p138 JARDINS DE GALLY,
p12 AMBIUS France,	p39 22 DEGRES,	p138 JARDINS DE GALLY,
p12 AMBIUS France,	p40 AMBIUS France,	p138 AMBIUS France,
p12 Green Team Interiors,	p40 AMBIUS France,	p139 Brighton Botanical,
p13 22 DEGRES,	p40 AMBIUS France,	p139 AMBIUS France,
p13 AMBIUS France,	p41 AMBIUS France,	p140 In-plants Scotland,
p14 Brighton Botanical,	p41 AMBIUS France,	p142 In-plants Scotland,
p12 Green Team Interiors,	p46 Plantforce,	p142 Green Team Interiors,
p15 AMBIUS France,	p47 AMBIUS France,	p143 PLANTFORCE,
p15 JARDINS DE GALLY,	p47 AMBIUS France,	p148 AMBIUS France,
p16 Green Team Interiors,	p48 22 DEGRES,	p148 22 DEGRES,
p18 22 DEGRES,	p48 22 DEGRES,	p149 AMBIUS France,
p18 ATTALA CREATIONS,	p48 JARDINS DE GALLY,	p150 AMBIUS France,
p18 22 DEGRES,	p50 NODAL SOLUTIONS,	p150 22 DEGRES,
p19 JARDINS DE GALLY,	p50 AMBIUS France,	p151 AMBIUS France,
p19 Garden House Design,	p50 AMBIUS France,	p158 AKISTUDIO,
p20 Plantforce,	p51 AMBIUS France,	p160 AMBIUS France,
p20 Plantforce,	p53 AMBIUS France,	p161 In-Plants Scotland,
p21 ATTALA CREATIONS,	p58 AMBIUS France,	p164 22 DEGRES,
p21 22 DEGRES,	p60 AMBIANCE France,	p165 Fiona Stephenson
p29 GreenTeam Interiors,	p64 Elen Green S.R.O,	Garden Designs,
p30 SAVI,	p65 Elen Green S.R.O,	p167 AMBIUS France,
p30 JARDINS DE	p66 JARDINS DE GALLY,	p167 AMBIUS France,
L'ORANGERIE,	p74 AMBIUS France,	p169 AMBIUS France,
p30 22 DEGRES,	p83 EXOPLANTES,	p170 L'ILE AUX FLEURS,
p31 Brighton Botanical,	p99 JARDINS DE GALLY,	p170 JARDIN EN
p31 ATTALA CREATIONS,	p118 Mathew Childs	CAPITALE,
p33 ATTALA CREATIONS,	Garden Design,	p170 In-Plants Scotland,
p36 AMBIANCE France,	p133 22 DEGRES,	p171 EXOPLANTES,
p37 EXOPLANTES,	p134 AMBIUS France,	p173 22 DEGRES,
p37 JARDINS DE	p134 AMBIUS France,	p173 22 DEGRES,
L'ORANGERIE,	p135 AMBIUS France,	p217 Plant Designs,
p37 22 DEGRES,	p135 AMBIUS France,	p218 AMBIUS France,
p37 AMBIUS France,	p135 L'ILE AUX FLEURS,	p222 EXOPLANTES,
p37 Mitie Landscapes,	p135 Abbiss Landscapes,	p223 Metagardens Garden
p38 GP plantscape,	p135 EXOPLANTES,	Design,
p38 EXOPLANTES,	p135 DIYAR architects,	p225 Goddards Landscape,
p38 AMBIUS SWEDEN,	p136 EXOPLANTES,	p237 PINSON PAYSAGES.

The majority of the photomontages in this catalogue were produced by Francesca Attala of Attala Creations and 22-degres (see details above) specifically on pages 13,15,16,17,22,49,58,67,68,69,70,71,72,73,74,75,78,79,86,87,89,97,101,106,109,113,126,136,140,141,145,146,147,148,149,151,153,155,156,157,162,163,171,172,186,190,192.

Other photomontages by Gordon McBryde and Caleb Rutherford.

Brochure Credits

Thanks to the following for providing photography locations:
Miller Homes, Zenith Structural Ltd & Kinnarps.

French Translations: Francesca Attala

Graphic design: Caleb Rutherford, eidetic
Contact: caleb@eidetic-design.co.uk Tel: +44 (0) 131 337 9724 Edinburgh

Printed in Scotland, UK by Scotprint, Haddington

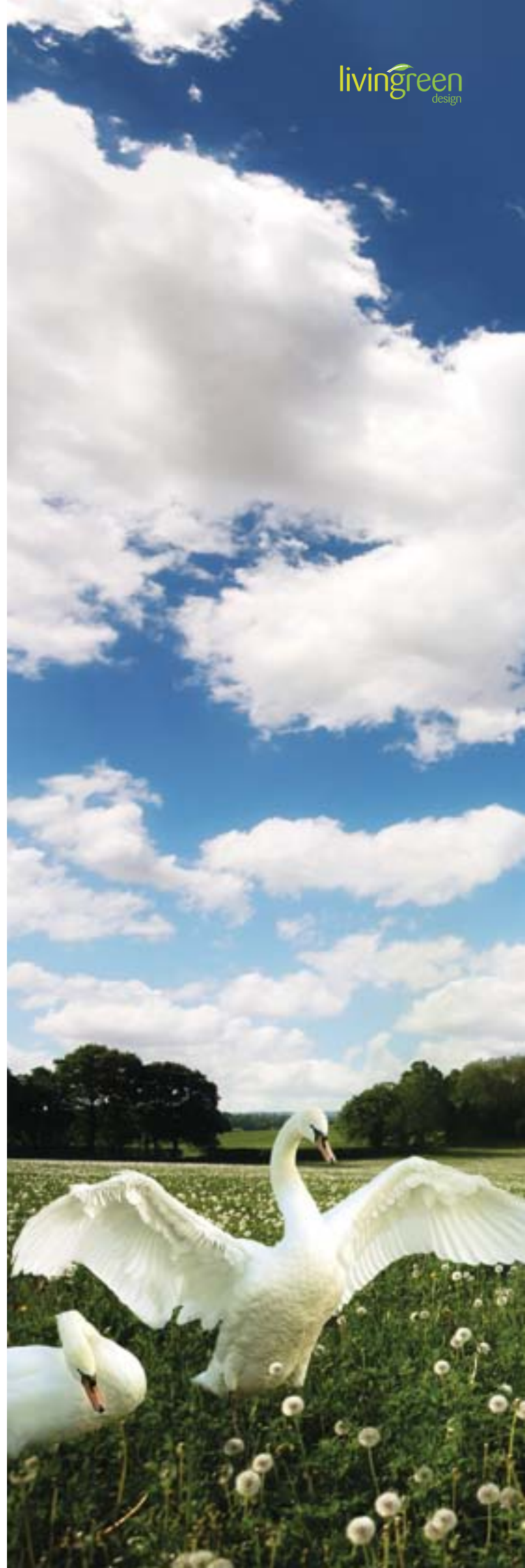

contents

Introduction	2
Environment and ethics	6
Spirit range	10
Curvy range	34
Holey Design range	56
Avant-garde range	62
Luna range	104
Pedestals, bowls + urns	110
Geo Design range	132
Ceramic Style	152
Garden Classics range	176
Terraces	206
Tree planters	212
Replica rocks	219
Bespoke design	222
Tanker Irrigation	228
Planter options	236
Index	240
Colours + Finishes	242

spirit

Express yourself with this unbeatable range of top quality but price competitive planters that are designed to complement each other. Each collection features trademark Spirit styling cues – curved corners, the same angle of taper and wide feature lips. Mix and match across the range and free your design Spirit.

New! Kubik and Cylik LITE. Best selling sizes of these popular ranges redefined and redesigned for an even more cost effective solution. Great design for larger scale projects without compromise on colours or quality of finish. The real thing... but LITE!

Exprimez-vous avec cette gamme imbattable de bacs de bonne qualité à des prix compétitifs qui sont conçus pour se compléter. Chaque collection de la marque, Spirit, possède les détails conforme à cette gamme – angles arrondis, même angle pour les bacs évasés et les bords larges.

Nouveau ! Kubik et Cylik LITE. Les tailles les plus vendues redessinées et repensées pour une solution encore plus économique. Conçus pour des projets plus importants, sans compromis sur la qualité, des couleurs ou des finitions. Toujours la qualité de l'original disponible désormais en LITE!





spirit

kubik

The ubiquitous classic. Use it everywhere.

Le classique unique. Employez-le partout.



Colours + Finishes

BS4800 and RAL Classic: Full colour range in polished gloss, satin, matt and textured matt finishes.

Standard colours: All finishes.

Polished Metallics: All finishes.

Textured Metallics: All finishes.

Polished Pearlescents: All finishes.





Polished Stardust: All finishes.

Natural: All finishes.

Dapple and Vintage: All finishes.

See page 242 for all colour and finish options.



Code	  	
KUDT1	230 x 230 x 250mm	TMS1
KU1	340 x 340 x 600mm	TWC3
KU2	420 x 420 x 800mm	TWC4
KU3	500 x 500 x 950mm	TWC6+
KU4	550 x 550 x 1200mm	TWC6+



cylik

Fluted vase complement to Cirkik.

Grand vase évasé.



Colours + Finishes

BS4800 and RAL Classic: Full colour range in polished gloss, satin, matt and textured matt finishes.

Standard colours: All finishes.

Polished Metallics: All finishes.

Textured Metallics: All finishes.

Polished Pearlescents: All finishes.



Polished Stardust: All finishes.

Natural: All finishes.

Dapple and Vintage: All finishes.

See page 242 for all colour and finish options.



Code	 	
CYL1	340 x 600mm	TWC3
CYL2	420 x 800mm	TWC4
CYL3	500 x 950mm	TWC6+
CYL4	550 x 1200mm	TWC6+
CYL5	560 x 1500mm	TWC6+



kubik lite & cylik lite

Redesigned & Redefined. Slightly smaller, lighter with new lip detail. Even better value with no compromise on quality or finish. Match with original Kubik and Cylik for other sizes.

Redessiné et redéfinie. Légèrement plus petit, plus léger avec un bord modifié. Plus économique sans compromis sur la qualité ou la finition. Assortis avec les Kubik et Cylik d'origine pour les autres tailles.



Colours + Finishes

BS4800 and RAL Classic: Full colour range in polished gloss, satin, matt and textured matt finishes.

Standard colours: All finishes.

Polished Metallics: All finishes.

Textured Metallics: All finishes.

Polished Pearlescents: All finishes.

Polished Stardust: All finishes.

Natural: All finishes.

Dapple and Vintage: All finishes.

See page 242 for all colour and finish options.



Code				
CYLT1	300 x 545	230mm	TWC2	
CYLT2	385 x 720	300mm	TWC3	

Code					
KULT1	300 x 300 x 545	230 x 230mm	TWC2		
KULT2	385 x 385 x 720	300 x 300mm	TWC3		



cirkik

Modern, clean and curvaceous. Desk top to tree planter.

Moderne et rond pour un bureau jusqu'aux grands spécimens.



Colours + Finishes

BS4800 and RAL Classic: Full colour range in polished gloss, satin, matt and textured matt finishes.

Standard colours: All finishes.

Polished Metallics: All finishes.

Textured Metallics: All finishes.

Polished Pearlescents: All finishes.

Polished Stardust: All finishes.

Natural: All finishes.

Dapple and Vintage: All finishes.

See page 242 for all colour and finish options.



Code	 	
CIR1	235 x 200mm	TMS1
CIR2	420 x 420mm	TWC4
CIR3	520 x 500mm	TWC6
CIR4	620 x 580mm	TWC8
CIR5	720 x 680mm	TWC10
CIR6	900 x 850mm	TWC12



quadik

Quirky and unconventional with bold rounded corners.

Cubique et original avec angles arrondis.



Colours + Finishes

BS4800 and RAL Classic: Full colour range in polished gloss, satin, matt and textured matt finishes.

Standard colours: All finishes.

Polished Metallics: All finishes.

Textured Metallics: All finishes.

Polished Pearlescents: All finishes.

Polished Stardust: All finishes.

Natural: All finishes.

Dapple and Vintage: All finishes.

See page 242 for all colour and finish options.



Code	  	
QUAD1	235 x 235 x 200mm	TMS1
QUAD2	420 x 420 x 420mm	TWC4
QUAD3	480 x 480 x 480mm	TWC6
QUAD4	600 x 600 x 580mm	TWC8
QUAD5	700 x 700 x 700mm	TWC10
QUAD6	900 x 900 x 900mm	TWC12



quadik plus

Be unconventional for longer. Tall with optional feature Hot Lip and planting insert.

Original et pratique. Avec l'accessoire 'Hot lips- bac de plantation' en option.



Colours + Finishes

BS4800 and RAL Classic: Full colour range in polished gloss, satin, matt and textured matt finishes.

Standard colours: All finishes.

Polished Metallics: All finishes.

Textured Metallics: All finishes.

Polished Pearlescents: All finishes.

Polished Stardust: All finishes.

Natural: All finishes.

Dapple and Vintage: All finishes.

See page 242 for all colour and finish options.



Code

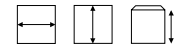

QUADPLO1

330 x 330 x 600mm

TWC3

QUADPLO2

430 x 430 x 800mm

TWC4



quadik plus hot lip inserts

Introducing a new concept for planting convenience and style. The Quadik Plus Hot Lip inserts make planting up simplicity itself. Assemble the Tanker irrigation, drop in and surround with compost – then plant as normal. The liners can be planted off site and simply dropped into each planter in the building to make a fantastic display that can be installed by a single technician without the need for full high top van transport. Better still, the Hot Lip feature means you can specify a different colour lip from the planter body and choose from flat or curved lips. Personalise each building floor with different colours, match interior decor combinations or reflect company logos – the possibilities are endless as you can specify Hot Lip in any RAL colour or any of our unique finishes. Hot Lip inserts are fantastic too for flowering plant changes – letting you plant up your replacements off site and simply swapping the inserts over on site with no mess and minimum time wasted.

Présentant un nouveau concept pour planter avec efficacité et style. Le 'Quadik Plus - Hotlips' fait de la plantation la simplicité elle-même. Assemblez et placez la réserve d'eau, 'Tanker', dans le bac et ajouter le terreau, terminez la plantation. Les bacs de plantation peuvent être préparés à l'avance et simplement posés dans chaque bac sur place. 'Hot lips' est disponible en toutes les couleurs RAL ou en finition 'Naturel', en version plate ou bombée. Il peut être assorti ou pas avec le bac. Personnalisez chaque étage d'un immeuble en différentes couleurs, créez des bacs avec le logo d'une entreprise ou assortissez avec une décoration intérieure.



Colours + Finishes

BS4800 and RAL Classic: Full colour range in polished gloss, satin, matt and textured matt finishes.

Standard colours: All finishes.

Polished Metallics: All finishes.

Textured Metallics: All finishes.

Polished Pearlescents: All finishes.

Polished Stardust: All finishes.

Natural: All finishes.

Dapple and Vintage: All finishes.

See page 242 for all colour and finish options.



Curved Lip Insert

Code	Diagram	Dimensions	Icon	Code
QDPLHLC01		343 x 343 x 370mm		TWC3
QDPLHLC02		445 x 445 x 420mm		TWC4



Flat Lip Insert

Code	Diagram	Dimensions	Icon	Code
QDPLHLF01		343 x 343 x 360mm		TWC3
QDPLHLF02		445 x 445 x 405mm		TWC4



Hot Lip inserts can be specified in any colour or finish. Here are a few examples but the possibilities are endless.

trifik

Truly terrific, space saving triangles with many combinations possible.

Triangles arrondis pour gagner de la place avec d'innombrables possibilités modulables.



Colours + Finishes

BS4800 and RAL Classic: Full colour range in polished gloss, satin, matt and textured matt finishes.

Standard colours: All finishes.

Polished Metallics: All finishes.

Textured Metallics: All finishes.

Polished Pearlescents: All finishes.





Polished Stardust: All finishes.

Natural: All finishes.

Dapple and Vintage: All finishes.

See page 242 for all colour and finish options.



Code	  	
TRIF01	310 x 333 x 540mm	TWC3
TRIF02	414 x 440 x 725mm	TWC4
TRIF03	516 x 547 x 855mm	TWC4



towik + linbar

Barriers and columns with soft curved edging. Use singly or in combinations.

Barrières et colonnes avec angles arrondis. Employez séparément ou en combinaisons modulaires.



Colours + Finishes

BS4800 and RAL Classic: Full colour range in polished gloss, satin, matt and textured matt finishes.

Standard colours: All finishes.

Polished Metallics: All finishes.

Textured Metallics: All finishes.

Polished Pearlescents: All finishes.





Polished Stardust: All finishes.





Natural: All finishes.

Dapple and Vintage: All finishes.

See page 242 for all colour and finish options.



Code	  	
TOK1	350 x 350 x 600mm	TWC4
TOK2	350 x 350 x 900mm	TWC4
TOK3	350 x 350 x 1200mm	TWC4

Code	  	
LINBAR1	900 x 350 x 900mm	TMS8
LINBAR2	1200 x 350 x 900mm	TMS10



linik planter + linik tall + bowl

New Link Tall barriers complete the Link trough and bowl selection. All complement the full Spirit range.

Nouveau Linik haut qui complète cette gamme existante avec la jardinière et les coupes. Tous sont assortis avec la gamme Spirit.



Colours + Finishes

BS4800 and RAL Classic: Full colour range in polished gloss, satin, matt and textured matt finishes.

Standard colours: All finishes.

Polished Metallics: All finishes.

Textured Metallics: All finishes.

Polished Pearlescents: All finishes.

Polished Stardust: All finishes.

Natural: All finishes.

Dapple and Vintage: All finishes.

See page 242 for all colour and finish options.







Linik Tall











Linik planter



Linik bowl

Code	  	
LINT1	750 x 300 x 450mm	TMS6
LINT2	750 x 300 x 700mm	TMS6

Code	  	
LIN1	500 x 200 x 200mm	TMS4
LIN2	1000 x 300 x 300mm	TMS8
LIN3	750 x 300 x 300mm	TMS6
LIN4	930 x 200 x 200mm	TMS8

Code	  	
LINBOW1	340 x 340 x 150mm	TMS2



ashaway & trashaway

Fire retardant Kubik planters featuring a high quality, simple to clean, stainless steel ashtray. A second ashtray can be fitted on request.

New Trashaway features both ashtray and a capacious bin. Trashaway only available in textured finishes.

Bacs Kubik ignifugés disposant d'un cendrier en inox de grande qualité, facile à nettoyer et vider avec une clé universelle. Un deuxième cendrier peut être rajouté sur demande.

Nouveau Trashaway offre à la fois un bac, un cendrier et une poubelle d'une grande capacité. Trashaway, en résine non feu, est disponible uniquement en finition texturée.



Colours + Finishes

BS4800 and RAL Classic: Full colour range in polished gloss and textured matt finishes.

Standard colours: All finishes.

Polished Metallics: Silver and graphite.

Textured Metallics: All finishes.

Natural: All finishes.

See page 242 for all colour and finish options.



Ashaway



Trashaway

Code		
ASHPL01	420 x 420 x 800mm	TWC4
ASHTR01	Additional ashtray	

Code		
TRAWY01	420 x 420 x 800mm	TWC4



Trashaway showing interior bin

classic

curves

Our signature range. Award winning, in house design and protected by European Design Right Registration. A true celebration of Curves, inspired by the Glamour of Marilyn Monroe, Bridget Bardot, Jayne Russell and now by Sophia Loren and Ursula Andress.

Curvy is fantastically flexible, use singularly as planters or sculptural pieces or in a multitude of combinations to make design walls or feature displays. Specify bold colour and add your own holes (see Holey Design). The important thing is... have fun!!

Notre gamme de signature, primée, conception originale et protégée par 'European Design Right'. Une véritable célébration de courbes, inspiré par le glamour de Marilyn Monroe, Brigitte Bardot, Jayne Russell et maintenant par Sophia Loren et Ursula Andress aussi.

La gamme Curvy est parfaitement modulable, utilisez seule comme une pièce sculpturale, sinon dans une multitude de combinaisons pour créer des écrans architecturaux. Précisez une couleur audacieuse et ajouter vos propres vides, voir des trous dans 'Holey design'... amusez-vous!





curvy

curvy

fun, funky shapes best in bold, bright colours



Ludique, des formes tendances réussies dans les couleurs vives



marilyn

The classic curve. Award-winning design.

Protected by full European Design Registration No 000821970-0003.

La courbe classique. Lauréat du prix de design. Protégé par le brevet No. 000821970-0003 European Design Registration.



Colours + Finishes

BS4800 and RAL Classic: Full colour range in polished gloss, satin, matt and textured matt finishes.

Standard colours: All finishes.

Polished Metallics: All finishes.

Textured Metallics: All finishes.

Polished Pearlescents: All finishes.

Polished Stardust: All finishes.





Natural: All finishes.

Dapple and Vintage: All finishes.

See page 242 for all colour and finish options.

Gold and Silver leaf finishes available



Code	  	
CURMA01	350 x 350 x 600mm	TWC4
CURMA02	350 x 350 x 900mm	TWC4
CURMA03	350 x 350 x 1200mm	TWC4



curvy s planters

Sculptural and elegant, planting is optional in the ultimate Curvy S and Double S. Make a statement with the monumental Curvy S XXL.

Sculptural et élégant, la plantation est facultative pour le Curvy S et Double S. Démarquez-vous avec la monumentale XXL Curvy S.



Colours + Finishes

BS4800 and RAL Classic: Full colour range in polished gloss, satin, matt and textured matt finishes.

Standard colours: All finishes.

Polished Metallics: All finishes.

Textured Metallics: All finishes.

Polished Pearlescents: All finishes.

Polished Stardust: All finishes.





Natural: All finishes.





Dapple and Vintage: All finishes.

See page 242 for all colour and finish options.

Gold and Silver leaf finishes available



Code	  	
CURS01	350 x 350 x 1200mm	TWC3
CURS02	350 x 350 x 1500mm	TWC3
CURS03	350 x 350 x 1800mm	TWC3
CURDS01 (Double S)	350 x 350 x 1800mm	TWC3

Code	  	 
CURSXXL01	700 x 700 x 1800	620 x 620mm TWC12



Curvy S XXL polished brilliant white with airbrush logo



Curvy S 02 polished pearlescent purple Holey Design p56

sophia

Classically elegant and architectural. Repeat for impact.

Classique, élégant et architectural. Répétez pour un impact visuel.



Colours + Finishes

BS4800 and RAL Classic: Full colour range in polished gloss, satin, matt and textured matt finishes.

Standard colours: All finishes.

Polished Metallics: All finishes.

Textured Metallics: All finishes.

Polished Pearlescents: All finishes.

Polished Stardust: All finishes.

Natural: All finishes.

Dapple and Vintage: All finishes.

See page 242 for all colour and finish options.

Gold and Silver leaf finishes available



Code



CURSOP01	260 x 350 x 600	170 x 260mm	TMS2
CURSOP02	350 x 350 x 900	260 x 260mm	TWC4
CURSOP03	460 x 350 x 1200	360 x 260mm	TWC4



ursula

A natural compliment to Sophia for features or walls.

Une partenaire naturelle pour Sophia, en solo ou pour créer des barrières.



Colours + Finishes

BS4800 and RAL Classic: Full colour range in polished gloss, satin, matt and textured matt finishes.

Standard colours: All finishes.

Polished Metallics: All finishes.

Textured Metallics: All finishes.

Polished Pearlescents: All finishes.

Polished Stardust: All finishes.

Natural: All finishes.

Dapple and Vintage: All finishes.

See page 242 for all colour and finish options.

Gold and Silver leaf
finishes available



Code				
CURURS01	510 x 350 x 600		260 x 260mm	TWC4
CURURS02	590 x 350 x 900		260 x 260mm	TWC4
CURURS03	670 x 350 x 1200		260 x 260mm	TWC4



bridget

Beautiful interlocking barriers that combine with Marilyn, Ursula and Sophia for funky features and stylish screening.

Protected by full European Design Registration No 000821970-0002 + 000821970-0001.

Belles barrières modulables qui se combinent avec Marilyn, Ursula et Sophia pour créer des cloisons design et actuelles.



Colours + Finishes

BS4800 and RAL Classic: Full colour range in polished gloss, satin, matt and textured matt finishes.

Standard colours: All finishes.

Polished Metallics: All finishes.

Textured Metallics: All finishes.

Polished Pearlescents: All finishes.

Polished Stardust: All finishes.

Natural: All finishes.

Dapple and Vintage: All finishes.

See page 242 for all colour and finish options.

Gold and Silver leaf finishes available



CURBRI01 (out/out)



CURBRI02 (in/out)

Code

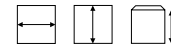

CURBRI01	900 x 350 x 900mm (out/out)	TMS8
CURBRI02	900 x 350 x 900mm (in/out)	TMS8
CURBRI03	900 x 350 x 600mm (out/out)	TMS8
CURBRI04	900 x 350 x 600mm (in/out)	TMS8





curvy s barrier

A sinuous curvaceous screen or stand alone highlight.

Un écran sinueux ou un élément seul courbe.

Colours + Finishes

BS4800 and RAL Classic: Full colour range in polished gloss, satin, matt and textured matt finishes.

Standard colours: All finishes.

Polished Metallics: All finishes.

Textured Metallics: All finishes.

Polished Pearlescents: All finishes.

Polished Stardust: All finishes.

Natural: All finishes.

Dapple and Vintage: All finishes.

See page 242 for all colour and finish options.

Gold and Silver leaf finishes available



Code

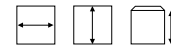

CURSB01

1200 x 350 x 700mm

TMS10

CURSB02

1200 x 350 x 1050mm

TMS10



curvy troughs

Use singly or combine for a sinuous, snaking ribbon of planting.

A décliner séparément ou en combinaisons modulaires.

Colours + Finishes

BS4800 and RAL Classic: Full colour range in polished gloss, satin, matt and textured matt finishes.

Standard colours: All finishes.

Polished Metallics: All finishes.

Textured Metallics: All finishes.

Polished Pearlescents: All finishes.



Polished Stardust: All finishes.

Natural: All finishes.

Dapple and Vintage: All finishes.

See page 242 for all colour and finish options.

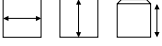
Gold and Silver leaf finishes available

Code		
CURTR01	600 x 350 x 350mm	TMN2 x 2
CURTR02	900 x 350 x 350mm	TMN3 x 2
CURTR03	1200 x 350 x 350mm	TMN4 x 2

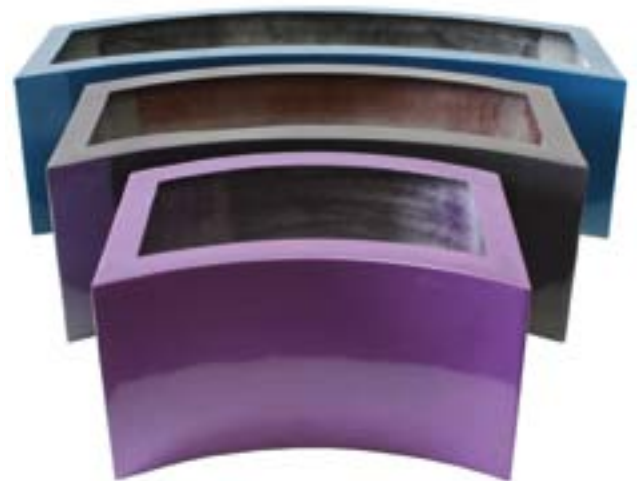

curvy desktop

Cute, mini planters and troughs to be used singly or together for the full Curvy effect in miniature.

Mini-pots et mini-jardinières à employer séparément ou ensemble pour produire l'effet 'Curvy' en miniature.



CURMARDT01



CURBRIT01

Colours + Finishes

BS4800 and RAL Classic: Full colour range in polished gloss, satin, matt and textured matt finishes.

Standard colours: All finishes.

Polished Metallics: All finishes.

Textured Metallics: All finishes.

Polished Pearlescents: All finishes.

Polished Stardust: All finishes.

Natural: All finishes.

Dapple and Vintage: All finishes.

See page 242 for all colour and finish options.

Gold and Silver leaf finishes available

Code

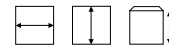

CURMARDT01 200 x 200 x 200mm

TMS1

CURBRIT01 550 x 200 x 200mm

TMS3



swan

A piece of art in its own right. Swan swims alone or with signets in tow.

Une œuvre d'art dans son propre droit. Le Cygne 'Swan' nage seul ou accompagnés de ces cygneaux.

Colours + Finishes

BS4800 and RAL Classic: Full colour range in polished gloss, satin, matt and textured matt finishes.

Standard colours: All finishes.

Polished Metallics: All finishes.

Textured Metallics: All finishes.

Polished Pearlescents: All finishes.





Polished Stardust: All finishes.

Natural: All finishes.

Dapple and Vintage: All finishes.

See page 242 for all colour and finish options.

Gold and Silver leaf finishes available

Code					
CURSWA01	740 x	350 x	1500	260 x 260mm	TWC4
CURSWA02	800 x	350 x	1800	260 x 260mm	TWC4



jayne planter + furniture

Both planter and table/stool combinations.
Suitable for use indoors and as patio furniture.

Protected by full European Design Registration No 000821970-0003.

Un bac et table/tabouret. Parfait pour l'usage à l'intérieur et à l'extérieur. Protégé par le brevet No. 000821970-0003.

Colours + Finishes

BS4800 and RAL Classic: Full colour range in polished gloss, satin, matt and textured matt finishes.

Standard colours: All finishes.

Polished Metallics: All finishes.

Textured Metallics: All finishes.

Polished Pearlescents: All finishes.

Polished Stardust: All finishes.





Natural: All finishes.



Dapple and Vintage: All finishes.

See page 242 for all colour and finish options.

Gold and Silver leaf finishes available



Code	  	
CURJAP01	400 x 400 x 400mm	TWC4
CURJAP02	550 x 550 x 550mm	TWC6/8
CURJAP03	700 x 700 x 700mm	TWC8/10

Code	  	
CURJAS01	400 x 400 x 400mm	Stool
CURJAT01	550 x 550 x 550mm	Table
CURJAT02	700 x 700 x 700mm	Table



curvy combinations

The beauty of Curvy is the endless combination possibilities, from extensive and varied planter walls for subdividing space, to fascinating and gorgeous standalone features. Take a look at the ideas below and be inspired to create your own unique arrangement – not forgetting you can use our Holey Design feature for even more individuality.

La beauté de la gamme Curvy est la possibilité de créer des compositions à l'infini et modulable : de cloisons variées pour diviser l'espace, au bac seul modern et sculpturale.

Soyez inspirés par les idées ci-dessous pour créer votre propre composition unique - sans oublier une touche encore plus créative en rajoutant les trous de 'Holey design'.

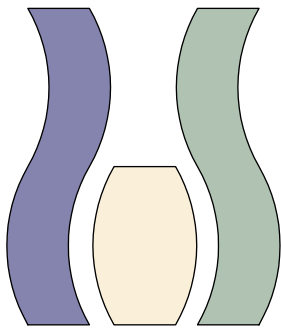

CURS03 CURURS02 CURS03

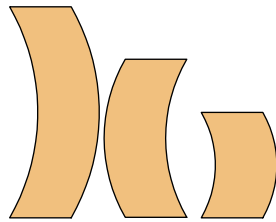

CURMA03 CURMA02 CURMA01

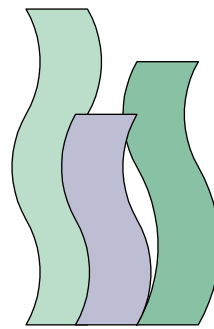
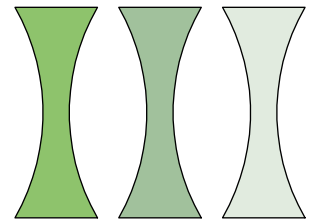
CURDS01 CURS02
CURS01

CURSOP03 x 3

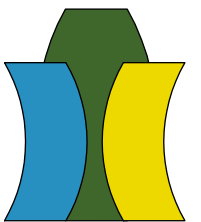
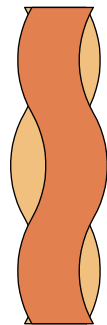
CURMA02 CURMA02
CURURS03

CURDS01 x 2

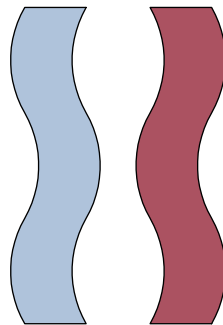

CURDS01 x 2

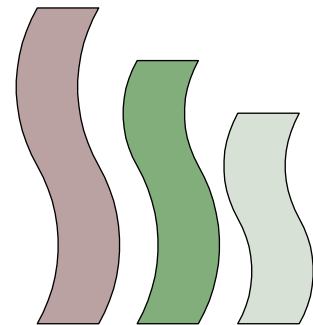
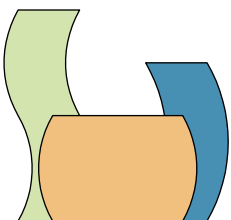
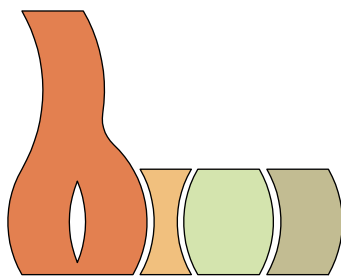
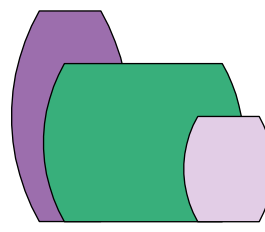
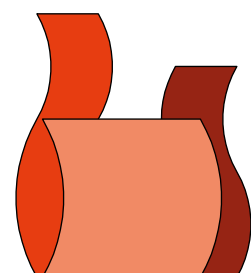
CURS03 CURS02
CURS01CURS01 CURMA02
CURBRI03CURSWA01 CURSOP01 CURMA01
CURURS01CURURS03 CURURS01
CURBRI01CURS02 CURS01
CURBRI02

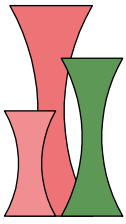

CURSOP01 CURSOP02
CURSOP03

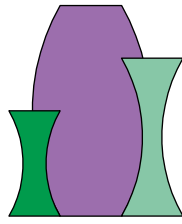

CURSOP01 CURSOP02
CURURS03

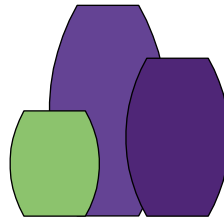

CURURS01 CURURS02
CURURS03

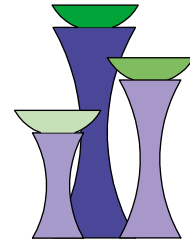

VANC01 VANC02
VANC03

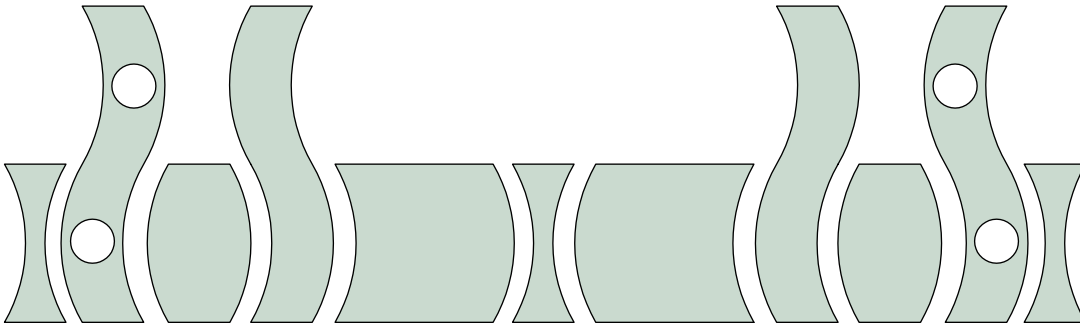

CURSOP02 CURURS02 CURBRI02 CURSOP02 CURBRI02 CURURS02 CURSOP02
CURSHD Special CURS03 CURSHD Special

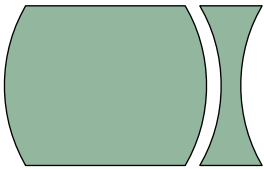

CURBRI01 CURSOP02

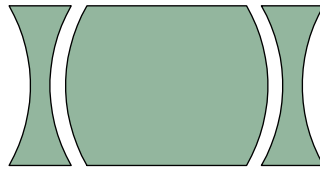

CURSOP02 CURBRI01 CURSOP02

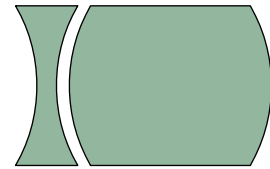

CURSOP02 CURBRI01

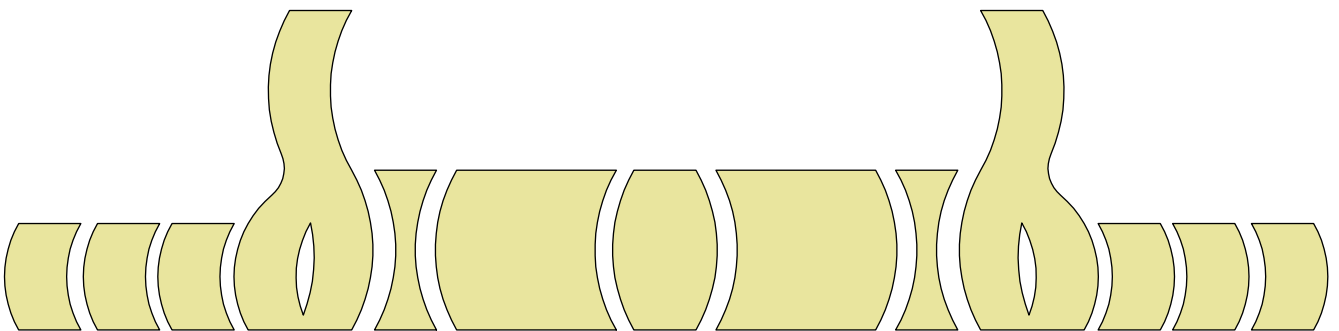

CURMA01 X 3 CURSWA02 CURSOP02 CURBRI02 CURURS02 CURBRI02 CURSOP02 CURSWA02 CURMA01 X 3

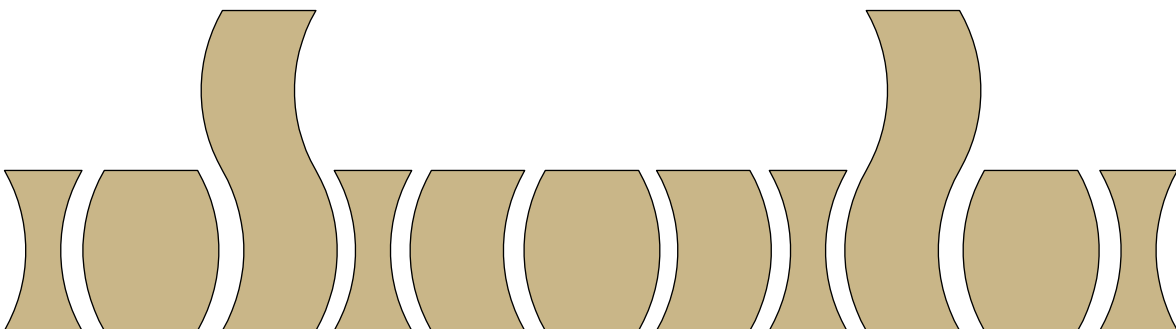

CURSOP01 CURURS01 CURS01 CURSOP01 CURMA01 CURURS01 CURMA01 CURSOP01 CURS01 CURURS01 CURSOP01

holey design

Create your own masterpiece or choose one of ours. Perforate your planter in the style of Barbera Hepworth using 5 different geometric shapes in various sizes. Just send us a sketch and we will do the rest

Créez votre propre chef-d'œuvre ou choisissez l'un des nôtres. Perforez votre bac dans le style de Barbera Hepworth en utilisant 5 différentes formes géométriques de différentes tailles. Il suffit de nous envoyer un croquis et nous ferons le reste.





holey design

holey design

Personalise a wide selection of Livinggreen planters with bespoke perforations in a variety of shapes. Takes design to a whole new level. Just send us your ideas or choose from one of our standard designs.

Personnalisez un large choix de bacs Livinggreen avec des perforations sur mesure dans une variété de formes. Envoyez-nous vos idées ou faites votre choix parmi un de nos modèles standards.



Colours + Finishes

BS4800 and RAL Classic: Full colour range in polished gloss, satin, matt and textured matt finishes.

Standard colours: All finishes.

Polished Metallics: All finishes.

Textured Metallics: All finishes.

Polished Pearlescents: All finishes.

Polished Stardust: All finishes.

Natural: All finishes.

Dapple and Vintage: All finishes.

See page 242 for all colour and finish options.

Gold and Silver leaf finishes available



Maxi Flare HD

Code

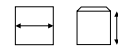

MAXFLAHD01 400 x 1200mm

TWC3

MAXFLAHD02 400 x 1500mm

TWC3



Barrier HD

Code

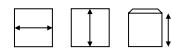

BARRHD01 900 x 300 x 900mm

TMS8



Curvy S HD

Code

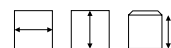

CURSHD01 350 x 350 x 1200mm

TWC3

CURSHD02 350 x 350 x 1500mm





TWC3

CURSHD03 350 x 350 x 1800mm

TWC3

holey design (continued)

Tower HD





Code	  	
TOWHD01	400 x 400 x 900mm	TMC3
TOWHD02	400 x 400 x 1200mm	TWC3



TOWHD1

TOWHD2

Linbar HD

Code	  	
LINBARHD01	900 x 350 x 900mm	TMS8



Models shown below are the only items that can be used to create holey design planters. Choose the model and size and add one or more of the four shapes listed in the sizes available as shown on our price list. Please always check with us that your design is achievable before quoting your customer.

Les modèles illustrés ci-dessous sont les seuls références qui peuvent être utilisées pour créer des bacs design troués : Holey design. Choisissez le modèle et la taille et ajouter une ou plusieurs des quatre formes énumérées dans les tailles disponibles, comme indiqué sur notre liste de prix. Merci de vérifier toujours avec nous que votre conception est réalisable avant d'informer votre client.



MODELS:

- Curvy S
- Curvy Marilyn
- Curvy Bridget
- Towik
- Tower
- Julius Octavia
- Pillar
- Geo Flare
- Linik
- Barrier

SHAPES:

- Circle
- Square
- Triangle
- Oval





avant-garde range

A collection of contemporary designs, each with a different personality to individualise and define. Perfect as a showcase for pearlescent and stardust finishes but also in bold bright colours.

Une collection de contenants contemporains, chacun avec une personnalité différente, à disposer seul ou dans un ensemble. Parfait pour démontrer les finitions 'perle' et 'stardust' mais également dans des couleurs tendances polies.



avant-garde

blob

Created for spectacular specimen planting of every size. Compliments without overshadowing.

Crée pour mettre en valeur des espèces spectaculaires, disponible en plusieurs tailles.



Colours + Finishes

BS4800 and RAL Classic: Full colour range in polished gloss, satin, matt and textured matt finishes.

Standard colours: All finishes.

Polished Metallics: All finishes.

Textured Metallics: All finishes.

Polished Pearlescents: All finishes.

Polished Stardust: All finishes.

Natural: All finishes.

Dapple and Vintage: All finishes.

See page 242 for all colour and finish options.

Gold and Silver leaf finishes available



Code					
BLOB01	650 x 560 x 500			445 x 420mm	TWC8
BLOB02	975 x 840 x 750			600 x 570mm	TCN6x2
BLOB03	1100 x 950 x 850			700 x 640mm	TCN6x3
BLOB04	1540 x 1330 x 1190			1000 x 960mm	TCN9x2



float

Broad solid lips with a sunken centre, standing proud of the ground. Despite their size, Floats seem to hang in the air.

Des bords larges avec un centre creux, malgré sa taille, Float semble être suspendu dans l'air.



Colours + Finishes

BS4800 and RAL Classic: Full colour range in polished gloss, satin, matt and textured matt finishes.

Standard colours: All finishes.

Polished Metallics: All finishes.

Textured Metallics: All finishes.

Polished Pearlescents: All finishes.

Polished Stardust: All finishes.

Natural: All finishes.

Dapple and Vintage: All finishes.





See page 242 for all colour and finish options.



FLOA01



FLOAT01

Code					
FLOA01	600 x 600 x 300	300 x 300mm	TWC2		
FLOA02	800 x 800 x 400	400 x 400mm	TWC3		
FLOA03	1000 x 1000 x 450	500 x 500mm	TWC6		
FLOA04	1200 x 1200 x 450	600 x 600mm	TMN4x2		
FLOAT01	900 x 550 x 300	600 x 250mm	TMS5		



bill

Our interpretation of the classic flowerpot. Features wide, straight sided rims.

Notre interprétation du pot de fleurs classique. Bords larges et carrés.





Colours + Finishes

BS4800 and RAL Classic: Full colour range in polished gloss, satin, matt and textured matt finishes.

Standard colours: All finishes.

Polished Metallics: All finishes.

Textured Metallics: All finishes.

Polished Pearlescents: All finishes.





Polished Stardust: All finishes.

Natural: All finishes.

Dapple and Vintage: All finishes.

See page 242 for all colour and finish options.

Gold and Silver leaf finishes available

Code				
BILL01	400 x 400		310mm	TWC3
BILL02	600 x 600		490mm	TWC6
BILL03	800 x 800		670mm	TWC10
BILL04	1000 x 1000		850mm	TWC12
BILL05	1200 x 1200		1050mm	TWC12
Tapered Tall				
BILL06	470 x 800		390mm	TWC3
BILL07	470 x 1000		390mm	TWC4



ben

Sharply modern with thick rims. Designed for feature plants up to 8m tall. Larger sizes on request.

Modern avec des bords généreux. Conçu pour des plantes spécimens jusqu'à 8m d'hauteur. Plus grandes tailles disponibles sur demande.





Colours + Finishes

BS4800 and RAL Classic: Full colour range in polished gloss, satin, matt and textured matt finishes.

Standard colours: All finishes.

Polished Metallics: All finishes.

Textured Metallics: All finishes.

Polished Pearlescents: All finishes.





Polished Stardust: All finishes.

Natural: All finishes.

Dapple and Vintage: All finishes.

See page 242 for all colour and finish options.

Gold and Silver leaf finishes available

Code	  	
BEN01	400 x 400 x 400mm	TWC3
BEN02	600 x 600 x 600mm	TWC6
BEN03	600 x 600 x 720mm	TWC6
BEN04	800 x 800 x 800mm	TWC10
BEN05	800 x 800 x 960mm	TWC10
BEN06	1000 x 1000 x 1000mm	TWC12
BEN07	1000 x 1000 x 1200mm	TWC12
BEN08	1200 x 1200 x 1200mm	ASK
Tapered Tall		
BEN09	470 x 470 x 900mm	TWC4
BEN10	475 x 475 x 1200mm	TWC4
BEN11	480 x 480 x 1500mm	TWC4



hug

Modular barriers and planters with interlocking, curved ends. Mix and match in height, width and colour. Striking as a stand alone planter.

Barrières modulables qui s'emboîtent avec des extrémités incurvées et courbes. Ludique, jouez avec les hauteurs, largeurs et couleurs.



Colours + Finishes

BS4800 and RAL Classic: Full colour range in polished gloss, satin, matt and textured matt finishes.

Standard colours: All finishes.

Polished Metallics: All finishes.

Textured Metallics: All finishes.

Polished Pearlescents: All finishes.

Polished Stardust: All finishes.

Natural: All finishes.

Dapple and Vintage: All finishes.

See page 242 for all colour and finish options.



Barrier HUG004-6



Planter HUG001-3



Barrier HUG1104-6



Planter HUG1101-3

Code



Planter

HUG001	500 x 350 x 600	410 x 260mm	TMS3
---------------	-----------------	-------------	------

HUG002	500 x 350 x 900	410 x 260mm	TMS3
---------------	-----------------	-------------	------

HUG003	500 x 350 x 1200	410 x 260mm	TMS3
---------------	------------------	-------------	------

Barrier

HUG004	1200 x 350 x 600	1100 x 260mm	TMS8
---------------	------------------	--------------	------

HUG005	1200 x 350 x 900	1100 x 260mm	TMS8
---------------	------------------	--------------	------

HUG006	1200 x 350 x 1200	1100 x 260mm	TMS8
---------------	-------------------	--------------	------

Planter

HUG1101	500 x 350 x 600	275 x 260mm	TWC2
----------------	-----------------	-------------	------

HUG1102	500 x 350 x 900	275 x 260mm	TWC2
----------------	-----------------	-------------	------

HUG1103	500 x 350 x 1200	275 x 260mm	TWC2
----------------	------------------	-------------	------

Barrier

HUG1104	1200 x 350 x 600	975 x 260mm	TMS7
----------------	------------------	-------------	------

HUG1105	1200 x 350 x 900	975 x 260mm	TMS7
----------------	------------------	-------------	------

HUG1106	1200 x 350 x 1200	975 x 260mm	TMS7
----------------	-------------------	-------------	------



ying + yang

Two sides of the same coin. Use one of each for dual design elegance or singly as space saving features.

Les pièces jumelles à disposer ensemble ou séparément.





Ying 01



Yang 01



Yang 02 in gold leaf

Colours + Finishes

BS4800 and RAL Classic: Full colour range in polished gloss, satin, matt and textured matt finishes.

Standard colours: All finishes.

Polished Metallics: All finishes.

Textured Metallics: All finishes.

Polished Pearlescents: All finishes.

Polished Stardust: All finishes.

Natural: All finishes.

Dapple and Vintage: All finishes.

See page 242 for all colour and finish options.

Gold and Silver leaf finishes available

Code



Code	Dimensions	Top Width	Finish
YING01 Narrow Top	340 x 790mm	220mm	TWC3
YING02 Narrow Top	420 x 1045mm	280mm	TWC4
YING03 Narrow Top	500x1600mm	330mm	TWC4
YANG01 Bulbous Top	340 x 790mm	220mm	TWC3
YANG02 Bulbous Top	420 x 1045mm	280mm	TWC4
YANG03 Bulbous Top	500x1600mm	330mm	TWC4



Ying 02 with Yang 01

stack

Original layered geometric design on elegant tapered flutes.

Une conception originale de couches géométriques sur élégantes flûtes coniques.



Colours + Finishes

BS4800 and RAL Classic: Full colour range in polished gloss, satin, matt and textured matt finishes.

Standard colours: All finishes.

Polished Metallics: All finishes.

Textured Metallics: All finishes.

Polished Pearlescents: All finishes.

Polished Stardust: All finishes.

Natural: All finishes.

See page 242 for all colour and finish options.



Code					
STAK01	275 x 275 x 730	200 x 200mm		TMS2	
STAK02	350 x 350 x 860	290 x 290mm		TMS4	
STAK03	460 x 460 x 1010	380 x 380mm		TMS4	



spin

Creating the illusion of movement through regular circular ribbing and complex reflections.

Création de l'illusion du mouvement par une surface nervurée régulière aux reflets intrigants.



Colours + Finishes

BS4800 and RAL Classic: Full colour range in polished gloss, satin, matt and textured matt finishes.

Standard colours: All finishes.

Polished Metallics: All finishes.

Textured Metallics: All finishes.

Polished Pearlescents: All finishes.





Polished Stardust: All finishes.

Natural: All finishes.

Dapple and Vintage: All finishes.

See page 242 for all colour and finish options.



Code				
SPIN01	450 x 535		380mm	TWC6
SPIN02	400 x 900		330mm	TWC4
SPIN03	450 x 1200		380mm	TWC4



flip

Reverse tapered flutes with feature raised base. Clean design for all types of planting.

Conique avec une base soulevée. Design épuré pour tous types de plantations.

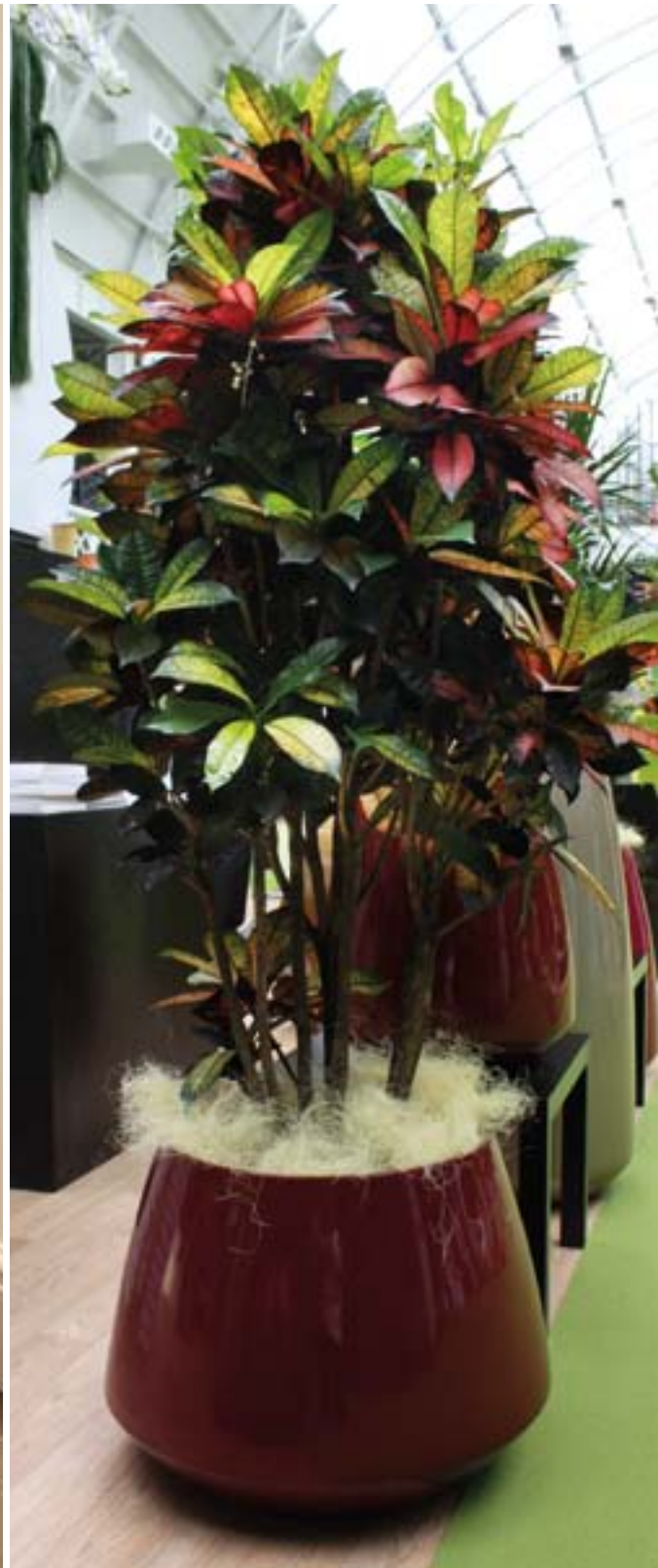

Colours + Finishes

BS4800 and RAL Classic: Full colour range in polished gloss, satin, matt and textured matt finishes.

Standard colours: All finishes.

Polished Metallics: All finishes.

Textured Metallics: All finishes.

Polished Pearlescents: All finishes.





Polished Stardust: All finishes.

Natural: All finishes.

Dapple and Vintage: All finishes.

See page 242 for all colour and finish options.



Code				
FLIP01	500 x 390	360mm	TWC4	
FLIP02	650 x 520	470mm	TWC6	
FLIP03	500 x 580	300mm	TWC4	
FLIP04	500 x 750	300mm	TWC4	
FLIP05	500 x 1050	300mm	TWC4	



fusion

Gently curved and slender creating large displays where space is limited.

Légèrement courbe et élégant, possibilité de créer une composition en hauteur quand l'espace est limité.



Dappled grey finish



Colours + Finishes

BS4800 and RAL Classic: Full colour range in polished gloss, satin, matt and textured matt finishes.

Standard colours: All finishes.

Polished Metallics: All finishes.

Textured Metallics: All finishes.

Polished Pearlescents: All finishes.

Polished Stardust: All finishes.





Natural: All finishes.

Dapple and Vintage: All finishes.

See page 242 for all colour and finish options.

Gold and Silver leaf finishes available



Code				
FUSION01	320 x 1000		230mm	TWC2
FUSION02	420 x 1300		290mm	TWC3
FUSION03	500 x 1600		340mm	TWC4



Fusion03 (dapple grey finish)

time

Doubly curvaceous with perfect symmetry top to bottom. Great stability and a large planting area.

Doublement courbe avec une symétrie parfaite. Grande stabilité et une surface de plantation importante.



Colours + Finishes

BS4800 and RAL Classic: Full colour range in polished gloss, satin, matt and textured matt finishes.

Standard colours: All finishes.

Polished Metallics: All finishes.

Textured Metallics: All finishes.

Polished Pearlescents: All finishes.

Polished Stardust: All finishes.

Natural: All finishes.

Dapple and Vintage: All finishes.

See page 242 for all colour and finish options.

Gold and Silver leaf
finishes available



Code



TIME01

440 x 1080

360mm

TWC3

TIME02

560 x 1360

450mm

TWC4



easter island

Ultra modern design inspired by the Moai statues. Each planter has an optional second planter or shelf which can be used to present brochures (reception areas), as a writing stand, a glass stand (for bars, hotels etc) or for lights, ornaments etc. Each planter also slots into the other for creating walls or special features.

Design modern, inspiré par les statues Moai de l'Île de Pâques. Chaque pot offre la possibilité d'un bac de plantation en plus ou une étagère en option. L'étagère peut être utilisée pour des brochures (accueils), comme une écritoire, un support pour un verre (bars, hôtels) ou pour un élément de décoration comme une lampe. Chaque bac est modulable avec les autres de la gamme, pour créer des cloisons rythmées ou barrières sculpturales.





EASIL01

EASIL02



EASILB01



Suggested layouts

Colours + Finishes

BS4800 and RAL Classic: Full colour range in polished gloss, satin, matt and textured matt finishes.

Standard colours: All finishes.

Polished Metallics: All finishes.

Textured Metallics: All finishes.

Polished Pearlescents: All finishes.

Polished Stardust: All finishes.

Natural: All finishes.

Dapple and Vintage: All finishes.

See page 242 for all colour and finish options.

Gold and Silver leaf finishes available

Supplied with topmost area in planter form and lower area as shelf as standard. Please specify at time of ordering for variations from this layout

Livré automatiquement en 'standard' avec le bac le plus élevé sous forme de bac à planter et la zone inférieure en étagère. Merci de spécifier au moment de passer la commande pour une variation de cette disposition.

Code					
EASIL01	400 x	350 x	1200	200 x 260mm	TMS2
Optional second planter	250 x	350 x	240	170 x 260mm	TMS2
EASIL02	450 x	350 x	1600	200 x 260mm	TMS2
Optional second planter	290 x	350 x	250	200 x 260mm	TMS2
EASILB01	1000 x	350 x	900	700 x 260mm	TMS6



Standard planter and shelf configuration

dune

Broad feature lips brighten foliage from below with reflected light. Beautiful in Pearlescent and Stardust.

Des bords généreux réfléchissant la lumière en dessous du feuillage. Sublime dans les finitions 'perle' et 'stardust'.



DUNE05 (pastel orange)



DUNE05 (pastel violet)

Colours + Finishes

BS4800 and RAL Classic: Full colour range in polished gloss, satin, matt and textured matt finishes.

Standard colours: All finishes.

Polished Metallics: All finishes.

Textured Metallics: All finishes.

Polished Pearlescents: All finishes.

Polished Stardust: All finishes.



Natural: All finishes.

Dapple and Vintage: All finishes.

See page 242 for all colour and finish options.

Gold and Silver leaf finishes available



Code	 	
DUNE01	500 x 510mm	TWC4
DUNE02	500 x 670mm	TWC6
DUNE03	670 x 670mm	TWC8
DUNE04	500 x 900mm	TWC4
DUNE05	500 x 1200mm	TWC4



wave

Create stunning snaking barriers, wrap around pillars or use as a stand alone feature. Highly flexible planter in 4 heights.

Créez des barrières qui serpentent, qui s'enroulent autour des colonnes, les quatre hauteurs sont modulables.



Colours + Finishes

BS4800 and RAL Classic: Full colour range in polished gloss, satin, matt and textured matt finishes.

Standard colours: All finishes.

Polished Metallics: All finishes.

Textured Metallics: All finishes.

Polished Pearlescents: All finishes.

Polished Stardust: All finishes.

Natural: All finishes.

Dapple and Vintage: All finishes.

See page 242 for all colour and finish options.



Code				
WAVE01	470 x 410 x 450	240 x 280mm	TWC4	
WAVE02	470 x 410 x 600	240 x 280mm	TWC4	
WAVE03	470 x 410 x 900	240 x 280mm	TWC4	
WAVE04	470 x 410 x 1200	240 x 280mm	TWC4	

Suggested layouts

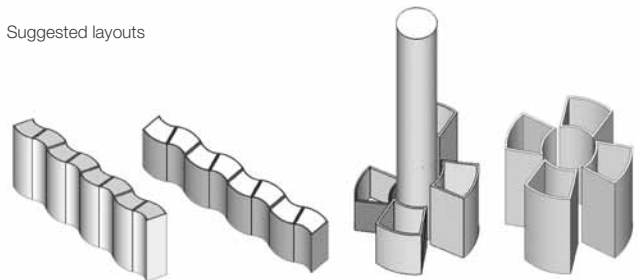

Wave barriers

Column planting



u.n.c

Write it large with our stunning three letter combination for fun dividers. Specify blank tops for writing areas or stands in a barrier run.

Écrivez-le en grand avec notre étonnante combinaison de trois lettres pour créer des séparations en s'amusant. Spécifiez en meuble étagère ou en pot de plantation.



Colours + Finishes

BS4800 and RAL Classic: Full colour range in polished gloss, satin, matt and textured matt finishes.

Standard colours: All finishes.

Polished Metallics: All finishes.

Textured Metallics: All finishes.

Polished Pearlescents: All finishes.

Polished Stardust: All finishes.

Natural: All finishes.

Dapple and Vintage: All finishes.

See page 242 for all colour and finish options.



UPLANT01



NPLANT01



CPLANT01

Code				
UPLANT01	900 x 300 x 900	230 x 230mm	820 x 220mm	TWC2
NPLANT01	900 x 300 x 900	820 x 220mm	820 x 220mm	TMS7
CPLANT01	900 x 300 x 900	820 x 220mm	820 x 220mm	TMS7

Suggested layout showing alternating planter and shelf tops

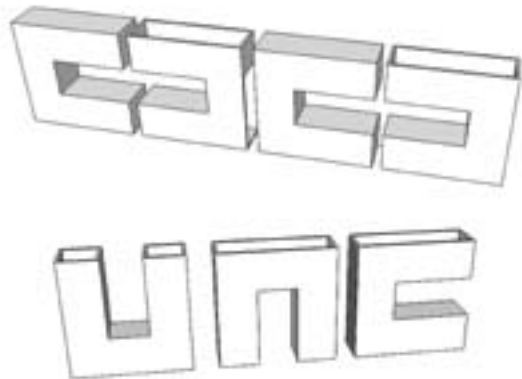

tulip

Two head sizes and any length of stem to 4m makes Tulip the ultimate plaything. Use in combination with Cloud Base for a stunning reception display. Use with reverse head as a base or on the single stem stand for a more discreet space saving display. All parts can be different colours if required.

Deux tailles et formes de tête et une longueur de tige jusqu'à 4m rend la Tulipe ludique. Utilisation en combinaison avec la Base de 'Cloud' / Nuage pour une composition spectaculaire. Utilisez avec la tête comme socle ou sur le stand pour une seule tige. Toutes les pièces (tige/tête/socle) peuvent être en couleurs différentes.





TULIPH02
on standard base

TULIPH01
on standard base



CLOUDB01

Colours + Finishes

BS4800 and RAL Classic: Full colour range in polished gloss, satin, matt and textured matt finishes.

Standard colours: All finishes.

Polished Metallics: All finishes.

Textured Metallics: All finishes.

Polished Pearlescents: All finishes.

Polished Stardust: All finishes.

Natural: All finishes.

Dapple and Vintage: All finishes.

See page 242 for all colour and finish options.

Code

TULIPH01

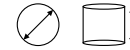

400 x 486



340mm



TWC3

TULIPH02

527 x 486

460mm

TWC4

Tulip Stem

TULIPST

110 x 110

1000-4000mm

Available in any length from 1000mm to 4000mm

Standard Base

TULIPSB01

Suitable for total height up to 2m only

Cloud Base

CLOUDB01

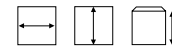

1660 x 900 x 100mm

Fits three tulip stems



TULIPH02 used with reversed head as a base



TULIPH01 (x2) & TULIPH02 with cloud base



vortex

Unique planting cups for stunningly presented displays. Engineered for stability when planted.

Coupe de plantation unique pour mettre en valeur des compositions élaborées ou plantes spécimen. Prévu pour être parfaitement stable une fois planté.



Colours + Finishes

BS4800 and RAL Classic: Full colour range in polished gloss, satin, matt and textured matt finishes.

Standard colours: All finishes.

Polished Metallics: All finishes.

Textured Metallics: All finishes.

Polished Pearlescents: All finishes.

Polished Stardust: All finishes.

Natural: All finishes.

Dapple and Vintage: All finishes.

See page 242 for all colour and finish options.

Gold and Silver leaf finishes available



Code



VORT01

440 x 750mm

TWC3

VORT02

560 x 950mm

TWC3



touch

The look of hammered metal without the expense.
Fabulous in metallic finishes but also in Stardust and Pearlescent.

L'aspect du métal martelé à moindre coût. Extraordinaire dans les finitions métalliques mais également dans le 'stardust' et 'perle'.



Polished metallic bronze



Polished metallic gold



Polished Stardust purple

Colours + Finishes

BS4800 and RAL Classic: Full colour range in polished gloss, satin, matt and textured matt finishes.

Standard colours: Polished, matt and satin only.

Polished Metallics: All finishes.

Textured Metallics: N/A

Polished Pearlescents: All finishes.



Polished Stardust: All finishes.

Natural: N/A

Dapple and Vintage: N/A

See page 242 for all colour and finish options.



Code	 	
TOUCH01	360 x 605mm	TWC3
TOUCH02	385 x 805mm	TWC4
TOUCH03	400 x 1005mm	TWC4



Polished metallic copper

bullit

Replicating handmade hammered metal designs but available in our beautiful coloured pearl, stardust and metallic finishes.

Inspiré par le métal martelé, mais disponible dans nos belles finitions perlé, stardust et métalliques.

Colours + Finishes

BS4800 and RAL Classic: Full colour range in polished gloss, satin, matt and textured matt finishes.

Standard colours: Polished, matt and satin only.

Polished Metallics: All finishes.

Textured Metallics: N/A

Polished Pearlescents: All finishes.

Polished Stardust: All finishes.

Natural: N/A

Dapple and Vintage: N/A

See page 242 for all colour and finish options.

Code

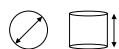

BULL01

180 x 500mm

BULL02

380 x 1020mm

TWC3



squeeze

Retro fun with the boldest of style statements.
Fantastic for bright colours.

Amusant type rétro avec une déclaration de style. Fantastique dans les couleurs vives.

Colours + Finishes

BS4800 and RAL Classic: Full colour range in polished gloss, satin, matt and textured matt finishes.

Standard colours: All finishes.

Polished Metallics: All finishes.

Textured Metallics: All finishes.

Polished Pearlescents: All finishes.

Polished Stardust: All finishes.

Natural: N/A

Dapple and Vintage: N/A

See page 242 for all colour and finish options.



Code

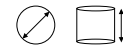

SQEZ01 530 x 440mm

TWC3

SQEZ02 750 x 590mm

TWC10

SQEZ03 420 x 695mm

TWC3

SQEZ04 570 x 900mm

TWC4



layer

Spheres with a twist. Geometric and stratified.

Sphères avec une différence. Géométriques et stratifiés.

Colours + Finishes

BS4800 and RAL Classic: Full colour range in polished gloss, satin, matt and textured matt finishes.

Standard colours: All finishes.

Polished Metallics: All finishes.

Textured Metallics: All finishes.

Polished Pearlescents: All finishes.

Polished Stardust: All finishes.

Natural: N/A

Dapple and Vintage: N/A

See page 242 for all colour and finish options.

Code

LAY01

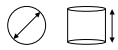

600 x 545mm



TWC4





luna

Conceived around the concept of the perfect sphere, Luna offers this and more with sphere planters, deep and shallow bowls completing this geometric range. Complete spheres feature a small flat point as standard for stability but can be specified as perfectly round. Ask us to convert Luna Full to a water feature or Luna Half to a hanging bowl for even more options. Try our natural finishes to create 'real' galvanised, rusting or stone balls – with none of the weight and at a fraction of the cost – and up to 1.2m diameter.

Conçu autour de la sphère parfaite, Luna propose cela et plus encore avec des formes sphériques, des coupes profondes et moins profondes complètent cette gamme géométrique. Les sphères complètes en standard disposent d'une petite partie plate pour la stabilité, mais elles sont également disponible parfaitement ronde. Demandez-nous de convertir Luna complète en fontaine d'eau ou la demie Luna en coupe suspendue pour encore plus de possibilités. Essayez nos finitions naturelles pour créer un effet 'réel': en rouille, plomb, pierre - avec un poids négligeable et à une fraction du coût du vrai - jusqu'à 1,2 m de diamètre.





luna

luna

Perfect spheres, Sphere planters and two bowl options complete this fabulous range. Luna Half or Full can be specified as hanging baskets.

Sphères parfaites, sphère en pot, en objet, et deux options en coupe complètent cette gamme inspirante. Prescrivez Luna en demie ou entière pour des paniers suspendus.



Aged lead Luna Full spheres on the WWF 50th anniversary garden at Hampton Court flower show



Luna Slice (polished black) as bespoke hanging baskets

Colours + Finishes

BS4800 and RAL Classic: Full colour range in polished gloss, satin, matt and textured matt finishes.

Standard colours: All finishes.

Polished Metallics: All finishes.

Textured Metallics: All finishes.

Polished Pearlescents: All finishes.

Polished Stardust: All finishes.

Natural: All finishes.



Dapple and Vintage: All finishes.

See page 242 for all colour and finish options.

Gold and Silver leaf finishes available







Luna Full

Code		
LUNAF01	350mm	NA
LUNAF02	590mm	NA
LUNAF03	780mm	NA
LUNAF04	1200mm	NA

Luna Slice







Code				
LUNAS01	350 x 290		220mm	TMS2
LUNAS02	590 x 470		300mm	TWC4
LUNAS03	780 x 680		450mm	TWC8
LUNAS04	1200 x 990		700mm	TWC10

Planting diameter can be increased by slicing the top lower on request

Luna Half



Code				
LUNAH01	350 x 150		300mm	TWC2
LUNAH02	590 x 240		500mm	TWC4
LUNAH03	780 x 350		740mm	TWC6
LUNAH04	1200 x 500		1080mm	TWC8

luna



Colours + Finishes

BS4800 and RAL Classic: Full colour range in polished gloss, satin, matt and textured matt finishes.

Standard colours: All finishes.

Polished Metallics: All finishes.

Textured Metallics: All finishes.

Polished Pearlescents: All finishes.

Polished Stardust: All finishes.

Natural: All finishes.





Dapple and Vintage: All finishes.

See page 242 for all colour and finish options.

Gold and Silver leaf finishes available



Luna Crescent

Code				
LUNAC01	335 x 100		285mm	NA
LUNAC02	525 x 160		475mm	TWC2
LUNAC03	760 x 230		700mm	TWC3
LUNAC04	1150 x 335		1050mm	TWC6



pedestals, bowls + urns

Inspirational combinations of modern and classical pedestals, bowls and vases for floral and plant displays. Mix and match in styles and sizes but also in colour and texture. All products are available in every RAL colour plus all our unique finishes. Try polished and textured finishes together in the same colour for added interest.

Compositions inspirées de colonnes classiques et modernes, des coupes et vases pour les compositions florales et végétales. Créez et composez des styles et tailles, mais aussi en couleur et finition. Tous les produits sont disponibles dans toutes les couleurs RAL ainsi que toutes nos finitions uniques. Essayez d'assortir une finition polie avec une finition texturée dans la même couleur pour se démarquer.





pedestals,
bowls + urns

pedestals + bowls

mix and match styles, colours and textures



Vancouver (polished metallic gold) and Rome (polished metallic black)



Deli (polished old English white)



Palma (polished primrose yellow)



Chicago and Rome (polished metallic black)



Chicago (polished pearlescent purple) and Rome (textured pearlescent purple)



Rio (polished metallic bronze) and Barcelona (textured brilliant white)



New York (polished metallic silver) and Rome (polished pearlescent red)



Stockholm (textured pistachio green)

pedestals



For temporary display work specify as lightweight for ease of carrying.

For permanent/semi-permanent displays specify as weighted for added stability.

La légèreté du produit facilite son transport et son installation pour un projet temporaire. Pour une composition permanente ou semi permanente les colonnes peuvent être lestées à la commande pour une stabilité supplémentaire.



modern pedestals

Chicago

Code	  
CHI01	250 x 250 x 610mm
CHI02	350 x 350 x 600mm
CHI03	350 x 350 x 900mm
CHI04	350 x 350 x 1200mm



New York

Code	  
NEWY01	280 x 280 x 600mm
NEWY02	340 x 340 x 900mm
NEWY03	320 x 320 x 1200mm
NEWY04	300 x 300 x 1500mm



Colours + Finishes

BS4800 and RAL Classic: Full colour range in polished gloss, satin, matt and textured matt finishes.

Standard colours: All finishes.

Polished Metallics: All finishes.

Textured Metallics: All finishes.

Polished Pearlescents: All finishes.

Polished Stardust: All finishes.

Natural: All finishes.



Dapple and Vintage: All finishes.

See page 242 for all colour and finish options.

Gold and Silver leaf finishes available





Tokyo

Code	 
TOKY01	350 x 600mm
TOKY02	350 x 750mm
TOKY03	350 x 900mm





Rio

Code	  
RIO01	350 x 350 x 600mm
RIO02	350 x 350 x 900mm
RIO03	350 x 350 x 1200mm





Moscow

Code	 
MOSC01	440 x 1080
MOSC02	560 x 1360

pedestals (continued)



modern pedestals continued

Vancouver

Code	  
VANC01	260 x 350 x 600mm
VANC02	350 x 350 x 900mm
VANC03	460 x 350 x 1200mm



Monaco

Code	  
MONA01	350 x 350 x 1200mm
MONA02	350 x 350 x 1500mm
MONA03	350 x 350 x 1800mm
Monaco Holey Design	
MONAHD01	350 x 350 x 1200mm
MONAHD02	350 x 350 x 1500mm
MONAHD03	350 x 350 x 1800mm





MONA01

MONAHD01

classical pedestals

Straight Fluted Pedestal

Code	  
STFLPED01	300 x 300 x 1200mm



Colours + Finishes

Classical Pedestals

BS4800 and RAL Classic: Full colour range in polished gloss, satin, matt and textured matt finishes.

Standard colours: All finishes.

Polished Metallics: All finishes.

Textured Metallics: All finishes.

Polished Pearlescents: All finishes.

Polished Stardust: All finishes.

Natural: All finishes.

Dapple and Vintage: N/A.

See page 242 for all colour and finish options.



SMFLPED01

LGFLPED01

Large & Small Fluted Pedestal

Code

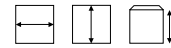

LGFLPED01

320 x 320 x 1220mm

SMFLPED01

320 x 320 x 840mm

Roman



Code

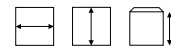

ROMPED01

330 x 330 x 680mm

Square



Code

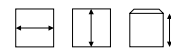

SQUPED01

400 x 400 x 600mm

combinations

of pedestals + bowls



Shanghai (polished hot pink)



Dallas (polished metallic silver)



New York (polished brilliant white) and Rome (polished metallic black)



Milan (polished metallic black)



Lyon 01 and 02 (polished pearlescent deep blue)



Rio and Rome (polished metallic gold)



Vienna (polished brilliant white)



Vegas (polished metallic black)

bowls

All supplied with felt pad bases and fully waterproofed to prevent any danger of leaks. Bowls can be supplied bolted and bonded to a pedestal base on request.

Toutes les coupes sont fournies avec des pastilles en feutrine. A la demande les coupes peuvent être visées ou collées sur une colonne.

Paris

Code



PARIS01

400 x 160mm

Ceramic style not smooth or regular



TMS1.5



Barcelona

Code

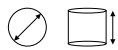

BARCE01

315 x 255mm

BARCE02

405 x 320mm

Ceramic style not smooth or regular



TMS1.5

TMS2



London

Code

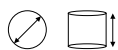

LOND01

305 x 153mm

LOND02

455 x 253mm

Ceramic style not smooth or regular



TMS1.5

TMS2



Colours + Finishes

BS4800 and RAL Classic: Full colour range in polished gloss, satin, matt and textured matt finishes.

Standard colours: All finishes.

Polished Metallics: All finishes.

Textured Metallics: All finishes.

Polished Pearlescents: All finishes.

Polished Stardust: All finishes.

Natural: All finishes.



Dapple and Vintage: All finishes.

See page 242 for all colour and finish options.

Gold and Silver leaf finishes available





Rome

Code	 	
ROME01	440 x 270mm	TWC2
ROME02	590 x 365mm	TWC3





Shanghai

Code	 	
SHANG01	345 x 100mm	N/A
SHANG02	435 x 112mm	N/A
SHANG03	545 x 135mm	N/A



Milan

Code	 	
MILAN01	195 x 400mm	N/A
MILAN02	250 x 500mm	N/A
MILAN03	265 x 605mm	N/A

bowls (continued)

Colours + Finishes

BS4800 and RAL Classic: Full colour range in polished gloss, satin, matt and textured matt finishes.

Standard colours: All finishes.

Polished Metallics: All finishes.

Textured Metallics: All finishes.

Polished Pearlescents: All finishes.

Polished Stardust: All finishes.

Natural: All finishes.

Dapple and Vintage: All finishes.

See page 242 for all colour and finish options.

Gold and Silver leaf
finishes available

Berlin

Code



BERLIN01

360 x 135mm

Ceramic style not smooth or regular



TMS1.5



Stockholm

Code

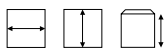

STOCK01

346 x 346 x 120mm

Ceramic style not smooth or regular



TMS1



Copenhagen

Code

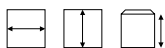

COPEN01

700 x 200 x 100mm

Ceramic style not smooth or regular



N/A



Colours + Finishes

BS4800 and RAL Classic: Full colour range in polished gloss, satin, matt and textured matt finishes.

Standard colours: All finishes.

Polished Metallics: All finishes.

Textured Metallics: All finishes.

Polished Pearlescents: All finishes.

Polished Stardust: All finishes.

Natural: All finishes.

Dapple and Vintage: All finishes.

See page 242 for all colour and finish options.

Gold and Silver leaf
finishes available



Oslo

Code

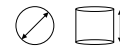

OSLO01

470 x 375mm

Ceramic style not smooth or regular



TWC2



Geneva

Code

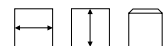

GENEVA

340 x 340 x 150mm



TMS1.5



Deli

Code

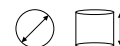

DELI01

200 x 200mm

Dapple, vintage, gold and silver leaf N/A



N/A

bowls (continued)

Colours + Finishes

BS4800 and RAL Classic: Full colour range in polished gloss, satin, matt and textured matt finishes.

Standard colours: All finishes.

Polished Metallics: All finishes.

Textured Metallics: All finishes.

Polished Pearlescents: All finishes.

Polished Stardust: All finishes.

Natural: All finishes.

Dapple and Vintage: All finishes.

See page 242 for all colour and finish options.

Gold and Silver leaf
finishes available

Vienna

Code



VIEN01 225 x 150 x 230mm

Ceramic style not smooth or regular



N/A



Sicily

Code



SICI01 470 x 165mm

SICI02 615 x 205mm



TMS1.5

TMS1.5



Fez

Code



FEZ01 210 x 600mm

Dapple, vintage, gold and silver leaf N/A



N/A



Colours + Finishes

BS4800 and RAL Classic: Full colour range in polished gloss, satin, matt and textured matt finishes.

Standard colours: All finishes.

Polished Metallics: All finishes.

Textured Metallics: All finishes.

Polished Pearlescents: All finishes.

Polished Stardust: All finishes.

Natural: All finishes.

Dapple and Vintage: All finishes.

See page 242 for all colour and finish options.

Gold and Silver leaf finishes available



Kyoto

Code



KYOT01

300 x 185 x 120mm

N/A

Ceramic style not smooth or regular



Lyon

Code

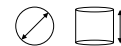

LYON01

160 x 185mm

N/A

LYON02

200 x 235mm

N/A



Palma

Code



PALM01

295 x 140mm

TMS1

Ceramic style not smooth or regular

modern pedestals

bowls + vases



Barcelona and Rio (polished pistachio green)



Copenhagen (polished pearlescent peacock blue)



Monaco (polished pearlescent purple) and Rome (polished pearlescent purple)



Vancouver (polished espresso brown) and Shanghai (polished metallic gold)



Fez (polished ocean turquoise)



bowls (continued)

Colours + Finishes

BS4800 and RAL Classic: Full colour range in polished gloss, satin, matt and textured matt finishes.

Standard colours: All finishes.

Polished Metallics: All finishes.

Textured Metallics: All finishes.

Polished Pearlescents: All finishes.

Polished Stardust: All finishes.

Natural: All finishes.

Dapple and Vintage: All finishes.

See page 242 for all colour and finish options.

Gold and Silver leaf finishes available

Vegas

Code

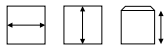

VEGA01

400 x 400 x 100mm



N/A



Phoenix

Code

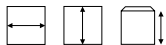

PHNX01

500 x 250 x 120mm



N/A

Raised by 1cm in the middle to give a floating effect



Dallas

Code

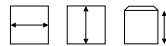

DALL01

300 x 300 x 120mm



N/A

Raised by 1cm in the middle to give a floating effect



Colours + Finishes

BS4800 and RAL Classic: Full colour range in polished gloss, satin, matt and textured matt finishes.

Standard colours: All finishes.

Polished Metallics: All finishes.

Textured Metallics: All finishes.

Polished Pearlescents: All finishes.

Polished Stardust: All finishes.

Natural: All finishes.

Dapple and Vintage: All finishes.

See page 242 for all colour and finish options.

Gold and Silver leaf finishes available



Havana

Code

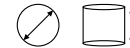

HAVA01

350 x 290

220mm

TMS2



Florence

Code

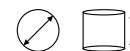

FLOR01

350 x 150

300mm

TWC2

FLOR02

590 x 240

500mm

TWC4



Minsk

Code

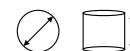

MINS01

335 x 100

285mm

NA

MINS02

525 x 160

475mm

TWC2

urns

Classic antique urns with breathtaking detail. Use singly or with our classical pedestal collection.

Urnes classiques antiques avec des détails à couper le souffle. Utilisez seuls ou avec notre collection piédestal classique.

Colours + Finishes

BS4800 and RAL Classic: Full colour range in polished gloss, satin, matt and textured matt finishes.

Standard colours: All finishes.

Polished Metallics: All finishes.

Textured Metallics: All finishes.

Polished Pearlescents: All finishes.

Polished Stardust: All finishes.

Natural: All finishes.

Dapple and Vintage: N/A.

See page 242 for all colour and finish options.



Roman Urn

Code

ROMURN01

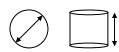

600 x 740



370mm



TWC4



Arundel Urn

Code

ARUURN01

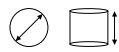

300 x 370



150mm



TMS1

ARUURN02

400 x 470

200mm

TMS1

ARUURN03

670 x 580

400mm

TWC2



ARUURN03



ARUURN01/02

Hampshire Urn

Code

HAMURN01

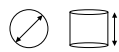

450 x 680



270mm



TWC3





geo design

A superb selection of architectural planters in strong geometric shapes. All feature clean angles and other sizes can easily be built to order. Like the Spirit range, Geo planters all complement each other and can be used in combination across the range for a cohesive scheme.

Un choix superbe de contenants architecturaux avec des formes géométriques aux angles nets. La gamme Geo est parfaitement complémentaire et modulable.





geo
design

barrier

stylish barriers

Stylish barriers in any size, for interiors and exteriors, roof gardens and receptions.

Barrières épurées disponibles en standard et sur mesure, pour l'intérieur et l'extérieur.





barrier

As well as our standard range, Barriers can be constructed in literally any size that will fit on a lorry. Using advanced strengthening materials Barriers will not bow no matter how large the size.

Les barrières sont disponibles sur mesure, renforcées pour les grandes dimensions elles ne se déforment pas.



Colours + Finishes

BS4800 and RAL Classic: Full colour range in polished gloss, satin, matt and textured matt finishes.

Standard colours: All finishes.

Polished Metallics: All finishes.

Textured Metallics: All finishes.

Polished Pearlescents: All finishes.



Polished Stardust: All finishes.

Natural: All finishes.

Dapple and Vintage: All finishes.

See page 242 for all colour and finish options.

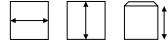

Code		
BARR01	1000 x 300 x 300mm	TMS8
BARR02	1200 x 300 x 400mm	TMS10
BARR03	1400 x 300 x 700mm	2 x TMN6
BARR04	900 x 300 x 900mm	TMS8
BARR05	1000 x 300 x 900mm	TMS8
BARR06	1000 x 300 x 700mm	TMS8
BARR07	1000 x 200 x 300mm	TMS8
BARR08	1500 x 300 x 300mm	TMS12
BARR09	1500 x 400 x 400mm	TMS12

Many other sizes available.
Please contact us with
your exact requirements

Window Box

BARRWB01	400 x 200 x 230mm	TMS3
BARRWB02	600 x 200 x 230mm	TMS5
BARRWB03	800 x 200 x 230mm	TMS7
BARRWB04	900 x 200 x 230mm	TMS8
BARRWB05	1000 x 200 x 230mm	TMS8
BARRWB06	1200 x 200 x 230mm	TMS10

cube

Used everywhere and anywhere. Sometimes great design comes naturally and is impossible to beat.

Une forme exceptionnellement polyvalente.



Colours + Finishes

BS4800 and RAL Classic: Full colour range in polished gloss, satin, matt and textured matt finishes.

Standard colours: All finishes.

Polished Metallics: All finishes.

Textured Metallics: All finishes.

Polished Pearlescents: All finishes.

Polished Stardust: All finishes.

Natural: All finishes.

Dapple and Vintage: All finishes.

See page 242 for all colour and finish options.



Code		
CUBEDT01	160 x 160 x 160mm	TMS1
CUBEDT02	200 x 200 x 200mm	TMS1
CUBE0	350 x 350 x 350mm	TWC3
CUBE1	400 x 400 x 400mm	TWC4
CUBE2	500 x 500 x 500mm	TWC4
CUBE3	600 x 600 x 600mm	TWC6
CUBE4	700 x 700 x 700mm	TWC10
CUBE5	1000 x 1000 x 1000mm	2 x TCN6
CUBE6	800 x 800 x 800mm	TWC10
CUBE7	900 x 900 x 900mm	TWC12
CUBE8	1200 x 1200 x 1200mm	3 x TCN9



tower

The strong lines of the Tower range make it a favourite for paired planting and informal screening.

Les lignes fortes de la gamme Tower en font l'idéal pour la plantation jumelée ou en écran.



Colours + Finishes

BS4800 and RAL Classic: Full colour range in polished gloss, satin, matt and textured matt finishes.

Standard colours: All finishes.

Polished Metallics: All finishes.

Textured Metallics: All finishes.

Polished Pearlescents: All finishes.





Polished Stardust: All finishes.

Natural: All finishes.

Dapple and Vintage: All finishes.

See page 242 for all colour and finish options.



Code	  	
TOW1	160 x 160 x 200mm	TMS1
TOW2	350 x 350 x 600mm	TWC4
TOW3	350 x 350 x 800mm	TWC4
TOW4	400 x 400 x 1200mm	TWC4/6
TOW5	400 x 400 x 1500mm	TWC4
TOW6	500 x 500 x 1200mm	TWC4/6
TOW7	400 x 400 x 900mm	TWC4
TOW8	400 x 400 x 1800mm	TWC4
TOW9	500 x 500 x 1500mm	TWC4/6
TOW10	500 x 500 x 1800mm	TWC4/6

All towers can be shortened to any height on request



pillar

So much more than a cost saving alternative to metal pillars, these are the ultimate space savers. Available in every colour and finish for style without compromise.

Moins cher et plus léger qu'en métal. Disponible dans chaque couleur et finition.



Colours + Finishes

BS4800 and RAL Classic: Full colour range in polished gloss, satin, matt and textured matt finishes.

Standard colours: All finishes.

Polished Metallics: All finishes.

Textured Metallics: All finishes.

Polished Pearlescents: All finishes.



Polished Stardust: All finishes.

Natural: All finishes.

Dapple and Vintage: All finishes.

See page 242 for all colour and finish options.



Code	 	
PILL01	350 x 600mm	TWC4
PILL02	350 x 750mm	TWC4
PILL03	350 x 900mm	TWC4
PILL04	350 x 1200mm	TWC4
PILL05	430 x 600mm	TWC4
PILL06	430 x 800mm	TWC4
PILL07	430 x 1000mm	TWC4
PILL08	430 x 1200mm	TWC4
PILL09	430 x 1500mm	TWC4

Pillars can be shortened to any height on request



geo round

A great utility design suitable for almost any location both interior and exterior.

Un design pratique et facilement adaptable à tout type d'endroit à la fois à l'intérieur et à l'extérieur.

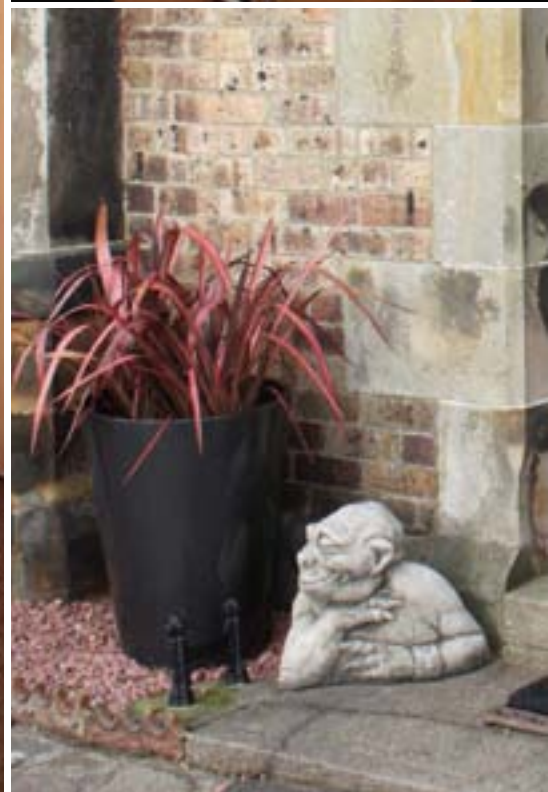
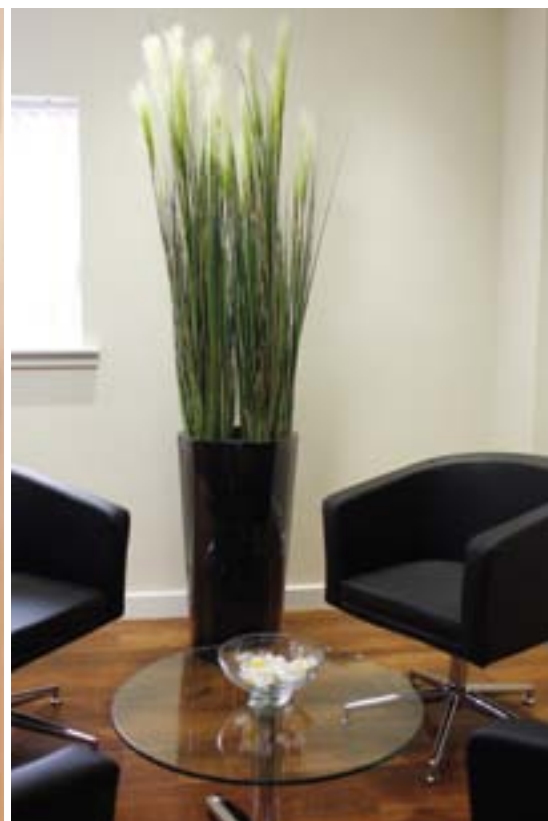

Colours + Finishes

BS4800 and RAL Classic: Full colour range in polished gloss, satin, matt and textured matt finishes.

Standard colours: All finishes.

Polished Metallics: All finishes.

Textured Metallics: All finishes.

Polished Pearlescents: All finishes.

Polished Stardust: All finishes.

Natural: All finishes.

Dapple and Vintage: All finishes.

See page 242 for all colour and finish options.



Code	 	
ROD01	400 x 300 x 400mm	TWC3
ROD02	400 x 300 x 750mm	TWC4
ROD03	400 x 300 x 1000mm	TWC4
ROD04	550 x 385 x 650mm	TWC8
ROD05	550 x 395 x 890mm	TWC6
ROD06	800 x 640 x 700mm	TWC12



cylinder

Classic perfect circles with broad lips available in every size including tree planters.

Cylindres parfaits disponibles avec des bords larges dans toutes les tailles y compris les grandes pour les arbres.



Colours + Finishes

BS4800 and RAL Classic: Full colour range in polished gloss, satin, matt and textured matt finishes.

Standard colours: All finishes.

Polished Metallics: All finishes.

Textured Metallics: All finishes.

Polished Pearlescents: All finishes.





Polished Stardust: All finishes.

Natural: All finishes.

Dapple and Vintage: All finishes.

See page 242 for all colour and finish options.



Code	 		
CYLIN01	400 x 400	300mm	TWC3
CYLIN02	500 x 500	400mm	TWC4
CYLIN03	600 x 600	480mm	TWC6
CYLIN04	700 x 700	560mm	TWC6
CYLIN05	800 x 800	640mm	TWC10
CYLIN06	900 x 900	720mm	TWC12
CYLIN07	1000 x 1000	800mm	TCN6 x 3
CYLIN08	1200 x 1200	960mm	TCN9 x 3

See tree planters for larger sizes



flare + maxi flare

Elegance personified, an architectural statement in their own right.

Élégance personnifiée, un bac architectural.



Colours + Finishes

BS4800 and RAL Classic: Full colour range in polished gloss, satin, matt and textured matt finishes.

Standard colours: All finishes.

Polished Metallics: All finishes.

Textured Metallics: All finishes.

Polished Pearlescents: All finishes.

Polished Stardust: All finishes.



Natural: All finishes.



Dapple and Vintage: All finishes.

See page 242 for all colour and finish options.

Gold and Silver leaf finishes available



Code	 	
FLA1	350 x 600mm	TWC4
FLA2	400 x 900mm	TWC4

Code	 	
MAXFLA1	400 x 1200mm	TWC4
MAXFLA2	400 x 1500mm	TWC4



triangle + diamond

Equilateral tall triangles can be interlocked in different sizes and colours to create features limited only by the imagination. Diamonds are eye-catching space dividers and troughs.

Les grands triangles équilatéraux peuvent s'assembler en différentes tailles et couleurs pour créer des compositions illimitées. Les Geo Diamants sont des jardinières attirantes et originales.



Colours + Finishes

BS4800 and RAL Classic: Full colour range in polished gloss, satin, matt and textured matt finishes.

Standard colours: All finishes.

Polished Metallics: All finishes.

Textured Metallics: All finishes.

Polished Pearlescents: All finishes.

Polished Stardust: All finishes.



Natural: All finishes.

Dapple and Vintage: All finishes.





See page 242 for all colour and finish options.



Triangle

Code	 	
TRI60	500 x 600mm	TWC4
TRI90	500 x 900mm	TWC4
TRI120	500 x 1200mm	TWC4
TRI150	500 x 1500mm	TWC4

Diamond

Code	  	
DIA30	450/1000 x 300mm	TMS7
DIA70	450/1000 x 700mm	TMS7
DIA100	450/1000 x 1000mm	TMS7



ceramic style

Taking the advantages of Advanced Composites to the maximum. This extensive collection features the handmade look, feel and texture of real ceramics and terracotta planters, but with none of the disadvantages. Lightweight, waterproof, frostproof, UV stable, almost unbreakable and available in any colour or finish; now you can specify ceramics anywhere.

Cette collection propose une large palette de contenants présentant l'aspect de la céramique et de la terre cuite. Léger, imperméable, ne craint ni le gel ni les UV, disponibles dans toutes les couleurs et finitions.



ceramic style

Pharaoh

Classic planting shapes studded with pyramid patterning. Suits almost any plant shape.

Formes classiques avec un motif pyramidal. La forme mets en valeur presque toutes les formes de plantes.



Colours + Finishes

BS4800 and RAL Classic: Full colour range in polished gloss, satin, matt and textured matt finishes.

Standard colours: All finishes.

Polished Metallics: All finishes.

Textured Metallics: All finishes.

Polished Pearlescents: All finishes.

Polished Stardust: All finishes.

Natural: All finishes.

Dapple and Vintage: N/A

See page 242 for all colour and finish options.



Code

PHAR01

PHAR02

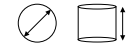

390 x 500mm

600 x 750mm



TWC3

TWC12



hex

A strong statement for feature planting. Polished finishes take full advantage of the reflective patterning.

Un design affirmé pour des plantations exceptionnelles. Les finitions polies mettent en valeur le motif réfléchissant.



Colours + Finishes

BS4800 and RAL Classic: Full colour range in polished gloss, satin, matt and textured matt finishes.

Standard colours: All finishes.

Polished Metallics: All finishes.

Textured Metallics: All finishes.

Polished Pearlescents: All finishes.

Polished Stardust: All finishes.



Natural: All finishes.

Dapple and Vintage: N/A

See page 242 for all colour and finish options.



Code
HEX01

 
660 x 800mm

TWC10



sphere

Planter balls with hand thrown appeal in stepped sizes.

Les sphères existent en plusieurs tailles.



Colours + Finishes

BS4800 and RAL Classic: Full colour range in polished gloss, satin, matt and textured matt finishes.

Standard colours: All finishes.

Polished Metallics: All finishes.

Textured Metallics: All finishes.

Polished Pearlescents: All finishes.





Polished Stardust: All finishes.

Natural: All finishes.

Dapple and Vintage: All finishes.

See page 242 for all colour and finish options.



Code				
SPHER01	470 x 375	300mm	TWC3	
SPHER02	640 x 505	440mm	TWC4	
SPHER03	800 x 640	500mm	TWC8	



antoinette

Fluted vases and planters with a rough, earthen finish.
Specify textured for a smoother, rippled look or Natural finishes for rustic stoneware.

Vases et contenants évasés avec finition rugueuse. Spécifier texturé pour un résultat plus lisse, ou 'Naturel' pour un effet rustique.



Colours + Finishes

BS4800 and RAL Classic: Full colour range in polished gloss, satin, matt and textured matt finishes.

Standard colours: All finishes.

Polished Metallics: All finishes.

Textured Metallics: All finishes.

Polished Pearlescents: All finishes.



Polished Stardust: All finishes.



Natural: All finishes.

Dapple and Vintage: All finishes.

See page 242 for all colour and finish options.



Code	 	
ANTVA1	300 x 700mm	TWC2
ANTVA2	380 x 900mm	TWC3
ANTVA3	500 x 1200mm	TWC4/6
ANTVA4	670 x 1600mm	TWC6/8

Code	 	
ANTPL1	420 x 400mm	TWC4
ANTPL2	500 x 500mm	TWC6
ANTPL3	650 x 650mm	TWC8
ANTPL4	800 x 800mm	TWC10/12



cubis

A perennial bestseller and ceramic style alternative to the Kubik from the Spirit range.

Un best-seller durable et une alternative en style céramique de modèle Kubik.

Colours + Finishes

BS4800 and RAL Classic: Full colour range in polished gloss, satin, matt and textured matt finishes.

Standard colours: All finishes.

Polished Metallics: All finishes.

Textured Metallics: All finishes.



Polished Pearlescents: All finishes.

Polished Stardust: All finishes.

Natural: All finishes.

Dapple and Vintage: All finishes.

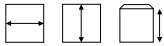
See page 242 for all colour and finish options.

Code		
CU1	180 x 180 x 220mm	TMS1
CU2	300 x 300 x 350mm	TWC2
CU3	340 x 340 x 600mm	TWC4
CU4	380 x 380 x 900mm	TWC4
CU5	230 x 230 x 180mm	TMS2
CU6	500 x 200 x 200mm	TMS4
CU7	900 x 300 x 250mm	TMS8
CU8	450 x 450 x 610mm	TWC6
CU9	460 x 460 x 910mm	TWC8



cleopatra

Featuring stylish barriers and troughs to complement tall ceramic vases.

Des bacs ronds et ovales, style céramique.



Colours + Finishes

BS4800 and RAL Classic: Full colour range in polished gloss, satin, matt and textured matt finishes.

Standard colours: All finishes.

Polished Metallics: All finishes.

Textured Metallics: All finishes.

Polished Pearlescents: All finishes.

Polished Stardust: All finishes.

Natural: All finishes.

Dapple and Vintage: All finishes.

See page 242 for all colour and finish options.

Code

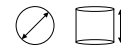

CLEO1 235 x 200mm

TMS1

CLEO2 395 x 400mm

TWC4

CLEO3 395 x 600mm

TWC4

CLEO4 460 x 900mm

TWC4/6

CLEO5 460 x 1200mm

TWC4/6

Code

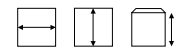

CLEO6 560 x 310 x 500mm

TMS4

CLEO7 680 x 440 x 300mm

TMS5

CLEO8 680 x 440 x 630mm

TMS5



bodacia

Classic ceramic egg pots and low wide bowls.

Pots en style céramique en forme d'œuf, coupes basses et larges.



Colours + Finishes

BS4800 and RAL Classic: Full colour range in polished gloss, satin, matt and textured matt finishes.

Standard colours: All finishes.

Polished Metallics: All finishes.

Textured Metallics: All finishes.

Polished Pearlescents: All finishes.



Polished Stardust: All finishes.



Natural: All finishes.

Dapple and Vintage: All finishes.

See page 242 for all colour and finish options.



Code	 	
BOD1	440 x 410mm	TWC4
BOD2	550 x 460mm	TWC6
BOD3	670 x 560mm	TWC8
BOD4	700 x 850mm	TWC10

Code	 	
BOD5	760 x 420mm	TWC8
BOD6	970 x 500mm	TWC10



julius

solid, ribbed and incredibly strong





julius

Les nervures fortes et étroites en font un classique pour les bacs à arbres et les toitures jardins. Avec une large gamme de tailles standard et la possibilité du sur mesure, Julius est le plus polyvalent de notre gamme et un best-seller.

Colours + Finishes

BS4800 and RAL Classic: Full colour range in polished gloss, satin, matt and textured matt finishes.

Standard colours: All finishes.

Polished Metallics: All finishes.

Textured Metallics: All finishes.



Polished Pearlescents: All finishes.



Polished Stardust: All finishes.

Natural: All finishes.

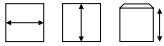
Dapple and Vintage: N/A

See page 242 for all colour and finish options.

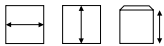
Code		
EMJU05	200 x 200 x 200mm	TMS1
EMJU01	380 x 380 x 400mm	TWC4
EMJU23	450 x 450 x 1000mm	TWC4
EMJU06	500 x 500 x 500mm	TWC6
EMJU10	600 x 600 x 500mm	TWC8
EMJU22	600 x 600 x 800mm	TWC8
EMJU11	700 x 700 x 600mm	TWC10
EMJU12	800 x 800 x 700mm	TWC10
EMJU13	1000 x 1000 x 1000mm	TCN6 (3)
EMJU14	1200 x 1200 x 1000mm	TCN9 (4)
EMJU20	1500 x 1500 x 1200mm	TCN12 (5)
EMJU21	2000 x 1200 x 1000mm	TCN18 (4)
EMJU02	380 x 380 x 600mm	TWC4/6
EMJU03	380 x 380 x 900mm	TWC4/6
EMJU04	380 x 380 x 1200mm	TWC4/6
EMJU07	500 x 500 x 700mm	TWC6
EMJU08	500 x 500 x 900mm	TWC6/8
EMJU09	500 x 500 x 1200mm	TWC6/8

Code		
EMJU15	400 x 200 x 200mm	TMS3
EMJU16	600 x 200 x 200mm	TMS4
EMJU17	900 x 200 x 200mm	TMS8
EMJU18	1000 x 300 x 300mm	TMS8
EMJU19	1000 x 300 x 700mm	TMS8

Many other barrier sizes available. Please ask for a quotation.



EMJU03



EMJU06



EMJU18



EMJU19

julius

Strong, close ribbing makes this a contemporary classic and favourite for tree planters and roof gardens. But with a huge range of standard sizes and the option to build any other size to order, Julius is the most versatile of our range – and justifiably a best seller.



julius

the most versatile planter of our range



julius octavia

Elegant tall fluted squares with the Julius feature ribbing.

Grandes colonnes évasées et nervurées.

Colours + Finishes

BS4800 and RAL Classic: Full colour range in polished gloss, satin, matt and textured matt finishes.

Standard colours: All finishes.

Polished Metallics: All finishes.

Textured Metallics: All finishes.

Polished Pearlescents: All finishes.

Polished Stardust: All finishes.

Natural: All finishes.

Dapple and Vintage: N/A

See page 242 for all colour and finish options.



Code

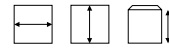

JULOC01

320 x 320 x 600mm

TWC3

JULOC02

400 x 400 x 900mm

TWC4

JULOC03

400 x 400 x 1200mm

TWC4

JULOC04

400 x 400 x 1500mm

TWC4



maximus

Strong design features combine to make this a striking planter with an excellent planting area.

Sa forme caractéristique donne à ce bac remarquable une excellente surface de plantation.



Colours + Finishes

BS4800 and RAL Classic: Full colour range in polished gloss, satin, matt and textured matt finishes.

Standard colours: All finishes.

Polished Metallics: All finishes.

Textured Metallics: All finishes.

Polished Pearlescents: All finishes.



Polished Stardust: All finishes.

Natural: All finishes.

Dapple and Vintage: N/A

See page 242 for all colour and finish options.



Code	 	
EMMAX01	330 x 600mm	TMS2
EMMAX02	520 x 920mm	TWC4
EMMAX03	440 x 590mm	TWC3



constantine + titus

Contemporary terracotta style cylinders but available in any colour or special finish.

Cylindres contemporains style terre cuite, disponible dans toutes les couleurs RAL et finitions 'Naturel'.

Colours + Finishes

BS4800 and RAL Classic: Full colour range in polished gloss, satin, matt and textured matt finishes.

Standard colours: All finishes.

Polished Metallics: All finishes.

Textured Metallics: All finishes.

Polished Pearlescents: All finishes.



Polished Stardust: All finishes.

Natural: All finishes.

Dapple and Vintage: All finishes.



See page 242 for all colour and finish options.

constantine

Code		
EMCO01	380 x 400mm	TWC4
EMCO02	380 x 600mm	TWC4
EMCO03	380 x 900mm	TWC4/6
Dapple and Vintage N/A		



titus

Code		
EMTI01	380 x 400mm	TWC4
EMTI02	380 x 600mm	TWC4
EMTI03	380 x 900mm	TWC4/6



bedouin + javan

Porcelain style smooth ceramics
in stepped sizes.

Style céramique, finition très polie et lisse.

Colours + Finishes

BS4800 and RAL Classic: Full colour range in polished gloss, satin, matt and textured matt finishes.

Standard colours: All finishes.

Polished Metallics: All finishes.

Textured Metallics: All finishes.

Polished Pearlescents: All finishes.

Polished Stardust: All finishes.



Natural: All finishes.

Dapple and Vintage: All finishes.

See page 242 for all colour and finish options.









Bedouin

Code	 	
B1	220 x 210mm	TMS1
B2	400 x 310mm	TWC2
B3	440 x 360mm	TWC3
B4	590 x 450mm	TWC4/6



Javan

Code	 	
JA1	250 x 200mm	TMS1
JA2	450 x 370mm	TWC3
JA3	550 x 450mm	TWC4/6
JA4	680 x 540mm	TWC8/10
JA7	700 x 750mm	TWC10/12
Dapple and Vintage N/A		

Code	  	
JA5	1000 x 300 x 300mm	TMS8
JA6	750 x 200 x 200mm	TMS5
Dapple and Vintage N/A		

garden classics

Despite the name, like all the Livingreen Design range, Garden Classics can be used as both garden and interior planters. However, these ranges have a distinct exterior flavour with design influences from throughout the world.

En dépit du nom, comme toutes la collection Living Green Designs, les classiques de jardin peuvent être employés en extérieur et en intérieur.





garden
classics

rose

Inspired by the Medieval rose and based on ancient lead panels, these incredibly detailed planters can also be specified as both watertanks (with optional lid) and self contained fountains (with optional backplate). Add your own initials, dates or names for a personalised planter that will last a lifetime.

Inspiré par la rose médiévale et basé sur des panneaux de plomb anciens, ces bacs incroyablement détaillés peuvent également être spécifiés comme réserves d'eau (avec couvercle en option) et fontaines (avec une plaque en option). Ajouter vos propres initiales, les dates ou les noms pour un bac personnalisé qui durera toute une vie.





ROSWB02



ROSE04



ROSEF02

Colours + Finishes

BS4800 and RAL Classic: Full colour range in textured matt only.

Standard colours: All finishes in textured matt only.

Polished Metallics: N/A.

Textured Metallics: All finishes.

Polished Pearlescents: N/A.

Polished Stardust: N/A.

Natural: All finishes.

Dapple and Vintage: N/A

See page 242 for all colour and finish options.

Code

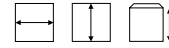

Planter

ROSE01	650 x 650 x 440mm	TWC8
ROSE02	940 x 430 x 640mm	TMN8x 2
ROSE03	520 x 520 x 520mm	TWC4
ROSE04	800 x 800 x 800mm	TWC10/12

Window box

ROSWB01	530 x 240 x 230mm	TMS4
ROSWB02	940 x 240 x 230mm	TMS8

Fountain

ROSEF01 940 x 430 x 640mm
(Back panel HT 1040mm)

ROSEF02 530 x 240 x 230mm
(Back panel HT 760mm)



ROSEF01 (aged lead)



balmoral

Accurate replicas of Elizabethan original lead panelling creates a splendid selection of period planting boxes and troughs.

Répliques exactes de panneaux en plomb d'origine élisabéthaine, une gamme de jardinières d'époque.



Colours + Finishes

BS4800 and RAL Classic: Full colour range in polished gloss, satin, matt and textured matt finishes.

Standard colours: All finishes.

Polished Metallics: All finishes.

Textured Metallics: All finishes.

Polished Pearlescents: All finishes.

Polished Stardust: All finishes.

Natural: All finishes.

Dapple and Vintage: N/A.





See page 242 for all colour and finish options.



BALMOR04



BALMOR05

Code	  	
BALMOR01	360 x 380 x 340mm	TWC3
BALMOR02	750 x 380 x 340mm	TCS6
BALMOR03	1100x 380 x 340mm	TCS9
BALMOR04	520 x 520 x 400mm	TWC6
BALMOR05	1000x 520 x 400mm	TCS9
BALMOR06	1500x 520 x 400mm	TCS12



BALMOR06 (textured graphite)



Detail (antique lead)



BALMOR06 (antique lead)

buckingham

Designed to compliment the historic but equally complimentary to more modern formal property.

Conçu pour compléter un style traditionnel, mais aussi un lieu plus moderne.



Colours + Finishes

BS4800 and RAL Classic: Full colour range in polished gloss, satin, matt and textured matt finishes.

Standard colours: All finishes.

Polished Metallics: All finishes.

Textured Metallics: All finishes.

Polished Pearlescents: All finishes.





Polished Stardust: All finishes.

Natural: All finishes.

Dapple and Vintage: N/A

See page 242 for all colour and finish options.



Code	  	
BUCKIN01	350 x 350 x 360mm	TWC3
BUCKIN02	600 x 350 x 360mm	TMS5
BUCKIN03	900 x 350 x 360mm	TCS6



cardinal

Decorated with Tudor roses, Cardinal planters have been crafted from an original 16th Century lead original pattern to create a flexible range of ancestral planters.

Décoré avec des roses Tudor, les bacs Cardinal ont été conçus à partir d'un modèle original en plomb du 16ème siècle.



Colours + Finishes

BS4800 and RAL Classic: Full colour range in textured matt only.

Standard colours: All finishes in textured matt only.

Polished Metallics: N/A.

Textured Metallics: All finishes.

Polished Pearlescents: N/A.



Polished Stardust: N/A.

Natural: All finishes.

Dapple and Vintage: N/A

See page 242 for all colour and finish options.

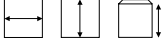

Code		
Planter		
CARDIN01	200 x 200 x 220mm	TMS1
CARDIN02	360 x 400 x 400mm	TWC3
CARDIN03	800 x 800 x 800mm	TWC8
CARDIN04	1000 x 350 x 400mm	TCS9
Window box		
CARDWB01	400 x 200 x 220mm	TMS3
CARDWB02	600 x 200 x 220mm	TMS5
CARDWB03	1000 x 200 x 220mm	TMS8



CARDWB02 (aged lead)

CARDIN03 (antique lead)

priory

Variations on a theme. Versaille style but with an oriental touch. Highly detailed.

Style Versailles avec une touche orientale, très élaboré.



Colours + Finishes

BS4800 and RAL Classic: Full colour range in textured matt only.

Standard colours: All finishes in textured matt only.

Polished Metallics: N/A.

Textured Metallics: All finishes.

Polished Pearlescents: N/A.

Polished Stardust: N/A.

Natural: All finishes.





Dapple and Vintage: N/A

See page 242 for all colour and finish options.

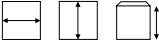

Copper blue

Rust

Code				
PRIORY1	295 x 295 x 390mm			TMS2.5
PRIORY2	380 x 380 x 420mm			TWC3
PRIORY3	440 x 440 x 585mm			TWC8
PRIORY4	575 x 575 x 700mm			TWC10
PRIORY5	710 x 710 x 880mm			TWC12
PRIORY6	1070 x 300 x 330mm			TMS8



bell

Ideal for larger scale planting both for trees and to create lush, wide planter beds.

Idéal pour les grands arbres et arbustes.



Bell 4 featuring integral pallet base

Colours + Finishes

BS4800 and RAL Classic: Full colour range in polished gloss, satin, matt and textured matt finishes.

Standard colours: All finishes.

Polished Metallics: All finishes.

Textured Metallics: All finishes.

Polished Pearlescents: All finishes.



Polished Stardust: All finishes.

Natural: All finishes.

Dapple and Vintage: N/A

See page 242 for all colour and finish options.



Code	 	
BELL1	600 x 300mm	TWC4
BELL2	900 x 450mm	TWC6
BELL3	1200 x 600mm	3 x TCN6
BELL4	1500 x 960mm	3 x TCN9



Highly realistic copper blue finish



Multicolour possibilities

beehive + vase

Traditional Cretan beehives and the spectacular beehive vase.
All the beauty of the originals but in every colour and finish.

Ruches Crétoises traditionnelles et leur vase spectaculaire. Toute la beauté des originaux en terre cuite mais disponible dans chaque couleur et finition.



Portland Stone finish, naturally weathered outdoors for 4 years

Colours + Finishes

BS4800 and RAL Classic: Full colour range in textured matt only.

Standard colours: All finishes in textured matt only.

Polished Metallics: N/A.

Textured Metallics: All finishes.

Polished Pearlescents: N/A.





Polished Stardust: N/A.





Natural: All finishes.

Dapple and Vintage: N/A

See page 242 for all colour and finish options.



Code				
BEE1	510 x 580	250mm	TWC4	
BEE2	600 x 760	310mm	TWC4	
BEE3	800 x 940	310mm	TWC4	

Code				
BEEVA1	540 x 1400	390mm (Vase)	TWC4	
BEEVA2	540 x 900	390mm (Vase)	TWC4	



brunel

Influenced by the great Victorian engineer with folded riveted 'iron' detailing.
The only choice for modern and historic industrial architecture.

Inspiré par le grand ingénieur victorien avec détails de fer plié et riveté.



Aged lead



Colours + Finishes

BS4800 and RAL Classic: Full colour range in polished gloss, satin, matt and textured matt finishes.

Standard colours: All finishes.

Polished Metallics: All finishes.

Textured Metallics: All finishes.

Polished Pearlescents: All finishes.

Polished Stardust: All finishes.

Natural: All finishes.

Dapple and Vintage: N/A.

See page 242 for all colour and finish options.



BRU9 with optional tap and lid



BRU7

Code

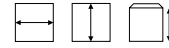

Square

BRU1	400 x 400 x 400mm	TWC4
-------------	-------------------	------

BRU2	500 x 500 x 500mm	TWC4
-------------	-------------------	------

BRU3	600 x 600 x 600mm	TWC6
-------------	-------------------	------

Trough

BRU8	1000 x 300 x 300mm	TMS8
-------------	--------------------	------

Water tank

BRU9	1200 x 600 x 800mm	TCS9
-------------	--------------------	------

Code

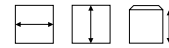

Tower

BRU4	450 x 450 x 600mm	TWC4
-------------	-------------------	------

BRU5	450 x 450 x 750mm	TWC4
-------------	-------------------	------

BRU6	450 x 450 x 900mm	TWC4
-------------	-------------------	------

BRU7	450 x 450 x 1200mm	TWC4
-------------	--------------------	------



Rust detail



Copper blue

tuscany

The look of hand thrown Tuscan terracotta but available in any finish or colour.

Aspect de la terre cuite toscane fait artisanalement mais disponible dans toutes les finitions et couleurs.



Outside the Casino in 'Casino Royale', Tuscany planters and 8m palms. © 2006 Danjag, LLC, United Artists Corp, Columbia Pictures Industries



Colours + Finishes

BS4800 and RAL Classic: Full colour range in polished gloss, satin, matt and textured matt finishes.

Standard colours: All finishes.

Polished Metallics: All finishes.

Textured Metallics: All finishes.

Polished Pearlescents: All finishes.





Polished Stardust: All finishes.

Natural: All finishes.

Dapple and Vintage: N/A

See page 242 for all colour and finish options.



Code	   Base	
TUSC1	260 x 190 x 160mm	TMS2
TUSC2	370 x 280 x 210mm	TMS2
TUSC3	520 x 370 x 300mm	TWC3
TUSC4	640 x 490 x 370mm	TWC4
TUSC5	840 x 660 x 480mm	TWC10
TUSC6	1030 x 820 x 540mm	TWC12
TUSC7	1500 x 1200 x 860mm	Ask for details



chelsea

Distinctly British panel planters
ideal for city planting.

Parfaits pour les plantations en ville.

Colours + Finishes

BS4800 and RAL Classic: Full colour range in polished gloss, satin, matt and textured matt finishes.

Standard colours: All finishes.

Polished Metallics: All finishes.

Textured Metallics: All finishes.



Polished Pearlescents: All finishes.

Polished Stardust: All finishes.

Natural: All finishes.

Dapple and Vintage: N/A

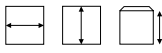
See page 242 for all colour and finish options.

Code		
CHEL1	300 x 300 x 355mm	TWC2
CHEL2	380 x 380 x 430mm	TWC3
CHEL3	450 x 450 x 535mm	TWC4
CHEL4	610 x 610 x 660mm	TWC6
CHEL5	920 x 225 x 255mm	TMS8
CHEL6	1000 x 300 x 300mm	TMS8



westminster

Panel planters with arts and crafts detail patterning.

Bacs décorés aux motifs artisanaux.

Colours + Finishes

BS4800 and RAL Classic: Full colour range in polished gloss, satin, matt and textured matt finishes.

Standard colours: All finishes.

Polished Metallics: All finishes.

Textured Metallics: All finishes.

Polished Pearlescents: All finishes.

Polished Stardust: All finishes.

Natural: All finishes.

Dapple and Vintage: N/A

See page 242 for all colour and finish options.



Code

WEST1

WEST2

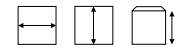

380 x 380 x 430mm

1000 x 300 x 300mm



TWC4

TMS8



swag



admiral & swag

Historic replicas of antique originals, featuring incredible detailing.

Répliques historiques d'originaux antiques, avec des détails incroyables.



SWAURN01



ADMIR01

Colours + Finishes

BS4800 and RAL Classic: Full colour range in textured matt only.

Standard colours: All finishes in textured matt only.

Polished Metallics: N/A.

Textured Metallics: All finishes.

Polished Pearlescents: N/A.

Polished Stardust: N/A.

Natural: All finishes.

Dapple and Vintage: N/A

See page 242 for all colour and finish options.

Code

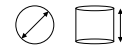

650 x 570



340mm



TWC10

SWAURN01

Code

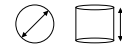

480 x 470



TWC4

ADMIR01



Copper blue detail



Textured graphite

interwovan

Delicate and tasteful small trough raised on small feet.

Une petite jardinière délicate et de bon goût légèrement bombée soulevée sur des petits pieds.

Colours + Finishes

BS4800 and RAL Classic: Full colour range in textured matt only.

Standard colours: All finishes in textured matt only.

Polished Metallics: N/A.

Textured Metallics: All finishes.

Polished Pearlescents: N/A.

Polished Stardust: N/A.

Natural: All finishes.

Daple and Vintage: N/A

See page 242 for all colour and finish options.

Code

INTWOT01

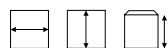

600 x 400 x 330mm



TMS5



lion

With or without the modern lion's head, Lion's massive presence is a perfect foil to Italian topiary.

Avec ou sans la tête de lion, ce bac est parfait pour l'art topiaire.

Colours + Finishes

BS4800 and RAL Classic: Full colour range in textured matt only.

Standard colours: All finishes in textured matt only.

Polished Metallics: N/A.

Textured Metallics: All finishes.

Polished Pearlescents: N/A.

Polished Stardust: N/A.

Natural: All finishes.

Dapple and Vintage: N/A

See page 242 for all colour and finish options.



Code

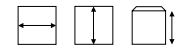

LION

630 x 630 x 570mm

TWC8

NOLION

630 x 630 x 570mm

TWC8



heron

Featuring a unique sculpture of a heron fishing on every side with a different look created by each special finish.

Comportant un héron en relief de chaque côté.

Colours + Finishes

BS4800 and RAL Classic: Full colour range in textured matt only.

Standard colours: All finishes in textured matt only.

Polished Metallics: N/A.

Textured Metallics: All finishes.



Polished Pearlescents: N/A.

Polished Stardust: N/A.

Natural: All finishes.

Dapple and Vintage: N/A

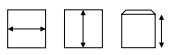
See page 242 for all colour and finish options.

Code		
HERON1	300 x 300 x 400mm	TWC3
HERON2	450 x 450 x 580mm	TWC4
HERON3	675 x 675 x 700mm	TWC8



watertanks

An unrivalled selection of period Watertanks which can also be turned into fountains on request by fitting a special backplate. A fantastic alternative to ugly plastic tanks, these fibreglass models are 100% frostproof and can be ordered with taps and lids as optional extras. All watertanks can also be used as planters.

Une sélection inégalée de réservoirs d'eau d'époque qui peuvent également être transformée en fontaines d'eau sur demande en rajoutant une plaque spéciale. Une excellente alternative aux réservoirs d'eau en plastique, ces modèles en fibre de verre sont 100% résistant au gel et peuvent être commandés avec un robinet ou couvercle en option.



1776 watertank

Code
1776WT

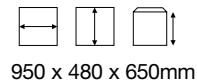

Rose square watertank

Code
ROSE04

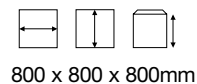

Cardinal watertank

Code
CARDIN03

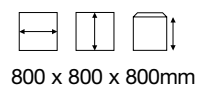

watertanks

Colours + Finishes

BS4800 and RAL Classic: Full colour range in textured matt only.

Standard colours: All finishes in textured matt only.

Polished Metallics: N/A.

Textured Metallics: All finishes.

Polished Pearlescents: N/A.

Polished Stardust: N/A.

Natural: All finishes.

Dapple and Vintage: N/A

See page 242 for all colour and finish options.

1692 watertank

Code

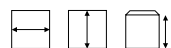

1692WT

700 x 700 x 750mm



Julius watertank

Code

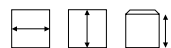

JULWT01

1000 x 500 x 700mm



Greenman watertank

Code

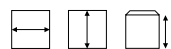

GRMAWT

980 x 540 x 680mm



Colours + Finishes

BS4800 and RAL Classic: Full colour range in textured matt only.

Standard colours: All finishes in textured matt only.

Polished Metallics: N/A.

Textured Metallics: All finishes.

Polished Pearlescents: N/A.

Polished Stardust: N/A.

Natural: All finishes.

Dapple and Vintage: N/A

See page 242 for all colour and finish options.



Brewers watertank

Code

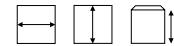

BRETAN01

830 x 390 x 630mm



Brunel watertank

Code

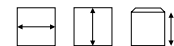

BRU9

1200 x 600 x 800mm

Shown in rust with optional tap and lid



Rose long watertank

Code

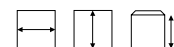

ROSE02

940 x 430 x 640mm

terraces

TERRACES is an exciting new collection of planter, seat and table products that form an integrated approach to landscape design. The range offers the flexible tools that, together with informed planting, help define space and movement and inspire the design of high quality environments within a wide range of public and commercial projects.

TERRASSES est une nouvelle gamme passionnante avec un choix étendu de bacs, sièges et tables qui ensemble forme une approche complète de l'aménagement paysager. La gamme offre des outils flexibles qui, avec une composition végétale professionnelle, aident à définir l'espace et la circulation et inspirent la conception des environnements de haute qualité dans un large éventail de projets publics et commerciaux.





Terraces

Terraces

Colours + Finishes

Terraces base units, made to a high quality finish in GRP, are available in white as standard. A wide range of colours is available to order.

Table tops, made from hard wearing compact laminate, are available in white as standard. A wide range of colours is available to order.

High quality, easily maintained faux leather is used to cover all seat pads. A wide range of colours is available to order.

Les bases de Terrasses sont fabriquées avec une finition de haute qualité en composite résine, elles sont disponibles en blanc en tant que standard. Une large gamme de couleurs est disponible sur commande.

Les plateaux de table, fabriqués à partir de stratifié compact hautement résistant, sont disponibles en blanc en tant que standard. Une large gamme de couleurs est disponible sur commande.

De haute qualité, facile à entretenir, le skaï, similicuir, est utilisé en revêtement pour toutes les galettes de sièges. Une large gamme de couleurs est disponible sur commande.



36TERS01



36TERT02



36TERP02



72TERS01



72TERT01



72TERP01

TERRACES 36°

Code



Seat

36TERS01 770 x 500 x 425

Table

36TERT01 770 x 500 x 425

36TERT02 770 x 500 x 575

36TERT03 770 x 500 x 725

36TERT04 770 x 500 x 875

36TERT05 770 x 500 x 1025

Planter

36TERP01 770 x 500 x 425 550 x 330mm TWC4

36TERP02 770 x 500 x 575 550 x 330mm TWC4

36TERP03 770 x 500 x 725 550 x 330mm TWC4

36TERP04 770 x 500 x 875 550 x 330mm TWC4

36TERP05 770 x 500 x 1025 550 x 330mm TWC4

TERRACES 72°

Code



Seat

72TERS01 1450 x 640 x 425mm

Table

72TERT01 1450 x 640 x 425mm

72TERT02 1450 x 640 x 575mm

72TERT03 1450 x 640 x 725mm

72TERT04 1450 x 640 x 875mm

72TERT05 1450 x 640 x 1025mm

Planter

72TERP01 1450 x 640 x 425 1200 x 330mm TMS10

72TERP02 1450 x 640 x 425 1200 x 330mm TMS10

72TERP03 1450 x 640 x 425 1200 x 330mm TMS10

72TERP04 1450 x 640 x 425 1200 x 330mm TMS10

72TERP05 1450 x 640 x 425 1200 x 330mm TMS10

TERRACES 360°

Code



Table

360TER900T01	900 x 425mm
360TER900T02	900 x 575mm
360TER900T03	900 x 725mm
360TER900T04	900 x 875mm
360TER900T05	900 x 1025mm

Planter

360TER900P01	900 x 425	600mm	TWC12
360TER900P02	900 x 575	600mm	TWC12
360TER900P03	900 x 725	600mm	TWC12
360TER900P04	900 x 875	600mm	TWC12
360TER900P05	900 x 1025	600mm	TWC12

Terraces 360 1200 seat

360TER1200S01	1200 x 425mm
----------------------	--------------

Terraces 360 1200 table

360TER1200T01	1200 x 425mm
----------------------	--------------

Terraces 360 1200 planter

360TER1200P01	1200 x 425	900mm	TMS1
----------------------	------------	-------	------

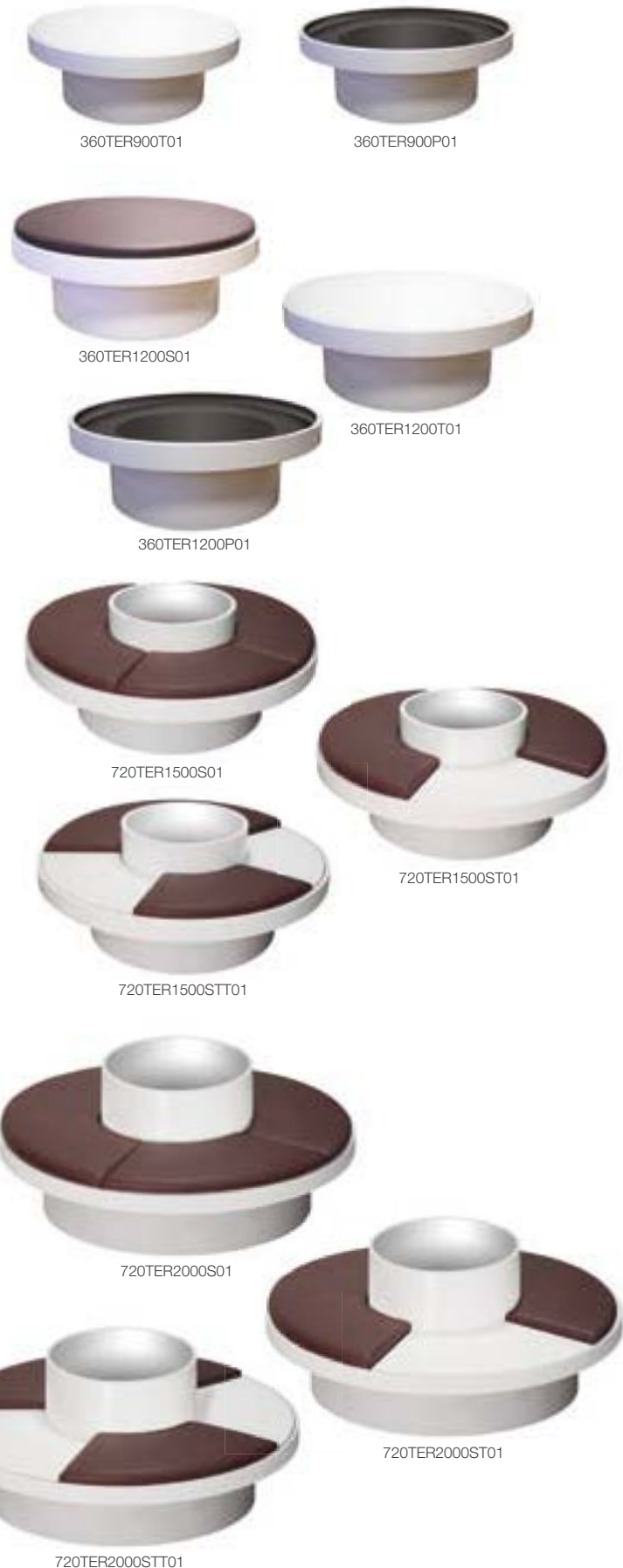

TERRACES 720°

Code



Terraces 720 1500

720TER1500S01	1500 x 425	610mm	TWC12
720TER1500ST01	1500 x 425	610mm	TWC12
720TER1500STT01	1500 x 425	610mm	TWC12

Terraces 720 2000

720TER2000S01	2000 x 425	860mm	TCN6 + TCN3 x 2
720TER2000ST01	2000 x 425	860mm	TCN6 + TCN3 x 2
720TER2000STT01	2000 x 425	860mm	TCN6 + TCN3 x 2

Terraces Planter 1500 (not illustrated)

Use with 72 seating

TER1500P01	1500 x 1200	1380mm
-------------------	-------------	--------

Terraces

While any of the Terraces components can be used singularly, they are designed to be combined together to provide integrated layouts featuring planters, seats and tables of varying size and height. The name 'Terraces' refers to its unique capacity for creating tiers of planting as shown below, but equally it can be used for simple planting and seating arrangements on the same plane. The drawings below illustrate some of the possibilities but Terraces is about using the shapes to create novel solutions to interior space planning and letting your imagination run free.

Sample arrangement

KEY

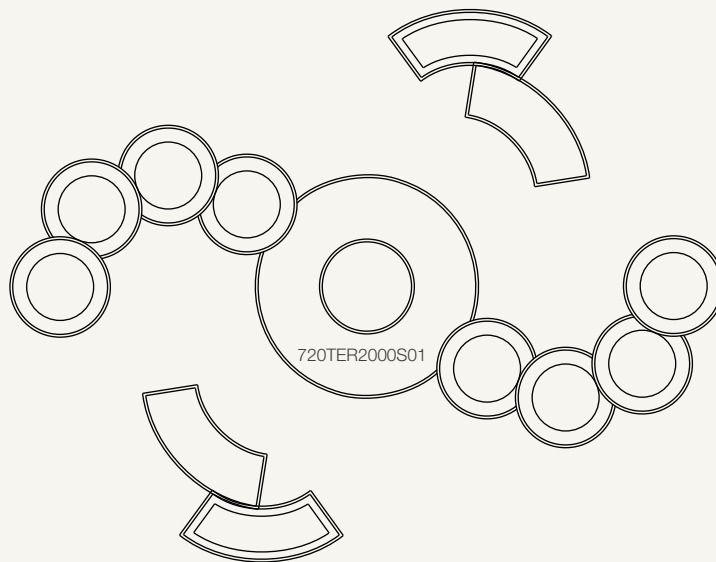
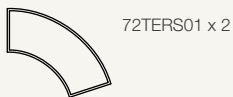

Further sample arrangements using various Terraces components.

TERRACES 72°
planters x 12
TERRACES 720°
1500mm x 3

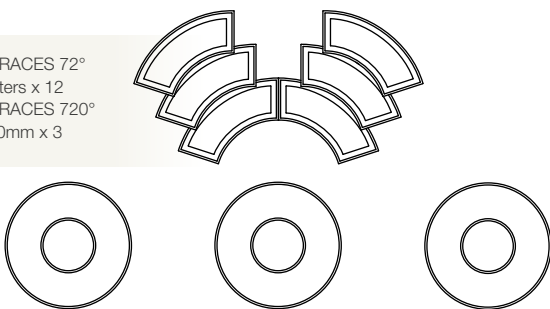

TERRACES 36°
planters x 4
TERRACES 72°
seats x 4
TERRACES 360°
1200mm table x 1

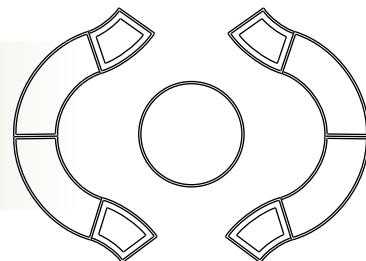

TERRACES 72°
seats x 4
TERRACES 72°
planter x 1
TERRACES 360°
1500mm planter x 1

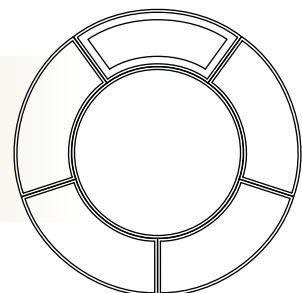

TERRACES 36°
planters x 3
TERRACES 72°
seats x 3
TERRACES 360°
1200mm planter x 1

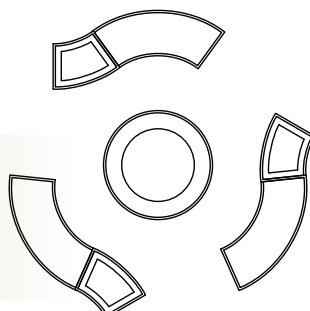

Alors que chaque composant de 'Terrasses' peut être utilisé singulièrement, ils sont conçus pour être combinés ensemble pour fournir des compositions modulables, des sièges et des tables de tailles et hauteurs variables. Le nom 'Terrasses' fait référence à sa capacité unique pour créer des niveaux de plantations comme indiqué ci-dessous, mais également les éléments peuvent être utilisés pour des plantations simples sur le même niveau. Les croquis ci-dessous illustrent quelques possibilités, mais 'Terrasses' consiste à utiliser les formes pour créer des solutions novatrices en décoration d'intérieur et de laisser exprimer librement votre imagination.

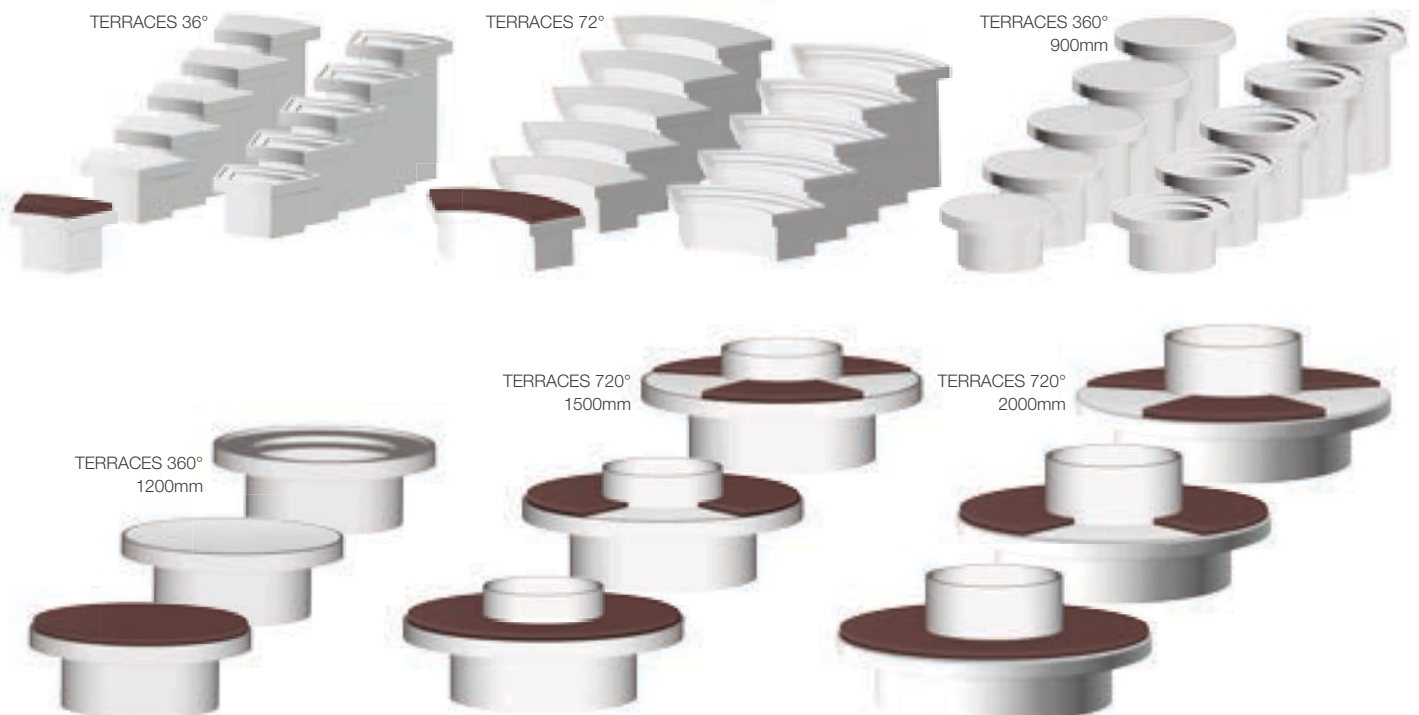
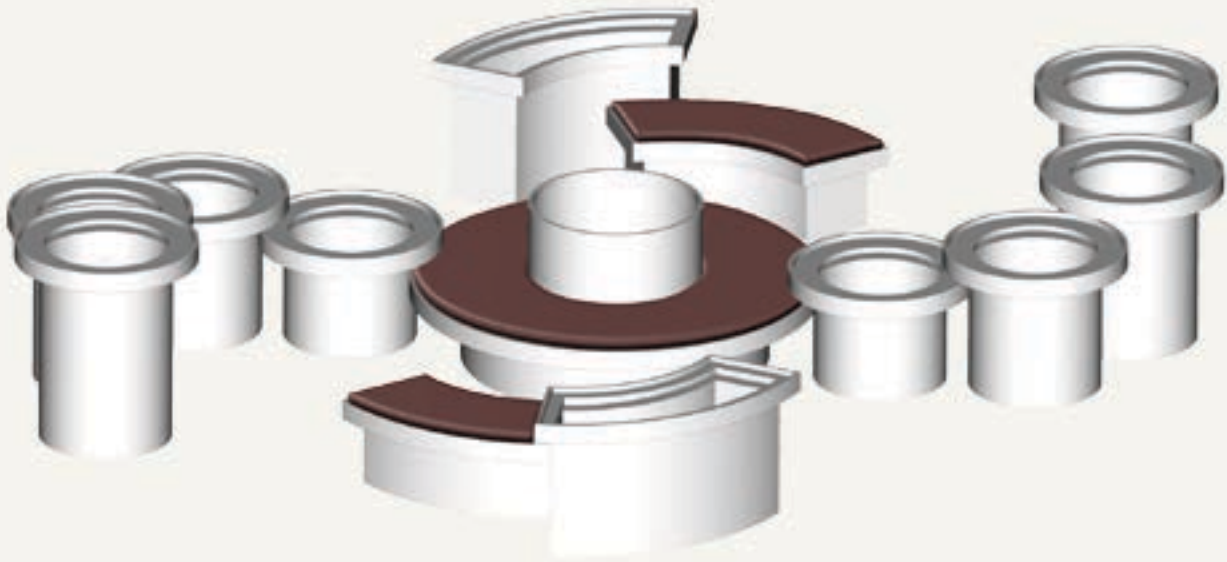

tree planters

the largest off-the-shelf range available

Livinggreen Design offers the largest and most varied selection of off the shelf tree planters available anywhere. We classify a tree planter as at least 90 x 90cm and capable of taking at least a 3m specimen. All are suitable for both interior and exterior use in the most demanding of environments. Such is our skill with tree planter design and fabrication we were chosen to create special planters for the James Bond film, Casino Royale.

Bacs à arbres XXL

Livinggreen Design offre le plus grand stock et le plus divers choix des bacs à arbres. Ces grands bacs à partir de 90 x 90cm peuvent supporter un arbre d'au moins 3m. Tous conviennent pour l'usage à l'intérieur et à l'extérieur. La qualité de ces modèles nous a permis de réaliser des bacs spéciaux pour le film de James Bond, Casino Royale.



Julius EMj14 (textured metallic graphite)



TREE8 (textured metallic silver)



'Casino Royale', Tuscany planters. © 2006 Danjag, LLC, United Artists Corp, Columbia Pictures Industries



Tree 4 (tuscan terracotta)

tree planters



TREE1 800 x 900mm
Irrigation: 3 No. TCN6



TREE2 1900 x 750mm
Irrigation: 4 No. TCN9



TREE3 1200 x 1000mm
Irrigation: Ask for details



TREE4 900 x 750mm
Irrigation: Ask for details



TREE5 980 x 840mm
Irrigation: Ask for details



TREE6 920 x 1020mm
Irrigation: Ask for details

Colours + Finishes

All tree planters are available in the finishes shown below. Certain models are available in further finishes (see page 242). Please check before ordering.

BS4800 and RAL Classic: Full colour range in textured matt only.

Standard colours: All finishes in textured matt only.

Textured Metallics: All finishes.

Natural: All finishes.



CUBE5 1000 x 1000 x 1000mm
CUBE8 1200 x 1200 x 1200mm
Larger sizes to order please ask
Irrigation: Ask for details



TUSC6 1030 x 820mm
Irrigation: Ask for details



TUSC7 1500 x 1200mm
Irrigation: Ask for details



CYLIN07 1000 x 1000mm
CYLIN08 1200 x 1200mm
TREE8 1500 x 1200mm
TREE9 2000 x 1200mm
Irrigation: Ask for details



EMJU13 1000 x 1000 x 1000mm
EMJU14 1200 x 1200 x 1000mm
EMJU20 1500 x 1500 x 1200mm
EMJU21 2000 x 1200 x 1000mm
Irrigation: Ask for details



BELL4
1500 x 960mm
Irrigation: Ask for details

tree planters

Suitable for both interior and exterior use in the most demanding of environments.



CIRKIK6 900 x 850mm
Irrigation: TWC12



BILL04 1000 x 1000mm
BILL05 1200 x 1200mm
Irrigation: TWC12



ROSE04 800 x 800 x 800mm
Irrigation: TWC12



QUAD6 900 x 900 x 900mm
Irrigation: TWC12



BEN06 1000 x 1000 x 1000mm
BEN07 1000 x 1000 x 1200mm
BEN08 1200 x 1200 x 1200mm
Irrigation: TWC12



CARDIN03 800 x 800 x 800mm
Irrigation: TWC8



720TER1500S01 1500 x 425
Irrigation: TWC12
720TER2000S01 2000 x 425
Irrigation: TCN6 + TCN3 x 2



BLOB01 975 x 840 x 750 Irrigation: TCN6x2
BLOB02 1100 x 950 x 850 Irrigation: TCN6x3
BLOB03 1540 x 1330 x 1190 Irrigation: TCN9x2



LUNAS04 1200 x 990
Irrigation: TWC10



Tree 4 (tuscan terracotta)



Tree 3 (textured flame red with pallet base)



Tree 2 (polished silver)

tree planters



CUBE5 (aged lead)



Quad 6 (polished graphite)



TREE6 (weathered terracotta)

replica rocks

Amazingly realistic and ultra-lightweight.

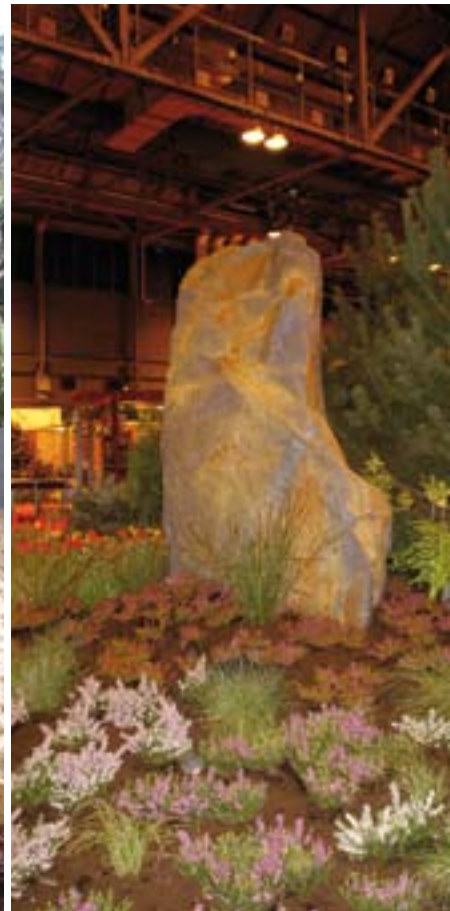

replica rocks

create rock features anywhere

Created for the TV and film industry, these AC rocks and standing stones are so realistic as to be indistinguishable from the real thing – except for the weight. Ideal for any location where crane access is an issue – atriums, courtyards, roundabouts etc.

Faux rochers

Créés pour la TV et l'industrie cinématographique, ces rochers en AC sont si réalistes qu'ils ne peuvent être distingués du vrai du faux - excepté le poids. Idéal pour tout endroit où l'accès d'une grue est problématique - les atriums, les cours, les ronds points etc.



Standing stone 01

Portland stone
1700 x 300mm

Standing stone 02

Sandstone
1900 x 450mm

Standing stone 03

Slate with rust and copper
2000 x 1200mm

Standing Stones

Standing stones (pic) – Ideal feature rocks, No2 is particularly suitable for supply as a water feature – please ask for details.

Les pierres debout

Idéales en composition, le No2 est particulièrement appropriée pour l'ajout d'une cascade - demandez les détails.



Metpost base

All standing stones and rocks can be supplied with a bonded on Metpost base which can be concreted into the ground if required.

Fixation – Pique en métal

Toutes les pierres et les rochers peuvent être fournis avec une pique en métal fixée sous la base qui peut être scellée au sol ou planté si nécessaire.

Colours + Finishes

All standing stones and rocks can be specified in either plain colours or with iron (rust) and/or copper seaming.

Standard finishes are as follows:

Plain: Mudstone (brown), Sandstone, Slate grey, Coal grey

Seamed: Slate base with iron seam

Slate base with iron and copper seam

Other rock finishes to special customer order.



Rock A
1000 x 650 x 400mm



Rock B
900 x 650 x 600mm



Rock C
900 x 700 x 400mm



Rock A1



Rock A2



Rock B1



Rock B2



Rock C1



Rock C2



Rock D
900 x 600 x 500mm



Rock E
900 x 750 x 550mm



Slate with rust



Slate with rust and copper



Sandstone



Rock D1



Rock D2



Rock E1



Rock E2

bespoke design

any size, any shape
any finish

Livinggreen Design offer a full bespoke design and build service to specifiers. With professional product designers on our team, we can take a sketched idea and using our CAD facility provide you with drawings and 3D models for approval prior to manufacture in Advanced Composites, metals, wood or any combination of these as required. Any size and finish can be supplied, with AC particularly suitable for roof gardens or anywhere where weight is an issue. Lighting can easily be incorporated if required as can logos and memorable dates (see page 236).

Design sur mesure

Taille, forme et finition sur mesure

Livinggreen Design offre un service complet de design sur mesure ainsi que des conseils aux prescripteurs. Avec les designers professionnels dans notre équipe, nous pouvons élaborer un croquis et vous fournir des schémas et des modèles 3D pour approbation avant leur fabrication. Ce service est disponible pour les AC, les métaux et le bois. Toutes les tailles et les finitions peuvent être assurées, avec des bacs en fibre de verre convenant particulièrement pour les toitures jardins et terrasses. L'éclairage peut facilement y être incorporé, de même pour les logos et des dates souvenirs (voir la page 236).



Balustrade for grade 1 listed building



Bespoke barriers, aged lead



Bespoke water feature

Concept to finished product – the surf planter.

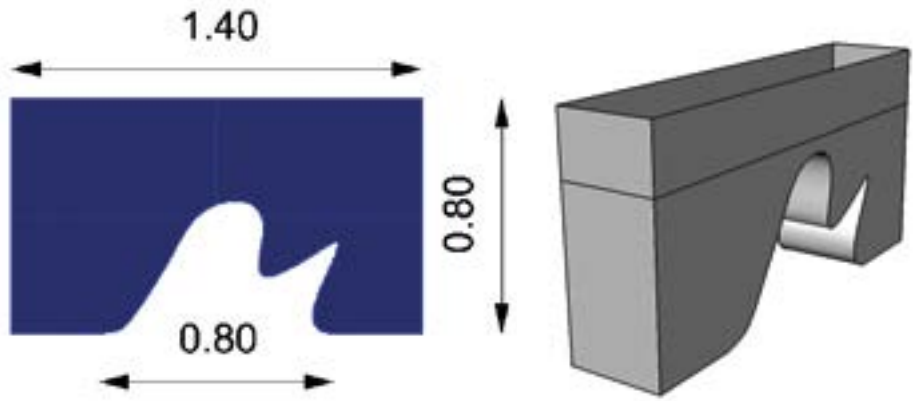
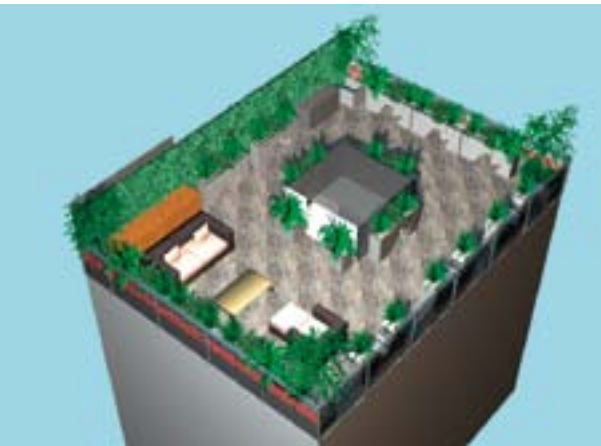

bespoke design

Lighting and castor bases can easily be included for any size of unit.

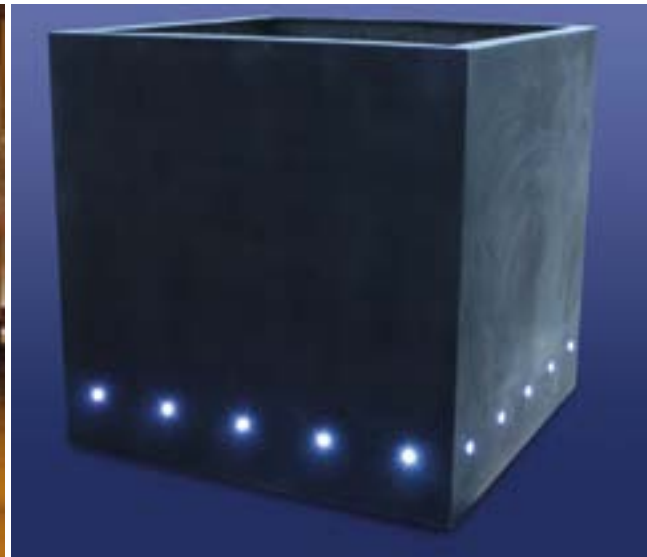

Bespoke diamonds on castor bases



Any length that can fit in a truck

Bespoke roof garden on suspended glass roof.

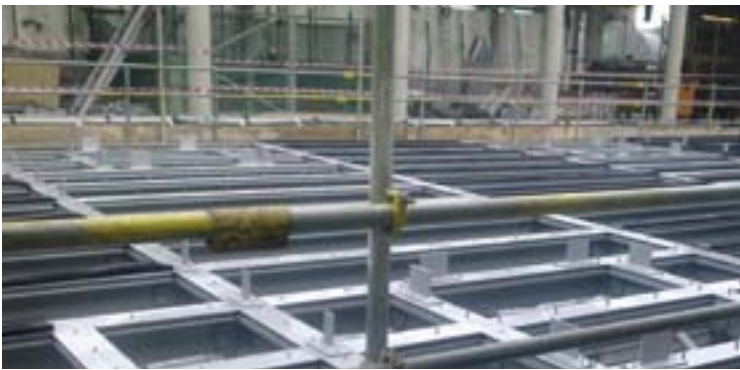
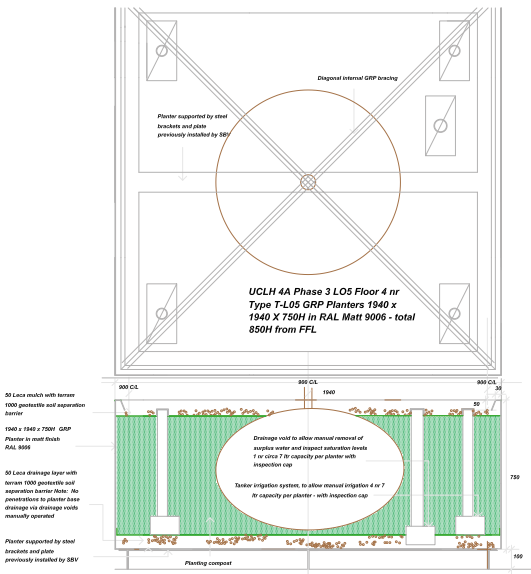

Construction of 2.4m diameter planting dishes – tooling, moulding and production.

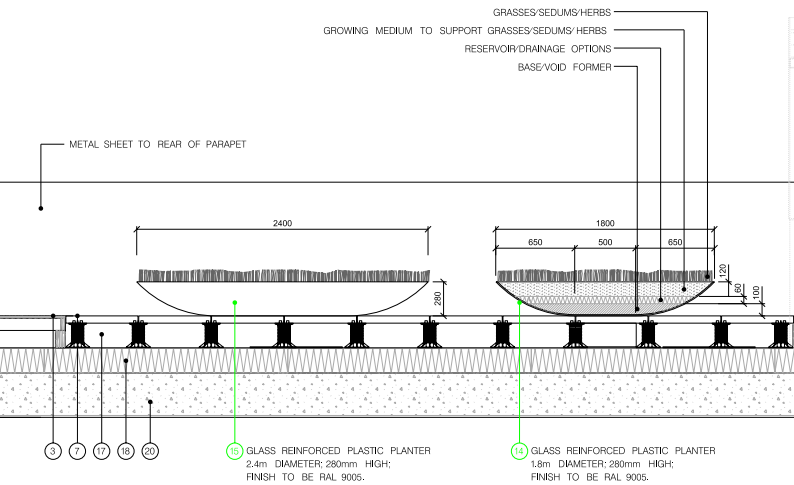

tanker irrigation

The Tanker sub soil irrigation system is the natural choice for cost-effective watering of planters, planting beds and tree pits in both exterior and interior schemes. Incredibly simple to use, all Tanker systems consist of a tank or reservoir positioned under the rootball of the plants and linked to the surface by a flexible or rigid filler pipe. Water is then transported from the tank to the soil as required via a specially designed Geotextile wick which works with any reasonably good soil or compost. Depending upon the size of the area to be irrigated, the tanks can be linked together to form a network, replicating the Earth's natural water table and providing ideal conditions for root growth.

Arrosage par réserve d'eau

La traduction en français de 'Tanker'-réserve d'eau, est téléchargeable en format PDF sur notre site www.livinggreendesign.net



Fitting tanker water cell...





Fitting Tanker Modular network up to 4m long with full automation to restricted depth roof garden for fine turf

tanker irrigation

There are many proven advantages of using Tanker:

- Less frequent watering:** independent research by the University of Reading has conclusively proved that plants in containers, hanging baskets or planting beds and irrigated using Tanker systems require watering only half as frequently as those planted without. Councils and landscapers have been able to slash maintenance labour budgets by using special Tanker hanging baskets, pillar and railings planters and also by retro fitting Tanker units to existing planters. For private gardens, home owners halve the burden of keeping their planters watered and can go on holiday in the summer with less worry about what they will find on their return.
- Water conservation:** As water is delivered straight to the rootball only as required by the plant, Tanker systems greatly reduce the amount of water required to irrigate any plant display. Even in a sealed system, such as a planter, the documented saving is at least 30% – for exterior beds, hanging baskets and drained planters, the savings will be much greater. With water restrictions a regular feature in many areas, this aspect of the system is becoming increasingly important to our customers.
- Healthier, better looking plants:** Tanker only delivers water to the roots as needed, eliminating the flood/drought cycle experienced by manually watered plants. Soil moisture is optimised and the plant does not experience water stress. The result is a denser, larger rooting system and more compact, healthier growth above

ground. Councils using the system report that the displays produced using bedding plants are the best they have ever experienced with more and larger flowers and growth so vigorous that in some cases it had to be cut back – and all achieved with less than half the watering visits previously required.

- Pays for itself in 3-6 months:** Depending upon the frequency of watering previously required, the labour saving alone will pay for these incredibly cost-effective units within 6 months. When you take into account that plants establish faster and are healthier long-term when watered using the system then other savings are guaranteed in plant replacement costs.

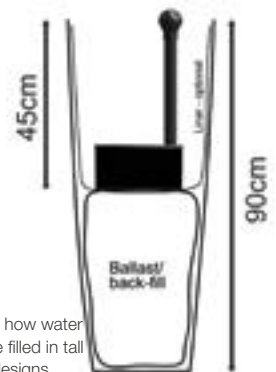

Schematic of how water cell should be filled in tall planter designs



Typical Water Cell installation



Various network options for Modular and Cylinder systems



There are Tanker systems to fit almost every possible situation.

WATER-CELL

- Tanker Water Cell: sealed reservoirs for irrigating individual planters. Available in sizes from 2l - 12l. Suitable for planters up to 90cm diameter.



Water Cell



Code	Litres	 
TWC2	2	220 x 60mm
TWC3	3	220 x 75mm
TWC4	4	220 x 113mm
TWC6	6	343 x 80mm
TWC8	8	343 x 100mm
TWC10	10	343 x 125mm
TWC12	12	343 x 150mm

MODULAR

- Tanker Modular: Available in both Solo (for individual planters) and Network (for larger planters and large beds). Modular units are just 5mm thick and 11cm wide making them ideal for trough planting, window boxes and containers where planting depth is limited. Modular Network is popular for planting beds where very large links can be constructed. Special units up to 4m long can be specified to irrigate lawns, bowling greens, golf greens etc.



Tanker Modular

Code	Litres	  
TMS1	0.75	125 x 120 x 55mm
TMS2	1.2	200 x 120 x 55mm
TMS3	1.8	300 x 120 x 55mm
TMS4	2.4	400 x 120 x 55mm
TMS5	3.0	500 x 120 x 55mm
TMS6	3.6	600 x 120 x 55mm
TMS7	4.2	700 x 120 x 55mm
TMS8	4.4	800 x 120 x 55mm
TMS10	6.0	1000 x 120 x 55mm
TMS12	7.2	1200 x 120 x 55mm
TMS15	9.0	1500 x 120 x 55mm
TMS20	12.0	2000 x 120 x 55mm

Network

TMN1	0.75	125 x 120 x 55mm
TMN2	1.2	200 x 120 x 55mm
TMN3	1.8	300 x 120 x 55mm
TMN4	2.4	400 x 120 x 55mm
TMN5	3.0	500 x 120 x 55mm
TMN6	3.6	600 x 120 x 55mm
TMN7	4.2	700 x 120 x 55mm
TMN8	4.4	800 x 120 x 55mm
TMN10	6.0	1000 x 120 x 55mm
TMN12	7.2	1200 x 120 x 55mm
TMN15	9.0	1500 x 120 x 55mm
TMN20	12.0	2000 x 120 x 55mm

Additional modular sizes up to 4 metres long available on request.



tanker irrigation

CYLINDER

- **Tanker Cylinder:** Like Modular, Cylinder is available in Solo and Network forms but its larger, circular calliper lends its use to very large tree planters, tree pits, car park beds, roundabouts etc.



Tanker Cylinder

Code	Litres	 
TCS3	3	330 x 110mm
TCS6	6	660 x 110mm
TCS8	8	800 x 110mm
TCS9	9	900 x 110mm
TCS12	12	1300 x 110mm
TCS15	15	1500 x 110mm
TCS20	20	2000 x 110mm



Network

TCN3	3	330 x 110mm
TCN6	6	660 x 110mm
TCN8	8	800 x 110mm
TCN9	9	900 x 110mm
TCN12	12	1300 x 110mm
TCN15	15	1500 x 110mm
TCN20	20	2000 x 110mm

- **Tanker Water Level Indicator:** For use in interior landscaping, the indicators are variable straight tubes fitted with a ball float and rod that provide an excellent indication of the depth of water at the base of any planter – perfect for Hydroculture and half-hydroculture growing systems. They are also useful in large sealed tree planters to indicate if there is excess water in the planter. Also available as a filler pipe with a removable lid and no indicator mechanism.



Water Level Indicator

Code		
WLI25	32mm	25mm
WLI30	32mm	30mm
WLI35	32mm	35mm
WLI40	32mm	40mm
WLI45	32mm	45mm
WLI50	32mm	50mm
WLI60	32mm	60mm
WLI70	32mm	70mm
WLI100	32mm	100mm

TANKER IRRIGATION



Rigid Filler Pipe

Each system can be specified with a number of accessories to fit different requirements.

- **Filler pipes:** A no cost choice of flexible or rigid filler pipe is available on both Water Cell and Modular Tanker systems. The flexible pipe is supplied in lengths up to 50m and can be cut to any size (see page 234). As it can also be bent around corners, it is the perfect choice for larger tree planters, for most exterior applications and for unusual size planters. The flexible pipe can be fitted with a water level indicator which is manually cut to size. Rigid pipes are pre-fitted with a ball float indicator, can be purchased in 5cm incremental lengths and are simply pushed into the tanks for fitting, making this the best and simplest solution for the majority of interior planters. Tanker Cylinder can only be fitted with flexible pipe and cannot be fitted with a water level indicator – however levels can still be read using a Dip Stick (see page 234).

- **Caps:** A choice of caps is available including Freeflow, Standard and Funnel. The Freeflow cap was designed specifically for use by interior landscapers. Open to the air for maximum soil aeration it is tamper proof and attaches securely to either the rigid or flexible pipe. The cap does not open and instead water is poured through a gate of specially shaped fins which are profiled to guide the water freely down the filler pipe without splash back from either bowser or watering can. The cap also features space to add a full colour bespoke advertising message – usually a company logo plus telephone number and web address. Freeflow caps also contain the water level indicator rod which is viewed through the fins and must be used with both rigid and flexible filler pipe where a water level indicator mechanism is fitted. Standard caps are the usual choice for exterior use or where a water level indicator is not required. The cap simply pushes over the end of the filler pipe making a very discrete closure. The Funnel is essentially an open version of the Freeflow cap and is fitted as standard to hanging baskets and pillar planters. A cover cap is available for the funnel making it a suitable alternative to the standard cap.



Code		
RFP25	32	25
RFP30	32	30
RFP35	32	35
RFP40	32	40
RFP45	32	45
RFP50	32	50
RFP60	32	60
RFP70	32	70
RFP100	32	100

Accessories



Freeflow Cap



Standard Cap



Funnel

tanker irrigation

- **Wick:** Tanker Wick are geotextile strips fitted to every Tank and are the heart of the system. As they are manufactured from a special combination of woven plastics, they will never deteriorate when left undisturbed. However where frequent replanting of planters is necessary, for example, hanging baskets and containers planted with bedding plants, it may become necessary to replace the wicks after a number of years. This can easily be carried out for all the Water Cell systems and wicks are supplied for each unit size precut to length. Modular systems, due to their design, are much less likely to require new wicks but if eventually this does become necessary then the units can be returned to us for refurbishment.
- **Dip Sticks:** Tanker Dip sticks are flexible capillary rods that can be put down the filler tube and pulled out to show the exact depth of water in that tank or planter. For use where water level indicators cannot be used and particularly suitable for large tree planters. Custom sizes available.
- **Floats:** Polystyrene floats suitable for use with the flexible filler pipe only. Cut to size. Supplied FOC with new flexible filler pipe installations where requested.
- **Stoppers:** These are used to seal the ends of Network units at the end of a run or to convert a network unit into a Solo tank. Supplied FOC with every new Network installation.
- **Flexible pipe:** Available in up to 50m lengths, this is both the connecting pipe between Network Tanks and also an optional filler tube instead of the rigid pipe system. Appropriate lengths are supplied FOC with new Solo and Network systems where required.

Accessories



Wick



Dip-stick



Float for flexible tube



Stopper for network systems



**Flexible filler
or
Connecting pipe
per metre**

tanker – research proven

“ In summary, planters containing Tanker systems will save you half your costs of watering while providing a more attractive, healthier plant with a much stronger and better developed root system.”

Tanker was invented some 25 years ago and at least two installations from that period survive and are still functioning perfectly today. However, to further prove the effectiveness of the system, and in particular its potential to dramatically cut the costs of watering seasonal exterior displays, Tanker has recently been the subject of intensive research at the world renowned University of Reading Horticultural Technology Unit.

The trials were carried out on typically planted interior office plant displays and also on contractor style hanging baskets, window boxes and exterior planters. In every case identical control units were set up without Tanker being fitted. All the units were watered whenever the soil moisture content fell below a predetermined point as measured by use of a Theta probe. The exterior planters were assessed for 70 days and the interior for 5 months before a destructive analysis was carried out to look at the root systems and the fresh weights of the plant material in each. The results are shown in the panel opposite and conclusively prove that fitting Tankers will both save money on maintenance and improve plant quality.



Above: Interior planter clearly showing superior plant development in Tanker (bottom) fitted planters after 70 days of trials.

Top: Roots systems: left – without Tanker; right– with Tanker
Bottom: Tanker fitted window boxes - Day 56

Proof Positive

A summary of results of trials conducted at the University of Reading summer 2004 on hanging baskets, window boxes, patio planters & interior displays.

- *The use of Tanker systems in all situations tested halved the number of watering visits required to maintain the plants.*
- *The amount of moisture in the soil was always more controlled with Tanker systems present – they were less likely to be either very wet or very dry – promoting better plant development.*
- *The plants in the Tanker watered units looked visually more pleasing than those in the control units having a better, more compact growth pattern.*
- *The root systems of the Tanker grown plants were far better developed than those that were top watered only. In exterior trials, the roots reached the bottom of the planters and formed dense masses while also being thicker and fleshier.*
- *Interior trials using Tanker or top watering alone proved that Tanker watered units required at least 30% less water and still produced a better display.*

planter options

Moulded names, initials and dates

Where our planters feature wide, flat surfaces we are able to add lettering and dates in moulded relief that is integral to the planter in the same finish and will last without deterioration for many, many years, even outdoors. Examples may include the name of a hotel or business, the initials of a couple getting married and the date, the date a company was established etc. Prices are per letter or number and dependent upon the finish required.

Noms, initiales et dates façonnés

Quand nos bacs sont dotés de larges surfaces planes nous sommes en mesure de rajouter du lettrage et des dates en relief, qui font partie intégrante du bac dans la même finition et durera sans se détériorer pendant de nombreuses années, même à l'extérieur. Exemples : le nom d'un hôtel ou société, les initiales d'un couple qui se marie avec la date. Les prix sont sur devis selon la finition par lettre et numéro..



Full colour logos or other designs

On planters that feature a suitable smooth, flat surface we are able to offer a full sign writing service. Logos, designs or any form of writing can be added using either Vinyl or paint stencilling (airbrushing) depending upon the colour combinations required and the eventual location of the planters. Suitable for use on exterior as well as interior planters, we now carry out all this work in our own spray shop making it much more cost effective than sending our planters to a third party sign writer. Prices are by quotation only and dependent upon the size and complexity of the project.

Logos en couleur ou autres dessins

Sur les bacs qui disposent d'une surface lisse et plane, nous sommes en mesure d'offrir un service complet de lettrage. Logos, dessins ou toute autre forme d'écriture peut être ajouté en adhésif vinyle ou au pochoir (aérographe) en fonction des combinaisons de couleurs nécessaires et l'endroit où les bacs seront placés. Convient pour une utilisation à l'extérieur ainsi qu'à l'intérieur, nous effectuons ce travail à l'usine. Les prix sont sur devis selon la taille et la complexité du projet.



Fire Retardant Construction

All our planters can, for additional cost, be manufactured using fire retardant gels and resins to produce an AC product that meets the British Standards Class 0 and Class 1 and the French Standard Class M1. These products are ideal for use in public areas and meet the requirements of government legislation. Each order for FR planters will be accompanied by a certificate stating the type of manufacture of the items ordered and the Standards met. The certificates can be issued in other languages than English on request. Please note that our standard products do not meet these FR standards and it is essential to order the planters as FR if this is what is required.

Fabrication ignifugée

Tous nos bacs peuvent, pour un coût additionnel et sur devis, être fabriqués en utilisant des gels et les résines ignifugées pour produire un produit qui répond aux réglementations : British Standards Classe 0 et Classe 1, et pour la réglementation française M1. Ces produits sont idéaux pour une utilisation dans les espaces publics et répondre aux exigences des normes incendies en vigueur. Chaque commande de bacs non feu sera accompagnée par un certificat indiquant le type de fabrication des articles commandés et les normes respectées. Les certificats peuvent être émis dans d'autres langues que l'anglais sur demande. Notez que nos produits standards ne sont pas conformes aux normes non feu donc il est indispensable de commander les bacs en précisant clairement quand ils devraient être ignifugés.



Bespoke FR Christmas tree surrounds for UK Train Stations

Lighting

Most planters can be specified to include lighting options for both interior and exterior use. These will be low voltage LED units powered by transformers. Both white and coloured or colour changing lights can be fitted and the number and their location is entirely up to you to specify. All electrics are contained within a sealed waterproof compartment within the planter which is reached via an access panel. Where the planter needs to be seen from every side the main access may be underneath but a small door will still be available to facilitate lighting unit replacement. Please contact us to discuss your requirements which we will be pleased to draw up for you.

Éclairage

La plupart des bacs peuvent être adaptés avec une option d'éclairage pour un usage à l'intérieur ou à l'extérieur. L'éclairage est en LED (basse tension) alimenté par un transformateur. Disponible en blanc, couleur ou des couleurs changeantes, le nombre et leur emplacement est sur mesure, entièrement à vous de préciser. Toute la partie électrique est dans un compartiment étanche imperméable à l'eau, avec un panneau d'accès. Lorsque le bac doit être vu de tous les côtés l'accès principal peut se trouver en dessous, mais une petite porte sera toujours disponible pour remplacer l'unité d'éclairage. Notre bureau d'étude étudie chaque projet.



Pallet bases

All our tree planters can be specified with a pallet base for ease of moving once planted. Each base is engineered for the style, size and weight loading of individual units and will incorporate strengthening materials to suit. It is also possible to construct hidden pallet bases but as well as adding to the cost these are often less practical and are not recommended unless the base is to be hardly used.

We recommend textured finishes where pallet bases are fitted as this finish is less likely to be damaged by the lifting and moving process and can be more easily repaired on site. Please note, pallet bases are intended for occasional use only.

Transpalette

Tous nos bacs à arbres peuvent être commandés avec un système de transpalette pour faciliter leurs déplacements une fois plantés. Chaque base est conçue selon le style, taille et le poids de chaque unité, avec un renforcement si nécessaire. Nous recommandons une finition texturée pour un bac au transpalette car elle est moins susceptible d'être endommagée en déplaçant le bac. Les bacs équipés avec un système de transpalette sont destinés à un usage occasionnel seulement.



planter options

Castor bases

All our planters can be specified to include a fully bonded in castor base, with or without brakes as required. Two main types of castor base are available

1. **Interior use base on furniture castors.** These are small, black plastic dual wheel castors with or without brakes and suitable for use typically on commercial carpet or carpet tiles. The base will be recessed and the castors invisible to create the illusion of a planter floating approx 2cm off the floor. Narrow planter bases may require the base not to be recessed to assure stability – you will be informed of this at the time of ordering. These are not suitable for heavy pile carpets or real wood flooring
2. **Exterior use base on heavy duty castors.** Where a unit is to be used outside and regularly moved we fit it with heavy duty castors directly onto the base with no recess. This allows the fitting and easy use of brakes which is not possible with a recessed base. These castor bases are engineered for regular use in a hostile environment.

All our castor bases are built to withstand the planted weight of the unit to which they are fitted and we can vary the design to meet the needs of the situation, for example, non marking castors or rubber castors for wooden floors etc – please just let us know your requirements before ordering. Castors can also be fitted to tree planters on request.

Please note, castor bases should be used with care and may fail if bumped regularly over carpet joining strips, kerbs and other obstructions.

Castor exterior



Broken

Unbroken

Roulettes

Tous nos bacs peuvent être prescrits avec des roulettes, avec ou sans freins (freins sur demande). Deux types de roulettes sont disponibles:

1. Utilisation à l'intérieur avec les roulettes de meubles. Ce sont de petites roulettes doubles noires en plastique avec ou sans freins et appropriées pour une utilisation généralement sur la moquette de bureau ou des dalles de moquette. La base sera remontée et les roulettes sont invisibles pour créer l'illusion d'un bac flottant d'environ 2cm du sol. Elles ne sont pas appropriées pour la moquette épaisse ou des parquets.
2. Utilisation à l'extérieur avec des roulettes pour charges lourdes. Lorsqu'un bac doit être utilisé à l'extérieur et régulièrement déplacé, il est équipé de roulettes pour charges lourdes directement sur la base qui n'est pas remontée. Ceci permet l'utilisation de freins qui n'est pas possible avec une base en retrait. Ces roulettes sont conçues pour une utilisation régulière dans un environnement hostile.

Toutes nos roulettes et leurs bases sont fabriquées pour supporter le poids planté de l'unité sur laquelle ils sont montés. On peut les étudier sur mesure afin de répondre aux besoins spécifiques, par exemple : roulettes qui ne marquent pas le sol ou des roulettes en caoutchouc pour un parquet, sur mesure pour les bacs à arbres etc – nous répondons à toutes vos questions avant de commander.

Merci de noter qu'un bac aux roulettes doit être utilisé avec soin et peut être endommagé s'il est heurté régulièrement contre les bordures ou autres obstacles.

Castor interior



Broken

Unbroken



Exterior castor base with brakes



Interior recessed castor base with brakes



Interior recessed castor base with brakes

False bases

All our planters but particularly those that are taller, typically over 60cm, can be specified with an integral false base, at any height, to create the perfect sized planting pocket. The base is made from a bonded in sheet of fibreglass sealed with a waterproof coating. Two types of base are available

1. False base for soil plants. Typically at 35 – 45cm down from the top of the lip – a standard specification is available for all planters typically false based on request. The waterproof lining covers the base and approx 10cm up the sides. These bases are NOT suitable for use with hydroculture or any other system which requires the base to hold a pool of water. We recommend Tanker Irrigation is used in conjunction with these bases
2. False base for hydroculture or any other water based system. Typically hydro bases will be fitted 23cm down from the lip – false bases can vary by +/- 1 cm in height and therefore this level of tolerance is essential. Hydro bases are fully double coated with our waterproofing plastic layer and are guaranteed waterproof.

It is essential to specify which type of false base is required at the time of ordering

Weights can also be added to the real planter base where stability is an issue but this must be requested at the time of ordering

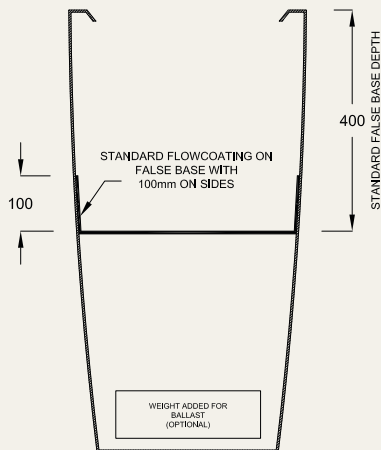

Example standard soil false base

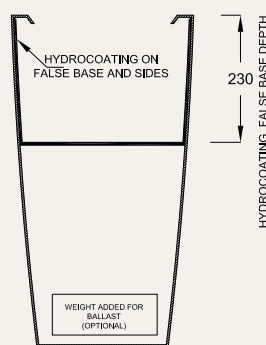

Example standard Hydroculture false base

Faux fonds

Tous nos bacs, mais plus particulièrement ceux qui sont grands, généralement plus de 60cm, peuvent être commandés avec un faux fond à n'importe quelle hauteur, pour créer une poche de plantation parfaite. Le faux fond est fabriqué avec une feuille de fibre de verre scellée avec un revêtement imperméable, étanche à l'eau. Deux types de faux fonds sont disponibles:

1. Faux fonds pour plantes en terre.
En règle générale à 35 - 45cm du bord. La partie imperméable recouvre la base et 5cm environ sur les côtés. Ces faux fonds ne sont pas adaptés pour une utilisation avec l'hydroculture ou tout autre système qui exige de maintenir un fond d'eau. Nous vous recommandons nos réserves d'eau 'Tanker' avec ces faux fonds.
2. Faux fond pour hydroculture. Typiquement situés à 23cm du bord – les faux fonds peuvent varier de +/- 1 cm de hauteur. Les faux fonds Hydro sont entièrement revêtus avec notre couche de matière plastique étanche et ils sont garantis imperméables.

Il est essentiel de spécifier le type de faux fond nécessaire au moment de passer la commande.

Les bacs peuvent être lestés également où la stabilité est un problème, merci de le préciser au moment de passer la commande.



Standard Hydroculture false base



Standard soil false base



Standard soil false base

index

Admiral	199	Curvy S HD	59	Linik	30-31	Spirit Range	10-33
Antoinette	160-161	Curvy Sophia	42-43	Lion	201	Square	117
Arundel Urn	130	Curvy Swan	52	Logos	236	Squeeze	101
Ashaway	32-33	Curvy Troughs	50	London	120	Stack	76-77
Avant Garde Range	62-103	Curvy Ursula	44-45	Luna Crescent	109	Stockholm	122
Balmoral	180-181	Cylik	14-15	Luna Full	107	Straight Fluted Pedestal	116
Barcelona	120	Cylik Lite	16-17	Luna Half	107	Swag	198-199
Barrier	134-137	Cylinder	146-147	Luna Range	104-109	Tanker Accessories	233-234
Barrier HD	59	Dallas	128	Luna Slice	107	Tanker Cylinder	232
Bedouin	175	Deli	123	Lyon	125	Tanker Irrigation	228-235
Beehive	190-191	Diamond	151	Maxi Flare	148-149	Tanker Modular	231
Beevase	190-191	Dune	88-89	Maxi Flare HD	59	Tanker Rigid Filler Pipe	233
Bell	188-189	Easter Island	86-87	Maximus	172-173	Tanker Water Cell	231
Ben	70-71	Environment & Ethics	6-7	Milan	121	Tanker Water Level Indicator	232
Berlin	122	False Bases	239	Minsk	129	Terrace 36°	208
Bespoke Design	222-227	Fez	124	Monaco	116	Terrace 360°	209
Bill	68-69	Flare	148-149	Monaco Holey Design	116	Terrace 72°	208
Blob	64-65	Flip	80-81	Moscow	115	Terrace 720°	209
Bodacia	164-165	Float	66-67	Moulded Names	236	Terraces	206-211
Bowls	120-125	Florence	129	New York	114	Time	84-85
Brunel	192-193	Fusion	82-83	Oslo	123	Titus	174
Buckingham	182-183	Garden Classics Range	176-205	Pallet Bases	237	Tokyo	115
Bullit	100	Geneva	123	Palma	125	Touch	98-99
Cardinal	184-185	Geo Design Range	132-151	Paris	120	Tower	140-141
Castor Bases	238	Geo Round	144-145	Pedestals	114-117	Tower HD	60
Ceramic Style Range	152-175	Hampshire Urn	130	Pedestals Bowls & Urns Range	110-131	Towik	28-29
Chelsea	196	Havana	129	Pharaoh	154-155	Trashaway	32-33
Chicago	114	Heron	202	Phoenix	128	Tree Planters	212-218
Cirkik	18-19	Hex	156-157	Pillar	142-143	Triangle	151
Cleopatra	163	Holey Design Range	56-61	Planter Options	236-239	Trifik	26-27
Colours & Finishes Available	241-242	Hug	72-73	Priory	186-187	Tulip	94-95
Constantine	174	Interwoven	200	Quadik	20-21	Tuscany	194-195
Contents	9	Introduction	2-5	Quadik Plus	22-23	U N C	92-93
Copenhagen	122	Javan	175	Quadik Plus Hot Lip Inserts	24-25	Urns	130-131
Credits	8	Julius	166-170	Replica Rocks	219-221	Vancouver	116
Cube	138-139	Julius Octavia	171	Rio	115	Vegas	128
Cubis	162	Kubik	12-13	Roman	117	Vienna	124
Curvy Bridget	46-48	Kubik Lite	16-17	Roman Urn	130	Vortex	96-97
Curvy Combinations	54-55	Kyoto	125	Rome	121	Water Tanks	203-205
Curvy Desktops	51	Large & Small Fluted Pedestal	117	Rose	178-179	Wave	90-91
Curvy Jayne + Furniture	53	Layer	102	Sanghai	121	Westminster	197
Curvy Marilyn	38-39	Lighting	237	Sicily	124	Yang	74-75
Curvy Range	34-55	Linbar	28-29	Sphere	158-159	Ying	74-75
Curvy S	40-41	Linbar HD	60	Spin	78-79		
Curvy S Barrier	49						

colours + finishes

Most Livinggreen planters are available in all the finishes detailed – but check the product page for a full listing as the design of some units makes certain finishes impractical.

La plupart des contenants de 'Livinggreen' sont disponibles avec toutes les finitions détaillées ci-dessous.

Veillez toutefois vérifier la compatibilité du choix de la finition avec la forme du bac, car certaines sont difficiles à obtenir selon les modèles choisis.

BS4800 and RAL Classic: Over 300 colours available in highly polished gloss, satin, matt or textured matt finishes so you can achieve a perfect match to other furnishings.

BS4800 et RAL Classique: Plus de 300 couleurs disponibles avec plusieurs finitions : polie, satin ou mate texturée. Ainsi nos contenants permettent de trouver l'accord parfait avec l'esprit et l'aménagement du lieu.

Standard Colours: Specially selected colours that are usually held in stock and will meet most requirements. Available in highly polished gloss, satin, matt and textured matt.

Couleurs standard: Certaines couleurs sélectionnées parmi les gammes citées sont habituellement en stock et répondent à la plupart des exigences. Il s'agit des finitions suivantes : polie, satin et mate texturée.

Polished Metallics: The closest finishes to polished metal. Also available in satin sheen.

Métalliques polies: Finitions les plus semblant au métal poli.

Textured Metallics: Matt metal finishes with a rippled effect.

Métalliques texturées: Finitions en effet métal mat texturée.

Polished Pearlescents: Deep, almost 3D colours.

Perle polies: Finition créant un effet de profondeur.

Polished Stardust: Vibrant colour with a hint of silver sparkle. *Other colours on request – check availability before ordering.*

Stardust polies: Couleur scintillante incrustée de petites paillettes argentées. *Plusieurs couleurs sur demande - vérifiez la disponibilité.*

Gold and Silver leaf: True luxury finishes where planters are hand gilded with genuine metal leaf, hand burnished and coated with multiple layers of clear lacquer. *Other leaf finishes available on request.*

Feuilles d'argent et feuille d'or: Les finitions de luxe, les bacs sont travaillés à la main avec des véritables feuilles en métal, ensuite polies à la main et recouvertes de plusieurs couches de vernis clair. *D'autres couleurs de feuilles sont disponibles sur demande.*

Please note we recommend Textured and Natural finishes if planters are to be used outdoors. However all our finishes are suitable for exterior use – please specify this at the time of ordering.

Nous recommandons pour des usages extérieurs d'employer des finitions texturées ou naturelles. Cependant toutes nos finitions conviennent pour l'usage à l'extérieur - spécifiez le lieu d'usage (intérieur ou extérieur) sur la commande.

Natural: Unique finishes that exactly mimic natural materials. *Please note all these finishes have not only the look but also behave like the real material, weathering naturally if outdoors. However, the surfaces will mark clothes if brushed against so use indoors only in low footfall areas. Rust can be matt lacquered to avoid this problem on request.*

Naturel: Finitions uniques qui imitent exactement les vrais matériaux naturels. *De plus elles les ressemblent en aspect et en comportement. Par exemple les finitions rouille et cuivre bleu vieillissent naturellement en usage extérieur. Attention, ces surfaces pourront marquer les vêtements, il est recommandé pour leur usage en intérieur de ne pas les disposer à proximité des endroits passants. La rouille peut être mate laquée à la demande pour éviter cet inconvénient.*

Dapple and Vintage: Unique multicolour finishes adding further opportunities to personalise your planters. Both styles are coated with clear lacquer giving extra shine and a more resilient finish.

Moucheté et Vintage: finitions multicolores uniques rajoutant encore plus de possibilités de personnaliser vos pots. Les deux finitions sont recouvertes de vernis clair donnant un éclat supplémentaire et une finition plus résistante.

Standard Colours - Couleurs standard



Polished Metallics - Métalliques polies

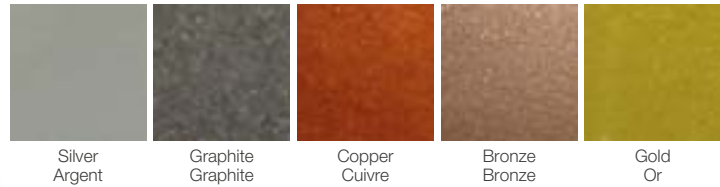

Textured Metallics - Métalliques texturées

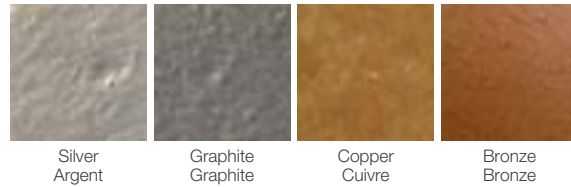

Polished Pearlescents - Perlé polies



Polished Stardust - Stardust polies



Gold and Silver leaf - Feuille d'or et Argent

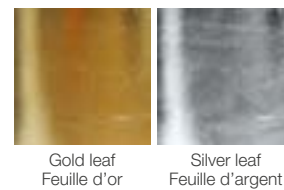

Natural - Naturel



Dapple - Moucheté



Vintage - vintage

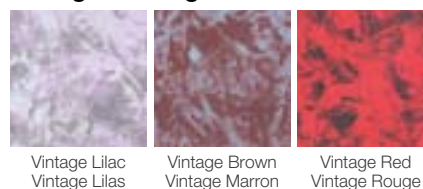

See over for
colours + finishes

ral classic colour chart

1000	1001	1002	1003	1004	1005	1006	1007	1011	1012	1013	1014	1015
1016	1017	1018	1019	1020	1021	1023	1024	1026	1027	1028	1032	1033
1034	1035	1036	1037	2000	2001	2002	2003	2004	2005	2007	2008	2009
2010	2011	2012	2013	3000	3001	3002	3003	3004	3005	3007	3009	3011
3012	3013	3014	3015	3016	3017	3018	3020	3022	3024	3026	3027	3031
3032	3033	4001	4002	4003	4004	4005	4006	4007	4008	4009	4010	4011
4012	5000	5001	5002	5003	5004	5005	5007	5008	5009	5010	5011	5012
5013	5014	5015	5017	5018	5019	5020	5021	5022	5023	5024	5025	5026
6000	6001	6002	6003	6004	6005	6006	6007	6008	6009	6010	6011	6012
6013	6014	6015	6016	6017	6018	6019	6020	6021	6022	6024	6025	6026
6027	6028	6029	6032	6033	6034	6035	6036	7000	7001	7002	7003	7004
7005	7006	7008	7009	7010	7011	7012	7013	7015	7016	7021	7022	7023
7024	7026	7030	7031	7032	7033	7034	7035	7036	7037	7038	7039	7040
7042	7043	7044	7045	7046	7047	7048	8000	8001	8002	8003	8004	8007
8008	8011	8012	8014	8015	8016	8017	8019	8022	8023	8024	8025	8028
8029	9001	9002	9003	9004	9005	9006	9007	9010	9011	9016	9017	9018
9022	9023	<p>NB: the colours shown in the above chart are only as accurate as the four colour printing process can achieve, therefore they should be used only as a guide.</p>										



livinggreen
design

www.livingreendesign.com

Livingreen Design is a brand name of Livingreen Design Ltd t: +44(0)131 440 9804 f: +44(0)131 440 9805