

## REPORT ITU-R BT.2140

**Transition from analogue to digital  
terrestrial broadcasting**

(2008)

**Note by the Chairman**

A Group was tasked to prepare a Report on the Transition from analogue to digital broadcasting by WP 6E of ITU-R with Decision annexed to the Chairman's Report as Corrigendum 1 to Annex 17 to Document 6E/39/30-01-2004 of WP 6E.

The Group had nine meetings and prepared a draft final version of the Report. Three meetings were held, the first at the EBU Headquarters in Geneva on 13 January 2004, the second in Milan on 26 and 27 February 2004 and the third, organized during the April 2004 meeting of WP 6E. As a result of these meetings the Group defined and adopted the Draft Contents of the Report. The next six meetings were held in Rome on 7-9 July 2004, in October 2004 during the meeting of WP 6E, in Venice on 3-4 March 2005, in Rome on 27-28 June 2005, in Seoul in August 2006, in Rome on 17-18 January 2007 and in Rome on 3-6 December 2007. At this meeting the Group concluded its work and will present its Final Report to the WP 6E meeting planned for May 2008.

The purpose of this Report is to help the Countries that are in the process of migrating from analogue to digital terrestrial broadcasting. The Report examines the reasons why this is happening and the technologies involved. It provides an overview of digital terrestrial sound and television broadcasting technologies and system migration. The Report outlines the available options for making that transition and the route to be followed.

The Report is divided into two parts. *Part 1* deals with the main issues related with the transition to digital, presents the principal problems and possible solutions. *Part 2* gives more detailed information on important aspects which have already been covered in Part 1.

**List of participants**

Arasteh K. (IRN), Bochent D. (F), Cane M. (I), Canzio A. (I), Cruciatti M. (I), Dotolev V. (RUS), Valderez de Almeida Donzelli (B), Fujii T. (J), Giudici P.V. (CVA), Hate M. (UK), Kantchev P. (BUL), Kim K. (KOR), Kisrawi N. (SYR), Lazzarini P. (CVA), Magenta A. (I), Masullo G. (I), Mege Ph. (F), Mimis V. (CAN), Montrucchio S. (I), Nalbandian A. (ARM), Olson L. (USA), Perpar S. (SVN), Perrazzino A. (I), Puigrefagut E. (EBU), Salvatori S. (CVA), Simic M. (Ser), Scotti A. (I), Spells G. (UK), Stanley G. (UK), Tsuchida K.(J), Vasseur P. (F).

## Part 1

## Contents

	<i>Page</i>
Chapter 1 .....	5
1 Introduction .....	5
1.1 Purpose of Report .....	5
1.2 General .....	5
1.3 Why Digital? - Technical Considerations.....	5
1.4 Why Digital? - Commercial and Regulatory Considerations .....	6
1.5 How Digital? - Technical and Regulatory Considerations .....	6
1.6 How Digital? - Commercial Considerations.....	7
1.7 ITU activities .....	8
1.8 The scope and the future of Radiocommunication Study Group 6.....	9
1.8.1 Introduction .....	9
1.8.2 The digital broadcasting chain.....	9
1.8.3 Outline for the future .....	11
Chapter 2 .....	13
2 Overview of broadcasting technologies.....	13
2.1 Introduction .....	13
2.1.1 ITU-R .....	13
2.1.2 ITU-T .....	13
2.1.3 ITU-D .....	14
2.1.4 Regional Radiocommunication Conference (RRC) .....	14
2.1.5 World Radiocommunication Conference (WRC-07) .....	15
2.2 Analogue broadcasting technologies and systems.....	15
2.3 Planning considerations for analogue and digital systems .....	15
2.3.1 Background .....	15
2.3.2 Sharing broadcasting frequencies bands with other primary services .....	16
2.4 Digital broadcasting technologies and systems .....	18
2.4.1 Digital Fundamentals.....	18
2.4.2 Background .....	18
2.5 Digital Sound Broadcasting.....	20
2.5.1 Description of digital sound broadcasting systems.....	22
2.6 Digital terrestrial television broadcasting .....	24
2.6.1 Introduction .....	24
2.6.2 Description of Digital Television Broadcasting systems.....	25
2.7 Summary .....	30
2.8 Evaluation of potential Digital Sound and TV Broadcasting systems.....	31
2.8.1 Evaluation of specific Terrestrial Digital Sound and TV Broadcasting .....	31
2.8.2 Hybrid systems .....	31

	<i>Page</i>
Chapter 3 .....	32
3 Application and implementation of digital broadcasting.....	32
3.1 Regulatory considerations .....	32
3.2 Efficient usage of broadcasting spectrum.....	33
3.3 Requirements of sound and television broadcasting services.....	33
3.3.1 Network aspects.....	33
3.3.2 Receiver aspects .....	34
3.4 Aspects related to the interoperability of systems .....	34
3.5 Components of digital sound broadcasting equipment.....	34
3.5.1 Transmitters .....	34
3.5.2 Antennas for transmission .....	34
3.5.3 Receivers .....	34
3.6 Components of digital television broadcasting equipment.....	35
3.6.1 Transmitters .....	35
3.6.2 Antennas for transmission .....	35
3.6.3 Receivers .....	36
3.7 Data broadcasting .....	36
3.8 Broadcasting services for mobile reception.....	37
3.9 Interference aspects .....	37
3.9.1 Interference free reception in the mobile environment.....	37
3.9.2 Impact of interference in end user environment .....	37
Chapter 4 .....	38
4 Transition issues .....	38
4.1 Spectrum availability.....	38
4.1.1 Considerations for the Digital Broadcasting.....	38
4.1.2 General considerations on Broadcasting Planning .....	40
4.2 Broadcasting planning principles .....	40
4.2.1 General considerations.....	40
4.2.2 Coverage of an allotment area .....	41
4.2.3 Allotment test points.....	41
4.2.4 Digital Sound Broadcasting in HF bands .....	42
4.3 Quality of service.....	42
4.4 Economical aspects of Spectrum utilization .....	42
4.5 Health, safety and other legal considerations .....	42
4.6 Switchover Analogue to Digital .....	42
4.6.1 Simulcast of analogue and digital services.....	42
4.6.2 Possible mechanisms for the implementation of digital broadcasting.....	43
4.6.3 Switchover Overview .....	43
Appendix 1 to Part 1 - Case Studies .....	45
1 Australia.....	45
2 Brazil .....	45
3 Bulgaria .....	46
4 Canada .....	46

	<i>Page</i>
5 Germany .....	46
6 Guinea.....	46
7 Italy.....	47
8 Japan .....	48
9 Mexico .....	48
10 Russian Federation.....	49
11 Tanzania	
12 United States of America.....	50
13 Republic of Korea.....	50
13.1 Digital TV for fixed reception .....	50
13.2 T-DMB for mobile reception.....	50
14 Venezuela .....	51
15 OCDE .....	51
16 European Union.....	51
Appendix 2 to Part 1 - Glossary (Abbreviations).....	52

## Chapter 1

### 1 Introduction

#### 1.1 Purpose of Report

Throughout the World, countries are in various stages of switching over from analog to digital terrestrial broadcasting. The digital systems utilized in different parts of the world are described in ITU-R Recommendations BS.1114-5 (for sound) and ITU-R BT.1306-3 (for television).

This Report attempts to provide an overview of the digital switch-over situation world-wide and will be updated regularly.

In 2006, the ITU's Regional Radiocommunication Conference (RRC-06) comprising 120 Administrations in Region 1 (except Mongolia) and Iran from Region 3, adopted a treaty Agreement (GE06 Agreement) that includes a frequency Plan for the digital sound and television broadcasting service. The Plan was developed based upon the digital sound T-DAB system and the digital television DVB-T system. This is a long-term Plan which is based on a mask concept and defined protection and interference criteria that would allow for further evolution of this Plan.<sup>1</sup>

#### 1.2 General

The process of migration, or “Switchover” from analogue to digital techniques can take many routes, each with its own advantages and disadvantages in terms of rapidity, the players involved, and the degree of government intervention. Often influenced by the local broadcasting legacy, each country will follow its own switchover path. Switchover implies more than a technical migration as the role of TV and radio in modern societies is economic, social and political. Appendix 1 Part 2 (Case studies) is intended to demonstrate the existing and planned transition from analogue to digital systems in different countries.

Switchover affects all segments in the broadcasting value-chain: from content production through transmission to reception, all of which require technical upgrading to support digital broadcasts. The serious challenge is to replace or upgrade the huge installed base of analogue receivers. This can be done with integrated digital receivers, or ‘set-top-boxes’ taking care to modify such things as antennas, dishes, cabling, etc. as appropriate.

While market forces and consumer demand will eventually drive the digitalisation of broadcasting it is important to remember that the change has been facilitated by technical development. In broadcasting, as in many other industries, changes are brought about as much, if not more, through the emergence and exploitation of new technologies than by a perceived business demand. With this in mind it is worth first briefly examining the benefits that digitisation might offer.

#### 1.3 Why Digital? - Technical Considerations

A primary benefit of digitalisation is greater control over channel performance. The overall performance of an analogue radiocommunications channel is dictated largely by the characteristics of the channel itself. The scope for exploiting the “trade-offs” implicit in Shannon’s Theorem (Shannon, C. E. [1949] *The Mathematical Theory of Information*: University of Illinois Press) is limited. By contrast, the overall performance of digital systems is largely governed by the quality of the conversion processes (analogue to digital and vice versa) provided that the capabilities of the channel are not exceeded. There is much greater

---

<sup>1</sup> Art. 5.1.3 of GE06 Agreement:

“5.1.3 A digital entry in the Plan may also be notified with characteristics different from those appearing in the Plan, for transmissions in the broadcasting service or in *other primary terrestrial services* operating in conformity with the *Radio Regulations*, provided that the peak power density in any 4 kHz of the above-mentioned notified assignments shall not exceed the spectral power density in the same 4 kHz of the digital entry in the Plan. Such use shall not claim more protection than that afforded to the above-mentioned digital entry.”

scope for exploiting the “Shannon trade-offs”, particularly if error correction techniques are used. In effect the performance of analogue systems tends to deteriorate as the channel performance deteriorates while digital systems remain as defined by the conversion processes until they fail completely. Unfortunately, this means that the subjective effects of channel performance on digital systems can be much more obtrusive when working close to the ultimate channel capacity.

Of seminal importance is the ability of digital systems to compress data into a smaller space with the consequently delay output of the signal. In the broadcasting context this means the use of compression coding techniques which allow relatively high sound and picture quality to be accommodated in a much smaller channel bandwidth. A related benefit is the ability to trade between quality (which is dictated primarily by the degree of compression) and spectral occupancy more or less at will.

The two factors taken together have allowed digital broadcasters to transmit various combinations of high definition (HDTV) and standard definition (SDTV) programs and ancillary data in the same amount of spectrum as one analogue channel while the transmitter power per channel is approximately one fifth of that for an analogue channel. The major selling point for digital TV systems is the ability to offer the viewer and listener more services, greater variety and higher technical quality.

Further to this, digital systems offer additional benefits. Firstly, the relatively easy addition of ancillary data services allows such features as automatic or semi automatic tuning, multiple camera angles, conditional access and the inclusion of supplementary (or even completely unrelated) data streams. Secondly, digital broadcasting techniques can offer credible ‘single frequency networks’. This in its turn makes for even more efficient use of available spectrum, potentially opening the door to even more audience choice. Another technical solution related to digital broadcasting technology is the possibility to adopt them for mobile receiving devices.

#### **1.4 Why Digital? - Commercial and Regulatory Considerations**

As already stated, the major commercial advantage of digital broadcasting is the ability to offer a greater range and diversity of services and applications. This is attractive from the broadcaster’s perspective since this can be done ultimately without the need for additional spectrum (after transition period) and with lower transmitter power. New commercial opportunities will exist. The more consistent, if not better, subjective quality can be a benefit to both providers and users, as can the ancillary services like automatic re-tuning on a car radio for example.

In an environment where the regulatory authority can charge users for the use of spectrum, the availability of a greater number of channels can generate greater income or allow lower rates to be charged to a wider range of users. Some in the regulatory community might even be keen to force the analogue switch off as soon as possible, commensurate with not causing disquiet among listeners and viewers, in order to release the spectrum for other uses.

There are, however, commercial drawbacks. For any individual broadcaster there is the cost of re-equipping and it is unlikely that this will be offset by increased revenue (advertising or subsidy). Persuading the audience to invest in new receivers, or set top boxes, is of fundamental importance to the venture. This cannot be stressed too highly and to do it, it is necessary either to offer a wider range of high quality programming or threaten to discontinue the analogue service. The latter course can be taken at the behest of the administration or government or by way of a commercial decision by the broadcasters. In some environments, spectral allocations are traded between broadcasters (and new entrants). The availability of more channels in such an environment will, in the short term at least, upset the commercial balance by depressing the value of the existing allocations.

#### **1.5 How Digital? - Technical and Regulatory Considerations**

There is little compatibility between digital and analogue broadcast transmission systems. While this can cause some transition problems it is generally advantageous because the digital systems have been optimised against their own technical and financial drivers and are not compromised by having to be compatible with less advanced existing technologies. A primary consideration with the familiar NTSC, PAL and SECAM analogue colour TV systems was their backward compatibility with the existing black and white transmissions.

Any technical transition, or “Switchover”, strategy must work within certain commercial and regulatory imperatives. Commercial considerations are discussed in more detail in the next section but in essence any transition strategy will probably demand the continued availability of analogue versions of existing programme streams until a high proportion of the audience is able to receive the digital services by one delivery means or another (satellite, cable or terrestrial broadcast). Typically, this will mean that digital and analogue versions of the same programmes are broadcast simultaneously during the transition period (i.e. simulcast). Various technical strategies can be and have been deployed to achieve this.

The easiest is to allocate a new band of spectrum to accommodate the new programmes. In the fullness of time, as migration takes place, the old spectrum can be given up. If necessary, and with careful planning and equipment design, it may eventually be possible to transfer the digital services back to the original band. Eureka 147 DAB has been introduced into Europe in this way. The technical characteristics of the system even allow different bands to be used in different countries.

Given the lower demands in both bandwidth and power of digital systems there can be scope for digital transmissions to fit into bands that are already occupied with other services. Typically this will involve a small deterioration in quality (an increase in interference) to the existing analogue services but this could be tolerable because:

- it is potentially small;
- it is temporary - until the digital service becomes the norm;
- it is a key element in facilitating the transition.

The introduction of digital terrestrial television services to UHF bands 4 and 5 in the United Kingdom is an example of this approach. Its effectiveness depends on the existing degree of band congestion.

Where a digital transmission can be made to occupy the same amount of spectrum and have the similar interference impact as an analogue signal it might be possible to simply replace an existing analogue service with a digital one or to use an existing, unused allocation. In most bands there are few unused allocations and so this strategy relies on there being broadcasters which simultaneously transmit the same material on different channels (or even platforms) and are prepared to risk one (the smaller) audience re-tuning to the other frequency. This strategy is currently being used in the AM bands, HF, MF and LF, to mount experimental DRM transmissions. In the HF bands there are possibilities to coordinate channels through the various informal co-ordinating bodies. There are however, still problems with congestion in the lower frequency HF bands and with the limited availability of suitable transmitting plant.

Another approach that is being pursued, notably in the USA with the IBOC systems, fits the digital signal simultaneously into the same channel as the analogue signal. This is only possible where the channelling arrangements allow it and great care needs to be taken to prevent unacceptable levels of co and adjacent channel interference.

If new spectrum is not available and the digital transmissions cannot co-exist with the analogue ones, the switchover might have to take place ‘overnight’. This will be expensive for all concerned.

## **1.6 How Digital? - Commercial Considerations**

It seems unlikely that there has been or will be any pressure from the audience to introduce digital services for their own sake. Audience take up is driven much more by the potential benefits:

- the availability of a wider range of services and applications,
- the availability of premium (conditional access - subscription) services and applications such as first run films and sport,
- improved formats such as wide screen, high definition and surround sound,
- improved sound and picture quality,
- programme associated data, metadata or even independent services like web pages,
- easier access – particularly to specialist material, and
- easier selection of programming – e.g. automatic switching between different LF, MF and HF transmitters or electronic programme guides.

These must be traded against the perceived cost of new equipment and possible subscription costs. It is essential therefore that the audience is presented with an attractive package of services and applications at a price that it is prepared to pay. The drivers on the industry are therefore the production of more and increasingly attractive programme content and the deployment of receivers at appropriate prices.

Receiver price is driven by a number of factors, not least the willingness of the broadcaster or regulator to subsidise the cost in order to promote sales and uptake of the service. DVB-S receivers in the UK are 'free issued' as part of an interactive subscription package. Any switch over strategy must recognise that, the user community can generally be divided in three in its willingness to invest in new technology. The 'early adopters' tend to be enthusiastic about technological development and will invest in new machinery simply in order to have it at an early stage. Such people will typically be prepared to pay a high price for new equipment. In the early stages of product life, the manufacturers rely on this community to offset some of the high development costs of new consumer equipment. The early adopters are followed by the 'mainstream'. These users will be much more circumspect about price and will compare the value they put on the new service/application with the cost of making the change before actually buying a new receiver. These people know that they intend to make the change but do so when the cost of the receiver has dropped (as it inevitably will) to the level they are prepared to pay. The third group, the 'unwilling' have typically decided that they will never change or they have sufficiently little interest in the subject that they are unaware of the development. These people will only change when they absolutely have to (perhaps because the analogue service is withdrawn) or when the price becomes so low that it is not important and digital has anyway become the standard.

This simplistic model of the market is clearly going to be distorted by factors such as subsidies and the threat of discontinuing the analogue services. The threat of discontinuation is a (market) driver that must be used with extreme caution. Public service broadcasters as well as the advertisers who fund a large part of the broadcasting industry will not be pleased to find themselves "cut off" from an established audience if 'switch off' is contemplated before a substantial proportion of it is able to receive the new service. The community of broadcasters will be unwilling to turn any of their services off before the audience drops to the point where the transmission cost is not viable.

One thing can be stated with certainty. Continued technical development and an ever expanding consumer base will mean that the cost of producing receivers will fall. This in turn will push down the purchase price. Continuous development in the integrated technology sector means that systems of ever greater complexity can be accommodated on small silicon chipsets. Receivers with diverse capabilities and single function machines can all use elements of the same chipset, the manufacturing cost of which depends far more on production volumes than on functionality. Stifled development of purely analogue receivers will mean that the time will come when they are more expensive than their much more capable digital brothers. At this point the pressure for switch over will be unstoppable.

While the broadcasters are potentially easier to persuade than the audience when it come to deploying new equipment, the process is not cost free. If transition is to be achieved within realistic timescales and budgets, every effort must be made to re-use existing analogue plant if at all possible. Thankfully, where services are to be mounted in existing frequency bands, the transmitters and antennas, which at the lower frequencies are usually expensive and difficult to replace, can often be adapted to work with the digital transmissions. Most of the DRM transmissions now currently being broadcast around Europe are carried on analogue transmitters which have been adapted. While these transmitters are not usually optimised for carrying digital transmissions, the design considerations are quiet different, this strategy can allow the plant to continue to be used for analogue services as well as digital during the transition period. In addition the cost of producing and transmitting analogue and digital versions of the same programme material at the same time must not be ignored.

## **1.7 ITU activities**

The ITU will continue to play a pivotal role in the regulation of spectrum usage and broadcast technologies. A debate on spectrum aspects of switchover has already been launched among some administrations within the spectrum policy framework. The top-level objective is to encourage efficient and flexible spectrum usage, while preserving the service mission of broadcasting. Among other things this will address the economic value of spectrum allocated to terrestrial broadcasting services and the transparency needed in



setting this value. It is not envisaged that the ITU should be involved at the level of, for example, common switch-off dates or the prohibition of selling analogue receivers. However, national digital broadcasting markets and policies will continue to be monitored.

The three ITU Sectors, each within its own sphere of competence, are responsible for activities and studies relating to broadcasting (see Chapter 2, Part 1, § 2.1). In particular, Radiocommunication Study Group 6 is mainly involved in this issue. Due to the explosive increase in the convergence of the various media, the introduction of digital technologies and taking into account the approach of Study Group 6 in studying the broadcasting service as an end-to-end chain, Study Group 6 is well placed to play an important role in the study of emerging services and applications. These services and applications involve the distribution of multimedia material by new means which include over-the-air distribution to portable and handheld receivers.

## **1.8 The scope and the future of Radiocommunication Study Group 6**

### **1.8.1 Introduction**

On the need to study the broadcasting service on an end-to-end basis, the Radiocommunication Assemblies (Istanbul 2000 and Geneva 2007) have already recognized that the broadcasting service must be studied on an end-to-end basis. Indeed, the terms of reference for Study Group 6 “Broadcasting services” clearly state that “the Study Group, recognizing that radiocommunication broadcasting extends from the production of programmes to their delivery to the general public studies those aspects related to production and radiocommunication, including the international exchange of programs as well as the overall quality of service.” In effect, broadcasting services are based on a long chain of technical operations that use different technologies and perform different functions, but are closely interrelated, since each operation strongly influences the operations that are located downstream in the chain.

The purpose of these considerations is to provide some further insight in the diversified structure of the broadcasting chain, in order to further clarify the reasons why it is essential to study broadcasting services in a single body. A single body collects all of the diverse expertise needed to cover all the links in the broadcasting chain, keeping in mind that the goal of those studies today, is to issue a set of harmonized ITU-R Recommendations. These Recommendations point the way to achieving the best possible quality of the media (audio, video and data) that broadcasting can provide to the end user (the home listener/viewer) most reliably and with the minimum expenditure of resources (e.g., with an efficient use of the spectrum).

### **1.8.2 The digital broadcasting chain**

Figure 1 shows a very simplified basic block diagram of the digital broadcasting chain. It includes four main conceptual blocks, namely the production block, the delivery block, the reception block and the presentation block.

The production block includes three main conceptual functions, namely: production, postproduction and recording.

Production covers the capture of the various media that form a program (program image and the various accompanying sound components) and their transformation from their original state as perceptual stimuli into their representation as digital signals. This block includes the mixing and sequencing of signals from various audio and video sources. It requires, inter alia, expert knowledge of human psychophysical perception to audiovisual stimuli, including knowledge of colorimetry, and of the sampling of audio and video signals.

Recording covers the recording, playback and archiving of audiovisual programs for their subsequent use. It is used when program material produced in the production block needs to be re-mixed or re-sequenced, or when it needs to be integrated with program material produced at different times. It also covers program archiving, which now attracts the keen interest of broadcasters, in view of the possibility to exploit their asset of recorded programs, for re-use on the air, or for sale on the national and international program market. This study requires in-depth knowledge of the available recording technologies, including knowledge of modern tapeless recording (recording on optical discs, solid-state memories and on computer-type memories) and on the ways to manage the access and exploitation of such program signals.

Postproduction covers all the technical operations required to put the captured program signals in their final form as a finished program. It includes the insertion of component elements in the program, such as the mixing of music and dialogue, the development of special visual effects such as reframing, matting or colouring, the dubbing of program sound, the insertion of archive material in studio sequences, the development of elements related to multimedia and interactive applications, etc. This study requires, inter alia, expert knowledge of the type and extent of interaction among the various postprocessing treatments of image or sound signals, when they are performed in tandem, one after the other, in view of the risk that, cumulating, they may impair the final quality of the image or sound.

FIGURE 1  
Conceptual block diagram of the broadcasting chain

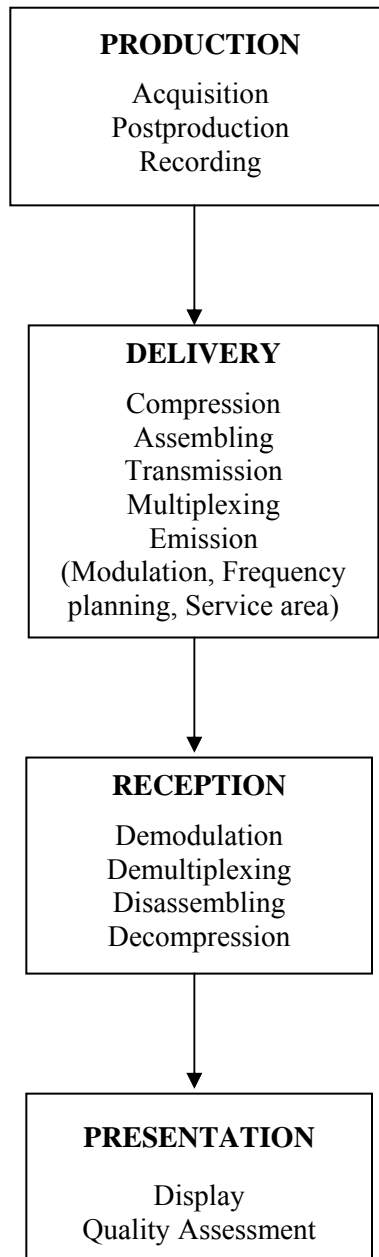

The delivery block includes four main conceptual functions, namely: compression, assembling, multiplexing and emission.

Compression covers the operations required to reduce the bit rate of each program component (video and audio signals, etc), in order that they will require as small a bit rate in the emission channel, as it is strictly necessary to deliver the intended image and sound quality to the end user. This study requires, inter alia, an in-depth knowledge of bit-rate-reduction mechanisms and of their impact on the perceptual quality of program material.

Assembling merges the various program components (video signals, audio signals, signals related to multimedia and interactive applications, etc.), in order that they form a properly structured, single serial data stream, that also carries any ancillary information required to manage the program, such as information on intellectual property rights, conditional access, copy protection, etc. This study, as the one described below, requires a good familiarity with the digital protocols used to smoothly multiplex various digital streams into a single stream, e.g.: preserving synchronization of audio and video

Multiplexing merges various program streams together, into a single data stream whose bit rate matches the data capacity of the transmission channel used to deliver the programs carried in the multiplexed stream. It also adds the data required to protect those program signals against errors introduced by the transmission channel. It is at this stage that statistical multiplexing can be best implemented, thus achieving greater exploitation of the bit rate available on the emission channel.

Emission modulates the multiplexed data stream on the channel carrier, in order that it may be broadcast in the foreseen delivery channel. It also studies the frequency plan, the location and design of the emitting antennas and their emitted power. This study requires an excellent grasp of the related spectrum implications, in order to adequately cover the intended service area while complying with the mandated requirements in terms of interference to and from the emissions of other transmitters.

The reception block of the broadcast chain implements functions that are the counterparts of the functions implemented in the delivery block, namely: demodulation, de-multiplexing, disassembling and decompression.

Demodulation operates on the modulated signal received by the receiver at the user premises, recovering the multiplexed bit stream and correcting as far as possible the errors introduced by the transmission channel.

Demultiplexing operates on the multiplexed bit stream, extracting from it the various program streams that are multiplexed on it.

Disassembling operates on a program stream selected among those demultiplexed in the previous function, recovering the compressed signals that contain the components of the selected program (video signal, various audio signals, and data).

Decompression operates on the compressed signals that compose the selected program, recovering them in their uncompressed form.

The presentation block operates on the decompressed signals, processing them in such a way that the original audio and video program material may be properly presented on the set (radio or television) at the end-user premises. This study requires matching the characteristics of the devices originally used to capture the program, to the characteristics of the user's display. With the current advent of new types of displays, this has become an important challenge.

### **1.8.3 Outline for the future**

Radiocommunication Study Group 6 grasped the multifaceted nature of broadcasting at an early stage of its activity and has promptly and efficiently addressed this challenge.

Study Group 6 was mandated to conduct end-to-end studies in the following domains:

- production of program material (all functions needed to repackage program material in order that it may also be distributed over the advanced applications such as internet, cellular phones, etc);
- digital signal compression, assembly of program material and relevant metadata;

- production of television programs for collective viewing in large halls, similar to movie theatres (almost completed);
- distribution of program material by terrestrial broadcasting and by satellite broadcasting service;
- program distribution over new, emerging media such as interactive broadcasting and “webcasting”;
- reception of broadcasting service by the end user;
- provide to the end user the best possible quality of picture and sound;
- subjective assessment and objective measurement of perceptual video and audio quality at the end of a chain, even on-line.

Indeed, the broadcasting chain described above applies to both traditional broadcasting and interactive broadcasting, whether it is over the air, by cable television, by fibre optics or via satellite. The identification of appropriate return channels and of the applicable digital protocols to achieve the desired degree of interactivity is being aggressively pursued in cooperation with other Sectors of the ITU.

Nowadays we witness an explosive increase in the convergence of various media in the wake of the pervasive introduction of digital technologies, the success of the approach taken by Radiocommunication Study Group 6 to the study of the broadcasting service as an end-to-end chain, might encourage extending its study to the repackaging of television program material for distribution by new broadcasting means such as over-the-air distribution of television program material to fixed, portable and handheld receivers or even for distribution of that material over cabled connections by “web-casting” or “cable-casting”.

## Chapter 2

### 2 Overview of broadcasting technologies

#### 2.1 Introduction

This chapter deals with ITU activities and studies concerning analogue and digital broadcasting systems.

The three ITU Sectors, each within its own sphere of competence, are responsible for activities and studies relating to broadcasting.

##### 2.1.1 ITU-R

###### *Radiocommunication Study Group 1 - Spectrum management*

- Recommendation ITU-R SM.1047 - National spectrum management
- Report ITU-R SM.2012 - Economic aspects of spectrum management and its Addendum
- Handbook - National Spectrum Management, 2005
- Handbook - Computer Aided Techniques for Spectrum Management, 2005
- Handbook - Spectrum Monitoring, 2002\*.

###### *Radiocommunication Study Group 3 - Radiowave propagation*

- Recommendation ITU-R P.1546 - Method for point-to-area predictions for terrestrial services in the frequency range 30 MHz to 3 000 MHz. This revised Recommendation replaces the two former Recommendations ITU-R P.370 and ITU-R P.529, which were the two main Recommendations containing propagation curves for use in predicting field strengths in the case of terrestrial mobile and broadcasting service systems.
- ITU-R Handbook - Terrestrial land mobile radiowave propagation in the VHF/UHF bands (2002).

###### *Radiocommunication Study Group 6 - Broadcasting service*

- In particular the activities of Working Party 6A (formerly Working Party 6E) which is responsible for terrestrial broadcasting standards and planning parameters. WP 6A created a Rapporteur Group to prepare a Report on digital broadcasting technologies and systems, interoperability of digital terrestrial systems with existing analogue networks, and methods of migration from analogue terrestrial techniques to digital techniques.
- Task Group 6/8 prepared a Report for the Regional Radiocommunication Conference-06 (RRC-06) which updated the Stockholm 1961 Plan and the Geneva Plan 1989 (see Chapter 4, Part 1).

##### 2.1.2 ITU-T

###### *SG 9 - Integrated broadband cable networks and television and sound transmission*

This is the lead study group on integrated broadband cable and television networks, with responsibility for studies relating to:

- the use of cable and hybrid networks, primarily designed for television and sound programme delivery to the home, such as integrated broadband networks to also carry voice or other time critical services, video on demand, interactive services, etc.;
- the use of telecommunication systems for contribution, primary distribution and secondary distribution of television, sound programmes and similar data services.

In ITU-T Study Group 9, dealing with integrated broadband cable networks and television and sound transmission, the following Questions and their relevant recommendations are to be found:

*Question 6/9* – Conditional access methods and practices for digital cable distribution to the home

*Question 12/9* – Cable Television delivery of advanced multimedia digital services and applications that use Internet Protocols (IP) and/or packet-based data

*Question 13/9* – (Voice and Video IP Applications over cable television networks.

*Study Group 9 is responsible for coordination with Radiocommunication Study Group 6 on matters relating to broadcasting.*

*SG 15:* In ITU-T Study Group 15 which covers optical and other transport networks, the following Questions and relevant associated Recommendations will be covered:

*Question 1/15* – Access network transport

This Question maintains a comprehensive standards overviews that is updated on a regular basis and can be found at the following website address:

<http://www.itu.int/ITU-T/studygroups/com15/index.asp>

*SG 16 - Multimedia services, systems and terminals.*

### **2.1.3 ITU-D**

Specific collaboration was initiated between ITU-D Study Group 2 and Radiocommunication Study Group 1 with respect to the implementation of WTDC-98 Resolution 9, entitled "Participation of countries, particularly developing countries, in frequency spectrum management", leading in the first instance to the adoption of a report in that regard. WTDC-02 adopted a revised version of Resolution 9 and required that the corresponding studies be pursued and associated with the work being done on ITU-D Question 21/1 - Calculation of frequency fees. The WTDC-06 has confirmed the same decisions and the work is ongoing. We also note that Question 21/2 is incorporated in Resolution 9 of WTDC-06.

In ITU-D Question 11-2/2 - Examination of terrestrial digital sound and television broadcasting technologies, and systems, including cost/benefit analyses, interoperability of digital terrestrial systems with existing analogue networks, and methods of migration from analogue terrestrial techniques to digital techniques, deals with this matter. It should be noted that a summary of the Questions and topics under study, as well as details of approved Recommendations and handbooks having a particular bearing on developing countries, are provided in ITU-D Study Group 2's Report on Question 9-2/2 - Identification of study topics in the ITU-T and ITU-R study groups which are of particular interest to developing countries.

In this Report, attention is drawn to the main points pertaining to Question 11-1/2:

### **2.1.4 Regional Radiocommunication Conference (RRC)**

Following the consultations initiated in 2000 regarding the holding of a regional radiocommunication conference (RRC) and planning of the future broadcasting service in the bands 174-230 MHz (VHF bands) and 470-862 MHz (UHF bands), the Plenipotentiary Conference adopted Resolution 117 (Marrakech, 2002) on determination of the planning area for terrestrial television and sound broadcasting in those bands at the regional radiocommunication conference.

At its 2003 session, the Council modified Resolution 1185 to take account of the decisions taken by the Plenipotentiary Conference (Marrakech, 2002) and draw up the agendas of the two sessions of the RRC. In accordance with Council Resolution 1185 (modified, 2003), a report was drawn up in Geneva during RRC-04 (May 2004). It served as the basis for the work of the first session of the RRC, with a view to facilitating the planning exercises prior to the second session and the form in which administrations should submit their requirements. The first session of the conference took place from 10 to 28 May 2004 in Geneva. The second and final session of the Conference took place from 15 May to 16 June 2006 in Geneva. The results are reported in Chapter 4 Part 1, § 4.1.2.

### 2.1.5 World Radiocommunication Conference (WRC-07)

WRC-07 decided to allocate conditionally on a co-primary basis some bands (790/806-862 MHz) to IMT, previously allocated on a primary basis to the broadcasting service (please refer to WRC-07 Final Acts, Article V, Table of Frequency Allocations).

## 2.2 Analogue broadcasting technologies and systems

Radiocommunication and the Broadcasting service based on the Nikola Tesla inventions, practically, were born at the end of XIX<sup>o</sup> century with the Marconi transmissions. Starting from the first decade of XX<sup>o</sup> century the scientific theories dealing with the issues of broadcasting were rapidly developed.

The first standard regarding the treatment of the signals on radio frequencies, contrary to our assumption, was the digital type (on-off). The standards used for wire telegraphy were applied to radio transmission, called “telegraphy without wires”. For the development of analogue systems and technology for radio broadcasting it was necessary to wait for the technological development of the “Diode” and “Triode” tubes. “Frequency modulation” and “phase modulation” systems (Recommendations ITU-R BS.467 and ITU-R BS.1194) have progressively complimented the ‘amplitude modulation’ systems (Recommendation ITU-R BS.598), created around 1930. Around 1940, the technologies and standards combining the analogue, amplitude modulation with frequency modulation for video and audio television systems, were the consequence of the intense studies on television systems. Different combinations have originated three different standards adopted by ITU-R around 1960, PAL, SECAM, and NTSC systems (Recommendation ITU-R BT.470). The development of advanced technology in the field of tubes, with the realisation of “Tetrode” “Pentode” “Klystron”, led to very compact and high efficiency transmitter and receiver equipment. That allowed the large development of analogue systems for radio and television. At the same time, the new technological invention of the solid state triode, “Transistor”, and all other solid state components, opened the way to the development of a new series of systems, primarily used for receiving equipment and for computer chips.

The satellite technologies came, in about 1960 starting with analogue systems, but rapidly changed to digital.

The new technologies enable the transmission of other data, which makes possible the convergence between broadcasting and telecommunications in general.

## 2.3 Planning considerations for analogue and digital systems

### 2.3.1 Background

At the international level, the ITU is in responsible for the preparation of the standards for broadcasting. The studies in ITU-R are carried out in SG 1 (spectrum issues), SG 6 (RF standards and planning parameters) and the relevant group of SG 2 of ITU-D.

The digital standardisation in ITU-R began in around 1960 and the first planning of analogue systems by satellite (WARC-77) opened the way for digital systems.

The technological convergence between broadcasting and computers, in around 1980, gave the impetus to study digital systems and to create digital technology. The low power linear amplifiers used for satellites (transponders) led to the revision of the use of analogue systems for satellite emission. All the chain from the transmitter (Tx) to the receiver (Rx) became digital. At WRC-2000 a fully digital broadcasting plan was created for ITU Regions 1 & 3.

Terrestrial analogue broadcasting was revised by the Regional Radiocommunication Conference, RRC in Region 1 and changed to digital in considering the advantages in spectrum saving, additional services, different types of services and better quality of service. The first part of this conference, which was held in May 2004 (RRC-04), prepared the planning procedure and parameters; the second part (RRC-06) took place in Geneva in May 2006 and prepared the final frequency plan.

In the year 2000 sound broadcasting created digital systems for different frequencies (DAB, DRM, and IBOC). The improvement in reception quality of digital radio may make some of the broadcasting bands more attractive to commercial broadcasters. ITU-R has standardised the system DRM for frequencies below 30 MHz and IBOC for the medium wave bands (Recommendation ITU-R BS.1514). Due to the fact that all

the new standards are based on digital technologies, the previous border in between sound broadcasting and TV broadcasting is disappearing. Nowadays, it is possible to broadcast sound, TV and data with all the digital standards such as ATSC, DVB-T, ISDB-T, DVB-H, ISDB-T<sub>SB</sub>, T-DMB and ChinaDTV. This means that with a single digital receiver or set top box it is possible to have access either to TV content, data or Radio services. In the rest of this document, the different standards will be analysed in a traditional way for use by either the sound broadcasting approach or the TV broadcasting approach

Digital technology, even if it is now mature, depends on the availability of low cost receivers. This facility has to be supported by a large availability of program emissions.

The transition period was obviously the main point for the final application of digital systems.

Another very crucial point for the transition from analogue to digital systems is the Planning.

All plans adopted by ITU until 2006 were mainly analogue plans, trying to satisfy the increasing demand for channels and on-air time from some Administrations. This growing demand has led to an increase in the level of interference within the available frequency spectrum. It shall be noted that the improvement of receiver characteristics has improved spectrum efficiency.

Digital techniques offer the possibility not only to trade quality for channel capacity but also to use the available capacity more effectively. Increased demand for channel capacity from commercial broadcasters means that both of these features will need to be exploited. The present situation, with the increasing demand for additional services from commercial operators leads to a demand for more spectrum. This demand can be satisfied by digital systems which offer higher reception quality together with improved spectrum utilisation. The launching of digital systems becomes very desirable. A good example is given by the Geneva-06 Plan (covering 120 Member States of the ITU), which has accommodated the increased demand for channels in Region 1 (except Mongolia) and in one country of Region 3 (Iran).

The need for additional spectrum during transition period to satisfy both analogue and digital systems shall be taken into consideration.

It should also be noted that the introduction of digital technology will lead to an improvement in spectrum efficiency.

### **2.3.2 Sharing broadcasting frequencies bands with other primary services**

In planning and using frequencies available for broadcasting, we should keep in mind, that broadcasting does not always have exclusive access to these frequencies and that sharing situations need to be taken into account.

The use of radio spectrum should be based on ITU Radio Regulations (RR), which in the Preamble states that:

*“In using frequency bands for radio services, Members shall bear in mind that radio frequencies and the geostationary-satellite orbit are limited natural resources and that they must be used rationally, efficiently and economically, in conformity with the provisions of these Regulations, so that countries or groups of countries may have equitable access to both, taking into account the special needs of the developing countries and the geographical situation of particular countries (No. 196 of the Constitution).”*

In Article 4 of the RR it is also stated that:

*“Member States undertake that in assigning frequencies to stations which are capable of causing harmful interference to the services rendered by the stations of another country, such assignments are to be made in accordance with the Table of Frequency Allocations and other provisions of these Regulations.”*



In Article 5 of the RR the Table of Frequency Allocations is given for frequencies from 9 kHz up to 275 GHz. For the allocation of frequencies the world has been divided into three Regions as shown on the following map:

FIGURE 2

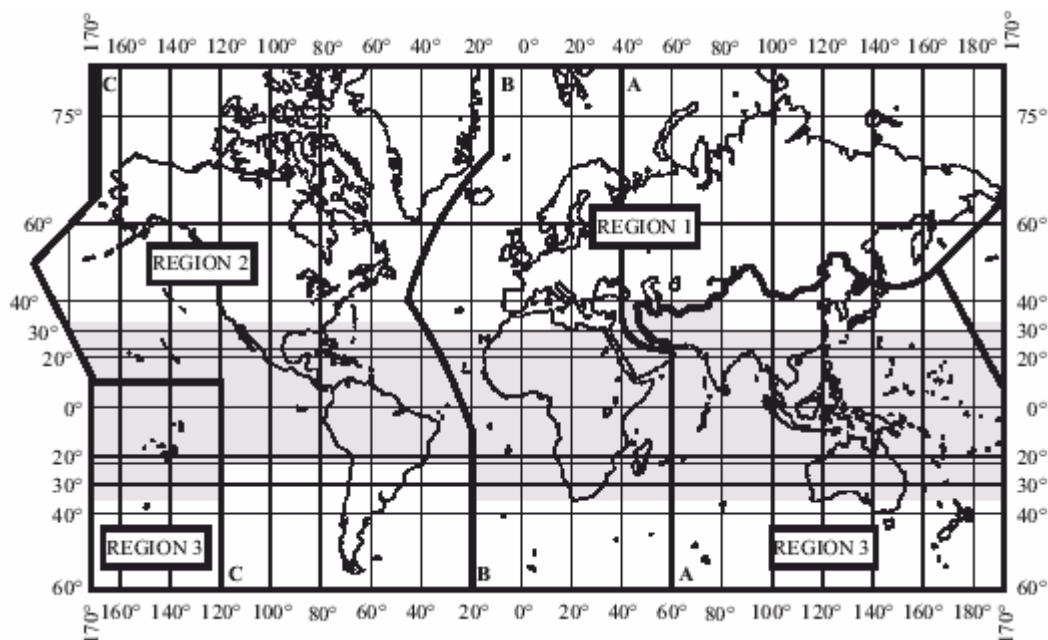

Where, in a box of the Table of Frequency Allocations a band is indicated as allocated to more than one service, either on a worldwide or Regional basis, such services may have two categories, primary or secondary. Primary services are printed in the Table of frequency allocations with capital letters (e.g. BROADCASTING) and secondary with normal characters (e.g. Fixed).

Stations of a secondary service:

- shall not cause harmful interference to stations of primary services to which frequencies are already assigned or to which frequencies may be assigned at a later date;
- cannot claim protection from harmful interference from stations of a primary service to which frequencies are already assigned or may be assigned at a later date;
- can claim protection, however, from harmful interference from stations of the same or other secondary service(s) to which frequencies may be assigned at a later date.

In the Table of Frequency Allocations we see that in different regions, different status is given to the services.

Additionally in footnotes to this Frequency Allocations tables, administrations from that Region, could have different situation in their country in comparison to the Region.

In international frequency planning the protection from and to other primary services should be taken into account. This may cause quite a lot of difficulties in planning of the digital broadcasting.

During the transition period the coexistence of broadcasting signals with other existing non broadcasting primary services in the same frequency bands is the most important issue to be solved by the administration and towards this end the Final Acts of WRC-07 are to be taken into consideration.

## 2.4 Digital broadcasting technologies and systems

### 2.4.1 Digital Fundamentals

There are a number of fundamental technologies which underpin digital broadcasting systems. The more important ones are summarised below.

#### 2.4.2 Background

The digital systems even though they were developed before, had to wait for the invention of the “RADAR”, and “LASER” technologies for their expansion.

Computer technology, now available on the market, equipped with transistors of 30 nm, frequency of 20 GHz or above, static memory of great capacity, permitting software and algorithms, which are always faster and powerful, gives the opportunity to facilitate the substitution of the analogue systems.

These new technologies can also facilitate the convergence between broadcasting and telecommunications.

In some ITU Member States digital sound and TV broadcasting is still a blossoming market, where current difficulties are more regulatory and economic than technological, although new projects continue to be launched.

In Europe, nearly all EU Member States have adopted policy measures to promote digital TV. Some of the EU Member States have also done the same for digital sound broadcasting.

##### 2.4.2.1 PCM and Sampling

Most digital signal representations and processes are based on pulse code modulation' (PCM). PCM was invented in the 1930s and allows an analogue waveform to be represented by a string of numbers known as a bitstream. In its simplest form these numbers are “1”s and “0” (on/off keying) representing binary quantities. The advantage of this over (then) conventional analogue transmission was that, provided the channel quality was sufficient to distinguish a “1” from a “0”, the original signal could be reconstructed to a defined accuracy. Digital systems process signals by manipulating the numbers. With ever more powerful and faster digital number crunching devices coming from the IT industry, the opportunities for advanced signal processing are considerable.

There are two fundamental elements to the PCM process.

First is ‘Sampling’. The analogue signal is represented by a series of discrete samples. While the analogue signal has to be sampled sufficiently often to allow an accurate version of the original to be re-constructed, there is no benefit in sampling more often than is necessary. The Nyquist-Shannon Sampling Theorem specifies the minimum sampling rate as greater than double the highest frequency component present in the analogue original. Sampling at a lower frequency gives rise to an effect called aliasing, familiar to most people from ‘western’ films where the wheels of the stagecoach appear to go backwards. In this instance the sampling frequency is the frame rate of the camera which is insufficient to resolve the positions of adjacent spokes of the wheel. The effect is used beneficially in stroboscopic examination of fast moving objects.

Second is ‘Digitisation’. Each individual sample has to be converted to a (usually) binary number using an analogue to digital converter. Given sufficient quality and resolution in the converter itself, this can be done to any level of accuracy. The price paid for high accuracy is long binary numbers which, in turn demand high bandwidth if they are to be transmitted in ‘real time’. The noise performance of the overall system is limited by the resolution of the analogue to digital conversion. Any digital representation of an analogue quantity has an error which is less than or equal to half the least significant bit in the binary number. This noise component is called quantisation noise and obviously reduces as the number of bits in the digital sample is increased.

##### 2.4.2.2 Bits, Symbols, QAM and IP

While the digital representation almost invariably uses binary numbers it can be wasteful in a channel capable of carrying analogue signals simply to transmit “1s” and “0s”. The channel capabilities can often be better exploited by using intermediate levels as well. By moving to four levels, “0”, “ $\frac{1}{3}$ ”, “ $\frac{2}{3}$ ”, and “1” for example, each level can be made to represent 2 binary bits; “00”, “01”, “10” and “11” respectively. Each discrete level or ‘symbol’ now carries double the amount of information. Depending on the noise in the

channel more levels can be resolved allowing each symbol to carry more information. In systems using a carrier or sub-carrier, the phase of the carrier can similarly be varied in discrete steps. This is called phase shift keying (PSK), often qualified as B(inary)PSK for  $180^\circ$  phase shifts and Q(uadrature)PSK for  $90^\circ$ .

Quadrature amplitude modulation (QAM) modulates both the amplitude and phase of the carrier simultaneously. Each symbol is defined by a unique combination of amplitude and phase, chosen to minimise the potential for interference (noise) to confuse any one symbol with others which are in close proximity in terms of amplitude and phase. While any set of symbols can be used, typically 64-QAM with 64 ( $2^6$ ) unique symbols and 16-QAM with 16 ( $2^4$ ) are the most common in broadcasting applications; 4-QAM is a variant of QPSK. 64-QAM carries 6 binary bits per symbol and 16-QAM carries 4.

Usually,  $N$ -QAM arrangements can be described mathematically. It can be seen that this gives rise to an even spread of  $N$  points on a complex plane. This is customarily called a “constellation”.

FIGURE 3

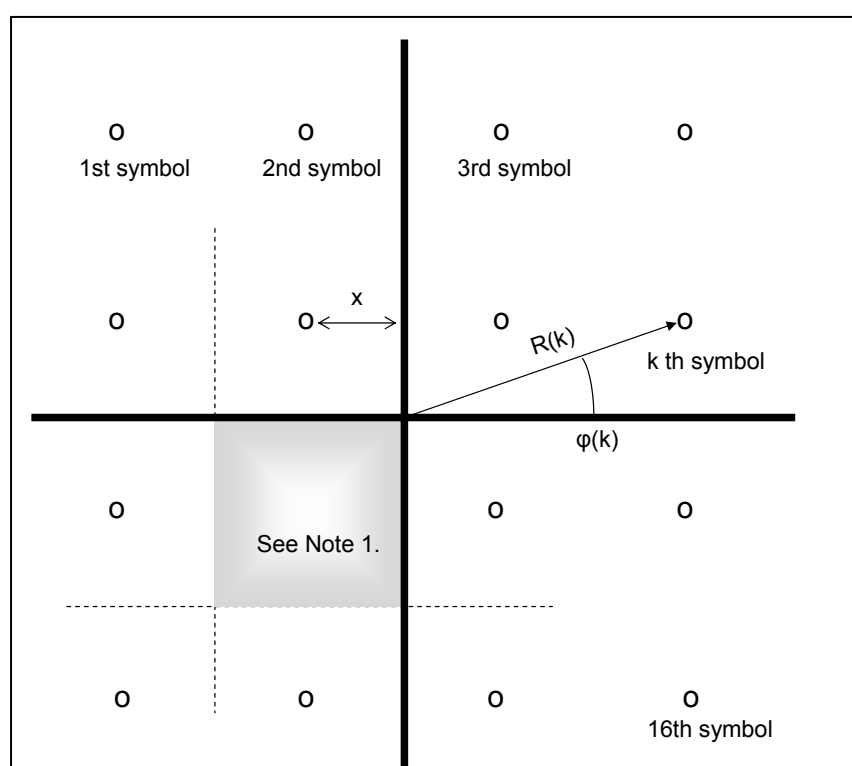

### CONSTELLATION 16-QAM

*Note 1:* Each point in the constellation occupies a box, the size of which ( $2x$  by  $2x$ ) is determined by the signal amplitude. If the combined effects of amplitude and phase noise serve to move the symbol into an adjacent box, accurate decoding is not possible because the symbol will be confused with one of its neighbours.

#### 2.4.2.3 Time and Frequency Division Multiplexing

It is often advantageous to transmit more than one bit stream in a given channel. One method, frequency division multiplexing (FDM) puts each bit stream on to a different sub-carrier and adds all of the sub-carriers together ready for transmission. This is a familiar technique and has been used for multiplexing analogue signals for a very long time. It relies on the total channel bandwidth being sufficient to accommodate the sum of the bandwidths of the individual components.

Time division multiplexing (TDM) can only be used with digital systems and places bits (or groups of bits) from one stream in a sequence with bits from other streams. In its simplest form a bit from stream 1 is followed by a bit from stream 2, then one from stream 3, etc. etc. until it is time to insert a bit from stream 1 again. Clearly, the more complicated the interleaving structure, the more sophisticated will be the timing and date recovery arrangements. Clearly, the throughput rate, in bits per second, of the channel must be greater than or equal to the sum of the bit rates of all the component bit streams.

Time and frequency interleaving and error correcting code are two other important techniques to be considered.

#### 2.4.2.4 Coded Orthogonal Frequency Division Multiplexing (COFDM)

Coded orthogonal frequency division multiplexing (COFDM) is used extensively in digital terrestrial broadcasting systems. Early experiments with digital broadcasting showed that there could be severe problems with multipath reception in urban areas. A delayed version of the signal could be received that was of comparable magnitude with the direct version and the delay was such that adjacent (or even further separated) symbols would become confused and interfere with each other. The solution was to reduce the effective bit rate and add a buffer interval (the so called “guard interval”) to allow the effect of any reflected contributions to stabilise. Rather than transmit the bitstream at full speed it was divided into a large number of sub-streams (almost the opposite of TDM), each with a much lower bitrate and each modulated onto a different sub carrier; a clear example of frequency division multiplexing. Since the bitrate on each sub-carrier was relatively small, they could be closely spaced and a large number fitted into the channel bandwidth. In COFDM systems, each carrier actually carries an  $N$ -QAM signal with  $N$  typically 4, 16 or 64 in broadcasting applications.

Conventionally, each sub-carrier in an FDM scheme is extracted from the multiplex by filtering before it is demodulated. This implies a certain separation, or “guard band”, between the modulated sub-carriers. If the frequencies of the sub carriers are chosen with care they can be made to be mathematically orthogonal. This means that they can be closer and can even overlap. Orthogonality means that the intrusive effect of an adjacent sub-carrier, when integrated over one whole symbol period, is reduced to almost zero; actually zero (only) if the adjacent sub-carrier is unmodulated. Very simply, there is a whole number of cycles of the adjacent sub-carrier within the symbol length when the wanted sub-carrier has been translated to base band.

Inevitably, any radio transmission channel will be affected by flat or selective fading. Hopefully, the channel bandwidth can be sufficient to minimise the former, but selective fading will occasionally take out one or a group of adjacent channels in the multiplex. Interleaving will mean that any errors in the received signal can be spread so as to have a small impact on a large number of samples rather than a gross effect on a few. Coding, or strictly error correcting coding, is used in COFDM to minimise the impact on the overall received signal of selective fading and the occasional “drop out”.

COFDM brings together most if not all of the techniques covered in earlier sections and gives a modulation scheme which is both efficient and robust.

## 2.5 Digital Sound Broadcasting

Digital sound broadcasting (DSB) has been launched in various locations in the world with various digital systems: DRM, DAB, IBOC and ISDB-T<sub>SB</sub>. In the USA, digital hybrid systems (Satellite and terrestrial) have been introduced: XM radio and Sirius. The business model of those systems implies subscription. In other parts of the world, radio is free to air since the beginning of radio broadcasting. The main problem is to replace millions of analogue receivers, often very cheap, by more expensive digital receivers during the introduction period.

Most consumers are not aware of digital radio and find analogue radio is good value for money. The gap in terms of quality and added-value from digital radio, or at least the information available to consumers, needs to be important enough to justify the additional cost for the average consumer, although prices are falling. Moreover, even if analogue radio switch-off did occur, little spectrum would be released in comparison with TV and it would likely be absorbed by increased demand for radio broadcasting services.

The situation is more delicate for “stand-alone” digital radio services; that is, services not bundled with digital TV service bouquets nor received over the Internet. Unlike in the United States of America and other parts of the world, digital satellite radio services are not yet broadcast in Europe. Digital terrestrial radio broadcasts started in 1995, based on the Eureka-147 - Digital Audio Broadcasting (DAB) standards. But there are almost no digital receivers on the market and therefore no listeners, although the situation started to improve in 2002, especially in the United Kingdom.

The main problem, as said before, is to replace millions of analogue receivers, often very cheap, by more expensive digital receivers. Most consumers are not aware of digital radio and find analogue radio is good

value for money. The added-value from digital radio, or at least the information available to consumers, does not yet seem sufficient to justify the additional cost for the average consumer, although prices are falling. In addition, subsidisation of receivers is difficult in Europe as the scope for pay radio is limited. Moreover, even if analogue radio switch-off did occur, little spectrum would be released in comparison with TV and it would likely be absorbed by increased demand for radio broadcasting services.

The migration from a radio service dependent primarily on the application of analogue technologies to one that is based on digital technologies has been evolving over the past 20 years with the emergence of performant algorithms, the evolution of computing power and the availability of digital signal processing (DSP) devices required to allow the introduction of digital sound broadcasting, first in the studio, then in the primary and secondary contribution network, and finally in the consumer area at affordable prices. (According to Moore's Law, the power of computation doubles every 18 months and thus speeds up the process of the introduction of digital technologies). The digital techniques applied to the modulation scheme provide transparent channels. The quality of each part of the sound broadcasting chain has to be close to perfect; the weakest element will be the bottleneck and the final quality will depend on it. Consequently, digital techniques will be applied from the studio up to the contribution network even to feed analogue transmitters such as AM and FM transmitters and obviously to feed digital broadcasting transmitters (DAB, DRM, etc.).

The main advantages of a migration from analogue sound broadcasting to digital are:

**a) *Better sound reception***

Since the introduction of new components and devices such as CD players and MP3 players, the public has wanted better audio quality, and even data broadcasting service capabilities.

At the end of the 1990s, European countries developed a new broadcasting service based on OFDM technology, using "state of the art" technologies such as T-DAB audio encoders. T-DAB has consequently constituted the development base of other worldwide systems: DRM, IBOC. The latest digital standards are using MPEG4 based audio compression standards. As an example, DRM includes three different audio compression solutions (algorithms): AAC+ for multipurpose sound, CELP for high quality speech encoding and HVXC for very low bit rate speech encoding. The three algorithms are part of MPEG4. The gain in term of bitrate between the first audio compression algorithms and the latest one is close to 4 times less for the same audio quality.

**b) *Attractive new content/programmes***

The introduction of digital technologies and highly efficient audio/video compression allow the introduction of numerous programmes (contents) compared with analogue systems, along with very high quality sound (FM as in the AM bands and CD quality on T-DAB as in stereo sound and multichannel surround sound systems (the 5.1 system for example) accompanying data presentation (programme guides, traffic information). Moreover, the digital sound systems can provide still pictures. In the case of video and/or data requirements, it is necessary for the listener to acquire a dedicated receiver.

The listener benefits from a number of new programmes as a result of the efficiency of the digital technology used: from 1 bit/hertz/s up to 4 bit/hertz/s.

**c) *Portability, mobility***

Users want the same capabilities and more in terms of portability and mobile reception as compared with analogue systems (AM, FM).

**d) *Efficiency***

The introduction of digital technologies allows:

- improved frequency efficiency in the allocated channel (more programmes) but also the use of the adjacent channel interference-free;
- a drastic reduction in radiated power for the some coverage area with a better audio quality: for example, for the DRM system, 80 kW instead of 250 kW peak power.

### 2.5.1 Description of digital sound broadcasting systems

Various digital systems have been developed for terrestrial sound broadcasting. The systems considered in this report are:

- DRM – Digital Radio Mondiale - (System A Recommendation ITU-R BS.1514).
- IBOC – In Band On Channel (System B Recommendation ITU-R BS.1514 and System C Recommendation ITU-R BS.1114).
- ISDB-T<sub>SB</sub> – Integrated Services Digital Broadcasting Terrestrial- (System F Recommendation ITU-R BS.1114).
- T-DAB – Terrestrial Digital Audio Broadcasting - (System A Recommendation ITU-R BS.1114).

(More detailed information on the above systems can be found in Part 2.)

#### 2.5.1.1 DRM

The terrestrial Digital Radio Mondiale (DRM), developed by the DRM International consortium (digital System A for Recommendation ITU-R BS.1514) is designed to provide high quality digital radio broadcasting for reception vehicular, portable and fixed receivers. It is designed to operate at any frequency below 30 MHz for terrestrial. The system allows the development of local services (MW and/or SW in the 26 MHz band), regional services (MW), national services (High power LW, MW, NVIS in SW and even SW from a transmitting site located at a hop from the targeted area) and finally international services for long and very long distance services (SW).

The DRM system is a rugged, yet highly spectrum and power-efficient, sound and data broadcasting system. It uses advanced digital techniques to remove redundancy and perceptually irrelevant information from the audio source signal, and then it applies closely-controlled redundancy to the transmitted signal for error correction. The transmitted information is then spread in both the frequency and time domains so that a high quality signal is obtained in the receiver, even when working in conditions of severe multipath propagation (skywave propagation), whether stationary, portable or mobile. Efficient spectrum utilization is achieved close to 4 bit/Hz/s. DRM allows to broadcast up to 4 different services in an ITU channel (9 or 10 kHz). Due to the use of OFDM modulation scheme, it allows a special feature of frequency reuse permits broadcasting networks to be extended, virtually without limit, using additional transmitters which are all synchronized and operating on the same radiated frequency (SFN). DRM standard includes different modulation modes according to the behaviour of the propagation channel, from a very ruggedized mode C up to a very efficient mode A (up to 37 kbits/s in a 10 kHz channel). DRM standard allows to use different kind of simulcast modes from the single channel simulcast (SCS) which is a compromise which permits to broadcast the same content both in analogue and digital in the same RF channel or multi channel simulcast (MCS) which consist in broadcasting the same content in Analogue and Digital either in two adjacent channels, or non adjacent channels or also using a combination of frequencies. As an example, broadcasting the analogue content in MW and the digital signal in SW.

Recently, the DRM consortium decided to extend the DRM standard in the VHF bands (band I and II) the specification of the extended standard will be available in a couple of years.

More detailed information on DRM can be found in § 1.1, Part 2.

#### 2.5.1.2 IBOC DSB

The In-Band On-Channel Digital Sound Broadcasting (IBOC DSB) system (used only in the United States of America) for operation in MW and VHF band II (Recommendations ITU-R BS.1514 and ITU-R BS.1114), also known as the HD Radio™ system, is designed to operate in three modes: “hybrid”, “extended hybrid” and “all-digital”. The mode of operation depends on the broadcasting frequency, the existing use of the spectrum and the service requirements of the broadcaster. The hybrid mode of operation permits simultaneous broadcast of identical program material in both an analogue and digital format within the channel currently occupied by the analogue signal. The extended hybrid mode also supports simulcasting but allows the broadcaster to add digital carriers closer to the existing analogue signal in order to obtain more digital capacity for advanced audio and data services. The all-digital mode provides enhanced capabilities for operation in the same channel after removal of the existing analogue signal or where the channel is not currently used for analogue broadcasts.

The IBOC DSB system is comprised of four basic components: the codec, which encodes and decodes the audio signal; FEC coding and interleaving which provides robustness through redundancy and diversity; the modem, which modulates and demodulates the signal; and blending, which provides a smooth transition from the digital to either the existing analogue signal, in the case of hybrid or extended hybrid operations, or a back-up digital signal, in the case of all-digital operations.

The IBOC DSB system offers broadcasters and listeners several benefits. At both VHF and MF, the system offers enhanced audio quality. VHF broadcasts provide near CD-quality and MF broadcasts offer VHF quality sound. The broadcasts also offer greater robustness to multipath interference in the VHF band and channel noise in the MF band. The system also allows broadcasters to offer multicasting, which permits broadcasters to introduce up to seven new digital audio channels in addition to the simulcast of existing analogue programming. The IBOC DSB offers program associated data as a basic feature. This allows the receiver to display artist name, song title information and other scrolling data. The system also allows broadcasters to offer advanced data services such as traffic and weather information, navigation system updates, stock quotes, audio storage and replay, and electronic programming guides.

More detailed information on IBOC DSB can be found in § 1.3, Part 2.

### **2.5.1.3 ISDB-T<sub>SB</sub>**

The Integrated Services Digital Broadcasting – Terrestrial for Sound Broadcasting ISDB-T<sub>SB</sub> system, (also known as digital system F of Recommendation ITU-R BS.1114, Annex 3), is designed to provide high-quality sound and data broadcasting with high reliability even in mobile reception. The system is also designed to provide flexibility, expandability, and commonality for multimedia broadcasting using terrestrial networks, and conform to system requirements given in Recommendation ITU-R BS.774.

The ISDB-T<sub>SB</sub> system is a rugged system which uses OFDM modulation, 2 dimensional frequency-time interleaving and concatenated error correction codes. The OFDM modulation used in the system is called BST (band segmented transmission) – OFDM. The system has commonality with ISDB-T system for digital terrestrial television broadcasting in the physical layer. The bandwidth of an OFDM block, called an OFDM-segment, is approximately 500 kHz. The system consists of one or three OFDM-segments; therefore the bandwidth of the system is approximately 500 kHz or 1.5 MHz

The ISDB-T<sub>SB</sub> system has a wide variety of transmission parameters such as carrier modulation scheme, coding rates of the inner error correction code, and length of time interleaving. Some of the carriers are assigned to control carriers which transmit the information on the transmission parameters. These control carriers are called TMCC carriers.

The ISDB-T<sub>SB</sub> system can use high compression audio coding methods such as MPEG-2 Layer II, AC-3 and MPEG-2 AAC. Also, the system adopts MPEG-2 systems. It has commonality and interoperability with many other systems which adopt MPEG-2 systems such as ISDB-S, ISDB-T, DVB-S and DVB-T.

More detailed information on ISDB-T<sub>SB</sub> can be found in § 1.4, Part 2.

### **2.5.1.4 T-DAB**

The Terrestrial Digital Audio Broadcasting (T-DAB) developed within Eureka 147 project, (digital System A of Recommendation ITU-R BS.1114) is designed to provide high quality, multi-service digital radio broadcasting for reception by vehicular, portable and fixed receivers. It is designed to operate at any frequency up to 3 000 MHz for terrestrial, satellite, hybrid (satellite and terrestrial), and cable broadcast delivery. The system is also designed as a flexible, general-purpose integrated services digital broadcasting (ISDB) system which can support a wide range of source and channel coding options, sound-programme associated data and independent data services, in conformity with the flexible and broad-ranging service and system requirements given in Recommendations ITU-R BO.789 and ITU-R BS.774.

The T-DAB system is a rugged, yet highly spectrum and power-efficient, sound and data broadcasting system. It uses advanced digital techniques to remove redundancy and perceptually irrelevant information from the audio source signal, and then it applies closely-controlled redundancy to the transmitted signal for error correction. The transmitted information is then spread in both the frequency and time domains so that a high quality signal is obtained in the receiver, even when working in conditions of severe multipath propagation, whether stationary or mobile.

Efficient spectrum utilization is achieved by interleaving multiple programme signals and a special feature of frequency reuse permits broadcasting networks to be extended, virtually without limit, using additional transmitter all synchronized and operating on the same radiated frequency (SFN).

More detailed information on T-DAB can be found in § 1.2, Part 2.

## **2.6 Digital terrestrial television broadcasting**

### **2.6.1 Introduction**

Digital TV was introduced in 1994 in the United States of America and in 1996 in Europe and Japan, first on satellite and soon after on cable and terrestrial networks, based on the Advanced Television Systems Committee (ATSC), Digital Video Broadcasting ('DVB') and Integrated Services Digital Broadcasting (ISDB) specifications.

The EU average household penetration was estimated in 2002 at 32 million (21%): satellite: 21.5 million (13.9%); cable 8.1 (5.2%); terrestrial 2.6 (1.7%). Digitisation of satellite TV is market-led.

With the advent of digital television, the public authorities must consider the future and make preparations for the transition from analogue to digital television to be as smooth as possible. The United States is scheduled to cease analogue television broadcasting in February of 2009. Japan is scheduled to cease analogue television broadcasting in July of 2011. Korea plans to make the transition from analogue to digital in December 2012. Some European countries have already decided to impose a cut-off date by which analogue television broadcasting will cease, with an EU-wide deadline already agreed for the year 2012. Brazil is scheduled to cease analogue television broadcasting in 2016.

There is therefore a need for government authorities to study the policy implications, proposed services, market (potential audience and financial volume), availability of channels for introducing digital television service and, of course, the technical integration of such a service in the existing analogue network.

The first stage in such a migration requires that a regulatory framework (law or ordinance) be set up to govern the introduction of digital television, specifying the number of multiplexes authorized (several broadcast channels per multiplex, one multiplex occupying the equivalent of an analogue channel) and the types of service.

The migration from a television service dependent primarily on the application of analogue technologies to one that is based on digital technologies has been evolving over the past thirty years. This television service migration is part of a natural outgrowth of the convergence of the television, telecommunications and computer arts and sciences through the shared use of digital technology.

The input and output signals of television systems, at the camera and at the receiver, respectively, are inherently analogue. Thus, the question "Why digital?" is a natural one.

While signal degradations in the analogue signal are cumulative and the characteristics of the degradations make them difficult to distinguish from the video signal, the ability to regenerate a digital pulse train exactly renders the digital signals theoretically immune to impairments from external sources. Digital bit streams can be interleaved within a single channel. This interleaving process allows for the emission, transmission, storage or processing of ancillary signals along with the video and associated audio. Further, compression techniques based on redundancy reduction can be applied to digitized video and audio services allowing the possibility of transmitting one HDTV service, multiple standard services or combinations of HDTV and SDTV in an existing broadcasting channel.

The arrival of the second and third generation component and composite digital video tape recorders, switchers, animated graphics and special effects machines and agreement on a serial digital signal interface by 1990 have sped up the move to implementation of the all-digital production facility. Digital production and use of digital tape recorders moved the broadcaster's practice on multi-generation editing from five generations of post-production editing using analogue technology to tens of generations using digital technology. The application of digital techniques has reduced camera set-up time from hours to near-instantaneous. Digital library systems made the location of recorded media transparent to the user. Computer control of the entire process penetrated deeply into the programme generation and distribution facility, bringing with it precise control and function repeatability.



The first use of digital broadcasting technologies has been for distribution between the studio and the transmitting sites either via satellite or terrestrial links.

Consequently the advantages of the digital terrestrial television broadcasting (DTTB) are as follows:

As well as more channels than analogue television, digital television terrestrial (DTT) offers advantages likely to encourage viewers to buy or rent a decoder in order to receive it:

- a) **Better images and sound** – A driving force behind the development of DTT was the ability to transmit high definition television (HDTV) to consumers. HDTV with high quality surround sound is the major focus of all delivery platforms including terrestrial broadcasting, satellite and cable. HDTV is also being delivered on disk using Blue-ray technology.
- b) **Attractive new programmes** – The attraction must be real and sufficient to capture audiences. Three types of channel are likely to arouse viewers' interest: general channels which either innovate or differentiate themselves from existing ones; more thematic channels, sufficiently encompassing and likely to appeal to a fairly broad target audience; and local or regional channels, which respond to the social, economic, and political concerns of viewers in their immediate geographic environment.
- c) **Portability** – In the absolute, this is the ideal technical solution: by means of an antenna integrated within or connected to the set, television can be received outdoors as well as anywhere in the house, even on a pocket set. In terms of broadcasting infrastructure, however, it will be costly, as the main transmitters will need additional relays in order to provide all viewers in the DTT coverage area with portable reception.
- d) **Interactivity** – DTT is also presented as offering viewers interactive services and applications – in other words, as allowing a dialogue between the television user and a service provider, for example provision of information, transaction services such as television shopping, gambling and banking. Ultimately, technological convergence should enable television to be the vector or the receptacle of multiple functions. However, the relatively slow take-up rate of the Internet in some countries where it is available shows that part of the population is reluctant to use such services. Their development may also be restricted by the narrow capacities of the available frequencies. Furthermore, some people are of the opinion that the television remote control is probably not the most user-friendly tool for navigating within an interactive programme or service, and it will be some time before there is any improvement in connection and response times.
- e) **Mobility** – One of the most obvious advantages of terrestrial broadcasting compared with other means of broadcasting is the capability to provide mobile reception for cars, trucks, buses and trains.

The most difficult switchover case is with terrestrial TV due to such factors as lack of spectrum in certain areas, cost of achieving wide coverage, relatively limited network capacity, competing TV offers already in place, and business mistakes.

However, there are significant national differences, notably in relation to market variables like penetration of individual TV networks (terrestrial, cable and satellite) and business models (free-to-air versus pay-TV), but there are also differences between national policies regarding the migration to digital broadcasting. So far, digital TV has mainly grown on the back of satellite pay-TV, with free-to-air still accounting for less than 20% of total digital TV viewing. In turn, pay-TV has been driven by multi-channel and premium programming, together with operators' subsidies for set-top-boxes.

### 2.6.2 Description of Digital Television Broadcasting systems

Various digital television systems have been developed for terrestrial broadcasting. The relevant systems are:

- ATSC DTV- Advanced Television Systems Committee - (System A).
- ATSC-M/H- Advanced Television Systems Committee Mobile & Handheld.
- ChinaDTV - (GB 20600-2006: "Framing structure, Channel coding and modulation for digital television terrestrial broadcasting system").
- DVB-H - Digital Video Broadcasting Handheld.
- DVB-T - Digital Video Broadcasting Terrestrial- (System B).
- ISDB-T - Integrated Services Digital Broadcasting Terrestrial- (System C).

- T-DMB compatible with T-DAB (Recommendation ITU-R BT.1833, ETSI TS 102 427 and ETSI TS 102 428).
- ISDB-T<sub>SB</sub> - Integrated Services Digital Broadcasting-Terrestrial Sound Broadcasting - (Recommendation ITU-R BT.1833 Multimedia System F).
- FLO – Forward Link Only (Recommendation ITU-R BT.1833, Multimedia System M, TIA-1099).

Details of systems A, B, C may be found in Recommendation ITU-R BT.1306 and in Report ITU-R BT.2035 - Guidelines and techniques for the evaluation of digital terrestrial television broadcasting systems. Recommendation ITU-R BT.1833 - Broadcasting of multimedia and data applications for mobile reception by handheld receivers, defines T-DMB as Multimedia System “A”, ISDB-T one segment as Multimedia System “C”, ISDB-T<sub>SB</sub> as Multimedia System “F”, DVB-H as Multimedia System “H” and Forward Link Only (FLO) as Multimedia System “M”.

For more details see Part 2.

### 2.6.2.1 ATSC

The ATSC Digital Television Standard was designed to maximize the ability to transmit high quality video and audio and ancillary data within a single 6 MHz terrestrial television broadcast channel. This design focus resulted in the advent of digital high definition television (HDTV) and multi channel surround-sound as well as the capability to provide multichannel standard definition and data broadcast and interactive services

The 8-VSB modulation mode for terrestrial broadcasting was designed for spectral efficiency, maximizing the data throughput with a low receiver carrier-to-noise ( $C/N$ ) threshold requirement, high immunity to both co-channel and adjacent channel interference and a high robustness to transmission errors. The characteristics of 8-VSB allow the use of DTV channels in a crowded spectrum environment that contains both analogue and digital television signals. Lower power requirements of 8-VSB allow ATSC DTV stations to exist on channels where analogue stations cannot due to interference constraints. The spectral efficiency and power requirement characteristics of 8-VSB are essential to the conversion of terrestrial broadcast transmission from analogue to digital since new spectrum is not allotted during the transition phase.

The ATSC system uses the MPEG-2 transport stream syntax for the packetization and multiplexing of video, audio, and data signals for digital broadcasting systems. The Program and System Information Protocol (PSIP) defined in ATSC standard A/65, is a small collection of tables designed to operate within every Transport Stream (TS) for terrestrial broadcast of digital television. Its purpose is to describe the information at the system and event levels for all virtual channels (channel numbers are not tied directly to the actual RF channel frequency) carried in a particular TS. Additionally, information for analogue channels as well as digital channels from other Transport Streams may be incorporated.

ATSC utilizes the MPEG-2 video stream syntax (Main Profile at High Level) for the coding of video. Table 1 lists the compression formats allowed in the ATSC Digital Television Standard. Note that both 60.00 Hz and 59.94 (60x1000/1001) Hz picture rates are allowed. Dual rates are allowed also at the picture rates of 30 Hz and 24 Hz.

TABLE 1

#### Compression formats

Vertical lines	Pixels	Aspect ratio	Picture rate
1080	1920	16:9	60I, 30P, 24P
720	1280	16:9	60P, 30P, 24P
480	704	16:9 and 4:3	60P, 60I, 30P, 24P
480	640	4:3	60P, 60I, 30P, 24P

The ATSC Standard - Digital Audio Compression (AC-3) as defined in the ATSC A/52B is used for the coding of audio. Enhanced AC-3 (E-AC-3) which provides additional coding tools and capabilities is also defined by the A/52B Standard.

ATSC has developed a suite of data broadcast standards and the ACAP standard for interactive television services.

### ATSC-M/H

ATSC-M/H (A/153) provides mobile/pedestrian/handheld broadcasting services using a portion of the ~19.39 Mbit/s ATSC 8-VSB payload, while the remainder is still available for HD and/or multiple SD television services. The M/H system is a dual-stream system—the ATSC service multiplex for existing digital television services and the M/H service multiplex for one or more mobile, pedestrian and handheld services.

The ATSC Mobile/Handheld service (M/H) shares the same RF channel as a standard ATSC broadcast service described in ATSC A/53. M/H is enabled by using a portion of the total available 19.4 Mbit/s bandwidth and utilizing delivery over IP transport. The overall M/H system is illustrated in Fig. 4.

FIGURE 4

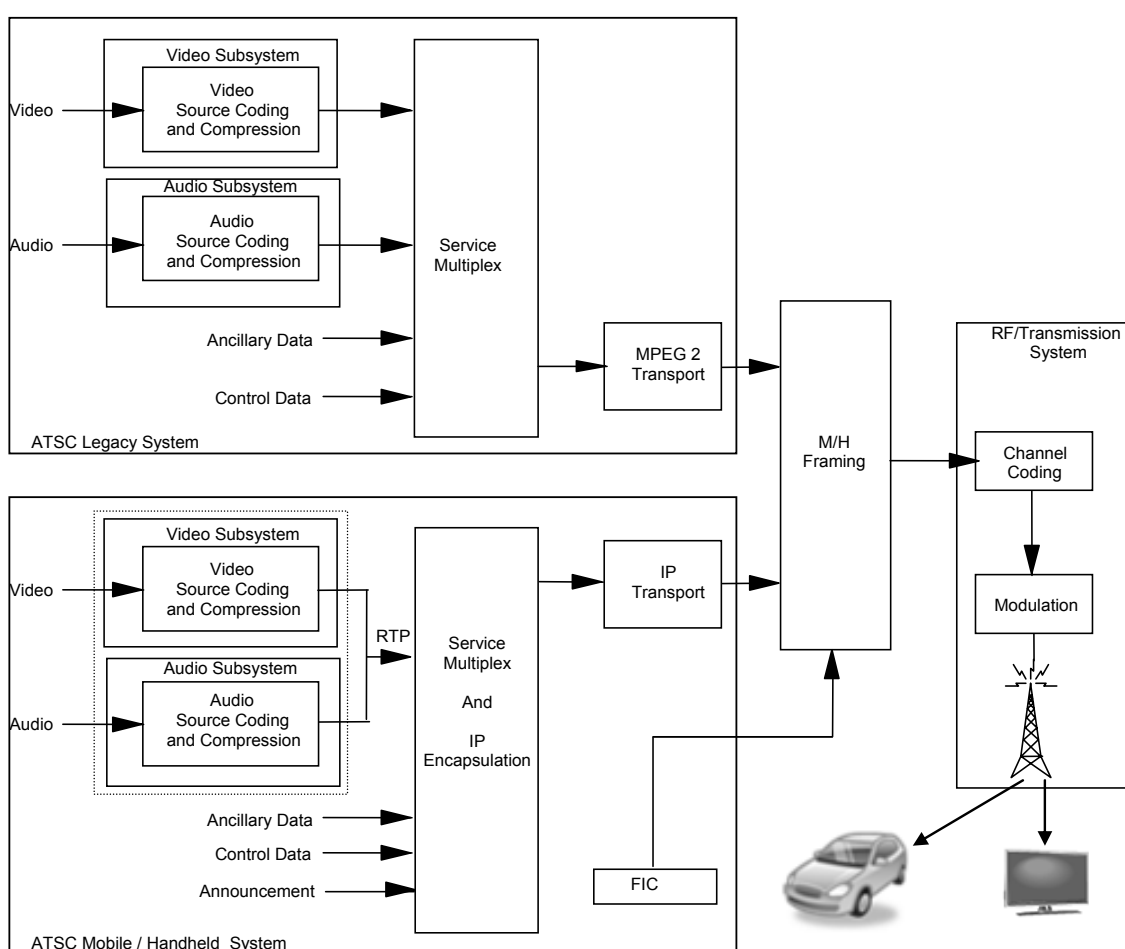

More detailed information on ATSC can be found in § 1.5, Part 2.

### 2.6.2.2 ChinaDTV

China DTTB national standard, “Framing structure, channel coding and modulation for digital television terrestrial broadcasting system” was issued on 18<sup>th</sup> August 2006 by standardization administration of China and was enforced on 1<sup>st</sup> August 2007. The ChinaDTV system was designed with built-in flexibility, adapt to variety of reception: it is capable of coping not only with fixed reception but also mobile reception, simultaneously supports the application in the adjacent channels to an analogue TV channel, and the framework of single frequency network with the same programme.

The ChinaDTV system had a special design of the PN sequence frame header and symbol guard interval insertion that can achieve rapid and efficient channel estimation and equalization, Low Density Parity Check coding (LDPC), spread spectrum transmission of the system information, etc. The system supports data rates from 4.813 Mbit/s to 32.486 Mbit/s, having application to standard-definition television (SDTV) and high-definition television (HDTV). Also the system was designed for the current 8 MHz TV channel spacing used in China.

It provides service flexibility, with constellation mapping of 64-QAM, 32-QAM, 16-QAM, 4-QAM, 4-QAM-NR, FEC coding LDPC (7488, 3008, (7488, 4512), (7488, 6016), frame header length PN420, PN595, PN945 and two kinds of convolutional interleaving possibility, if desired, of many options. Mobile reception is possible for 4-QAM-NR, 4-QAM even 16-QAM and also for higher modulation orders, proven by extensive laboratory measurements and field trials under different channel conditions.

The system had strong robustness under different environments, against the echoes from terrain or buildings or co-channel signals from distant transmitters or in an SFN. This capability will improve spectrum utilization efficiency when planning digital television services in crowded spectrum conditions as occurs in China.

The ChinaDTV system included randomization for energy dispersal, channel coding, interleaving, constellation mapping, framing structure, processing of frame information, processing of baseband signals and RF signals in every 8MHz digital television band in UHF and VHF spectrum.

Now, a series of relevant digital terrestrial television specifications are under development, and several transmitting stations in Olympic cities are being established, and the HDTV program has been launched in Beijing in October, 2007.

### **2.6.2.3 DVB-H**

The merger of audiovisual and telecommunication services has already been implemented, as most telecommunication actors envisage having TV over xDSL. No doubt the user will soon require the associated service environment to be available on the move. Services can be expected to benefit from a window of opportunity of 8-15 years (eight years is the approximate time frame from now until analogue TV simulcast is turned off in most countries, while 10-15 years is the time before new radio systems, whose requirements are currently being discussed under the label "4G", are rolled out-assuming it will take ten years for 3G to reach break-even point). The opportunity comes from the fact that cellular associated with DVB-T/H would potentially have some of the expected 4G capabilities.

At the basis for the commercial provision of convergent services in mobility, particularly use is made of the DVB-T/DVB-H standard and the concept of wireless communication networks (GSM/GPRS, UMTS) combined with terrestrial DVB broadcast networks.

In the new business and regulatory environment, the longer-term activities of various international work-groups such as DVB and 3GPP have slowed down as industry searches for a shorter-term return on investment. The project will bridge this recent trend with the latest technological developments, allowing DVB in particular to keep its worldwide domination as a broadcasting standard toolbox by supporting the design and testing of the DVB-H standard that is necessary because DVB-T is presently being challenged by ISDB-T in mobility and power consumption issues.

A study on mobile TV (October 2007) was made by the Policy Department of the Economic and Scientific Policy Directorate of the European Parliament.

More detailed information on DVB-H can be found in Part 2, § 1.7.

### **2.6.2.4 DVB-T**

The Digital Video Broadcasting – Terrestrial (DVB-T) system was essentially designed with built-in flexibility, in order to be able to adapt to all channels: it is capable of coping not only with clear channel but with interleaved planning, i.e. in the adjacent channels to an analogue transmission, and even co-channel operation for the same programme by different transmitters (SFN).

The multi-carrier (DVB-T) system was designed originally for the 8 MHz UHF channel spacing used in Europe and has been adapted to fit 7 and 6 MHz channels. Depending on the choice of coding and

modulation parameters, data rates from 20 to 30 Mbit/s can be realized to deliver high quality digital television through the broadcasting channels. Equally, lower data rates can be employed in cases where additional ruggedness is considered to be desirable.

It also permits service flexibility, with the possibility of reception by rooftop antennas and also, if desired, of portable reception. Mobile reception is possible for quadrature phase shift keying (QPSK) and also for higher modulation orders, proven by extensive laboratory measurements and field trials under different channel conditions.

The system was also designed to be robust against interference from delayed signals, either echoes from terrain or buildings or signals from distant transmitters in an SFN. This capability will improve spectrum utilization efficiency when planning digital television services in crowded spectrum conditions as occurs in Europe.

The DVB-T system features a number of selectable parameters, which allows it to accommodate a large range of values for  $C/N$  ratio and channel behaviour, allowing fixed, portable, or mobile reception, with a trade-off in the usable bit rate. The range of parameters allows the broadcasters to select an appropriate mode for the foreseen application. For instance, a very robust mode (with correspondingly lower payload) is needed to ensure portable reception. A moderately robust mode with a higher payload could be used where the digital services are interleaved with analogue services (for example in the adjacent channels to analogue). The less robust modes with the highest payloads can be used if a clear channel is available for digital television broadcasting.

More detailed information on DVB-T can be found in Part 1, § 1.6.

#### 2.6.2.5 ISDB-T

The Integrated Services Digital Broadcasting - Terrestrial (ISDB-T) system (used in Japan) is designed to provide reliable high-quality video, sound, and data broadcasting not only for fixed receivers but also for portable/mobile receivers. The system is also provided flexibility, expandability, and commonality/interoperability for multimedia broadcasting. The system is rugged because it uses orthogonal frequency division multiplexing (OFDM) modulation, two-dimensional (time-domain and frequency-domain) interleaving, and concatenated error-correction codes.

The ISDB-T system uses OFDM modulation associated with band segmentation which is called band-segmented transmission OFDM (BST-OFDM). The ISDB-T system consists of 13 OFDM segments. Each segment has a bandwidth  $B/14$  MHz ( $B$  means the bandwidth of a terrestrial TV channel: 6, 7 or 8 MHz depending the region), so one segment occupies bandwidth  $6/14$  MHz (428.57 kHz),  $7/14$  MHz (500 kHz) or  $8/14$  MHz (571.29 kHz). The system has a wide variety of transmission parameters for choosing the carrier modulation scheme, coding rate of the inner error-correcting code, length of time interleaving, etc. Each segment is assigned to a layer, for which a set of transmission parameters can be selected individually.

The system supports hierarchical transmission of up to three layers (Layers A, B, and C). The transmission parameters can be changed in each of these layers. In particular, the centre segment of this hierarchical transmission can be received by handheld receivers (called "One-Seg"). Owing to the common structure of each OFDM segment, a one-segment receiver can "partially" receive a program transmitted on the centre segment of an ISDB-T signal (partial reception is the name given to the means by which a receiver picks out only part of the transmission bandwidth). The system has three transmission modes (Modes 1, 2, and 3) having different carrier intervals in order to deal with a variety of conditions such as the variable guard-interval length as determined by the network configuration and the Doppler shift occurring in mobile reception.

The system uses MPEG-2 Video coding and MPEG-2 advanced audio coding (AAC). Moreover, it adopts MPEG-2 Systems for encapsulating data streams. Therefore various forms of digital content, such as sound, text, still pictures, and other data, can be transmitted simultaneously. It has commonality and interoperability with other systems using MPEG-2 Systems, such as ISDB-S, ISDB-C, and ISDB-T<sub>SB</sub>.

More detailed information on ISDB-T can be found in Part 2, § 1.8.

### 2.6.2.6 T-DMB

For mobile multimedia broadcasting services, the Republic of Korea developed a video standard, Terrestrial Digital Multimedia Broadcasting (T-DMB), which is fully backward compatible with T-DAB. Terrestrial Digital Multimedia Broadcasting (T-DMB) is designed to provide video services for users in mobile environment with the backward compatibility with Digital Sound Broadcasting (DSB) System A. The MPEG-4 AVC is known to have compression efficiency as high as up to twice that of MPEG-4 Part 2 Visual (ISO/IEC 14496-2). The MPEG-4 BSAC is known to have the same compression efficiency as MPEG-4 AAC (Advanced Audio Coding) and is characterized by its additional functionality of fine grain scalability. The Binary Format for Scene (BIFS) provides a flexible composition capability for various multimedia objects in conjunction with MPEG-4 Synchronization Layer (SL) that enables smooth rendering of different types of multimedia objects for interactive services. For audio services, DSB System A in Recommendation ITU-R BS.1114 uses MUSICAM, however T-DMB system does MPEG-4 BSAC or MPEG-4 AAC as well as MUSICAM to provide enriched service supplemented by still pictures and texts.

More detailed information is given the Report ITU-R BT 2049 and in § 1.9.1, Part 2.

### 2.6.2.7 Forward Link Only (FLO)

Forward link only (FLO) is a mobile digital broadcasting technology designed to provide mobile reception of broadcast multimedia content on handsets to address the physical limitations of the handheld terminal, including power consumption, memory, mobility, and form-factor constraints. Service elements of FLO include reception of real-time broadcast video and audio streams; access to multimedia services, and wide area and localized content in the same carrier. FLO system is designed to support access control, subscription management, and interactive services via IP.

### 2.6.2.8 ISDB-T<sub>SB</sub>

ISDB-T<sub>SB</sub> system is known as Multimedia System “F” of Recommendation ITU-R BT.1833, is designed to provide video, high-quality audio and data services which can be configured flexibly. In addition, support of script interpreter for rich content format provides content and service flexibility in multimedia broadcasting for handheld receivers.

More detailed information is given in § 2.5.1.3.

## 2.7 Summary

TABLE 2

Standard	Channels	Band	Modulation	Applicable standards
ATSC	6 MHz	UHF/VHF	8-VSB	A/52,A/53, A/65, A/153
ChinaDTV	8 MHz	UHF/VHF	OFDM	GB 20600-2006
DVB-T	6, 7 and 8 MHz	UHF/VHF	OFDM	EN 300 744
DVB-H	5, 6, 7 and 8 MHz	UHF/VHF	OFDM	EN 302 304
ISDB-T	6, 7 and 8 MHz	UHF/VHF	Segmented OFDM	ARIB STD-B31
T-DMB	1.75 MHz	VHF/1.5GHz	OFDM	ETSI TS 102 427 and ETSI TS 102 428
FLO	5, 6, 7 and 8 MHz	UHF/VHF	OFDM	TIA 1099
ISDB-T <sub>SB</sub>	0.43, 0.50, 0.57 MHz 1.29, 1.50, 1.71 MHz	UHF/VHF	Segmented OFDM	ARIB STD-B29

## 2.8 Evaluation of potential Digital Sound and TV Broadcasting systems

In recent times, several digital broadcasting systems have been proposed in different areas of the world.

All of the currently implemented systems are based on the availability of a high efficiency encoding system with the capability to compress the bit rate needed to transmit digital contents to values compatible with the characteristics of the available on-air channels.

For TV broadcasting, the MPEG standard is currently almost globally adopted in its various levels, even though newer and possibly even more efficient encoding standards have been recently proposed.

The different currently available digital transmission systems have been proposed in different times, and the newer ones are supposed to benefit from the analysis of advantages and disadvantages of the previously proposed ones.

In the search for a real “killer application” for digital broadcasting, of the utmost importance is the capability of the digital standard to adapt to possible advanced broadcasting services. Concerning digital TV broadcasting, this includes interactivity, datacasting, portable and mobile reception.

### 2.8.1 Evaluation of specific Terrestrial Digital Sound and TV Broadcasting

The available standards for digital TV and sound broadcasting can be roughly divided in two groups:

- Single carrier codes (like 8-VSB, used in the USA standard ATSC-DTT)  
The 8-VSB system is based on coding the digital information to be transmitted using amplitude only (8 levels). The modulated signal is then processed through a Nyquist filter, in order to reduce the transmission bandwidth.
- Multicarrier (various evolutions of COFDM, on which DVB-T and DAB -adopted in Europe and in Countries involved in the RCC-06-, ISDB-T –adopted in Japan-, and other codes are based.

The COFDM approach is based on splitting the data between a high number of carriers within the operating channel. The digital information associated to each carrier can then be coded using amplitude and phase (e.g. QPSK, 16-QAM, 64-QAM). Together, the digital data simultaneously transmitted and associated to the different carriers constitute an OFDM symbol.

COFDM-based codes allow the transmission through the physical channel of a multiplex, consisting of several contents that can then be selected and extracted by the receiver.

Moreover, the signal spreading over many carriers distributed over the whole channel width, together with the error-recovery systems introduced to safeguard the data integrity, make it possible to consider COFDM-based systems, like DVB-T, also for the implementation of SFN networks, in which the same frequency is used for the transmission over adjacent coverage areas and the implied fading due to co-channel interference between signals originated by transmitters operating on the same frequency is recovered due to the COFDM system characteristics. Commercial SFN networks (in DVB-T) have been rolled out for instance in Australia and in Spain.

The same high immunity to interferences makes COFDM digital broadcasting systems also suitable for mobile reception. Especially suited to this purpose is the recently issued standards for handheld receptions listed under Recommendation ITU-R BT.1833. In this case, special attention has been paid to preserving battery life, error correction mechanism, etc. in order to enhance the system’s robustness.

The ATSC has developed the ATSC-M/H system which allows broadcasters to use their existing DTV channel to provide service to mobile and handheld devices while maintaining backwards compatibility with the large population of DTV receivers.

For more details, see Part 2, Chapter 1.

### 2.8.2 Hybrid systems

Some satellite systems use the terrestrial component to improve the quality of service: XM radio, Sirius. More information is available for Digital System E in the Recommendations ITU-R BO.1130 and ITU-R BS.1547. Other systems may use similar approach.

## Chapter 3

### 3 Application and implementation of digital broadcasting

Traditionally, broadcasting and telecommunications have been treated as separate, vertical markets. Digital convergence, which means the same digital content can be transported over any of those networks, has a potential to create new horizontal markets within each level of the value chain such as content, service provision, network operation and terminals thereby opening up an abundance of new business opportunities. For the first time, people would be able to access any multimedia services from any type of delivery platforms such as fixed, portable and mobile with reasonable costs.

Switchover, i.e. the transition, from analogue to digital broadcasting is a complex process with social and economic implications going well beyond the pure technical migration. Digital broadcasting development is positive as it improves both the range and quality of services, notably thanks to digital compression. This improves both spectrum efficiency and network payloads.

Sound and Digital TV switchover should be an inclusive process encompassing various networks, business models and services, including free to-air TV, better picture quality or data and interactive services. Analogue switch-off should only take place when digital broadcasting has achieved almost universal penetration, taking all the above possibilities into account, to minimise social cost. Policy intervention should take place at national level in the first instance, considering market and policy differences between Member States in the area of broadcasting. However, the ITU has also a role to play, in particular in view of the internal market aspects. Possible ITU contributions concern notably: benchmarking, equipment standards, consumer information, facilitating and promoting access to added value services.

The industry is in the process of developing technologies that will make digital convergence a reality. Digital convergence allows content and service providers to deliver their offers through multiple delivery mechanisms. Correspondingly, consumers can access services via various terminals delivering multimedia content and more services via a single terminal. This blurs the borderlines between the traditional broadcasting and electronic communication sectors and consequently has a profound effect in the future of media distribution. Consequently, regulatory provisions must be carefully elaborated to reflect those changes.

#### 3.1 Regulatory considerations

Regulation should allow multimedia service provision through all types of delivery networks, and regulations should ensure that a level playing field exists for all actors in the new horizontal markets and should correct imperfections of the market. To facilitate this process, the existing political and regulatory structures need to be adapted.

It is also important that spectrum policy (which includes and takes into account items such as allocations, assignments, and liberalization) provide access for all contenders in a harmonized, open, transparent and non-discriminatory way, and the means for sufficient and appropriate delivery capacity. In order to facilitate the development of global service and delivery, as well as interoperability and economies of scale in the production of equipment, a globally harmonized spectrum usage should be encouraged, without preventing, at the same time, the flexibility needed for the creation of a competitive and technologically advanced scenario through spectrum management and licensing. In addition, the spectrum usage should also allow for regional differences in the amount of spectrum required for content delivery and for interactive services, since customer demand and interest may differ between regions.

Both telecommunications and broadcast networks have until now evolved under separate, vertically oriented standards and regulations. Broadcasting has been for radio and TV, and telecommunication has been for voice. Recently also data communications has evolved under its own IT-labelled umbrella. With digitization the borderlines between telecommunication, TV and radio services and data communication are disappearing. As a result, it will become increasingly difficult to define or categorize future delivery structures by the type of services that are delivered through them. Accordingly, new definitions will be needed in relation to regulatory aspects.



The new regulatory environment should also allow multimedia service provision through all types of delivery networks (broadcasting and mobile). In fact, network usage expands and becomes more flexible when it is not bound to the transmission of certain kinds of content. The expansion of usage will increase the desire to invest in the building of networks, and their technological improvement.

### **3.2 Efficient usage of broadcasting spectrum**

The migration from analogue to digital broadcasting has already commenced in some countries and is expected to continue throughout the world for the next few years. The actual duration of parallel analogue and digital broadcasting, i.e. the date when the analogue transmissions will end, will vary from country to country (2010 has been stated as an objective for a number of European countries concerning digital TV).

There are a number of elements to this transition:

- the switch on of digital TV,
- the switch off of analogue TV, and
- how to deal with the reuse of analogue TV spectrum (“refarming”).

This development will bring about significant new capacity for new services, as digital content can be broadcast in a fraction of the radio bandwidth that would be required for the equivalent transmission in analogue mode. Consequently, a much larger offering of digital TV programming is technically feasible while using less of the available radio spectrum. Furthermore, new types of digital services and content can be offered through this digital broadcast spectrum, both during the introduction of the digital technology is introduced but even more so also once analogue broadcasting has ceased - even while significantly increasing the quantity of broadcast TV (video) programming. Thus there is a significant opportunity for both additional TV and radio broadcasting, as well as for other interactive services in the fixed, portable and mobile environments, for example IP datacasting and interactive services.

The full benefits of the all-digital future will only be realized once analogue switch-off has been completed. The key issue will be to ensure the availability of many different services by many different service providers, as well as to guarantee openness and neutrality, which will pave the road for innovative services, technological innovation and vigorous competition to the benefit of the consumer and the entire economy.

### **3.3 Requirements of sound and television broadcasting services**

#### **3.3.1 Network aspects**

The advantage of digital terrestrial broadcasting in terms of portability, mobility, integrated receivers and set-top reception fully justify the maximization of terrestrial coverage. In many countries most households receive analogue broadcasting by terrestrial means. For those households who only want digital free-to-air services there will be a strong expectation of receiving these services by terrestrial means. The existing terrestrial analogue network infrastructure can be fully utilized for this.

The concept of single frequency networks (SFNs) is efficient in saving the spectrum required to offer service to a limited geographical area.

However, for DVB-T, by having both 2K and 8K modes as well as several guard intervals, the system can offer efficient tools for planning SFNs for various purposes including mobile reception. As is widely known in the broadcasting world, by also using gap fillers or repeaters, transmitters can easily enhance reception with full compatibility with respect to future upgrades, and portable and mobile reception possibilities will be better. This means that network extensions and modification for mobile or portable reception can be implemented at reasonable costs.

Users are moving rapidly towards a mobile lifestyle. 2G, 3G and future technologies have taught us to use mobile cellular technology in our everyday communication. By receiving mobile broadcasting datacast services over DVB-T/H in conjunction with 2G/3G as a return channel, consumers will be able to receive new kinds of content services and have increased interactivity. Joint utilization of DVB-T/H and cellular network technologies will provide consumers with location-independent and personalized services.

### 3.3.2 Receiver aspects

There will likely be four main types of receiver:

- 1 Fixed digital TV and set-top boxes for fixed reception using either roof-top antennas or fixed indoor antennas.
- 2 Portable TV or radio sets.
- 3 Car-installed terminals and mobile hand-held terminals, possibly integrating with 2G/3G cellular functions.
- 4 Mobile/portable broadband wireless systems.

Types 3 and 4, i.e. hand-held and portable terminals, will be battery operated and must focus on low power consumption. Therefore extra care has to be taken to make the radio environment such that this would be possible, and also user-friendly and convenient from the terminal and RF viewpoints. In particular, as regards TV one of the major concerns with the current environment is the placement of digital channels all over the UHF spectrum so that high-power analogue channels are adjacent to digital ones. This sets up very high linearity requirements from the terminal's RF components, and thus consumes excessive power. Having a unified part of the spectrum reserved only for portable/mobile digital data broadcasting and broadband wireless would help to ease the situation considerably.

### 3.4 Aspects related to the interoperability of systems

Regarding more sophisticated functionalities such as *Application Program Interfaces* ('API'), interoperable and open solutions for interactive TV services must be encouraged. The Member States will decide whether it is necessary to mandate certain standards to improve interoperability and freedom of choice for users. Indeed, these two criteria will likely contribute to consumer uptake of digital broadcasting in a market-led switchover scenario, thus minimizing the need for public intervention.

The interoperability of systems is facilitated by the introduction of new technologies and convergence of services.

For more information, see Part 2.

### 3.5 Components of digital sound broadcasting equipment

#### 3.5.1 Transmitters

Non-linear sound transmitters cannot be modified and re-used for digital systems. For this reason all transmitters of this type will have to be replaced during the transition period. Depending on the switch-off period, some transmitters capable of simulcasting the emissions may have to be installed. From the point of view of Broadcasters the economic problems become relevant.

Newly built transmitters for the LF, MF, and HF bands are ready for digital operation.

#### 3.5.2 Antennas for transmission

During the transition period, broadband antennas for use in the MF, HF, VHF frequency bands do not present any difficulty from the technical/economical point of view because technological intervention are not required.

Narrow-band antennas for use in the MF HF, VHF frequency bands produce relevant attenuation and phase rotation on digital carriers with a consequential reduction in quality. In this case relevant technical/economical intervention are required depending of power applied to antenna and type of system used.

For LF emission the real problem is the bandwidth of the antenna together with the associated economical and technical issues.

#### 3.5.3 Receivers

The user is expecting an affordable and easy-to-use terminal, capable of receiving both digital and analogue sound broadcasting services.

The first consumer digital terminals were available in the marketplace from the end of 2003.

With regard to the digital market, for example in Italy there is interest in terminals which operate in VHF and a portion of L band (1452 to 1492 MHz).

It is expected that the majority of effort for industry in the near future will be concentrated on portable and mobile/handheld receivers, provided that the necessary frequency spectrum will be available.

Also, it has to be taken into account that this kind of terminal needs integrated networks and service platforms while, historically, they have evolved independently.

In fact, in particular, it has to be noted that:

- Telecom networks focus on wireless and wired interactive communications between individuals.
- Broadcast networks deliver one-way programmes to mass consumer audiences.

Data networks meet the ever-increasing demands of internet traffic and file download for business and domestic users.

During transition from analogue to digital systems, broadband antennas for reception in LF, MF HF, VHF, UHF frequency bands do not present any difficulty from the technical/economical point of view because technological intervention are not required.

Narrow-band antennas for reception in LF, MF HF, VHF, UHF frequency bands produce relevant attenuation and phase rotation on digital carriers with a consequential reduction in quality.

### **3.6 Components of digital television broadcasting equipment**

As far as TV broadcasting is concerned, the digital TV standards can be considered to be finalised. Now the interoperability between different makes of transmission system components and the compatibility of the transmission systems with the available makes of set-top boxes (STB) on the market has to be checked in detail.

#### **3.6.1 Transmitters**

In addition to replacing the existing analogue modulator with a suitable digital modulator in order to convert analogue equipment to digital, the following points have to be considered with the utmost care:

- Capability of the system to operate in “common amplification”, i.e. amplifying the whole signal, and not its separate carriers (e.g. audio and video carriers).
- Linearity of the system, with low intermodulation, that in digital is expressed by the shoulder level.
- Stability and phase noise produced by the reference frequency sources.
- Capability of the system control logic to interface the new components requested to convert the system to digital (i.e. the digital modulator).

In recent times, a large proportion of manufactured analogue equipment (most of all for TV applications in VHF and UHF frequency bands) feature a so-called “digital ready” conditioning that improves its suitability to be converted to digital. Anyway, the actual feasibility of this operation and the implied costs has to be specifically checked on a case-by-case basis.

#### **3.6.2 Antennas for transmission**

VHF and UHF antenna systems in use for TV broadcasting are generally well suited to operate additionally with digital signals on the same channel. In this case, no further critical issues are expected in terms of RF bandwidth, as the channel width is the same as used for analogue broadcasting. Antenna re-tuning could be needed in case the operational channel in digital is different from the one previously used in analogue, or when a new digital channel is added to the existing analogue channels of operation, without replacing any of them. Even though a large number of antenna components feature wideband characteristics, a change of operating frequency within the same frequency band (VHF or UHF IV or UHF V) implies a need to check the antenna tuning. In many cases, possible incompatibility problems could be solved by tuning the input characteristics, that could be generally obtained using specific tuning devices, and checking the phasing of

the feed lines. In other cases, a new antenna design is required to comply with the new operational condition.

As far as DAB services are concerned, these are transmitted at completely different frequencies (VHF and L band) and therefore completely new antennas are required. At the VHF band, as the operation channel bandwidth is narrower than that used for TV, antenna systems designed for TV broadcasting at VHF seem also to be suitable for DAB broadcasting at the same frequency.

### **3.6.3 Receivers**

Old TV analogue receivers can be maintained with the addition of set-top-boxes compliant with the standard used. Consequently the TV transition can be changed progressively.

Integrated digital TV sets are available on the market for various standards.

#### **3.6.3.1 Distribution network**

In the case of community reception a new distribution network may be required.

#### **3.6.3.2 Antennas for reception**

Modification to the antenna is not normally required. However, in certain cases, depending on the planning criteria applied and service area obtained, a modification may be necessary.

### **3.7 Data broadcasting**

This involves the delivery of multimedia content direct to a computer or other digital devices. This is affected by installing a specific data card into the receiving device and converting it into a format that can be utilised by the computer or other digital devices. The use of Internet and the adoption of Internet protocol has revolutionised the commercial market of multimedia broadcasting worldwide. There are a number of standards being developed across Europe, the United States and Japan for multimedia broadcasting and standardization has also been ongoing in ITU.

Citing the benefits of digital broadcasting technologies it is clear that migration from analogue to digital will be universal over time. The pivotal factors for the success of the technologies are the availability of higher bandwidth, cheaper receivers, frequency spectrum for efficient global usage and interoperability issues with the existing analogue networks.

Before migrating from analogue to digital broadcasting, it is always essential to identify the market. The market and consumers look for usability and quality in technology and services. However, it is proved that both digital radio and TV have a range of benefits compared with their analogue counterparts. They are:

- Better images and sound
- Attractive new programmes
- Portability
- Interactivity
- New services
- Lower radiated power of the transmitters.

These factors strengthen the viability of the future digital market. The digital technologies provide opportunities for new advanced services, as now has been proved by the Internet enabled ventures (e-businesses) and many companies are emerging which will satisfy the varying and sophisticated needs of consumers. The players must also be customer focused and always ready to serve the customers and users of the technologies.

The relevant problems are related to multiplexing, data bit rate, the video bit rate and the audio bit rate with consequent different choice or usage of algorithms, software and compressions. The above problems may be influenced also by the type of propagation (e.g. ionospheric propagation).

### **3.8 Broadcasting services for mobile reception**

There are multimedia systems for mobile reception by handheld receivers developed within Radiocommunication Study Group 6 as described in Annexes of Recommendation ITU-R BT.1833 - Broadcasting of multimedia and data applications for mobile reception by handheld receiver.

For more information, see also Part 2, Chapter 2.

### **3.9 Interference aspects**

#### **3.9.1 Interference free reception in the mobile environment**

Having experienced the quality of service (QoS) of stationary (analogue) terrestrial broadcasting for many years, future users of mobile broadcasting services will not only demand a higher level of QoS (clearer TV pictures, higher sound quality) but also demand that this is sustained in the mobile environment where multipath-reflections and Doppler-shifts introduce substantial BER in the broadcasted data stream.

Here it is important to note, that these systems will not only be used to receive broadcast content in the traditional sense, but also be capable of offering error free downloads of purchased source code and even executable code, which of course has to reach the target clients uncorrupted.

The practical implementation of mitigating such interference is not trivial, but has already found different solutions in some of the new standards/specifications emerging.

#### **3.9.2 Impact of interference in end user environment**

The audio or video receivers are normally affected by local interference created by manmade noise and/or by other services. The system efficiencies can be improved when the cause of the interference has been mitigated.

The PC, the mobile telephone and/or domestic equipment (electric razor, microwave oven, etc.) are the principal equipment producing greater interference to fix or portable audio and video receivers.

The interference impact of Power Line Transmission (PLT) is under study in Radiocommunicacion Study Group 6. To mitigate this impact each Administration has to consider the possibility to define and apply appropriate protection values.

## Chapter 4

### 4 Transition issues

In general, spectrum, technology, legal requirements and obligations on digital broadcasting services drive the implementation of digital broadcasting.

#### 4.1 Spectrum availability

##### 4.1.1 Considerations for the Digital Broadcasting

###### 4.1.1.1 Technological convergence

With the introduction of digital techniques and technologies in digital broadcasting the difference between digital broadcasting, computing and other telecommunications systems seems to become smaller and smaller. Therefore technological convergence of these applications becomes possible.

Different technologies offer different opportunities for different types of services, like sound, television, additional data etc.

As digital services in principle offer both improved quality and/or more programmes in the same frequency bandwidth, the broadcaster has the possibility to offer new attractive services in addition to broadcasting.

On the other hand technologies in mobile telephony services can offer services similar to broadcasting, with limited quality but for portable reception.

###### 4.1.1.2 Obligations

In some countries, obligations to transmit certain channels have been traditionally imposed on certain networks. Some broadcasters argue that extension of these obligations to digital networks will help switchover to digital technology as users expect to find the same service they already have in analogue. However, network operators express concerns about the proportion of these measures and the absence of appropriate compensation. In any event, the obligation can be clearly defined.

###### 4.1.1.3 Copyright

As a general rule, transmission in digital as well as analogue (simulcast) of a copyright protected service results in additional copyright payments even though few or no additional viewers are involved. Such demands may be perceived as a disincentive to provide or extend digital services. Rights holders, including their representatives, should be encouraged to offer appropriate terms for the simultaneous transmission of analogue and digital through the same delivery mechanism where migration is the aim. Future copyright licences should also facilitate modifications or enrichment of services and data to improve accessibility for users with special needs.

Developments in digital broadcasting can also be constrained by the inability of citizens to legally obtain access to TV programmes other than those originating in the country where they reside. Although such access is technically possible, it is, in some instances, not authorised by Rights holders, given the territorial nature of copyright.

###### 4.1.1.4 Diversity of digital broadcasting services

Digital broadcasting will attract different consumer segments if it is associated with a variety of services not available, or only partially available, in analogue, such as:

- fixed, portable and mobile reception;
- increased audio and picture quality, including wide-screen and high-definition television;
- data and interactive services, notably ‘Information Society services’;
- increased number of programs transmitted and therefore possibility for higher diversity of programs and possibility also of more regional and local programs.

Such digital service diversity is helpful for extending the appeal of digital TV beyond multi-channel and premium pay services. These have been the predominant digital TV services since the beginning of the

market, but are usually not a driver where analogue multi-channel is available. Maximising digital service diversity will help ensure differentiation from analogue and serve the needs of population segments and markets that are interested in other types of digital television services.

Public authorities can encourage the availability of added value content on TV networks in different ways.

First, ensuring government information is increasingly available. Much of this information is very valuable to citizens and is often cheaply available. It is possible to build on the work done on e-government and ensure the information is formatted to be displayed on TV in accessible formats. Action by Member States can provide critical mass and reduce costs thanks to economies of scale. This implies interoperable and horizontal solutions, as ‘platform-agnostic’ as possible, to facilitate exchanges between administrations.

Secondly, various Member States initiatives in the areas of *e-content*, *e-government*, *e-learning*, *e-health*, can support public-private partnerships regarding the provision of added value content, government-related or not, on digital broadcasting networks.

Thirdly, service competition can be stimulated through the implementation of National and International regulatory provisions on third party access to electronic communication networks and facilities. Services concerned can include traditional broadcast programming but also interactive services, such as messaging services allowing for interaction between users, thus stimulating uptake through direct network effects.

Finally, wide-screen and high definition formats will stimulate the consumer take-up of digital television.

#### 4.1.1.5 Spectrum Management

Limited availability of terrestrial broadcasting spectrum is both an important justification and challenge for switchover.

The spectrum situation varies from one region to another. In areas where spectrum is over-crowded simulcasting is more challenging and there is greater pressure analogue services to be switched off early.

Spectrum management has traditionally been closely controlled by national governments. In addition, a high degree of international co-ordination of spectrum management takes place within the ITU. These international fora focus on two major issues:

- avoidance of cross-border interference;
- promoting the availability of communication services and equipment on a global and/or regional scale by fostering the harmonisation of the frequency bands used for specific purposes.

In spectrum management it is necessary to distinguish “allocation”, “allotment” and “assignment” issues. See respectively Nos. 1.16, 1.17 and 1.18 of the RR.

Allocation refers to the types of services delivered over specific spectrum bands (terrestrial mobile, fixed satellite, radio astronomy or other), on which harmonisation decisions are largely agreed at international level. Nevertheless, the distinction between different services may be increasingly challenged by market and technological developments, notably associated with digital convergence, calling for more flexible approaches to spectrum allocation. This issue affects, but actually goes well beyond, the switchover debate. Frequency assignment refers to granting of rights to use specific frequencies to a station.

The actual organisation of switchover and the timing of analogue switch-off are important factors. In Region 1 and some countries in Region 3 the provision of analogue services in one country could constrain the use of the same frequency bands in another. This tension between the priorities of different national governments is particularly acute for broadcasting signals because of the long distances they typically travel, due to their high power and their use of low transmitting frequencies (VHF and UHF bands). So switchover progress in these countries, and all its attendant benefits, may be held up by slower migration in neighbour countries.

Technical discussions on co-ordination issues have been taking place for some years in the ITU. In particular, a two-session ITU Regional Radiocommunication Conference, covering the whole European Broadcasting Area, Africa and contiguous countries, was held place to review the current frequency co-ordination planning for terrestrial broadcasting (the ‘1961 Stockholm plan’ and Geneva 89 and their subsequent updates), so as to facilitate the digital transition and prepare the post-switch off scenario. The first session was held in 2004 and the second session in 2006. These inter-governmental negotiations have a technical focus and decisions are not necessarily based on shared policy goals, with outcomes which may not

be in line with market developments. The selection of co-ordination mechanisms according to specific technical criteria may also lead to the exclusion of other alternatives, possibly reducing market competition and consumers' welfare.

In this context, it seems justified to develop policy orientations on spectrum management and switchover to achieve the goals of the internal market, addressing in particular the three aspects mentioned: assignment mechanisms; organisation and time scales of the migration. This would help clarify the real stakes of the switchover, in particular who will benefit from it, when and how. That would provide certainty for all those involved, help establish their respective responsibilities.

#### 4.1.2 General considerations on Broadcasting Planning

As explained before, there is a general trend for introduction of digital techniques to replace analogue broadcasting. However, because of the very large numbers of broadcasting receivers in use and the long life expected for such receivers, it is clear that a changeover from analogue to digital broadcasting will not take place very rapidly in all countries. Indeed, the changeover can be expected to take many years in most countries. It is therefore necessary to consider very carefully how the changeover can be managed to ensure the end result is successful. It is also necessary to consider very carefully the transition period between an all-analogue situation and an all-digital situation if harmful interference to broadcasting reception is to be avoided.

In the context of transition, it must be stressed that there are two separate phases to be considered. The first phase occurs when digital transmissions are introduced into broadcasting bands, which are already occupied, more or less completely, by analogue transmissions which remain in operation. The second phase occurs when the analogue transmissions are switched off allowing the opportunity to introduce additional digital transmissions. Planning considerations during these two phases are likely to be very different but, at present, sufficient information is only available to allow detailed examination of different approaches for the first phase.

In preparation for the first session of Regional Radiocommunication Conference (RRC-04) the Task Group 6/8 produced an input document containing several planning scenarios.

The second session of the Regional Radiocommunication Conference (RRC-06) established digital terrestrial broadcasting DVB-T plan for television systems in Band III (VHF), Bands IV and V (UHF), and digital terrestrial sound broadcasting T-DAB plan in Band III (VHF) in Region 1 and certain Countries in Region 3, known as Geneva-06 Plan. This text can be accessed via internet at [http://www.itu.int/ITU-R/conferences/rrc/rrc-06/plan\\_process/index.html](http://www.itu.int/ITU-R/conferences/rrc/rrc-06/plan_process/index.html).

## 4.2 Broadcasting planning principles

### 4.2.1 General considerations

The planning of terrestrial analogue broadcasting services during the Stockholm and Geneva Conferences was based on the concept of an 'assignment' defined in No. 1.18 of the RR as:

*“Authorization given by an administration for a radio station to use a radio frequency or radio frequency channel under specified conditions.”*

In the context of producing a plan using an assignment planning approach, an assignment consists of a (single) transmitter site (specified in terms of longitude and latitude), with given effective radiated power (e.r.p.), effective antenna height, transmitter radiation pattern, etc. These parameters are chosen to ensure acceptable reception (or coverage) of an intended program in an area associated with, and usually surrounding, the transmitter location. However, the desired coverage of the assignment is not explicitly taken into account during the development of the plan and, in principle, cannot be determined until the plan had been finalised.

As more attention is now being placed on the need for a plan to achieve protection of a known coverage area and as digital techniques offer greater potential for planning approaches, the concept of assignment planning has come under close examination. This has evolved into a related but more flexible concept termed 'allotment planning'. An allotment is defined in No. 1.17 of the RR as:

*“Entry of a designated frequency channel in an agreed plan, adopted by a competent conference, for use by one or more administrations for a terrestrial or space radiocommunication service in one or*



*more identified countries or geographical area and under specified conditions.”*

However, in order to avoid difficulties with regard to the competence of administrations in territories other than their own, in the context of planning for terrestrial broadcasting services, this definition can be taken to mean:

*“Entry of a designated frequency channel in an agreed plan, adopted by a competent conference, for use by an administration for a terrestrial broadcasting service within its own territory, or geographic areas within its territory, and under specific conditions.”*

#### **4.2.2 Coverage of an allotment area**

Allotment planning may be used to ensure that the area which is intended to be protected against interference is taken into account during the development of a plan. The coverage of an allotment may be achieved by using:

- A single frequency network (SFN) consisting of a group of transmitters whose precise site locations and other technical characteristics are known at the time when the plan is made because the transmitter infrastructure has already been determined. In this case, the interference potential of the network can be represented by the set of assignments forming the SFN.
- A single transmitter with known characteristics at a pre-determined site. The interference potential is represented by the assignment.
- A single frequency network (SFN) consisting of a group of transmitters whose precise site locations and other technical characteristics have not been determined at the time when the plan is made. In this case, the interference potential of the network must be represented by means of a reference network.
- In the case where a small area is to be covered but where there have been no decisions regarding the choice of transmitter site or other characteristics, the interference potential may be represented by a single transmitter.

See Recommendation ITU-R SM.1050-1.

#### **4.2.3 Allotment test points**

Once the coverage area for an allotment has been decided, its boundary must be explicitly defined by means of test points. These test points will serve several purposes.

First of all, the allotment test points will define the geographical position, shape, and size of the allotment, that is, the ‘allotment boundary’:

- For this purpose, the test points are to be specified using, where appropriate, an agreed set of national boundaries and coastlines (as contained in the ITU IDWM), in terms of degrees, minutes, and seconds of longitude and latitude.
- An allotment area will be represented by the polygon (or polygons) defined by the specified test points (which will be the vertices of each polygon). Because only a limited number of test points can be usefully treated, the match between the polygon (or polygons) and the desired coverage may not be exact; therefore the choice of test points must be made carefully to demarcate the allotment area to a sufficient degree of accuracy.
- The test points for a given polygon should be ordered so that, when straight lines are drawn between consecutive points, a closed polygon is formed with no sides intersecting and containing the intended coverage area. This means that the coordinates of the first test point and the last test point in the sequence for the polygon must be identical (i.e., they represent the same physical point) so that the polygon ‘closes’.

Secondly, for calculations during planning in those cases where the interference potential of the allotment is represented by means of reference networks rather than by actual assignments, the test points will be used for the locations of the source of the interference that is associated with the allotment. In this way the interference potential of the allotment can be assessed.

Thirdly, for calculations during planning, the interference level due to other allotments or assignments will be calculated for the allotment test points. For this reason they should be ‘reasonably’ spaced. This means

that they should give a 'good' approximation to the intended coverage area, the idea being that any potential interference within the polygon (i.e., the coverage area) will be no more than that occurring at the test points; too large a spacing may not assure this aim. On the other hand, too small a spacing may be 'overkill' and only lead to superfluous calculations.

#### **4.2.4 Digital Sound Broadcasting in HF bands**

WRC 03 decided to encourage the introduction of Digital Radio Mondiale (DRM) by the broadcasting service in the HF bands on condition that the protection ratios are compliant with Resolution 543 (WRC-03).

There have been various discussions in the informal coordination groups and in the Broadcasting Unions on different approaches to implementing DRM transmission in the HF bands. At present, no method has provided any real benefit over the existing procedures in Article 12 of the RR.

Consequently, DRM transmissions are being introduced using the informal coordination procedure of Article 12. This gives broadcasters the greatest flexibility when planning DRM transmissions as they are free to select any new frequency using the existing and well known procedures. Any unexpected interference to existing analogue transmissions is then resolved using these informal coordination procedures. Furthermore, it allows broadcasters to change an existing analogue frequency to digital modulation for part of the transmission.

Other strategies may need to be considered in the future as the number of digital transmissions increases.

### **4.3 Quality of service**

An important part of assuring the quality of any broadcast transmission comes from monitoring the transmitted signals within the target coverage area. In the case of analogue services, this has generally been accomplished by using a high quality receiver for signal reception. The signal strength is then read from a calibrated meter, whilst making a subjective assessment of the signal quality. Such an assessment has historically been made by someone in the target area tuning a receiver to the required service and then watching and/or listening to it in real time. More recently, this manual method has been supplemented by using unmanned remotely controlled or scheduled receivers to receive the signals and record the signal strength, together with a sample of the received signal. The move to using a digital transmission system enables the monitoring of reception to be completely automated.

### **4.4 Economical aspects of Spectrum utilization**

For more information it is necessary to take into account Report ITU-R SM.2012 - Economic aspects of spectrum management, and Resolution 9 of WTDC-06 - Joint group between ITU-R and ITU-D for spectrum management.

See also Part 2.

### **4.5 Health, safety and other legal considerations**

During any transition from Analogue to Digital broadcasting due care must be taken to ensure that transmission systems conform to all prevailing standards and recommendations concerning the limits of electromagnetic radiation hazards in force and the health and safety of staff and the general public.

Recommendation ITU-R BS.1698 contains the precautions to be taken into account. In Part 2 there is a summary of the important part of this Recommendation.

### **4.6 Switchover Analogue to Digital**

#### **4.6.1 Simulcast of analogue and digital services**

##### **4.6.1.1 Advantages and disadvantages of simulcast**

There are several kinds of possible Simulcast. In this report we consider only the following:-

- Single channel simulcast: a single channel carrying both analogue and digital versions of the same content.
- Multi channel simulcast: The same content is broadcast in analogue and digital in two (possibly adjacent) channels. The concept of multi channel simulcast can be extended to using as an example MW bands for the Analogue signal and HF for the digital content or the contrary.

One example of DRM simulcast is given in Part 2.

#### **4.6.1.2 Advantages and disadvantages of Single Frequency Networks (SFN)**

The main advantage is to use only one RF channel to deliver the same content all over a coverage area. The main weakness is that the content needs to be exactly the same and that local or regional services are not any more possible.

#### **4.6.1.3 Spectrum availability**

In some Countries where there is congestion in the broadcasting bands the transition could be difficult. Solutions should be found by National Administrations.

#### **4.6.2 Possible mechanisms for the implementation of digital broadcasting**

In the case of AM broadcasting in the HF, MF and LF bands all existing frequencies appear to be already occupied. It may be possible to use the same frequencies as used for analogue transmissions additionally for a digital one. However the interference caused to other stations, or caused by other stations to existing ones, should not exceed the values used in existing frequency plans. For the DRM system the value of  $-7$  dB seems to be adequate on an interim basis.

The most important parameter in deciding when to change over to digital is the availability of receivers capable of decoding the digital signal. For this reason a transition period is needed, during which emissions will be transmitted in both analogue and digital techniques.

When the number of digital receivers will exceed say 95% of all receivers or all listeners, the analogue services can be discontinued.

For the introduction of T-DAB the situation is somewhat easier. For this type of digital sound broadcasting service some TV channels in Band III (mostly channel 12) and also channels in Band L (c/a 1.5 GHz) are foreseen in some countries.

During the transition period the analogue transmissions will remain in the FM band (in most European countries from 87.5 MHz to 108 MHz). After that period this band may also be used for digital transmissions.

A more difficult problem seems to be the digital terrestrial television. In a majority of West European countries all available television channels are used for analogue transmissions. In some countries there are some free channels in the band channel 61 to 69, because part of this band was used by other services.

Another possibility may be to use channels, which were restricted during analogue TV planning, so called planning constrains (in USA called "TABO" channels).

However the strategy may be quite different from region to region of the planning area and even from country to country.

In general, when replacing the existing analogue transmission with digital for the same coverage area with the same quality of service, the radiated power will be lower.

#### **4.6.3 Switchover Overview**

In the field of radio and television (jointly referred to as 'broadcasting'), 'switchover' refers to the migration process from analogue to digital broadcasting, starting with the introduction of digital and ending with the switch-off of analogue broadcasting. Many routes are possible in terms of the speed and length of the process, the parties involved, and the degree of government intervention.

Each country follows its own switchover path, often influenced by local broadcasting legacy.

Ideally, the final analogue switch-off should take place when digital broadcasting has achieved widespread penetration and very few analogue homes remain. Otherwise the impact would be socially regressive, if many homes were simply deprived of TV or radio services; or economically damaging, if expensive or distorting public policy measures were implemented to avoid such a negative outcome.

Switchover implies much more than a technical migration. Considering the role of TV and radio in modern societies, that impact is not only economic but also social and political. Switchover affects all segments in

the broadcasting value-chain, namely: content production, transmission and reception. All require technical upgrading to support digital broadcasts. The main challenge is on the reception side: to replace or upgrade the huge installed base of analogue receivers. This can be done with integrated digital television or radio receivers, or 'set-top-boxes' connected to the analogue TV set. Moreover, connection points (antennas, dishes, cabling) must often also be adapted.

The switchover cases for TV and radio are quite different. Digital TV market penetration is much greater. Analogue and digital TV are provided on various networks, mainly cable, satellite and terrestrial (over VHF and UHF frequency bands). Digital audio-visual content can be also supported by the internet and, still marginally, *Digital Subscriber Lines* ('DSL') networks. Each network has specific strengths and weaknesses. So television switchover is a 'multi-network' or 'multi-platform' process and digital TV is not synonymous with digital terrestrial TV. However, the debate often focuses on terrestrial TV because of the potential recovery of spectrum currently used by analogue terrestrial TV, and traditional government involvement in this area.

Nor is digital TV equal to interactive TV. The former concerns the type of communication network and is the focus of the present document; the latter refers to specific services that can be provided over that network. In practice, the roll-out of networks and services are related. Finally, digital TV is not just pay-TV; free-to-air digital TV offerings also exist in some Member States.

As to the benefits of digital broadcasting, some are associated with the switchover process itself, others would be only achieved at the end, when analogue broadcasts have ceased. All benefits derive from the possibility of processing and compressing digital data, making much more efficient use of network capacity than is the case with analogue signals. This can be exploited in several ways. Firstly, it enables the offering of new or improved broadcasting services: additional programming; programme-related enhancements; better picture and audio quality; data and interactive services, including 'Information Society' and internet-like services. Secondly, it provides increased market competition and innovation, thanks to the potential arrival of new entrants at different levels in the value-chain, for instance new broadcasters or developers of interactive applications.

In addition, switchover implies specific benefits for some categories of market players: reduction of transmission costs; opportunity for increased sales of digital receivers; easier storage and processing of content. In fact, the potential benefits and difficulties vary according to the stakeholders, as well as the local context and networks considered.

In any event, in the short-term, switchover involves significant costs and difficulties associated with the need to: introduce technical upgrades in all segments of the value chain and review spectrum mechanisms and approaches; develop attractive services to drive demand, without which the overall process could be financially and politically unsustainable; and overcome scepticism and even resistance from some industrial players and citizens, who may see risks in changing the status quo in the broadcasting sector.

Currently, the migration to digital broadcasting has been affected by the situation in the information and communications sector, characterised by limited capital availability. This removes part of the pressure to accelerate switchover in order to release spectrum. Moreover, market potential for interactive TV and convergent services is taking time to materialise and consumer willingness to pay for this remains uncertain.

In summary, progress is slower than anticipated and doubts are expressed about switch-off targets in certain countries. TV and radio broadcasts will be fully digital one day but it is difficult to know when and how. In some EU countries switchover could be a long process and its outcome is uncertain. For instance, the extent to which spectrum will be recovered and reallocated more efficiently will depend on political and market circumstances.

## Appendix 1 to Part 1

### Case Studies

#### Overview of National case studies

This appendix presents an overview of the approach and current status of Digital Terrestrial Television Broadcasting (DTTB) in several Countries.

Below there is a summary of action done by different Countries.

More information is available in Part 2.

#### 1 Australia

Australia is served by an extensive network of PAL-B analogue, and more recently by DVB-T digital (8k carrier mode, 64QAM, 2/3 or 3/4 FEC). Terrestrial television broadcasting transmitting sites operate in both VHF and UHF bands on a 7 MHz raster and at present simulcast both analogue and digital signals. In introducing digital television, Australia has planned for seven digital television networks in most areas – five to replace the existing analogue networks plus two new digital networks. Digital television services commenced in major metropolitan regions on 1 January 2001 and have been progressively deployed in regional areas.

A feature of the Australian transmitter deployment is that a large percentage of the population receives signals from a small number of high power “main station” transmitters with typical coverage areas of up to 150 km. For digital services the radiated power levels of those main station transmitters is up to 100 kW e.r.p at VHF and up to 1250 kW e.r.p at UHF. In addition to high power main station services, repeater stations to cover deficient coverage areas are extensively used. They may be implemented using either a multi-frequency network (MFN) or a single frequency network (SFN) approach.

HDTV is a key feature of digital terrestrial television in Australia and has been an important driver in the uptake of digital television. The Australian Government has been committed to ensuring that digital television would be as affordable as possible. Although broadcasters have been required to provide at least a minimum amount of high definition television programming for those who have HDTV sets, they have also been required to provide their broadcasts in SDTV format. Transmission of SDTV format programming not only provides viewers with the ability to access the additional features of digital broadcasting, but it also gives consumers with a cheaper conversion path for obtaining digital services.

The Australian Government has announced that 31 December 2013 will be the date by which the last analogue transmitter will be switched off.

#### 2 Brazil

Beforehand, it's important to note that the country's channel planning is not DTTB standard-specific, since it contemplates the particularities of each existing DTTB standards. DTTB is to replace existing analogue TV by using UHF (channels 14 to 69) frequency bands. DTTB stations will have similar service areas as presently analogue stations do. Simulcasting of existent analogue channels and new digital ones is the approach applied during the transition phase.

In June 2006, the Brazilian government adopted, by the issue of Decree No. 5820, the ISDB-T digital television standard (Recommendation ITU-R BT.1306 System C) as a base for the terrestrial transmission. The video coding is the ITU-T Recommendation H.264 (MPEG-4/AVC) and the data coding is an innovative system harmonizing international Application Program Interfaces - APIs with local middleware development.

To make the transition to digital possible, up to December 2006, 1893 digital channels had been made available by the National Telecommunications Agency (Agência Nacional de Telecomunicações - Anatel).

This work still continues and there will be more than 6100 digital channels in Brazil until 2013. Considering that each analogue channel must have its digital correspondent, more than 12200 channels, including analogue and digital, must be available during the “simulcast” period.

On December 2<sup>nd</sup>, 2007, the first official implementations of the Brazilian DTT system began commercial operations in the city of São Paulo and, in the 2<sup>nd</sup> semester of 2008, there were already 10 commercial broadcasters operating in the city. Although test transmissions were being held since May 2007, the Brazilian government established December 2<sup>nd</sup> as the official system launch date.

The Brazilian digital transmission system provides important features, such as high definition and standard resolution pictures, data delivery, interactive communication, portable and mobile services, with the required technical flexibility to better serve the viewers.

Brazilian Authorities consider that keeping the free and open TV model is essential to the DTTB success and to bring its benefits to the entire Brazilian society.

In 2007, more than 85% out of 56,45 million households in Brazil had TV sets that received only free, over-the-air TV service. This testifies to the importance of a free TV model to Brazil.

### **3 Bulgaria**

Simulcasting between analogue and digital terrestrial TV broadcasting will be applied but not permitted for more than a year duration, except in remote rural areas.

Two phases of transition to digital TV terrestrial broadcasting will enable gradual transition to digital.

Six nation-wide DVB-T and DVB-H MFN/SFN networks-licensed operators must ensure full population coverage in all fifteen allotment zones: first three by December 2012, remaining three by June 2015.

Twenty seven regional SFN networks must ensure 90-95% population coverage in all fifteen allotment zones: first twelve SFNs by January 2010, remaining fifteen SFNs by December 2012.

License applications for digital terrestrial HDTV broadcasting shall be submitted by December 2011 and licenses may be granted shortly.

Interactive services and applications will be encouraged.

Switch-off of all analogue TV terrestrial transmissions will be completed by December 2012.

Transition to digital terrestrial TV Broadcasting shall be terminated by June 2015 and factual digital dividend be established.

### **4 Canada**

Canada adopted the ATSC standard in 1997. The first commercial DTT station went on the air in Toronto in early 2003. Currently, there are about 2 dozen DTT stations across the country broadcasting in the major markets such as Toronto, Montreal, Vancouver and Ottawa. About 33% of the population of can receive at least on Canadian DTT station. The Canadian Radio-television and Telecommunications Commission (CRTC) mandated August 31, 2011 as the date to shut-down analog TV in Canada. As a result, most major television networks are actively planning their transition to digital to meet the CRTC deadline.

Test transmissions are being carried out by the Communications Research Center (CRC) using distributed transmission networks such as SFN –Single Frequency Network and digital on-channel repeaters (DOCR). The purpose of the tests is to identify the solutions that are needed to overcome coverage difficulties due to terrain and to explore possibilities in the area of pedestrian and mobile reception of DTT services.

### **5 Germany**

DTTB was officially launched on 1 November 2002 and, by the end of 2008, all transmissions were completely digital, using the DVB-T standard. The business model is free-to-air broadcasting. The country’s channel planning is based on the framework of the national frequency rights resulting from the ITU-R Geneva Agreement 2006 (GE-06), using predominantly the service concept "portable outdoor" (RPC-2

according to the Geneva Plan plus one or several assignments per city for high-power transmitter). This service concept generally enables indoor reception in the German agglomerations, which makes up one half of the total area, where typically more than twenty digital programmes are available in standard definition (SD) quality. Outside of these agglomerations, DVB-T can either be received as "portable outdoor" or by using directive antennae. With respect to HDTV, first test transmissions have taken place. Trials are also carried out concerning the transmission of sound radio programmes within a DVB-T multiplex.

There are various types of receivers on the market, ranging from USB dongles for PC and laptops over small portable TV sets for handheld and in-car reception (screen size typically between 5 and 7 inch of diameter) to set-top boxes and stand-alone TV sets for stationary reception (typically with flat-screen displays). In May 2008, the first mobile phones with integrated DVB-T receivers appeared on the market. In addition, car navigation systems are nowadays equipped with DVB-T receivers.

The switch-off started in Berlin-Brandenburg in August 2003. Already by the end of 2003, some six million people were able to receive 26 digital channels in SD quality in the city of Berlin and the federal member state of Brandenburg. This was the first switch-off of terrestrial analogue television worldwide. This success can be ascribed in part to the Government, which decreed that the service was to be totally free of charge, and which provided, only in 2003, free decoders to the poorest households. Under no other circumstances, the purchase of DVB-T receivers was subsidised. By the end of 2007, more than 85% of the German population (68 Million people) could already receive digital terrestrial television. More than nine million receivers had been sold by that date. The success of DVB-T in Germany was due to the fact that the reception of a multitude of German-speaking programmes was available to the general public free-of-charge. In 2008, DVB-T is used by 16,8% of the households in Berlin –Brandenburg.

In other metropolitan areas, DVB-T transmissions started in 2004. One key element of the German approach was the implementation of the digital broadcasting service region by region, initially after an announced transition period of as little as six months and later on without any simulcast period. By the end of 2008, the switch-over will definitely have been completed (two years earlier than originally planned).

By the end of 2008, some 15 Million DVB-T receivers are expected to have been sold since the launch of the service. Nevertheless, for their primary TV service in the households (large flat screen in the living room) approximately 90 percent of the Germans still rely on cable TV or satellite distribution.

## **6 Guinea**

The advance of satellite broadcasting slows down the process of migration from analogue to digital broadcasting in terrestrial television. However, DTTB launching is under consideration. Two alternatives are examined, either to close down the analogue system and construct an entirely digital network, or to deploy a hybrid system (analogue and digital). The latter option would seem to be the most appropriate for developing countries. In respect to channel planning and platforms, the DVB-T standard is perceived as less costly and more advantageous to developing countries during the transition period. This will allow for more fruitful regional consultation, among adjoining countries, aimed at harmonizing the technical facilities to be used when introducing digital broadcasting equipment.

## **7 Italy**

Scheduled DTTB services were started in December 2003. The country's channel planning is based on the European standard, DVB-T. Six multiplexes at national level are in operation, conveying in excess more than 42 TV channels. Tens of local digital channels have become progressively available along the last years. The current coverage of population, in terms of reach of digital signals, is more than 70% in complex. In the model, free TV coexists with pay-per-view services, introduced one year after the start-up of the system. Four millions set top boxes are installed in the Italian households as of end of year 2006. This means that 20% of Italian households are provided of digital TV boxes.

Broadcasters have provided a wide range of MHP-based interactive services such as digital teletext, news information, weather forecasts, audience polling and EPG. Furthermore, the government (both central and local Administration) is providing experimental "t-government" (offering e-government services by using interactivity on TV set) services in aim to help bridge the digital divide.

The switch-off of analogue broadcasting has been scheduled for 2012. A Plan for National Switch over has been presented in September 2008 by Italian Administration. Analog Switch off in Sardinia Island has been fixed for 31 October 2008; the next all-digital area will be Aosta Valley, where switch-off will be fixed by the end of 2008.

## 8 Japan

Terrestrial TV broadcasting is a fundamental medium in Japan. There are 48 million households and 100 million TV sets. Terrestrial broadcasters have established many relay stations to provide maximum coverage throughout the mountainous archipelago; there are more than 3000 transmitter sites. Due to the heavy use of UHF channels by existing analogue relay stations, assigning digital channels without migrating analogue stations is impossible. As a result, many analogue TV channels are forced to shift to other UHF channels. Therefore, the digitization of terrestrial television broadcasting is extremely important in Japan.

The country's channel planning for digital terrestrial television broadcasting (DTTB) is based on the planning criteria for ISDB-T.

Since the start of DTTB in December 2003 in the three major metropolitan areas of Tokyo, Nagoya, and Osaka, service coverage has been expanded; as of December 2007, more than 90% of households were covered. Smaller relay stations will be set up until 2011, and full digital migration will be completed by that year. The switch-off of analogue broadcasting is scheduled in 2011, which was mandated by regulations.

ISDB-T, which is the DTTB transmission system in Japan, provides a hierarchical transmission feature. This enables part of the band to be allocated for fixed reception (mainly HDTV) and the rest for handheld reception (called "One-Seg").

For example, pure HDTV programs produced with a 1080i format cover more than 90% of all programs in general channel of NHK. Moreover, all broadcasters are providing data broadcasting carrying various lifestyle information and supplemental program information.

HDTV receivers for automobiles have been on the market since 2005, and 1.8 million automobile TV receivers have been shipped to August 2008.

One-Seg service for handheld receivers using centre segment of ISDB-T signal started in April 2006. One-Seg receivers have been on the market since 2006, and over 40 million One-Seg receivers have been shipped to August 2008.

## 9 Mexico

In Mexico, the broadcasting sound and television is an activity of public interest, and therefore, it is necessary for these services to be provided under the best technological conditions, in benefit of the population. For this reason in 1999 was established the Consultative Committee of Digital Technologies for Broadcasting (the Committee), in which the industry and the government consensually analyze and evaluate, the development and transition process implemented in other countries. In the year 2000, the Committee established the commitments with such agreements; experimental operations have been conducted with digital technology for radio and television.

In addition, the Committee participated in various meetings of Radiocommunication Study Group 6, which provided the necessary technical information to evaluate the development level of the digital standards analyzed at the ITU. Furthermore, the committee conducted meetings with digital TV technology developers to learn the strengths and weaknesses of each of the standards from the source, as well as any situation of concern in the transition process due to equipment availability and cost.

The Committee considered that it had the key elements to recommend the adoption of the *digital television terrestrial (DTT) standard and its transition policy*; the corresponding agreement was issued on July 2<sup>nd</sup>, 2004. The Agreement established: the adoption of Standard A/53 on the ATSC; the transition process with legal certainty for all parties involved; the objective conditions for process follow-up to evaluate the development, and the objectives, goals, requirements, conditions and obligations.

Due to the costs that the terrestrial digital television transition policy involves for concessionaries, licensees, producers, advertisers and TV viewers in general, this is a long-term process. For this reason the following



elements were taken into account to establish a transition schedule: a flexible and gradual installation process for DTT stations; development periods within this process subject to review, and minimum goals based on population density.

At the April 11, 2006, the regulatory authority for broadcasting sound and television corresponds to the Federal Telecommunication Commission who has given special attention to the supervision and control of the DTT transition. At these date, 35 stations transmitting with digital technologies in 10 principals cities of the country.

## **10 Russian Federation**

5 DVB-T transmitters are working at present time and one more will be launched in nearest future. All of them have experimental status and used for investigations of compatibility between DVB-T and analogue (SECAM-K) television broadcasting, but also proposed to be full-functional DVB-T services.

Transition from analogue to digital TV in the Russian Federation at the first stage assumes the replacement of an analogue signal into digital one with preservation of the existing standard of decomposition of a signal. Such signal can be reproduced not only by colour TV set, but also by black-and-white TV set having a special receiver box.

In Russia before the introduction of digital TV it is required to carry out an experimental broadcasting. In connection to this there were organized experimental broadcasting areas in Moscow – 32, 34 TVch; Saint-Petersburg – 34 TVch; Nizhniy Novgorod – 50 TVch; Vladivostok – 51 TVch; Chelyabinsk – 30 TVch.

The broadcasting is conducted in standard of DVB-T. Now researches of an opportunity of interactive reception on mobile television receivers with the liquid crystal display are conducted, the return channel is planned to realize through GSM network.

For the further introduction of digital TV broadcasting a planning of DVB-T frequency assignments, both in European Broadcasting Area and to the west from longitude 170°E is carried out. Now the majority of planned frequency assignments to DVB-T stations is coordinated with other Administrations, 37 frequency assignments are included in the Plan (Stockholm, 1961), 4 frequency assignments are included in MIFR.

Furthermore 24 frequency assignments to DVB-T stations are coordinated and in the near future will be included in the Plan (Stockholm - 61) and in Lists of existing and planned TV stations for the territories of extended planning area.

MHP-based interactive services are possible, but the penetration of telephone and telecommunication systems –that are not yet at a nationwide extent- is a critical element that shall be taken into deep consideration.

## **11 Tanzania**

Tanzania falls under ITU Region1 with the Tanzania Communications Regulatory Authority (TCRA) (representing Tanzania at the ITU) the regulatory body of Communications, Broadcasting and Postal sectors. TCRA represented the country in RRC-04 and RRC-06 processes which yielded two public consultation documents followed by workshops, annual conferences and forums aimed at addressing how digital terrestrial broadcasting will be implemented, managed and regulated. The consultations yielded initial framework on the new broadcasting landscape in Tanzania which is introduction of signal distributors branded Multiplex Operators (MUX). It is proposed of two commercial Multiplex Operators and one Public Service Multiplex Operator under the initial licensing framework.

Among measures undertaken by TCRA is the introduction of the Converged Licensing Framework (CLF) with four (4) major licences:

- 1 Network Facility
- 2 Network Service
- 3 Content Service
- 4 Application Service

to address the complex licensing issues associated with convergence and digitization, formation of the National Technical Committee to handle migration and work out the roadmap to full digital broadcasting, formation of the interim Work Group on Digital Broadcasting (WGDB) within the Authority with experts from broadcasting, spectrum management, ICT development and legal sector to address the following issues:- consider licensing issues of MUX, National Plan of Digital Broadcasting and simulcast period, licensing of other services such as, Mobile TV, IPTV, consider and adopt a positional paper on availability of STB and editing the final document on Digital Broadcasting.

In April, 2008, TCRA announced an Expression Of Interest (EOI) for prequalification for provision of digital multiplex services with a positive response. Processes to amend the Tanzania ICT Policy, 2003 and other applicable laws steered by the Government are smoothly ongoing. Channels are available for implementation of DTT country wide after initial Digital Plan and four phases are initially proposed to be updated soon.

## **12 United States of America**

The United States has moved forward aggressively with the implementation of DTV using the ATSC Digital Television (DTV). At the request of the FCC, 28 stations in the ten largest cities volunteered to launch DTT service in November 1998, six months ahead of the deadline established by the FCC. Six months later (May 1999) all stations in the top 10 markets that were affiliated with the four largest broadcast networks were required to provide service, and in another six months (November 1999) this requirement was extended to the affiliates of the four largest networks in all of the 30 largest cities. All commercial broadcasters were required to be on the air by May 2002 and all non-commercial broadcasters by May 2003. In early 2006, legislation was enacted by the U.S. Congress requiring broadcasters to terminate their analog transmissions by February 17, 2009. This legislation included provision of up to \$1.5 billion to subsidize the purchase by television viewers of digital-to-analog set-top converters that could be used to view DTT signals on existing analog television receivers. The FCC adopted regulations that phased in a requirement for inclusion of ATSC receiving capability starting with the largest TV sets first, in 2004, and for all sets over 13 inches by July 2007. In November 2005 the FCC amended its rules to advance the date for the completion of the phase-in period to March 1, 2007, and to apply the requirement to all receivers regardless of screen size. Thus, since March 1, 2007 every television set sold in the U.S. has contained a ATSC DTT reception and decoding capabilities. The U.S. Consumer Electronics Association predicts that 34 million ATSC DTT receivers per year will be sold in the U.S. alone by 2007, with a cumulative total of 152 million ATSC receivers by 2009. Broadcasters and manufacturers are now in the process of planning for the rollout of mobile and handheld services using the ATSC-M/H system.

## **13 Republic of Korea**

The Republic of Korea started digital terrestrial television broadcasting in 2001, digital satellite broadcasting in 2002, and terrestrial multimedia broadcasting in 2005. Cable TV is also in service of digital programs since 2002.

### **13.1 Digital TV for fixed reception**

The Republic of Korea adopted ATSC system in 1997 for digital transition of analogue television broadcasting in the UHF band to obtain high definition quality within 6 MHz raster and conducted field tests in 1999 and 2000. There are 160 ATSC transmitters currently installed around the country covering about 92% of territory as of 2006. It was not an easy job to find frequencies for digital television stations, because the UHF band is already occupied with analogue television broadcasting. In order to facilitate frequency assignments, Equalization Digital On-Channel Repeater and Distributed Translator are devised for ATSC system to use same frequencies.

### **13.2 T-DMB for mobile reception**

For mobile multimedia broadcasting service, the Republic of Korea developed the Terrestrial Digital Multimedia Broadcasting (T-DMB). T-DMB pilot services were conducted in Band III in Seoul metropolitan area and its vicinity and field test results showed good mobile reception quality. Field test results were submitted to WP 6M meeting held in April 2004 and included in the Report ITU-R BT.2049 (see also

Doc. 6E/186). In December 2005, the Republic of Korea launched commercial service of T-DMB in Seoul Metropolitan area and expanded to the nationwide services in March 2007.

#### **14 Venezuela**

DTTB is going to be introduced through a process assisted by the National Regulator, that is CONATEL– National Commission of Telecommunications. The process is split into different stages: feasibility study, forum and operating tables, trials and standard adoption. This process is under developments. Trials have been conducted but there is not yet a clear orientation toward a specific channel planning or a specific standard.

#### **15 OCDE**

The major part of the OCDE document published in June 2003 with the following title: "The Implications of convergence for regulation of electronic communications" from the Committee for Information, Computer and Communications Policy, is dedicated to the place of broadcasting in electronic communications (Doc. DSTI/ICCP/TISP (2003)5).

#### **16 European Union**

Information regarding Digital video broadcasting spectrum issue in Europe (Finland, France, Spain, Sweden, and United Kingdom) can be found in the ITU-D Report regarding Question 11-1/2.

## Appendix 2 to Part 1

### Glossary (Abbreviations)

AAC	Advanced Audio Coding
AFS	Alternative Frequency Switching
AM	Amplitude Modulation
ATSC	Advanced Television Systems Committee
ATSC-DTT	Advanced Television Systems Committee – Digital Terrestrial Transmission
ATSC M/H	Advanced Television Systems Committee Mobile / Handheld
BER	Bit Error Rate
BPF	Band Pass Filter
BST	Band Segmented Transmission
CA	Conditional Access
CELP	Code Excited Linear Prediction
COFDM	Coded Orthogonal Frequency Division Multiplex
DAB	Digital Audio Broadcasting
DC	Direct Current
DCP	Distribution and Communications Protocol
DDC	Digital Down Conversion
ChinaDTV	China Digital Television - Terrestrial
xDSL	x Digital Subscriber Line
DRM	Digital Radio Mondiale
DSB	Digital Sound Broadcasting
DVB	Digital Video Broadcasting
DVB-H	Digital Video Broadcasting - Handheld
DVB-T	Digital Video Broadcasting – Terrestrial
ETSI	European Telecommunications Standards Institute
FAC	Fast Access Channel
FDM	Frequency Division Multiplex
FEC	Forward Error Correction
FLO	Forward Link Only
FM	Frequency Modulation
GPRS	General Packet Radio Service
GPS	Global Positioning System
GSM	Global System for Mobile communication
HF	High Frequency
HVXC	Harmonic Vector excitation Coding
IBOC	In Band On Channel
IDS	iDAB Data Service
IEC	International Electrotechnical Committee

IP	Internet Protocol
IPR	Intellectual Property Right
IRD	Integrated Receiver and Decoder
ISDB	Integrated Services Digital Broadcasting
ISDB-T	Integrated Services Digital Broadcasting- Terrestrial
ISDB-T <sub>SB</sub>	Integrated Services Digital Broadcasting- Terrestrial Sound Broadcasting
ISDN	Integrated Services Digital Network
ITU-D	International Telecommunications Union – Telecommunication Development Sector
ITU-R	International Telecommunications Union - Radiocommunication Sector
ITU-T	International Telecommunications Union - Telecommunication Standardization Sector
LAN	Local Area Network
LF	Low Frequency
LMDS	Local Multipoint Distribution System
LW	Long Wave
MCI	Modulator Control Interface
MCS	Multiple Channel Simulcast
MDI	Multiplex Distribution Interface
MER	Modulation Error Ratio
MHP	Multimedia Home Platform
MLC	Multi Level Coding
MLDS	Multimedia Local Distribution System
MF	Medium Frequency
MFN	Multi Frequency Network
MMDS	Multichannel Multipoint Distribution System
MPEG	Moving Picture Experts Group
MSC	Main Service Channel
MUX	Multiplexer
MW	Medium Wave
NTP	Network Time Protocol
NTSC	National Television System Committee
NVIS	Near Vertical Incidence Sky-wave
NVOD	Near Video On Demand
OCDE	Organisation pour le Commerce et le Développement Economique
OFDM	Orthogonal Frequency Division Multiplex
PC	Personal Computer
PDA	Personal Digital Assistant
PFT	Protection, Fragmentation and Transport
PSTN	Public Switching Telephone Network
QAM	Quadrature Amplitude Modulation
QoSAM	Quality of Service in the digitized AM bands
QPSK	Quadrature Phase Shift Keying
RA	Radiocommunication Assembly of ITU-R
RBDS	Radio Broadcasting Data System

RDS	Radio Data System
RF	Radio Frequency
RFP	Radio Frequency Phase
RRB	Radio Regulatory Board of ITU
RSCI	Receiver Status and Control Interface
RT	Remote Terminal
SBR	Spectral Band Replication
SCE	Service Component Encoder
SCS	Single Channel Simulcast
SDC	Service Description Channel
SDI	Service Distribution Interface
SFN	Single Frequency Network
SNR	Signal to Noise Ratio
SOHO	Small Business or Home Business
SW	Short Wave
T-DAB	Terrestrial Digital Audio Broadcasting
T-DMB	Terrestrial Digital Multimedia Broadcasting
TMCC	Transmission and Multiplexing Configuration Control
UEP	Unequal Error Protection
UDP	User Datagram Protocol
UMTS	Universal Mobile Telecommunications System
USB	Universal Serial Bus
VOD	Video On Demand
VSAT	Very Small Aperture Terminal
VSB	Vestigial Sideband
WAN	Wide Area Network
WARC	World Administrative Radiocommunication Conference
WLL	Wireless Local Loop
WRC	World Radiocommunication Conference
WTDC	World Telecommunication Development Conference

## Part 2

## Contents

	<i>Page</i>
Chapter 1 .....	59
1.1 DRM .....	59
1.1.1 Features of the system design for the markets to be served by the Digital Radio Mondiale (DRM) system.....	59
1.1.2 Brief description of the DRM system.....	60
1.1.3 Transmitter considerations .....	63
1.1.4 Over the air.....	63
1.1.5 Selecting, demodulation and decoding of a DRM system signal at a receiver.....	63
1.1.6 Ongoing case study in Italy since 2006: DRM daytime MW Tests for frequencies below 1 MHz.....	63
1.2 T-DAB general .....	65
1.2.1 Frequency bands.....	65
1.2.2 T-DAB in Band III .....	66
1.2.3 Location of transmitters.....	66
1.3 IBOC .....	66
1.3.1 IBOC Overview.....	66
1.3.2 The IBOC System Technical Design .....	67
1.3.2 Services .....	68
1.3.3 System components.....	68
1.3.4 Operating modes.....	69
1.3.5 Generation of the signal .....	71
1.3.6 Reception of the signal .....	74
1.4 ISDB-T <sub>SB</sub> .....	75
1.4.1 Features of ISDB-T <sub>SB</sub> .....	75
1.4.2 Transmission parameters .....	77
1.4.3 Source coding.....	78
1.4.4 Multiplexing.....	78
1.4.5 Channel coding.....	79
1.4.6 Delay adjustment.....	80
1.4.7 Modulation .....	80
1.5 ATSC.....	83
1.6 DVB-T.....	89
1.6.1 DVB-T variants .....	89
1.6.2 Hierarchical variant .....	89
1.6.3 Guard interval.....	89
1.6.4 DVB-T in Band III .....	89
1.7 DVB-H .....	90
1.7.1 Building and validating an open and scalable network architecture .....	90
1.7.2 Content, services and applications .....	90
1.7.3 User devices .....	90
1.7.4 Networks .....	91

	<i>Page</i>
1.8	ISDB-T ..... 92
1.8.1	ISDB-T Transmission Parameters ..... 92
1.8.2	Hierarchical Transmission ..... 93
1.8.3	Outline of ISDB-T ..... 94
1.9	T-DMB ..... 95
1.9.1	T-DMB General ..... 96
1.9.2	System architecture ..... 96
1.9.3	Video service transmission architecture ..... 96
1.9.4	Video multiplexer architecture ..... 98
1.9.5	T-DMB specifications ..... 100
1.10	LMDS (Local Multipoint Distribution System) ..... 100
1.10.1	Use of LMDS systems ..... 100
1.10.2	Some key factors in the technology ..... 101
1.10.3	Technological trends and objective constraints ..... 101
1.10.4	Target market foreseen for LMDS ..... 101
1.11	Forward Link Only (FLO) ..... 100
1.11.1	Introduction ..... 100
1.11.2	Forward Link Only system architecture ..... 101
1.11.3	Forward Link Only system overview ..... 101
1.11.4	FLO specification ..... 103
Chapter 2	..... 105
2.1	Aspects related to interoperability of systems ..... 105
2.1.1	Digital reception ..... 105
2.1.2	Encouragement to deployment of digital receivers ..... 105
2.1.3	Consumer information on digital equipment and switchover ..... 105
2.1.4	Integrated digital television receivers ..... 106
2.1.5	Digital connectivity ..... 106
2.1.6	Access for users with special needs ..... 106
2.1.7	Removal of obstacles to the reception of digital broadcasting ..... 106
2.1.8	Effects on citizens ..... 107
2.2	Mobile services ..... 107
2.2.1	Sound ..... 107
2.2.2	Mobile TV ..... 107
2.2.3	Enhanced mobile TV ..... 108
Chapter 3	..... 110
3.1	Report of TG 6/8 ..... 110
3.2	UMTS/GSM and DVB-T Convergence ..... 110
3.3	DRM simulcast ..... 111
3.4	Service planning ..... 112
3.4.1	DRM overview ..... 112
3.5	Market impact ..... 117
3.5.1	Market complexity; plurality of scenarios and stakeholders ..... 117
3.5.2	The case for public intervention ..... 117
3.6	General strategy and co-ordination ..... 120
3.6.1	Transparent strategy and monitoring ..... 120



	<i>Page</i>	
3.6.2	Regulation allowing for business autonomy and co-operation .....	120
3.6.3	Proportionate and technologically neutral regulation .....	120
3.7	Problems related to the interoperability of systems .....	121
3.7.1	Digital reception.....	121
3.7.2	Encouragement to deployment of digital receivers.....	121
3.7.3	Consumer information on digital equipment and switchover .....	121
3.7.4	Integrated digital television receivers .....	122
3.7.5	Digital connectivity.....	122
3.7.6	Interoperability of services.....	122
3.7.7	Access for users with special needs .....	122
3.7.8	Removal of obstacles to the reception of digital broadcasting.....	122
3.8	Precautions to control the direct health effects of RF radiation .....	123
3.8.1	Employee (occupational) precautionary measures.....	123
3.8.2	Precautionary measures in relation to the general public.....	124
3.9	Precautions to control the indirect RF radiation hazards.....	124
3.10	Field-strength values to be determined.....	125
3.11	Additional evaluation methods.....	126
3.11.1	Dosimetry.....	126
3.11.2	Specific Absorption Rate (SAR) measurement.....	127
3.11.3	Electric field measurement.....	127
3.11.4	Temperature measurement .....	128
3.11.5	Calorimetric measurement .....	128
3.11.6	Body current measurement .....	128
3.11.7	Contact current measurement.....	129
3.11.8	Touch voltage measurement.....	129
3.12	Legal consideration .....	130
Appendix 1 to Part 2.....		131
1	Australia .....	131
1.1	Digital terrestrial television broadcasting in Australia.....	130
1.2	DTTB System Selection.....	130
1.3	Simulcast of SDTV and HDTV programmes.....	130
1.4	Use of Single Frequency Networks (SFNs) .....	131
1.5	Planning parameters and interference threshold limits.....	131
1.6	Comparison of ITU-R and Australian television planning parameters .....	131
1.7	Digital television minimum median field strengths .....	131
1.8	Digital television protection ratios .....	132
2	Brazil .....	132
2.1	Introduction .....	132
1.2	Methodology Applied for Digital Terrestrial Television Channel Planning and its Respective Results.....	132
2.3	Legislation and Regulatory adjustments for the deployment of Digital TV in Brazil.....	136
2.4	The Brazilian Digital Television System (SBTVD) Forum .....	139
2.5	Current status of the DTT deployment.....	142
2.6	Conclusion.....	143
3	Bulgaria .....	144

	<i>Page</i>
3.1	Background of country TV broadcasting market ..... 143
3.2	Purpose and mission of the analogur to digital terrestrial TV transition..... 144
3.3	Impact of the digital terrestrial broadcasting Plan of RRC-06 and GE 06 Agreement ..... 145
3.4	Transition to digital terrestrial TV broadcasting ..... 145
4	Canada ..... 148
4.1	National planning strategies and policy considerations ..... 149
4.2	DTV/HDTV History..... 150
5	Germany ..... 160
6	Guinea ..... 161
7	Italy..... 162
7.1	Legal Framework ..... 161
7.2	Laws and Provisions for DTT ..... 161
7.3	DTT at Present..... 162
7.4	The "Italia Digitale" Committee..... 162
7.5	The "Technical Area" Concept..... 162
7.6	The A.S.O. Plan..... 163
7.7	The DTT Receivers Penetration ..... 164
7.8	40% DTT Capacity..... 164
7.9	The Italian DTT Offer ..... 164
7.10	Historical Considerations ..... 165
8	Japan..... 177
8.1	History in Brief ..... 176
8.2	Time schedule for digital terrestrial television ..... 176
8.3	Frequency Situation..... 176
8.4	TV channels in Tokyo ..... 177
8.5	Transmission Antennas ..... 177
8.6	Shipments of ISDB-T receivers in Japan ..... 178
8.7	Technical Characteristics of ISDB-T ..... 179
8.8	Applications on ISDB-T..... 179
8.9	Outline of ISDB-T transmission scheme, and related ARIB standards, ITU-R Rec..... 184
8.10	Emergency warning by broadcasting ..... 184
9	Russian Federation ..... 189
10	Tanzania ..... 192
11	United States of America..... 195
12	Republic of Korea ..... 198
12.1	Digital TV for fixed reception..... 198
12.2	T-DMB for mobile reception..... 199
13	Venezuela ..... 200
	Appendix 2 to Part 2 – Definitions ..... 202

## Chapter 1

### 1.1 DRM

#### 1.1.1 Features of the system design for the markets to be served by the Digital Radio Mondiale (DRM) system

The DRM system, is a flexible digital sound broadcasting (DSB) system for use in the terrestrial broadcasting bands below 30 MHz. (Recommendation ITU-R BS.1514)

It is important to recognize that the consumer radio receiver of the near future will need to be capable of decoding any or all of several terrestrial transmissions; that is, narrow-band digital (for <30 MHz RF), wider band digital (for >30 MHz RF), and analogue for the LF, MF, HF bands and the VHF/FM band. The DRM system will be an important component within the receiver. It is unlikely that a consumer radio receiver designed to receive terrestrial transmissions with a digital capability would exclude the analogue capability.

In the consumer radio receiver, the DRM system will provide the capability to receive digital radio (sound, program related data, other data, and still pictures) in all the broadcasting bands below 30 MHz. It can function in an independent manner, but, as stated above, will more likely be part of a more comprehensive receiver – much like the majority of today's receivers that include AM and FM band analogue reception capability.

The DRM system is designed to be used in either 9 or 10 kHz channels or multiples of these channel bandwidths. Differences in detail on how much of the available bit stream for these channels is used for audio, for error protection and correction, and for data depend on the allocated band (LF, MF, or HF) and on the intended use (for example, ground wave, short distance sky wave or long distance sky wave). In other words, there are modal trade-offs available so that the system can match the diverse needs of broadcasters worldwide. As indicated in the next section, when regulatory procedures are in place to use channels of greater bandwidth than 9/10 kHz, the DRM system's audio quality and total bit stream capability can be greatly improved.

The DRM system employs advanced audio coding (AAC), supplemented by spectral band replication (SBR) as its main digital encoding. SBR improves perceived audio quality by a technique of higher baseband frequency enhancement using information from the lower frequencies as cues. OFDM/QAM is used for the channel coding and modulation, along with time interleaving and forward error correction (FEC) using multi-level coding (MLC) based on a convolutional code. Pilot reference symbols are used to derive channel equalization information at the receiver. The combination of these techniques results in higher quality sound with more robust reception within the intended coverage area when compared with that of currently used AM.

The system performs well under severe propagation conditions, such as those encountered under long distance multipath HF sky-wave propagation, as well as under easier to cope with MF groundwave propagation. In the latter case, maximum use is made of the AAC and SBR source coding algorithms, leading to much higher quality audio than that achieved by AM, since a minimal amount of error correction has to be employed. For many HF propagation conditions, the necessity to achieve a high degree of robustness reduces the audio quality compared to MF digital; nevertheless, the audio quality is still better than current AM quality.

The design permits the use of the DRM system within a single frequency network (SFN).

It also provides the capability for automatic frequency switching, which is of particular value for broadcasters who send the same signals at different transmission frequencies. For example, this is done routinely by large HF broadcasting organizations using AM to increase the probability of at least one good signal in the intended reception area. The DRM system can enable a suitable receiver to select the best frequency for a programme automatically without any effort on the part of the listener.

## 1.1.2 Brief description of the DRM system

### 1.1.2.1 Overall design

FIGURE 1

Block diagram of input to a transmitter

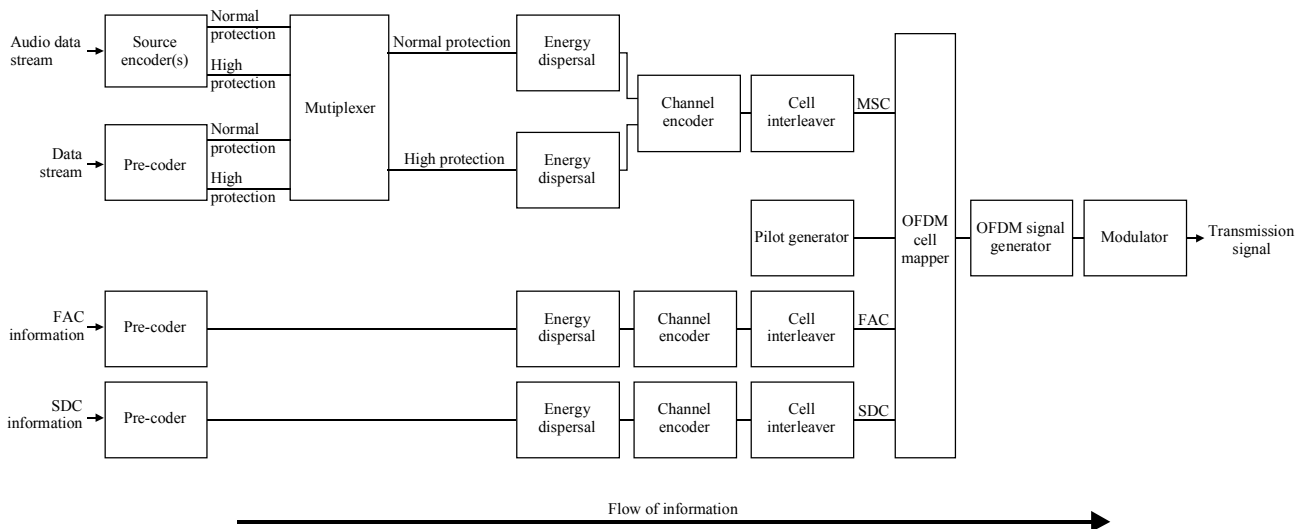

MSC: main service channel

1514-01

Figure 1 describes the general flow of the different classes of information (audio, data, etc.) from encoding on the left of the Figure to a DRM system transmitter exciter on the right. Although a receiver diagram is not included as a figure, it would represent the inverse of this diagram.

On the left are two classes of input information:

- the encoded audio and data that are combined in the main service multiplexer;
- information channels that bypass the multiplexer that are known as fast access channel (FAC) and service description channel (SDC)

The audio source encoder and the data pre-coders ensure the adaptation of the input streams onto an appropriate digital format. Their output may comprise two parts requiring two different levels of protection within the subsequent channel encoder.

The multiplex combines the protection levels of all data and audio services.

The energy dispersal provides a deterministic, selective complementing of bits in order to reduce the possibility that systematic patterns result in unwanted regularity in the transmitted signal.

The channel encoder adds redundant information as a means for error correction and defines the mapping of the digital encoded information into QAM cells. The system has the capability, if a broadcaster desires, to convey two categories of “bits”, with one category more heavily protected than the other.

Cell interleaving spreads consecutive QAM cells onto a sequence of cells, quasi-randomly separated in time and frequency, in order to provide an additional element of robustness in the transmission of the audio in time-frequency dispersive channels.

The pilot generator injects information that permits a receiver to derive channel equalization information, thereby allowing for coherent demodulation of the signal.

The OFDM cell mapper collects the different classes of cells and places them on a time-frequency grid.

The OFDM signal generator transforms each ensemble of cells with the same time index to a time domain representation of the signal, containing a plurality of carriers. The complete time-domain OFDM symbol is

then obtained from this time domain representation by inserting a guard interval—a cyclic repetition of a portion of the signal.

The modulator converts the digital representation of the OFDM signal into the analogue signal that will be transmitted via a transmitter/antenna over the air. This operation involves frequency up-conversion, digital-to-analogue conversion, and filtering so that the emitted signal complies with ITU-R spectral requirements.

With a non-linear high-powered transmitter, the signal is first split into its amplitude and phase components (this can advantageously be done in the digital domain), and then recombined (by the action of the transmitter itself) prior to final emission.

### 1.1.2.2 Audio source coding

FIGURE 2  
Source coding overview

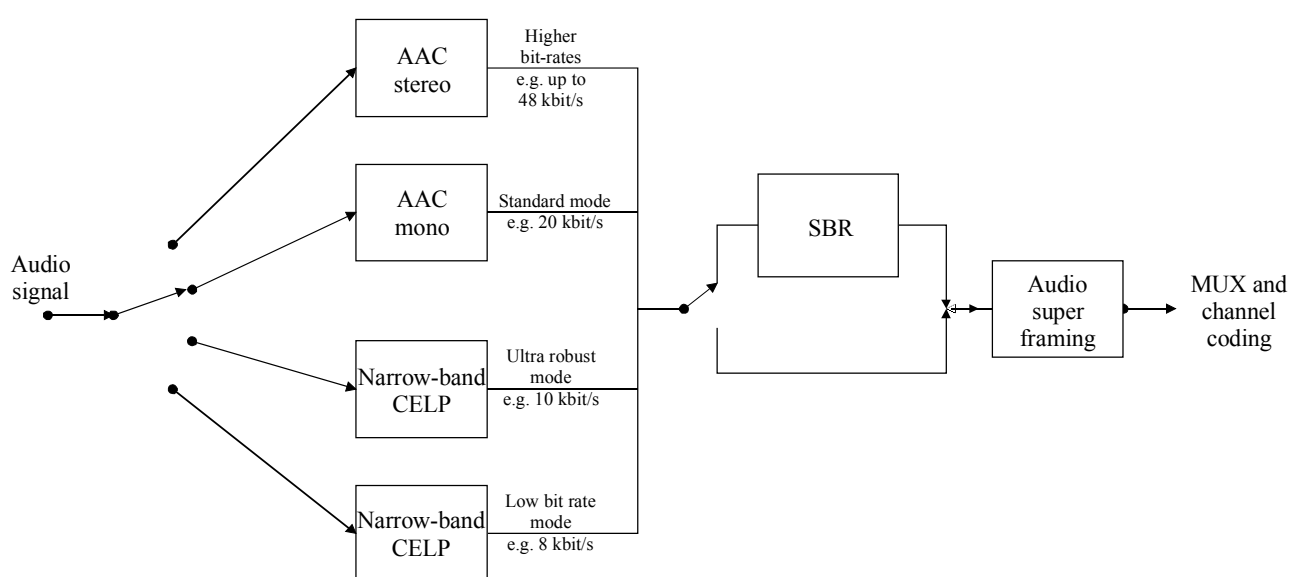

CELP: code excited linear prediction

1514-02

The source coding options available for the DRM system are depicted in Fig. 2. All of these options, with the exception of the one at the top of the figure (AAC stereo), are designed to be used within the current 9/10 kHz channels for sound broadcasting below 30 MHz. The CELP option provides relatively low bit-rate speech encoding and the AAC option employs a subset of standardized MPEG-4 for low bit rates (that is, up to 48 kbit/s). These options can be enhanced by a bandwidth-enhancement tool, such as the SBR depicted in the figure. Representative output bit rates are noted in the figure. All of this is selectable by the broadcaster.

Special care is taken so that the encoded audio can be compressed into audio superframes of constant time length (400 ms). Multiplexing and unequal error protection (UEP) of audio/speech services is effected by means of the multiplex and channel coding components.

As an example of the structure, consider the path in Fig. 2 of AAC mono plus SBR. For this, there are the following properties:

Frame length:	40 ms
AAC sampling rate:	24 kHz
SBR sampling rate:	48 kHz
AAC frequency range:	0-6.0 kHz
SBR frequency range:	6.0-15.2 kHz
SBR average bit rate:	2 kbit/s per channel.

In this case, there is a basic audio signal 6 kHz wide, which provides audio quality better than standard AM, plus the enhancement using the SBR technique that extends this to 15.2 kHz. All of this consumes approximately 22 kbit/s. The bitstream per frame contains a fraction of highly protected AAC and SBR data of fixed size, plus the majority of AAC and SBR data, less protected, of variable size. The fixed-time-length audio superframe of 400 ms is composed of several of these frames.

### 1.1.2.3 Multiplex, including special channels

As noted in Fig. 1, the DRM system total multiplex consists of three channels: the MSC, the FAC and the SDC. The MSC contains the services, audio and data. The FAC provides information on the signal bandwidth and other such parameters and is also used to allow service selection information for fast scanning. The SDC gives information to a receiver on how to decode the MSC, how to find alternate sources of the same data, and gives attributes to the services within the multiplex.

The MSC multiplex may contain up to four services, any one of which can be audio or data. The gross bit rate of the MSC is dependent upon the channel bandwidth and transmission mode being used. In all cases, it is divided into 400 ms frames.

The FAC's structure is also built around a 400 ms frame. The channel parameters are included in every FAC frame. The service parameters are carried in successive FAC frames, one service per frame. The names of the FAC channel parameters are: base/enhancement flag, identity, spectrum occupancy, interleaver depth flag, modulation mode, number of services, reconfiguration index, and reserved for future use. These use a total of 20 bits. The service parameters within the FAC are: service identifier, short identifier, CA (conditional access) indication, language, audio/data flag, and reserved for future use. These use a total of 44 bits. (Details on these parameters, including field size, are given in the system specification.)

The SDC's frame periodicity is 1 200 ms. Without detailing the use for each of the many elements within the SDC's fields, the names of them are: multiplex description, label, conditional access, frequency information, frequency schedule information, application information, announcement support and switching, coverage region identification, time and date information, audio information, FAC copy information, and linkage data. As well as conveying this data, the fact that the SDC is inserted periodically into the waveform is exploited to enable seamless switching between alternate frequencies.

### 1.1.2.4 Channel coding and modulation

The coding/modulation scheme used is a variety of coded orthogonal FDM (COFDM) which combines OFDM with MLC based on convolutional coding. These two main components are supplemented by cell interleaving and the provision of pilot cells for instantaneous channel estimation, which together mitigate the effects of short-term fading, whether selective or flat.

Taken together, this combination provides excellent transmission and signal protection possibilities in the narrow 9/10 kHz channels in the long-wave, medium-wave and short-wave broadcasting frequency bands. And it can also be effectively used at these broadcasting frequencies for wider channel bandwidths in the event that these are permitted from a regulatory standpoint in the future.

For OFDM, the transmitted signal is composed of a succession of symbols, each including a guard interval – a cyclic prefix which provides robustness against delay spread. Orthogonality refers to the fact that, in the case of the design of the DRM system, each symbol contains approximately 200 subcarriers spaced across the 9/10 kHz in such a way that their signals do not interfere with each other (are orthogonal). The precise number of subcarriers, and other parameter considerations, are a function of the mode used: ground wave, sky wave, and highly robust transmissions.

QAM is used for the modulation that is impressed upon each of the various subcarriers to convey the information. Two primary QAM constellations are used: 64-QAM and 16-QAM. A QPSK mode is also incorporated for highly robust signalling (but not for the MSC).

The interleaver time span for HF transmission is in the range of 2.4 s to cope with time- and frequency-selective fading. Owing to less difficult propagation conditions, a shortened interleaver with 0.8 s time span can be applied for LF and MF frequencies.

The multi-level convolutional coding scheme will use code rates in the range between 0.5 and 0.8, with the lower rate being associated with the difficult HF propagation conditions.

### 1.1.3 Transmitter considerations

The DRM system exciter can be used to impress signals on both linear and non-linear transmitters. It is expected that high-powered non-linear transmitters will be the normal way of serving the broadcasters. This is similar to current practice which exists for double-sideband amplitude modulation.

Because of this need, over the past few years, using the DRM system and other prototypes, effort has been spent to determine how these non-linear transmitters can be used with narrow-band digital signals. The results have been encouraging, as can be seen from recent DRM system field tests.

Briefly, the incoming signal to a Class C (non-linear amplification) transmitter needs to be split into its amplitude and phase components prior to final amplification. The former is passed via the anode circuitry, the latter through the grid circuitry. These are then combined with the appropriate time synchronization to form the output of the transmitter.

Measurements of the output spectra show the following: the energy of the digital signal is more or less evenly spread across the 9/10 kHz assigned channel; the shoulders are steep, and drop rapidly to 40 dB or so below the spectral density level within the assigned 9/10 kHz channel, and the power spectral density levels continue to decrease at a lower rate beyond  $\pm 4.5/5.0$  kHz from the central frequency of the assigned channel.

### 1.1.4 Over the air

The digital phase/amplitude information on the RF signal is corrupted to different degrees as the RF signal propagates. Some of the HF channels provide challenging situations of fairly rapid flat fading, multipath interference that produces frequency-selective fading and large path delay spreads in time, and ionospherically induced high levels of Doppler shifts and Doppler spreads.

The error protection and error correction incorporated in the DRM system design mitigates these effects to a great degree. This permits the receiver to accurately decode the transmitted digital information.

### 1.1.5 Selecting, demodulation and decoding of a DRM system signal at a receiver

A receiver must be able to detect which particular DRM system mode is being transmitted, and handle it appropriately. This is done by way of the use of many of the field entries within the FAC and SDC.

Once the appropriate mode is identified (and is repeatedly verified), the demodulation process is the inverse of that shown in the upper half of Fig. 1, the diagram of the transmitter blocks.

Similarly, the receiver is also informed what services are present, and, for example, how source decoding of an audio service should be performed.

### 1.1.6 Ongoing case study in Italy since 2006: DRM daytime MW Tests for frequencies below 1 MHz

The transmission site located near Milan was used to provide for an initial field test on frequency (693 kHz). The DRM signal is being broadcast by a station in Siziano, located 20 kilometres south of Milan. The same site is used to broadcast RAI's regular analogue MW signals.

The analogue transmitter (working on 200 kW at 900 kHz) was combined with the digital transmitter (working on 34 kW at 693 kHz) and radiated by the same antenna structure.

On the basis of acquired data for the DRM transmission we can reach the following conclusions.

The whole north-west part of Italy is completely covered with a signal strength with a level greater than the minimum one indicated in Recommendation ITU-R BS.1698 for the adopted configuration transmission parameters (38,6 dB $\mu$ V/m). Moreover minimum SNR of 14,1 dB was exceeded in each measurement point, also in deep valleys. The extension of coverage area can be identified with national border (Sestriere, Ceresole Reale, Domodossola and Bormio). On the east direction the DRM signal is available up to Trieste on which seacoast the field strength is 48,5 dB $\mu$ V/m with a SNR of 21,7 dB. Due to particular topography and poor ground conductivity the Brennero valley was covered only before the town of Trento. In south-east direction DRM is available up to just before Ancona. In south direction DRM reaches all Liguria coast, and a part of Tuscany coast up to Grosseto town. The cities of Genova, Savona, La Spezia and Livorno are also covered.

The whole coverage results are indicated on Map 1. The inner contour shows the coverage area in which both commercial and professional receivers were able to decode DRM signal. The outer contour shows the coverage area in which only professional receiver was able to decode DRM signal.

MAP 1

## Measured coverage area



— Receiving area professional receiver only

— Receiving area professional & commercial receivers

The service area shown on Map 2 is computed on the basis of  $45 \text{ dB}\mu\text{V/m}$  for towns below 1,000 living persons and of  $53 \text{ dB}\mu\text{V/m}$  for towns with more than 1 000 living persons.

At the moment, about 150 static measurement points were verified.

Some data analysis was done in order to identify locations where reception was not available because of local particular situations:

- in the centre town of Turin, 125 km far from the transmitter, in 1 of 12 measurement points the performance of DRM signal has been damaged by an electric feeder for public transport. At that point was recorded a SNR of 13,4 dB with a signal strength of  $52,1 \text{ dB}\mu\text{V/m}$  and no audio decoding;
- northern from Milan, at the beginning of Valtellina valley (93 km far from the transmitter) some topographical situations and poor ground conductivity cause low signal strength ( $35,7 \text{ dB}\mu\text{V/m}$ ) and SNR (8,5 dB). Travelling along the valley route the signal and SNR come back to increase up to Bormio city, 170 km far from the transmitter.



MAP 2

Predicted coverage area (according to Recommendation ITU-R P.368-7)

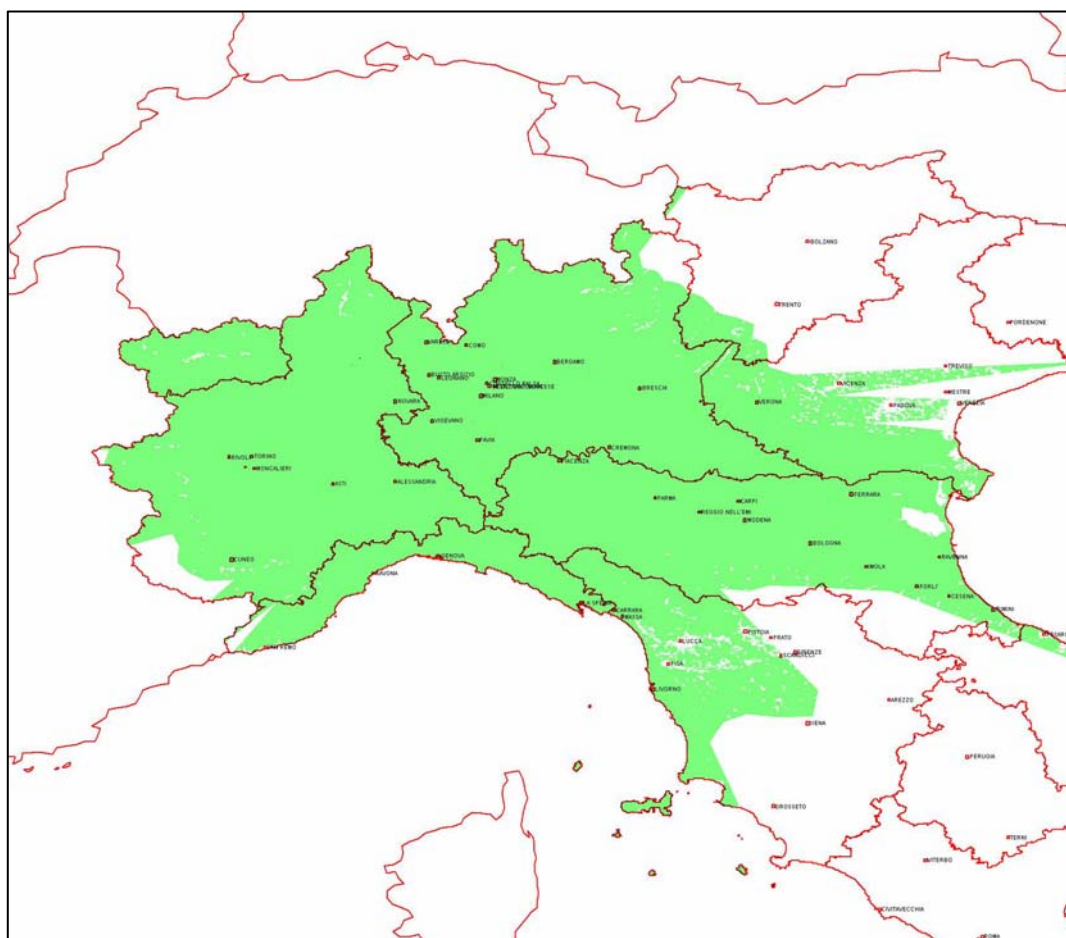

During day time no discernable broadcasting interference situations were recorded in the whole predicted and measured coverage area.

As can be easily noted, measured and predicted area match quite well.

## 1.2 T-DAB general

The multi-carrier T-DAB system as adopted by the majority of countries in Europe and also in some countries outside the European continent, has been designed with a bandwidth of about 1.5 MHz. Frequency blocks have been fit in to the 7 MHz VHF channel scheme. A mean rate of about 1.15 Mbit/s is available for the delivery of high quality CD-like sound services in conjunction with text, data and images, for fixed, portable and mobile receivers.

### 1.2.1 Frequency bands

#### 1.2.1.1 General

The Plan to be established by the second session of Regional Radio Conference (RRC-06) should contain assignments and/or allotments for digital broadcasting stations in the following bands:

- Band III (174 to 230 MHz);
- Bands IV and V (470 to 862 MHz).

The European countries after evaluating the other possible options have finally adopted the T-DAB system for Band III.

### 1.2.1.2 Frequencies for sound channels in the planning area

It is to be noted that whilst the frequency band from 174 to 216 MHz is primarily used for terrestrial analogue television, there are also some T-DAB allotments in this band. The frequency band 216-230 MHz (240 MHz in some countries) is mainly allocated to T-DAB in European countries; nevertheless there is still widespread use of part of this band for television.

Ultimately, a flexible approach will be required as regards the use of T-DAB, or DVB-T, in specific channels in Band III because of the different situations and time-frames all over the planning area, or even within one country. Sharing criteria and clear procedures for both kinds of use are therefore required.

### 1.2.2 T-DAB in Band III

Band III is seen as the optimum solution for a T-DAB band to provide a terrestrial T-DAB service.

The band does not suffer from a number of the anomalous propagation characteristics which are a problem in Band I such as sporadic E and F2 layer propagation. Man-made noise is significantly lower in Band III than in Band I, and Band III frequencies are still sufficiently low that the Doppler shift created by moving vehicles at motorway speeds will not create a problem for operation in Mode 1 of the digital system A specification.

This is made possible by a rugged system design that allows seamless and fade-free reception even in highly disruptive conditions, largely dominated by multipath propagation.

It has to be noted that Band II was also considered for T-DAB, but this turned out not to be viable due to the congested situation in many areas.

### 1.2.3 Location of transmitters

It should be noted that in the case of an SFN the separation distance between transmitters influences the choice of guard interval, which in turn determines the size of the network. The separation distance and the effective height influence the effective radiated power. In the implementation of T-DAB existing transmitting site infrastructures have been used where possible, with the addition of some new supplementary sites. The latter have been adopted in order to fulfil the SFN requirements.

## 1.3 IBOC

### 1.3.1 IBOC Overview

The IBOC system was designed for regions where limited spectrum prevents the allocation of new spectrum for digital broadcasting. The IBOC system allows broadcasters to simultaneously transmit an analogue and digital signal without the need for additional spectrum for the digital signal. The IBOC system takes advantage of unused portions of the spectrum on either side of the analogue carrier (as defined by the service frequency allocation "mask") and implements frequency re-use by including digital carriers in quadrature to the existing analogue carrier. In either case, the analogue signals are in close proximity to the digital signals and great care must be taken to prevent unwanted interference between them.

The IBOC system offers a number of advantages for broadcasters, consumers and regulators. The IBOC system replicates the existing coverage patterns of each radio station thereby retaining the existing economic value of the station. Broadcasters can convert to digital broadcasts with a modest investment and retain the vast majority of their existing physical plant. In addition, the introduction of the digital signal in the existing channel allows the broadcaster to retain the station's existing dial position. Because the system supports simulcast of the analogue and digital signals, consumers are able to upgrade to digital over an extended period and taking into account normal equipment replacement cycles. Regulators benefit because there is no need for spectrum allocations or licensing of new stations.

The IBOC system offers the following features:

- CD quality audio in the VHF-band and VHF quality audio in the MF band.
- Digital coverage equivalent to existing analogue coverage. In areas where the digital signal is lost, the system automatically blends to the analogue back-up signal to ensure digital coverage is never less than existing analogue coverage.

- Advanced coding technologies and time diversity between the analogue and digital signals ensure a robust signal.
- The VHF system has demonstrated significant robustness in the presence of severe multipath, and the MF system has demonstrated significant robustness in the presence of impulse noise.
- The VHF system offers options for introducing new audio and data services ranging from 1 to 300 kbit/s depending on the mode of operation.

The IBOC system has been tested in North and South America, Europe and Asia. It is currently in operation in approximately 1 800 stations throughout the United States of America. This has added more than 900 new multicast audio streams using existing VHF stations. The system has been used for demonstrations, testing and/or ongoing operations in Brazil, China, France, Indonesia, Mexico, the Philippines, Switzerland, Ukraine, Vietnam.

The IBOC system has been standardized by the National Radio Systems Committee (NRSC), a standards setting organization sponsored by the National Association of Broadcasters and the Consumer Electronics Association in the United States. The current version of the standard, NRSC-5-B is available from the NRSC at [www.nrsstandards.org](http://www.nrsstandards.org).

Currently, there are commercially available IBOC receivers in most market segments. OEM receivers are available in the United States as standard equipment or a factory installed option for many major auto manufacturers. More than sixty models of aftermarket automobile receivers, tabletop receivers, home HiFi receivers and car converter products are available from national and local retailers throughout the United States. As the cost of components and the power consumption levels are reduced in the near future, it is anticipated that mobile receivers will become available.

### 1.3.2 The IBOC System Technical Design

The IBOC system is designed to permit a smooth evolution from current analog modulation to a fully digital system. This system can deliver digital audio and data services to mobile, portable, and fixed receivers from terrestrial transmitters in the existing Medium Frequency (MF) and Very High Frequency (VHF) radio bands. The system is designed to allow broadcasters to continue to transmit analog MF and VHF simultaneously with new, higher-quality and more robust digital signals, allowing broadcasters and their listeners to convert from analog to digital radio while maintaining each station's current frequency allocation.

The IBOC system allows a broadcast station to offer multiple services. A service can be thought of as a logical grouping of application data identified by the IBOC system. Services are grouped into one of two categories:

- 1 Core Services:
  - a) Main Program Service (both Audio (MPA) and Data (PAD))
  - b) Station Information Service (SIS)
- 2 Advanced Application Services (AAS)

The flow of service content through the IBOC broadcast system is as follows:

- a) Service content enters the IBOC broadcast system via Service Interfaces;
- b) Content is assembled for transport using a specific protocol;
- c) It is routed over logical channels via the Channel Multiplex.

It is waveform modulated via the Waveform / Transmission System for over-the-air transmission.

The system employs coding to reduce the sampled audio signal bit rate and baseband signal processing to increase the robustness of the signal in the transmission channel. This allows a high quality audio signal plus ancillary data to be transmitted in band segments and at low levels which do not interfere with the existing analog signals.

### 1.3.2 Services

#### 1.3.2.1 Main Program Service (MPS)

The Main Program Service is a direct extension of traditional analog radio. MPS allows the transmission of existing analog radio-programming in both analog and digital formats. This allows for a smooth transition from analog to digital radio.

Radio receivers that are not IBOC enabled can continue to receive the traditional analog radio signal, while IBOC receivers can receive both digital and analog signals via the same frequency band. In addition to digital audio, MPS includes digital data related to the audio programming. This is also referred to as Program Associated Data (PAD).

#### 1.3.2.2 Station Information Service (SIS)

The Station Information Service provides the necessary radio station control and identification information, such as station call sign identification, time and location reference information. SIS can be considered a built-in service that is readily available on all IBOC stations. SIS is a required IBOC service and is provided dedicated bandwidth.

#### 1.3.2.3 Supplemental Program Service (SPS)

The Supplemental Program Service allows broadcasters to introduce up to seven new digital audio channels depending on the throughput devoted to the SPS. The SPS includes support for Program Associated Data for each program stream.

#### 1.3.2.4 Advanced Application Services (AAS):

AAS is a complete framework in which new applications may be built. In addition to allowing multiple data applications to share the Waveform / Transmission medium, AAS provides a common transport mechanism as well as a unified Application Programming Interface (API). On the transmission side, broadcasters utilize the common AAS interface to insert service(s) into their signal; receiver manufacturers utilize the AAS 'toolkit' to efficiently access these new services for the end-user. AAS includes separate audio programming such as reading services and other secondary audio and data services.

### 1.3.3 System components

#### 1.3.3.1 Codec

The IBOC DSB system uses the HDC codec supplemented by SBR. This delivers high quality "FM-like" stereo audio within the bandwidth constraints imposed on operations below 30 MHz. To further enhance the robustness of the digital audio beyond that provided by FEC and interleaving, special error concealment techniques are employed by the audio codecs to mask the effects of errors in the input bit-stream. Furthermore, the audio codec bit-stream format provides the flexibility of allowing future enhancements to the basic audio coding techniques.

#### 1.3.3.2 Modulation techniques

The IBOC DSB system uses QAM. QAM has a bandwidth efficiency that is sufficient for transmission of "FM-like" stereo audio quality as well as providing adequate coverage areas in the available bandwidth.

The system also uses a multi-carrier approach called OFDM. OFDM is a scheme in which many QAM carriers can be frequency-division multiplexed in an orthogonal fashion such that there is no interference among the carriers. When combined with FEC coding and interleaving, the digital signal's robustness is further enhanced. The OFDM structure naturally supports FEC coding techniques that maximize performance in the non-uniform interference environment.

#### 1.3.3.3 FEC coding and interleaving

FEC coding and interleaving in the transmission system greatly improve the reliability of the transmitted information by carefully adding redundant information that is used by the receiver to correct errors occurring in the transmission path. Advanced FEC coding techniques have been specifically designed based on detailed interference studies to exploit the non-uniform nature of the interference in these bands. Also, special

interleaving techniques have been designed to spread burst errors over time and frequency to assist the FEC decoder in its decision-making process.

A major problem confronting systems operating below 30 MHz is the existence of grounded conductive structures that can cause rapid changes in amplitude and phase that are not uniformly distributed across the band. To correct for this, the IBOC DSB system uses equalization techniques to ensure that the phase and amplitude of the OFDM digital carriers are sufficiently maintained to ensure proper recovery of the digital information. The combination of advanced FEC coding, channel equalization, and optimal interleaving techniques allows the IBOC DSB system to deliver reliable reception of digital audio in a mobile environment.

#### **1.3.3.4 Blend**

The IBOC DSB system employs time diversity between two independent transmissions of the same audio source to provide robust reception during outages typical of a mobile environment. In the hybrid system the analogue signal serves as the backup signal, while in the all-digital system a separate digital audio stream serves as the backup signal. The IBOC DSB system provides this capability by delaying the backup transmission by a fixed time offset of several seconds relative to the main audio transmission. This delay proves useful for the implementation of a blend function. During tuning, blend allows transition from the instantly acquired back-up signal to the main signal after it has been acquired. Once acquired, blend allows transition to the back-up signal when the main signal is corrupted. When a signal outage occurs, the receiver blends seamlessly to the backup audio that, by virtue of its time diversity with the main signal, does not experience the same outage.

Digital systems depend on an interleaver to spread errors across time and reduce outages. Generally longer interleavers provide greater robustness at the expense of acquisition time. The blend feature provides a means of quickly acquiring the back-up signal upon tuning or re-acquisition without compromising full performance.

### **1.3.4 Operating modes**

#### **1.3.4.1 Hybrid MF mode**

In the hybrid waveform, the digital signal is transmitted in sidebands on either side of the analogue host signal as well as beneath the analogue host signal as shown in Fig. 3. The power level of each OFDM subcarrier is fixed relative to the main carrier as indicated in Fig. 3. The OFDM carriers, or digital carriers, extend approximately  $\pm 14.7$  kHz from the AM carrier. The digital carriers directly beneath the analogue signal spectrum are modulated in a manner to avoid interference with the analogue signal. These carriers are grouped in pairs, with a pair consisting of two carriers that are equidistant in frequency from the AM carrier. Each pair is termed a complementary pair and the entire group of carriers is called the complementary carriers. For each pair, the modulation applied to one carrier is the negative conjugate of the modulation applied to the other carrier. This places the sum of the carriers in quadrature to the AM carrier, thereby minimizing the interference to the analogue signal when detected by an envelope detector. Placing the complementary carriers in quadrature to the analogue signal also permits demodulation of the complementary carriers in the presence of the high level AM carrier and analogue signal. The price paid for placing the complementary carriers in quadrature with the AM carriers is that the information content on the complementary carriers is only half of that for independent digital carriers.

The hybrid mode is designed for stations operating at MF in areas where it is necessary to provide for a rational transition from analogue to digital. The hybrid mode makes it possible to introduce the digital services without causing harmful interference to the existing host analogue signal.

To maximize the reception of the digital audio, the IBOC DSB system uses a layered codec where the compressed audio is split into two separate information streams: core and enhanced. The core stream provides the basic audio information whereas the enhanced stream provides higher quality and stereo information. The FEC coding and placement of the audio streams on the OFDM carriers is designed to provide a very robust core stream and a less robust enhancement stream. For the hybrid system the core information is placed on high-powered carriers  $\pm 10$  to 15 kHz from the analogue carrier while the enhanced information is placed on the OFDM carriers from 0 to  $\pm 10$  kHz.

FIGURE 3  
Hybrid MF IBOC DSB power spectral density

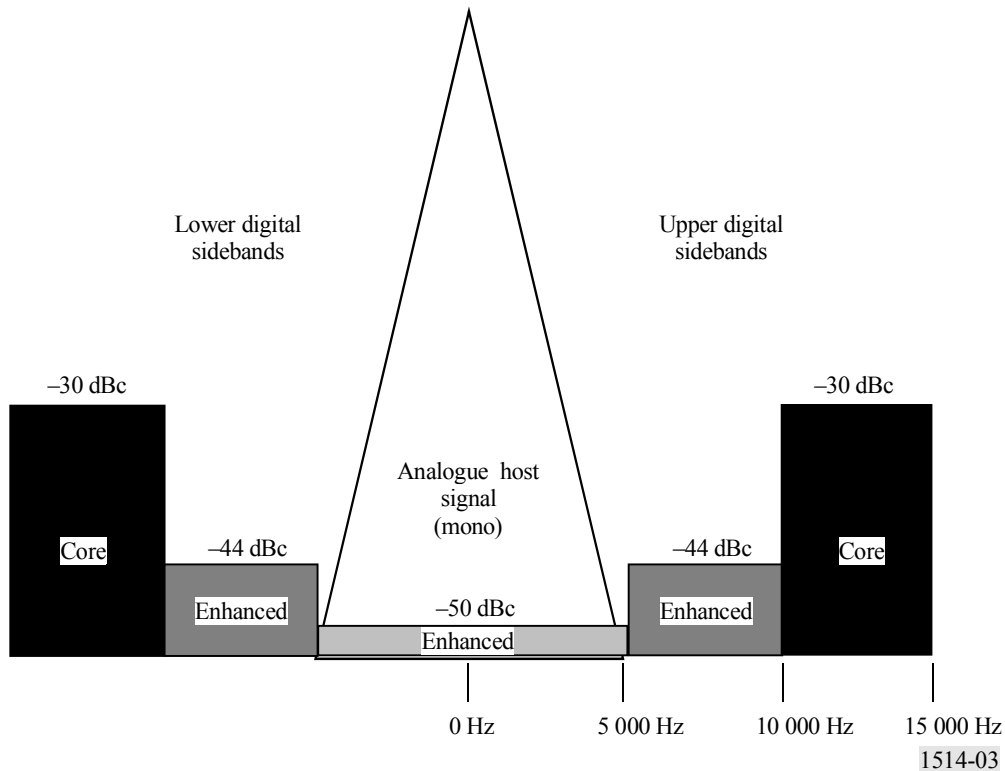

To protect the core audio stream from interference and channel impairments the IBOC DSB system uses a form of channel coding with the special ability to puncture the original code in various overlapping partitions (i.e., main, backup, lower sideband and upper sideband). Each of the four overlapping partitions survives independently as a good code. The lower and upper sideband partitions allow the IBOC DSB system to operate even in the presence of a strong interferer on either the lower or upper adjacent, while the main and backup partitions allow the IBOC DSB system to be acquired quickly and be robust to short-term outages such as those caused by grounded conductive structures.

In the hybrid system the core audio throughput is approximately 20 kbit/s while the enhanced audio throughput adds approximately 16 kbit/s.

#### 1.3.4.2 All-digital MF mode

The all-digital mode allows for enhanced digital performance after deletion of the existing analogue signal. Broadcasters may choose to implement the all-digital mode in areas where there are no existing analogue stations that need to be protected or after a sufficient period of operations in the hybrid mode for significant penetration of digital receivers in the market place.

As shown in Fig. 4, the principal difference between the hybrid mode and the all-digital mode is deletion of the analogue signal and the increase in power of the carriers that were previously under the analogue signal. The additional power in the all-digital waveform increases robustness, and the “stepped” waveform is optimized for performance under strong adjacent channel interference.

The same layered codec and FEC methods, with identical rates (i.e. ~20 kbit/s for the core audio and ~16 kbit/s for the enhanced audio), are used in the all-digital system as is used in the hybrid system. This simplifies the design of a receiver having to support both systems.

FIGURE 4  
All-digital MF IBOC DSB power spectral density

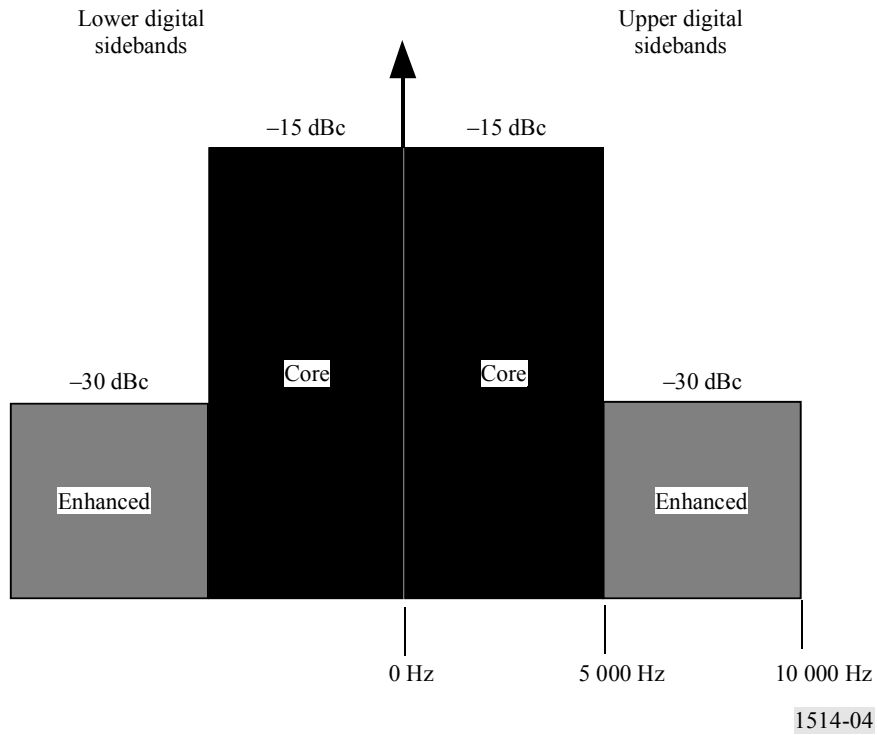

1.3.4.3 Hybrid VHF mode

The digital signal is transmitted in sidebands on either side of the analogue FM signal. Each sideband is comprised of ten frequency partitions, which are allocated among subcarriers 356 through 545, or  $-356$  through  $-545$ . Subcarriers 546 and  $-546$ , also included in the sidebands, are additional reference subcarriers. The amplitude of the subcarrier within the sidebands is uniformly scaled by an *amplitude scale factor*.

FIGURE 5  
Spectrum of the hybrid waveform–service mode  
(The level of the digital subcarriers is such that the total power of these carriers is 20 dB below the nominal power of the FM analogue carrier)

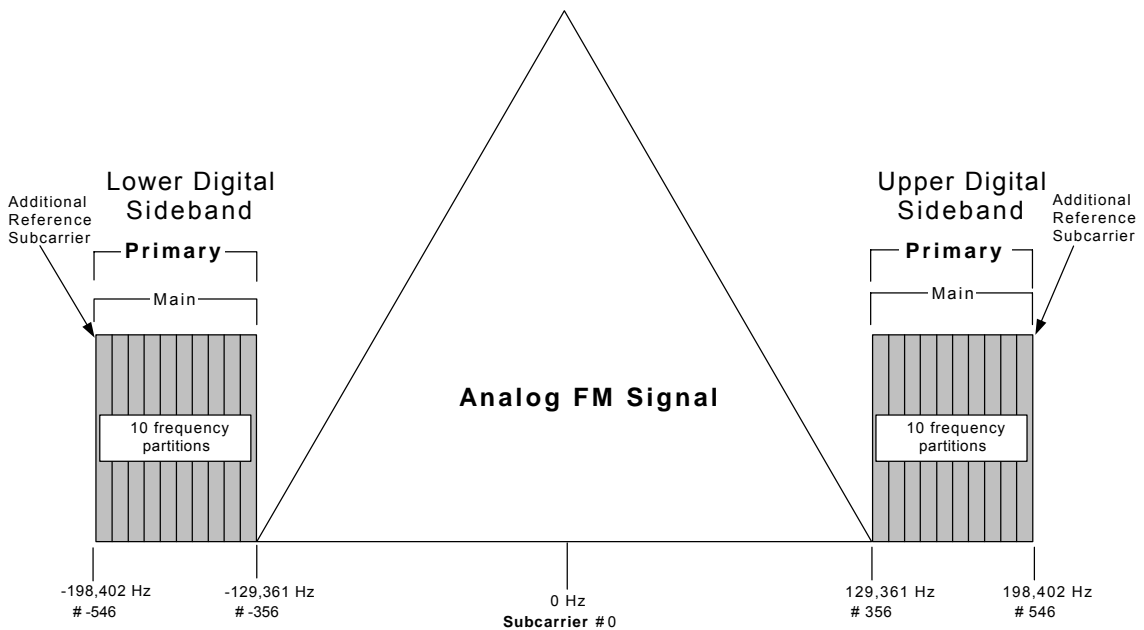

### 1.3.4.4 All Digital VHF mode

The All Digital waveform is constructed by removing the analogue signal, fully expanding the bandwidth of the primary digital sidebands, and adding lower-power secondary sidebands in the spectrum vacated by the analogue signal. The spectrum of the All Digital waveform is shown in Fig. 6.

FIGURE 6

#### Spectrum of the all digital waveform

(The level of the digital subcarriers is such that the total power of these carriers is no more than 10 dB below the nominal power of the FM analogue carrier that it replaces)

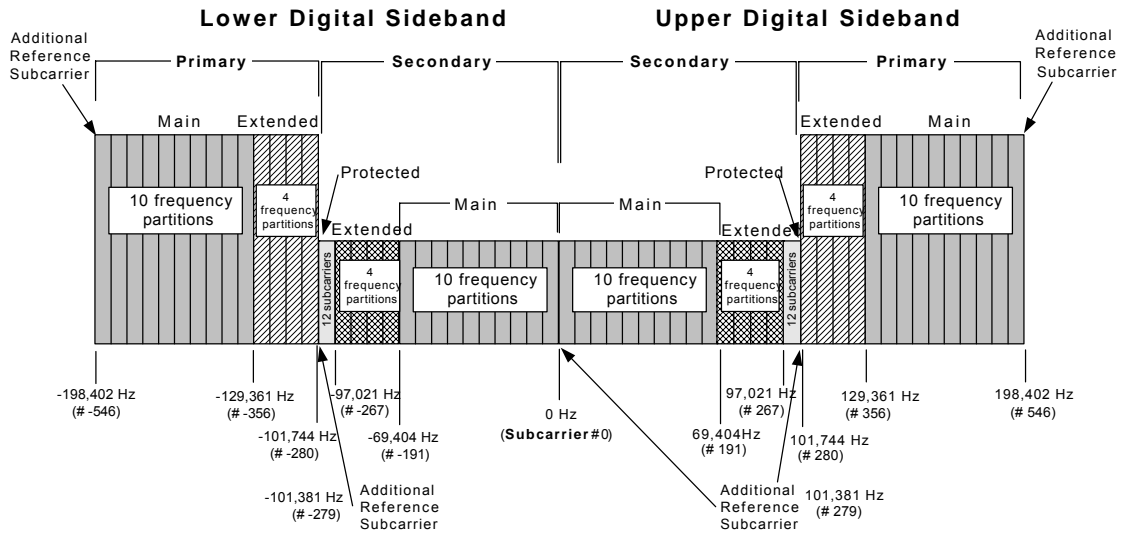

## 1.3.5 Generation of the signal

### 1.3.5.1 Transmission Subsystems

A basic block diagram representation of the system is shown in Fig. 7. It represents the IBOC digital radio system as three major subsystems.

- Audio source coding and compression
- Transport and Service Multiplex
- RF/Transmission.

#### 1.3.5.1.1 Audio Source Coding and Compression

The Audio subsystem performs the source coding and compression of the sampled digitized Main Program Service (MPS) audio program material. “Source coding and compression” refers to the bit rate reduction methods, also known as data compression, appropriate for application to the audio digital data stream. In hybrid modes the MPS audio is also analog modulated directly onto the carrier for reception by conventional analog receivers. Several categories of data may also be transmitted on the digital signal including station identification, messages related to the audio program material, and general data services.



FIGURE 7  
IBOC digital radio broadcasting model

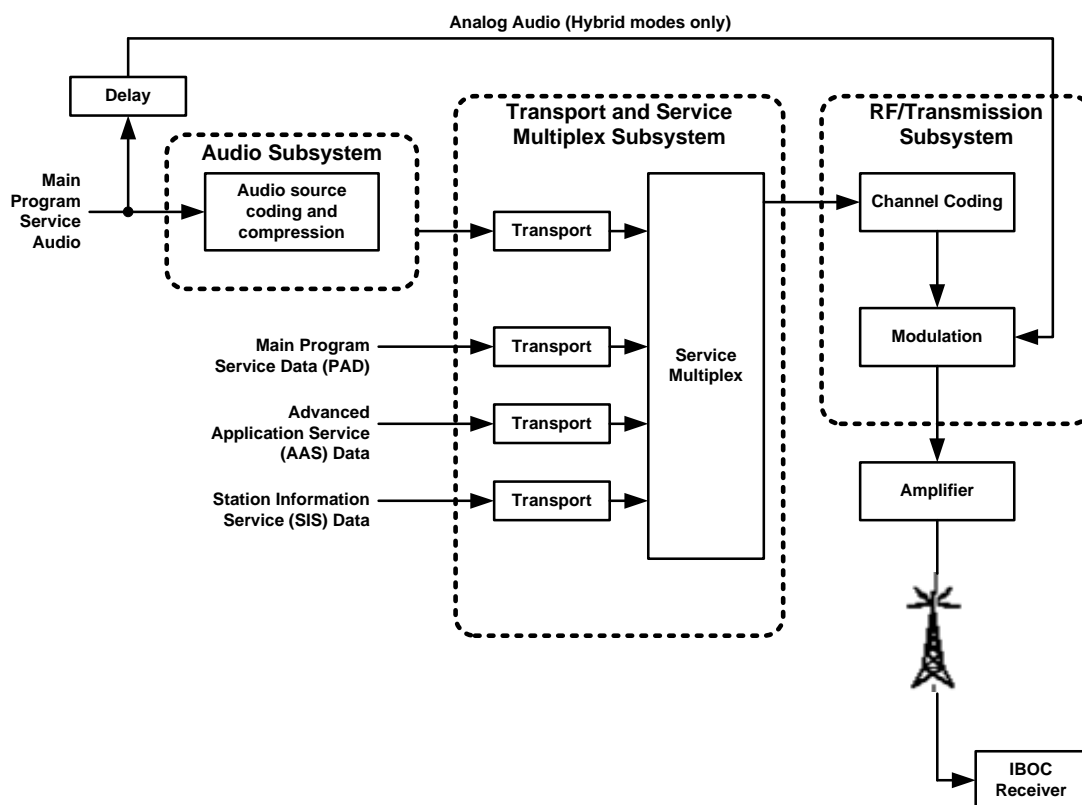

### 1.3.5.1.2 Transport and Service Multiplex

“Transport and service multiplex” refers to the means of dividing the digital data stream into “packets” of information, the means of uniquely identifying each packet or packet type (data or audio), and the appropriate methods of multiplexing audio data stream packets and data stream packets into a single information stream. The transport protocols have been developed specifically to support data and audio transmission in the MF and VHF radio bands.

### 1.3.5.1.3 RF/Transmission System

“RF/Transmission” refers to channel coding and modulation. The channel coder takes the multiplexed bit stream and applies coding and interleaving that can be used by the receiver to reconstruct the data from the received signal which, because of transmission impairments, may not accurately represent the transmitted signal. The processed bit stream is modulated onto the OFDM subcarriers which are transformed to time domain pulses, concatenated, and up-converted to the VHF band.

FIGURE 8  
RF/Transmission function in context of overall system

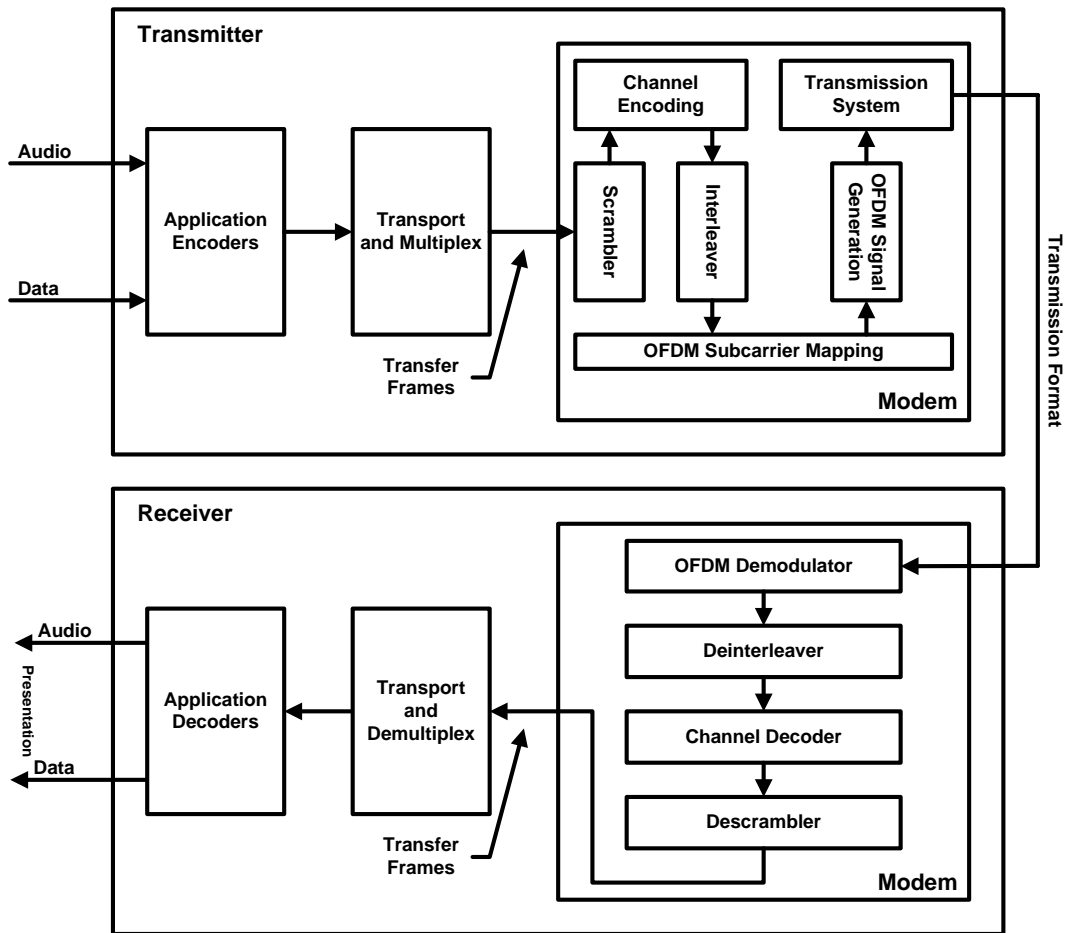

### 1.3.6 Reception of the signal

A functional block diagram of an MF IBOC receiver is presented in Fig. 9. The signal is received by a conventional RF front end and converted to IF, in a manner similar to existing analogue receivers. Unlike typical analogue receivers, however, the signal is filtered, A/D converted at IF, and digitally down converted to baseband in-phase and quadrature signal components. The hybrid signal is then split into analogue and DSB components. The analogue component is then demodulated to produce a digitally sampled audio signal. The DSB signal is synchronized and demodulated into symbols. These symbols are deframed for subsequent deinterleaving and FEC decoding. The resulting bit stream is processed by the audio decoder to produce the digital stereo DSB output. This DSB audio signal is delayed by the same amount of time as the analogue signal was delayed at the transmitter. The audio blend function blends the digital signal to the analogue signal if the digital signal is corrupted and is also used to quickly acquire the signal during tuning or reacquisition.

Noise blanking is an integral part of the IBOC receiver and is used to improve digital and analogue reception. Receivers use tuned circuits to filter out adjacent channels and intermodulation products. These tuned circuits tend to “ring”, or stretch out short pulses into longer interruptions. A noise blanker senses the impulse and turns off the RF stages for the short duration of the pulse, effectively limiting the effects on the analogue “listenability,” of ringing. Short pulses have a minimal effect on the digital data stream and increases “listenability of the analogue signal” (see Note 1).

NOTE 1 – The data paths and the noise blanker circuit are not shown for simplicity.

FIGURE 9  
Hybrid MF IBOC typical receiver block diagram

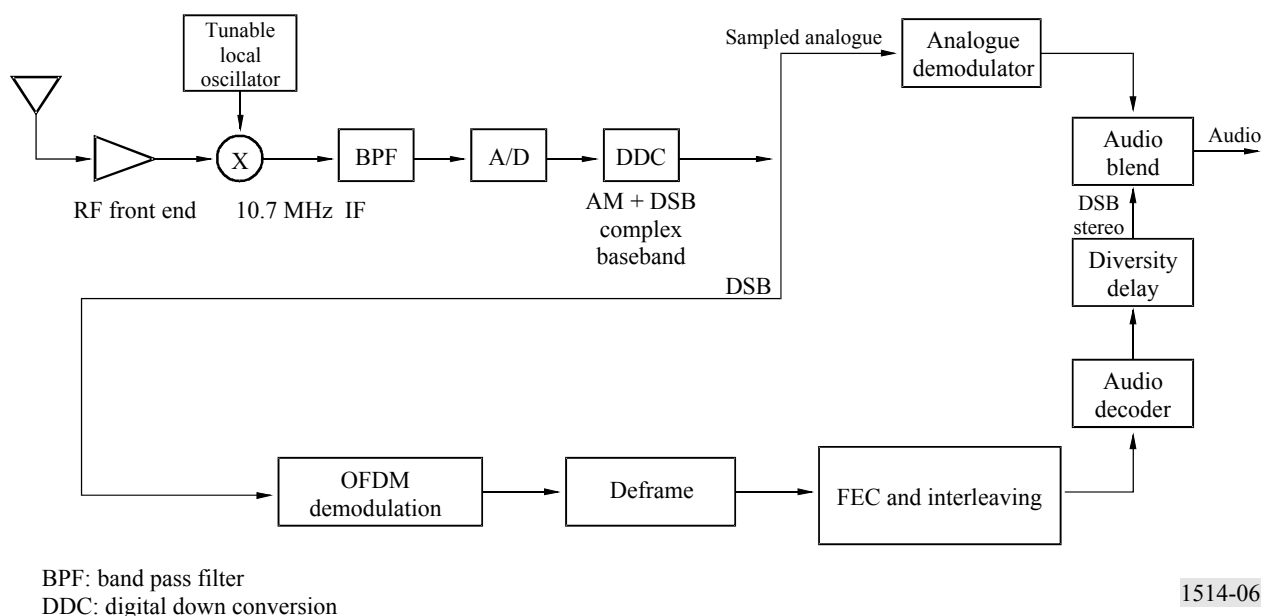

## 1.4 ISDB-T<sub>SB</sub>

### 1.4.1 Features of ISDB-T<sub>SB</sub>

#### 1.4.1.1 Ruggedness of ISDB-T<sub>SB</sub>

The ISDB-T<sub>SB</sub> system uses OFDM modulation, two-dimensional frequency-time interleaving and concatenated error correction codes. OFDM is a multi-carrier modulation method, and it is a multipath-proof modulation method, especially adding a guard interval in the time domain. The transmitted information is spread in both the frequency and time domains by interleaving, and then the information is corrected by the Viterbi and Reed-Solomon (RS) decoder. Therefore a high quality signal is obtained in the receiver, even when working in conditions of severe multipath propagation, whether stationary or mobile.

#### 1.4.1.2 Wide variety of transmission

The ISDB-T<sub>SB</sub> system adopts BST-OFDM, and consists of one or three OFDM-segments. That is single-segment transmission and triple-segment transmission. A bandwidth of OFDM-segment is defined in one of three ways depending on the reference channel raster of 6, 7 or 8 MHz. The bandwidth is a fourteenth of the reference channel bandwidth (6, 7 or 8 MHz), that is, 429 kHz (6/14 MHz), 500 kHz (7/14 MHz), 571 kHz (8/14 MHz). The bandwidth of OFDM-segment should be selected in compliance with the frequency situation in each country.

The bandwidth of single-segment is around 500 kHz, therefore the bandwidth of single-segment transmission and triple-segment transmission is approximately 500 kHz and 1.5 MHz.

The ISDB-T<sub>SB</sub> system has three alternative transmission modes which allow the use of a wide range of transmitting frequencies, and four alternative guard interval lengths for the design of the distance between SFN transmitters. These transmission modes have been designed to cope with Doppler spread and delay spread, for mobile reception in presence of multipath echoes.

### 1.4.1.3 Flexibility

A multiplex structure of the ISDB-T<sub>SB</sub> system is fully compliant with MPEG-2 systems architecture. Therefore various digital contents such as sound, text, still picture and data can be transmitted simultaneously.

In addition, according to the broadcaster's purpose, they can select the carrier modulation method, error correction coding rate, length of time interleaving, etc. of the system. There are four kinds of carrier modulation method of DQPSK, QPSK, 16-QAM and 64-QAM, five kinds of coding rate of 1/2, 2/3, 3/4, 5/6 and 7/8, and five kinds of time interleaving length from 0 to approximately 1 s. The TMCC carrier transmits the information to the receiver indicating the kind of modulation method and coding rate that are used in the system.

### 1.4.1.4 Flexibility Commonality and interoperability

The ISDB-T<sub>SB</sub> system uses BST-OFDM modulation and adopts MPEG-2 systems. Therefore the system has commonality with the ISDB-T system for digital terrestrial television broadcasting (DTTB) in the physical layer, and has commonality with the systems such as ISDB-T, ISDB-S, DVB-T and DVB-S which adopt MPEG-2 Systems in the transport layer.

### 1.4.1.5 Efficient transmission and source coding

The ISDB-T<sub>SB</sub> system uses a highly-spectrum efficient modulation method of OFDM. Also, it permits frequency reuse broadcasting networks to be extended using additional transmitters all operating on the same radiated frequency.

In addition, the channels of independent broadcasters can be transmitted together without guardbands from the same transmitter as long as the frequency and bit synchronization are kept the same between the channels.

The ISDB-T<sub>SB</sub> system can adopt MPEG-2 AAC. Near CD quality can be realized at a bit rate of 144 kbit/s for stereo.

### 1.4.1.6 Independency of broadcasters

The ISDB-T<sub>SB</sub> system is a narrow-band system for transmission of one sound programme at least. Therefore broadcasters can have their own RF channel in which they can select transmission parameters independently.

### 1.4.1.7 Low-power consumption

Almost all devices can be made small and light weight by developing LSI chips. The most important aspect of efforts to reduce battery size is that the power consumption of a device must be low. The slower the system clock, the lower the power consumption. Therefore, a narrow-band, low bit rate system like single-segment transmission can allow for the receiver to be both portable and lightweight.

### 1.4.1.8 Hierarchical transmission and partial reception

In the triple-segment transmission, both one layer transmission and hierarchical transmission can be achieved. There are two layers of A and B in the hierarchical transmission. The transmission parameters of carrier modulation scheme, coding rates of the inner code and a length of the time interleaving can be changed in the different layers.

The centre segment of hierarchical transmission is able to be received by single-segment receiver. Owing to the common structure of an OFDM segment, a single-segment receiver can partially receive a centre segment of full-band ISDB-T signal whenever an independent program is transmitted in the centre segment.

Figure 10 shows an example of hierarchical transmission and partial reception.

FIGURE 10

Example diagram of hierarchical transmission and partial reception

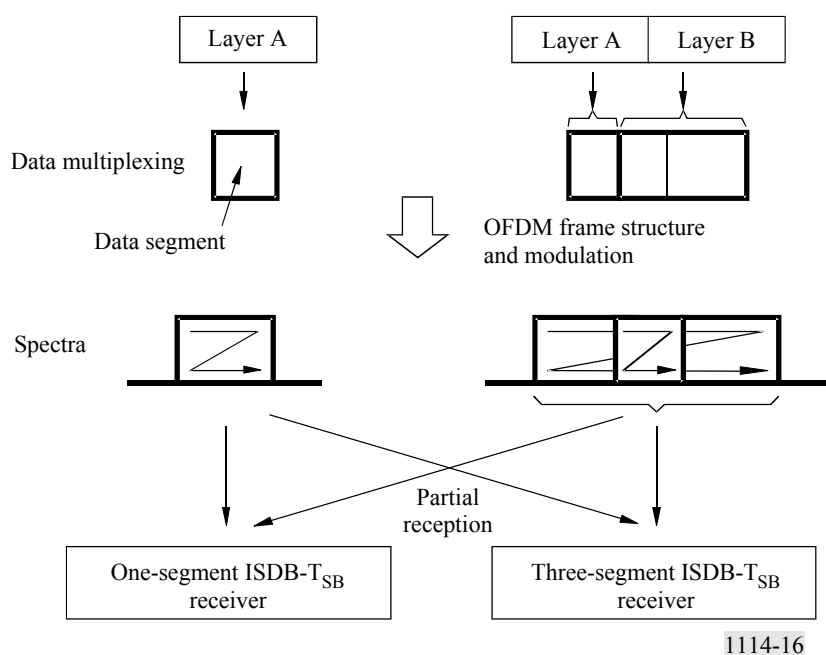

### 1.4.2 Transmission parameters

The ISDB-T<sub>SB</sub> system can be assigned to 6 MHz, 7 MHz or 8 MHz channel raster. Segment bandwidth is defined to be a fourteenth of channel bandwidth, therefore that is 429 kHz (6/14 MHz), 500 kHz (7/14 MHz) or 571 kHz (8/14 MHz). However, the segment bandwidth should be selected in compliance with the frequency situation in each country.

The transmission parameters for the ISDB-T<sub>SB</sub> system are shown in Table 1.

TABLE 1

Transmission parameters for the ISDB-T<sub>SB</sub>

Mode		Mode 1	Mode 2	Mode 3
Total number of segments <sup>(1)</sup> ( $N_s = n_d + n_c$ )		1, 3		
Reference channel raster ( $BWf$ ) (MHz)		6, 7, 8		
Segment bandwidth ( $BWs$ ) (kHz)		$BWf \times 1\ 000/14$		
Used bandwidth ( $BWu$ ) (kHz)		$BWs \times N_s + C_s$		
Number of segments for differential modulation		$n_d$		
Number of segments for coherent modulation		$n_c$		
Carrier spacing ( $C_s$ ) (kHz)		$BWs/108$	$BWs/216$	$BWs/432$
Number of carriers	Total	$108 \times N_s + 1$	$216 \times N_s + 1$	$432 \times N_s + 1$
	Data	$96 \times N_s$	$192 \times N_s$	$384 \times N_s$
	SP <sup>(2)</sup>	$9 \times n_c$	$18 \times n_c$	$36 \times n_c$
	CP <sup>(2)</sup>	$n_d + 1$	$n_d + 1$	$n_d + 1$
	TMCC <sup>(3)</sup>	$n_c + 5 \times n_d$	$2 \times n_c + 10 \times n_d$	$4 \times n_c + 20 \times n_d$
	AC1 <sup>(4)</sup>	$2 \times N_s$	$4 + N_s$	$8 \times N_s$
	AC2 <sup>(4)</sup>	$4 \times n_d$	$9 \times n_d$	$19 \times n_d$

TABLE 1 (*end*)

Mode	Mode 1	Mode 2	Mode 3	Mode
Carrier modulation	DQPSK, QPSK, 16-QAM, 64-QAM			
Number of symbol per frame	204			
Useful symbol duration ( $T_u$ ) ( $\mu$ s)	1 000/ $C_s$			
Guard interval duration ( $T_g$ )	1/4, 1/8, 1/16 or 1/32 of $T_u$			
Total symbol duration ( $T_s$ )	$T_u + T_g$			
Frame duration ( $T_f$ )	$T_s \times 204$			
FFT samples ( $F_s$ )	256 ( $N_s = 1$ ) 512 ( $N_s = 3$ )	512 ( $N_s = 1$ ) 1024 ( $N_s = 3$ )	1024 ( $N_s = 1$ ) 2048 ( $N_s = 3$ )	
FFT sample clock ( $F_{sc}$ ) (MHz)	$F_{sc} = F_s/T_u$			
Inner code	Convolutional code (Coding rate = 1/2, 2/3, 3/4, 5/6, 7/8) (Mother code = 1/2)			
Outer code	(204,188) RS code			
Time interleave parameter ( $I$ )	0, 4, 8, 16, 32	0, 2, 4, 8, 16	0, 1, 2, 4, 8	
Length of time interleaving	$I \times 95 \times T_s$			

FFT: fast Fourier transform.

- (1) The ISDB-T<sub>SB</sub> system uses 1 or 3 segments for sound services, while any number of segments may be used for other services such as television services. (Compare with System C of Recommendation ITU-R BT.1306.)
- (2) SP (scattered pilot), and CP (continual pilot) can be used for frequency synchronization and channel estimation. The number of CP includes CPs on all segments and a CP for higher edge of whole bandwidth.
- (3) TMCC carries information on transmission parameters.
- (4) AC (auxiliary channel) carries ancillary information for network operation.

### 1.4.3 Source coding

The multiplex structure of the ISDB-T<sub>SB</sub> system is fully compliant with MPEG-2 systems architecture, therefore MPEG-2 transport stream packets (TSPs) containing compressed digital audio signal can be transmitted. Digital audio compression methods such as MPEG-2 Layer II audio specified in ISO/IEC 13818-3, AC-3 (Digital Audio Compression Standard specified in ATSC Document A/52) and MPEG-2 AAC specified in ISO/IEC 13818-7 can be applied to the ISDB-T<sub>SB</sub> system.

### 1.4.4 Multiplexing

The multiplex of the ISDB-T<sub>SB</sub> system is compatible with MPEG-2 TS ISO/IEC 13818-1. In addition, multiplex frame and TMCC descriptors are defined for hierarchical transmission with single TS.

Considering maximum interoperation among a number of digital broadcasting systems, e.g. ISDB-S recommended in Recommendation ITU-R BO.1408, ISDB-T recommended in Recommendation ITU-R BT.1306 (System C) and broadcasting-satellite service (sound) system using the 2.6 GHz band recommended in Recommendation ITU-R BO.1130 (System E), these systems can exchange broadcasting data streams with other broadcasting systems through this interface.

#### 1.4.4.1 Multiplex frame

To achieve hierarchical transmission using the BST-OFDM scheme, the ISDB-T<sub>SB</sub> system defines a multiplex frame of TS within the scope of MPEG-2 systems. In the multiplex frame, the TS is a continual stream of 204-byte RS-TSP composed of 188-byte TSP and 16 bytes of null data or RS parity.

The duration of the multiplex frame is adjusted to that of the OFDM frame by counting RS-TSPs using a clock that is two times faster than the inverse FFT (IFFT) sampling clock in the case of single-segment transmission. In the case of the triple-segment transmission the duration of the multiple frame is adjusted to that of the OFDM frame by counting RS-TSPs using a clock that is four times faster than the IFFT sampling clock.

### 1.4.5 Channel coding

This section describes the channel coding block, which receives the packets arranged in the multiplex frame and passes the channel-coded blocks forward to the OFDM modulation block.

#### 1.4.5.1 Functional block diagram of channel coding

Figure 11 shows the functional block diagram of channel coding of the ISDB-T<sub>SB</sub> system.

The duration of the multiplex frame coincides with the OFDM frame by counting the bytes in the multiplex frame using a faster clock than IFFT-sampling rate described in the previous section.

At the interface between the multiplex block and the outer coding block, the head byte of the multiplex frame (corresponding to the sync-byte of TSP) is regarded as the head byte of the OFDM frame. In bit-wise description, the most significant bit of the head byte is regarded as the synchronization bit of OFDM frame.

For the triple-segment layered transmission, the RS-TSP stream is divided into two layers in accordance with the transmission-control information. In each layer, coding rate of the inner error correction code, carrier-modulation scheme, and time-interleaving length can be specified independently.

FIGURE 11

Channel coding diagram

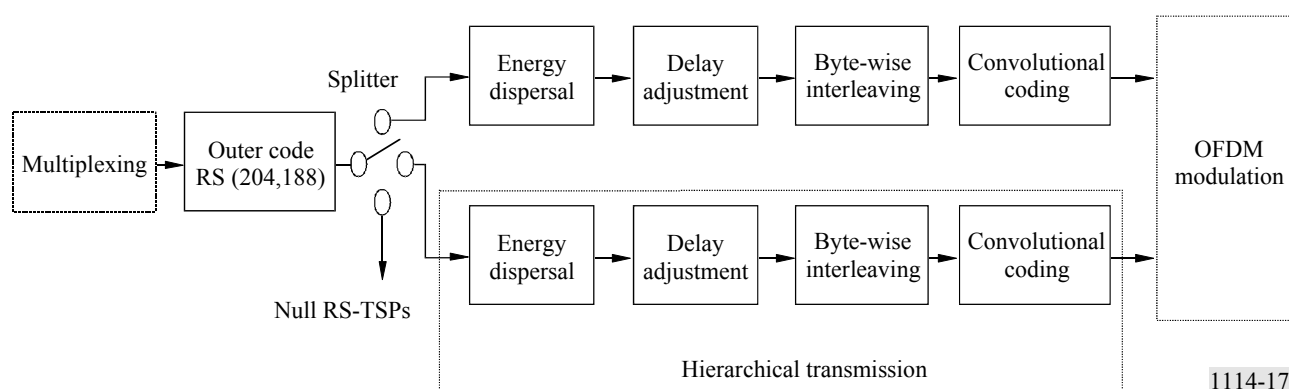

#### 1.4.5.2 Outer coding

RS (204,188) shortened code is applied to each MPEG-2 TSP to generate an error protected TSP that is RS-TSP. The RS (208,188) code can correct up to eight random erroneous bytes in a received 204-byte word.

$$\text{Field generator polynomial: } p(x) = x^8 + x^4 + x^3 + x^2 + 1$$

$$\text{Code generator polynomial: } g(x) = (x - \lambda^0)(x - \lambda^1)(x - \lambda^2)(x - \lambda^3) \cdots (x - \lambda^{15})$$

where  $\lambda = 02_h$ .

It should be noted that null TSPs from the multiplexer are also coded to RS (204,188) packets.

MPEG-2 TSP and RS-TSP (RS error protected TSP) are shown in Fig. 12. RS error protected TSP is also called transmission TSP.

FIGURE 12  
MPEG-2 TSP and RS-TSP (transmission TSP)



a) MPEG-2 TSP

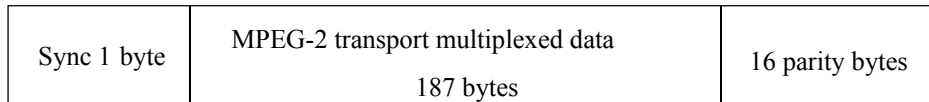

b) RS-TSP (transmission TSP), RS (204,188) error protected TSP

1114-18

### 1.4.5.3 Energy dispersal

In order to ensure adequate binary transitions, the data from the splitter is randomized with pseudo-random binary sequence (PRBS).

The polynomial for the PRBS generator shall be:

$$g(x) = x^{15} + x^{14} + 1$$

### 1.4.6 Delay adjustment

In the byte-wise interleaving, the delay caused in the interleaving process differs from stream to stream of different layer depending on its properties (i.e. modulation and channel coding). In order to compensate for the delay difference including de-interleaving in the receiver, the delay adjustment is carried out prior to the byte-wise interleaving on the transmission side.

#### 1.4.6.1 Byte-wise interleaving (inter-code interleaving)

Convolutional byte-wise interleaving with length of  $I = 12$  is applied to the 204-byte error protected and randomized packets. The interleaving may be composed of  $I = 12$  branches, cyclically connected to the input byte-stream by the input switch. Each branch  $j$  shall be a first-in first-out (FIFO) shift register, with length of  $j \times 17$  bytes. The cells of the FIFO shall contain 1 byte, and the input and output switches shall be synchronized.

The de-interleaving is similar, in principle, to the interleaving, but the branch indices are reversed. Total delay caused by interleaving and de-interleaving is  $17 \times 11 \times 12$  bytes (corresponding to 11 TSPs).

#### 1.4.6.2 Inner coding (convolutional codes)

The ISDB-T<sub>SB</sub> system shall allow for a range of punctured convolutional codes, based on a mother convolutional code of rate 1/2 with 64 states. Coding rates of the codes are 1/2, 2/3, 3/4, 5/6 and 7/8. This will allow selection of the most appropriate property of error correction for a given service or data rate in the ISDB-T<sub>SB</sub> services including mobile services. The generator polynomials of the mother code are  $G_1 = 171_{\text{oct}}$  for X output and  $G_2 = 133_{\text{oct}}$  for Y output.

### 1.4.7 Modulation

Configuration of the modulation block is shown in Figs. 13 and 14. After bit-wise interleaving, data of each layer are mapped to the complex domain.



FIGURE 13

Modulation block diagram

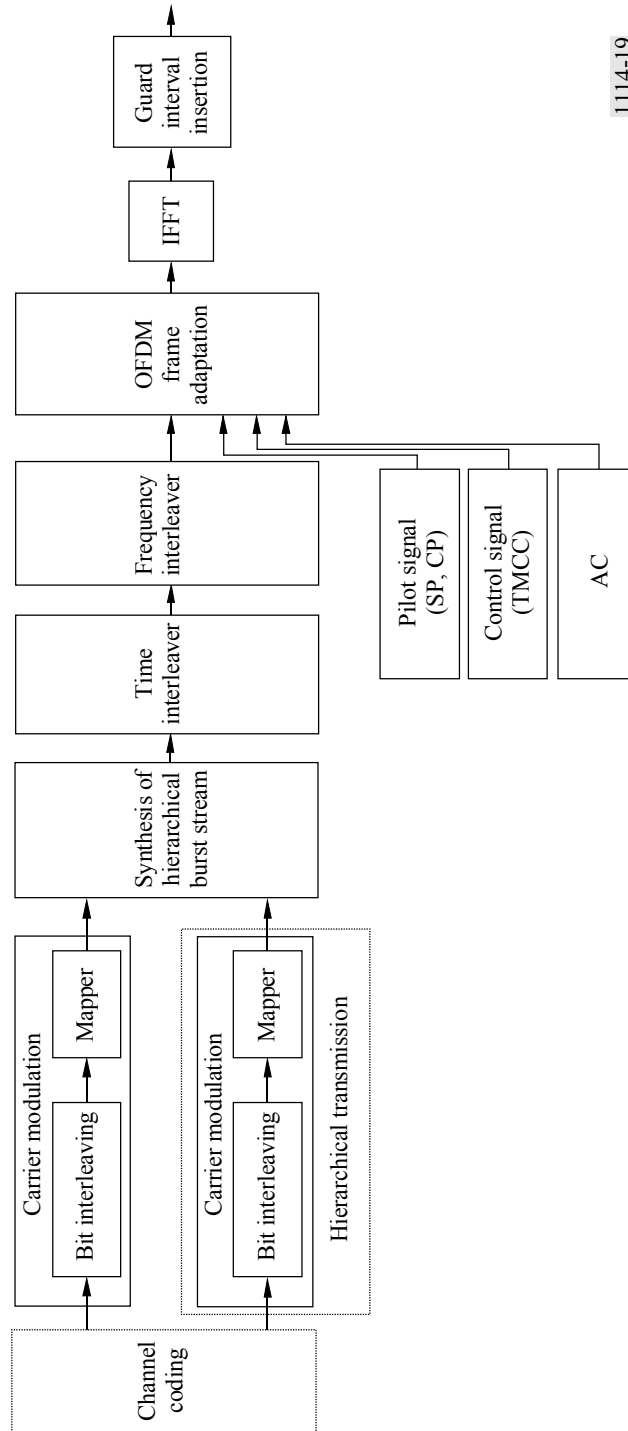

1114-19

FIGURE 14

## Configuration of carrier modulation block

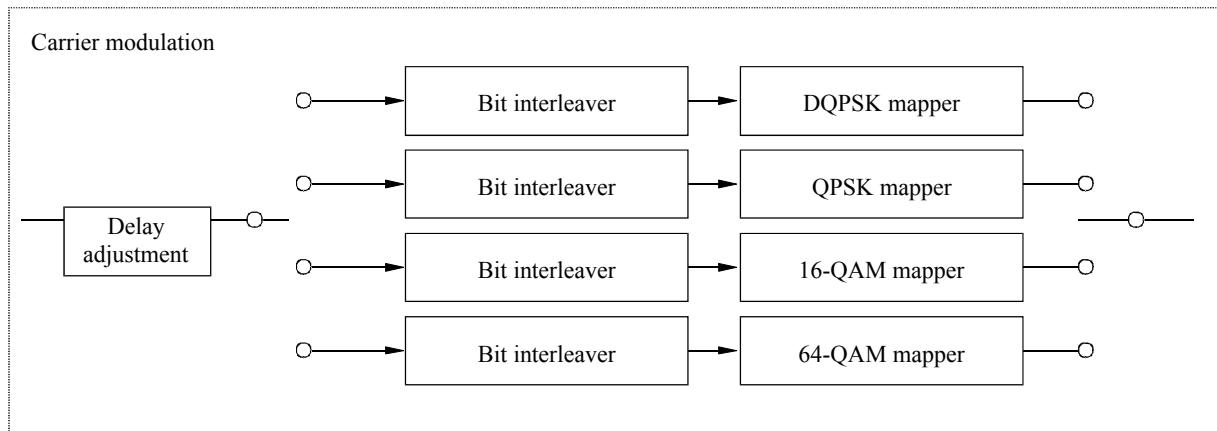

1114-20

**1.4.7.1 Delay adjustment for bit interleave**

Bit interleave causes the delay of 120 complex data ( $I+jQ$ ) as described in the next section. By adding proper delay, total delay in transmitter and receiver is adjusted to the amount of two OFDM symbols.

**1.4.7.2 Bit interleaving and mapping**

One of the carrier modulation schemes among DQPSK, QPSK, 16-QAM and 64-QAM is selectable for this System. The serial bit-sequence at the output of the inner coder is converted into a 2-bit parallel sequence to undergo  $\pi/4$ -shift DQPSK mapping or QPSK mapping, by which  $n$  bits of I-axis and Q-axis data are delivered. The number  $n$  may depend on the hardware implementation. In the case of 16-QAM, the sequence is converted into a 4-bit parallel sequence. In 64-QAM, it is converted into a 6-bit parallel sequence. After the serial-to-parallel conversion, bit-interleaving is carried out by inserting maximum 120-bit delay.

**1.4.7.3 Data segment**

Data segment is defined as a table of addresses for complex data, on which rate conversion, time interleaving, and frequency interleaving shall be executed. The data segment corresponds to the data portion of OFDM segment.

**1.4.7.4 Synthesis of layer-data streams**

After being channel-coded and mapped, complex data of each layer are inputted every one symbol to pre-assigned data-segments.

The data stored in all data segments are cyclically read with the IFFT-sample clock; then rate conversions and synthesis of layer data streams are carried out.

**1.4.7.5 Time interleaving**

After synthesis, symbol-wise time interleaving is carried out. The length of time-interleaving is changeable from 0 to approximately 1 s, and shall be specified for each layer.

**1.4.7.6 Frequency interleaving**

Frequency interleaving consists of inter-segment frequency interleaving, intra-segment carrier rotation, and intra-segment carrier randomization. Inter-segment frequency interleaving is taken among the segments having the same modulation scheme. Inter-segment frequency interleaving can be carried out only for triple-segment transmission. After carrier rotation, carrier randomization is performed depending on the randomization table.

1.4.7.7 OFDM segment-frame structure

Data segments are arranged into OFDM segment-frame every 204 symbols by adding pilots such as CP, SP, TMCC and AC. The modulation phase of CP is fixed at every OFDM symbol. SP is inserted in every 12 carriers and in every 4 OFDM symbols in the case of coherent modulation method. The TMCC carrier carries transmission parameters such as carrier modulation, coding rate and time interleaving for the receiver control. The AC carrier carries the ancillary information.

1.5 ATSC

Overview of the ATSC Digital Television System

The ATSC Digital Television (DTV) standard ushered in a new era in television broadcasting. The impact of DTV is more significant than simply moving from an analog system to a digital system. Rather, DTV permits a level of flexibility wholly unattainable with analog broadcasting. The ATSC Digital Television Standard describes a system designed to transmit high quality video and audio and ancillary data within a single 6 MHz terrestrial television broadcast channel. The design emphasis on quality resulted in the advent of digital HDTV and multi channel surround-sound. The ATSC system pioneered a layered architecture that separates picture formats, compression coding, data transport and digital transmission as shown in Fig. 15.

FIGURE 15

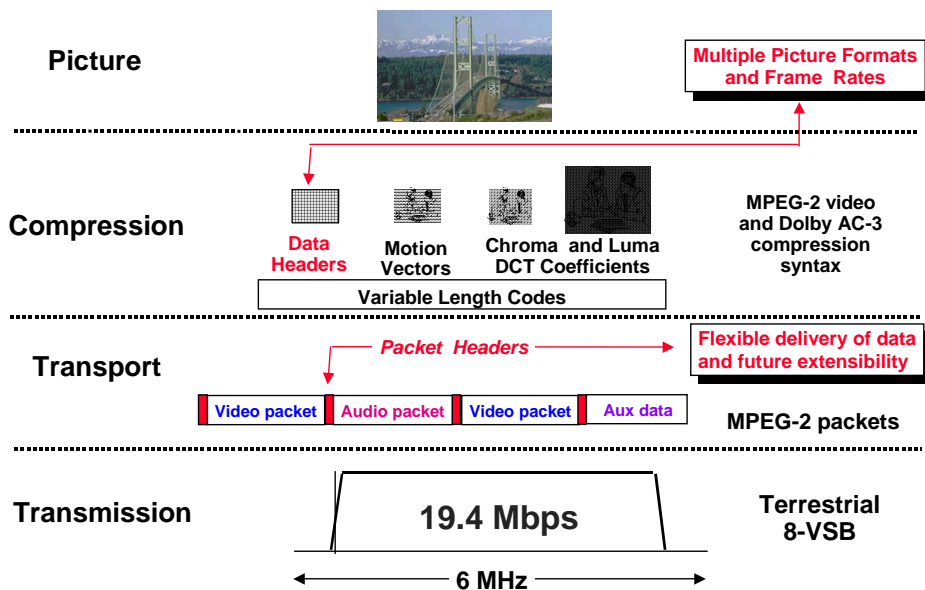

A block diagram of the system is provided in Fig. 16.

FIGURE 16

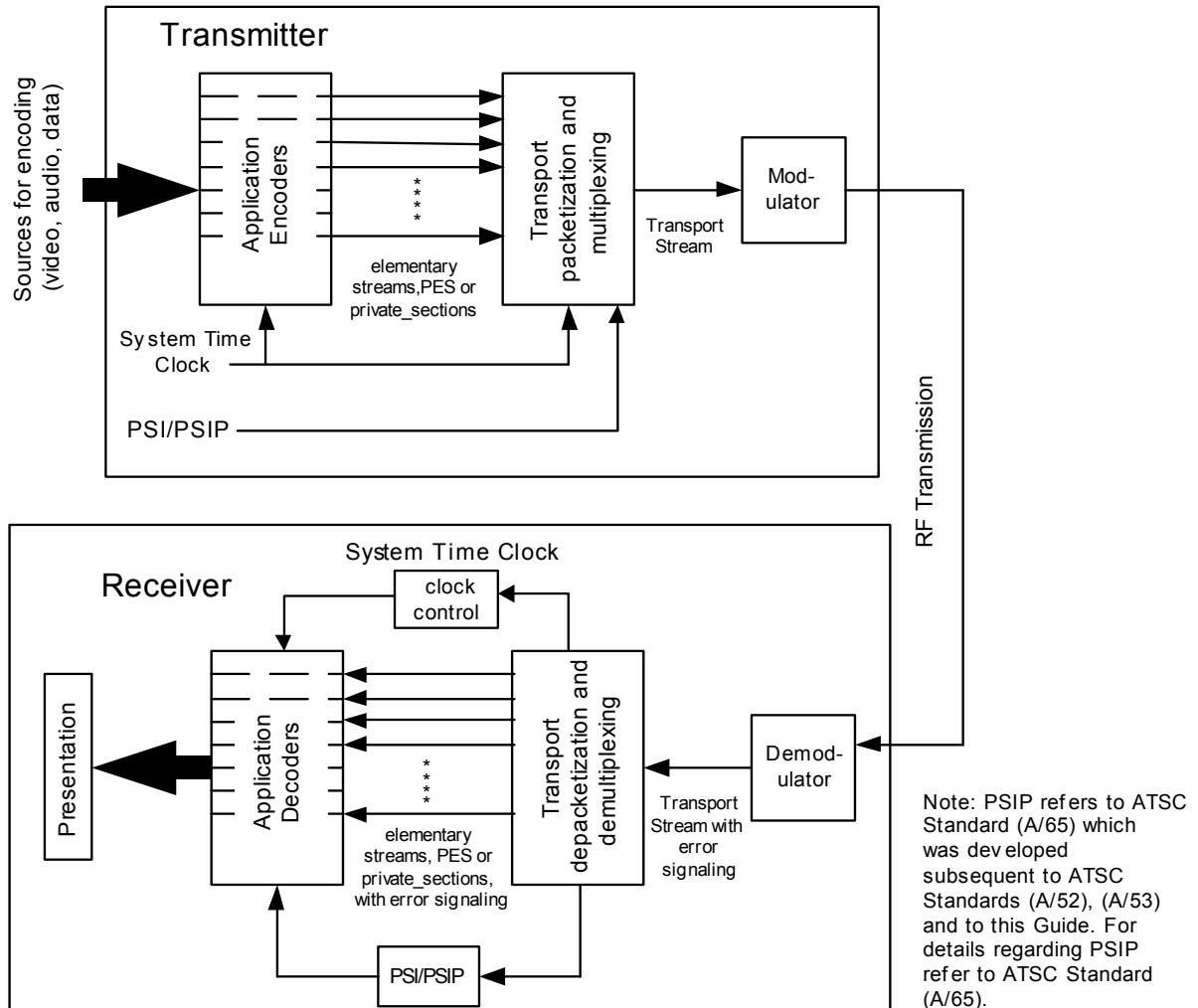

### Video Formats

The source video formats for the ATSC standard were carefully selected for their interoperability characteristics with film (wide aspect ratio and 24 fps), computers (square pixels and progressive scanning), and legacy television systems (480 lines and ITU-601 sampling), as illustrated in Fig. 3. In addition, the HDTV formats and the square pixel SDTV format are related by simple 3:2 ratios, allowing high quality, yet economical conversion among these formats. ATSC system.

### Video Compression

The ATSC DTV Standard specifies the MPEG-2 video stream syntax (Main Profile at High Level) for the coding of video. The ATSC DTV Standard defines the video formats for HDTV and SDTV (Table 2).

TABLE 2

**Digital Television Standard Video Formats\***

Vertical lines	Pixels	Aspect ratio	Picture rate
1080	1920	16:9	60I, 30P, 24P
720	1280	16:9	60P, 30P, 24P
480	704	16:9 and 4:3	60P, 60I, 30P, 24P
480	640	4:3	60P, 60I, 30P, 24P

\*Note that both 60.00 Hz and 59.94 (60x1000/1001) Hz picture rates are allowed. Dual rates are allowed also at the picture rates of 30 Hz and 24 Hz.

ATSC consumer receivers are designed to decode all HDTV and SDTV streams providing program service providers with maximum flexibility.

ATSC also provides the ability to utilize Advanced Video Coding (AVC) within an ATSC DTV transmission. Part 1 of ATSC A/72, "Video System and Characteristics of AVC in the ATSC Digital Television System," and "Part 2 "AVC Video Transport Subsystem Characteristics". The standard details the methodology to utilize Advanced Video Coding (AVC) within an ATSC DTV transmission. AVC which was developed by the ITU-T Video Coding Experts Group together with the ISO/IEC Moving Picture Experts Group is also known as H.264 and MPEG-4 Part 10. The A/72 Standard defines constraints with respect to AVC, compression format restraints, low delay and still picture modes, and bit stream specifications.

**Audio Compression**

The ATSC DTV Standard utilizes "Digital Audio Compression (AC-3)" for the coding of audio as based upon the ATSC A/52 Standard.

**Transport**

Transport defines the methodology of dividing each bit stream into "packets" of information. The ATSC system employs the MPEG-2 transport stream syntax for the packetization and multiplexing of video, audio, and data signals for digital broadcasting systems.

The ATSC A/65 Program and System Information Protocol (PSIP) describes the information at the system and event levels for all virtual channels (channel numbers are not tied directly to the actual RF channel frequency) carried in a particular TS. Additionally, information for analog channels as well as digital channels from other Transport Streams may be incorporated.

There are two main categories of information in the ATSC PSIP Standard (A65), system information and program data. System information allows navigation and access of the channels within the DTV transport stream, and the program data provides necessary information for efficient browsing and event selection. Some tables announce future events and some are used to locate the digital streams that make up an event. The PSIP data are carried via a collection of hierarchically arranged tables, repeated in the packet stream at frequent intervals.

**RF Transmission**

"RF Transmission" refers to channel coding and modulation. The channel coder takes the packetized digital bit stream, reformats it and adds additional information that assists the receiver in extracting the original data from the received signal, which due to transmission impairments may contain errors. In order to protect against both burst and random errors, the packet data is interleaved before transmission and Reed-Solomon [isn't a reference needed?] forward error correcting codes are added. The modulation (or physical layer) uses the digital bit stream information to modulate a carrier for the transmitted signal. The basic modulation

system offers two modes: an 8-VSB mode and a 16-VSB mode. The 8-VSB mode was designed for spectral efficiency, maximizing the data throughput with a low receiver carrier-to-noise ( $C/N$ ) threshold requirement, high immunity to both co-channel and adjacent channel interference, and high robustness to transmission errors. The attributes of 8-VSB allow DTV channels to co-exist in a crowded spectrum environment that contains both analog and digital television signals. In addition, the lower power requirements (typically, 12 dB lower than analog NTSC) of 8-VSB allow ATSC DTV stations to exist on channels where analog stations cannot due to interference constraints. The spectral efficiency and power requirement characteristics of 8-VSB are essential to the conversion of terrestrial broadcast transmission from analog to digital since new spectrum is not allotted during the transition phase.

### ATSC-M/H System Overview

The ATSC Mobile/Handheld service (M/H) shares the same RF channel as a standard ATSC broadcast service described in ATSC A/53. M/H is enabled by using a portion of the total available 19.4 Mbit/s bandwidth and utilizing delivery over IP transport. A block diagram representation of the broadcast system is shown in Fig. 17.

Central to the M/H system are additions to the physical layer of the ATSC transmission system that are easily decodable under high Doppler rate conditions. Extra training sequences and forward error correction (FEC) are added to assist reception of the enhanced stream(s). Consideration has also been given to the many system details that make such a signal compatible with legacy ATSC receivers, particularly audio decoder buffer constraints; but also such constraints as MPEG transport packet header standards, requirements for legacy PSIP carriage, etc. These changes do not alter the emitted spectral characteristics. The ATSC-M/H system broadcast protocol stack is illustrated in Fig. 17.

FIGURE 17  
ATSC-M/H broadcast protocol stack

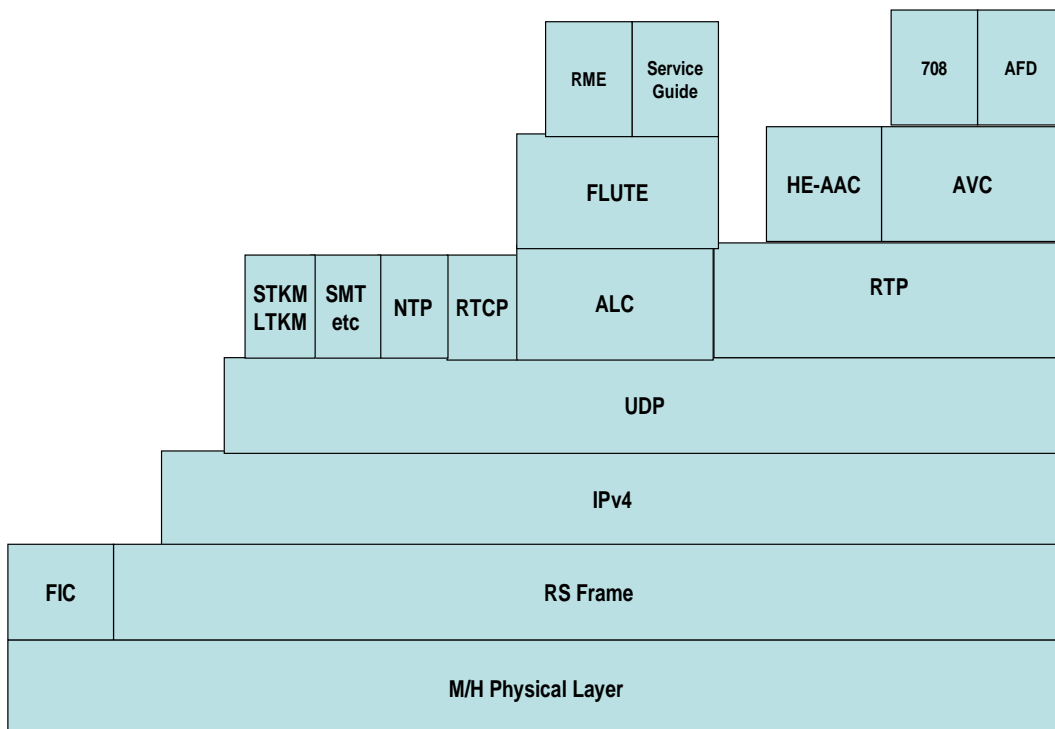

## Description of A/153 Parts

The following sections provide an over view of the Parts that make up the ATSC-M/H system.

### *Part 2 - RF/ Transmission*

M/H data is partitioned into Ensembles, each of which contains one or more services. Each Ensemble uses an independent RS Frame (an FEC structure), and furthermore, each Ensemble may be coded to a different level of error protection depending on the application. M/H encoding includes FEC at both the packet and trellis levels, plus the insertion of long and regularly spaced training sequences into the M/H data. Robust and reliable control data is also inserted for use by M/H receivers. The M/H system provides bursted transmission of the M/H data, which allows the M/H receiver to cycle power in the tuner and demodulator for energy saving.

### *Part 3 - Service Multiplex and Transport Subsystem*

In the ATSC-M/H physical layer system, the M/H data is transferred by a time-slicing mechanism to improve the receiver's power management capacity. Each M/H Frame time interval is divided into 5 sub-intervals of equal length, called M/H Subframes. Each M/H Subframe is in turn divided into 4 sub-divisions of length 48.4 ms, the time it takes to transmit one VSB frame. These VSB frame time intervals are in turn divided into 4 M/H Slots each (for a total of 16 M/H Slots in each M/H Subframe).

The M/H data to be transmitted is packaged into a set of consecutive RS Frames, where this set of RS Frames logically forms an M/H Ensemble. The data from each RS Frame to be transmitted during a single M/H Frame is split up into chunks called M/H Groups, and the M/H Groups are organized into M/H Parades, where an M/H Parade carries the M/H Groups from up to two RS Frames but not less than one. The number of M/H Groups belonging to an M/H Parade is always a multiple of 5, and the M/H Groups in the M/H Parade go into M/H Slots that are equally divided among the M/H Subframes of the M/H Frame.

The RS Frame is the basic data delivery unit, into which the IP datagrams are encapsulated. While an M/H Parade always carries a Primary RS Frame, it may carry an additional Secondary RS Frame as output of the baseband process. The number of RS Frames and the size of each RS Frame are determined by the transmission mode of the M/H physical layer subsystem. Typically, the size of the Primary RS Frame is bigger than the size of Secondary RS Frame, when they are carried in one M/H Parade.

The Fast Information Channel (FIC) is a separate data channel from the data channel delivered through RS Frames. The main purpose of the FIC is to efficiently deliver essential information for rapid M/H Service acquisition. This information primarily includes binding information between M/H Services and the M/H Ensembles carrying them, plus version information for the M/H Service Signaling Channel of each M/H Ensemble.

In ATSC-M/H, an "M/H Service" is similar in general concept to a virtual channel as defined in ATSC A/65C [10]. An M/H Service is a package of IP streams transmitted through M/H Multiplex, which forms a sequence of programs under the control of a broadcaster which can be broadcast as part of a schedule. Typical examples of M/H Services include TV services and audio services. Collections of M/H Services are structured into M/H Ensembles, each of which consists of a set of consecutive RS Frames.

In general, there are two types of files that might be delivered using the methods described in this standard. The first of these is content files, such as music or video files. The second type of file that may be transmitted is a portion of the service guide. This includes long- and short-term keys for service protection, logos, and SDP files. In either case, the delivery mechanisms are the same and it is up to the terminal to resolve the purpose of the files.

### *Part 4 - Announcement*

In an M/H system, the Services available on that system (or another system) are announced via the Announcement subsystem. Services are announced using a Service Guide. A Service Guide is a special M/H Service that is declared in the Service Signaling subsystem. An M/H receiver determines available Service Guides by reading the Guide Access Table for M/H (GAT-MH). This table lists the Service Guides present in the M/H broadcast, gives information about the service provider for each guide, and gives access information for each guide.

The ATSC-M/H Service Guide is an OMA BCAST Service Guide, with constraints and extensions as specified in this standard. A Service Guide is delivered using one or more IP streams. The main stream delivers the Announcement Channel, and zero or more streams are used to deliver the guide data. If separate streams are not provided, guide data is carried in the Announcement Channel stream.

#### *Part 5 - Application Framework*

The primary objective for the M/H platform is to deliver a set of audio and/or video services from a transmission site to mobile or portable devices. The Application Framework enables the broadcaster of the audio-visual service to author supplemental content to define and control various additional elements to be used in conjunction with the M/H audio-visual service. It enables one to define auxiliary (graphical) components, layout for the service, transitions between layouts and composition of audio-visual components with auxiliary data components. Furthermore, it enables the broadcaster to send remote events to modify the presentation and to control presentation timeline. The Application Framework further enables coherent rendering of the service and its layout over a variety of device classes and platforms, rendering of action buttons and input fields, and event handling and scripting associated with such buttons and fields.

#### *Part 6 - Service Protection*

Service Protection refers to the protection of content, be that files or streams, during its delivery to a receiver. Service Protection assumes no responsibility for content after it has been delivered to the receiver. It is intended for subscription management. It is an access control mechanism, only.

The ATSC-M/H Service Protection system is based on the OMA BCAST DRM Profile. It consists of the following components:

- Key provisioning
- Layer 1 registration
- Long-Term Key Message (LTKM), including the use of Broadcast Rights Objects (BCROs) to deliver LTKMs
- Short-Term Key Messages (STKM)
- Traffic encryption.

The system relies on the following encryption standards:

- Advanced Encryption Standard (AES)
- Secure Internet Protocol (IPsec)
- Traffic Encryption Key (TEK)

In the OMA BCAST DRM Profile there are two modes for Service Protection—interactive and broadcast-only mode. In interactive mode, the receiver supports an interaction channel to communicate with a service provider, to receive Service and/or Content Protection rights. In broadcast-only mode, the receiver does not use an interaction channel to communicate with a service provider. Requests are made by the user through some out-of-band mechanism to the service provider, such as calling a service provider phone number or accessing the service provider website.

#### *Part 7 - AVC and SVC Video System*

The M/H system uses MPEG-4 AVC and SVC video coding as described in ISO/IEC 14496 Part 10, with certain constraints.

#### *Part 8 - HE AAC Audio System*

The M/H system uses MPEG-4 HE AAC v2 audio coding as described in ISO/IEC 14496 Part 3, with certain constraints. HE AAC v2 is used to code mono or stereo audio. HE AAC v2 is the combination of three audio coding tools, MPEG-4 AAC, Spectral Band Replication (SBR) and Parametric Stereo (PS).



### *System Configuration Signaling*

Recognizing that the mobile sector of the economy is subject to rapid technology change, the needs for continued viability of the system in the face of change were formalized. As there are many technological elements of the system, they were grouped into functional units called elementary subsystems.

## **1.6 DVB-T**

### **1.6.1 DVB-T variants**

The DVB-T standard allows for different levels of modulation and different code rates to be used to trade bit rate versus ruggedness. As some variants can be selected as representative of the much larger set of all variants, it will be necessary to select such a sub-set for the planning Conference. This sub-set is useful to avoid too many options that would otherwise need to be displayed.

The non-hierarchical variants are chosen as being typical of some expressed requirements and are close to others; for the DVB-T example, it is to be expected that channel requirements for a variant with a code rate of 2/3 will be similar to those for a variant with a code rate of 3/4, for the same modulation.

**A2: QPSK, 2/3:** this variant provides a low data capacity of only 6 to 8 Mbit/s but it does provide a very rugged service.

**B2: 16-QAM, 2/3:** the data capacity is moderate at 13 Mbit/s to 16 Mbit/s and this variant may be of interest for providing reasonably rugged services especially for portable or mobile reception.

**C2: 64-QAM, 2/3:** this variant has a high data capacity, 20 Mbit/s to 24 Mbit/s but provides less rugged services and is particularly sensitive to self-interference effects in large area SFNs.

### **1.6.2 Hierarchical variant**

Hierarchical DVB-T system variants mean that the MPEG-2 bit stream is divided into two parts: the high priority stream and the low priority stream. The high priority stream is the rugged part of the hierarchical system and uses QPSK modulation and an appropriate code rate to provide the necessary protection against noise and interference. Because of the type of modulation, the data capacity is low (about 5 to 6 Mbit/s). However, the *C/I* ratio is worse than that for a non-hierarchical QPSK system although the data capacity is the same as that of a QPSK system of the same code rate.

The low priority stream is the more fragile part of the hierarchical system and may be either 16-QAM or 64-QAM. Not much consideration has been given to a low priority stream using 16-QAM because the data capacity of the low priority stream is about the same as that of the high priority stream. A low priority stream using 64-QAM provides about twice the capacity of the high priority QPSK stream. Its exact capacity relative to that of the high priority stream depends on the relative code rate of the two streams.

The hierarchical system variants could be used in several ways. One example would be for a combination of fixed and mobile services in the same area, where the high priority stream gives robust mobile coverage and the low priority stream provides fixed antenna reception.

### **1.6.3 Guard interval**

OFDM, as used in DVB-T, exhibits relatively long symbol periods due to its multi-carrier nature. This long symbol period provides a degree of protection against inter-symbol interference caused by multipath propagation. This protection can, however, be greatly enhanced by use of a guard interval. The guard interval is a cyclic extension of the symbol. In simplistic terms, a section of the start of the symbol is simply added to the end of the symbol.

For MFNs, small guard intervals are used while for SFNs, larger guard intervals are required. There is a trade-off between the length of the guard interval and the data capacity. For a given DVB-T variant, a larger guard interval length implies a lower data capacity.

### **1.6.4 DVB-T in Band III**

There are indications that the use of Band III (174-230 MHz) is being considered for DVB-T in some countries. Band III propagation is particularly suitable for portable and mobile reception, because of the

uniform field strength distribution that can be achieved in that band, together with the possibility of achieving large area coverage with lower power than would be needed using UHF frequencies. However, in some parts of the planning area (eastern Mediterranean area and Gulf area) the situation is different due to propagation anomalies such as ducting and super-refraction.

A challenge to be faced within Band III is the existence of several channelling arrangements, including the use of 7 MHz and 8 MHz bandwidth channels. Any possible move to a uniform channel raster presents a long-term challenge due to the existing complex non-uniform situation.

The following advantages have led to an increased interest in DVB-T in VHF Band III:

- coverage for large areas is achieved with fewer transmitters than are required at UHF;
- mobile reception (reduction of Doppler effect).

At VHF, propagation conditions are different from UHF; therefore suitable networks may also be different. Furthermore the Doppler shift for mobile reception is less at VHF than at UHF due to the lower frequencies. This is a clear advantage for VHF when administrations consider deploying mobile DVB-T.

## **1.7 DVB-H**

### **1.7.1 Building and validating an open and scalable network architecture**

The interworking points between the different domains and actors will also be identified with the objective of defining interworking units whenever required. System engineering rules will be articulated in order to cope with scalability issues. This in particular requires identifying the parameters that are key when scaling up the system. This is crucial to allow the successful progressive introduction of open systems with distributed management functions.

Field trials that include testing of an open operational architecture composed of several broadcast cells will give final input on the viability of the overall system. The novelty will consist in having an open demonstrator addressing the complete/commercial-like architecture. Roaming will be tested between different partners' sites, for instance. Feedback from a panel of users will determine whether the services have sufficiently user-friendly interfaces and will qualify the technical and commercial viability of the services.

Technology development in the project is articulated around three domains that intend to make particularly innovative contributions on:

- content, services and applications,
- user devices,
- networks.

### **1.7.2 Content, services and applications**

The business motivation in this area is to increase content/service creation productivity because of the increasingly diverse means of accessing services in terms of networks and terminals. This productivity is enhanced only at the expense of making common as many steps as possible in the content/service creation process.

In content generation and production, the migration from the more or less autonomous production workflows of separate departments to workflows where content is created in a multitude of formats to be transmitted via a number of platforms and channels to different terminals will be planned. Content will be produced, generated and edited from a number of sources. A central server architecture connected to a content management system will be implemented allowing for quick, cost-efficient and automated content editing. A mechanism will be established for ensuring that user privacy and security is kept in a common digital environment.

### **1.7.3 User devices**

The main user-device-related objective is to pave the way for the commercial introduction of end-user devices able to provide intuitive access to mobile/portable broadcast and broadband services in collaborating

networks. The eEurope 2005 action plan recognizes that the development of such terminals is crucial to social inclusion.

#### 1.7.4 Networks

Assuming that national regulations will evolve according to EC recommendations, the opportunity exists to deploy new networks specifically targeting broadcast-based mobile and indoor reception, with better geographical granularity (i.e. smaller cells). This will lead to the definition and field validation of deployment rules for a cellularized DVB-T/H system. Because of the potential co-location of low power DVB-T/H transmitters with 2G/3G base stations, co-existence rules will be defined, depending on the identified interference scenarios.

Digital Video Broadcasting Handheld (DVB-H) is a new standard for digital terrestrial TV broadcasting to handheld portable/mobile terminals.

It has been standardised in 2004 by ETSI EN 302 304: “Digital Video Broadcasting (DVB); Transmission System for Handheld Terminals” (DVB H).

The introduction of DVB-H implied to modify slightly few DVB standards. DVB-T has been improved with the introduction of a 4 K carriers mode, a depth interleaver, new time stamps (TPS) and a 5 MHz RF bandwidth. Some people are thinking to introduce 1,5, 3 and 4,5 MHz RF bandwidth in order to fit with the frequency grid in the L band in region 1 and 3 (RRC). 5 MHz RF channel is used in USA in the L band.

FIGURE 18

#### DVB-H standards family

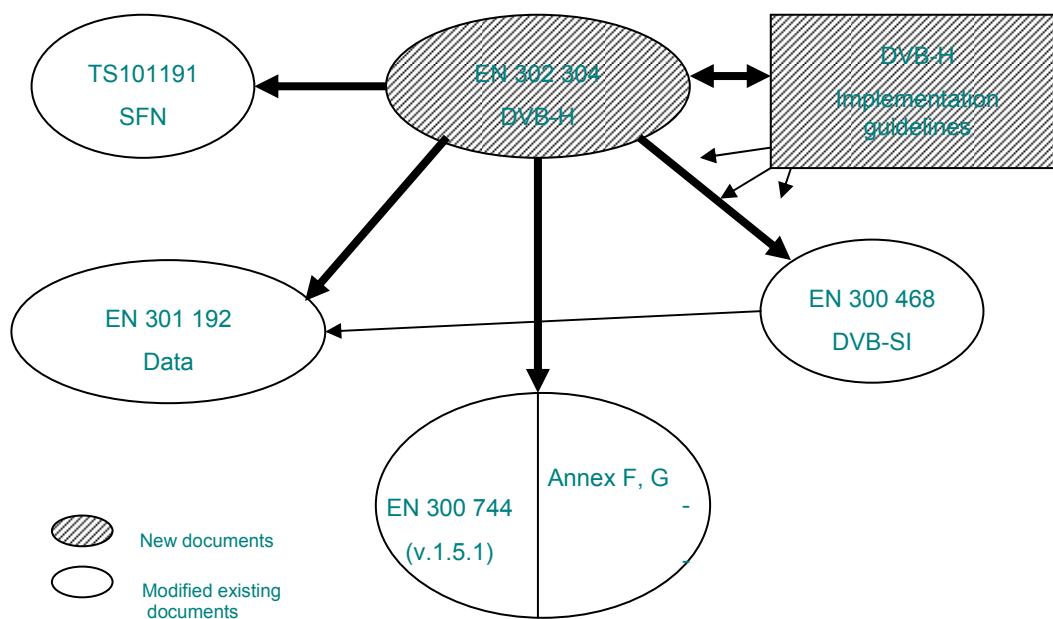

The main objective is to deliver various content (video and audio) compressed with MPEG4 encapsulated in IP bursts. One of the main challenges was to reduce the power consumption of the handheld devices (mobile phones, PDA or portable PC) and to allow the reception in various conditions.

In the future, it could be large power transmitter in order to cover a great number of users at once (one to many) with a dedicated format of content and even to be able to deliver interactive services in small cells with low power transmitters compatible with GSM or UMTS cells.

There are two options in term of frequency usage:

- UHF for large coverage areas, from one DVB-H service up to a full channel filled with DVB-H services (see figure hereafter which shows a DVB-T service + several DVB-H services in the same channel. The DVB-T transport stream (service 4 ) has a constant bitrate the other services (1, 2 and 3) are DVB-H IP bursts).
- L bands for small coverage areas with full channel filled with DVB-H services.

FIGURE 19

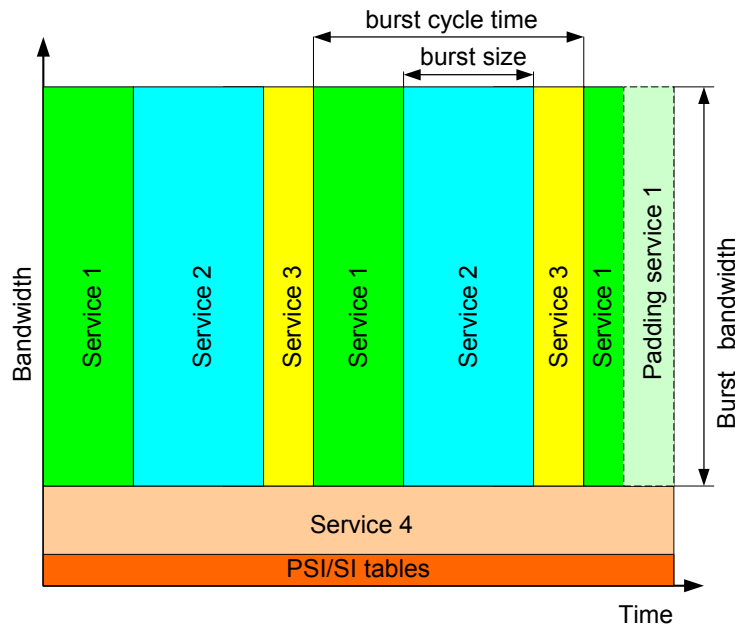

In one 8 MHz channel, it is possible to broadcast up to 50 different programs with an average of 400 kbits/s MPEG4 streams.

The definition of the image is fitting with the size of the display of the handheld device which means (CIF or QVGA).

DVB-H benefits of the advantages of OFDM modulation scheme combined with IP slicing.

In term of usage, DVB-H is a relevant example of converging technology: Convergence between Broadcasting and Telecommunication. However, the introduction of that technology has to be managed carefully in term of frequency allocation and/or sharing.

## 1.8 ISDB-T

### 1.8.1 ISDB-T Transmission Parameters

ISDB-T consists of 13 OFDM segments. One OFDM segment corresponds to a frequency spectrum having a bandwidth of  $B/14$  MHz (B means the bandwidth of a terrestrial TV channel: 6, 7 or 8 MHz), so one segment occupies bandwidth  $6/14$  MHz (428.57 kHz),  $7/14$  MHz (500 kHz) or  $8/14$  MHz (571.29 kHz). Television broadcasting employs 13 segments with a transmission bandwidth of about 5.6MHz, 6.5 MHz or 7.4 MHz.

ISDB-T has three transmission modes having different carrier intervals in order to deal with a variety of conditions such as the variable guard interval as determined by the network configuration and the Doppler shift occurring in mobile reception. In Mode 1, one segment consists of 108 carriers, while Modes 2 and 3

feature two times and four times that number of carriers, respectively. Table 2 lists the basic parameters of each mode in ISDB-T system.

A digital signal is transmitted in sets of symbols. The active symbol duration is the reciprocal of the carrier spacing – this condition prevents carriers in the band from interfering with each other. The guard interval is a time-redundant section of information that adds a copy of the latter portion of a symbol to the symbol's "front porch" with the aim of absorbing interference from multi-path-delayed waves. Accordingly, increasing the guard-interval duration in the signal decreases the information bit rate. An OFDM frame consists of 204 symbols with guard intervals attached regardless of the transmission mode. The time interleaving duration in real time depends on the parameters set at the digital-signal stage and on the guard-interval duration, and consequently the values shown in Table 3 for these parameters are approximate.

The error-correction scheme uses concatenated codes, namely, Reed-Solomon (204,188) code for the outer code and convolutional code for the inner code. The information bit rate takes on various values depending on the selected modulation scheme, inner-code coding rate, and guard-interval ratio. The range shown in Table 2 reflects the minimum and maximum values for 13 segments.

TABLE 3  
Basic parameter of ISDB-T system

Transmission parameter	Mode 1	Mode 2	Mode 3
Number of segments	13		
Bandwidth	5.57 MHz (6M*)	5.57 MHz (6M*)	5.57 MHz (6M*)
	6.50 MHz (7M*)	6.50 MHz (7M*)	6.50 MHz (7M*)
	7.43 MHz (8M*)	7.43 MHz (8M*)	7.43 MHz (8M*)
Carrier spacing	3.968 kHz (6M*)	1.948 kHz (6M*)	0.992 kHz (6M*)
	4.629 kHz (7M*)	2.361 kHz (7M*)	1.157 kHz (7M*)
	5.271 kHz (8M*)	2.645 kHz (8M*)	1.322 kHz (8M*)
Number of carriers	1405	2809	5617
Active symbol duration	252 $\mu$ s (6M*)	504 $\mu$ s (6M*)	1008 $\mu$ s (6M*)
	216 $\mu$ s (7M*)	432 $\mu$ s (7M*)	864 $\mu$ s (7M*)
	189 $\mu$ s (8M*)	378 $\mu$ s (8M*)	756 $\mu$ s (8M*)
Guard interval duration	1/4, 1/8, 1/16, 1/32 of active symbol duration		
Carrier modulation	QPSK, 16-QAM, 64-QAM, DQPSK		
Number of symbols per frame	204		
Time interleaving duration	0, 0.1s, 0.2s, 0.4s		
Inner code	Convolutional coding (1/2, 2/3, 3/4, 5/6, 7/8)		
Outer code	RS(204,188)		
Information bit rate	3.65-23.2 Mbit/s (6M*)		
	4.26-27.1 Mbit/s (7M*)		
	4.87-31.0 Mbit/s (8M*)		
Hierarchical transmission	Maximum 3 levels (Layer A, B, C)		

\* Bandwidth of a terrestrial TV channel.

### 1.8.2 Hierarchical Transmission

A mixture of fixed-reception programs and handheld reception programs is made possible through hierarchical transmission achievable by band division within a channel. "Hierarchical transmission" means that the three elements of channel coding, namely, the modulation scheme, the coding rate of convolutional

error-correcting code, and the time interleaving duration, can be independently selected. Time and frequency interleaving are each performed in their respective hierarchical data segment.

As described above, the smallest hierarchical unit in a frequency spectrum is one OFDM segment. Referring to Fig. 20, one television channel consists of 13 OFDM segments, and up to three hierarchical layers (Layers A, B, and C) can be set with regard to these segments. If the OFDM signal is transmitted using only one layer, the layer is A. If the signal is transmitted using two layers, the center “rugged” layer is A and the outer layer is B. If the signal is transmitted using three layers, the center “rugged” layer is A, the middle layer is B, and the outer layer is C. Taking the channel-selection operation of the receiver into account, a frequency spectrum segmented in this way must follow a rule for arranging segments. In addition, one layer can be set for the single center segment as a partial-reception segment for handheld receivers of one-segment services. In this case, the center segment is Layer A. Using the entire band in this way is called ISDB-T. Audio broadcasts and one-segment services feature a basic one-segment format as well as a three-segment expanded format, both referred to as ISDB-T<sub>SB</sub>.

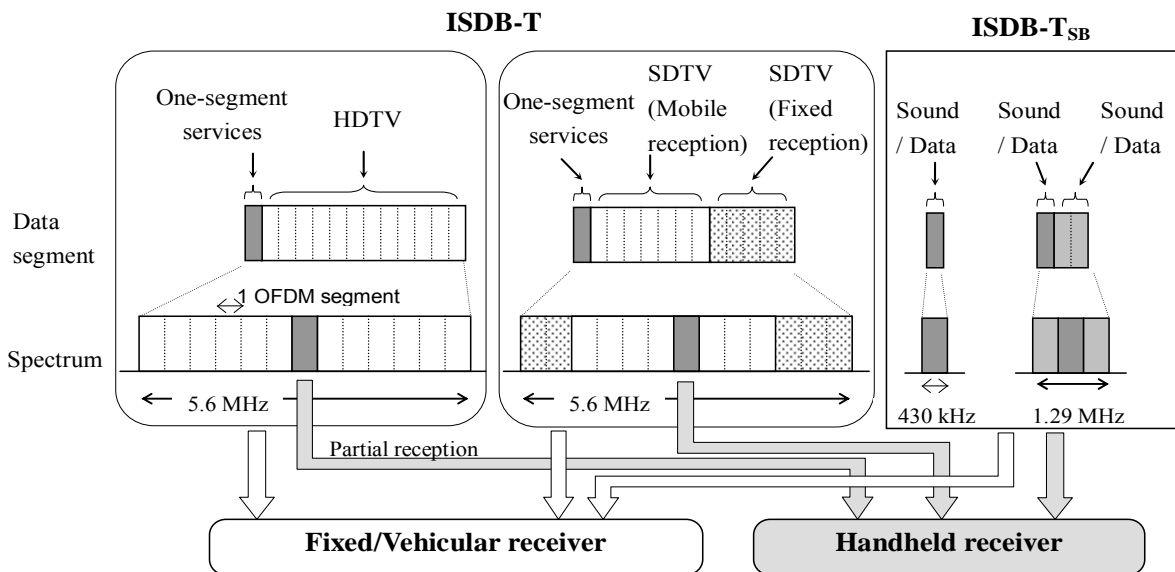

FIGURE 20

ISDB-T service examples and transmission signals

### 1.8.3 Outline of ISDB-T

Figure 21 shows ISDB-T system configuration. This system uses MPEG-2 Video coding and MPEG-2 advanced audio coding (AAC) for source coding. Moreover, it adopts MPEG-2 Systems for encapsulating data streams. Therefore, various digital content such as sound, text, still pictures, and other data can be transmitted simultaneously. For channel coding, transmission parameters may be individually set for each layer, making for flexible channel composition. Furthermore, to achieve an interface between multiple MPEG-2 Transport Streams (TSs) and the Channel coding, these TSs are re-multiplexed into a single TS. In addition, transmission control information, such as channel segment configuration, transmission parameters, etc., are sent to the receiver in the form of a transmission multiplexing configuration control (TMCC) signal.

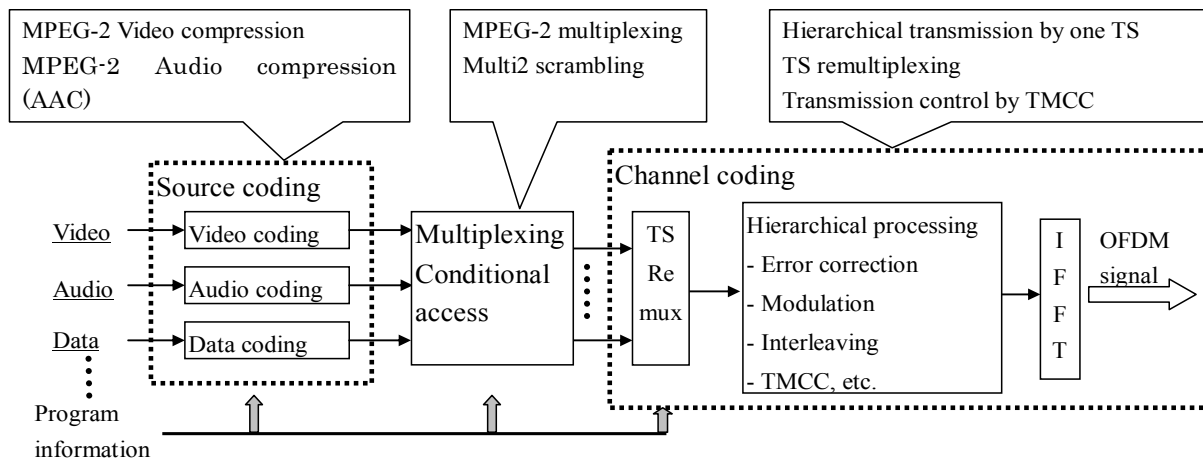

FIGURE 21

**ISDB-T system configuration****1.9 T-DMB****1.9.1 T-DMB General**

Terrestrial Digital Multimedia Broadcasting (T-DMB) system, is the extended system compatible with Digital Sound Broadcasting System A, which enables video services by using T-DAB networks for handheld receivers in mobile environment. This system uses frequency bands of band III and L-band, which T-DAB networks are in operation.

T-DMB provides multimedia services including video, audio, and interactive data. For audio services it uses MUSICAM as specified in DSB System A and for video services MPEG-4 standards. ITU-T H.264 | MPEG-4 AVC standard is used for video, MPEG-4 ER-BSAC or MPEG-4 HE AAC for the associated audio, and MPEG-4 BIFS and MPEG-4 SL for interactive data. Outer channel coding of Reed-Solomon code applies to guarantee the good performance of video reception.

Field test results and the summary of T-DMB specification are included in the Report ITU-R BT.2049. The specification of T-DMB was standardized by ETSI in 2005. ETSI TS 102 427 and ETSI TS 102 428 describe error protection mechanism and the A/V codec of the T-DMB system, respectively. A variety of receivers are in the market: PC (laptop) type, vehicular type, and PDA type as well as mobile phone.

**1.9.2 System architecture**

The system for the T-DMB video services has the architecture that transmits MPEG-4 contents encapsulated using "MPEG-4 over MPEG-2 TS" specification as illustrated in Fig. 21.

Video service is delivered through the stream mode of DSB System A transmission mechanism. In order to maintain bit error rates extremely low, this service uses the error protection mechanism described in ETSI TS 102 427. This video service is composed of three layers: contents compression layer, synchronization layer, and transport layer. In the contents compression layer in ETSI TS 102 428, ITU-T H.264 | ISO/IEC 14496-10 AVC is employed for video compression, ISO/IEC 14496-3 ER-BSAC/HE-AAC for audio compression, and ISO/IEC 14496-11 BIFS for auxiliary interactive data services.

To synchronize audio-visual contents both temporally and spatially, ISO/IEC 14496-1 SL is employed in the synchronization layer. In the transport layer specified in ETSI TS 102 428, some appropriate restrictions are employed for the multiplexing of compressed audiovisual data.



FIGURE 22

## Conceptual architecture for the video services

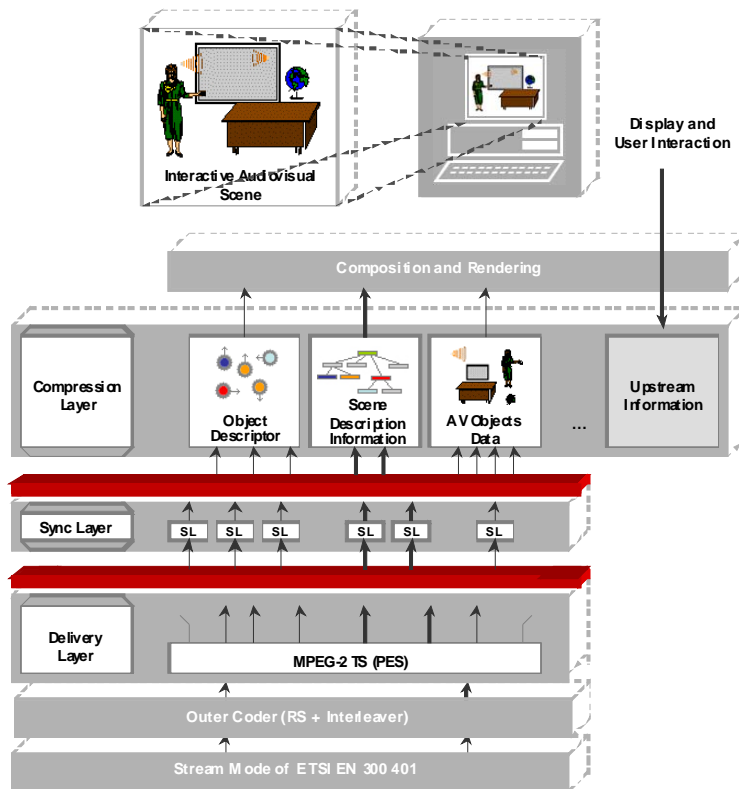

### 1.9.3. Video service transmission architecture

The conceptual transmission architecture for video services is shown in Fig. 23. The video, audio, and auxiliary data information for a video service are multiplexed into an MPEG-2 TS and further outer-coded by the video multiplexer. It is transmitted by using the stream mode specified in DSB System A.

FIGURE 23  
 Conceptual transmission architecture for the video services

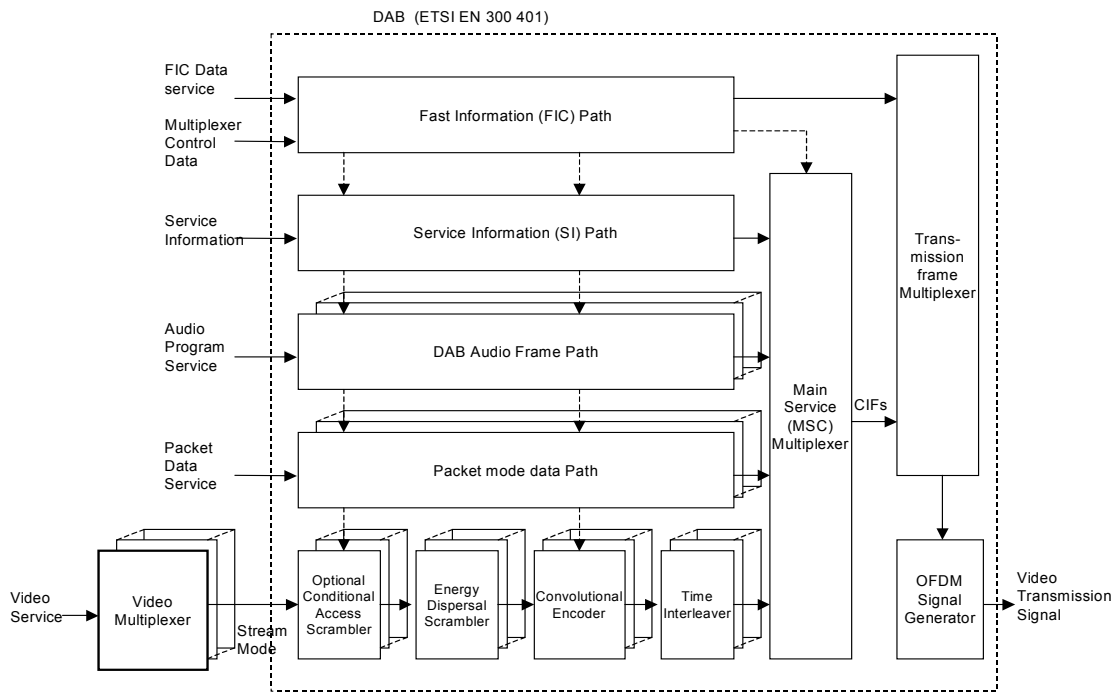

**1.9.4. Video multiplexer architecture**

The conceptual architecture of the video multiplexer for a video service is shown in Fig. 24.

FIGURE 24  
Architecture of the video multiplexer

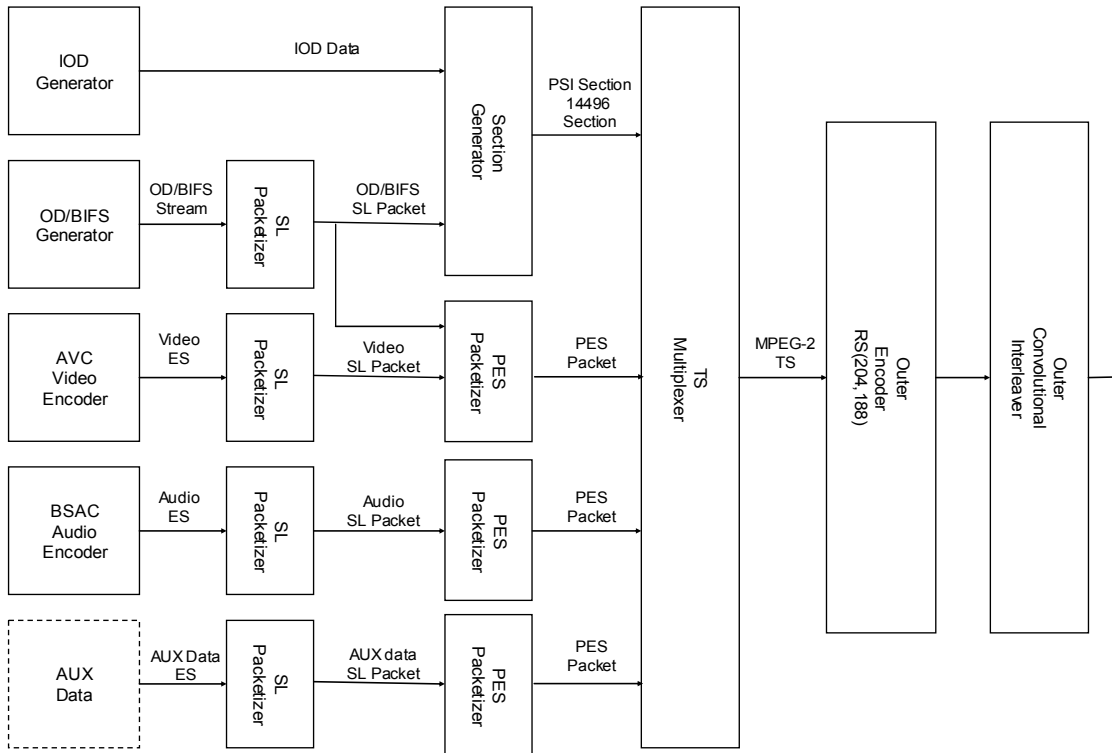

### 1.9.5. T-DMB specifications

The list of specifications for T-DMB is shown in Table 4.

TABLE 4  
T-DMB specifications

Physical Layer	Recommendation ITU-R BS.1114 System A
Encapsulation and protocols for transmission of content	ETSI EN 300 401
	ETSI TS 102 427
	ISO/IEC 13818-1
	ISO/IEC 14496-1
	ETSI TR 101 497
	ETSI TS 101 759
	ETSI ES 201 735
	ETSI TS 101 499
	ETSI TS 101 498-1
ETSI TS 101 498-2	
Multimedia Content Format	ETSI EN 301 234
	ISO/IEC 14496-11
Audio Coding	MPEG-2 Layer II
	MPEG 4 ER BSAC/MPEG 4 HE-AAC
	ETSI TS 102 428
Video Coding	ITU-T Rec. H.264 / MPEG-4 AVC
	ETSI TS 102 428

### 1.10 LMDS (Local Multipoint Distribution System)

Since the very preliminary applications of digital terrestrial broadcasting, interactive and multimedia applications seemed bound to play an important role in the take-off of the new broadcasting standard. Later on, the availability of MHP standard and of MHP-compatible set-top boxes definitely opened the doors to interactive and multimedia applications.

Interactive and multimedia terrestrial TV became a key part of the service in Finland, where are operational in MHP standard since 2002 and interactivity is currently tested also on the Digital Terrestrial TV networks of Spain, Germany, and Singapore (**other countries are invited to send a contribution on this**). With the current launch of Digital Terrestrial Television in Italy, multimedia applications are getting a considerable interest, also for what concerns interaction with public administration (T-government) and education.

Some countries have started a field trial of IP over digital TV broadcasting.

#### 1.10.1 Use of LMDS systems

##### 1.10.1.1 The LMDS technology approaching the market of multimedia delivery

LMDS at 42 GHz is now a mature technology in terrestrial digital video broadcasting with the capability to have a great amount of band to offer services to the customers. For example multichannel LMDS and MPEG2 compression coding system - allowing multiple digital time-shifted programs inside the same 33 MHz video channel - permit NVOD (Near Video On Demand) services, without any "return connection" between the customer and the Service Provider.

Services with a low interactivity level like Video on Demand (VOD), Games or Home Shopping applications, can be achieved over LMDS with telephone return channel: most of the commercial DVB Set Top Boxes (decoders) already include internal telephone modem. Also Internet access with telephone return channel is achievable, deserving some LMDS down-link channels to deliver Internet traffic.

*(All sub-sections describe the situation in European Union. Other administrations are invited to provide further information on their own scenarios.)*

LMDS technology is rapidly evolving and the introduction of higher levels of interactivity, will move applications from pure entertainment to Wireless Local Loop (WLL) services. In-band return channels offer attractive independence from PSTN (Public Switching Telephone Network) for Service Providers. Interactivity is pushing LMDS and WLL applications into a merge whose continuous technology evolution will contribute extending profitable business penetration.

Some WLL services promise profitable commercial businesses for Small Business or Home Business (SOHO) subscribers; in particular high speed Internet surfing seems to be a valuable service for most of the users.

### **1.10.2 Some key factors in the technology**

The choice of the complete system architecture requires a deep analysis of communication scenarios, network scenarios and traffic characteristics. The required capacity of a network depends on a large number of parameters, including the number of users, the applications they use, the protocol efficiency and the frequency re-use strategy. Access protocols must be able to cope with traffic loading near saturation.

### **1.10.3 Technological trends and objective constraints**

Technology improvements, especially in the millimetre component field, will contribute to extend interactive LMDS services into large commercial business but, on the other hand, millimeter-wave Remote Terminal (RT) transceiver architecture must be maintained as simple as possible in order to be cost effective. Available throughput rate per customer must be traded-off with RT architecture complexity, Base Stations content feeding, modulation schemes, RT output power and return path link budget.

The design of application oriented LMDS network services in real environments appears to be an issue to be solved on a case by case basis. Besides automatic design procedures can help in the design producing an optimised network topology and architecture, cost and infrastructure implications must be carefully evaluated for each situation.

The main arguments in favour of the LMDS technology are increased data rates available to the user, the possibility to deliver both general content services and to customise dedicated services within well delimited geographical areas. Moreover it's considerable the opportunity for the operators to expand their network over a few years in terms of number of customers and services offered.

One of the most important factors affecting the success of Broadband Wireless Access Operators is the initial amount of spectrum licensed per Operator by the Administration. Another important factor is the availability of additional spectrum to meet demand as Broadband Wireless Access systems rollout. In fact, whilst a modest amount spectrum may be available in the short term, it will not be sufficient in a long term perspective where an increasing number of competitors and services will face the market.

### **1.10.4 Target market foreseen for LMDS**

Due to the propagation limitation, line of sight users are mandatory. The target market for Broadband Wireless Access systems could be a single or multi-tenant building within the coverage area of the cell with clear line of sight to the base station, and sufficient traffic volume to economically support the cost of the network infrastructure. There is also the need of a wired building in order to allow the distribution of forward and return channel, needed if a high interactivity level is requested, to each user from the RF terminal on the rooftop.

## **1.11 Forward Link Only (FLO)**

### **1.11.1 Introduction**

Video and other rich multimedia services on a cellular phone have been primarily delivered via existing 3G wireless networks. Until recently this delivery was primarily via unicast wireless networks, although the availability of multicast methods within the existing unicast networks is increasing. The broadcast-multicast mechanisms of these 3G networks are basically added onto the existing unicast physical layer. For

simultaneous wide distribution of content, typically beyond a few users per sector, it is generally accepted as economically advantageous to transition to broadcast-multicast delivery.

While the cost reduction that can be achieved by a broadcast mode within a unicast framework can be significant, even greater efficiencies can be achieved by a dedicated broadcast-multicast overlay. This is the underlying philosophy behind the Forward Link Only technology for broadcasting of multimedia data to handheld mobile devices.

### 1.11.2 Forward Link Only system architecture

A Forward Link Only system is comprised of four sub-systems namely Network Operation Centre (NOC – which consists of a National Operation Centre and one or more Local Operation Centres), Forward Link Only Transmitters, IMT-2000 networks, and Forward Link Only-enabled devices. Figure 25 shown below is a schematic diagram of an example of Forward Link Only system architecture.

FIGURE 25

Forward Link Only system architecture example

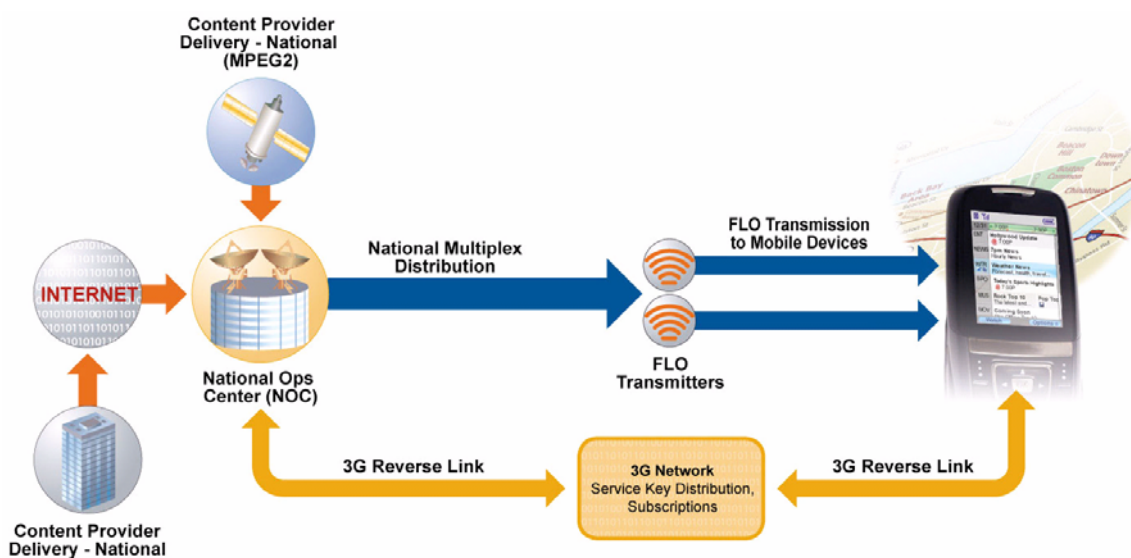

### 1.11.3 Forward Link Only system overview

#### 1.11.3.1 Content acquisition and distribution

In a Forward Link Only network, content that is representative of a linear real-time channel is received directly from content providers, typically in MPEG-2 format, utilizing off-the-shelf infrastructure equipment. Non real-time content is received by a content server, typically via an IP link. The content is then reformatted into Forward Link Only packet streams and redistributed over a single or multiple frequency network (SFN or MFN). The transport mechanism for the distribution of this content to the Forward Link Only transmitter may be via satellite, fibre, etc. At one or more locations in the target market, the content is received and the Forward Link Only packets are converted to Forward Link Only waveforms and radiated out to the devices in the market using Forward Link Only transmitters. If any local content is provided, it would have been combined with the wide area content and radiated out as well. Only users of the service may receive the content. The content may be stored on the mobile device for future viewing, in accordance to a service programme guide, or delivered in real-time for live streaming to the user device given a linear feed of content. Content may consist of high quality video (QVGA) and audio (MPEG-4 HE-AAC)<sup>2</sup> as well

<sup>2</sup> High Efficiency AAC (HE AAC) audio profile is specified in “ISO/IEC 14496-3:2001/AMD 1:2003” and is accessible through the ISO/IEC website. The performance of the HE-AAC profile coder is documented in the publicly available formal verification test report WG 11 (MPEG) N 6009.

as IP data streams. An IMT-2000 cellular network or reverse communication channel is required to provide interactivity and facilitate user authorization to the service.

### 1.11.3.2 Multimedia and data applications services

A reasonable Forward Link Only-based programming line-up for 25 frames-per-second QVGA video, with stereo audio, in a single 8 MHz bandwidth frequency allocation, includes 25 to 27 real-time streaming video channels of wide area content including some real-time streaming video channels of local market specific content. The allocation between local and wide area content is flexible and can be varied during the course of the programming day, if desired. In addition to wide area and local content, a large number of IP data channels can be included in the service delivery.

### 1.11.3.3 Power consumption optimization

The Forward Link Only technology simultaneously optimizes power consumption, frequency diversity, and time diversity. The Forward Link Only air interface employs time division multiplexing (TDM) to transmit each content stream at specific intervals within the Forward Link Only waveform. The mobile device accesses overhead information to determine which time intervals a desired content stream is transmitted. The mobile device receiver circuitry powers up only during the time periods in which the desired content stream is transmitted and is powered down otherwise.

Mobile users can channel surf with the same ease as they would with digital satellite or cable systems at home.

### 1.11.3.4 Wide and local area content

As shown in Fig. 26, Forward Link Only supports the co-existence of local and wide area coverage within a single Radio Frequency (RF) channel. When utilizing a SFN, it eliminates the need for complex handoffs for coverage areas. The content that is of common interest to all the receivers in a wide area network is synchronously transmitted by all of the transmitters. Content of regional or local interest can be carried in a specific market.

FIGURE 26

**Hierarchy of local and wide area SFNs**

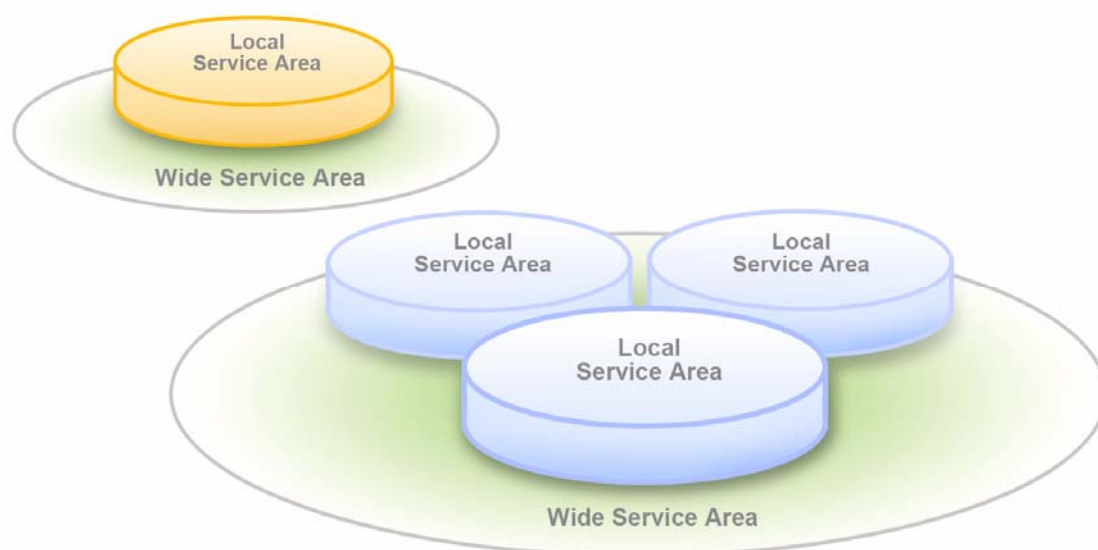

### 1.11.3.5 Layered modulation

To provide the best possible quality of service, Forward Link Only technology supports the use of layered modulation. With layered modulation, the Forward Link Only data stream is divided into a base layer that all users can decode, and an enhancement layer that users with a higher signal to noise ratio (SNR) can also decode. The majority of locations will be able to receive both layers of the signal. The base layer has superior coverage as compared to non-layered mode of similar total capacity. The combined use of layered modulation and source coding allows for graceful degradation of service and the ability to receive in locations or speeds that could not otherwise have reception. For the end user, this efficiency means that a Forward Link Only network can provide a better coverage with good quality services, especially video, which requires significantly more bandwidth than other multimedia services.

### 1.11.4 FLO Specification

Standardizing of the Forward Link Only technology has been achieved in the Telecommunications Industry Association (TIA) as Standard TIA-1099 and is further coordinated through the FLO Forum, [www.floforum.org](http://www.floforum.org).

Other informative references related to the Multimedia system “M” performance include:

- TIA-1102: Minimum Performance Specification for Terrestrial Mobile Multimedia Multicast Forward Link Only Devices.
- TIA-1103: Minimum Performance Specification for Terrestrial Mobile Multimedia Multicast Forward Link Only Transmitters.
- TIA-1104: Test Application Protocol for Terrestrial Mobile Multimedia Multicast Forward Link Only Transmitters and Devices.



## Chapter 2

### 2.1 Aspects related to interoperability of systems

#### 2.1.1 Digital reception

Ensuring that most users are equipped with digital receivers is the main challenge for switchover and a pre-condition for switch-off. Finding a solution for all receivers in the home, not just the main receiver, just adds to the challenge. The two basic options are digital converters or set-top-boxes connected to analogue receivers, and integrated digital receivers. Moreover, additional reception facilities such as cabling, antennas, dishes, etc are often necessary.

There must be a large range of digital reception solutions to suit various user segments. This means choice of functionality, price and commercial formulas. Equipment cost is not a major barrier to the consumer of pay-TV services since some pay-TV operators subsidise it, having already deployed millions of set-top-boxes. However, pay-TV will not achieve the widespread penetration of digital TV only. Now the main challenge concerns the creation of “horizontal” markets for unsubsidized receivers supporting free-to-air digital TV services, where consumers pay the full cost from day on Co-existence of the two business models is important for wide-spread digital TV market penetration.

Availability of cheap receivers is essential to minimize entry barriers for consumers. Most of them must be equipped before the switch-off can take place. Equipment costs should not be much higher than in analogue and services at least comparable, thus offering a cheap entry point to digital TV. This is the way the market seems to go now. Of course consumers should also have options to buy expensive equipment supporting sophisticated services. Service and equipment diversity also contributes to wide-spread digital TV market penetration.

#### 2.1.2 Encouragement to deployment of digital receivers

Free movement of goods within the internal market requires that national authorities do not impose administrative constraints for commercializing digital broadcasting equipment and compulsory technical requirements.

Some ITU Member States envisage public subsidies for digital equipment through schemes aimed at the whole population or just specific groups. The risk with the first scheme is discouraging purchases, including purchases of more sophisticated equipment than the one subsidized. The risk with the second scheme is trading of devices between subsidized and unsubsidized population groups.

Several other forms of incentives have been considered by some Member States, for instance temporary and digressive reduction of the license fee for homes with digital equipment to encourage fast digital migration, etc. Some Member States allow a reduced rate of VAT on pay-per-view and subscription broadcasting services. The financial implication and parties affected are different, so each option should be carefully analyzed and implemented.

#### 2.1.3 Consumer information on digital equipment and switchover

Consumer information is crucial to drive digital equipment sales in a market-led approach to switchover. Consumers should be empowered to plan their own migration rather than being forced and thus deprived by this process. They should be well informed of the timing and consequences of switchover so as to take their own decisions on services and equipment from a wide range of choices. They must be aware of what various devices can offer, what are the prospects of analogue equipment obsolescence and the possibilities for upgrading. Information and labelling should also be available in accessible formats for consumers with disabilities.

Informing consumers is the responsibility of equipment manufacturers, retailers and service providers, who need to co-ordinate their action and send clear messages whilst respecting competition law. Labelling schemes for analogue and digital equipment, with explanatory notices and/ or logos, based on voluntary industry commitment, would be particularly useful. The goal would be to send consumers positive and negative signals about, respectively, digital-compliant and analogue-only receiver equipment. This information should mirror national switchover policies, including indicative national or regional switch-off

dates. Especially as an analogue switch-off date approaches in a particular Member State, its consumers should be clearly warned about the risks of equipment obsolescence.

Policy intervention in this area has been proposed in some ITU countries. However, Member States cannot impose *de jure* or *de facto* compulsory labelling schemes without prior notification. Notification enables a compatibility assessment of such measures with internal market rules to be undertaken. Where necessary, a certain degree of harmonization could be envisaged so that the approach to labelling would be common whilst tailoring its implementation to local circumstances, such as national switch-off dates. Labelling specifications could be approved by consumer and standardization bodies.

#### **2.1.4 Integrated digital television receivers**

The prohibition of selling analogue-only television receivers according to a staggered calendar was approved and is now fully implemented in the United States. It is being debated in some EU Member States. All EU countries would have to implement the obligation more or less simultaneously to preserve homogeneity within the internal market. This would have greater impact in countries where digital penetration remains low and strain the principle of subsidiarity traditionally applied in broadcasting policy.

Another potential drawback of compulsory integrated digital receivers would be the extra cost for consumers which, depending on the exact technical requirements, could however be partly offset by economies of scale. The impact would be greater in those countries where digital TV is less developed. Concerns can be also raised as to the technological neutrality of the measure. If only one type of digital tuner were to be mandated, this would presumably favour the dominant analogue TV network, often terrestrial.

#### **2.1.5 Digital connectivity**

Currently, digital TV signals are almost always displayed on analogue TV sets connected to a digital set-top-box, which decodes those signals, through the analogue 'SCART' socket or connector. That means digital signals are converted into analogue signals before being displayed. This is acceptable for today's television receivers, based on cathode ray tubes and small screen sizes. However, the quality penalty is more perceptible on big screens using new digital display technologies. Moreover, the lack of systematically implemented and enabled digital connectors prevents the transfer of digital information between digital TV receivers and other digital devices in the home. But digital connectivity raises copyright security concerns, in particular that insufficiently protected digital content could be illegally copied or distributed. The possibilities for implementing digital connectors should be further explored as an incentive to consumer equipment switchover. A number of options exist to interconnect digital TV equipment, fulfilling different requirements but it is still unclear which way the market will go.

#### **2.1.6 Access for users with special needs**

Access to digital broadcasting should include citizens with special needs, notably people with disabilities and older persons. However, while digital broadcasting offers greater possibilities than analogue in this area, these are not yet supported by digital equipment on the market. Harmonized approaches can reduce costs through economies of scale, thus facilitating the marketing of relevant functionalities.

#### **2.1.7 Removal of obstacles to the reception of digital broadcasting**

Infrastructure competition stimulates market development, increasing consumer choice, quality of service and price competition. This may be constrained in some areas by legal, administrative or contractual restrictions on the deployment of infrastructure or reception facilities. Authorities will need to arbitrate between promoting digital broadcasting and the fundamental freedom to receive information and services, therefore facilitating network competition, and other policy objectives on town planning, environmental protection or other areas. With that proviso, national authorities should encourage network competition. By way of example, some Member States have already adopted measures in support of this objective, for instance by requiring the provision of multi-network reception facilities in new apartment blocks, facilitating their installation in existing blocks (for instance by reducing the required threshold of tenants' votes), or by removing restrictive clauses in property or renting contracts. Co-ordination between national and local authorities is important since local authorities are often responsible for the practical implementation of this type of measure.

### **2.1.8 Effects on citizens**

In all transition periods there are a lot of actors, but the past has shown the principal actors are the users. The decision of the users is in all cases oriented by market forces that, driven politically by Administrations and Manufacturers with the support of Broadcasters, can promote the opinion for change to oldest analogical systems and buy the new digital equipment. What is very important and urgent is the coordination among the different actors. In fact if the users are ready to buy new equipment and the manufacturers have produced the equipment, is very important to have a “frequency planning” program prepared by Administrations and, at the same time, a sufficient number of programs emitted, with interesting contents attract the attention of users and promote the change.

The users are moving fast towards a mobile 2G/3G lifestyle and future technologies have taught us to use mobile technology in our everyday communication. By receiving mobile broadcasting services in conjunction with 2G/3G as a return channel, consumers will be able to receive a new kind of content service and have increased interactivity. Joint utilization of digital broadcasting and existing and new cellular/cellular-type network technologies will provide consumers with location-independent and personalized services. Additionally, the delivery of digital media content via several distribution channels strengthens the availability of information society services, as they could be provided in various manners, via different network transmission methods. The use of more extensive and diverse communication networks promotes the availability of additional services and the development of content and receivers at affordable prices. This will mean information society services, including public services, can be made more accessible and cheaper than ever for all citizens by combining the usage of different types of distribution communication networks or by offering them via one communication network.

For digital television and radio the crucial conditions for success require a public that is informed on the facilities and benefits offered by the new digital services, including technical enhancements, additional programmes and services. The public must be aware of the additional service opportunities digital broadcasting and consumer electronics will offer. (For example, initiatives in this direction (i.e. to raise the public's awareness) are already ongoing in some European countries.) In addition, geographical access to digital services should be maximized and the new services should be accessible on the shortest time-scale.

Open access to public services of the information society should be encouraged, and directly developed whenever possible. This will support and speed up the implementation and success of digital broadcasting and additional datacast services. The lifetime of consumer products is in general expected typically to be from 5 to 10 years, and in some instances more. This requires stable systems, open access and the possibility of upgrading. This can only be assured when there are common, widely adopted standards jointly agreed among market players.

## **2.2 Mobile services**

### **2.2.1 Sound**

Mobile sound service consists of traditional Audio programs. The small devices and low price are requested. One important problem is Long battery lives.

Compared to stationary reception of broadcasting, the portable broadcast receiver is introducing this new user requirement, which can only be met, if the broadcasting link system allows for low power consumption of the receiving handheld terminals.

This has been taken into account through different means in some of the standards/specifications, which have already been elaborated on a regional/national basis.

### **2.2.2 Mobile TV**

Mobile TV services consist of traditional TV programs or TV-like programs. TV type of services presented to mobile handheld devices with small screens is predicted to be designed different from content offered to large screen receiving terminals in a stationary broadcasting environment.

Instead of users watching a two-hour movie on the smaller screen of a handheld terminal, a more typical usage scenario would be to watch news flashes, sports features, music videos, weather forecasts, stock exchange reports and other such content, which is suitable for “ad hoc” consumption during smaller time slots.

### 2.2.3 Enhanced mobile TV

Online TV shopping, chat, gaming and quiz plus voting are examples of functionalities, which may be introduced as enhancements to the mobile TV to allow a true interactive mobile broadcasting experience.

#### 2.2.3.1 The Electronic Service Guide (ESG)

Especially in the mobile environment it is important for the user to be able to navigate through the various broadcast service offerings in an easy and formalized way. Electronic Service Guide (ESG) contains information of the available services and how those can be accessed. The concept of the ESG has been found to be a well-accepted way for the user on the move to discover, select, and purchase the broadcasted services he/she is interested in.

#### 2.2.3.2 Data

The mobile TV programs may be supplemented by auxiliary data associated with the basic service. Such information could be part of the broadcast or can be accessed on demand via the interactivity link.

The additional background information may include links to the service provider's web pages, video clips, sound tracks, games, etc.

*In Table 5, an overview of currently known mobile broadcasting transmission mechanisms is provided. The technical characteristics shown are subject to change and are by no means exhaustive but provided for comparison only.*

TABLE 5

Mobile digital broadcasting transport mechanisms

Standard or Spec.	Modulation	Transport stream	RF channel (MUX) size (MHz)	Int. Broadcast bands	Terminal power reduction methodology	Regional national origin
DVB-H	QPSK or 16-QAM COFDM	IP/MPE-FEC/ MPEG2 TS	8	IV and V	Time slicing	Region 1 (Europe)
ISDB-T	QPSK or 16-QAM COFDM	MPEG2 TS	0.433	IV and V	Bandwidth shrinking	Region 3 (Japan)
T-DMB	DQPSK COFDM	MPEG2 TS	1.75	III and 1.5 GHz	Optimised narrow bandwidth	Region 3 (Rep. of Korea)

#### 2.2.3.3 Implementation of interactivity

It is therefore natural for the mobile user community to expect interactivity as a basic characteristic of future mobile broadcasting services, an expectation that several ongoing trials have confirmed.

#### 2.2.3.4 The interaction channel implementation

##### 2.2.3.4.1 Digital mobile telephony

As the major part of the world standards of digital mobile telephony including IMT-2000 offer two-way data services, one approach to implement interactivity seem to be the incorporation of such mobile technology in the user terminals.

Apart from offering the user all state-of-the-art mobile telephone services, this way of implementation of interactivity with the broadcasting service offerings provide immediately a reliable control link for all such

broadcasting services. It allows the user to respond and interact with the broadcasting system and to receive control codes through a secure environment.

This approach may also take advantage of the global roaming characteristics of many mobile technologies as well as of the wide-area coverage characteristics of mobile telephone technology throughout the world.

#### 2.2.3.4.2 Interaction channel making use of the broadcast spectrum

This approach has been studied in the past, but major difficulties with global circulation of user equipment capable of transmitting into the broadcast spectrum have so far been a substantial hurdle. The development of a new two-way data transport standard may also delay the progress.

#### 2.2.3.4.3 Summary of interaction channel methodologies

TABLE 6

**Interaction channel methodologies for interactive mobile broadcasting systems**

Methodology	Reference standards/ Specifications	Carrier service	Link peak bit rate (bps)
Mobile telephony	IMT-2000	HSDPA (Device Category 10)	14 Mbit/s
		HSUPA (E-DCH)	3.84 Mbit/s
	Global system for mobile communications (GSM)	GPRS (Device Category 10)	85.6 kbit/s
		EGPRS	236.8 kbit/s
Other			
Broadcasting in-band	NA	NA	NA

## Chapter 3

### 3.1 Report of TG 6/8

The report of TG 6/8, in Chapter 3 - Planning principle, methods and approach, § 3.4.2.3 to the first session of the RRC gave considerable information about four planning scenarios which were intended to indicate that any general planning philosophy wish expressed by an administration could be satisfied. There is, of course, no intention to imply that the detailed requirements submitted by administrations can all be satisfied. In fact, it is extremely unlikely that all requirements can be satisfied because there are natural limitations on the capacity of the available spectrum and it is to be expected that the initial requirements from administrations will exceed that natural capacity. Compromises will therefore need to be made by administrations in order to achieve a satisfactory plan.

The planning scenarios in the TG report are intended to respond to a wider range of planning options than are likely to be required by administrations. This is necessary if there is to be certainty that all general planning philosophies can be dealt with. However, it means that only very limited attention needs to be given to planning scenario 1 which seems unlikely to be needed in practice as it can be replaced by planning scenario 2 with no loss of generality.

This is because the intention of planning scenario 1, which was to allow for the case where an analogue station remains operational for an indefinite period, can be achieved by planning scenario 2, which allowed for continued protection of an analogue station with a subsequent change to digital operation in the same channel at the end of a transition period. If an administration does decide not to convert an existing analogue station to digital operation, it just means that the transition period for that station is extended indefinitely.

It may also be the case that scenario 4, which allowed for the planning of digital stations with no constraints imposed by reuse of existing analogue channels, is unlikely to be of general value. This is because if there is no reuse of existing (or planned) channels, it becomes almost impossible to ensure protection of both analogue and digital stations during the transition period, especially in the case where the administrations of neighbouring countries have different timetables for effecting the transition from analogue to digital.

However, there is one situation in which the application of scenario 4 could become very important. This is where there is part of the spectrum in which there is no current analogue broadcasting, and preferably no planned analogue broadcasting either. Under these circumstances, the channels for digital broadcasting stations can be planned to make fully efficient use of the spectrum. The latter is not possible in the case where there is considerable reuse of the channels of the existing analogue stations, as the optimum distance spacing between a pair of analogue stations and that between the same pair of stations operating digitally may be different. This necessarily introduces some inefficiency in the use of the spectrum. On the other hand, reuse of channels makes it possible to plan for a transition from analogue to digital with a reasonable hope of controlling interference levels and the possibility for viewers and broadcasters to make use of the existing infrastructure to a large extent.

It will have been noted that in the limited discussion of the two planning scenarios above, there is an assumption that different scenarios can be adopted by different administrations and also in different parts of the planning area. The adoption of different scenarios can be considered at an even more detailed level, that is at the level of individual broadcasting stations. One example would be where an administration considers that a particular analogue station needs to be maintained in operation for a long period while some other analogue station (or stations) can be changed to digital operation in the very short term. The converse is also true. An administration can decide that for some specific reason, and there can be many such reasons, an analogue station should be changed to digital operation as early as possible while other stations can be left as analogue for a much longer time.

### 3.2 UMTS/GSM and DVB-T Convergence

The ad hoc group DVB-UMTS/GPRS/GSM has classified the co-operation of DVB-T and UMTS/GSM/GPRS for commercial applications in different scenarios. This classification typically uses the broadcast channel for the down-load (unidirectional way), and the telecommunication channel (PSTN,

xDSL, GSM, GPRS, UMTS, and...) for the up/down-load (unidirectional/bi-directional way). Particularly are addressed the user view for services built on Telco/Broadcast convergence.

There are many scenarios that can be considered for a co-coordinated use of UMTS/GPRS/GSM and DVB networks. These range from the simple sharing of content to the sharing of spectrum. A basic assumption for a co-operation of mobile network is that terminals are able to access both networks (DVB and UMTS/GPRS/GSM). Such a co-operation of both networks will improve the capabilities and varieties of services, the economics for the user and, hopefully, the ease of handling. It combines the network service modes of both network and thus enables new solutions for applications. Of course, there will still be services, which need only one network. Some applications like interactive TV can use also separate terminals, e.g. a set top box (IRD) of a UMTS/GPRS/GSM mobile terminal. Furthermore, the co-operation of networks enables the use of the UMTS/GPRS/GSM operator's services like customer relationship management and billing for all services.

Initially, the work of DVB-UMTS/GPRS/GSM group has focused on the provision of services using the DVB-T and UMTS/GPRS/GSM platforms. The specifications will be developed in different stages, corresponding to the availability of present hardware and software products and the development time required for new solutions mainly:

- a) Interactive Broadcast services (video, data); use of UMTS/GPRS/GSM as a return channel for interactive TV. UMTS shall be able to substitute GSM as a return channel for these services for dial in access and further for Internet based access.
- b) Integration at the terminal level. No definitive co-operation of networks is required. The specification covers only the terminal, which is able to switch between the two networks and related services. The user has the choice to select the service of DVB or UMTS/GPRS/GSM to get requested information.
- c) Integration at terminal and network levels. Co-operation of networks with applications using both co-operating network resources. Terminals are firstly portable PCs, PDAs etc combined with a UMTS/GPRS/GSM "modem" for interactive services, which run on a co-operative software platform, e.g. in a domestic or car environment. The mobile handset and the broadcast receiver can connect (for example) into the PC via USB ports. The data allocation in the DVB Transport Stream can be used for IP data carousel play out and multicasting/unicasting; UMTS/GPRS/GSM will operate as an interaction channel for Internet services.
- d) Mobile operation: full mobility and range of co-operative services within a single handset (terminal). Delivery of DVB content and services over UMTS/GPRS/GSM will be supported. Content can be delivered via IP over the DVB-T platform, in all or part of the multiplex or (suitably re-purposed) over UMTS/GPRS/GSM.

The co-operation platform will incorporate all functions that enable inter-working between legacy domains (broadcast, cellular), or new functions that are not available in any legacy domain.

### 3.3 DRM simulcast

Simulcast is an option of particular interest to broadcasters who have to continue to satisfy existing analogue listeners for several years to come, but wish to introduce DRM services as soon as possible. In many cases these broadcasters are restricted in the ways in which the digital service can be introduced. For example they may have a single MF assignments and no prospect of receiving an additional frequency assignment to start a digital only version of their service. They may also be keen to avoid having to make a short-term investment in an additional transmitter and/or antenna and site to start a digital service on a new frequency.

These broadcasters would like to be able to transmit simultaneously both the existing analogue service and a new DRM service, with the same content, whilst using the existing transmitter and antenna. This option is probably most applicable to broadcasters with LF or MF assignments, where there is generally less freedom to use new frequencies, although there may be similar SW applications where NVIS is used for domestic radio coverage. In an ideal world these broadcasters would like to be able to transmit a service using single channel simulcast (SCS), so that both the analogue and digital signals are contained wholly within the assigned 9 or 10 kHz channel.

Strictly the term simulcast can be taken to describe the simultaneous transmission of more than one signal carrying the same programme content. In this context it often describes the simultaneous transmission of analogue and digital versions of the same programme from the same transmitter and therefore from a common location. However, it could also mean that only the antenna is common, as well as that both transmitter and antenna are common to the two services. In some cases it could be more economic to add a new lower powered transmitter for the DRM service, feeding the same antenna, rather than making extensive modifications to an older less suitable transmitter, currently carrying the analogue service.

DRM supports a number of different simulcast options. Currently the supported simulcast modes require the use of additional spectrum outside an assigned 9 or 10 kHz channel (Multi-Channel or Multi-frequency Simulcast, MCS). The DRM signal can be located in the next adjacent upper or lower channel and can occupy a half or whole channel depending on the bandwidth option chosen. Significant testing, both in the laboratory and in the field, has been carried out to determine the optimum level of DRM signal needed to provide a good quality DRM service, whilst avoiding significant impact on the continuing analogue service. The conclusion is that a satisfactory compromise can be obtained when the DRM power level is around 14-16 dBs below the adjacent analogue signal. In an ideal world it would also be possible to transmit both an analogue and a digital signal within the same channel (9 or 10 kHz) so that the analogue service could be received, without interference from the digital signal, on any analogue receiver. At the same time the digital service could be received in high quality audio on a digital receiver. However, although promising proposals for a SCS option are currently being evaluated, certain compromises will almost certainly need to be made. Amongst these are likely to be a reduced digital service data rate, which will adversely impact on audio quality, and a reduced service area compared to the analogue service if interference to the analogue service is to be avoided. In the case of the analogue service there is likely to be some impact on the background noise level due to the presence of the digital signal, and the impact is likely to be dependent on the design of the analogue receiver. Nevertheless, there is optimism that most of these problems will be overcome, or significantly reduced, as a result of the ongoing development work.

Even if single channel simulcast may prove a difficult goal to achieve, the other options mentioned above, which require wider bandwidths, can already be implemented. These options will still allow some reduction in transmission equipment investment by allowing the use of the existing antenna and/or transmitter that already carries the current analogue service.

### **3.4 Service planning**

#### **3.4.1 DRM overview**

Planning procedures within the AM broadcasting bands below 30 MHz need to be considered in two parts. Within the AM bands contained in the LF and MF part of this spectrum, there are pre-existing regional plans which lay down the fixed assignments or allotments to be used for transmissions by each member country of the ITU. In the HF bands, planning is done on a much more flexible basis, which takes into account the diurnal, seasonal and solar variations in propagation when the allocation of spectrum is determined. In the case of MF and LF spectrum two agreements are in force, the Geneva 1975 Agreement, which covers ITU Regions 1 and 3 and employs a 9 kHz frequency grid, and the Rio Agreements of 1981 and 1988, which cover Region 2 and employ a 10 kHz frequency grid. In the case of HF planning, all three regions use the same frequency grid of 10 kHz and planning, for most countries, is carried out through the auspices of the informal HFCC/ASBU/ABU-HFCC coordination process, with the resultant twice-yearly plan being registered at the ITU by administrations.

##### **3.4.1.1 Regions 1 and 3 – LF and MF planning**

Within these two Regions only Region 1 currently has assignments for and uses the LF band. Therefore the majority of assignments for both regions are in the MF band. Under the existing GE75 Plan, existing assignments are listed with their power, antenna details and transmitter location. Any change to this situation, for a particular assignment, requires a recalculation of the transmission parameters to ensure that the protection ratios for other assignments in the Plan, which might be adversely affected by the change, do not deteriorate by more than 0.5 dB. This is also the means by which new assignments have been and can be introduced into the Plan. In September 2002 the ITU Radiocommunication Bureau published Circular Letter CCR/20 under which the RRB with Rules of Procedure to provide the possibility to introduce DRM transmissions into the MF band in Regions 1 and 3 and the LF band in Region 1. Until this issue is agreed by



a competent conference the following course of action may be taken by administrations on a provisional basis.

In the case of existing assignments already within the GE75 Plan the ITU-R Letter allows these to be converted to DRM assignments on the basis that they operate with an average DRM power at least 7 dB below that of the currently assigned analogue DSB service carrier power.

In the case of new assignments, which it is proposed should be introduced under the existing GE75 Plan, planning is carried out as if it were to be a new analogue DSB Assignment. If such a new analogue assignment is allowable within the plan, then it may be introduced as a DRM service, provided it is operated at an average power level at least 7 dB below the allowable new analogue assignment.

In both the above cases it is important to note that only DRM Modes A and B using 9 kHz bandwidth are approved for use under this change in the Rules of Procedure.

#### **3.4.1.2 Region 2 – MF planning**

The introduction of DRM services in the MF band in Region 2, within the confines of the Rio 1981 (R81) Agreement, is much more problematical. This is due to a stipulation to the effect that § 4.2 of Annex 2 to this Agreement imposes on the classes of emission, other than A3E (that is DSB with full carrier), the condition of being receivable by receivers employing envelope detectors. The later Rio 1988 (R88) Plan, which extends the allowable extent of the MF band in this Region, does not impose such a similar condition. However the ITU RRB did not currently feel able to make a determination for a draft change in the Rules of Procedure for either agreement and so DRM services are not currently envisaged as feasible within the MF band in Region 2. This does not entirely preclude the use of DRM transmissions in this band should an Administration wish to authorise its use within its territory on a non-interference and non-protected basis.

The RRB discussed in its determination the question of whether simulcast systems might be allowable under the R81 plan, as they were receivable on a receiver employing an envelope detector. However the Board expressed concern about the bandwidth requirements of such systems, as they generally required between 20 and 30 kHz of spectrum to accommodate both the analogue DSB signal and the digital counterpart.

Except for a single channel simulcast version of the DRM system (see § 3.3), which was not specified at the time of the RRB's determination, all other DRM simulcast proposals involve the use of between 20 and 30 kHz of spectrum. In some Region 2 territories such a system option would be potentially allowable within the terms of locally applied spectrum masks with which broadcast services in the MF band must comply. These spectrum masks are generally more relaxed than the ITU-R transmission spectrum mask and envisage lowered but significant levels of energy being radiated up to 10 or 15 kHz away from the assigned channel centre frequency. In such cases the DRM hierarchical transmission modes could be operated in conjunction with an analogue DSB signal to occupy a total of 20 or 30 kHz of spectrum. The analogue signal, at full assigned power, could occupy 10 kHz of spectrum with the base and enhancement DRM transmissions occupying 5 or 10 kHz of spectrum immediately above and below the analogue signal.

#### **3.4.1.3 Regions 1, 2, and 3 – HF bands**

Due to the diurnal (day/night-time), seasonal and sun spot related variations in propagation which take place in the SW bands, planning requires that frequency schedules are generally valid for only a six month period. For the majority of international SW broadcasters and operators this requires that intended transmissions are coordinated informally through the HFCC/ASBU/ABU-HFC in order to reduce the potential for interference to a minimum. This procedure is equally being observed for the introduction of DRM transmissions into these bands. Under current coordination procedures DRM transmissions may be introduced under similar principles to that in the MF bands. That is the service is first coordinated as if it were an analogue DSB service and then a DRM transmission substituted with a power level at least 7dB lower than the allowable analogue transmission. The provisional protection ratios adopted during WRC03, for the protection of analogue DSB transmissions from DRM transmissions, show small variations according to DRM mode and modulation. However, in all cases, these variations are smaller than the precision of the propagation prediction tools and can be discounted for the purposes of coordination.

#### 3.4.1.4 The 26 MHz SW/HF band

The 26 MHz broadcasting band allocation is seldom used for traditional short-wave broadcasting. This is due to the frequency being too high for reliable sky-wave propagation during most of the 11-year sunspot cycle in most parts of the world. To a lesser degree, the same is true for the 21 and 19 MHz bands. These bands, particularly the 26 MHz one, could easily be used for DRM broadcasting to a more local audience. Tests in Europe have produced very encouraging results. In the UK tests were part of a local single frequency network of 3 transmitting stations for which the power used was only 10 watts per transmitter. Another test using a single 100-200 W transmitter at a high altitude site close to Geneva showed excellent coverage and quality around the city.

For the line-of-sight services, which are proposed within these bands, Modes A, or B are likely to offer the optimum results. It may sometimes be possible, in some countries and with regulatory approval, to employ the wideband 20 kHz option to improve the audio quality still further. To obtain the best performance from this type of service, it is likely that it will need to be planned in a similar way to an FM service. That is with the antenna at a high level, with respect to the coverage area, and with average powers in the range of 100 to 200 W. It must be recognised, however, that for a period of the sunspot cycle around its maximum, significant interference may be experienced to the local service area. This interference is most likely to be caused by high power international 26 MHz transmissions, as conditions will then make these possible. There may also be interference from other, more local, low powered transmissions, if efforts are not made to minimise sky-wave radiation from them.

#### 3.4.1.5 Near vertical incidence sky-wave (NVIS)

This type of propagation is typically used for in-country SW coverage in tropical zones. The "near vertical" geometry causes multiple reflections between ground and the reflecting ionospheric layers. The result is illustrated in Fig. 27, where several significant reflections are seen to arrive at the receiver antenna. It has been observed during transmissions that at certain times of day, such as dawn and dusk, these reflections can have similar energy and be spread over a period of several milliseconds. In order to prevent destructive interference it is important to ensure that these reflections arrive inside the guard interval otherwise the system will fail.

FIGURE 27

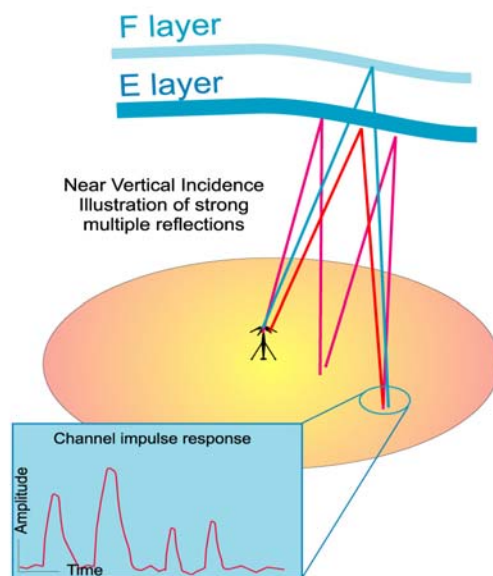

At the same time as these multiple impulses are observed they can also be subject to high values of Doppler spread. This is due to the constant movement of the reflecting layers and is more significant compared to long path reflections, due to the fact that for NVIS the movement represents a greater proportion of the ground to ionospheric distance. The result of the conjunction of these two phenomena is simultaneously high

values of delay and Doppler spread. This can only be overcome by the use of a long guard interval in conjunction with wider frequency spacing for the OFDM carriers. However, because the signal strength can be quite high due to the short paths, signal to noise ratio is often not the limiting factor in NVIS and so 64-QAM may be useable for the MSC. Even so, due to the frequent need to use Mode D because of its higher resistance to Doppler and delay spread, the usable data rate of this mode, in a 10 kHz channel, will be quite low. This low data rate may force the use of CELP+SBR audio coding, rather than AAC, unless it is possible to use the 20 kHz wideband option. In this case AAC+SBR becomes possible providing near mono FM, or even stereo quality in good conditions.

### 3.4.1.6 Single Frequency Networks (SFNs)

Although analogue synchronous networks are often used to provide extended coverage, there will always be problems with mutual interference in at least some parts of the overlap areas. This usually requires the use of additional frequencies to supplement coverage in these areas. With careful design, this problem can be all but eliminated in the case of a DRM SFN. Figure 28 shows a much-simplified arrangement for a DRM SFN, using 6 transmitters. In the area of overlap between areas 1 to 4 it can be seen that signals may be received from all four transmitters at the same time. Provided these signals all arrive within the guard interval they will reinforce each other and reception should be improved in this area over that obtainable from any one transmitter. It is important to note that the transmitted signals must be identical for reinforcement, rather than interference, to occur.

FIGURE 28

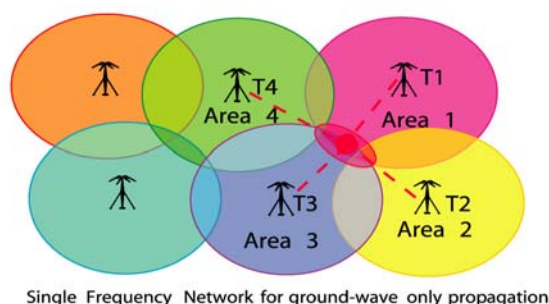

Care will need to be taken however to ensure that the network continues to work effectively after dark. Then sky-wave propagation may allow more distant transmitters in the network to contribute signal into the local service area of parts of the SFN. If the propagation path is of sufficient length, and the signal strength is high enough, it may cause interference due to the sky-wave signal being delayed by more than the guard interval. Preventative measures to be taken could include ensuring that sky-wave radiation is minimised by suitable antenna design and changing to a more robust transmission mode, with a longer guard interval, during times of sky-wave propagation.

SFN operation is, in principle, possible using two or more MF or SW transmitters providing service entirely using sky-wave propagation. However the technical requirements are quite onerous, since each of the signals must be timed to arrive simultaneously over the whole of the coverage area. Otherwise they will cause mutual interference rather than reinforcement. This may require real-time monitoring of signals received at several points in the intended coverage area.

Without this, predicting the propagation transition time from transmitter to receivers in the coverage area may prove difficult to achieve sufficiently accurately in advance.

#### **3.4.1.7 Coverage planning**

At the time of writing there are no planning tools available which have been specifically designed to calculate coverage and availability for DRM transmissions. However a number of DRM Members plan to rectify this situation by setting up a new project to design software planning tools which takes into account the additional propagation parameter needs of the DRM system. For the moment though, it remains necessary to make a calculation of field strength in the target coverage area based on an analogue DSB transmission. This can then be related to the required signal strength for a DRM transmission using a particular combination of robustness Mode, MSC constellation and code rate to provide the necessary SNR for service. For ground-wave services, this method can be expected to provide results close to observed measurements, as the path is simple, and little, if any, multi-path is introduced to cause signal distortions.

For sky-wave services the prediction is much more complex, as the resultant service will depend not only upon the delivered signal strength but on the level of Doppler and Delay spread to which the signal will be subject. Most software based prediction tools either do not estimate these parameters or, if they do, do not produce reliable results. Nevertheless, for the time being, the existing analogue prediction tools will continue to be used, as they are all that is available. However, it is anticipated that new tools will be developed in the near future, which will aim to provide an estimate of these additional propagation parameters. These tools will be designed to recommend the combination of transmission parameters that best meet the needs of a broadcaster for a specific transmission path and target zone.

In general the average power requirements of a DRM transmission will be less than that of the equivalent analogue transmission. In part this is due to the fact that a DRM transmission will have a higher peak to mean ratio than an analogue DSB signal.

A simple analogue DSB signal will consist of a single carrier at zero modulation whilst at 100% modulation there will be the addition of two sidebands which together will increase the power output of the transmitter to 1.5 times the carrier power. The use of power saving, where the carrier level depends on the modulation level, will modify this relationship, so that the average power output and consumption of the transmitter will be lowered compared to the absence of such a system. Because the DRM signal has a peak to mean power ratio of approximately 10 dB the transmitter must be operated in a backed off condition in order to avoid the digital signal being clipped within the various stages of the transmitter. Should excessive signal clipping occur within the transmitter, it would cause the generation of in channel intermodulation products. These products would cause inter-symbol interference and this can impact adversely on the receiver performance.

#### **3.4.1.8 DRM reception monitoring**

An important part of assuring the quality of any radio transmission comes from monitoring the transmitted signals within the target coverage area. In the case of analogue services, this has generally been accomplished by using a high quality receiver for signal reception. The signal strength is then read from a calibrated meter, whilst making a subjective assessment of the audio quality. Such an assessment has historically been made by someone in the target area tuning a receiver to the required service and then listening to it in real time. More recently, this manual method has been supplemented by using unmanned remotely controlled or scheduled receivers to receive the signals and record the signal strength, together with a sample of the audio. The move to using a digital transmission system enables the monitoring of reception to be completely automated. To this end DRM has developed a specification and protocol for the control interface (RSCI). If manufacturers of professional receivers use this specification it will ensure that an operator can use monitoring receivers of more than one manufacturer to build a monitoring network, but use the same software to control and download data from all these receivers. Furthermore this opens the possibility for several operators or broadcasters to share the same receivers, if they so wish.

Because a DRM transmission uses digital coding it facilitates the recording of data that can characterise the reception quality. This information can include not only the signal strength and audio quality, which can be assessed from the audio bit error rate, but also continuous parameters describing the quality and nature of the transmission channel. Over time the accumulation of this information should lead to an improved understanding of the propagation behaviour of the ionosphere.

Data acquired by the monitoring receiver can be stored locally and downloaded from the reception site on a regular basis, to provide evidence of the performance of a particular transmission, or accessed in near real time. In either case the most likely method of transmitting this information back to the broadcaster will be by means of the Internet, or if that is not available, by directly dialling the receiver using a telephone line and modem connection.

In some cases it may be possible to permanently connect to the monitoring receiver(s) either via the Internet, using broadband, or a local network connection or, perhaps, via VSAT terminals. In any of these cases it becomes possible to acquire information about the quality of the service in the target coverage area on a near real-time basis. In this case, by providing a real time method for collating and analysing the reception data, it becomes possible to optimise the transmission parameters of the service(s) in real time. This optimisation process requires the employment of a computer system, which amalgamates the reception data from a number of monitoring receivers in the coverage area. Based on this data, the analysis and prediction algorithm within the computer makes near real-time adjustments to transmission parameters, such as the transmission Mode, MSC modulation and code-rate, to achieve a pre-defined quality of service.

A validation of that concept has been done in the framework of the QoSAM project in 2003 and 2004.

### **3.5 Market impact**

#### **3.5.1 Market complexity; plurality of scenarios and stakeholders**

There is no single switchover pattern or formula. Experiences vary according to the local circumstances and from one network to another. Consequently, the general analysis provided here could only be a simplification. The switchover debate tends to focus on terrestrial TV for two reasons: greater difficulties for a market-led digitisation than other networks; and higher political stakes and government involvement, mainly because of the pressure to recover spectrum, and a wide-spread perception associating terrestrial with universal free-to-air broadcasting services.

Switchover is a complex and long process involving many variables and affecting more or less directly many parties, namely: users/ consumers, industry and public authorities. Each group can be further subdivided into smaller segments. For instance, users can be categorised according to their attitude towards digital TV: current or potential pay-TV subscribers, assuming that all pay-TV will be digital sooner or later; current or potential free-to-air digital TV viewers, who have bought or are ready to buy a digital receiver; viewers who will be always reluctant to adopt any form of digital TV, pay or free-to-air, for various reasons. The switchover strategies adopted will obviously determine, and be determined by, the respective percentage of each user category. In particular, the extent to which market forces alone can achieve digitisation will depend on the number and resilience of consumers reluctant to migrate to digital TV.

Switchover also concerns many industry players, such as content creators, service providers, network operators or equipment manufacturers. Some were already active in the analogue broadcasting market, others look for new business opportunities. Likewise, various departments in national and international administrations are interested in switchover insofar as it affects the achievement of policy objectives.

#### **3.5.2 The case for public intervention**

A key question is whether public authorities should intervene to accelerate switchover and/ or otherwise influence the process. That would be justified under *two premises*: first, the extent to which general interests are at stake; that is, how far there are potential benefits and/ or problems for the society as a whole, rather than just for certain groups or individuals. Secondly, market failure; that is, market forces alone fail to deliver in terms of collective welfare. In other words, market players' behaviour does not fully internalise switchover costs. Assessing the existence and intensity of both premises is largely a matter of political judgement by the competent authority, which, in the case of broadcasting, tends to be national and/ or regional authorities. In any case, such judgement should not be arbitrary but supported by sound market analysis.

As to general interests, potential benefits from digitisation can be oriented towards various policy goals: social, cultural, political, economic, etc. Usually there are trade-offs to make between them. For instance, part of the spectrum released by analogue switch-off could be redistributed in order to transfer this resource

to operators who would use it to support different services or 'reinvested' in broadcasting to improve and extend the service.

The broadcasting sector is not comparable to any other sector, as it plays a central role in modern democratic societies, notably in the development and transmission of social values. Broadcasting offers a unique combination of features. Its widespread penetration provides almost complete coverage of the population across different broadcasting networks; provision of substantial quantities of news and current affairs together with cultural programming mean that it both influences and reflects public opinion and socio-cultural values. Switchover may affect these general interests. It will be important to ensure the continuing availability of a variety of television services, without discrimination and on the basis of equal opportunities, to all parts of the population. In particular, this is a pre-condition for public service broadcasters to fulfil their special obligations.

The likelihood of market failure is linked to the complexity of the environment where switchover takes place, and the interactions between the main parties involved. All have interests to defend and seek to influence the main variables: introduction or not of digital terrestrial TV, speed of the migration and switch-off timing, convenience and type of public intervention. However, coordinated action from the main stakeholders, rather than confrontation of individual strategies, is likely to lead to the collective optimum: a swift and efficient switch-off, with the minimum negative social and economic implications.

At least in the case of terrestrial television and radio, a series of structural failures hinder market co-operation and slow down switchover, notably (free riding) behaviour, oligopoly situations and 'chicken and egg' deadlocks. More specifically, the parties benefiting the most from switchover (equipment manufacturers or potential beneficiaries of released spectrum, including new broadcasters) may be different from those likely to bear the costs (final users or current broadcasters). So the latter have little incentive to internalise the costs and contribute to the switchover. Overcoming this kind of situation would require setting up co-ordination mechanisms to share benefits and costs between all parties involved, ideally with little or no public intervention. In this regard, public authorities, especially those responsible for competition law, must make careful judgements as to the right balance between market competition and cooperation between relevant parties. Those judgements must be based on clear understanding of both market dynamics and policy goals pursued.

### 3.5.2.1 Modalities

If the need for public intervention is established, decisions must be taken about its modalities, within a coherent switchover strategy. Any intervention should be transparent and proportionate as to the policy objectives pursued, market obstacles, and implementing details. This would provide certainty for all parties to prepare themselves and would limit the scope for arbitrary or discriminatory measures.

Five principles and guidelines for regulatory action can be established. Regulation should:

- Be based on clearly defined policy objectives.
- Be the minimum necessary to meet those objectives.
- Further enhance legal certainty in a dynamic market.
- Aim to be technologically neutral.
- Be enforced as closely as possible to the activities being regulated.

A key area in national switchover strategies is the approach to digital broadcasting licensing and regulatory obligations attached thereto. This involves policy choices on network competition versus complementarity, number of operators, roll-out calendar and map, etc. Otherwise, there is a variety of possible intervention instruments and measures to encourage switchover, ranging from encouragement measures, like information campaigns, to compulsory ones, like analogue turn-off dates, or mandatory standards for equipment including digital tuners. They can also vary according to the parties targeted (consumers, equipment manufacturers, broadcasters, potential users of released spectrum, others). The impact of the planned measures should be evaluated through prospective economic analysis to ensure that the expected cost and benefits are fairly distributed; public policy should not lead to situations where some parties will be forced to bear most switchover costs whilst others will enjoy the benefits.

Timing is a key element of any intervention on switchover. Premature or late action can be useless and even counterproductive insofar as it introduces market distortion. Timely intervention requires good knowledge of market status and evolution, and therefore regular monitoring and analysis. In principle, an early switch-off is likely to be more controversial, but a more distant date may reduce any beneficial impact. In this connection, three main phases can be identified in TV switchover: the take-up phase driven by pay-TV, where sooner or later operators convert subscribers to digital; the consolidation phase, starting now in the countries where digital TV is the most advanced, where some consumers decide to equip themselves with digital devices to receive free-to-air digital TV; the closure phase, where users still not interested in any type of digital TV are forced to adopt it, with or without public support for the acquisition of a digital receiver.

Public intervention can support digital TV penetration in all three phases but stronger measures should be confined to the closure stage, after industry has made all possible efforts to increase consumer uptake. This requires that authorities ensure a favourable and predictable regulatory environment, and intensify their action when the market cannot deliver further. That may be the case when it is considered that digital broadcasting is not progressing quickly enough to achieve policy targets.

### **3.5.2.2 Risks**

Broadcasting has a stronger tradition of policy intervention than other information and communication sectors like telecommunications, where the impact of liberalisation has been greater. This is justified by the political and social relevance of broadcasting content, which calls for the enforcement of minimum quality and pluralism requirements. Policy intervention is even greater in the case of terrestrial broadcasting because of its heavy use of spectrum, a scarce public resource, and the already-cited perception associating terrestrial with universal free-to-air TV services.

However, the contexts surrounding the introduction of analogue and digital broadcasting are very different. When analogue broadcasting was introduced, only the terrestrial option existed; there was no competition and the market was entirely shaped by regulatory intervention. Now, there are various types of networks, high market competition and faster technological change. Under these circumstances, the transition to digital broadcasting represents a big industrial challenge that must be led by the market. Intervention from public authorities to facilitate and supervise the process could be justified insofar as general interests are at stake.

The risks from both public intervention or absence of it must be assessed. Non-intervention can result in market failure and jeopardise general interest goals in the sense explained above. As to the risk from public intervention, it includes policy-driven approaches captured by industrial parties seeking to offset commercial risk, thus reducing competition and pressure to innovate. This could result in perverse effects, like ‘moral hazard’ or market inaction, and ultimately slow the switchover process down. In practice, these parties may exaggerate the advantages from digital broadcasting, mixing private and collective benefits. Then, they might persuade authorities to support them (legally, financially or otherwise) in the name of general interests to gain a competitive edge over rivals. If not transparently justified, this could distort the market.

Moreover, public intervention, or the simple announcement of it, that turns out to be inappropriate for any reason (disproportionate, discriminatory, untimely, etc) can be counterproductive. It can create additional obstacles to digital broadcasting uptake, by stimulating an appetite for more public intervention than would have been necessary otherwise. For instance, if a government announces too early that digital receivers will be offered to all remaining analogue users shortly before analogue switch-off, there will be little incentive for those users to buy receivers. Also, untimely imposition of technical standards that are immature or require costly implementation may discourage investment. Finally, all intervention by national authorities must be compatible with existing law.

### **3.5.2.3 Policy orientations**

As explained, market forces must drive the switchover process focusing on users. The challenge is to stimulate demand so that it is a service-led process rather than a simple infrastructure change with no perceived added-value for citizens. Consequently, the various consumer segments must be offered packages of services and equipment that are attractive to them; that is, stimulating, user-friendly and affordable. This is primarily a task for market players.

There is however also scope for policy intervention considering the social and industrial general interest at stake, and that some key elements of the process are the responsibility of public authorities. Such

intervention must be conducted in the first instance by national and/ or regional authorities, which are the most directly responsible for broadcasting content policy and licensing.

### **3.6 General strategy and co-ordination**

#### **3.6.1 Transparent strategy and monitoring**

As indicated, policy transparency improves certainty for market players (including consumers), encourages co-ordinated action, and ultimately facilitates the switchover. Therefore will be important calls upon Member States to publish by end 2003 their intentions regarding a possible switchover. This could cover, in particular, the way they organise and monitor the process, stakeholders' involvement, and policy instruments intended to promote switchover.

At ITU level, comparison of national experiences and regular monitoring would provide useful information on policy and market status. This would help identifying possible actions to develop internal market synergies.

#### **3.6.2 Regulation allowing for business autonomy and co-operation**

Developing digital broadcasting markets is a complex process requiring significant investment from many players to: roll-out networks, develop enabling technologies, sell terminals, offer compelling services, and encourage user uptake. Industry must have incentives to invest and autonomy to search for winning formulas. This requires a stable regulatory environment, including licensing terms for service operators with a duration that enables an appropriate return on investment, taking into account the additional costs caused by the transition and with the possibility of licence renewal so as to provide an adequate incentive. Licensing terms should also facilitate provision of sufficient network capacity to support a variety of services.

However, authorities should monitor market evolution, consult with industry, and be ready to review or flexibly interpret conditions relevant to switchover where justified, for example conditions concerning the calendar for roll-out and territorial coverage, technical choices on transmission and terminals, ownership thresholds, price caps, taxes, simulcast extent and timing, or obligations to provide certain programming. Authorities may have trade-offs to make between a faster switchover and other policy objectives, for instance regarding the degree of pluralism, and they need to consider the impact of policy choices on market competition. The challenge is to find the right balance between different policy objectives while respecting legal requirements, in order to maximise collective welfare. For instance, as argued below, co-ordination and cooperation between different industries is important for switchover. While various public policy objectives can be taken into consideration in this context, competent authorities must ensure maximum transparency regarding such objectives and the necessary means to achieve them. This should go beyond vague references to the goal of digital switchover and/or the Information Society.

Co-ordinated and synchronised action may be necessary to achieve critical mass. Co-operation between industry players at various levels of the value-chain must be therefore facilitated, especially in the initial market stages, which imply trial and error testing. This can be organised through joint investment and risk sharing schemes for technological research, launch of new equipment and services, and promotion. Authorities may contribute through financing or regulation, as is done in some Member States for both digital TV and radio.

Co-ordination is particularly relevant in horizontal markets, such as free-to-air broadcasting. Unlike pay broadcasting, no dominant party controls the value-chain and 'free-riding' behaviour can result in collective business failure. Sharing responsibility for commercial promotion and consumer after-sale service, notably in face of difficulties with signal reception or receiver equipment, is particularly important.

In the case of digital radio, apart from favourable regulatory frameworks in the Member States, it appears that synchronised implementation across the ITU Member States is important to increase market synergies.

#### **3.6.3 Proportionate and technologically neutral regulation**

In terms of political feasibility, switch-off in a given territory can only take place when nearly all households receive digital services. In order to promote the fast and efficient achievement of this objective, all transmission networks should be taken into account (primarily cable, satellite or terrestrial). This approach recognises that network competition contributes to the roll-out process. This implies a regulatory level playing field. In principle, each network should compete on its own strengths. Any public support for one



particular option cannot be excluded but should be justified by well-defined general interests, and implemented in a proportionate way. Otherwise it would appear discriminatory and could jeopardise investments in other networks. In particular, each individual network should not necessarily enjoy the same position in the digital landscape as in the analogue landscape. The objective should be to achieve a fast and efficient switchover. Efficiency should include preserving the general interest missions of broadcasting, while limiting public expense.

Finally, any public financial support to digital broadcasting needs to be compatible with State aids rules and in line with national laws.

### **3.7 Problems related to the interoperability of systems**

In Europe the scenario is as follows.

#### **3.7.1 Digital reception**

Ensuring that most users are equipped with digital receivers is the main challenge for switchover and a pre-condition for switch-off. Finding a solution for all receivers in the home, not just the main receiver, just adds to the challenge. The two basic options are digital converters or set-top-boxes connected to analogue receivers, and integrated digital receivers. Moreover, additional reception facilities such as cabling, antennas, dishes, etc are often necessary.

There must be a large range of digital reception solutions to suit various user segments. This means choice of functionality, price and commercial formulas. Equipment cost is not a major barrier to the consumer of pay-TV services since some pay-TV operators subsidise it, having already deployed millions of set-top-boxes. However, pay-TV will not achieve the widespread penetration of digital TV only. Now the main challenge concerns the creation of 'horizontal' markets for unsubsidised receivers supporting free-to-air digital TV services, where consumers pay the full cost from day one. Co-existence of the two business models is important for wide-spread digital TV market penetration.

Availability of cheap receivers is essential to minimise entry barriers for consumers. Most of them must be equipped before the switch-off can take place. Equipment costs should not be much higher than in analogue and services at least comparable, thus offering a cheap entry point to digital TV. This is the way the market seems to go now. Of course consumers should also have options to buy expensive equipment supporting sophisticated services. Service and equipment diversity also contributes to wide-spread digital TV market penetration.

#### **3.7.2 Encouragement to deployment of digital receivers**

Free movement of goods within the internal market requires that national authorities do not impose administrative constraints for commercialising digital broadcasting equipment and compulsory technical requirements.

Some ITU Member States envisage public subsidies for digital equipment through schemes aimed at the whole population or just specific groups. The risk with the first scheme is discouraging purchases, including purchases of more sophisticated equipment than the one subsidised. The risk with the second scheme is trading of devices between subsidised and unsubsidised population groups.

Several other forms of incentives have been considered by some Member States, for instance temporary and digressive reduction of the licence fee for homes with digital equipment to encourage fast digital migration, etc. Some Member States allow a reduced rate of VAT on pay-per-view and subscription broadcasting services. The financial implications and parties affected are different, so each option should be carefully analysed and implemented.

#### **3.7.3 Consumer information on digital equipment and switchover**

Consumer information is crucial to drive digital equipment sales in a market-led approach to switchover. Consumers should be empowered to plan their own migration rather than being forced and thus deprived by this process. They should be well-informed of the timing and consequences of switchover so as to take their own decisions on services and equipment from a wide range of choices. They must be aware of what various devices can offer, what are the prospects of analogue equipment obsolescence and the possibilities for

upgrading. Information and labelling should also be available in accessible formats for consumers with disabilities.

Informing consumers is the responsibility of equipment manufacturers, retailers and service providers, who need to co-ordinate their action and send clear messages whilst respecting competition law. Labelling schemes for analogue and digital equipment, with explanatory notices and/ or logos, based on voluntary industry commitment, would be particularly useful. The goal would be to send consumers positive and negative signals about, respectively, digital-compliant and analogue-only receiver equipment. This information should mirror national switchover policies, including indicative national or regional switch-off dates. Especially as an analogue switch-off date approaches in a particular Member State, its consumers should be clearly warned about the risks of equipment obsolescence.

Policy intervention in this area has been proposed in some EU and third countries. However, Member States cannot impose *de jure* or *de facto* compulsory labelling schemes without prior notification. Notification enables a compatibility assessment of such measures with internal market rules to be undertaken. Where necessary, a certain degree of harmonisation could be envisaged so that the approach to labelling would be common whilst tailoring its implementation to local circumstances, such as national switch-off dates. Labelling specifications could be approved by consumer and standardisation bodies.

#### **3.7.4 Integrated digital television receivers**

The prohibition of selling analogue-only television receivers according to a staggered calendar has been completely implemented in the United States and debated in some EU Member States. All countries would have to implement the obligation more or less simultaneously to preserve homogeneity within the internal market. This would have greater impact in countries where digital penetration remains low and strain the principle of subsidiarity traditionally applied in broadcasting policy.

Although a potential drawback of compulsory integrated digital receivers would be the extra cost for consumers but the increase is likely to be minimal because of economies of scale.

#### **3.7.5 Digital connectivity**

Digital connectivity raises copyright security concerns, in particular that insufficiently protected digital content could be illegally copied or distributed. A number of options exist to interconnect digital TV equipment, fulfilling different requirements but it is still unclear which way the market will go in the long term as home networking strategies are implemented.

#### **3.7.6 Interoperability of services**

Regarding more sophisticated functionalities such as *Application Programme Interfaces* (API), interoperable and open solutions for interactive TV services must be encouraged. The Member States will decide whether it is necessary to mandate certain standards to improve interoperability and freedom of choice for users. Indeed, these two criteria will likely contribute to consumer uptake of digital broadcasting in a market-led switchover scenario, thus minimising the need for public intervention.

#### **3.7.7 Access for users with special needs**

Access to digital broadcasting should include citizens with special needs, notably people with disabilities and older persons. However, while digital broadcasting offers greater possibilities than analogue in this area, these are not yet supported by digital equipment in some markets. Harmonised approaches can reduce costs through economies of scale, thus facilitating the marketing of relevant functionalities.

#### **3.7.8 Removal of obstacles to the reception of digital broadcasting**

Infrastructure competition stimulates market development, increasing consumer choice, quality of service and price competition. This may be constrained in some areas by legal, administrative or contractual restrictions on the deployment of infrastructure or reception facilities. Authorities will need to arbitrate between promoting digital broadcasting and the fundamental freedom to receive information and services, therefore facilitating network competition, and other policy objectives on town planning, environmental protection or other areas. With that proviso, national authorities should encourage network competition. By way of example, some Member States have already adopted measures in support of this objective, for instance by requiring the provision of multi-network reception facilities in new apartment blocks, facilitating

their installation in existing blocks (for instance by reducing the required threshold of tenants' votes), or by removing restrictive clauses in property or renting contracts. Co-ordination between national and local authorities is important since local authorities are often responsible for the practical implementation of this type of measure.

### **3.8 Precautions to control the direct health effects of RF radiation**

Recommendation ITU-R BS.1698 contains the precautions to be taken into account. Two groups of people are considered in terms of the precautions that can reasonably be taken. The first group is employees at, or regular official visitors to, transmitting stations. Whilst this group may be at a more frequent risk, the extent to which control measures can be applied is much greater than that for the second group, being members of the general public.

#### **3.8.1 Employee (occupational) precautionary measures**

##### **3.8.1.1 Physical measures**

Some form of protective barrier must be provided to restrict access to any area where either the basic biological limits are exceeded or contact with exposed RF conductors is possible. Access to such areas must only be possible with the use of a key or some form of tool. Mechanical or electrical interlocking should be provided to enclosures where access for maintenance is needed. Screening of equipment should be sufficiently effective to reduce the level of RF radiation.

Other physical measures such as warning lights or signs should also be used in addition to, but not instead of, protective barriers.

The risk of shock or burns from RF voltages induced on conducting objects, such as fences and support structures, should be minimized by efficient and properly maintained RF earthing arrangements. Particular attention should be paid to the earthing of any temporary cables or wire ropes, such as winch bonds, etc.

Where such objects need to be handled in a RF field, additional protection from shocks or burns should be provided by the wearing of heavy-duty gloves and through effective labelling.

##### **3.8.1.2 Operational procedures**

RF radiation risk assessments must be carried out by suitably trained and experienced staff at regular intervals and also when any significant changes are made to a transmitting station. The initial objective must include the identification of the following:

- The areas where people may be exposed to “derived” or “investigation” levels.
- The different groups of people, e.g. employees, site sharers, general public etc., who may be exposed.
- The consequences of fault conditions, such as leakage from RF flanges, antenna misalignment or operational errors.

An initial check on the RF radiation levels can be done by calculation or mathematical modelling, but some sample measurements should also be carried out for verification purposes. In most cases, however, measurements will be needed to determine RF radiation levels more accurately. The actual quantities to be measured (E field, H field, power flux-density, induced current) should be determined based on the specific circumstances. These include station frequencies, field region (near/far field) being measured and whether it is proposed to check compliance with basic restrictions (SAR) or only “derived/investigation” levels. These circumstances will also largely determine whether the three individual field components should be measured separately or whether an isotropic instrument should be used. RF radiation surveys should then be carried out by staff trained in the use of such instruments, following prescribed measurement procedures, and recording results in a specified format.

A nominated competent person should be made responsible for the identification and provision of suitable types within any organization or company. Such measuring instruments must always be used in accordance with manufacturers' instructions and be subject to regular functional testing and calibration. Labels showing expiry dates must be fixed to instruments following such tests or calibration. Records of calibration should be kept, including whether adjustments and/or repairs were needed on each occasion. This information should then be used to determine the interval between calibrations.

Systems of work should be implemented that not only ensure that RF radiation limits are not exceeded, but also minimize exposure in terms of time and number of employees. Maintenance work, in areas subject to access restrictions due to high RF radiation levels, should be planned around scheduled transmission breaks or radiation pattern changes where possible. However, there should always be a balance between exposure to RF radiation and other risks, such as working on masts at night, even when floodlit. Where necessary, transmitters should be switched to reduced power or turned off to allow safe access for maintenance or repair work.

Prohibited areas on transmitting stations must be clearly defined and marked, and “permit to work” systems should be implemented. Appropriate arrangements should be put in place for any systems, antennas, combiners or areas shared by other organizations. All staff who regularly work in areas with high levels of RF radiation should be issued with some form of personal alarm or RF hazard meter.

Records must be kept of exposure above specified RF radiation levels. Companies or organizations responsible for operating transmitting stations should monitor the health of staff who regularly work in areas with high levels of RF radiation and take part in epidemiological surveys, where appropriate.

Details of general policies and procedures relating to RF radiation safety should be included in written safety instructions and given to all appropriate staff. In addition, local instructions for each transmitting station should be issued to ensure compliance with such policies and procedures.

Safety training should also include the nature and effects of RF radiation, the medical aspects and safety standards.

### **3.8.2 Precautionary measures in relation to the general public**

#### **3.8.2.1 Physical measures**

Similar considerations apply to the general public, as those detailed in § 3.8.1.1 for employees.

Particular attention should be given to areas where RF radiation limits could be exceeded under fault conditions. Protective barriers should be provided in the form of perimeter fencing, suitably earthed where needed. Additional hazard warning signs will probably be necessary.

#### **3.8.2.2 Operational procedures**

Risk assessments, carried out under § 3.8.1.2 above, must take into account the possibility of members of the public having medical implants. A procedure for providing health hazard information to such potential visitors should be adopted with appropriate restricted access procedures. Basic RF safety instructions should be provided for regular site visitors.

The need to carry out RF radiation surveys beyond site boundaries must be considered, in particular where induced voltages in external metallic structures (cranes, bridges, buildings etc.) may cause minor burns or shock. In carrying out such surveys the possibility of the field strength increasing with distance, usually due to rising terrain, should be taken into account. Where necessary, a procedure for monitoring planning applications or other development proposals should be implemented.

An example which illustrates the text above is given in § 3.10 and Figs. 29 and 30 of this Report.

### **3.9 Precautions to control the indirect RF radiation hazards**

Indirect effects of RF radiation, such as ignition hazards to flammable substances, may occur at levels well below the “derived/investigation” levels particularly at MF/HF. This is because flammable substances may be stored on a site having associated conducting structures, such as pipe work, that could act as a fairly efficient receiving antenna. Actual risks are, however, rare, but may include industrial processing plants, fuel storage facilities and petrol filling stations. Detailed evaluation is, however, far from simple. The general procedure recommended below is, therefore, based on progressive elimination. The detailed precautions adopted will however need to take account of any national standards or legislation in the country concerned.

An initial assessment should be carried out, based on practical, worst case estimates, of the minimum separation needed between a particular type of transmitter and a conducting structure to avoid such a hazard. The first step in doing this is to determine the minimum field strength that might present an ignition hazard for the particular transmitter frequencies in use. This is a function of the type of flammable substance and the

perimeter of any loop formed by metallic structures, usually pipe work, and can most easily be determined from tables or graphs. The vulnerable area should then be determined from this minimum field strength by calculation, mathematical modelling or from tables/graphs.

If the vulnerable area, as determined above, contains any such sites on which flammable substances are stored, or if any are being planned, a more detailed assessment should then be made. This should be based on the actual dimensions of any metallic structures, the gas category of the flammable substance(s) being stored and the measured field strength. This detailed assessment should be carried out by calculation of the extractable power from the metallic structure to determine whether this exceeds the minimum ignition energy of the flammable substance. Should this be the case, then the extractable power should be measured and any necessary modifications to the structure and/or other safeguards implemented.

In a similar category to ignition hazards, is the possible detonation of explosive materials. This will very rarely be encountered but detailed guidance is available from national standards, such as BS 6657 in the United Kingdom. Other indirect effects that should be considered include interference to the safety systems of vehicles, machines, cranes etc. close to, or within the boundaries of, transmitting stations. The immunity of these systems is covered by electromagnetic compatibility (EMC) regulations and CISPR.

Where necessary, precautions similar in principle to those described above may need to be applied.

### 3.10 Field-strength values to be determined

Preliminary, using data given by a number of international and national authorities concerned with the health aspects of EMFs, the range of electrical and magnetic field strengths are shown in Figs. 29 and 30, respectively.

These curves/graphs should not be used as a basis for an administration's regulatory requirements. They represent a composite view of the limits currently depicted and are certain to evolve over time. As such, they are merely illustrative of the methodology that could be applied to develop useful standards within an administration.

Also, it must be recognized that results of independent studies of the subject are not entirely consistent and as a result the interpretation of the results by responsible authorities has in the past and will continue in the future to result in differing requirements in different countries.

FIGURE 29

The range of the electrical field strengths derived from the tables given by international and national authorities concerned with the health aspects of EMFs

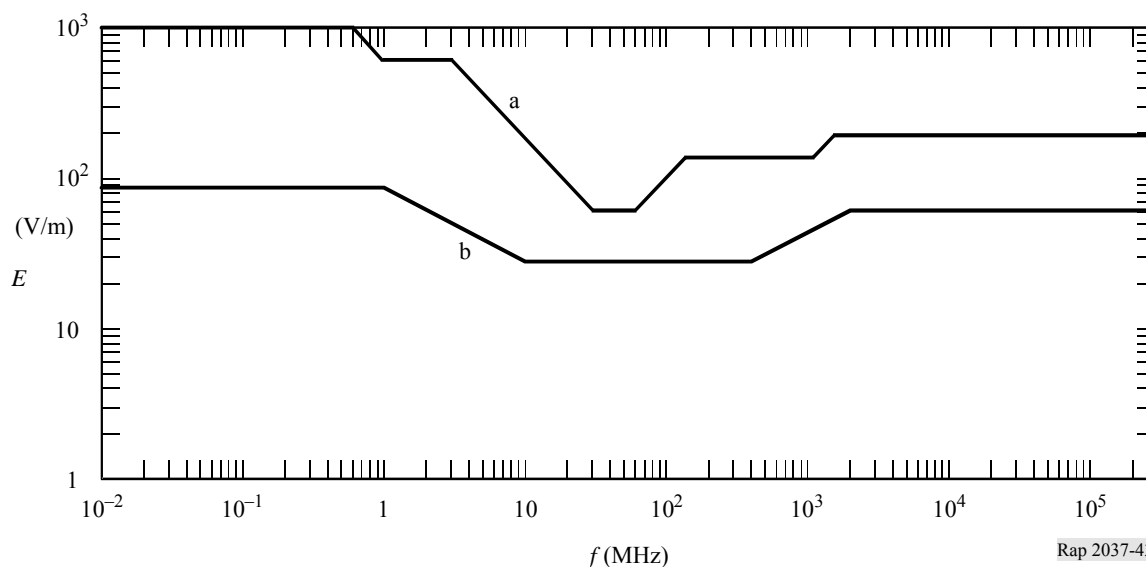

The curves “a” and “b” represent the upper and lower boundaries respectively of some known, existing recommendations for RF exposures levels (presented in this section, as example). All curves from authorities making such recommendation lie between these boundaries, and any curve between curves “a” and “b” should allow adequate broadcasting services.

FIGURE 30

**The range of the magnetic field strengths derived from the tables given by international and national authorities concerned with the health aspects of EMFs**

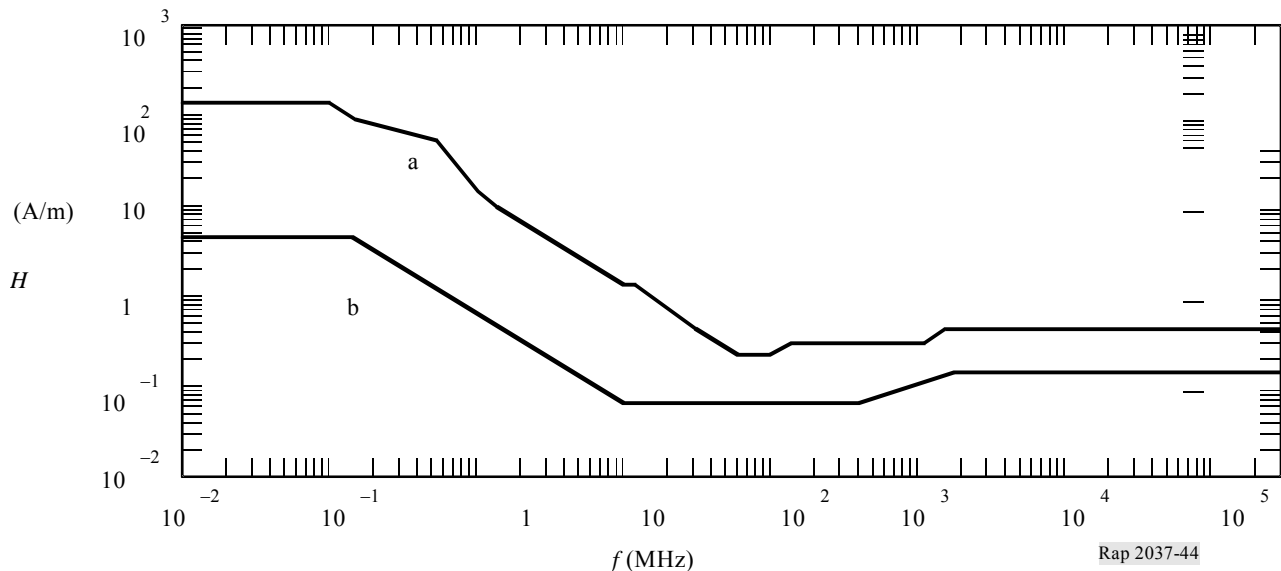

The curves “a” and “b” represent the upper and lower boundaries respectively of some known, existing recommendations for RF exposures levels (presented here, as example). All curves from authorities making such recommendation lie between these boundaries, and any curve between curves “a” and “b” should allow adequate broadcasting services.

The differences between the suggested maximum levels at the same frequency (Figs. 29 and 30) depend on different conditions considered by the various sources suggesting the limits.

### 3.11 Additional evaluation methods

#### 3.11.1 Dosimetry

The application of dosimetric concepts enables the link to be established between external (i.e. outside the body) field strengths and internal quantities of electric field strength, induced current density and the energy absorption rate in tissues. The development of experimental and numerical dosimetry has been complementary. Both approaches necessitate approximations to the simulation of human exposure; however the development of tissue equivalent materials and minimally disturbing probes in the experimental domain and the use of anatomically realistic models for computational purposes have improved the understanding of the interaction of RF fields with the body.

Whereas current density is the quantity most clearly related to the biological effects at low frequencies, it is the specific energy absorption rate (SAR), which becomes the more significant quantity as frequencies increase towards wavelengths comparable to the human body dimensions.

In most exposure situations the SAR can only be inferred from measured field strengths in the environment using dosimetric models. At frequencies below 100 MHz non-invasive techniques have been used to measure induced current, and in extended uniform fields, external electric field strengths have been related to induced current as a function of frequency. In the body resonance region, exposures of practical significance arise in

the reactive near field where coupling of the incident field with the body is difficult to establish owing to non-uniformity of the field and changing alignment between field and body. In addition, localized increases in current density and SAR may arise in parts of the body as a consequence of the restricted geometrical cross-section of the more conductive tissues.

Dosimetric quantities can be calculated by use of suitable numeric procedures and calculational models of the human body. On the other hand such quantities can be measured using suitable physical models (phantoms).

### 3.11.2 Specific Absorption Rate (SAR) measurement

The Specific Absorption Rate, SAR (W/kg), is the basic limit quantity of most RF exposure regulations and standards. SAR is a measure of the rate of electromagnetic energy dissipated per unit mass of tissue.

The Specific Absorption Rate (SAR) may be specified as the value normalized over the whole body mass (sometimes referred to as the “whole body averaged SAR”) or the localized value over a small volume of tissue (“localized SAR”).

SAR can be ascertained from the internal quantities in three ways, as indicated by the following equation:

$$\text{SAR} = \frac{\sigma E^2}{\rho} = C_i \frac{dT}{dt} = \frac{J^2}{\sigma \rho}$$

where:

- $E$ : value of the internal electric field strength in the body tissue ( $\text{V m}^{-1}$ )
- $\sigma$ : conductivity of body tissue ( $\text{S m}^{-1}$ )
- $\rho$ : density of body tissue ( $\text{kg m}^{-3}$ )
- $C_i$ : heat capacity of body tissue ( $\text{J kg}^{-1} \text{ }^\circ\text{C}^{-1}$ )
- $dT/dt$ : time derivative of temperature in body tissue ( $\text{C s}^{-1}$ )
- $J$ : value of the induced current density in the body tissue ( $\text{A m}^2$ ).

The local SAR in an incremental mass ( $dm$ ) is defined as the time derivative of the incremental absorbed energy ( $dW$ ) divided by the mass:

$$\text{SAR} = d/dt (dW/dm)$$

This quantity value is important from two standpoints; the resulting non-uniform distribution of energy absorption when exposed to a uniform plane wave, and the localized energy absorption arising from non-uniform fields in close proximity to a source of exposure.

Exposure regulations or standards contain derived electric and magnetic field limits. The underlying dosimetric concept assures that compliance with the (external) derived levels will assure compliance with the basic SAR limits. However, external or internal SAR measurements can also be used to show compliance. For partial-body near-field exposure conditions, the external electromagnetic fields may be difficult to measure, or may exceed the derived limits although the local SAR is below the basic limits. In these cases internal SAR measurements in body models have to be conducted. The most important methods to measure SAR will be described below.

### 3.11.3 Electric field measurement

The SAR is also proportional to the squared RMS electric field strength  $E$  (V/m) inside the exposed tissue:

$$\text{SAR} = \sigma E^2 / \rho$$

where  $\sigma$  (S/m) is the conductivity and  $\rho$  ( $\text{kg/m}^3$ ) is the mass density of the tissue material at the position of interest. Using an isotropic electric field probe, the local SAR inside an irradiated body model can be determined. By moving the probe and repeating the electric field measurements in the whole body or in a part of the body, the SAR distribution and the whole body or partial-body averaged SAR values can be determined. A single electric field measurement takes only a few seconds, which means that three-

dimensional SAR distributions can be determined with high spatial resolution and with a reasonable measurement time (typically less than an hour).

### 3.11.4 Temperature measurement

The SAR is proportional to initial rate of temperature rise  $dT/dt$  (C/s) in the tissue of an exposed object:

$$\text{SAR} = c \Delta T / \Delta t$$

where  $c$  is the specific heat capacity of the tissue material (J/kgC). Using certain temperature probes, the local SAR inside an irradiated body model can be determined. One or more probes are used to determine the temperature rise  $\Delta T$  during a short exposure time  $\Delta t$  (typically less than 30 s to prevent heat transfer). The initial rate of temperature rise is approximated by  $\Delta T / \Delta t$ , and the local SAR value is calculated for each measurement position. By repeating the temperature measurements in the whole body or in a part of the body, the SAR distribution and the whole-body or partial-body averaged SAR values can be determined.

Three-dimensional SAR-distribution measurements are very time consuming due to the large number of measurement points. To achieve a reasonable measurement time the number of points has to be limited. This means that it is very difficult to measure strongly non-uniform SAR distributions accurately. The accuracy of temperature measurements may also be affected by thermal conduction and convection during measurements, or between measurements.

### 3.11.5 Calorimetric measurement

The whole-body average SAR can be determined using calorimetric methods. In a normal calorimetric measurement, a full-size or scaled body model at thermal equilibrium is irradiated for a period of time. A calorimeter is then used to measure the heat flow from the body, until the model is at thermal equilibrium again. The obtained total absorbed energy is then divided by the exposure time and the mass of the body model, which gives the whole-body SAR. The calorimetric twin-well technique uses two calorimeters and two identical body models. One of the models is irradiated, and the other one is used as a thermal reference. This means that the measurement can be performed under less well-controlled thermal conditions than a normal calorimetric measurement.

Calorimetric measurements give rather accurate determinations of whole-body SAR, but do not give any information about the internal SAR distribution. To get accurate results a sufficient amount of energy deposition is required. The total time of a measurement, which is determined by the time to reach thermal equilibrium after exposure, may be up to several hours. Partial body SAR can be measured by using partial-body phantoms and small calorimeters.

### 3.11.6 Body current measurement

Measurement devices for body current may be carried out in two categories:

- Measurement devices for body to ground current.
- Measurement devices for contact current.

#### 3.11.6.1 Induced body currents

Internal body currents are induced in persons occur from partial or whole-body exposure of the body to RF fields in the absence of contact with objects other than the ground.

The two principal techniques used for measuring body currents include clamp-on type (solenoidal) current transformers for measuring current flowing in the limbs, and parallel plate systems that permit the measurement of currents flowing to ground through the feet.

Clamp-on current transformer instruments have been developed that can be worn.

The meter unit is mounted either directly on the transformer or connected through a fibre-optic link to provide a display of the current flowing in a limb around which the current transformer is clamped. Current sensing in these units may be accomplished using either narrow-band techniques, e.g., spectrum analysers or tuned receivers (which offer the advantage of being able to determine the frequency distribution of the induced current in multi-source environments, or broadband techniques using diode detection or thermal conversion.



Instruments have been designed to provide true r.m.s. indications in the presence of multiple frequencies and/or amplitude-modulated waveforms.

The upper frequency response of current transformers is usually limited to about 100 MHz however air cored transformers (as opposed to ferrite-cored), have been used to extend the upper frequency response of these instruments. Whilst air-cored transformers are lighter and therefore useful for longer term measurements, they are significantly less sensitive than ferrite cored devices.

An alternative to the clamp-on device is the parallel plate system. In this instrument, the body current flows through the feet to a conductive top plate, through some form of current sensor mounted between the plates, and thereby to ground. The current flowing between the top and bottom plates may be determined by measuring the RF voltage drop across a low impedance resistor. Alternatively, a small aperture RF current transformer or a vacuum thermocouple may be used to measure the current flowing through the conductor between the two plates.

Instruments with a flat frequency response between 3 kHz and 100 MHz are available.

There are several issues that should be considered when selecting an instrument for measuring induced current.

Firstly, stand-on meters are subject to the influence of electric-field induced displacement currents from fields terminating on the top plate. Investigations have shown that apparent errors arising in the absence of a person are not material to the operation of the meters when a person is present.

Secondly, the sum of both ankle currents measured with clamp-on type metres tends to be slightly greater than the corresponding value indicated with plate type meters. The magnitude of this effect, which is a function the RF frequency and meter geometry, is not likely to be material. Nonetheless, the more accurate method of assessing limb currents is the current transformer. The precise method of measurement may depend upon the requirements of protection guidelines against which compliance assessments are made.

Thirdly, the ability to measure induced currents in limbs under realistic grounding conditions such as found in practice need to be considered. In particular, the differing degree of electrical contact between the ground and bottom plate of the parallel plate system and the actual ground surface may affect the apparent current flowing to ground (Ref.).

Measurements can be made using antennas designed to be equivalent to a person. This enables a standardized approach to be used and permit current measurements to be made without the need for people to be exposed to potentially hazardous currents and fields.

### **3.11.7 Contact current measurement**

The current measurement device has to be inserted between the hand of the person and the conductive object. The measurement technique may consist of a metallic probe (definite contact area) to be held by hand at one end of the probe while the other end is touched to the conductive object. A clamp-on current sensor (current transformer) can be used to measure the contact current which is flowing into the hand in contact with the conductive object.

Alternative methods are:

- the measurement of the potential difference (voltage drop) across a non-inductive resistor (resistance range of 5-10  $\Omega$ ) connected in series between the object and the metallic probe holding in hand;
- a thermocouple milliammeter placed directly in series.

The wiring connections and the current meter must be set up in such way that interference and errors due to “pick-up” are minimized.

In the case where excessively high currents are expected an electrical network of resistors and capacitors can simulate the body’s equivalent impedance.

### **3.11.8 Touch voltage measurement**

The touch voltage (no-load-voltage) is measured by means of a suitable voltmeter or oscilloscope for the frequency range under consideration. The measurement devices are connected between the conductive object

charged by field induced voltage and reference potential (ground). The input impedance of the voltmeter must not be smaller than 10 k $\Omega$ .

### 3.12 Legal consideration

The legal and health aspects connected with the safety for R.F. services are strategic for the project of one transmitting centre. The values of the field strength should be compatible with the security of neighbouring living people and with the house TV set, telephones, and household appliances. Not only the medical aiding equipment but also the pacemaker, hearing aid systems and other personal aids, may suffer from radio-frequencies interference.

The levels indicated in Fig. 29 of § 3.10 are accepted levels to be maintained at the border of the transmission centre land. The above levels are considered suitable for a radioservice and are to be considered valid also for the quality of a radioservice. Consequently, from the above levels one derives the extension of the controlled area and the location of one transmission centre. Naturally, a transmitter centre located inside a city has much more constraints in comparison with a transmitter centre located in the countryside. Each administration or broadcaster may choose the values of the e.m. reference field (Fig. 29), but, if the value is too low: either the radio services do not have the necessary quality (e.g. because the E.R.P. cannot reach the necessary values), or the necessary land extension is too large with consequent high cost for the construction of the transmission centre.

Currently the sensitivity of the people living near the transmitter centres, is very high for possible problems caused by the radio frequency. For legal consideration one clear indication of the perimeter and extension of the controlled area (where the values of e.m.f. are higher or equal to the values of Fig. 29) should be clearly indicated: one fence, one wall or, at least some appropriate signposting, with indication of e.m.f. value, need to be installed.

From urbanization point of view the construction of residential buildings must be forbidden inside the controlled area. The above aspects connected with the e.m.f. must be treated in the same manner as the ambient ecologic, landscape and panorama problems.

## Appendix 1 to Part 2

### 1 Australia

#### 1.1 Digital terrestrial television broadcasting in Australia

Australia is served by an extensive network of PAL-B analogue, and more recently by DVB-T digital, terrestrial television broadcasting transmitting sites. A feature of the transmitter deployments in Australia is that a very large proportion of the population receives signals from a relatively small number of high power “main station” transmitters that have large coverage areas, typically 100-150 km in diameter. Radiated power levels at main station VHF Band III transmitters can be up to 500 kW e.r.p for analogue and up to 100 kW e.r.p. for digital. The radiated power levels at main station UHF Band IV and V transmitters can be up to 2 000 kW e.r.p for analogue and up to 1 250 kW e.r.p. for digital.

As a consequence of the sparse distribution of terrestrial transmitter sites, analogue main station assignments in Australia were generally planned on the basis of noise-limited reception rather than interference limited reception. This has meant that the so-called analogue taboo channels (e.g. adjacent channels, image channels and local-oscillator channels) are usually unencumbered by other (out-of-area) TV signals. Most of the population of Australia has access to five free-to-air analogue TV services.

In introducing digital television, Australia has planned for seven digital television networks in most areas - a digital network for each of the existing analogue networks plus two new digital networks. Australian digital television services commenced in metropolitan regions on 1 January 2001 and subsequently have been progressively deployed in regional areas. The relevant federal government legislation stipulated a simulcast period of eight years. During the simulcast period, existing analogue television transmissions have continued and an additional digital signal has been brought into service. The digital service is required to carry a standard definition (SDTV) digital version of the programmes being provided on the analogue service.

In December 2007 the Australian government changed the simulcast period, announcing that 31 December 2013 will be the date by which the last analogue transmitter will be switched off.

#### 1.2 DTTB System Selection

The first step in the DTV conversion process was a comparative assessment process that led to the selection of DVB-T (8k carrier mode) as the preferred digital television transmission standard and the determination of system planning parameters such as interference protection ratios and minimum required signal levels. The availability of this information permitted the conduct of a preliminary study of possible DTV channel allocations. The conclusions of this preliminary study showed that it would be possible to allocate a complete TV channel (7 MHz wide in Australia at both VHF and UHF) to each existing analogue service to permit its conversion to DTV as well as provide additional channels for new digital-only services.

In 1998 legislation that set the framework for the establishment of DTV services was passed by the Australian Parliament. In that legislation the government determined that each broadcaster would be loaned spectrum to provide a digital service that matched the coverage of the analogue service as closely as possible. Further legislation was also enacted to establish the detail of the regulatory regime to apply to the provision of digital television and datacasting.

#### 1.3 Simulcast of SDTV and HDTV programmes

The Australian government has been committed to ensuring that digital television would be as affordable as possible. Although broadcasters have been required to provide at least a minimum amount of high definition television programming for those who can afford HDTV sets, they have also been required to provide their broadcast in SDTV format. SDTV programming provides viewers with a picture quality that is generally superior to the analogue television service. Currently two additional SDTV digital-only programme streams are transmitted on national broadcaster networks and three more commercial SDTV programme streams could be available from 1 January 2009. The transmission of SDTV format programming not only provides viewers with the ability to access the additional features of digital broadcasting, but also provides consumers with a digital conversion path that is cheaper than the alternative approach of purchasing a HDTV set or a HD set top box.

HDTV is a key feature of digital terrestrial television in Australia. Broadcasters are required to transmit HDTV programmes for a minimum of 1 040 hours per year. The government has not specified any particular technical parameters for HDTV, and broadcasters have been able to adopt and use of the MPEG-2 MP@HL format for transmission (i.e. 576/50p, 720/50p, 1080/50i). However, Australian broadcasters have expressed a preference that programme production and exchange should be based on 1080i line formats.

By requiring both SDTV and HDTV programming, viewers have been given a choice in digital television products but at the same time allowed broadcasters scope to demonstrate the appeal of HDTV.

#### **1.4 Use of Single Frequency Networks (SFNs)**

Digital television services have been introduced in Australia, using either a multi-frequency network (MFN) or a single frequency network (SFN) approach. In either case, the digital television service is provided from a network that consists of a high-powered central (or parent) transmitter that may be supported by, or contribute signal to off-air feed, a number of low-powered in-fill or area-extension re-transmitters.

In the MFN case, the re-transmitters operate on a different channel (or channels) from the parent transmitter while, in the SFN case, the re-transmitters may either operate on the same channel as the parent transmitter (if not an off air feed); or on another channel in one or more SFN re-transmission networks, which can be off air feed from the parent<sup>3</sup>.

In the later case, the parent transmitter is operated in the MFN mode, albeit with SFN timing information embedded into the signal for use by the SFN re-transmission network(s). In a few cases more than one parent transmitter, together with their re-transmitters operate as an SFN.

#### **1.5 Planning parameters and interference threshold limits**

Australia's planning for digital television services takes into account a legislated requirement that "... in SDTV digital mode in that area should achieve the same level of coverage and potential reception quality as is achieved by the transmission of that service in analog mode in the same area". Following this approach, Australia's digital services are typically planned with a maximum e.r.p. of 6 dB less than same band analogue television services.

Planning guidelines in Australia also specify minimum median field strengths (referred to a measurement height of 10 m above local terrain) of 44, 50 and 54 dB $\mu$ V/m for Band III, IV and V digital television services respectively<sup>4</sup>. To minimise the "cliff-effect", digital television services are planned to achieve the required protection ratio for better than 99% of the time, irrespective of whether the interference is considered to be continuous or tropospheric in nature.

#### **1.6 Comparison of ITU-R and Australian television planning parameters**

The following text summarises differences between Australian television planning parameters, including minimum field strengths and protection ratios and the corresponding Recommendation ITU-R BT.1368 parameters for the protection of DVB-T digital television services.

Australian planning for both analogue and digital terrestrial television is based on an assumption of fixed reception using outdoor receiving antennas. Therefore protection ratios relevant to Ricean channels are used where available. The DVB-T mode 64-QAM with 2/3 FEC and a 1/8 guard interval has been adopted as the basis for digital television planning, however to achieve a higher picture quality for the SD/HD simulcast, most broadcasters have selected 64-QAM with 3/4 FEC and 1/16 guard interval.

#### **1.7 Digital television minimum median field strengths**

Australian digital television planning is based on provision of minimum median field strength levels of 44, 50 and 54 dB $\mu$ V/m in Bands III, IV and V respectively. These values are reasonably close to the values that can be derived from the sample calculation value provided in Table 44 of Recommendation ITU-R

<sup>3</sup> In a limited number of cases a parent station may feed several SFNs that may each operate on a different channel.

<sup>4</sup> Refer [http://www.acma.gov.au/WEB/STANDARD/pc=PC\\_91853](http://www.acma.gov.au/WEB/STANDARD/pc=PC_91853).

BT.1368-7<sup>5</sup>. The Australian values are, respectively, 0.1, 0.9 or 2.8 dB higher than values that would be derived from the Recommendation. The differences are due to: inclusion of a 1 dB higher receiver noise figure allowance in Bands III and V; use of 6.7 rather than 7.6 MHz for the receiver bandwidth; inclusion of a 1 dB allowance for man-made noise in VHF Band III; different combinations of antenna gain/feeder loss in Bands III and IV; and, use of frequencies at the top rather than the middle of each band as the reference frequency for the calculation. The Australian minimum field strength calculations also include a 1 dB ‘Interference Margin’ for the support of co-channel, frequency re-use planning.

## 1.8 Digital television protection ratios

Protection ratios for digital-digital and digital-analogue co-channel and adjacent channel interference from other television broadcasting services were first defined in July 1999. Only minor changes have been made to those original values. The values used in Australian planning are the same as the 64-QAM, 2/3 FEC values set out in Recommendation ITU-R BT.1368-7<sup>6</sup>.

The relevant protection ratios are not to be exceeded for more than 1% of the time. That is, the E(50,1) value is used for the interfering field strength.

## 2 Brazil

The digital terrestrial television broadcasting channel planning and the deployment of the DTTB in Brazil.

### 2.1 Introduction

This chapter presents the work that has been conducted by the National Telecommunications Agency (Agência Nacional de Telecomunicações - Anatel) related to channel planning regarding the introduction of the Digital Terrestrial Television Broadcasting (DTTB) in Brazil and the stages for its deployment. The text consolidates three contributions (RGQ11-1/2/93-E, 95-E and 185-E) submitted by the Brazilian Administration to the Rapporteur’s Group on Question 11-1/2 during the meetings held on September 8<sup>th</sup> 2003 and May 31<sup>st</sup> 2004, both in Geneva. The Rapporteur’s Group Meeting of September 2003 “proposed that the contributions of Brazil should be documented on the ITU Web site as a case study on the introduction of digital terrestrial TV broadcasting”(2/REP/012-E). This proposal was approved in the Plenary Session of the Study Group 2 on September 11<sup>th</sup> 2003. As a result of these decisions, this Annex presents the methodology, the results and the current work Anatel is undertaking on the completion of the DTTB channel planning. In addition, it is important to observe that the country’s channel planning is not related to any specific DTTB standard, since it contemplates the particularities of each existing DTTB standards.

### 2.2 Methodology applied for digital terrestrial television channel planning and its respective results

This section describes the methodology applied by Brazil to prepare its channel planning for the deployment of the DTTB in the country and its results. The applied methodology is independent of the DTTB standard adopted. A working group under the coordination of Anatel and representatives from the Brazilian TV networks has been working on digital terrestrial television channel planning since 1999.

#### 2.2.1 Digital television channel planning strategy

When it comes to coverage, Brazilian TV networks present quite different characteristics among themselves. They can be either regional networks or national networks, which encompass regional networks, or eventually independent full TV station with strict local penetration. Figure 31 indicates the distribution of full TV stations (in stars) and relay stations (in circles) of a particular Brazilian network with distributed generation and national penetration.

<sup>5</sup> Australian planning is based on provision of a service at 80% of locations within 200 m by 200 m areas. A 4.5 dB correction factor is applied to convert from a 50% of locations to an 80% locations field strength value.

<sup>6</sup> The original 1999 values were adopted following protection ratio measurements made in 1998 using the “traditional” wanted-to-wanted protection ratio measurement approach, rather than the more recent  $C/(I+N)$  approach that appeared in Recommendation ITU-R BT.1368-1 (and later revisions).

The preparation of the Basic Plan for DTTB began in September 1999. Since then, specific premises have been established. They are as follows:

- digital television will replace existing analogue TV by using UHF (channels 14 to 69) frequency bands;
- the main objective of channel planning is to assure that digital television stations will have service areas similar to their corresponding analogue stations service areas;
- during the initial stage called the ‘transition period’, analogue and digital channels will perform simultaneous broadcast (simulcasting);
- digital television planning will be carried out in three phases: “Phase 1” only for those cities where active full TV stations are in place and, in a later stage; “Phase 2” for those cities whose population is over one hundred thousand inhabitants with only television relay stations; and “Phase 3” for others cities with television relay stations;
- whenever is possible, digital stations will have to operate on the maximum power of its class<sup>7</sup>.

FIGURE 31

Network with distributed generation and national penetration (Phases 1 and 2)

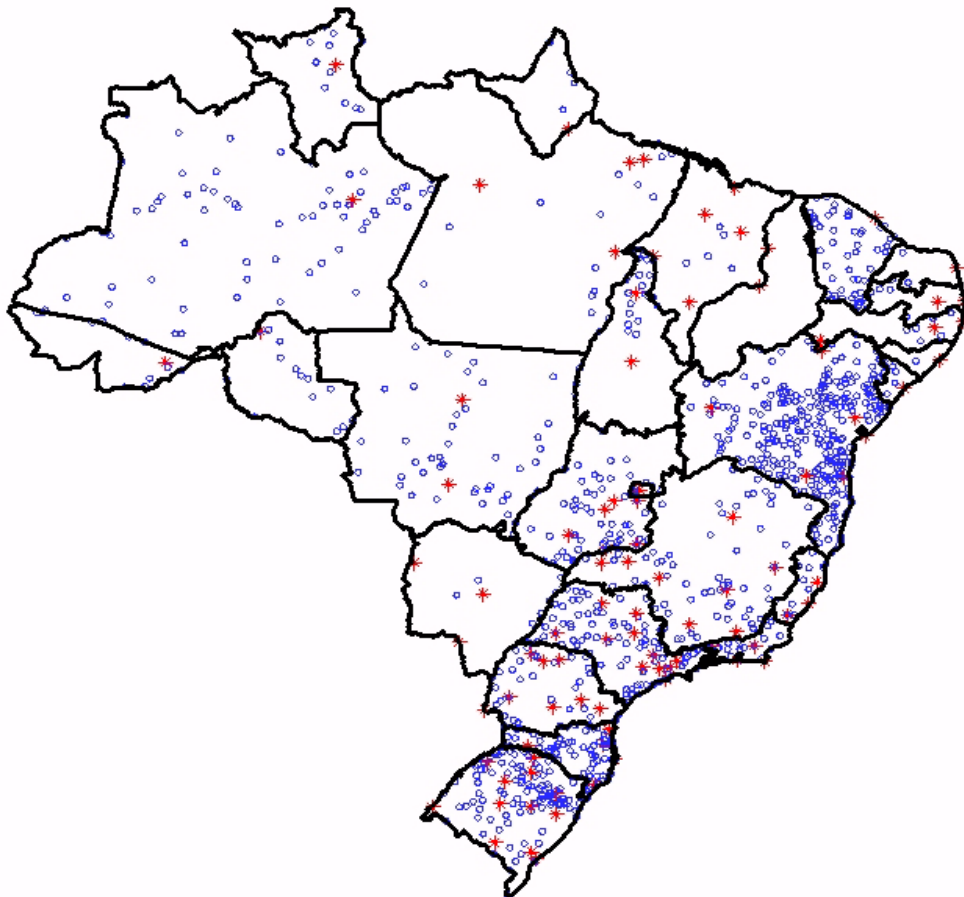

<sup>7</sup> Brazilian TV Stations are classified into Special, A, B or C Class according to the ERP (Effective Radiated Power) that they are authorized to transmit by Anatel. The ERP limits for each class are defined in the national technical regulation for television broadcasting.

Because of the preparation for the Basic Plan for Digital Television Channel Distribution (PBTVD<sup>8</sup>), Anatel has suspended, from October 1999 to April 2005, allocation of new analogue channels, and changes of the technical characteristics in the existing channels in regions of Brazil under heavy spectrum usage. From February 2002 to April 2005, the same policy was applied to the remaining regions. After the publication of the PBTVD, item 1.3.3, Anatel resumed activities on the analogue channels allotment plan, proceeding with the inclusion of new analogue channels. It's important to observe that PBTVD will continue to use the frequency band currently allocated to analogue transmission.

### 2.2.2 Phases of digital television channel planning

The channel plan studies were divided in three phases. The first phase focused on making digital channels available to broadcast simultaneously with a specific and already existing analogue channels, those authorized to provide television service on municipalities where at least one generator station covers.

The second phase focused on the availability of digital channels for simulcasting in municipalities with population above one hundred thousand inhabitants and that are covered only by relay stations. This phase also included a review of the first phase, in order to meet the demand in all municipalities to which authorizations to install new television operating networks were granted after the beginning of the first phase.

In the year of 2006, Brazilian government initiated the third phase of digital channel planning studies. This phase deadline is June 2011. It includes the allotment of digital channels for the relay stations on the remaining cities and a digital channel revision on the previous phases allotment plan.

### 2.2.3 Channel planning results

The first phase, concluded in September 2002, made available 1 151 digital channels in 164 municipalities, as presented in Fig. 32.

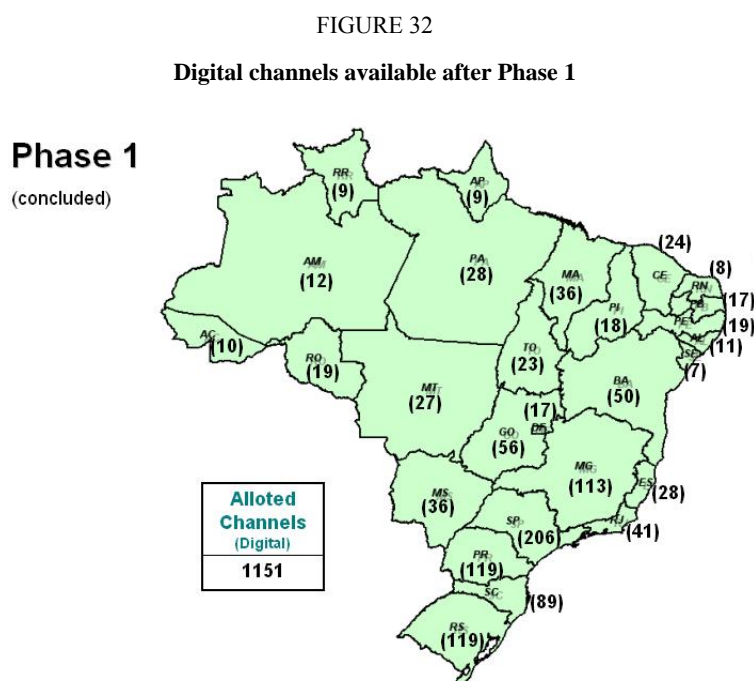

<sup>8</sup> Basic Plan for Digital Television Channel Distribution (PBTVD) is the official name designated for the Digital Television Allotment Plan in Brazil.

The second phase, concluded in March 2003, made further allocation of 742 digital channels in 132 municipalities. As a result of the conclusion of both Phases 1 and 2, 1893 channels were made available for the introduction of Digital Terrestrial Television Broadcasting (DTTB) in Brazil as presented in Fig. 33.

FIGURE 33  
Results obtained after the conclusion of Phase 2

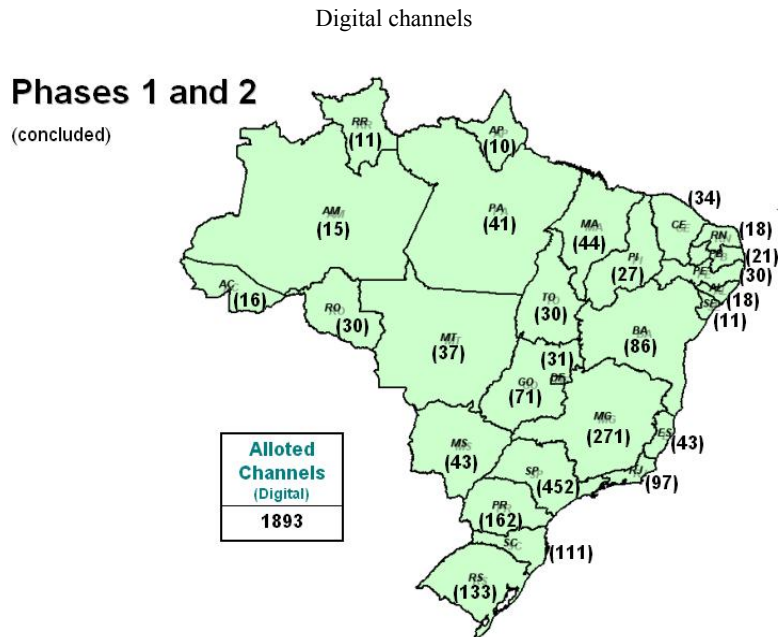

After the conclusion of the third phase, which is currently in progress, it's planned 6 144 digital channels in Brazil, as presented in Fig. 34.

FIGURE 34  
Digital channels allotted after the conclusion of Phase 3

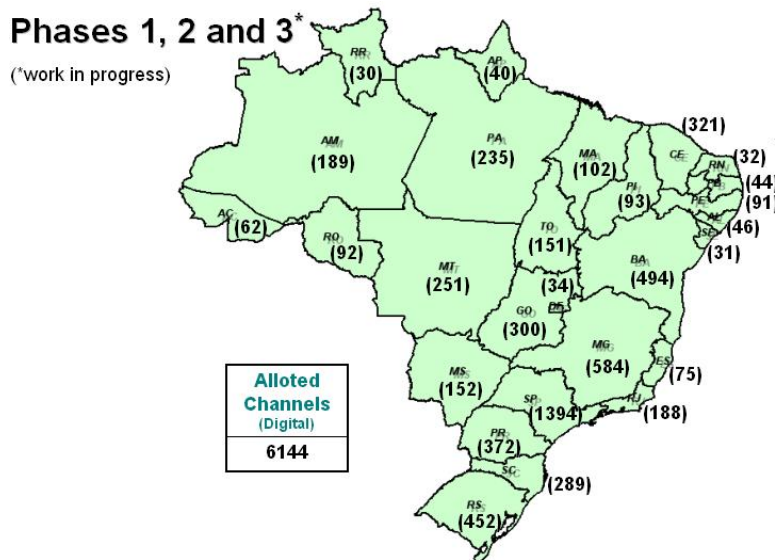



The Basic Plan for Digital Television Channel Distribution (PBTVD) has been successful in assuring that the service areas of digital television stations is similar to its related analogue stations. The PBTVD encompasses 296 Brazilian municipalities, whose total population is approximately 110 million inhabitants. These municipalities are either covered by a generator television station service or their population is over one hundred thousand inhabitants and there is, at least, one operating relay station in the city. Only in service analogue channels were taken into account for the channel planning. Therefore, up to August 2008, 2 157 digital channels have been made available by the National Telecommunications Agency (Agência Nacional de Telecomunicações - Anatel) and there will be more than 6 100 digital channels in Brazil until 2013. Thus, more than 12 200 channels, analogue or digital, will be available during the “simulcast” period from 2013 to 2016.

### **2.3 Legislation and Regulatory adjustments for the deployment of Digital TV in Brazil**

In order to deploy the Brazilian System of Digital TV (SBTVD), adjustments to the legislation and to the regulatory framework were needed. This process had five important stages, as listed below.

#### **2.3.1 Stage 1: Creation of the Brazilian System of Digital Television (SBTVD)**

The first stage: the creation of the Brazilian System of Digital TV (SBTVD), was initiated by the Decree 4.901, of 26 of November of 2003, which:

- Established the aims of the Brazilian System of Digital Television (SBTVD).
- Created the Development Committee of the SBTVD with the scope of studying and elaborating a report<sup>9</sup> with proposals for:
  - 1 The definition of the reference model for the Brazilian system of digital television.
  - 2 The standard of television to be adopted in the Country.
  - 3 The form of exploitation of the digital television service
  - 4 The period and framework of the transition from analogue to digital system.
- Created an Advisory Committee and a Steering Group, which jointly compose the SBTVD, along with the Development Committee.

#### **2.3.2 Stage 2: Digital Technology updates in regulatory documentation**

The Stage 2, which was based on digital technology updates in the regulatory framework, was approved by Anatel Resolution N. 398, on April 7<sup>th</sup> 2005<sup>10</sup>. This Regulatory document presents technical aspects of sounds and images broadcasting and television retransmission, with the purpose of:

- Ensuring the quality of the signal in the coverage area.
- Preventing harmful interferences over currently authorized, and already installed, telecommunication stations.
- Establishing the technical criteria of viability projects designing, especially those regarding to inclusions in channel allotment plans, and modifications on technical installations.

The revision of the technical regulation for television broadcasting also included the procedure for calculation of viability involving channels of Digital TV<sup>11</sup> and the adoption of Recommendation UIT-R P.1546<sup>12</sup>.

---

<sup>9</sup> [http://sbtvd.cpqd.com.br/cmp\\_tvdigital/divulgacao/anexos/76\\_146\\_Modelo\\_Ref\\_PD301236A0002A\\_RT\\_08\\_A.pdf](http://sbtvd.cpqd.com.br/cmp_tvdigital/divulgacao/anexos/76_146_Modelo_Ref_PD301236A0002A_RT_08_A.pdf)

<sup>10</sup> [http://www.anatel.gov.br/Portal/documentos/biblioteca/resolucao/2005/res\\_398\\_2005.pdf](http://www.anatel.gov.br/Portal/documentos/biblioteca/resolucao/2005/res_398_2005.pdf)

<sup>11</sup> [http://www.anatel.gov.br/Portal/documentos/biblioteca/resolucao/2005/anexo\\_res\\_398\\_2005.pdf](http://www.anatel.gov.br/Portal/documentos/biblioteca/resolucao/2005/anexo_res_398_2005.pdf)

<sup>12</sup> [http://www.anatel.gov.br/Portal/documentos/biblioteca/resolucao/2005/anexoii\\_res\\_398\\_2005.pdf](http://www.anatel.gov.br/Portal/documentos/biblioteca/resolucao/2005/anexoii_res_398_2005.pdf)

### 2.3.3 Stage 3: Creation of Basic Plan for Digital Channel Distribution (PBTVD)

The Stage 3 startup occurred with the publication of Anatel Resolution 407, on June 10<sup>th</sup> 2005<sup>13</sup>. This document approved the Brazilian Digital Television Channel Allotment Plan, officially named as Basic Plan for Digital Channel Distribution - PBTVD<sup>14</sup>, referred to in item 1.2.3, Fig. 33. It also allocated, considering the guidelines discussed on item 1.2.1, 1893 digital television channels in 306 localities. In sum, in 2005, the Basic Plan of Distribution of Television Channels (PBTVD) contained a total of 473 generator TV stations (analogue stations), 9845 relay TV stations and 1207 stations in cities where its populations is more than one hundred thousand inhabitants

### 2.3.4 Stage 4: Definition of the Digital Terrestrial Television system and the transition period guidelines

The Stage 4 started with the Decree No 5,820, on June 29<sup>th</sup> 2006<sup>15</sup>, defining that the SBTVD-T would adopt, as a base, the standard of signals designed by ISDB-T (Integrated Services Digital Broadcasting), also incorporating the technological innovations approved by the Development Committee. Beyond those definitions, the document presented the guidelines for the transition period from analogue to digital TV. The Decree also laid down the following points:

- Creation of the SBTVD Forum<sup>16</sup>;
- Made possible:
  - Simultaneous fixed, mobile and portable transmission.
  - Interactivity.
  - High Definition (HDTV) and Standard Definition Television (SDTV).
- Defined the consignment of one digital channel for each existing analogue channel, regarding the transition period. The preference is for the digital channel allocation in the UHF band (channels 14 - 59), rather than in the VHF band - high (channels 7 - 13).
- Deployment sequence, first starting with the TV stations.
- Established that, after signing the assignment contract, the installation projects must be submitted by the broadcasting companies to the Ministry of Communications within 6 months. Afterwards, the digital transmissions should start within 18 months.
- Defined that, after July 1<sup>st</sup> 2013, only digital technology television channels will be granted by the Ministry of Communication for television broadcasting.
- Defined the date of June 29<sup>th</sup> 2016 as the switch-off date of analogue transmission.

Creation of 4 (four) digital public channels for the national Government.

### 2.3.5 Stage 5: Establishment of conditions for assignment contract of the additional channel for the digital and analogue simultaneous transmission

The Ministry of Communication (MC) ordinance N° 652<sup>17</sup>, which has been published on the 10<sup>th</sup> of October, 2006, initiated Stage 5 by establishing the assignment contract conditions for the additional channel, which

---

<sup>13</sup> [http://www.anatel.gov.br/Portal/documentos/biblioteca/resolucao/2005/res\\_407\\_2005.pdf](http://www.anatel.gov.br/Portal/documentos/biblioteca/resolucao/2005/res_407_2005.pdf)

<sup>14</sup> [http://www.anatel.gov.br/Portal/documentos/biblioteca/resolucao/2005/anexo\\_res\\_407\\_2005.pdf](http://www.anatel.gov.br/Portal/documentos/biblioteca/resolucao/2005/anexo_res_407_2005.pdf)

<sup>15</sup> [http://www.planalto.gov.br/ccivil/\\_Ato2004-2006/2006/Decreto/D5820.htm](http://www.planalto.gov.br/ccivil/_Ato2004-2006/2006/Decreto/D5820.htm)

<sup>16</sup> <http://www.forumsbtvd.org.br>

<sup>17</sup> <http://www.mc.gov.br/sites/600/695/00001879.pdf>

shall be used during the digital and analogue simultaneous transmission period (Simulcast). It has also included the schedule for the transition, as defined below:

- The assignment contract will observe the PBTVD.
- The digital channel will have to:
  - I Provide the same coverage as its analogue counterpart;
  - II Provide efficient management of the analogue and digital transmissions;
  - III Prevent interferences.

FIGURE 35

**Transition period in Brazil (analogue to digital television)**

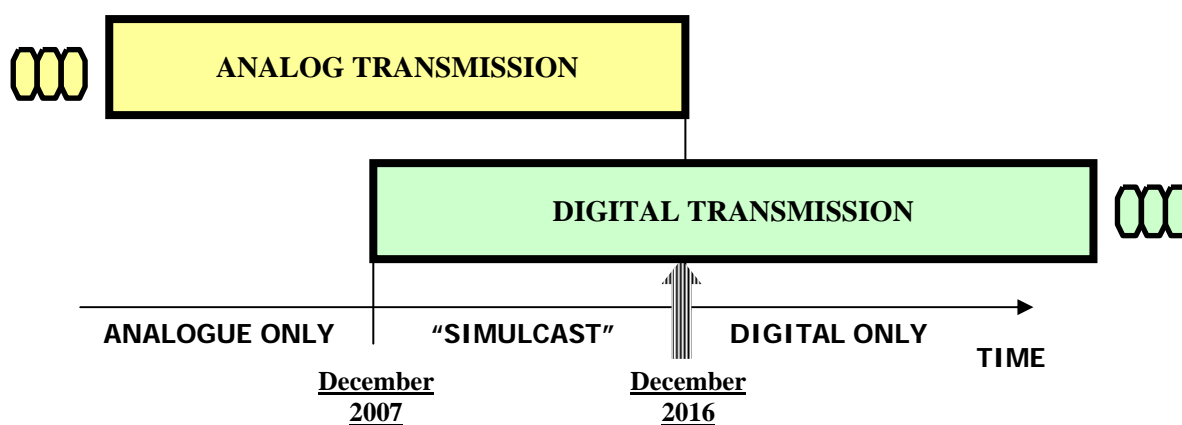

Table 7 presents the planning phases for assignment contracts of additional channels and the schedule for their commercial deployment.<sup>18</sup>

According to the plan, migration priority is given to generator TV stations and, later, to the relay stations located in Capitals and the Federal District. The signing of assignment contracts by relay station operators in the remaining cities will take place at the last stage.

After the assignment contract is signed, the TV Broadcaster may start to test and then commercially deploys the system.

<sup>18</sup> <http://www.forumsbtvd.org.br/cronograma.php>.

TABLE 7

**Schedule for the assignment contract and commercial deployment of Digital TV**

Phase of planning (Item 1.2.3)	Station TV type	Cities (Group)	Assignment contract schedule	Commercial deployment schedule
Phase 1	TV stations	São Paulo (SP)	Up to 12/29/2006	12/29/2007
Phase 1	TV stations	Belo Horizonte, Brasília, Rio de Janeiro, Salvador e Fortaleza (G1)	Up to 11/30/2007	Up to 01/31/2010
Phase 1	TV stations	Belém, Curitiba, Goiânia, Manaus, Porto Alegre e Recife (G2)	Up to 03/31/2008	Up to 05/31/2010
Phase 1	TV stations	Campo Grande, Cuiabá, João Pessoa, Maceió, Natal, São Luis e Teresina (G3)	Up to 07/31/2008	Up to 09/31/2010
Phase 1	TV stations	Aracaju, Boa Vista, Florianópolis, Macapá, Palmas, Porto Velho, Rio Branco e Vitória (G4)	Up to 11/30/2008	Up to 01/31/2011
Phase 1	TV stations	Other Cities with TV Stations (G5)	Up to 03/31/2009	Up to 05/31/2011
Phase 2	Relay stations	Cities of the Groups SP, G1, G2, G3, G4 (Capitals and Federal District)	Up to 04/30/2009	Up to 06/31/2011
Phases 2 and 3	Relay stations	Other Cities with Relay Stations	Up to 04/30/2011	Up to 06/30/2013

**2.4 The Brazilian Digital Television System (SBTVD) Forum**

After the release of Presidential Decree 5,820, the role of private organizations in the development of DTT was intensified, mainly because of the SBTVD Forum.

The Forum is a nonprofit entity, whose main objectives are supporting and fostering the development and implementation of best practices to the Brazilian digital television broadcasting success. The most important participants of broadcasting, reception-and-transmission-equipment-manufacturing, and software industries are part of this Forum.

The Forum's main tasks are: to identify and harmonize the system's requirements; to define and manage the technical specifications; to promote and coordinate technical cooperation among television broadcasters, transmission-and-reception-equipment manufacturers, the software industry, and research-and-education institutions; to propose solutions to matters related to intellectual property aspects of the Brazilian DTT system; to propose and develop solutions to matters related to the development of human resources; and to support and promote the Brazilian standard in the country and overseas.

Besides the private sector, federal government representatives also participate in the Forum. And such participation is considered very important, since it allows those representatives to closely follow the discussions taking place, while strengthening the relationship between forum members and public regulators.

**2.4.1 Objectives**

The Forum of Brazil's Terrestrial Digital TV Broadcasting System was formally instated in December 2006. The Forum's mission is to help and encourage the installation or improvement of the digital sound and image transmission and receiving system in Brazil, promoting standards and quality that meet the demands of the users.

The purpose of this Forum is to propose voluntary or mandatory technical norms, standards, and regulations for Brazil's terrestrial digital television broadcasting system, and, in addition, to promote representation, relations, and integration with other national and international institutions.

## 2.4.2 Structure and Composition

There are three membership categories: Full Members, Effective Members, and Observers. The full members, who have the right to vote and the obligation to pay annual dues, belong to the following sectors:

- a) Broadcasting stations.
- b) Manufacturers of receiver or transmitter equipment.
- c) Software industry.
- d) Teaching and research institutions that carry out activities directly involving Brazil's digital TV system.

Effective members come from sectors that are different from those mentioned previously, but they must also pay annual dues. The observer members are those who, when formally invited by the Council, accept to enter the Forum, without any voting rights and without the obligation to pay annual dues.

The Deliberative Council is comprised of 13 councilor members elected by the General Assembly. The Council shall be able to draw up general policies of action, strategies, and priorities, adopt the results of the work, and refer them to the Development Committee of the Federal Government.

FIGURE 36

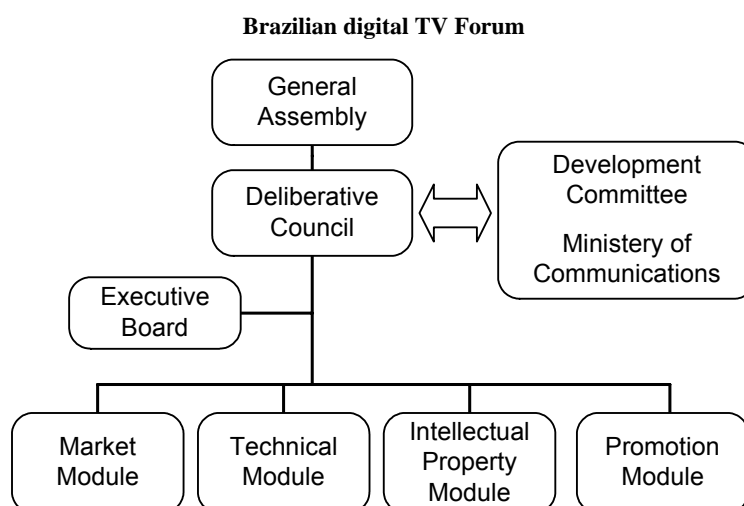

## 2.4.3 Modules Assignments

The Forum is comprised of four modules that address different aspects of the Digital TV implementation effort.

### 2.4.3.1 Market Module

The market module must identify the needs, wishes, and opportunities of the market, defining functional requirements, time limits for availability, and costs, and coordinating the relationship between the various sectors represented in the Forum.

This module checks conformity with the technical specifications and requirements that are drawn up and analyzes and proposes solutions to issues related to planning the implementation of terrestrial digital television.

#### 2.4.3.2 Technical Module

The technical module coordinates the efforts relative to the technical specifications of Brazil's digital TV system and research and development activities, identifies specification needs, and defines the availability of

technical solutions referring to the generation, distribution, and receiving of the digital TV system, including high definition, standard definition, mobility, portability, data services, interactivity, content protection, and conditional access.

This module also coordinates the efforts to harmonize technical specifications with other national and international institutions.

### 2.4.3.3 Intellectual Property Module

The intellectual property module must coordinate efforts in the search of solutions regarding intellectual property, drawing up policies and practices to be adopted among the members and proposing the legal approach to these issues to the competent institutions.

This module also helps and monitors the negotiation of royalties linked to the incorporation of technologies along with their holders and informs the council about the costs involved in the techniques being adopted or incorporated.

### 2.4.3.4 Promotion Module

The promotion module coordinates efforts to promote, distribute, and disseminate Brazil's system. This module must promote seminars and courses; publish newspapers, bulletins, and other carriers of information. The Promotion Module is also responsible for organizing the common activities of broadcasters and industries aimed at increasing the awareness about the advantages of the Digital TV system.

## 2.4.4 Outline of the Technical Standards

Standardization activities, performed by the Technical Module, are divided among eight subgroups of specialist volunteer members, which work in the sectors of the broadcasters, consumer electronics, transmitters and software industries and universities. The working groups are organized as below.

FIGURE 37

**Brazilian standardization structure**

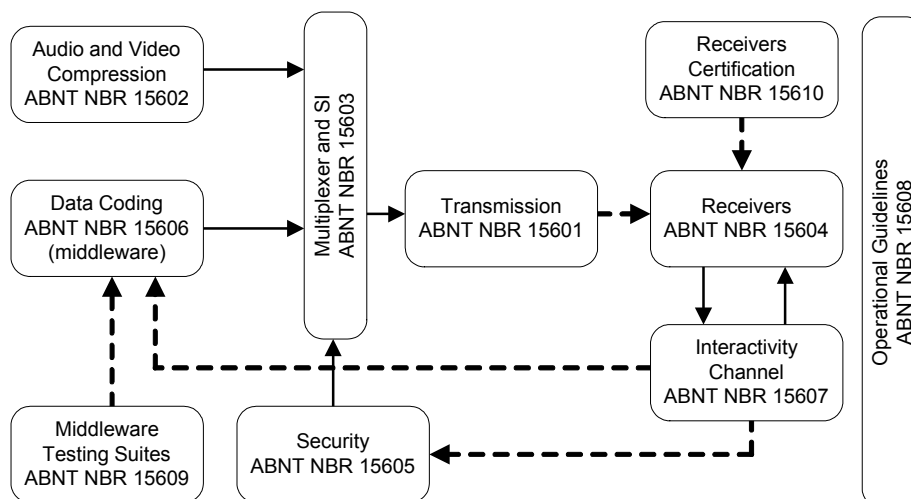

The standards for the digital terrestrial television, showed in the Fig. 37, are listed below:<sup>19</sup>

- ABNT NBR 15601:2007 – Transmission system
- ABNT NBR 15602:2007 – Video coding, audio coding and multiplexing

<sup>19</sup> <http://www.abnt.org.br/tvdigital/TVDIGITAL.html>

- ABNT NBR 15603:2007 – Multiplexing and service information (SI)
- ABNT NBR 15604:2007 – Receivers
- ABNT NBR 15605:2007 – Security issues (under approval)
- ABNT NBR 15606:2007 – Data coding and transmission specification (partial)
- ABNT NBR 15607:2007 – Interactive channel (partial)
- ABNT NBR 15608:2007 – Operational guidelines
- ABNT NBR 15609:2007 – Middleware test suit (internal working document)
- ABNT NBR 15610:2007 – Tests for receivers (internal working document).

## **2.5 Current Status of the DTT deployment**

On December 2<sup>nd</sup>, 2007, the first official implementations of the Brazilian DTT system began commercial operations in the city of São Paulo and, by mid-2008, there were already 10 commercial broadcasters operating in this city. Although tests were already being conducted since May, 2007, the government chose the December date as the official date of the system launch.

According to the schedule established by the government, all analog TV broadcasters must also be transmitting digital until 2013. Furthermore, the switch-off of the analog systems is schedule to take place in 2016. However, in 2008, the actual deployment of DTT transmissions in Brazil was moving ahead of the schedule. Stimulated by the increasing interest in the new technology, many broadcasters have been investing earlier than required by law and have been starting digital transmissions sooner than expected. The accelerated implementation was also due to the tax-reduction incentives offered by the government, and to the new applications made possible by the DTT system, such as portable reception.

In the first six months after the official commercial launch, DTT transmissions in Brazil is a reality in São Paulo, Rio de Janeiro, Belo Horizonte and Goiânia, and 10 other cities were scheduled to get digital broadcasting yet in 2008. By the third quarter of this year, DTT signals already covered over 21 million people, and were expected to reach 30 major cities and state capitals by the end of 2009.

The robustness of DTT signals, as well as the superior video and audio quality provided by the technology, represents a big step forward in the technical quality on content access of lower income population. The market penetration of television devices in Brazil and its close relationship with the general population are clues to enable us to devise the huge market that DTT will offer in the next few years.

### **2.5.1 DTT market in 2008**

In the third quarter of 2008, there were already over 30 different DTT receivers available in the market, with functionalities and designs aimed to different economic segments and user preferences. Among those models, there could be found portable reception devices (1-Seg), including portable TVs, computer USB tuners and cell phones. For fixed reception, consumers could choose between standard definition and high definition devices, although all broadcasters have been transmitting in high definition (1080i). There were already over 50 h a week of original HDTV programming, and a growing demand from viewers.

Since the commercial start of DTT in Brazil, consumers were able to see a significant fall in the prices of reception devices, with the proliferation of additional manufacturers and models. As an example, by the third quarter of 2008, portable one-seg receivers for computers could be found for prices around US\$ 100, while high-definition fixed-reception set-top devices could be found in the US\$ 180 to US\$ 300 price range. It was not unusual to find special offers to lower income consumers that split the price of the receiver in up to 12 monthly payments.

By that same time, the industry had already provided many solutions for the high-end DTT market, such as full-HD displays with integrated digital tuners. Many manufacturers offered displays with integrated receivers, with sizes ranging from 32 to 52 inches, for a price to the consumer starting at around US\$ 1.500.

Since the beginning of transmissions, market prices for DTT receivers have been falling gradually, as the market moves from the early adopters to the ordinary consumers. That expected movement has been regarded by broadcasters and industry as proof of the successful introduction of DTT. It's a trend that is

expected to intensify with the beginning of transmissions in other cities. As of mid-2008, manufacturers have been preparing for Christmas, when a surge in demand for reception devices is expected. The general expectations are that the demand for DTT receivers and integrated TVs will grow steadily over the following years.

## 2.6 Conclusion

The opinion of the majority of the concerned entities is that the introduction of digital TV in Brazil has been very successful. The better images and sound quality, the portable TV with in-band “one-seg” technology, the future interactivity with the user and the digital convergence are the most evident benefits of the new technology. Nonetheless, keeping terrestrial television a free and open service, providing ways for the social inclusion of a growing number of citizens, as well as offering them an important mean of entertainment, education and cultural integration, at local, regional, and national levels, are not less important objectives for system that has been prepared to serve a vast country such as Brazil, both in territorial and demographic senses.

One of the first steps on the transition process was the development of the Digital Television Channel Plan, that has been conducted by the National Telecommunications Agency (Agência Nacional de Telecomunicações - Anatel) since 1999. At the end of the channel planning process, not later than 2013, it is expected that more than 6 100 digital channels have been assigned. In the full “simulcast” period, from 2013 to 2016, more than 12 200 analogue and digital channels are supposed to be in operation. This fact illustrates the magnitude of the task that has been assigned to Anatel, and that has been so far successfully executed by the Agency.

An important cornerstone of the successful introduction of the digital terrestrial TV in Brazil was the creation of the Brazilian Digital Television System Forum, or SBTVD Forum, in 2006. The Forum, whose members are TV network operators, equipment manufacturers, the software industry, education and research institutions, plus some other invited institutions and individuals, has had an important role in supporting and fostering the development and implementation of digital television in the country. It is also responsible for defining the best practices for the deployment of the system. By working close with the Japanese experts on the ISDB-T standards, the Forum has created a vast knowledge base about the implementation of DTT, and has contributed to the formation of a large number of professionals with competence on the subject.

## 3 Bulgaria

With due consideration of the complexity and far reaching consequences of the transition from analogue to digital, relevant Strategic Plan for Introduction of Terrestrial TV Broadcasting (DVB-T) in the Republic of Bulgaria has been elaborated and approved at session of the Council of Ministers of 31 January 2008 (Reference: Protocol No 5 by decision on Agenda item 24). Its main considerations and key aspects are provided herewith.

### 3.1 Background of country TV broadcasting market

#### 3.1.1 TV Programme licences

As of January 2008, a total of 203 TV programmes have been licensed for delivery to the population of this country by cable television, terrestrial broadcasting and via satellite.

**3.1.1.1** The terrestrial broadcasting component ensures analogue delivery of the total of seven TV programmes as follows:

- a) Three nation-wide TV programmes, namely:
  - “**Channel 1**” of the Bulgarian National Television (BNT) with population coverage of 98,3% achieved by 677 high power main transmitters, relay transmitters and low power fill-in transmitting stations in Frequency Bands II, III, IV and V;
  - “**bTV**” with population coverage of 97% achieved by 676 high power main transmitters, relay transmitters and low power fill-in stations in Frequency Bands III, IV and V; and



- “Nova” exceeding 70% population coverage achieved by total of 143 transmitters, with comparatively lesser number of high power main transmitters and with a growing network of relay transmitters and low power fill-in transmitting stations, all operating in Frequency Bands IV and V.

b) In addition there are four regional TV programmes licensed to be on air in the towns of Blagoevgrad, Plovdiv, Russe and Varna.

**3.1.1.2** Remaining 196 licenses are issued for TV programme delivery via cable or satellite.

### **3.1.2 Public/Commercial/Temporary licensed operators**

Seventeen licenses are issued to public broadcasting operators and 169 licenses to commercial broadcasting operators totalling 186 regular licenses. Furthermore, the said regular licenses are supplemented by additional 42 specific licenses (temporary in nature but still in force) for terrestrial analogue broadcasting.

### **3.1.3 Cable/Satellite/Terrestrial delivery**

It is estimated that predominantly around 63% of the country population is served by cable network delivery, 7% of the population by satellite and about 30% of the population receives TV programming via terrestrial broadcasting channels. While every country town is served via cable TV network delivery only about 28% of the villages of this country are served by cable TV. It is expected that cable TV network delivery would reach its saturation limit at 75% of the population coverage.

The country population having access to terrestrial TV broadcasting only is estimated to be within 10 to 11% range.

### **3.1.4 Digital terrestrial TV broadcasting**

Only one digital terrestrial TV broadcasting operator has been licensed to serve the area of Sofia City since 2004.

## **3.2 Purpose and mission of the analogue to digital terrestrial TV transition**

The said Plan for introduction of digital terrestrial broadcasting aims not only at retaining the number of users who, in spite of having access to cable, terrestrial and satellite delivery, have already chosen to use analogue terrestrial delivery, but also has set the target of increasing the number of digital terrestrial delivery users in nearest future. Indeed the Plan has the objective of creating an enabling competitive environment thus effectively preventing the monopolistic cable and satellite delivery operators' grasp at the market.

Towards this end, the digital terrestrial broadcasting shall be deployed under certain conditions as follows:

- free of charge delivery to users (not more than one encrypted programme per multiplex be permitted);
- initial number of programmes delivered shall be not less than 15;
- programmes delivered be composed of an attractive-to-viewers blend of national, regional and local origin;
- HDTV programme delivery license applications be allowed by 2011;
- better quality and offer of additional/interactive e-services and applications, in consistency with Directives 2002/21/EC (Framework Directive) and 2002/19/EC (Access Directive) of the European Parliament and the Council of 7 March 2002; and
- mobile outdoor reception predominantly for cars and portable reception inside of buildings expected to be used for the purpose of second and third household receivers.

The said Transition Plan has defined the strategic aspects of:

- population coverage objectives and criteria;
- Multiple Frequency Network (MFN) approach dedicated only to nation-wide coverage, while Single Frequency Network (SFN) approach will be applied explicitly to allotment zones;

- initial build-up of SFN network broadcast coverage of densely populated towns and areas (Island Coverage) within any allotment zone followed by further gradual network extension until the entire allotment zone coverage has been achieved;
- optimization of number of multiplexes within allotment zones;
- granting license or temporary permission to any new analogue terrestrial broadcasting operator applicant will be severely restricted;
- parallel broadcasting of both the analogue and the digital (simulcast) being limited to one year duration upon the expiry of which the concerned analogue broadcasting license/s will be terminated. Thus the reuse of liberated spectrum of analogue broadcasting is provided for further build-up of digital terrestrial TV broadcasting networks as per the Plan;
- establishing criteria for switch-off of analogue TV broadcasting, but not later than end 2012;
- nation-wide coverage by digital terrestrial broadcasting to be completed in all zones by end 2015;
- factual digital dividend definition; and
- timely supply of Set Top Boxes (STB) to the population at affordable prices and risks involved.

### **3.3 Impact of the digital terrestrial broadcasting Plan of RRC-06 and GE 06 Agreement**

RRC-06 and GE 06 Agreement guarantee to the Bulgarian Administration to have at its disposal and use at its discretion 10 nation-wide networks for terrestrial digital TV broadcasting, supplemented by 34 regional networks and by 23 networks dedicated to the regions of Sofia and Varna.

### **3.4 Transition to digital terrestrial TV broadcasting**

The said transition will be executed into two phases as follows:

#### **3.4.1 First phase-start of the transition**

##### **3.4.1.1 Three nation-wide digital terrestrial TV networks**

Three nation wide MFN/SFN networks, all DVB-T, will be licensed to operators for deployment in allotment zones of Burgas, Plovdiv, Ruse, Sofia, Stara Zagora, Varna and Vidin by June 2008.

Licensed operators shall start “Island Coverage” broadcast within said allotment zones as from January 2009 and they must achieve at least 75% population coverage within said allotment zones by December 2012.

Exactly one year later, after the simulcast expiry, new licenses will be granted to operators with obligation to start “Island Coverage” broadcast within allotment zones of Blagoevgrad, Kurdzhali, Pleven, Smolyan and Shumen and they must achieve at least 75% population coverage by December 2011.

Furthermore, relevant licensees must ensure full population coverage inclusively for the above-mentioned twelve allotment zones by December 2012.

##### **3.4.1.2 Twelve regional digital terrestrial TV networks**

Twelve regional SFN networks will be licensed to operators within allotment zones of Burgas, Plovdiv, Sofia and Varna (three SFN networks each) by June 2008. Licensees shall start “Island Coverage” broadcast within said allotment zones by January 2009 followed by ensuring of full population coverage for the said four allotment zones by January 2010.

#### **3.4.2 Second phase of the transition**

##### **3.4.2.1 Additional three nation-wide digital terrestrial TV networks**

Furthermore, three nation-wide MFN/SFN networks, two of them DVB-T plus one DVB-H, will be licensed to operators for deployment in the allotment zones of Burgas, Plovdiv, Ruse, Sofia, Stara Zagora, Varna and Vidin by July 2010.

Licensed operators shall start “Island Coverage” broadcast within said allotment zones as from January 2011 and they must ensure at least 75% population coverage of said allotment zones by December 2013.

Exactly one year later, after the simulcast expiry, new licenses will be granted to operators by July 2011 with obligations to start “Island Coverage” broadcast within the allotment zones of Blagoevgrad, Kurdzhali, Pleven, Smolyan by January 2012, being followed by obligations to ensure at least 75% population coverage by July 2014.

Furthermore, relevant licensees must ensure full population coverage inclusively for the above-mentioned twelve allotment zones by July 2015.

#### **3.4.2.2 Additional fifteen regional digital terrestrial TV networks**

Fifteen regional SFN networks will be licensed to operators for deployment in the allotment zones of Blagoevgrad, Burgas, Kardzhali, Pleven, Plovdiv, Ruse, Smolyan, Sofia, Sofia-City, Stara Zagora, Strandzha, Shumen, Varna, Varna-City and Vidin by July 2010.

These licensees will be obliged to start “Island Coverage” broadcast within said allotment zones as from January 2011 and they will be required to ensure 90-95% of population coverage in the above-mentioned allotment areas by December 2012.

#### **3.4.3 Allotment zones**

Figure 37 defines the distribution of allotment zones on the map of Bulgaria as per RRC-06.

#### **3.4.4 HDTV**

Subject to license application/s for digital terrestrial HDTV broadcasting network/s being submitted latest by December 2011 to competent regulatory authorities, or upon initiative of competent regulatory authority, license/s may be granted to relevant operator/s for deployment and operation of digital High Definition TV terrestrial broadcasting network/s.

#### **3.4.5 One Year Simulcast Limitation**

The period of parallel broadcasting of both analogue and digital terrestrial TV broadcasting (simulcast) is limited to one year after the start up of digital terrestrial broadcasting within relevant “Island”. Upon expiry of this one-year period all analogue terrestrial TV broadcasting transmitters within the “Island” territory coverage will be switched-off as a principle, however exceptions may be granted spectrum permitting, in particular for remote rural areas.

Appropriate measures will be taken to ensure adequate spectrum allocation/s in order to guarantee the practical implementation of this key requirement.

#### **3.4.6 “Must carry” obligation**

The Electronic Communications Law, May 2007, Article 47(2).1 stipulates that any digital terrestrial broadcasting network, be it radio or television, must carry two Bulgarian programmes. It is within the purview of the Electronic Media Council (EMC), empowered by this Law, to decide on the programme allocation within any network. Furthermore, it is the EMC who decides on the network to broadcast the programme/s of Bulgarian National Television, but within the said limitation of two Bulgarian programmes per network.

Taking into account the existing spectrum constraints, the Second Phase of the Transition Plan (see § 2.4.2) may be implemented only on condition that relevant spectrum indeed be liberated by the already licensed operators for analogue terrestrial digital TV broadcasting with nation-wide coverage networks. In this regard and in order to ensure that the above-mentioned requirement of the Electronic Communications Law will be met, either the said licensed operators must have new licenses granted for nation-wide network coverage of digital terrestrial TV broadcasting during the First Phase of Transition (see § 4.1), or alternatively, in consistency with the decision of the EMC on the network assigned to carry the programme/s of Bulgarian National Television (BNT) a “must carry” obligation be imposed on relevant operator/s, being licensed as First Three Nation-wide digital terrestrial TV Broadcaster during the First Phase of Transition to carry obligatorily the programme/s of Bulgarian National Television.

### 3.4.7 Analogue switch-off

Switch-off of any analogue TV terrestrial broadcasting transmission in the country will be imposed by December 2012 at the latest.

### 3.4.8 Digital dividend

The switchover from analogue to digital broadcasting will create new distribution networks and expand the potential for wireless innovation and services. The digital dividend accruing from efficiencies in spectrum usage will allow more channels to be carried with variety of fast data transmission rates and lead to greater convergence of services.

The inherent consistency of data flows over long distances and flexibility offered by digital terrestrial broadcasting will support mobile reception of video, internet and multimedia data, making applications, services and information accessible and usable anywhere and at any time. Along with the introduction of innovations such as Handheld TV Broadcast (DVB-H) and High-Definition Television (HDTV), it will provide greater bandwidth which, in full consistency with “European Parliament resolution Towards a European policy on the radio spectrum” {2006/2212(INI)}, could increase the widespread availability of affordable mobile/wireless broadband, including in rural areas.

Services ancillary to broadcasting (wireless microphones, talk back links), planned on a national basis, could also be extended.

Because of the complex and interleaving reasons, associated inter alia with the said purpose and mission of the introduction of digital TV terrestrial broadcasting in this country, it will be very difficult in the mid-term future to quantify the spectrum which will be available for use of services other than broadcasting. Therefore it is foreseen that the factual quantitative balance of the spectrum liberated will be done not earlier than the complete analogue switch-off at the end of 2012 and not later than end 2015, in full conformity with the decisions taken at the WRC-07.

FIGURE 38  
Allotment zones for the Republic of Bulgaria defined by RRC-06

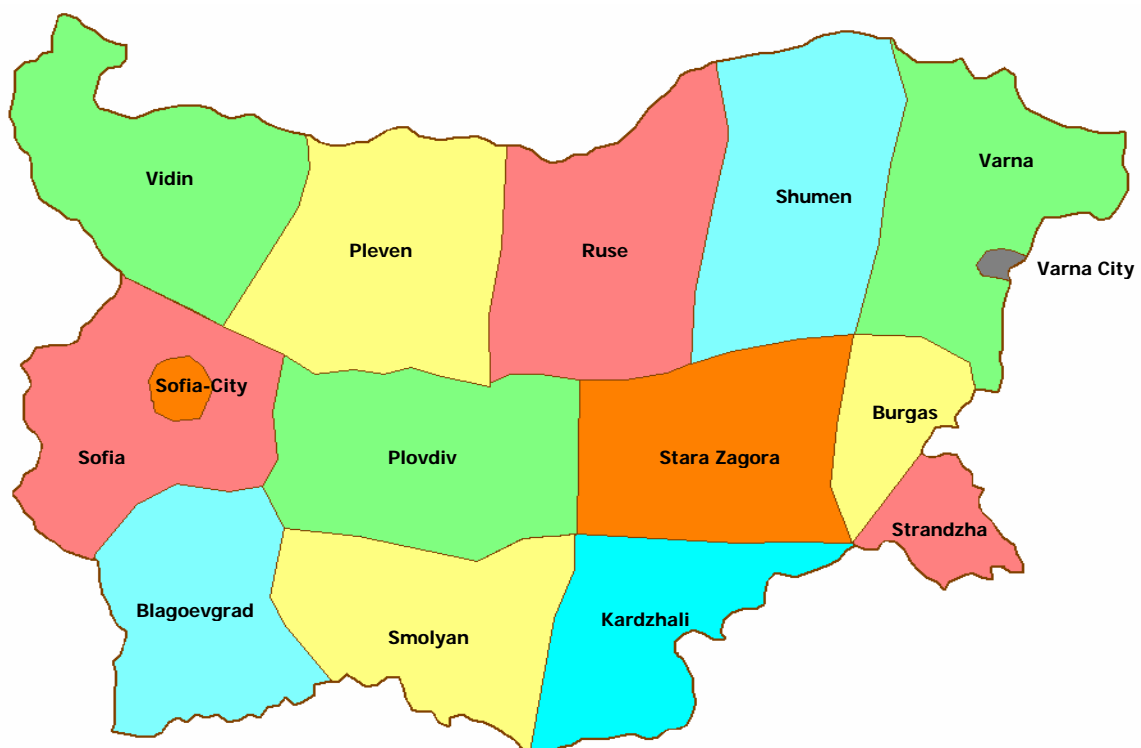

## **4 Canada**

### **4.1 National planning strategies and policy considerations**

#### **4.1.1 Introduction**

For almost 25 years Canada has carried-out, research, demonstrations, put in place a Task Force, Working Groups, Industry Associations, Regulatory initiatives with minimal government involvement and with a policy firmly based on the market place for the transition to digital terrestrial television. Although the core of all of this work has focussed on terrestrial television transition, there have been some notable diversions along the way including the Advanced Broadcasting Systems of Canada (ABSOC), which dealt with video compression issues for standard digital terrestrial television, cable and satellite.

ABSOC recommended that a digital Task Force look at all the issues surrounding the implementation of Digital Television (DTV) in Canada and the Government set one up in late 1995. It included all industry segments and completed its work in late 1997 with a report presented to the Ministers of Canadian Heritage and Industry Canada.

Following the Task Force report Industry Canada responded by accepting the recommendation to adopt the American Television Systems Committee (ATSC) transmission standard for terrestrial DTV services and made spectrum available to all licensed terrestrial television broadcasters for digital services. The broadcasters, distributors and manufacturers set up an industry association to manage and facilitate the transition realizing another recommendation, Canadian Digital Television (CDTV).

Over the next eight years CDTV working with the industry and the relevant interest groups and government departments, provided a platform for testing the technology, educating both the industry and the consumer, demonstrating HDTV services, and encouraging the production and distribution of HDTV programs and services. Over this period, the Canadian Radio-television and Telecommunications Commission (CRTC) also provided a regulatory framework for terrestrial television broadcasters and pay and specialty services to make the transition to digital High Definition service. The important point to note is that the emphasis of all of these initiatives was not just the introduction of DTV service but that service providing HDTV programs. The benefit for the citizen/consumer was defined both informally and formally as improved video and audio as characterized by HDTV.

In 1999, the industry defined Canada's DTV transition strategy as a fast follow by two years of the US roll out of DTV services. This strategy was consistent with the market place approach and ensured that the high-end costs associated with early adoption of new technology were avoided for both broadcasters and consumers.

A lot has changed in the broadcast environment since the beginnings of HDTV in the eighties. Broadcasters have lost market share to viewing in both in real terms to pay and specialty services as well as viewers receiving their service directly from the transmitter in favour of distributed cable and satellite. More than 30% of all viewing was from terrestrial transmitters in the eighties where today that figure hovers around 10% or even lower in some markets. Consequently, broadcasters have been reluctant to build digital transmission infrastructure noting that there simply is not a business case to do so. There are currently 12 DTV transmitters on the air concentrated in Toronto, Vancouver and Montreal, even though more than 40 temporary licenses have been granted.

Over this time, progress was made in creating digital HD infrastructure in network operations of the major networks and the production community is just now beginning to embrace HD production. However, for the most part the Canadian terrestrial television broadcast system remains a standard definition one (as do the pay and specialty services) and in many regional centres an analogue throwback.

It is against this background that the CRTC is conducting a television policy review and the Minister of Heritage requested an examination of the impact of new technology on the Canadian Broadcasting System. A lot has changed since the Task Force reported 9 years ago. Internet delivery, Video on Demand, mobile television and consumer empowering personal video recorders and devices have and will have an increasing impact on the traditional broadcast model and in fact on the fundamentals of the Canadian Broadcasting system as Canadians have historically understood it. Decisions made by the CRTC, Government and the interests of the Broadcasting system over the coming 12 months will have a profound impact on the future of broadcasting generally and the roll out of conventional terrestrial broadcast services in particular.

The remainder of the paper will look more closely at the history, present circumstances and future options.

## **4.2 DTV/HDTV History**

### **4.2.1 The Early Years**

Canadian engagement with digital television is rooted in the industry's early interest in High Definition Television (HDTV) as far back as 1982. In that year, the Canadian Broadcasting Corporation (CBC) and the Department of Communications and its research centre organized a Colloquium in Ottawa that drew delegates from all over the world to discuss HDTV and how to develop it as a future service. For almost a decade, there were follow up conferences, demonstrations and debate.

It is probably fair to say that the Department of Communications led a lot of Canada's participation through the eighties and into the nineties. In 1987, a major public demonstration of the Japanese MUSE system of HDTV was done with the cooperation of government, a number of Canadian industry players and the Japanese. It was successful but not practical for terrestrial display in North America because of the amount of bandwidth needed for broadcast, although the Japanese used the MUSE technology from the late eighties through to today via Satellite DTH. At the same time, the CBC produced the first North American High Definition program series, Chasing Rainbows.

As the eighties drew to a close the Canadian Government was involved in that process testing proponents of five different systems in 1991/92 and then the eventual successful effort in the mid nineties. Canada worked closely with US industry and agencies in this process. At the same time Canadian industry recognized the need to become involved in the digital initiatives became apparent and in 1990 ABSOC was set up to perform that role.

From 1990 through to 1997 ABSOC played an important role of both informing the industry on digital developments and recommending standards and practises for MPEG 2 compression technologies as it effected production and distribution of standard digital television. Representing a cross section of the broadcast and distribution community with government liaison and support ABSOC brought a practicality and application to the new digital technologies as they developed.

As the initiative matured and accepted a new digital transmission technology capable of delivering High Definition signals within MHz of spectrum or multicast digital delivery of standard television, ABSOC came to realize that Canada needed to focus on what this new technology meant for Canadian viewers and the broadcast industry. They recommended a Task Force to examine the elements required to implement digital television in Canada and the government responded by naming a Task Force in November of 1995.

It is important to understand the environment that Canadian broadcasters enjoyed in the mid nineties. Although conventional broadcasters faced increasing market fragmentation, they still enjoyed a transmitted market share of their viewers of over 20%. Although pay and specialty services were growing, they had not fragmented the audience share to the degree that would develop and is seen today. The internet as a delivery mechanism, video on demand and other platforms that define today's multi platform broadcast world were barely a dream very much on the horizon but in a business sense not a huge blip on anyone's radar screen. By the end of the nineties, the view of the broadcast world was rapidly disintegrating. What was real was MPEG 2 compression, which made possible digital standard television satellite and cable delivery. Providing for more pay and specialty services with cheaper delivery to Broadcasting Distribution Undertaking (BDU) head ends and production facilities, and the prospect of better quality pictures and sound with HD services very far down the road.

For the newly announced Digital Task Force these problems were all in the future and it focussed on its mandate to recommend the best way to implement digital television for Canada.

### **Digital Television Task Force**

The Task Force was truly representative of all industry interests plus the production and consumer manufacturers' community. Over ninety people were on the Task Force or committees and many more were consulted throughout the Task Force's work. It has been noted that Canada does Royal Commissions and Task Forces very well, as they are often vehicles for inaction. However, they also do some remarkable work from time to time and by the time the Task Force reported in late 1997 an industry had been somewhat

educated, consulted and had arrived at a consensus; albeit kicking, screaming and probably thinking that many of its recommendations were so far down the road that there was nothing really to worry about.

The seventeen recommendations were rooted in the work of four committees who recommended the substance to the Task Force members. The committees included; technology, production, policy and regulation, and economics, consumer services and products. It is interesting to note as Canada moved to an implementation stage those areas of work continue to provide guidance and direction. While it is not useful to review the entire Task Force report and recommendations, it is useful to recognize that much was achieved and many recommendations were acted on:

The ATSC transmission standard, A53, was adopted by Canada and a subsequent allotment plan was adopted providing digital spectrum for all licensed analogue conventional broadcasters. Broadcasters were to make the transition to digital transmission while retaining their analogue spectrum for simulcast until the transition was complete. This was important since it provided a secure business basis for broadcasters to begin the transition.

Many of the policy and regulatory recommendations have found their way into CRTC licensing and carriage frameworks. Again, this was to provide stability during the transition for the industry business models, as they were understood at the time.

A period was suggested for the digital transition with an end date that would be a year to 18 months behind the US. While not acted upon in Canada, virtually every other country in the world has either a notional or a firm target date for analogue shutdown. The Canadian transition has lacked clarity and definition in the absence of such an initiative.

Initiatives concerning the production community for training and HDTV content were never acted upon and regrettably this industry sector has lagged behind many in the global community and Canada has a lack of HD production.

The recommendation to set up an industry organization to help manage, facilitate and advise government on the transition was put into place and will be discussed later in this paper.

Some recommendations like that calling for a universal box which would work for terrestrial television and distributed BDU services were not realized and probably too idealistic.

One recommendation calling for universally available terrestrial services is worth noting:

#### **“Recommendation Fourteen”**

Basic terrestrial broadcast television services that are freely and universally available are central to achieving the objectives of the Canadian broadcasting system. This must continue in future digital terrestrial distribution packages.

Freely available broadcast television services are the foundation of the Canadian broadcasting system. This universality of access must be preserved in the emerging digital system.”

This was fundamental to the system in 1997 but in today’s environment terrestrial broadcasters are not committed to this principle given the change in how viewers receive their television services. In fact, the costs associated with this recommendation and the lack of any kind of business case will characterize the discussions of future policy hearings. This issue has also characterized the industry reluctance to move ahead with the digital transition in a timely way.

In looking back, the Task Force got many things right as evidenced by the overwhelming number of recommendations implemented. It set the agenda for the transition for terrestrial services and coincidentally the pay and specialty services. However, it did not anticipate the rapid change in the broadcast environment; its multi platform distribution opportunities and the availability of the devices, which would empower consumers with both choice and schedule. Combined with a market place approach these factors inhibited a timely transition to digital High definition services.

#### **Implementation 1998 to 2006**

Following the Task Force report the broadcasting and distribution industry, along with manufacturers and producers came together to create CDTV, as recommended by the Task Force. In September of 1998 the organization was formally created as a not profit association, with by-laws, a Board of Directors based on

industry sectors and a work plan. Relevant Government Departments and the CRTC were welcome to participate and contribute to committee work and observe in Board meetings.

The Board created Working Groups in the technology, policy and regulation, economics and marketing, communication and education and production. This was not very different from the original Task Force committees. These working groups were a part of the association to a greater or lesser extent through the life of the association responding to the approved work plans from the Board and the changing environment

The work of the association was totally funded by the industry with both direct and indirect funding. Industry Canada provided funds to test the frequency allotments at the CDTV test transmitter in Ottawa in 1998/99.

For eight years, CDTV represented the industry in helping manage and facilitate the transition. The early years focussed on testing, education, and understanding the standards. As time passed demonstrations, seminars, policy, regulation and business models dominated the agenda. Over the last few years CDTV focussed on operational implementation, the creation of HDTV programming, consumer education and awareness, and the impact of new technology including; improved compression technology, IPTV and mobile service. Throughout its mandate, CDTV participated with ATSC committees and on the Board, bringing back to the Canadian broadcasters and relevant government departments and agencies changes and improvements to the ATSC family of digital standards and Canadian input to those discussions.

An industry association that tries for consensus on issues, or at the very least an overwhelming majority is not the easiest of vehicles to manage in an environment of competing interests and agendas. The consensus and goodwill, which characterized the Task Force was not always seen as CDTV grappled with some of the business and regulatory issues where the interests of the principals were seen to be on the line. Yet for all of that the achievements were many over the life of the association and in fact defined the steps of the transition to digital terrestrial television to date.

Test transmitters were set up and operated in Ottawa, Toronto and Montreal. These gave the broadcasters and distribution communities the opportunity to work with the new digital transmission standard, understand its properties, coverage areas and delivery to BDU head ends.

The transmitters were used to test the frequency allotments (funding from Industry Canada), coverage reach, receiver strength and signal strength. This work became increasingly important, as improvements were made to off air receiver reception.

Canada was also called upon by consumer electronic manufacturers and the ATSC to test improvements and additions to the ATSC family of transmission standards.

Demonstrations for both the public and the industry of HDTV programming and delivery on the Canadian broadcasting system.

Seminars and workshops were held to explain to and educate the industry on the full range of the issues surrounding the production and distribution of digital High Definition programs.

A great deal of time and effort was spent on attempting to develop business models that digital terrestrial television in terms of program and non program related data and multi channel delivery. It was hoped that these models could lead to additional resources to help fund the transition. While the process certainly educated the industry there was not a consensus on the right model or an agreement between the conventional broadcasters and the distributors over revenue sharing of distributed terrestrial data and services.

Costs for the transition were also carefully calculated and included transmission, master controls, editing and production all in high definition. Suggestions for upgrading as equipment became obsolete were made available so that the capital costs of conversion would not be an overnight hit and distort budgets. Again, the identification and process were helpful but no overall industry plan was adopted.

Very early in the transition the Board of Directors of CDTV created the policy of a two-year lag behind the US in Canada's transition to digital television. This built on a recommendation in the Task Force report that suggested a year to 18 months. Given the Government's view that Canada's transition to digital high definition broadcasting should be driven by the market this two-year lag policy was sensible and virtually adopted by all parties. It was successful in saving the industry and consumers a great deal of the costs associated with the early adoption of new technology.



Education and consumer awareness was a major focus of the transition work. This work involved not only the broadcast and distribution industry but the consumer electronic manufacturers and the retail sector as well. Several editions of pamphlets aimed first at the retailers and then directly at the consumers were prepared and delivered through retail outlets and reprinted in consumer electronic magazines. They explained digital television and all the choices and variables in services, programs and consumer equipment. This work was recognized as an effective tool in education and adopted by other countries as part of their transition work.

From the work done on consumer education it was decided that a web based information source of information would be a useful tool. CDTV resourced and created a bilingual consumer section open to everyone on its website. Since its creation a couple of years ago hundreds of thousands of Canadians have used it to gather more information about HDTV. In addition a 15-minute infomercial and several 30 s promos were produced and aired to both provide HD information and push people to the website. Similar efforts will be required in the future, as analogue shutdown becomes a reality in Canada.

The education, training and development of the independent production on HD production were the final major projects taken on by CDTV to aid the transition. Again, a bilingual website was created that contained information and practical experience about, equipment, facilities, production and editing of HD material. Originally conceived as a series of training modules that may be adapted to workshop environments, the website has proven a valuable tool for Canada's content creators. It is sad to note that additional funding could not be achieved to run workshops in all regions of the country to work with the production and broadcast community to create a better understanding of the challenges associated with HD production and how to meet these practically and efficiently. The production of HD content is still very modest in Canada but this is beginning to change and it should be encouraged.

While the core mission was on terrestrial broadcasting a great deal of time and effort was spent on assisting pay and specialty services to make the transition and supporting their needs for effective policies and regulation, facilities and capacity, and education.

During this period CDTV became the principle source of HD information in Canada for both trade press and general media. In the late nineties and in the early part of the two thousands the interest tended to be more industry related but today the Canadian consumer is engaged and very hungry for relevant information. Importantly, it is not about digital television that engages the consumer but it is High Definition, which is capturing their interest.

It is probably fair to ask if a transition association like CDTV was working so well, why it ceased its work a few months ago. Probably for two basic reasons:

The environment in 1998 was very different than it is today. There was less concentration in the broadcast industry and generally more reliance on associations to represent the industry sectors in designated areas. Emerging platforms and new technologies like IPTV and mobile applications were not a huge market factor in 1998, yet they are increasingly dominating discussions today.

At the core broadcasters, who were to make the transition from analogue to digital transmission platforms, drove CDTV. As markets fragmented and viewing reception for transmitter received services declined, the consensus achieved by the Task Force to transit to digital transmitted services began to break down and eventually eroded the support for an association whose mandate was to see the transition through.

With the above in mind, the industry members felt the association had gone as far as it could and its mandate was complete from their perspective given the new environmental realities. Many elements of this 8-year phase of Canada's DTV transition were done well and made substantial contributions to the process. Issues of timeliness, a focus on what the Canadian broadcast system should be when the transition is complete, and an end date for analogue needs to be urgently answered before the transition may proceed.

### ***The Present***

#### *The Current Players and the Issues*

Canadian broadcasters have demonstrated reluctance to build transmission infrastructure and thus there are only transmitters in Toronto, Montreal and Vancouver as noted earlier in this text.

Conventional broadcasters have invested in considerable digital HD equipment in their network centres but very little in regional locations across the country. To date they have depended on cable and satellite delivery of their HD signal to locations across the country. In some cases because of cable and satellite bandwidth constraints and the strict application of the carriage rules, this national coverage is not as good as the broadcasters would like.

There are no French language networks, which are providing digitally transmitted HD or SD services aside from SRC. Most of the transition developments have been within English services. While there have been more than 40 temporary licenses issued there have been relatively few actually act upon. Most of these are English services. With some 12 transmitters on the air and broadcasters reluctant to build out their digital transmission infrastructure the future of conventional terrestrial television, has we have historically understood it, seems to be poised for a change.

Digital HDTV set penetration is projected to be over 3 million by year-end in Canada and most of the sets now coming to market have built in tuners.

Hook ups to HD services from a BDU are still modest in Canada with numbers approaching 600K by year-end in Canada. This figure is expected to dramatically increase over the next few years.

It is difficult to assess IPTV, mobile, and multi platform delivery and their impact on the terrestrial digital transition. All industry sectors are coping with these challenging issues and they are increasingly becoming central issues in developing future business models. However, it is difficult to suggest that conventional broadcasters have not made the transition to transmitted digital services because of these emerging technologies. At this stage, they are just too peripheral to the core business. The only apparent reason is the declining viewing to terrestrial services directly from the transmitter and the costs of duplicating the existing analogue system with digital transmitters for a decreasing audience return. In simple terms, there is no business case.

Although this paper focuses on terrestrial television it is important to understand the steps taken by the BDU industry to increase capacity that provides both more choice and HDTV capacity. Cable has worked to upgrade its capacity in recent years and has migrated its customer base to digital delivery with demonstrable success. The end of analogue conventional television would ease the bandwidth crunch that is clearly apparent in a transitional environment. Measures to speed up this process would benefit both the consumer and the industry interests. By necessity, these measures must be part of an agreed overall transition plan with a firm analogue shut off date.

Satellite DTH providers are already all digital but face similar capacity issues in this transitional phase which must be addressed. Likewise, Satellite carriers will face increasing demand and capacity issues as more services move to digital HDTV demanding more bandwidth in a finite satellite universe. Delivery to BDU head end, collection and backhaul in a HD environment puts tremendous pressure on the carrier and cost for the service provider whether conventional or pay and specialty. New compression technology and new Satellites may well be part of the solution for DTH providers and Carriers but a definable end to the digital transition would provide some certainty in the market place for all the players.

The above discussion provides some of the background that the recently held Television Review and the Canadian Government Directive concerning the impact of new technology on the future of broadcasting has considered. The reports and decisions, which arrive from it, will be very important to the future digital transition of the industry.

In reviewing the many submissions for consideration in this process, it was clear that most conventional broadcasters do not want duplicate their entire analogue transmitter structure and many see little or no future in transmitted services at all. The difficulty of these submissions is there seems to be no clear alternative or plan for what a new conventional broadcast system would look like in a non-analogue world.

Virtually every country in the world, which has embarked on a Digital Transition plan for terrestrial services, whether it includes HDTV or not, has a definable plan including scope and timeframe. The Canadian situation has suffered from this lack of definition and this now needs to be addressed.

### ***Action Required***

In order to expedite the transition of Digital Television, the regulatory process would have to address the following issues:

A policy decision about the future of terrestrial television.

If transmitted terrestrial services are to remain in the digital world do they mirror the current analogue coverage, a part of that coverage or not at all?

If there are Canadians disenfranchised by a decision to reduce transmitter coverage how do they receive their basic service?

Coincidental with this decision an analogue shut off date needs to be established with definable and measurable milestones.

A plan for informing the public and ensuring that all Canadians can receive a television signal with analogue shut off needs to be established.

The digital benefit for consumers needs to be defined (HDTV and/or enhanced choice) and realized by conventional and pay and specialty broadcasters.

Attention needs to focus on the new technologies; how they can both challenge and enhance the core conventional services in a multi platform environment.

Capacity needs to be assessed in the distribution system to ensure that all services that need to transit to digital HDTV can do so in a timely cost efficient manner. There will be a capacity crunch and it cannot be a barrier to transition.

A plan for regional and local participation in the digital transition needs to be addressed, including local HD production and services.

A plan for the creation of Canadian HDTV content in all program genres to service Canadian HD services that now rely largely on foreign produced HD product.

It is worth repeating that a great deal of good work has been accomplished in the last decade and it is important to see these suggestions in light of that work and building upon it. At the same time, the current transition to digital HDTV is in crisis and needs to be firmly put on track, particularly for conventional terrestrial broadcasters. Canada has gained a lot of first hand experience and knowledge of other countries and their challenges and triumphs. It is now time to take that experience and knowledge and resolve the future of the Canadian Broadcasting System in the digital HD world.

### ***The Future***

Given the changes to the broadcast environment in the last decade, it is difficult if not foolhardy to try to predict the future. None the less there is some givens that can shape our environment over the next few years.

High Definition programming will become the new norm over the coming years throughout most of the developed world.

All the new emerging technologies and platforms will have a business impact that will benefit and challenge the core conventional broadcast business in a multi platform environment characterized by quality, choice, and consumer empowerment.

Content will need to be created at the highest possible level of quality for shelf life and conversion for multi platform delivery. The 1080 progressive production standard will be the international HDTV program exchange standard. HD delivery will be either 720p or 1080 depending on spectrum availability and the nature of the service distributed

The ATSC family of standards will evolve to an advanced compression codec which will enhance the value of terrestrial television spectrum, this is already happening with the DVB-T standard. Future digital receivers will be capable of receiving both MPEG 2 and MPEG 4 signals (France is currently rolling out these boxes as part of their DTV transition).

Further work on the development of improvements in the ATSC system and receiver sensitivity with emphasis on work which may lead to solutions for wireless services and broadcast services in remote communities. This could be a part of the answer for bringing transmitted digital services to rural Canada.

A plan for analogue shutdown with a responsible agency or group who may be held accountable by the viewer and citizen will be critical to analogue shut off.

The Canadian Broadcasting System will continue to enjoy a balance of cable and satellite delivery along with the internet, and telecommunications services all providing real time, video on demand, and streaming services to the viewer. Consumer devices will enhance the viewer as programmer but for the foreseeable future conventional television will continue to drive the industry in terms of content and national, regional, and local reflection. Wireless delivery of these services has a role to play within this system.

### **Conclusion**

Canadian distribution and collection of programming via satellite led the world in using this new technology to the benefit of broadcasting. Canada built the longest stereo FM network in the world. And Canada's television production industry has thrived in the most competitive market in the world producing indigenous product for Canadians, while producing and selling for the rest of the world. Not bad! Canada has done so with the right balance of policy, regulation, incentives, creativity and entrepreneurial skill.

Canada is again at another critical point in its broadcast history. The environment has rapidly changed and yet the issue of valued Canadian services for all Canadians in all parts of the country remains as the constant core issue. Decisions made over the coming year will provide the framework that will define Canadian success in completing the digital transition to HD service for conventional broadcasting and in turn the rest of the system. These are important decisions that require a timely response. Not to respond will leave the current system in disarray and less relevant for both the Canadian viewer and the global community in which it has been a player.

## **ATSC-DTV distributed transmission network**

### **Introduction**

Distributed transmission (DTx) network is a network of transmitters that covers a large service area with a number of synchronized transmitters operating on the same TV channel. DTx offers interesting possibilities for digital TV transmission systems.

As explained in the ATSC Recommended Practice for Design of Synchronized Multiple Transmitter Networks<sup>20</sup>, DTx networks have a number of benefits over the single central transmitter approach, which has so far been the usual way of covering a large service area with analogue TV transmission. These benefits include:

- More uniform and higher average signal levels throughout the coverage area
- More reliable indoor reception
- Stronger signals at the edges of the service area without increasing interference to neighboring stations
- Less overall effective radiated power (ERP) and/or antenna height resulting in less interference.

DTx networks can also reduce the number of channels used to cover a large service area and can free spectrum for other applications such as interactive TV, multimedia broadcasting, or any other application that may come up in the future.

As a trade-off for these benefits, implementation of a DTx network requires a very careful design when a DTV adjacent channel is operating in the same market area<sup>21</sup>. A more serious limitation on the

---

<sup>20</sup> Advanced Television System Committee (ATSC), Recommended Practice – A/111, “Design of Synchronized Multiple Transmitter Networks.”

<sup>21</sup> Advanced Television System Committee (ATSC), Recommended Practice – A/111, “Design of Synchronized Multiple Transmitter Networks.”

DTx operation is that in the possible presence of NTSC adjacent channels operating within the same market area. In such cases, implementation would be very challenging if not impossible. This is due to the higher protection ratios required by NTSC, as opposed to DTV, from an adjacent channel DTV. However, such limitation will not exist after the transition period from NTSC to DTV.

Another important issue affecting the design of a DTx network is the ATSC-DTV receivers' performance with respect to their multipath handling capabilities. Better receivers, capable of handling stronger pre- and post-multipath distortions (pre- and post-echoes) on a wider range of delays, make DTx network design more flexible and simpler. On the other hand, receivers with weaker multipath handling capabilities put more restrictions on the design and implementation of DTx networks.

In addition to providing many guidelines for designing a DTx network and managing its internal and external interference under different conditions, the above mentioned Recommended Practice proposes three methods (or their combinations) for implementing a DTx network.

### **DTx Methods**

The first method is distributed transmitter network, commonly known as single frequency network (SFN), consisting of a central studio that sends baseband signal or video-audio data stream to the SFN transmitters via studio-transmitter-links (STL). STLs can be fiber optics, microwave links, satellite links, etc. The SFNs may be costly to implement and operate. The SFN transmitters in this configuration require subtle (and rather complex) processes for their frequency and time synchronization with each other.

The second method is called distributed translator network in which the transmitters contributing to the SFN, which are some coherent translators all operating on the same channel, translate the frequency of an over-the-air signal received from a main DTV transmitter to a second RF channel. This eliminates the need for a costly Studio to Transmitter Links (STL). On the other hand, frequency and time synchronization for this configuration is quite simpler than the first method. During the translation process to the designated output channel, necessary corrections may also be applied to the signal. In this configuration, however, the main transmitter feeding the coherent translators is operating on another channel and is not part of the SFN. But one may consider this as a sort of frequency diversity in the overlapping coverage area of the main transmitter and the SFN.

The third method consists of digital on-channel repeaters (DOCR) that can differ from each other in the way that they process the signal through the path from their input to their output antennas. The DOCRs contributing to the SFN again pick up their inputs from a main transmitter, eliminating the need for any STL, and transmit on the same channel as they receive. Each DOCR can work on the basis of direct RF operation, conversion to IF or to baseband and up-convert again to the same channel as it receives. In order to form an SFN, however, all the repeaters' outputs should be synchronized with each other and also with the main transmitter feeding them.

With this approach, two limiting factors exist on the operation of the network. First, the main transmitter signal can create advanced multipath (pre-echo) in the overlapping coverage areas between the main transmitter and the repeaters. For creating pre-echo, the repeater's signal must be dominant in such overlapping areas. This may be problematic to the ATSC legacy receivers that are vulnerable to pre-echoes. Second, depending on the amount of feedback from DOCR transmitting to receiving antenna, there is a power limitation on the repeaters' output.

The Communications Research Centre (CRC) of Canada has already studied, by performing various field tests, different applications of direct RF operation OCRs and their performance under different conditions, and has published the results<sup>22, 23</sup>. The below study focuses on the second configuration of distributed transmission network, which is "distributed translators".

---

<sup>22</sup> SALEHIAN, K., GUILLET, M., CARON, B. and KENNEDY, A: On-channel repeater for digital television broadcasting service. *IEEE Trans. Broadcast.*, Vol. 48, 2, p. 97-102.

<sup>23</sup> SALEHIAN, K., CARON, B. and GUILLET, M. Using on-channel repeater to improve reception in DTV broadcasting service area. *IEEE Trans. Broadcast.*, Vol. 49, 3, p. 309-313.

### Setup and Methodology

The distributed transmission network under consideration by the CRC consisted of three coherent translators. The translators received their input signal on channel 67 (788-794 MHz) from a medium power DTV transmitter having a tower height and EHAAT of 209 and 215.4 meters, and located at about 30 km south of Ottawa, Canada. This DTV transmitter covers Ottawa and its surroundings with an average ERP of 30 kW through a horizontally polarized omni-directional antenna system.

The translators converted the received channel 67 to channel 54 (710-716 MHz) through direct RF to RF operation. They were all frequency synchronized and their timing was adjusted to make them transmit with no delay with respect to each other.

The translators were installed on the top of three high-rise buildings in downtown Ottawa. They covered a common rectangular target area of approximately 1.66 by 1.14 km, and their output powers, which were between 15 to 25 Watts ERP (enough to cover the small rectangular target area), were adjusted to produce equal signal strengths at the centre of the target area. Figure 38 shows the relative locations of the three synchronized translators along with their overlapping target area. Also shown is the direction of transmission of the three translators' output antennas and their 60° beam width. The main DTV station, which covers the whole Ottawa area including its downtown in which the DTx target area is located, is outside the map in the bottom right direction at a distance of 25 km from the centre of the target area.

### Receiving conditions

The receiving conditions for these tests were intentionally selected to make a worst case scenario for the study. A single target area was selected for all three translators (see Fig. 39). In this way, the translators could create a lot of artificial multipaths (active echoes) in the target area. On the other hand, the downtown canyon, in which such target area was located, made the situation worse by creating additional static and dynamic multipath through reflections of each of the translator's signal from high-rise buildings and moving vehicles (passive echoes).

FIGURE 39

**Ottawa distributed translator network. The rectangular target area is  $1.6 \times 1.14$  km**

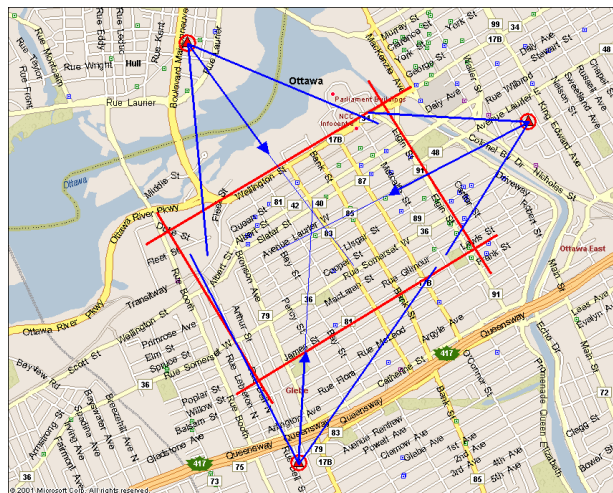

The measurement points were at the corners of the grids of a lattice covering the target area. A total of 59 points, at distances between 100 to 200 m from each other were measured. For the measurements, which were made on the street sidewalks at about 1.5 m above ground level (AGL), two types of antennas were used, an omni-directional antenna and a low gain directional antenna (usually used for indoor reception) with about 5 dB gain and 60° beam width.

Both antennas were made active by connecting them to a low noise amplifier (LNA) of about 1.2 dB noise figure and 20 dB gain, and also a band pass (BP) filter installed on the same stand as the antennas.

#### *Characteristics of the receivers used for the tests*

For these tests, two types of receivers were used, a new prototype, and an older generation receiver. The new prototype receiver, as compared with the older generation, was capable of handling pre-and post-echoes with a much wider delay range.

Figure 40 shows the relative attenuation of a single static echo at different delays, at which the receivers are at the threshold of visibility (TOV). As it is seen, the older generation receiver (Receiver G in the figure) could operate with about -5 dB echo in the range of -3 to +40  $\mu$ s. The new generation receiver (Receiver V in the figure), on the other hand, could handle pre and post echoes over a wider range. It was capable of handling -10 dB pre- or post-echo with a delay spread of -50 to +50  $\mu$ s, or -5 dB echo in the range of -25 to +25  $\mu$ s.

FIGURE 40

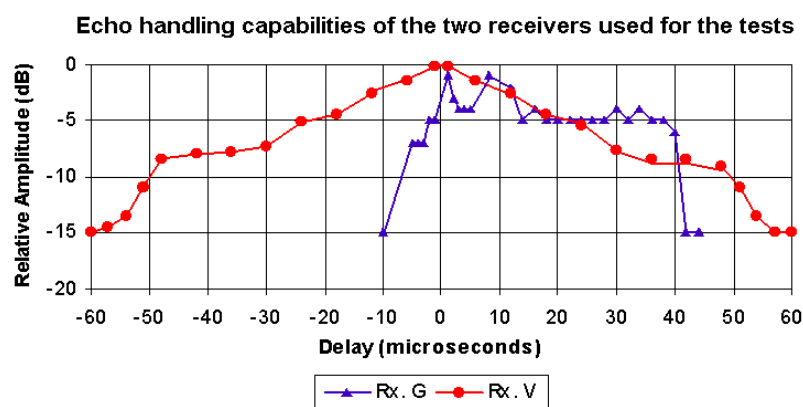

#### *Performance of the two receivers used for the tests*

##### *Test results*

In the first phase of the tests, the feasibility of implementation of such a network was verified. In the next phase of the study, measurements were performed in 59 points inside the target area. Table 8 shows the percentage of locations in which successful reception was achieved.

TABLE 8

#### Percentage of reception points with successful reception

	DTx (CH-54)	
	New Prototype Rx.	Older Generation Rx.
Directional Rx. Ant	97%	54%
Omni-directional Rx. Ant.	71%	19%
	Main Tx (CH-67)	
	New Prototype Rx.	Older Generation Rx.
Directional Rx. Ant	93%	36%
Omni-directional Rx. Ant.	44%	10%

Table 8 shows the results for DTx (CH-54) and also for the single distant transmitter (CH-67), using the new prototype and the older generation receivers, and also using directional and omni-directional antennas. As it is seen, the results are somehow better, under all circumstances, with the DTx network as compared to the single transmitter configuration.

Comparison of the results, however, can be made based on the type of the receiver, type of the receiving antenna, or type of coverage. What is quite evident is that under any condition, the reception situation is remarkably improved when the new generation receiver is used instead of the older generation receiver. Another major improvement can also be seen with using directional antenna instead of omni-directional antenna for both DTx and single transmitter. This has probably been due to the attenuation effect of the antenna on signals coming from the directions other than the main signal and acting as multipath.

Another important result that can be highlighted from this table is the fact that the DTx network, as compared to single transmitter configuration, has improved the situation also for the older generation receiver under all conditions (although not significant in all cases). The most significant improvement is when directional receiving-antenna is used. Under this condition, distributed transmission could improve the percentage of points with successful reception from 36% for single transmitter configuration to 54% for DTx network.

### ***Conclusion***

For the study in this section, a distributed transmission (DTx) network, consisting of three coherent translators, was used to cover parts of the coverage area of a single transmitter. Two types of receivers and two types of receiving antennas were used and measurements were made in both channels corresponding to the DTx network and the single distant transmitter. The reception conditions were made very tough by choosing overlapping coverage area located in the hostile downtown environment for the DTx network, and also by making the measurements at 1.5 m AGL on the street sidewalks.

The results showed that the DTx network had better reception availability than the single transmitter, especially when omni-directional receiving antenna was used.

The results also showed remarkable improvement in the performance of a new prototype receiver in the SFN environment, as compared to an older generation receiver that was used in the tests. This was because of the major improvement in the multipath handling capabilities of the new prototype receiver, which makes the implementation and operation of ATSC distributed transmission networks possible and reliable.

Another important result was the impact of even small directivity of the receiving antenna on reception. Directional receiving antenna, as compared to the omni-directional one, could provide successful reception for a greater percentage of the measurement points.

The test results also demonstrated reception improvement for the older generation receiver under SFN operation. However, because that receiver was only one generation older than the new prototype one, more tests are required to investigate the performance of the legacy receivers in a distributed transmission environment.

## **5 Germany**

DTTB was officially launched on 1 November 2002 and, by the end of 2008, all transmissions were completely digital, using the DVB-T standard. The business model is free-to-air broadcasting. The country's channel planning is based on the framework of the national frequency rights resulting from the ITU-R Geneva Agreement 2006 (GE-06), using predominantly the service concept "portable outdoor" (RPC-2 according to the Geneva Plan plus one or several assignments per city for high-power transmitter). This service concept generally enables indoor reception in the German agglomerations, which makes up one half of the total area, where typically more than twenty digital programmes are available in standard definition (SD) quality. Outside of these agglomerations, DVB-T can either be received as "portable outdoor" or by using directive antennae. With respect to HDTV, first test transmissions have taken place. Trials are also carried out concerning the transmission of sound radio programmes within a DVB-T multiplex.

There are various types of receivers on the market, ranging from USB dongles for PC and laptops over small portable TV sets for handheld and in-car reception (screen size typically between 5 and 7 inch of diameter) to set-top boxes and stand-alone TV sets for stationary reception (typically with flat-screen displays). In May



2008, the first mobile phones with integrated DVB-T receivers appeared on the market. In addition, car navigation systems are nowadays equipped with DVB-T receivers.

The switch-off started in Berlin-Brandenburg in August 2003. Already by the end of 2003, some six million people were able to receive 26 digital channels in SD quality in the city of Berlin and the federal member state of Brandenburg. This was the first switch-off of terrestrial analogue television worldwide. This success can be ascribed in part to the Government, which decreed that the service was to be totally free of charge, and which provided, only in 2003, free decoders to the poorest households. Under no other circumstances, the purchase of DVB-T receivers was subsidised. By the end of 2007, more than 85% of the German population (68 million people) could already receive digital terrestrial television. More than nine million receivers had been sold by that date. The success of DVB-T in Germany was due to the fact that the reception of a multitude of German-speaking programmes was available to the general public free-of-charge. In 2008, DVB-T is used by 16,8% of the households in Berlin –Brandenburg.

In other metropolitan areas, DVB-T transmissions started in 2004. One key element of the German approach was the implementation of the digital broadcasting service region by region, initially after an announced transition period of as little as six months and later on without any simulcast period. By the end of 2008, the switch-over will definitely have been completed (two years earlier than originally planned).

By the end of 2008, some 15 million DVB-T receivers are expected to have been sold since the launch of the service. Nevertheless, for their primary TV service in the households (large flat screen in the living room) approximately 90% of the Germans still rely on cable TV or satellite distribution.

Detailed information could be found at following links:

<http://www.alm.de/fileadmin/forschungsprojekte/GSDZ/digitalisierungsbericht2008D.pdf>

and

<http://www.ueberallfernsehen.de/>

## 6 Guinea

### *Legal and regulatory aspects*

It has to be acknowledged that analogue radio and television broadcasting are not very developed in certain African countries, for example the Republic of Guinea, where radio broadcasting was introduced only in 1952, and television in 1977.

The transmission medium initially used was the radio-relay network, constructed in 1977.

Today, this network, operated by the Department of Posts and Telecommunications and digitized to the tune of 85%, does not carry television and radio signals owing to the advance of satellite broadcasting, which is favoured by the Government. However, we are convinced that the rapid development of radio and television broadcasting will of necessity involve digitization through liberalization of the audiovisual sphere.

### *Legal and regulatory framework for DTT*

In the Republic of Guinea, the tools and infrastructures conducive to the rapid opening up of digital radio and television broadcasting are to be found in different sectors, with much of the equipment (radio and television transmitters, studios) being administered by the Ministry of Information, while other equipment (shortwave and medium wave radio transmitters and terrestrial radio-relay transmission facilities) is administered by the Ministry of Posts and Telecommunications. The Government would be better advised, with support from the development partners, to group the various communication media under the same authority, pending the opening up of the audiovisual sphere.

### *Technical aspects*

Two alternatives may be envisaged for the migration from analogue broadcasting to DTT:

- close down the analogue system and construct an entirely digital network, or
- deploy a hybrid system (analogue and digital).

The second option would seem to be the most appropriate for developing countries. It involves using the existing analogue network with a certain amount of refitting and the construction of a number of sites. However, the paramount requirement for making the DTT network more operational is a redistribution (replanning) of the frequencies used, this being the task of the regional radiocommunication conference (RRC) over the coming months.

Furthermore, the fact that our States currently use the radio-relay network for their radio and television signals leads us to recommend, for those countries that share a common border, that they jointly replan their frequencies and select the same digital television system, namely DVB-T, which is technically more adaptable than the ATSC(A) and ISDB-T(C) standards. The B(DVB-T) standard is less costly and more advantageous to developing countries during the transition period. This will allow for more fruitful regional consultation aimed at harmonizing the technical facilities to be used when introducing digital broadcasting equipment.

## **7 Italy**

### **7.1 Legal Framework**

The bodies involved in Italy in the spectrum management and planning are:

- Ministry of communication (MIN COM): entitled for spectrum allocation and for private and public services frequency assignment for civil utilisation as well as the elaboration of the assignment plans apart of broadcasting services. The Ministry is also in charge of representing Italy in relevant international bodies, such as, ITU, CEPT, EC.
- Authority of telecommunications (AGCOM): entitled of frequency planning for broadcasting services. The Authority was appointed in 1997.

The main AGCOM tools are Plans and Resolutions for broadcasting services. During last years different Plans were defined:

- 1998: Analogue TV Plan
- 2002: DAB Plan for VHF-Band and L-Band
- 2003: DTT Plan.

Up to now none of these Plans has been implemented. Probably the difficulties are related to the actual use of the very overcrowded Italian radio electric spectrum:

- 10 National Analogue broadcasters (Rai1, Rai2, Rai3, Canale 5, Italia 1, Rete 4, La 7, MTV, ReteA-Allmusic, Rete Capri)
- 7 National Digital broadcasters (Rai-MuxA; Rai-MuxB; Mediaset1, Mediaset2; PrimaTV-Dfree; TIMB-MBOne; ReteA-AllMusic)
- 584 local broadcasters (divided in two politically strong associations).

A total of 24 000 transmitters/frequencies are today used in Italy.

### **7.2 Laws and Provisions for DTT**

In 2001 Italian Parliament approved a law (n. 66/01 updated in 2007), which envisages the complete transition from analogue to digital terrestrial television by the end of 2012 (the previous term for A.S.O. was 2008).

In 2004 a further law (n. 112/04), under the co-ordination of the Ministry of Communications, fixed a number of pre-operating activities which have been undertaken by the public and private Italian broadcasters. In this context RAI obligations were to implement 2 DTT Multiplexes which had to reach:

- 50% of national population coverage by the end of 2003.
- 70% of national population coverage by the end of 2004.

### 7.3 DTT at Present

The coverage of the digital national broadcasters is reported in Table 9 (source: MinCom –2007).

TABLE 9  
DTT national broadcaster coverage

<i>Broadcaster</i>	<i>Mux</i>	<i>Transmitters</i>	<i>Coverage (% Pop.)</i>
<i>RAI</i>	<i>Rai DVB A</i>	66	71%
<i>RAI</i>	<i>Rai DVB B</i>	75	71%
<i>RTI</i>	<i>Mediaset 1</i>	373	79%
<i>RTI</i>	<i>Mediaset 2</i>	278	78%
<i>Prima TV</i>	<i>Dfree</i>	261	78%
<i>TIMB (La7)</i>	<i>MBOne</i>	155	65%
<i>Rete A</i>	<i>Rete A All Music</i>	32	50%

### 7.4 The “Italia Digitale” Committee

A solution to the complexity in the process of Italian digitisation, seems to be emerging from the work which has been carrying out by the “Italia Digitale” committee. In August 2006 the Minister for Communications set this national committee bringing together: broadcasters (national and local), network operators, Ministry, Authority, universities.

The goal is to define the way to achieve the national switch off for the transition to DTT service according to the results of GE06 Plan trying, where possible, to release frequencies in order to create a digital dividend.

The Committee is divided in two different groups:

- The “Steering Group” (with address purpose), chaired by the Italian Minister for Communications.
- The “Technical Group” (a group for the technical support), divided in different working groups: communication to users, data and research, assistance to users, network development and monitoring, regulatory aspects, contents and programs (for digital television).

The main task assigned to the Working Group “Network development and monitoring” (of the Technical Group), is the definition and scheduling of the so named “All digital” Areas (in which the analogue switch off has been accomplished).

### 7.5 The “Technical Area” Concept

The best approach to identify the “All digital” areas appeared to be taking into account the present broadcasting network architecture. This has been done introducing the “Technical Area” concept: part of the country not necessarily limited by administrative boundaries.

In Fig. 41 is illustrated a comparison between the Italian Administrative Regions (Fig. 41a)) and Technical Areas geographies (Fig. 41b)).

FIGURE 41

The Technical Areas

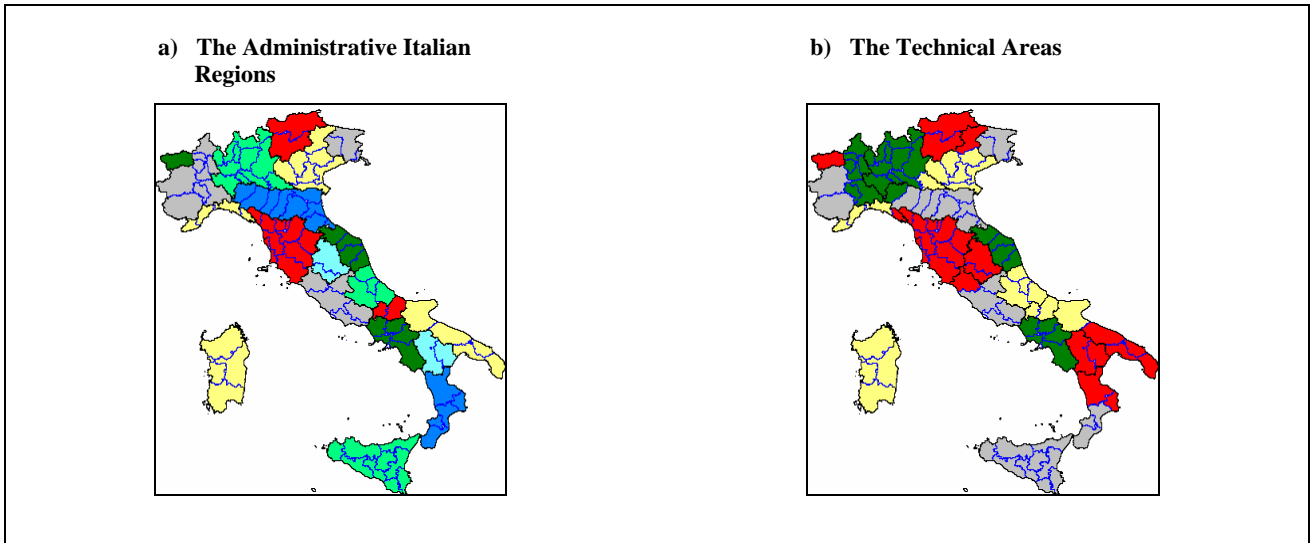

7.6 The A.S.O. Plan

The full plan for national switchover was presented on 10 September 2008 by Ministry of Communication; it is subdivided in 8 semesters as detailed in Fig. 42.

Analogue switch-off is currently underway in Sardinia and Val d'Aost and will soon begin in the provinces of Turin and Cuneo and the regions of Trentino and Alto Adige.

FIGURE 42

The 8 semesters of the A.S.O. Plan

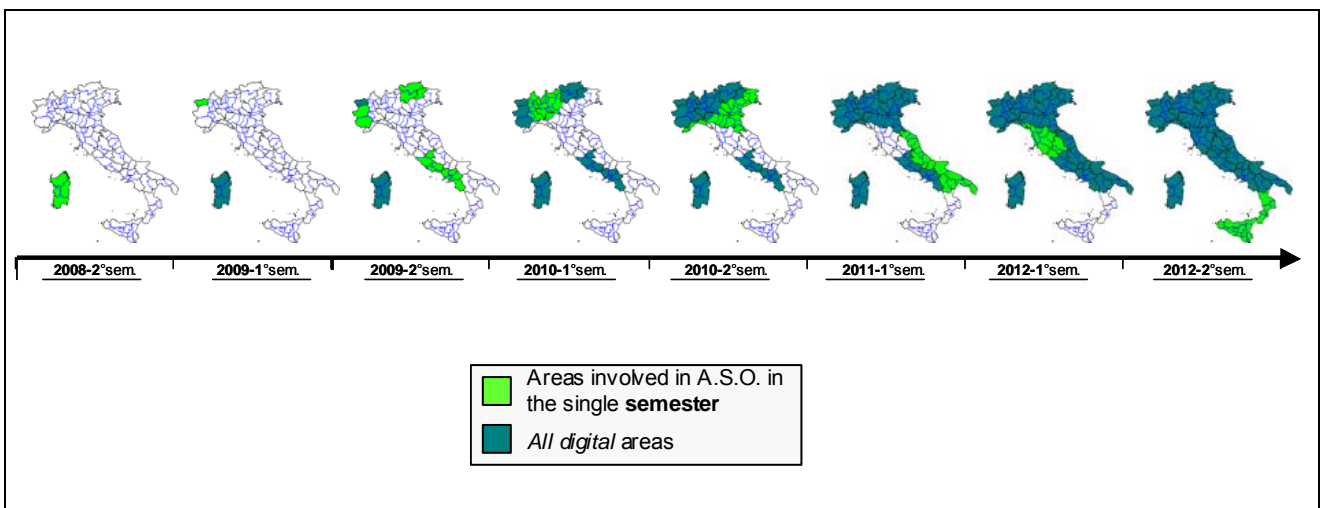

The advantages of this approach are:

- ease in industrial decoder distribution;
- ease in direct communication to users due to the fact that the cities involved in switch off are exactly defined;

- minimization of the area with analogue-digital simulcast encouraging the technological renewal trend similarity to the allotment attribution of the GE06 Plan.

### 7.7 The DTT Receivers Penetration

According to the latest estimates at the end of May 2008 the number of DTT households (with at least one DTT receiver in the main family home) has risen to 5.912.000, with a net growth of 130 thousand (+2.2%) units in April (“Digital TV Monitor” survey by Makno).

Between April and May the overall number of DTT receivers increased from 6.288.000 to 6.427.196 implying a monthly growth of 140 thousand units.

### 7.8 40% DTT Capacity

The 2001 law n. 66 obliges Rai, Mediaset and Telecom Italia Media to handover 40% of transmission capacity to third parties. Thanks to this law in august 2008 AGCOM has received 25 programme applications from 17 different companies wishing to gain access to DTT. A special commission has to draw-up the list of channels to which AGCOM will allocate transmission capacity.

The applicants include international companies such as Disney; NBC Universal, with two requests; Swedish.

Airplus with six requests; ESPN; Turner Entertainment Networks; the English Top Up TV, and Qvc, specialized in teleshopping. There are also regional TV networks such as Telelombardia and Antenna 3 Nord Est as well as other national broadcasters: Sitcom, Class Editori, AnicaFlash (Coming Soon) and Rete Blu. Other national applicants include Infront Italy (with two requests), Archimede and finally Consorzio Alfabet, which will only be officially set-up if their application is successful.

### 7.9 The Italian DTT Offer

Italian DTT offer includes 28 FTA national channels (including 9 terrestrial analogues) as well as Pay services. There are 6 all-news channels; 3 channels each for the entertainment, music and sports areas; kids’ programmes have two thematic channels: Boing and Rai Gulp. Pay offers, including PPV, generally cover the areas of film, fiction, sports and kids (with Disney Channel’s recent entry).

Moreover since June 2008 Rai has been broadcasting HD programs in the areas of Rome, Turin, Milan, Sardinia and Valle d’Aosta. The European Football Cup and the Peking Olympics were broadcasted through DTT in high quality 16:9 format on RAI 2 and on RAI Sport Più.

FIGURE 43

The Italian DTT offer (source: e-Media Institute)

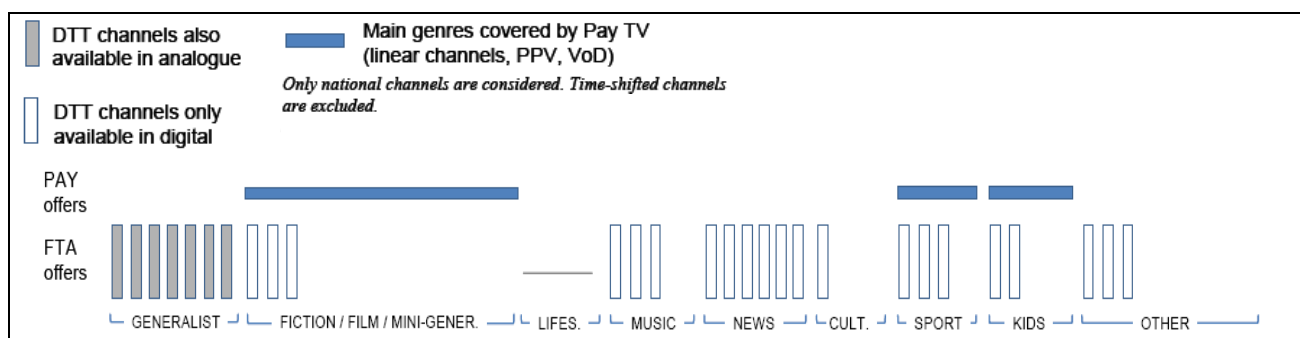

## 7.10 Historical Considerations

### Introduction

Digital Terrestrial Television in Italy existed only in project plans and in technical laboratories until late 2003. Scheduled DTT services were started in December 2003. Six multiplexes at national level are in operation, conveying in excess more than 42 TV channels. At the moment this report is being written, tens of interactive services are already available on top of audio-video services. Tens of local digital channels have become progressively available. The current coverage of population, in terms of reach of digital signals, is more than 70% in complex. Pay-per-view services, via prepaid (possibly rechargeable) smart-cards have been introduced one year after the start-up of the system, with virtually no breaking of the free-to-air, interoperability characteristics of the set top box. Four millions set top boxes are installed in the Italian households as of end of year 2006. This means that 20% of Italian households are provided of digital TV boxes. By all benchmarks this appears as a major success story, so far.

This contribution aims at describing some key factors of the Italian way to Digital Terrestrial Television:

The new value chain and the new stakeholders

Deployment of digital networks

The spread of set top boxes

The availability of audio-video contents

The challenge of interactivity, as a means to achieve t-government

The challenge of interactivity, as a means to attract revenue into the new DTT market

Cooperation and coordination of actors at national level.

#### *The challenges at stake*

The go-ahead to digital terrestrial television has given a decisive jolt to the reorganisation of television broadcasting by designing new scenarios that are modelling attractive business opportunities, new content and technological innovation on the part of all the players involved in the transition from analogue to digital.

A variety of problems have yet to be confronted and solved, as may well be imagined for an experimentation of a profoundly structural nature both in terms of the investment needed and the numbers involved. But there is great enthusiasm for the new challenge and a desire to find ample space for sharing experiences and comparing notes, as long as the switch-off date, year 2012 is reached with everything in order.

The stakes in digital are high, ranging from content to the technological capacity to create infrastructures able to sustain the change.

The passage to digital and the abandonment of analogue broadcasts will transform the traditional television set into a new, practical, interactive consumer appliance in which traditional TV functions will converge with computing and the latest applications of remote communication technologies. Remote medical consultation and distance teaching, T-government are just some examples of what digital television will be able to offer ordinary citizens. And all this will allow Italians direct access to new services directly from their own homes, instead of having to suffer long queues in public and private offices.

While television consumption used to be passive, with digital TV public interaction will become more dynamic. With analogue TV the user has to use the remote control and change programmes, while digital TV will shift the user towards a higher, more complete composition of genres.

Digital terrestrial television is therefore set for integration with new forms of social globalisation, creating new codes for the time consumed in front of the TV set. It will take on the appearance of a new medium able to guarantee connection to information and interactivity.

Feedback from viewers will become an integral part of content planning, development and organisation. And the commercial spin-off, expected to be substantial, should not be forgotten if the packaging of more complex products, with its effect on the production system, changes distribution as well.

With the introduction of digital TV also the traditional professional figures will be caused to change, such as the installers, who will tend rather to become sellers of entertainment and bits. But the broadcasters will also

change, and will have the opportunity to choose whether to become just a seller of band and megabytes or to keep also the role of producers of content, which will have a knock-on effect on the entire industrial fabric and on its potential for development.

#### *Brief history before start of scheduled DTT services*

The history of DTT in Italy starts in the early Nineties, with active participation of technical experts from Italian broadcasting operators and industry in the works of the international DVB group, since the time of its formation. Digital techniques are first applied on satellite systems, where there is a more dramatic needs of optimising spectrum use, given the cost of satellite payload and the need to definitely improve quality of reception. Along the Nineties the transition from analogue to digital satellite TV takes place. Similar needs, for a more rational use of spectrum and for better quality of reception, arise for terrestrial television, leading to studying the feasibility of introduction of DTT in Italy.

In 1997, the Parliament act 249/97 establishes the Authority on communications (AGCOM), which is given the task – among others – of drafting a national frequency assignment plan. For the first time in Italian legislation, DTT is mentioned, by foreseeing an ad hoc frequency reservation for trials of this new technique. Such plan is actually issued in 1998.

In 1999 the AGCOM sets up a DTT National Committee, i.e. a Forum bringing together broadcasters, network operators, industry, universities and R&D institutes. The results of the work, carried out by four Study Groups on service requirements, network and frequency planning, architectural and costs evaluation, planning of the launching phase, are reported in the White Book published in September 2000 and submitted by the AGCOM to the Parliament. The White Book also suggests the opportunity of financial incentives for local broadcasters to free up frequencies.

In 2001 the Italian Parliament approved act n. 66/01, which, in conjunction with subsequent Acts and amendments, envisages the complete transition from analogue to digital terrestrial television (switch-off) after a predefined period of coexistence of both systems. According to this law the AGCOM elaborates and publishes at beginning of February 2003 the plan for digital television broadcasting named planning of first level.

During the following years, under the co-ordination of the Ministry of Communications, a number of pre-operating activities are undertaken by the public and some private Italian broadcasters in all Italian territory. Concertation activities and joint demonstrative trials are carried out to ascertain the feasibility of transition from several viewpoints: technical, economical, regulatory and marketing.

It is during this time that the Italian Administration, in agreement with major players in the broadcasting arena, gives a strong push to go for fully interactive digital terrestrial television (see specific paragraphs in the sequel). Interactivity has since then become a major watermark of the Italian way to digital terrestrial television.

#### *The value chain of DTT*

The analogue terrestrial television market is vertically structured, i.e. one single stakeholder, owner of the licence to transmit, covers the entire chain of production, transport, distribution and broadcasting.

In the Italian DTT market, a single stakeholder role is replaced by three roles:

- *content provider*, which is responsible for the production of audio/video services;
- *network operator*, which uses a set of frequencies to operate a network of transmission sites, through which a set of audio/video services and multimedia/data services is broadcast on a national or local level;
- *service provider*, which provides conditional access services or information services (data services).

Content providers and service providers need an authorization from the State in order to operate. Network operators need a licence.

In Italy, special emphasis has been given to interactive services, which foresee communication, through connection of the set top box to a telecom network, with servers belonging to service providers (possibly third-parties with respect to the network operator and the content provider), to exchange data of specific, personal or private interest upon request by the user. Therefore, the value chain of DTT completes with the

role of *telecom operator*, as the provider of the so-called return channel. Interactive service provision requires the set up of a (possibly distributed) system called service center, relaying information among the broadcaster playout center, the application and data repositories in the domain of the service provider and the user set top box.

The above described value chain revolutionises the traditional television business model and opens up the market place to a number of newcomers, not only broadcasters, but also third-party service providers like public administrations, public utilities, healthcare establishments, schools, and so on.

#### *The transition from analogue to digital terrestrial*

Since year 2000, it was understood in Italy that an orderly and effective transition process from the analogue to the digital system could only be possible by coordinated effort of a number of stakeholder roles. In fact the process involves the following phases, to be achieved concurrently and in parallel: deployment of digital networks with progressive coverage of the population; adaptation of existing receiving antennas whenever necessary; provisioning of digital receivers in all households, availability of audio-video, multimedia and interactive contents.

#### *Deployment of digital networks*

The overcrowded Italian analogue system (the result of several stratified provisions, across more than twenty years, often introduced as patches to intricate problems) did not allow to have a given number of VHF and/or UHF channels consistently reserved in all transmission sites for implementation of as much Single Frequency Networks (SFN) as needed to broadcast DTT services. Therefore, a pragmatic approach was taken: digital broadcasting was allowed from transmission sites where frequencies would be available or could be made available by reclaiming them from the analogue domain. To this purpose, i.e. for the sake of converting usage of frequencies from analogue to digital, legal provisions have been made for *frequency trading*. Otherwise said, to build a digital network (multiplex) the broadcasters have two options: (a) buy licensed frequencies from other broadcasters; (b) convert to digital operations the so-called redundant frequencies, i.e. channels used in several areas just for little improvement of the analogue coverage.

The Parliament Act n. 66/2001 and the related regulatory package 435/01/CONS of AGCOM, plus the Parliament Act n. 112/2004 do provide the legal framework for fair trade of frequencies in the evolution towards an “all digital” scene. In this perspective, and according to the orientation of the other Member Countries of the European Union (at the moment this report is being written the furthest term for the transition from analogue to digital transmissions in Europe is established in year 2012), that legal framework is still evolving.

#### *The situation of digital networks as of end of year 2006*

By following the approach described above, national broadcasters have been able to set up digital networks, covering more than 70% of the population. By visiting the website [www.dgtvi.it](http://www.dgtvi.it) TV viewers can check whether their town is covered by digital signals and find out which multiplexes and from which transmission sites are available in their area. In major areas even 5 or 6 multiplexes are available.

From the side of RAI, only six months after the starting date of the digital transmissions, 80 DVB-T transmitters were already operating in the greatest Italian cities. At the moment this report is being written, more than 150 DVB-T transmitters have been achieved by RAI and are operating, for a coverage of more than 70% of the population. Two multiplexes are radiated.

Mediaset is strongly committed in experiments on DVB-T systems to accelerate the introduction of digital terrestrial television. Mediaset has 93 DVB-T transmitters operating and covers a significant percentage of the Italian population with one multiplex. All these transmitters are obtained from conversion from existing analogue ones. A similar number of digital transmitters is also planned in the near future, to further enlarge the coverage. The existing multiplex includes MHP interactive applications.

As regards other broadcasters, Home Shopping Europe is using 17 DVB-T transmitters, Rete A is using 163 DVB-T transmitters, LA7 is using 121 DVB-T transmitters and Prima TV is using 58 DVB-T transmitters.

A significant number of local broadcasters have been able to trade frequencies to be devoted to the digital exercise. Those that could not purchase such frequencies, have only one option: keep analogue broadcasting,



until availability of set top boxes in their area of coverage guarantees a digital audience greater than the analogue one. Since transition regulations impose that actual digital emissions do take place, for an analogue broadcaster be enabled to apply for a long-term licence in the DTT market, the most common solution for minor local broadcasters is to reserve some lowest-audience hours of the 24hour-day for digital trials. It must be said, that the most recent transmission systems are dual, i.e. are able to toggle from analogue to digital mode.

It is obvious that for any analogue broadcasting station that closes down, the system will be able to activate at least five DTT channels. Therefore, at some stage, there should be a landslide effect in the availability of frequencies.

#### *Adaptation of receiving antenna installations*

On-field experience has shown that receiving antenna installations are, in most cases (70-80% according to different sources), directly reusable to receive the digital signals. Most interventions are related to re-adaptation of centralised installations (one single antenna serving a number of apartments), where some VHF-UHF channels may have been filtered out (to avoid interference) or ad-hoc selections of channels have been designed (like for instance in hotel installations).

#### *Provisioning of set top boxes for the households*

By encouragement from the Ministry of communications and voluntary concertation and commitment by all major stakeholders, the Italian DTT STB:

is broadcaster-independent: no hard pre-setting or customisation in the STB by any particular broadcaster;

is interoperable, i.e. works with any channel or service from any broadcaster;

has no subscription associated with it;

accommodates CA for pay-services, while remaining interoperable. CA is embedded in smart cards and in ad-hoc software add-on's that can be downloaded as OTA upgrades.

The STB model selected in Italy, by concerted voluntary agreement among all market players, is conformant to the "interactive broadcasting profile" of DVB-MHP specification version 1.0.3 (endorsed as ETSI TS 101 812). This standard defines a hardware-independent middleware for digital broadcast services, allowing the consumer to choose their own MHP device (set-top box, digital TV set, multimedia PC, etc) and plug it in to work with their preferred digital video service operators. The conformance to the MHP platform allows users to purchase any MHP-compliant device (STB or iDTV, from any manufacturer) and receive TV programmes and interactive services from any MHP-compliant broadcaster.

Interactive services are implemented via software applications that are delivered to the client MHP-compliant device via the broadcast DVB-T channel, and they run on the middleware. Interactivity is supported through an interactive TCP/IP-based channel; the presence and the support of this auxiliary channel, at present implemented mostly as a PSTN modem, is mandatory for interactive decoders in the Italian market.

Significant is the "new" usage introduced for the remote control, since in this new context it allows the user to make with a single touch operations that actually requires the involvement of a plurality of tools and means: phones, PCs, mail, etc. The convergence over a single device opens new and interesting scenarios, since it makes more simple and intuitive for the TV user to interact at various levels and in real-time with the TV programme: it allows the TV user to navigate across an enriched and interactive TV content.

Navigation is also expedited by the association between contexts which the user can move across and related standardized colours of buttons of the remote control. Common actions are associated to standardized colours too.

Finally, the MHP platform enables the user to navigate without loosing contact with the current TV programme: this feature is provided by overlapping A/V content and graphics.

#### *Availability of digital contents*

Current availability of digital contents (audio-video services and interactive services) is reported at the [www.dgtvi.it](http://www.dgtvi.it) site. At the time of writing, almost 42 TV channels are available on a national basis (11 of them

are simulcast of analogue ones, but most often enhanced with multimedia and interactive services; 20 are brand-new channels not available in any other platform; others are re-broadcast of satellite channels). Among these 42 TV channels, 31 are Free-To-Air channels, while 11 are for payment (usually a pre-paid event-based purchase model is applied).

Some tens of superteletext services are already available. The development of EPG, super-teletext and interactive advertising applications is ongoing, based on the DVB-MHP open API platform. Each major broadcaster has his own EPG, although there are plans for a system-wide EPG service.

Some interactive services with exchange of personal data are in place. Transactive services are in the focus of several t-government projects (see below): worth of note are some trials of t-banking services. T-government applications (information regarding Public Administrations, payment of taxes, retirement funds) are being developed in the framework of the DTT Commission, under the auspices of the Communication Ministry.

### ***The challenge of interactivity***

Since the year 2000 the European Council has introduced the concept of *e-government*, as inclusion of public administrations and citizens in the information society. The digital terrestrial platform, powered with interactivity, has been seen as a new candidate access path to services for citizens, in addition and in complement to Internet browsing via pc and via cellular phones. The Italian government has promoted interactive digital terrestrial television as a means to overcome the divide between citizens endowed with digital multimedia devices and computers for Internet access and citizens that can only rely on traditional appliances (among which, the TV set virtually available in every household).

At the moment of writing, the Italian government is strongly committed to support the spread of connectivity and interactivity nationwide, through different media: broad band access and digital terrestrial television infrastructures are in the focus of public investments.

### ***Service classification***

Services of the information society were classified in three categories:

- **informative services**, conveying information along with audio-video programs (just like in teletext). Obviously, the only information that can be conveyed in this way, is that of general interest for the viewers. The user can “browse” through pages, by interacting by means of the remote control.
- **interactive services**, enabling users to access and manipulate data of their own specific interest, although neither private nor sensitive. Access to such data requires connecting, through a return path, to a **service center**, which in turn accesses data repositories of service providers to fetch (deliver) data requested (supplied) by users.
- **transactive services**, enabling users to access and manipulate data of their own specific interest that should be protected from unauthorised viewing and usage, either for the sake of privacy or for financial security.

Examples of informative services are Superteletext, the natural multimedia evolution of plain old teletext, and the Electronic Program Guide (EPG). Another category of informative services is broadcast by some network operators under agreement with some Public Administrations, regions or municipalities, wishing to offer portals with news of relevance for the local communities, announcement on available facilities, useful contacts and addresses, charities, etc.

An example of an interactive service is retrieving data related to a motor vehicle, from the public registrar of ACI (Automobil Club Italia): users input a plate number via the remote control and the system replies with public data such as the owner, his/her address, power of the engine, annual payable traffic fee, etc.

Speaking of transactive services, we can refer to the reservation of a medical visit, or the reading of a medical diagnose. In this case, the user should not only input his/her health insurance number but also be authenticated and authorised by the system. We can also refer to financial transactions, like in the case of on-line purchases or operations on one’s own bank account. Not only for immediate and safe input of personal data, but also for the sake of data protection and security a smart-card could be used. The ability to use

transactive services will enable the decoder to be a simple but powerful terminal for on-line reservations, purchase of theatre tickets, air-tickets, delivery of administrative documents, tax payment and e-commerce.

#### *Business models for interactivity*

Interactivity can boost considerable turn-over, if proper charging model and revenue sharing models (among the different stakeholders roles contributing the provision of interactive services) are devised.

As regards charging models, the prevailing attitude of service consumers in Italy is clear: services should be convenient to use and should be payable on a mere per-use base (no scheduled bills, possibly). The huge success of prepaid rechargeable SIM cards in cellular telephony is a clear proof of this statement. The success of the SMS is another example: users' willingness to pay is related to the perceived usefulness of a service in front of a nominal (micro)payment requested (although price is very high compared with the real cost of providing the service). Considering, by instance, that in 2003, the total revenue from SMS collected by Italian mobile operators was in the order of a few billion euro, it is reasonable to foresee that a comparable pattern (in frequency of usage and in the charging model) for interactive services over the DTT platform might generate a revenue figure that can compare with the current annual amount of investment on advertising through TV. Interactivity becomes then a means to inject definitely more significant resources on the new DTT system, compared with the analogue system. Even for t-government services the payment of nominal fees (in the order of a few tens of cents) for each usage might generate a cash-flow that would probably make service provision self-sustainable.

As regards revenue sharing models, one could think of the sharing model used in relation with premium-rate numbers in telephony or other similar schemes. In this case the sharing of revenue should involve the service provider, the content provider (hosting pointers to the service from within its audio-video programs), the network operator and the telecom operator.

Digital terrestrial television comes along in a special historical moment. Just after the success of GSM and SMS, just when Internet services are taking up, just when pre-paid models for charging are more and more acceptable to people. Interactive DTT inherits several assets from its analogue predecessor: user friendliness, easy of use, amount of time the average viewer spends in watching TV. It can also inherit some assets from the usage of internet, micropayment and prepaid cards.

#### *Opportunities for local broadcasters*

Local broadcasters will keep their role of providers of TV contents of local or topical interest. They can evolve into network operators at local level. They can also "go aboard" a multiplex operated by other parties and become mere content providers.

However, the area where most opportunities are offered to local broadcasters is the area of interactive services, for several reasons.

Most services are intrinsically of local scope. Imagine, e.g., reservations of museum, shows and restaurants and administrative operations with the municipalities or with the utility companies.

Local broadcasters, when operating a multiplex, are not likely to fill it with audio-video contents. They will have a huge percentage of available bandwidth in the multiplex that can be used for data services.

#### *Interactive services already on air*

According to the above framework, new services have been designed and realized to exploit the potentials of DTT based on the MHP platform. A first range of services is:

- enrichments of news services;
- more versatile animation and graphics;
- polling applications;
- games and quiz;
- interactive advertising.

These services, that keep a strong relationship with the TV content, are called *content-related services*. In Fig. 44 some shots from real TV screens are provided as examples.

FIGURE 44

Examples of content-related (left picture, courtesy from RAI; courtesy from Mediaset)

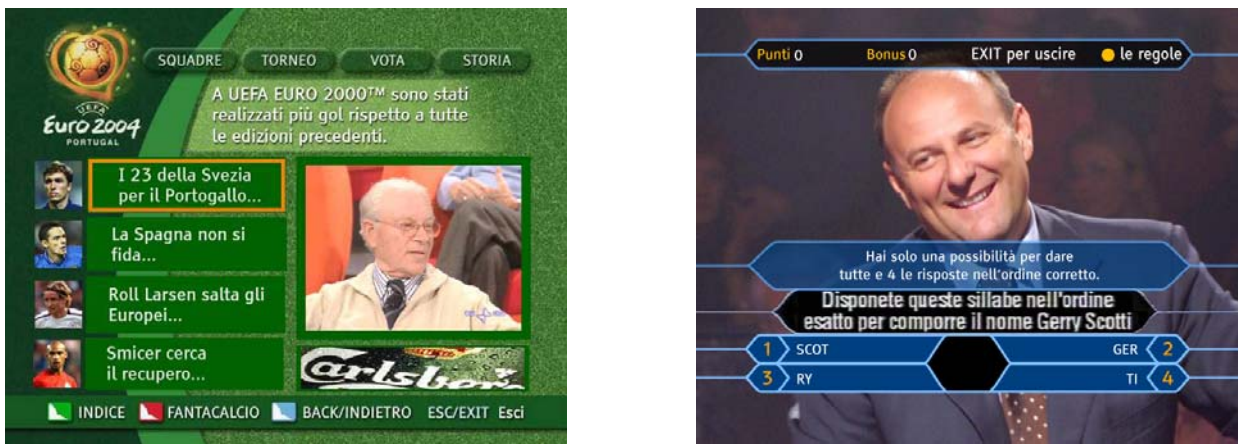

In Fig. 45, an example of a non content-related service is reported. It is an Electronic Programme Guide (EPG) service, that provides the user with information over the whole TV offer.

FIGURE 45

Example of EPG (Courtesy from RAI)



The EPG designed for DTT allows the operator to unify the presentation layout of its offer at the bouquet level, and to customize it in respect to the other operators. It enables also the enrichment with enhanced graphics and images, and the adoption of specific creative solutions for each class of users.

Of course, in the non content-related range of services T-Government services are included (examples of screen shots are provided in Figs. 46 and 47). This new level of interactive enables the user to gain access to services provided by a plenty of public institutions (hospitals, schools, local and central administration, ...) while staying at home. Private entities, like banks, travel agencies, ... are also reachable.

FIGURE 46

Examples of T-Government services offered through DTT (courtesy from RAI )



FIGURE 47

Examples of T-Government services offered through DTT (left picture: courtesy from La7. Right picture: courtesy from Mediaset )

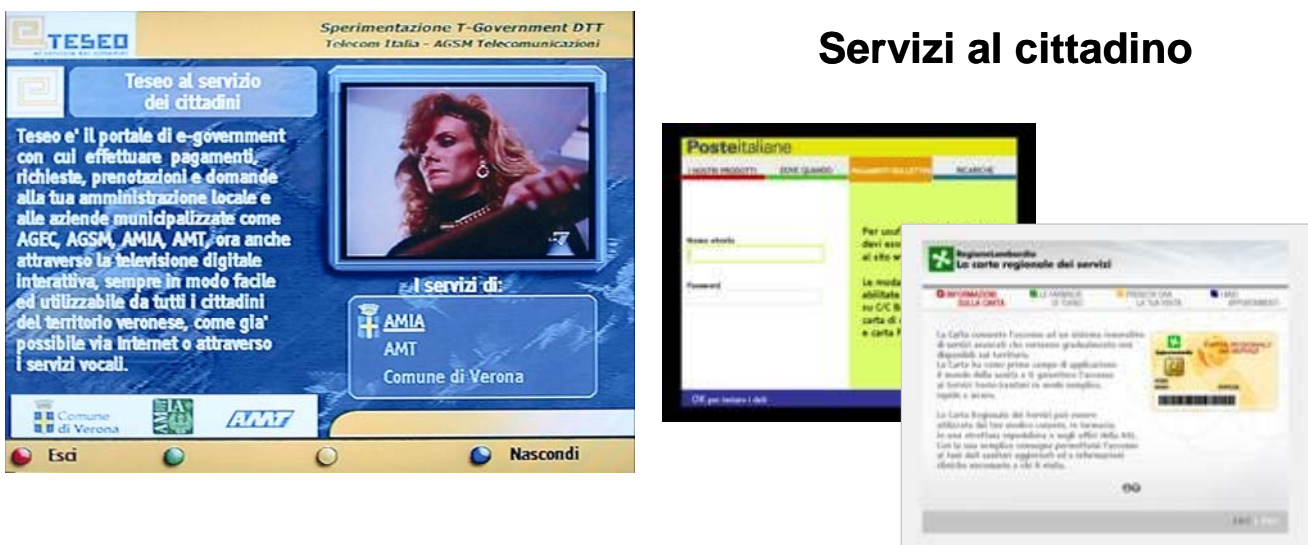

### Interactive services of the near future

The Research Centre of RAI has developed a prototype portal for T-government services to be offered through the DTT infrastructure, based on MHP platform. In particular, the present effort is focused on the user interface and on a user assistance service, including audio and video, that shall help the user in using the “new” digital TV and shall provide her information and interactivity.

Figure 48 shows a picture spilled from a demo of this new services, realized with the courtesy of a well known Italian anchorwoman.

In the effective MHP implementation of this application, A/V clips shall be delivered to the receiver through the broadcast channel, together with application code. Timing and bandwidth considerations strictly suggest to investigate the possibility of caching data on the STB, reducing consequently bandwidth allocation for this service. Present memory availability of commercial STB is not appropriate for this kind of demand, neither it's envisaged future implementation will meet the requirements whether not equipped with large capacity devices like Hard Disks.

FIGURE 48

User assistance services with a set of predefined A/V clips (courtesy from RAI)



Another interesting perspective for the evolution of DTT is offered by its integration in the context of digital home networks. A new scenario the Research Centre of RAI is exploring in the scope of some international research project is the integration of the MHP STB with the home automation network. Thus, the TV set offers a very intuitive, easy-to-use interface for handling and interacting with domestic devices while staying on the sofa. This kind of service is particularly targeted to senior citizens or people with special needs.

Still open, in particular from the point of view of mass feasibility, is the problem of interfacing MHP STBs and commercial available home automation systems. There is a lack of standardization that must be fulfilled before a mass deployment of this solution be possible, but lot of efforts are currently spent in this directions.

An important part of the Italian project for DTT is the use of DTT receivers to provide T-Government services to the citizens. For that purpose, the receivers will need to be able to interact with different smart cards issued or to be issued by the Authorities, such as:

- national electronic ID card;
- national local government service cards;
- health service cards.

The level of access to the contents of those cards is determined by:

- the security of the reader terminal (in this case the receiver);
- the security of the circumstances in which the terminal is used;
- the security of the interaction channel when a distant interaction is expected;
- the exact level of service that will be provided to the citizen.

Furthermore it is envisioned that the receiver shall also be used as a banking terminal for program acquisitions, e-commerce transactions and financial/banking transactions. The security requirements for those services are evolving, and the European Union – to foster trust in e-services - is supporting different projects to produce unified recommendations and solutions.

#### *National level recommendations for smart cards*

The protocols for those cards, and the exact security requirements for the services, are not yet fully defined. Different solutions exist at European and International levels, some standardized and other proprietary.

As a minimum, the receiver shall be compatible with:

- citizen's service cards;
- conditional access smart cards.

This compatibility can be reached by different means:

a single smart card reader (ISO 7816) with the different protocol stacks implemented;

a smart card reader and a Common Interface slot;

a Common Interface slot populated with a smart card reader module.

In case A, switching between service card and conditional access card shall not require rebooting of the receiver or a multi-menu navigation. Selection of the active conditional access may be done through the set-up menu. In case C, the smart card reader shall be provided as a default. In all cases mentioned above (A, B and C), it is recommended that the smart card reader be compatible with the EMV specification for banking terminals.

For non-CA services, the receiver shall implement the SATSA proposal by Sun Microsystems Inc., which is supported by the current MHP specification.

#### *Public promotion of T-government projects*

To encourage the uptake of T-government, the Ministry of communications and the Ministry for Innovation Technologies have launched a funding scheme for projects presented by public administration, as well as service and utility providers. Financing, overall management and supervision of projects have been assigned to Fondazione Ugo Bordoni and CNIPA. Two categories of projects are funded: (a) those privileging simplicity and effectiveness of use, by as many citizens as possible; (b) those targeting innovative solutions like authentication, authorisation of users, on-line payments (based on use of smart-cards) and always-on return path (xDSL, GPRS, UMTS). Projects are entitled to funding after passing an evaluation procedure. Real-time broadcast of developed services with real user panels is required as a working commitment for successful projects.

At the moment of writing, more than 34 millions of Euros of public funds have been assigned as co-financing to projects enforced by local administrations in cooperation with broadcasters and third parties.

RAI is actively participating, in cooperation with local administrations (Regione Emilia Romagna, Comune di Roma, Regione Lombardia and Comune di Reggio Calabria), to four projects that received a very high ranking in the evaluation procedure from the Public Authority, and for which the planned total investments (from partners and from the Government) amounts to about 6 millions of Euros.

#### ***Cooperating while competing***

A key factor for the success of DTT in Italy so far has been close cooperation among all stakeholders, from the same and from different categories (service providers, content providers, network operators, telecom operators).

Cooperation has been strongly encouraged by the Government, by mandating Fondazione Ugo Bordoni (an independent research and consultancy institute closely cooperating with the Ministry of Communications for several decades), to set up the following collaborative initiatives:

- DGTVi, the association of digital terrestrial broadcasters;
- Ambiente Digitale, the association of interactive content providers and interactive application developers;

- Sistema Digitale, the association of equipment manufacturers, of middleware providers and system integrators.

It is worth noting that the above initiatives put together in excess of 100 stakeholders, thus showing that Interactive Digital Terrestrial Television has got the focus of the entire ICT sector and is considered a good business potential by a high number of enterprises in Italy.

*Dgtvi (www.dgtvi.it)*

This association includes four national digital broadcasters (RAI, Mediaset, Telecom Italia, D-Free), a long-established association of national and local analogue broadcasters (FRT) and Fondazione Ugo Bordoni. The main mission of the association is to promote the uptake of DTT in Italy by harmonising potentially diverging approaches, by ensuring interoperability of decoders, conformance to standards and security of OTA applications/services, and by communicating with all stakeholders of the value chain and with final users. The activity of the association results in the publication of technical specs (like for instance, the D-Book, a localised consolidation of DVB and MHP specifications for set top boxes) and in the organisation of communication events of major impact for policy makers and opinion leaders.

*Ambiente Digitale (www.ambientedigitale.it)*

This association includes network and telecom operators, CE manufacturers, software corporations and public bodies; and its network relies on more than 160 companies active in the digital weaving factory.

The goals of the association include the development of an application service market, new ways of interacting and browsing, the definition of best practices in DTT service design, development and offering. The association is also willing to harmonise services, applications and software platforms and user interfaces to services for better usability. Stressing the specificity of interactive DTT with respect to the WEB (too complex for most citizens) is also within the goals of the association.

*Sistema Digitale (www.sistemadigitale.it)*

The association aims at promoting the development of DTT devices and equipment, in the interest of the users and in respect of competition and fair interest of stakeholders. Monitoring evolution of technology, planning roll-out of new technologies, interacting with public institutions and monitoring the ICT multimedia and interactive market are also activities within the scope of the association.

### ***Boosting the switch-over process***

To boost the switch-over process, anticipated switch-off is being planned in selected areas of the country (Sardinia, March 2008, and Aosta Valley, October 2008), identified in regions that are “islands” from a geographical or an e.m. viewpoint. In these areas, named also “all digital zones” all broadcasters (national and local) will use their best endeavour to show that digital TV is within everybody’s reach and users are not going to regret analogue TV. In January 2007, the active operators in the main towns of these regions are going to definitely and simultaneously turn into digital one of their analogue TV channel each. Complete switch-off will be synchronously applied by all stakeholders. At the moment of writing, the purchase of STBs by residents of these areas is being encouraged with special provisions.

### ***Technological evolution and perspectives beyond switch-off***

**High definition TV.** This is no longer a dream, thank to digital encoding and transmission technology and to flat display technology. In digital technology and with MPEG-2 an HDTV channel will use 10-15 Mbit/s, thus saturating between 50 and 75% of the capacity of a multiplex. Obviously, in Italy, where there is already trouble in claiming frequencies to be converted to the digital mode, there is little chance for adoption of HDTV before switch-off. Thereafter, there should be enough bandwidth available for HDTV services. At the moment of writing, at least an HDTV trial has started on a local basis (at RAI labs in Torino, for Winter Olympics in 2006). Meanwhile, the introduction of MPEG-4/H.264 will make it possible to fit an HDTV signal in the same bandwidth that is nowadays necessary for an MPEG-2 encode SDTV signal. High definition may then become “the television” of tomorrow.

**Mobile TV in handheld devices.** Mobile TV via IP streaming not in GPRS/EDGE/UMTS mode, but in DVB-H mode, appears an attractive solution. With the adoption of DVB-H a major step towards full convergence of TV, mobile telephony and Internet will be achieved. The terminal has two radio interfaces, in the GPRS/EDGE/UMTS spectrum range and in the DVB-H range. Reception of broadcast audio-video



programs occur through DVB-H, while reception of video on demand and specific and private data exchange occur through UMTS. DVB-H experiments have been launched in late 2004 in Italy (primarily, at RAI research labs in Torino). At the moment of writing, DVB-H technology-based consumer services have been made commercially available from major mobile phones operators.

From the viewpoint of business we will experience a further widening of the value chain. Video content providers will not intervene only in the broadcast chain, but also in the return channel. Mobile operators may become content providers on the DVB-H interface too. Digital right management will become a major issue, in order to preserve motivation in the production of contents of good quality.

## 8 Japan

### 8.1 History in Brief

The digital broadcasting system was discussed in Japan by the Telecommunications Technology Council (TTC) of the Ministry of Post and Telecommunications – MPT (current MIC: Ministry of Internal Affairs and Communications), and detailed technical matters have been discussed at the Association of Radio Industries and Businesses (ARIB).

ISDB (Integrated Services Digital Broadcasting) is an emerging digital broadcasting concept. With ISDB, everything is handled digitally. The three kinds of systems, ISDB-S (Satellite), ISDB-T (Terrestrial) and ISDB-C (Cable) were developed in Japan to provide flexibility, expandability and commonality for the multimedia broadcasting services using each network.

Based on the results of field trials, ISDB-T system was found to offer superior reception characteristics; and consequently, the ISDB-T system was adopted in Japan as the digital terrestrial television broadcasting (DTTB) system and digital terrestrial sound broadcasting (ISDB-T<sub>SB</sub>) system in 1999.

### 8.2 Time schedule for digital terrestrial television

Figure 49 shown below presents the time schedule for Digital Broadcasting in Japan.

Digital terrestrial broadcasting was launched in December 2003 in Tokyo, Osaka and Nagoya metropolitan areas. In addition, digital terrestrial broadcasting has started at the main cities in all other prefectures as of the end of 2006. The service areas become wider step by step. Analog terrestrial television broadcasting will be terminated in 2011.

FIGURE 49

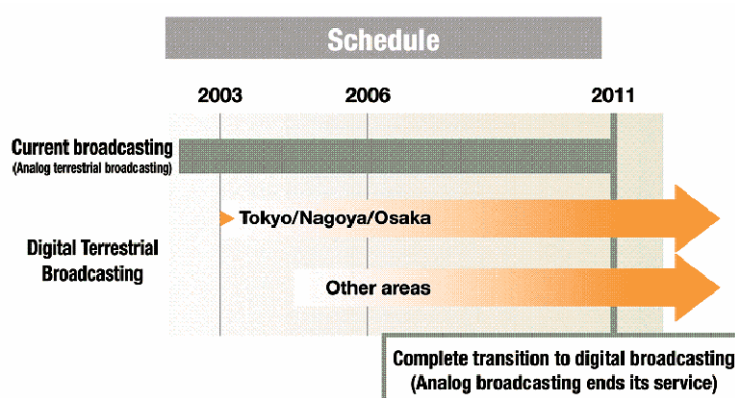

### 8.3 Frequency Situation

Analog terrestrial broadcasting utilizes MFN (Multi-Frequency Network), a transmission scheme that uses a different transmitting frequency in each service area. MFN with many transmitting stations is a solution for delivering programs to the national audience without causing harmful radio interference among service areas. Approximately 15,000 transmitting stations for analog terrestrial television broadcasting were constructed throughout Japan. So there are not enough frequencies for digital television broadcasting.

The Japanese Government is undertaking a huge program which will cost around 180 billion Yen (approx. 1.8 billion US \$) to move a quantity of analog television stations to the upper part of the spectrum in order to free up the frequencies for digital television.

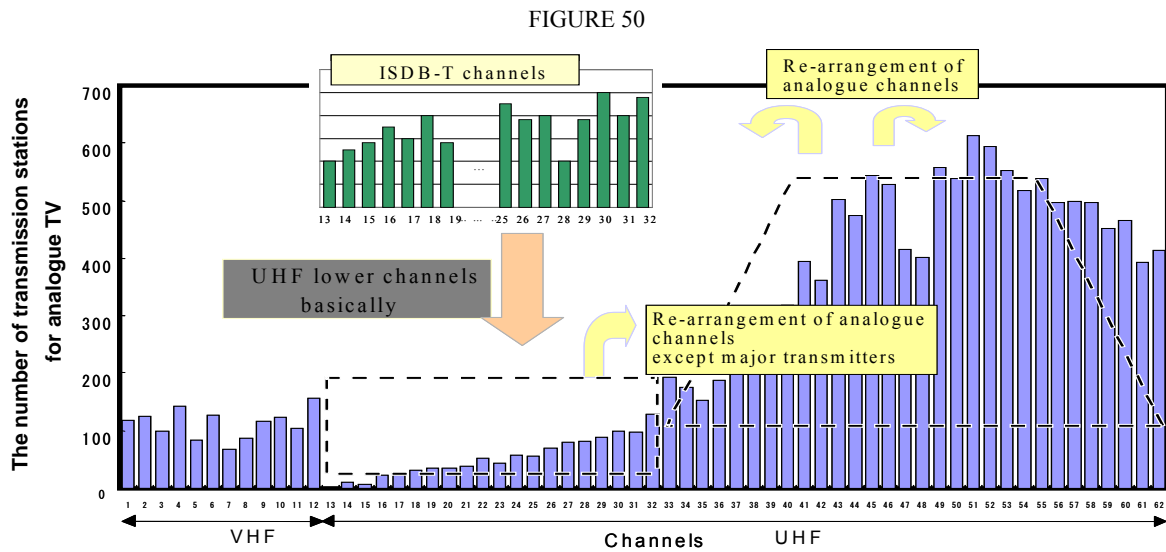

#### 8.4 TV channels in Tokyo

Nine digital TV channels are transmitted from Tokyo tower.

FIGURE 51  
Nine ISDB-T channels in Tokyo area



#### 8.5 Transmission Antennas

In the Tokyo area, broadcasters have placed new antennas at a height of 250 m on Tokyo Tower. A transmitter room was built under the tower's large observatory. In the Nagoya area, a new facility with a

246-m steel tower and a broadcasting station has opened in Seto city. In the Osaka area, broadcasters installed antennas on their own towers. An overview of these facilities is shown in Fig. 52.

FIGURE 52

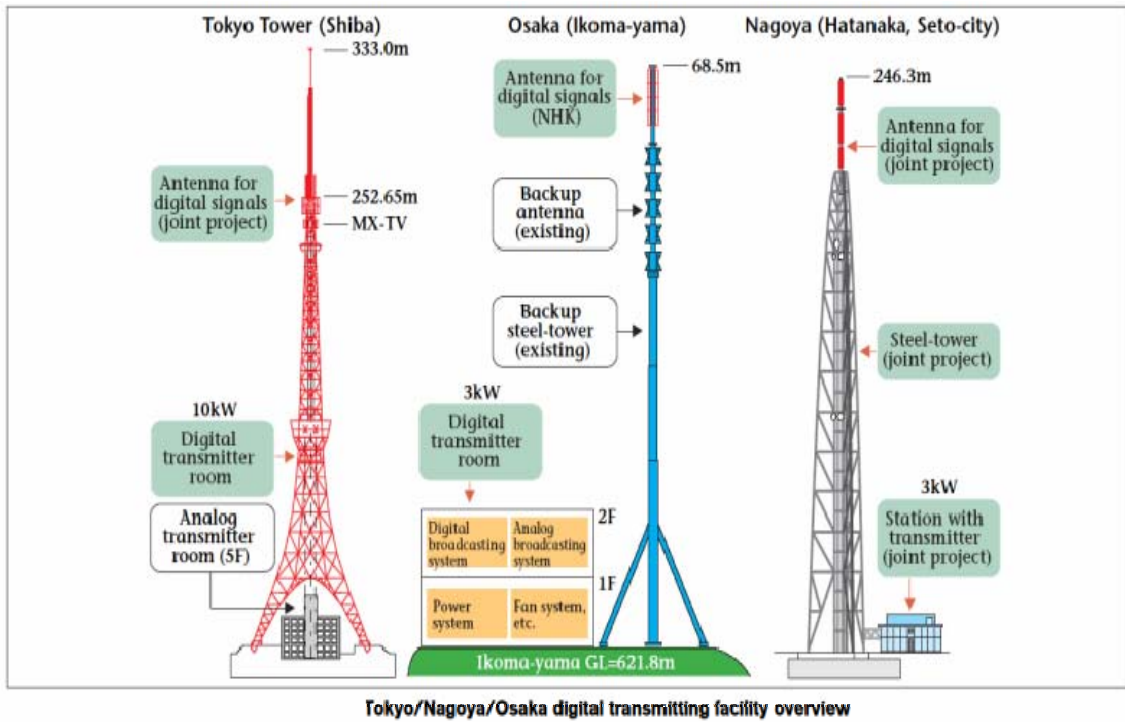

### 8.6 Shipments of ISDB-T receivers in Japan

Although digital terrestrial broadcasting started only approximately 4 years ago (December 2003), over 25 million ISDB-T receivers have been shipped to date (50 million households in Japan).

FIGURE 53

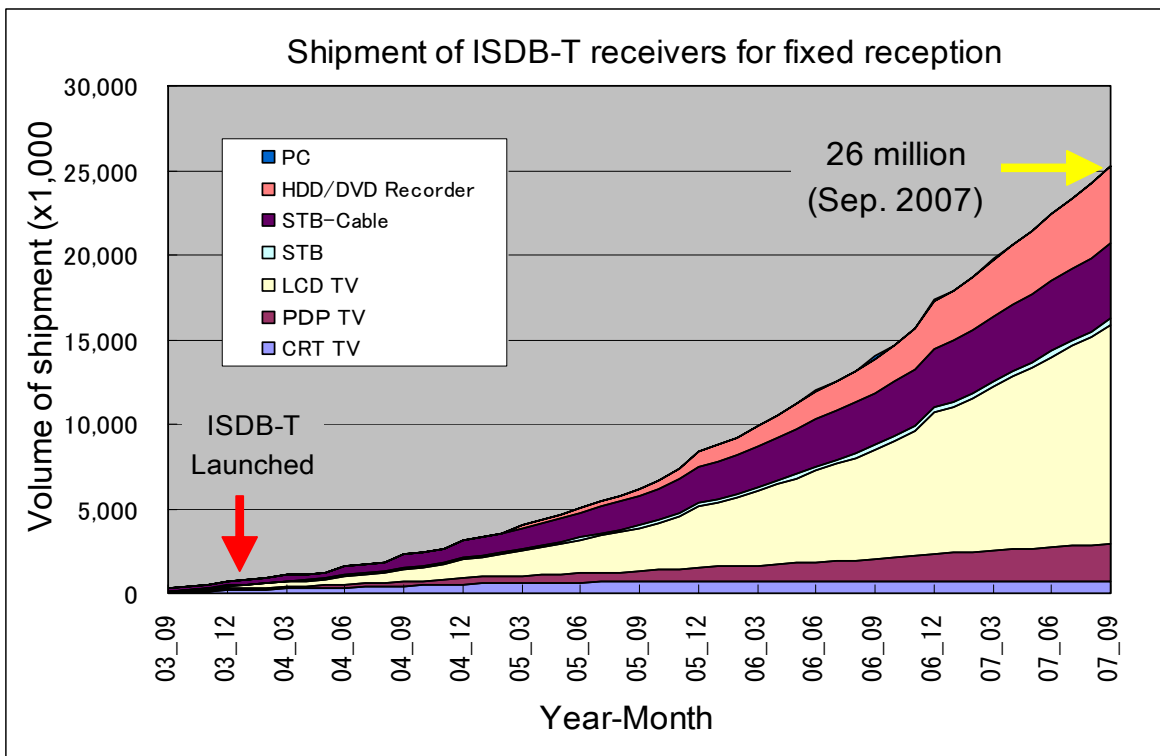

### 8.7 Technical Characteristics of ISDB-T

The system compatibility between digital television and digital sound broadcasting is taken into consideration in ISDB-T. ISDB-T with full segments serves digital terrestrial television broadcasting and ISDB-T<sub>SB</sub> using one segment or three segments serves digital terrestrial sound broadcasting.

ISDB-T is also capable of providing data broadcasting consisting of text, diagrams, still pictures, and video image for handheld devices, in addition to high quality pictures and stereo sound. In contrast with digital satellite broadcasting, it is able to feature detailed local interest information. Furthermore, it has great potential to diffuse information to mobile multimedia terminals, such as car radios and pocket-sized receivers.

The following requirements were considered in the development of ISDB-T.

It should:

- be capable of providing a variety of video, sound, and data services;
- be sufficiently robust to any multipath and fading interference encountered during portable or mobile reception,
- have separate receivers dedicated to television, sound, and data, as well as fully integrated receivers,
- be flexible enough to accommodate different service configurations and ensure flexible use of transmission capacity,
- be extendible enough to ensure that future needs can be met,
- accommodate single frequency networks (SFN),
- use vacant frequencies effectively, and
- be compatible with existing analog services and other digital services.

To comply with all the specified requirements ISDB-T made use of a series of unique tools such as the OFDM modulation system associated with band segmentation, which gives the system great flexibility and the possibility of hierarchical transmission, time interleaving which contributes to achieving the necessary robustness for mobile and portable reception besides giving the system powerful robustness against impulsive noise and TMCC (Transmission and Multiplex Configuration Control) which allows dynamic change of transmission parameters in order to set the system for optimized performance depending on the type of broadcasting (HDTV, mobile reception, etc).

These unique characteristics make ISDB-T able to provide a wide range of applications such as those presented in the next chapter.

### 8.8 Applications on ISDB-T

In this section some examples of applications on ISDB-T are shown.

**HDTV program in 6 MHz**

A HDTV program requires 6 MHz bandwidth.

FIGURE 54

**Multi SDTV programs in 6 MHz**

Three SDTV programs require 6 MHz bandwidth.

FIGURE 55

**EPG (Electronic Program Guide)**

An Electronic Program Guide which presents program guide information in table form enables a user to quickly and seamlessly go from a TV channel selection mode to a TV program selection mode.

FIGURE 56

	1 (月)	2 (火)	3 (水)	4 (木)	5 (金)	6 (土)	7 (日)	8 (月)
	NHK G NHK 総合・東京				NHK E NHK 教育・東京			
8		8:15 阪神NHK情報きりり 一週連続テレビ小説一				8:00 NHK俳句		
		8:30 NHK週刊ニュース				8:30 国しほわんこの和のこころ		
9		9:15 国算計診断 おすずめ色々ライフ				8:35 国おあきんといっしょ		
		9:30 国外授業ようこそ先輩				9:00 国あいのて		
10		10:05 国NHKネットワーク				9:15 国科学大好き土よう塾		
		10:54 国国				10:00 国と子のTVスクール		
		11:00 国国新日本紀行ふたたび				10:45 国国中学生日記		
11		11:40 NHK映像ファイル あの人に会いたい				11:15 国国一斉会キミにききたい!		
						11:45 国国週刊手話ニュース		

FIGURE 57

Top menu



**Data broadcasting**

Data broadcasting provides a variety of information such as anytime news, weather forecast, traffic information and program related data.

**Internet access**

All ISDB-T receivers can access to the Internet.

FIGURE 58

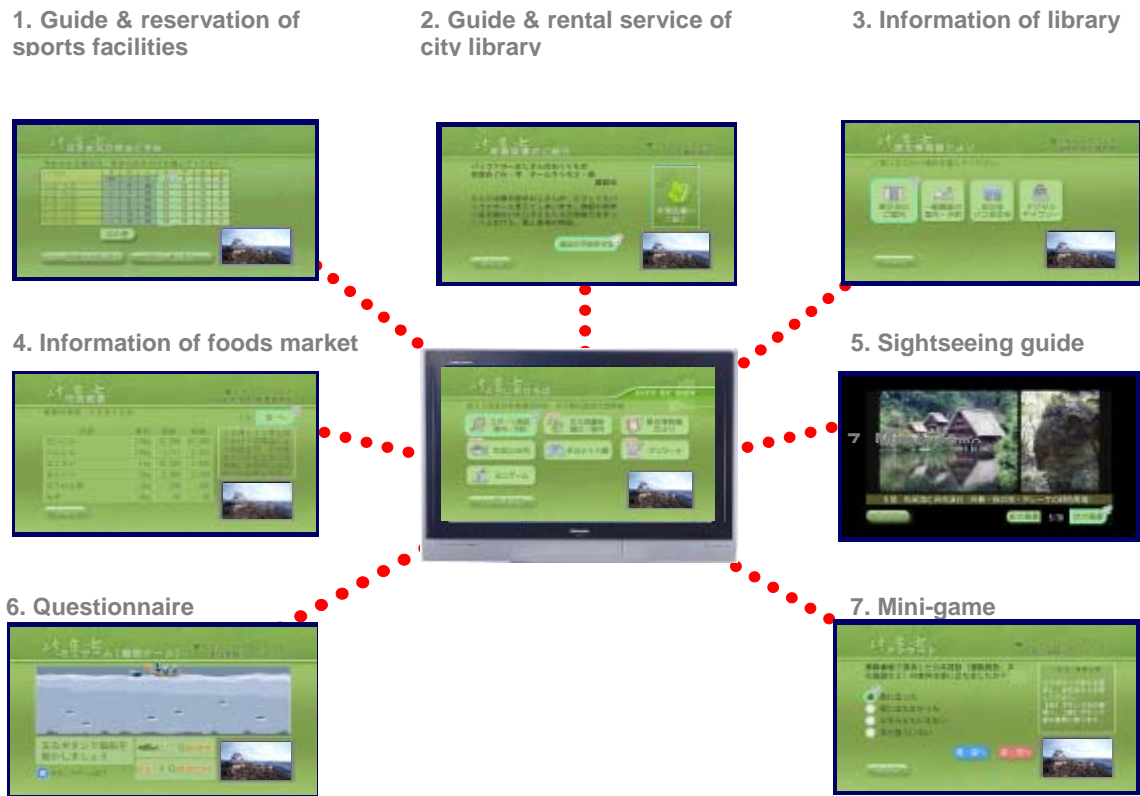

**HDTV Mobile reception**

HDTV program broadcasted through the ISDB-T system can be received even in mobile reception. Several car receivers are on the market.

FIGURE 59



### One-Seg service : TV service for handheld/portable receivers

One-Seg TV service for cellular phones or portable TV receivers was launched in April 2006 in Japan. Such a terminal with a communications link is able to receive network-linked data broadcasting.

FIGURE 60



### Human-friendly broadcasting services

Digital broadcasting has a variety of forms, from textual data and diagrams to regular video and audio data. It is intended to exploit this diversity to provide human-friendly broadcasting services that would be accessible to everyone, including the elderly and people with physical impairments.

FIGURE 61





## 8.9 Outline of ISDB-T transmission scheme, and related ARIB standards, ITU-R Recommendations

TABLE 10

Item	Contents	ARIB standards	ITU-R Recommendations	
Video coding	MPEG-2 Video (ISO/IEC 13818-2)	STD-B32	BT.1208	
Audio coding	MPEG-2 AAC (ISO/IEC 13818-7)	STD-B32	BS.1115	
Data broadcasting	BML (XHTML), ECMA Script	STD-B24	BT.1699	
Multiplex	MPEG-2 Systems (ISO/IEC 13818-1)	STD-B10, STD-B32	BT.1300, BT.1209	
Conditional access	Multi 2	STD-B25	–	
Transmission	ISDB-T transmission	STD-B31	BT.1306 System C	
Channel Bandwidth	6MHz, 7MHz, 8MHz			
Modulation	Segmented OFDM (13 segment / ch)			
Mode, guard	Mode : 1, 2, 3 Guard Interval ratio : 1/4, 1/8, 1/16, 1/32			
Carrier Modulation	QPSK, 16QAM, 64QAM, DQPSK			
Error correction	Inner			Convolutional code (Coding rate : 1/2, 2/3, 3/4, 5/6, 7/8)
	Outer			(204, 188) Reed-Solomon code
Interleave	Frequency and time interleave Time interleave : 0 - 0.5 sec			
Information bit rate (depends on parameters)	6MHz : 3.7 – 23.2 Mbit/s 7MHz : 4.3 – 27.1 Mbit/s 8MHz : 4.9 – 31.0 Mbit/s			
Receiver	ISDB-T receiver	STD-B21	–	
Operational guideline	ISDB-T broadcasting operation	TR-B14	–	

### 8.10 Emergency warning by broadcasting

Early warning against massive natural disasters such as earthquakes, tsunamis, hurricanes and volcanic activity, is a very effective measure for those who may suffer from the effects. Emergency warning by broadcasting is very effective to inform many people of the event and its related information for defending their lives and properties from disaster. In this chapter some emergency warning systems using broadcasting are shown.

#### 8.10.1 Automatic activation of handheld receivers by EWS (Emergency Warning System) signals (See Recommendation ITU-R BT/BO.1774)

The Emergency Warning System (EWS) described in Recommendation ITU-R BT/BO.1774 enables a public warning to be made in the case of emergency due to disasters etc. through analog radio and/or analog TV sound channels. As analog broadcasting is one of the most widespread broadcasting services, it is quite effective to make the public warning using this method.

Digital terrestrial broadcasting has an emergency warning mechanism similar to that of analog broadcasting. Broadcasting differs from communications in that it can send information to a large number of handheld receivers at the same time. The ability to activate handheld receivers to receive emergency information

would lead to a reduction in the damages caused by a disaster. For this to be effective, a handheld receiver would have to be in constant stand-by mode for the EWS signals, but if the power consumption were too high, it would be difficult to maintain stand-by for a long time.

To solve this problem, a low-power-consumption EWS signals stand-by circuit that can maintain stand-by for the digital terrestrial broadcasting EWS signals has been studied.

Figure 61 shows handheld receiver activation using EWS signals of digital terrestrial broadcasting.

An EWS signal is indicated by bit 26 of the TMCC (transmission and multiplexing configuration control) signals comprising 204 bits in System C of Recommendation ITU-R BT.1306-3. In the case of Mode 3 (number of carriers: 5,617), the number of TMCC carriers is 52 in total for 13 segments, or four carriers per segment. The TMCC signals modulated by differential binary phase shift keying (DBPSK) are transmitted at an interval of approximately 0.2 s.

To achieve remote activation, the EWS signals in one or more TMCC carriers are to be continuously monitored by each receiver. Furthermore, continuous monitoring shall be achieved without substantially shortening the stand-by time of handheld receivers. To reduce the power consumption, a dedicated stand-by algorithm is introduced that:

- a) extracts only TMCC carriers, and
- b) monitors only the EWS signals by limiting time slots.

The function for EWS stand-by with very low power consumption has been verified.

The remote activation technique which uses the EWS signals in TMCC can also be applied to the fixed receivers in System C of Recommendation ITU-R BT.1306-3. Many existing TV receivers are able to receive the EWS signal. In the case of analog TV receivers, they turn on automatically when the TV receiver detects the EWS signal even if the switch is off, and the viewer can obtain the urgent information. However, digital TV receivers can receive this signal only when the switch of the TV receivers is turned on under the current situation. Fundamentally, the operation when the EWS signal is received is established by the product specification of each manufacturer.

FIGURE 62

**Handheld receiver activation using EWS signals  
of digital terrestrial broadcasting**

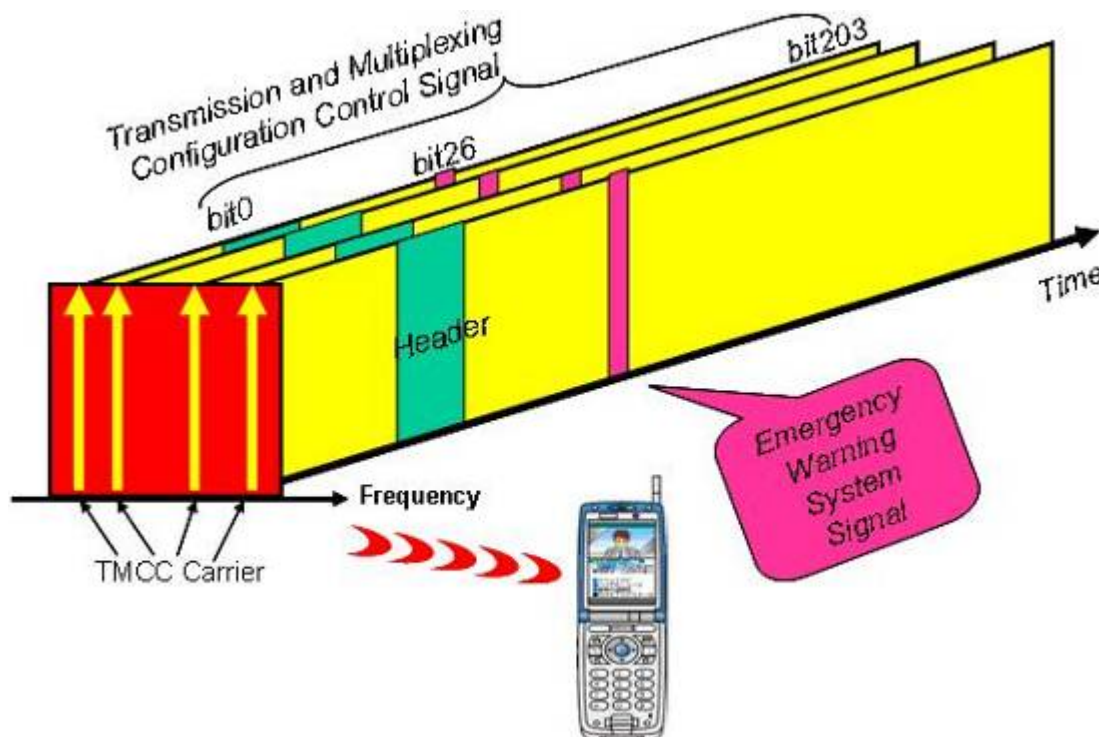

### 8.10.2 Earthquake and Tsunami information services via data broadcasting

In January 2007 Japan began offering earthquake and tsunami information via data broadcasts, using three delivery media—BS (broadcast satellite) digital broadcasts, terrestrial digital broadcasts, and terrestrial digital broadcasts for mobile receivers (One-Seg). The features of this new “earthquake and tsunami information” service are that it enables people to get information about earthquakes that have just occurred or past earthquakes, and to rapidly learn of any impending danger due to a tsunami following an earthquake.

The content of “earthquake and tsunami information” via data broadcast is based on the information obtained from the Japan Meteorological Agency (JMA). The data broadcast content production system (hereinafter “production system”) processes data received from outside the station and automatically produces content in BML format\*. The content that is automatically generated by the production system is registered to the data broadcast transmission system and then broadcasted. Earthquake and tsunami information is also produced automatically.

In the case of “earthquake and tsunami information” content, data delivered to the broadcaster from the JMA is first received by the “earthquake tsunami database system” which is commonly used by broadcasters for managing earthquake and tsunami information. Then, data is transferred to the “earthquake tsunami gateway (GW)” which is a dedicated system developed for “earthquake and tsunami information” content. The GW converts the data to data broadcast-ready format and sends it to the production system. Thus, content is produced automatically. The system configuration for “earthquake and tsunami information” service is shown below.

FIGURE 63

System configuration for earthquake and tsunami information

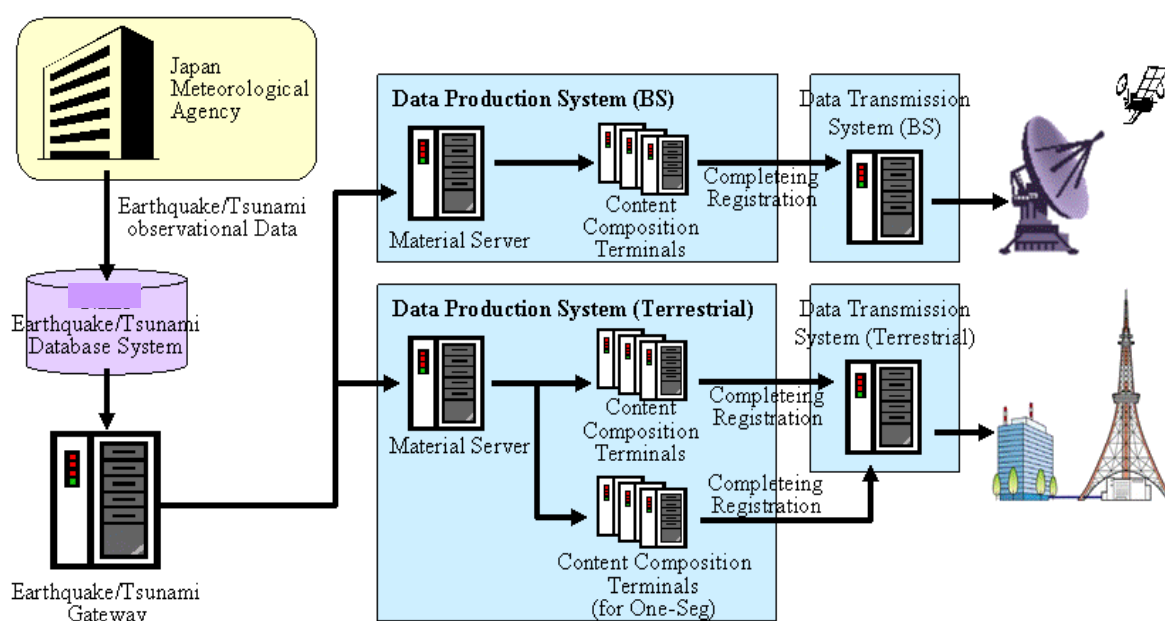

\* BML is an XML-based data content format as described in Recommendation ITU-R BT.1699, originally developed by the ARIB.

The “earthquake and tsunami information” service consists essentially of six kinds of screens. These are “Earthquake occurrence notification,” “Latest earthquake information,” “Most recent earthquakes,” “Tsunami Warnings/Advisories,” “Tsunami- Related earthquake information,” and “Tsunami monitoring information.” At the bottom of each screen are buttons for moving to other screens, and viewers can use a remote controller to switch between any of these screens.

Within a month of the commencement of earthquake and tsunami information services in January 2007, there were five occurrences of earthquakes of intensity 3 or higher, and information on these earthquakes was delivered via data broadcasts. On each occasion, the automatic production function to enable data broadcasts immediately after they occur worked effectively to enable the earthquake information to be broadcast rapidly. Due to the large volume of information involved in reporting earthquake magnitudes for areas throughout Japan, on regular TV services viewers sometimes fail to see the information relevant to their areas of residence. The data broadcasts, in contrast, were found to be extremely useful, because they enabled people to display relevant information after the broadcast was made, using their remote controllers. So the service is very helpful for this reason, too.

### 8.10.3 Broadcasting earthquake early warning

The Japan Meteorological Agency has introduced an Earthquake Early Warning system, which can alert people to an approaching earthquake upon detecting its initial small-scale vibrations (Primary waves) and by getting an estimated fix on its epicentre and magnitude (scale). The system can predict such factors as the amount of time remaining until the arrival of the earthquake’s main and potentially destructive vibrations (Secondary waves), and the intensity (degree of jolting). The Agency will issue an Earthquake Early Warning in the event the earthquake is likely to have a minimum intensity of 5 on the Japanese scale of intensity which runs from 0 to 7, alerting people that they can expect severe jolting within the next several or fifty or so seconds’ time.

Japan Broadcasting Corporation (NHK) has developed a system for relaying the alerts issued by the Meteorological Agency. The system, which commenced operation on 1 October 2007, can relay alerts nationwide via all of NHK’s radio and television channels.

Any Earthquake Early Warning issued by the Meteorological Agency must be conveyed to the public promptly and in a readily intelligible format. The system adopted by NHK for relaying such alerts is characterised by the following features:

1 *Alerts are broadcasted on all NHK radio and television channels*

Any alert is simultaneously broadcasted on all twelve NHK radio and television channels.

2 *The alerts are fully automated*

Speed is essential, which means a fully automated system is in place for relaying an alert the moment it is received from the Meteorological Agency, without any decision or intervention from a member of NHK staff.

3 *A special chime sounds in the event an alert is being issued*

A distinctive chime sounds and a CG (computer Graphics) appears on the television screen when an alert is being issued. The CG provides a map and lists the names of the prefectures that can expect jolting.

The alert is superimposed on all nationwide and local NHK TV broadcasts.

On NHK radio stations, an alert issued from Tokyo will interrupt all nationwide and local broadcasts. The warning chime is followed by a synthesised voice announcing the prefectures that can expect seismic jolting.

## 9 Russian Federation

*Strategy basics for transition from analogue to digital broadcasting within an individual region (based on the experience of introduction of DVB-T broadcasting in the Primorsky region of Russia)*

Modernization of a regional broadcasting network aims at updating the transmission firmware of the TV and radio broadcasting network in a region, expanding the range and list of services provided by the broadcasting operator to the users, increasing revenue for the operator and effecting a phased transformation of such an operator into an information package provider for the region allowing both commercial and social problems to be solved.

*Overall strategy of updating the regional TV and radio transmission network and transition to digital broadcasting in the region*

As a rule the degree of wear of analogue transmitters operated in the region is pretty high. The useful life of many transmitters is already over. Replacement of worn-out analogue transmitters by new analogue equipment appears senseless both from the technological and economic point of view, as in the transition to digital broadcasting it will be necessary to replace such new transmitters again with digital ones, this time long before the end of their useful life. Besides, one cannot see any ways of compensating for such replacement costs as analogue broadcasting in principle cannot support the new information services and products that the population would be prepared to buy and that could generate additional revenue for broadcasting operators. In this connection it seems worthwhile making the transition to digital broadcasting in the region without delay.

It is evident that transition to digital broadcasting should be effected within the framework of current frequency arrangements, that is digital TV programmes should be broadcast in the same frequency bands as analogue broadcasting formerly. This means that overnight transition to digital broadcasting should be accompanied by stopping analogue broadcasting of the same programmes within the coverage area where such transition takes place.

It goes without saying that overnight transition to digital broadcasting is not possible without equipping the population with digital receivers, i.e. subscriber set-top boxes (STBs). Transition to digital broadcasting can only be effected provided that every subscriber has such an STB, so that in the transition process no small group's interests suffer. A broadcasting operator is not responsible for the provision of STBs to the population. Without going in detail on the organization of such provision one should mention that this problem must be solved through local funding under a comprehensive target programme implemented by the regional administration with the help of private investments. Thus the financial burden should be distributed between the commercial structures of the region the overwhelming majority of which is interested in new advanced interactive multimedia infocommunication services and products (including e-commerce and e-banking systems) supported by digital broadcasting. Introduction of such systems within a united regional information system (to be described below) may give a powerful impetus to business development in the region with the corresponding growth of commercial structures' turnover and revenues.

As for providing STBs for digital broadcasting to the population, this should be done according to a uniform schedule approved by the administration and coordinated with the broadcasters in one transmitter broadcasting coverage zone after another. Under the schedule, STBs should be provided to all rather than part of the people residing within one coverage zone, then another and so on. This will ensure the possibility of making a final transition to digital broadcasting in the region successfully. The STBs themselves are multipurpose interactive terminals capable of supporting a wide range of modern interactive information services and products besides broadcasting.

It is clear that transmitters replacing the old worn-out analogue ones should be hybrid, i.e. equally capable of operating both in analogue and digital broadcasting mode. At the first stage such a newly installed transmitter will operate in analogue mode. Later on when the population in the coverage zone is 100% equipped with STBs the transmitter will go over to digital mode with the DVB-T modulator switched on and the driver replaced (it is desirable to have both devices supplied in a complete set with the transmitter). It goes without saying that at the first stage the transmitter will broadcast only those programmes that used to be broadcast for the given coverage zone in analogue mode. Thus the next problem that arises is of most importance for urban areas where several TV programmes can be received within one coverage zone. In each broadcasting zone several analogue programmes broadcast by different transmitters may be received. Digital

broadcasting is multiprogram, i.e. one digital transmitter will broadcast all those programmes that used to be broadcast by several analogue transmitters. Thus only one “head” analogue transmitter should be chosen out of the group for the coverage zone to be replaced by hybrid equipment. The transmitter should be connected with MPEG-2 signal feeder lines for all the TV programmes broadcast for the given coverage zone. All the signals should be joined together in a multiplexer into an MPEG-2 transport flow and fed into the DVB-T modulator. After this the transmitter may be switched over to the digital broadcasting mode and the analogue broadcasting of other transmitters may be stopped and dismantled.

It is clear that transition to digital broadcasting should entail an increase in the number of programmes provided to the population. As a result the situation should emerge when the regional programme package (i.e. all the programmes that are currently broadcast to at least part of the population of the region) will be accessible to every TV viewer. Of course with time the package should be expanded gradually with new commercial programmes (including pay programmes) and with free regional programmes of social and informational importance. To achieve this it is necessary to solve the problem of constructing a full regional network of TV programmes supply and distribution, i.e. when each programme received in the region via satellite channels or produced in the region itself would be supplied to every transmitter (or a group of transmitters) operated in the region. The problem can be best solved on the basis of a fibre-optic line laid in the region and running through its major populated areas. Fibre-optic line branches, i.e. TV programmes supply lines to other populated areas of the region, should be based on the existing radio relay lines or MMDS systems. Moreover the radio relay lines must be updated to transmit digital data streams. This can be done through using modems and MUXes ensuring the transmission of digital data streams along the existing radio relay lines at the rate of 51 Mbit/s. The equipment will digitize the radio relay lines and at the same time the UHF equipment installed will remain intact. In many cases MMDS systems can also be used to bring digital broadcasting programmes to home cable networks. Naturally to expand the digital broadcasting programmes package broadcast to the population it is necessary to install some additional digital transmitters. However it is important that reception of digital broadcasting programme packages from several DVB-T transmitters by outdoor antennas in many cases may be ensured without amending the existing home cable networks.

The regional programme package may be expanded both through increasing the number of programmes made up in the region itself and through receiving more programmes via satellite communication channels.

#### *Stages of comprehensive modernization of the regional TV and radio broadcasting network*

Thus with the above approaches the following stages of comprehensive modernization of the regional TV and radio broadcasting network for transition to digital broadcasting can be defined:

- distribution of DVB-T STB to the population. STB manufacture funding may be effected within a target programme of the regional administration funded by regional investors. The STBs should be multifunctional interactive terminals supporting a wide range of modern multimedia services and products along with broadcasting;
- choosing a “head” transmitter out of the operating ones in each broadcasting zone to be replaced by a hybrid unit (with analogue broadcasting at the initial stage) with digital signals of all the programmes broadcast in the area fed to the latter;
- starting digital DVB-T broadcasting of those programmes that used to be analogue from the head transmitter, stopping analogue broadcasting and dismantling all the other transmitters in the broadcasting zone with the process going on in one broadcasting zone after another as these are ready for the change;
- constructing a regional TV programmes supply and distribution network on the basis of fibre-optic lines and digital radio relay lines, MMDS and cable lines used in the “last mile” section;
- as the regional distribution network is expanded bringing the regional TV programme package (i.e. all the programmes coming to the region via satellite channels and all the regional programmes) to each populated area in the region, with further expansion of the range of such programmes, including new regional ones (regional TV, commercial programmes); installing new DVB-T transmitters;
- on the basis of digital TV broadcasting, organizing data transmission (including web and web-type multimedia services) from the very beginning of digital TV broadcasting to provide to the

population modern infocommunication services and products, both socially-oriented and commercial;

- introducing interactive products from the very beginning of digital TV broadcasting, primarily web and web-type services on TV broadcasting basis;
- constructing in the region a united interactive information multimedia regional network on the basis of subscriber's STB with an interactive platform specially designed to take care of the region's needs and interests and a uniform system of conditional access chosen upon agreement reached between digital broadcasting operators.

Further development of the TV and radio broadcasting transmission network in the region, expansion of the range of services and network functions through interactive servicing and provision of multimedia services

Transition to digital broadcasting is not the end of TV and radio broadcasting transmission network modernization. It goes without saying that more TV broadcasting programmes will bring more revenue for broadcasting operators. However, the largest source of higher revenues is in the sphere of provision of a wide range of modern infocommunication services and products on the broadcasting basis to corporate and individual users. Technologically this can be achieved through encapsulation of multimedia data streams (including web and web-type services data) into TV broadcasting digital flows. Reception of the above services and their data display on the TV screen will be done with the help of digital TV broadcasting STBs. The same STBs with their software and firmware support return channels organized on telephone lines (on the basis of built-in dial-up modems) or with xDSL facilities or, provided there are home cable lines, HFC (hybrid fibre cable) on the basis of the DOCSIS standard (built-in or external DOCSIS modems connected with the STBs by Ethernet interface).

*Overall description of information and interactive services and products based on digital TV broadcasting. The initial stage of introduction of the services in the region*

Enhanced TV and interactive TV are principally new TV broadcasting services that can only be provided on the basis of digital broadcasting. The concept of enhanced TV envisages pay services with a coded signal that requires using smart cards and conditional access systems. Private companies leasing equipment from the operator may provide such services to the population under subscription for pay packages. Moreover the possibility of free reception of the social programmes package (both national and regional) by the population remains.

Enhanced TV envisages the technology of pseudo-interactive DVB-T services without a return channel. These include various information services and reference materials, such as TV – the press, weather forecasts, ratings, advertisement channels, etc. In transition to digital broadcasting such services may be provided at once in those populated areas of the region where there is a shortage of telephones and where it is yet impossible to organize a return channel for full-scale interactive service.

In the towns of the region with sufficient telephone penetration, interactive systems may be deployed on the basis of a return channel on a telephone line. A return channel can support various e-commerce services, on-line shops as well as rating votes and population polls that are important socially and may be needed by the regional administration. At the same time high-rate access to the Internet on dedicated digital DVB-T channels may be provided. For this a TV viewer will not need a PC as in this case its function will be performed by the STB for digital broadcasting: it will display web pages on the screen after appropriate reformatting and rescaling of text and graphic objects in web pages in a way allowing their display on the screen of a standard definition TV set. The web browser is operated with the help of a cordless keyboard. Connection does not require any additional time, as the Internet channel is permanently available. In fact the service is a factor of new quality of life, as television becomes a powerful information gateway concentrating most advanced information technologies that enable any person regardless of his or her age, education and social status to be a full-scale member of the global information infrastructure without buying a PC, just with the help of a familiar TV set. The digital TV broadcasting STB supports the Internet access and e-mail functions.

At the next stage of deploying a digital TV broadcasting system in the region it becomes possible to extend the interactive services to remote rural areas with insufficient telephone penetration. This becomes possible through using return channel cordless DVB-RCT technology.

*Construction of a united interactive multipurpose information system on the basis of digital TV broadcasting in a region*

If there are return channels, the following interactive infocommunication services may be provided on the basis of digital TV broadcasting to corporate and individual users:

- access to the Internet without using a PC;
- e-trade;
- e-commerce;
- management of a bank account, including execution of commercial transactions at a distance using a digital signature;
- e-system for ordering municipal services;
- communal utilities payment e-system;
- services base on “video-on-demand” technology;
- cottage industry e-systems;
- e-health;
- e-learning systems;
- virtual CD-ROM;
- web games.

All together the above-listed information services may form a united interactive multipurpose information system implemented on the basis of a single user's interface (browser) and a uniform interactive platform. Thus a broadcasting operator may become a provider of the service system to corporate and individual users. It makes sense to shape such systems on a regional basis. For this there should be in the region data formation centres for corresponding information services, including specialized servers and devices for encapsulation of the said services in TV broadcasting signals. Server software represents a multifunctional software package including, in particular, billing modules, modules of interoperation with banking payment systems, advertising management, mediametrics collection and processing of return (interactive) channels data, etc. The user part of the software for such a system (browser) is installed in the digital broadcasting STBs.

Without going into detail concerning the construction and functioning of such a system it is possible to point out its major sources of additional revenues for the operator. These include among others subscription fee charged on the basis of a conditional access system (implemented through STB smart cards). However, it is advertisers' payments that constitute the most important source of revenue for the operator of an interactive information system. Advertising in interactive information systems radically differs from traditional linear advertising in analogue broadcasting. Its main distinction lies in its target nature (different groups of users get different advertisements) and in the built-in function of measuring the audience (mediametrics). Actually STBs can support the following functions:

1 Assignment of a consumer index to the subscriber. When a subscriber is switched in the system a questionnaire is displayed on the screen with a number of items referring to the subscriber's social status, age, sex, revenue, interests in various spheres, goods and services of interest, etc. (such a poll may be repeated in certain periods of time, e.g. annually, to identify the changes, if any). The questionnaire aims at establishing what type of advertising should be supplied to the subscriber. The questionnaire is based on multiple choices. A given consumer index is assigned depending on the choice of answers. The index is forwarded to the operator's server and further on is used to identify the advertising materials to be supplied to this subscriber.

2 Mediametrics of TV programmes. An STB registers each switch over from one TV channel to another and certainly the viewing time on each channel. Periodically (say, once a day) the obtained viewing data is forwarded to the operator's server. The function allows calculation of the exact rather than approximate rating of TV programmes.



3 Advertising mediometrics. Each payment for goods and services effected by a subscriber with an STB (supporting the e-payments function) is registered and the information about the type of goods or services bought is transmitted to the operator's server where the connection between the purchase of the goods and services and their advertising supplied to the subscriber earlier is analysed. This function is necessary to appraise the effectiveness of advertising materials.

It is clear that with these functions the operator of an interactive information system obtains data of vital importance both for TV companies (programme ratings) and advertisers (much higher effectiveness of advertising thanks to its target character, information about the effectiveness of advertising materials). This enhances the attractiveness of the system for the TV companies and advertisers and affects the operator's revenues accordingly.

Another important source of revenue for the operator is payments by commercial structures selling goods and services within the framework of the e-trade system, as part of the system as a whole. The e-trade system is in great demand for commercial structures as it enables these to increase significantly their sales. A new market is open to the sellers - electronic retail sales with immediate payment for goods and services in non-cash form via e-banking.

TV viewers may choose the goods via the on-line shops system in which they may view video clips of the goods, order these to be delivered to their homes or not and pay for them with the help of their smart card. Foreign practice confirms great success of such projects as in addition to convenience and time saving the customer pays less for the goods than in traditional shops (thanks to lower seller's overheads and non-cash payments) and due to that fact that e-payment systems in closed digital TV networks are more reliable than those on the Internet.

If the above regional interactive information system based on digital broadcasting is established in a region as a next logical step after overall transition to digital broadcasting in the region, it would also be logical to base the system of subscription fees on a uniform conditional access system. It goes without saying that such a system should have an open (socially oriented) component and a commercial component and subscription fees will be charged only for services provided by the commercial component.

## 10 Tanzania

### Introduction

Tanzania has been addressing the migration from analogue to digital terrestrial broadcasting immediately after the RRC-04. The Tanzania Communications Regulatory Authority (TCRA), the regulator of Communications, Broadcasting and Postal sectors participated in the RRC-06 processes. After RRC-06, two consultation documents were issued followed by workshops, annual conferences and forums aimed at addressing how digital terrestrial broadcasting will be implemented, managed and regulated in Tanzania.

Important issues addressed, include the way digital television operates and its efficient use of frequency spectrum resource and its associated value added services.

Furthermore, the Authority has worked out major issues that will guide smooth migration.

Among the measures undertaken by TCRA is the introduction of the Converged Licensing Framework (CLF) with four (4) major licences, 1. Network Facility Licence, 2. Network Service Licence, 3. Content Licence 4. Application Service Licence addresses the complex licensing issues associated with digitization.

To realize smooth migration, TCRA produced two consultation documents on digital broadcasting which were discussed by all stakeholders. National Technical Committee has been formed to handle migration issues and workout the roadmap to full digital broadcasting in Tanzania.

The consultations, yielded initial framework on the new broadcasting landscape in Tanzania. The new broadcasting chain landscape is such that, there will be two distinctive features namely, the Content Service Provider and Signal Distributor who will be charged with multiplexing. There will be *two commercial Multiplex Operators, and one Public Service Multiplex Operator under the initial licensing framework* that will be charged with the responsibility of signal distribution.

Tanzania, a country at the eastern coast of the African continent, spans 1122Sq. Kilometres with a population of 36 million inhabitants. Tanzania falls under ITU Region1. There are 26 licensed analogue television stations, out of which 4 are national coverage, 5 regional coverage (covering ten administrative district areas) and the rest district administrative coverage.

There are also three (3) licensed digital satellite pay television stations and one digital terrestrial television operator in the City of Dar Es salaam under a pilot DVB-T project. There are 95 analogue television transmitters countrywide.

After the two consultation processes between 2005 and 2007, a final document on “The Transition from Analogue to Digital Terrestrial Broadcasting in Tanzania” addressing the Regulatory and Legal Framework under which Digital Television will be implemented, managed and regulated. The Authority has so far run an awareness campaign among the media stakeholders during the consultation process that has come up with the roadmap for licensing of Multiplex Operators. The Authority has so far achieved the following goals and is set to licence the pilot project in the financial year, 2008/2009 on a phased approach basis.

In the interim period, the Authority has formed the Work Group on Digital Broadcasting (WGDB) with experts from broadcasting, spectrum management, ICT development and legal sector tasked to address the following issues:

- Consider licensing issues of MUX.
- Consider National Plan of Digital Broadcasting and simulcast period.
- Consider Licensing issues of other services like, Mobile TV, IPTV etc.
- Consider and adopt a positional paper on availability of STB.
- Editing of the final document on Digital Broadcasting in Tanzania.

In April, 2008, TCRA announced an Expression Of Interest (EOI) for prequalification for interested parties to submit their interest for provision of digital multiplex services in Tanzania. The response was positive.

The Authority has postponed licensing of new television applicants from 2007 in order to audit the UHF and VHF channels countrywide and plan for digital terrestrial services countrywide during simulcast period. The digital plan status will be ready before the end of this year.

The digital plan will give detail to the WRC-07 decisions, on smooth implementation of digital broadcasting.

The Authority is carrying out an exercise of reviewing the Broadcasting Services Act, 1993, Tanzania Communications Act, 1993 and the Tanzania Communications Regulatory Authority Act, 2003 with a view of incorporating Digital Terrestrial Broadcasting and Multiplex Operator a legal force.

The Authority will embark on public awareness campaign on digital migration and coordinate with neighbouring countries on best ways of efficient utilization of spectrum, interference mitigation and protection of existing analogue services during dual illumination.

#### *Digital Migration Policy in Tanzania*

The Tanzanian ICT Policy, 2003 governs the digital migration process in Tanzania.

And the realization of digital dividend prior to WRC 07 by allocating the broadcasting sub band 825.285-862 MHz (about 37 MHz) for CDMA mobile operators realizing digital dividend earlier.

Tanzania’s position during WRC-07 was very clear. It supported new broadcasting band at 470-790 MHz to promote mobile phone industry as a catalyst to universal access. The mobile industry penetration in the past few years has dominated the communication market than fixed lines whose roll out has been slowing down.

The Authority is constructively engaging the Government on possibilities of giving out subsidies to importation of set-top-boxes so as to make them available to common people.

TCRA in collaboration with the Government is setting up policies and recommendations on availability of set-top boxes. The idea of fees from the dividend is still raw and under discussion.

Migration from Analogue to Digital broadcasting in Tanzania in Tanzania is policy driven. It has taken TCRA three years to prepare broadcasters for the uptake of digital broadcasting. Worries have been on the fate of the analogue infrastructure investment and 'fear' of revocation of frequency channels by incumbents. Worries have even been on consumers on the availability of affordable set-top boxes.

Tanzania has adopted phased migration approach. This will help correct mistakes experienced in initial stages of implementation.

Tanzania will switch off analogue systems by 2015 and the chances of doing it before that time is clear.

Challenges on licensing; There are digital TV products which the Authority is working on the proper framework to cater for the country's ICT trend.

There have been concerns during the migration process on existing analogue infrastructure.

During consultations, it was agreed that, the licensed multiplex operator enters into agreement with analogue broadcasters to use part of their usable infrastructure.

Tanzania is actively participating in all activities pertaining to digital broadcasting in Region 1 of the ITU and the CTO-Digital Broadcasting Forum in Johannesburg every year. This has been instrumental in having common migration strategies and has acted as sensitizing machinery among participating African nations. Even those that have not initiated efforts to migrate from Analogue to Digital broadcasting have been supported to initiate steps towards migration.

Organizations like Communications Regulatory Authorities of Southern Africa (CRASA) and East African Communication Regulatory authorities are engaged in efforts aimed at successful implementation of digital broadcasting.

## **11 United States of America**

### **Background**

The United States has moved forward aggressively with the implementation of DTV using the ATSC Digital Television (DTV) Standard, a powerful technology that is transforming the nature of broadcast television service. This new broadcast transmission standard provides broadcasters with many new capabilities to serve the public, such as HDTV and standard resolution pictures, multicasting, data delivery, interactive communication, robust reception modes, and other features. These capabilities provide broadcasters the technical flexibility and options to compete with other digital media such as cable and direct broadcast satellite services. The ATSC DTV standard was developed through a lengthy initial specification process that began in 1987 and its evolution is continuing today, due to the flexibility for extending the digital system to include new capabilities as technology continues to develop. Coincident with the development of the transmission technology, the U.S. Government, through actions by its Federal Communications Commission (FCC) and legislation by the U.S. Congress, has developed public policies under which digital television is being implemented.

The U.S. Government is implementing broadcast DTV service as a replacement technology for the existing analog National Television System Committee (NTSC) technology that has been used for transmission of broadcast television service in the United States since the late 1940s. Under this policy approach, all eligible existing television stations were provided a second channel to be used for DTV service during a transition period from the analog to digital operation. This transition period, which began in 1998, is intended to facilitate an orderly change to the digital television technology while taking account of consumer investments in analog television sets. At the end of this transition period, TV stations will cease analog transmissions so that all broadcast television service will then be in the digital format. The FCC will also recover one of each TV station's two channels at this time. Because operation with the ATSC standard is very spectrum efficient, it is possible for all of the existing TV stations to operate in a much smaller amount of spectrum bandwidth, thereby allowing a portion of the existing TV channels 2-69 to be recovered for new uses. The U.S. Government plan is for all DTV stations to operate on channels 2-51 (the DTV core spectrum) after the transition ends and to recover channels 52-69 (698 MHz to 806 MHz) for new uses.

After very careful consideration and review in the FCC's public rule making processes, the Commission afforded broadcasters great flexibility in the use of their DTT channels. Broadcasters were required at least to

match the hours of operation of their existing analog station. For example, if the analog station operated 24 hours/day, then the digital station would also be required to operate 24 h/day.

Broadcasters were given almost unlimited flexibility in the services that could be offered over their 6 MHz digital channel. They were required to offer one free-to-air video program service with resolution equivalent to their existing analog service. Beyond this, they could offer whatever other services they chose on the digital channel.

The FCC did not impose any requirement that broadcasters offer HDTV, and there is no legal requirement for U.S. broadcasters to offer HDTV. However, HDTV was the initial focal point of the U.S. transition to DTT broadcasting, and it has remained the centerpiece application throughout the U.S. deployment.

Pay services were explicitly permitted by the FCC, once a single, free, standard-definition program had been provided. If broadcasters do use their DTT channel to offer services for which a subscription fee or charge is required in order to receive service, they are required to pay the U.S. government a spectrum use fee in the amount of 5% of gross revenues from any such service.

The basic transition plan followed in the U.S. was to require stations affiliated with the four largest TV networks in the 30 largest cities to implement DTT first, while allowing more time for stations in smaller cities to make the transition. In addition, public TV stations were given an extra year beyond the deadline that applied to commercial stations. The FCC's initial plan applied to approximately 1,600 commercial and non-commercial (public) stations. Transition planning for low-power TV stations and for translators was deferred for several years, but has now been completed. Low power TV stations generally will be allowed to transition to DTV operation on their existing channels. In addition, if they so desire and a channel is available, low power stations may request a "companion channel" for DTV operation during the transition. The FCC further stated that it would establish a deadline at the end of the transition for low power stations that would be after the end of the transition for full service stations.

Each station was given a new assignment for its DTT broadcast channel, along with an antenna height, antenna pattern and maximum radiated power level, in an effort to replicate the station's analog coverage area. Assignments for all 1,600 stations were made shortly after the FCC formally adopted the ATSC Standard and approximately 18 months before the launch of commercial DTT service.

At the request of the FCC, 28 stations in the ten largest cities volunteered to launch DTT service in November 1998, six months ahead of the deadline established by the FCC. Six months later (May 1999) all stations in the top 10 markets that were affiliated with the four largest broadcast networks were required to provide service, and in another six months (November 1999) this requirement was extended to the affiliates of the four largest networks in all of the 30 largest cities. All commercial broadcasters were required to be on the air by May 2002 and all non-commercial broadcasters by May 2003. Broadcasters who could not meet these deadlines were allowed to apply for a six-month extension and in some cases a second six-month extension under certain circumstances.

The U.S. Congress and the FCC are determined to conclude the transition to DTT broadcasting as rapidly as possible for a variety of reasons, most notably to recapture 108 MHz of invaluable nationwide spectrum that will be made available once analog TV transmissions cease. Broadcasters also want to make the conversion as rapidly as possible in order to eliminate the expense of operating two TV stations in parallel.

In early 2006, legislation was enacted by the U.S. Congress requiring broadcasters to terminate their analog transmissions by February 17, 2009. This legislation included provision of up to \$1.5 billion to subsidize the purchase by television viewers of digital-to-analog set-top converters that could be used to view DTT signals on existing analog television receivers.

Each television household would be permitted to apply for up to two \$40 coupons that could be used to purchase such converters, with only one coupon allowed per converter. The price of these converters is typically about \$50 (without a coupon).

The FCC adopted regulations that phased in a requirement for inclusion of ATSC receiving capability starting with the largest TV sets first, in 2004, and for all sets over 13 inches by July 2007. In November 2005 the FCC amended its rules to advance the date for the completion of the phase-in period to March 1, 2007, and to apply the requirement to all receivers regardless of screen size. Thus, every television set sold in the U.S. must now contain ATSC DTT reception and decoding capabilities. The U.S. Consumer

Electronics Association predicts that over 100 million integrated ATSC DTT receivers per year will be sold in the U.S. alone by 2009. This is in addition to ATSC HDTV Set-top boxes and digital to analog converters.

Although it is not required by the government, all DTV receivers available in the United States are capable of decoding all ATSC specified video formats. All-format decoding is essential to permit the introduction of HDTV – later, if not initially.

While there are no government requirements for DTT receiver performance, on a voluntary basis (and upon the recommendation of the FCC) the ATSC has adopted a recommended practice giving performance parameter guidelines for DTT receivers.

### **Implementation Progress**

The United States is now in the final stages of its DTV transition and there have been many challenges that have been faced and overcome in the period since 1997. In recent years the desire of the U.S. Government to recover TV channels 52-69 for new uses has given rise to greater emphasis on completing the transition as rapidly as possible. The FCC has taken a variety of steps to achieve a rapid conclusion to the transition and to ensure that the benefits and services of DTV broadcasting are available to all Americans. The U.S. Congress has also enacted legislation that mandates the end of analog television transmissions on February 17, 2009.

DTT broadcasting is moving ahead at a feverish pace. More than 1,700 DTV stations are on the air in 211 metropolitan areas, reaching 99.99% of U.S. television households with at least one digital signal. More than 90% of households have access to at least five digital signals, and more than 80% have access to at least eight. In the largest U.S. cities, as many as 23 digital stations are on the air.

HDTV programming is widely available, not only via DTT broadcasts, but over cable and satellite systems as well. Most network primetime and sports programming is now produced in HDTV. Local TV stations are beginning to offer their local news in HDTV.

Manufacturers throughout the world have responded to this demand by developing and marketing more than 750 different models of HDTV and other ATSC DTT consumer products, using a wide variety of new display technologies. Competition is frenzied, with prices continuing to fall rapidly and sales skyrocketing. Since late 1998 when the service was launched and March 31, 2006, more than 30 million units of DTT consumer products worth more than \$50 billion have been sold in the U.S. alone. Moreover, sales are continuing to grow exponentially, with projected sales for all of 2006 of approximately 20 million units worth \$30 billion.

Standard-definition (SDTV) integrated 27" ATSC receivers are now available for as little as US\$299, and integrated 27" HDTV receivers for as little as US\$430. Indeed, prices for HDTVs are converging rapidly with those for analog color TVs. It is no longer possible to purchase a large-screen analog color TV in the U.S. They have all been replaced by digital HDTVs. This trend will accelerate and spread to smaller screen sizes over the next few years as prices continue to fall and as the phase-in of the FCC's tuner mandate is completed. Under this regulation, all television receivers sold in the U.S. must have ATSC tuning and decoding capability by March 2007. As a result, by 2007 an estimated *34 million* ATSC receivers per year will be sold in the U.S. alone, with cumulative sales reaching *152 million* by 2009. Such massive sales volumes will further drive down the price of ATSC receivers, such that many experts believe that within three or four years, virtually all TV sets sold in the U.S. will be HDTVs, because they will cost no more than analog color TVs by that time, even at the smaller screen sizes.

In addition to HDTV, broadcasters in the U.S. are using DTT to provide innovative packages of new services. Some broadcasters are providing multiple simultaneous programs of SDTV. This is especially important for public broadcasters in achieving their goals to support public education, providing multiple education programs instead of just one program at one time. Many commercial broadcasters are now offering a main program in HDTV, plus another SDTV program such as 24-hour news or weather. Some broadcasters are also pooling their excess capacity to offer basic pay-TV platforms in competition with cable and satellite systems.

Broadcasters are also beginning to offer various data services using the ATSC family of standards, including interactive information services.

The U.S. government is planning to complete the transition to DTT broadcasting by February 2009, in order to free up extremely valuable nationwide spectrum that can be used to promote public safety and national security, and to support new wireless services that will be engines of economic growth for decades to come. To support its decision to end analog television transmissions, the U.S. Congress urged the development of an inexpensive digital-to-analog set-top converter box to permit consumers to view DTT signals on their existing analog TV sets. Several manufacturers responded, demonstrating prototype converters that are expected to cost US\$50 by 2008, if sold in large quantities.

With respect to reception by portable hand-held receivers or in fast-moving vehicles, the ATSC Standard was not originally designed to provide this type of reception. Rather, the goal was to deliver the largest possible payload data rate to the largest service area, to ensure that broadcasters could reach the largest possible audience with high-quality HDTV images and associated surround sound.

Now that HDTV is firmly in hand, however, U.S. broadcasters are showing increasing interest in receiving DTV signals in moving vehicles and by pedestrians with hand-held devices. A number of companies have been working on adding such applications to the ATSC Standard.

### **Conclusion**

The implementation of digital television service based on the ATSC family of standards is moving ahead dramatically in the U.S. (HDTV is firmly entrenched, and is replacing analog color television at a rapid pace. SDTV multicasting and information services are also important and are being expanded, as broadcasters learn to take full advantage of the rich possibilities of DTT broadcasting using the ATSC family of standards. A cornucopia of dazzling new consumer products is available, at rapidly falling prices that make DTT receivers affordable for all socio-economic classes. Continuing improvements in ATSC receivers and further extensions and new additions to the ATSC family of standards are laying the groundwork for additional new services and applications in the future.

The U.S. is now in the final stages of its transition to digital television broadcasting, with a hard date set for the end of analog transmissions. Ending analog transmissions will mark the end of the transition to DTT broadcasting, which will permit the recovery of extremely valuable spectrum that will support new wireless services that will be engines of economic growth for decades to come.

## **12 Republic of Korea**

The Republic of Korea decided digital transition from analogue broadcasting services to provide spectrum efficient and high quality services. With careful studies and field test, standards to achieve effectively the digital transition of each analogue media were chosen. For fixed reception at home, high quality services on large screen display will be major service models but low or intermediate quality acceptable on small and handheld receivers for mobile reception.

In the Republic of Korea, digital terrestrial television broadcasting was started in 2001, digital satellite broadcasting in 2002, and terrestrial multimedia broadcasting in 2005. Cable TV is also in service of digital programs since 2002.

### **12.1 Digital TV for fixed reception**

Terrestrial television sets may be appropriate receivers to enjoy high definition video and multi-channel audio with a large screen at home. The Republic of Korea adopted ATSC system in 1997 for digital transition of analogue television broadcasting in the UHF band according to the policy to obtain high definition quality within 6 MHz raster and conducted field tests in 1999 and 2000.

There are 160 ATSC transmitters currently installed around the country covering about 92% of territory as of 2006. Several principles were given to digital terrestrial television broadcasters to follow government policies on digital transition as follows:

Simulcast of analogue and digital broadcasting until analogue switchover

Requirement of minimum time for HDTV programs (annually increasing)

Return of frequencies allocated to analogue television stations

It was not an easy job to find frequencies for digital television stations, because the UHF band from 470-752 MHz is already occupied with analogue television broadcasting. Hence, the band of 752-806, currently allocated to fixed and mobile services in Korea, was decided to use for broadcasting services during the transition time only, but these bands will be returned after analogue switchover. In order to facilitate frequency assignments, Equalization Digital On-Channel Repeater and Distributed Translator are devised for ATSC system to use same frequencies.

More than 4 million Set-Top-Boxes, about 23% of households, were sold as of 2006. It is expected to increase penetration rates of Set-Top-Boxes, since data broadcasting was started in 2005. Data services provide information on dramas or records of sports games as well as EPG.

## 12.2 T-DMB for mobile reception

For mobile multimedia broadcasting service, the Republic of Korea developed the video standard, which is fully backward compatible with the T-DAB, and named as Terrestrial Digital Multimedia Broadcasting (T-DMB). The specification of T-DMB was standardized as ETSI TS102 427 and ETSI TS 102 428 and submitted to WP 6M for a new recommendation of mobile multimedia broadcasting by handheld receivers.

T-DMB pilot services were conducted in Band III in Seoul metropolitan area and its vicinity and field test results showed good mobile reception quality. Field test results were submitted to 6M meeting held in April 2004 and included in the Report ITU-R BT. 2049 (see also Doc. 6E/186).

In December 2005, the Republic of Korea launched commercial service of T-DMB in Seoul Metropolitan area and expanded to the nationwide services in March 2007. Each broadcaster provides two video services or one video with three audio services within an ensemble and optionally with data services.

The whole territory was divided into seven regions including Jeju Island for business. One national broadcaster and seventeen regional broadcasters were licensed to serve T-DMB nationwide. It was intended to serve each region with the same frequency and most transmitters are linked with Single Frequency Networks to cover the wanted regional area. Fortunately, Seoul Metropolitan area is assigned two TV channels, 8 and 12, and served by six broadcasters. In order to allocate frequencies to T-DMB stations, frequencies of 44 analogue TVR in the band III were changed after simulation of mutual interference and analysis. The channel assignment plan in the Band III for the services is shown in Fig. 63.

However some transmitters in southern part do not have same frequencies due to pre-occupied frequencies for analogue TV stations and some regions consist of Multi Frequency Networks; Channel 7 and Channel 8 of the south-western region, Channel 7 and Channel 9 of the middle of eastern region, Channel 9 and Channel 12 of south-eastern region and Channel 8 and Channel 12 of Jeju Island. Hand-over technology was implemented on receivers for continued reception of a wanted service, even in other ensembles or different RF channels, while moving into other network.

In order to enjoy T-DMB services even underground, low powered T-DMB gap-fillers, which receive outdoor T-DMB signals and retransmit, were installed at 294 points to cover the whole lines of Metros in Seoul.

A variety of commercial receivers for portable or handheld reception are introduced in the market. Since the launch of T-DMB service in December 2005, 3.14 million receivers are sold in Korea as of 31 January 2007.

Data services such as EPG, TPEG and BWS are in services and interactive services using return channel will be appeared soon with the cooperation of telecommunication operators. These data services are expected to produce pay services for business by providing information on traffic jam, stock and even Internet access.

FIGURE 64

Channel Assignments for T-DMB in Korea

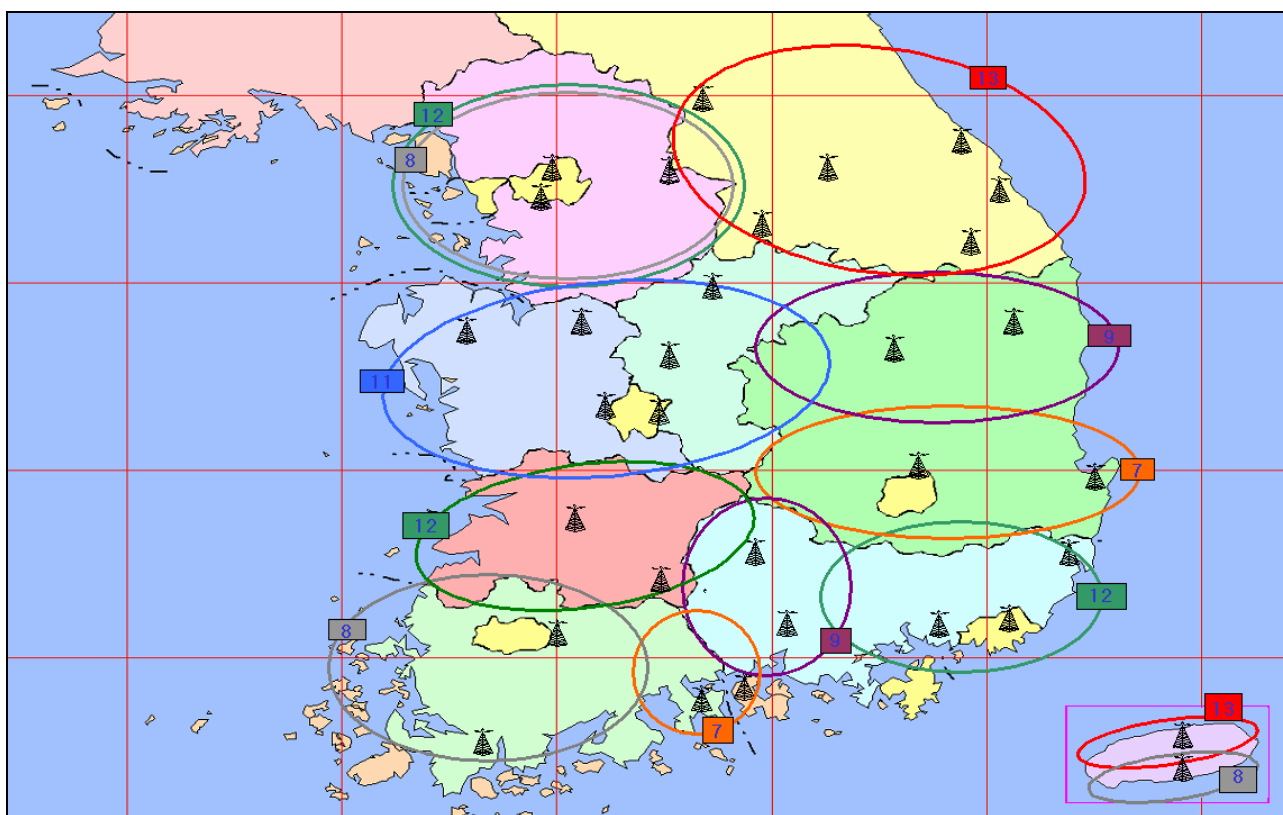

### 13 Venezuela

Adoption of standards for digital sound and digital television in Venezuela

#### Introduction

In order to assist in the selection of Digital Radio and Television systems in Venezuela, the National Commission of Telecommunications (CONATEL) has created a Digital Radio and Television project, supported by constant research. Its ultimate goal is advancing the tasks for the introduction of this service, and thus, making Digital Radio and Television systems in Venezuela a medium-term reality.

#### *Digital Radio and Television project – Development stages*

The development of the Digital Radio and Television project involves four (4) stages, as described below:

*Stage 1: Feasibility study (technical, economic and legal aspects)*

The tasks that comprised the feasibility study –still under development- are the following:

Review of national television and radio stations regarding location, frequency, service quality, technology and regulatory aspects.

Review of digital radio and television technology development, equipment suppliers, costs, comparison and selection of the most suitable technology.

Detailed study of the band frequencies that are to be assigned to analog and digital radio and television stations, with the purpose of optimizing the use of spectrum.

Study of the required investments, economic impact and investment recuperation involved in the switching from analogical to digital radio and television systems.



Evaluation of foreign experiences regarding this matter, and possible variables for the acceptance of this technology in Venezuela.

Documental analysis of digital radio and television regulations.

*Stage 2: Forum and operating tables*

During this stage, contacts are made with companies in charged of the development of digital radio and television standards, as well as with equipment suppliers and regulation departments, with the cooperation of domestic radio and television operators.

*Stage 3: Trials*

Trials help to adopt suitable policies to benefit Venezuela's technological smooth switch to digital radio and television. This stage will produce both experimental and regulating experiences:

*Trials*

Switch to the digital system.

Setting of regulation framework.

In general, domestic and foreign investments for the development of new technologies require a regulation framework, which will settle the rules for their evolution and put into practice.

The efficient performance of the above-mentioned functions will be a key aspect to plan legally sustained trials for digital radio and television systems, which can prove trustful and safe for both domestic and foreign investors. Besides, this option will facilitate the study of spectrum shares, not assigned to digital radio and television.

Other important legal aspects relate to the obligation to mention the specific spectrum share to be used by the incumbent. This share can only be used and exploited within the specific cover indicated on a special permission.

Besides, getting a special permission will not grant expectations of rights to incumbents or preferential rights whatsoever in getting of a grant for the use and exploitation of the spectrum share necessary for developing all the activities foreseen by the regulations. Once a special permission has expired, its incumbent will not be able to continue using the spectrum shares assigned, unless they update their permission.

Incumbents with special permission will not obtain any counter-payment from users because of service rendering during trials. Once the trial is over, they should present a detailed report about the activities carried out and the results obtained. At any given moment, CONATEL can inspect or supervise the trials.

For the special permission, the interested incumbents will have to indicate the accurate date for the beginning of trials and the length the trials (up to three months).

If there are justifiable reasons, the beginning of trials can be adjourned unless decided otherwise by CONATEL. The trials can only be adjourned once.

During the deliberation period, CONATEL can require any concerning information from the incumbents, in order to evaluate the application. In this case, CONATEL will notify the titular that they have 10 days to submit their requirements. From the date of the application, CONATEL can interrupt the deliberation period for ten days. Due to the complexity of the matter, this period can be extended up to fifteen continuous days.

*Stage 4: Standards adoption*

This stage is the milestone for the digital radio and television adoption process. The fitting of the legislation in force to the characteristics of the chosen system will provide strength and trust to the process of putting digital radio and television services into practice in Venezuela.

## Appendix 2 to Part 2

### 1 Definitions

From Radio Regulations.

#### Section II – Specific terms related to frequency management

**1.16** *allocation* (of a frequency band): Entry in the Table of Frequency Allocations of a given frequency band for the purpose of its use by one or more terrestrial or space *radiocommunication services* or the *radio astronomy service* under specified conditions. This term shall also be applied to the frequency band concerned.

**1.17** *allotment* (of a radio frequency or radio frequency channel): Entry of a designated frequency channel in an agreed plan, adopted by a competent conference, for use by one or more administrations for a terrestrial or space *radiocommunication service* in one or more identified countries or geographical areas and under specified conditions.

**1.18** *assignment* (of a radio frequency or radio frequency channel): Authorization given by an administration for a radio *station* to use a radio frequency or radio frequency channel under specified conditions.

#### Section III – Radio services

**1.19** *radiocommunication service*: A service as defined in this Section involving the transmission, *emission* and/or reception of *radio waves* for specific *telecommunication* purposes.

In these Regulations, unless otherwise stated, any radiocommunication service relates to *terrestrial radiocommunication*.

**1.20** *fixed service*: A *radiocommunication service* between specified fixed points.

**1.24** *mobile service*: A *radiocommunication service* between *mobile* and *land stations*, or between *mobile stations* (CV).

**1.26** *land mobile service*: A *mobile service* between *base stations* and *land mobile stations*, or between *land mobile stations*.

**1.38** *broadcasting service*: A *radiocommunication service* in which the transmissions are intended for direct reception by the general public. This service may include sound transmissions, *television* transmissions or other types of transmission (CS).

**1.39** *broadcasting-satellite service*: A *radiocommunication service* in which signals transmitted or retransmitted by *space stations* are intended for direct reception by the general public.

In the broadcasting-satellite service, the term “direct reception” shall encompass both *individual reception* and *community reception*.

**1.56** *amateur service*: A *radiocommunication service* for the purpose of self-training, intercommunication and technical investigations carried out by amateurs, that is, by duly authorized persons interested in radio technique solely with a personal aim and without pecuniary interest.

**1.57** *amateur-satellite service*: A *radiocommunication service* using *space stations* on earth *satellites* for the same purposes as those of the *amateur service*.

#### Section IV – Radio stations and systems

**1.61** *station*: One or more transmitters or receivers or a combination of transmitters and receivers, including the accessory equipment, necessary at one location for carrying on a *radiocommunication service*, or the *radio astronomy service*.

Each station shall be classified by the service in which it operates permanently or temporarily.

**1.62** *terrestrial station*: A station effecting *terrestrial radiocommunication*.

In these Regulations, unless otherwise stated, any *station* is a terrestrial station.

**1.63** *earth station*: A station located either on the Earth's surface or within the major portion of the Earth's atmosphere and intended for communication:

- with one or more *space stations*; or
- with one or more *stations* of the same kind by means of one or more reflecting *satellites* or other objects in space.

**1.66** *fixed station*: A station in the *fixed service*.

**1.66A** *high altitude platform station*: A station located on an object at an altitude of 20 to 50 km and at a specified, nominal, fixed point relative to the Earth.

**1.67** *mobile station*: A station in the *mobile service* intended to be used while in motion or during halts at unspecified points.

**1.68** *mobile earth station*: An *earth station* in the *mobile-satellite service* intended to be used while in motion or during halts at unspecified points.

**1.69** *land station*: A station in the *mobile service* not intended to be used while in motion.

**1.70** *land earth station*: An *earth station* in the *fixed-satellite service* or, in some cases, in the *mobile-satellite service*, located at a specified fixed point or within a specified area on land to provide a *feeder link* for the *mobile-satellite service*.

**1.71** *base station*: A *land station* in the *land mobile service*.

**1.72** *base earth station*: An *earth station* in the *fixed-satellite service* or, in some cases, in the *land mobile-satellite service*, located at a specified fixed point or within a specified area on land to provide a *feeder link* for the *land mobile-satellite service*.

**1.73** *land mobile station*: A *mobile station* in the *land mobile service* capable of surface movement within the geographical limits of a country or continent.

**1.74** *land mobile earth station*: A *mobile earth station* in the *land mobile-satellite service* capable of surface movement within the geographical limits of a country or continent.

**1.75** *coast station*: A *land station* in the *maritime mobile service*.

**1.76** *coast earth station*: An *earth station* in the *fixed-satellite service* or, in some cases, in the *maritime mobile-satellite service*, located at a specified fixed point on land to provide a *feeder link* for the *maritime mobile-satellite service*.

**1.77** *ship station*: A *mobile station* in the *maritime mobile service* located on board a vessel which is not permanently moored, other than a *survival craft station*.

**1.78** *ship earth station*: A *mobile earth station* in the *maritime mobile-satellite service* located on board ship.

**1.79** *on-board communication station*: A low-powered *mobile station* in the *maritime mobile service* intended for use for internal communications on board a ship, or between a ship and its lifeboats and life-rafts during lifeboat drills or operations, or for communication within a group of vessels being towed or pushed, as well as for line handling and mooring instructions.

**1.80** *port station*: A *coast station* in the *port operations service*.

**1.81** *aeronautical station*: A *land station* in the *aeronautical mobile service*.

In certain instances, an aeronautical station may be located, for example, on board ship or on a platform at sea.

**1.82** *aeronautical earth station*: An earth station in the *fixed-satellite service*, or, in some cases, in the *aeronautical mobile-satellite service*, located at a specified fixed point on land to provide a *feeder link* for the *aeronautical mobile-satellite service*.

**1.84** *aircraft earth station*: A mobile earth station in the *aeronautical mobile-satellite service* located on board an aircraft.

**1.85** *broadcasting station*: A station in the *broadcasting service*.

**1.96** *amateur station*: A station in the *amateur service*.

**1.97** *radio astronomy station*: A station in the *radio astronomy service*.

**1.98** *experimental station*: A station utilizing *radio waves* in experiments with a view to the development of science or technique.

This definition does not include *amateur stations*.

**1.128** *television*: A form of *telecommunication* for the transmission of transient images of fixed or moving objects.

**1.129** *individual reception* (in the *broadcasting-satellite service*): The reception of *emissions* from a *space station* in the *broadcasting-satellite service* by simple domestic installations and in particular those possessing small antennae.

**1.130** *community reception* (in the *broadcasting-satellite service*): The reception of *emissions* from a *space station* in the *broadcasting-satellite service* by receiving equipment, which in some cases may be complex and have antennae larger than those used for *individual reception*, and intended for use:

- by a group of the general public at one location; or
- through a distribution system covering a limited area.

**1.134** *telecommand*: The use of *telecommunication* for the transmission of signals to initiate, modify or terminate functions of equipment at a distance.

## Section VI – Characteristics of emissions and radio equipment

**1.137** *radiation*: The outward flow of energy from any source in the form of *radio waves*.

**1.138** *emission*: *Radiation* produced, or the production of *radiation*, by a radio transmitting *station*.

For example, the energy radiated by the local oscillator of a radio receiver would not be an emission but a *radiation*.

**1.139** *class of emission*: The set of characteristics of an *emission*, designated by standard symbols, e.g. type of modulation of the main carrier, modulating signal, type of information to be transmitted, and also, if appropriate, any additional signal characteristics.

**1.140** *single-sideband emission*: An amplitude modulated *emission* with one sideband only.

**1.141** *full carrier single-sideband emission*: A *single-sideband emission* without reduction of the carrier.

**1.142** *reduced carrier single-sideband emission*: A *single-sideband emission* in which the degree of carrier suppression enables the carrier to be reconstituted and to be used for demodulation.

**1.143** *suppressed carrier single-sideband emission*: A *single-sideband emission* in which the carrier is virtually suppressed and not intended to be used for demodulation.

**1.144** *out-of-band emission*\*: Emission on a frequency or frequencies immediately outside the *necessary bandwidth* which results from the modulation process, but excluding *spurious emissions*.

**1.145** *spurious emission*\*: Emission on a frequency or frequencies which are outside the *necessary bandwidth* and the level of which may be reduced without affecting the corresponding transmission of information. Spurious emissions include harmonic *emissions*, parasitic *emissions*, intermodulation products and frequency conversion products, but exclude *out-of-band emissions*.

**1.146** *unwanted emissions*\*: Consist of *spurious emissions* and *out-of-band emissions*.

**1.146A** *out-of-band domain* (of an emission): The frequency range, immediately outside the necessary bandwidth but excluding the *spurious domain*, in which *out-of-band emissions* generally predominate. *Out-of-band emissions*, defined based on their source, occur in the out-of-band domain and, to a lesser extent, in the *spurious domain*. *Spurious emissions* likewise may occur in the out-of-band domain as well as in the *spurious domain*. (WRC-03)

**1.146B** *spurious domain* (of an emission): The frequency range beyond the *out-of-band domain* in which *spurious emissions* generally predominate. (WRC-03)

**1.147** *assigned frequency band*: The frequency band within which the *emission* of a *station* is authorized; the width of the band equals the *necessary bandwidth* plus twice the absolute value of the *frequency tolerance*. Where *space stations* are concerned, the assigned frequency band includes twice the maximum Doppler shift that may occur in relation to any point of the Earth's surface.

**1.148** *assigned frequency*: The centre of the frequency band assigned to a *station*.

**1.149** *characteristic frequency*: A frequency which can be easily identified and measured in a given *emission*.

A carrier frequency may, for example, be designated as the characteristic frequency.

**1.150** *reference frequency*: A frequency having a fixed and specified position with respect to the *assigned frequency*. The displacement of this frequency with respect to the *assigned frequency* has the same absolute value and sign that the displacement of the *characteristic frequency* has with respect to the centre of the frequency band occupied by the *emission*.

**1.151** *frequency tolerance*: The maximum permissible departure by the centre frequency of the frequency band occupied by an *emission* from the *assigned frequency* or, by the *characteristic frequency* of an *emission* from the *reference frequency*.

The frequency tolerance is expressed in parts in  $10^6$  or in hertz.

**1.152** *necessary bandwidth*: For a given *class of emission*, the width of the frequency band which is just sufficient to ensure the transmission of information at the rate and with the quality required under specified conditions.

**1.153** *occupied bandwidth*: The width of a frequency band such that, below the lower and above the upper frequency limits, the *mean powers* emitted are each equal to a specified percentage  $\beta/2$  of the total *mean power* of a given *emission*.

Unless otherwise specified in an ITU-R Recommendation for the appropriate *class of emission*, the value of  $\beta/2$  should be taken as 0.5%.

**1.154** *right-hand* (clockwise) *polarized wave*: An elliptically- or circularly-polarized wave, in which the electric field vector, observed in any fixed plane, normal to the direction of propagation, whilst looking in the direction of propagation, rotates with time in a right-hand or clockwise direction.

\* The terms associated with the definitions given by Nos. **1.144**, **1.145** and **1.146** shall be expressed in the working languages as follows:

Numbers	In French	In English	In Spanish
<b>1.144</b>	Emission hors bande	Out-of-band emission	Emisión fuera de banda
<b>1.145</b>	Rayonnement non essentiel	Spurious emission	Emisión no esencial
<b>1.146</b>	Rayonnements non désirés	Unwanted emissions	Emisiones no deseadas

**1.155** *left-hand* (anticlockwise) *polarized wave*: An elliptically- or circularly-polarized wave, in which the electric field vector, observed in any fixed plane, normal to the direction of propagation, whilst looking in the direction of propagation, rotates with time in a left-hand or anticlockwise direction.

**1.156** *power*: Whenever the power of a radio transmitter, etc. is referred to it shall be expressed in one of the following forms, according to the class of *emission*, using the arbitrary symbols indicated:

- *peak envelope power* ( $PX$  or  $pX$ );
- *mean power* ( $PY$  or  $pY$ );
- *carrier power* ( $PZ$  or  $pZ$ ).

For different *classes of emission*, the relationships between *peak envelope power*, *mean power* and *carrier power*, under the conditions of normal operation and of no modulation, are contained in ITU-R Recommendations which may be used as a guide.

For use in formulae, the symbol  $p$  denotes power expressed in watts and the symbol  $P$  denotes power expressed in decibels relative to a reference level.

**1.157** *peak envelope power* (of a radio transmitter): The average power supplied to the antenna transmission line by a transmitter during one radio frequency cycle at the crest of the modulation envelope taken under normal operating conditions.

**1.158** *mean power* (of a radio transmitter): The average power supplied to the antenna transmission line by a transmitter during an interval of time sufficiently long compared with the lowest frequency encountered in the modulation taken under normal operating conditions.

**1.159** *carrier power* (of a radio transmitter): The average power supplied to the antenna transmission line by a transmitter during one radio frequency cycle taken under the condition of no modulation.

**1.160** *gain of an antenna*: The ratio, usually expressed in decibels, of the power required at the input of a loss-free reference antenna to the power supplied to the input of the given antenna to produce, in a given direction, the same field strength or the same power flux-density at the same distance. When not specified otherwise, the gain refers to the direction of maximum *radiation*. The gain may be considered for a specified polarization.

Depending on the choice of the reference antenna a distinction is made between:

- a) absolute or isotropic gain ( $G_i$ ), when the reference antenna is an isotropic antenna isolated in space;
- b) gain relative to a half-wave dipole ( $G_d$ ), when the reference antenna is a half-wave dipole isolated in space whose equatorial plane contains the given direction;
- c) gain relative to a short vertical antenna ( $G_v$ ), when the reference antenna is a linear conductor, much shorter than one quarter of the wavelength, normal to the surface of a perfectly conducting plane which contains the given direction.

**1.161** *equivalent isotropically radiated power (e.i.r.p.)*: The product of the power supplied to the antenna and the antenna gain in a given direction relative to an isotropic antenna (*absolute or isotropic gain*).

**1.162** *effective radiated power (e.r.p.)* (in a given direction): The product of the power supplied to the antenna and its *gain relative to a half-wave dipole* in a given direction.

**1.163** *effective monopole radiated power (e.m.r.p.)* (in a given direction): The product of the power supplied to the antenna and its *gain relative to a short vertical antenna* in a given direction.

**1.164** *tropospheric scatter*: The propagation of *radio waves* by scattering as a result of irregularities or discontinuities in the physical properties of the troposphere.

**1.165** *ionospheric scatter*: The propagation of *radio waves* by scattering as a result of irregularities or discontinuities in the ionization of the ionosphere.

For all definitions and terminology see the ITU database:

<http://www.itu.int/ITU-R/go/terminology-database> .