

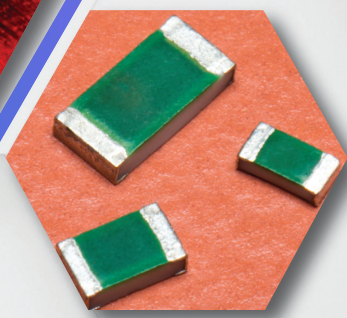

KOA SPEER ELECTRONICS, INC.

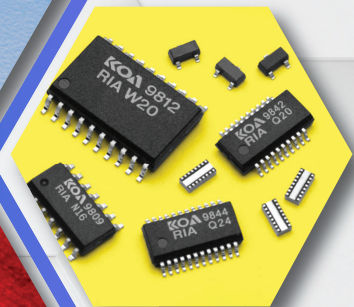

passive components

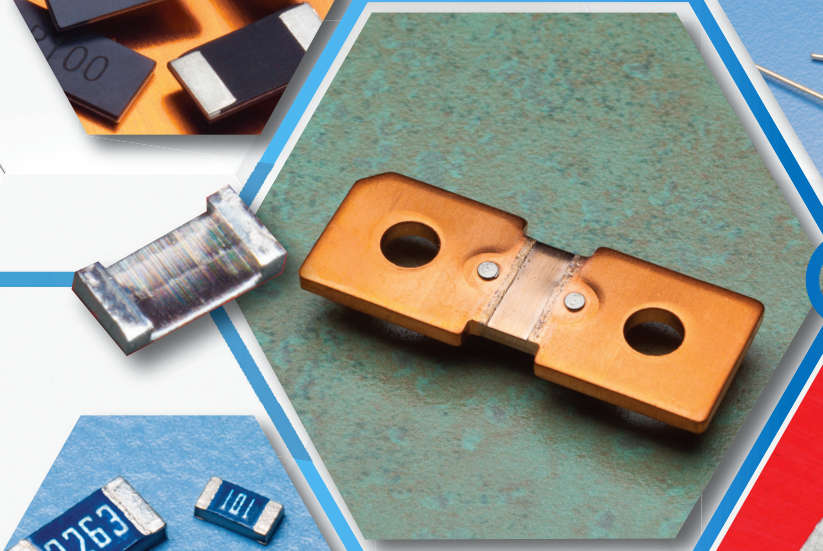
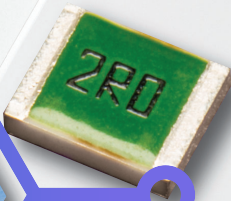
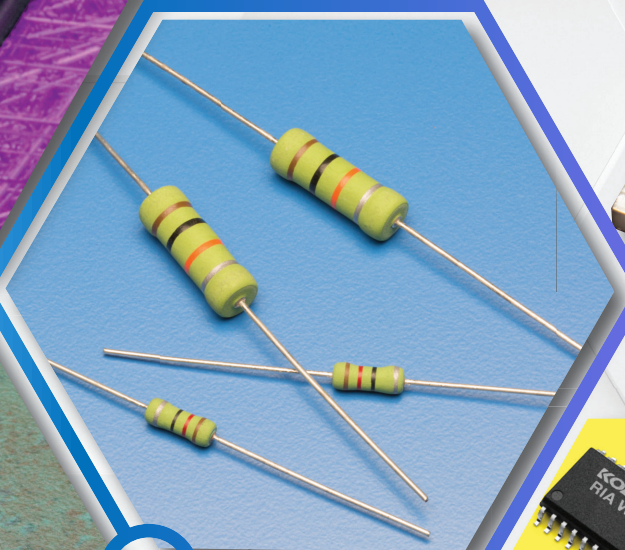

From
Concept to Reality

Our wide range of passive component solutions will help you make the leap

Whether you're designing the car of tomorrow or connecting the Internet of Things, you need cutting-edge product solutions to bring your design to fruition. At KOA Speer, we're the ideal partner to help you do just that. Our constantly expanding line of passive components will give you the solution to make your concept a reality!

Quality 1st



You expect product quality from any component that makes it into one of your designs. But in today's competitive global marketplace, there's more to the quality equation.

At KOA Speer, our Quality 1st initiative reinforces our organization wide focus on serving you at the highest possible level.



Our commitment to quality in everything we do is paying off... in the past two years we've received ten major customer quality awards. We're the industry's most recognized and awarded supplier for achieving the highest product quality, on-time delivery and responsive customer service.

ISO 9001:2015 IATF16949:2016

KOA SPEER... More Than Just Resistors

Resistors



Precision • Surge • Wide Terminal
High Voltage • Thin Film
High Temperature • Embedded • General Purpose
Networks • Anti-Sulfur • Fusing • Melf

Low Resistance Current Sense/Shunts



Metal Plate • Thick Film • Power Shunt
Molded • Wide Terminal

Leaded Resistors

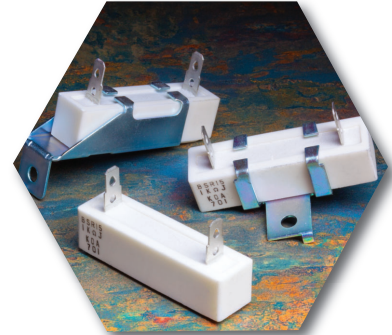

General Purpose Carbon Film
Precision Metal Film • High Voltage • Power
Wirewound • Current Sense • Networks
Fusing • Jumpers

Thermistors/ Thermal Sensors

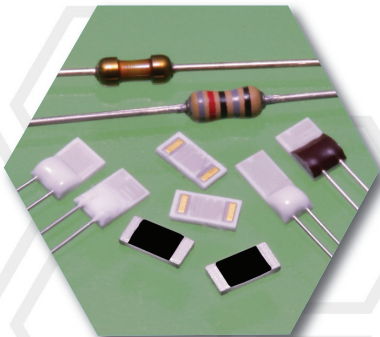

Platinum Thin Film
Thin Film Linear PTC
Thick Film Linear PTC
NTC Thermistors • PTC Thermistors

Inductors

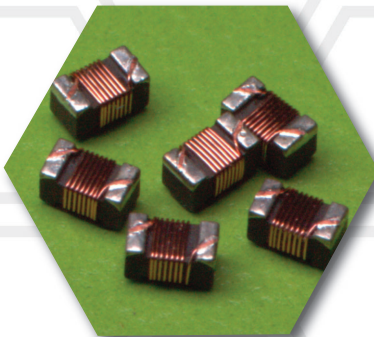

Chip Inductors • Power Inductors

Fuses

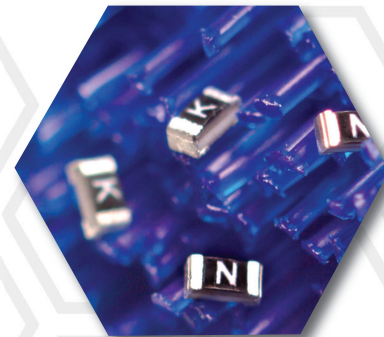

Thin Film • Automotive • Anti-Pulse
Fast Blow • Anti-Surge

Varistors



Chip Varistors • Automotive Varistors

LTCC Substrates

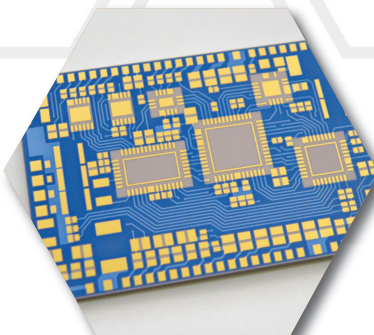

LTCC Substrates • Hybrid IC

Other Products



Check Terminal • Lab Kits

This is an interactive PDF, all products in Table of Contents and Alphabetical Index (p 8) are linked to those pages in the PDF.
At the top of each product page clicking on the logo  will return you to Table of Contents (p 6).

Type	Category	Part Type	Description	Pages
	More Than Just Resistors			3
	Table of Contents			4-5
	Alphabetical Index			6
	Product ID Card			7-8
	Current Sense Resistors Selection Guide			9-10
	Automotive Selection Guide			11-12
	Precision Selection Guide			13
	Power Density Selection Guide			14
	Restrictions of Hazardous Solutions			15
Resistors	Surface Mount Resistors	Cautions & Terms	General precautions	16-17
			Introduction of the Derating Curve	18-19
			Resistors	20
	General	RK73B	General purpose 2%, 5% tolerance thick film chip resistors	21-22
		RK73H	Precision 0.5%, 1% tolerance thick film chip resistors	23-24
		RK73Z	Zero ohm jumper chip resistors	25-26
	Precision	RK73G	50 ppm/°C thick film chip resistors	27-28
		RS73	25 ppm/°C thick film chip resistors	29-30
		RN73H	High stability thin film chip resistors	31-32
		RN73R	Thin film chip resistors	33-34
	Wide Terminal	NEW WN73H	Wide terminal thin film chip resistors	35-36
		WK73R	Wide-terminal thick film chip resistors	37-38
		WK73R (High Power)	Extended power wide-terminal thick film chip resistors	39-40
		WG73	Anti-surge wide-terminal thick film chip resistors	41-42
	Anti Surge	SG73	Extremely high pulse thick film chip resistors	43-44
		SG73P	High-pulse thick film chip resistors	45-46
		SG73S	High voltage surge thick film chip resistors	47-49
		SG73G	50 ppm/°C high-pulse thick film chip resistors	50-51
	High Voltage	HV73	High-voltage thick film chip resistors	52-53
		HV73V	Automotive high-voltage thick film chip resistors	54-55
	High Temperature	HSG73P	200°C high-temperature thick film chip resistors	56-57
	Anti Sulfuration	RK73-RT	Sulfur-resistant general-purpose thick film chip resistors	58-60
		RK73G-RT	Sulfur-resistant 50 ppm/°C thick film chip resistors	61-62
		RS73-RT	Sulfur-resistant 25 ppm/°C thick film chip resistors	63-64
		HSG73P-RT	Sulfur-resistant 200°C high-temperature thick film chip resistors	65-66
		WK73-RT	Sulfur-resistant wide terminal thick film chip resistors	67-68
		WK73-RT (High Power)	Sulfur-resistant extended power wide-terminal thick film chip resistors	69-70
		SG73-RT	Sulfur-resistant extremely high pulse thick film chip resistors	71-72
		SG73P-RT	Sulfur-resistant high-pulse thick film chip resistors	73-74
		SG73S-RT	Sulfur-resistant high voltage surge thick film chip resistors	75-77
		HV73-RT	Sulfur-resistant high-voltage thick film chip resistors	78-79
		HV73V-RT	Sulfur-resistant automotive high-voltage thick film chip resistors	80-81
		SR73-RT	Sulfur-resistant low-value thick film chip resistors	82-83
	Molded Heat-Cycle	SLR	Molded thick film resistors	84-85
		MWS	Molded wirewound resistors	86-87
	Fusing Resistors	RF73	Fusing chip resistors	88-89
	Cylindrical	RN41, RD41, CC	MELF resistors	90-92
	Networks	CNN	Thin film chip resistor array	93-94
		HVD	High precision high-voltage dividers	95-96
		RB(X), RD(X), RT(X)	High precision thin film networks	97-99
		RIA, RNX	High precision thin film arrays	100
		RTY	High precision voltage dividers	101
Low Resistance Current Sense/Shunts	HS		Extremely high current shunts	102-103
	PSL2		Two-terminal current sense shunts	104-105
	PSF4		Four-terminal current sense shunts	106-107
	TLR2A		Small size metal plate current sense resistors	108-109
	TLR		Metal plate current sense resistors	110-111
	TLR-W-P		Extended power metal plate current sense resistors	112-113
	TLRZ		High-current jumpers	114-115
	TLRH		High power metal plate current sense resistors	116-117
	SL, SLN, SLZ, TSL		Molded metal plate current sense resistors	118-120
	SLW, SLN		Extended power molded metal plate current sense resistors	121-122
	WK73S		Wide-terminal current sense thick film chip resistors	123-124
	WK73S (High Power)		Extended power wide-terminal current sense thick film chip resistors	125-126
	WU73		75 ppm/°C wide-terminal current sense thick film chip resistors	127-128
	UR73V		Automotive current sense thick film chip resistors	129-130
	UR73		Current sense thick film chip resistors	131-132

This is an interactive PDF, all products in Table of Contents and Alphabetical Index (p 8) are linked to those pages in the PDF.
At the top of each product page clicking on the logo  will return you to Table of Contents (p 6).

	SR73	Low-value thick film chip resistors	133-135		
	SR73 (High Power)	Extended power low-value thick film chip resistors	136-137		
	CSR	Four-terminal molded metal plate current sense resistors	138-139		
Leaded Resistors	General	.CF	Carbon film through-hole resistors	140-141	
		MF, MFS, RK	Metal film through-hole resistors	142-143	
		SN3A/3D	High-power metal film through-hole resistors	144-145	
		SNF	5% metal film through-hole resistors	146-147	
		J	Zero ohm molded jumpers	148-149	
		JL	Jumper wire	150	
		Z	Zero ohm conformal coat jumpers	151-152	
	Precision	.RNS	MIL approved metal film leaded resistors	153-154	
	High Voltage	RCR	Anti-surge metal glaze through-hole resistors	155-156	
		GS	High-voltage metal glaze through-hole resistors	157-158	
		PCF	Anti-pulse ceramic composition through-hole resistors	159-160	
		HPC	High-power anti-pulse ceramic composition through-hole resistors	161-162	
		CPCN	Ceramic composition MELF resistors	163-164	
	Power Type	PSN, PV, PSO, PN, PWW, PAP	High-voltage cylindrical resistors	165-167	
		MOS (X)	High-power metal oxide film through-hole resistors	168-171	
SPR (X)		High-power carbon film through-hole resistors	172-173		
CWFS		Fusing wirewound through-hole resistors	174-175		
CW, CWP, CWH		Wirewound through-hole resistors	176-178		
RW		High-power wirewound through-hole resistors	179-180		
BGR, BWR, BSR		Ceramic case through-hole resistors	181-185		
BGRV, BWRV, BSRV		Automotive ceramic case through-hole resistors	186-188		
BPR		Ceramic case metal plate through-hole resistors	189-190		
LR		Custom milliohm resistors	191-192		
Fusing Resistors	RF	Fusing through-hole resistors	193-194		
	RF25CC	Constant-current fusing through-hole resistors	195-196		
Thermistors/Thermal Sensors	Caution & Terms		Thermal Sensors	197	
	Platinum Thin Film (SMD)	.SDT73H, SDT73S	Thermal sensors	198-199	
		SDT73V	Automotive thermal sensors	200-201	
		SDT310VASP2	Small axial through-hole thermal sensors, fast response	202-204	
	Platinum Thin Film (Leaded)	SDT310HCTP	Small radial through-hole thermal sensors	205-207	
		SDT310	Through-hole thermal sensors	208-210	
		SDT101	Cylindrical through-hole thermal sensors	211-212	
	Platinum Thin Film (Custom)	ST	Thermal sensors	213-216	
		Linear P.T.C. (SMD)	LP73	High-resolution thin film chip thermal sensors	217-218
		LT73V	Automotive thin film chip thermal sensors	219-220	
		LT73	Thin film chip thermal sensors	221-222	
	Linear P.T.C. (Leaded)	LP	Metal film through-hole thermal sensors	223-224	
	Inductors	Caution & Terms		Inductors	225
		MHL	Multilayer ceramic inductor	226-227	
CZB		Multilayer ferrite bead	228-229		
CZP		Multilayer power ferrite bead	230-231		
Circuit Protection	Fuses	Caution & Terms		Fusing Components	232
		Flat Chip	TF	Thin film chip fuse	233-234
		Flat Chip	TF16VN	Chip current fuse (Automotive)	235-236
		Ceramic Case	.CCF1N	Anti-surge chip fuses	237-238
		Ceramic Case	.CCF1F	Fast-blow anti-surge chip fuses	239-240
	Varistors	Caution & Terms		Varistors	241
		NV73	Metal oxide varistor	242-246	
NV73DL		Multilayer type metal oxide varistors (Automotive)	247-248		
Substrates & Other Products	KLC	LTCC multilayer substrates	249-250		
	KLCJ	Custom module	251		
	KA	Hybrid IC	252		
	RC	Test point chip	253		
Appendix	A - Packaging - Surface Mount Components		254-255		
	B - Pad Dimensions		256-259		
	C - Packaging - Leaded Components		260-268		
	D - Marking and Standard Values		269-271		
Additional Information	Lab Kits		272-273		
	KOA Sales Representatives		274		
	KOA Distributors		275-276		
	Global Network		277		

resistors

current sense

leaded resistors

thermal sensors

inductors

circuit protection

substrates & others

appendix & add. information

This is an interactive PDF, all products in Table of Contents and Alphabetical Index (p 8) are linked to those pages in the PDF.
 At the top of each product page clicking on the logo  will return you to Table of Contents (p 6).

Type	Pages		
Alphabetical Index	6	MHL	226-227
Automotive Selection Guide	11-12	More Than Just Resistors	3
BGR	181-185	MOS (X)	168-171
BGRV	186-188	MWS	86-87
BPR	189-190	NV73	242-246
BSR	181-185	NV73DL	247-248
BSRV	186-188	PAP	165-167
BWR	181-185	PCF	159-160
BWRV	186-188	PN	165-167
CC	90-92	Power Density Selection Guide	14
CCF1F	239-240	Precision Selection Guide	13
CCF1N	237-238	Product ID Card	7-8
CF	140-141	PSF4	106-107
CNN	93-94	PSL2	104-105
CPCN	163-164	PSN	165-167
CSR	138-139	PSO	165-167
Current Sense Resistors		PV	165-167
Selection Guide	9-10	PWW	165-167
CW	176-178	RB(X)	97-99
CWFS	174-175	RC	253
CWH	176-178	RCR	155-156
CWP	176-178	RD(X)	97-99
CZB	228-229	RD41	90-92
CZP	230-231	Resistors - Caution & Terms	20
Fuses - Caution & Terms	232	Restrictions of Hazardous Solutions	15
General Precaution -		RF	193-194
Caution & Terms	16-17	RF25CC	195-196
GS	157-158	RF73	88-89
HPC	161-162	RIA	100
HS	102-103	RK	142-143
HSG73P	56-57	RK73-RT	58-60
HSG73P-RT	65-66	RK73B	21-22
HV73	52-53	RK73G	27-28
HV73-RT	78-79	RK73G-RT	61-62
HV73V	54-55	RK73H	23-24
HV73V-RT	80-81	RK73Z	25-26
HVD	95-96	RN41	90-92
Inductors - Caution & Terms	225	RN73H	31-32
Intro of the Derating Curve	18-19	RN73R	33-34
J	148-149	RNS	153-154
JL	150	RNX	100
KA	252	RS73	29-30
KLC	249-250	RS73-RT	63-64
KLCJ	251	RT(X)	97-99
LP	223-224	RTY	101
LP73	217-218	RW	179-180
LR	191-192	SDT101	211-212
LT73	221-222	SDT310	208-210
LT73V	219-220	SDT310HCTP	205-207
MF	142-143	SDT310VASP2	202-204
MFS	142-143	SDT73H	198-199
		SDT73S	198-199
		SDT73V	200-201
		SG73	43-44
		SG73-RT	71-72
		SG73G	50-51
		SG73P	45-46
		SG73P-RT	73-74
		SG73S	47-49
		SG73S-RT	75-77
		SL	118-120
		SLN2	118-120
		SLN3, SLN5	121-122
		SLR	84-85
		SLW	121-122
		SLZ	118-120
		SN3A/3D	144-145
		SNF	146-147
		SPR (X)	172-173
		SR73	133-135
		SR73 (High Power)	136-137
		SR73-RT	82-83
		ST	213-216
		Table of Contents	4-5
		TF	233-234
		TF16VN	235-236
		Thermal Sensors - Caution & Terms	197
		TLR	110-111
		TLR-W-P	112-113
		TLR2A	108-109
		TLRH	116-117
		TLRZ	114-115
		TSL	118-120
		UR73	131-132
		UR73V	129-130
		Varistors - Caution & Terms	241
		WG73	41-42
		WK73-RT	67-68
		WK73-RT (High Power)	69-70
		WK73R	37-38
		WK73R (High Power)	39-40
		WK73S	123-124
		WK73S (High Power)	125-126
		WN73H...	35-36
		WU73	127-128
		Z	151-152
		Appendix A	254-255
		Appendix B	256-259
		Appendix C	260-268
		Appendix D	269-271
		Lab Kits	272-273
		KOA Sales Representatives	274
		KOA Distributors	275-276
		Global Network	277



KOA SPEER ELECTRONICS, INC.

Product Line Card

www.koaspeer.com

Category	Type	1F	1H	1E	1J	2A	2B	2E	2H(W2H)	3A(W3A)
		Size (inch (mm))	01005 (0.4×0.2)	0201 (0.6×0.3)	0402 (1.0×0.5)	0603 (1.6×0.8)	0805 (2.0×1.25)	1206 (3.2×1.6)	1210 (3.2×2.5)	2010 (5.0×2.5)
Thin Film Resistors	Precision	RN73H /RN73R		- / -	- / -	- / -	- / -	100 / -		
	Precision	RS73		(RT)	(RT)	(RT)	(RT)	(RT)		
	Precision	RK73G		(RT/AT)	(RT/AT)	(RT/AT)	(RT/AT)	(RT)		
Anti Surge Anti Pulse	SG73/S/P		- / -	- / -	- / -	- / -	- / -	100 / -	102 / -	102 / -
	SG73G		(AT)	(AT)	(AT)	(AT)	(AT)	(AT)		
	HSG73P		(RT/AT)	(RT/AT)	(RT/AT)	(RT/AT)	(RT/AT)	(RT/AT)		
Thick Film Resistors	High Temperature			(RT/AT)	(RT/AT)	(RT/AT)	(RT/AT)	(RT/AT)		
	Wide Terminal			(RT)	(RT)	(RT)	(RT)	(RT)	102 (RT)	102 (RT)
	High Voltage			(RT/AT)	(RT/AT)	(RT/AT)	(RT/AT)	(RT/AT)	516 (RT)	516 (RT)
Protectors	General		- / -	- / -	- / -	- / -	- / -	100 / -	1001 / -	102 / -
	Jumper		(RT)	(RT/AT)	(RT/AT)	(RT/AT)	(RT/AT)	(RT)	(RT)	(RT)
	Current Fuses			(RT/AT)	(RT/AT)	(RT/AT)	(RT/AT)	(RT)	(RT)	(RT)

Resistance Tolerance: ±0.05%, T.C.R.: ±5 × 10⁻⁶/K ~
 Resistance Tolerance: ±0.1%, T.C.R.: ±25 × 10⁻⁶/K ~
 Resistance Tolerance: ±0.25%, T.C.R.: ±50 × 10⁻⁶/K ~
 Power Rating: 0.1W ~ 1W (SG73P, 1E: 0.25W, 1J: 0.33W, 2A: 0.5W, 2B: 0.75W, 2E: 1W), SG73S: For Surge, SG73P: For Pulse
 Resistance Tolerance: ±0.25%, T.C.R.: ±50 × 10⁻⁶/K, For Pulse
 Power Rating, 1E: 0.2W, 1J: 0.33W, 2A: 0.5W, 2B: 0.75W, Operating Temp., Sn Terminal: ~175°C, Au Terminal: ~200°C
 Resistance Range, WK73R: 10Ω ~ 1MΩ, WK73S: 10mΩ ~ 9.76Ω, Power Rating: 0.33W ~ 3W
 Resistance Range: 560mΩ ~ 1kΩ, Power Rating, 2B: 1W, 2H: 1.5W, 3A: 2W, For Pulse
 Resistance Range: 10kΩ ~ 100MΩ, Max. Working Voltage, 1J: 350V, 2A: 400V, 2B: 500V, 2H: 2,000V (D.C.), 3A: 3,000V (D.C.)
 Resistance Tolerance, RK73H: ±0.5%, ±1%, RK73B: ±2%, ±5%
 Resistance, 50mΩ Max. (1H(RT): 100mΩ Max.), Current Rating, 1F · 1H: 0.5A, 1E · 1J: 1A, 2A ~ W3A: 2A
 Rated Current: 0.40A ~ 3.15A, Rated Voltage: DC32V ~ DC125V, For Automotive
 RT: Anti sulfuration type are available AT: Heat shock resistance type are available

Category	Type		1F	1H	1E	1J	2A	2B	2E	2H(W2H)	3A(W3A)
	Size	inch (mm)	01005 (0.4×0.2)	0201 (0.6×0.3)	0402 (1.0×0.5)	0603 (1.6×0.8)	0805 (2.0×1.25)	1206 (3.2×1.6)	1210 (3.2×2.5)	2010 (5.0×2.5)	2512 (6.4×3.2)
Thick Film Resistors	Low Resistance	SR73		-	(RT)	(RT)	(RT)	(RT)	(RT)	R100	R100
		UR73/D/V		/	/	/	/	/	/	/	/
Shunt Resistors (Metal Plate)	Current Sensing	WU73									
	Jumper	TLR									
Leaded Resistors (Ceramic)	High Voltage	TLRZ									
	Power Resistor										







Resistance Range: 24mΩ ~ 10Ω, T.C.R.: ±100 × 10⁻⁶/K ~

Resistance Range: 10mΩ ~ 100mΩ, T.C.R.: ±75 × 10⁻⁶/K ~

Resistance Range: 10mΩ ~ 100mΩ, T.C.R.: ±75 × 10⁻⁶/K ~, Wide Terminal

Resistance Range: 0.5mΩ ~ 20mΩ, Power Rating: 0.5W ~ 5W, T.C.R.: ±50 × 10⁻⁶/K ~

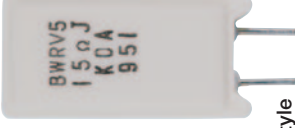
0.2mΩ Max.(1E:0.5mΩ Max), 1E: 10A, 1J: 26A, 2A: 31.6A, 2B: 50A

Category	Type	Size	Image
High Voltage	PCF	1/2W	
		1W	
Power Resistor	HPC	1/2W	
		3W	
Power Resistor	BGRV BWRV BSRV	5W	
		20W	

Resistance Range: 3.3Ω ~ 390kΩ, Power Rating: 0.5W, 1W, 2W, Max.Pulse Voltage, 1/2W: 10kV, 1W: 14kV, 2W: 20kV

Resistance Range: 3.3Ω ~ 390kΩ, Power Rating: 0.5W, 1W, 2W, 3W, 4W, 5W, Max.Pulse Voltage, 1/2W: 8kV, 1W: 15kV, 2W ~ 5W: 25kV

Power Rating: 3W, 5W, 7W, 10W, 15W, 20W, 30W, 40W(60W), BGRV: Wirewound(Glass Core), BWRV: Wirewound(Ceramic Core), BSRV: Metal oxide film(Ceramic Core), For Automotive



Current Sense Resistors Selection Guide

KOA SPEER ELECTRONICS, INC.

KOA offers complete family of Current Sense Resistors capable of sensing large to small currents with ultra-low resistance

Applications: Current management sensor including charge/discharge of secondary batteries • Current control sensor of motors and DC/DC converters • Circuit protecting sensor by overcurrent detection

Current Sense Resistors

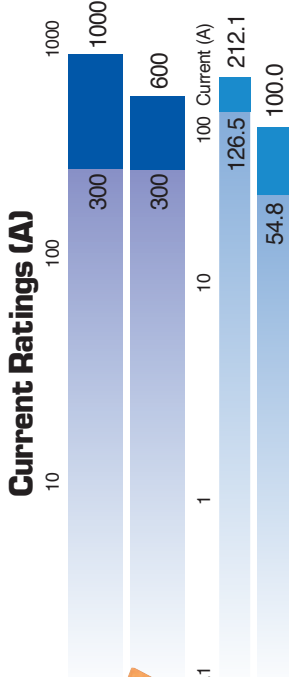

Series	Resistance Range	Rated Power	Size (Inch)	Tolerance
Large Current Shunt Resistors	50μΩ	50W	40x22mm 80x22mm	±5%
Power Shunt Chip Resistors	100/200μΩ	36W/18W	40x15mm 80x18mm	±5%
Metal Plate Chip Type Low Resistance Resistors	0.2m/0.3m/0.5m	8W/9W	2512	±1%
Metal Plate Resistive Element	0.5m/1mΩ	5W/3W	1216	±1%

Series	Resistance Range	Rated Power	Size (Inch)	Tolerance
Metal Plate Resistive Element	0.5m~10mΩ	3W~5W	2512	±1%
Metal Plate Resistive Element	0.5m~10mΩ	2W	2512	±1%
Metal Plate Resistive Element	0.5m~10mΩ	2W	2010	±1%
Metal Plate Resistive Element	0.5m~20mΩ	3W/1.5W	1206	±1%
Metal Plate Resistive Element	0.5m~20mΩ	1W	1206	±1%
Metal Plate Resistive Element	1m~10mΩ	1W	2010	±1%
Metal Plate Resistive Element	2m~10mΩ	1W	0805	±1%
Metal Plate Resistive Element	1m~20mΩ	0.5W	1206	±1%
Metal Plate Resistive Element	6m~120mΩ	4~5W	2512	±1%
Metal Plate Resistive Element	10m~270mΩ	2W	2512	±1%
Metal Plate Resistive Element	12m~100mΩ	0.25~0.5W	0805	±1%

Series	Resistance Range	Rated Power	Size (Inch)	Tolerance
Current Sense Chip Resistors	3m~200mΩ	7W	4527	±0.5,1,1%
Metal Plate Resistive Element	5m~200mΩ	3W	4527	±0.5,1,5%
Mold Package	5m~200mΩ	2W	4527	±0.5,1,5%
High Reliability	3m~360mΩ	2W	4527	±0.5,1,2,5%
Metal Plate Resistive Element	3m~300mΩ	1.5W/1W/1W	2512	±0.5,1,2,5%
Mold Package	5m~100mΩ	1W/0.75W	2010	±1,5%

Current Sense Resistors

Current Ratings (A)

100 Current (A)

10

1

0.1

Resistance Range	Rated Power	Size (Inch)	Tolerance
10m~9.76Ω	1.5~2W/3W	1225	±1.5%
10m~9.76Ω	1W/2W	1020	±1.5%
10m~9.76Ω	0.75~1W/1.5W	0612	±1.5%
20m~9.76Ω	1W	0508	±0.5, 1.5%
10m~100mΩ	1W/1.5W	0612	±1%

Specifications

Resistance Range	Rated Power	Size (Inch)	Tolerance
10m~1Ω	0.5~1W	1206	±1%
10m~100mΩ	0.5W	0805	±1%
10m~100mΩ	1W	2512	±1%
10m~100mΩ	0.75W	2010	±1%
10m~100mΩ	0.5W	1206	±1%
10m~100mΩ	0.33W	0805	±1%
10m~100mΩ	0.25W	0603	±1%
24m~100mΩ	0.125W	0402	±1%

Resistance Range	Rated Power	Size (Inch)	Tolerance
39m~10Ω	1W/2W	2512	±1.2, 5%
33m~10Ω	0.75W	2010	±1.2, 5%
24m~10Ω	0.5~0.66W	1210	±1.2, 5%
30m~10Ω	0.33~0.5W	1206	±0.5, 1.2, 5%
30m~10Ω	0.33~0.5W	0805	±0.5, 1.2, 5%
100m~10Ω	0.2~0.25W	0603	±1.2, 5%
100m~10Ω	0.166W	0402	±1.2, 5%
180m~10Ω	0.1W	0201	±1.5%

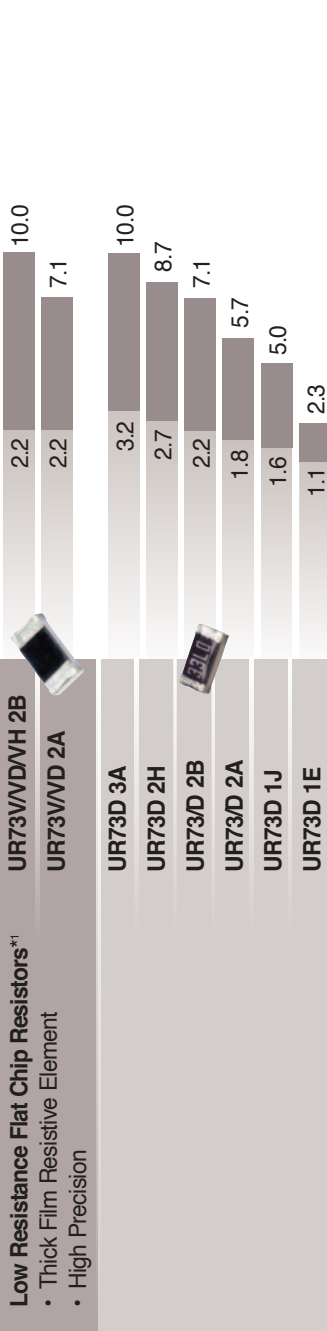

Resistance Range	Rated Current	Size (Inch)
Max. 0.5mΩ	44A	2512
Max. 0.2mΩ	50A	1206
Max. 0.2mΩ	31.6A	0805
Max. 0.2mΩ	26A	0603
Max. 0.5mΩ	10A	0402

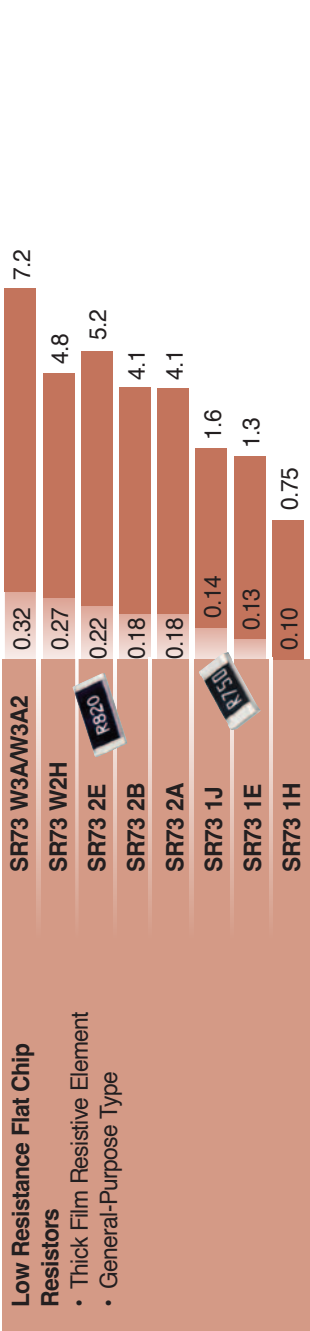

Resistance Range	Rated Current	Size (Inch)
Max. 0.5mΩ	44A	2512
Max. 0.2mΩ	50A	1206
Max. 0.2mΩ	31.6A	0805
Max. 0.2mΩ	26A	0603
Max. 0.5mΩ	10A	0402















This selection guide plots the current value calculated from (Power rating÷upper or lower limit of resistance). Please build the design considering heat dissipation.
 This is the guideline to select products by current value. Please confirm product specification for actual design and selecting products and use the products based on the precautions to use.
 Please confirm our catalog or delivery specification for the details of each product.

*1 UR73/UR73D is only applied for car accessories as automotive use. Please ask us for details.

AUTOMOTIVE APPLICATION RESISTORS



APPLICATION

General Purpose	High Precision	High Precision & High Reliability	Wide Terminal	Surge & Pulse	High Heat & Pulse	High Voltage & Voltage Sensing	Precharge & Discharge	Current Sensing & Low Resistance	Circuit Protection/Fuse	Thermal Sensing	Jumpers
RK73B/H* (incl. AT ver.) 	RK73G* 	RS73*, RN73H** RN73R** 	WK73R* 	SG73(S/P/G)* WG73 	HSG73P* 	HV73V* 	B_RV** HPC** & PCF** 	UR73V**, WK73S* WU73, TLR(H)** 	TF16VN 	SDT73V 	RK73Z* TLRZ** 
ICE - Power Unit - Engine ECU											
ICE - Power Unit - Exhaust Gas Sensor ECU											
ICE - Power Unit - Engine Ignition System											
ICE - Fuel Injection System											
EV - Power Control Unit											
EV - On-Board Charger											
EV - Battery Management System											
EV - In-Wheel Motor											
EV - Motor Drive Inverter											
EV - EPS											
EV - Electronic Parking Brake ECU											
EV - Charging Station											
Drive/Brake - Transmission ECU											
Drive/Brake - Braking ECU (ABS/ASC/ESC)											
Autonomous Driving - ECU											
Autonomous Driving - Radar											
Autonomous Driving - Sensing Camera											
Autonomous Driving - LiDAR											
Autonomous Driving - Sonar ECU											
Autonomous Driving - Driver Monitoring Sys.											













* Available in Anti-Sulfur Version
 ** Non-Sulfur Sensitive

ICE EV Drive/Brake Autonomous Driving

(Continued on other side >)



APPLICATION

General Purpose	High Precision	High Precision & High Reliability	Wide Terminal	Surge & Pulse	High Heat & Pulse	High Voltage & Voltage Sensing	Precharge & Discharge	Current Sensing & Low Resistance	Circuit Protection/Fuse	Thermal Sensing	Jumpers
RK73B/H* (incl. AT ver.) 	RK73G* 	RS73*, RN73H** RN73R** 	WK73R* 	SG73(S/P/G)* WG73 	HSG73P* 	HV73V* 	B_RV** HPC** & PCF** 	UR73V**, WK73S* WU73, TLR(H)** 	TF16VN 	SDT73V 	RK73Z* TLRZ** 
Body/Security - Integrated ECU											
Body/Security - Gateway ECU											
Body/Security - Lamp Module											
Body/Security - Door Control Module											
Body/Security - Airbag ECU											
Body/Security - Air Conditioning Controller											
Body/Security - Digital Mirror											
Body/Security - Air Conditioning Compressor											
Infotainment - Cockpit											
Infotainment - HUD ECU											
Infotainment - ITS Connect											

* Available in Anti-Sulfur Version

** Non-Sulfur Sensitive





Body/Security

Infotainment

PRECISION THICK & THIN FILM RESISTORS

PRECISION THICK & THIN FILM RESISTORS SELECTION GUIDE

PRODUCT SERIES

	RK73H 	RK73G 	RS73 	RN73R 	RN73H 
CHARACTERISTICS					
Technology	Thick Film	Thick Film	Thick Film	Thin Film	Thin Film
TCR (ppm/°C)	100-400	50	25-50	5-100	5-100
Tolerance	.5%-1%	.25%-1%	.1%-1%	0.05%-1%	0.05%-1%
Endurance Test Temp & Hrs.	70°C, 1,000h	70°C, 1,000h	85°C, 1,000h	85°C, 1,000h	85°C, 3,000h
Endurance Test Limit %*	2%-3%	2%-3%	.2%-4%	0.10%	0.10%
Endurance Test Typical %*	.75%-1%	.6%-1%	.05%-2%	0.04%	0.03%

* Size &/or value dependent

GOOD

BEST



KOA SPEER ELECTRONICS, INC.

POWER DENSITY/DOWNSIZING PRODUCT OPTIONS

Watt	2512	2010	1210	1206	0805	0603	0402	0201	01005
0.03									RK73B/H1F*
0.05								RK73B/H1H*	
0.1						RK73B/H1J*	RK73B/H1E*	SR731H	
0.125						RK73B/H1J*	SG73P/S1E*		
0.2							SG73P/S1E*		
0.25				RK73B/H2B*	RK73B/H2A*	SR731J*	SG73P1EW		
					SG73P/S2A*				
0.33				SG73P/S2B*	SR732A*	SG73P/S1J*	WK73R1E		
				SR732B*		WN73H1J †			
0.5								WK73R1J	
				RK73B/H2E*	SG73P/S2A*				
				SG73P/S2E*					
				SR732E*					
0.75				RK73B/H2H*	SG73P/S2E*	WK73R/S2B*	WK73R2A*		
				SR732H*		SG73P/S2B*			
1.0				RK73B/H3A*	WK73R/S2H*	WG732B	WK73R/S2A*		
				SR733A		WN73H2B			
						WU732B			
						WK73R/S2B*			
						UR73V (D/H) 2B**			
1.5				WK73R/S3A*	WG732H	WK73R/S2B15*			
						WU732B15			
2.0				RK73B/HW3A2*	WK73R/S2H2*				
				WG733A					
				WK73R/S3A*					
3.0				WK73R/S3A3*					

= Rated Terminal Temp. below 125°C

Rated Terminal Temp. is above 125°C unless otherwise noted

* Available in Anti-Sulfur Version ** Non-Sulfur Sensitive † = 0.3 Watt

For further information, please contact Engineering@koaspeer.com

199 Bolivar Drive • Bradford, PA 16701 • USA • 814-362-5536 • Fax: 814-362-8883 • www.koaspeer.com

KOA Speer Electronics, Inc.



At KOA, we know taking care of the environment is important. That is why we have taken the steps to ensure we offer a product that fits your needs while adhering to global environmental regulations. In 2006, we complied with the EU's RoHS Directive, allowing us to offer products that are RoHS compliant, and in 2007 we met guidelines outlined in the IT Products Pollution Control Act for the People's Republic of China. In addition, we are now enforcing stricter chemical regulations set by Europe through watching the chemical input of our products. Our laboratory is now ISO/IEC 17025 certified, and we are constantly working to think of ways to improve our technology, such as by offering halogen-free specifications. By actively addressing our environmental impact today, you can be certain KOA will be there in your future.

EU RoHS

The restriction of Hazardous Substances Directive (2002/95/EC), (RoHS), became effective on July 1 of 2006 requiring the usage of restriction of following six hazardous substances in the manufacture of electrical and electronic equipment placed on the market. This directive was amended on June 8 of 2011, to Recast Directive 2011/65/EU of the European Parliament and of the Council. The original directive was expired as of January 2, 2013 and replaced by a new directive (2011/65/EU) on the following day. Later, Annex II (Restricted Substances List) was amended by Commission Delegated Directive (2015/863/EU) and four phthalates were added to the restricted substances list. The followings are restricted substances and maximum concentration:

- Lead (0.1wt%)
- Mercury (0.1wt%)
- Cadmium (0.01wt%)
- Hexavalent Chromium (0.1wt%)
- Polybrominated biphenyls [PBBs] (0.1wt%)
- Polybrominated diphenyl ethers [PBDEs] (0.1wt%)
- Bis (2-ethylhexyl) phthalate [DEHP] (0.1wt%)
- Butyl benzyl phthalate [BBP] (0.1wt%)
- Dibutyl phthalate [DBP] (0.1wt%)
- Diisobutyl phthalate [DIBP] (0.1wt%)

* The percentage in parentheses show the maximum concentration value in the homogeneous material.

The restriction of applications in the annex in the directive is exempted.

KOA's products applicable with this exemption to EU RoHS2 are as follows (as of July 2022):

- Copper alloy containing up to 4% lead by weight 6(c).
- Electrical and electronic components containing lead in a glass or ceramic other than dielectric ceramic in capacitors, e.g. piezoelectronic devices, or in a glass or ceramic matrix compound 7(c)-I.

To meet EU RoHS2, you need to choose lead (Pb) free material for termination surface material when our product has both type designation, leaded and lead free. Please contact our sales representatives for details.

Revised Chinese RoHS

(Management Methods for the Restriction of the Use of Hazardous Substances in Electrical and Electronic Products)

China RoHS became effective in March 2007 and the Revised China RoHS was promulgated in January 2016 and became effective on July 1, 2016. The compliance management catalog (target products) and exemption list for the second step (inclusion restriction) were released in March 2018 and we must comply with requirements of the "evaluation system" from November 1, 2019.

For each product, we disclose the content information of the six hazardous substances directed by China RoHS. Please contact our sales representatives for details.

REACH

"Regulation concerning the Registration, Evaluation, Authorization and Restriction of Chemicals" (REACH) has been enforced on June 1 of 2007 in EU area.

This regulation is aiming at safety evaluation and risk management of chemical substances, which are required to register according to the amount if used in businesses. Substance of Very High Concern (SVHC) must be registered if it is included in article. The European Waste Framework Directive has also been revised. As a result, products placed on the EU market after January 2021 are required to register SCIP data if the concentration of SVHC exceeds 0.1wt% in order to also provide information on environmentally hazardous substances to waste disposal companies. Information communication on such substances is also required throughout the supply chain using information communication tools such as chemSHERPA.

Precautions

All product specifications and data are subject to change without prior notice. Be sure to request and confirm the latest technical specifications before you order or use a part.

Matters common to all products

General

- For precautions in general, refer to "JEITA RCR-1001C Safety application guide on components for using electronic and electrical equipment" issued by JEITA.
- While the information and figures on the durability performance of the products we provide are accurate and highly reliable, based on fixed test conditions, please conduct advance testing with your own products. If you are unable to determine the suitability for each application, please be sure to contact us beforehand.

Disclaimer

- These products have been designed and manufactured for general use and are not intended for use in the following applications or those involving equivalent risks. When considering use of these products for these applications, etc., please be sure to contact us in advance. In addition, regarding the conditions such as the scope of the warranty provided to our customers, without special agreement in writing, we bear no responsibility whatsoever for any complaints, damage, etc. regarding these products when used for these applications, etc.
 - Applications requiring high reliability (Ex.: gas/plumbing/electrical systems, etc., 24-hour continuous operation systems, settlement systems and other applications handling rights and assets, etc.)
 - Applications requiring a high degree of safety (Ex.: automobiles, aerospace facilities, railway facilities, medical devices, safety equipment, other applications which may involve risk to life or limb, etc.)
 - Applications in harsh environments (Ex.: equipment installed outdoors, equipment exposed to chemical pollution, equipment exposed to electromagnetic interference, equipment receiving vibration/impacts, etc.)
 - Applications under conditions and/or in environments not listed in the Catalogs.
- Consider sufficient fail-safe design if the products are used in applications requiring high reliability. Ensure safety of a whole system by setting proactive circuits and redundant circuits to avoid the single failure of the product leading to unsafety of the equipment.

Environment for Use

- Unless otherwise specified, these products are not to be used in special environments. Examine and confirm performance and reliability before you use KOA products in any of the following environments:
 - Under direct sunlight, exposed to the outside or to dust.
 - In liquids such as water, oil, organic solvent, or liquid chemicals or in areas where these liquids are used.
 - In locations where the products are exposed to salt-water breezes or corrosive gases, including SO₂, H₂S, Cl₂, NH₃, NO₂, etc.
 - In locations with high static electricity and strong electromagnetic waves.
 - In locations subject to condensation from dew.
 - When the products or PCBs are sealed and coated by resin or other coating materials.
 - In locations where the products are exposed to the fumes of lubricating oil.

Sulfuration

- Products with silver-based electrodes may increase in resistance in atmospheres containing sulfur gases (SO₂, H₂S, etc.) or when exposed to sulfide compounds. Take anti-sulfur measures in these environments.

Anti-pulse Characteristics

- If transient overloads such as power pulse or voltage/current surges are applied to KOA products, performance and reliability may be degraded. Contact KOA for data on antipulse characteristics and design help.
- Pay attention to discharges between terminations (arc-over) when high voltages are applied.

Storage

- Store KOA products in dust-free areas and keep them away from extreme temperatures; moisture; condensation; direct sunlight; salt-water breezes; corrosive gases such as SO₂, H₂S, Cl₂, NH₃, NO₂, etc.; or fumes from lubricating oil. Use desiccants if necessary.
- Please contact KOA for conditions and length of storage.

Storage of the Products with Lead-free Termination

- Solderability may degrade faster for products with Pb-free terminals than for products with Pb-bearing terminals.

Mounting

- Avoid physical damage or shock to the products, which may happen by holding them with hard tools like pliers or tweezers or by imperfect mounting-machine alignment. This damage may affect electrical characteristics or lead to disconnection or cracking.
- If the bottom point of the mounting nozzle is too low, a product could be pushed onto the PCB, which may deteriorate electrical characteristics or lead to cracking. Decelerate the nozzle just before mounting, and mount the product after correcting PCB deformations.
- Do not use products that have fallen during mounting or that have already been removed from a PCB.
- Contact KOA if PCBs are molded or sealed by coating material after component mounting.
- Do not stack PCBs after mounting, because this may damage the components.
- The electrical characteristics of film-type resistors and sensors may be changed by electrostatic overvoltage. Keep electrostatic discharge away from components when assembling and handling by monitoring machines and human contact.
- Prevent or eliminate the introduction of ionic substances like salt, salinity, or sweat, as these substances may degrade resistance due to moisture or corrosion.

Soldering

- Perform soldering within the temperature, time, and number of cycles specified for the product or its precautions. If a product is exposed to high temperatures for long periods of time, its color or electrical characteristics may change or disconnection may occur.
- Prevent any external force from being applied to the products until solder has cooled.
- Handle carefully to prevent mechanical stresses, such as from the bending or warping of a PCB, on the solder fillet.
- Confirm that solder flux residue does not affect the product.
- Confirm that components are in place when conductive adhesive is used in place of solder.

Precautions for Soldering with Lead-free Solder

- In Pb-free soldering, temperature may be higher than in the use of eutectic solder. Confirm that soldering is acceptable under actual conditions.
- Solder fillets may lift off double-sided boards with through holes. Confirm the solder strength on actual board material before assembly.

Washing

- Confirm that solder flux residue does not remain after washing, because it may cause deterioration of moisture and corrosion resistance.
- Confirm reliability in advance when using no-clean solder, water, or a soluble agent.
- Since Pb-free solder may contain many ionic materials, use RMA type solder or flux or wash sufficiently.
- Wash thoroughly after soldering to remove ionic substances like sweat and salinity. Control the washing agent appropriately to remove all ionic substances. Consult KOA when using a washing agent such as acid, alkaline, or organic solvent other than alcohol.
- Ultrasonic washing may damage products due to vibration resonance. High hydraulic pressure may also damage products. Ask KOA in advance for washing conditions.
- Dry products thoroughly after washing.

Dispose of the Products

- Observe appropriate laws and regulations for handling and disposal of products or packing materials.

The following precautions apply to surface mount devices

Precautions Related to PCB Bending Stress

- Arrange the long side of chip components parallel with the direction of the smaller coefficient of thermal expansion in anisotropic PCBs.
- Cracking of the solder fillet may occur with thermal cycling, because of mismatch of coefficients of thermal expansion between the board and the component. Pad size, amount of solder, and amount of heat radiating from the PCB must be designed carefully, especially with large components of 5 mm x 2.5 mm or larger.
- If products are mounted near a depaneling line, the termination or component may be damaged by large stresses during depaneling. Mount the products as shown in the following figure to minimize depaneling stress.

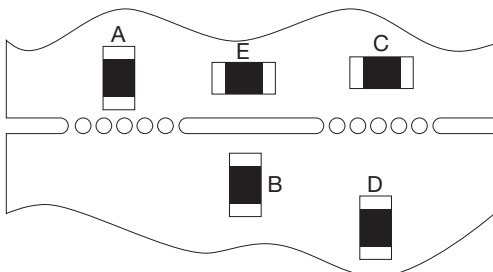

The level of stress on terminations $A > B \neq C > D > E$

- Use proper layouts to avoid stress from warping, bending, or deformation of the board in order to avoid solder cracking or component damage.

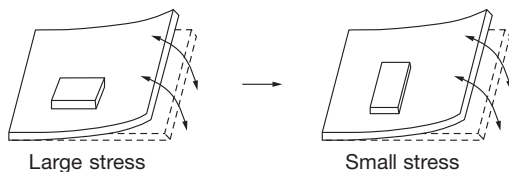

- Pay careful attention to products mounted near the edge of the board or near connectors, since stresses may happen during connection.
- Pay careful attention to layout when products are mounted near large components, when solder solidifies, it creates a stress in directions based on the large components, and cracking may occur.

- Design each land on right and left to have the same size. Different land size may change characteristics or cause cracks and tombstone effect while the solder is cooled down.

Mounting and Soldering

- Poor mounting machine adjustment may cause cracking, chipping, or alignment errors. Check and inspect the mounting machine in advance.
- Set backup pins in an appropriate layout to avoid damage to components mounted on the back of the board. Do not set these pins at nozzle positions.
- Adjust the bottom dead point of a dispenser away from the board when you apply adhesive to avoid damage to components mounted on the back of the board.
- Confirm that products solder properly if wave soldering is used.
- Pay close attention to amount of solder, since an improper amount may create a large stress on the component and cause cracking or malfunctions.

Soldering with a Soldering Iron

- Solder using a soldering iron at the temperature specified in the technical specifications or precautions for each product.
- Perform preheating as much as possible.
- Keep the tip of the soldering iron away from the body and the product terminal.
- Avoid physical damage or shock to components when using hard tools like pliers and tweezers.

The following precautions apply to lead type devices

Mechanical Stress

- Play close attention to vibration resonance after mounting.
- Do not add additional bending or twisting stresses to the product.
- Fix large components firmly.
- When lead wires are to be bent, use a large radius of curvature to avoid excessive stress on the terminal joint. Excessive stresses may cause the lead wire to separate from the electrode cap and damage the product.
- Do not add excessive stresses to the product body when lead wires are cut or held by the mounting machine.

Temperature Rise

- Pay close attention to heat radiation and interaction with other components, since large resistors general a large amount of heat when the rated power is applied.

Introduction of the Derating Curves Based on the Terminal Part Temperature

Background

Recently, the miniaturization, high power density and high temperature of the usage environment for the automotive devices have advanced. And requests for resistors to conform to the high temperature is increasing. Figure 1 is the derating curve based on the terminal part temperature and this is introduced to realize these requests for the surface mount resistors safely. Rated terminal part temperature is the maximum terminal part temperature of the surface mount resistor at which the rated power may be applied continuously including the temperature rise by self heat generation.

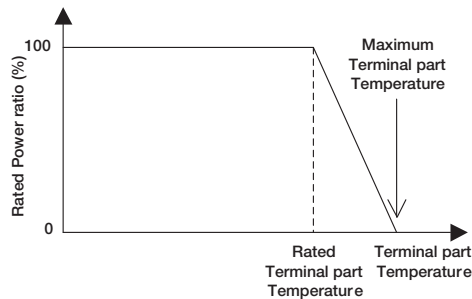

Figure 1. Derating curve based on the terminal part temperature

The derating curves based on the terminal part temperature is already used in the metal plate type ultra-low resistance value resistors for current sensing. It is because these resistors are used in sensing of large currents such as inverters and converters which the terminal part temperature rise irrelevantly from the ambient temperature because of the generated heat from the nearby switching elements or the large current applied to the copper pattern. This point of view was deployed to the general resistors as well.

Overview of the Establishment of the Derating Curves Based on Ambient Temperature

The traditional derating curve, which is based on ambient temperature, was defined by IEC and JIS during the vacuum tube era, long before the appearance of surface-mount resistors. At the time, there were no printed circuit boards, and cylindrical resistors with lead wires were held above the board by lug terminals, as shown in figure 2.

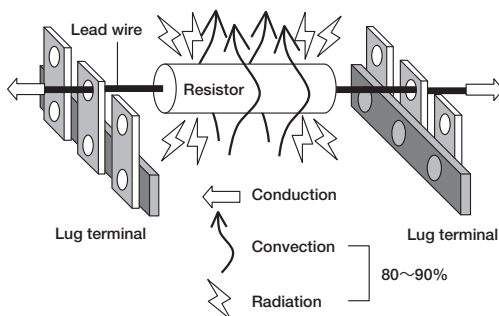

Figure 2. Heat dissipation of cylindrical resistors

The Joule heat that is generated in the resistor is dissipated in three pathways regardless of the shape of the resistor. The first path is conduction to the connected parts such as the terminal. The second path is convection including the heat transfer to the atmosphere by natural convection and air-flow. The third path is radiation by infrared.

The larger the area connected to the resistor becomes, the larger the heat conduction will be. And the larger the surface area of the resistor becomes, larger the convection and radiation will be.

When cylindrical resistors with lead wires are mounted on lug terminals, the lead wire is long and thin, so the thermal resistance to conduction is high, and

heat dissipation through that path is low. On the other hand, the dissipation of heat by convection and radiation is high, because the surface area of the resistor is large. Simulation shows that 80% to 90% of the heat from a cylindrical, lead-wire resistor is dissipated directly into the ambient air. The temperature of the resistor can be calculated by adding the temperature rise caused by self-heating to the ambient temperature. Because the ambient is sufficient to estimate the thermal resistance for most of the heat dissipation, the traditional derating curve was based on it.

Heat Dissipation of Surface Mount Resistors

Figure 3 shows the main heat dissipation paths for modern surface mount resistors. This type of resistor has only a small surface area, so convection and radiation have proportionally less heat dissipation. On the other hand, since the device is directly connected to the PCB pattern by a large part of the surface area, conduction will be the primary path for heat dissipation. In general, conduction through the terminal to the board represents over 90% of the heat dissipation, even when convection and radiation are presumed to be at their maximum levels. Therefore, the terminal temperature, on the main heat pathway, is the best location to monitor for controlling power dissipation.

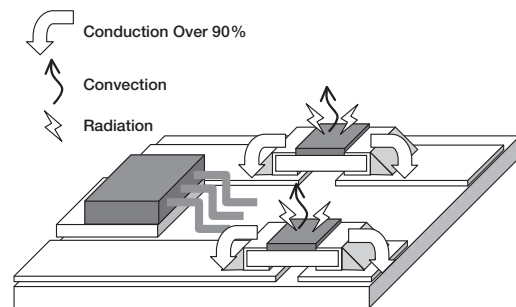

Figure 3. Heat dissipation of surface mount resistors

Derating Curve Suitable for the Surface Mount Resistor

As shown in figure 4, when a given amount of power is applied to the resistor, any given point on the resistor's surface will have the same temperature rise over the terminal temperature, regardless of ambient temperature. This is because there is very little heat dissipation from the resistor's surface to the ambient air.

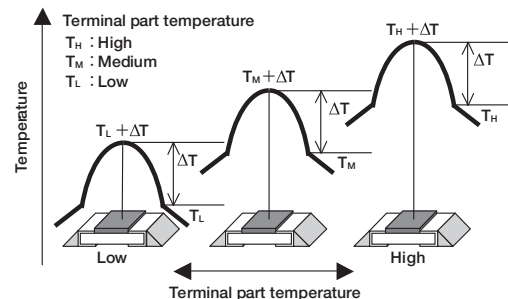

Figure 4. Contributing factor to the temperature of the surface mount resistor

However, surface temperatures at a given power will differ between different PCB designs, since the terminal temperature will be different. When resistors are mounted close to each other or other heat-generating devices, as shown in figure 5, there is a possibility that the temperature will be higher than the 70°C ambient temperature threshold used in the traditional JIS/IEC derating curve.

The traditional derating curve based on ambient temperature usually uses 70°C as the ambient temperature above which parts are to be derated. There will be no problem if resistors are used with sufficient electrical and thermal margin, but recent trends to miniaturization, high power density, and high-temperature use have reduced margins on design.

Redefining derating based on terminal temperature is a way to better represent the capabilities of the part. KOA will provide a derating curve suitable for surface mount resistors, based on testing under conditions where power rating is defined in terms of terminal temperature (as seen in terms & definitions).

Derating curves

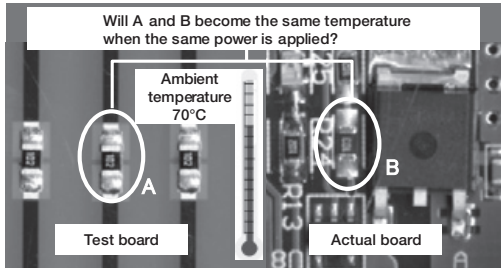

Figure 5. Temperature differs depending on the board

How to Use the Derating Curve Based on the Terminal Part Temperature

Here are some examples on using terminal temperature derating that lead to greater factors of safety, reduction in number of resistors, or use of a smaller component. The prior conditions will be the following (Be aware that the terminal part temperature does not always become 120°C when the ambient temperature is 100°C):

- (1) Ambient temperature of the board: 100°C
- (2) Terminal temperature of the surface mount resistor: 120°C
- (3) Actual power load: 0.05W

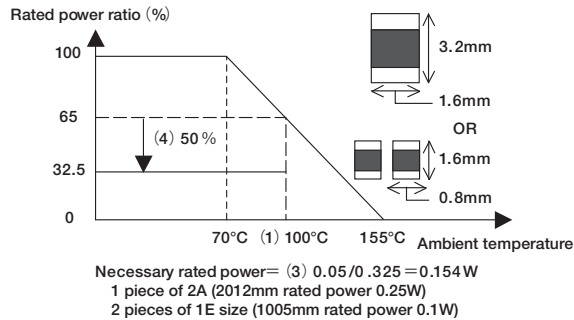

Figure 6. Selection by the traditional derating curve

- (4) Required margin of safety below rating according to designer's internal guidelines: 50%

The required power rating for the resistor using the ambient-temperature derating curve is calculated from conditions (1), (3), and (4). Figure 6 shows this result. For KOA's RK73B resistor series, one piece of 2A size, or two pieces of 1W size will be required.

However, when a resistor is selected using the terminal-temperature derating curve, which is better suited to surface-mount parts, conditions (2), (3), and (4) show that a single 1E (0402) size RK73B resistor would be sufficient.

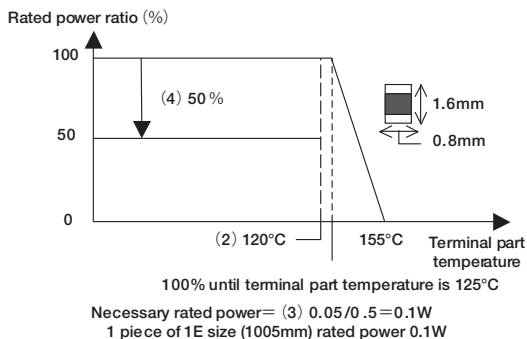

Figure 7. Selection using a terminal-temperature derating curve

As seen above, the number of resistors and the mounting area can be reasonably reduced by using the proper derating curve based on terminal temperature, and this will lead to cost savings.

Type	Power Rating	Rated Ambient Temp.	Rated Terminal Part Temp.
SG73S 2A	0.25W	70°C	125°C
SG73P 2A	0.5W	70°C	100°C

Table 1. Rating column of products with 2 rated power

Specifications given herein may be changed at any time without prior notice. Please confirm technical specifications before you order and/or use.

12/14/22

Derating curve suitable for the surface mount resistor

As shown in Table 1, for the surface mount resistors, there are products that have 2 rated powers for the same type in the rating column. The high rated power is basically available and applicable only to boards with adequate heat dissipation design for example multilayer boards, DCB (direct copper bonding) boards and single layer boards with wide heat dissipation area land. Therefore, the horizontal axis of the derating curve for high rated power is only defined with the terminal part temperature and please be careful that the conventional derating curve defined by the ambient temperature cannot be used in this case. For these products, "-" will be shown in the rated ambient temperature column which means "Not Applicable."

In addition, we implement load life tests for the products with high rated power by using a test board that can specially control the terminal part temperature. In the case of Table 1, there will be 3 derating curves as shown from Figure 8 to Figure 10.

How to use each derating curve is shown as the following.

When 0.25W is the rated power

When the terminal part temperature can be measured:

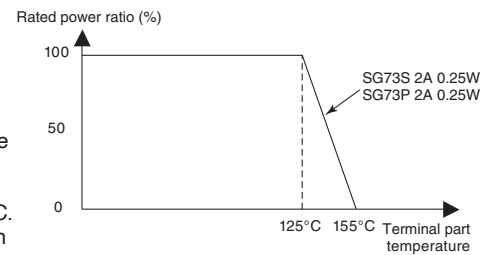

Figure 8. Derating curve of 0.25W rated power based on terminal part temperature

The derating curve in Figure 8 can be applicable and it can be used with rated power 0.25W up to terminal part temperature 125°C. The derating curve with the horizontal axis

based on the terminal part temperature supercedes the conventional derating curve with the horizontal axis based on the ambient temperature. Therefore, even when the ambient temperature exceeds 100°C, it can be used with rated power 0.25W as long as the terminal part temperature is below 125°C.

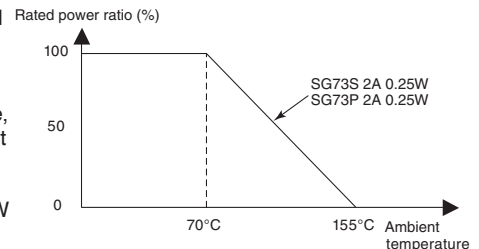

Figure 9. Derating curve of 0.25W rated power based on ambient temperature

When the terminal part temperature is not measured and only the ambient temperature is measured:

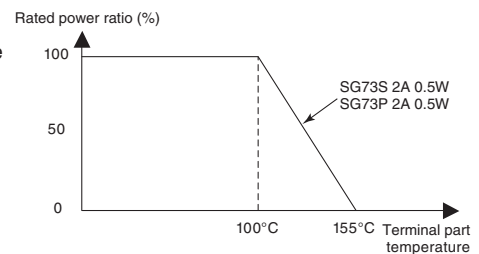

Figure 10. Derating curve of 0.5W rated power based on terminal part temperature

The product may be used by derating the load power from the ambient temperature 70°C according to the conventional derating curve shown in Figure 9. However, as

mentioned in the past descriptions, the temperature of the resistor differs according to the wiring patterns and heat generating components nearby, even when the ambient temperature is the same, so it is not a derating method with good precision.

When 0.5W is the rated power

Managing the terminal part temperature is the requirement to apply the rated power 0.5W. Only the derating curve with the horizontal axis based on the terminal part temperature as shown in Fig.10 can be used but it can assure up to the high power. The product can be used with 0.5W if the terminal part temperature is below 100°C.

Reference: IEC TR 63091:2017 "Study for the derating curve of surface mount fixed resistors-derating curves based on the thermal part temperature."

Precautions for the Resistors

Refer to the precautions of common matters for all products in the beginning of this catalog for the matters common to all products.

General in Fixed Resistors

- When the resistors are operated in ambient temperature above the rated temperature, the power rating must be derated according to the derating curve.
- Resistors in general may emit flame, fire or smoke when overload is applied.
- Flame retardant resistors may emit smoke or appear red hot when overload is applied but are unlikely to emit flame or fire.
- When the resistors are sealed and coated by coating materials such as resin, deterioration of the resistor by thermal stress or resin may affect the characteristics. Confirm with KOA for the performance and reliability specifications in advance.
When the resin absorbs moisture, the resistance to moisture and corrosion of the resistor may deteriorate, so be aware.
- When the resistor is coated, potted or molded by resin materials, the curing stress could cause peeling of protective coating and cracking of solder fillet, resulting in resistance change and disconnection. Do not coat nor seal the flame retardant coated resistors.
- Allow enough time for cooling after mounting metal film resistors, before washing off the flux. Residues of ionic substances may deteriorate resistances to moisture and corrosion.
- Cylindrical film resistors have inductance due to the spiral trimming. Please be aware when using in a high-frequency circuit.
- The flame retardant resistors are weak against mechanical stress compared with the general resistors due to the special coating. Please do not apply impact, vibration or pinching with pliers, tweezers to the resistor body. Do not apply any external force to the protective coating until drying is fully completed after washing.

Wirewound Type Resistors

- Wirewound type resistors have inductances and parasitic capacitances resulting from the winding structure. Therefore, they could resonate when used in a high frequency circuit.

Fusing Resistors

- Confirm beforehand that the overload condition of the abnormal situations are within the fusing characteristics.
- Contact KOA in advance when excess overload above the rated voltage is continuously applied, since there is a possibility of damage accumulated in the resistor.
- The arc phenomenon may occur when high voltage is applied again after fusing by over current. Make sure to use the product below the maximum open circuit voltage.
- Contact KOA about the maximum open circuit voltage, it varies depending on the product type and resistance.
- The fusing characteristics could change when the resistors are coated, potted and molded by resin materials.

Reference

- For the basic precautions of using resistors, refer to the technical report, "JEITA RCR-2121B Safety application guide for fixed resistors for use in electronic equipment", issued by JEITA.

Terms and Definitions

Nominal Resistance

- Designed resistance value usually indicated on the resistor.

Power Rating

- Maximum allowable power at rated temperature. Some of our chip resistor arrays and networks specify the power rating for the entire package, as opposed to each element.

Rated Ambient Temperature

- Maximum ambient temperature at which the power rating may be applied continuously. The rated ambient temperature refers to the temperature around the resistor mounted inside the equipment, not to the air temperature outside the equipment.

Rated Terminal Part Temperature

- Maximum terminal part temperature of the surface mount resistor at which the power rating may be applied continuously. Includes the temperature rise by self heat generation.

Derating Curve

- Curve that expresses the relation between ambient temperature or terminal part temperature and the maximum allowable power, which is generally expressed in percentage.

Rated Voltage

- Maximum allowable D.C. or A.C. voltage, to be continuously applied to a resistor or a resistor element.

$$\text{Rated Voltage (V)} = \sqrt{\text{Rated Power (W)} \times \text{Nominal Resistance Value (\Omega)}}$$

Rated voltage shall be the calculated value or max. working voltage, whichever is lower.

Critical Resistance

- The maximum nominal resistance value at which the rated power can be applied without exceeding the maximum working voltage. The rated voltage is equal to the max. working voltage at the critical resistance value.

Max. Working Voltage

- Maximum D.C. or A.C. voltage (rms) that can be continuously applied to the terminations of a resistor. However, the maximum value of the applicable voltage is the rated voltage at the critical resistance value or lower.

Maximum working voltage and rated voltage are calculated D.C. voltage based on rated power. Sine wave is assumed for the A.C. voltage so the peak voltage should be $\sqrt{2}$ times the maximum working voltage. When the wave form is not a sine wave, or when the resistance value exceeds the critical resistance, please contact us for the applicable peak voltage.

Overload Voltage

- Allowable voltage which is applied for 5 sec. according to the short time overload test. Overload voltage shall be 2.5 times of rated voltage or max. overload voltage, whichever is lower.

Maximum Overload Voltage

- Largest value of overload voltage

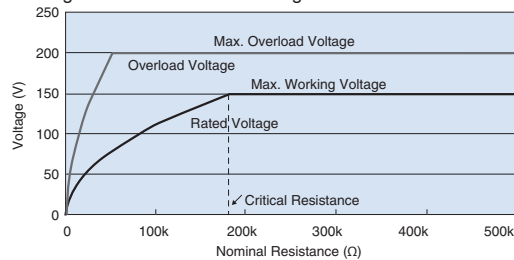

Example of Various Voltage of RK73G 2A

Dielectric Withstanding Voltage

- A.C. voltage (rms) that can be applied to a designated spot between the electrode and the outer coating for one minute according to the proof test.

Temperature Coefficient of Resistance (T.C.R.)

- Relative variation of resistance between two given temperatures when temperature is changed by 1K, which is calculated by the following formula.

$$\text{T.C.R. } (\times 10^{-6}/\text{K}) = \frac{R - R_0}{R_0} \times \frac{1 \times 10^6}{T - T_0}$$

R : Resistance value (Ω) at T

R₀ : Resistance value (Ω) at T₀

T : Measured test temperature (°C)

T₀ : Measured base temperature (°C)

applications and ratings

Part Designation	Power Rating	Rated Ambient Temp.	Rated Terminal Part Temp.	T.C.R. (x10 ⁻⁶ /K)	Resistance Range		Maximum Working Voltage	Maximum Overload Voltage	Operating Temperature Range		
					G±2% E-24	J±5% E-24					
RK73B1F (01005)	0.03W	70°C	125°C	±200	100kΩ - 1MΩ	100kΩ - 10MΩ	20V	30V	-55°C to +125°C		
					±250	10Ω - 91kΩ				10Ω - 91kΩ	
					0~+300	1Ω - 9.1Ω				1Ω - 9.1Ω	
RK73B1H (0201)	0.05W					±200	10Ω - 10MΩ	10Ω - 10MΩ		25V	50V
RK73B1E (0402)	0.1W					±400	—	1Ω - 9.1Ω			
RK73B1J (0603)	0.1W					±200	1Ω - 10MΩ	1Ω - 10MΩ		75V	100V
	0.125W					±400	—	11MΩ - 22MΩ			
RK73B2A (0805)	0.25W					±200	1Ω - 1kΩ	1Ω - 1kΩ		150V	200V
RK73B2B (1206)	0.25W					±200	1Ω - 1MΩ	1Ω - 1MΩ			
RK73B2E (1210)	0.50W					±200	1Ω - 5.6MΩ	1Ω - 5.6MΩ		200V	400V
						±400	6.2MΩ - 10MΩ	6.2MΩ - 22MΩ			
RK73BW2H/2H (2010)	0.75W					±200	10Ω - 5.6MΩ	1Ω - 5.6MΩ		200V	400V
RK73BW3A/3A (2512)	1.0W					±400	—	6.2MΩ - 22MΩ			
RK73BW3A2 (2512)	2.0W			95°C		±200	10Ω - 5.6MΩ	1Ω - 5.6MΩ		200V	400V
						±400	—	6.2MΩ - 22MΩ			

Rated voltage = $\sqrt{\text{Power rating} \times \text{resistance value}}$ or max. working voltage, whichever is lower

If any questions arise on whether to use the "Rated Ambient Temperature" or the "Rated Terminal Part Temperature" in your usage conditions, please give priority to the "Rated Terminal Part Temperature." Prior to use and for more details, refer to "Introduction of the derating curves based on the terminal part temperature" in the beginning of our catalog. Temperature rise at high power will depend on PCB layout. Be sure to contact factory prior to use and monitor terminal part temperature.

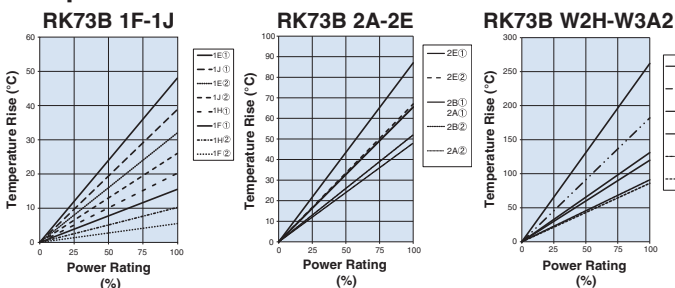
 environmental applications
 Temperature Rise

Regarding the temperature rise, the value of the temperature varies per conditions and board for use since the temperature is measured under our measuring conditions.

One-Pulse Limiting Electric Power

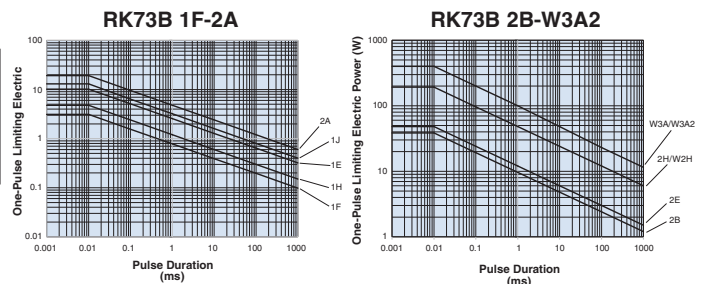

The maximum applicable voltage is equal to the max. overload voltage. Please ask us about the resistance characteristic of continuous applied pulse. The pulse endurance values are not assured values, so be sure to check the products on actual equipment when you use them.

Performance Characteristics

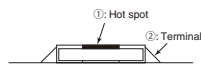

Parameter	Requirement Δ R (%+0.1Ω)		Test Method
	Limit	Typical	
Resistance	Within specified tolerance	—	25°C
T.C.R.	Within specified T.C.R.	—	+25°C/-55°C and +25°C/+125°C
Overload (Short time)	±2%	±1%: 1F ±0.5%: Others	Rated Voltage x 2.5 for 5 seconds (1E, 2B, W3A2: Rated Voltage x 2 for 5 seconds)
Resistance to Soldering Heat	±1%: 1F~W3A2 (10Ω≤R≤1MΩ) ±3%: 1F~W3A2 (R<10Ω, R>1MΩ)	±0.5%: 1F~W3A2 (10Ω≤R≤1MΩ); ±1%: 1F~W3A2 (R<10Ω, R>1MΩ)	260°C ± 5°C, 10 seconds ± 1 second
Rapid Change of Temperature	±1%: 1F, Characteristic (A) Heat Shock Resistance ±0.5%: Others	±0.5%: 1F, Characteristic (A) Heat Shock Resistance ±0.3%: Others	Characteristic (Nil) Standard: -55°C (30 minutes), +125°C (30 minutes), 100 cycles Characteristic (A) Heat Shock Resistance: -55°C (30 minutes), +125°C (30 minutes), 1000 cycles
Moisture Resistance	±2%: 1J, 2A, 2B ±3%: Others	±0.75%: 1J, 2A, 2B ±1.5%: 1F; ±1%: Others	40°C ± 2°C, 90%~95% RH, 1000 hours, 1.5 hr ON, 0.5 hr OFF cycle
Endurance at 70°C	±2%: 1J, 2A, 2B ±3%: Others	±0.75%: 1J, 2A, 2B ±1%: Others	70°C ± 2°C or rated terminal part temperature ± 2°C, 1000 hours, 1.5 hr ON, 0.5 hr OFF cycle
High Temperature Exposure	±1%	±0.5%: 1F ±0.3%: Others	+125°C, 1000 hours: 1F +155°C, 1000 hours: 1H, 1E, 1J, 2A, 2B, 2E, W2H, W3A, W3A2

Specifications given herein may be changed at any time without prior notice. Please confirm technical specifications before you order and/or use.

4/26/22



features

- Wide lineup from 01005 to 2512 size
- Excellent heat resistance and weather resistance are ensured by the use of metal glaze thick film
- Suitable for both flow and reflow solderings
- Products with lead-free terminations meet EU RoHS requirements. EU RoHS regulation is not intended for Pb-glass contained in electrode, resistor element and glass.
- AEC-Q200 Tested: 0201 (1H), 0402 (1E), 0603 (1J), 0805 (2A), 1206 (2B), 1210 (2E), 2010 (2H/W2H), 2512 (3A/W3A/W3A2)

dimensions and construction

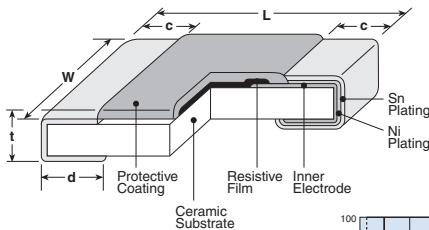

Derating Curve

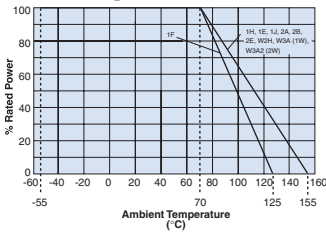

For resistors operated at an ambient temperature of 70°C or higher, the power shall be derated in accordance with the above derating curve.

When the terminal part temperature of the resistor exceeds the rated terminal part temperature shown above, the power shall be derated according to the derating curve. Please refer to "Introduction of the derating curves based on the terminal part temperature" on the beginning of our catalog before use

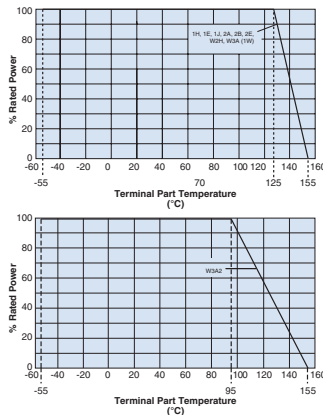

*Parentheses indicate EIA package size codes.

** RK73H 2H, 3A and 3A2 are also still available (different "d" dimensions = 0.4 +0.2/-0.1mm)

Type* (Inch Size Code)	Dimensions inches (mm)				
	L	W	c	d	t
1F (01005)	.016±.0008 (0.4±0.02)	.008±.0008 (0.2±0.02)	.004±.001 (0.1±0.03)	.004±.001 (0.11±0.03)	.005±.0008 (0.13±0.02)
1H (0201)	.024±.001 (0.6±0.03)	.012±.001 (0.3±0.03)	.004±.002 (0.1±0.05)	.006±.002 (0.15±0.05)	.009±.001 (0.23±0.03)
1E (0402)	.039 +.004 -.002 (1.0 +0.1 -0.05)	.02±.002 (0.5±0.05)	.008±.004 (0.2±0.1)	.01 +.002 -.004 (0.25 +0.05 -0.1)	.014±.002 (0.35±0.05)
1E AT (0402)			.01±.004 (0.25±0.1)	.012±.006 (0.3±0.15)	
1J (0603)	.063±.008 (1.6±0.2)	.031±.004 (0.8±0.1)	.012±.004 (0.3±0.1)	.012±.004 (0.3±0.1)	.018±.004 (0.45±0.1)
1J AT (0603)			.014±.006 (0.35±0.15)	.02±.008 (0.5±0.2)	
2A (0805)	.079±.008 (2.0±0.2)	.049±.004 (1.25±0.1)	.016±.008 (0.4±0.2)	.012 +.008 -.004 (0.3 +0.2 -0.1)	.02±.004 (0.5±0.1)
2A AT (0805)			.018±.010 (0.45±0.25)	.024±.008 (0.6±0.2)	.022±.004 (0.55±0.1)
2B (1206)	.126±.008 (3.2±0.2)	.063±.008 (1.6±0.2)	.02±.012 (0.5±0.3)	.016 +.008 -.004 (0.4 +0.2 -0.1)	.024±.004 (0.6±0.1)
2B AT (1206)			.022±.014 (0.55±0.35)	.031±.008 (0.8±0.2)	
2E (1210)		.102±.008 (2.6±0.2)		.016 +.008 -.004 (0.4 +0.2 -0.1)	.024±.004 (0.6±0.1)
2H (2010)	.197±.008 (5.0±0.2)	.098±.008 (2.5±0.2)			
W2H *1 (2010)			.02±.012 (0.5±0.3)	.026±.006 (0.65±0.15)	
3A *1 (2512)	.248±.008 (6.3±0.2)	.122±.008 (3.1±0.2)		.016 +.008 -.004 (0.4 +0.2 -0.1)	
W3A/W3A2 *1 (2512)				.026±.006 (0.65±0.15)	

ordering information

RK73H	2B		T	TD	1003	F
Type	Size	Characteristics	Termination Material	Packaging	Nominal Resistance	Tolerance
	1F, 1H 1E, 1J 2A, 2B 2E W2H W3A 2H, 3A W3A2	Nil: Standard A: Heat shock resistance *2	T: Sn G: Au *3 (L: Sn/Pb*4)	TX: 4mm width - 1mm pitch plastic embossed TBL - TCM: 2mm pitch press paper *5 TPL - TP: 2mm pitch punch paper TD: 4mm pitch punch paper TE: 4mm pitch plastic embossed Other non-standard reel sizes available, contact factory for other options	3 significant figures + 1 multiplier "R" indicates decimal on value <100Ω	D: ±0.5% F: ±1%
		*2 With type A only T is available as the terminal surface material			The terminal surface material lead free is standard.	
		*3 Products with gold plated electrodes are also available with 1E, 1J and 2A types (10Ω~1MΩ), so please consult with us			For further information on packaging, please refer to Appendix A	
		*4 With type 1F, 1H, W2H, W3A, W3A2 only T is available as the terminal surface material				
		*5 Standard taping specification of 1H is TCM. Previously available "TC(10,000pcs/Reel)" is not recommended for new designs.				

Specifications given herein may be changed at any time without prior notice. Please confirm technical specifications before you order and/or use.

11/03/23

applications and ratings

Part Designation	Power Rating	Rated Ambient Temp.	Rated Terminal Part Temp.	T.C.R. (x10 ⁻⁶ /K)	Resistance Range		Maximum Working Voltage	Maximum Overload Voltage	Operating Temperature Range	
					D±0.5% E-24, E-96	F±1% E-24, E-96*				
RK73H1F (01005)	0.03W	70°C	125°C	±200	—	100kΩ - 2MΩ*	20V	30V	-55°C to +125°C	
					—	10Ω - 91kΩ*				
RK73H1H (0201)	0.05W				±200	10Ω - 1MΩ	10Ω - 10MΩ*	25V		50V
					±400	—	1.0Ω - 9.1Ω*			
RK73H1E (0402)	0.1W				±100	10Ω - 1MΩ	10Ω - 1MΩ	75V		100V
					±200	—	1.0Ω - 9.76Ω, 1.02MΩ - 10MΩ			
RK73H1J (0603)	0.1W				±100	1.02kΩ - 1MΩ	1.02kΩ - 1MΩ	75V		100V
					±200	—	1.02MΩ - 10MΩ			
	0.125W				±100	10Ω - 1kΩ	10Ω - 1kΩ	150V		200V
					±200	—	1.0Ω - 9.76Ω			
RK73H2A (0805)	0.25W				±100	10Ω - 1MΩ	10Ω - 1MΩ	200V		400V
					±200	—	1.0Ω - 9.76Ω			
RK73H2B (1206)	0.25W	±100	10Ω - 1MΩ	10Ω - 1MΩ	200V	400V				
		±200	—	1.0Ω - 9.76Ω, 1.02MΩ - 5.6MΩ						
RK73H2E (1210)	0.5W	±100	10Ω - 1MΩ	10Ω - 1MΩ	200V	400V				
		±200	—	1.0Ω - 9.76Ω, 1.02MΩ - 5.6MΩ						
RK73HW2H/2H (2010)	0.75W	±100	10Ω - 1MΩ	10Ω - 1MΩ	200V	400V				
		±200	—	1.0Ω - 9.76Ω, 1.02MΩ - 5.6MΩ						
RK73HW3A/3A (2512)	1.0W	±100	10Ω - 1MΩ	10Ω - 1MΩ	200V	400V				
		±200	—	1.0Ω - 9.76Ω, 1.02MΩ - 5.6MΩ						
RK73HW3A2 (2512)	2.0W	95°C	125°C	±100	10Ω - 1MΩ	10Ω - 1MΩ	200V	400V		
					±200	—			1.0Ω - 9.76Ω, 1.02MΩ - 5.6MΩ	
±400	—				5.62MΩ - 10MΩ					
±100	10Ω - 1MΩ				10Ω - 1MΩ	200V	400V			
±200	—				1.0Ω - 9.76Ω, 1.02MΩ - 5.6MΩ					
±400	—				5.62MΩ - 10MΩ					

 Rated voltage = $\sqrt{\text{Power rating} \times \text{resistance value}}$ or max. working voltage, whichever is lower

 *The nominal resistance value for RK73H1F ($10\Omega \leq R \leq 2M\Omega$) and RK73H1H ($1\Omega \leq R \leq 9.1\Omega$, $1M\Omega \leq R \leq 10M\Omega$) is E24.

If any questions arise whether to use the "Rated Ambient Temperature" or the "Rated Terminal Part Temperature," please give priority to the "Rated Terminal Part Temperature."

Prior to use and for more details refer to "Introduction of the derating curves based on the terminal part temperature" in the beginning of the catalog.

While using under high power, the temperature of the product may increase depending on the condition of heat dissipation from PCB.

Be sure to check the terminal part temperature as well as precautions to use on delivery specification before use.

environmental applications

Temperature Rise

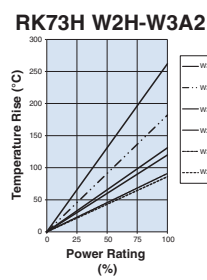
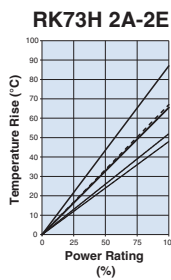
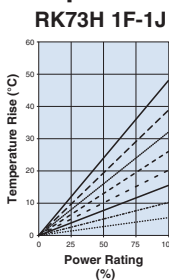

One-Pulse Limiting Electric Power

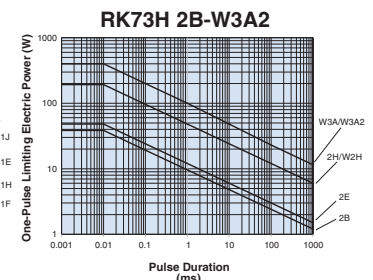
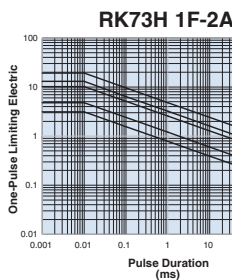

Regarding the temperature rise, the value of the temperature varies per conditions and board for use since the temperature is measured under our measuring conditions.

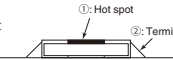
 Measurement condition
 Room temperature: 25°C
 PCB: FR-4t = 1.6mm
 Cu foil thickness: 35μm

The maximum applicable voltage is equal to the max. overload voltage. Please ask us about the resistance characteristic of continuous applied pulse. The pulse endurance values are not assured values, so be sure to check the products on actual equipment when you use them.

Performance Characteristics

Parameter	Requirement ΔR (%±0.1Ω)		Test Method
	Limit	Typical	
Resistance	Within specified tolerance	—	25°C
T.C.R.	Within specified T.C.R.	—	+25°C/-55°C and +25°C/+125°C
Overload (Short time)	±2%	±1%: 1F; ±0.5%: Others	Rated Voltage x 2.5 for 5 seconds (1E, 2B, W3A2: Rated Voltage x 2 for 5 seconds)
Resistance to Soldering Heat	±1%: 1F ~ W3A2 (10Ω ≤ R ≤ 1MΩ); ±3%: 1H ~ W3A2 (R < 10Ω, R > 1MΩ)	±0.5%: 1F ~ W3A2 (10Ω < R < 1MΩ); ±1%: 1H ~ W3A2 (R < 10Ω, R > 1MΩ)	260°C ± 5°C, 10 seconds ± 1 second
Rapid Change of Temperature	±1%: 1F, Characteristic (A) Heat Shock Resistance ±0.5% Others	±0.5%: 1F, Characteristic (A) Heat Shock Resistance ±0.3% Others	Characteristic (Nil) Standard: -55°C (30 minutes), +125°C (30 minutes), 100 cycles Characteristic (A) Heat Shock Resistance: -55°C (30 minutes), +125°C (30 minutes), 1000 cycles
Moisture Resistance	±2%: 1J, 2A, 2B ±3%: Others	±0.75%: 1J, 2A, 2B; ±1.5%: 1F, ±1%: Other	40°C ± 2°C, 90%-95% RH, 1000 hours, 1.5 hr ON, 0.5 hr OFF cycle
Endurance at 70°C	±2%: 1J, 2A, 2B; ±3%: Others	±0.75%: 1J, 2A, 2B; ±1%: Others	70°C ± 2°C, 1000 hours, 1.5 hr ON, 0.5 hr OFF cycle
High Temperature Exposure	±1%	±0.5%: 1F ±0.3%: Others	+125°C, 1000 hours: 1F; +155°C, 1000 hours: 1E, 1H, 1J, 2A, 2B, 2E, 2H/W2H, 3A/W3A/W3A2

Specifications given herein may be changed at any time without prior notice. Please confirm technical specifications before you order and/or use.

2/06/24

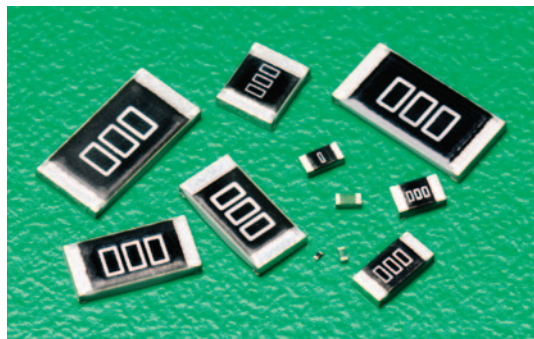

features

- Wide lineup from 01005 to 2512 size
- Excellent heat resistance and weather resistance, because of the use of glaze thick film as resistive film
- Suitable for both flow and reflow solderings
- Products with lead-free terminations meet EU RoHS requirements. EU RoHS regulation is not intended for Pb-glass contained in electrode, resistor element and glass.
- AEC-Q200 Tested: 0201(1H), 0402(1E), 0603(1J), 0805(2A), 1206(2B), 1210(2E), 2010(2H/W2H), 2512(3A/W3A)

dimensions and construction

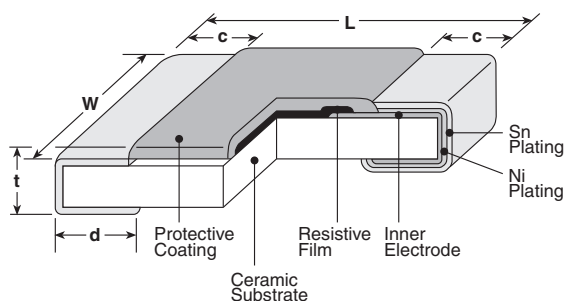

Derating Curve

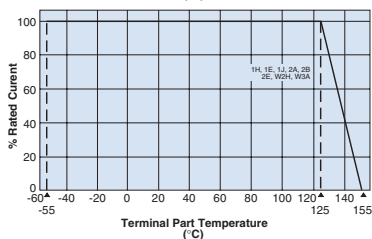
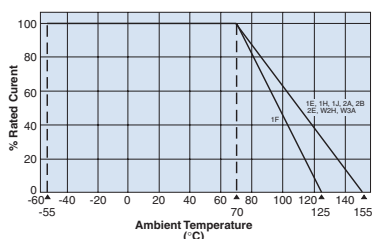

Type (Inch Size Code)	Dimensions inches (mm)				
	L	W	c	d	t
1F (01005)	.016±.0008 (0.4±0.02)	.008±.0008 (0.2±0.02)	.004±.001 (0.10±0.03)	.004±.001 (0.11±0.03)	.005±.0008 (0.13±0.02)
1H (0201)	.024±.001 (0.6±0.03)	.012±.001 (0.3±0.03)	.004±.002 (0.1±0.05)	.006±.002 (0.15±0.05)	.009±.001 (0.23±0.03)
1E (0402)	.039 ^{+0.004} _{-.002} (1.0 ^{+0.1} _{-.05})	.02±.002 (0.5±0.05)	.008±.004 (0.2±0.1)	.01 ^{+0.002} _{-.004} (0.25 ^{+0.05} _{-.01})	.014±.002 (0.35±0.05)
1E AT (0402)			.01±.004 (0.25±0.1)	.012±.006 (0.3±0.15)	
1J (0603)	.063±.008 (1.6±0.2)	.031±.004 (0.8±0.1)	.012±.004 (0.3±0.1)	.012±.004 (0.3±0.1)	.018±.004 (0.45±0.1)
1J AT (0603)			.014±.006 (0.35±0.15)	.02±.008 (0.5±0.2)	
2A (0805)	.079±.008 (2.0±0.2)	.049±.004 (1.25±0.1)	.016±.008 (0.4±0.2)	.012 ^{+0.008} _{-.004} (0.3 ^{+0.2} _{-.01})	.02±.004 (0.5±0.1)
2A AT (0805)			.018±.010 (0.45±0.25)	.024±.008 (0.6±0.2)	
2B (1206)	.126±.008 (3.2±0.2)	.063±.008 (1.6±0.2)	.02±.012 (0.5±0.3)	.016 ^{+0.008} _{-.004} (0.4 ^{+0.2} _{-.01})	.024±.004 (0.6±0.1)
2B AT (1206)			.022±.014 (0.55±0.35)	.031±.008 (0.8±0.2)	
2E (1210)	.197±.008 (5.0±0.2)	.098±.008 (2.5±0.2)	.102±.008 (2.6±0.2)	.026±.006 (0.65±0.15)	
2H (2010)				.02±.012 (0.5±0.3)	
W2H ¹ (2010)	.248±.008 (6.3±0.2)	.122±.008 (3.1±0.2)	.026±.006 (0.65±0.15)		.026±.006 (0.65±0.15)
3A (2512)				.016 ^{+0.008} _{-.004} (0.4 ^{+0.2} _{-.01})	
W3A ¹ (2512)	.026±.006 (0.65±0.15)				

¹ RK73Z 2H and RK73Z 3A are also still available (different "d" dimensions = 0.4 +0.2/-0.1mm)

ordering information

RK73Z	2B		T	TD
Type	Size	Characteristics	Termination Material	Packaging
	1F 2E 1H W2H 1E W3A 1J 2H 2A 3A 2B	Nil: Standard A: Heat shock resistance *2	T: Sn G: Au *3 (L:Sn/Pb *4)	TX: 4mm width - 1mm pitch plastic embossed TBL - TCM: 2mm pitch press paper *5 TPL - TP: 2mm pitch punch paper TD: 4mm pitch punch paper TE: 4mm pitch plastic embossed Other non-standard reel sizes available, contact factory for other options

*2 With type A only T is available as the terminal surface material.

*3 Products with gold plated electrodes are also available with 1E, 1J and 2A types (10Ω~1MΩ), so please consult with us.

*4 With type 1F, 1H, W2H, W3A, W3A2 only T is available as the terminal surface material.

For further information on packaging, please refer to Appendix A

*5 Standard taping specification of 1H is TCM. Previously available "TC (10,000pcs/Reel)" is not recommended for new designs

applications and ratings

Part Designation	Rated Ambient Temperature	Rated Terminal Part Temperature	Maximum Continuous Current @ 70°C	Maximum Overload Current @ 70°C (for < 1 second)	Maximum Resistance	Operating Temperature Range
RK73Z1F	70°C	—	0.5 Amps	1.0 Amp Max.	50mΩ	-55°C to +125°C
RK73Z1H		125°C	0.5 Amps	1.0 Amp Max.		-55°C to +155°C
RK73Z1E RK73Z1J			1.0 Amps	2 Amp Max.		
RK73Z2A			2.0 Amps	5 Amp Max.		
RK73Z2B RK73Z2E RK73Z2H/W2H RK73Z3A/W3A			2.0 Amps	10 Amp Max.		

environmental applications

One-Pulse Limiting Electric Power

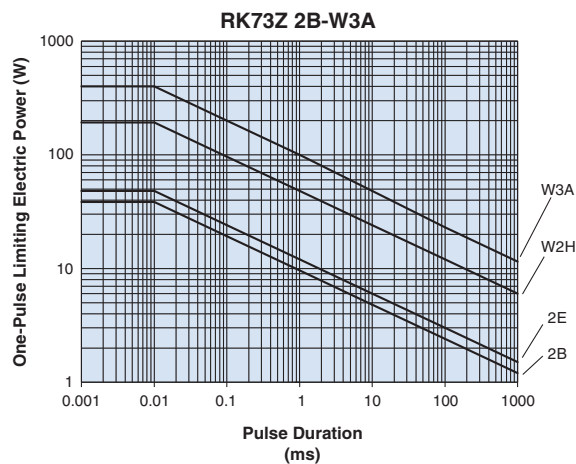
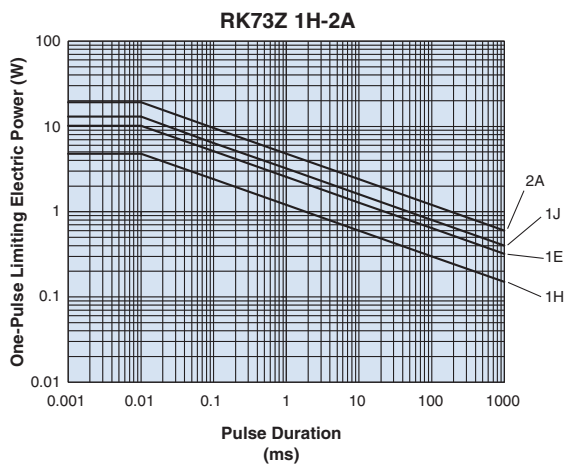

Please ask us about the resistance characteristic of continuous applied pulse.
 Please calculate One-Pulse Limiting Electric Power using upper limit of resistance (50mΩ or 100mΩ) for applied current.
 The pulse endurance values are not assured values, so be sure to check the products on actual equipment when you use them.

Performance Characteristics

Parameter	Requirement		Test Method
	Limit	Typical	
Resistance	50mΩ Max. after the test	15mΩ Max. after the test	25°C
Overload (Short time)	50mΩ Max. after the test	18mΩ Max. after the test	Maximum overload current for 5 seconds , 1 cycle
Resistance to Solder Heat	50mΩ Max. after the test	15mΩ Max. after the test	260°C ± 5°C, 10 seconds ± 1 second
Rapid Change of Temperature	50mΩ Max. after the test	15mΩ Max. after the test	Characteristic (Nil) Standard: -55°C (30 minutes), +125°C (30 minutes), 100 cycles Characteristic (A) Heat Shock Resistance: -55°C (30 minutes), +125°C (30 minutes), 1000 cycles
Moisture Resistance	100mΩ Max. after the test	18mΩ Max. after the test	40°C ± 2°C, 90%-95% RH, 1000 hours, 1.5 hr ON, 0.5 hr OFF cycle
Endurance at 70°C	100mΩ Max. after the test	18mΩ Max. after the test	70°C ± 2°C, 1000 hours, 1.5 hr ON, 0.5 hr OFF cycle
High Temperature Exposure	100mΩ Max. after the test	15mΩ Max. after the test	+125°C, 1000 hours: 1F +155°C, 1000 hours: 1H, 1E, 1J, 2A, 2B, 2E, W2H/2H, W3A/3A

Specifications given herein may be changed at any time without prior notice. Please confirm technical specifications before you order and/or use.

4/26/22

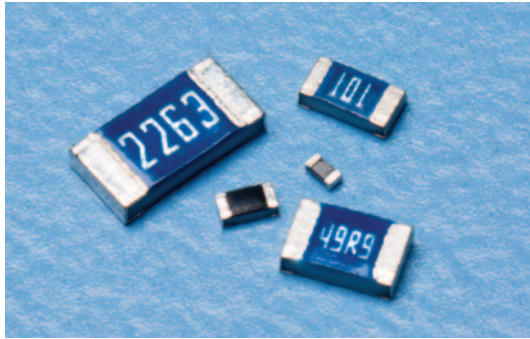

features

- Metal-glaze thick film resistor for surface mounting
- High precision resistor with T.C.R. of ± 50 ppm/°C and tolerance of $\pm 0.25\%$, $\pm 0.5\%$ or $\pm 1\%$
- Suitable for both flow and reflow solderings
- Products with lead-free terminations meet EU RoHS requirements. EU RoHS regulation is not intended for Pb-glass contained in electrode, resistor element and glass.
- AEC-Q200 Tested

dimensions and construction

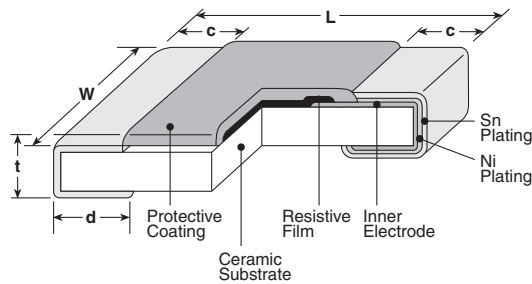

Type (Inch Size Code)	Dimensions inches (mm)				
	L	W	c	d	t
1H (0201)	.024±.001 (0.6±0.03)	.012±.001 (0.3±0.03)	.004±.002 (0.1±0.05)	.006±.002 (0.15±0.05)	.009±.001 (0.23±0.03)
1E (0402)	.039 ^{+0.004} _{-.002} (1.0 ^{+0.1} _{-0.05})	.02±.002 (0.5±0.05)	.008±.004 (0.2±0.1)	.01 ^{+0.002} _{-.004} (0.25 ^{+0.05} _{-0.1})	.014±.002 (0.35±0.05)
1E AT (0402)			.01±.004 (0.25±0.1)	.012±.006 (0.3±0.15)	
1J (0603)	.063±.008 (1.6±0.2)	.031±.004 (0.8±0.1)	.012±.004 (0.3±0.1)	.012±.004 (0.3±0.1)	.018±.004 (0.45±0.1)
1J AT (0603)			.014±.006 (0.35±0.15)	.02±.008 (0.5±0.2)	
2A (0805)	.079±.008 (2.0±0.2)	.049±.004 (1.25±0.1)	.016±.008 (0.4±0.2)	.012 ^{+0.008} _{-.004} (0.3 ^{+0.2} _{-0.1})	.02±.004 (0.5±0.1)
2A AT (0805)			.018±.010 (0.45±0.25)	.024±.008 (0.6±0.2)	
2B (1206)	.126±.008 (3.2±0.2)	.063±.008 (1.6±0.2)	.02±.012 (0.5±0.3)	.016 ^{+0.008} _{-.004} (0.4 ^{+0.2} _{-0.1})	.024±.004 (0.6±0.1)
2B AT (1206)			.022±.014 (0.55±0.35)	.031±.008 (0.8±0.2)	

Derating Curve

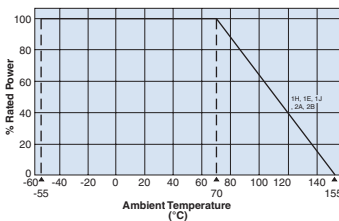

For resistors operated at an ambient temperature of 70°C or above, a power rating shall be derated in accordance with the above derating curve.

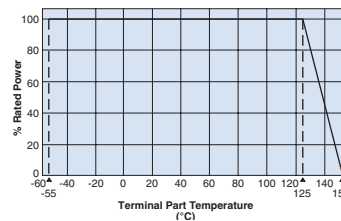

For resistors operated at a terminal part temperature of described for each size or above, a power rating shall be derated in accordance with the above derating curve. Please refer to "Introduction of the derating curve based on the terminal part temperature" in the beginning of our catalog before use.

ordering information

RK73G	1J		T	TD	1003	F
Type	Size	Characteristic	Termination Material	Packaging	Nominal Resistance	Tolerance
	1H 1E 1J 2A 2B	Nil: Standard A: Heat shock resistance *1	T: Sn (L:Sn/Pb*2)	TCM: 2mm pitch press paper *3 TPL - TP: 2mm pitch punch paper TD: 4mm pitch punch paper TE: 4mm pitch plastic embossed	3 significant figures + 1 multiplier "R" indicates decimal on value <100Ω	C: $\pm 0.25\%$ D: $\pm 0.5\%$ F: $\pm 1\%$

*1 With type A, only T is available as the terminal surface material.
*2 With type 1H, only T is available as the terminal surface material.
The terminal surface material lead free is standard.
For further information on packaging, please refer to Appendix A

*3 Standard taping specification of 1H is TCM. Previously available "TC (10,000pcs/Reel)" is not recommended for new designs

applications and ratings

Part Designation*	Power Rating	Rated Ambient Temp.	Rated Terminal Part Temp.	T.C.R. (ppm/°C) Max.	Resistance Range			Absolute Maximum Working Voltage	Absolute Maximum Overload Voltage		
					New E-24, E-96 (C±0.25%)	E-24, E-96 (D±0.5%)	E-24, E-96 (F±1%)				
RK73G1H (0201)	.05W	70°C	125°C	±50	—	100Ω - 1MΩ**	100Ω - 1MΩ**	25V	50V		
RK73G1E (0402)	.10W									50V	100V
RK73G1J (0603)	.10W									75V	150V
RK73G2A (0805)	.125W							100Ω - 1MΩ	10Ω - 1MΩ	150V	200V
RK73G2B (1206)	.25W									200V	400V

Operating Temperature Range: -55°C ~ +155°C

* Parentheses indicate EIA package size codes. ** RK73G1H available in E-24 decade values only

environmental applications

Temperature Rise

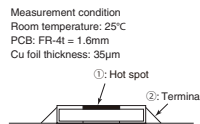
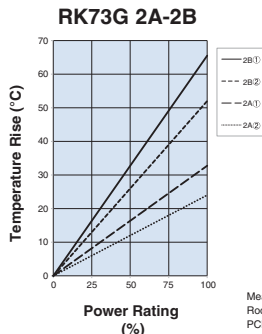
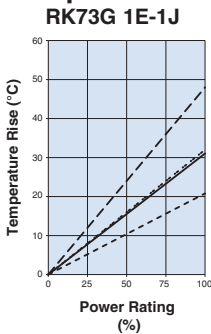

Regarding the temperature rise, the value of the temperature varies per conditions and board for use since the temperature is measured under our measuring conditions.

One-Pulse Limiting Electric Power

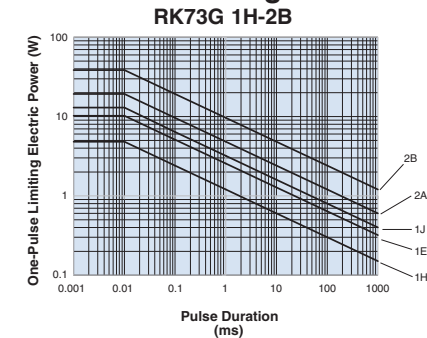

The maximum applicable voltage is equal to the max. overload voltage. Please ask us about the resistance characteristic of continuous applied pulse. The pulse endurance values are not assured values, so be sure to check the products on actual equipment when you use them.

Performance Characteristics

Parameter	Requirement $\Delta R \pm(\%+0.1\Omega)$		Test Method
	Limit	Typical	
Resistance	Within specified tolerance	—	25°C
T.C.R.	Within specified T.C.R.	—	1H: +25°C/+125°C, 1E, 1J, 2A, 2B: +25°C/-55°C and +25°C/+125°C
Overload (Short time)	±2%	±0.6%	Rated Voltage x 2.5 for 5 seconds (1E, 2B: Rated Voltage x 2 for 5 seconds)
Resistance to Solder Heat	±1%	±1%: 1H, ±0.4%: 1E, 1J, 2A, 2B	260°C ± 5°C, 10 seconds ± 1 second
Rapid Change of Temperature	±0.5%: Characteristic (Nil) Standard 1%: Characteristic (A) Heat Shock Resistance	±0.3%: Characteristic (Nil) Standard 0.5%: Characteristic (A) Heat Shock Resistance	Characteristic (Nil) Standard -55°C (30 minutes), +125°C (30 minutes), 100 cycles Characteristic (A) Heat Shock Resistance -55°C (30 minutes), +125°C (30 minutes), 1000 cycles
Moisture Resistance	±2%: 1J, 2A, 2B ±3%: 1H, 1E	±0.6%: 1J, 2A, 2B; ±1%: 1H, 1E	40°C ± 2°C, 90%-95% RH, 1000 hours, 1.5 hr ON, 0.5 hr OFF cycle
Endurance at 70°C	±2%: 1J, 2A, 2B ±3%: 1H, 1E	±0.6%: 1J, 2A, 2B; ±1%: 1H, 1E	70°C ± 2°C, 1000 hours, 1.5 hr ON, 0.5 hr OFF cycle
High Temperature Exposure	±1%	±0.6%	+155°C, 1000 hours

For Surface Temperature Rise Graph see Environmental Applications. Additional environmental applications can also be found at www.koaspeer.com

Specifications given herein may be changed at any time without prior notice. Please confirm technical specifications before you order and/or use.

11/17/23

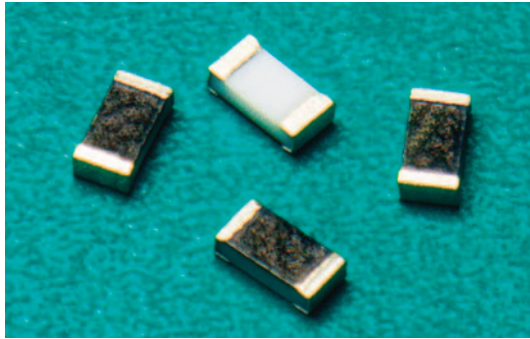

features

- Metal-glaze thick film resistor for surface mounting
- High precision resistor with T.C.R. $\pm 25 \times 10^{-6}/K$ and tolerance $\pm 0.1\%$
- High reliability with ΔR of $\pm 0.2\%$ and $\pm 0.5\%$ in the reliability test
- Suitable for both flow and reflow solderings
- Products with lead-free terminations meet EU RoHS requirements. EU RoHS regulation is not intended for Pb-glass contained in electrode, resistor element and glass.
- AEC-Q200 Tested

dimensions and construction

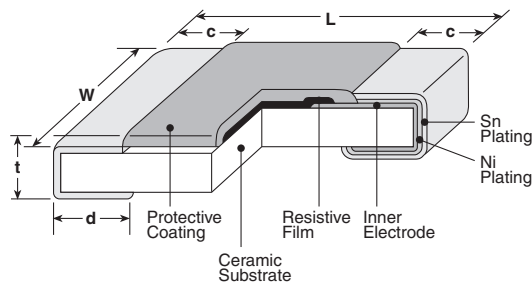

Type (Inch Size Code)	Dimensions inches (mm)				
	L	W	c	d	t
1E (0402)	.039 ^{+0.004} / _{-0.002} (1.0 ^{+0.1} / _{-0.05})	.020 \pm .002 (0.5 \pm 0.05)	.008 \pm .004 (0.2 \pm 0.1)	.010 ^{+0.002} / _{-0.05} (0.25 ^{+0.2} / _{-0.1})	.014 \pm .002 (0.35 \pm 0.05)
1J (0603)	.063 \pm .008 (1.6 \pm 0.2)	.031 \pm .004 (0.8 \pm 0.1)	.008 \pm .004 (0.2 \pm 0.1)	.012 \pm .004 (0.3 \pm 0.1)	.018 \pm .004 (0.45 \pm 0.1)
2A (0805)	.079 \pm .008 (2.0 \pm 0.2)	.049 \pm .004 (1.25 \pm 0.1)	.010 \pm .006 (0.25 \pm 0.15)	.012 ^{+0.008} / _{-0.04} (0.3 ^{+0.2} / _{-0.1})	.020 \pm .004 (0.5 \pm 0.1)
2B (1206)	.126 \pm .008 (3.2 \pm 0.2)	.063 \pm .008 (1.6 \pm 0.2)	.014 \pm .006 (0.35 \pm 0.15)	.016 ^{+0.008} / _{-0.04} (0.4 ^{+0.2} / _{-0.1})	.024 \pm .004 (0.6 \pm 0.1)

Derating Curve

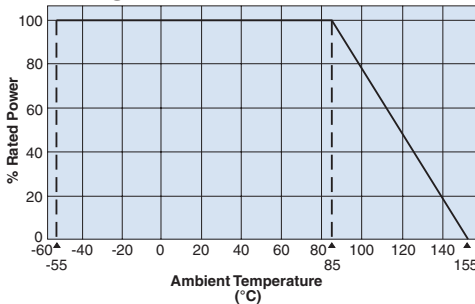

For resistors operated at an ambient temperature of 85°C or above, a power rating shall be derated in accordance with the derating curve.

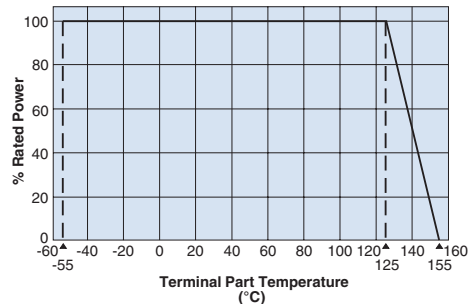

For resistors operated terminal part temperature of described for each size or above, a power rating shall be derated in accordance with the derating curve. Please refer to "Introduction of the derating curve based on the terminal part temperature" in the beginning of our catalog before use.

ordering information

RS73F	1J	T	TD	1002	B
Type	Power Rating	Termination Material	Packaging	Nominal Resistance	Tolerance
RS73F RS73G	1E: 0.125W 1J: 0.2W 2A: 0.25W 2B: 0.33W	T: Sn	TD: 4mm pitch punched paper TPL-TP: 2mm pitch punched paper For further information on packaging, please refer to Appendix A	4 digits	B: $\pm 0.1\%$ C: $\pm 0.25\%$ D: $\pm 0.5\%$ F: $\pm 1\%$

applications and ratings

Part Designation	Power Rating	Rated Ambient Temp.	Rated Terminal Part Temp.	T.C.R. (X 10 ⁻⁶ /K)	Resistance Range*2				Maximum Working Voltage	Maximum Overload Voltage	Operating Temperature Range
					B±0.1% E-24, E-96	C±0.25% E-24, E-96	D±0.5% E-24, E-96	F±1% E-24, E-96			
RS73F1E (0402)	.125W	85°C	+125°C	±25*1	300Ω - 100kΩ	300Ω - 1MΩ	300Ω - 1MΩ	300Ω - 1MΩ	75V	100V	-55°C to +155°C
RS73G1E (0402)				±50							
RS73F1J (0603)	.2W			±25*1	10Ω - 1MΩ	10Ω - 1MΩ	10Ω - 1MΩ	10Ω - 1MΩ	100V	150V	
RS73G1J (0603)				±50							
RS73F2A (0805)	.25W			±25*1	10Ω - 3MΩ	10Ω - 6.8MΩ	10Ω - 10MΩ	10Ω - 10MΩ	150V	300V	
RS73G2A (0805)				±50							
RS73F2B (1206)	.33W			±25*1	10Ω - 5.1MΩ	10Ω - 5.1MΩ	10Ω - 10MΩ	10Ω - 10MΩ	200V	400V	
RS73G2B (1206)				±50							

Rated voltage = $\sqrt{\text{Power rating} \times \text{resistance value}}$ or max. working voltage, whichever is lower

*1 Measurement Temperature: +25°C/+125°C. Cold T.C.R. (-55°C/+25°C) is -50~+25x10⁻⁶/K

*2 Please inquire about E-192

If any questions arise whether to use the "Rated Ambient Temperature" or the "Rated Terminal Part Temperature," please give priority to the "Rated Terminal Part Temperature." Prior to use and for more details refer to "Introduction of the derating curves in the terminal part temperature" in the beginning of the catalog.

environmental applications

Temperature Rise

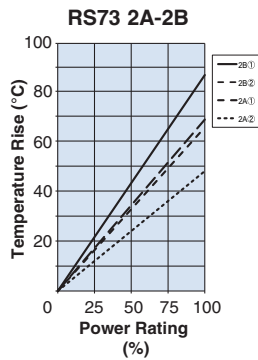
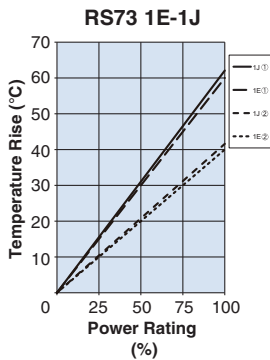

Regarding the temperature rise, the value of the temperature varies per conditions and board for use since the temperature is measured under our measuring conditions.

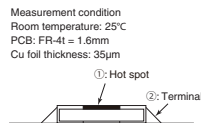

Measurement condition
Room temperature: 25°C
PCB: FR-4t = 1.6mm
Cu foil thickness: 35µm

One-Pulse Limiting Electric Power

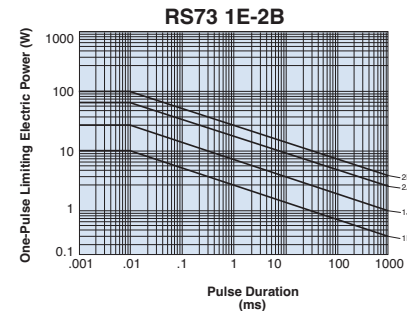

The maximum applicable voltage is equal to the max. overload voltage. Please ask us about the resistance characteristic of continuous applied pulse. The pulse endurance values are not assured values, so be sure to check the products on actual equipment when you use them.

Performance Characteristics

Parameter	Requirement $\Delta R \pm(\%+0.05\Omega)$		Test Method
	Limit	Typical	
Resistance	Within specified tolerance	—	25°C
T.C.R.	Within specified T.C.R.	—	+25°C/-55°C and +25°C/+125°C
Overload (Short time)	±0.2%	±0.03%	Rated Voltage x 2.5 for 5 seconds
Resistance to Solder Heat	±0.2%	±0.1%	260°C ± 5°C, 10 seconds ± 1 second
Rapid Change of Temperature	0.2: 1E (300Ω≤R≤20kΩ) 1J (10Ω≤R≤1MΩ) 2A, 2B (10Ω≤R≤10MΩ) 0.4: others	0.05: 1E (300Ω≤R≤20kΩ) 1J (10Ω≤R≤1MΩ) 2A, 2B (10Ω≤R≤10MΩ) 0.2: others	-55°C (30 minutes), +125°C (30 minutes), 1000 cycles
Moisture Resistance	0.2: 1E (300Ω≤R≤10kΩ) 1J (10Ω≤R≤200kΩ) 2A, 2B (10Ω≤R≤10MΩ) 0.4~0.5: others	0.04: 1E (300Ω≤R≤10kΩ) 1J (10Ω≤R≤200kΩ) 2A, 2B (10Ω≤R≤10MΩ) 0.08: others	40°C ± 2°C, 90%-95% RH, 1000 hours, 1.5 hr ON, 0.5 hr OFF cycle
Endurance at 85°C	0.2: 1E (300Ω≤R≤20kΩ) 1J (10Ω≤R≤1MΩ) 2A, 2B (10Ω≤R≤10MΩ) 0.4: others	0.05: 1E (300Ω≤R≤20kΩ) 1J (10Ω≤R≤1MΩ) 2A, 2B (10Ω≤R≤10MΩ) 0.2: others	85°C ± 2°C, 1000 hours, 1.5 hr ON, 0.5 hr OFF cycle
High Temperature Exposure	0.2: 1E (300Ω≤R≤10kΩ) 1J (10Ω≤R≤200kΩ) 2A, 2B (10Ω≤R≤100kΩ) 0.4~0.5: others	0.1: 1E (300Ω≤R≤10kΩ) 1J (10Ω≤R≤200kΩ) 2A, 2B (10Ω≤R≤100kΩ) 0.2~0.3: others	+155°C, 1000 hours

Specifications given herein may be changed at any time without prior notice. Please confirm technical specifications before you order and/or use.

11/17/23



features

- High reliability with ΔR of $\pm 0.1\%$ in the long-term reliability test
- Endurance at 85°C (3,000h): ΔR of $\pm 0.1\%$
- Operating temperature range $\sim 155^\circ\text{C}$
- Rated ambient temperature: 85°C
- High precision type $\pm 0.05\%$ is available
- Low current noise
- High reliability and high stability at elevated temperatures
- Improved moisture resistance by glass passivation layer
- Sulfur resistance verified according to ASTM B 809-95
- Products meet EU RoHS requirements
- AEC-Q200 Tested

dimensions and construction

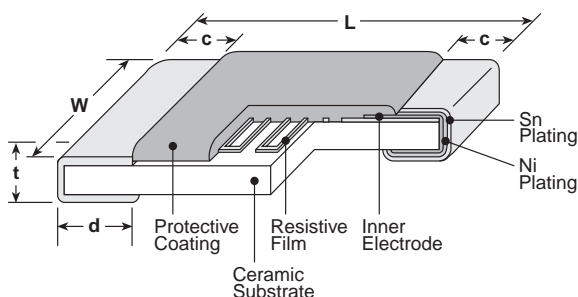

Type (Inch Size Code)	Dimensions inches (mm)				
	L	W	c	d	t
1E (0402)	.039 ^{+0.004} _{-.002} (1.0 ^{+0.1} _{-0.05})	.020 \pm .002 (0.5 \pm 0.05)	.010 \pm .004 (0.25 \pm 0.1)	.010 ^{+0.002} _{-.004} (0.25 ^{+0.05} _{-0.1})	.014 \pm .002 (0.35 \pm 0.05)
1J (0603)	.063 \pm .008 (1.6 \pm 0.2)	.031 \pm .004 (0.8 \pm 0.1)	.012 \pm .004 (0.3 \pm 0.1)	.012 \pm .004 (0.3 \pm 0.1)	.018 \pm .004 (0.45 \pm 0.1)
2A (0805)	.079 \pm .008 (2.0 \pm 0.2)	.049 \pm .008 (1.25 \pm 0.2)	.016 \pm .008 (0.4 \pm 0.2)	.012 ^{+0.008} _{-.004} (0.3 ^{+0.2} _{-0.1})	.02 \pm .004 (0.5 \pm 0.1)
2B (1206)	.126 \pm .008 (3.2 \pm 0.2)	.063 \pm .008 (1.6 \pm 0.2)	.02 \pm .012 (0.5 \pm 0.3)	.016 ^{+0.008} _{-.004} (0.4 ^{+0.2} _{-0.1})	.024 \pm .004 (0.6 \pm 0.1)
2E (1210)		.098 \pm .008 (2.5 \pm 0.2)			

Derating Curve

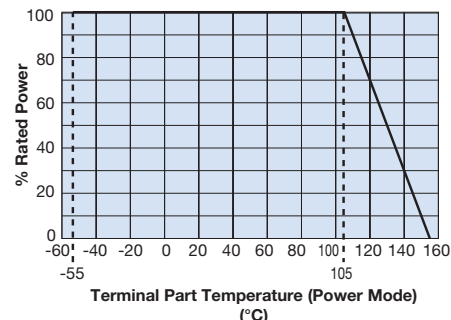
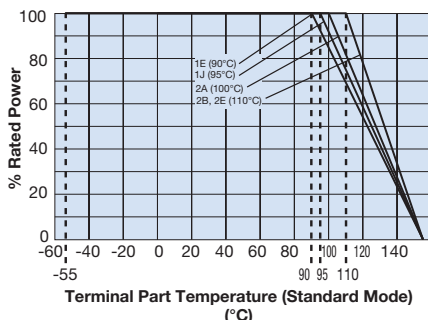
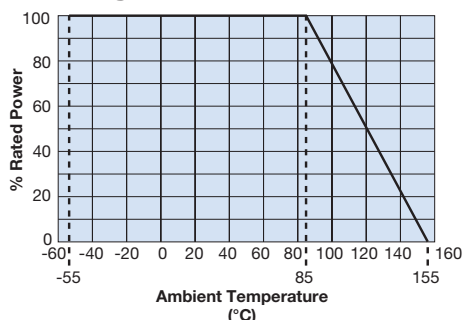

For resistors operated at an ambient temperature of 85°C or above, a power rating shall be derated in accordance with the above derating curve.

When the terminal part temperature of the resistor exceeds the rated terminal part temperature shown above, the power shall be derated according to the derating curve. Please refer to "Introduction of the derating curves based on the terminal part temperature" on the beginning of our catalog before use.

ordering information

RN73H	2B	T	TD	1002	B	25
Type	Size	Termination Material	Packaging	Nominal Resistance	Resistance Tolerance	T.C.R. (ppm/°C)
	1E 1J 2A 2B 2E	T: Sn G: Au (1E, 1J only)	TP: 0402 only: 7" 2mm pitch punched paper TD: 0603, 0805, 1206, 1210: 7" 4mm pitch punched paper TE: 0805, 1206, 1210: 7" embossed plastic For further information on packaging, please refer to Appendix A	3 significant figures + 1 multiplier "R" indicates decimal on value <100Ω	A: $\pm 0.05\%$ B: $\pm 0.1\%$ C: $\pm 0.25\%$ D: $\pm 0.5\%$ F: $\pm 1.0\%$	05 10 25 50 100

Specifications given herein may be changed at any time without prior notice. Please confirm technical specifications before you order and/or use.

8/20/24

long term precision thin (metal) film flat chip resistors (high reliability, for automotive)

applications and ratings

Part Designation	Power Rating @ 85°C	Rated Ambient Temp.	Rated Terminal Part Temp.	T.C.R. (ppm/°C) Max.	Resistance Range (Ω) E-24, E-96, E-192*					Maximum Working Voltage	Maximum Overload Voltage
					(A±0.05%)	(B±0.1%)	(C±0.25%)	(D±0.5%)	(F±1.0%)		
RN73H1E	0.063W	85°C	90°C	±5	—	220~10k	—	—	—	50V	100V
				±10	—	47~100k	47~100k	47~100k	47~100k		
				±25	—	47~300k	47~300k	47~300k	47~300k		
	0.1W	85°C	105°C	±50	—	47~300k	47~300k	10~300k	10~300k	50V	100V
				±5	—	220~10k	—	—	—		
				±10	—	47~100k	47~100k	47~100k	47~100k		
RN73H1J	0.1W	85°C	95°C	±25	—	47~300k	47~300k	47~300k	47~300k	75V	150V
				±50	—	47~300k	47~300k	47~300k	47~300k		
				±100	—	—	—	10~1M	10~1M		
	0.125W	85°C	105°C	±5	100~59k	100~59k	—	—	—	75V	150V
				±10	47~59k	47~360k	47~360k	47~360k	47~360k		
				±25	47~59k	47~1M	47~1M	47~1M	47~1M		
RN73H2A	0.125W	85°C	100°C	±50	—	15~1M	15~1M	10~1M	10~1M	150V	300V
				±100	—	—	—	10~1M	10~1M		
				±5	100~100k	100~100k	—	—	—		
	0.25W	85°C	105°C	±10	47~100k	47~1M	47~1M	47~1M	47~1M	150V	300V
				±25	47~100k	47~1.5M	47~1.5M	47~1.5M	47~1.5M		
				±50	—	47~1.5M	47~1.5M	47~1.5M	47~1.5M		
RN73H2B	0.25W	85°C	110°C	±100	—	—	—	47~1.5M	47~1.5M	200V	400V
				±5	100~300k	100~300k	—	—	—		
				±10	47~300k	47~1M	47~1M	47~1M	47~1M		
	0.4W	85°C	105°C	±25	47~300k	47~1M	47~1M	47~1M	47~1M	200V	400V
				±50	—	47~1M	47~1M	47~1M	47~1M		
				±100	—	—	—	47~1M	47~1M		
RN73H2E	0.25W	85°C	110°C	±10	100~510k	100~510k	100~510k	100~510k	100~510k	200V	400V
				±25	51~510k	15~1M	15~1M	10~1M	10~1M		
				±50	—	15~1M	15~1M	10~1M	10~1M		
	0.5W	85°C	105°C	±100	—	—	—	10~1M	10~1M	200V	400V
				±10	100~510k	100~510k	100~510k	100~510k	100~510k		
				±25	51~510k	47~1M	47~1M	47~1M	47~1M		
±50	—	47~1M	47~1M	47~1M	47~1M	47~1M	47~1M	47~1M			

* No marking on E-192 values. Operating Temperature: -55°C to +155°C. If any questions arise whether to use the "Rated Ambient Temperature" or the "Rated Terminal Part Temperature" in your usage conditions, please give priority to the "Rated Terminal Part Temperature".

environmental applications - Performance Characteristics

Parameter	Requirement $\Delta R \pm(\%+0.05\Omega)$		Test Method
	Limit	Typical	
Resistance	Within specified tolerance	—	25°C
T.C.R.	Within specified T.C.R.	—	+25°C/+125°C: T.C.R. +5 (x10 ⁻⁶ /K); +25°C/-55°C and +25°C/+155°C: others
Overload (Short time)	Standard Mode: ±0.05%	±0.01%	Rated Voltage x 2.5 or Max. overload voltage, whichever is less, for 5 seconds
	Power Mode: ±0.05%	±0.01%	1E, 1J: Rated voltage x2.0 or Max overload voltage, whichever is less, for 5 seconds 2A,2B, 2E: Rated voltage x1.5 or Max overload voltage, whichever is less, for 5 seconds
Resistance to Solder Heat	±0.5%**	±0.01%	260°C ± 5°C, 10 seconds ± 1 second
Rapid Change of Temperature	±0.1%**	±0.02%	1E, 1J, 2A: -55°C (30 minutes), +155°C (30 minutes), 1000 cycles 2B, 2E: -55°C (30 minutes), +155°C (30 minutes), 500 cycles
Moisture Resistance	Standard Mode: ±0.1%**	±0.05%	85°C±2°C, 85%±5%RH, 1000h. Rated voltage or Max working voltage, whichever is less. 1.5h ON/0.5h OFF cycle
	Power Mode: ±0.1%**	±0.04%	85°C±2°C, 85%±5%RH, 1000h. Rated power x0.1 or Max working voltage, whichever is less
Endurance at 85°C	Standard Mode: 0.1%	±0.03%	Rated terminal part temp. ±2°C or Rated ambient temp. 85°C±2°C, 3000h 1.5h ON/0.5h OFF cycle
	Power Mode: ±0.2%	±0.04%	Rated terminal part temp. ±2°C or Rated ambient temp. 85°C±2°C, 3000h 1.5h ON/0.5h OFF cycle
High Temperature Exposure	±0.1%**	±0.05%	+155°C, 1000 hours

Precautions for Use

- The property and electrostatically measured taping materials are used for the components, but attention should be paid to the fact that there is some danger the parts absorb on the top tapes to cause a failure in the mounting and the parts are destructed by static electricity (1J, 2A, 2B, 2E: 1kV and more, 1E: 0.5kV and more at Human Body Model 100pF, 1.5kΩ) to change the resistance in the conditions of an excessive dryness or after the parts are given vibration for a long time as they are packaged on the tapes. Similarly, care should be given not to apply the excessive static electricity when mounting on the boards.
- ionic impurities such as flux etc. that are attached to these products or those mounted onto a PCB, negatively affect their moisture resistance, corrosion resistance, etc. The flux may contain ionic substances like chlorine, acid, etc. while perspiration and saliva include ionic impurities like sodium (Na⁺), chlorine (Cl⁻) etc. Therefore these kinds of ionic substances may induce electrical corrosion when they invade into the products. Either thorough washing or using RMA solder and flux are necessary since lead free solder contains ionic substances. Washing process is needed, before putting on moisture proof material in order to prevent electrical corrosion.
- The upper electrodes could be peeled off when a heat-resistant masking tape is attached to the mounted chip resistors and then detached from them. It is confirmed that the adhesiveness gets stronger due to the exposure to heat under mounting. Accordingly, we recommend the use of masking tape be refrained. If the use of heat-resistant masking tape is unavoidable, please make sure that the adhesives on the tape do not directly come in contact with the product.
- When high-pressure shower cleaning is implemented, there is a possibility of exfoliation of the top electrodes caused by the water pressure stress so please avoid the implementation.
- If the implementation is unavoidable, then please evaluate the products beforehand.

** Depends on resistance value, please contact KOA Speer for details.

For Surface Temperature Rise Graph see Environmental Applications. Additional environmental applications can also be found at www.koaspeer.com
Specifications given herein may be changed at any time without prior notice. Please confirm technical specifications before you order and/or use. 8/20/24

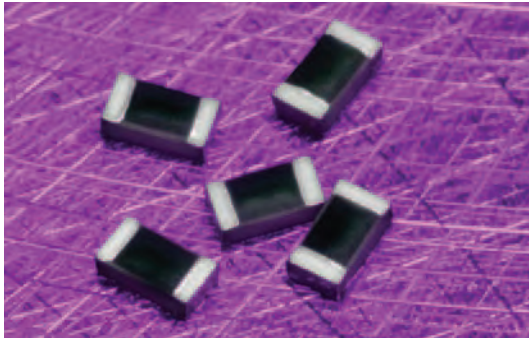

features

- High reliability with ΔR of $\pm 0.1\% \sim \pm 0.25\%$ in the long-term reliability test
- Endurance at 85°C (1,000h): ΔR of $\pm 0.1\%$
- Operating temperature range $\sim 155^\circ\text{C}$
- Rated ambient temperature: 85°C
- High precision type $\pm 0.05\%$ is also available
- Low current noise
- Improved moisture resistance by high humidity protective coating
- Suitable for control circuits in various industrial equipment
- Sulfur resistance verified according to ASTM B 809-95
- Products meet EU RoHS requirements
- AEC-Q200 Tested

dimensions and construction

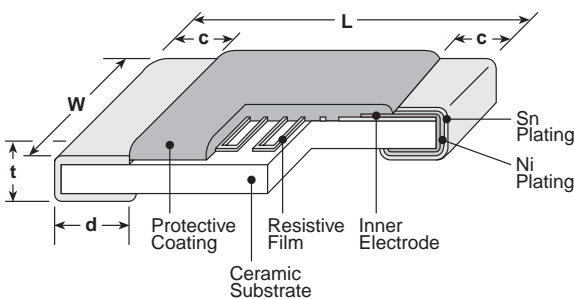

Type (Inch Size Code)	Dimensions inches (mm)				
	L	W	c	d	t
1E (0402)	.039 ^{+0.004} _{-.002} (1.0 ^{+0.1} _{-0.05})	.020±.002 (0.5±0.05)	.010±.004 (0.25±0.1)	.010 ^{+0.002} _{-.004} (0.25 ^{+0.05} _{-0.1})	.014±.002 (0.35±0.05)
1J (0603)	.063±.008 (1.6±0.2)	.031±.004 (0.8±0.1)	.012±.004 (0.3±0.1)	.012±.004 (0.3±0.1)	.018±.004 (0.45±0.1)
2A (0805)	.079±.008 (2.0±0.2)	.049±.008 (1.25±0.2)	.016±.008 (0.4±0.2)	.012 ^{+0.008} _{-.004} (0.3 ^{+0.2} _{-0.1})	.02±.004 (0.5±0.1)
2B (1206)	.126±.008 (3.2±0.2)	.063±.008 (1.6±0.2)	.02±.012 (0.5±0.3)	.016 ^{+0.008} _{-.004} (0.4 ^{+0.2} _{-0.1})	.024±.004 (0.6±0.1)
2E (1210)	.126±.008 (3.2±0.2)	.098±.008 (2.5±0.2)	.02±.012 (0.5±0.3)	.016 ^{+0.008} _{-.004} (0.4 ^{+0.2} _{-0.1})	.024±.004 (0.6±0.1)

Derating Curve

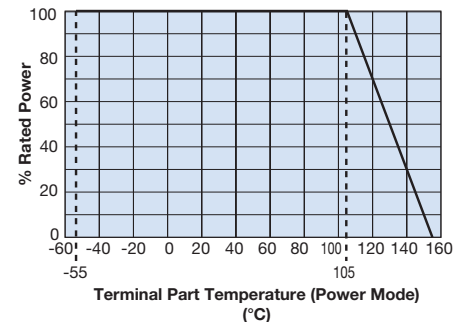
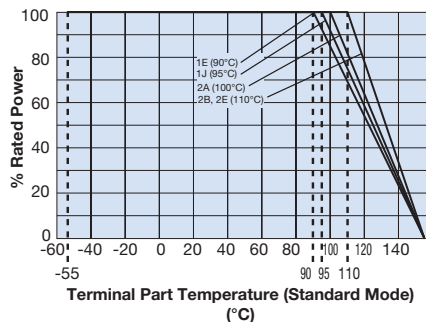
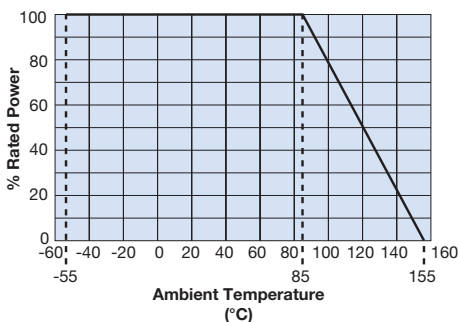

For resistors operated at an ambient temperature of 85°C or above, a power rating shall be derated in accordance with the above derating curve.

When the terminal part temperature of the resistor exceeds the rated terminal part temperature shown above, the power shall be derated according to the derating curve. Please refer to "Introduction of the derating curves based on the terminal part temperature" on the beginning of our catalog before use.

ordering information

RN73R	2B	T	TD	1002	B	25
Type	Size	Termination Material	Packaging	Nominal Resistance	Resistance Tolerance	T.C.R. (ppm/°C)
	1E 1J 2A 2B 2E	T: Sn	TP: 2mm pitch punched paper TD: 4mm pitch punched paper TE: 4mm pitch plastic embossed For further information on packaging, please refer to Appendix A	3 significant figures + 1 multiplier "R" indicates decimal on value <100Ω	A: $\pm 0.05\%$ B: $\pm 0.1\%$ C: $\pm 0.25\%$ D: $\pm 0.5\%$ F: $\pm 1.0\%$	05 10 25 50 100

Specifications given herein may be changed at any time without prior notice. Please confirm technical specifications before you order and/or use.

8/20/24

precision thin (metal) film flat chip resistors (high reliability)

applications and ratings

Part Designation	Power Rating @ 85°C	Rated Ambient Temp.	Rated Terminal Part Temp.	T.C.R. (x10 ⁻⁶ /K)	Resistance Range (Ω) E-24, E-96, E-192*					Maximum Working Voltage	Maximum Overload Voltage
					(A±0.05%)	(B±0.1%)	(C±0.25%)	(D±0.5%)	(F±1.0%)		
RN73R1E	0.063W	85°C	90°C	±10	—	47~10k	47~10k	47~10k	47~10k	50V	100V
				±25	—	47~300k	47~300k	47~300k	47~300k		
				±50	—	47~300k	47~300k	10~300k	10~300k		
	0.1W	85°C	105°C	±10	—	47~10k	47~10k	47~10k	47~10k		
				±25	—	47~300k	47~300k	47~300k	47~300k		
				±50	—	47~300k	47~300k	47~300k	47~300k		
RN73R1J	0.1W	85°C	95°C	±5	100~59k	100~59k	—	—	75V	150V	
				±10	47~59k	47~59k	47~59k	47~59k			47~59k
				±25	47~59k	15~1M	15~1M	10~1M			10~1M
	0.125W	85°C	105°C	±50	—	15~1M	15~1M	10~1M			10~1M
				±100	—	—	—	10~1M			10~1M
				±5	100~59k	100~59k	—	—			—
RN73R2A	0.125W	85°C	100°C	±10	47~100k	47~100k	47~100k	47~100k	150V	300V	
				±25	47~100k	15~1.5M	15~1.5M	10~1.5M			10~1.5M
				±50	—	15~1.5M	15~1.5M	10~1.5M			10~1.5M
	0.25W	85°C	105°C	±100	—	—	—	10~1.5M			10~1.5M
				±5	100~100k	100~100k	—	—			—
				±10	47~100k	47~100k	47~100k	47~100k			47~100k
RN73R2B	0.25W	85°C	110°C	±25	47~100k	47~1.5M	47~1.5M	47~1.5M	200V	400V	
				±50	—	47~1.5M	47~1.5M	47~1.5M			47~1.5M
				±100	—	—	—	47~1.5M			47~1.5M
	0.4W	85°C	105°C	±5	100~300k	100~300k	—	—			
				±10	47~300k	47~300k	47~300k	47~300k			47~300k
				±25	47~300k	15~1M	15~1M	10~1M			10~1M
RN73R2E	0.25W	85°C	110°C	±50	—	15~1M	15~1M	10~1M	200V	400V	
				±100	—	—	—	10~1M			10~1M
				±5	100~300k	100~300k	—	—			—
	0.5W	85°C	105°C	±10	100~510k	100~510k	100~510k	100~510k			
				±25	51~510k	47~1M	47~1M	47~1M			47~1M
				±50	—	47~1M	47~1M	47~1M			47~1M

Operating Temperature: -55°C to +155°C. Rated voltage = $\sqrt{\text{Power rating} \times \text{resistance value}}$ or max. working voltage, whichever is lower. If any questions arise whether to use the "Rated Ambient Temperature" or the "Rated Terminal Part Temperature" in your usage conditions, please give priority to the "Rated Terminal Part Temperature".

environmental applications - Performance Characteristics

Parameter	Requirement $\Delta R \pm(\%+0.05\Omega)$		Test Method
	Limit	Typical	
Resistance	Within specified tolerance	—	25°C
T.C.R.	Within specified T.C.R.	—	+25°C/+125°C: T.C.R. +5 (x10 ⁻⁶ /K); +25°C/-55°C and +25°C/+155°C: others
Overload (Short time)	Standard Mode: ±0.05%	±0.01%	Rated Voltage x 2.5 or Max. overload voltage, whichever is less, for 5 seconds
	Power Mode: ±0.05%	±0.01%	1E, 1J: Rated voltage x2.0 or Max overload voltage, whichever is less, for 5 seconds 2A, 2B, 2E: Rated voltage x1.5 or Max overload voltage, whichever is less, for 5 seconds
Resistance to Solder Heat	±0.5%**	±0.01%	260°C ± 5°C, 10 seconds ± 1 second
Rapid Change of Temperature	±0.1%**	±0.04%	1E, 1J, 2A: -55°C (30 minutes), +155°C (30 minutes), 1000 cycles 2B, 2E: -55°C (30 minutes), +155°C (30 minutes), 500 cycles
Moisture Resistance	Standard Mode: ±0.25%**	±0.07%	85°C±2°C, 85%±5%RH, 1000h. Rated voltage or Max working voltage, whichever is less. 1.5h ON/0.5h OFF cycle
	Power Mode: ±0.25%**	±0.06%	85°C±2°C, 85%±5%RH, 1000h. Rated power x0.1 or Max working voltage, whichever is less
Endurance at 85°C	Standard Mode: ±0.1%	±0.04%	Rated terminal part temp. ±2°C or Rated ambient temp. 85°C±2°C, 1000h 1.5h ON/0.5h OFF cycle
	Power Mode: ±0.2%	±0.05%	Rated terminal part temp. ±2°C or Rated ambient temp. 85°C±2°C, 1000h 1.5h ON/0.5h OFF cycle
High Temperature Exposure	±0.25%**	±0.10%	+155°C, 1000 hours

Precautions for Use

- The property and electrostatically measured taping materials are used for the components, but attention should be paid to the fact that there is some danger the parts absorb on the top tapes to cause a failure in the mounting and the parts are destructed by static electricity (1J, 2A, 2B, 2E: 1kV and more, 1E: 0.5kV and more at Human Body Model 100pF, 1.5kΩ) to change the resistance in the conditions of an excessive dryness or after the parts are given vibration for a long time as they are packaged on the tapes. Similarly, care should be given not to apply the excessive static electricity when mounting on the boards.
- Ionic impurities such as flux etc. that are attached to these products or those mounted onto a PCB, negatively affect their moisture resistance, corrosion resistance, etc. The flux may contain ionic substances like chlorine, acid, etc. while perspiration and saliva include ionic impurities like sodium (Na⁺), chlorine (Cl⁻) etc. Therefore these kinds of ionic substances may induce electrical corrosion when they invade into the products. Either thorough washing or using RMA solder and flux are necessary since lead free solder contains ionic substances. Washing process is needed, before putting on moisture proof material in order to prevent electrical corrosion.
- The upper electrodes could be peeled off when a heat-resistant masking tape is attached to the mounted chip resistors and then detached from them. It is confirmed that the adhesiveness gets stronger due to the exposure to heat under mounting. Accordingly, we recommend the use of masking tape be refrained. If the use of heat-resistant masking tape is unavoidable, please make sure that the adhesives on the tape do not directly come in contact with the product.
- When high-pressure shower cleaning is implemented, there is a possibility of exfoliation of the top electrodes caused by the water pressure stress so please avoid the implementation.
- If the implementation is unavoidable, then please evaluate the products beforehand.

** Depends on resistance value, please contact KOA Speer for details.

For Surface Temperature Rise Graph see Environmental Applications. Additional environmental applications can also be found at www.koaspeer.com
Specifications given herein may be changed at any time without prior notice. Please confirm technical specifications before you order and/or use. 9/09/24

NEW

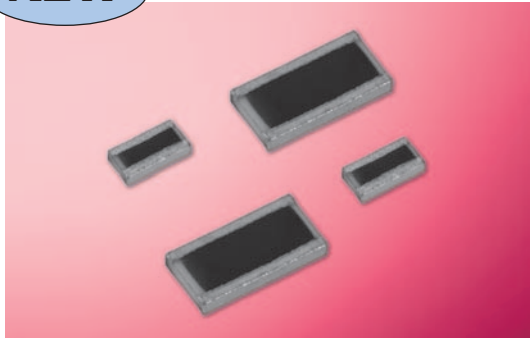

EU RoHS
COMPLIANT

features

- SMD metal film resistors of wide terminal type
- High precision type $\pm 0.1\%$ is also available as standard
- High performance T.C.R. ± 10 ppm/ $^{\circ}\text{C}$ is also available as standard
- Low current noise
- Operating temperature range $\sim 155^{\circ}\text{C}$
Rated ambient temperature: 85°C
- High reliability with ΔR of $\pm 0.1\%$ in the long-term reliability test
- Endurance at 85°C (1,000h): ΔR of $\pm 0.1\%$
- Improved moisture resistance by special protective coating
- High precision resistor solution for tough environments, especially in high reliable automotive, medical and industrial applications
- Suitable for both flow and reflow solderings
- Products meet EU RoHS requirements
- AEC-Q200 Tested
- Sulfur resistance verified according to ASTM B 809-95

dimensions and construction

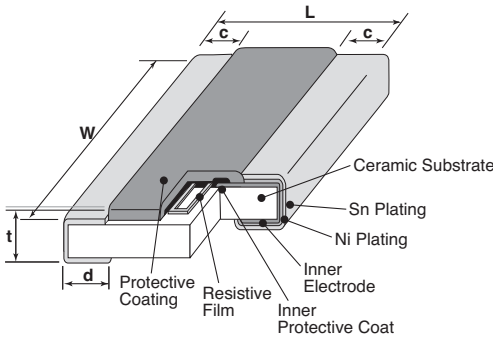

Type (Inch Size Code)	Dimensions inches (mm)				
	L	W	c	d	t
1J (0306)	.031 \pm .004 (0.8 \pm 0.1)	.063 \pm .008 (1.6 \pm 0.2)	.008 \pm .004 (0.2 \pm 0.1)	.008 \pm .004 (0.2 \pm 0.1)	.014 \pm .004 (0.35 \pm 0.1)
2B (0612)	.063 \pm .008 (1.6 \pm 0.2)	.122 \pm .008 (3.1 \pm 0.2)	.010 \pm .004 (0.25 \pm 0.1)	.012 \pm .006 (0.3 \pm 0.15)	.018 \pm .004 (0.45 \pm 0.1)

ordering information

WN73H	2B	T	TD	1002	B	25
Type	Power Rating 1J: 0.3W 2B: 1W	Termination Surface Material T : Sn	Packaging TD: 4mm pitch paper For further information on packaging, please refer to Appendix A	Nominal Resistance 4 digits	Resistance Tolerance B: $\pm 0.1\%$ C: $\pm 0.25\%$ D: $\pm 0.5\%$	T.C.R. (X $10^{-6}/\text{K}$) 10 25 50

applications and ratings

Part Designation	Power Rating	Rated Ambient Temperature	Rated Terminal Part Temperature	T.C.R. (X 10 ⁻⁶ /K)	Resistance Range (Ω) E24 · E96			Maximum Working Voltage	Maximum Overload Voltage	Operating Temperature Range
					B: ±0.1%	C: ±0.25%	D: ±0.5%			
1J	0.3W	85°C	±125°C	±10	100 ~ 43k	100 ~ 43k	100 ~ 43k	75V	150V	-55°C to +155°C
				±25	15 ~ 100k	15 ~ 100k	10 ~ 100k			
				±50	15 ~ 100k	15 ~ 100k	10 ~ 100k			
2B	1W	85°C	±125°C	±10	100 ~ 100k	100 ~ 100k	100 ~ 100k	100V	200V	-55°C to +155°C
				±25	15 ~ 100k	15 ~ 100k	15 ~ 100k			
				±50	15 ~ 100k	15 ~ 100k	15 ~ 100k			

Rated voltage = $\sqrt{\text{Power rating} \times \text{resistance value}}$ or max. working voltage, whichever is lower

If any questions arise whether to use the "Rated Ambient Temperature" or the "Rated Terminal Part Temperature" in your usage conditions, please give priority to the "Rated Terminal Part Temperature."

Prior to use and for more details, please refer to the "Introduction of the derating curves based on the terminal part temperature" in the beginning of our catalog.

environmental applications

Derating Curve

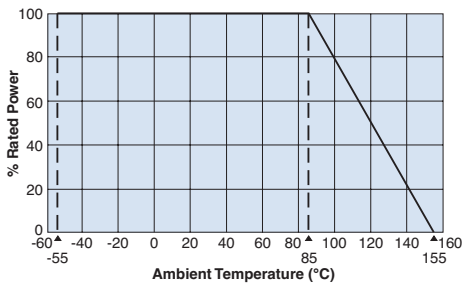

For resistors operated at an ambient temperature of 85°C or above, a power rating shall be derated in accordance with the above derating curve.

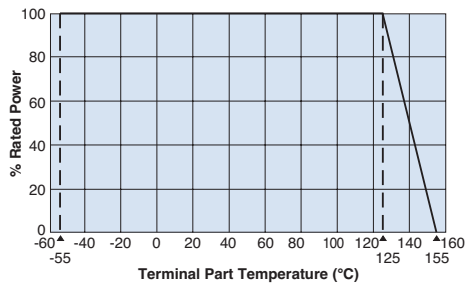

When the terminal part temperature of the resistor exceeds the rated terminal part temperature shown above, the power shall be derated according to the derating curve.

Please refer to "Introduction of the derating curves based on the terminal part temperature" on the beginning of our catalog before use.

Performance Characteristics

Parameter	Requirement $\Delta R \pm(\%+0.05\Omega)$		Test Method
	Limit	Typical	
Resistance	Within specified tolerance	—	25°C
T.C.R.	Within specified T.C.R.	—	+25°C/-55°C and +25°C/+155°C
Overload (Short time)	±0.1%	±0.03%	Rated voltage x 2.0 or Max. overload., whichever is less, for 5 seconds
Resistance to Solder Heat	±0.1%	±0.03%	260°C ± 5°C, 10 seconds ± 1 second
Rapid Change of Temperature	±0.1%*	±0.03%	-55°C (30 minutes), +155°C (30 minutes), 1000 cycles
Moisture Resistance	±0.1%*	±0.04%	85°C ± 2°C, 85%±5% RH, 1000 hours, 1.5 hr ON, 0.5 hr OFF cycle
"Endurance at 85°C or rated terminal part temperature"	±0.1%*	±0.04%	85°C ± 2°C or rated terminal part temperature ±2°C, 1000 hours, 1.5 hr ON, 0.5 hr OFF cycle
High Temperature Exposure	±0.1%*%	±0.04%	+155°C, 1000 hours

* Depends on resistance value



features

- Wide-side termination (reverse-geometry) type flat chip resistor
- High reliability and performance with T.C.R. $\pm 100 \times 10^{-6}/K$, resistance tolerance $\pm 0.5\%$
- Products with lead-free terminations meet EU RoHS requirements. EU RoHS regulation is not intended for Pb-glass contained in electrode, resistor element and glass.
- AEC-Q200 Tested

dimensions and construction

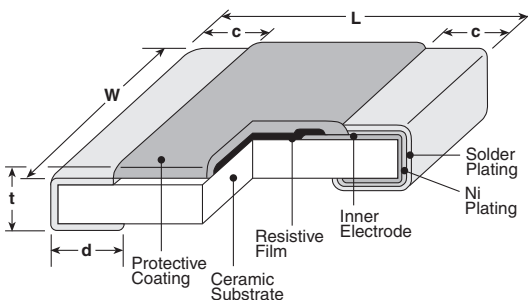

Type (Inch Size Code)	Dimensions inches (mm)				
	L	W	c	d	t
1E (0204)	.020±.002 (0.5±0.05)	.039±.002 (1.0±0.05)	.006±.002 (0.15±0.05)	.006±.002 (0.15±0.05)	.014±.002 (0.35±0.05)
1J (0306)	.031±.004 (0.8±0.1)	.063±.004 (1.6±0.1)	.006±.004 (0.15±0.1)	.008±.004 (0.2±0.1)	.018±.004 (0.45±0.1)
2A (0508)	.049±.006 (1.25±0.15)	.079±.006 (2.0±0.15)	.012±.008 (0.3±0.2)	.014±.008 (0.35±0.2)	.022±.004 (0.55±0.1)
2B (0612)	.063±.006 (1.6±0.15)	.126±.008 (3.2±0.2)	.012±.008 (0.3±0.2)	.018±.006 (0.45±0.15)	.024±.004 (0.6±0.1)
2H (1020)	.098±.006 (2.5±0.15)	.197±.006 (5.0±0.15)	.016±.008 (0.4±0.2)	.030±.006 (0.75±0.15)	
3A (1225)	.122±.006 (3.1±0.15)	.252±.006 (6.3±0.15)	.018±.008 (0.45±0.2)		

Derating Curve

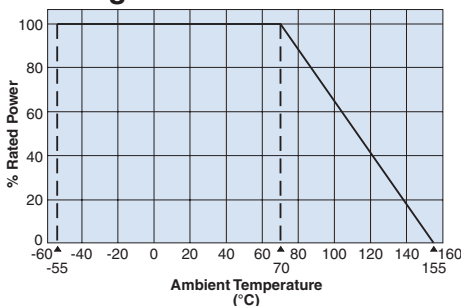

For resistors operated at an ambient temperature of 70°C or above, a power rating shall be derated in accordance with the above derating curve.

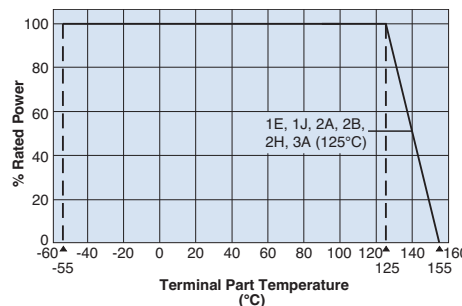

For resistors operated terminal temperature of described for each size or above, a power rating shall be derated in accordance with the derating curve above.

Please refer to "Introduction of the derating curve based on the terminal part temperature" in the beginning of our catalog before use.

If you want to use at rated power (*1), use derating curves based on the terminal part temperature on the right side graph.

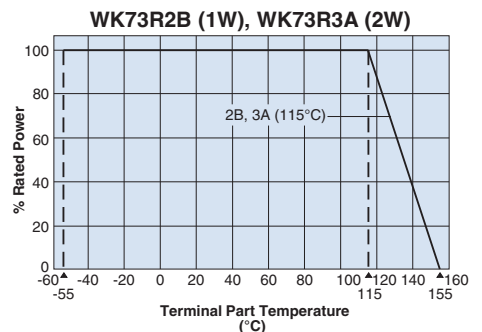

ordering information

WK73R	1J	T	TE	33L0	F
Type	Size	Termination Material	Packaging	Nominal Resistance	Resistance Tolerance
WK73R	1E: 0.33W 1J: 0.5W 2A: 0.75W, 1W 2B: 0.75W, 1W 2H: 1W 3A: 1.5W, 2W	T: Sn	TP: 0204: 7" 2mm pitch punched paper TD: 0306, 0508, 0612: 7" 4mm pitch punched paper TE: 1020, 1225: 7" embossed plastic For further information on packaging, please refer to Appendix A	±1%: 3 significant figures + 1 multiplier "R" indicates decimal on value <100Ω ±5%: 2 significant figures + 1 multiplier "R" indicates decimal on values <10Ω All values less than 0.1Ω (100mΩ) are expressed in mΩ with "L" as decimal. Ex: 33mΩ, 1% = 33L0	D: ±0.5% F: ±1% J: ±5%

applications and ratings

Part Designation	Power Rating	Rated Ambient Temp.	Rated Terminal Part Temp.	T.C.R. (X 10 ⁻⁶ /K)	Resistance Range (Ω)			Maximum Working Voltage	Maximum Overload Voltage	Operating Temp. Range
					D±0.5% E-24/E-96	F±1% E-24/E-96	J±5% E-24			
WK73R1E	0.33W ¹	70°C	125°C	±100	—	10 - 1M	10 - 1M	75V	100V	-55°C to +155°C
WK73R1J	0.5W ¹	70°C	125°C	±100	—	10 - 1M	10 - 1M	150V	200V	
WK73R2A	0.75W ¹	70°C	125°C	±100	—	20.5k - 1M	22k - 1M	200V	400V	
	1.0W ¹	70°C	125°C	±100	—	10 - 20k	10 - 20k			
WK73R2B	0.75W ¹	70°C	125°C	±100	10 - 1M	10 - 1M	10 - 1M	200V	400V	
	1.0W ¹	70°C	115°C	±100	10 - 9.76k	10 - 9.76k	10 - 9.1k			
WK73R2H	1.0W	70°C	125°C	±100	—	10 - 430k	10 - 430k	200V	400V	
				±200	—	432k - 1M	470k - 1M			
WK73R3A	1.5W	70°C	125°C	±100	—	10 - 330k	10 - 330k	200V	400V	
				±200	—	332k - 1M	360k - 1M			
	2.0W ¹	70°C	115°C	±100	—	10 - 330k	10 - 330k			
				±200	—	332k - 1M	360k - 1M			

Rated voltage = $\sqrt{\text{Power rating} \times \text{resistance value}}$ or max. working voltage, whichever is lower

¹ If you want to use at rated power use derating curves based on the terminal part temperature on the right side graph located on previous page. If any questions arise whether to use the "Rated Ambient Temperature" or the "Rated Terminal Part Temperature", please give priority to the "Rated Terminal Part Temperature." For more details refer to the "Introduction of the derating curves based on the terminal part temperature" in the beginning of the catalog

environmental applications

Temperature Rise

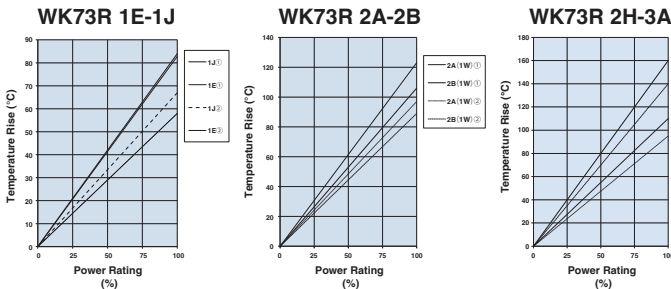

Regarding the temperature rise, the value of the temperature varies per conditions and board for use since the temperature is measured under our measuring conditions.

Measurement condition
 Room temperature: 25°C
 PCB: FR-4t = 1.6mm
 Cu foil thickness: 35μm

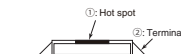

One-Pulse Limiting Electric Power

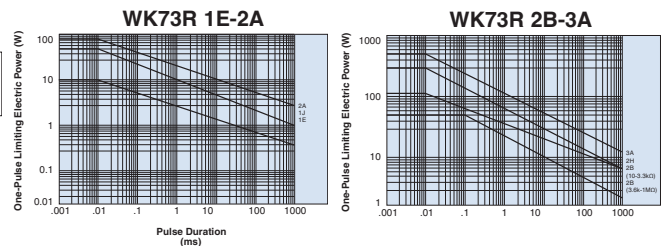

The maximum applicable voltage is equal to the max. overload voltage. Please ask us about the resistance characteristic of continuous applied pulse. The pulse endurance values are not assured values, so be sure to check the products on actual equipment when you use them.

Performance Characteristics

Parameter	Requirement Δ R ±(%+0.005Ω)		Test Method
	Limit	Typical	
Resistance	Within specified tolerance	—	25°C
T.C.R.	Within specified T.C.R.	—	+25°C/-55°C and +25°C/+125°C
Overload (Short time)	±2%	±0.2%	WK73R1E (0.33W), WK73R1J (0.5W), WK73R2A (0.75W, 1W), WK73R3A (2W): Rated voltage x2.0 for 5 seconds. WK73R2B, R2H, R3A: Rated voltage x2.5 for 3 seconds
Resistance to Solder Heat	±1%	±0.2%	260°C ± 5°C, 10 seconds ± 1 second
Bending Test	±1%	±0.1%	Holding point 90mm, Bending 1 time, Bending 5mm
Rapid Change of Temperature	±2%	±1%	-55°C (30 minutes), +125°C (30 minutes), 1000 cycles
Moisture Resistance	±3%: 1E ±2%: All others	±1%: 1E ±0.2%: All others	40°C ± 2°C, 90%-95% RH, 1000 hours, 1.5 hr ON, 0.5 hr OFF cycle
Endurance at 70°C	±3%: 1E ±2%: All others	±1%: 1E ±0.2%: All others	70°C ± 2°C, 1000 hours, 1.5 hr ON, 0.5 hr OFF cycle
High Temperature Exposure	±1%	±0.2%	+155°C, 1000 hours

Additional environmental applications can also be found at www.koaspeer.com

Specifications given herein may be changed at any time without prior notice. Please confirm technical specifications before you order and/or use.

10/20/23

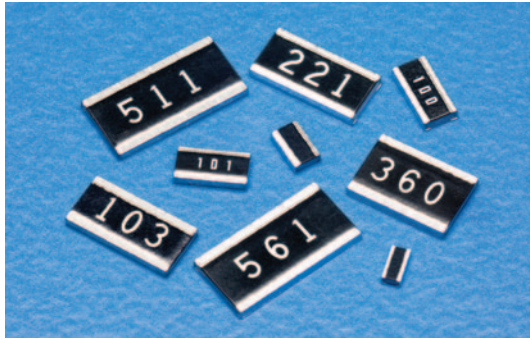

features

- Wide-side termination (reverse-geometry) type flat chip resistor
- High reliability and performance with T.C.R. $\pm 100 \times 10^{-6}/K$, resistance tolerance $\pm 0.5\%$
- Products with lead-free terminations meet EU RoHS requirements. EU RoHS regulation is not intended for Pb-glass contained in electrode, resistor element and glass.
- AEC-Q200 Tested

dimensions and construction

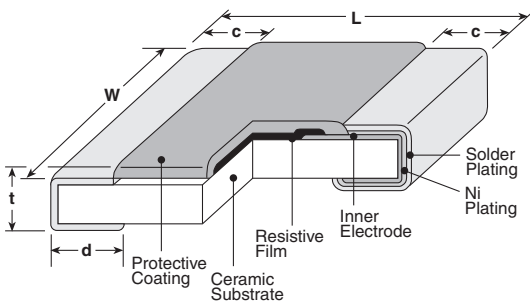

Type (Inch Size Code)	Dimensions inches (mm)				
	L	W	c	d	t
2B15 (0612)	.063±.006 (1.6±0.15)	.126±.008 (3.2±0.2)	.012±.008 (0.3±0.2)	.018±.006 (0.45±0.15)	.024±.004 (0.6±0.1)
2H2 (1020)	.098±.006 (2.5±0.15)	.197±.006 (5.0±0.15)	.016±.008 (0.4±0.2)	.030±.006 (0.75±0.15)	
3A3 (1225)	.122±.006 (3.1±0.15)	.252±.006 (6.3±0.15)	.018±.008 (0.45±0.2)		

Derating Curve

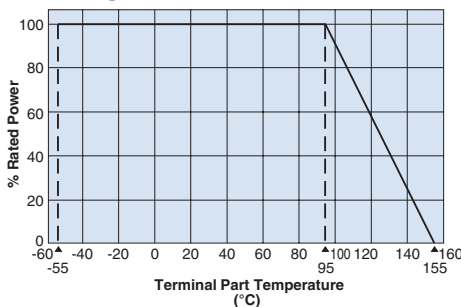

For resistors operated terminal temperature of described for each size or above, a power rating shall be derated in accordance with the derating curve above. Please refer to "Introduction of the derating curve based on the terminal part temperature" in the beginning of our catalog before use.

ordering information

WK73R	2H2	T	TE	1002	F
Type	Size	Termination Material	Packaging	Nominal Resistance	Resistance Tolerance
WK73R	New 2B15: 0.15W 2H2: 2W 3A3: 3W	T: Sn	TD: 0612: 7" 4mm pitch punched paper TE: 1020, 1225: 7" 4mm pitch embossed plastic For further information on packaging, please refer to Appendix A	±1%: 3 significant figures + 1 multiplier "R" indicates decimal on value <100Ω ±5%: 2 significant figures + 1 multiplier "R" indicates decimal on values <10Ω	D: ±0.5% F: ±1% J: ±5%

Contact us when you have control request for environmental hazardous material other than the substance specified by EU RoHS.

Specifications given herein may be changed at any time without prior notice. Please confirm technical specifications before you order and/or use.

11/15/23

applications and ratings

Part Designation	Power Rating	Rated Ambient Temp.	Rated Terminal Part Temp.	T.C.R. (X 10 ⁻⁶ /K)	Resistance Range (Ω)			Maximum Working Voltage	Maximum Overload Voltage	Operating Temp. Range
					D±0.5% E-24/E-96	F±1% E-24/E-96	J±5% E-24			
WK73R2B15	1.5W*1	70°C	95°C	±100	10 - 9.76k	10 - 9.76k	10 - 9.1k	200V	400V	-55°C to +155°C
WK73R2H2	2.0W*1	70°C	95°C	±100	—	10 - 430k	10 - 430k	200V	400V	
				±200	—	432k - 1M	470k - 1M			
WK73R3A3	3.0W*1	70°C	95°C	±100	—	10 - 330k	10 - 330k	200V	400V	
				±200	—	332k - 1M	360k - 1M			

Rated voltage = $\sqrt{\text{Power rating} \times \text{resistance value}}$ or max. working voltage, whichever is lower

*1 If you use at the rated power, please keep the condition that the terminal of the resistor is below the rated terminal part temperature.

Please refer to the derating curves based on the terminal temperature of right side on the next page.

If any questions arise whether to use the "Rated Ambient Temperature" or the "Rated Terminal Part Temperature" in your usage conditions, please give priority to the "Rated Terminal Part Temperature". For more details, please refer to "Introduction of the derating curves based on the terminal part temperature" on the beginning of our catalog.

environmental applications

Temperature Rise

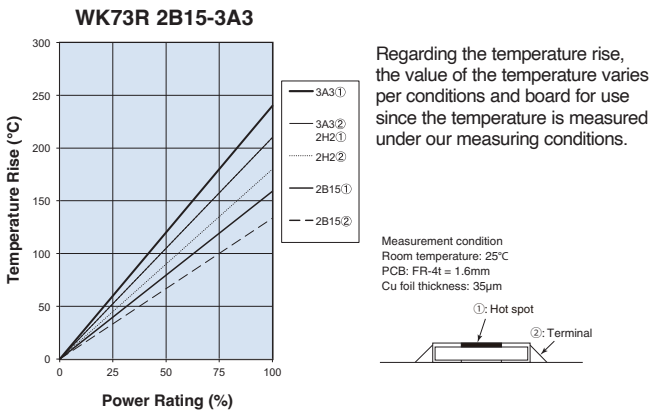

One-Pulse Limiting Electric Power

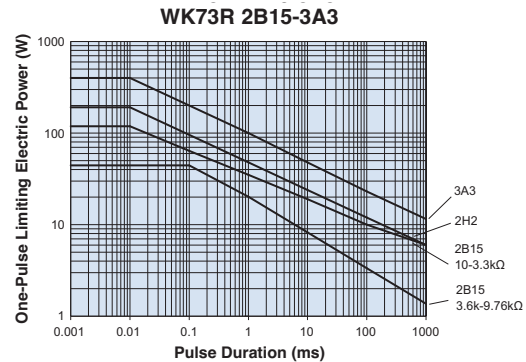

Performance Characteristics

Parameter	Requirement Δ R ±(%+0.005Ω)		Test Method
	Limit	Typical	
Resistance	Within specified tolerance	—	25°C
T.C.R.	Within specified T.C.R.	—	+25°C/-55°C and +25°C/+125°C
Overload (Short time)	±2%	±0.2%	Rated voltage x 2.0 for 5 seconds
Resistance to Solder Heat	±1%	±0.2%	260°C ± 5°C, 10 seconds ± 1 second
Bending Test	±1%	±0.1%	Holding point 90mm, Bending 1 time, Bending 5mm
Rapid Change of Temperature	±2%	±1%	-55°C (30 minutes), +125°C (30 minutes), 1000 cycles
Moisture Resistance	±2%	±0.2%	40°C ± 2°C, 90%-95% RH, 1000 hours, 1.5 hr ON, 0.5 hr OFF cycle
Endurance at 70°C	±2%	±0.2%	70°C ± 2°C, 1000 hours, 1.5 hr ON, 0.5 hr OFF cycle
High Temperature Exposure	±1%	±0.2%	+155°C, 1000 hours

Additional environmental applications can also be found at www.koaspeer.com

Specifications given herein may be changed at any time without prior notice. Please confirm technical specifications before you order and/or use.

11/15/23

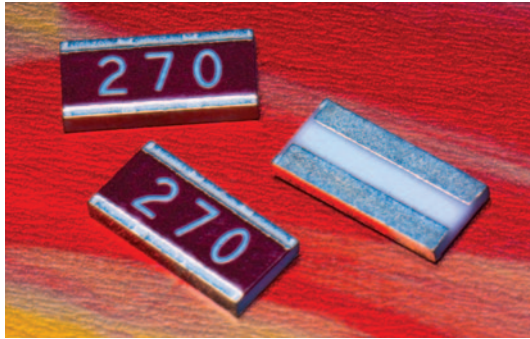

features

- Superior to WK73 series in pulse withstanding voltage
- Suitable for both flow and reflow solderings
- Products meet EU RoHS requirements
- AEC-Q200 Tested

dimensions and construction

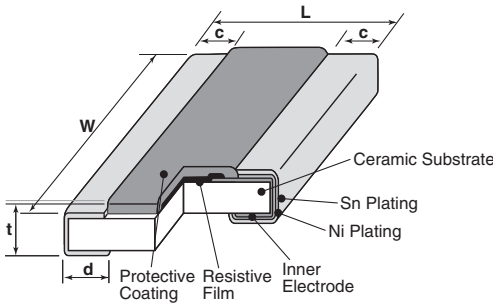

Type (Inch Size Code)	Dimensions inches (mm)				
	L	W	c	d	t
2B (0612)	$.063 \pm .008$ ($1.6 \pm .02$)	$.126 \pm .012$ ($3.2 \pm .03$)	$.012 \pm .008$ (0.3 ± 0.2)	$.018 \pm .006$ (0.45 ± 0.15)	$.024 \pm .004$ (0.6 ± 0.1)
2H (1020)	$.098 \pm .006$ (2.5 ± 0.15)	$.197 \pm .006$ (5.0 ± 0.15)	$.016 \pm .008$ (0.4 ± 0.2)	$.030 \pm .006$ (0.75 ± 0.15)	$.024 \pm .004$ (0.6 ± 0.1)
3A (1225)	$.122 \pm .004$ ($3.1 \pm .01$)	$.248 \pm .006$ (6.3 ± 0.15)	$.018 \pm .008$ (0.45 ± 0.2)	$.030 \pm .006$ (0.75 ± 0.15)	$.024 \pm .004$ (0.6 ± 0.1)

Derating Curve

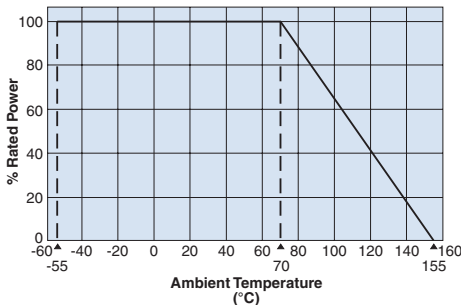

For resistors operated at an ambient temperature of 70°C or above, a power rating shall be derated in accordance with the above derating curve.

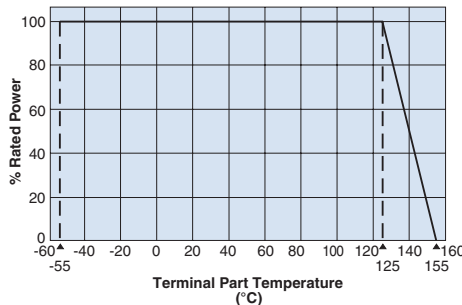

For resistors operated terminal temperature of described for each size or above, a power rating shall be derated in accordance with the derating curve. Please refer to "Introduction of the derating curve based on the terminal part temperature" in the beginning of our catalog before use.

ordering information

WG73	2H	T	TE	101	K
Type	Power Rating 2B: 1W 2H: 1.5W 3A: 2W	Termination Surface Material T : Sn	Packaging TD: 4mm pitch punch paper TE: 4mm pitch embossed plastic For further information on packaging, please refer to Appendix A	Nominal Resistance 3 digits	Resistance Tolerance K: ±10% M: ±20%

applications and ratings

Part Designation	Power Rating	Rated Ambient Temperature	Rated Terminal Part Temperature	T.C.R. (X 10 ⁻⁶ /K)	Resistance Range (Ω)		Maximum Working Voltage	Maximum Overload Voltage	Operating Temperature Range
					K±10% E-12	M±20% E-12			
WG732B	1.0W	70°C	±125°C	±100	560m ~ 1k	560m ~ 1k	200V	400V	-55°C to +155°C
WG732H	1.5W	70°C	±125°C	±100	560m ~ 1k	560m ~ 1k	200V	400V	-55°C to +155°C
WG733A	2.0W	70°C	±125°C	±100	560m ~ 1k	560m ~ 1k	200V	400V	-55°C to +155°C

Rated voltage = $\sqrt{\text{Power rating} \times \text{resistance value}}$ or max. working voltage, whichever is lower

If any questions arise whether to use the "Rated Ambient Temperature" or the "Rated Terminal Part Temperature" in your usage conditions, please give priority to the "Rated Terminal Part Temperature."

Prior to use and for more details, please refer to the "Introduction of the derating curves based on the terminal part temperature" in the beginning of our catalog.

environmental applications

Temperature Rise

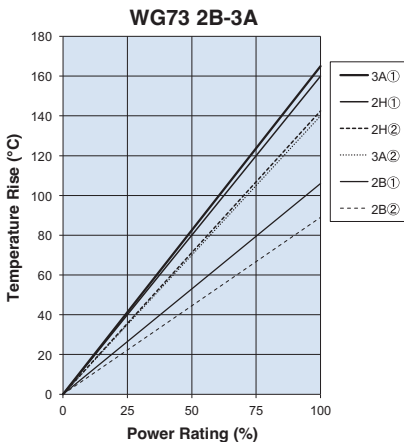

Regarding the temperature rise, the value of the temperature varies per conditions and board for use since the temperature is measured under our measuring conditions.

Measurement condition
 Room temperature: 25°C
 PCB: FR-4t = 1.6mm
 Cu foil thickness: 35μm

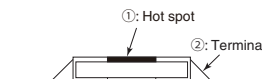

One-Pulse Limiting Electric Power

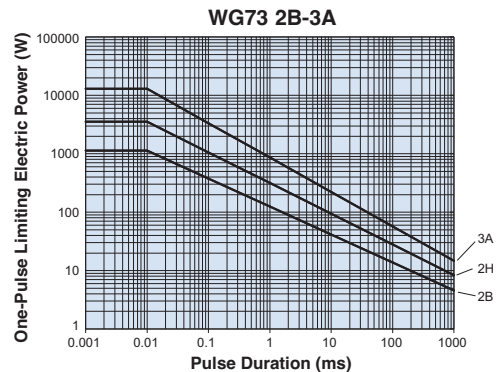

The maximum applicable voltage is equal to the max. overload voltage. Please ask us about the resistance characteristic of continuous applied pulse. The pulse endurance values are not assured values, so be sure to check the products on actual equipment when you use them.

Performance Characteristics

Parameter	Requirement Δ R ±(%+0.005Ω)		Test Method
	Limit	Typical	
Resistance	Within specified tolerance	—	25°C
T.C.R.	Within specified T.C.R.	—	+25°C/-55°C and +25°C/+125°C
Overload (Short time)	±2%	±0.2%	Rated voltage (DC) x 2.5 for 5 seconds
Resistance to Solder Heat	±1%	±0.2%	260°C ± 5°C, 10 seconds ± 1 second
Bending Test	±1%	±0.1%	Holding point 90mm, Bending 1 time, Bending 5mm
Rapid Change of Temperature	±2%	±1%	-55°C (30 minutes), +125°C (30 minutes), 1000 cycles
Moisture Resistance	±2%	±0.2%	40°C ± 2°C, 90%-95% RH, 1000 hours, 1.5 hr ON, 0.5 hr OFF cycle
Endurance at 70°C	±2%	±0.2%	70°C ± 2°C, 1000 hours, 1.5 hr ON, 0.5 hr OFF cycle
High Temperature Exposure	±1%	±0.2%	+155°C, 1000 hours

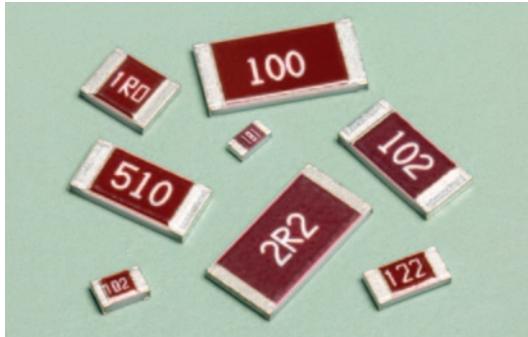

features

- Superior to RK73 series chip resistors in surge withstanding voltage and pulse withstanding voltage
- Suitable for both reflow and flow solderings
- Products with lead-free terminations meet EU RoHS requirements. EU RoHS regulation is not intended for Pb-glass contained in electrode, resistor element and glass.
- AEC-Q200 Tested: 0603(1J), 0805(2A), 1206(2B), 1210(2E), 2010(2H/W2H), 2512(3A/W3A)

dimensions and construction

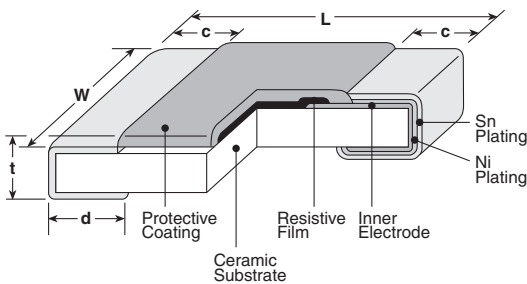

Derating Curve

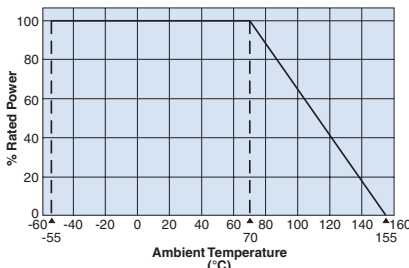

For resistors operated at an ambient temperature of 70°C or above, a power rating shall be derated in accordance with the derating curve.

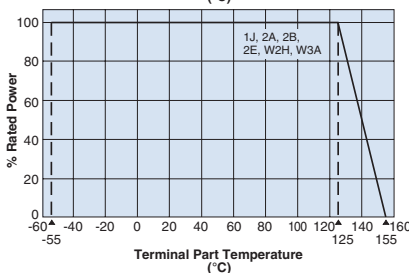

For resistors operated at a terminal part temperature of described for each size or above, a power rating shall be derated in accordance with the derating curve.

Please refer to "Introduction of the derating curve based on the terminal part temperature" in the beginning of our catalog before use.

Type (Inch Size Code)	Dimensions inches (mm)				
	L	W	c	d	t
SG731J (0603)	.063±.008 (1.6±0.2)	.031±.004 (0.8±0.1)	.012±.004 (0.3±0.1)	.012±.004 (0.3±0.1)	.018±.004 (0.45±0.1)
SG731J AT (0603)			.014±.006 (0.35±0.15)	.02±.008 (0.5±0.2)	
SG732A (0805)	.079±.008 (2.0±0.2)	.049±.004 (1.25±0.1)	.016±.008 (0.4±0.2)	.012 ^{+0.008} _{-.004} (0.3 ^{+0.2} _{-.01})	.02±.004 (0.5±0.1)
SG732A AT (0805)			.018±.010 (0.45±0.25)	.024±.008 (0.6±0.2)	
SG732B (1206)	.126±.008 (3.2±0.2)	.063±.008 (1.6±0.2)	.02±.012 (0.5±0.3)	.016 ^{+0.008} _{-.004} (0.4 ^{+0.2} _{-.01})	.024±.004 (0.6±0.1)
SG732B AT (1206)			.022±.014 (0.55±0.35)	.031±.008 (0.8±0.2)	
SG732E (1210)	.197±.008 (5.0±0.2)	.098±.008 (2.5±0.2)	.02±.012 (0.5±0.3)	.016 ^{+0.008} _{-.004} (0.4 ^{+0.2} _{-.01})	.024±.004 (0.6±0.1)
SG732H (2010)					
SG73W2H (2010)	.248±.008 (6.3±0.2)	.122±.008 (3.1±0.2)	.02±.012 (0.5±0.3)	.026±.006 (0.65±0.15)	.024±.004 (0.6±0.1)
SG733A (2512)				.016 ^{+0.008} _{-.004} (0.4 ^{+0.2} _{-.01})	
SG73W3A (2512)				.026±.006 (0.65±0.15)	

ordering information

SG73	2B		T	TD	102	K
Type	Size	Characteristics	Termination Material	Packaging	Nominal Resistance	Tolerance
SG73	1J 2A 2B 2E W2H W3A 2H 3A	Nil: Standard A: Heat shock resistance *1 *1 With type A, only T is available as the terminal surface material. *2 With SG73 W2H, W3A only the symbol T is available as the terminal surface material. The terminal surface material lead free is standard. For further information on packaging, please refer to Appendix A	T: Sn (L: Sn/Pb*)	TP: 0603, 0805: 7" 2mm pitch punch paper TD: 0603, 0805, 1206, 1210: 7" 4mm pitch punched paper TE: 0805, 1206, 1210, 2010 & 2512: 7" 4mm embossed plastic	±10%, ±20%: 2 significant figures + 1 multiplier "R" indicates decimal on value <10Ω	K: ±10% M: ±20%

Specifications given herein may be changed at any time without prior notice. Please confirm technical specifications before you order and/or use.

10/24/23

applications and ratings

Part Designation	Power Rating	Rated Ambient Temp.	Rated Terminal Part Temp.	T.C.R. (ppm/°C) Max.	Resistance Range (E-12) (K±10%, M±20%)	Absolute Maximum Working Voltage	Absolute Maximum Overload Voltage	Operating Temp. Range
SG731J (0603)	0.1W	70°C	125°C	±400	1Ω - 8.2Ω	50V	100V	-55°C to +155°C
SG732A (0805)	0.125W	70°C	125°C	±200	10Ω - 1MΩ			
SG732B (1206)	.33W	70°C	125°C	±400	1Ω - 8.2Ω	150V	200V	
SG732E (1210)	0.5W	70°C	125°C	±200	10Ω - 1MΩ			
SG732H/W2H (2010)	0.75W	70°C	125°C	±400	1Ω - 8.2Ω	200V	400V	
SG733A/W3A (2512)	1W	70°C	125°C	±200	10Ω - 1MΩ			

Parentheses indicate EIA package size codes. Rated voltage = $\sqrt{\text{Power rating} \times \text{resistance value}}$ or max. working voltage, whichever is lower. If any questions should arise whether to use the "Rated Ambient Temperature" or the "Rated Terminal Part Temperature," please give priority to the "Rated Terminal Part Temperature." Prior to use and for more details refer to "Introduction of the derating curves on the terminal part temperature" in the beginning of the catalog.

environmental applications

Temperature Rise

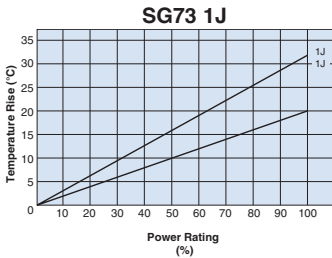

Regarding the temperature rise, the value of the temperature varies per conditions and board for use since the temperature is measured under our measuring conditions.

Measurement condition
Room temperature: 25°C
PCB: FR-4t = 1.6mm
Cu foil thickness: 35μm

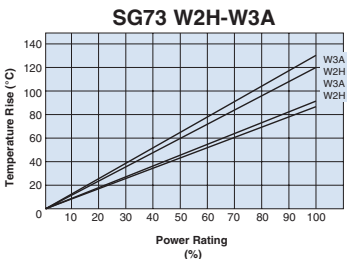
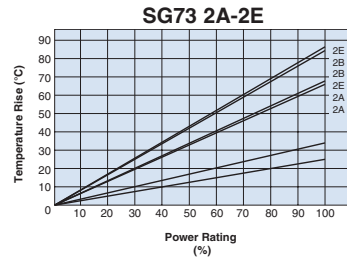
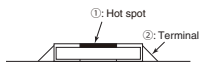

One-Pulse Limiting Electric Power

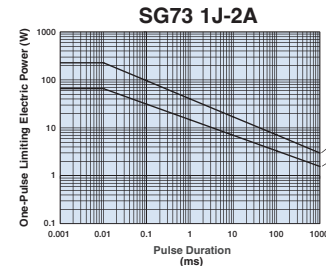

The maximum applicable voltage is equal to the max. overload voltage. Please contact factory for resistance characteristics of continuous applied pulse.

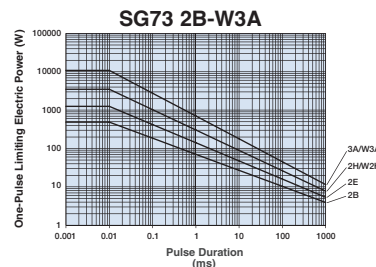

Performance Characteristics

Parameter	Requirement $\Delta R \pm(\%+0.1\Omega)$		Test Method
	Limit	Typical	
Resistance	Within specified tolerance	—	25°C
T.C.R.	Within specified T.C.R.	—	+25°C/-55°C and +25°C/+125°C
Overload (Short time)	±2%	±0.5%	Rated Voltage x 2.5 for 5 seconds
Resistance to Solder Heat	±1%	±0.75%	260°C ± 5°C, 10 seconds ± 1 second
Rapid Change of Temperature	±0.5%: Characteristic (Nil) Standard ±1%: Characteristic (A) Heat Shock Resistance	±0.3%: Characteristic (Nil) Standard ±0.5%: Characteristic (A) Heat Shock Resistance	Characteristic (Nil) Standard: -55°C (30 min.)/+125°C (30 min.) 100 cycles Characteristic (A) Heat Shock Resistance: -55°C (30 min.)/+125°C (30 min.) 1000 cycles
Moisture Resistance	±3%	±0.75%	40°C ± 2°C, 90%~95%RH, 1000 hours; 1.5 hr ON, 0.5 hr OFF cycle
Endurance at 70°C	±3%	±0.75%	70°C ± 2°C, 1000 hours, 1.5 hr ON, 0.5 hr OFF cycle
High Temperature Exposure	±1%	±0.3%	+155°C, 1000 hours

Additional environmental applications can also be found at www.koaspeer.com

Specifications given herein may be changed at any time without prior notice. Please confirm technical specifications before you order and/or use.

5/11/22

**anti-surge endured pulse power
thick film chip resistor**

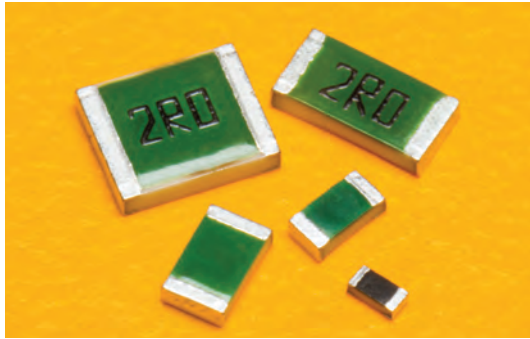

features

- Superior to RK73B/RK73H series in pulse withstanding voltage and high power
- Down to $\pm 0.5\%$ tolerance
- Suitable for both reflow and flow solderings
- Products with lead-free terminations meet EU RoHS requirements. EU RoHS regulation is not intended for Pb-glass contained in electrode, resistor element and glass.
- AEC-Q200 Tested

dimensions and construction

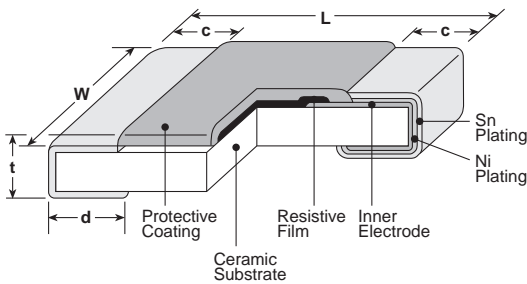

Derating Curve

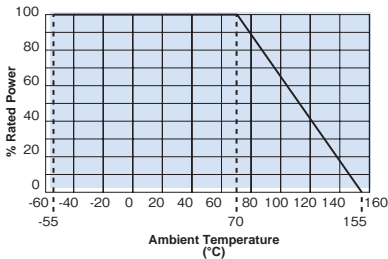

For resistors operated at an ambient temperature of 70°C or above, a power rating shall be derated in accordance with the derating curve.

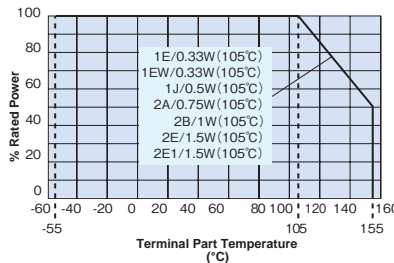
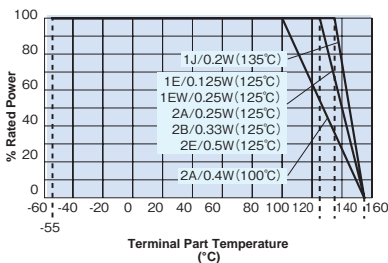

When the terminal part temperature of the resistor exceeds the rated terminal part temperature in the Applications and Ratings chart, the power shall be derated according to the derating curves on the left.

If you want to use at the rated power of ^{*1,3}, please use the derating curves based on the terminal part temperature of the far left graph.

Please refer to "Introduction of the derating curves based on the terminal part temperature" on the beginning of our catalog before use.

Type (Inch Size Code)	Dimensions inches (mm)				
	L	W	c	d	t
SG73P1E (0402)	.039 ^{+0.004} _{-.002} (1.0 ^{+0.1} _{-0.05})	.02±.002 (0.5±0.05)	.006±.004 (0.15±0.1)	.010 ^{+0.002} _{-.004} (0.25 ^{+0.05} _{-0.1})	.014±.002 (0.35±0.05)
SG73P1EW (0402)	.039 ^{+0.004} _{-.002} (1.0 ^{+0.1} _{-0.05})	.02±.002 (0.5±0.05)	.006±.004 (0.15±0.1)	.010 ^{+0.002} _{-.004} (0.25 ^{+0.05} _{-0.1})	.014±.002 (0.35±0.05)
SG73P1J (0603)	.063±.008 (1.6±0.2)	.031±.004 (0.8±0.1)	.012±.004 (0.3±0.1)	.012±.004 (0.3±0.1)	.018±.004 (0.45±0.1)
SG73P1J AT (0603)			.014±.006 (0.35±0.15)	.02±.008 (0.5±0.2)	
SG73P2A (0805)	.079±.008 (2.0±0.2)	.049±.004 (1.25±0.1)	.012 ^{+0.008} _{-.004} (0.3 ^{+0.2} _{-0.1})	.012 ^{+0.008} _{-.004} (0.3 ^{+0.2} _{-0.1})	.02±.004 (0.5±0.1)
SG73P2A AT (0805)			.018±.010 (0.45±0.25)	.024±.008 (0.6±0.2)	
SG73P2B (1206)	.126±.008 (3.2±0.2)	.063±.008 (1.6±0.2)	.016 ^{+0.008} _{-.004} (0.4 ^{+0.2} _{-0.1})	.016 ^{+0.008} _{-.004} (0.4 ^{+0.2} _{-0.1})	.024±.004 (0.6±0.1)
SG73P2B AT (1206)			.022±.014 (0.55±0.35)	.031±.008 (0.8±0.2)	
SG73P2E SG73P2E1 (1210)			.102±.008 (2.6±0.2)	.016 ^{+0.008} _{-.004} (0.4 ^{+0.2} _{-0.1})	

ordering information

SG73P	2B		T	TD	1001	F
Type	Size	Characteristic	Termination Material	Packaging	Nominal Resistance	Tolerance
SG73P	1E 1EW 1J 2A 2B 2E 2E1	Nil: Standard A: Heat shock resistance * * 1J, 2A, and 2B are available for heat shock resistance Contact us when you have control request for environmental hazardous material other than the substance specified by EU RoHS. For further information on packaging, please refer to Appendix A	T: Sn	TP: 0402, 0603, 0805: 7" 2mm pitch punch paper TD: 0603, 0805, 1206, 1210: 7" 4mm pitch punched paper TE: 0805, 1206, 1210: 7" 4mm embossed plastic	$\pm 0.5\%$, $\pm 1\%$: 3 significant figures + 1 multiplier "R" indicates decimal on value <100Ω $\pm 2\%$, $\pm 5\%$: 2 significant figures + 1 multiplier "R" indicates decimal on value <10Ω	D: $\pm 0.5\%$ F: $\pm 1\%$ G: $\pm 2\%$ J: $\pm 5\%$

Specifications given herein may be changed at any time without prior notice. Please confirm technical specifications before you order and/or use.

9/10/24

**anti-surge endured pulse power
thick film chip resistor**
applications and ratings

Part Designation	Power Rating	Rated Ambient Temp.	Rated Terminal Part Temp.	T.C.R. (ppm/°C) Max.	Resistance Range (Ω)			Absolute Maximum Working Voltage	Absolute Maximum Overload Voltage	Operating Temp. Range
					(E-24)/E-96 (D±0.5%)	(E-24)/E-96 (F±1%)	(E-24) (G±2%, J±5%)			
SG73P1E (0402)	0.125W	70°C	125°C	±200	10 - 1M	1 - 1M	1 - 10M	75V	100V	-55°C to +155°C
	0.33W	—	105°C							
SG73P1EW (0402)	0.25W*1	70°C	125°C	±100	10 - 1M	10 - 1M	10 - 1M	75V	100V	
	0.33W	—	105°C	±200	—	1 - 9.76	1 - 9.1 1.1M - 10M			
SG73P1J (0603)	0.2W	70°C	135°C	±100	510 - 576k	510 - 576k	510 - 560k	150V	200V	
				±100**	10 - 499 590k - 1M	1 - 499 590k - 1M	1 - 470 620k - 10M			
	0.5W	—	105°C	±100	510 - 576k	510 - 576k	510 - 560k			
				±100**	10 - 499 590k - 1M	1 - 499 590k - 1M	1 - 470 620k - 10M			
SG73P2A (0805)	0.25W	70°C	125°C	±100	100 - 100k	100 - 100k	100 - 100k	400V	600V (800V)**	
				±200	10 - 97.6 102k - 1M	1 - 97.6 102k - 1M	1 - 91 110k - 10M			
SG73P2A (0805)	0.75W	—	105°C	±100	100 - 100k	100 - 100k	100 - 100k	400V	600V (800V)**	
				±200	10 - 97.6 102k - 1M	1 - 97.6 102k - 1M	1 - 91 110k - 10M			
SG73P2B (1206)	0.33W	70°C	125°C	±100	300 - 1M	300 - 1M	300 - 1.1M	200V	400V	
				±200	10 - 294	1 - 294	1 - 270 1.2M - 10M			
SG73P2B (1206)	1W	—	105°C	±100	300 - 1M	300 - 1M	300 - 1.1M	200V	400V	
				±200	10 - 294	1 - 294	1 - 270 1.2M - 10M			
SG73P2E (1210)	0.5W	70°C	125°C	±200	10 - 1M	1 - 1M	1 - 10M	200V	400V	
				±100	10 - 1M	1 - 1M	1 - 10M			
SG73P2E (1210)	1.5W	—	105°C	±200	10 - 1M	1 - 1M	1 - 10M	200V	400V	
				±100	10 - 1M	1 - 1M	1 - 10M			
SG73P2E1 (1210)	1.5W	—	105°C	±200	10 - 1M	1 - 1M	1 - 10M	200V	400V	

Parentheses indicate EIA package size codes. Rated voltage = $\sqrt{\text{Power rating} \times \text{resistance value}}$ or max. working voltage, whichever is lower. *1 Rated power derating applies only if permitted Terminal Part Temp is not exceeded. ** Cold T.C.R. (-55°C ~ +25°C) is $+150 \times 10^{-6}/\text{K}$ ** Applies when power rating is 0.4W or lower. Please contact KOA Speer for how to handle a specific surge/pulse. If any questions should arise whether to use the "Rated Ambient Temperature" or the "Rated Terminal Part Temperature," please give priority to the "Rated Terminal Part Temperature." Prior to use and for more details refer to "Introduction of the derating curves on the terminal part temperature" in the beginning of the catalog.

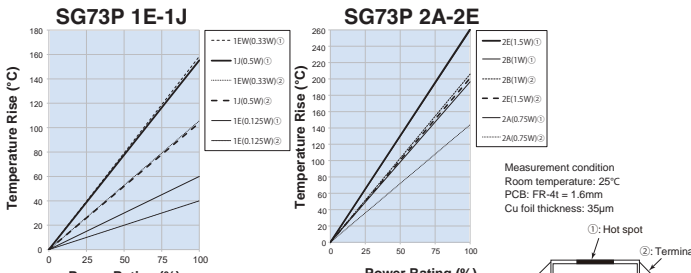
environmental applications
Temperature Rise

Regarding the temperature rise, the value of the temperature varies per conditions and board for use since the temperature is measured under our measuring conditions.

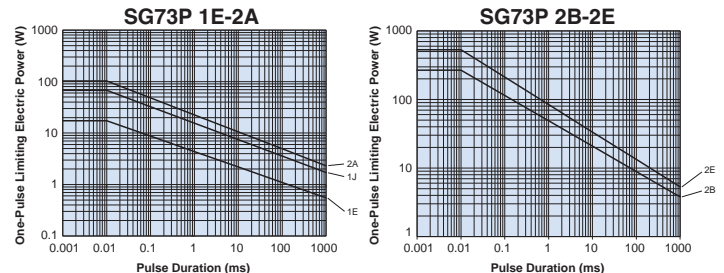
One-Pulse Limiting Electric Power

The maximum applicable voltage is equal to the max. overload voltage.
 Please ask us about the resistance characteristic of continuous applied pulse.
 The pulse endurance values are not assured values, so be sure to check the products on actual equipment when you use them.

Performance Characteristics

Parameter	Requirement $\Delta R \pm(\%+0.1\%)$		Test Method													
	Limit	Typical														
Resistance	Within specified tolerance	—	25°C													
T.C.R.	Within specified T.C.R.	—	+25°C/-55°C and +25°C/+125°C													
Overload (Short time)	±2%	±0.5%	Overload for 5s													
			<table border="1"> <thead> <tr> <th>Type</th> <th>1E</th> <th>1EW</th> <th>1J</th> <th>2A</th> <th>2B</th> <th>2E</th> <th>2E1</th> </tr> </thead> <tbody> <tr> <td>Overload</td> <td>1.25W</td> <td>1.25W</td> <td>2.063W</td> <td>2W (1.6W*3)</td> <td>3W</td> <td>4W</td> <td>4W</td> </tr> </tbody> </table>	Type	1E	1EW	1J	2A	2B	2E	2E1	Overload	1.25W	1.25W	2.063W	2W (1.6W*3)
Type	1E	1EW	1J	2A	2B	2E	2E1									
Overload	1.25W	1.25W	2.063W	2W (1.6W*3)	3W	4W	4W									
Resistance to Solder Heat	±1%	±0.75%	260°C ± 5°C, 10 seconds ± 1 second													
Rapid Change of Temperature	±0.5%: Characteristic (Nil) Standard ±1%: Characteristic (A) Heat Shock Resistance	±0.3%: Characteristic (Nil) Standard ±0.5%: Characteristic (A) Heat Shock Resistance	Characteristic (Nil) Standard: -55°C (30 min.)/+125°C (30 min.) 100 cycles Characteristic (A) Heat Shock Resistance: -55°C (30 min.)/+125°C (30 min.) 1000 cycles													
Moisture Resistance	±3%	±0.75%	40°C ± 2°C, 90%~95%RH, 1000 hours; 1.5 hr ON, 0.5 hr OFF cycle													
Endurance at 70°C	±3%	±0.75%	70°C ± 2°C or rated terminal part temperature ± 2°C 1000h; 1.5h ON/0.5h OFF cycle													
High Temperature Exposure	±1%	±0.3%	+155°C, 1000 hours													

Additional environmental applications can also be found at www.koaspeer.com

Specifications given herein may be changed at any time without prior notice. Please confirm technical specifications before you order and/or use.

9/04/24

**anti-surge endured surge voltage
thick film chip resistor**

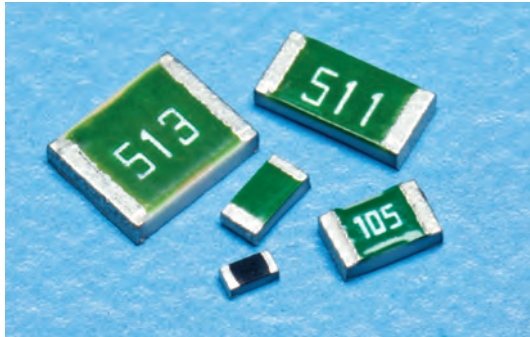

features

- Superior to RK73B/RK73H series in surge withstanding voltage and high power
- ESD withstanding; down to $\pm 0.5\%$ tolerance
- Suitable for both reflow and flow solderings
- Products with lead-free terminations meet EU RoHS requirements. EU RoHS regulation is not intended for Pb-glass contained in electrode, resistor element and glass.
- AEC-Q200 Tested

dimensions and construction

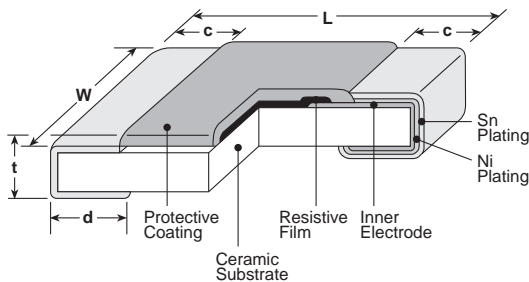

Type (Inch Size Code)	Dimensions inches (mm)				
	L	W	c	d	t
SG73S1E (0402)	.039 ^{+0.004} _{-.002} (1.0 ^{+0.1} _{-0.05})	.02±.002 (0.5±0.05)	.006±.004 (0.15±0.1)	.010 ^{+0.002} _{-.004} (0.25 ^{+0.05} _{-0.1})	.014±.002 (0.35±0.05)
SG73S1J (0603)	.063±.008 (1.6±0.2)	.031±.004 (0.8±0.1)	.012±.004 (0.3±0.1)	.012±.004 (0.3±0.1)	.018±.004 (0.45±0.1)
SG73S1J AT (0603)			.014±.006 (0.35±0.15)	.02±.008 (0.5±0.2)	
SG73S2A (0805)	.079±.008 (2.0±0.2)	.049±.004 (1.25±0.1)	.012 ^{+0.008} _{-.004} (0.3 ^{+0.2} _{-0.1})	.012 ^{+0.008} _{-.004} (0.3 ^{+0.2} _{-0.1})	.02±.004 (0.5±0.1)
SG73S2A AT (0805)			.018±.010 (0.45±0.25)	.024±.008 (0.6±0.2)	
SG73S2B (1206)	.126±.008 (3.2±0.2)	.063±.008 (1.6±0.2)	.016 ^{+0.008} _{-.004} (0.4 ^{+0.2} _{-0.1})	.016 ^{+0.008} _{-.004} (0.4 ^{+0.2} _{-0.1})	.024±.004 (0.6±0.1)
SG73S2B AT (1203)			.022±.014 (0.55±0.35)	.031±.008 (0.8±0.2)	
SG73S2E SG73S2E1 (1210)			.102±.008 (2.6±0.2)	.016 ^{+0.008} _{-.004} (0.4 ^{+0.2} _{-0.1})	

ordering information

SG73S	2B		T	TD	1001	F
Type	Size	Characteristic	Termination Material	Packaging	Nominal Resistance	Tolerance
SG73S	1E 1J 2A 2B 2E 2E1	Nil: Standard A: Heat shock resistance *	T: Sn	TP: 0402, 0603, 0805: 7" 2mm pitch punch paper TD: 0603, 0805, 1206, 1210: 7" 4mm pitch punched paper TE: 0805, 1206, 1210: 7" 4mm embossed plastic	$\pm 0.5\%$, $\pm 1\%$: 3 significant figures + 1 multiplier "R" indicates decimal on value <100 Ω $\pm 2\%$, $\pm 5\%$: 2 significant figures + 1 multiplier "R" indicates decimal on value <10 Ω	D: $\pm 0.5\%$ F: $\pm 1\%$ G: $\pm 2\%$ J: $\pm 5\%$

* With type A, only T is available as the terminal surface material.

Contact us when you have control request for environmental hazardous material other than the substance specified by EU RoHS.

For further information on packaging, please refer to Appendix A

applications and ratings

Part Designation	Power Rating	Rated Ambient Temp.	Rated Terminal Part Temp.	T.C.R. (ppm/°C) Max.	Resistance Range (Ω)			Maximum Working Voltage	Maximum Overload Voltage	Operating Temp. Range
					(E-24)/E-96 (D±0.5%)	(E-24)/E-96 (F±1%)	(E-24) (G±2%, J±5%)			
SG73S1E (0402)	0.125W	70°C	125°C	±200	10 - 1M	1 - 1M	1 - 10M	75V	100V	-55°C to +155°C
	0.33W	—	105°C							
SG73S1J (0603)	0.2W	70°C	135°C	±100	510 - 576k	510 - 576k	510 - 560k	150V	200V	
				±100* ¹	10 - 499	1 - 499	1 - 470			
	0.5W	—	105°C	±100	510 - 576k	510 - 576k	510 - 560k			
				±100* ¹	10 - 499	1 - 499	1 - 470			
SG73S2A (0805)	0.25W	70°C	125°C	±200	10 - 1M	1 - 1M	1 - 10M	400V	600V (800V)* ²	
	0.75W	—	105°C							
SG73S2B (1206)	0.33W	70°C	125°C	±200	10 - 1M	1 - 1M	1 - 10M	200V	400V	
	1W	—	105°C							
SG73S2E (1210)	0.5W	70°C	125°C	±200	10 - 1M	1 - 1M	1 - 10M	200V	400V	
	1.5W	—	105°C							
SG73S2E1 (1210)	1.5W	—	105°C	±200	10 - 1M	1 - 1M	1 - 10M	200V	400V	

*¹ Cold T.C.R. (-55°C ~ +25°C) is +150 x 10⁻⁶/K

*² Applies when power rating is 0.4W or lower.

Rated voltage = $\sqrt{\text{Power rating} \times \text{resistance value}}$ or max. working voltage, whichever is lower

Please contact KOA Speer for how to handle a specific surge/pulse

If any questions should arise whether to use the "Rated Ambient Temperature" or the "Rated Terminal Part Temperature," please give priority to the "Rated Terminal Part Temperature." Prior to use and for more details refer to "Introduction of the derating curves on the terminal part temperature" in the beginning of the catalog.

environmental applications

Derating Curve

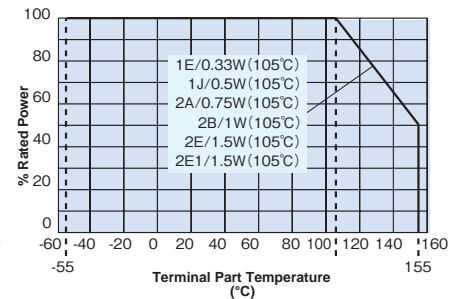
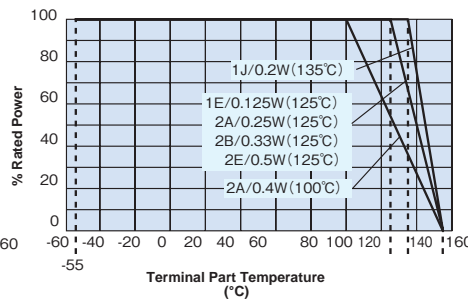
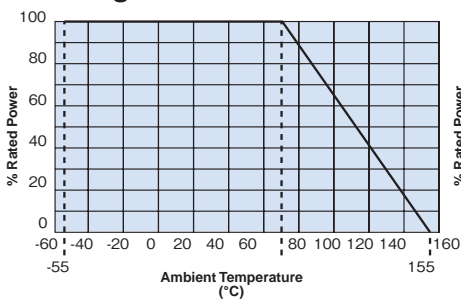

For resistors operated at an ambient temperature of 70°C or above, a power rating shall be derated in accordance with the derating curve.

For resistors operated at a terminal part temperature of described for each size or above, a power rating shall be derated in accordance with the derating curve.

Please refer to "Introduction of the derating curve based on the terminal part temperature" in the beginning of our catalog before use.

If you want to use the rated power of *², please use the derating curve based on the terminal part temperature above.

Additional environmental applications can also be found at www.koaspeer.com

Specifications given herein may be changed at any time without prior notice. Please confirm technical specifications before you order and/or use.

9/04/24

**anti-surge endured surge voltage
thick film chip resistor**

environmental applications (continued)

ESD Limiting Voltage

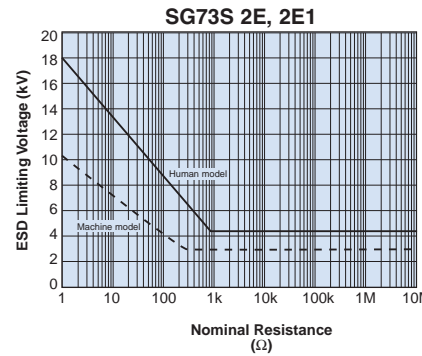
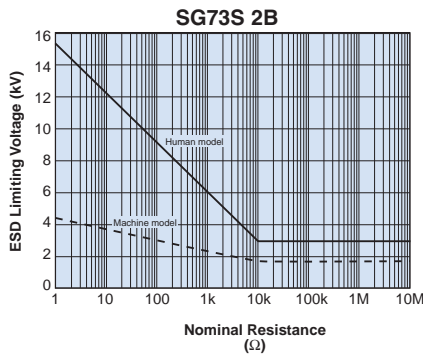
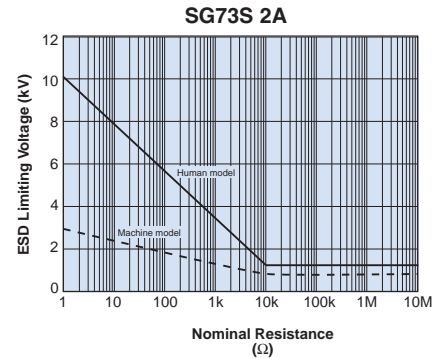
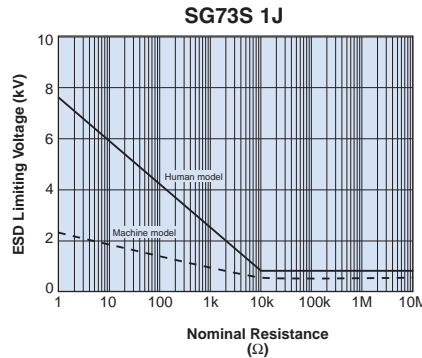
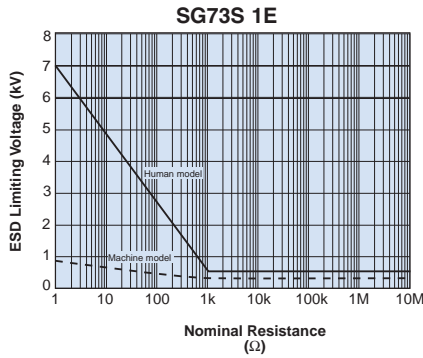

Temperature Rise

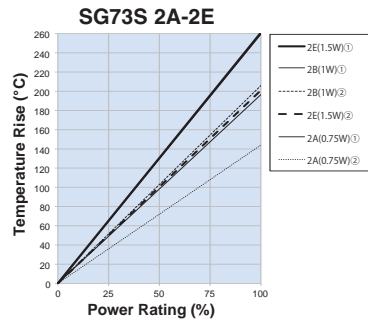
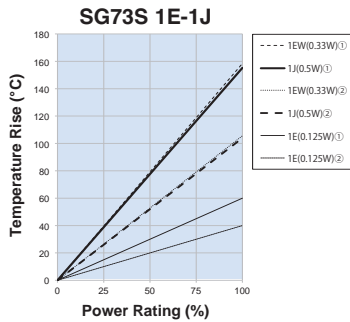

Regarding the temperature rise, the value of the temperature varies per conditions and board for use since the temperature is measured under our measuring conditions.

Measurement condition
Room temperature: 25°C
PCB: FR-4t = 1.6mm
Cu foil thickness: 35μm

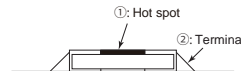

Performance Characteristics

Parameter	Requirement $\Delta R \pm(\%+0.1\Omega)$		Test Method														
	Limit	Typical															
Resistance	Within specified tolerance	—	25°C														
T.C.R.	Within specified T.C.R.	—	+25°C/-55°C and +25°C/+125°C														
Overload (Short time)	$\pm 2\%$	$\pm 0.5\%$	Overload for 5s <table border="1"> <tr> <th>Type</th> <th>1E</th> <th>1J</th> <th>2A</th> <th>2B</th> <th>2E</th> <th>2E1</th> </tr> <tr> <td>Overload</td> <td>1.25W</td> <td>2.063W</td> <td>2W (1.6W*2)</td> <td>3W</td> <td>4W</td> <td>4W</td> </tr> </table>	Type	1E	1J	2A	2B	2E	2E1	Overload	1.25W	2.063W	2W (1.6W*2)	3W	4W	4W
Type	1E	1J	2A	2B	2E	2E1											
Overload	1.25W	2.063W	2W (1.6W*2)	3W	4W	4W											
Resistance to Solder Heat	$\pm 1\%$	$\pm 0.75\%$	260°C \pm 5°C, 10 seconds \pm 1 second														
Rapid Change of Temperature	$\pm 0.5\%$: Characteristic (Nil) Standard $\pm 1\%$: Characteristic (A) Heat Shock Resistance	$\pm 0.3\%$: Characteristic (Nil) Standard $\pm 0.5\%$: Characteristic (A) Heat Shock Resistance	Characteristic (Nil) Standard: -55°C (30 min.)/+125°C (30 min.) 100 cycles Characteristic (A) Heat Shock Resistance: -55°C (30 min.)/+125°C (30 min.) 1000 cycles														
Moisture Resistance	$\pm 3\%$	$\pm 0.75\%$	40°C \pm 2°C, 90%~95%RH, 1000 hours; 1.5 hr ON, 0.5 hr OFF cycle														
Endurance at 70°C	$\pm 3\%$	$\pm 0.75\%$	70°C \pm 2°C or rated terminal part temp. \pm 2°C 1000 hours; 1.5 hr ON, 0.5 hr OFF cycle														
High Temperature Exposure	$\pm 1\%$	$\pm 0.3\%$	+155°C, 1000 hours														

Specifications given herein may be changed at any time without prior notice. Please confirm technical specifications before you order and/or use.

8/09/24

endured pulse power flat chip resistors (ultra precision grade)

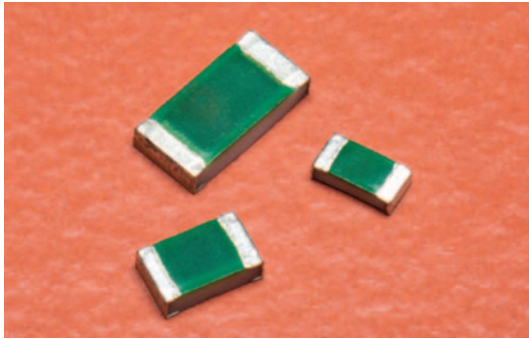

features

- Superior to RK73 series chip resistors in pulse withstanding voltage and high power
- High Precision resistor with T.C.R. $\pm 50 \times 10^{-6}/K$ and Tolerance $\pm 0.25\%$
- Suitable for both reflow and flow solderings
- Products with lead-free terminations meet EU RoHS requirements. EU RoHS regulation is not intended for Pb-glass contained in electrode, resistor element and glass.
- AEC-Q200 Tested

dimensions and construction

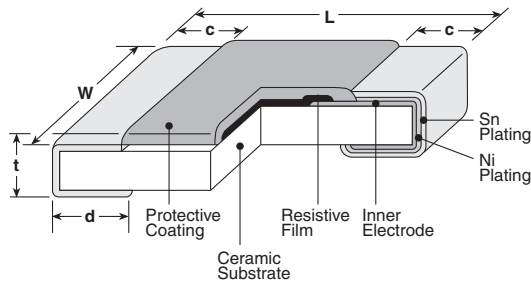

Type (Inch Size Code)	Dimensions inches (mm)				
	L	W	c	d	t
SG73G1J (0603)	.063±.008 (1.6±0.2)	.031±.004 (0.8±0.1)	.012±.004 (0.3±0.1)	.012±.004 (0.3±0.1)	.018±.004 (0.45±0.1)
SG73G1J AT (0603)			.014±.006 (0.35±0.15)	.02±.008 (0.5±0.2)	
SG73G2A (0805)	.079±.008 (2.0±0.2)	.049±.004 (1.25±0.1)	.012 ^{+0.008} _{-0.004} (0.3 ^{+0.2} _{-0.1})	.012 ^{+0.008} _{-0.004} (0.3 ^{+0.2} _{-0.1})	.02±.004 (0.5±0.1)
SG73G2A AT (0805)			.018±.010 (0.45±0.25)	.024±.008 (0.6±0.2)	
SG73G2B (1206)	.126±.008 (3.2±0.2)	.063±.008 (1.6±0.2)	.016 ^{+0.008} _{-0.004} (0.4 ^{+0.2} _{-0.1})	.016 ^{+0.008} _{-0.004} (0.4 ^{+0.2} _{-0.1})	.024±.004 (0.6±0.1)
SG73G2B AT (1206)			.022±.014 (0.55±0.35)	.031±.008 (0.8±0.2)	

Derating Curve

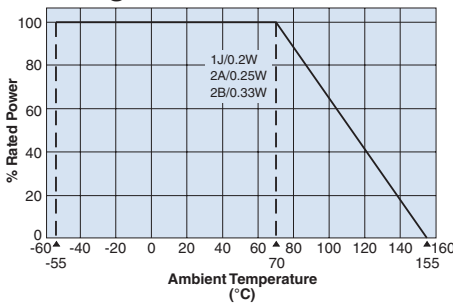

For resistors operated at an ambient temperature of 70°C or above, a power rating shall be derated in accordance with the derating curve.

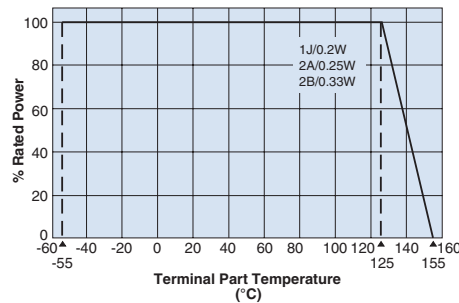

For resistors operated at a terminal part temperature of described for each size or above, a power rating shall be derated in accordance with the derating curve. Please refer to "Introduction of the derating curve based on the terminal part temperature" in the beginning of our catalog before use. *1 If you want to use the rated power of *1, please use the derating curve based on the terminal part temperature on the right hand side.

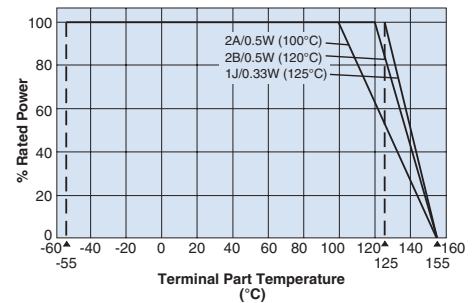

ordering information

SG73G	2A		T	TD	1002	D
Type	Power Rating	Characteristics	Termination Material	Packaging	Nominal Resistance	Tolerance
SG73G	1J 2A 2B	Nil: Standard A: Heat shock resistance *1	T: Sn	TP: 2mm pitch punch paper TD: 4mm pitch punched paper TE: 4mm pitch embossed plastic For further information on packaging, please refer to Appendix A	D: 3 significant figures + 1 multiplier "R" indicates decimal on value <100Ω	C: $\pm 0.25\%$ D: $\pm 0.5\%$

*1 With type A, only T is available as the terminal surface material. Contact us when you have control request for environmental hazardous material other than the substance specified by EU RoHS.

Specifications given herein may be changed at any time without prior notice. Please confirm technical specifications before you order and/or use.

11/09/23

applications and ratings

Part Designation	Power Rating	Rated Ambient Temp.	Rated Terminal Part Temp.	T.C.R. (ppm/°C) Max.	Resistance Range (Ω) C±0.25%, D±0.5% E-24/E-96	Absolute Maximum Working Voltage	Absolute Maximum Overload Voltage	Operating Temp. Range
SG73G1J (0603)	0.2W	70°C	125°C	±50	10 - 1M	150V	200V	-55°C to +155°C
	0.33W*1	70°C	125°C					
SG73G2A (0805)	0.25W	70°C	125°C	±50	10 - 1M	200V	400V	
	0.5W*1	70°C	100°C					
SG73G2B (1206)	0.33W	70°C	125°C	±50	10 - 1M	200V	400V	
	0.5W*1	70°C	120°C					

Parentheses indicate EIA package size codes. Rated voltage = $\sqrt{\text{Power rating} \times \text{resistance value}}$ or max. working voltage, whichever is lower. If any questions should arise whether to use the "Rated Ambient Temperature" or the "Rated Terminal Part Temperature," please give priority to the "Rated Terminal Part Temperature." Prior to use and for more details refer to "Introduction of the derating curves on the terminal part temperature" in the beginning of the catalog. *1 If you want to use the rated power of *1, please use the derating curve based on the terminal part temperature on the previous page.

environmental applications

Temperature Rise

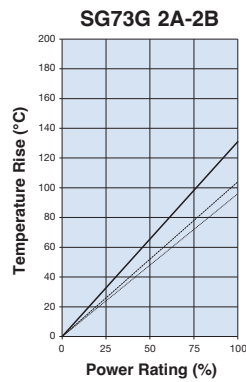
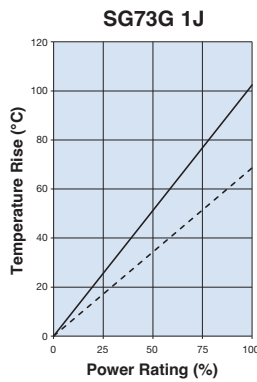

Measurement condition
Room temperature: 25°C
PCB: FR-4t = 1.6mm
Cu foil thickness: 35μm

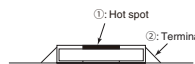

Regarding the temperature rise, the value of the temperature varies per conditions and board for use since the temperature is measured under our measuring conditions.

One-Pulse Limiting Electric Power

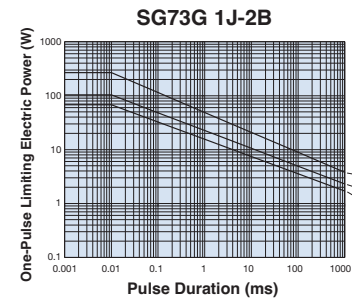

The maximum applicable voltage is equal to the max. overload voltage.

Please ask us about the resistance characteristic of continuous applied pulse.

The pulse endurance values are not assured values, so be sure to check the products on actual equipment when you use them.

Performance Characteristics

Parameter	Requirement $\Delta R \pm(\%+0.1\Omega)$		Test Method
	Limit	Typical	
Resistance	Within specified tolerance	—	25°C
T.C.R.	Within specified T.C.R.	—	+25°C/-55°C and +25°C/+125°C
Overload (Short time)	±2%	±0.5%	Rated Voltage x 2.5 for 5 seconds (2A: 0.5W rated voltage x 2 for 5 seconds)
Resistance to Solder Heat	±1%	±0.75%	260°C ± 5°C, 10 seconds ± 1 second
Rapid Change of Temperature	±0.5%: Characteristic (Nil) Standard ±1%: Characteristic (A) Heat Shock Resistance	±0.3%: Characteristic (Nil) Standard ±0.5%: Characteristic (A) Heat Shock Resistance	Characteristic (Nil) Standard: -55°C (30 min.)/+125°C (30 min.) 100 cycles Characteristic (A) Heat Shock Resistance: -55°C (30 min.)/+125°C (30 min.) 1000 cycles
Moisture Resistance	±2%	±0.75%	40°C ± 2°C, 90%~95%RH, 1000 hours; 1.5 hr ON, 0.5 hr OFF cycle
Endurance at 70°C	±2%	±0.75%	70°C ± 2°C, 1000 hours, 1.5 hr ON, 0.5 hr OFF cycle
High Temperature Exposure	±1%	±0.3%	+155°C, 1000 hours

Additional environmental applications can also be found at www.koaspeer.com

Specifications given herein may be changed at any time without prior notice. Please confirm technical specifications before you order and/or use.

11/09/23

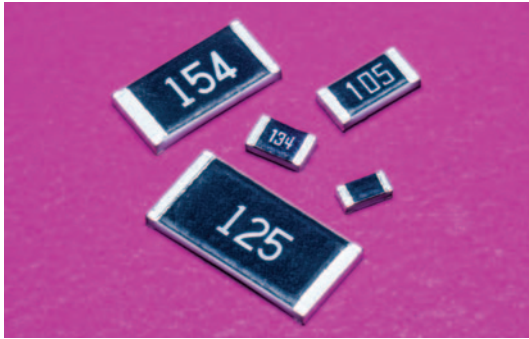

features

- Superior to RK73 series in maximum working voltage
- Products with lead-free terminations meet EU RoHS requirements. EU RoHS regulation is not intended for Pb-glass contained in electrode, resistor element and glass.

dimensions and construction

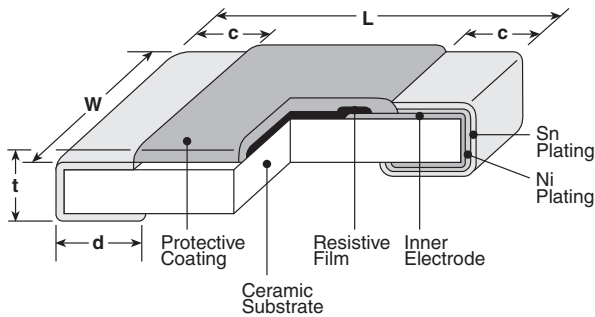

Type (Inch Size Code)	Dimensions inches (mm)				
	L	W	c	d	t
1J (0603)	.063±.008 (1.6±0.2)	.031±.004 (0.8±0.1)	.012±.004 (0.3±0.1)	.012±.004 (0.3±0.1)	.018±.004 (0.45±0.1)
2A (0805)	.079±.008 (2.0±0.2)	.049±.004 (1.25±0.1)	.016±.008 (0.4±0.2)	.012 ^{+0.008} _{-0.004} (0.3 ^{+0.2} _{-0.1})	.02±.004 (0.5±0.1)
2B (1206)	.126±.008 (3.2±0.2)	.063±.008 (1.6±0.2)	.02±.012 (0.5±0.3)	.016 ^{+0.008} _{-0.004} (0.4 ^{+0.2} _{-0.1})	.024±.004 (0.6±0.1)
2H (2010)	.197±.008 (5.0±0.2)	.098±.008 (2.5±0.2)	.02±.012 (0.5±0.3)	.016 ^{+0.008} _{-0.004} (0.4 ^{+0.2} _{-0.1})	.024±.004 (0.6±0.1)
3A (2512)	.248±.008 (6.3±0.2)	.122±.008 (3.1±0.2)	.02±.012 (0.5±0.3)	.016 ^{+0.008} _{-0.004} (0.4 ^{+0.2} _{-0.1})	.024±.004 (0.6±0.1)

Derating Curve

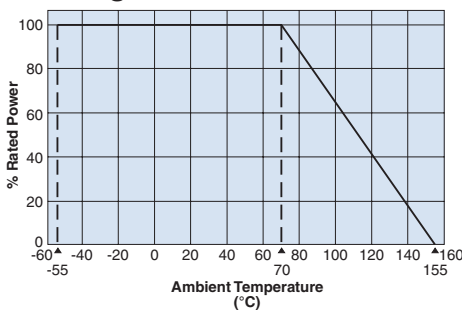

For resistors operated at an ambient temperature of 70°C or above, a power rating shall be derated in accordance with the above derating curve.

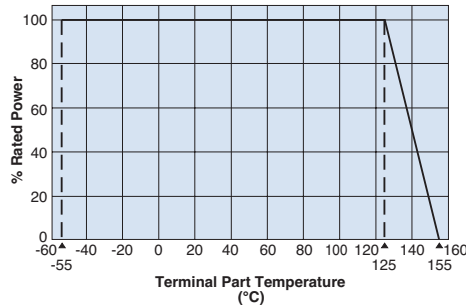

For resistors operated at a terminal part temperature of described for each size or above, a power rating shall be derated in accordance with the above derating curve.

Please refer to "Introduction of the derating curve based on the terminal part temperature" in the beginning of our catalog before use.

ordering information

HV73	2B	T	TD	1004	F
Type	Size	Termination Material	Packaging	Nominal Resistance	Resistance Tolerance
	1J: 0.1W 2A: 0.25W 2B: 0.25W 2H: 0.5W 3A: 1W	T: Sn	TD: 0603, 0805, 1206: 7" 4mm pitch punched paper TE: 2010 & 2512: 7" embossed plastic For further information on packaging, please refer to Appendix A	±0.5%, ±1%: 3 significant figures + 1 multiplier ±2%, ±5%: 2 significant figures + 1 multiplier	D: ±0.5% F: ±1% G: ±2% J: ±5%

applications and ratings

Part Designation	Power Rating @ 70°C	Rated Ambient Temp.	Rated Terminal Part Temp.	T.C.R. (ppm/°C) Max.	Resistance Range (Ω)				Absolute Maximum Working Voltage	Maximum Overload Voltage (D.C.)*	Operating Temp. Range
					E-24/E-96 (D±0.5%)	E-24/E-96 (F±1%)	E-24 (G±2%)	E-24 (J±5%)			
1J	0.1W	70°C	125°C	±100**	—	10k - 10M	10k - 10M	10k - 10M	350V	500V*	-55°C to +155°C
2A	0.25W	70°C	125°C	±100	100k - 1M	100k - 10M	100k - 10M	100k - 10M	400V	800V*	
				±200	—	—	—	11M - 51M			
2B	0.25W	70°C	125°C	±100	100k - 1M	100k - 10M	100k - 10M	100k - 10M	800V	1000V*	
				±200	—	—	—	11M - 51M			
2H	0.5W	70°C	125°C	±100	100k - 1M	100k - 10M	100k - 10M	100k - 10M	2000V (D.C.)	3000V*	
				±200	—	10.2M - 51M	11M - 51M	11M - 51M			
				±300	—	51.1M - 100M	56M - 100M	56M - 100M			
3A	1W	70°C	125°C	±100	43k - 1M	43k - 10M	43k - 10M	43k - 10M	3000V (D.C.)	4000V*	
				±200	—	10.2M - 20M	11M - 20M	11M - 51M			

* Max. overload voltage is specified by D.C. voltage

** Cold T.C.R. (-55°C ~ +25°C) of 1.02MΩ ~ 10MΩ is +200x10⁻⁶/K

If any questions should arise whether to use the “Rated Ambient Temperature” or the “Rated Terminal Part Temperature,” please give priority to the “Rated Terminal Part Temperature.” Prior to use and for more details refer to “Introduction of the derating curves on the terminal part temperature” in the beginning of the catalog.

Rated voltage = $\sqrt{\text{Power rating} \times \text{resistance value}}$ or max. working voltage, whichever is lower

environmental applications

Temperature Rise

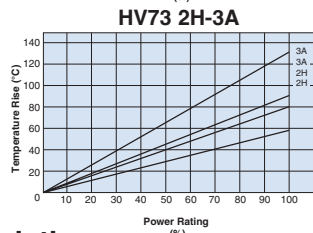
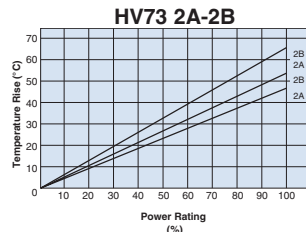
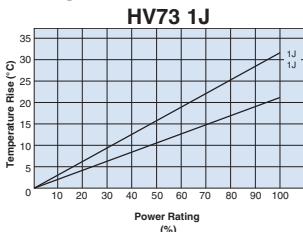

Regarding the temperature rise, the value of the temperature varies per conditions and board for use since the temperature is measured under our measuring conditions.

One-Pulse Limiting Electric Power

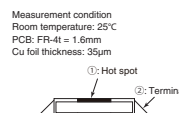
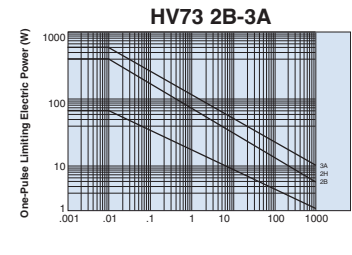
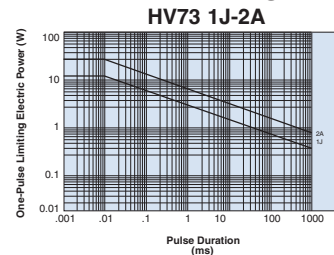

Measurement condition
Room temperature: 25°C
PCB: FR-4t = 1.6mm
Cu foil thickness: 35µm

The maximum applicable voltage is equal to the max. overload voltage. Please ask us about the resistance characteristic of continuous applied pulse. The pulse endurance values are not assured values, so be sure to check the products on actual equipment when you use them.

Performance Characteristics

Parameter	Requirement Δ R ±(%+0.1Ω)		Test Method
	Limit	Typical	
Resistance	Within regulated tolerance	—	25°C
T.C.R.	Within specified T.C.R.	—	+25°C/-55°C and +25°C/+125°C
Overload (Short time)	±2%	±0.5%	Rated Voltage (D.C.) x 2.5 for 5 seconds
Resistance to Solder Heat	±1%	±0.5%	260°C ± 5°C, 10 seconds ± 1 second
Rapid Change of Temperature	±0.5%: (10kΩ ≤ R ≤ 10MΩ) ±1%: (10MΩ ≤ R ≤ 100MΩ)	±0.3%: (10kΩ ≤ R ≤ 10MΩ) ±0.5%: (10MΩ ≤ R ≤ 100MΩ)	-55°C (30 minutes), +125°C (30 minutes), 100 cycles
Moisture Resistance	±2%	±0.75%	40°C ± 2°C, 90%-95% RH, 1000 hours, 1.5 hr ON, 0.5 hr OFF cycle
Endurance at 70°C	±2%	±0.75%	70°C ± 2°C, 1000 hours, 1.5 hr ON, 0.5 hr OFF cycle
High Temperature Exposure	±2%	±0.3%	+155°C, 1000 hours

Additional environmental applications can also be found at www.koaspeer.com

Specifications given herein may be changed at any time without prior notice. Please confirm technical specifications before you order and/or use.

5/17/23



features

- Superior to RK73 series in maximum working voltage
- Suitable for flow and reflow solderings
- Products meet EU RoHS requirements. EU RoHS regulation is not intended for Pb-glass contained in electrode, resistor element and glass.
- Suitable for high reliable applications like automotives
- AEC-Q200 tested

dimensions and construction

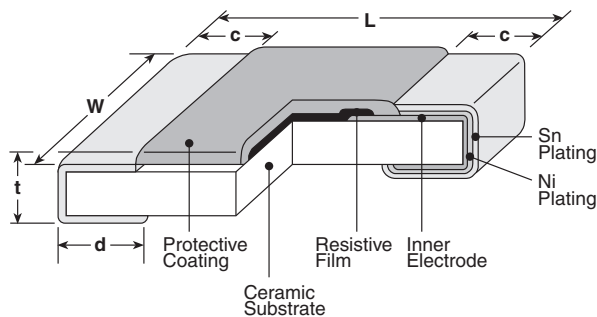

Type (Inch Size Code)	Dimensions inches (mm)				
	L	W	c	d	t
1J (0603)	.063±.008 (1.6±0.2)	.031±.004 (0.8±0.1)	.012±.004 (0.3±0.1)	.012±.004 (0.3±0.1)	.018±.004 (0.45±0.1)
1J AT (0603)			.014±.006 (0.35±0.15)	.02±.008 (0.5±0.2)	
2A (0805)	.079±.008 (2.0±0.2)	.049±.004 (1.25±0.1)	.016±.008 (0.4±0.2)	.012 ^{+0.008} _{-0.004} (0.3 ^{+0.2} _{-0.1})	.02±.004 (0.5±0.1)
2A AT (0805)			.018±.010 (0.45±0.25)	.024±.008 (0.6±0.2)	.022±.004 (0.55±0.1)
2B (1206)	.126±.008 (3.2±0.2)	.063±.008 (1.6±0.2)	.02±.012 (0.5±0.3)	.016 ^{+0.008} _{-0.004} (0.4 ^{+0.2} _{-0.1})	.024±.004 (0.6±0.1)
2B AT (1206)			.022±.014 (0.55±0.35)	.031±.008 (0.8±0.2)	

Derating Curve

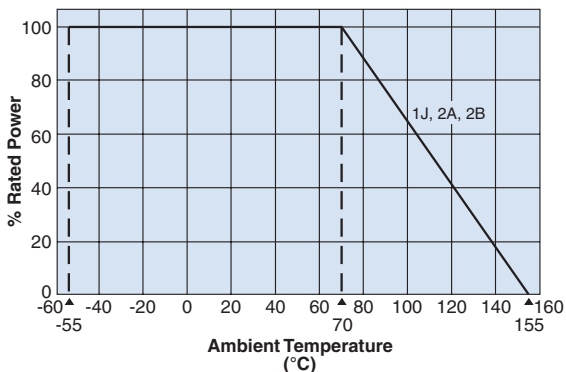

For resistors operated at an ambient temperature of 70°C or above, a power rating shall be derated in accordance with the above derating curve.

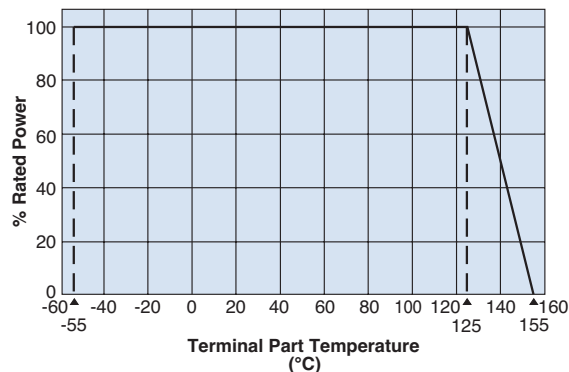

For resistors operated at a terminal part temperature of described for each size or above, a power rating shall be derated in accordance with the above derating curve.

Please refer to "Introduction of the derating curve based on the terminal part temperature" in the beginning of our catalog before use.

ordering information

HV73V	2A		T	TD	104	J
Type	Size	Characteristics	Termination Material	Packaging	Nominal Resistance	Resistance Tolerance
HV73V	1J: 0.1W 2A: 0.25W 2B: 0.33W	Nil: Standard A: Heat shock resistance *1	T: Sn	TD: 7" 4mm pitch punched paper For further information on packaging, please refer to Appendix A	±0.5%, ±1%: 3 significant figures + 1 multiplier ±2%, ±5%: 2 significant figures +1 multiplier	D: ±0.5% F: ±1% G: ±2% J: ±5%

*1 No resistance marking

applications and ratings

Part Designation	Power Rating @ 70°C	Rated Ambient Temp.	Rated Terminal Part Temp.	T.C.R. (ppm/°C) Max.	Resistance Range (Ω)				Maximum Working Voltage	Maximum Overload Voltage (D.C.)* ²	Operating Temperature Range
					E-24/E-96 (D±0.5%)	E-24/E-96 (F±1%)	E-24 (G±2%)	E-24 (J±5%)			
HV73V1J	0.1W	70°C	125°C	±100* ³	—	10k - 10M	10k - 10M	10k - 10M	350V	500V*	-55°C to +155°C
HV73V2A	0.25W	70°C	125°C	±100	100k - 1M	100k - 10M	100k - 10M	100k - 10M	400V	800V*	
				±200	—	—	—	11M - 51M			
HV73V2B	0.33W	70°C	125°C	±100	100k - 1M	100k - 10M	100k - 10M	100k - 10M	800V	1200V*	
				±200	—	—	—	11M - 51M			

Rated voltage = $\sqrt{\text{Power rating} \times \text{resistance value}}$ or max. working voltage, whichever is lower

*² Maximum Overload Voltage is specified by D.C. voltage *³ Cold T.C.R. (-55°C ~ +25°C) of 1.02MΩ ~ 10MΩ is +200x10⁻⁶/K

If any questions should arise whether to use the "Rated Ambient Temperature" or the "Rated Terminal Part Temperature," please give priority to the "Rated Terminal Part Temperature." Prior to use and for more details refer to "Introduction of the derating curves on the terminal part temperature" in the beginning of the catalog.

environmental applications

Temperature Rise

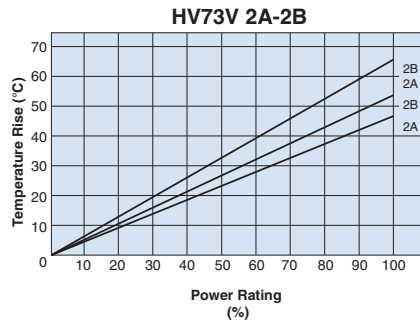
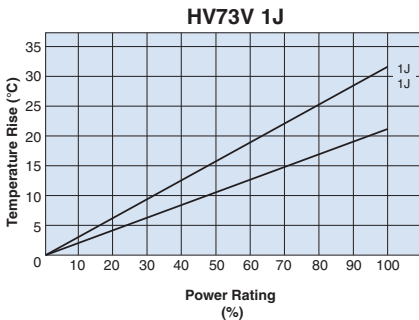

Regarding the temperature rise, the value of the temperature varies per conditions and board for use since the temperature is measured under our measuring conditions.

Measurement condition
Room temperature: 25°C
PCB: FR-4t = 1.6mm
Cu foil thickness: 35µm

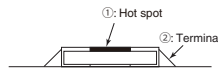

One-Pulse Limiting Electric Power

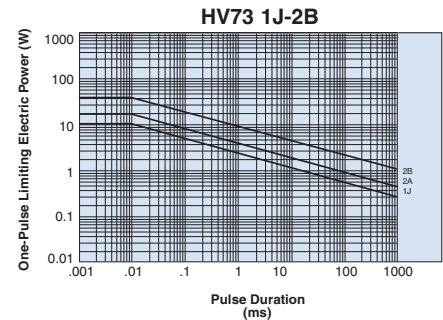

The maximum applicable voltage is equal to the max. overload voltage. Please contact factory for resistance characteristics of continuous applied pulse.

Performance Characteristics

Parameter	Requirement Δ R ±(%+0.1Ω)		Test Method
	Limit	Typical	
Resistance	Within regulated tolerance	—	25°C
T.C.R.	Within specified T.C.R.	—	+25°C/-55°C and +25°C/+125°C
Overload (Short time)	±2%	±0.5%	Rated Voltage (D.C.) x 2.5 for 5 seconds
Resistance to Solder Heat	±1%	±0.5%	260°C ± 5°C, 10 seconds ± 1 second
Rapid Change of Temperature	±0.5%: (10kΩ≤R≤10MΩ) ±1%: (11MΩ≤R≤51MΩ) ±1%: (Characteristic A) Heat Shock Resistance	±0.3%: (10kΩ≤R≤10MΩ) ±0.5%: (11MΩ≤R≤51MΩ) ±0.5%: Characteristic (A) Heat Shock Resistance	Characteristic (Nil) Standard: -55°C (30 minutes), +125°C (30 minutes), 100 cycles Characteristic (A) Heat Shock Resistance: -55°C (30 minutes), +125°C (30 minutes), 1000 cycles
Moisture Resistance	±2%	±0.75%	40°C ± 2°C, 90%-95% RH, 1000 hours, 1.5 hr ON, 0.5 hr OFF cycle
Endurance at 70°C	±2%	±0.75%	70°C ± 2°C, 1000 hours, 1.5 hr ON, 0.5 hr OFF cycle
High Temperature Exposure	±2%	±0.3%	+155°C, 1000 hours

Additional environmental applications can also be found at www.koaspeer.com

Specifications given herein may be changed at any time without prior notice. Please confirm technical specifications before you order and/or use.

11/01/23

high temperature flat chip resistors

features

- High heat resistance that can be used even at high temperatures of 155°C or higher. The maximum operating temperature of Sn plating products compatible with solder mounting is 175°C, and Au plating products compatible with conductive glue mounting is 200°C.
- Excellent heat resistance and weather resistance are ensured by the use of metal glaze thick film
- High stability and high reliability with the triple-layer structure of electrode
- Superior to RK73 series chip resistors pulse withstanding voltage and high power
- Applicable to various kinds of automatic mounters for taping, etc
- Products meet EU RoHS requirements. EU RoHS regulation is not intended for Pb-glass contained in electrode, resistor element and glass.
- AEC-Q200 Tested

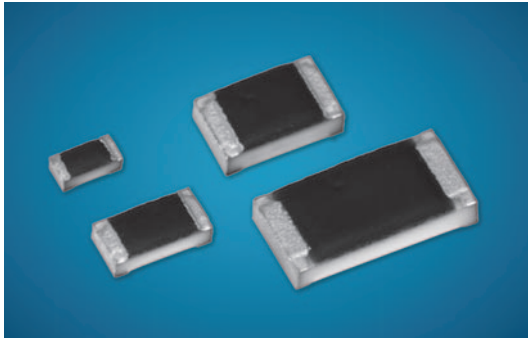

dimensions and construction

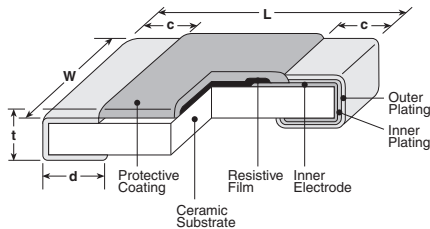

Derating Curve

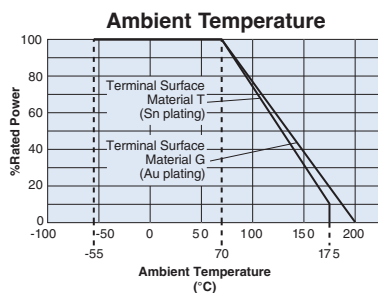

For resistors operated at an ambient temperature of 70°C or above, a power rating shall be derated in accordance with the derating curve.

Type (Inch Size Code)	Dimensions inches (mm)				
	L	W	c	d	t
1E (0402)	.039 ^{+0.003} / _{-.002} (1.0 ^{+0.1} / _{-0.05})	.020±.002 (0.5±0.05)	.008±.006 (0.2±0.15)	.010 ^{+0.002} / _{-.004} (0.25 ^{+0.05} / _{-0.1})	.014±.002 (0.35±0.05)
1E AT (0402)				.012±.006 (0.3±0.15)	
1J (0603)	.063±.008 (1.6±0.2)	.031±.004 (0.8±0.1)	.012±.006 (0.3±0.15)	.012±.004 (0.3±0.1)	.018±.004 (0.45±0.1)
1J AT (0603)				.014±.006 (0.35±0.15)	
2A (0805)	.079±.008 (2.0±0.2)	.049±.004 (1.25±0.1)	.016±.010 (0.4±0.25)	.012 ^{+0.008} / _{-.004} (0.3 ^{+0.2} / _{-0.1})	.02±.004 (0.5±0.1)
2A AT (0805)				.018±.010 (0.45±0.25)	
2B (1206)	.126±.008 (3.2±0.2)	.063±.008 (1.6±0.2)	.022±.014 (0.55±0.35)	.016 ^{+0.008} / _{-.004} (0.4 ^{+0.2} / _{-0.1})	.024±.004 (0.6±0.1)
2B AT (1206)				.031±.008 (0.8±0.2)	

Terminal Part Temperature Applied to Sn Plating Products

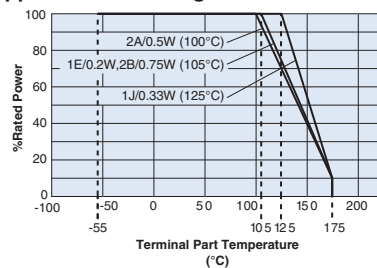
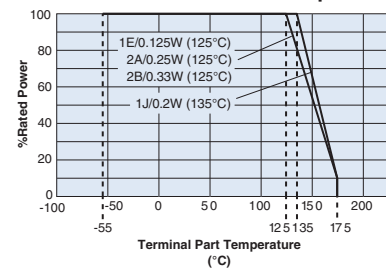

When the terminal part temperature of the resistor exceeds the rated terminal part temperature shown above, the power shall be derated according to the derating curve. If you want to use at the rated power of *1, please use the derating curves based on the terminal part temperature of right side. Please refer to "Introduction of the derating curves based on the terminal part temperature" in the beginning of our catalog before use.

ordering information

HSG73P	2B		G	TD	103	J
Type	Power Rating	Characteristic	Terminal Surface Material	Packaging	Nominal Resistance	Tolerance
	1E: 0.125W, 0.2W 1J: 0.2W, 0.33W 2A: 0.25W, 0.5W 2B: 0.33W, 0.75W	Nil: Standard A: Heat Shock Resistance*1	T: Sn G: Au	TP: 2mm pitch punch paper TD: 4mm pitch punched paper For further information on packaging, please refer to Appendix A	F: 4 digits J: 3 digits	F: ±1% J: ±5%

*1 With type A only T is available as the terminal surface material.

Contact us when you have control request for environmental hazardous material other than the substance specified by EU RoHS.

Specifications given herein may be changed at any time without prior notice. Please confirm technical specifications before you order and/or use.

11/14/23

applications and ratings

Part Designation	Power Rating	Rated Ambient Temp.		Rated Term. Part Temp.		T.C.R. (x10 ⁻⁶ /K) Max.	Resistance Range		Maximum Working Voltage	Maximum Overload Voltage
		Term. Surf. Material: T (Sn plating)	Term. Surf. Material: G (Au plating)	Term. Surf. Material: T (Sn plating)	Term. Surf. Material: G (Au plating)		F: ±1% E24	J: ±5% E24		
HSG73P1E (0402)	0.125W	70°C	70°C	125°C	—	±200	10Ω~1MΩ	1Ω~10MΩ	75V	100V
	0.2W ¹	70°C	—	105°C	—					
HSG73P1J (0603)	0.2W	70°C	70°C	135°C	—	±200	10Ω~1MΩ	1Ω~10MΩ	150V	200V
	0.33W ¹	70°C	—	125°C	—					
HSG73P2A (0805)	0.25W	70°C	70°C	125°C	—	±200	10Ω~1MΩ	1Ω~10MΩ	200V	400V
	0.5W ¹	70°C	—	100°C	—					
HSG73P2B (1206)	0.33W	70°C	70°C	125°C	—	±200	10Ω~1MΩ	1Ω~10MΩ	200V	400V
	0.75W ¹	70°C	—	105°C	—					

Operating Temperature Range : -55°C ~ +175°C (Terminal Surface Material: T), -55°C ~ +200°C (Terminal Surface Material: G)

Rated voltage = $\sqrt{\text{Power rating} \times \text{resistance value}}$ or max. working voltage, whichever is lower

*1 If you use at the rated power, please keep the condition that the terminal of the resistor is below the rated terminal part temperature.

Please refer to the derating curves based on the terminal temperature.

If any questions arise whether to use the "Rated Ambient Temperature" or the "Rated Terminal Part Temperature" in your usage conditions, please give priority to the "Rated Terminal Part Temperature"

environmental applications

Temperature Rise

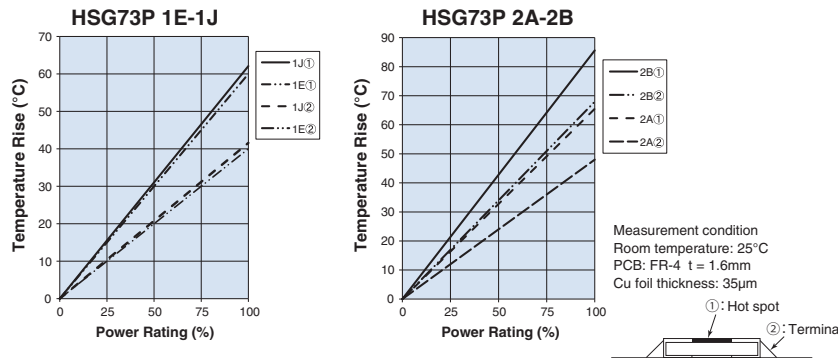

Regarding the temperature rise, the value of the temperature varies per conditions and board for use since the temperature is measured under our measuring conditions.

One-Pulse Limiting Electric Power

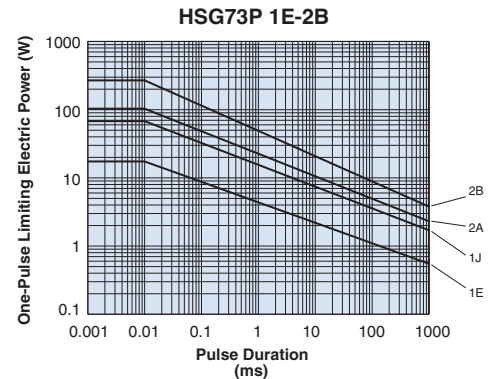

The maximum applicable voltage is equal to the max. overload voltage. Please ask us about the resistance characteristic of continuous applied pulse.

Performance Characteristics

Parameter	Requirement $\Delta R \pm(\%+0.1\Omega)$		Test Method
	Limit	Typical	
Resistance	Within specified tolerance	—	25°C
T.C.R.	Within specified T.C.R.	—	Characteristic (Nil) Standard: +25°C/-55°C, +25°C/+125°C Characteristic (A) Heat shock resistance: +25°C/-55°C, +25°C/+175°C
Overload (Short time)	±2%	±0.5%	Rated Voltage x 2.5 for 5 seconds (2A: 0.5W; 2B: 0.75W Rated Voltage x 2 for 5 seconds)
Rapid Change of Temperature	±0.5%: Characteristic (Nil) Standard 1%: Characteristic (A) Heat Shock Resistance	±0.3%: Characteristic (Nil) Standard 0.5%: Characteristic (A) Heat Shock Resistance	Characteristic (Nil) Standard: -55°C (30 min.)/+125°C (30 min.) 100 cycles Characteristic (A) Heat Shock Resistance: -55°C (30 min.)/+175°C (30 min.) 1000 cycles
Moisture Resistance	±2%: 1J, 2A, 2B ±3%: 1E	±0.75%: 1J, 2A, 2B ±1%: 1E	40°C ± 2°C, 90%-95% RH, 1000 hours, 1.5 hr ON, 0.5 hr OFF cycle
Endurance at 70°C	±2%: 1J, 2A, 2B ±3%: 1E	±0.75%: 1J, 2A, 2B ±1%: 1E	70°C ± 2°C, 1000 hours, 1.5 hr ON, 0.5 hr OFF cycle
High Temperature Exposure	±2%	±0.5%	+200°C, 1000 hours (Terminal Surface Material [G]: Au plating products)
Endurance at 175°C	±1%	±0.3%	+175°C, 1000 hours, Power Rating×10% (Terminal Surface Material [T]: Sn plating products)

For Surface Temperature Rise Graph see Environmental Applications. Additional environmental applications can also be found at www.koaspeer.com

Specifications given herein may be changed at any time without prior notice. Please confirm technical specifications before you order and/or use.

11/09/22

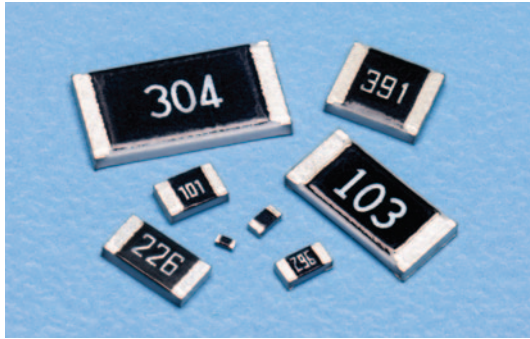

features

- Excellent anti-sulfuration characteristic due to using high sulfuration-proof inner top electrode material
- Excellent heat resistance and weather resistance are ensured by the use of metal glaze thick film
- High stability and high reliability with the triple-layer structure of electrode
- Suitable for both flow and reflow
- Products with lead-free terminations meet EU RoHS requirements. EU RoHS regulation is not intended for Pb-glass contained in electrode, resistor element and glass.
- AEC-Q200 Tested: 0201 (1H), 0402 (1E), 0603 (1J), 0805 (2A), 1206 (2B), 1210 (2E), 2010 (W2H), 2512 (W3A)

dimensions and construction

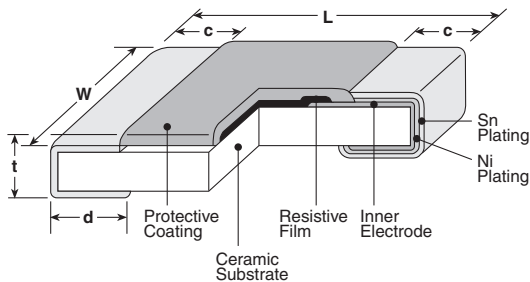

Type (Inch Size Code)	Dimensions inches (mm)				
	L	W	c	d	t
1F (01005)	.016±.001 (0.4±0.02)	.008±.001 (0.2±0.02)	.004±.001 (0.1±0.03)	.004±.001 (0.11±0.03)	.005±.001 (0.13±0.02)
1H (0201)	.024±.001 (0.6±0.03)	.012±.001 (0.3±0.03)	.004±.002 (0.1±0.05)	.006±.002 (0.15±0.05)	.009±.001 (0.23±0.03)
1E (0402)	.039 ^{+0.004} _{-0.002} (1.0 ^{+0.1} _{-0.05})	.02±.002 (0.5±0.05)	.008±.004 (0.2±0.1)	.01 ^{+0.002} _{-0.004} (0.25 ^{+0.05} _{-0.1})	.014±.002 (0.35±0.05)
1J (0603)	.063±.008 (1.6±0.2)	.031±.004 (0.8±0.1)	.012±.004 (0.3±0.1)	.012±.004 (0.3±0.1)	.018±.004 (0.45±0.1)
2A (0805)	.079±.008 (2.0±0.2)	.049±.004 (1.25±0.1)	.016±.008 (0.4±0.2)	.012 ^{+0.008} _{-0.004} (0.3 ^{+0.2} _{-0.1})	.02±.004 (0.5±0.1)
2B (1206)	.126±.008 (3.2±0.2)	.063±.008 (1.6±0.2)	.02±.012 (0.5±0.3)	.016 ^{+0.008} _{-0.004} (0.4 ^{+0.2} _{-0.1})	.024±.004 (0.6±0.1)
2E (1210)		.102±.008 (2.6±0.2)			
W2H (2010)	.197±.008 (5.0±0.2)	.098±.008 (2.5±0.2)	.02±.012 (0.5±0.3)	.026±.006 (0.65±0.15)	.024±.004 (0.6±0.1)
W3A/ W3A2 ¹ (2512)	.248±.008 (6.3±0.2)	.122±.008 (3.1±0.2)			

¹ RK73Z exempt

ordering information

RK73H	2A	R	T	TD	1002	F
Type	Power Rating	Characteristic	Termination Material	Packaging	Nominal Resistance	Resistance Tolerance
RK73B RK73H RK73Z	1F 1H 1E 1J 2A 2B 2E W2H W3A W3A2	R: Anti-Sulfur	T: Sn	TX: 4mm width - 1mm pitch plastic embossed TBL - TCM: 2mm pitch press paper ^{*2} TPL - TP: 2mm pitch punch paper TD: 4mm pitch punch paper TE: 4mm pitch plastic embossed Other nonstandard reel sizes available, contact factory for other options For further information on packaging, please refer to Appendix A	RK73B: 3 digits RK73H: 4 digits RK73Z: None	D: ±0.5% F: ±1% G: ±2% J: ±5%

² Standard taping specification of 1H is TCM. Previously available "TC (10,000pcs/Reel)" is not recommended for new designs.

applications and ratings RK73B/RK73H

Part Designation	Power Rating	Rated Ambient Temp.	Rated Terminal Part Temp.	T.C.R. (ppm/°C) Max.	Resistance Range				Maximum Working Voltage	Maximum Overload Voltage	Operating Temp. Range
					RK73H		RK73B				
					D±0.5% E24, E96	F±1% E24, E96 ³	G±2% E24	J±5% E24			
1F	0.03W	70°C	125°C	±200	—	100kΩ - 2MΩ ²	100kΩ - 1MΩ	100kΩ - 10MΩ	20V	30V	-55°C to +125°C
				±250		10Ω - 91kΩ ²	10Ω - 91kΩ	10Ω - 91kΩ			
				0 - +300		—	1Ω - 9.1Ω	1Ω - 9.1Ω			
1H	0.05W			±200	100Ω - 100kΩ	100Ω - 1MΩ	—	100 - 1M	25V	50V	
±300	—			10Ω - 97.6Ω	10Ω - 91Ω						
1E	0.1W			±100	100Ω - 1MΩ	10Ω - 1MΩ	—	—	75V	100V	
1J	0.1W			±200	—	1.02MΩ - 10MΩ	10Ω - 10MΩ	1Ω - 10MΩ			
				±100	1.02kΩ - 1MΩ	1.02kΩ - 1MΩ	—	—			
	±200			—	1.02MΩ - 10MΩ	1.1kΩ - 10MΩ	1.1kΩ - 10MΩ				
	±100			100Ω - 1kΩ	10Ω - 1kΩ	—	—				
2A	0.25W			±200	—	1.02MΩ - 10MΩ	10Ω - 10MΩ	1Ω - 10MΩ			
				±100	100Ω - 1MΩ	10Ω - 1MΩ	—	—			
2B	0.25W	±100	100Ω - 1MΩ	10Ω - 1MΩ	—	—	200V	400V			
2E	0.5W	±200	—	1.02MΩ - 10MΩ	10Ω - 10MΩ	1Ω - 10MΩ					
		±100	100Ω - 1MΩ	10Ω - 1MΩ	—	—					
	±200	—	—	10Ω - 1MΩ	1Ω - 1MΩ						
	±100	10Ω - 1MΩ	10Ω - 1MΩ	—	—						
W2H	0.75W	±200	—	1 - 9.76 1.02MΩ - 10MΩ	1Ω - 10MΩ	1Ω - 10MΩ					
W3A	1W	±100	10Ω - 1MΩ	10Ω - 1MΩ	—	—					
W3A2	2W ⁴	±200	—	1.02MΩ - 10MΩ	10Ω - 10MΩ	1Ω - 10MΩ	95°C	—			
		±100	10Ω - 1MΩ	10Ω - 1MΩ	—	—					

Rated voltage = $\sqrt{\text{Power rating} \times \text{resistance value}}$ or max. working voltage, whichever is lower

³The nominal resistance value for RK73H1F (F:±1%) is E24

⁴ If you use at the rated power, please keep the condition that the terminal of the resistor is below the rated terminal part temperature. Please refer to the derating curves based on the terminal temperature.

If any questions arise whether to use the "Rated Ambient Temperature" or the "Rated Terminal Part Temperature," in your usage conditions, please give priority to the "Rated Terminal Part Temperature." Prior to use and for more details refer to "Introduction of the derating curves in the terminal part temperature" in the beginning of the catalog.

While using under high power, the temperature of the product may increase depending on the condition of heat dissipation from PCB. Be sure to check the terminal part temperature as well as precautions to use on delivery specification before use.

Derating Curve

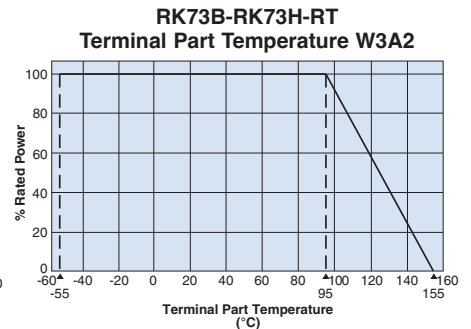
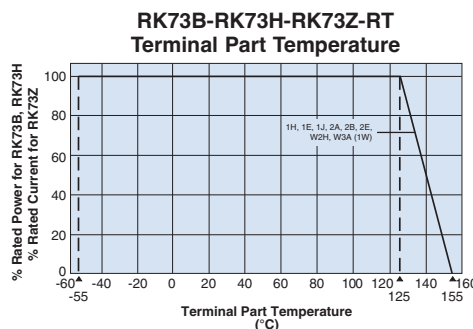
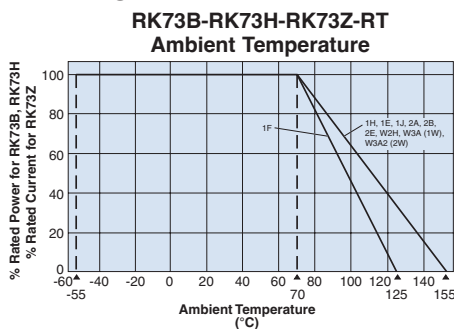

For resistors operated at an ambient temperature of 70°C or higher, the power (for RK73B, RK73H) or a current rating (for RK73Z) shall be derated in accordance with the above derating curve.

When the terminal part temperature of the resistor exceeds the rated terminal part temperature shown above, the power shall be derated according to the derating curve.

Please refer to "Introduction of the derating curves based on the terminal part temperature" on the beginning of our catalog before use.

applications and ratings (continued)

RK73Z

Part Designation	Rated Ambient Temperature	Rated Terminal Part Temperature	Resistance	Current Rating	Maximum Surge Current	Operating Temperature Range
1H	+70°C	+125°C	100mΩ max.	0.5A	1A	-55°C to +155°C
1E			50mΩ max.	1A	2A	
1J				2A	5A	
2A			10A			
2B						
2E						
W2H						
W3A						

environmental applications

Performance Characteristics

Parameter	RK73H, RK73B Requirement ΔR $\pm(\%+0.1\Omega)$		RK73Z Requirement		Test Method
	Limit	Typical	Limit	Typical	
Resistance	Within specified tolerance	—	$R \leq 100\text{m}\Omega$: 1H $R \leq 50\text{m}\Omega$: All others	$R \leq 90\text{m}\Omega$: 1H $R \leq 40\text{m}\Omega$: All others	25°C
T.C.R.	Within specified T.C.R.	—	—	—	+25°C/-55°C and +25°C/+125°C
Overload (Short time)	$\pm 2\%$	$\pm 1\%$: 1F $\pm 0.8\%$: All others	$R \leq 100\text{m}\Omega$: 1H $R \leq 50\text{m}\Omega$: All others	$R \leq 90\text{m}\Omega$: 1H $R \leq 40\text{m}\Omega$: All others	RK73B, RK73H Rated Voltage x 2.5 for 5 seconds (1E, 2B, W3A2: Rated Voltage x 2 for 5 seconds) RK73Z: Max. overload current for 5 seconds
Resistance to Solder Heat	$\pm 1\%$: $10\Omega \leq R \leq 1\text{M}\Omega$ $\pm 3\%$: $R < 10\Omega$, $R > 1\text{M}\Omega$	$\pm 1\%$: $R < 10\Omega$, $R > 1\text{M}\Omega$ $\pm 0.5\%$: All others	$R \leq 100\text{m}\Omega$: 1H $R \leq 50\text{m}\Omega$: All others	$R \leq 90\text{m}\Omega$: 1H $R \leq 40\text{m}\Omega$: All others	260°C \pm 5°C, 10 seconds \pm 1 second
Rapid Change of Temperature	$\pm 1\%$: 1F $\pm 0.5\%$: All others	$\pm 0.5\%$: 1F $\pm 0.3\%$: All others	$R \leq 100\text{m}\Omega$: 1H $R \leq 50\text{m}\Omega$: All others	$R \leq 90\text{m}\Omega$: 1H $R \leq 40\text{m}\Omega$: All others	-55°C (30 minutes), +125°C (30 minutes), 100 cycles
Moisture Resistance	$\pm 2\%$: 1J, 2A, 2B $\pm 3\%$: All others	$\pm 0.75\%$: 1J, 2A, 2B $\pm 1.5\%$: 1F $\pm 1\%$: All others	$R \leq 150\text{m}\Omega$: 1H $R \leq 100\text{m}\Omega$: All others	$R \leq 100\text{m}\Omega$: 1H $R \leq 50\text{m}\Omega$: All others	40°C \pm 2°C, 90%-95% RH, 1000 hours, 1.5 hr ON, 0.5 hr OFF cycle
Endurance at 70°C	$\pm 2\%$: 1J, 2A, 2B $\pm 3\%$: All others	$\pm 0.75\%$: 1J, 2A, 2B $\pm 1\%$: All others	$R \leq 150\text{m}\Omega$: 1H $R \leq 100\text{m}\Omega$: All others	$R \leq 100\text{m}\Omega$: 1H $R \leq 50\text{m}\Omega$: All others	70°C \pm 2°C, 1000 hours, 1.5 hr ON, 0.5 hr OFF cycle
High Temperature Exposure	$\pm 1\%$	$\pm 0.5\%$	$R \leq 150\text{m}\Omega$: 1H $R \leq 100\text{m}\Omega$: All others	$R \leq 100\text{m}\Omega$: 1H $R \leq 50\text{m}\Omega$: All others	+125°C, 1000 hours: 1F; +155°C, 1000 hours: 1H, 1E, 1J, 2A, 2B, 2E, W2H, W3A
Sulfuration Test	$\pm 5\%$	$\pm 0.3\%$: 1F, 1H $\pm 0.2\%$: All others	$R \leq 150\text{m}\Omega$: 1H $R \leq 100\text{m}\Omega$: All others	$R \leq 100\text{m}\Omega$: 1H $R \leq 50\text{m}\Omega$: All others	Soaked in industrial oil with 3.5% sulfur concentration 105°C \pm 3°C, 500 hours

Please refer to conventional products for characteristic data such as temperature rise.

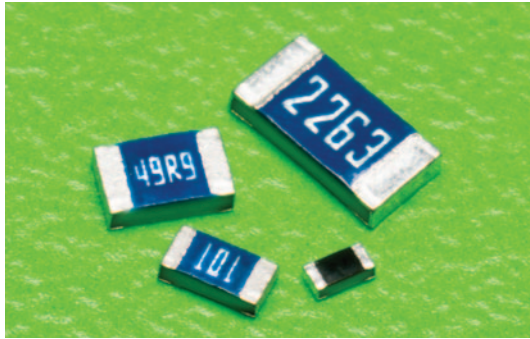

features

- Excellent anti-sulfuration characteristic due to using high sulfuration-proof inner top electrode material
- Metal-glaze thick film resistor for surface mounting
- High precision resistor with T.C.R. $\pm 50 \times 10^{-6}/K$ and tolerance $\pm 0.25\%$
- Suitable for both flow and reflow solderings
- Products with lead-free terminations meet EU RoHS requirements. EU RoHS regulation is not intended for Pb-glass contained in electrode, resistor element and glass.
- AEC-Q200 Tested

dimensions and construction

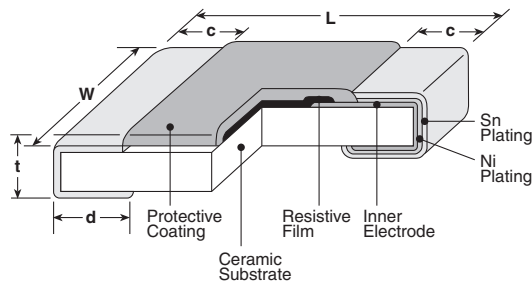

Type (Inch Size Code)	Dimensions inches (mm)				
	L	W	c	d	t
1E (0402)	.039 ^{+0.004} _{-.002} (1.0 ^{+0.1} _{-0.05})	.02±.002 (0.5±0.05)	.008±.004 (0.2±0.1)	.01 ^{+0.002} _{-.004} (0.25 ^{+0.05} _{-0.1})	.014±.002 (0.35±0.05)
1J (0603)	.063±.008 (1.6±0.2)	.031±.004 (0.8±0.1)	.012±.004 (0.3±0.1)	.012±.004 (0.3±0.1)	.018±.004 (0.45±0.1)
2A (0805)	.079±.008 (2.0±0.2)	.049±.004 (1.25±0.1)	.016±.008 (0.4±0.2)	.012 ^{+0.008} _{-.004} (0.3 ^{+0.2} _{-0.1})	.02±.004 (0.5±0.1)
2B (1206)	.126±.008 (3.2±0.2)	.063±.008 (1.6±0.2)	.02±.012 (0.5±0.3)	.016 ^{+0.008} _{-.004} (0.4 ^{+0.2} _{-0.1})	.024±.004 (0.6±0.1)

Derating Curve

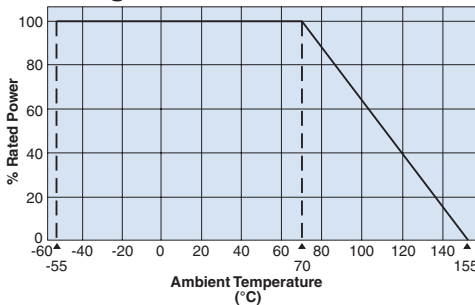

For resistors operated at an ambient temperature of 70°C or above, a power rating shall be derated in accordance with the derating curve.

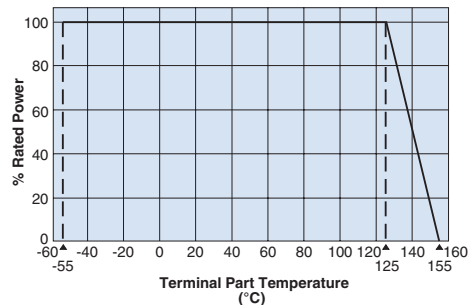

For resistors operated terminal part temperature of described for each size or above, a power rating shall be derated in accordance with the derating curve. Please refer to "Introduction of the derating curve based on the terminal part temperature" in the beginning of our catalog before use.

ordering information

RK73G	2A	R	T	TD	1002	D
Type	Size	Characteristic	Termination Material	Packaging	Nominal Resistance	Tolerance
	1E: 0.1W 1J: 0.1W 2A: 0.125W 2B: 0.25W	R: Anti-Sulfur	T: Sn	TPL: 0402 only: 2mm pitch punched paper TP: 0402, 0603: 7" 2mm pitch punched paper TD: 0603, 0805, 1206: 7" 4mm pitch punched paper TE: 0805, 1206: 7" 4mm plastic embossed For further information on packaging, please refer to Appendix A	3 significant figures + 1 multiplier "R" indicates decimal on value <100Ω	C: ±0.25% D: ±0.5% F: ±1%

applications and ratings

Part Designation	Power Rating	Rated Ambient Temp.	Rated Terminal Part Temp.	T.C.R. (X 10 ⁻⁶ /K)	Resistance Range			Maximum Working Voltage	Maximum Overload Voltage	Operating Temperature Range
					E-24, E-96 (C±0.25%)	E-24, E-96 (D±0.5%)	E-24, E-96 (F±1%)			
RK73G1E (0402)	1/10W (.10W)	+70°C	+125°C	±50	—	30Ω - 1MΩ	30Ω - 1MΩ	50V	100V	-55°C to +155°C
RK73G1J (0603)	1/10W (.10W)				75V			150V		
RK73G2A (0805)	1/8W (.125W)				100Ω - 1MΩ			150V	200V	
RK73G2B (1206)	1/4W (.25W)				200V			400V		

Rated voltage = $\sqrt{\text{Power rating} \times \text{resistance value}}$ or max. working voltage, whichever is lower

If any questions arise whether to use the "Rated Ambient Temperature" or the "Rated Terminal Part Temperature," please give priority to the "Rated Terminal Part Temperature." Prior to use and for more details refer to "Introduction of the derating curves in the terminal part temperature" in the beginning of the catalog.

environmental applications

Performance Characteristics

Parameter	Requirement ~ R ±(%+0.1Ω)		Test Method
	Limit	Typical	
Resistance	Within specified tolerance	—	25°C
T.C.R.	Within specified T.C.R.	—	+25°C/-55°C and +25°C/+125°C
Overload (Short time)	±2%	±0.6%	Rated Voltage x 2.5 for 5 seconds (1E, 2B: Rated Voltage x 2 for 5 seconds)
Resistance to Solder Heat	±1%	±0.4%	260°C ± 5°C, 10 seconds ± 1 second
Rapid Change of Temperature	±0.5%	±0.3%	-55°C (30 minutes), +125°C (30 minutes), 100 cycles
Moisture Resistance	±2%: 1J, 2A, 2B ±3%: 1E	±0.6%: 1J, 2A, 2B; ±1%: 1E	40°C ± 2°C, 90%-95% RH, 1000 hours, 1.5 hr ON, 0.5 hr OFF cycle
Endurance at 70°C	±2%: 1J, 2A, 2B ±3%: 1E	±0.6%: 1J, 2A, 2B; ±1%: 1E	70°C ± 2°C, 1000 hours, 1.5 hr ON, 0.5 hr OFF cycle
High Temperature Exposure	±1%	±0.6%	+155°C, 1000 hours
Sulfuration Test	±5%	±0.2%	Soaked in industrial oil with sulfur substance 3.5% contained 105°C ± 3°C, 500 hours

Please refer to conventional products for characteristic data such as temperature rise.

For Surface Temperature Rise Graph see Environmental Applications. Additional environmental applications can also be found at www.koaspeer.com

Specifications given herein may be changed at any time without prior notice. Please confirm technical specifications before you order and/or use.

11/06/19

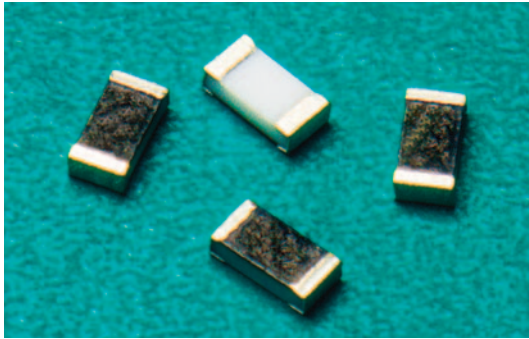

features

- Excellent anti-sulfuration characteristic due to using high sulfuration-proof inner top electrode material
- Metal-glaze thick film resistor for surface mounting
- High precision resistor with T.C.R. down to 25 ppm and tolerance as tight as $\pm 0.1\%$
- High reliability with ΔR of $\pm 0.2\%$ and $\pm 0.5\%$ in the reliability test
- Suitable for both flow and reflow solderings
- Products with lead-free terminations meet EU RoHS requirements. EU RoHS regulation is not intended for Pb-glass contained in electrode, resistor element and glass.
- AEC-Q200 Tested

dimensions and construction

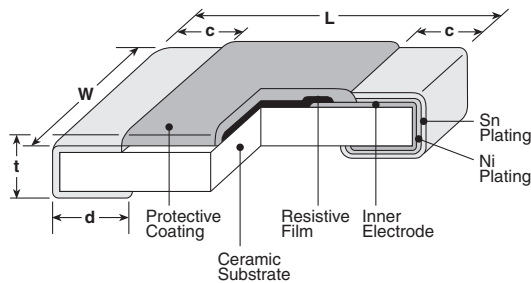

Type (Inch Size Code)	Dimensions inches (mm)				
	L	W	c	d	t
1E (0402)	.039 ^{+0.004} / _{-.002} (1.0 ^{+0.1} / _{-0.05})	.020 \pm .002 (0.5 \pm 0.05)	.008 \pm .004 (0.2 \pm 0.1)	.010 ^{+0.02} / _{-.004} (0.25 ^{+0.05} / _{-0.1})	.014 \pm .002 (0.35 \pm 0.05)
1J (0603)	.063 \pm .008 (1.6 \pm 0.2)	.031 \pm .004 (0.8 \pm 0.1)	.008 \pm .004 (0.2 \pm 0.1)	.012 \pm .004 (0.3 \pm 0.1)	.018 \pm .004 (0.45 \pm 0.1)
2A (0805)	.079 \pm .008 (2.0 \pm 0.2)	.049 \pm .004 (1.25 \pm 0.1)	.010 \pm .006 (0.25 \pm 0.15)	.012 ^{+0.008} / _{-.004} (0.3 ^{+0.2} / _{-0.1})	.020 \pm .004 (0.5 \pm 0.1)
2B (1206)	.126 \pm .008 (3.2 \pm 0.2)	.063 \pm .008 (1.6 \pm 0.2)	.014 \pm .006 (0.35 \pm 0.15)	.016 ^{+0.008} / _{-.004} (0.4 ^{+0.2} / _{-0.1})	.024 \pm .004 (0.6 \pm 0.1)

Derating Curve

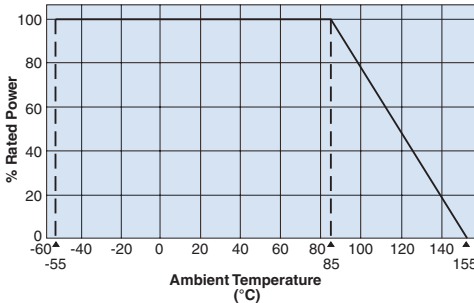

For resistors operated at an ambient temperature of 85°C or above, a power rating shall be derated in accordance with the derating curve.

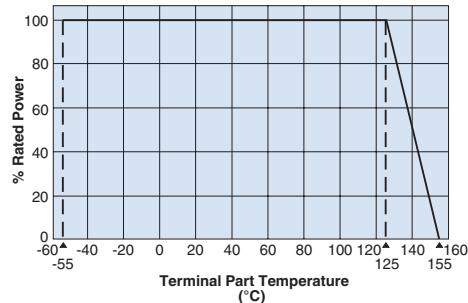

For resistors operated terminal part temperature of described for each size or above, a power rating shall be derated in accordance with the derating curve. Please refer to "Introduction of the derating curve based on the terminal part temperature" in the beginning of our catalog before use.

ordering information

RS73F	1J	R	T	TD	1002	B
Type	Power Rating	Characteristic	Termination Material	Packaging	Nominal Resistance	Tolerance
RS73F RS73G	1E: 0.125W 1J: 0.2W 2A: 0.25W 2B: 0.33W	R: Anti-Sulfur	T: Sn	TPL-TP: 2mm pitch punch paper TD: 4mm pitch punched paper For further information on packaging, please refer to Appendix A	4 digits	B: $\pm 0.1\%$ C: $\pm 0.25\%$ D: $\pm 0.5\%$ F: $\pm 1\%$

applications and ratings

Part Designation	Power Rating	Rated Ambient Temp.	Rated Terminal Part Temp.	T.C.R. (X 10 ⁻⁶ /K)	Resistance Range* ²				Maximum Working Voltage	Maximum Overload Voltage	Operating Temperature Range
					B±0.1% E-24, E-96	C±0.25% E-24, E-96	D±0.5% E-24, E-96	F±1% E-24, E-96			
RS73F1E (0402)	.125W	85°C	+125°C	±25* ¹	300Ω - 100kΩ	300Ω - 1MΩ	300Ω - 1MΩ	300Ω - 1MΩ	75V	100V	-55°C to +155°C
RS73G1E (0402)				±50							
RS73F1J (0603)	.2W			±25* ¹	10Ω - 1MΩ	10Ω - 1MΩ	10Ω - 1MΩ	10Ω - 1MΩ	100V	150V	
RS73G1J (0603)				±50							
RS73F2A (0805)	.25W			±25* ¹	10Ω - 3MΩ	10Ω - 6.8MΩ	10Ω - 10MΩ	10Ω - 10MΩ	150V	300V	
RS73G2A (0805)				±50							
RS73F2B (1206)	.33W			±25* ¹	10Ω - 5.1MΩ	10Ω - 5.1MΩ			200V	400V	
RS73G2B (1206)				±50							

Rated voltage = $\sqrt{\text{Power rating} \times \text{resistance value}}$ or max. working voltage, whichever is lower

*¹ Measurement Temperature: +25°C/+125°C. Cold T.C.R. (-55°C/+25°C) is -50~+25x10⁻⁶/K

² Please inquire about E-192

If any questions arise whether to use the "Rated Ambient Temperature" or the "Rated Terminal Part Temperature," please give priority to the "Rated Terminal Part Temperature." Prior to use and for more details refer to "Introduction of the derating curves in the terminal part temperature" in the beginning of the catalog.

environmental applications

Performance Characteristics

Parameter	Requirement $\Delta R \pm(\%+0.05\Omega)$		Test Method
	Limit	Typical	
Resistance	Within specified tolerance	—	25°C
T.C.R.	Within specified T.C.R.	—	+25°C/-55°C and +25°C/+125°C
Overload (Short time)	±0.2%	±0.03%	Rated Voltage x 2.5 for 5 seconds
Resistance to Solder Heat	±0.2%	±0.1%	260°C ± 5°C, 10 seconds ± 1 second
Rapid Change of Temperature	0.2: 1E (300Ω≤R≤20kΩ) 1J (10Ω≤R≤1MΩ) 2A, 2B (10Ω≤R≤10MΩ) 0.4: others	0.05: 1E (300Ω≤R≤20kΩ) 1J (10Ω≤R≤1MΩ) 2A, 2B (10Ω≤R≤10MΩ) 0.2: others	-55°C (30 minutes), +125°C (30 minutes), 1000 cycles
Moisture Resistance	0.2: 1E (300Ω≤R≤10kΩ) 1J (10Ω≤R≤200kΩ) 2A, 2B (10Ω≤R≤10MΩ) 0.4~0.5: others	0.04: 1E (300Ω≤R≤10kΩ) 1J (10Ω≤R≤200kΩ) 2A, 2B (10Ω≤R≤10MΩ) 0.08: others	40°C ± 2°C, 90%-95% RH, 1000 hours, 1.5 hr ON, 0.5 hr OFF cycle
Endurance at 85°C	0.2: 1E (300Ω≤R≤20kΩ) 1J (10Ω≤R≤1MΩ) 2A, 2B (10Ω≤R≤10MΩ) 0.4: others	0.05: 1E (300Ω≤R≤20kΩ) 1J (10Ω≤R≤200kΩ) 2A, 2B (10Ω≤R≤10MΩ) 0.2: others	85°C ± 2°C, 1000 hours, 1.5 hr ON, 0.5 hr OFF cycle
High Temperature Exposure	0.2: 1E (300Ω≤R≤10kΩ) 1J (10Ω≤R≤200kΩ) 2A, 2B (10Ω≤R≤100kΩ) 0.4~0.5: others	0.1: 1E (300Ω≤R≤10kΩ) 1J (10Ω≤R≤200kΩ) 2A, 2B (10Ω≤R≤100kΩ) 0.2~0.3: others	+155°C, 1000 hours
Sulfuration Test	±5%	±0.2%	Soaked in industrial oil with sulfur substance 3.5% 105°C ± 3°C, 500hr

Please refer to conventional products for characteristic data such as temperature rise.

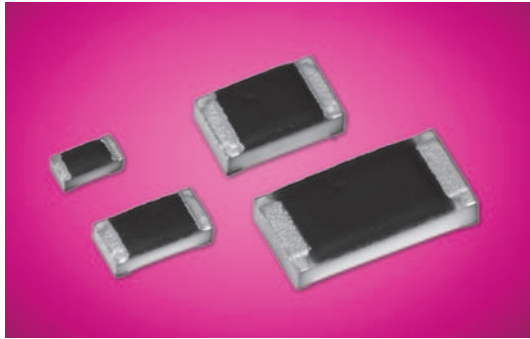

features

- Excellent anti-sulfuration characteristic due to using high sulfuration-proof inner top electrode material
- High heat resistance that can be used even at high temperatures of 155°C or higher. The maximum operating temperature of Sn plating products compatible with solder mounting is 175°C.
- Excellent heat resistance and weather resistance are ensured by the use of metal glaze thick film
- High stability and high reliability with the triple-layer structure of electrode
- Superior to RK73 series chip resistors pulse withstanding voltage and high power
- Applicable to various kinds of automatic mounters for taping, etc
- Products meet EU RoHS requirements. EU RoHS regulation is not intended for Pb-glass contained in electrode, resistor element and glass.
- AEC-Q200 Tested

dimensions and construction

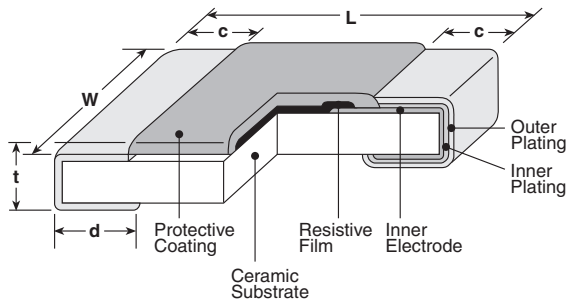

Type (Inch Size Code)	Dimensions inches (mm)				
	L	W	c	d	t
1E (0402)	.039 ^{+0.003} _{-.002} (1.0 ^{+0.1} _{-0.05})	.020±.002 (0.5±0.05)	.008±.006 (0.2±0.15)	.010 ^{+0.002} _{-.004} (0.25 ^{+0.05} _{-0.1})	.014±.002 (0.35±0.05)
1J (0603)	.063±.008 (1.6±0.2)	.031±.004 (0.8±0.1)	.012±.006 (0.3±0.15)	.012±.004 (0.3±0.1)	.018±.004 (0.45±0.1)
2A (0805)	.079±.008 (2.0±0.2)	.049±.004 (1.25±0.1)	.016±.010 (0.4±0.25)	.012 ^{+0.008} _{-.004} (0.3 ^{+0.2} _{-0.1})	.02±.004 (0.5±0.1)
2B (1206)	.126±.008 (3.2±0.2)	.063±.008 (1.6±0.2)	.022±.014 (0.55±0.35)	.016 ^{+0.008} _{-.004} (0.4 ^{+0.2} _{-0.1})	.024±.004 (0.6±0.1)

ordering information

HSG73P	2B	R	T	TD	103	J
Type	Power Rating	Characteristic	Terminal Surface Material	Packaging	Nominal Resistance	Tolerance
	1E: 0.125W, 0.2W ^{*1} 1J: 0.2W, 0.33W ^{*1} 2A: 0.25W, 0.5W ^{*1} 2B: 0.33W, 0.75W ^{*1}	R: Anti-Sulfuration	T: Sn	TP: 2mm pitch punch paper TD: 4mm pitch punched paper For further information on packaging, please refer to Appendix A	F: 4 digits J: 3 digits	F: ±1% J: ±5%

*1 If you use at the rated power, please keep the condition that the terminal of the resistor is below the rated terminal part temperature.

Contact us when you have control request for environmental hazardous material other than the substance specified by EU RoHS.

Specifications given herein may be changed at any time without prior notice. Please confirm technical specifications before you order and/or use.

11/01/23

applications and ratings

Part Designation	Power Rating	Rated Ambient Temp.	Rated Terminal Part Temp.	T.C.R. (x10 ⁻⁶ /K) Max.	Resistance Range		Maximum Working Voltage	Maximum Overload Voltage
					F: ±1% E24	J: ±5% E24		
HSG73P1E (0402)	0.125W	70°C	125°C	±200	10Ω~1MΩ	1Ω~10MΩ	75V	100V
	0.2W ^{*1}	70°C	105°C					
HSG73P1J (0603)	0.2W	70°C	135°C	±200	10Ω~1MΩ	1Ω~10MΩ	150V	200V
	0.33W ^{*1}	70°C	125°C					
HSG73P2A (0805)	0.25W	70°C	125°C	±200	10Ω~1MΩ	1Ω~10MΩ	200V	400V
	0.5W ^{*1}	70°C	100°C					
HSG73P2B (1206)	0.33W	70°C	125°C	±200	10Ω~1MΩ	1Ω~10MΩ	200V	400V
	0.75W ^{*1}	70°C	105°C					

Operating Temperature Range : -55°C ~ +175°C

Rated voltage = $\sqrt{\text{Power rating} \times \text{resistance value}}$ or max. working voltage, whichever is lower

*1 If you use at the rated power, please keep the condition that the terminal of the resistor is below the rated terminal part temperature.

Please refer to the derating curves based on the terminal temperature.

If any questions arise whether to use the "Rated Ambient Temperature" or the "Rated Terminal Part Temperature" in your usage conditions, please give priority to the "Rated Terminal Part Temperature"

Derating Curve

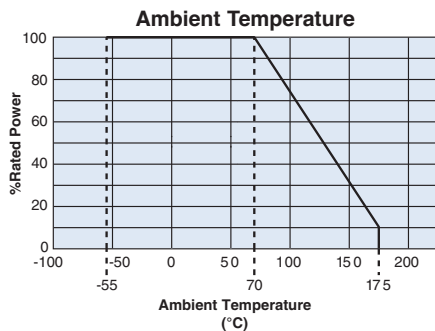

For resistors operated at an ambient temperature of 70°C or above, a power rating shall be derated in accordance with the derating curve.

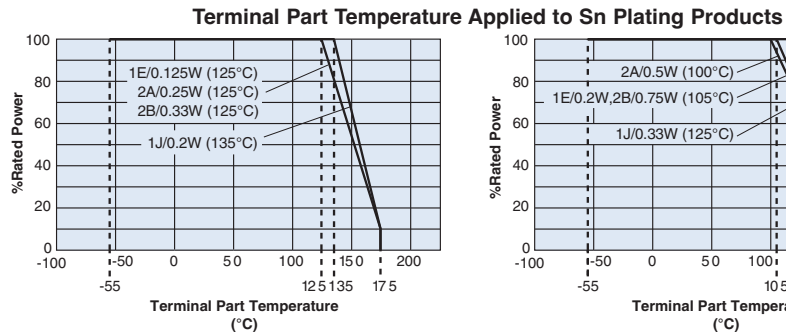

When the terminal part temperature of the resistor exceeds the rated terminal part temperature shown above, the power shall be derated according to the derating curve.

If you want to use at the rated power of *1, please use the derating curves based on the terminal part temperature of right side.

Please refer to "Introduction of the derating curves based on the terminal part temperature" in the beginning of our catalog before use.

environmental applications

Performance Characteristics

Parameter	Requirement $\Delta R \pm(\%+0.1\Omega)$		Test Method
	Limit	Typical	
Resistance	Within specified tolerance	—	25°C
T.C.R.	Within specified T.C.R.	—	+25°C/-55°C, +25°C/+125°C
Overload (Short time)	±2%	±0.5%	Rated Voltage x 2.5 for 5 seconds (2B: Rated Voltage x 2 for 5 seconds)
Rapid Change of Temperature	±0.5%	±0.3%	-55°C (30 min.)/+125°C (30 min.) 100 cycles
Moisture Resistance	±2%: 1J, 2A, 2B ±3%: 1E	±0.75%: 1J, 2A, 2B ±1%: 1E	40°C ± 2°C, 90%-95% RH, 1000 hours, 1.5 hr ON, 0.5 hr OFF cycle
Endurance at 70°C	±2%: 1J, 2A, 2B ±3%: 1E	±0.75%: 1J, 2A, 2B ±1%: 1E	70°C ± 2°C, 1000 hours, 1.5 hr ON, 0.5 hr OFF cycle
Endurance at 175°C	±1%	±0.3%	+175°C, 1000 hours, Power Rating×10%
Sufuration Test	±5%	±0.2%	Soaked in industrial oil with sulfur substance 3.5% contained, 105°C ± 3°C, 500 hours

For Surface Temperature Rise Graph see Environmental Applications. Additional environmental applications can also be found at www.koaspeer.com

Specifications given herein may be changed at any time without prior notice. Please confirm technical specifications before you order and/or use.

5/11/22



features

- Anti-sulfuration type, wide-side termination (reverse-geometry) type flat chip resistor
- Excellent anti-sulfuration characteristic due to using high sulfuration-proof inner top electrode material
- Suitable for both flow and reflow solderings
- Products meet EU RoHS requirements. EU RoHS regulation is not intended for Pb-glass contained in electrode, resistor element and glass.
- AEC-Q200 Tested

dimensions and construction

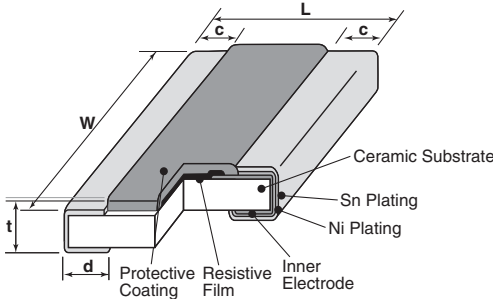

Type (Inch Size Code)	Dimensions inches (mm)				
	L	W	c	d	t
2A (0508)	.049±.006 (1.25±0.15)	.079±.006 (2.0±0.15)	.012±.008 (0.3±0.2)	.014±.008 (0.35±0.2)	.022±.004 (0.55±0.1)
2B (0612)	.063±.008 (1.6±.0.2)	.126±.012 (3.2±.0.3)	.012±.008 (0.3±0.2)	.018±.006 (0.45±0.15)	.024±.004 (0.6±0.1)
2H (1020)	.098±.008 (2.5±.0.2)	.197±.008 (5.0±.0.2)	.016±.008 (0.4±0.2)	.030±.006 (0.75±0.15)	
3A (1225)	.122±.004 (3.1±.0.1)	.248±.006 (6.3±0.15)	.018±.008 (0.45±0.2)	.030±.006 (0.75±0.15)	.024±.004 (0.6±0.1)

Derating Curve

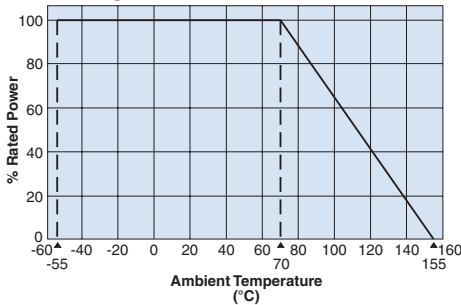

For resistors operated at an ambient temperature of 70°C or above, a power rating shall be derated in accordance with the above derating curve.

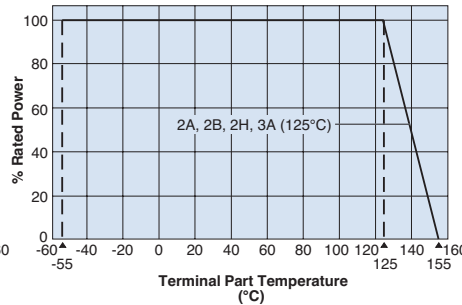

For resistors operated terminal temperature of described for each size or above, a power rating shall be derated in accordance with the derating curve.

Please refer to "Introduction of the derating curve based on the terminal part temperature" in the beginning of our catalog before use.

When using Power Rating', please use the derating curves based on the terminal part temperature on the right side.

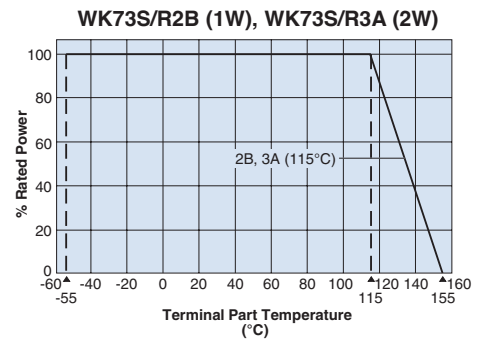

ordering information

WK73R	2B	R	T	TD	10R0	F
Type	Size	Characteristic	Termination Material	Packaging	Nominal Resistance*	Resistance Tolerance
WK73S WK73R	2A: 0.75W, 1W 2B: 0.75W, 1W 2H: 1W 3A: 1.5W, 2W	R: Anti-Sulfur	T: Sn	TD: 4mm pitch punched paper TE: 4mm pitch embossed plastic For further information on packaging, please refer to Appendix A	±1%: 4 digits ±5%: 3 digits	F: ±1% J: ±5%

* Resistance value, 3 digits:
1~9.1Ω, 1R0~9R1
Resistance value, 4 digits:
1~9.76Ω, 1R00~9R76

applications and ratings

Part Designation	Power Rating	Rated Ambient Temperature	Rated Terminal Part Temperature	T.C.R. (X 10 ⁻⁶ /K)	Resistance Range (Ω)		Maximum Working Voltage	Maximum Overload Voltage	Operating Temperature Range
					F±1% E-24 · E-96	J±5% E-24			
WK73S2A	1.0W ¹	70°C	125°C	±100	1 ~ 9.76	1 ~ 9.1	200V	400V	-55°C to +155°C
WK73R2A	0.75W ¹	70°C	125°C	±100	20.5k ~ 1M	22k ~ 1M			
	1.0W ¹	70°C	125°C	±100	10 ~ 20k	10 ~ 20k			
WK73S2B	0.75W	70°C	125°C	±100	1 ~ 9.76	1 ~ 9.1			
	1.0W ¹	70°C	115°C	±100	1 ~ 9.76	1 ~ 9.1			
WK73R2B	0.75W	70°C	125°C	±100	10 ~ 9.76k	10 ~ 9.1k			
				±200	10k ~ 1M	10k ~ 1M			
	1.0W ¹	70°C	115°C	±100	10 ~ 9.76k	10 ~ 9.1k			
WK73S2H	1.0W	70°C	125°C	±100	1 ~ 9.76	1 ~ 9.1	200V	400V	
WK73R2H	1.0W	70°C	125°C	±150	0.2 ~ 0.976	0.2 ~ 0.91			
				±100	10 ~ 430k	10 ~ 430k			
WK73S3A	1.5W	70°C	125°C	±100	1 ~ 9.76	1 ~ 9.1	200V	400V	
	2.0W ¹	70°C	115°C	±100	1 ~ 9.76	1 ~ 9.1			
WK73R3A	1.5W	70°C	125°C	±100	10 ~ 330k	10 ~ 330k			
				±200	332k - 1M	360k - 1M			
	2.0W ¹	70°C	115°C	±100	10 ~ 330k	10 ~ 330k			
				±200	332k - 1M	360k - 1M			

Rated voltage = $\sqrt{\text{Power rating} \times \text{resistance value}}$ or max. working voltage, whichever is lower

¹ When using Power Rating, please use the derating curves based on the terminal part temperature on the right side of the graph located on the previous page.

If any questions should arise whether to use the "Rated Ambient Temperature" or the "Rated Terminal Part Temperature", please give priority to the "Rated Terminal Part Temperature." Prior to use and for more details refer to the "Introduction of the derating curves based on the terminal part temperature" in the beginning of the catalog.

environmental applications

Performance Characteristics

Parameter	Requirement Δ R ±(%+0.005Ω)		Test Method
	Limit	Typical	
Resistance	Within specified tolerance	—	25°C
T.C.R.	Within specified T.C.R.	—	+25°C/-55°C and +25°C/+125°C
Overload (Short time)	±2%	±0.2%	WK732B, S2H, R2H: Rated voltage x 2.5 for 5 seconds WK73S/R2A (0.75W, 1W), WK73S/R2B (1W), WK73S/R3A (2W): Rated voltage x 2.0 for 5 seconds
Resistance to Solder Heat	±1%	±0.2%	260°C ± 5°C, 10 seconds ± 1 second
Bending Test	±1%	±0.1%	Holding point 90mm, Bending 1 time, Bending 5mm
Rapid Change of Temperature	±2%	±1%	-55°C (30 minutes), +125°C (30 minutes), 100 cycles
Moisture Resistance	±2%	±0.2%	40°C ± 2°C, 90%-95% RH, 1000 hours, 1.5 hr ON, 0.5 hr OFF cycle
Endurance at 70°C	±2%	±0.2%	70°C ± 2°C, 1000 hours, 1.5 hr ON, 0.5 hr OFF cycle
High Temperature Exposure	±1%	±0.2%	+155°C, 1000 hours
Sulfuration Test	±5%	±0.2%	Soaked in industrial oil with 3.5% sulfur concentration 105°C ± 3°C, 500 hours

Please refer to conventional products for characteristic data such as temperature rise.

Additional environmental applications can also be found at www.koaspeer.com

Specifications given herein may be changed at any time without prior notice. Please confirm technical specifications before you order and/or use.

10/20/23



features

- Anti-sulfuration type, wide-side termination (reverse-geometry) type flat chip resistor
- Excellent anti-sulfuration characteristic due to using high sulfuration-proof inner top electrode material
- Suitable for both flow and reflow solderings
- Products meet EU RoHS requirements. EU RoHS regulation is not intended for Pb-glass contained in electrode, resistor element and glass.
- AEC-Q200 Tested

dimensions and construction

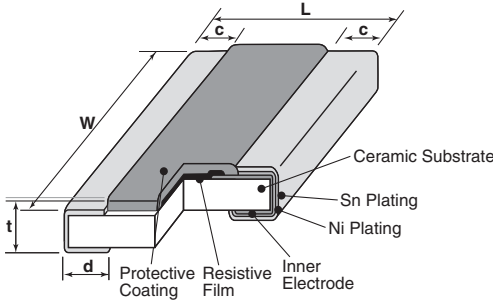

Type (Inch Size Code)	Dimensions inches (mm)				
	L	W	c	d	t
2B15 (0612)	$.063 \pm .008$ ($1.6 \pm .02$)	$.126 \pm .012$ ($3.2 \pm .03$)	$.012 \pm .008$ (0.3 ± 0.2)	$.018 \pm .006$ (0.45 ± 0.15)	$.024 \pm .004$ (0.6 ± 0.1)
2H2 (1020)	$.098 \pm .008$ ($2.5 \pm .02$)	$.197 \pm .008$ ($5.0 \pm .02$)	$.016 \pm .008$ (0.4 ± 0.2)	$.030 \pm .006$ (0.75 ± 0.15)	$.024 \pm .004$ (0.6 ± 0.1)
3A3 (1225)	$.122 \pm .004$ ($3.1 \pm .01$)	$.248 \pm .006$ (6.3 ± 0.15)	$.018 \pm .008$ (0.45 ± 0.2)	$.030 \pm .006$ (0.75 ± 0.15)	$.024 \pm .004$ (0.6 ± 0.1)

Derating Curve

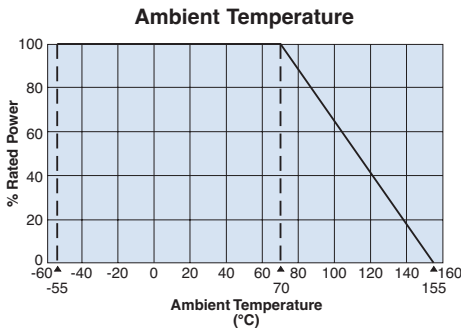

For resistors operated at an ambient temperature of 70°C or above, a power rating shall be derated in accordance with the above derating curve.

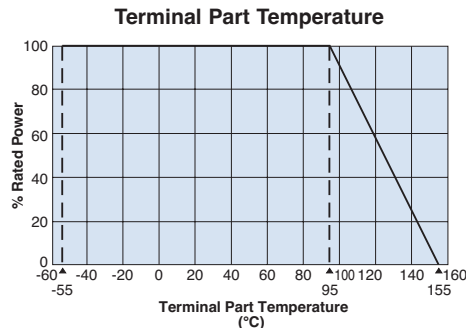

For resistors operated terminal temperature of described for each size or above, a power rating shall be derated in accordance with the derating curve. Please refer to "Introduction of the derating curve based on the terminal part temperature" in the beginning of our catalog before use.

ordering information

WK73R	2B15	R	T	TD	10R0	F
Type	Size	Characteristic	Termination Material	Packaging	Nominal Resistance	Resistance Tolerance
WK73S WK73R	2B15: 1.5W 2H2: 2W 3A3: 3W	R: Anti-Sulfur	T: Sn	TD: 0612: 7" 4mm pitch punched paper TE: 1020, 1225: 7" 4mm pitch embossed plastic For further information on packaging, please refer to Appendix A	±1%: 3 significant figures + 1 multiplier "R" indicates decimal on value <100Ω ±5%: 2 significant figures + 1 multiplier "R" indicates decimal on values <10Ω	F: ±1% J: ±5%

Contact us when you have control request for environmental hazardous material other than the substance specified by EU RoHS.

Specifications given herein may be changed at any time without prior notice. Please confirm technical specifications before you order and/or use.

11/27/23

applications and ratings

Part Designation	Power Rating	Rated Ambient Temp.	Rated Terminal Part Temp.	T.C.R. (X 10 ⁻⁶ /K)	Resistance Range (Ω)		Maximum Working Voltage	Maximum Overload Voltage	Operating Temperature Range
					F±1% E-24 · E-96	J±5% E-24			
WK73S2B15RT	1.5W ¹	70°C	95°C	±100	1 ~ 9.76	1 ~ 9.1	200V	400V	-55°C to +155°C
				±150	0.3 ~ 0.976	0.3 ~ 0.91			
WK73R2B15RT	1.5W ¹	70°C	95°C	±100	10 ~ 9.76k	10 ~ 9.1k	200V	400V	
				±100	1 ~ 9.76	1 ~ 9.1			
WK73S2H2RT	2.0W ¹	70°C	95°C	±100	0.2 ~ 0.976	0.2 ~ 0.91	200V	400V	
				±150	10 ~ 430k	10 ~ 430k			
WK73R2H2RT	2.0W ¹	70°C	95°C	±100	10 ~ 430k	10 ~ 430k	200V	400V	
				±200	432k - 1M	470k - 1M			
WK73S3A3RT	3.0W ¹	70°C	95°C	±100	1 ~ 9.76	1 ~ 9.1	200V	400V	
				±100	10 ~ 330k	10 ~ 330k			
WK73R3A3RT	3.0W ¹	70°C	95°C	±100	10 ~ 330k	10 ~ 330k	200V	400V	
				±200	332k - 1M	360k - 1M			

Rated voltage = $\sqrt{\text{Power rating} \times \text{resistance value}}$ or max. working voltage, whichever is lower

*1 If you use at the rated power, please keep the condition that the terminal of the resistor is below the rated terminal part temperature.

Please refer to the derating curves based on the terminal temperature of right side on the next page.

For more details, please refer to "Introduction of the derating curves based on the terminal part temperature" on the beginning of our catalog.

Operating Temperature Range: -55°C ~ +155°C

environmental applications

Performance Characteristics

Parameter	Requirement $\Delta R \pm(\%+0.005\Omega)$		Test Method
	Limit	Typical	
Resistance	Within specified tolerance	—	25°C
T.C.R.	Within specified T.C.R.	—	+25°C/-55°C and +25°C/+125°C
Overload (Short time)	±2%	±0.2%	Rated voltage x 2.0 for 5 seconds
Resistance to Solder Heat	±1%	±0.2%	260°C ± 5°C, 10 seconds ± 1 second
Bending Test	±1%	±0.1%	Holding point 90mm, Bending 1 time, Bending 5mm
Rapid Change of Temperature	±2%	±1%	-55°C (30 minutes), +125°C (30 minutes), 1000 cycles
Moisture Resistance	±2%	±0.2%	40°C ± 2°C, 90%-95% RH, 1000 hours, 1.5 hr ON, 0.5 hr OFF cycle
Endurance at 70°C	±2%	±0.2%	70°C ± 2°C, 1000 hours, 1.5 hr ON, 0.5 hr OFF cycle
High Temperature Exposure	±1%	±0.2%	+155°C, 1000 hours
Sulfuration Test	±5%	±0.2%	Soaked in industrial oil with 3.5% sulfur concentration 105°C ± 3°C, 500 hours

Please refer to conventional products for characteristic data such as temperature rise.



features

- Excellent anti-sulfuration characteristic due to using high sulfuration-proof inner top electrode material/pulse
- Superior to RK73 series chip resistors in pulse withstanding voltage
- Suitable for both reflow and flow solderings
- Products with lead-free terminations meet EU RoHS requirements. EU RoHS regulation is not intended for Pb-glass contained in electrode, resistor element and glass.
- AEC-Q200 Tested

dimensions and construction

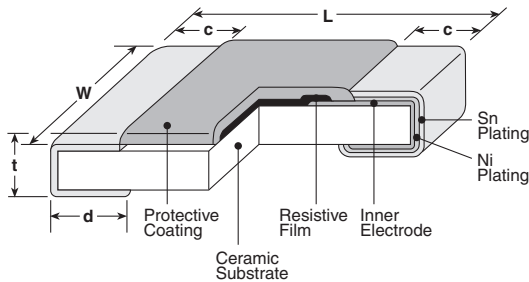

Type (Inch Size Code)	Dimensions inches (mm)				
	L	W	c	d	t
SG73 1J (0603)	.063±.008 (1.6±0.2)	.031±.004 (0.8±0.1)	.012±.004 (0.3±0.1)	.012±.004 (0.3±0.1)	.018±.004 (0.45±0.1)
SG73 2A (0805)	.079±.008 (2.0±0.2)	.049±.004 (1.25±0.1)	.016±.008 (0.4±0.2)	.012 ^{+0.008} _{-.004} (0.3 ^{+0.2} _{-.1})	.02±.004 (0.5±0.1)
SG73 2B (1206)	.126±.008 (3.2±0.2)	.063±.008 (1.6±0.2)	.02±.012 (0.5±0.3)	.016 ^{+0.008} _{-.004} (0.4 ^{+0.2} _{-.1})	.024±.004 (0.6±0.1)
SG73 2E (1210)		.102±.008 (2.6±0.2)			
SG73 W2H (2010)	.197±.008 (5.0±0.2)	.098±.008 (2.5±0.2)		.026±.006 (0.65±0.15)	
SG73 W3A (2512)	.248±.008 (6.3±0.2)	.122±.008 (3.1±0.2)			

ordering information

SG73	2A	R	T	TD	103	K
Type	Power Rating	Characteristic	Termination Material	Packaging	Nominal Resistance	Resistance Tolerance
SG73	1J 2A 2B 2E W2H W3A	R: Anti-Sulfur	T: Sn	TP: 0402, 0603, 0805: 7" 2mm pitch punch paper TD: 0603, 0805, 1206, 1210: 7" 4mm pitch punched paper TE: 0805, 1206, 1210, 2010 & 2512: 7" 4mm embossed plastic For further information on packaging, please refer to Appendix A	±10%, ±20%: 2 significant figures + 1 multiplier "R" indicates decimal on value <10Ω	K: ±10% M: ±20%

applications and ratings

Part Designation	Power Rating	Rated Ambient Temp.	Rated Terminal Part Temp.	T.C.R. (ppm/°C) Max.	Resistance Range K: ±10% M: ±20% E-12	Maximum Working Voltage	Maximum Overload Voltage	Operating Temp. Range
SG73 1J (0603)	0.1W	70°C	125°C	±400	1Ω - 8.2Ω	50V	100V	-55°C to +155°C
				±200	10Ω - 1MΩ			
SG73 2A (0805)	0.125W	70°C	125°C	±400	1Ω - 8.2Ω	150V	200V	
				±200	10Ω - 1MΩ			
SG73 2B (1206)	0.33W	70°C	125°C	±400	1Ω - 8.2Ω	200V	400V	
				±200	10Ω - 1MΩ			
SG73 2E (1210)	0.50W	70°C	125°C	±400	1Ω - 8.2Ω			
				±200	10Ω - 1MΩ			
SG73 W2H (2010)	0.75W	70°C	125°C	±400	1Ω - 8.2Ω			
				±200	10Ω - 1MΩ			
SG73 W3A (2512)	1W	70°C	125°C	±400	1Ω - 8.2Ω			
				±200	10Ω - 1MΩ			

Rated voltage = $\sqrt{\text{Power rating} \times \text{resistance value}}$ or max. working voltage, whichever is lower

If any questions should arise whether to use the "Rated Ambient Temperature" or the "Rated Terminal Part Temperature," please give priority to the "Rated Terminal Part Temperature." Prior to use and for more details refer to "Introduction of the derating curves on the terminal part temperature" in the beginning of the catalog.

environmental applications

Derating Curve

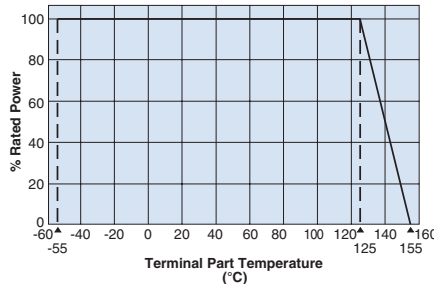
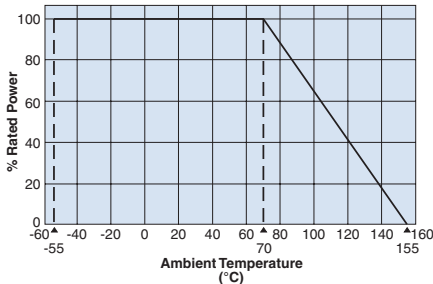

For resistors operated at an ambient temperature of 70°C or above, a power rating shall be derated in accordance with the derating curve.

For resistors operated at a terminal part temperature of described for each size or above, a power rating shall be derated in accordance with the derating curve.

Please refer to "Introduction of the derating curve based on the terminal part temperature" in the beginning of our catalog before use.

Performance Characteristics

Parameter	Requirement $\Delta R \pm(\%+0.1\Omega)$		Test Method
	Limit	Typical	
Resistance	Within specified tolerance	—	25°C
T.C.R.	Within specified T.C.R.	—	+25°C/-55°C and +25°C/+125°C
Overload (Short time)	±2%	±0.5%	Rated Voltage x 2.5 for 5 seconds
Resistance to Solder Heat	±1%	±0.75%	260°C ± 5°C, 10 seconds ± 1 second
Rapid Change of Temperature	±0.5%	±0.3%	-55°C (30 minutes), +125°C (30 minutes), 100 cycles
Moisture Resistance	±3%	±0.75%	40°C ± 2°C, 90%~95%RH, 1000 hours; 1.5 hr ON, 0.5 hr OFF cycle
Endurance at 70°C	±3%	±0.75%	70°C ± 2°C, 1000 hours, 1.5 hr ON, 0.5 hr OFF cycle
High Temperature Exposure	±1%	±0.3%	+155°C, 1000 hours
Sulfuration Test	±5%	±0.2%	Soaked in industrial oil with 3.5% sulfur concentration 105°C ± 3°C, 500 hours

Additional environmental applications can also be found at www.koaspeer.com

Specifications given herein may be changed at any time without prior notice. Please confirm technical specifications before you order and/or use.

12/10/20

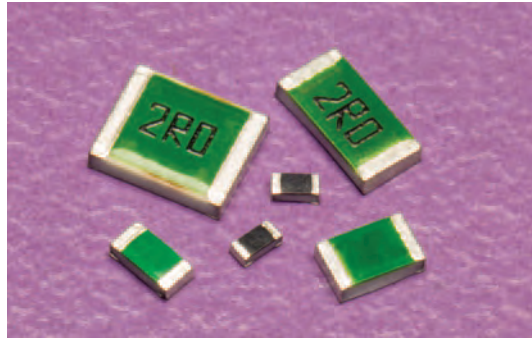

features

- Excellent anti-sulfuration characteristic due to using high sulfuration-proof inner top electrode material
- Superior to RK73 series chip resistors in pulse withstanding voltage and high power
- SG73P (for pulse) are able to select resistance tolerance is available from $\pm 0.5\%$
- Suitable for both reflow and flow solderings
- Products with lead-free terminations meet EU RoHS requirements. EU RoHS regulation is not intended for Pb-glass contained in electrode, resistor element and glass.
- AEC-Q200 Tested



dimensions and construction

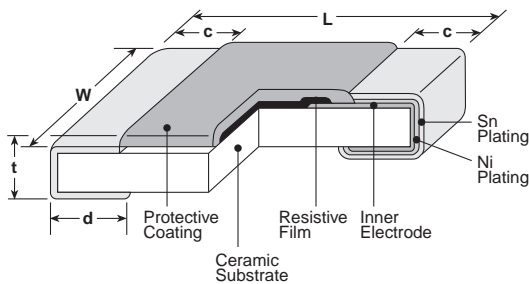

Type (Inch Size Code)	Dimensions inches (mm)				
	L	W	c	d	t
SG73P 1E (0402)	.039 ^{+0.004} _{-.002} (1.0 ^{+0.1} _{-0.05})	.020 \pm .002 (0.5 \pm 0.05)	.006 \pm .004 (0.15 \pm 0.1)	.010 ^{+0.002} _{-.004} (0.25 ^{+0.05} _{-0.1})	.014 \pm .002 (0.35 \pm 0.05)
SG73P 1J (0603)	.063 \pm .008 (1.6 \pm 0.2)	.031 \pm .004 (0.8 \pm 0.1)	.012 \pm .004 (0.3 \pm 0.1)	.012 \pm .004 (0.3 \pm 0.1)	.018 \pm .004 (0.45 \pm 0.1)
SG73P 2A (0805)	.079 \pm .008 (2.0 \pm 0.2)	.049 \pm .004 (1.25 \pm 0.1)	.012 ^{+0.008} _{-.004} (0.3 ^{+0.2} _{-0.1})	.012 ^{+0.008} _{-.004} (0.3 ^{+0.2} _{-0.1})	.020 \pm .004 (0.5 \pm 0.1)
SG73P 2B (1206)	.126 \pm .008 (3.2 \pm 0.2)	.063 \pm .008 (1.6 \pm 0.2)	.016 ^{+0.008} _{-.004} (0.4 ^{+0.2} _{-0.1})	.016 ^{+0.008} _{-.004} (0.4 ^{+0.2} _{-0.1})	.024 \pm .004 (0.6 \pm 0.1)
SG73P 2E SG73P 2E1 (1210)		.102 \pm .008 (2.6 \pm 0.2)			

ordering information

SG73P	2A	R	T	TD	103	J
Type	Power Rating	Characteristic	Termination Material	Packaging	Nominal Resistance	Resistance Tolerance
SG73P	1E 1J 2A 2B 2E1	R: Anti-Sulfur	T: Sn	TP: 0402, 0603, 0805: 7" 2mm pitch punch paper TD: 0603, 0805, 1206, 1210: 7" 4mm pitch punched paper TE: 0805, 1206, 1210: 7" 4mm embossed plastic For further information on packaging, please refer to Appendix A	$\pm 0.5\%$, $\pm 1\%$: 3 significant figures + 1 multiplier $\pm 2\%$, $\pm 5\%$: 2 significant figures + 1 multiplier "R" indicates decimal on value <10 Ω	D: $\pm 0.5\%$ F: $\pm 1\%$ G: $\pm 2\%$ J: $\pm 5\%$

applications and ratings

Part Designation	Power Rating	Rated Ambient Temp.	Rated Terminal Part Temp.	T.C.R. (ppm/°C) Max.	Resistance Range				Maximum Working Voltage	Maximum Overload Voltage	Operating Temp. Range																									
					D: ±0.5% E-24, E-96	F: ±1% E-24, E-96	G: ±2% E-24	J: ±5% E-24																												
SG73P 1E	0.125W	70°C	125°C	±200	100Ω - 1MΩ	10Ω - 1MΩ	10Ω - 10MΩ	1Ω - 10MΩ	75V	100V	-55°C to +155°C																									
	0.33W	—	105°C																																	
SG73P 1J	0.2W	70°C	135°C	±100*1					100Ω - 1MΩ	10Ω - 1MΩ		10Ω - 10MΩ	1Ω - 10MΩ	150V	200V	-55°C to +155°C																				
	0.5W	—	105°C																																	
SG73P 2A	0.25W	70°C	125°C	±200										100Ω - 1MΩ	10Ω - 1MΩ		10Ω - 10MΩ	1Ω - 10MΩ	400V	600V (800V)*2	-55°C to +155°C															
	0.75W	—	105°C																																	
SG73P 2B	0.33W	70°C	125°C	±200															100Ω - 1MΩ	10Ω - 1MΩ		10Ω - 10MΩ	1Ω - 10MΩ	200V	400V	-55°C to +155°C										
	1W	—	105°C																																	
SG73P 2E	0.5W	70°C	125°C	±200																				100Ω - 1MΩ	10Ω - 1MΩ		10Ω - 10MΩ	1Ω - 10MΩ	200V	400V	-55°C to +155°C					
	1.5W	—	105°C																																	
SG73P 2E1	1.5W	—	105°C	±200																									100Ω - 1MΩ	10Ω - 1MΩ		10Ω - 10MΩ	1Ω - 10MΩ	200V	400V	-55°C to +155°C

*1 Cold T.C.R. (-55°C ~ +25°C) is $\pm 150 \times 10^{-6}/K$

*2 Applies when power rating is 0.4W or lower.

Rated voltage = $\sqrt{\text{Power rating} \times \text{resistance value}}$ or max. working voltage, whichever is lower

If any questions should arise whether to use the "Rated Ambient Temperature" or the "Rated Terminal Part Temperature," please give priority to the "Rated Terminal Part Temperature." Prior to use and for more details refer to "Introduction of the derating curves on the terminal part temperature" in the beginning of the catalog.

environmental applications Derating Curve

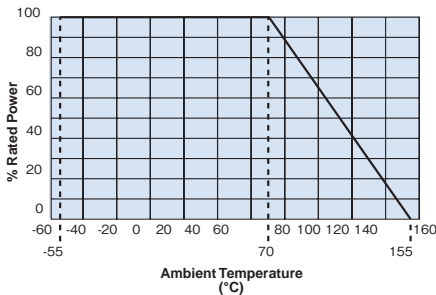

For resistors operated at an ambient temperature of 70°C or above, a power rating shall be derated in accordance with the derating curve.

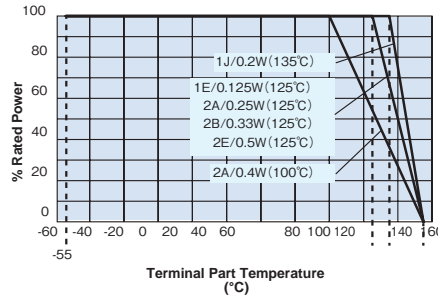

For resistors operated at a terminal part temperature of described for each size or above, a power rating shall be derated in accordance with the derating curve.

Please refer to "Introduction of the derating curve based on the terminal part temperature" in the beginning of our catalog before use.

If you want to use the rated power of *2 please use the derating curve based on the terminal part temperature above.

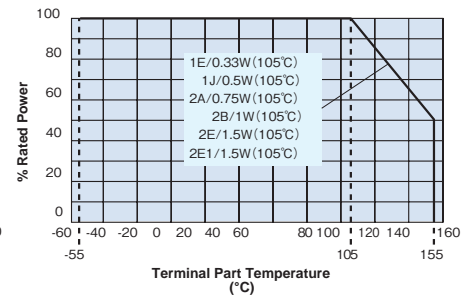

Performance Characteristics

Parameter	Requirement $\Delta R \pm(\%+0.1\Omega)$		Test Method														
	Limit	Typical															
Resistance	Within specified tolerance	—	25°C														
T.C.R.	Within specified T.C.R.	—	+25°C/-55°C and +25°C/+125°C														
Overload (Short time)	±2%	±0.5%	Overload for 5s <table border="1"> <thead> <tr> <th>Type</th> <th>1E</th> <th>1J</th> <th>2A</th> <th>2B</th> <th>2E</th> <th>2E1</th> </tr> </thead> <tbody> <tr> <td>Overload</td> <td>1.25W</td> <td>2.063W</td> <td>2W 1.6W*2</td> <td>3W</td> <td>4W</td> <td>4W</td> </tr> </tbody> </table>	Type	1E	1J	2A	2B	2E	2E1	Overload	1.25W	2.063W	2W 1.6W*2	3W	4W	4W
Type	1E	1J	2A	2B	2E	2E1											
Overload	1.25W	2.063W	2W 1.6W*2	3W	4W	4W											
Resistance to Solder Heat	±1%	±0.75%	260°C ± 5°C, 10 seconds ± 1 second														
Rapid Change of Temperature	±0.5%	±0.3%	-55°C (30 minutes), +125°C (30 minutes), 100 cycles														
Moisture Resistance	±3%	±0.75%	40°C ± 2°C, 90%~95%RH, 1000 hours; 1.5 hr ON, 0.5 hr OFF cycle														
Endurance at 70°C	±3%	±0.75%	70°C ± 2°C or rated terminal part temperature ± 2°C 1000h; 1.5h ON/0.5h OFF cycle														
High Temperature Exposure	±1%	±0.3%	+155°C, 1000 hours														
Sulfuration Test	±5%	±0.2%	Soaked in industrial oil with 3.5% sulfur concentration 105°C ± 3°C, 500 hours														

Please refer to conventional products for characteristic data such as temperature rise.

Additional environmental applications can also be found at www.koaspeer.com

Specifications given herein may be changed at any time without prior notice. Please confirm technical specifications before you order and/or use.

9/04/24

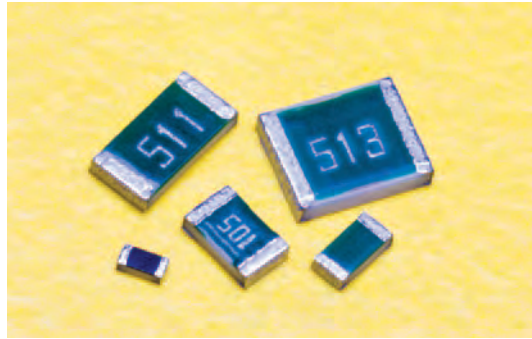

features

- Excellent anti-sulfuration characteristic due to using high sulfuration-proof inner top electrode material
- Superior to RK73 series chip resistors in surge withstanding voltage and high power
- Resistance tolerances for the SG73S series are available as low as 0.5%
- Suitable for both reflow and flow solderings
- Products with lead-free terminations meet EU RoHS requirements. EU RoHS regulation is not intended for Pb-glass contained in electrode, resistor element and glass.
- AEC-Q200 Tested



dimensions and construction

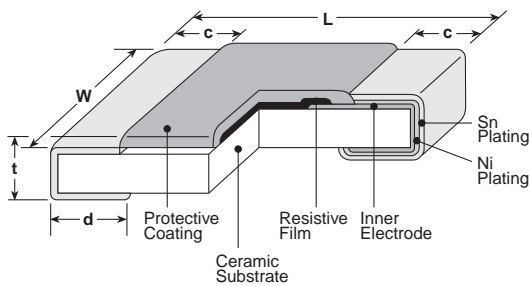

Type (Inch Size Code)	Dimensions inches (mm)				
	L	W	c	d	t
SG73S 1E, (0402)	.039 ^{+0.004} _{-.002} (1.0 ^{+0.1} _{-0.05})	.020±.002 (0.5±0.05)	.006±.004 (0.15±0.1)	.010 ^{+0.002} _{-.004} (0.25 ^{+0.05} _{-0.1})	.014±.002 (0.35±0.05)
SG73S 1J, (0603)	.063±.008 (1.6±0.2)	.031±.004 (0.8±0.1)	.012±.004 (0.3±0.1)	.012±.004 (0.3±0.1)	.018±.004 (0.45±0.1)
SG73S 2A, (0805)	.079±.008 (2.0±0.2)	.049±.004 (1.25±0.1)	.012 ^{+0.008} _{-.004} (0.3 ^{+0.2} _{-0.1})	.012 ^{+0.008} _{-.004} (0.3 ^{+0.2} _{-0.1})	.020±.004 (0.5±0.1)
SG73S 2B, (1206)	.126±.008 (3.2±0.2)	.063±.008 (1.6±0.2)	.016 ^{+0.008} _{-.004} (0.4 ^{+0.2} _{-0.1})	.016 ^{+0.008} _{-.004} (0.4 ^{+0.2} _{-0.1})	.024±.004 (0.6±0.1)
SG73S 2E, SG73S 2E1 (1210)		.102±.008 (2.6±0.2)			

ordering information

SG73S	2A	R	T	TD	103	J
Type	Power Rating	Characteristic	Termination Material	Packaging	Nominal Resistance	Resistance Tolerance
SG73S	1E 1J 2A 2B 2E 2E1	R: Anti-Sulfur	T: Sn	TP: 0402, 0603, 0805: 7" 2mm pitch punch paper TD: 0603, 0805, 1206, 1210: 7" 4mm pitch punched paper TE: 0805, 1206, 1210: 7" 4mm embossed plastic For further information on packaging, please refer to Appendix A	±0.5%, ±1%: 3 significant figures + 1 multiplier ±2%, ±5%: 2 significant figures + 1 multiplier "R" indicates decimal on value <10Ω	D: ±0.5% F: ±1% G: ±2% J: ±5%

applications and ratings

Part Designation	Power Rating	Rated Ambient Temp.	Rated Terminal Part Temp.	T.C.R. (ppm/°C) Max.	Resistance Range				Maximum Working Voltage	Maximum Overload Voltage	Operating Temp. Range
					D: ±0.5% E-24, E-96	F: ±1% E-24, E-96	G: ±2% E-24	J: ±5% E-24			
SG73S 1E	0.125W	70°C	125°C	±200	100Ω - 1MΩ	10Ω - 1MΩ	10Ω - 10MΩ	1Ω - 10MΩ	75V	100V	-55°C to +155°C
	0.33W	—	105°C								
SG73S 1J	0.2W	70°C	135°C	±100*1					400V	600V (800V)*2	
	0.5W	—	105°C								
SG73S 2A	0.25W	70°C	125°C	±200					200V	400V	
	0.75W	—	105°C								
SG73S 2B	0.33W	70°C	125°C	±200					200V	400V	
	1.0W	—	105°C								
SG73S 2E	0.5W	70°C	125°C	±200					200V	400V	
	1.5W	—	105°C								
SG73S 2E1	1.5W	—	105°C	±200							

*1Cold T.C.R. (-55°C ~ +25°C) is $\pm 150 \times 10^{-6}/K$

*2Applies when power rating is 0.4W or lower.

Rated voltage = $\sqrt{\text{Power rating} \times \text{resistance value or max. working voltage}}$, whichever is lower

If any questions should arise whether to use the "Rated Ambient Temperature" or the "Rated Terminal Part Temperature," please give priority to the "Rated Terminal Part Temperature." Prior to use and for more details refer to "Introduction of the derating curves on the terminal part temperature" in the beginning of the catalog.

environmental applications Derating Curve

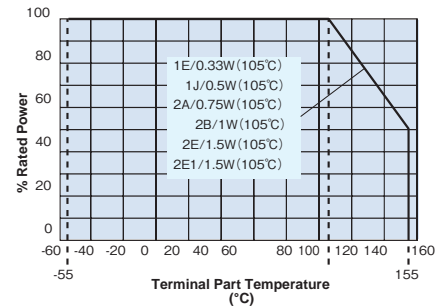
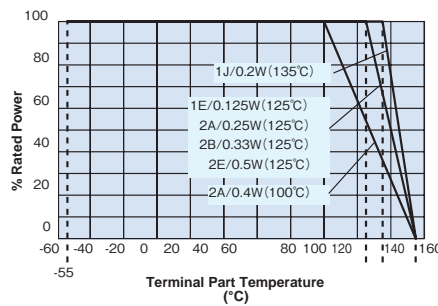
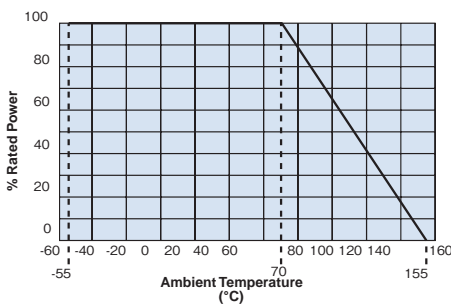

For resistors operated at an ambient temperature of 70°C or above, a power rating shall be derated in accordance with the derating curve.

For resistors operated at a terminal part temperature of described for each size or above, a power rating shall be derated in accordance with the derating curve.

Please refer to "Introduction of the derating curve based on the terminal part temperature" in the beginning of our catalog before use.

If you want to use the rated power of *, please use the derating curve based on the terminal part temperature above.

Additional environmental applications can also be found at www.koaspeer.com

Specifications given herein may be changed at any time without prior notice. Please confirm technical specifications before you order and/or use.

9/04/24

environmental applications (continued)

Performance Characteristics

Parameter	Requirement $\Delta R \pm(\%+0.1\Omega)$		Test Method											
	Limit	Typical												
Resistance	Within specified tolerance	—	25°C											
T.C.R.	Within specified T.C.R.	—	+25°C/-55°C and +25°C/+125°C											
Overload (Short time)	±2%	±0.5%	Overload for 5s											
			<table border="1"> <thead> <tr> <th>Type</th> <th>1E</th> <th>1J</th> <th>2A</th> <th>2B</th> <th>2E</th> <th>2E1</th> </tr> </thead> <tbody> <tr> <td>Overload</td> <td>1.25W</td> <td>2.063W</td> <td>2W(1.6W²)</td> <td>3W</td> <td>4W</td> <td>4W</td> </tr> </tbody> </table>	Type	1E	1J	2A	2B	2E	2E1	Overload	1.25W	2.063W	2W(1.6W ²)
Type	1E	1J	2A	2B	2E	2E1								
Overload	1.25W	2.063W	2W(1.6W ²)	3W	4W	4W								
Resistance to Solder Heat	±1%	±0.75%	260°C ± 5°C, 10 seconds ± 1 second											
Rapid Change of Temperature	±0.5%	±0.3%	-55°C (30 minutes), +125°C (30 minutes), 100 cycles											
Moisture Resistance	±3%	±0.75%	40°C ± 2°C, 90%~95%RH, 1000 hours; 1.5 hr ON, 0.5 hr OFF cycle											
Endurance at 70°C	±3%	±0.75%	70°C ± 2°C or rated terminal part temperature ± 2°C 1000 hours; 1.5 hr ON, 0.5 hr OFF cycle											
High Temperature Exposure	±1%	±0.3%	+155°C, 1000 hours											
Sulfuration Test	±5%	±0.2%	Soaked in industrial oil with 3.5% sulfur concentration 105°C ± 3°C, 500 hours											

Please refer to conventional products for characteristic data such as temperature rise.

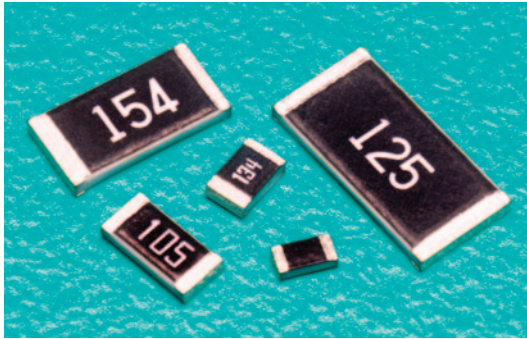

features

- Superior to RK73 series in maximum working voltage
- Suitable for flow and reflow solderings
- Products meet EU RoHS requirements. EU RoHS regulation is not intended for Pb-glass contained in electrode, resistor element and glass.
- Excellent anti-sulfuration characteristics due to using high sulfuration-proof inner top electrode material

dimensions and construction

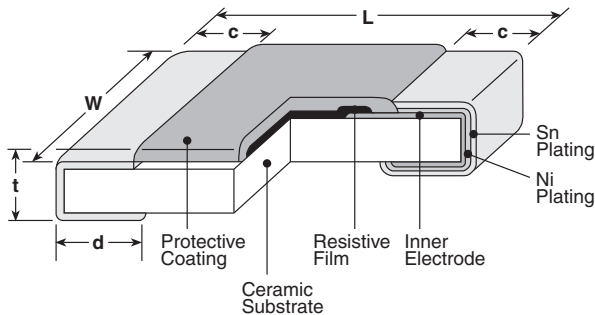

Type (Inch Size Code)	Dimensions inches (mm)				
	L	W	c	d	t
1J (0603)	.063±.008 (1.6±0.2)	.031±.004 (0.8±0.1)	.012±.004 (0.3±0.1)	.012±.004 (0.3±0.1)	.018±.004 (0.45±0.1)
2A (0805)	.079±.008 (2.0±0.2)	.049±.004 (1.25±0.1)	.016±.008 (0.4±0.2)	.012 ^{+0.008} _{-.004} (0.3 ^{+0.2} _{-0.1})	.02±.004 (0.5±0.1)
2B (1206)	.126±.008 (3.2±0.2)	.063±.008 (1.6±0.2)	.02±.012 (0.5±0.3)	.016 ^{+0.008} _{-.004} (0.4 ^{+0.2} _{-0.1})	.024±.004 (0.6±0.1)
2H (2010)	.197±.008 (5.0±0.2)	.098±.008 (2.5±0.2)	.02±.012 (0.5±0.3)	.016 ^{+0.008} _{-.004} (0.4 ^{+0.2} _{-0.1})	.024±.004 (0.6±0.1)
3A (2512)	.248±.008 (6.3±0.2)	.122±.008 (3.1±0.2)	.02±.012 (0.5±0.3)	.016 ^{+0.008} _{-.004} (0.4 ^{+0.2} _{-0.1})	.024±.004 (0.6±0.1)

ordering information

HV73	2B	R	T	TD	1004	F
Type	Size	Characteristic	Termination Material	Packaging	Nominal Resistance	Resistance Tolerance
	1J: 0.1W 2A: 0.25W 2B: 0.25W 2H: 0.5W 3A: 1W	R: Anti-Sulfur	T: Sn	TD: 7" 4mm pitch punched paper TE: 7" 4mm pitch embossed plastic For further information on packaging, please refer to Appendix A	±0.5%, ±1%: 3 significant figures +1 multiplier ±2%, ±5%: 2 significant figures + 1 multiplier	D: ±0.5% F: ±1% G: ±2% J: ±5%

applications and ratings

Part Designation	Power Rating @ 70°C	Rated Ambient Temp.	Rated Terminal Part Temp.	T.C.R. (ppm/°C) Max.	Resistance Range (Ω)				Maximum Working Voltage	Maximum Overload Voltage (D.C.)*	Operating Temperature Range
					E-24/E-96 (D±0.5%)	E-24/E-96 (F±1%)	E-24 (G±2%)	E-24 (J±5%)			
1J	0.1W	70°C	125°C	±100**	—	10k - 10M	10k - 10M	10k - 10M	350V	500V*	-55°C to +155°C
2A	0.25W	70°C	125°C	±100	100k - 1M	100k - 10M	100k - 10M	100k - 10M	400V	800V*	
				±200	—	—	—	11M - 51M			
2B	0.25W	70°C	125°C	±100	100k - 1M	100k - 10M	100k - 10M	100k - 10M	800V	1000V*	
				±200	—	—	—	11M - 51M			
2H	0.5W	70°C	125°C	±100	100k - 1M	100k - 10M	100k - 10M	100k - 10M	2000V (D.C.)	3000V*	
				±200	—	—	—	11M - 51M			
3A	1W	70°C	125°C	±100	43k - 1M	43k - 10M	43k - 10M	43k - 10M	3000V (D.C.)	4000V*	
				±200	—	10.2M - 20M	11M - 20M	11M - 51M			

Rated voltage = $\sqrt{\text{Power rating} \times \text{resistance value}}$ or max. working voltage, whichever is lower

* Maximum Overload Voltage is specified by D.C. voltage ** Cold T.C.R. (-55°C ~ +25°C) of 1.02MΩ ~ 10MΩ is +200x10⁻⁶/K

If any questions should arise whether to use the "Rated Ambient Temperature" or the "Rated Terminal Part Temperature," please give priority to the "Rated Terminal Part Temperature." Prior to use and for more details refer to "Introduction of the derating curves on the terminal part temperature" in the beginning of the catalog.

environmental applications

Derating Curve

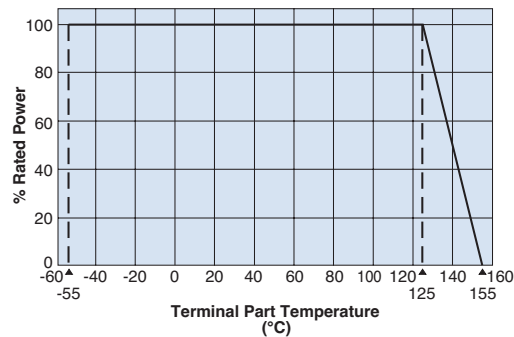
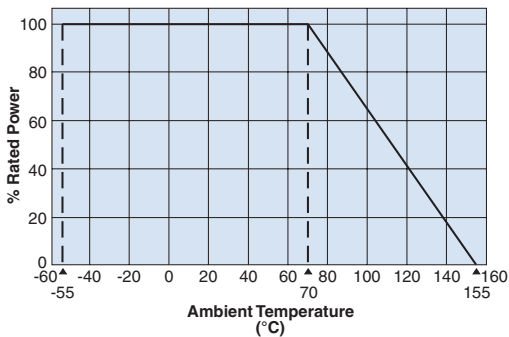

For resistors operated at an ambient temperature of 70°C or above, a power rating shall be derated in accordance with the above derating curve.

For resistors operated at a terminal part temperature of described for each size or above, a power rating shall be derated in accordance with the above derating curve.

Please refer to "Introduction of the derating curves based on the terminal part temperature" in the beginning of our catalog before use.

Performance Characteristics

Parameter	Requirement Δ R ±(%+0.1Ω)		Test Method
	Limit	Typical	
Resistance	Within regulated tolerance	—	25°C
T.C.R.	Within specified T.C.R.	—	+25°C/-55°C and +25°C/+125°C
Overload (Short time)	±2%	±0.5%	Rated Voltage (D.C.) x 2.5 for 5 seconds
Resistance to Solder Heat	±1%	±0.5%	260°C ± 5°C, 10 seconds ± 1 second
Rapid Change of Temperature	±0.5%: (10kΩ≤R≤10MΩ) ±1%: (11MΩ≤R≤51MΩ)	±0.3%: (10kΩ≤R≤10MΩ) ±0.5%: (11MΩ≤R≤51MΩ)	-55°C (30 minutes), +125°C (30 minutes), 100 cycles
Moisture Resistance	±2%	±0.75%	40°C ± 2°C, 90%-95% RH, 1000 hours, 1.5 hr ON, 0.5 hr OFF cycle
Endurance at 70°C	±2%	±0.75%	70°C ± 2°C, 1000 hours, 1.5 hr ON, 0.5 hr OFF cycle
High Temperature Exposure	±2%	±0.3%	+155°C, 1000 hours
Sulfuration Test	±5%	±0.2%	Soaked in industrial oil with 3.5% sulfur concentration 105°C ± 3°C, 500 hours

Please refer to conventional products for characteristic data such as temperature rise.

Additional environmental applications can also be found at www.koaspeer.com

Specifications given herein may be changed at any time without prior notice. Please confirm technical specifications before you order and/or use.

7/06/23



features

- Superior to RK73 series in maximum working voltage
- Suitable for flow and reflow solderings
- Products meet EU RoHS requirements. EU RoHS regulation is not intended for Pb-glass contained in electrode, resistor element and glass.
- Excellent anti-sulfuration characteristic due to using high sulfuration-proof inner top electrode material
- Suitable for high reliable applications like automotives
- AEC-Q200 tested

dimensions and construction

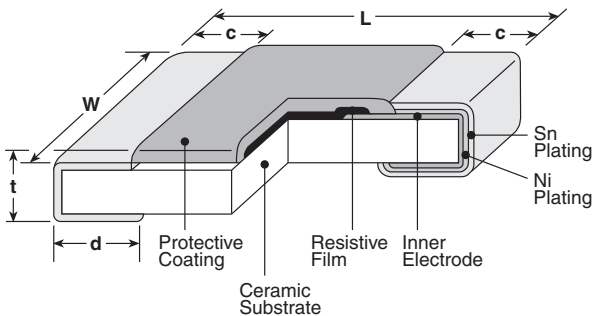

Type (Inch Size Code)	Dimensions inches (mm)				
	L	W	c	d	t
1J (0603)	.063±.008 (1.6±0.2)	.031±.004 (0.8±0.1)	.012±.004 (0.3±0.1)	.012±.004 (0.3±0.1)	.018±.004 (0.45±0.1)
2A (0805)	.079±.008 (2.0±0.2)	.049±.004 (1.25±0.1)	.016±.008 (0.4±0.2)	.012 ^{+0.008} _{-.004} (0.3 ^{+0.2} _{-0.1})	.02±.004 (0.5±0.1)
2B (1206)	.126±.008 (3.2±0.2)	.063±.008 (1.6±0.2)	.02±.012 (0.5±0.3)	.016 ^{+0.008} _{-.004} (0.4 ^{+0.2} _{-0.1})	.024±.004 (0.6±0.1)

ordering information

HV73V	2A	R	T	TD	104	J
Type	Size	Characteristic	Termination Material	Packaging	Nominal Resistance	Resistance Tolerance
HV73V	1J: 0.1W 2A: 0.25W 2B: 0.33W	R: Anti-Sulfur	T: Sn	TD: 7" 4mm pitch punched paper For further information on packaging, please refer to Appendix A	±0.5%, ±1%: 3 significant figures + 1 multiplier ±2%, ±5%: 2 significant figures + 1 multiplier	D: ±0.5% F: ±1% G: ±2% J: ±5%

applications and ratings

Part Designation	Power Rating @ 70°C	Rated Ambient Temp.	Rated Terminal Part Temp.	T.C.R. (ppm/°C) Max.	Resistance Range (Ω)				Maximum Working Voltage	Maximum Overload Voltage (D.C.)*	Operating Temperature Range
					E-24/E-96 (D±0.5%)	E-24/E-96 (F±1%)	E-24 (G±2%)	E-24 (J±5%)			
HV73V1J	0.1W	70°C	125°C	±100**	—	10k - 10M	10k - 10M	10k - 10M	350V	500V*	-55°C to +155°C
HV73V2A	0.25W	70°C	125°C	±100	100k - 1M	100k - 10M	100k - 10M	100k - 10M	400V	800V*	
				±200	—	—	—	11M - 51M			
HV73V2B	0.33W	70°C	125°C	±100	100k - 1M	100k - 10M	100k - 10M	100k - 10M	800V	1200V*	
				±200	—	—	—	11M - 51M			

Rated voltage = $\sqrt{\text{Power rating} \times \text{resistance value}}$ or max. working voltage, whichever is lower

* Maximum Overload Voltage is specified by D.C. voltage ** Cold T.C.R. (-55°C ~ +25°C) of 1.02MΩ ~ 10MΩ is +200x10⁻⁶/K

If any questions should arise whether to use the "Rated Ambient Temperature" or the "Rated Terminal Part Temperature," please give priority to the "Rated Terminal Part Temperature." Prior to use and for more details refer to "Introduction of the derating curves on the terminal part temperature" in the beginning of the catalog.

environmental applications

Derating Curve

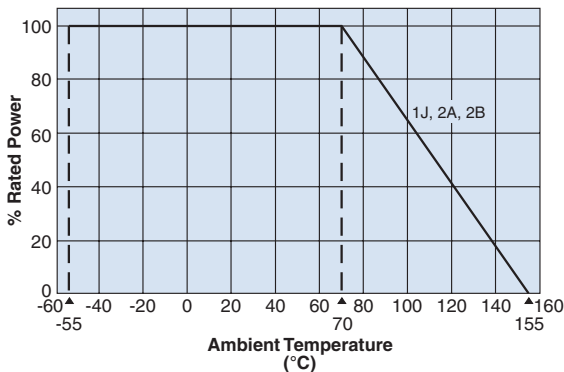

For resistors operated at an ambient temperature of 70°C or above, a power rating shall be derated in accordance with the above derating curve.

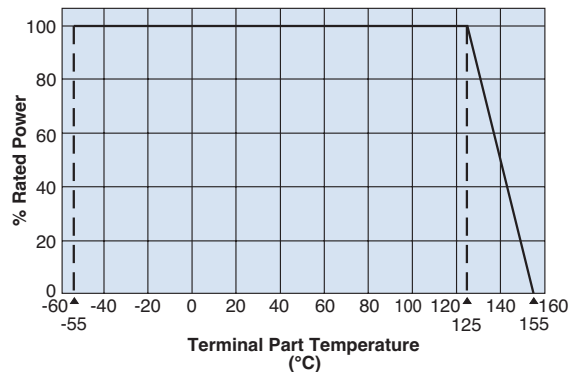

For resistors operated at a terminal part temperature of described for each size or above, a power rating shall be derated in accordance with the above derating curve.

Please refer to "Introduction of the derating curve based on the terminal part temperature" in the beginning of our catalog before use.

Performance Characteristics

Parameter	Requirement Δ R ±(%+0.1Ω)		Test Method
	Limit	Typical	
Resistance	Within regulated tolerance	—	25°C
T.C.R.	Within specified T.C.R.	—	+25°C/-55°C and +25°C/+125°C
Overload (Short time)	±2%	±0.5%	Rated Voltage (D.C.) x 2.5 for 5 seconds
Resistance to Solder Heat	±1%	±0.5%	260°C ± 5°C, 10 seconds ± 1 second
Rapid Change of Temperature	±0.5%: (10kΩ≤R≤10MΩ) ±1%: (11MΩ≤R≤51MΩ)	±0.3%: (10kΩ≤R≤10MΩ) ±0.5%: (11MΩ≤R≤51MΩ)	-55°C (30 minutes), +125°C (30 minutes), 100 cycles
Moisture Resistance	±2%	±0.75%	40°C ± 2°C, 90%-95% RH, 1000 hours, 1.5 hr ON, 0.5 hr OFF cycle
Endurance at 70°C	±2%	±0.75%	70°C ± 2°C, 1000 hours, 1.5 hr ON, 0.5 hr OFF cycle
High Temperature Exposure	±2%	±0.3%	+155°C, 1000 hours
Sulfuration Test	±5%	±0.2%	Soaked in industrial oil with sulfur substance 3.5% contained 105°C ± 3°C, 500 hours

Please refer to conventional products for characteristic data such as temperature rise.

Additional environmental applications can also be found at www.koaspeer.com

Specifications given herein may be changed at any time without prior notice. Please confirm technical specifications before you order and/or use.

7/06/23

low resistance flat chip resistors (anti sulfuration)

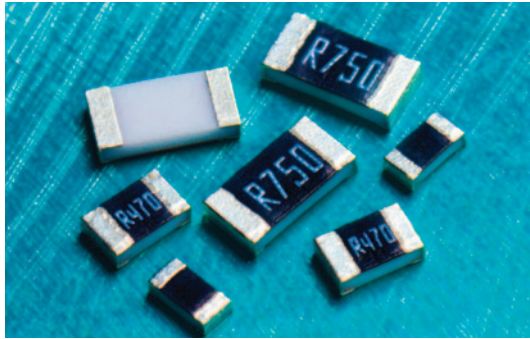

features

- Excellent anti-sulfuration characteristic due to using high sulfuration-proof inner top electrode material
- Current detecting resistors for power supply, motor circuits, etc
- High reliability and performance with resistance tolerance ± 1.0 , T.C.R. $\pm 100 \times 10^{-6}/K$
- Suitable for both reflow and flow solderings
- Products with lead free termination meet EU RoHS requirements. EU RoHS regulation is not intended for Pb-glass contained in electrode, resistor element and glass.
- AEC-Q200 Tested

dimensions and construction

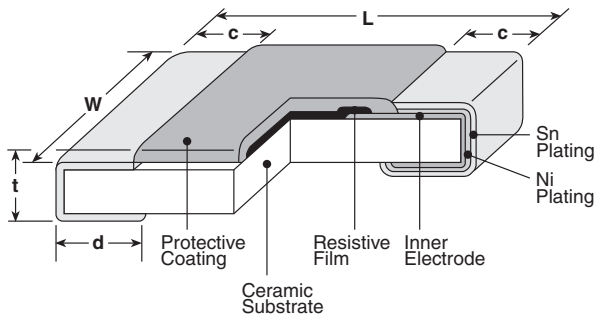

Type (Inch Size Code)	Resistance Range (Ω)	Dimensions inches (mm)				
		L	W	c	d	t
1E (0402)	1 - 10	$.039^{+0.004}_{-0.002}$ ($1.0^{+0.1}_{-0.05}$)	$.020^{+0.004}_{-0.002}$ ($0.5^{+0.1}_{-0.05}$)	$.008 \pm .004$ (0.2 ± 0.1)	$.010 \pm .004$ (0.25 ± 0.1)	$.014 \pm .002$ (0.35 ± 0.05)
1J (0603)	0.1 - 0.43	$.063 \pm .008$ (1.6 ± 0.2)	$.031^{+0.006}_{-0.004}$ ($0.8^{+0.15}_{-0.1}$)	$.014^{+0.006}_{-0.004}$ ($0.35^{+0.15}_{-0.1}$)	$.014^{+0.008}_{-0.004}$ ($0.35^{+0.2}$)	$.018 \pm .004$ (0.45 ± 0.1)
		0.47 - 10		$.014 \pm .004$ (0.35 ± 0.1)	$.014 \pm .004$ (0.35 ± 0.1)	
2A (0805)	0.1 - 0.43	$.079 \pm .008$ (2.0 ± 0.2)	$.049 \pm .004$ (1.25 ± 0.1)	$.016 \pm .008$ (0.4 ± 0.2)	$.016^{+0.008}_{-0.004}$ ($0.4^{+0.2}_{-0.1}$)	$.02 \pm .004$ (0.5 ± 0.1)
		0.47 - 10			$.012^{+0.008}_{-0.004}$ ($0.3^{+0.2}$)	
2B (1206)	0.1 - 0.43	$.126 \pm .008$ (3.2 ± 0.2)	$.063 \pm .008$ (1.6 ± 0.2)	$.02 \pm .012$ (0.5 ± 0.3)	$.02^{+0.008}_{-0.004}$ ($0.5^{+0.2}_{-0.1}$)	$.024 \pm .004$ (0.6 ± 0.1)
		0.47 - 10			$.016^{+0.008}_{-0.004}$ ($0.4^{+0.2}_{-0.1}$)	
2E (1210)	0.1 - 0.39	$.126 \pm .008$ (3.2 ± 0.2)	$.102 \pm .008$ (2.6 ± 0.2)	$.02 \pm .012$ (0.5 ± 0.3)	$.02^{+0.008}_{-0.004}$ ($0.5^{+0.2}_{-0.1}$)	$.024 \pm .004$ (0.6 ± 0.1)
		0.43 - 10			$.016^{+0.008}_{-0.004}$ ($0.4^{+0.2}_{-0.1}$)	

Derating Curve

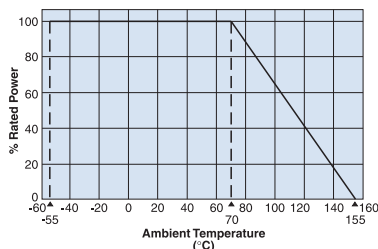

For resistors operated at an ambient temperature of 70°C or above, a power rating shall be derated in accordance with the derating curve.

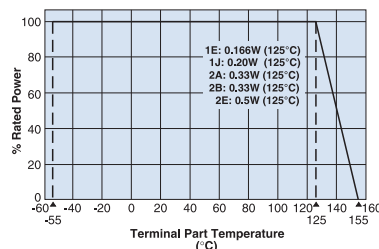

For resistors operated at a terminal part temperature of described for each size or above, a power rating shall be derated in accordance with the derating curve.

Please refer to "Introduction of the derating curve based on the terminal part temperature" in the beginning of our catalog before use.

SR73 2A (0.5W), SR73 2B (0.5W), SR73 2E (0.66W)

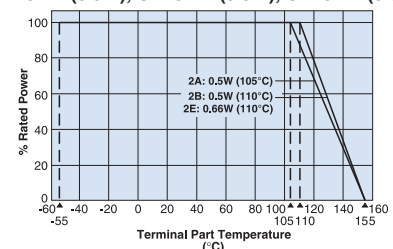

ordering information

SR73	2B	R	T	TD	R10	J
Type	Size	Characteristic	Termination Material	Packaging	Nominal Resistance	Tolerance
	1E: 0.166W 1J: 0.2W 2A: 0.33W, 0.5W 2B: 0.33W, 0.5W 2E: 0.5W, 0.66W	R: Anti-Sulfur	T: Sn	TD: 7" 4mm pitch punch paper TPL, TP: 0402 only, 7" 2mm pitch paper For further information on packaging, please refer to Appendix A	$\pm 2\%$, $\pm 5\%$: 2 significant figures + 1 multiplier "R" indicates decimal on values $< 10\Omega$ $\pm 1\%$: 3 significant figures + 1 multiplier "R" indicates decimal on values $< 100\Omega$	F: $\pm 1\%$ G: $\pm 2\%$ J: $\pm 5\%$

Specifications given herein may be changed at any time without prior notice. Please confirm technical specifications before you order and/or use.

12/15/22

applications and ratings

Part Designation	Power Rating	Rated Ambient Temperature	Rated Terminal Part Temp.	T.C.R. (ppm/°C) Max.	Resistance Range			Operating Temperature Range
					F (±1%) E-24, E-96 ¹	G (±2%) E-24	J (±5%) E-24	
SR731ERT (0402)	0.166W	70°C	125°C	±200	1Ω - 10Ω	1Ω - 10Ω	1Ω - 10Ω	-55°C to +155°C
SR731JRT (0603)	0.2W	70°C	125°C	±200	0.2Ω - 10Ω	0.2Ω - 10Ω	0.2Ω - 10Ω	
SR732ART (0805)	0.33W	70°C	125°C	±300	0.1Ω - 0.18Ω	0.1Ω - 0.18Ω	0.1Ω - 0.18Ω	
				±100	0.47Ω - 10Ω	—	—	
				±200	0.2Ω - 0.43Ω	0.2Ω - 10Ω	0.2Ω - 10Ω	
SR732ART (0805)	0.5W*	70°C	105°C	±250	0.1Ω - 0.18Ω	0.1Ω - 0.18Ω	0.1Ω - 0.18Ω	
				±100	0.47Ω - 10Ω	—	—	
				±200	0.2Ω - 0.43Ω	0.2Ω - 10Ω	0.2Ω - 10Ω	
SR732BRT (1206)	0.33W	70°C	125°C	±250	0.1Ω - 0.18Ω	0.1Ω - 0.18Ω	0.1Ω - 0.18Ω	
				±100	0.47Ω - 10Ω	—	—	
				±200	0.2Ω - 0.43Ω	0.2Ω - 10Ω	0.2Ω - 10Ω	
SR732BRT (1206)	0.5W*	70°C	110°C	±250	0.1Ω - 0.18Ω	0.1Ω - 0.18Ω	0.1Ω - 0.18Ω	
				±100	0.47Ω - 10Ω	—	—	
				±200	0.2Ω - 0.43Ω	0.2Ω - 10Ω	0.2Ω - 10Ω	
SR732ERT (1210)	0.5W	70°C	125°C	±250	—	—	0.1Ω - 0.18Ω	
				±100	0.43Ω - 10Ω	—	—	
				±200	0.2Ω - 0.39Ω	0.2Ω - 10Ω	0.2Ω - 10Ω	
SR732ERT (1210)	0.66W*	70°C	110°C	±250	—	—	0.1Ω - 0.18Ω	
				±100	0.43Ω - 10Ω	—	—	
				±200	0.2Ω - 0.39Ω	0.2Ω - 10Ω	0.2Ω - 10Ω	

Rated voltage = $\sqrt{\text{Power rating} \times \text{resistance value}}$ or max. working voltage, whichever is lower

¹ The nominal resistance value for SR731E (1Ω~10Ω), SR731J, 2A, 2B (0.1Ω~0.43Ω) and SR732E (0.1Ω~0.39Ω) is in E24

* Please use the derating curve based on the terminal part temperature.

If any questions should arise whether to use the "Rated Ambient Temperature" or the "Rated Terminal Part Temperature," please give priority to the "Rated Terminal Part Temperature." Prior to use and for more details refer to "Introduction of the derating curves on the terminal part temperature" in the beginning of the catalog.

environmental applications

Performance Characteristics

Parameter	Requirement Δ R ±(%+0.005Ω)		Test Method
	Limit	Typical	
Resistance	Within specified tolerance	—	25°C
T.C.R.	Within specified T.C.R.	—	+25°C/-55°C and +25°C/+125°C
Overload (Short time)	±2%	±0.5%	Rated voltage x 2.5 for 5 seconds
Resistance to Solder Heat	±1%	±0.3%	260°C ± 5°C, 10 seconds ± 1 second
Rapid Change of Temperature	±1%	±0.3%	-55°C (30 minutes), +125°C (30 minutes), 100 cycles
Moisture Resistance	±2%	±1%	40°C ± 2°C, 90%-95% RH, 1000 hours, 1.5 hr ON, 0.5 hr OFF cycle
Endurance at 70°C	±2%	±1%	70°C ± 2°C, 1000 hours, 1.5 hr ON, 0.5 hr OFF cycle
High Temperature Exposure	±1%	±0.3%	+155°C, 1000 hours
Sulfuration Test	±5%	±0.2%	Soaked in industrial oil with sulfur substance 3.5% contained, 105°C ±3°C, 500 hours

Please refer to conventional products for characteristic data such as temperature rise.



features

- Thick film resistor protected by liquid crystal polymer resin
- Excellent heat cycle characteristics
- Encapsulated with flame retardant resin molding. (UL94 V-0)
- High operating temperature range up to 180°C
- Products meet EU RoHS requirements. EU RoHS regulation is not intended for Pb-glass contained in electrode, resistor element and glass.
- AEC-Q200 Tested

dimensions and construction

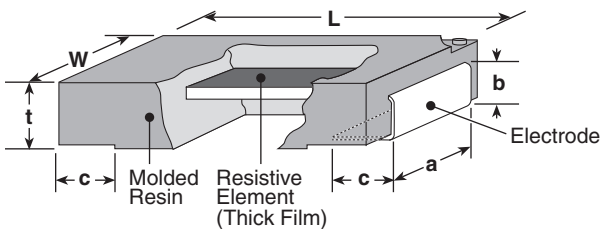

Size Code	Dimensions inches (mm)					
	L	W	t	a	b	c
SLR1 (2512)	.248±.012 (6.3±0.3)	.122±.008 (3.1±0.2)	.075±.008 (1.9±0.2)	.094±.008 (2.4±0.2)	.047±.008 (1.2±0.2)	.047±.012 (1.2±0.3)

ordering information

SLR	1	T	TE	R301	F
Type	Power Rating	Terminal Surface Material	Packaging	Nominal Resistance	Resistance Tolerance
SLR	1: 1.0W	T: Sn	TE: 8mm Pitch embossed plastic TED: 8mm Pitch embossed plastic	D, F: 4 digits J: 3 digits	D: ±0.5% F: ±1% J: ±5%

Resistance Value (Ω)	3 Digits	Resistance Value (Ω)	4 Digits
0.33 ~ 0.91	R33 ~ R91	0.301 ~ 0.976	R301 ~ R976
1 ~ 9.1	1R0 ~ 9R1	1 ~ 9.76	R100 ~ 9R76

Contact us when you have control request for environmental hazardous material other than the substance specified by EU RoHS.

For further information on packaging please refer to Appendix A.

applications and ratings

Part Designation	Power Rating	Rated Ambient Temp.	Rated Terminal Part Temperature	Resistance Range (Ω)			T.C.R. (X10 ⁻⁶ /K)	Maximum Working Voltage	Maximum Overload Voltage	Operating Temp. Range
				D: ±0.5% E24, E96	F: ±1% E24, E96	J: ±5% E24				
SLR1	1W	70°C	90°C	301m - 1M	301m - 1M	330m - 1M	±100	200V	400V	-55°C to +180°C

Rated voltage = $\sqrt{\text{Power Rating} \times \text{Resistance Value}}$ or Max. working voltage, whichever is lower

If any questions should arise whether to use the "Rated Ambient Temperature" or the "Rated Terminal Part Temperature," please give priority to the "Rated Terminal Part Temperature." Prior to use and for more details refer to "Introduction of the derating curves on the terminal part temperature" in the beginning of the catalog.

environmental applications

Derating Curve

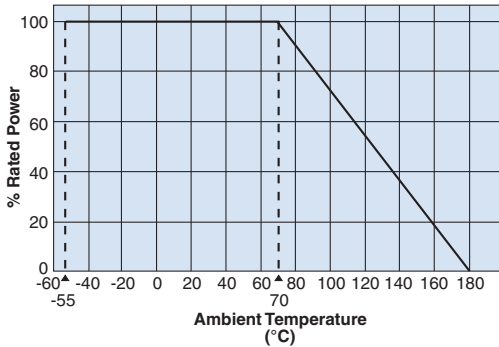

For resistors operated at an ambient temperature of 70°C or above, a power rating shall be derated in accordance with the above derating curve.

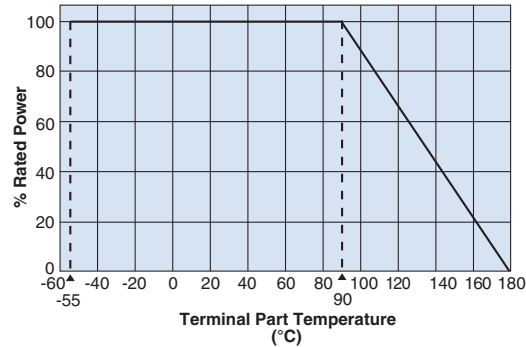

For resistors operated at a terminal part temperature of described for each size or above, a power rating shall be derated in accordance with the derating curve. Please refer to "Introduction of the derating curve based on the terminal part temperature" in the beginning of our catalog before use.

Temperature Rise

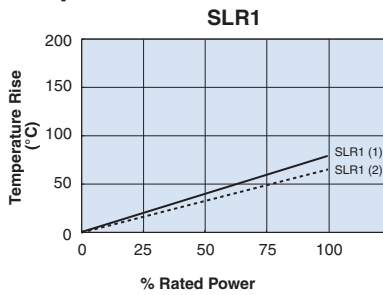

Regarding the temperature rise, the value of the temperature varies per conditions and board for use since the temperature is measured under our measuring conditions.

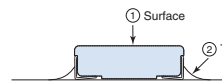

Measurement condition
Room temperature: 25°C
PCB: FR-4t = 1.6mm
Cu foil thickness: 35μm

One-Pulse Limiting Electric Power

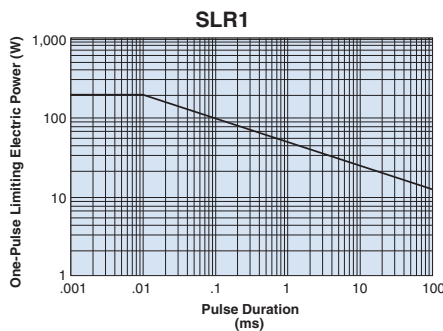

The maximum applicable voltage is equal to the max. overload voltage.

Please ask us about the resistance characteristic of continuous applied pulse.

The pulse endurance values are not assured values, so be sure to check the products on actual equipment when you use them.

Performance Characteristics

Parameter	Requirement Δ R ±%		Test Method
	Limit	Typical	
Resistance	Within specified tolerance	—	25°C
T.C.R.	Within specified T.C.R.	—	+25°C/+125°C
Overload (Short time)	±1%	±0.1%	Rated power times 5 for 5 seconds
Resistance to Solder Heat	±1%	±0.3%	260°C ± 5°C, 10 ± 1 second
Rapid Change of Temperature	±1%	±0.4%	-55°C (30 minutes), +155°C (30 minutes), 1000 cycles
Moisture Resistance	±2%	±0.2%	40°C ± 2°C, 90%~95%RH, 1000 hours, 1.5 hr ON, 0.5 hr OFF cycle
Endurance at 70°C	±2%	±0.2%	70°C ± 2°C, 1000 hours, 1.5 hr ON, 0.5 hr OFF cycle



features

- Flame retardant coating (UL94 V-0)
- It has excellent pulse resistance and is suitable as a surface mount component for precharge resistance, snubber resistance, and damping resistance
- AEC-Q200 tested
- Products with EU RoHS requirements

dimensions and construction

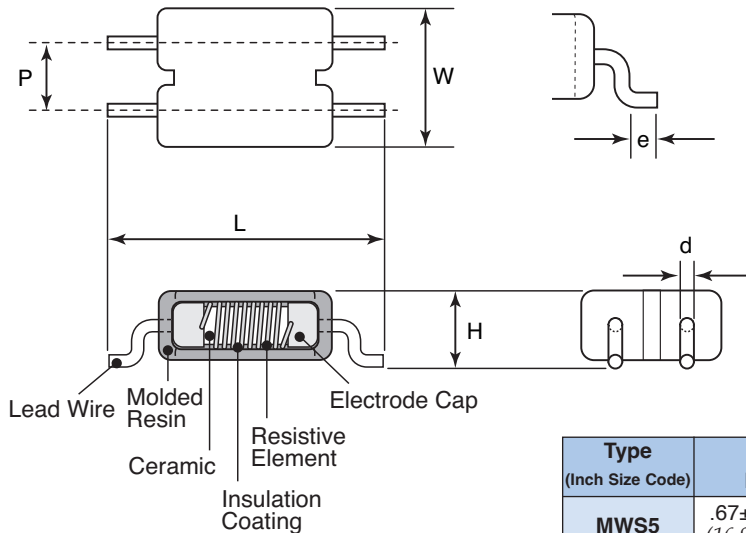

Type (Inch Size Code)	Dimensions inches (mm)					
	L	W	H	P	e	d (Nom.)
MWS5	.67±.008 (16.9±0.2)	.34±.008 (8.6±0.2)	.19±.008 (4.8±0.2)	.17±.008 (4.2±0.2)	.06±.008 (1.4±0.2)	.03 (0.8)

ordering information

MWS	5	C	TEG	100	J
Type	Power Rating	Terminal Surface Material	Taping	Nominal Resistance	Resistance Tolerance
	5: 5W	C: SnCu	TEG: 12mm pitch plastic embossed	3 digits	J: ±5%

Contact us when you have control request for environmental hazardous material other than the substance specified by EU RoHS.

For further information on packaging, please refer to Appendix A.

applications and ratings

Part Designation	Power Rating		Rated Terminal Part Temperature	Resistance Range (Ω) J: ±5% (E24)	T.C.R. (x10 ⁻⁶ /K)	Operating Temperature Range
	Package	Piece				
MWS5	5W	2.5W	+130°C	1 - 470	±200	-55°C to +200°C

Rated voltage = $\sqrt{\text{Power rating} \times \text{resistance value}}$

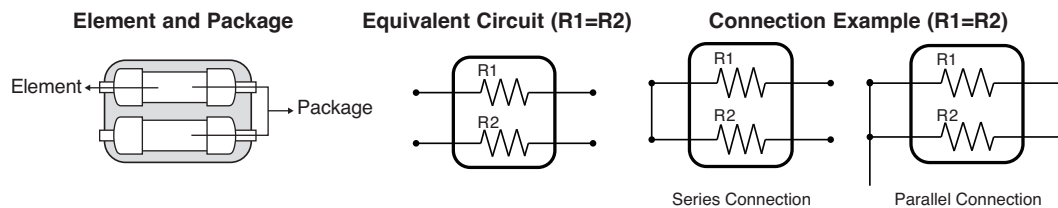

environmental applications

Derating Curve

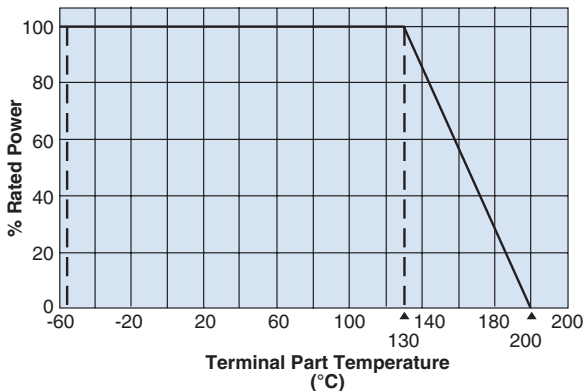

When the terminal part temperature of the resistor exceeds the rated terminal part temperature shown, the power shall be derated according to the derating curve. Please refer to "Introduction of the derating curves based on the terminal part temperature" on the beginning of our catalog before use.

Performance Characteristics

Parameter	Requirement Δ R ±(%+0.05Ω)		Test Method
	Limit	Typical	
Resistance	Within specified tolerance	—	25°C
T.C.R.	Within specified T.C.R.	—	+25°C/-55°C and +25°C/+125°C
Rapid Change of Temperature	±2%	±0.6%	-55°C (30 minutes), +155°C (30 minutes), 1000 cycles
Overload (Short time)	±5%	±2%	Power Rating x 4, 5 seconds
Resistance to Solder Heat	±1%	±0.8%	350°C ± 10°C, 3.5 seconds or 260°C ± 5°C, 10 seconds
Moisture Resistance	±5%	±3%	Power Rating x 1/10, 85°C, 80~85% RH, 1000 hours, 1.5 hr ON, 0.5 hr OFF cycle
Endurance of Rated Terminal Part Temperature	±5%	±3%	130°C ± 2°C, Rated Voltage, 1000 hours, 1.5 hr ON, 0.5 hr OFF cycle
Resistance to Solvent	No abnormality in appearance such as disappearance of making, etc.	—	On immersing the sample in IPA for 3 minutes, the resistor surface should be lightly wiped with a dry cloth (velvet or gauze)
High Temperature Exposure	±2%	±0.3%	+155°C, 1000 hours

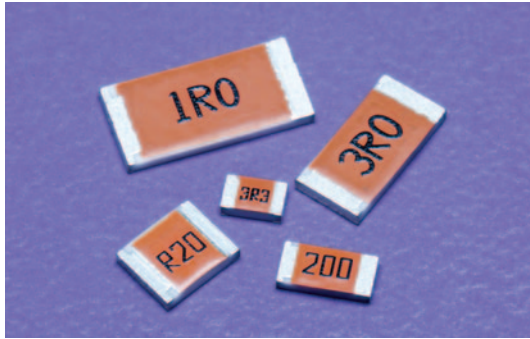

features

- In normal condition, it works as a resistor and when excessive voltage is applied, it protects circuits by fusing quickly
- The same shape as RK73 series
- Suitable for both flow and reflow solderings
- Products with lead-free terminations meet EU RoHS requirements. EU RoHS regulation is not intended for Pb-glass contained in electrode, resistor element and glass.
- Recognized by safety standard UL1412. (0603 (1J) is not recognized)

dimensions and construction

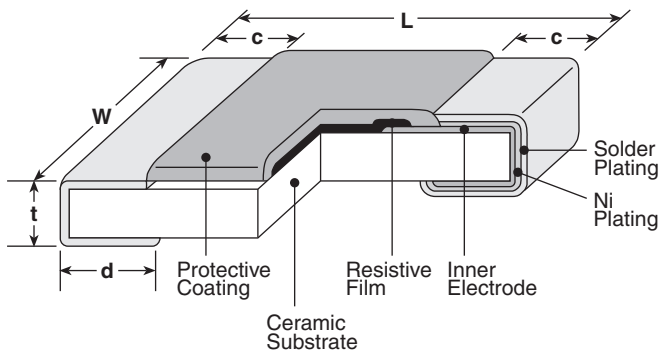

Type (Inch Size Code)	Dimensions inches (mm)				
	L	W	c	d	t
1J (0603)	.063±.008 (1.6±0.2)	.031±.004 (0.8±0.1)	.012±.004 (0.3±0.1)	.012±.004 (0.3±0.1)	.02±.004 (0.5±0.1)
2A (0805)	.079±.008 (2.0±0.2)	.049±.004 (1.25±0.1)	.016±.008 (0.4±0.2)	.012 ^{+0.008} _{-.004} (0.3 ^{+0.2} _{-.01})	
2B (1206)	.126±.008 (3.2±0.2)	.063±.008 (1.6±0.2)	.02±.012 (0.5±0.3)	.016 ^{+0.008} _{-.004} (0.4 ^{+0.2} _{-.01})	.024±.004 (0.6±0.1)
2E (1210)		.102±.008 (2.6±0.2)			
2H (2010)	.197±.008 (5.0±0.2)	.098±.008 (2.5±0.2)			
3A (2512)	.248±.008 (6.3±0.2)	.122±.008 (3.1±0.2)			

ordering information

RF73	2B	T	TD	100	J
Type	Size Code	Termination Material	Packaging	Nominal Resistance	Tolerance
	1J: 0603 2A: 0805 2B: 1206 2E: 1210 2H: 2010 3A: 2512	T: Sn (Other termination styles may be available, please contact factory for options)	TD: 7" 4mm pitch punch paper (0603, 0805, 1206, 1210: 5,000 pieces/reel) TE: 7" 4mm pitch embossed plastic (0805, 1206, 1210, 2010, 2512: 4,000 pieces/reel)	2 significant figures + 1 multiplier "R" indicates decimal on value <10Ω	J: ±5%

For further information on packaging, please refer to Appendix A.

applications and ratings

Part Designation	Power Rating @ 70°C	T.C.R. (ppm/°C) Max.	Resistance Range E-24	Resistance Tolerance	Fusing Characteristics					Operating Temperature Range	
					Fusing Power Resistance Range						Fusing Time
RF731J	0.063W	+1000 ~ -500 (1.0Ω-3.3Ω) ±500 (3.6Ω-100Ω)	1Ω-100Ω	J: ±5%	—	2.6W 1.0Ω	2.4W 1.1Ω-20Ω	2.1W 22Ω-100Ω	—	60 sec. max.	-55°C to +125°C
RF732A	0.1W	+1000 ~ -500 (0.2Ω-4.3Ω) ±500 (4.7Ω-510Ω)	0.2Ω-510Ω		3.0W 0.2Ω-0.47Ω	2.6W 0.51Ω-1.0Ω	2.4W 1.1Ω-20Ω	2.1W 22Ω-100Ω	2.0W 110Ω-510Ω		
RF732B	0.125W				3.75W 0.2Ω-0.47Ω	2.875W 0.51Ω-10Ω	2.5W 11Ω-24Ω	2.0W 27Ω-100Ω	1.75W 110Ω-510Ω		
RF732E	0.25W				4.5W 0.2Ω-0.47Ω	4.1W 0.51Ω-4.7Ω	3.5W 5.1Ω-27Ω	3.2W 30Ω-100Ω	3.0W 110Ω-510Ω		
RF732H	0.50W				5.5W 0.2Ω-0.47Ω	5.0W 0.51Ω-4.7Ω	4.0W 5.1Ω-27Ω	3.5W 30Ω-100Ω	3.2W 110Ω-510Ω		
RF733A	1.0W				6.5W 0.2Ω-0.47Ω	6.0W 0.51Ω-4.7Ω	5.0W 5.1Ω-30Ω	4.5W 33Ω-100Ω	4.0W 110Ω-510Ω		

Rated ambient temperature: +70°C

environmental applications

Derating Curve

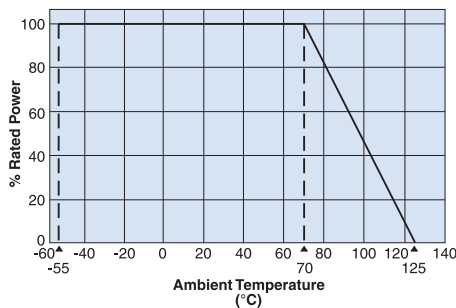

For resistors operated at an ambient temperature of 70°C or above, a power rating shall be derated in accordance with the above derating curve.

One-Pulse Limiting Electric Power

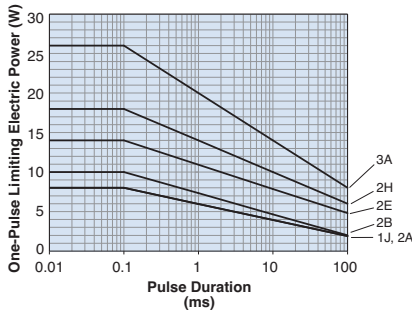

Please ask us about the resistance characteristic of continuous applied pulse. The pulse endurance values are not assured values, so be sure to check the products on actual equipment when you use them.

Example of Fusing Characteristics

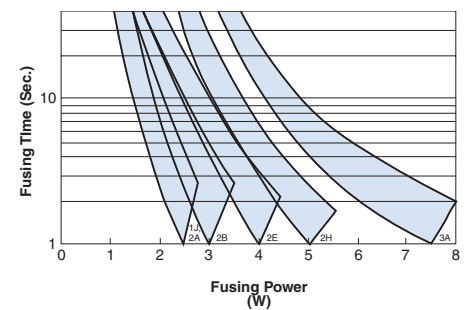

Performance Characteristics

Parameter	Requirement Δ R ±(% + 0.1Ω)		Test Method
	Limit	Typical	
Resistance	Within specified tolerance	—	25°C
T.C.R.	Within specified T.C.R.	—	+25°C/-55°C and +25°C/+125°C
Overload (Short Time)	±5.0%	±2.0%	Rated voltage x 2 for 5 seconds (except 2E, 2H, 3A: x 1.5)
Resistance to Solder Heat	±3.0%	0.5%	260°C ± 5°C for 10 seconds ± 1 second
Rapid Change of Temperature	±0.5%: 2A~3A ±3.0%: 1J	±0.3%: 2A~3A ±0.6%: 1J	-55°C (30 minutes)/ +125°C (30 minutes) 5 cycles
Moisture Resistance	±5.0%	±2.0%	40°C ± 2°C, 90 - 95% RH, 500 hours, 1.5 hr ON, 0.5 hr OFF cycle
Endurance at 70°C	±5.0%	±1.0%	70°C ± 2°C, 1000 hours, 1.5 hr ON, 0.5 hr OFF cycle
High Temperature Exposure	±1.0%	±0.6%	+125°C, 100 hours

RN41: MELF type fixed metal film resistors
RD41: MELF type fixed carbon film resistors
CC: MELF type cross-conductors

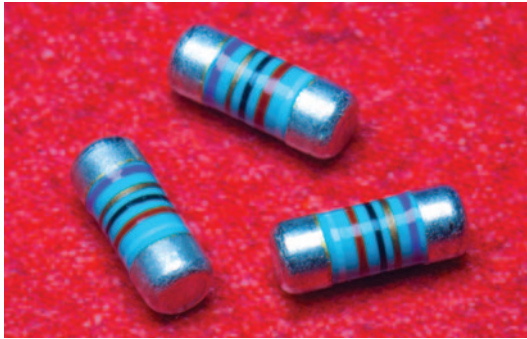

features

- Free direction for mounting due to cylindrical design
- High precision products (Resistance tolerance $\pm 0.1\%$ and T.C.R. $\pm 25 \times 10^{-6}/K$) available (RN41)
- The electrode strength is firm
- The noise characteristics are excellent
- Suitable for reflow, flow and iron soldering
- Products meet EU RoHS requirements
- AEC-Q200 tested (RN41 2ES/3AS, CC 12M/25)

dimensions and construction

RN41, RD41

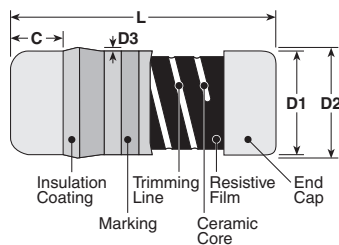

CC

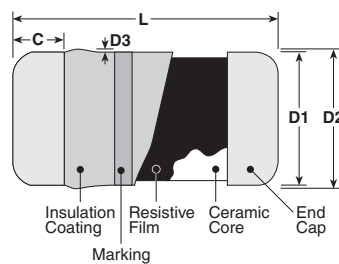

Type (Inch/DIN Size Code)	Dimensions inches (mm)				
	L	C	D1	D2 (max.)	D3 (max.)
2ES (1406/0204)	.138 \pm .008 (3.5 \pm 0.2)	.02 ~ .035 (0.5 ~ 0.9)	.055 \pm .004 (1.4 \pm 0.1)	.061 (1.55)	.004 (0.1)
CC12M (1406/0204)	.138 \pm .008 (3.5 \pm 0.2)	.02 ~ .035 (0.5 ~ 0.9)	.055 \pm .004 (1.4 \pm 0.1)	.061 (1.55)	.004 (0.1)
2E (2309/0207)	.232 \pm .008 (5.9 \pm 0.2)	.02 (0.5 min.)	.087 \pm .004 (2.2 \pm 0.1)	.094 (2.4)	.006 (0.15)
3AS (2309/0207)	.232 \pm .008 (5.9 \pm 0.2)	.02 (0.5 min.)	.087 \pm .004 (2.2 \pm 0.1)	.094 (2.4)	.006 (0.15)
CC25 (2309/0207)	.232 \pm .008 (5.9 \pm 0.2)	.02 (0.5 min.)	.087 \pm .004 (2.2 \pm 0.1)	.094 (2.4)	.006 (0.15)

ordering information

RN41	2ES	T	TE	1001	F	50*
Type	Size	Termination Material	Packaging	Nominal Resistance	Tolerance	T.C.R. (ppm/°C)
RN41 RD41	2ES: 0.25W, 0.4W 2E: 0.25W 3AS: 1W	T: Sn	TE: 7" embossed plastic (2ES - 3,000 pieces/reel) (2E, 3AS - 1,500 pieces/reel)	$\pm 2\%$, $\pm 5\%$: 2 significant figures + 1 multiplier. "R" indicates decimal on values $< 10\Omega$ $\pm 0.1\%$, $\pm 0.25\%$, $\pm 0.5\%$, $\pm 1\%$: 3 significant figures + 1 multiplier. "R" indicates decimal on values $< 100\Omega$	B: $\pm 0.1\%$ C: $\pm 0.25\%$ D: $\pm 0.5\%$ F: $\pm 1\%$ G: $\pm 2\%$ J: $\pm 5\%$	25: ± 25 50: ± 50 Nil: RD41
CC12M		T	TE			
Type		Termination Material	Packaging			
CC12M CC25		T: Sn	TE: 7" embossed plastic			

* T.C.R. noted for RN41 only

For further information on packaging, please refer to Appendix A.

Specifications given herein may be changed at any time without prior notice. Please confirm technical specifications before you order and/or use.

11/16/22

applications and ratings

Part Designation	Power Rating @ 70°C	Rated Ambient Temp.	Rated Terminal Part Temp.	T.C.R. (ppm/°C) Max.	Resistance Range (Ω)						Max. Working Voltage	Max. Overload Voltage
					E-24, E-96 (B±0.1%)	E-24, E-96 (C±0.25%)	E-24, E-96 (D±0.5%)	E-24, E-96 (F±1%)	E-24 (G±2%)	E-24 (J±5%)		
RN412ES	1/4W (.25W)	70°C	90°C	±25	43-511k	100-100k	100-604k	—	—	—	200V	400V
		70°C	90°C	±50	—	—	—	1-5.11M	—	0.22-0.91		
RN412ES	2/5W (.4W) ^{*1*2}	—	90°C	±50	—	—	—	1-5.11M	—	0.22-0.91	200V	400V
RN413AS	1W ^{*1*2}	70°C	—	±50	—	—	—	1-1M	—	0.22-0.91	400V	600V
RD412ES	1/4W (.25W)	70°C	—	— ^{*3}	—	—	—	—	2.2 - 1.0M	2.2 - 1.0M	200V	400V
RD412E	1/4W (.25W)	70°C	—	— ^{*3}	—	—	—	—	1.0 - 2.2M	1.0 - 2.2M	300V	600V

Rated voltage = $\sqrt{\text{Power Rating} \times \text{Resistance Value}}$ or Maximum Working Voltage, whichever is lower
 Operating Temperature Range: -55°C to +155°C

- ^{*1} A power rating is guaranteed at the terminal part temperature
 If any questions should arise whether to use the "Rated Ambient Temperature" or the "Rated Terminal Part Temperature," please give priority to the "Rated Terminal Part Temperature." Prior to use and for more details refer to "Introduction of the derating curves on the terminal part temperature" in the beginning of the catalog.
- ^{*2} A power rating shall be guaranteed with a method shown in the Performance Characteristics. Please contact factory prior to use.
- ^{*3} Please contact factory for T.C.R. of RD41

Part Designation	Current Rating	Rated Ambient Temp.	Maximum Resistance
CC12M	2A	+70°C	20 mΩ or less
CC25	5A		

environmental applications

Derating Curve

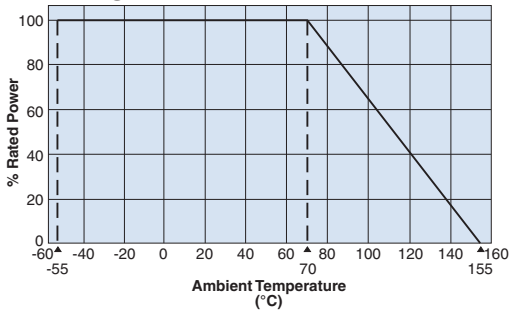

For resistors operated at an ambient temperature of 70°C or above, a power rating shall be derated in accordance with the above derating curve.
 Please contact us about CC series' derating curve.

RN412ES, RN413AS

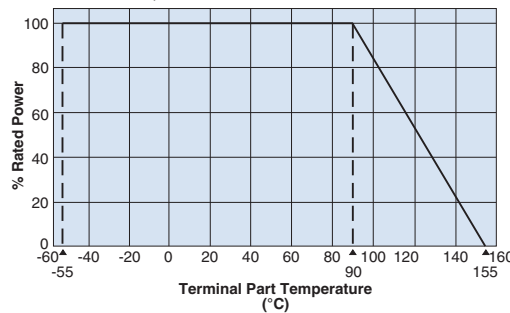

For resistors operated at a terminal part temperature of described for each size or above, a power rating shall be derated in accordance with the derating curve.
 Please refer to "Introduction of the derating curve based on the terminal part temperature" in the beginning of our catalog before use.

Performance Characteristics

Parameter	Type	Requirement $\Delta R \pm(\%+0.05\Omega)^{**}$		Test Method
		Limit	Typical	
Resistance	RN41 RD41	Within specified tolerance	—	25°C
T.C.R.	RN41 RD41	Within specified T.C.R.	—	+25°C/+125°C
Overload (Short time)	RN41	2ES: Test Group D	±0.3%	Rated voltage x 2.5 for 5 seconds or Max. overload voltage, whichever is lower, for 5 seconds
	RD41	±1%	±0.5%	
Intermittent Overload	RD41	±1%	—	Rated voltage x 4 or Max. intermittent overload voltage, whichever is lower, 10,000 cycles
Resistance to Soldering Heat	RN41	2ES: Test Group D	—	260°C ± 5°C, 10 seconds ± 1 second
	RD41	±1%	±0.5%	
Rapid Change of Temperature	RN41	2ES: Test Group D	—	-55°C (30 minutes), +125°C (30 minutes), 5 cycles
	RD41	±1%	±0.75%	
Moisture Resistance	RN41	2ES: Test Group C	—	40°C ± 2°C, 90 ~ 95% RH, 1000 hours, 1.5 hr ON, 0.5 hr OFF cycle
	RD41	±5%	±2.5%	
Endurance at 70°C	RN41	2ES: Test Group A	—	70°C ± 2°C, 1000 hours, 1.5 hr ON, 0.5 hr OFF cycle
	RD41	±2%	±1%	
Low Temperature Exposure	RD41	±1%	±0.75%	-55°C, 1 hour
High Temperature Exposure	RN41	2ES: Test Group C	±0.75%	155°C, 2 hours
	RD41	±2%	±1%	RN41: 2ES, 3AS: 155°C, 1000 hours

** Performance requirement for RN41 3AS are different from above, so consult with KOA about the detail.

RN41 Test Group

Stability Class	Resistance Range	Limit Resistance Changing Attests (Test Group)			
		A	B	C	D
0.25	10~332kΩ	±(0.25% + 0.05Ω)	±(0.50% + 0.05Ω)	±(0.25% + 0.05Ω)	±(0.05% + 0.05Ω)
0.5	1~<10Ω			±(0.50% + 0.05Ω)	±(0.10% + 0.05Ω)
1	0.22~<1Ω	±(0.50% + 0.05Ω)	±(1.00% + 0.05Ω)	±(1.00% + 0.05Ω)	±(0.25% + 0.05Ω)
2	>332kΩ~5.11MΩ			±(2.00% + 0.05Ω)	±(0.50% + 0.05Ω)



features

- Metal film chip network resistors
- Excellent in relative T.C.R. and relative accuracy
- Pair resistors for high precision OP-amplifiers
- As custom products, any pairs between 1kΩ and 100kΩ are available on request
- Products with lead-free terminations meet EU RoHS and China RoHS requirements

dimensions and construction

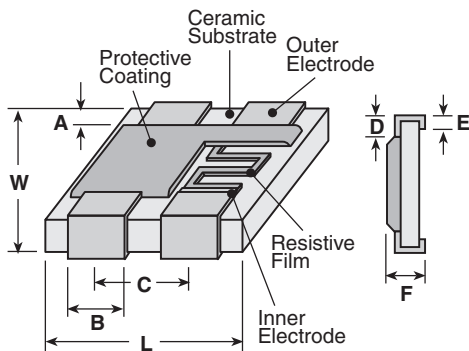

Size Code	Dimensions inches (mm)							
	A	B	C	D	E	F	L	W
CNN	.016±.012 (0.4±0.3)	.028±.006 (0.7±0.15)	.050 (1.27)	.016±.012 (0.4±0.3)	.012±.008 (0.3±0.2)	.020±.004 (0.5±0.1)	.10±.008 (2.54±0.2)	.079±.008 (2.0±0.2)

circuit schematic

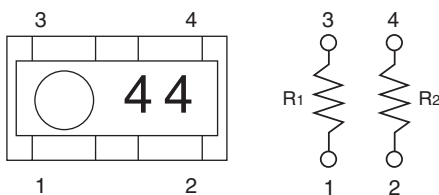

	Resistance					
R1	1kΩ	1kΩ	1kΩ	10kΩ	10kΩ	100kΩ
R2	1kΩ	10kΩ	100kΩ	10kΩ	100kΩ	100kΩ

CNN: Custom products of any pairs between 1kΩ and 100kΩ are available on request

	Marking					
R1*	3	3	3	4	4	5
R2**	3	4	5	4	5	5

* First marking number

** Second marking number

ordering information

CNN	2A	2	T	TE	103/103	B	A
Type	Style	Number of Elements	Termination Material	Packaging	Nominal Resistance	Resistance Tolerance	Resistance Ratio
CNN		2	T: Sn	TE: 4 mm pitch embossed plastic	2 significant figures + multiplier	B: ±0.1% C: ±0.25%	A: 0.05% B: 0.1%

For further information on packaging, please refer to Appendix A.

Specifications given herein may be changed at any time without prior notice. Please confirm technical specifications before you order and/or use.

10/22/20

applications and ratings

Part Designation	Power Rating w/Element	Resistance (Ω)	Resistance Tolerance		T.C.R. (ppm/ $^{\circ}$ C)		Maximum Working Voltage	Maximum Overload Voltage	Rated Ambient Temperature	Operating Temperature Range
			Absolute	Relative	Absolute	Relative				
CNN	0.05	1k,10k,100k	B: $\pm 0.1\%$ C: $\pm 0.25\%$	A: $\pm 0.05\%$ B: $\pm 0.1\%$	± 25	5	50V	100V	+70 $^{\circ}$ C	-55 $^{\circ}$ C to +125 $^{\circ}$ C

environmental applications

Derating Curve

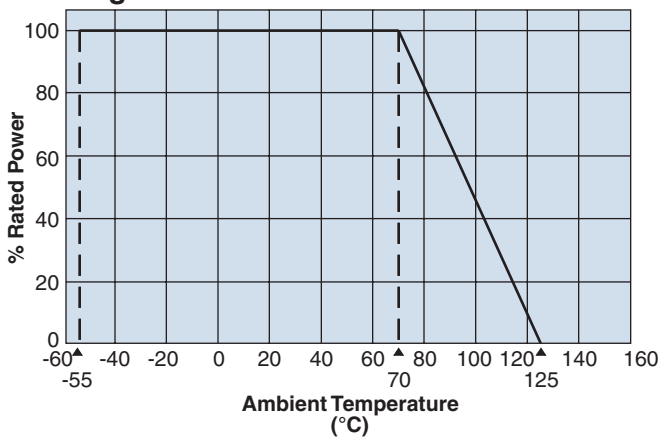

Application Example

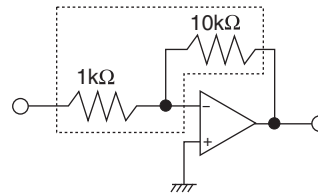

Performance Characteristics

Parameter	Requirement $\Delta R \pm(\%+0.05\Omega)$		Test Method
	Limit	Typical	
Resistance	Within specified tolerance	—	25 $^{\circ}$ C
T.C.R.	Within specified T.C.R.	—	+25 $^{\circ}$ C/-55 $^{\circ}$ C, +25 $^{\circ}$ C/+125 $^{\circ}$ C
Overload (Short time)	$\pm 0.1\%$	$\pm 0.01\%$	Rated voltage x 2.5 or Max. overload volume, whichever is less, for 5 seconds
Resistance to Soldering Heat	$\pm 0.1\%$	$\pm 0.02\%$	260 $^{\circ}$ C $\pm 5^{\circ}$ C, 10 seconds ± 1 second
Rapid Change of Temperature	$\pm 0.25\%$	$\pm 0.01\%$	-55 $^{\circ}$ C (30 minutes), +125 $^{\circ}$ C (30 minutes), 5 cycles
Moisture Resistance	$\pm 0.25\%$	$\pm 0.03\%$	40 $^{\circ}$ C $\pm 2^{\circ}$ C, 90 - 95% RH, 1000 hours, 1.5 hr ON, 0.5 hr OFF cycle
Endurance at 70 $^{\circ}$ C	$\pm 0.25\%$	$\pm 0.03\%$	70 $^{\circ}$ C $\pm 2^{\circ}$ C, 1000 hours, 1.5 hr ON, 0.5 hr OFF cycle
High Temperature Exposure	$\pm 0.25\%$	$\pm 0.02\%$	+125 $^{\circ}$ C, 100 hours

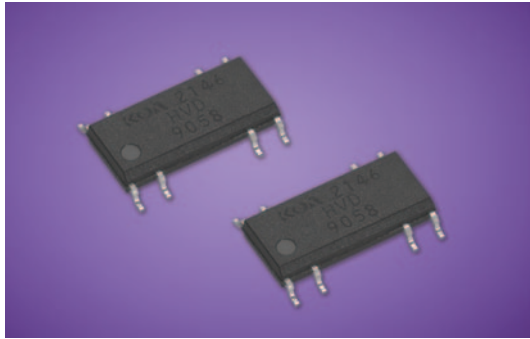

features

- High precision high voltage divider
- Maximum resistance value 51MΩ, maximum working voltage 1000V, maximum resistance ratio 1000:1
- Relative precision of pair resistors are guaranteed
- Higher integration saves board space and overall assembly costs
- Excellent reliability with standard molded IC package
- Suitable for reflow soldering
- Products meet EU RoHS requirements
- AEC-Q200 tested

dimensions and construction

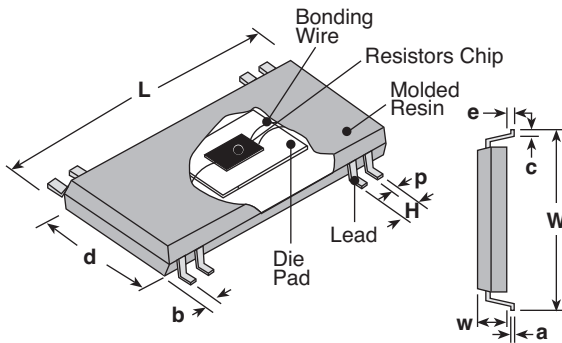

Type	Dimensions inches (mm)				
	L ±0.2	W ±0.2	w ±0.2	H ±0.2	p ±0.1
HVD	.341 (8.66)	.236 (5.99)	.063 (1.60)	.059 (1.50)	.010 (0.25)

Type	Dimensions inches (mm)				
	a ±0.1	b ±0.1	c ±0.2	d ±0.1	e ±0.1
HVD	.008 (0.20)	.011 (0.29)	.026 (0.66)	.150 (3.81)	.007 (0.18)

circuit schematic

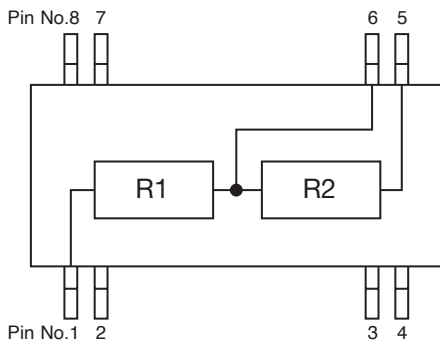

ordering information

HVD	P08	T	TE	9XXX
Circuit Code	Package Symbol	Termination Surface Material	Packaging	Custom Code
HVD: High Voltage Divider	Package type symbol + Number of pins	T: Sn	TE: Embossed plastic	

Contact KOA when you have a control request for environmental hazardous material other than the substance specified by EU RoHS.

For further information on packaging, please refer to Appendix A.

Specifications given herein may be changed at any time without prior notice. Please confirm technical specifications before you order and/or use.

5/10/24

applications and ratings

Part Designation	Max. Working Voltage	Power Rating /Resistor Element	Resistance Range Resistance Ratio 10:1~1,000:1 (R1+R2)/R2	Absolute Resistance Tolerance	Relative Resistance Tolerance	T.C.R. (X10 ⁻⁶ /K)	Relative T.C.R. Tracking	Rated Ambient Temperature	Operating Temperature Range
R1	1000V	250mW	0.5MΩ ~ 51MΩ	±0.1%, ±0.25%, ±0.5%, ±1%	0.1% 0.25%	±25 ±50	10 25	+85°C	-55°C to +155°C
R2	15V	50mW	4.5kΩ ~ 1MΩ	—	0.5%				

Rated voltage = $\sqrt{\text{Power rating} \times \text{resistance value}}$ or max. working voltage, whichever is lower

Guaranteed value differs depending on resistance value

environmental applications

Derating Curve

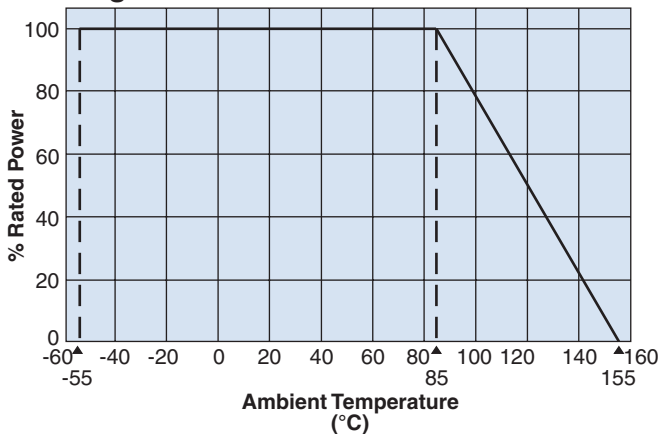

For resistors operated at an ambient temperature of 85°C or above, a power rating shall be derated in accordance with the derating curve.

Performance Characteristics

Parameter	Requirement $\Delta R \pm(\%+0.05\Omega)$		Test Method
	Limit	Typical	
Resistance	Within specified tolerance	—	25°C
T.C.R.	Within specified T.C.R.	—	+25°C/-55°C, +25°C/+155°C
Resistance to Soldering Heat	±0.1%	±0.02%	260°C ± 5°C, 10 seconds ± 1 second
Rapid Change of Temperature	±0.1%	±0.01%	-55°C (30 minutes), +155°C (30 minutes), 1000 cycles
Moisture Resistance	±0.1%	±0.02%	85°C ± 2°C, 85% ± 5% RH, 1000 hours, 1.5 hr ON, 0.5 hr OFF cycle
Endurance at 85°C	±0.1%	±0.01%	85°C ± 2°C, 1000 hours, 1.5 hr ON, 0.5 hr OFF cycle
High Temperature Exposure	±0.1%	±0.03%	+155°C, 1000 hours

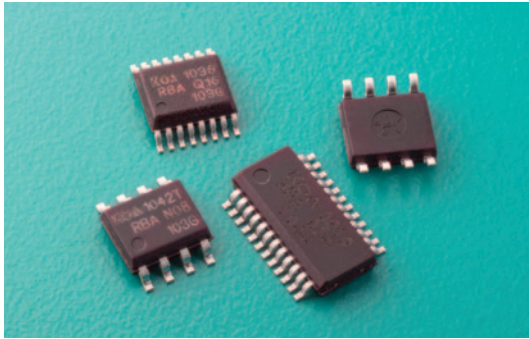

features

- Thin film (metal film) resistor array on silicon wafer
- Excellent resistance matching, TCR tracking and stabilities
- Custom circuits are available with flexible layout (Different resistance combinations possible)
- High integration saves board space and overall assembly costs
- Excellent reliability with standard molded IC package
- Suitable for reflow soldering
- Products with lead-free terminations meet EU RoHS and China RoHS requirements

dimensions and construction

SOT-23

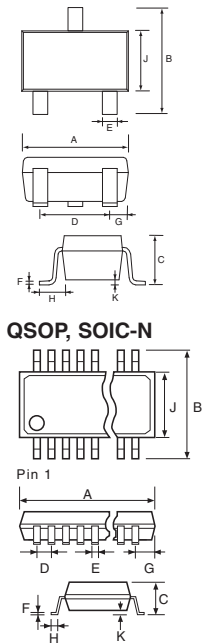

Package Symbol	Package	Pins	Dimensions inches (mm)									
			A ±0.2	B ±0.2	C ±0.2	D ±0.1	E ±0.1	F ±0.1	G ±0.1	H ±0.2	J ±0.2	K ±0.1
S03	SOT-23	3	.115 (2.92)	.091 (2.3)	.037 (0.95)	.075 (1.910)	.017 (0.44)	.005 (0.13)	.020 (0.51)	.021 (0.53)	.051 (1.3)	.004 (0.11)
Q16	QSOP	16	.193 (4.90)	.236 (5.99)	.063 (1.60)	.025 (0.635)	.010 (0.25)	.008 (0.20)	.008 (0.20)	.026 (0.66)	.150 (3.81)	.007 (0.18)
Q20		20	.058 (1.47)									
Q24		24	.033 (0.84)									
N08	SOIC-N	8	.190 (4.83)	.050 (1.27)	.016 (0.41)	.020 (0.52)	.008 (0.20)	.026 (0.66)	.150 (3.81)	.007 (0.18)		
N14		14	.341 (8.66)									
N16		16	.390 (9.91)									

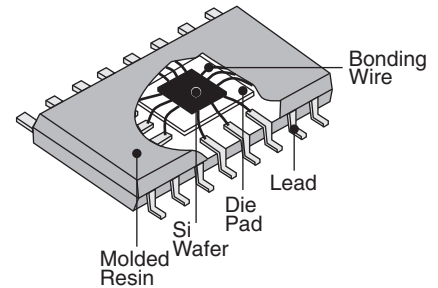

ordering information

RBA, RBB

RBA	Q20	T	TEB	1002	B	E	B	T
Circuit Code	Package Symbol	Termination Material	Packaging	Nominal Resistance	Absolute Tolerance	T.C.R.	Relative Res. Toler.	T.C.R. Tracking
RBA: Bussed resistor network RBB: High speed bussed network	Package type symbol + number of pins Q16, Q20, Q24: QSOP N08, N14, N16: SOIC narrow	T: Sn	TEB: 13" embossed plastic	B, C, D, F: 4 digits G, J: 3 digits	B: ±0.1% C: ±0.25% D: ±0.5% F: ±1% G: ±2% J: ±5%	T: ±10 E: ±25 C: ±50 H: ±100	A: ±0.05% B: ±0.1% C: ±0.25% D: ±0.5% F: ±1% G: ±2% Blank: Not specified	Y: ±05 T: ±10 E: ±25 C: ±50 Blank: Not specified

For further information on packaging, please refer to Appendix A.

Specifications given herein may be changed at any time without prior notice. Please confirm technical specifications before you order and/or use.

10/22/20

ordering information (continued)

RTX

RTX	S03	T	TE	7011
Circuit Code	Package Symbol	Termination Material	Packaging	Custom Code
RTX: SOT-23 Resistor network	Package type symbol + number of pins	T: Sn (L: Sn/Pb)	TE: 7" embossed plastic (RTX SOT-23 only)	

RDA, RDB

RDA	Q20	T	TEB	471J	511J	E
Circuit Code	Package Symbol	Termination Material	Packaging	Nominal Resistance & Tolerance of R1	Nominal Resistance & Tolerance of R2	T.C.R.
RDA: Dual terminator network RDB: Differential terminator network	Package type symbol + number of pins Q16, Q20: QSOP N16: SOIC narrow	T: Sn (L: Sn/Pb)	TEB: 13" embossed plastic	3 digits: G: $\pm 2\%$, J: $\pm 5\%$	3 digits: G: $\pm 2\%$, J: $\pm 5\%$	E: ± 25 C: ± 50 H: ± 100

Specifications are limited by the circuit and resistance value. Please contact us separately.

ratings

Package		QSOP			SOIC			SOT-23
Package Symbol		Q16	Q20	Q24	N08	N14	N16	S03
Package Power Rating		0.8W	1.0W	1.0W	0.4W	0.6W	0.8W	0.2W
Resistance Range	10 Ω ~ 1k Ω	Power rating 200mW/resistor element ¹						
	1.1k Ω ~	Power rating 50mW/resistor element ¹						
Max. Working Voltage		100V						
Rated Voltage		$\sqrt{\text{Rated power} \times \text{nominal resistance value}}$, rated voltage should not exceed max. working voltage						
Rated Ambient Temp.		+70°C						
Operating Temp. Range		-55°C ~ +125°C ²						

Above ratings are based on the thermal resistance using multi-layer circuit board (EIA/JESD51). For mounting on a mono-layer board, power derating shall be needed. Please contact us about conditions.

¹ Total power consumption of all elements should not exceed the package power rating.

² About operating temperature range -55°C ~ +155°C. We can provide custom devices. Please contact us.

applications and ratings

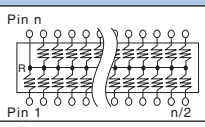
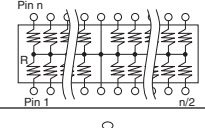
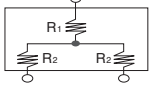
Circuit Code	Circuit Schematics	Number of Pins	T.C.R. (x10 ⁻⁶ /K)	Resistance Range (Ω) E24 & Absolute Tolerance	
				F: $\pm 1\%$	G: $\pm 2\%$, J: $\pm 5\%$
RBA		8, 14, 16, 20, 24	E: ± 25	100 ~ 100k	100 ~ 100k
			C: ± 50	51 ~ 100k	51 ~ 100k
			H: ± 100	30 ~ 100k	10 ~ 100k
RBB		8, 14, 16, 20, 24	E: ± 25	100 ~ 100k	100 ~ 100k
			C: ± 50	51 ~ 100k	51 ~ 100k
			H: ± 100	30 ~ 100k	10 ~ 100k
RTX		3 (SOT-23 only)	E: ± 25	100 ~ 40k	100 ~ 40k
			C: ± 50	51 ~ 40k	51 ~ 40k
			H: ± 100		

applications and ratings (continued)

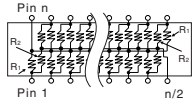
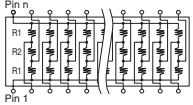
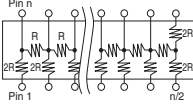
Circuit Code	Circuit Schematics	Number of Pins	T.C.R.	Resistance Range (Ω) E24 & Absolute Tolerance G: $\pm 2\%$, J: $\pm 5\%$
RDA		16, 20	E: ± 25	R1= 150 ~ 10k R1: R2= 1:1 ~ 1:4
			C: ± 50	
			H: ± 100	
RDB		16, 20	E: ± 25	R1= 150 ~ 10k R1: R2= 1:1 ~ 1:4
			C: ± 50	
			H: ± 100	
RLA		14, 16	H: ± 100	1k ~ 30k

environmental applications

Performance Characteristics

Parameter	Requirement $\Delta R \pm(\%+0.05\Omega)$		Test Method
	Limit	Typical	
Resistance	Within specified tolerance		25°C
T.C.R.	Within specified T.C.R.		+25°C/-55°C, +25°C/+125°C
Resistance to Soldering Heat	$\pm 0.1\% ^3$	$\pm 0.05\%$	260°C $\pm 5^\circ\text{C}$, 10 seconds ± 1 second
Rapid Change of Temperature	$\pm 0.5\% ^3$	$\pm 0.05\%$	-55°C (30 minutes), +125°C (30 minutes), 100 cycles
Moisture Resistance	$\pm 0.5\% ^3$	$\pm 0.05\%$	40°C $\pm 2^\circ\text{C}$, 90 - 95% RH, 1000 hours, 1.5 hr ON, 0.5 hr OFF cycle
Endurance at 70°C	$\pm 0.25\% ^3$	$\pm 0.05\%$	70°C $\pm 2^\circ\text{C}$, 1000 hours, 1.5 hr ON, 0.5 hr OFF cycle
High Temperature Exposure	$\pm 0.25\% ^3$	$\pm 0.1\%$	+125°C, 1000 hours

³ Guaranteed value differs depending on resistance values.

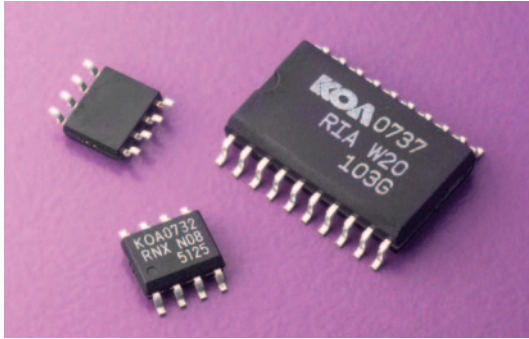

features

- High precision resistor networks
- Combination of different resistance is available for custom circuit
- TCR tracking down to 5ppm/°C
- Marking: Black body color

ordering information

RIA

RIA	Q20	T	TE	1002	B	E	B	T
Circuit Code	Package Symbol	Termination Material	Packaging	Nominal Resistance	Absolute Tolerance	T.C.R.	Relative Res. Toler.	T.C.R. Tracking
RIA: Isolated resistor network	Package type symbol + number of pins Q16, Q20, Q24: QSOP N08, N14, N16: SOIC narrow	T: Sn	TE: Embossed plastic	4 digits 3 digits	B: ±0.1% C: ±0.25% D: ±0.5% F: ±1% G: ±2% J: ±5%	T: ±10 E: ±25 C: ±50 H: ±100	A: ±0.05% B: ±0.1% C: ±0.25% D: ±0.5% F: ±1% G: ±2% Blank: Not specified	Y: ±05 T: ±10 E: ±25 C: ±50 Blank: Not specified

Specifications are limited by the circuit and resistance value. Please contact us separately.

RNX

RNX	Q20	T	TE	5001
Circuit Code	Package Symbol	Termination Material	Packaging	Custom Code
RNX: Custom Resistor network	Package type symbol + number of pins	T: Sn (L: Sn/Pb)	TE: Embossed plastic	

For further information on packaging, please refer to Appendix A.

ratings

Product Code	Number of Pins	T.C.R.	Resistance Range (E24) and Resistance Tolerance					Relative Resist. Tol.	TCR Tracking
			B: ±0.1%	C: ±0.25%	D: ±0.5%	F: ±1%	G: ±2%, J: ±5%		
RIA RNX	8, 14, 16, 20, 24	T: ±10	510Ω ~ 100kΩ	510Ω ~ 100kΩ	510Ω ~ 100kΩ	510Ω ~ 100kΩ	510Ω ~ 100kΩ	0.05%, 0.1%, 0.25%, 0.5%, 1%, 2%	5, 10, 25, 50
		E: ±25			100Ω ~ 510kΩ	100Ω ~ 510kΩ	100Ω ~ 510kΩ		
		C: ±50			51Ω ~ 510kΩ	51Ω ~ 510kΩ	51Ω ~ 510kΩ		
		H: ±100			30Ω ~ 510kΩ	10Ω ~ 510kΩ	10Ω ~ 510kΩ		

Rated power (70°C): 10Ω~1kΩ 200mW/element 1.1kΩ~50mW/element
Please inquire of us about your custom devices and circuits. (Different resistance combination available) Depending on the circuit and package, much higher resistances are possible. For RIA20, 24 pin, highest resistance value/element is up to 100kΩ.

circuit schematic

RIA - High Precision Resistor Networks

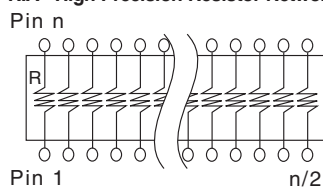

Please ask about your custom devices and circuits.

RNX - Custom High Precision Resistor Networks

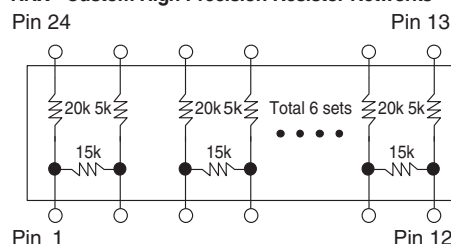

environmental applications

Derating Curve

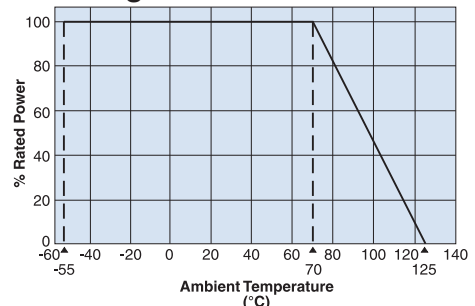

For resistors operated at an ambient temperature of 70°C or above, a power rating shall be derated in accordance with the derating curve.

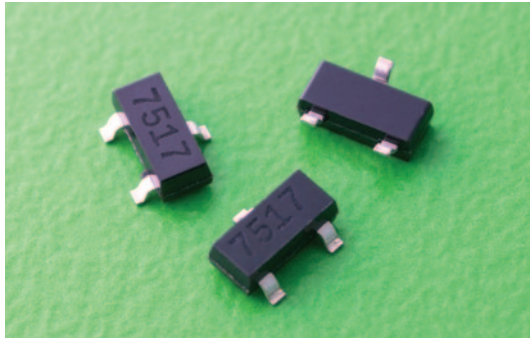

features

- Expanded flexibility of component layout
- Relative precision of pair resistors are guaranteed
- TCR tracking down to 5ppm/°C

ordering information

RTY	S03	T	TE	7516
Circuit Code	Package Symbol	Termination Material	Packaging	Custom Code
RTY: SOT-23 Resistor network	Package type symbol + number of pins	T: Sn	TE: 7" embossed plastic	

ratings

Product Code	T.C.R.	Resistance Range (Ω) (E24) and Resistance Tolerance					Relative Resist. Tol.	TCR Tracking
		B: $\pm 0.1\%$	C: $\pm 0.25\%$	D: $\pm 0.5\%$	F: $\pm 1\%$	G: $\pm 2\%$, J: $\pm 5\%$		
RTY	T: ± 10	1k Ω ~ 40k Ω	1k Ω ~ 40k Ω	1k Ω ~ 40k Ω	1k Ω ~ 40k Ω	1k Ω ~ 40k Ω	0.05%, 0.1%, 0.25%, 0.5%, 1%, 2%	5, 10, 25, 50
	E: ± 25	1k Ω ~ 150k Ω	1k Ω ~ 150k Ω	100 Ω ~ 150k Ω	100 Ω ~ 150k Ω	100 Ω ~ 150k Ω		
	C: ± 50			51 Ω ~ 200k Ω	51 Ω ~ 200k Ω	51 Ω ~ 200k Ω		
	H: ± 100			30 Ω ~ 200k Ω	30 Ω ~ 200k Ω	30 Ω ~ 200k Ω		

Specifications are limited by the circuit and resistance value. Please contact us separately.

circuit schematic

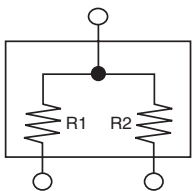

ratings

Package Symbol	Package	Number of Pins	Package Power Rating (W)
S03	SOT-23	3	0.2

example of application

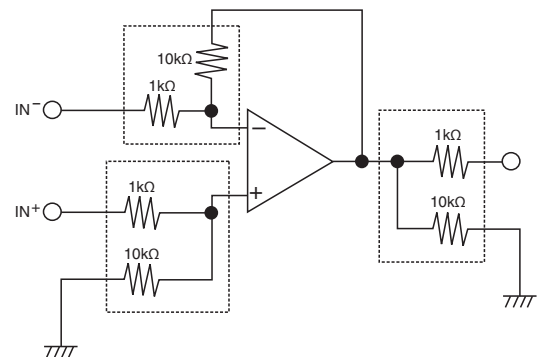

typical characteristics

Endurance at 70°C (Typical: 1k Ω , 8 resistors/package)

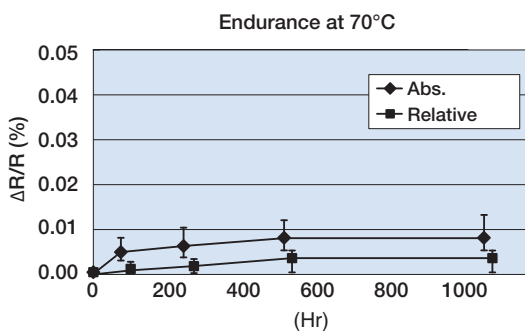

merit of thin film resistor networks

Metal thin film resistors formed by sputtering method have very similar characteristic among pair resistors. When their characteristic of T.C.R., aging, etc. for relative precision is requested, it's very suitable to apply thin film resistor networks to utilize the characteristic as above.

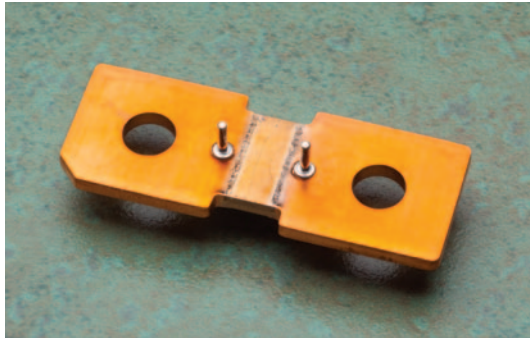

features

- Ultra low resistance, suitable for large current sensing
- Excellent T.C.R. achieved ($50 \pm 25 \times 10^{-6}/K$)
- Correct electric current detection by a voltage pin is possible
- Bus bar and cable can be screwed on
- 2D code means individual resistance information
- Products meet EU RoHS requirements
- AEC-Q200 Tested

dimensions and construction*1

Type (Inch Size Code)	Resistance (Ω)	Dimensions inches (mm)					Weight (g) (1pcs)	
		L	W	A	ϕa	ϕb	t	
HSAN2P4022M5	50 μ	1.57 \pm 0.10 (40.0 \pm 0.25)	.866 \pm 0.10 (22.0 \pm 0.25)	.335 \pm 0.008 (8.5 \pm 0.2)	.039 \pm 0.008 (1.0 \pm 0.2)	.213 \pm 0.004 (5.4 \pm 0.1)	.079 \pm 0.008 (2.0 \pm 0.2)	
HSAN2P8022M8		3.15 \pm 0.10 (80.0 \pm 0.25)				.327 \pm 0.004 (8.3 \pm 0.1)		
HSAN2P4015M5	100 μ	1.57 \pm 0.10 (40.0 \pm 0.25)	.591 \pm 0.10 (15.0 \pm 0.25)	.335 \pm 0.008 (8.5 \pm 0.2)	.039 \pm 0.008 (1.0 \pm 0.2)	.213 \pm 0.004 (5.4 \pm 0.1)	.079 \pm 0.008 (2.0 \pm 0.2)	
HSBN2P8018M8		3.15 \pm 0.10 (80.0 \pm 0.25)				.472 \pm 0.008 (12.0 \pm 0.2)		.327 \pm 0.004 (8.3 \pm 0.1)
HSAN2P4015M5	200 μ	1.57 \pm 0.10 (40.0 \pm 0.25)	.591 \pm 0.10 (15.0 \pm 0.25)	.335 \pm 0.008 (8.5 \pm 0.2)	.039 \pm 0.008 (1.0 \pm 0.2)	.213 \pm 0.004 (5.4 \pm 0.1)	.039 \pm 0.008 (1.0 \pm 0.2)	5

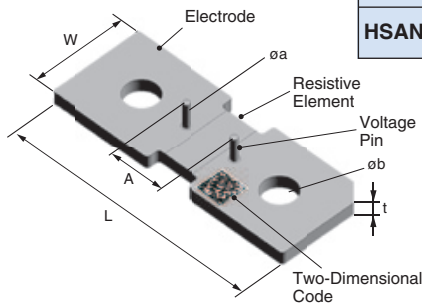

Derating Curve

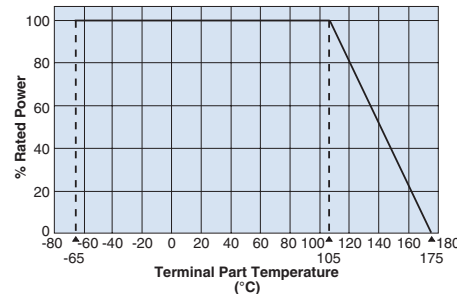

For resistors operated terminal temperature of described for each size or above, a power rating shall be derated in accordance with the derating curve above.

Please refer to "Introduction of the derating curve based on the terminal part temperature" in the beginning of our catalog before use.

ordering information

HS	A	N	2P	4015
Type	Size	Surface Condition	Number of Voltage Pin	Outward Form Size
HS	A: 5mm B: 8.2mm	N: Pure Copper	0P: 0 pin 2P: 2 pin *1	4022: 50 $\mu\Omega$ 8022: 50 $\mu\Omega$ 4015: 100 $\mu\Omega$ 200 $\mu\Omega$ 8018: 100 $\mu\Omega$ Length x Width
M5	PT	L10	J	Y
Fastening Hole	Packing Form	Nominal Resistance	Resistance Tolerance	2D Code
M5: M5 Hole M8: M8 Hole *1	PT: Tray	50U: 50 $\mu\Omega$ L10: 100 $\mu\Omega$ L20: 200 $\mu\Omega$	J: \pm 5%	Nil: Non code Y: With Resistance Value

See Appendix C

*1 Voltage pin: ϕ 1mm, length 4mm, Sn plating. Contact KOA factory for custom type request

Contact KOA factory when you have control request for environmental hazardous material other than the substance specified by EU RoHS

Specifications given herein may be changed at any time without prior notice. Please confirm technical specifications before you order and/or use.

11/09/22

applications and ratings

Part Designation	Power Rating*2	T.C.R. (X 10 ⁻⁶ /K)	Resistance Range (Ω)	Rated Terminal Part Temp.	Operating Temp. Range
HS	50W (1000A)	75±50	50μ	105°C	-65°C to +175°C
	36W (600A)	50±25	100μ		
	18W (300A)		200μ		

*2 A power rating shall be guaranteed with a method shown in the item (: Performance)

environmental applications

One-Pulse Limiting Electric Power

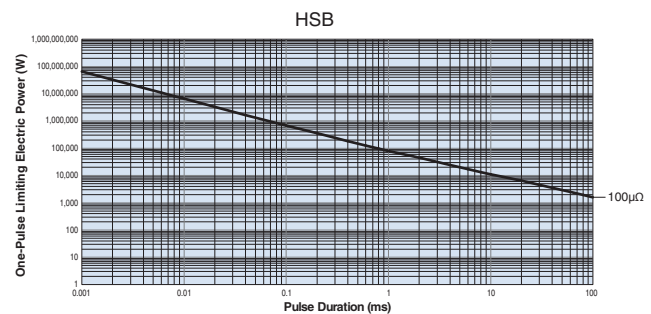
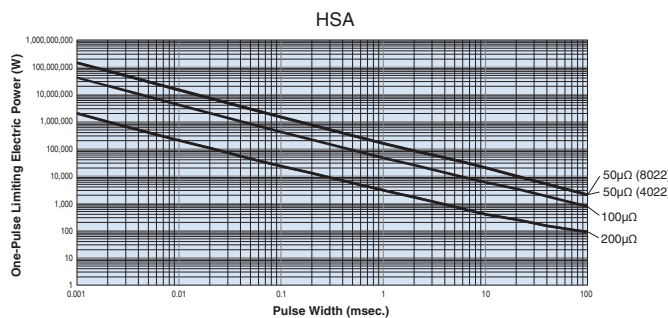

Please ask us about the resistance characteristic of continuous applied pulse.

The pulse endurance values are not assured values, so be sure to check the products on actual equipment when you use them.

Thermal Resistance

Resistance (Ω)	Rth (°C/W)
50μ	0.57
100μ	1.2
200μ	2.3

$$R_{th} = (H_s - t_s) / \text{Power}$$

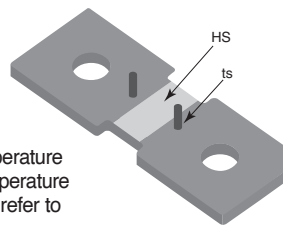

Regarding the temperature rise, the value of the temperature varies per conditions and board for use since the temperature is measured under our measuring conditions. Please refer to us before use.

The temperature of the resistor will increase the same ΔT from the standard terminal part temperature regardless of the ambient temperature when the same power is applied. This is because there is hardly any heat dissipation from the resistor surface to the ambient air.

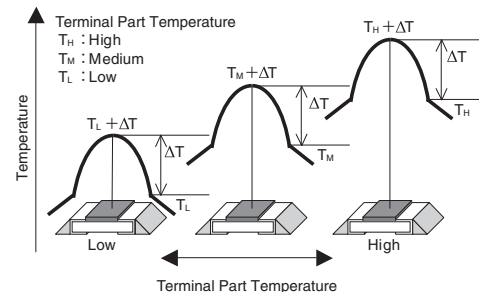

Performance Characteristics

Parameter	Requirement Δ R %		Test Method
	Limit	Typical	
Resistance	Within regulated tolerance	—	25°C
T.C.R.	Within specified T.C.R.	—	50μΩ: +25°C/+125°C; 100μΩ, 200μΩ: +25°C/+100°C
Rapid Change of Temperature	±0.5	-0.1	-55°C (30 minutes), +150°C (30 minutes), 1000 cycles
Endurance at 105°C and Less of Terminal Part Temperature	±1	-0.1	Terminal part temperature: 105°C ± 3°C, 1000 hours, 1.5 hr ON, 0.5 hr OFF cycle
Low Temperature Exposure	±0.5	-0.05	-65°C, 1000 hours
High Temperature Exposure	±1	-0.4	175°C, 1000 hours

Additional environmental applications can also be found at www.koaspeer.com

Specifications given herein may be changed at any time without prior notice. Please confirm technical specifications before you order and/or use.

11/09/22

current sense

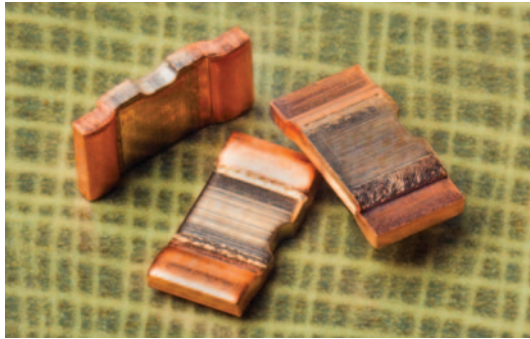

features

- Ultra low resistance, suitable for large current sensing
- Automatic mounting machines are applicable
- Suitable for reflow soldering (Not suitable for flow soldering)
- Products meet EU RoHS requirements
- AEC-Q200 tested

dimensions and construction

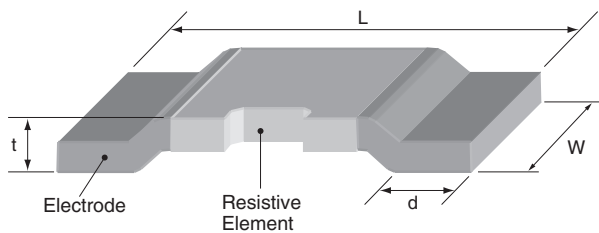

Type (Inch Size Code)	Resist. (Ω)	Dimensions inches (mm)			
		L	W	d	t
PSL2 (2512)	0.2m				.055±.006 (1.40±0.15)
	0.3m	.248±.006 (6.3±0.15)	.124±.006 (3.15±0.15)	.045±.006 (1.15±0.15)	.052±.006 (1.32±0.15)
	0.5m				.044±.006 (1.12±0.15)

Derating Curve

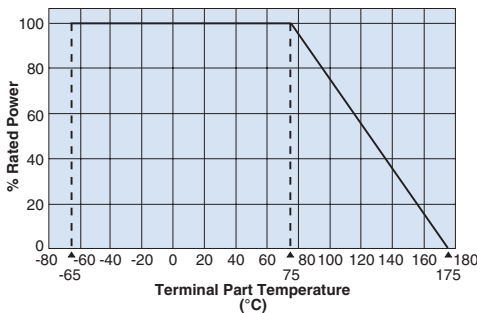

For resistors operated at a terminal part temperature of described for each size or above, a power rating shall be derated in accordance with the derating curve.

Please refer to "Introduction of the derating curve based on the terminal part temperature" in the beginning of our catalog before use.

ordering information

PS	L	2	N	TEB	L500	F
Type	Power Rating L (0.2m): 9W L (0.3m): 8W L (0.5m): 8W	Termination Number	Termination Material N: Pure Copper	Packaging TEB: 8mm pitch plastic embossed	Nominal Resistance 4 digits: all values less than 100m Ω are expressed in m Ω with "L" as decimal Ex: 0.5m Ω - L500 1m Ω = 1L00	Tolerance F: \pm 1%

For further information on packaging, please refer to Appendix A.

applications and ratings

Part Designation	Power Rating (Current Rating)	T.C.R. (ppm/°C) Max.	Resistance Range	Resistance Tolerance	Rated Terminal Part Temperature	Operating Temperature Range
PSL2	9W (212A)	250±100	0.2mΩ	F: ±1%	75°C	-65°C to +175°C
	8W (163A)	±175	0.3mΩ			
	8W (126A)	±115	0.5mΩ			

environmental applications

One-Pulse Limiting Electric Power

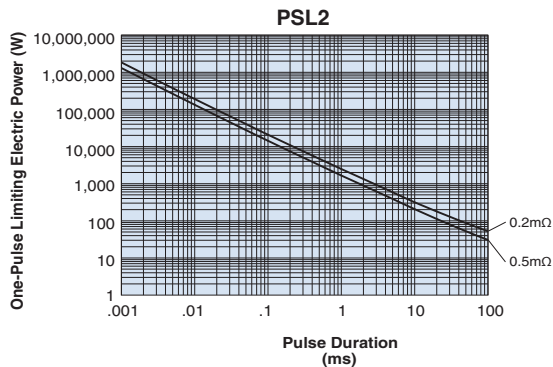

Please ask us about the resistance characteristic of continuous applied pulse.

The pulse endurance values are not assured values, so be sure to check the products on actual equipment when you use them.

Thermal Resistance

Type	Resistance (Ω)	Rth (°C/W)
PSL2	0.2m	3.2
	0.5m	6.7

$$R_{th} = (H_s - t_s) / \text{Power}$$

Regarding the temperature rise, the value of the temperature varies per conditions and board for use since the temperature is measured under our measuring conditions. Please refer to us before use.

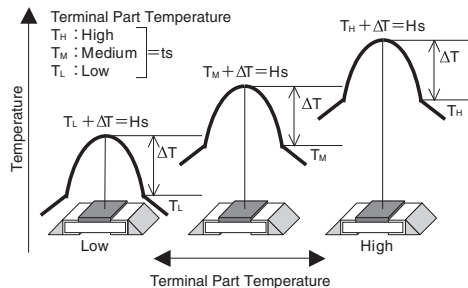

The temperature of the resistor will increase the same ΔT from the standard terminal part temperature regardless of the ambient temperature when the same power is applied. This is because there is hardly any heat dissipation from the resistor surface to the ambient air.

Performance Characteristics

Parameter	Requirement ΔR ±%		Test Method
	Limit	Typical	
Resistance	Within specified tolerance	—	25°C
T.C.R.	Within specified T.C.R.	—	+25°C/+125°C
Overload (Short time)	±0.5%	±0.1%	0.2m: 27W for 5 seconds; 0.3m, 0.5m: 24W for 5 seconds
Resistance to Solder Heat	±0.5%	±0.1%	260°C ± 5°C, 15 seconds ± 1 second
Rapid Change of Temperature	±0.5%	±0.1%	-55°C (30 minutes), +150°C (30 minutes), 1,000 cycles
Moisture Resistance	±0.5%	±0.05%	85°C ± 3°C, 85% ± 3°C RH, 1000 hours, 10% Bias
Endurance at 75°C and Less of Terminal Part Temperature	±1.0%	±0.3%	Terminal part temperature: 75°C ± 3°C, 1000 hours, 1.5 hr ON, 0.5 hr OFF cycle
Low Temperature Exposure	±0.5%	±0.02%	-65°C, 1000 hours
High Temperature Exposure	±1%	±0.5%	+175°C, 1,000 hours

current sense



features

- Correcter electric current detection is possible with 4-terminal construction
- Excellent T.C.R. achieved ($\pm 50 \times 10^{-6}/K$)
- Ultra low resistance, suitable for large current sensing
- Automatic mounting machines are applicable
- Suitable for reflow soldering (Not suitable for flow soldering)
- Products meet EU RoHS requirements
- AEC-Q200 tested

dimensions and construction

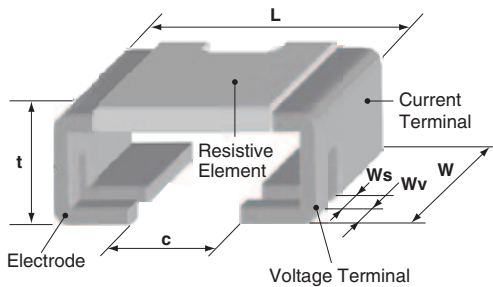

Type (Inch Size Code)	Resist. (Ω)	Dimensions inches (mm)					
		L	W	c	Ws	Wv	t
PSF4 (1216)	0.5m	.118±.004 (3.0±0.1)	.150±.004 (3.8±0.1)	.037±.006 (0.95±0.15)	.028±.002 (0.7±0.05)	.020±.002 (0.5±0.05)	.071±.004 (1.8±0.1)
	1m						

Derating Curve

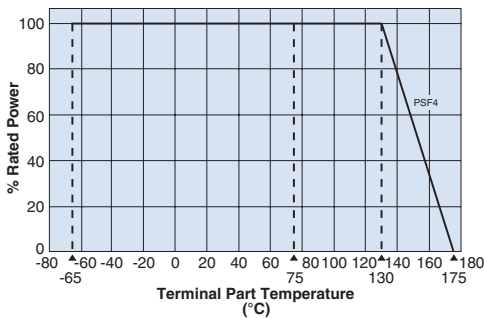

When the terminal part temperature of the resistor exceeds the rated terminal part temperature shown, the power shall be derated according to the derating curve.

Please refer to "Introduction of the derating curve based on the terminal part temperature" in the beginning of our catalog before use.

ordering information

PS	F	4	N	TEB	L500	F
Type	Power Rating F (0.5m): 5W F (1m): 3W	Termination Number	Termination Material N: Pure Copper	Packaging TEB: Plastic embossed	Nominal Resistance 4 digits: all values less than 100m Ω are expressed in m Ω with "L" as decimal Ex: 0.5m Ω - L500 1m Ω - 1L00	Tolerance F: $\pm 1\%$

Contact us when you have control request for environmental hazardous material other than the substance specified by EU RoHS.

For further information on packaging, please refer to Appendix A.

applications and ratings

Part Designation	Power Rating (Current Rating)	T.C.R. (ppm/°C) Max.	Resistance Range	Resistance Tolerance	Rated Terminal Part Temperature	Operating Temperature Range
PSF4	5W (100A)	±50	0.5mΩ	F: ±1%	130°C	-65°C to +175°C
	3W (54A)		1mΩ			

pad dimensions

Type (Inch Size Code)	Dimensions inches (mm)								
	A	B	C	D	E	F	G	H	I
PSF4 (1216)	.024 (0.6)	.142 (3.6)	.116 (2.95)	.059 (1.5)	.020 (0.5)	.024 (0.6)	.142 (3.6)	.028 (0.7)	.059 (1.5)

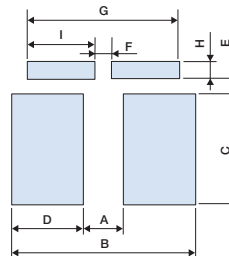

These pad dimensions are only for standard pattern and the characteristics are not guaranteed, which you are suggested to confirm before use.

environmental applications

One-Pulse Limiting Electric Power

PSF4

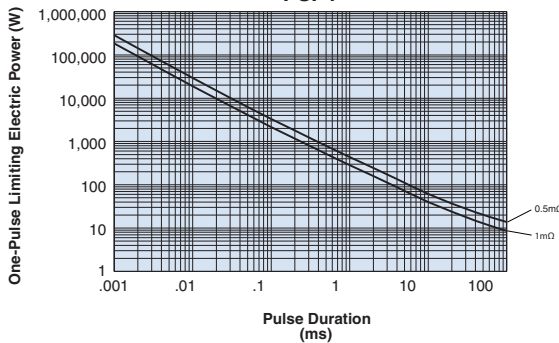

Please ask us about the resistance characteristic of continuous applied pulse.

The pulse endurance values are not assured values, so be sure to check the products on actual equipment when you use them.

Thermal Resistance

Type	Resistance (Ω)	Rth (°C/W)
PSF4	0.5m	8
	1m	14

$R_{th} = (H_s - t_s) / \text{Power}$

Regarding the temperature rise, the value of the temperature varies per conditions and board for use since the temperature is measured under our measuring conditions. Please refer to us before use.

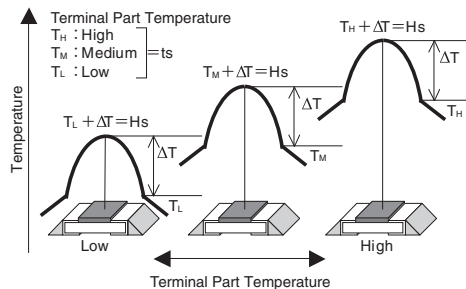

The temperature of the resistor will increase the same ΔT from the standard terminal part temperature regardless of the ambient temperature when the same power is applied. This is because there is hardly any heat dissipation from the resistor surface to the ambient air.

Performance Characteristics

Parameter	Requirement $\Delta R \pm\%$		Test Method
	Limit	Typical	
Resistance	Within specified tolerance	—	+25°C
T.C.R.	Within specified T.C.R.	—	+25°C/+125°C
Overload (Short time)	±0.5%	±0.1%	0.5mΩ: 15W for 5 seconds; 1mΩ: 9W for 5 seconds
Resistance to Solder Heat	±0.5%	±0.1%	260°C ± 5°C, 15 seconds ± 1 second
Rapid Change of Temperature	±0.5%	±0.1%	-55°C (30 minutes), +150°C (30 minutes), 1,000 cycles
Moisture Resistance	±0.5%	±0.05%	85°C ± 3°C, 85% ± 3% RH, 1000 hours, 10% Bias
Endurance at Rated Terminal Part Temperature	±1.0%	±0.5%	Terminal part temperature: 130°C ± 3°C, 1000 hours, 1.5 hr ON, 0.5 hr OFF cycle
Low Temperature Exposure	±0.5%	±0.01%	-65°C, 1000 hours
High Temperature Exposure	±1%	±0.6%	+175°C, 1,000 hours

Specifications given herein may be changed at any time without prior notice. Please confirm technical specifications before you order and/or use.



features

- SMD type of small size, metal plate low resistance resistor for current detection
- Low height suitable for use of small equipment such as mobile phone
- High reliability and performance with T.C.R $\pm 100 \times 10^{-6}/K$
- Suitable for reflow soldering (Not suitable for flow soldering)
- Products meet EU RoHS requirements
- AEC-Q200 Tested 0805 (2A)

dimensions and construction

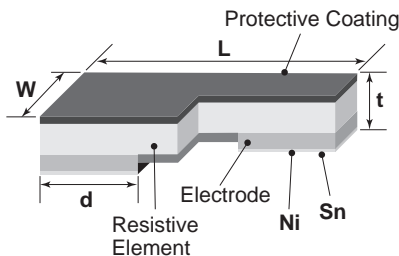

Size Code	Resistance	Dimensions inches (mm)			
		L	W	d	t
TLR2A (0805)	2m Ω	.079 \pm .008 (2.00 \pm 0.20)	.049 \pm .008 (1.25 \pm 0.20)	.024 \pm .008 (0.60 \pm 0.20)	.012 \pm .006 (0.30 \pm 0.15)
	3m Ω			.024 \pm .008 (0.60 \pm 0.20)	.010 \pm .006 (0.25 \pm 0.15)
	4m Ω			.018 \pm .008 (0.45 \pm 0.20)	
	5m Ω			.026 \pm .008 (0.65 \pm 0.20)	
	6m Ω			.022 \pm .008 (0.55 \pm 0.20)	.012 \pm .006 (0.30 \pm 0.15)
	7m Ω			.020 \pm .008 (0.50 \pm 0.20)	
	8m Ω			.020 \pm .008 (0.50 \pm 0.20)	
	9m Ω			.018 \pm .008 (0.45 \pm 0.20)	.016 \pm .006 (0.26 \pm 0.15)
	10m Ω			.014 \pm .008 (0.35 \pm 0.20)	

Derating Curve

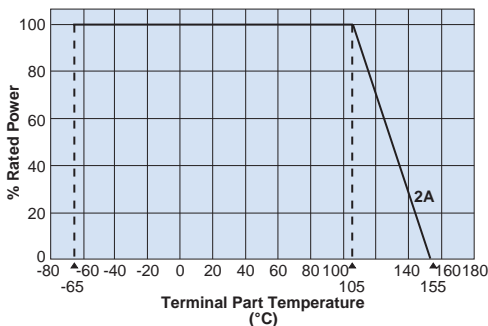

For resistors operated at an ambient temperature of 105°C or above, a power rating shall be derated in accordance with the above derating curve.

ordering information

TLR	2A	T	TD	10L0	J
Type	Power Rating	Termination Material	Packaging	Nominal Resistance	Resistance Tolerance
TLR	2A: 1W	T: Sn	TD: 7" 4mm pitch punch paper	$\pm 1\%$: 4 digits All values less than 0.1 Ω (100m) are expressed in m Ω with "L" as decimal Ex: 1m Ω = 1L00	F: $\pm 1\%$

For further information on packaging, please refer to Appendix A.

Specifications given herein may be changed at any time without prior notice. Please confirm technical specifications before you order and/or use.

8/28/24

applications and ratings

Part Designation	Power Rating	T.C.R. (ppm/°C) Max.	Standard Resistance (Ω)	Resistance Tolerance	Rated Terminal Part Temperature	Operating Temperature Range
TLR2A	1W	±100	2m, 3m, 4m, 5m, 6m, 7m, 8m, 9m, 10m	F: ±1%	105°C	-65°C to +155°C

environmental applications

One-Pulse Limiting Electric Power

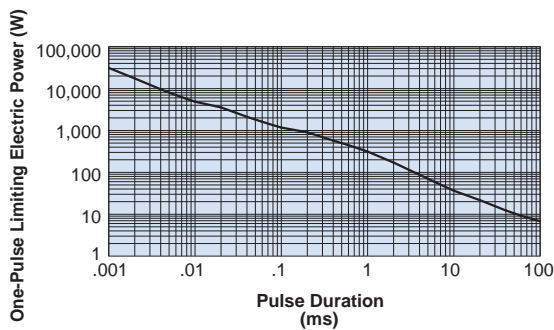

Please ask us about the resistance characteristic of continuous applied pulse.
The pulse endurance values are not assured values, so be sure to check the products on actual equipment when you use them.

Thermal Resistance

Type	Resistance (Ω)	Rth (°C/W)
TLR2A	2m	26.1
	10m	54.7

$$R_{th} = (H_s - t_s) / \text{Power}$$

Regarding the temperature rise, the value of the temperature varies per conditions and board for use since the temperature is measured under our measuring conditions. Please refer to us before use.

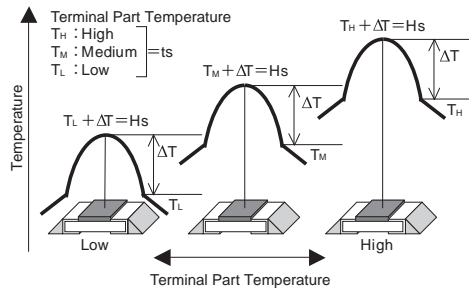

The temperature of the resistor will increase the same ΔT from the standard terminal part temperature regardless of the ambient temperature when the same power is applied. This is because there is hardly any heat dissipation from the resistor surface to the ambient air.

Performance Characteristics

Parameter	Requirement ΔR %		Test Method
	Limit	Typical	
Resistance	Within regulated tolerance	—	25°C
T.C.R.	Within specified T.C.R.	—	+25°C/+125°C
Overload (Short time)	±1	±0.05	Rated power x 2.5 for 5 seconds
Resistance to Solder Heat	±1	±0.01	260°C ± 5°C, 10 ~ 12 seconds
Rapid Change of Temperature	±1	±0.2	-55°C (15 minutes), +150°C (15 minutes), 1000 cycles
Moisture Resistance	±1	±0.3	85°C, 85%RH, 1000 hours, 10% Bias
Endurance at 105°C and Less of Terminal Part Temperature	±1	±0.4	Terminal part temperature: 105°C, 1000 hours, 1.5 hr ON, 0.5 hr OFF cycle
Low Temperature Exposure	±1	±0.05	-65°C, 96 hours
High Temperature Exposure	±1 (2~4m, 7~10m) ±2 (5m, 6m)	±0.5 (2~4m, 7~10m) ±0.8 (5m, 6m)	155°C, 1000 hours

Note: Please contact factory for the TLRZ Performance Characteristics



features

- Ultra low height with a thickness of 0.6mm, suitable for use of small equipment
- Excellent high-frequency characteristics
- Ultra low resistances (0.5mΩ~), suitable for large current sensing
- Suitable for reflow soldering (Not suitable for flow soldering)
- Products meet EU RoHS requirements
- AEC-Q200 Tested

dimensions and construction

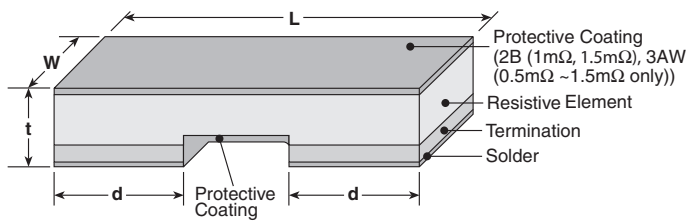

Derating Curve

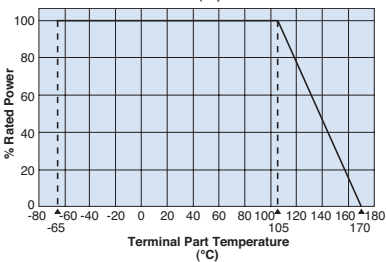
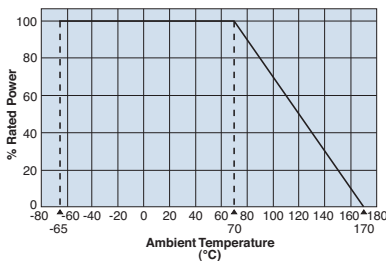

Size Code	Resistance	Dimensions inches (mm)			
		L	W	d	t
TLR2B TLR2BN	1m 1.5m	.126±.008 (3.20±0.20)	.063±.008 (1.60±0.20)	.043±.008 (1.10±0.20)	.024±.008 (0.60±0.20)
	2m, 3m, 4m, 5m, 6m, 7m, 8m, 9m, 10m, 11m, 12m, 13m, 15m, 16m, 18m, 20m			.020±.008 (0.50±0.20)	
TLR2H	1m	.200±.008 (5.00±0.20)	.100±.008 (2.50±0.20)	.071±.008 (1.80±0.20)	.026±.008 (0.65±0.20)
	2m - 6m 7m - 10m			.060±.008 (1.50±0.20) .020±.008 (0.50±0.20)	
TLR3AW	0.5mΩ	.25±.01 (6.35±0.25)	.125±.01 (3.18±0.25)	.107±.01 (2.725±0.25)	.024±.01 (0.60±0.25)
	0.68mΩ, 0.75mΩ, 0.82mΩ,			.105±.01 (2.675±0.25)	
	1mΩ, 1.5mΩ, 2mΩ, 3mΩ, 4mΩ			.087±.01 (2.20±0.25)	
	5mΩ, 6mΩ, 7mΩ, 8mΩ			.047±.01 (1.20±0.25)	
9mΩ, 10mΩ	.030±.01 (0.77±0.25)				

ordering information

TLR	3AW	D	TE	2L00	F	75
Type	Power Rating 2BN: 0.5W 2B: 0.5W 2H: 1W 3AW: 2W	Termination Material D: SnAgCu	Packaging TE: 7" 8mm pitch embossed plastic (3AW) TE: 7" 4mm pitch embossed plastic (2H only) TD: 7" 4mm pitch punched paper (2B/2BN only)	Nominal Resistance ±1%: 4 digits All values less than 0.1Ω (100m) are expressed in mW with "L" as decimal Ex: 2mΩ = 2L00	Tolerance F: ±1%	T.C.R. 50ppm/°C 75ppm/°C Blank: 150ppm/°C

For further information on packaging, please refer to Appendix A.

Specifications given herein may be changed at any time without prior notice. Please confirm technical specifications before you order and/or use.

11/28/22

applications and ratings

Part Designation	Power Rating	Rated Ambient Temperature	Rated Terminal Part Temperature	T.C.R. (ppm/°C) Max.*	Standard Resistance (Ω)	Resistance Tolerance	Operating Temperature Range
TLR2B	1/2W (.5W)	70°C	105°C	±50	2m,3m,4m,5m,6m,7m,8m,9m,10m,11m,12m,13m,15m,16m,18m,20m	F: ±1%	-65°C to +155°C** -65°C to +170°C**
				±75	1m,1.5m,2m,3m,4m,5m,6m,7m,8m,9m,10m,11m,12m,13m,15m,16m,18m,20m		
TLR2BN				±150	1m,1.5m,2m,3m,4m,5m,6m,7m,8m,10m,11m,12m,13m,15m,16m,18m,20m		
TLR2H	1W	70°C	105°C	±50	1m,2m,3m,4m,5m,6m,7m,8m,9m,10m	F: ±1%	-65°C to +155°C** -65°C to +170°C**
				±75			
TLR3AW	2W	70°C	105°C	±50	2m,3m,4m,5m,6m,7m,8m,9m,10m	F: ±1%	-65°C to +155°C** -65°C to +170°C**
				±75	0.5m,0.68m,0.75m,0.82m,1m,1.5m,2m*,3m,4m,5m,6m,7m,8m,9m,10m		
				±150			

* Contact factory for 2mΩ dimensions

** Please reference High Temperature Performance Characteristics in the below table

If any questions should arise whether to use the "Rated Ambient Temperature" or the "Rated Terminal Part Temperature," please give priority to the "Rated Terminal Part Temperature." Prior to use and for more details refer to "Introduction of the derating curves on the terminal part temperature" in the beginning of the catalog.

environmental applications

One-Pulse Limiting Electric Power

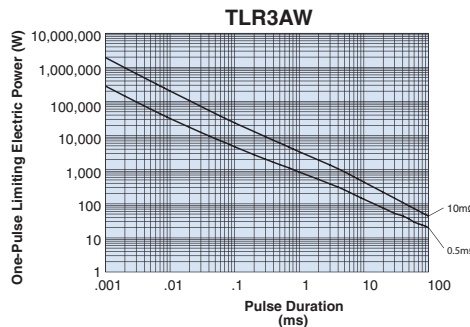
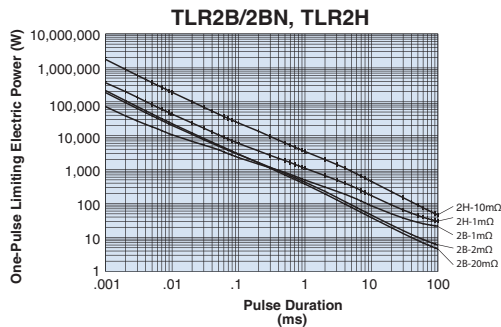

Please ask us about the resistance characteristic of continuous applied pulse. The pulse endurance values are not assured values, so be sure to check the products on actual equipment when you use them.

Thermal Resistance

Type	Size	Resistance (Ω)	Rth (°C/W)
TLR	2B 2BN	1m	11.8
		2m	18.3
		20m	116
	2H	1m	17
		10m	61.1
	3AW	0.5m	6
10m		62	

$$R_{th} = (H_s - t_s) / \text{Power}$$

Regarding the temperature rise, the value of the temperature varies per conditions and board for use since the temperature is measured under our measuring conditions. Please refer to us before use.

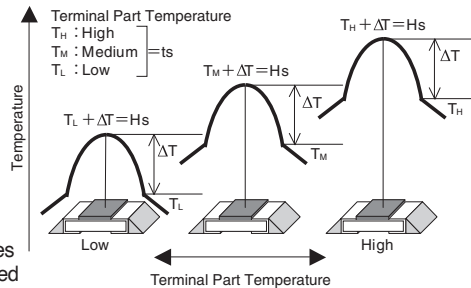

The temperature of the resistor will increase the same ΔT from the standard terminal part temperature regardless of the ambient temperature when the same power is applied. This is because there is hardly any heat dissipation from the resistor surface to the ambient air.

Performance Characteristics

Parameter	Requirement $\Delta R \pm\%$		Test Method
	Limit	Typical	
Resistance	Within regulated tolerance	—	25°C
T.C.R.	Within specified T.C.R.	—	+25°C/+125°C
Resistance to Solder Heat	±0.5%	±0.3%	260°C ± 5°C, 10 seconds +2/-0 seconds
Rapid Change of Temperature	±0.5%	±0.4%	-55°C (15 minutes), +150°C (15 minutes), 1000 cycles
Moisture Resistance	±0.5%	±0.1%	MIL-STD-202, Method 106, 0% power, 7a and 7b not required
Biased Humidity	±0.5%	±0.1%	85°C ± 2°C, 85% RH, 1000 hours, 10% bias
Endurance (Ambient Temp.)	±1.0%	±0.3%	70°C ± 2°C, 1000 hours, 1.5 hr ON, 0.5 hr OFF cycle
High Temperature Exposure**	±1.0%	±0.6%	±155°C (2B, 2H, 3AW), 1000 hours
	±2.0%	—	±170°C (2B, 2H, 3AW), 1000 hours

Specifications given herein may be changed at any time without prior notice. Please confirm technical specifications before you order and/or use.

11/28/22

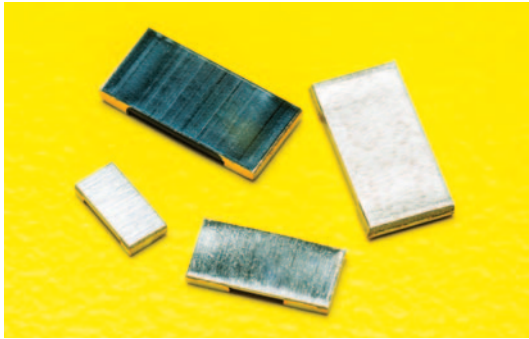

features

- Ultra low height with a thickness of 0.6mm, suitable for use of small equipment
- Ultra low resistances (0.5mΩ~), suitable for large current sensing
- Suitable for reflow soldering (Not suitable for flow soldering)
- Products meet EU RoHS requirements
- AEC-Q200 Tested

dimensions and construction

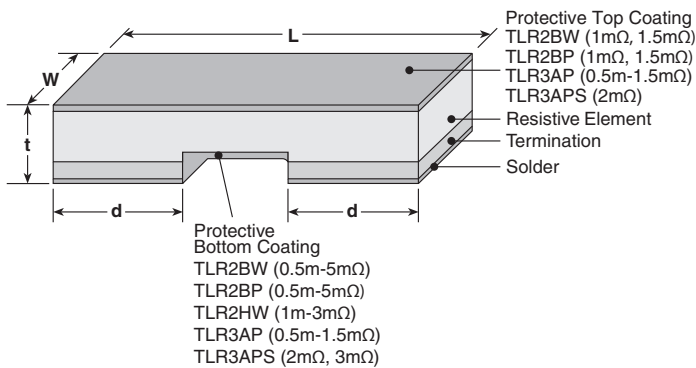

Derating Curve

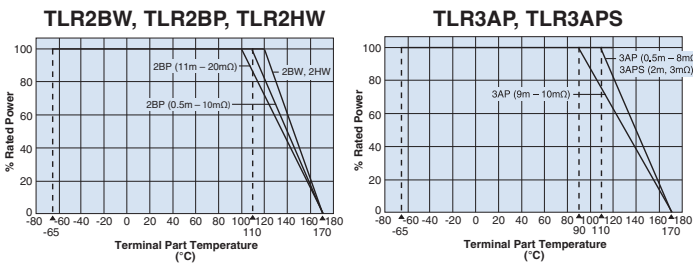

For resistors operated at a terminal part temperature of described for each size or above, a power rating shall be derated in accordance with the derating curve. Please refer to "Introduction of the derating curve based in the terminal part temperature" in the beginning of our catalog before use.

Size Code	Resistance	Dimensions inches (mm)			
		L	W	d	t
TLR2BW	0.5mΩ			.049±.008 (1.25±0.20)	.028±.008 (0.70±0.20)
	1mΩ 1.5mΩ	.126±.008 (3.20±0.20)	.063±.008 (1.60±0.20)	.043±.008 (1.10±0.20)	.024±.008 (0.60±0.20)
	2mΩ - 20mΩ			.020±.008 (0.50±0.20)	
TLR2BP	0.5mΩ			.049±.008 (1.25±0.20)	.028±.008 (0.70±0.20)
	1mΩ, 1.5mΩ	.126±.008 (3.20±0.20)	.063±.008 (1.60±0.20)	.043±.008 (1.10±0.20)	.024±.008 (0.60±0.20)
	2mΩ - 20mΩ			.020±.008 (0.50±0.20)	
TLR2HW	0.5mΩ			.075±.008 (1.90±0.20)	.028±.008 (0.70±0.20)
	1mΩ	.200±.008 (5.00±0.20)	.100±.008 (2.50±0.20)	.071±.008 (1.80±0.20)	.026±.008 (0.65±0.20)
	1.5mΩ				
	2mΩ - 6mΩ			.060±.008 (1.50±0.20)	.024±.008 (0.60±0.20)
TLR3AP	0.5mΩ			.107±.01 (2.725±0.25)	.024±.01 (0.60±0.25)
	0.68mΩ, 0.75mΩ, 0.82mΩ			.105±.01 (2.675±0.25)	
	1mΩ, 1.5mΩ, 3mΩ, 4mΩ	.25±.01 (6.35±0.25)	.125±.01 (3.18±0.25)	.087±.01 (2.20±0.25)	
	2mΩ			.098±.01 (2.50±0.25)	
	5mΩ, 6mΩ, 7mΩ, 8mΩ			.047±.01 (1.20±0.25)	
	9mΩ, 10mΩ			.030±.01 (0.77±0.25)	
TLR3APS	2mΩ, 3mΩ	.25±.01 (6.35±0.25)	.125±.01 (3.18±0.25)	.047±.01 (1.20±0.25)	.024±.01 (0.60±0.25)

ordering information

TLR	2BW	D	TD	10L0	F	75
Type	Power Rating	Termination Material	Packaging	Nominal Resistance	Tolerance	T.C.R.
	2BW: 1W 2BP: 1.5W, 3W 2HW: 2W 3AP: 3W, 5W 3APS: 3W	D: SnAgCu	TD: 7" 4mm pitch punched paper TE: 7" 4mm embossed plastic	±1%: 4 digits All values less than 0.1Ω (100m) are expressed in mW with "L" as decimal Ex: 2mΩ = 2L00	F: ±1%	50: 50ppm/°C 75: 75ppm/°C

For further information on packaging, please refer to Appendix A.

Specifications given herein may be changed at any time without prior notice. Please confirm technical specifications before you order and/or use.

11/28/22

applications and ratings

Part Designation	Power Rating	T.C.R. (ppm/°C) Max.	Standard Resistance (Ω)	Resistance Tolerance	Rated Terminal Part Temperature	Operating Temperature Range
TLR2BW	1W	±50	2m,3m,4m,5m,6m,7m,8m,9m,10m,11m,12m,13m,15m,16m,18m,20m	F: ±1%	+120°C and less	-65°C to +170°C
		±75	0.5m,1m,1.5m,2m,3m,4m,5m,6m,7m,8m,9m,10m,11m,12m,13m,15m,16m,18m,20m			
TLR2BP	1.5W	±50	5m,6m,7m,8m,9m,10m 11m,12m,13m,15m,16m,18m,20m	F: ±1%	+110°C and less	-65°C to +170°C
		±75	5m,6m,7m,8m,9m,10m 11m,12m,13m,15m,16m,18m,20m		+100°C and less	
	3W	±50	2m,3m,4m	F: ±1%	+110°C and less	
		±75	0.5m,1m,1.5m,2m,3m,4m		+100°C and less	
TLR2HW	2W	±50 ±75	0.5m,1m,1.5m,2m,2.5m,3m,4m,5m,6m,7m,8m,9m,10m	F: ±1%	+120°C and less	-65°C to +170°C
TLR3AP	3W	±50	5m,6m,7m,8m,9m,10m	F: ±1%	5m ~ 8m: +110°C and less	-65°C to +170°C
		±75			9m, 10m: +90°C and less	
	5W	±50	2m,3m,4m	F: ±1%	0.5m~1m, 2m~4m: +110°C and less	-65°C to +170°C
		±75	0.5m,0.68m,0.75m,0.82m,1m,1.5m,2m,3m,4m		1.5m: +90°C and less	
TLR3APS	3W	±50, ±75	2m,3m	F: ±1%	+110°C and less	-65°C to +170°C

environmental applications

One-Pulse Limiting Electric Power

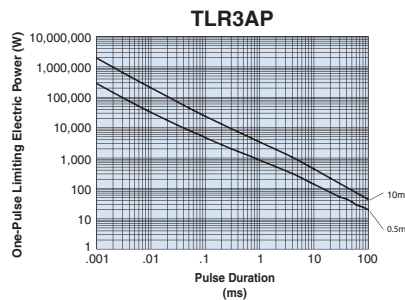
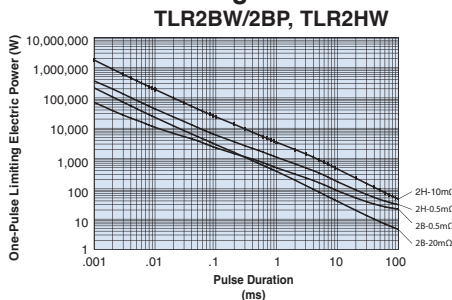

Please ask us about the resistance characteristic of continuous applied pulse. The pulse endurance values are not assured values, so be sure to check the products on actual equipment when you use them.

Thermal Resistance

Type	Size	Resistance (Ω)	Rth (°C/W)
TLR	2BW/2BP	0.5m	7.2
		20m	116
	2HW	0.5m	9
		10m	61.1
	3AP	0.5m	6
		10m	62

$$R_{th} = (H_s - t_s) / \text{Power}$$

Regarding the temperature rise, the value of the temperature varies per conditions and board for use since the temperature is measured under our measuring conditions. Please refer to us before use.

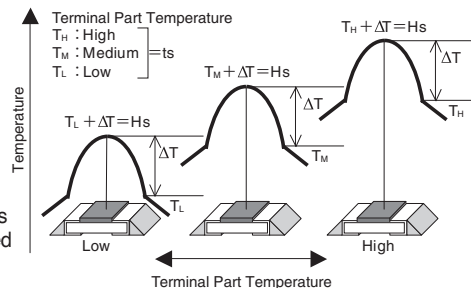

The temperature of the resistor will increase the same ΔT from the standard terminal part temperature regardless of the ambient temperature when the same power is applied. This is because there is hardly any heat dissipation from the resistor surface to the ambient air.

Performance Characteristics

Parameter	Requirement $\Delta R \pm\%$		Test Method
	Limit	Typical	
Resistance	Within regulated tolerance	—	25°C
T.C.R.	Within specified T.C.R.	—	+25°C/+125°C
Resistance to Solder Heat	±0.5%	±0.3%	260°C ± 5°C, 10 ± 2 seconds
Rapid Change of Temperature	±0.5%	±0.3%	-55°C (15 minutes), +150°C (15 minutes), 1000 cycles
Moisture Resistance	±0.5%	±0.1%	MIL-STD-202-106, 0% power, 7a and 7b not required
Biased Humidity	±0.5%	±0.1%	85°C ± 2°C, 85% RH, 1000 hours, 10% bias
Endurance of Rated Terminal Part Temperature	±1.0%	±0.3%	120°C ± 2°C (2BW, 2HW), 110°C ± 2°C (3AP 0.5m~1mΩ, 2m~8mΩ) 90°C ± 2°C (3AP 1.5mΩ, 9mΩ~10mΩ), 110°C ± 2°C (2BP 0.5mΩ~10mΩ) 100°C ± 2°C (2BP 11mΩ~20mΩ), 110°C ± 2°C (3APS 2mΩ, 3mΩ) 1000 hours, 1.5 hr ON, 0.5 hr OFF cycle
High Temperature Exposure	±1.0%	±0.6%	±155°C, 1000 hours
	±2.0%	±0.8%	±170°C, 1000 hours

Specifications given herein may be changed at any time without prior notice. Please confirm technical specifications before you order and/or use.

7/21/23

current sense

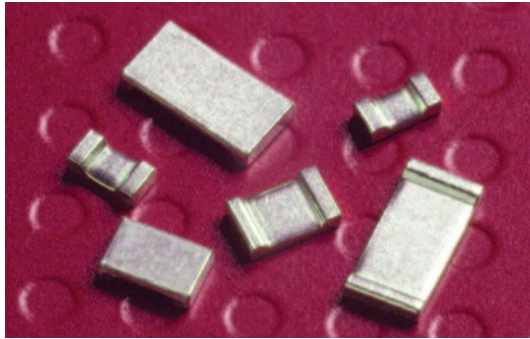

features

- SMD type of small size, high rated current zero ohm jumper
- Low height suitable for use of small equipment such as mobile phone
- Suitable for reflow soldering (Not suitable for flow soldering)
- Products meet EU RoHS requirements
- AEC-Q200 Tested

dimensions and construction

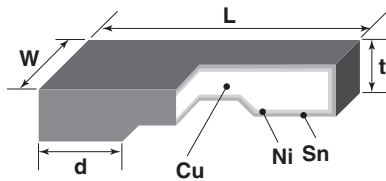

Size Code	Dimensions inches (mm)			
	L	W	d	t
TLRZ1E (0402)	.039±.004 (1.00±0.10)	.020±.004 (0.50±0.10)	.008±.004 (0.20±0.10)	.016±.002 (0.40±0.05)
TLRZ1J (0603)	.063±.004 (1.60±0.10)	.031±.004 (0.80±0.10)	.012±.004 (0.30±0.10)	.020±.002 (0.5±0.05)
TLRZ2A (0805)	.079±.004 (2.00±0.10)	.049±.004 (1.25±0.10)	.012±.004 (0.30±0.10)	
TLRZ2B (1206)	.126±.004 (3.20±0.10)	.063±.004 (1.60±0.10)	.012±.004 (0.30±0.10)	

Derating Curve

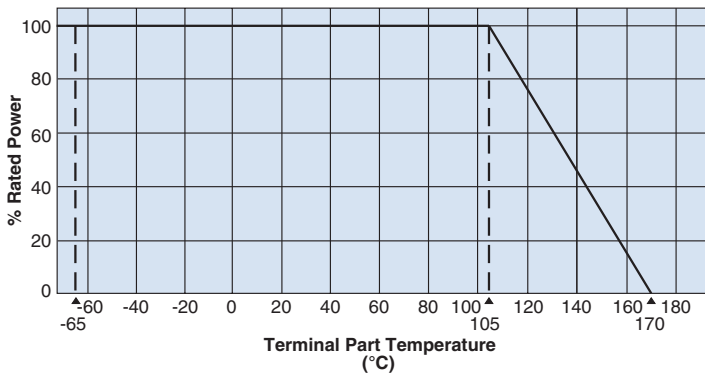

For resistors operated at an ambient temperature of 105°C or above, a power rating shall be derated in accordance with the above derating curve.

ordering information

TLRZ	1E	T	TB
Type	Current Rating	Termination Material	Packaging
TLRZ	1E: 10A 1J: 26A 2A: 31.6A 2B: 50A	T: Sn	TB: 7" pitch pressed paper (TLRZ1E only) TD: 7" 4mm pitch punch paper

For further information on packaging, please refer to Appendix A.

Specifications given herein may be changed at any time without prior notice. Please confirm technical specifications before you order and/or use.

9/13/21

applications and ratings

Part Designation	Current Rating	Standard Resistance (Ω)	Rated Terminal Part Temperature	Operating Temperature Range
TLRZ1E	10A	0.5m max.	105°C and less	-65°C to +170°C
TLRZ1J	26A	0.2m max.	105°C and less	
TLRZ2A	31.6A	0.2m max.	105°C and less	
TLRZ2B	50A	0.2m max.	105°C and less	

environmental applications

One-Pulse Limiting Electric Current

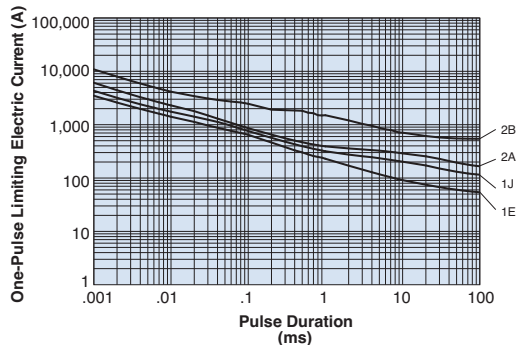

Please ask us about the resistance characteristic of continuous applied pulse.

The pulse endurance values are not assured values, so be sure to check the products on actual equipment when you use them.

Thermal Resistance

Type	Size	Rth
TLRZ	1E	<0.5°C/W
	1J	
	2A	
	2B	

$$R_{th} = (H_s - t_s) / \text{Power}$$

Regarding the temperature rise, the value of the temperature varies per conditions and board for use since the temperature is measured under our measuring conditions. Please refer to us before use.

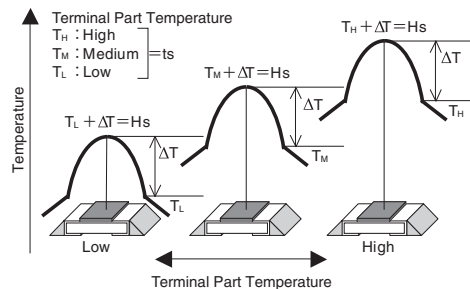

The temperature of the resistor will increase the same ΔT from the standard terminal part temperature regardless of the ambient temperature when the same power is applied. This is because there is hardly any heat dissipation from the resistor surface to the ambient air.

Performance Characteristics

Parameter	Requirement (ΔR %)		Test Method
	Limit	Typical	
Resistance	1E: Max 0.5mΩ 1J/2A/2B: Max 0.2mΩ	1E: Max 0.25mΩ 1J/2A/2B: Max 0.15mΩ	25°C
Overload (Short time)			1E: 20A; 1J/2A: 40A; 2B: 80A for 5 seconds
Resistance to Solder Heat			260°C ± 5°C, 10 ~ 12 seconds
Rapid Change of Temperature			-55°C (30 minutes), +155°C (30 minutes), 1000 cycles
Moisture Resistance			85°C, 85%RH, 1E: 1A; 1J/2A: 2A; 2B: 4A, 1000 hours
Endurance of Rated Terminal Part Temperature			Terminal part temperature: 105°C, 1000 hours, 1.5 hr ON, 0.5 hr OFF cycle
Low Temperature Exposure			-65°C, 1000 hours
High Temperature Exposure			170°C, 1000 hours

Note: Please contact factory for the TLRZ Performance Characteristics

Specifications given herein may be changed at any time without prior notice. Please confirm technical specifications before you order and/or use.

9/11/23

current sense



features

- SMD Type of small size, low resistance resistor for current detection
- Carrier metal plate inside, resistor of high radiation of heat structure (3AW, 3AP)
- High reliability and performance with low T.C.R.
- Automatic mounting machines are applicable
- Suitable for reflow soldering (2A: Not suitable for wave soldering)
- Products meet EU RoHS requirements
- AEC-Q200 Tested

dimensions and construction

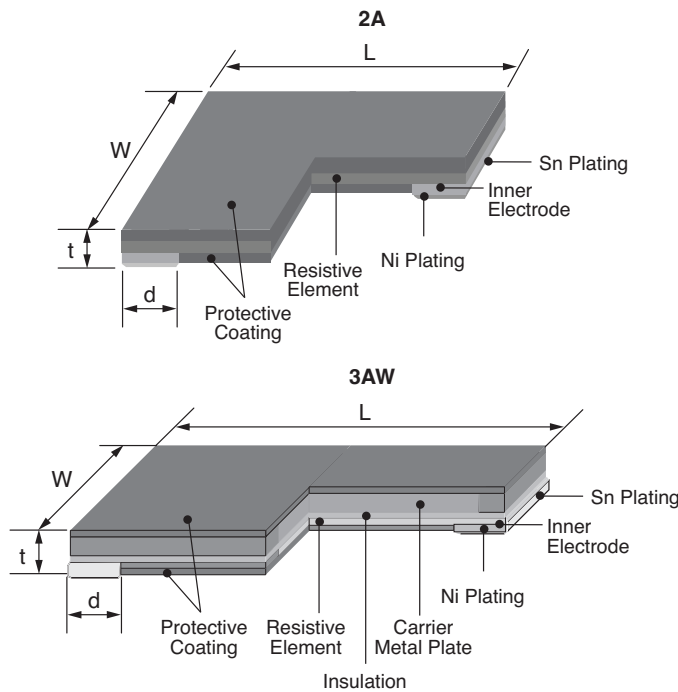

Size Code (Inch)	Resistance (Ω)	Dimensions inches (mm)			
		L	W	d	t
TLRH 2A (0805)	12m~100m	.079±.008 (2.00±0.20)	.049±.008 (1.25±0.20)	.014±.008 (0.35±0.20)	.010±.006 (0.25±0.15)
TLRH 3AW (2512)	10m~270m	.248±.008 (6.30±0.20)	.126±.008 (3.20±0.20)	.030±.008 (0.75±0.20)	.020±.008 (0.50±0.20)
TLRH 3AP (2512)	6m~39m	.248±.008 (6.30±0.20)	.126±.008 (3.20±0.20)	.071±.008 (1.8±0.20)	.020±.008 (0.50±0.20)
	40m~120m			.051±.008 (1.3±0.20)	

Derating Curve

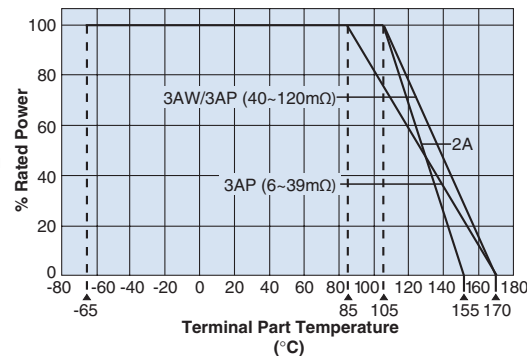

For resistors operated at a terminal part temperature of described for each size or above, a power rating shall be derated in accordance with the derating curve. Please refer to "Introduction of the derating curve based on the terminal part temperature" in the beginning of our catalog before use.

ordering information

TLRH	3AW	T	TE	33L0	F
Type	Power Rating	Terminal Surface Material	Packaging	Nominal Resistance	Tolerance
	2A (12~27mΩ): 0.5W (33~50mΩ): 0.33W (56~100mΩ): 0.25W 3AW: 2.0W 3AP: (6~39mΩ): 5.0W (40~120mΩ): 4.0W	T: Sn	2A: TD: 7" 4mm pitch punched paper 3AW, 3AP: TE: 7" punched plastic	±1%: 4 digits All values less than 0.1Ω (100m) are expressed in mW with "L" as decimal Ex: 2mΩ = 2L00 2A: No marking	F: ±1%

For further information on packaging, please refer to Appendix A.

applications and ratings

Part Designation	Power Rating	T.C.R. (x10 ⁻⁶ /K)	Resistance Range (Ω) F: ±1% (E12)	Rated Terminal Part Temperature	Operating Temperature Range
TLRH 2A	0.25W	±75	56m~100m	+105°C	-65°C~+155°C
	0.33W		33m ~ 50m		
	0.50W		12m ~ 27m		
TLRH 3AW	2.0W	±75	10m~22m		
		±50	24m~270m		
TLRH 3AP	4.0W	±50	40m, 47m, 50m~120m		
		±50	18m, 20m, 22m, 25m~39m		
	5.0W	±75	6m, 7m, 8m, 9m, 10m, 12m		

current sense

environmental applications

One-Pulse Limiting Electric Power

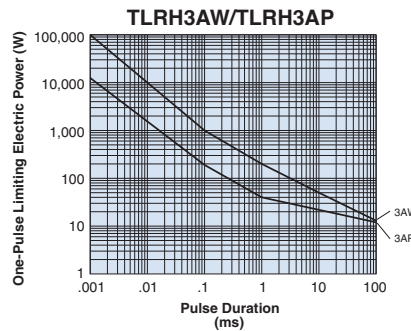
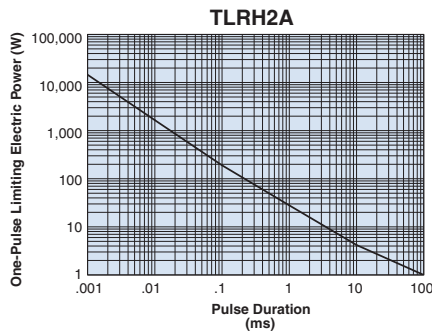

Please ask us about the resistance characteristic of continuous applied pulse.
The pulse endurance values are not assured values, so be sure to check the products on actual equipment when you use them.

Thermal Resistance

Type	Size	Resistance (Ω)	Rth (°C/W)
TLRH	2A	27m	123
		50m	195
		100m	280
	3AW	10m	5.2
		270m	7.4
		18m	7.4
3AP	120m	4.1	

$R_{th} = (H_s - t_s) / \text{Power}$

Regarding the temperature rise, the value of the temperature varies per conditions and board for use since the temperature is measured under our measuring conditions. Please refer to us before use.

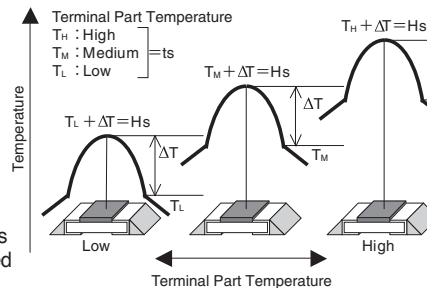

The temperature of the resistor will increase the same ΔT from the standard terminal part temperature regardless of the ambient temperature when the same power is applied. This is because there is hardly any heat dissipation from the resistor surface to the ambient air.

Performance Characteristics

Parameter	Requirement Δ R%		Test Method
	Limit	Typical	
Resistance	Within specified tolerance	—	25°C
T.C.R.	Within specified T.C.R.	—	+25°C/+100°C
Overload (Short time)	±0.5%	2A: ±0.05% 3AW,3AP: ±0.2%	2A, 3AW: Rated power x 2.5 for 5 seconds 3AP: Rated power x 8W for 5 seconds
Resistance to Soldering Heat	±0.5%	±0.1%	260°C ±5°C, 10 seconds ~ 12 seconds
Rapid Change of Temperature	±0.5%	2A: ±0.2% 3AW,3AP: ±0.1%	-55°C (15min.)/+150°C (15min.) 1000 cycles
Moisture Resistance	±0.5%	±0.1%	85°C ±2°C, 85% RH, 1000 hours, 10% Bias
Endurance at 105°C and Less of Terminal Part Temperature	±1%	2A: ±0.45% 3AW,3AP: ±0.3%	2A, 3AW, 3AP (40~120mΩ): 105°C, ±2°C; 3AP (6~39mΩ): 85°C ±2°C 1000 hours, 1.5 hours ON/0.5 hour OFF cycle
Low Temperature Exposure	±0.5%	2A: ±0.05% 3AW,3AP: ±0.02%	-65°C, 96 hours
High Temperature Exposure	±1%	2A: ±0.5% 3AW,3AP: ±0.2%	2A, 3AP: +155°C, 1000 hours (6~12mΩ) 3AW, 3AP: +170°C, 1000 hours (18~120mΩ)
		3AP: ±0.2%	3AP: +170°C, 1000 hours (6~12mΩ)

Specifications given herein may be changed at any time without prior notice. Please confirm technical specifications before you order and/or use.

7/21/23

current sense

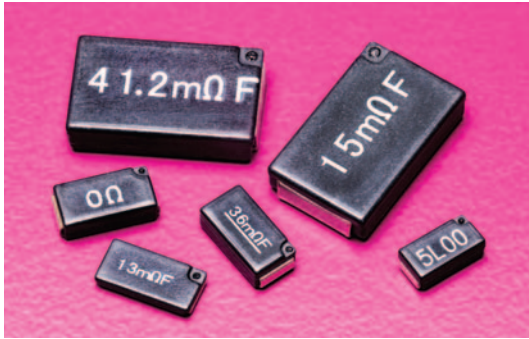

features

- SMD type of small size, ultra-low resistance (3mΩ~) and high accuracy (±0.5%) resistor for current sensing
- Flameproof UL94V0 molded polymer case
- Excellent dimension accuracy, mountability and shock resistance
- Excellent terminal strength and solderability due to structure of a metal plate terminal electrode
- Easy to absorb the thermal expansion and shrinkage because of a metal plate terminal structure
- Suitable for flow, reflow and iron solderings
- Low profile type available (TSL)
- Wide range operating temperature -55°C to +180°C
- Products with lead-free terminations meet EU RoHS requirements
- AEC-Q200 Tested

dimensions and construction

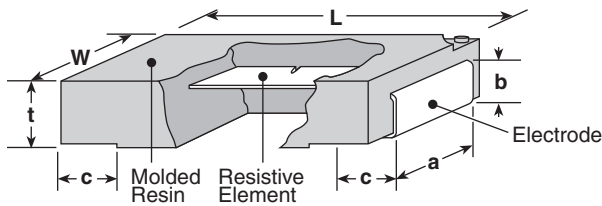

Size Code	Dimensions inches (mm)					
	L	W	t	a	b	c
SL07 (2010)	.197±.012 (5.0±0.3)	.098±.008 (2.5±0.2)	.067±.008 (1.7±0.2)	.079±.008 (2.0±0.2)	.047±.008 (0.9±0.2)	.035±.012 (1.2±0.3)
TSL1 (2512)	.248±.012 (6.3±0.3)	.122±.008 (3.1±0.2)	.039±.008 (1.0±0.2)	.094±.008 (2.4±0.2)	.028±.008 (0.7±0.2)	.047±.012 (1.2±0.3)
SL1,SLZ1 (2512)	.248±.012 (6.3±0.3)	.122±.008 (3.1±0.2)	.075±.008 (1.9±0.2)	.094±.008 (2.4±0.2)	.047±.008 (1.2±0.2)	.047±.012 (1.2±0.3)
SL2 (4527)	.453±.012 (11.5±0.3)	.276±.008 (7.0±0.2)	.098±.008 (2.5±0.2)	.197±.008 (5.0±0.2)	.067±.008 (1.7±0.2)	.102±.02 (2.6±0.5)
SLN2 (4527)	.453±.012 (11.5±0.3)	.276±.008 (7.0±0.2)	.094±.008 (2.4±0.2)	.217±.008 (5.5±0.2)	.063±.008 (1.6±0.2)	.100±.016 (2.55±0.4)
SL3 (4527)	.453±.012 (11.5±0.3)	.276±.008 (7.0±0.2)	.098±.008 (2.5±0.2)	.197±.008 (5.0±0.2)	.067±.008 (1.7±0.2)	.102±.02 (2.6±0.5)

ordering information

SL	1	T	TE	20L0	F	75
Type	Power Rating	Termination Material	Packaging	Nominal Resistance	Tolerance	T.C.R. (x10⁻⁶/K)
TSL SL SLN	07: 0.75W 1: 1W 2: 2W 3: 3W	T: Sn	TE: 7" embossed plastic TED:SL2/SLN2 & SL3 For further information on packaging please refer to Appendix A	±0.5%, ±1%: 4 digits ±2%, ±5%: 3 digits All values less than 0.1Ω (100m) are expressed in mΩ with "L" as decimal Ex: 2mΩ = 2L00 0.1Ω: R100; 5mΩ: 5L0	D: ±0.5% F: ±1% G: ±2% J: ±5%	Nil: 0-150 0-200 ±75 (SLN2) ±100 ±110 ±180 50: ±50 (SL1) 75: ±75 (SL1)
SLZ	1	T	TE			
Type	Current Rating	Termination Material	Packaging			
	1:44A	T: Sn	TE: 8 mm pitch plastic embossed			

applications and ratings

Part Designation	Power Rating	Rated Ambient Temp.	Rated Terminal Part Temperature	Resistance Range (Ω)*				T.C.R. (ppm/ $^{\circ}$ C) Max.	Operating Temp. Range
				D: $\pm 0.5\%$ E24, E96***	F: $\pm 1\%$ E24, E96***	G: $\pm 2\%$ E24	J: $\pm 5\%$ E24		
SL07	0.75W	70 $^{\circ}$ C	145 $^{\circ}$ C	—	5m - 100m	—	5m - 100m	0~200: R<11m Ω 0~150: R \geq 11m Ω	-55 $^{\circ}$ C to +180 $^{\circ}$ C
TSL1	1W		125 $^{\circ}$ C	10m - 100m	5m - 100m	—	5m - 100m	± 180 : R<15m Ω ± 100 : R \geq 15m Ω	
SL1	1W		125 $^{\circ}$ C	10m - 102m	5m - 102m	3m, 4m	3m - 100m	± 180 : R<15m Ω ± 100 : R \geq 15m Ω	
SL1 (TCR ± 50 ppm)	1W		125 $^{\circ}$ C	34.8m - 200m	34.8m - 200m	—	36m - 200m	± 50 ppm	
SL1 (TCR ± 75 ppm)	1W		125 $^{\circ}$ C	20m - 300m	20m - 300m	—	20m - 300m	± 75 ppm	
SL2	2W		125 $^{\circ}$ C	10m ~ 360m	5m ~ 360m	3m, 4m	3m ~ 360m	± 180 : R<11m Ω ± 100 : R \geq 11m Ω	
SLN2	2W		105 $^{\circ}$ C	5m - 200m	5m - 200m	—	5m - 200m	± 110 : R<10m Ω ± 75 : R \geq 10m Ω	
SL3	3W		125 $^{\circ}$ C	10m Ω - 100m Ω	5m Ω - 100m Ω	—	5m Ω - 100m Ω	± 180 : R<11m Ω ± 100 : R \geq 11m Ω	
SLZ1**	—		140 $^{\circ}$ C	0.5m Ω Max.	0.5m Ω Max.	0.5m Ω Max.	0.5m Ω Max.	4000 Max.	

* 3m, 4m, 5m, 6m, 7m, 8m, 9m also available inside each resistance range

** SLZ1: Current rating: 44A

*** SL07 and SL1 (T.C.R.: $\pm 50/\pm 75$ ppm, 102m Ω =<R=<200m Ω) offer only E24 series

If any questions should arise whether to use the "Rated Ambient Temperature" or the "Rated Terminal Part Temperature," please give priority to the "Rated Terminal Part Temperature." Prior to use and for more details refer to "Introduction of the derating curves on the terminal part temperature" in the beginning of the catalog.

environmental applications

Derating Curve

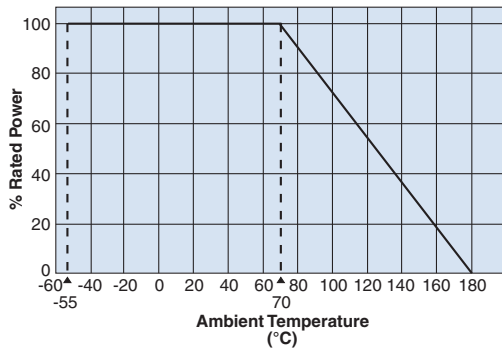

For resistors operated at an ambient temperature of 70 $^{\circ}$ C or above, a power rating shall be derated in accordance with the above derating curve.

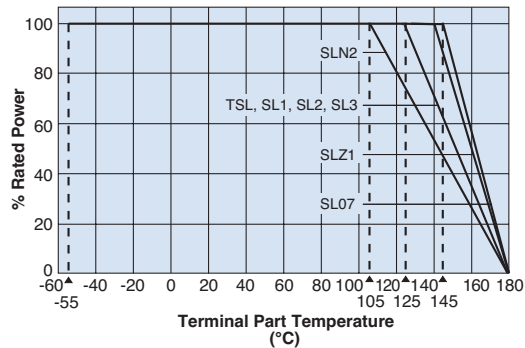

For resistors operated at a terminal part temperature of described for each size or above, a power rating shall be derated in accordance with the derating curve.

Please refer to "Introduction of the derating curve based on the terminal part temperature" in the beginning of our catalog before use.

current sense

One-Pulse Limiting Electric Power

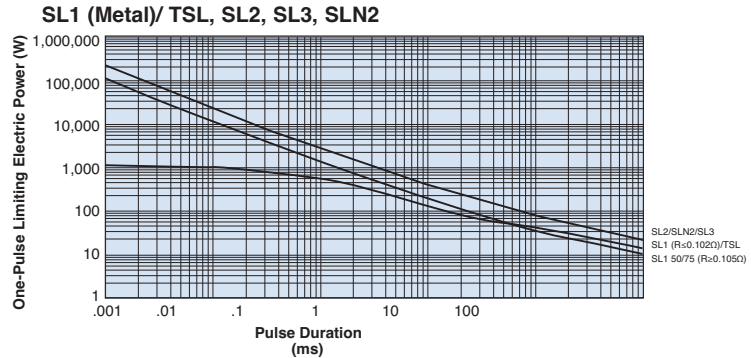
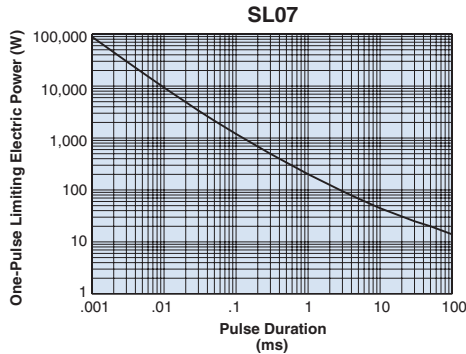

Thermal Resistance

Type	Resistance (Ω)	Rth (°C/W)
SL07	5m	26
	22m	48
	100m	78
SL1 TSL	5m	16
	20m	39
	100m	59
SL2	5m	16
	20m	41
	200m	55
SLN2	5m	19
	11m	24
	200m	46

$$R_{th} = (H_s - t_s) / \text{Power}$$

Regarding the temperature rise, the value of the temperature varies per conditions and board for use since the temperature is measured under our measuring conditions. Please refer to us before use.

Please ask us about the resistance characteristic of continuous applied pulse. The pulse endurance values are not assured values, so be sure to check the products on actual equipment when you use them.

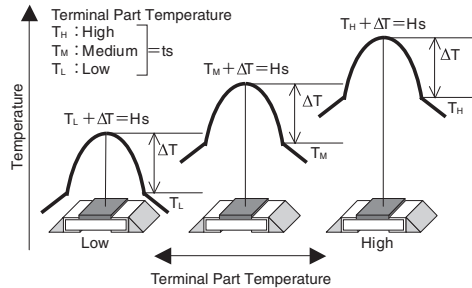

The temperature of the resistor will increase the same ΔT from the standard terminal part temperature regardless of the ambient temperature when the same power is applied. This is because there is hardly any heat dissipation from the resistor surface to the ambient air.

Performance Characteristics

Parameter	Requirement $\Delta R \pm\%$		Test Method
	Limit	Typical	
Resistance	Within specified tolerance	—	25°C
T.C.R.	Within specified T.C.R.	—	+25°C/+125°C
Overload (Short time)	$\pm 1\%$: SL07, TSL1, SL1, SL2, SL3 $\pm 0.5\%$: SLN2	$\pm 1\%$: SL07, TSL1, SL1, SL2, SL3 $\pm 0.25\%$: SLN2	SL07: Rated power x 4 for 5 seconds, TSL1: Rated power x 2.5 for 5 seconds, SL1, SL2, SLN2, SL3: Rated power x 5 for 5 seconds, SL1 (T.C.R.: +50/+75): Rated power x4 for 5 seconds
Resistance to Solder Heat	$\pm 1\%$: SL07, TSL1, SL1, SL2, SL3	$\pm 1\%$: SL07, TSL1, SL1, SL2, SL3	260°C \pm 5°C, 10 \pm 1 second
	$\pm 0.5\%$: SLN2	$\pm 0.5\%$: SLN2	260°C \pm 5°C, 10~12 seconds
Rapid Change of Temperature	$\pm 1\%$: SL07, TSL1, SL1, SL2, SL3	$\pm 0.5\%$: SL07, TSL1, SL1, SL2, SL3	-55°C (30 minutes), +150°C (30 minutes), 1000 cycles
	$\pm 0.5\%$: SLN2	$\pm 0.25\%$: SLN2	-55°C (15 minutes), +150°C (15 minutes), 1000 cycles
Moisture Resistance	$\pm 2\%$: SL07, TSL1, SL1, SL2, SL3	$\pm 0.5\%$: SL07, TSL1, SL1, SL2, SL3	40°C \pm 2°C, 90%~95%RH, 1000 hours, 1.5 hr ON, 0.5 hr OFF cycle
	$\pm 0.5\%$: SLN2	$\pm 0.25\%$: SLN2	85°C \pm 2°C, 85% \pm 3%RH, 1000 hours, Rated power x 0.1
Endurance at 70°C	$\pm 2\%$: SL07, TSL1, SL1, SL2, SL3 $\pm 1\%$: SLN2	$\pm 1\%$	70°C \pm 2°C, 1000 hours, 1.5 hr ON, 0.5 hr OFF cycle
Low Temperature Exposure	$\pm 0.5\%$	$\pm 0.25\%$	SL07, TSL1, SL1, SL2, SL3: -55°C, 1 hour; SLN2: -65°C, 24 hours

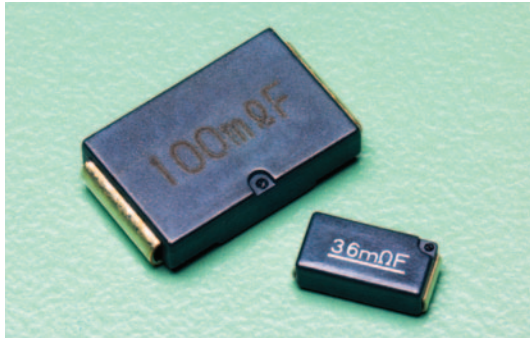

features

- SMD type of small size, ultra-low resistance (3mΩ~) and high accuracy (±0.5%) resistor for current sensing
- Flameproof UL94V0 molded polymer case
- Excellent dimension accuracy, mountability and shock resistance
- Excellent terminal strength and solderability due to structure of a metal plate terminal electrode
- Easy to absorb the thermal expansion and shrinkage because of a metal plate terminal structure
- Suitable for flow, reflow and iron solderings
- Products with lead-free terminations meet EU RoHS requirements. EU RoHS regulation is not intended for Pb-glass contained in electrode, resistor element and glass.
- AEC-Q200 Tested

current sense

dimensions and construction

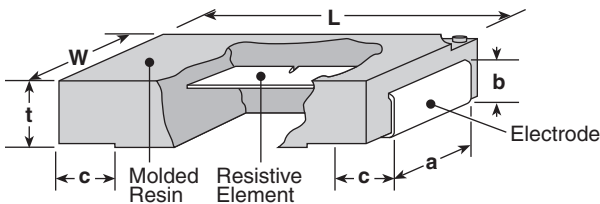

Size Code	Dimensions inches (mm)					
	L	W	t	a	b	c
SLW07 (2010)	.197±.012 (5.0±0.3)	.098±.008 (2.5±0.2)	.067±.008 (1.7±0.2)	.079±.008 (2.0±0.2)	.047±.008 (0.9±0.2)	.035±.012 (1.2±0.3)
SLW1 (2512)	.248±.012 (6.3±0.3)	.122±.008 (3.1±0.2)	.075±.008 (1.9±0.2)	.094±.008 (2.4±0.2)	.047±.008 (1.2±0.2)	.047±.012 (1.2±0.3)
SLN3 (4527)	.453±.012 (11.5±0.3)	.276±.008 (7.0±0.2)	.094±.008 (2.4±0.2)	.217±.008 (5.5±0.2)	.063±.008 (1.6±0.2)	.100±.016 (2.55±0.4)
SLN5 (4527)	.453±.012 (11.5±0.3)	.276±.008 (7.0±0.2)	.098±.008 (2.5±0.2)	.217±.008 (5.5±0.2)	.075±.008 (1.9±0.2)	.100±.016 (2.55±0.4)

ordering information

SL	1	T	TE	10L0	F	75
Type	Size & Power Ratings	Termination Material	Packaging	Nominal Resistance	Tolerance	T.C.R. (x10⁻⁴/K)
SL SLN	W07: 1W W1: 1.5W 3: 3W 5: 7W	T: Sn	TE: SLW07 & SLW1 TED: SLN3 & SLN5 For further information on packaging please refer to Appendix A	±0.5%, ±1%: 4 digits ±5%: 3 digits All values less than 0.1Ω (100m) are expressed in mΩ with "L" as decimal Ex: 2mΩ = 2L00	D: ±0.5% F: ±1% J: ±5%	Nil: 0-150 0-200 ±75 (SLN3/SLN5) ±100 ±110 ±180 50: ±50 (SLW1) 75: ±75 (SLW1)

applications and ratings

Part Designation	Power Rating	Resistance Range (Ω)*			T.C.R. (ppm/°C) Max.	Rated Terminal Part Temperature	Operating Temperature Range
		D: ±0.5% E24, E96***	F: ±1% E24, E96***	J: ±5% E24			
SLW07	1W	—	5m - 100m		0~200: R≤10mΩ 0~150: R≥11mΩ	145°C	-55°C to +180°C
SLW1	1.5W	10m - 100m	5m - 100m	3m - 100m	±180: R < 15mΩ ±100: R ≥ 15mΩ ±75: 20m ≤ R ≤ 100mΩ ±50: 34.8m ≤ R ≤ 100mΩ	120°C	
SLN3	3W	5m - 200m			±110: R < 10mΩ ±75: R ≥ 10mΩ	105°C	
SLN5	7W (5W)**	3m - 200m		—		70°C (120°C)**	

* 5m, 6m, 7m, 8m, 9mΩ also available inside resistance range

** In case the rated terminal part temperature of 120°C, the rated power shall be 5W

*** SLW07 and SLN5 (3m~4.7mΩ) offer only E24 series

environmental applications

Derating Curve

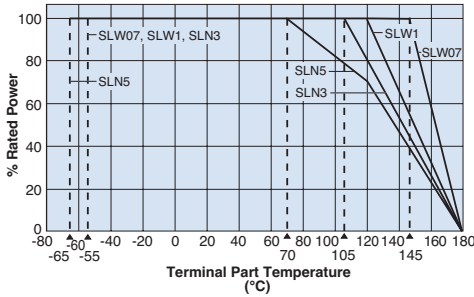

For resistors operated at a terminal part temperature of described for each size or above, a power rating shall be derated in accordance with the derating curve. Please refer to "Introduction of the derating curve based on the terminal part temperature" in the beginning of our catalog before use.

One-Pulse Limiting Electric Power

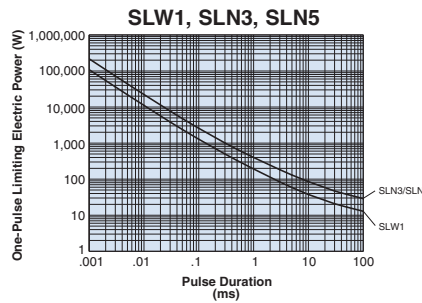
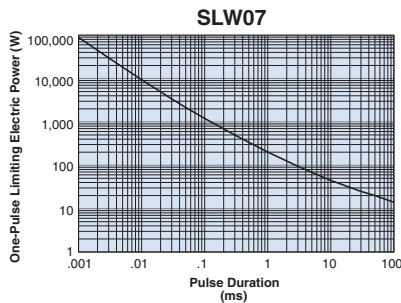

Please ask us about the resistance characteristic of continuous applied pulse. The pulse endurance values are not assured values, so be sure to check the products on actual equipment when you use them.

Thermal Resistance

Type	Resistance (Ω)	Rth (°C/W)
SLW07	5m	26
	22m	48
	100m	78
SLW1	5m	16
	20m	39
	100m	59
SLN3	5m	19
	11m	24
	200m	46
SLN5	5m	11
	30m	19
	200m	15

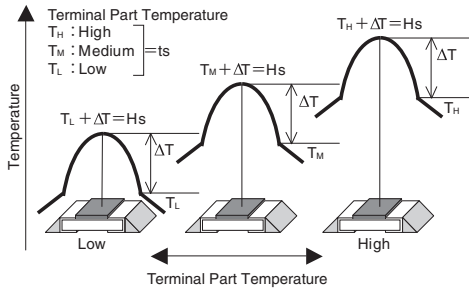

The temperature of the resistor will increase the same ΔT from the standard terminal part temperature regardless of the ambient temperature when the same power is applied. This is because there is hardly any heat dissipation from the resistor surface to the ambient air.

$$R_{th} = (H_s - t_s) / \text{Power}$$

Regarding the temperature rise, the value of the temperature varies per conditions and board for use since the temperature is measured under our measuring conditions. Please refer to us before use.

Performance Characteristics

Parameter	Requirement $\Delta R \pm\%$		Test Method
	Limit	Typical	
Resistance	Within specified tolerance	—	25°C
T.C.R.	Within specified T.C.R.	—	+25°C/+125°C
Overload (Short time)	±1%: SLW07, SLW1 ±0.5%: SLN3 ±2%: SLN5	±1%: SLW07, SLW1 ±0.25%: SLN3 ±0.5%: SLN5	SLW07: 3W for 5 seconds, SLW1: 5W for 5 seconds, SLW1 (T.C.R: ±50/±75): 4W for 5 seconds, SLN3: 10W for 5 seconds, SLN5: 15W for 5 seconds
Resistance to Solder Heat	±1%: SLW07, SLW1	±1%: SLW07, SLW1	260°C ± 5°C, 10 ± 1 second
	±0.5%: SLN3, SLN5	±0.5%: SLN3, SLN5	260°C ± 5°C, 10~12 seconds
Rapid Change of Temperature	±1%: SLW07, SLW1	±0.5%: SLW07, SLW1	-55°C (30 minutes), +150°C (30 minutes), 1000 cycles
	±0.5%: SLN3, SLN5	±0.3%: SLN3, SLN5	-55°C (15 minutes), +150°C (15 minutes), 1000 cycles
Moisture Resistance	±2%: SLW07, SLW1	±1%: SLW07, SLW1	40°C ± 2°C, 90%~95%RH, 1000 hours, 1.5 hr ON, 0.5 hr OFF cycle
	±0.5%: SLN3, SLN5	±0.35%: SLN3, SLN5	SLN3: 85°C ± 2°C, 85% RH, 1000 hours, 0.3W SLN5: 85°C ± 2°C, 85% RH, 1000 hours, 0.7W
Endurance of Rated Terminal Part Temperature	±2%	±1% ±1.2%: SLN5	Terminal part temperature: 145°C (SLW07), 120°C (SLW1, SLN5: 5W), 105°C (SLN3), 70°C (SLN5: 7W), 1000 hours, 1.5 hr ON, 0.5 hr OFF cycle,
Low Temperature Exposure	±0.5%	±0.25%	SLW07, SLW1: -55°C, 1 hour; SLN3, SLN5: -65°C, 24 hours

Specifications given herein may be changed at any time without prior notice. Please confirm technical specifications before you order and/or use.

6/20/23



features

- Wide-side termination (reverse-geometry) type flat chip resistor
- High reliability and performance with T.C.R. $\pm 100 \times 10^{-6}/K$, resistance tolerance $\pm 0.5\%$
- Suitable for both reflow and flow solderings
- Products with lead-free terminations meet EU RoHS requirements. EU RoHS regulation is not intended for Pb-glass contained in electrode, resistor element and glass.
- AEC-Q200 Tested

dimensions and construction

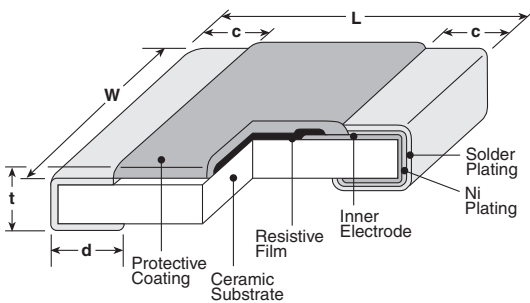

Type (Inch Size Code)	Dimensions inches (mm)				
	L	W	c	d	t
2A (0508)	.049±.006 (1.25±0.15)	.079±.006 (2.0±0.15)	.016±.006 (0.4±0.15)	.014±.008 (0.35±0.2)	.022±.004 (0.55±0.1)
			.012±.008 (0.3±0.2)		
2B (0612)	.063±.006 (1.6±0.15)	.126±.008 (3.2±0.2)	.012±.008 (0.3±0.2)	.018±.006 (0.45±0.15)	
2H (1020)	.098±.006 (2.5±0.15)	.197±.006 (5.0±0.15)	.016±.008 (0.4±0.2)	.030±.006 (0.75±0.15)	.024±.004 (0.6±0.1)
3A (1225)	.122±.006 (3.1±0.15)	.252±.006 (6.3±0.15)	.018±.008 (0.45±0.2)		

Derating Curve

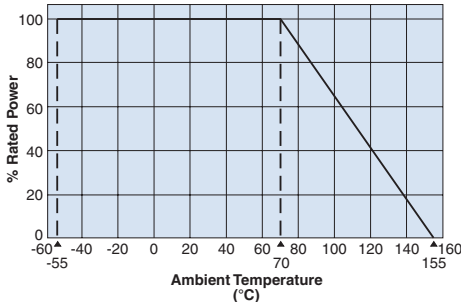

For resistors operated at an ambient temperature of 70°C or above, a power rating shall be derated in accordance with the above derating curve.

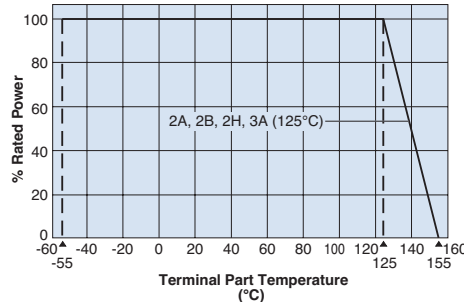

For resistors operated terminal temperature of described for each size or above, a power rating shall be derated in accordance with the derating curve above.

Please refer to "Introduction of the derating curve based on the terminal part temperature" in the beginning of our catalog before use.

If you want to use at rated power (*1), use derating curves based on the terminal part temperature on the right side graph.

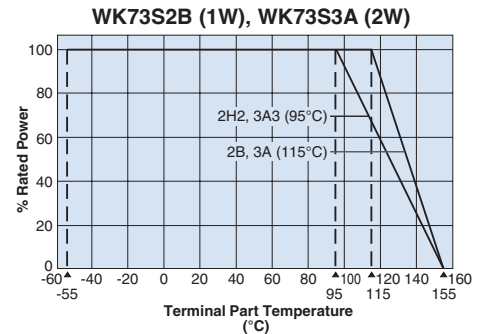

ordering information

WK73S	2A	T	TE	33L0	F
Type	Size	Termination Material	Packaging	Nominal Resistance	Resistance Tolerance
WK73S	2A: 1W 2B: 0.75W, 1W 2H: 1W 3A: 1.5W, 2W	T: Sn	TD: 0508, 0612: 7" 4mm pitch punched paper TE: 1020, 1225: 7" embossed plastic For further information on packaging, please refer to Appendix A	±1%: 3 significant figures + 1 multiplier "R" indicates decimal on value <100Ω ±5%: 2 significant figures + 1 multiplier "R" indicates decimal on values <10Ω All values less than 0.1Ω (100mΩ) are expressed in mΩ with "L" as decimal. Ex: 33mΩ, 1% = 33L0	D: ±0.5% F: ±1% J: ±5%

applications and ratings

current sense

Part Designation	Power Rating	Rated Ambient Temp.	Rated Terminal Part Temp.	T.C.R. (X 10 ⁻⁶ /K)	Resistance Range (Ω)			Operating Temp. Range
					D±0.5% E-24/E-96	F±1% E-24/E-96	J±5% E-24	
WK73S2A	1.0W ¹	70°C	125°C	±100	—	1 - 9.76	1 - 9.1	-55°C to +155°C
				0~+200	—	30m - 976m	30m - 910m	
				0~+300	—	20m - 29.4m	20m - 27m	
WK73S2B	0.75W	70°C	125°C	±100	430m - 9.76	430m - 9.76	430m - 9.1	
				±200	—	30m - 422m	30m - 390m	
				±800	—	—	10m - 27m	
	1.0W ¹	70°C	115°C	±100	430m - 9.76	430m - 9.76	430m - 9.1	
				±200	—	30m - 422m	30m - 390m	
				±800	—	—	10m - 27m	
WK73S2H	1.0W	70°C	125°C	±100	—	220m - 9.76	220m - 9.1	
				±200	—	27m - 215m	27m - 200m	
				±800	—	—	10m - 24m	
WK73S3A	1.5W	70°C	125°C	±100	—	360m - 9.76	360m - 9.1	
				±200	—	33m - 357m	33m - 330m	
				±300	—	22m - 32.4m	22m - 30m	
				±800	—	—	10m - 20m	
	2.0W ¹	70°C	115°C	±100	—	360m - 9.76	360m - 9.1	
				±200	—	33m - 357m	33m - 330m	
				±300	—	22m - 32.4m	22m - 30m	
				±800	—	—	10m - 20m	

Rated voltage = $\sqrt{\text{Power rating} \times \text{resistance value}}$

¹ If you want to use at rated power use derating curves based on the terminal part temperature on the right side graph located on previous page.

If any questions arise whether to use the "Rated Ambient Temperature" or the "Rated Terminal Part Temperature", please give priority to the "Rated Terminal Part Temperature." For more details refer to the "Introduction of the derating curves based on the terminal part temperature" in the beginning of the catalog

Temperature Rise

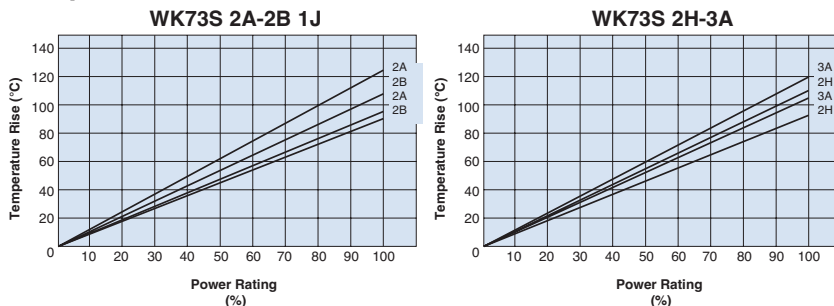

Regarding the temperature rise, the value of the temperature varies per conditions and board for use since the temperature is measured under our measuring conditions.

Measurement condition
Room temperature: 25°C
PCB: FR-4t = 1.6mm
Cu foil thickness: 35µm

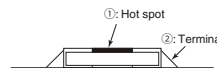

One-Pulse Limiting Electric Power

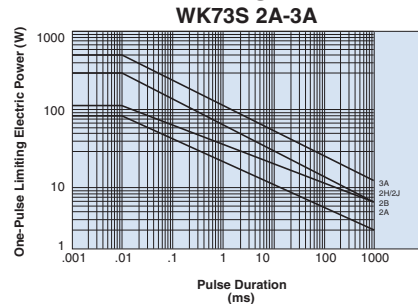

Please ask us about the resistance characteristic of continuous applied pulse.

environmental applications

Performance Characteristics

Parameter	Requirement Δ R ±(%+0.005Ω)		Test Method
	Limit	Typical	
Resistance	Within specified tolerance	—	25°C
T.C.R.	Within specified T.C.R.	—	+25°C/-55°C and +25°C/+125°C
Overload (Short time)	±2%	±0.2%	Rated voltage x2.5 for 5 seconds (WK73S2A, WK73S2B (1W), WK73S3A (2W)): Rated voltage x2.0 for 5 seconds)
Resistance to Solder Heat	±1%	±0.2%	260°C ± 5°C, 10 seconds ± 1 second
Bending Test	±1%	±0.1%	Holding point 90mm, Bending 1 time, Bending 5mm
Rapid Change of Temperature	±2%	±1%	-55°C (30 minutes), +125°C (30 minutes), 1000 cycles
Moisture Resistance	±2%	±0.2%	40°C ± 2°C, 90%-95% RH, 1000 hours, 1.5 hr ON, 0.5 hr OFF cycle
Endurance at 70°C	±2%	±0.2%	70°C ± 2°C or rated terminal part temperature ± 2°C, 1000 hours, 1.5 hr ON, 0.5 hr OFF cycle
High Temperature Exposure	±2%: WK73S (±5%) ±1%: all others	±0.5%: WK73S (±5%) ±0.2%: all others	+155°C, 1000 hours

Additional environmental applications can also be found at www.koaspeer.com

Specifications given herein may be changed at any time without prior notice. Please confirm technical specifications before you order and/or use.

10/20/23



features

- Wide-side termination (reverse-geometry) type flat chip resistor
- High reliability and performance with T.C.R. $\pm 100 \times 10^{-6}/K$, resistance tolerance $\pm 1\%$
- Suitable for both reflow and flow solderings
- Products with lead-free terminations meet EU RoHS requirements. EU RoHS regulation is not intended for Pb-glass contained in electrode, resistor element and glass.
- AEC-Q200 Tested

dimensions and construction

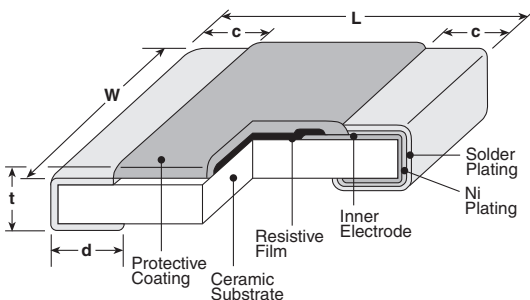

Type (Inch Size Code)	Dimensions inches (mm)				
	L	W	c	d	t
2B15 (0612)	.063±.006 (1.6±0.15)	.126±.008 (3.2±0.2)	.012±.008 (0.3±0.2)	.018±.006 (0.45±0.15)	.024±.004 (0.6±0.1)
2H2 (1020)	.098±.006 (2.5±0.15)	.197±.006 (5.0±0.15)	.016±.008 (0.4±0.2)	.030±.006 (0.75±0.15)	
3A3 (1225)	.122±.006 (3.1±0.15)	.252±.006 (6.3±0.15)	.018±.008 (0.45±0.2)		

Derating Curve

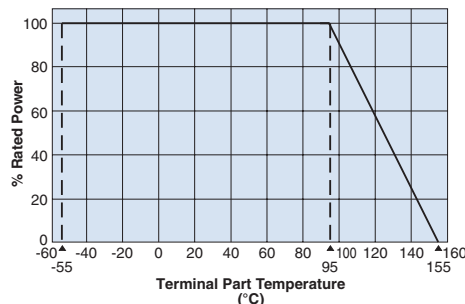
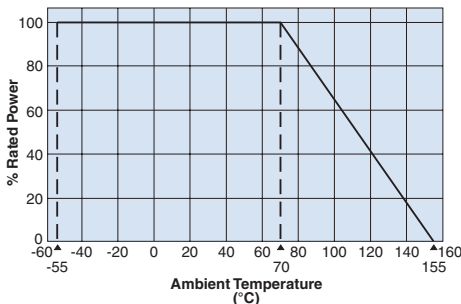

For resistors operated at an ambient temperature of 70°C or above, a power rating shall be derated in accordance with the above derating curve.

When the terminal part temperature of the resistor exceeds the rated terminal part temperature shown above, the power shall be derated according to the derating curve. Please refer to "Introduction of the derating curve based on the terminal part temperature" in the beginning of our catalog before use.

ordering information

WK73S	2H2	T	TE	33L0	F
Type	Size	Termination Material	Packaging	Nominal Resistance	Resistance Tolerance
WK73S	2B15: 1.5W 2H2: 2W 3A3: 3W	T: Sn	TD: 0612: 7" 4mm pitch punched paper TE: 1020, 1225: 7" 4mm pitch embossed plastic For further information on packaging, please refer to Appendix A	±0.5%, ±1%: 3 significant figures + 1 multiplier "R" indicates decimal on value <100Ω ±5%: 2 significant figures + 1 multiplier "R" indicates decimal on values <10Ω All values less than 0.1Ω (100mΩ) are expressed in mΩ with "L" as decimal. Ex: 33mΩ, 1% = 33L0	D: ±0.5% F: ±1% J: ±5%

Contact us when you have control request for environmental hazardous material other than the substance specified by EU RoHS.

applications and ratings

Part Designation	Power Rating	Rated Ambient Temp.	Rated Terminal Part Temp.	T.C.R. (X 10 ⁻⁶ /K)	Resistance Range (Ω)			Operating Temp. Range
					D±0.5% E-24/E-96	F±1% E-24/E-96	J±5% E-24	
WK73S2B15	1.5W ¹	70°C	95°C	±100	430m - 9.76	430m - 9.76	430m - 9.1	-55°C to +155°C
				±200	—	30m - 422m	30m - 390m	
				±800	—	—	10m - 27m	
WK73S2H2	2.0W ¹	70°C	95°C	±100	—	220m - 9.76	220m - 9.1	
				±200	—	27m - 215m	27m - 200m	
				±800	—	—	10m - 24m	
WK73S3A3	3.0W ¹	70°C	95°C	±100	—	360m - 9.76	360m - 9.1	
				±200	—	33m - 357m	33m - 330m	
				±300	—	22m - 32.4m	22m - 30m	
				±800	—	—	10m - 20m	

Rated voltage = $\sqrt{\text{Power rating} \times \text{resistance value}}$

*1 If you use at the rated power, please keep the condition that the terminal of the resistor is below the rated terminal part temperature. Please refer to the derating curves based on the terminal temperature of right side on the next page.

If any questions arise whether to use the "Rated Ambient Temperature" or the "Rated Terminal Part Temperature" in your usage conditions, please give priority to the "Rated Terminal Part Temperature".

For more details, please refer to "Introduction of the derating curves based on the terminal part temperature" on the beginning of our catalog.

environmental applications

Temperature Rise

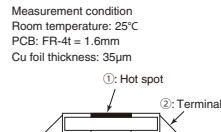
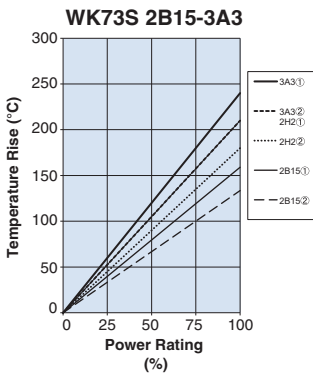

Regarding the temperature rise, the value of the temperature varies per conditions and board for use since the temperature is measured under our measuring conditions.

One-Pulse Limiting Electric Power

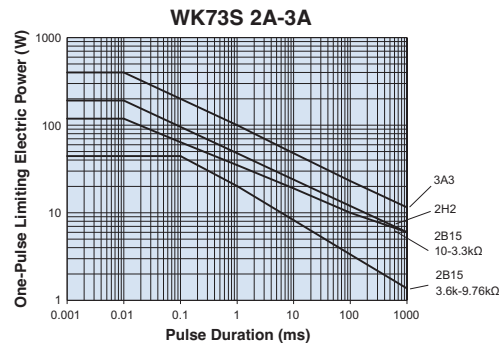

Please ask us about the resistance characteristic of continuous applied pulse.

The pulse endurance values are not assured values, so be sure to check the products on actual equipment when you use them.

Performance Characteristics

Parameter	Requirement Δ R ±(%+0.005Ω)		Test Method
	Limit	Typical	
Resistance	Within specified tolerance	—	25°C
T.C.R.	Within specified T.C.R.	—	+25°C/-55°C and +25°C/+125°C
Overload (Short time)	±2%	±0.2%	Rated voltage x 2.0 for 5 seconds
Resistance to Solder Heat	±1%	±0.2%	260°C ± 5°C, 10 seconds ± 1 second
Bending Test	±1%	±0.1%	Holding point 90mm, Bending 1 time, Bending 5mm
Rapid Change of Temperature	±2%	±1%	-55°C (30 minutes)/ +125°C (30 minutes), 1000 cycles
Moisture Resistance	±2%	±0.2%	40°C ± 2°C, 90%-95% RH, 1000 hours, 1.5 hr ON, 0.5 hr OFF cycle
Endurance at 70°C	±2%	±0.2%	70°C ± 2°C or rated terminal part temperature ±2°C, 1000 hours, 1.5 hr ON, 0.5 hr OFF cycle
High Temperature Exposure	±2%: J (±5%) ±1%: all others	±0.5%: J (±5%) ±0.2%: all others	+155°C, 1000 hours

Additional environmental applications can also be found at www.koaspeer.com

Specifications given herein may be changed at any time without prior notice. Please confirm technical specifications before you order and/or use.

11/15/23



features

- Wide terminal type flat chip resistor
- High reliability and performance with T.C.R. $\pm 75 \times 10^{-6}/K$, resistance tolerance $\pm 1\%$
- Suitable for flow and reflow solderings
- This product meets EU RoHS requirements. EU RoHS regulation is not intended for Pb-glass contained in electrode, resistor element and glass.
- AEC-Q200 Tested

dimensions and construction

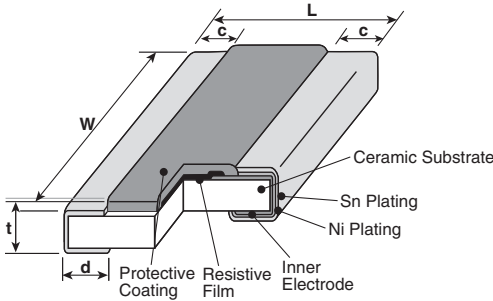

Type (Inch Size Code)	Dimensions inches (mm)				
	L	W	c	d	t
2B (0612)	.063±.006 (1.6±0.15)	.126± ^{+0.004} _{-.012} (3.2± ^{+0.1} _{-.3})	.016±.008 (0.4±0.2)	.018±.006 (0.45±0.15)	.024±.004 (0.6±0.1)
2B15 (0612)	.063±.006 (1.6±0.15)	.126± ^{+0.004} _{-.012} (3.2± ^{+0.1} _{-.3})	.016±.008 (0.4±0.2)	.018±.006 (0.45±0.15)	.024±.004 (0.6±0.1)

Derating Curve

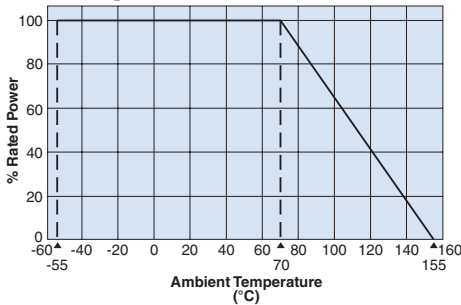

For resistors operated at an ambient temperature of 70°C or above, the power rating shall be derated in accordance with the above derating curve.

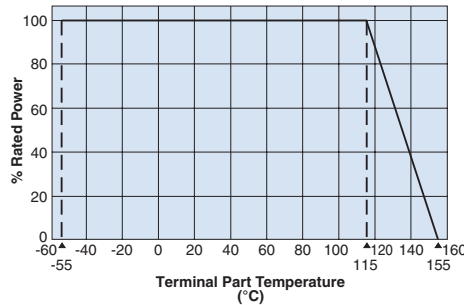

For resistors operated at a terminal part temperature of described for each size or above, the power rating shall be derated in accordance with the above derating curve. Please refer to the "Introduction of the derating curves based on terminal part temperature" in the beginning of the catalog.

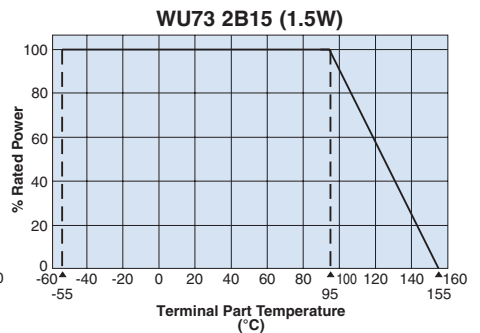

ordering information

WU73	2B	T	TD	10L0	F
Type	Size	Termination Material	Packaging	Nominal Resistance	Resistance Tolerance
WU73	2B: 1W 2B15: 1.5W	T : Sn	TD: 7" 4mm pitch punched paper For further information on packaging, please refer to Appendix A	4 digits: all values less than 100mΩ are expressed in mΩ with "L" as decimal. Ex: 10mΩ = 10L0	F: ±1%

Contact us when you have control request for environmental hazardous material other than the substance specified by EU RoHS.

Specifications given herein may be changed at any time without prior notice. Please confirm technical specifications before you order and/or use.

11/16/23

applications and ratings

Part Designation	Power Rating	Rated Ambient Temperature	Rated Terminal Part Temperature	T.C.R. (X 10 ⁻⁶ /K)	Resistance Range (Ω) E-24, 25m, 50m*1	Resistance Tolerance	Operating Temperature Range
WU732B	1.0W	70°C	115°C	±100	10m~12m	F: ±1%	-55°C to +155°C
				±75	13m~27m		
				±100	30m~100m		
WU732B15	1.5W*2	70°C	95°C	±100	10m~12m	F: ±1%	-55°C to +155°C
				±75	13m~27m		
				±100	30m~100m		

Rated voltage = $\sqrt{\text{Power rating} \times \text{resistance value}}$

*1 25mΩ and 50mΩ are available

*2 If you use at the rated power, please keep the condition that the terminal of the resistor is below the rated terminal part temperature.

Please refer to the derating curves based on the terminal temperature of right side on the next page.

If any questions should arise whether to use the "Rated Ambient Temperature" or the "Rated Terminal Part Temperature," please give priority to the "Rated Terminal Part Temperature." Prior to use and for more details refer to "Introduction of the derating curves on the terminal part temperature" in the beginning of the catalog.

environmental applications

Temperature Rise

WU73 2B

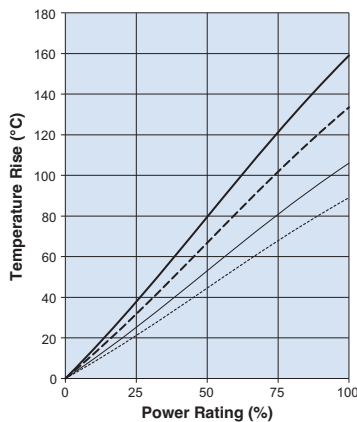

Regarding the temperature rise, the value of the temperature varies per conditions and board for use since the temperature is measured under our measuring conditions.

Measurement condition
Room temperature: 25°C
PCB: FR-4t = 1.6mm
Cu foil thickness: 35μm

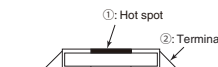

One-Pulse Limiting Electric Power

WU73 2B/2B15

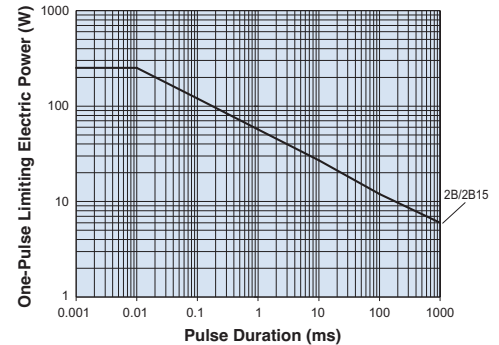

Please ask us about the resistance characteristic of continuous applied pulse. The pulse endurance values are not assured values, so be sure to check the products on actual equipment when you use them.

Performance Characteristics

Parameter	Requirement Δ R ±(%+0.005Ω)		Test Method
	Limit	Typical	
Resistance	Within specified tolerance	—	25°C
T.C.R.	Within specified T.C.R.	—	+25°C/-55°C and +25°C/+125°C
Overload (Short time)	±2%	±0.2%	Rated Voltage x 2 for 5 seconds
Resistance to Solder Heat	±1%	±0.2%	260°C ± 5°C, 10 seconds ± 1 second
Bending Test	±1%	±0.1%	Holding point 90mm, Bending 1 time, Bending 5mm
Rapid Change of Temperature	±2%	±0.3%	-55°C (30 minutes), +125°C (30 minutes), 1000 cycles
Moisture Resistance	±2%	±0.1%	40°C ± 2°C, 90%-95% RH, 1000 hours, 1.5 hr ON, 0.5 hr OFF cycle
Endurance at 70°C	±2%	±0.2%	70°C ± 2°C or rated terminal part temperature ±2°C, 1000 hours, 1.5 hr ON, 0.5 hr OFF cycle
High Temperature Exposure	±1%	±0.1%	+155°C, 1000 hours

Additional environmental applications can also be found at www.koaspeer.com

Specifications given herein may be changed at any time without prior notice. Please confirm technical specifications before you order and/or use.

11/16/23



features

- Current detecting resistors for power supplies, motor circuits, etc.
- Low resistance (100mΩ or under) and high accuracy (±1%) for current detection
- High reliability and performance with T.C.R. $\pm 75 \times 10^{-6}/K$
- Suitable for flow and reflow solderings
- Products will meet EU RoHS requirements
- AEC-Q200 tested
- Operating temperature range $\sim 155^{\circ}C$

dimensions and construction

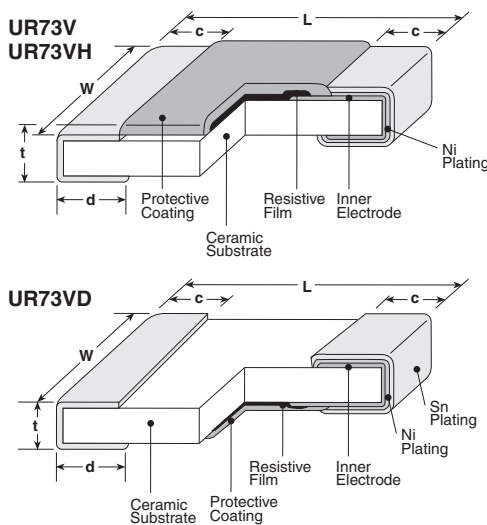

Size Code	Resistance Range (Ω)	Dimensions inches (mm)				
		L	W	c	d	t
UR73V 2A (0805)	39m~100m	.079±.008 (2.0±0.2)	.049±.008 (1.25±0.2)	.016±.008 (0.4±0.2)	.016±.008 (0.4±0.2)	.024±.004 (0.6±0.1)
	10m~16m	.079±.008 (2.0±0.2)	.049±.008 (1.25±0.2)	.016±.008 (0.4±0.2)	.028±.008 (0.7±0.2)	.024±.004 (0.6±0.1)
18m~36m	.024±.008 (0.6±0.2)					
UR73V 2B (1206)	30m~33m	.126±.008 (3.2±0.2)	.063±.008 (1.6±0.2)	.039±.012 (1.0±0.3)	.016 ^{+0.008} _{-.004} (0.4 ^{+0.2} _{-0.1})	.024±.004 (0.6±0.1)
	36m~39m			.035±.012 (0.9±0.3)		
	43m~100m			.026±.012 (0.65±0.3)		
UR73VD 2B (1206)	10m~13m	.126±.008 (3.2±0.2)	.063±.008 (1.6±0.2)	.016±.012 (0.4±0.3)	.016 ^{+0.008} _{-.004} (0.4 ^{+0.2} _{-0.1})	.049±.008 (1.25±0.2)
	15m~16m					.045±.008 (1.15±0.2)
	18m~20m					.043±.008 (1.1±0.2)
	22m~27m					.039±.008 (1.0±0.2)
NEW UR73VH 2B (1206)	100m~1Ω	.126±.008 (3.2±0.2)	.063±.008 (1.6±0.2)	.026±.012 (0.65±0.3)	.016 ^{+0.008} _{-.004} (0.4 ^{+0.2} _{-0.1})	.024±.004 (0.6±0.1)

Derating Curve

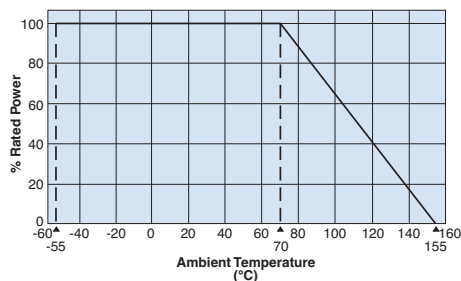

For resistors operated at an ambient temperature of 70°C or above, the power rating shall be derated in accordance with the above derating curve.

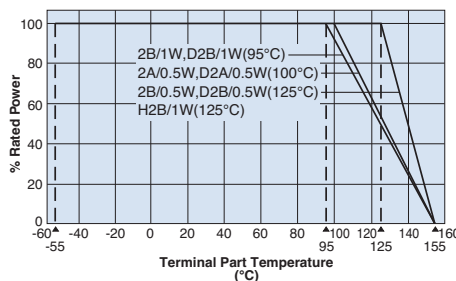

For resistors operated at a terminal part temperature of described for each size or above, the power rating shall be derated in accordance with the above derating curve. Please refer to "Introduction of the derating curve based on the terminal part temperature" in the beginning of our catalog prior use.

ordering information

UR73V	2B	T	TD	30L0	F
Type	Power Rating	Termination Material	Packaging	Nominal Resistance	Tolerance
UR73V UR73VH UR73VD: Face-down	2A: 0.5W 2B: 0.5W 2B: 1W	T: Sn	TD: 4mm pitch punch paper	"R" indicates decimal on values = 100mΩ Ex: R100 = 100mΩ "L" indicates decimal on values <100mΩ Ex: 10L0 = 10mΩ	F: ±1%
For further information on packaging, please refer to Appendix A.					

Specifications given herein may be changed at any time without prior notice. Please confirm technical specifications before you order and/or use.

11/07/23

applications and ratings

Part Designation	Power ¹ Rating	Rated Ambient Temperature	Rated Terminal Temperature	T.C.R. (X10 ⁻⁶ /K)	Resistance Range (Ω) E24 & 25m, 50m ^{2,3}	Resistance Tolerance	Operating Temperature Range
UR73V 2A	0.5W	70°C	100°C	±75	39m~100m	F: ±1%	-55°C to +155°C
UR73VD 2A	0.5W	70°C	100°C	0~+250	10m~11m		
				0~+150	12m~13m		
				±75	15m~36m		
UR73V 2B	0.5W	70°C	125°C	±75	33m~75m		
				±100	30m, 82m~100m		
				±75	33m~75m		
UR73VD 2B	0.5W	70°C	125°C	0~+250	10m~11m		
				±75	12m~27m		
				0~+250	10m, 11m		
UR73VD 2B	1W ⁴	70°C	95°C	±75	12m~27m		
				±100	100m~1Ω		
NEW UR73VH 2B	1W ⁴	70°C	125°C	±100	100m~1Ω		

¹ Rated voltage = $\sqrt{\text{Power Rating} \times \text{Resistance Value}}$

² 25mΩ and 50mΩ available

³ E96 is available in UR73VH

⁴ Please keep the resistor operating according to the derating curve of the terminal part temperature based on the specified power rating.

If any questions should arise whether to use the "Rated Ambient Temperature" or the "Rated Terminal Part Temperature," please give priority to the "Rated Terminal Part Temperature." Prior to use and for more details refer to "Introduction of the derating curves on the terminal part temperature" in the beginning of the catalog.

environmental applications

Temperature Rise

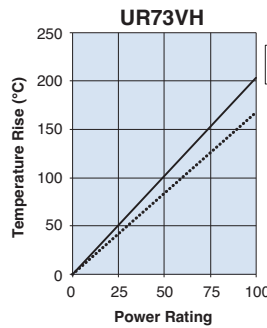
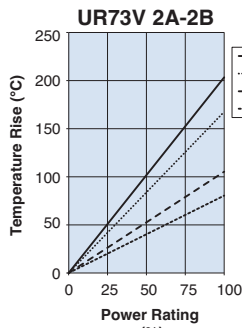
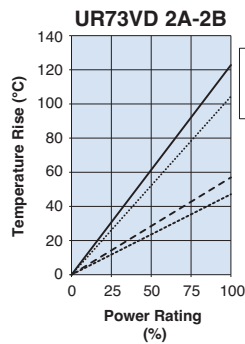

Regarding the temperature rise, the value of the temperature varies per conditions and board for use since the temperature is measured under our measuring conditions.

UR73V/UR73VH
Measurement condition
Room temperature: 25°C
PCB: FR-4t = 1.6mm
Cu foil thickness: 35μm



UR73VD
Measurement condition
Room temperature: 25°C
PCB: FR-4t = 1.6mm
Cu foil thickness: 35μm

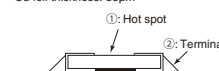

One-Pulse Limiting Electric Power

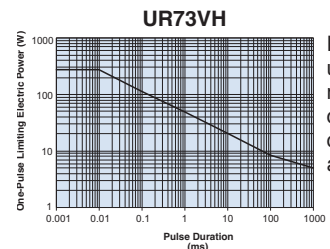
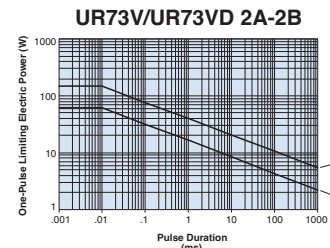

Please ask us about the resistance characteristic of continuous applied pulse.

Performance Characteristics

Parameter	Requirement ΔR ±(%+0.005Ω)		Test Method
	Limit	Typical	
Resistance	Within specified tolerance	—	25°C
T.C.R.	Within specified T.C.R.	—	UR73V/UR73VD: +25°C/-55°C and +25°C/+125°C UR73VH: +25°C/-55°C and +25°C/+155°C
Overload (Short time)	±2%	±0.5%	Rated voltage x 2.5 for 5 seconds (2B: 1W: Rated voltage 2 for 5 seconds)
Resistance to Solder Heat	±1%	±0.3%	260°C ± 5°C, 10 ± 1 second
Rapid Change of Temperature	±1%	±0.5%	UR73V/UR73VD: -55°C (30 minutes), +125°C (30 minutes), 100 cycles UR73VH: -55°C (30 minutes), +155°C (30 minutes), 100 cycles
Moisture Resistance	±2%	±1%	40°C ± 2°C, 90%~95%RH, 1000 hours, 1.5 hr ON, 0.5 hr OFF cycle
Endurance at 70°C	±2%	±1%	70°C ± 2°C or rated terminal part temperature ±2°C, 1000 hours, 1.5 hr ON, 0.5 hr OFF cycle
High Temperature Exposure	±1%	±0.3%	+155°C, 1000 hours

Specifications given herein may be changed at any time without prior notice. Please confirm technical specifications before you order and/or use.

6/10/24

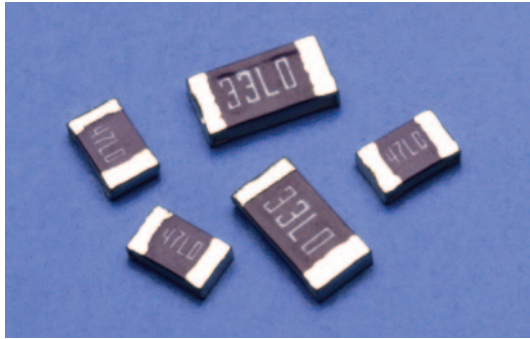

features

- Current detecting resistors for power supplies, motor circuits, etc.
- Low resistance (100mΩ or under) and high accuracy resistors (±1%) for current detection
- High reliability and performance with T.C.R. $\pm 100 \times 10^{-6}/K$
- Products meet EU RoHS requirements

current sense

dimensions and construction

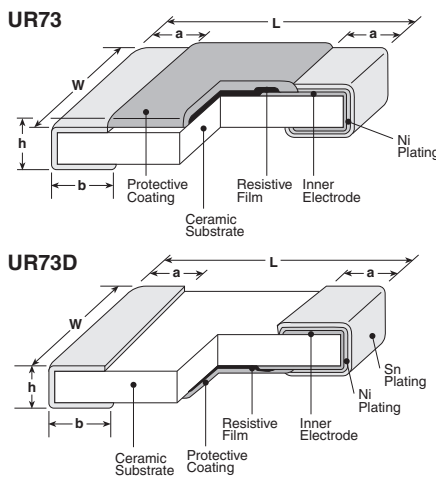

Size Code	Resistance Range (Ω)	Dimensions inches (mm)				
		L	W	h	a	b
D1E (0402)	24m ~ 100m	.039 ^{+0.004} / _{-0.002}	.020 ^{+0.004} / _{-0.002}	.016±.002	.010±.004	.012±.004
		(1.0 ^{+0.1} / _{-0.05})	(0.5 ^{+0.1} / _{-0.05})	(0.4±0.05)	(0.25±0.1)	(0.3±0.1)
D1J (0603)	10m ~ 27m	.063±.008	.031 ^{+0.005} / _{-0.004}	.02±.004	.014±.004	.022±.004
	30m ~ 100m					(0.55±0.1)
D2A (0805)	10m ~ 16m	.079±.008	.049±.008	.022±.004	.016±.008	.024±.008
	18m ~ 30m					(0.6±0.2)
2A (0805)	33m ~ 100m	.079±.008	.049±.008	.02±.004	.016±.008	.012 ^{+0.008} / _{-.004}
						(0.3 ^{+0.2} / _{-0.1})
D2B (1206)	10m ~ 16m	.126±.008	.063±.008	.024±.004	.020±.008	.039±.008
	18m ~ 27m					(1.0±0.2)
2B (1206)	30m ~ 100m	.126±.008	.063±.008	.024±.004	.020±.012	.016 ^{+0.008} / _{-.004}
						(0.4 ^{+0.2} / _{-0.1})
D2H (2010)	10m ~ 30m	.197±.008	.098±.008	.026±.004	.026±.012	.063±.012
	33m ~ 100m					(1.6±0.3)
D3A (2512)	10m ~ 30m	.248±.008	.122±.008	.024±.004	.031±.012	.079±.012
	33m ~ 100m					(2.0±0.3)

Derating Curve

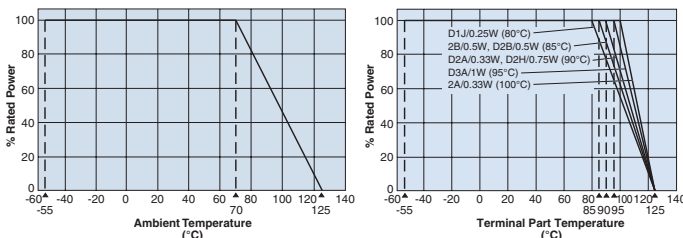

For resistors operated at an ambient temperature of 70°C or above, a power rating shall be derated in accordance with the above derating curve.

For resistors operated at a terminal part temperature of described for each size or above, a power rating shall be derated in accordance with the derating curve.

Please refer to "Introduction of the derating curve based on the terminal part temperature" in the beginning of our catalog prior use.

ordering information

UR73	2A	T	TD	R100	F
Type	Power Rating	Termination Material	Packaging	Nominal Resistance	Tolerance
UR73 UR73D	1E: 0.125W 1J: 0.25W 2A: 0.33W 2B: 0.5W 2H: 0.75W 3A: 1W	T: Sn	TP: 2mm pitch punch paper (1E) TD: 7" punched paper tape (1J, 2A, 2B) TE: 7" embossed plastic (2H, 3A)	"R" indicates decimal on values = 100mΩ Ex: R100 = 100mΩ "L" indicates decimal on values <100mΩ Ex: 10L0 = 10mΩ	F: ±1%

For further information on packaging, please refer to Appendix A.

Specifications given herein may be changed at any time without prior notice. Please confirm technical specifications before you order and/or use.

11/08/23

applications and ratings

current sense

Part Designation	Power Rating	Rated Ambient Temperature	Rated Terminal Part Temp.	T.C.R. (ppm/°C) Max.	Resistance Range	Operating Temperature Range
					F (±1%) E-24, 25mΩ, 50mΩ	
UR73D1E	1/8W (.125W)	70°C	—	±100	30mΩ - 100mΩ	-55°C to +125°C
				±500	24mΩ - 27mΩ	
UR73D1J	1/4W (.25W)	70°C	80°C	±100	47mΩ - 100mΩ	
				±200	30mΩ - 43mΩ	
				±300	10mΩ - 27mΩ	
UR73D2A	1/3W (.33W)	70°C	90°C	±250	10mΩ - 30mΩ	
UR732A	1/3W (.33W)	70°C	100°C	±100	47mΩ - 100mΩ	
				±250	33mΩ - 43mΩ	
UR73D2B	1/2W (.5W)	70°C	85°C	±200	10mΩ - 27mΩ	
UR732B	1/2W (.5W)	70°C	85°C	±100	47mΩ - 100mΩ	
				±200	30mΩ - 43mΩ	
UR73D2H	3/4W (.75W)	70°C	90°C	±100	33mΩ - 100mΩ	
				±250	10mΩ - 30mΩ	
UR73D3A	1W (1W)	70°C	95°C	±100	33mΩ - 100mΩ	
				±250	10mΩ - 30mΩ	

Rated voltage = $\sqrt{P \cdot R}$

If any questions should arise whether to use the "Rated Ambient Temperature" or the "Rated Terminal Part Temperature," please give priority to the "Rated Terminal Part Temperature." Prior to use and for more details refer to "Introduction of the derating curves on the terminal part temperature" in the beginning of the catalog.

environmental applications
Temperature Rise

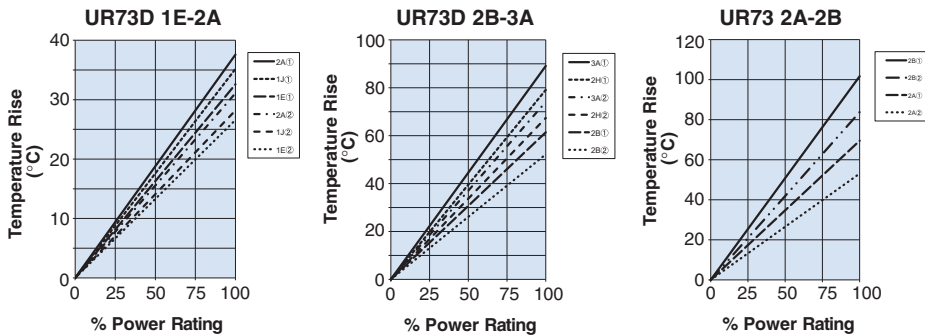

Regarding the temperature rise, the value of the temperature varies per conditions and board for use since the temperature is measured under our measuring conditions.

UR73
Measurement condition
Room temperature: 25°C
PCB: FR-4t = 1.6mm
Cu foil thickness: 35µm

UR73D
Measurement condition
Room temperature: 25°C
PCB: FR-4t = 1.6mm
Cu foil thickness: 35µm



Please ask us about the resistance characteristic of continuous applied pulse

One-Pulse Limiting Electric Power

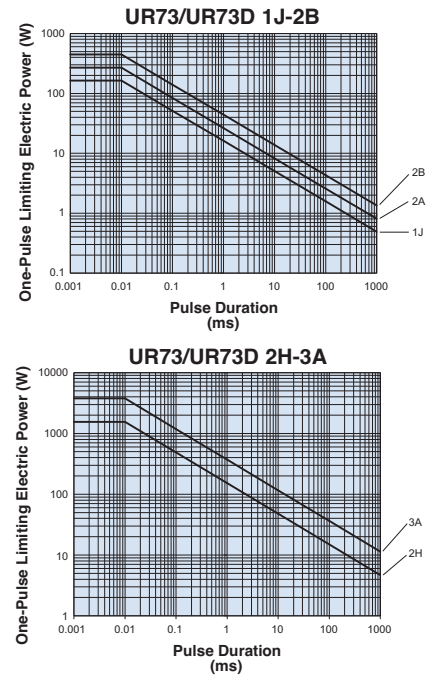

Performance Characteristics

Parameter	Requirement $\Delta R \pm(\%+0.005\Omega)$		Test Method
	Limit	Typical	
Resistance	Within specified tolerance	—	25°C
T.C.R.	Within specified T.C.R.	—	+25°C/+55°C and +25°C/+125°C
Overload (Short time)	±2%	±0.5%	Rated voltage x 2.5 for 5 seconds
Resistance to Solder Heat	±1%	±0.3%	260°C ± 5°C, 10 ± 1 second
Rapid Change of Temperature	±1%	±0.5%	-55°C (30 minutes), +125°C (30 minutes), 100 cycles
Moisture Resistance	±2%	±1%	40°C ± 2°C, 90%~95%RH, 1000 hours, 1.5 hr ON, 0.5 hr OFF cycle
Endurance at 70°C	±2%	±1%	70°C ± 2°C or rated terminal part temperature ±2°C 1000 hours, 1.5 hr ON, 0.5 hr OFF cycle
High Temperature Exposure	±1%	±0.3%	+125°C, 1000 hours

Specifications given herein may be changed at any time without prior notice. Please confirm technical specifications before you order and/or use.

11/08/23

10-ohm 0.5%, 1%, 2%, 5% tolerance thick film current sense resistor

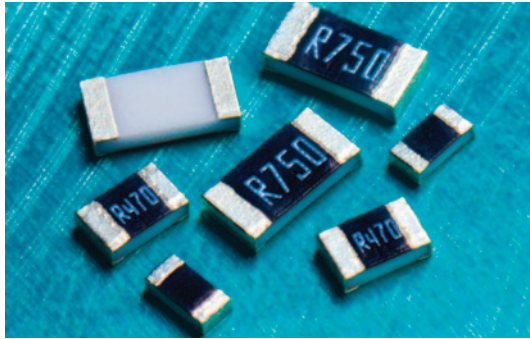

features

- Current detecting resistors for power supply, motor circuits, etc.
- High reliability and performance with resistance tolerance $\pm 0.5\%$, T.C.R. $\pm 100 \times 10^{-6} / K$
- Suitable for both reflow and flow solderings
- Products with lead-free terminations meet EU RoHS requirements. EU RoHS regulation is not intended for Pb-glass contained in electrode, resistor element and glass.
- AEC-Q200 Tested: 0402 (1E), 0603 (1J), 0805 (2A), 1206 (2B), 1210 (2E), 2010 (2H/W2H), 2512 (3A/W3A)

current sense

dimensions and construction

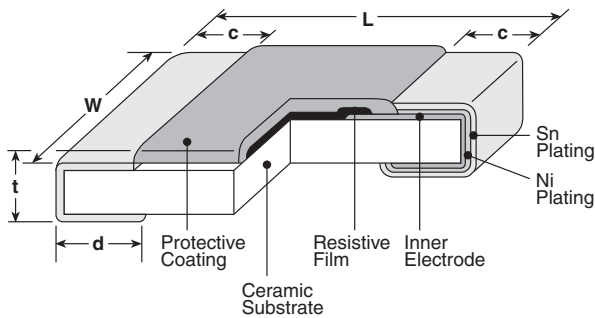

Type (Inch Size Code)	Dimensions inches (mm)				
	L	W	c	d	t
1H (0201)	.024±.001 (0.6±0.03)	.012±.001 (0.3±0.03)	.004±.002 (0.1±0.05)	.006±.002 (0.15±0.05)	.009±.001 (0.23±0.03)
1E (0402)	.039 ^{+0.004} _{-.002} (1.0 ^{+0.1} _{-.05})	.02 ^{+0.004} _{-.002} (0.5 ^{+0.1} _{-.05})	.01±.004 (0.25±0.1)	.01±.004 (0.25±0.1)	.014±.002 (0.35±0.05)
1J (0603)	.063±.008 (1.6±0.2)	.031 ^{+0.006} _{-.004} (0.8 ^{+0.15} _{-.01})	.014±.004 (0.35±0.1)	.014±.004 (0.35±0.1)	.018±.004 (0.45±0.1)
2A (0805)	.079±.008 (2.0±0.2)	.049±.004 (1.25±0.1)	.016±.008 (0.4±0.2)	.012 ^{+0.008} _{-.004} (0.3 ^{+0.2} _{-.1})	.02±.004 (0.5±0.1)
2B (1206)	.126±.008 (3.2±0.2)	.063±.008 (1.6±0.2)	.02±.012 (0.5±0.3)	.016 ^{+0.008} _{-.004} (0.4 ^{+0.2} _{-.1})	.024±.004 (0.6±0.1)
2E (1210)		.102±.008 (2.6±0.2)			
2H (2010)	.197±.008 (5.0±0.2)	.098±.008 (2.5±0.2)			
W2H (2010)				.026±.006 (0.65±0.15)	
3A (2512)	.248±.008 (6.3±0.2)	.122±.008 (3.1±0.2)		.016 ^{+0.008} _{-.004} (0.4 ^{+0.2} _{-.1})	
W3A (2512)			.026±.006 (0.65±0.15)		

ordering information

SR73	2B	T	TD	1R00	F
Type	Size	Termination Material	Packaging	Nominal Resistance	Tolerance
1H	1E	T: Sn G: Au ² (L: Sn/Pb) ³	TCM: 2mm pitch press paper ⁴ TPL - TP: 2mm pitch punch paper TD: 4mm pitch punch paper TE: 4mm pitch plastic embossed For further information on packaging, please refer to Appendix A	$\pm 2\%$, $\pm 5\%$: 2 significant figures + 1 multiplier "R" indicates decimal on value $< 10\Omega$ $\pm 1\%$: 3 significant figures + 1 multiplier "R" indicates decimal on value $< 100\Omega$ All values less than 0.1Ω ($100m\Omega$) are expressed in $m\Omega$ with "L" as decimal Example: $20m\Omega = 20L$ (3-digit)	D: $\pm 0.5\%$ F: $\pm 1\%$ G: $\pm 2\%$ J: $\pm 5\%$
2A	2B				
2E	2E				
2H	2H	² Products with gold plated electrodes are also available only 1J, 2A and 2B type ($0.1\Omega \sim 10\Omega$, F: $\pm 1\%$, J: $\pm 5\%$), so please consult with us.			
W2H	3A	³ With type 1H, W2H and W3A, W3A2 only T is available as the terminal surface material.			
3A	W3A	⁴ Standard taping specification of 1H is TCM. Previously available. "TC (10,000pcs/Reel)" is not recommended for new designs.			

10-ohm 0.5%, 1%, 2%, 5% tolerance thick film current sense resistor

applications and ratings

current sense

Part Designation	Power Rating	Rated Ambient Temp.	Rated Terminal Part Temp.	T.C.R. (ppm/°C) Max.	Resistance Range			
					E-24, E-96 (D±0.5%)	E-24, E-96 (F±1%)	E-24 (G±2%)	E-24 (J±5%)
SR731H (0201)	0.1W	70°C	—	0 ~ +400 0 ~ +500	—	1Ω - 10Ω*	—	0.27Ω - 10Ω 0.18Ω - 0.24Ω
SR731E (0402)	1/6W	70°C	125°C	±200 ±300 ±500	— — —	0.51Ω - 10Ω* 0.2Ω - 0.47Ω* 0.1Ω - 0.18Ω*	0.51Ω - 10Ω 0.2Ω - 0.47Ω 0.1Ω - 0.18Ω	0.51Ω - 10Ω 0.2Ω - 0.47Ω 0.1Ω - 0.18Ω
SR731J (0603)	1/5W 1/4W	70°C 70°C	125°C 125°C	±200	—	1.02Ω - 10Ω 0.1Ω - 1Ω	1.1Ω - 10Ω 0.1Ω - 1Ω	1.1Ω - 10Ω 0.1Ω - 1Ω
SR732A (0805)	1/3W	70°C	125°C	±100	0.15Ω - 10Ω	0.1Ω - 10Ω	—	—
				±200	—	—	0.1Ω - 10Ω	0.1Ω - 10Ω
				±500	—	—	—	0.051Ω - 0.091Ω
	1/2W ¹	70°C	105°C	±800	—	—	—	0.030Ω - 0.047Ω
				±100	0.15Ω - 10Ω	0.1Ω - 10Ω	—	—
				±200	—	—	0.1Ω - 10Ω	0.1Ω - 10Ω
SR732B (1206)	1/3W	70°C	125°C	±500	—	—	—	0.051Ω - 0.091Ω
				±800	—	—	—	0.030Ω - 0.047Ω
				±100	0.15Ω - 10Ω	0.1Ω - 10Ω	—	—
	1/2W ¹	70°C	110°C	±200	—	—	0.1Ω - 10Ω	0.1Ω - 10Ω
				±500	—	—	—	0.056Ω - 0.091Ω
				±800	—	—	—	0.030Ω - 0.051Ω
SR732E (1210)	1/2W	70°C	125°C	±100	0.15Ω - 10Ω	0.1Ω - 10Ω	—	—
				±200	—	—	0.1Ω - 10Ω	0.1Ω - 10Ω
				±500	—	—	—	0.036Ω - 0.043Ω
	2/3W ¹	70°C	110°C	±1000	—	—	—	0.024Ω - 0.033Ω
				±100	—	0.1Ω - 10Ω	—	—
				±200	—	—	0.1Ω - 10Ω	0.047Ω - 10Ω
SR732H/W2H (2010)	3/4W	70°C	125°C	±500	—	—	—	0.036Ω - 0.043Ω
				±800	—	—	—	0.024Ω - 0.033Ω
				±100	—	0.1Ω - 10Ω	—	—
				±200	—	—	0.1Ω - 10Ω	0.1Ω - 10Ω
				±500	—	—	—	0.056Ω - 0.091Ω
				±800	—	—	—	0.033Ω - 0.051Ω
SR733A/W3A (2512)	1W	70°C	125°C	±100	—	0.1Ω - 10Ω	—	—
				±200	—	—	0.1Ω - 10Ω	0.1Ω - 10Ω
				±500	—	—	—	0.056Ω - 0.091Ω
				±800	—	—	—	0.033Ω - 0.051Ω
				±100	—	0.1Ω - 10Ω	—	—
				±200	—	—	0.1Ω - 10Ω	0.1Ω - 10Ω

* 1H, 1E (F: ±1%) E-24 values only.

Operating Temp: -55°C to +125°C (SR731H only), -55°C to +150°C

If any questions should arise whether to use the "Rated Ambient Temperature" or the "Rated Terminal Part Temperature," please give priority to the "Rated Terminal Part Temperature." Prior to use and for more details refer to "Introduction of the derating curves on the terminal part temperature" in the beginning of the catalog.

¹ Prior to use, refer to the "Higher Power Ratings" in the beginning of catalog. Rated voltage = $\sqrt{\text{Power rating} \times \text{resistance value}}$ or max. working voltage, whichever is lower

environmental applications

Derating Curve

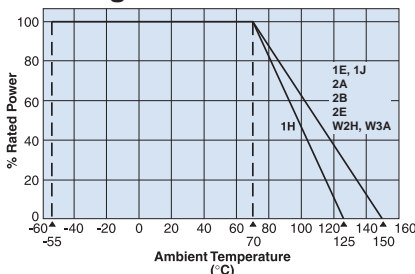

For resistors operated at an ambient temperature of 70°C or above, a power rating shall be derated in accordance with the derating curve.

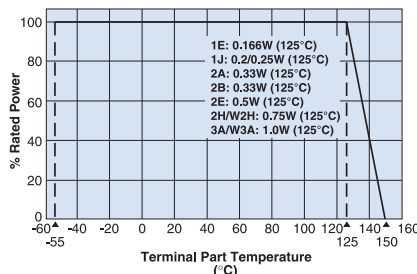

For resistors operated at a terminal part temperature of described for each size or above, a power rating shall be derated in accordance with the derating curve.

Please refer to "Introduction of the derating curve based on the terminal part temperature" on the beginning of our catalog before use.

SR73 2A (0.5W), SR73 2B (0.5W), SR73 2E (0.66W)

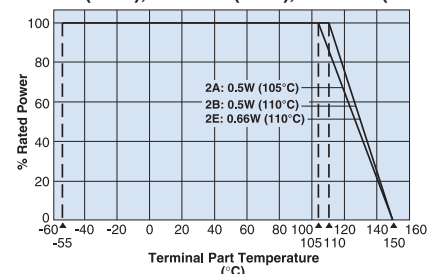

10-ohm 0.5%, 1%, 2%, 5% tolerance thick film current sense resistor

Temperature Rise

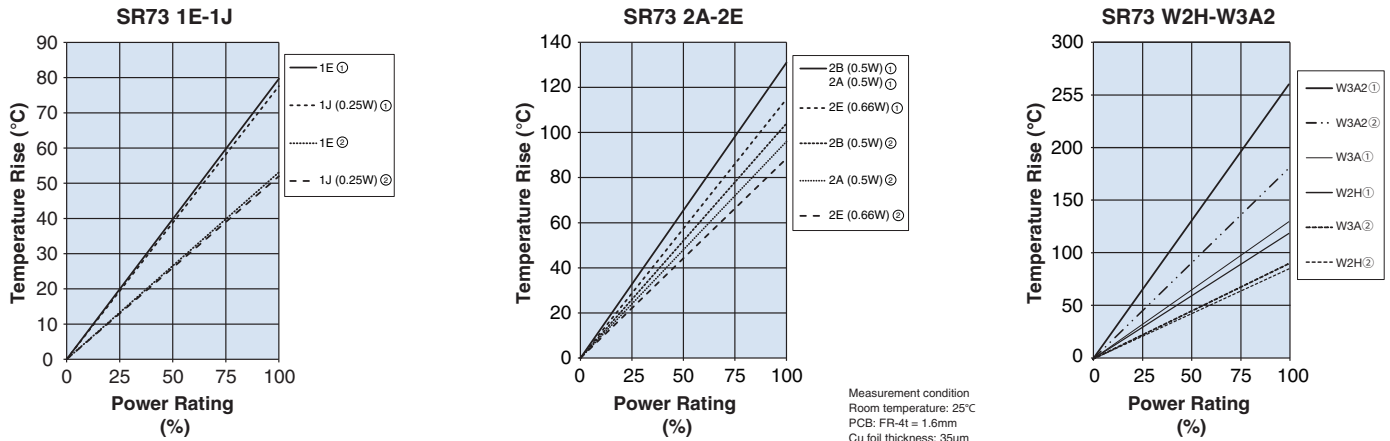

Regarding the temperature rise, the value of the temperature varies per conditions and board for use since the temperature is measured under our measuring conditions.



current sense

One-Pulse Limiting Electric Power

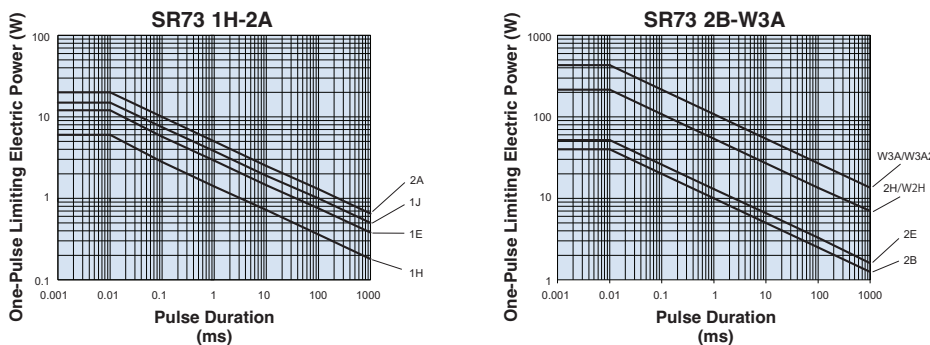

Please contact factory for resistance characteristics of continuous applied pulse.

Performance Characteristics

Parameter	Requirement $\Delta R \pm(\%+0.005\Omega)$		Test Method
	Limit	Typical	
Resistance	Within specified tolerance	—	25°C
T.C.R.	Within specified T.C.R.	—	+25°C/-55°C and +25°C/+125°C
Overload (Short time)	±2%	±0.5%	Rated voltage x 2.5 for 5 seconds
Resistance to Solder Heat	1H: ±3%, 1E~W3A: ±1%	1H: ±0.75% 1E~W3A: ±0.3%	260°C ± 5°C, 10 seconds ± 1 second
Rapid Change of Temperature	±1%	±0.3%	-40°C (30 minutes), +125°C (30 minutes), 100 cycles
Moisture Resistance	1H: ±3% 1E~W3A: ±2%	±1%	40°C ± 2°C, 90%-95% RH, 1000 hours, 1.5 hr ON, 0.5 hr OFF cycle
Endurance at 70°C	1H: ±3% 1E~W3A: ±2%	±1%	70°C ± 2°C or rated terminal part temperature ±2°C, 1000 hours, 1.5 hr ON, 0.5 hr OFF cycle
High Temperature Exposure	±1%	±0.3%	1H: +125°C, 1000 hours; 1E, 1J, 2A, 2B, 2E, 2H/W2H, 3A/W3A: +150°C, 1000 hours

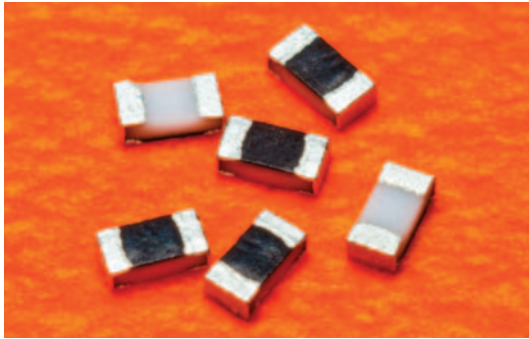

features

- Current detecting resistors for power supply, motor circuits, etc.
- High reliability and performance with resistance tolerance $\pm 0.5\%$, T.C.R. $\pm 100 \times 10^{-6}/K$
- Suitable for both reflow and flow solderings
- Products with lead-free terminations meet EU RoHS requirements. EU RoHS regulation is not intended for Pb-glass contained in electrode, resistor element and glass.
- AEC-Q200 Tested

dimensions and construction

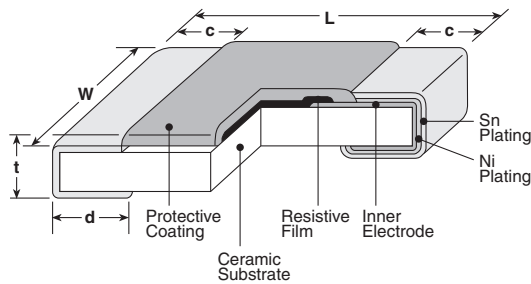

Type (Inch Size Code)	Dimensions inches (mm)				
	L	W	c	d	t
3A2 (2512)	.248 \pm .008 (6.3 \pm 0.2)	.122 \pm .008 (3.1 \pm 0.2)	.02 \pm .012 (0.5 \pm 0.3)	.016 ^{+0.008} _{-.004} (0.4 ^{+0.2} _{-0.1})	.024 \pm .004 (0.6 \pm 0.1)
W3A2 (2512)				.026 \pm .006 (0.65 \pm 0.15)	

Derating Curve

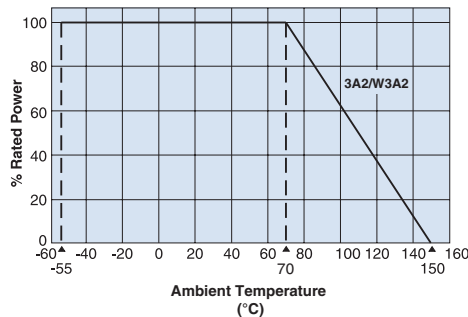

For resistors operated at an ambient temperature of 70°C or above, the power rating shall be derated in accordance with the above derating curve.

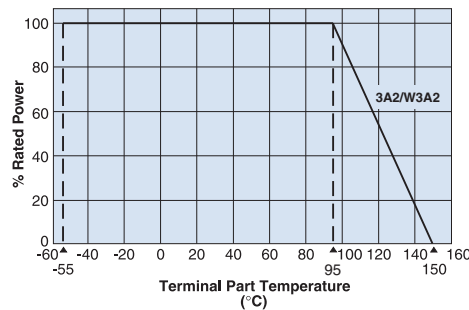

For resistors operated at a terminal part temperature of described for each size or above, a power rating shall be derated in accordance with the derating curve. Please refer to "Introduction of the derating curve based on the terminal part temperature" in the beginning of our catalog before use.

ordering information

SR73	3A2	T	TE	1R00	F
Type	Size	Termination Material	Packaging	Nominal Resistance	Tolerance
	3A2 W3A2	T: Sn	TE: 7" embossed plastic For further information on packaging, please refer to Appendix A	$\pm 2\%$, $\pm 5\%$: 2 significant figures + 1 multiplier "R" indicates decimal on value $< 10\Omega$ $\pm 1\%$: 3 significant figures + 1 multiplier "R" indicates decimal on value $< 100\Omega$ All values less than 0.1 Ω (100m Ω) are expressed in m Ω with "L" as decimal Example: 20m Ω = 20L (3-digit)	F: $\pm 1\%$ G: $\pm 2\%$ J: $\pm 5\%$

applications and ratings

Part Designation*	Power Rating	Rated Ambient Temp.	Rated Terminal Part Temp.	T.C.R. (ppm/°C) Max.	Resistance Range			
					E-24, E-96 (D±0.5%)	E-24, E-96 (F±1%)	E-24 (G±2%)	E-24 (J±5%)
SR733A2/W3A2 (2512)	2W	70°C	95°C	±100	—	0.1Ω - 10Ω	—	—
				±200	—	—	0.1Ω - 10Ω	0.1Ω - 10Ω
				±500	—	—	—	0.056Ω - 0.091Ω
				±800	—	—	—	0.039Ω - 0.051Ω

* Parentheses indicate EIA package size codes. Operating Temp: -55°C to +150°C
 Prior to use and for more details refer to "Introduction of the derating curves on the terminal part temperature" in the beginning of the catalog.

environmental applications

Temperature Rise

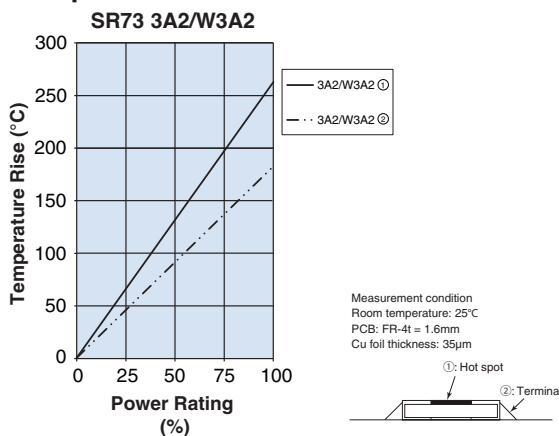

Regarding the temperature rise, the value of the temperature varies per conditions and board for use since the temperature is measured under our measuring conditions.

One-Pulse Limiting Electric Power

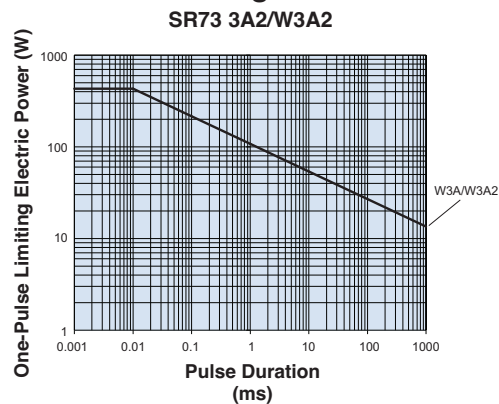

Please contact factory for resistance characteristics of continuous applied pulse.

Performance Characteristics

Parameter	Requirement $\Delta R \pm(\%+0.005\Omega)$		Test Method
	Limit	Typical	
Resistance	Within specified tolerance	—	25°C
T.C.R.	Within specified T.C.R.	—	+25°C/-55°C and +25°C/+125°C
Overload (Short time)	±2%	±0.5%	Rated voltage x 2.0 for 5 seconds
Resistance to Solder Heat	±1%	±0.3%	260°C ± 5°C, 10 seconds ± 1 second
Rapid Change of Temperature	±1%	±0.3%	-40°C (30 minutes), +125°C (30 minutes), 100 cycles
Moisture Resistance	±2%	±1%	40°C ± 2°C, 90%-95% RH, 1000 hours, 1.5 hr ON, 0.5 hr OFF cycle
Endurance at 70°C	±2%	±1%	70°C ± 2°C or rated terminal part temperature ±2°C, 1000 hours, 1.5 hr ON, 0.5 hr OFF cycle
High Temperature Exposure	±1%	±0.3%	+150°C, 1000 hours

four-terminal current sense resistor



current sense



features

- Extremely low resistance and high precision tolerance
- Low T.C.R. achieved ($\pm 50\text{ppm}/^\circ\text{C}$)
- Flameproof UL94V0
- Products with lead-free terminations meet EU RoHS and China RoHS requirements

dimensions and construction

Size Code	Dimensions inches (mm)										
	L	W	t	a	b	c	d	e	f	g	h
CSR1	.425±.02 (10.8±0.5)	.244±.012 (6.2±0.3)	.083±.008 (2.1±0.2)	.118±.012 (3.0±0.3)	.031±.008 (0.8±0.2)	.055±.02 (1.4±0.5)	.047±.02 (1.2±0.5)	.051±.012 (1.3±0.3)	.051±.012 (1.3±0.3)	.197±.004 (5.0±0.1)	.098±.004 (2.5±0.1)
CSR2	.504±.02 (12.8±0.5)	.323±.012 (8.2±0.3)	.122±.008 (3.1±0.2)	.197±.012 (5.0±0.3)	.039±.008 (1.0±0.2)	.079±.02 (2.0±0.5)	.079±.02 (2.0±0.5)	.087±.012 (2.2±0.3)	.087±.012 (2.2±0.3)	.236±.004 (6.0±0.1)	.118±.004 (3.0±0.1)

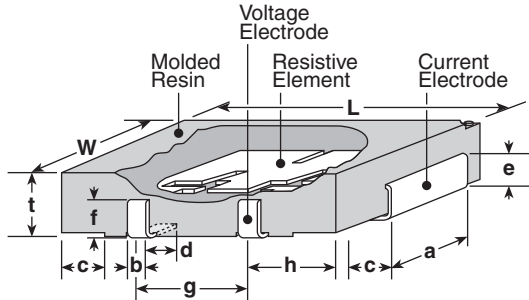

ordering information

CSR	1	T	TED	10L0	F
Type	Power Rating 1: 1W 2: 2W	Termination Material T: Sn	Packaging TED: CSR1 TEB: CSR2 (1,000 pieces/reel)	Nominal Resistance In milliohms: 3 significant figures "L" indicates decimal point	Tolerance D: ±0.5% F: ±1%

For further information on packaging, please refer to Appendix A.

typical circuit schematic

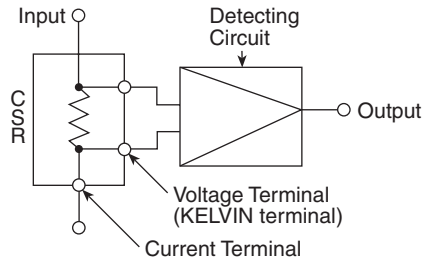

applications and ratings

Part Designation	Power Rating	T.C.R. (ppm/°C) Max.	Resistance Range E-12	Resistance Tolerance	Rated Ambient Temperature	Operating Temperature Range
CSR1	1W	±50	5mΩ - 50mΩ	D: ±0.5%, F: ±1%	+70°C	-55°C to +125°C
CSR2	2W			F: ±1%		

environmental applications

Derating Curve

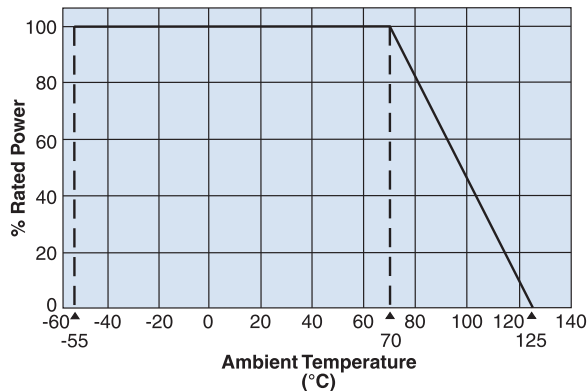

For resistors operated at an ambient temperature of 70°C or above, a power rating shall be derated in accordance with the above derating curve.

Surface Temperature Rise

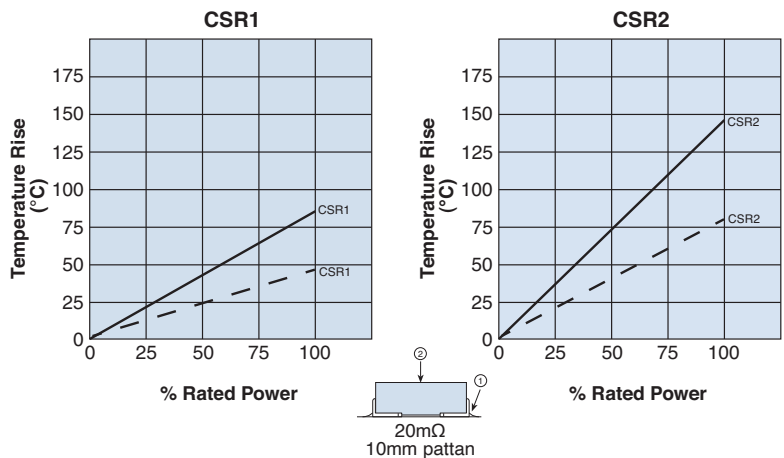

Regarding the temperature rise, the value of the temperature varies per conditions and board for use since the temperature is measured under our measuring conditions. Please refer to us before use.

Performance Characteristics

Parameter	Requirement Δ R ±%		Test Method
	Limit	Typical	
Resistance	Within regulated tolerance	—	25°C
T.C.R.	Within specified T.C.R.	—	+25°C/+125°C
Overload (Short Time)	±1.0%	±1.0%	Rated power x 5 for 5 seconds
Resistance to Solder Heat	±1.0%	±1.0%	260°C ± 5°C, 10 seconds ± 1 second
Rapid Change of Temperature	±1.0%	±0.5%	-55°C (30 minutes), +125°C (30 minutes), 500 cycles
Moisture Resistance	±2.0%	±0.5%	40°C ± 2°C, 90 - 95% RH, 1000 hours, 1.5 hr ON, 0.5 hr OFF cycle
Endurance at 70°C	±1.0%	±0.5%	70°C ± 2°C, 1000 hours, 1.5 hr ON, 0.5 hr OFF cycle
Low Temperature Exposure	±0.5%	±0.25%	-55°C, 1 hour
High Temperature Exposure	±0.5%	±0.25%	+125°C, 100 hours

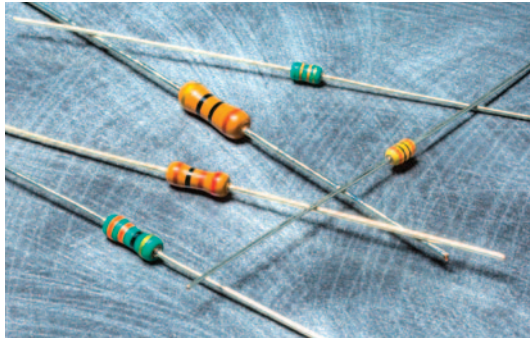

features

- Flameproof coating is available (specify “CFP”)
- Reduced body size (specify “CFS/CFPS”)
- Suitable for automatic machine insertion
- Stronger in pulse resistance than chip resistors of the same type
- Products with lead-free terminations meet EU RoHS and China RoHS requirements

leaded resistors

dimensions and construction

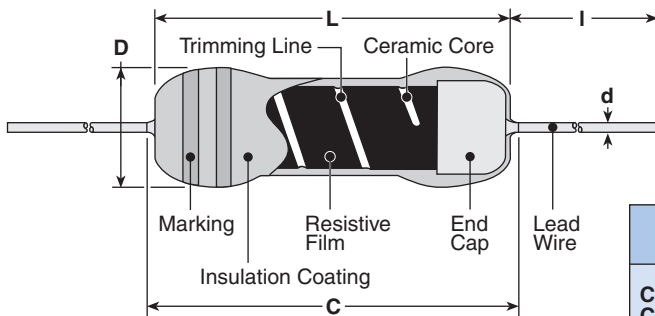

Type	Dimensions inches (mm)				I**	
	L	C (max.)	D	d (nom.)	Standard	Long
CFS1/4 CFPS1/4	.126±.008 (3.2±0.2)	.134 (3.4)	.067 ^{+0.008} / _{-.004} (1.7 ^{+0.2} / _{-0.1})	.018 (0.45)	.551 Min.* (14.0 Min.)	.787 Min.*** (20.0 Min.)
CF1/4 CFP1/4	.240± ^{+0.028} / _{-.02} (6.1± ^{+0.7} / _{-0.5})	.280 (7.1)	.092±.012 (2.3±0.3)	.024 (0.6)		
CFS1/2 CFPS1/2	.248±.02 (6.3±0.5)	.280 (7.1)	.112± ^{+0.012} / _{-.026} (2.85± ^{+0.3} / _{-0.65})	.024 (0.6)	.787 Min. (20.0 Min.)	—
CFB1/2 CFPB1/2	.354±.039 (9.0±1.0)	.433 (11.0)	.138±.02 (3.5±0.5)	.028 (0.7)		

* Forming code S is applied for bulk type.
 ** Lead length changes depending on taping and forming type.
 *** Long type is custom-made

ordering information

CF	1/4	C	T52	R	103	J
Type	Power Rating	Termination Material	Taping and Forming	Packaging	Nominal Resistance	Tolerance
CF CFP	S1/4: 0.25W 1/4: 0.25W S1/2: 0.5W B1/2: 0.5W	C: SnCu	Axial: T26, T52, L52 Radial: VT, MT, MHT, VTP, VTE U Forming: U, UCL M Forming: M5, M10, M12.5 L Forming: L10, L12.5 S Forming: S	A: Ammo R: Reel	2 significant figures + 1 multiplier “R” indicates decimal on value <10Ω	G: ±2% J: ±5%

For further information on packaging, please refer to Appendix C.

applications and ratings

Part Designation	Power Rating @ 70°C	Minimum Dielectric Withstanding Voltage	T.C.R. (ppm/°C)				Resistance Range E-24 (G±2%)	Resistance Range E-24 (J±5%)	Absolute Maximum Working Voltage	Absolute Maximum Overload Voltage	
			+350 to -450	0 to -700	0 to -1000	0 to -1300					
CFS1/4	0.25W	300V	2.2Ω - 47kΩ	51kΩ - 100kΩ	110kΩ - 330kΩ	360kΩ - 1MΩ	10Ω - 1MΩ	10Ω - 330kΩ	2.2Ω - 1MΩ	250V	500V
CFPS1/4								10Ω - 100kΩ	2.2Ω - 1MΩ		
CF1/4		500V	2.2Ω - 100kΩ	110kΩ - 330kΩ	360kΩ - 1MΩ	1.1MΩ - 5.1MΩ		2.2Ω - 5.1MΩ	300V	600V	
CFP1/4						—		2.2Ω - 1MΩ			
CFS1/2	0.50W	700V	1.0Ω - 91kΩ	100kΩ - 1MΩ	1.1MΩ - 2.2MΩ	2.4MΩ - 5.1MΩ	1.0Ω - 5.1MΩ	350V	700V		
CFPS1/2			2.2Ω - 91kΩ		—	—	2.2Ω - 1MΩ				
CFB1/2	0.50W	700V	2.2Ω - 100kΩ	110kΩ - 1MΩ	1.1MΩ - 2.2MΩ	2.4MΩ - 5.1MΩ	2.2Ω - 5.1MΩ	400V	800V		
CFPB1/2	0.50W	700V	2.2Ω - 100kΩ	110kΩ - 1MΩ	—	—	2.2Ω - 1MΩ	400V	800V		

Operating temperature: -55°C ~ +155°C

environmental applications

Derating Curve

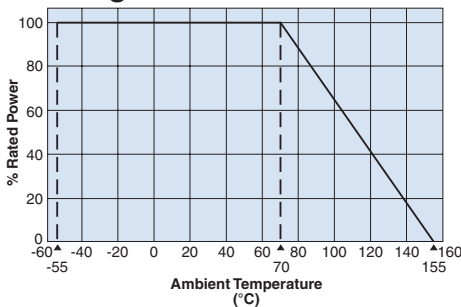

Surface Temperature Rise

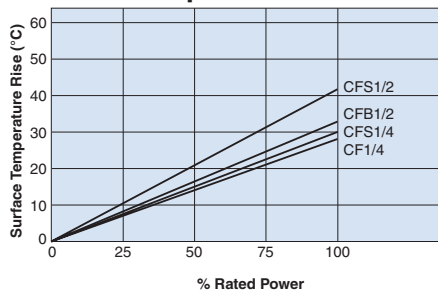

Load Life @ 70°C, 1000 Hr

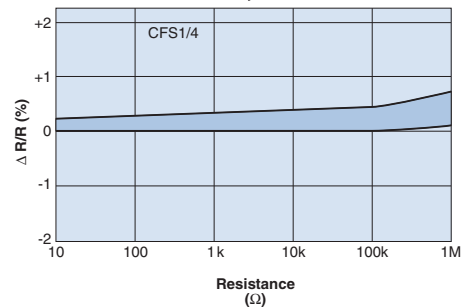

For resistors operated at an ambient temperature of 70°C or above, a power rating shall be derated in accordance with the above derating curve.

Performance Characteristics

Parameter	Requirement ΔR ±(% + 0.05Ω)		Test Method
	Limit	Typical	
Resistance	Within specified tolerance	—	Measuring points are at 10mm ±1mm from the end cap.
T.C.R.	Within specified T.C.R.	—	+25°C/+125°C
Overload (Short time)	±1%	±0.5%	Rated voltage x 2.5 or max. overload voltage for 5 seconds, whichever is lower
Resistance to Solder Heat	±1%	±0.5%	260°C ±5°C, 10 seconds ± 1 second, 350°C ± 10°C, 3.5 seconds ± 0.5 second
Terminal Strength	No lead-coming off and loose terminals	—	Twist 360°C, 5 times
Rapid Change of Temperature	±1%	±0.5%	-55°C (30 minutes), +125°C (30 minutes), 5 cycles
Moisture Resistance	±5%	±2.5%	40°C ± 2°C, 90 - 95% RH, 1000 hours, 1.5 hr ON, 0.5 hr OFF cycle
Endurance at 70°C	±3%	±1.5%	70°C ± 2°C, 1000 hours, 1.5 hr ON, 0.5 hr OFF cycle
Resistance to Solvent (CFP & CFPS only)	No abnormality in appearance. Marking shall be easily legible.	—	Ultrasonic washing with Isopropyl alcohol for 2 minutes. Power: 0.3W/cm², f: 28kHz, temp: 35°C±5°C
Flame Retardant (CFP & CFPS only)	No evidence of flaming or self-flaming	—	Flame test: The test flame shall be applied and removed for each 15 seconds respectively to repeat the cycle 5 times. Overload flame retardant: AC Voltage corresponding to 2, 4, 8, 16 and 32 times the power rating shall be applied for each 1 minute until disconnection occurs. However the applied voltage shall not exceed 4 times the maximum operating voltage.

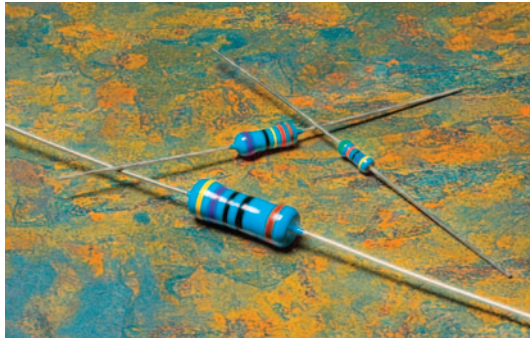

features

- Semi-precision metal film resistors
- Meets requirements of MIL-R-22684
- Suitable for automatic machine insertion
- MFS two times the power rating of the standard body type
- Products with lead-free terminations meet EU RoHS and China RoHS requirements
- AEC-Q200 Tested: MF1/4, MFS1/4, MFS1/2

dimensions and construction

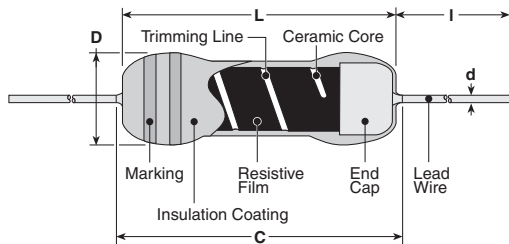

Derating Curve

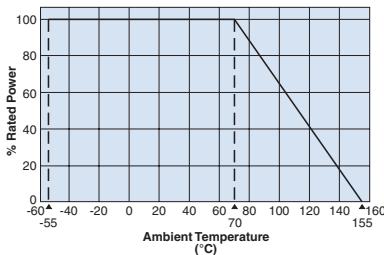

Surface Temperature Rise

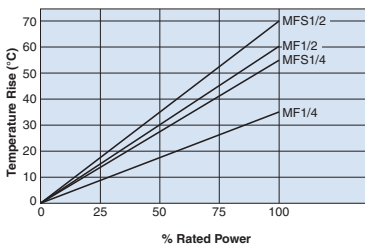

Type	Dimensions inches (mm)				
	L (ref.)	C (max.)	D	d (nom.)	I*
MFS1/4	.126 ^{+0.02} _{-.008} (3.2 ^{+0.5} _{-0.2})	.133 (3.4)	.066 ^{+0.016} _{-.004} (1.7 ^{+0.4} _{-0.1})	.018 (0.45)	1.10±.118 (28.0±3.0)
MF1/4	.248±.02 (6.3±0.5)	.280 (7.1)	.091±.012 (2.3±0.3)	.024 (0.6)	
MFS1/2	.248±.02 (6.3±0.5)	.280 (7.1)	.091±.012 (2.3±0.3)	.024 (0.6)	1.10 ^{+0.012} _{-.016} (28.0 ^{+3.0} _{-4.0})
MF1/2C MF1/2D	.354±.04 (9.0±1.0)	.437 (11.1)	.138 ^{+0.016} _{-.02} (3.5 ^{+0.4} _{-0.5})	.024 (0.6)	
MF1/2L	.354±.04 (9.0±1.0)	.437 (11.1)	.138±.016 (3.5±0.4)	.024 (0.6)	1.10±.118 (28.0±3.0)
RK1/4	.248±.02 (6.3±0.5)	.280 (7.1)	.091±.012 (2.3±0.3)	.024 (0.6)	0.94 min. (24.0 min.)
RK1/2	.374±.04 (9.5±1.0)	.437 (11.1)	.138±.016 (3.5±0.4)	.024 (0.6)	
RK1	.610±.04 (15.5±1.0)	.720 (18.3)	.217±.02 (5.5±0.5)	.031 (0.8)	1.50±.118 (38.0±3.0)

* Lead length changes depending on taping and forming.

ordering information

MF	1/2	D	C	T52	R	1003	F
Type	Power Rating	T.C.R.	Termination Material	Taping and Forming	Packaging	Nominal Resistance	Tolerance
MF MFS RK	1/4: 0.25W 1/2: 0.50W 1: 1W	C: ±50 D: ±100 L: ±200 G: ±250 B: ±350	C: SnCu	1/4: T26, T52, VT, VTP, VTE, MT, M, U, M10, M12.5 1/2: T26, T52, VTP, VTE, M12.5, M15 1: T521	A: Ammo R: Reel	+2%: 2 significant figures + 1 multiplier +0.5%, +1%: 3 significant figures + 1 multiplier "R" indicates decimal on value <100Ω	D: ±0.5% F: ±1% G: ±2% J: ±5%

For further information on packaging, please refer to Appendix C.

Specifications given herein may be changed at any time without prior notice. Please confirm technical specifications before you order and/or use.

7/9/24

applications and ratings

Part Designation	Power Rating @ 70°C	Minimum Dielectric Withstanding Voltage	T.C.R. (ppm/°C)	Resistance Range (Ω)				Absolute Maximum Working Voltage	Absolute Maximum Overload Voltage	Operating Temperature Range
				(D±0.5%) E-24 E-192	(F±1.0%) E-24 E-96	(G±2.0%) E-24	(J±5.0%) E-24			
MFS1/4C	0.25W	300V	C: ±50	49.9 - 562k	10 - 1M	—	—	250V	500V	-55°C to +155°C
MFS1/4D			D: ±100							
MF1/4C	0.25W	500V	C: ±50	10 - 2.21M	10 - 2.21M	—	—	250V	500V	
MF1/4D			D: ±100							
MF1/4L			L: ±200	—	1.0 - 10	0.51 - 10				
MFS1/2C	0.50W	500V	C: ±50	10 - 1M	10 - 2.21M	10 - 2.2M	—	350V	700V	
MFS1/2D			D: ±100							
MF1/2C	0.50W	700V	C: ±50	10 - 5.05M	10 - 4.99M	—	—	350V	700V	
MF1/2D			D: ±100							
MF1/2L			L: ±200	—	1.0 - 10	0.51 - 10Ω				
RK1/4D	0.25W	500V	D: ±100	—	3.09M - 25M	—	—	500V	700V	
RK1/4L			L: ±200	—	—	3.3M - 33M	3.3M - 33M			
RK1/4B			B: ±350	—	100k - 25M	100k - 33M	100k - 33M			
RK1/2D	0.50W	700V	D: ±100	—	5.11M - 33M	—	—	700V	1000V	
RK1/2L			L: ±200	—	—	6.2M - 33M	6.2M - 33M			
RK1/2B			B: ±350	—	100k - 35M	100k - 51M	100k - 51M			
RK1BC	1W	1000V	B: ±350	—	100k - 51M	100k - 100M	100k - 100M	1000V	1500V	
RK1/2G*	0.50W	700V	G: ±250	—	—	—	1M - 12M	350V	700V	

* Discharge path resistor

environmental applications

Performance Characteristics

Parameter	Requirement Δ R ±(% + 0.05Ω)		Test Method
	Limit	Typical	
Resistance	Within specified tolerance	—	25°C
T.C.R.	Within specified T.C.R.	—	Room temperature, +100°C, RK: +25°C/+125°C
Overload (Short Time)	RK: ±1%, RK1/2G: ±2.5% MF: ±0.5%	RK: ±0.6%, RK1/2G: ±1% MF: ±0.3%	RK, MFS1/4, MF1/4, MF1/2: Rated voltage x 2.5 or max. overload voltage, whichever is lower, for 5 seconds; MFS1/2: Rated voltage x 2 or max. overload voltage for 5 seconds, whichever is less
Resistance to Solder Heat	RK: ±1%; RK1/2G: ±5%; MFS: ±0.75%; MF1/4, MFS1/2, MF1/2: ±0.5%	RK: ±0.5%; RK1/2G: ±1% MFS1/4: ±0.4%; MF1/4, MFS1/2, MF1/2: ±0.25%	260°C ± 5°C, 10 seconds ± 1 second or RK: 350°C ± 10°C, 3.5 seconds ± 0.5 second
Dielectric Withstanding Voltage	No breakdown	—	RK: 1 minute
Insulation Resistance	Not less than 10,000MΩ	—	RK: 100V, 1 minute
Rapid Change of Temperature	RK, MF: ±1%; RK1/2G: ±5%	MF: ±0.3%; RK: ±0.5%, RK1/2G: ±1%	-55°C (30 minutes), +155°C (30 minutes), 5 cycles
Moisture Resistance	RK: ±5%; RK1/2G: ±10%; MFS1/4: ±1.5%; MF1/4, MFS1/2, MF1/2: ±1%	RK: ±2%; RK1/2G: ±5%; MFS1/4: ±1%; MF1/4, MFS1/2, MF1/2: ±0.75%	40°C ± 2°C, 90 - 95% RH, 1000 hours, 1.5 hr ON, 0.5 hr OFF cycle
Endurance at 70°C	RK: ±5%; RK1/2G: ±10%; MFS1/4: ±1.5%; MF1/4, MFS1/2, MF1/2: ±1%	RK: ±2%; RK1/2G: ±5%; MFS1/4: ±1%; MF1/4, MFS1/2, MF1/2: ±0.75%	70°C ± 2°C, 1000 hours, 1.5 hr ON, 0.5 hr OFF cycle
Resistance to Solvent	No abnormality in appearance. Marking shall be easily legible	—	RK: The resistor shall be immersed for 5 seconds in IPA
Impulse	No such abnormalities as short-circuit, burnout, breakdown, etc.	—	RK: Discharge from 1000pF capacitor 50 pulses. Internal 2.5 seconds. Charge voltage: 1.25kV (RK1/4), 2.5kV (RK1/2) and 6kV (RK1)

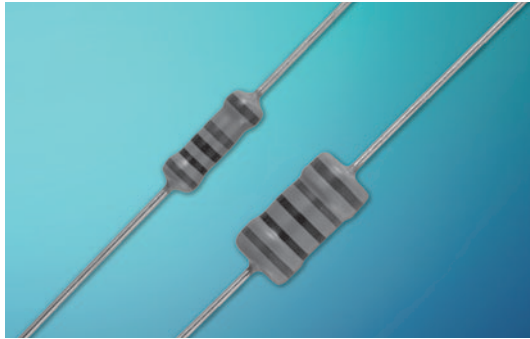

features

- High precision and low T.C.R. metal film resistor
- Excellent stability for a long time
- Products meet EU RoHS requirements

leaded resistors

dimensions and construction

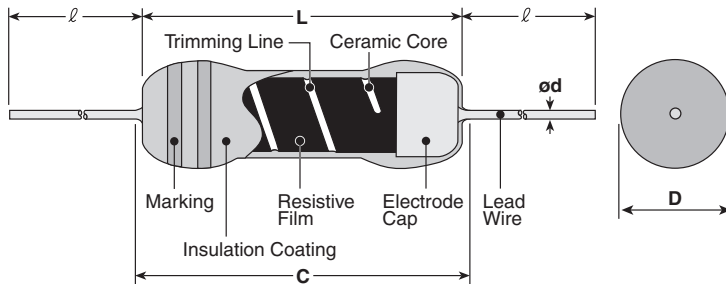

Type	Dimensions inches (mm)				
	L	C (max.)	D	d (nom.)	l
SN3A	.555±.08 (14.1±2.0)	.720 (18.3)	.189±.039 (4.8±1.0)	.039 (1.0)	1.50±.118 (38±3)
SN3D	.650±.08 (16.5±2.0)	.846 (21.5)	.331±.039 (8.4±1.0)	.039 (1.0)	

ordering information

SN	3A	D	C	1002	F
Type	Power Rating	T.C.R. (x10 ⁻⁵ /K)	Termination Surface Material	Nominal Resistance	Resistance Tolerance
	3A: 1W 3D: 2W	C: ±50 D: ±100 L: ±200	C: SnCu	D, F: 4 digits G: 3 digits	D: ±0.5% F: ±1% G: ±2%

Contact KOA when you have control request for environmental hazardous material other than the substance specified by EU RoHS.

For further information on packaging, please refer to Appendix C.

applications and ratings

Part Designation	Power Rating	T.C.R. (x10 ⁻⁶ /K)	Resistance Range (Ω)			Maximum Working Voltage	Maximum Overload Voltage	Dielectric Withstanding Voltage	Rated Ambient Temp.	Operating Temp. Range
			D: ±0.5% E24, E192	F: ±1% E24, E96	G: ±2% E24					
SN3ACC	1W	C: ±50	—	10 - 1M	—	500V	1000V	1000V	+70°C	-55°C to +155°C
SN3ADC		D: ±100	10 - 1M	10 - 1M	10 - 1M					
SN3ALC		L: ±200	—	4.99 - 10	1 - 10					
SN3DDC	2W	D: ±100	10 - 1.5M	10 - 1.5M	10 - 1.5M					
SN3DLC		L: ±200	—	—	5.1 - 10					

Rated voltage = $\sqrt{\text{Power Rating} \times \text{Resistance Value}}$ or Max. working voltage, whichever is lower.

environmental applications

Derating Curve

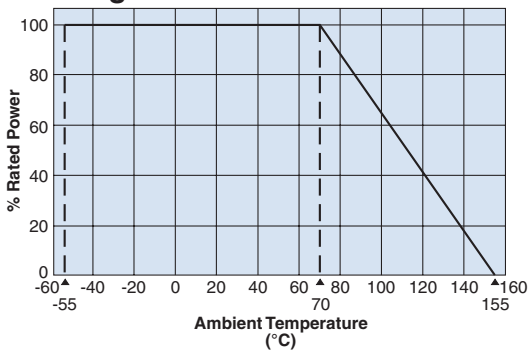

For resistors operated at an ambient temperature of 70°C or above, a power rating shall be derated in accordance with the above derating curve.

Performance Characteristics

Parameter	Requirement $\Delta R \pm(\% + 0.05\Omega)$ Limit	Test Method
Resistance	Within specified tolerance	25°C
T.C.R.	Within specified T.C.R.	+25°C/+125°C
Overload (Short time)	±0.5%	Rated voltage x 2.5 or max. overload voltage, whichever is lower, for 5 seconds
Resistance to Solder Heat	±0.25%	260°C ±5°C, 10 seconds ± 1 second
Rapid Change of Temperature	±0.5%	-55°C (30 minutes)/+155°C (30 minutes), 5 cycles
Moisture Resistance	±1%	40°C ± 2°C, 90 - 95% RH, 1000 hours, 1.5 hr ON/0.5 hr OFF cycle
Endurance at 70°C	±1%	70°C ± 2°C, 1000 hours, 1.5 hr ON/0.5 hr OFF cycle

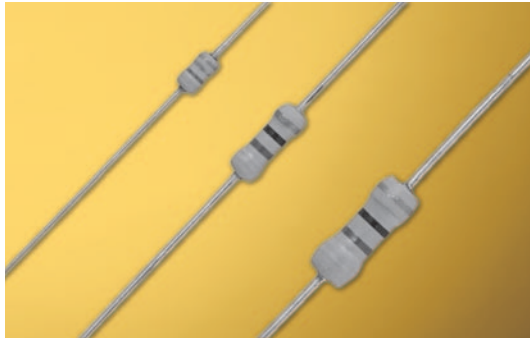

features

- Flame retardant coating (Equivalent to UL94 V-0)
- Automatic insertion is applicable
- Various types of formings are available
- Products meet EU RoHS requirements

leaded resistors

dimensions and construction

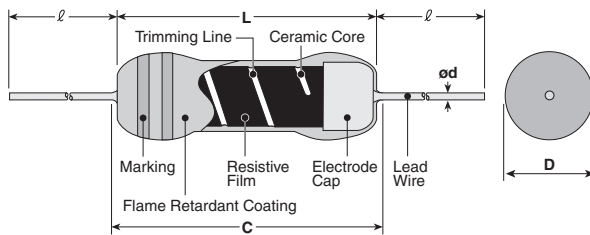

Type	Dimensions inches (mm)				ℓ***	
	L	C (max.)	D	d (nom.)	Standard	Long
SNF2C	.126±.008 (3.2±0.2)	.134 (3.4)	.067 ^{+0.008} / _{-0.004} (1.7 ^{+0.2} / _{-0.1})	.018 (0.45)	.551 Min.* (14.0 Min.)	.787 Min.** (20.0 Min.)
SNF2E	.240±.02 (6.1±0.5)	.280 (7.1)	.092±.012 (2.3±0.3)	.024 (0.6)		
SNF2H	.354±.039 (9.0±1.0)	.433 (11.0)	.138±.02 (3.5±0.5)	.028 (0.7)	.787 Min. (20.0 Min.)	—

* Forming code S is applied for bulk type.

** Long type is custom-made

*** Lead length changes depending on taping and forming type

ordering information

SNF	2E	C	T52	A	100	F
Type	Power Rating	Termination Surface Material	Taping & Forming	Packaging	Nominal Resistance	Resistance Tolerance
	2C: 0.25W 2E: 0.25W 2H: 0.5W	C: SnCu	S: Standard Nil: Long SNF2CC: S, Nil, T26, T52, M5F SNF2EC: S, Nil, T26, T52, M10F, M12.5R SNF2HC: Nil, T52, M12.5K, M15K	A: Ammo R: Reel Nil: Box	3 digits	J: ±5%

Contact KOA when you have control request for environmental hazardous material other than the substance specified by EU RoHS.

For further information on packaging, please refer to Appendix C.

applications and ratings

Part Designation	Power Rating	Resistance Range (Ω) J: ±5% E24	T.C.R. (x10 ⁻⁶ /K)	Maximum Working Voltage	Maximum Overload Voltage	Dielectric Withstanding Voltage	Rated Ambient Temp.	Operating Temp. Range
SNF2CC	0.25W	0.47 - 9.1	+350 - -450	$E = \sqrt{P \times R}$ (V)	Ex2.5 (V)	300V	+70°C	-55°C to +155°C
SNF2EC		0.47 - 100				500V		
SNF2HC	0.50W					700V		

Rated voltage = $\sqrt{\text{Power Rating} \times \text{Resistance Value}}$

environmental applications

Derating Curve

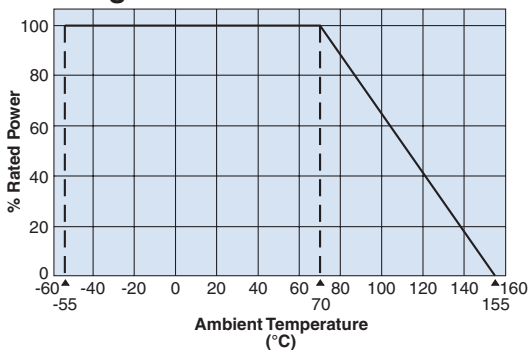

For resistors operated at an ambient temperature of 70°C or above, a power rating shall be derated in accordance with the above derating curve.

Performance Characteristics

Parameter	Requirement $\Delta R \pm(\% + 0.05\Omega)$		Test Method
	Limit	Typical	
Resistance	Within specified tolerance	—	25°C
T.C.R.	Within specified T.C.R.	—	+25°C/+125°C
Overload (Short time)	±1%	±0.5%	Rated voltage x 2.5 or max. overload voltage, whichever is lower, for 5 seconds
Resistance to Solder Heat	±1%	±0.5%	260°C ±5°C, 10 seconds ± 1 second, 350°C ± 10°C, 3.5 seconds ± 0.5 second
Terminal Strength	No lead-coming off and loose terminals	—	Twist 360°C, 5 times
Rapid Change of Temperature	±1%	±0.5%	-55°C (30 minutes)/ +125°C (30 minutes), 5 cycles
Moisture Resistance	±5%	±2.5%	40°C ± 2°C, 90 - 95% RH, 1000 hours, 1.5 hr ON/0.5 hr OFF cycle
Endurance at 70°C	±3%	±1.5%	70°C ± 2°C, 1000 hours, 1.5 hr ON, 0.5 hr OFF cycle
Resistance to Solvent	No abnormality in appearance. Marking shall be easily legible.	—	Ultrasonic washing with Isopropyl alcohol for 2 minutes. Power: 0.3W/cm ² , f: 28kHz, Temp: 35°C±5°C
Flame Retardant	No evidence of flaming or self-flaming	—	Flame test: The test flame shall be applied and removed for each 15 seconds respectively to repeat the cycle 5 times. Overload flame retardant: AC Voltage corresponding to 2, 4, 8, 16 and 32 times the power rating shall be applied for each 1 minute until disconnection occurs. However the applied voltage shall not exceed 4 times the maximum operating voltage.

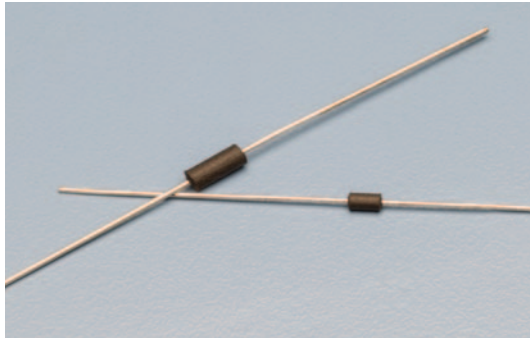

features

- Type J are molded
- Suitable for automatic machine insertion
- Marking: Type J are black, no marking
- Products meet EU RoHS requirements

leaded
resistors

dimensions and construction

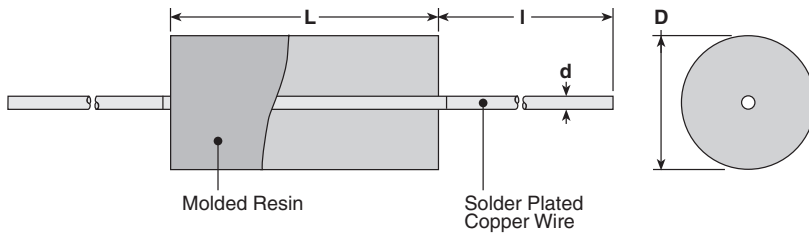

Type	Dimensions inches (mm)			I ¹ Standard
	L (ref.) ¹	D	d (nom.)	
J1/6Z	.134 ^{+0.004} / _{-0.008} (3.4 ^{+0.1} / _{-0.2})	.067±.008 (1.7±0.2)	.020 (0.5)	1.18±.118 (30.0±3.0)
J1/4Z	.256±.02 (6.5±0.5)	.091 ⁺⁰ / _{-.012} (2.3 ⁺⁰ / _{-.3})	.024 (0.6)	

¹ Lead length changes depending on taping and forming type.

ordering information

1/6Z	C	T52	A
Type	Termination Material	Taping and Forming	Packaging
J1/4Z J1/6Z	C: SnCu	T26, T52	A: Ammo R: Reel

For further information on packaging, please refer to Appendix C.

applications and ratings

Part Designation	Maximum Allowable Current	Rated Ambient Temperature	Operating Temperature Range
J1/6ZC	8A	+70°C	-55°C to +125°C
J1/4ZC	10A		

environmental applications

Derating Curve

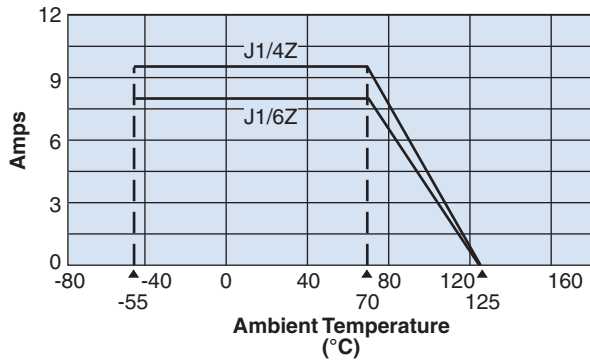

For resistors operated at an ambient temperature of 70°C or above, a power rating shall be derated in accordance with the above derating curve.

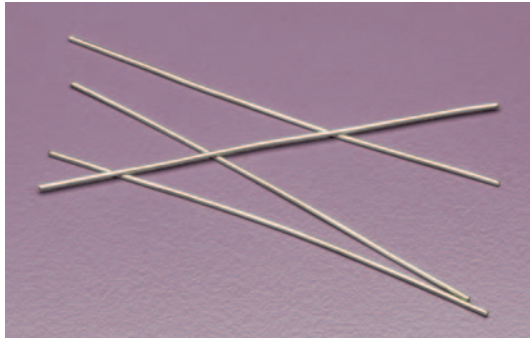

features

- Suitable for automatic machine insertion
- Products meet EU RoHS requirements

leaded resistors

dimensions and construction

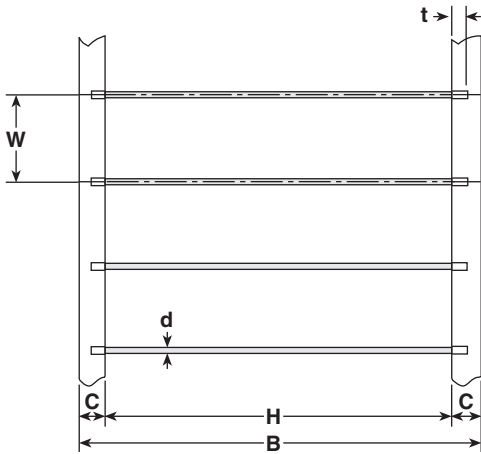

T52 Type	Dimensions inches (mm)					
	H	B	C	W	t (max.)	d nominal
JL5						.02 (0.5)
JL6	2.05±.039 (52.0±1.0)	2.54±.039 (64.5±1.0)	.244±.02 (6.2±0.5)	.2±.015 (5.08±0.38)	.098 (2.5)	.024 (0.6)
JL8						.031 (0.8)

T26 Type	Dimensions inches (mm)					
	H	B	C	W	t (max.)	d nominal
JL5						.02 (0.5)
JL6	1.02 ^{+0.039} ₋₀ (26.0 ⁺¹ ₋₀)	1.54±.039 (39.0±1.0)	.244±.02 (6.2±0.5)	.1972±.012 (5.0±0.3)	.098 (2.5)	.024 (0.6)
JL8						.031 (0.8)

applications and ratings

Part Designation	Maximum Resistance	Maximum Current Ratings	Rated Ambient Temp.	Operating Temp. Range
JL5	10mΩ	8 Amps	+70°C	-55°C ~ +125°C
JL6		10 Amps		
JL8		12 Amps		

ordering information

JL	8	C	T52	A
Type	Nominal Diameter	Termination Material	Taping and Forming	Packaging
	5 (24 gauge) 6 (22 gauge) 8 (20 gauge)	C: SnCu (Other termination styles available, contact factory for options)	T26, T52	A: Ammo

For further information on packaging, please refer to Appendix C.

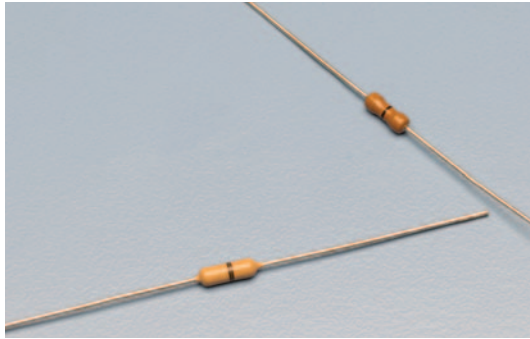

features

- Zero OHM resistors are the same shape as the CFS1/4 and CF 1/4 series
- Type Z are conformal coated
- Suitable for automatic machine insertion
- Marking: Type Z are tan color, single black band identifier
- Markings: Ivory (Z16), venetian red (Z25)
- Products meet EU RoHS requirements

dimensions and construction

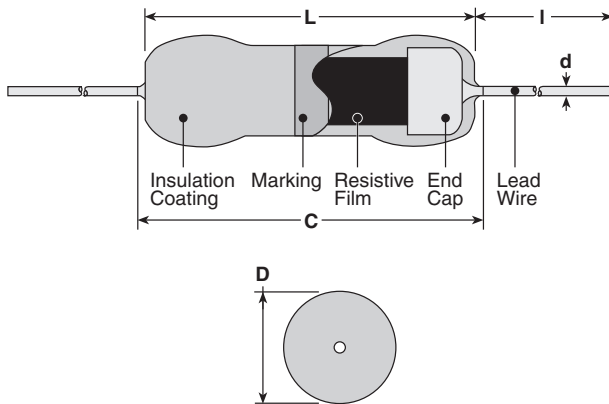

Type	Dimensions inches (mm)				I ¹	
	L (ref.) ¹	C (max.)	D	d (nom.)	Standard	Long
Z16	.126±.008 (3.2±0.2)	.134 (3.4)	.067 ^{+0.008} _{-0.004} (1.7 ^{+0.2} _{-0.1})	.018 (0.45)	.551 Min. ² (14.0 Min.)	.787 Min. ³ (20.0 Min.)
Z25	.240±.02 (6.1±0.5)	.280 (7.1)	.091±.012 (2.3±0.3)	.024 (0.6)	1.18 ^{+1.18} _{-.16} (30.0 ^{+3.0} _{-4.0})	—
Z25Y	.228 (5.8)		.087 ^{+0.016} _{-0.008} (2.2 ^{+0.4} _{-0.2})			

¹ Lead length changes depending on taping and forming type.
² Forming code S is applied for bulk type.
³ Long type is custom-made.

ordering information

Z16	C	T52	A
Type	Termination Material	Taping and Forming	Packaging
Z16 Z25 Z25Y	C: SnCu	T26, T52	A: Ammo R: Reel

For further information on packaging, please refer to Appendix C.

applications and ratings

Part Designation	Maximum Amperage	Minimum Dielectric Withstanding Voltage	Resistance	Rated Ambient Temperature	Operating Temperature Range
Z16	1.5A	300V	20mΩ or less	+70°C	-55°C to +155°C
Z25	2.5A	500V			
Z25Y	15A	500V			

environmental applications

Derating Curve

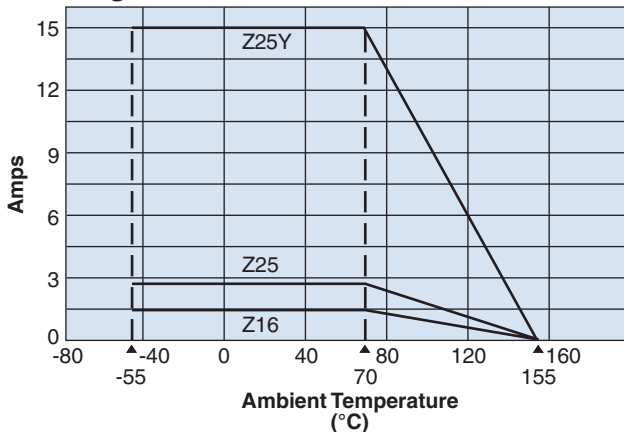

For resistors operated at an ambient temperature of 70°C or above, a power rating shall be derated in accordance with the above derating curve.

Performance Characteristics

Parameter	Requirement	Test Method JIS C5201-1
Resistance	20mΩ or less	Measuring points are 10mm ± 1mm from the end cap
Resistance to Solder Heat		260°C ± 5°C, 10 seconds ± 1 second, 350°C ± 10°C, 3.5 seconds ± 0.5 second
Terminal Strength	No mechanical damages	(Pulling Test) Z16: 5N, 30 seconds, Z25: 10N, 30 seconds (Twist Test) 360°, 5 times (Bending Test) 5N, 90°, 2 times (Z16: 2.5N)
Rapid Change of Temperature	20mΩ or less	-55°C (30 minutes)/+125°C (30 minutes), 5 cycles
Moisture Resistance		40°C ± 2°C, 90-95% RH, 1000 hours, 1.5 hr ON, 0.5 hr OFF cycle
Endurance @ 70°C		70°C ± 2°C, 1000 hours, 1.5 hr ON, 0.5 hr OFF cycle
Solvent Resistance	No visible damages to protective coating and marking	Isopropyl alcohol with ultrasonic cleansing for 2 minutes Power: 0.3W/cm ² , f: 28kHz, Temperature: 35°C ± 5°C



features

- High precision resistors with resistance tolerance $\pm 0.1\%$ and T.C.R. $\pm 5 \times 10^{-6}/K$
- Suitable for automatic machine insertion
- Products meet EU RoHS requirements
- AEC-Q200 Tested: RNS1 only
- Excellent long term stability in resistance values

leaded resistors

dimensions and construction

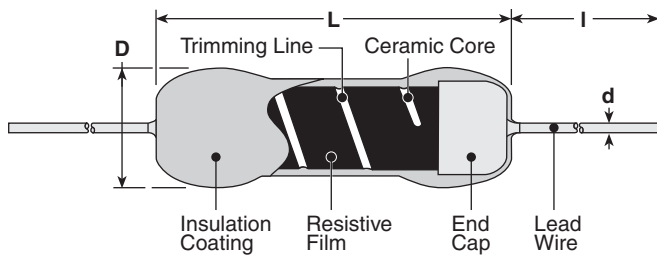

Type	Dimensions inches (mm)			
	L (ref.)	D	d	I*
RNS1/8	.250±.04 (6.4±1)	.091±.02 (2.3±0.5)	.024 (0.6)	1.496 (38)
RNS1/4	.374±.04 (9.5±1)	.138±.02 (3.5±0.5)		
RNS1/2	.531±.04 (13.5±1)	.138±.02 (3.5±0.5)		
RNS1	.610±.04 (15.5±1)	.216±.02 (5.5±0.5)	.031 (0.8)	

* Lead length changes depending on taping and forming type.

ordering information

RNS	1/8	E	C	T52	R	1001	F
Type	Power Rating	T.C.R.	Termination Material	Taping and Forming	Packaging	Nominal Resistance	Tolerance
	1/8: 0.125W 1/4: 0.25W 1/2: 0.5W 1: 1W	Y: ±5 T: ±10 E: ±25 C: ±50	C: SnCu	1/8: T26, T52, VT*, VTP*, VTE* 1/4, 1/2: T52 1: T521	A: Ammo R: Reel Nil: Box	3 significant figures + 1 multiplier "R" indicates decimal on value <100Ω	B: ±0.1% C: ±0.25% D: ±0.5% F: ±1.0%

* ±5 ppm/°C and ±10ppm/°C options are not available in radial taping.

For further information on packaging, please refer to Appendix C.

applications and ratings

Part Designation	Power Rating	T.C.R. (ppm/°C) Max.	Resistance Range E-24, E-192 (B±0.1%)	Resistance Range E-24, E-192 (C±0.25%)	Resistance Range E-24, E-192 (D±0.5%)	Resistance Range E-24, E-96 (F±1.0%)	Absolute Maximum Working Voltage	Absolute Maximum Overload Voltage	Minimum Dielectric Withstanding Voltage	Rated Ambient Temp.	Operating Temp. Range				
RNS1/8	0.125W	Y: ±5	100Ω - 100kΩ	100Ω - 100kΩ	100Ω - 100kΩ	100Ω - 100kΩ	200V	400V	500V	+70°C	-25°C to +85°C				
		T: ±10	100Ω - 200kΩ	100Ω - 200kΩ	100Ω - 200kΩ	100Ω - 200kΩ									
		E: ±25	5.1Ω - 750kΩ	5.1Ω - 1.62MΩ	0.2Ω - 2MΩ	0.2Ω - 2MΩ									
		C: ±50	5.1Ω - 750kΩ	5.1Ω - 1.62MΩ	0.2Ω - 2MΩ	0.2Ω - 2MΩ									
RNS1/4	0.25W	E: ±25	5.1Ω - 1MΩ	5.1Ω - 2MΩ	0.2Ω - 2MΩ	0.2Ω - 2MΩ	250V	500V	700V		+70°C	-55°C to +165°C			
		C: ±50	5.1Ω - 1.5MΩ	5.1Ω - 2MΩ	0.2Ω - 5.1MΩ	0.2Ω - 5.1MΩ									
RNS1/2	0.50W	E: ±25	5.1Ω - 1.5MΩ	5.1Ω - 2MΩ	0.2Ω - 2.4MΩ	0.2Ω - 4.7MΩ	300V	600V	700V				+70°C	-55°C to +165°C	
		C: ±50	5.1Ω - 2MΩ	5.1Ω - 2.4MΩ	0.2Ω - 5.1MΩ	0.2Ω - 5.1MΩ									
RNS1	1W	E: ±25	5.1Ω - 2MΩ	5.1Ω - 2.4MΩ	0.2Ω - 5.1MΩ	0.2Ω - 5.1MΩ	350V	700V	1000V	+70°C					-55°C to +165°C
		C: ±50	5.1Ω - 2.4MΩ	5.1Ω - 2.4MΩ	0.2Ω - 5.1MΩ	0.2Ω - 6.8MΩ									

environmental applications

Derating Curve

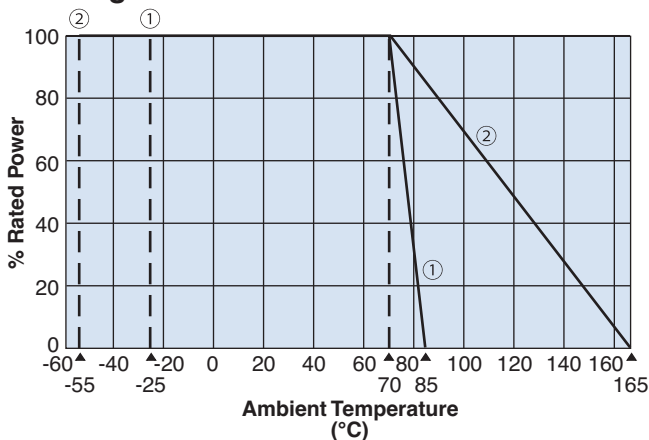

① T.C.R.: Y ($\pm 5 \times 10^{-6}/K$), T ($\pm 10 \times 10^{-6}/K$)
 ② T.C.R.: E ($\pm 25 \times 10^{-6}/K$), C ($\pm 50 \times 10^{-6}/K$)

For resistors operated at an ambient temperature of 70°C or above, a power rating shall be derated in accordance with the above derating curve.

Performance Characteristics

Parameter	Requirement $\Delta R \pm(\% + 0.05\Omega)$		Test Method
	Limit	Typical	
Resistance	Within specified tolerance	—	25°C
T.C.R.	Within specified T.C.R.	—	Y, T: +25°C/+65°C; E, C: +25°C/+125°C
Overload (Short time)	±0.25%	±0.15%	Rated voltage x 2.5 or max. overload voltage for 5 seconds, whichever is lower
Resistance to Solder Heat	±0.2%	±0.075%	350°C ± 10°C, 3.5 seconds ± 0.5 second
Rapid Change of Temperature	±0.2%	±0.075%	-55°C (30 minutes), +85°C (30 minutes), 5 cycles
Moisture Resistance	±0.75%	±0.5%	40°C ± 2°C, 90 - 95% RH, 1000 hours, 1.5 hr ON, 0.5 hr OFF cycle
Endurance at 70°C	±0.5%	±0.35%	70°C ± 2°C, 1000 hours, 1.5 hr ON, 0.5 hr OFF cycle

anti-surge power type leaded resistor



features

- Excellent anti-surge characteristics
- Stable characteristics of moisture resistance up to high resistance range
- RCR50 +(1MΩ - 12MΩ), RCR50EN (1MΩ - 12MΩ) and RCR60 (1MΩ - 12MΩ) are discharge resistors recognized by UL1676 and c-UL(CSA-C22.2 No.1-M94)
- RCR25EN (100kΩ~33MΩ), RCR50EN (100kΩ - 33MΩ) and RCR60 (100kΩ - 56MΩ) is approved by EN6234-68-1 G.10 safety
- Products with lead-free terminations meet EU RoHS requirements. EU RoHS regulation is not intended for Pb-glass contained in electrode, resistor element and glass.
- Surface mount style "N" forming is suitable for automatic mounting

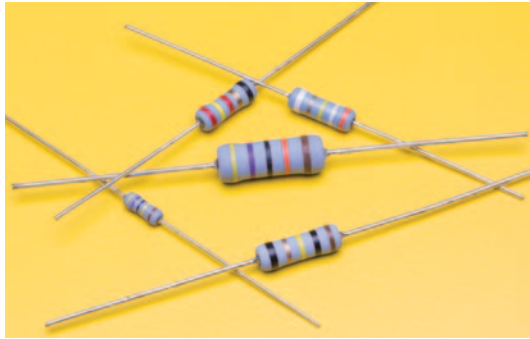

dimensions and construction

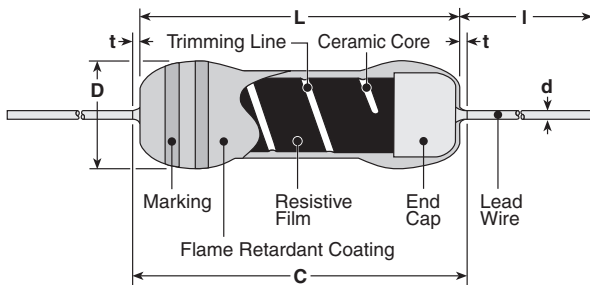

* Lead length changes depending on taping and forming.

Type	Dimensions inches (mm)					
	L	C (max.)	t (max.)	D	d (nom.)	I*
RCR16	.126±.008 (3.2±0.2)	.134 (3.4)	—	.067 ^{+0.08} _{-.004} (1.7 ^{+0.2} _{-0.1})	.018 (0.45)	.787 Min. (20.0 Min.)
RCR25 RCR25EN	.248±.02 (6.3±0.5)	.28 (7.1)	—	.098±.02 (2.5±0.5)	.024 (0.6)	
RCR50(+) RCR50EN	.374±.039 (9.5±1.0)	—	.118 (3.0)	.138±.016 (3.5±0.4)	.028 (0.7)	
RCR60	.374 ^{+0.039} _{-.004} (9.5 ^{+1.0} _{-0.2})					
RCR75	.472±.039 (12±1.0)	—	.118 (3.0)	.157±.02 (4.0±0.5)	.031 (0.8)	
RCR100	.610±.039 (15.5±1.0)	—	.118 (3.0)	.236 ^{+0.039} _{-.016} (6.0 ^{+1.0} _{-0.4})	.031 (0.8)	

ordering information

RCR	50	EN	C	T52	A	105	J
Type	Power Rating	Safety Appr. Marking	Termination Material	Taping and Forming	Packaging	Nominal Resistance	Tolerance
RCR	16: 0.25W 25: 0.25W 50: 0.5W 60: 1W 75: 2W 100: 3W	RCR50+: + RCR25EN, RCR50EN: EN Blank: Others	C: SnCu	RCR16: M5F, T26, T52 RCR25, RCR25EN: M10F, T26, T52 RCR50(+), EN): L15A, M15F, T52 RCR60: L15A, M15F, T52 RCR75: L15A, N17, T52 RCR100: L20A, L25A, M20E, N20, T521, T631	A: Ammo R: Reel TEB: Plastic embossed: N forming	2 significant figures + 1 multiplier for ±5% 3 significant figures + 1 multiplier for ±1%	F: ±1% J: ±5%

applications and ratings

Part Designation	Power Rating @ 70°C	Minimum Dielectric Withstanding Voltage	Resistance Range E-24, E-96 (F±1%)	Resistance Range E-24 (J±5%)	Absolute Maximum Working Voltage	Absolute Maximum Overload Voltage	Operating Temperature Range
RCR16	0.25W	300V	100kΩ - 5.1MΩ	100kΩ - 5.1MΩ	500V	1000V	-55°C to +155°C
RCR25 RCR25EN	0.25W	700V	100kΩ - 9.1MΩ	100kΩ - 33MΩ	DC 1600V AC 1150V	DC 2000V AC 1500V	
RCR50	0.5W	700V	3.3Ω - 910kΩ	3.3Ω - 910kΩ 13MΩ - 33MΩ	2000V 2000V	2500V 2500V	
RCR50+	0.5W	700V	1MΩ - 9.1MΩ	1MΩ - 12MΩ	2000V	2500V	
RCR50EN	0.5W	700V	100kΩ - 9.1MΩ	100kΩ - 33MΩ	2000V	2500V	
RCR60	1.0W	700V	100kΩ - 9.1MΩ	100kΩ - 56MΩ	4000V	5000V	
RCR75	2.0W	700V	100kΩ - 9.1MΩ	100kΩ - 100MΩ	5000V	5000V	
RCR100	3.0W	1000V	100kΩ - 9.1MΩ	100kΩ - 51MΩ	5000V	5000V	

For further information on packaging, please refer to Appendix C.

Specifications given herein may be changed at any time without prior notice. Please confirm technical specifications before you order and/or use.

11/16/23

environmental applications

Derating Curve

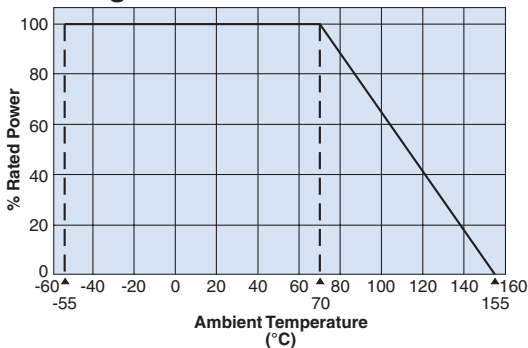

For resistors operated at an ambient temperature of 70°C or above, a power rating shall be derated in accordance with the above derating curve.

Notice of Surge Load

Surge withstanding load voltage for the resistors cannot be guaranteed when the undermentioned 4 items get to a remarkable overload in comparison with the conditions shown by surge withstanding voltage in Anti-surge characteristics. Please contact KOA in advance if such a case is anticipated.

1. Peak voltage to be applied
2. Pulse width
3. Conditions of protecting insulation around the resistor
4. Situation of proximity conductivity object

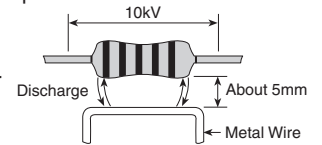

For example: In the figure, a metal wire is placed less than 5mm away from the resistor body, there is such a case that causes an electric discharge by a surge load 10kV and then destroys the outer coating.

Approvals Awarded

Type	UL1676 & c-UL (CSA-C22.2 No.1-M94)	EN62368-1 G.10
RCR25EN	—	○
RCR50+	—	—
RCR50EN	○(1MΩ~12MΩ)	○
RCR60	—	○

Performance Characteristics

Parameter	Requirement Δ R ±(% + 0.05%)			Typical	Test Method
	Limit				
Resistance	Within regulated tolerance			—	Measuring points are 10mm ± 1mm from the end cap
T.C.R.	Type	T.C.R.	Resistance Range	—	+25°C/+125°C
	RCR16	±200ppm/°C	100kΩ - 5.1MΩ		
	RCR25 (EN)	±350ppm/°C	100kΩ - 33MΩ		
	RCR50 (+)	±500ppm/°C	3.3Ω - 91kΩ		
		±350ppm/°C	100kΩ - 33MΩ		
	RCR50EN	±350ppm/°C	100kΩ - 33MΩ		
	RCR60	±350ppm/°C	100kΩ - 56MΩ		
	RCR75	±350ppm/°C	100kΩ - 100MΩ		
RCR100	±200ppm/°C	100kΩ - 51MΩ			
Overload	1%			0.5%	Rated voltage x 2.5 or maximum overload voltage, whichever is lower, for 5 seconds
Resistance to Solder Heat	1%			0.5%	260°C ± 5°C, 10 seconds ± 1 second or 350°C ± 10°C, 3.5 seconds ± 0.5 seconds
Terminal Strength	No mechanical damage			—	Twist 360°, 5 times
Rapid Change of Temperature	1%			0.5%	-55°C (30 minutes)/+155°C (30 minutes), 5 cycles
Moisture Resistance	5%			2.5%	40°C ± 2°C, 90-95% RH, 1000 hours, 1.5 hr ON, 0.5 hr OFF cycle RCR16, 25, 50 (+), 60 : Rated Voltage RCR75, 100 : Power Ratingx0.1
Endurance @ 70°C	5%			2.5%	70°C ± 2°C, 1000 hours, Rated Voltage, 1.5 hr ON, 0.5 hr OFF cycle
Resistance to Solvent	No abnormality in appearance. Markings shall be easily legible.			—	Isopropyl alcohol with ultrasonic washing, 2 minutes Power: 0.3W/cm ² , f: 28kHz, Temperature: 35°C ± 5°C
Surge Withstanding	10%			2.5%	Discharge test: 2kV - 10kV, 0.01μF capacitor discharge pulse, 10 times (1 pulse/5 seconds maximum)
Applied Voltage		2kV	3kV	3.3Ω - 6.2Ω: 10kV 6.8Ω - 10Ω: 7kV 11Ω - 9.1kΩ: 5kV 10kΩ - 91kΩ: 7kV 100kΩ - 33MΩ: 10kV	10kV
EN60065 Test (RCR50EN, RCR60 only)	20%			—	Discharge test: 10kV, 1000pF capacitor discharge pulse, 50 times (1 pulse/5 seconds maximum)

Specifications given herein may be changed at any time without prior notice. Please confirm technical specifications before you order and/or use.

11/16/23

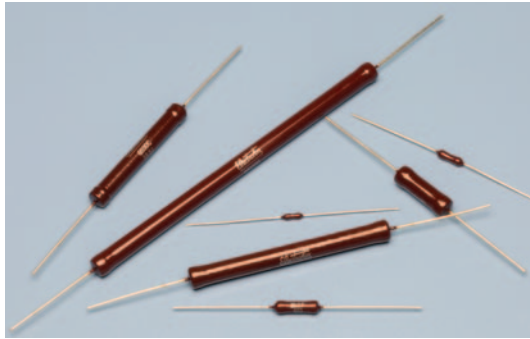

features

- Miniature construction can endure to high voltage and high power
- Excellent in anti-surge characteristics
- Wide resistance range of 500kΩ - 10GΩ and small T.C.R.
- Product meets EU RoHS requirements. EU RoHS regulation is not intended for Pb-glass contained in resistor element and brass cap.

dimensions and construction

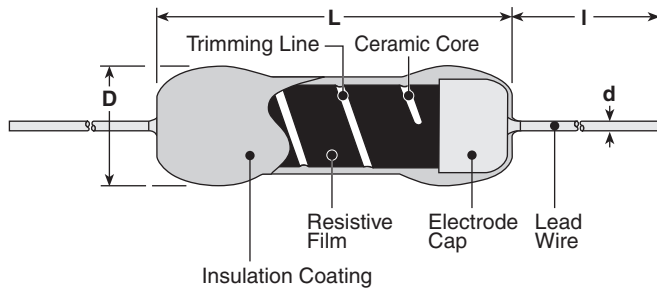

Type	Dimensions inches (mm)			
	L	D	d (Nominal)	l
GS 1/4	.248±.039 (6.3±1.0)	.091±.020 (2.3±0.5)	.026 (0.65)	1.50±.118 (38.0±3.0)
GS 1/2	.374±.039 (9.5±1.0)	.138±.024 (3.5±0.6)	.031 (0.8)	
GS 1	.591±.059 (15.0±1.5)	.177±.039 (4.5±1.0)		
GS 2	.945±.059 (24.0±1.5)	.311±.039 (7.9±1.0)	.039 (1.0)	1.50±.118 (38.0±3.0)
GS 3	2.05±.079 (52.0±2.0)			
GS 5	2.99±.079 (76.0±2.0)			
GS 7	3.82±.118 (97.0±3.0)			
GS 10	4.61±.118 (117.0±3.0)			
GS 12	5.39±.118 (137.0±3.0)			

leaded resistors

Derating Curve

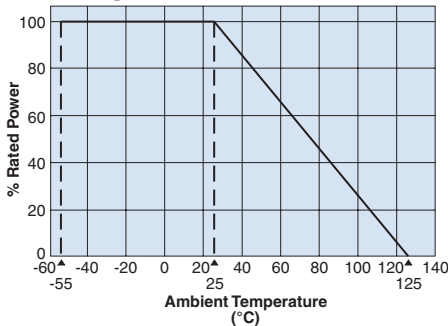

For resistors operated at an ambient temperature of 25°C or above, a power rating shall be derated in accordance with the above derating curve.

Surface Temperature Rise

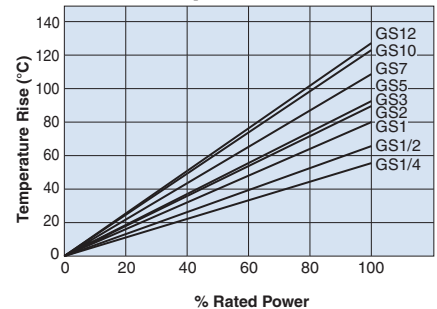

ordering information

GS	1/2	L	C	106	J
Type	Power Rating	T.C.R.	Termination Surface Material	Nominal Resistance	Resistance Tolerance
	1/4: 0.25W 1/2: 0.5W 1: 1W 2: 2W 3: 3W 5: 5W 7: 7W 10: 10W 12: 12W	D: ±100 L: ±200	C: SnCu	±2%, ±5%, ±10%: 2 significant figures + 1 multiplier ±0.5%, ±1%: 3 significant figures + 1 multiplier	D: ±0.5% F: ±1% G: ±2% J: ±5% K: ±10%

For further information on packaging, please refer to Appendix C.

Specifications given herein may be changed at any time without prior notice. Please confirm technical specifications before you order and/or use.

10/28/21

applications and ratings

leaded resistors

Part Designation	Power Rating	T.C.R. (ppm/°C) Max.	Resistance Range (Ω)					Max. Working Voltage	Max. Overload Voltage	Impulse Withstand Voltage	Rated Ambient Temperature	Operating Temperature Range
			E-24 & 25, 50x10 ⁿ									
			(D±0.5%)	(F±1%)	(G±2%)	(J±5%)	(K±10%)					
GS1/4	0.25W	D: ±100	500K-20M					0.5kV	1kV	1.25kV	+25°C	-55°C to +125°C
		L: ±200										
GS1/2	0.5W	D: ±100					1kV	2kV	2.5kV			
		L: ±200										
GS1	1W	D: ±100		500K	-100M		3kV	4.5kV	6kV			
		L: ±200										
GS2	2W	D: ±100	500K-50M				5kV	7.5kV	10kV			
		L: ±200										
GS3	3W	D: ±100					15kV	20kV	30kV			
		L: ±200										
GS5	5W	D: ±100					20kV	30kV	40kV			
		L: ±200										
GS7	7W	D: ±100	1M-50M	1M-100M	1M-500M	1M-500M	1M-500M	30kV	40kV	50kV		
		L: ±200	500K-50M	500K-100M	500K-1G	500K-10G	500K-10G					
GS10	10W	D: ±100	1M-50M	1M-100M	1M-500M	1M-500M	1M-500M	35kV	50kV	60kV		
		L: ±200	500K-50M	500K-100M	500K-1G	500K-10G	500K-10G					
GS12	12W	D: ±100	1M-50M	1M-100M	1M-500M	1M-500M	1M-500M	40kV	60kV	70kV		
		L: ±200	500K-50M	500K-100M	500K-1G	500K-10G	500K-10G					

environmental applications
Performance Characteristics

Parameter	Requirement Δ R ±%	Test Method
Resistance	Within regulated tolerance	25°C
T.C.R.	Within specified T.C.R.	+25°C/125°C
Overload (Short time)	2%: T.C.R. 200x10 ⁻⁶ /K 0.5%: T.C.R. 100x10 ⁻⁶ /K	Rated voltage x 2.5 (GS1/4, GS1/2), rated voltage x 2 (GS1-GS12) or Max. overload voltage, whichever is lower for 5 seconds
Resistance to Solder Heat	2%: T.C.R. 200x10 ⁻⁶ /K 0.5%: T.C.R. 100x10 ⁻⁶ /K	350°C ± 10°C, 3 seconds ± 0.5 seconds or 260°C ± 5°C, 10 seconds ± 1 second
Rapid Change of Temperature	2%: T.C.R. 200x10 ⁻⁶ /K 0.5%: T.C.R. 100x10 ⁻⁶ /K	-55°C (30 minutes)/ +125°C (30 minutes), 5 cycles
Moisture Resistance	5%: T.C.R. 200x10 ⁻⁶ /K 2%: T.C.R. 100x10 ⁻⁶ /K	40°C, 90% - 95%RH, 1000h
Endurance @ 25°C	3%: T.C.R. 200x10 ⁻⁶ /K 2%: T.C.R. 100x10 ⁻⁶ /K	25°C, 1000 hours 1.5 hr ON/0.5 hr OFF cycle
Voltage Coefficient	±50x10 ⁻⁶ /V: T.C.R. 200x10 ⁻⁶ /K ±10x10 ⁻⁶ /V: T.C.R. 100x10 ⁻⁶ /K	GS1/4, 1/2 only, Rated voltage or max. working voltage, whichever is lower and 1/10 of its voltage
Voltage Characteristics	5%: T.C.R. 200x10 ⁻⁶ /K 3%: T.C.R. 100x10 ⁻⁶ /K	GS1 - 12, Rated voltage or max. working voltage, whichever is lower and 1/10 of its voltage
Resistance to Solvent	No evidence of damage to protective coating and marking	Soaking in IPA for 1 minute and brushing 10 times -3 cycles - liquid temperature 25°C ±5°C
Impulse Withstand Voltage	No abnormality in appearance and flash-over	An impulse voltage shall be applied 5 times at an interval of 1 minute

Specifications given herein may be changed at any time without prior notice. Please confirm technical specifications before you order and/or use.

11/09/22

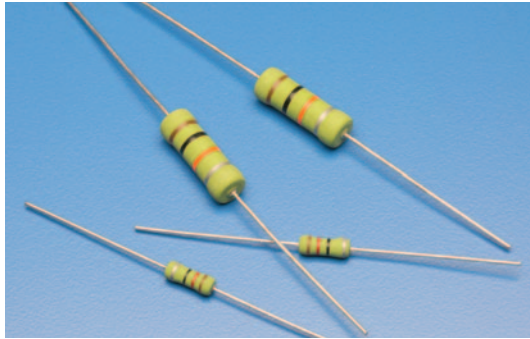

features

- KOA original bulk ceramic resistors
- Flame retardant coating (Equivalent of UL94V0)
- Excellent in in-pulse and inrush current characteristics
- Non-inductive resistors
- Products meet EU RoHS requirements
- Higher reliability against disconnection compared to wirewound resistors and film resistors
- AEC-Q200 Tested

leaded resistors

dimensions and construction

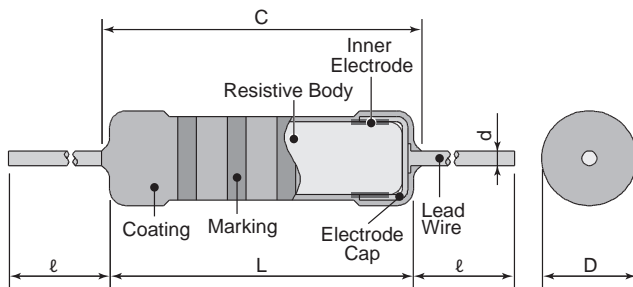

Type	Dimensions inches (mm)				
	L	C (max.)	D	d (nom.)	I*
PCF1/2	.354±.039 (9.0±1.0)	.437 (11.1)	.138±.02 (3.5±0.5)	.028 (0.7)	1.18±.118 (30.0±3.0)
PCF1	0.65±.039 (16.5±1.0)	.748 (19.0)	.217±.039 (5.5±1.0)	.031 (0.8)	1.50±.118 (38.0±3.0)
PCF2	.748±.039 (19.0±1.0)	.886 (22.5)	.276±.039 (7.0±1.0)		

* Lead length changes depending on taping type

ordering information

PCF	1	C	T631	R	103	K
Type	Power Rating	Termination Material	Taping	Packaging	Nominal Resistance	Tolerance
PCF	1/2: 0.5W 1: 1W 2: 2W	C: SnCu	1/2: T52 1: T631 2: T631	R: Reel	2 significant figures + 1 multiplier	K: ±10% M: ±20%

taping

Type	Axial Taping	
	T52	T631
PCF1/2	○	—
PCF1	—	○
PCF2	—	○

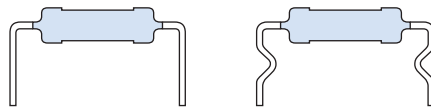

Contact us for lead forming details.

For further information on packaging, please refer to Appendix C.

applications and ratings

Part Designation	Power Rating @ 70°C	Resistance Range (Ω)		T.C.R. (x10 ⁻⁶ /K)	Maximum Working Voltage	Maximum Overload Voltage	Dielectric Withstanding Voltage	Rated Ambient Temp.	Operating Temp. Range
		K: ±10% E-12	M: ±20% E-6						
PCF1/2	0.5W	4.7 - 100K	4.7 - 100K	-500 ~ -1300: 3.3Ω≤R<10Ω -600 ~ -1500: 10Ω≤R<100Ω -700 ~ -1800: 100Ω≤R<1kΩ -900 ~ -1900: 1kΩ≤R<100kΩ -900 ~ -2000: 100kΩ≤R<200kΩ -900 ~ -2200: 200kΩ≤R<390kΩ	200V	400V	500V	+70°C	-40°C to +200°C
PCF1	1.0W	3.3 - 390K	3.3 - 330K	300V	600V				
PCF2	2.0W			400V	800V	700V			

Rated Voltage = $\sqrt{\text{Power Rating} \times \text{Resistance Value}}$ or Maximum Working Voltage, whichever is lower.

environmental applications

Derating Curve

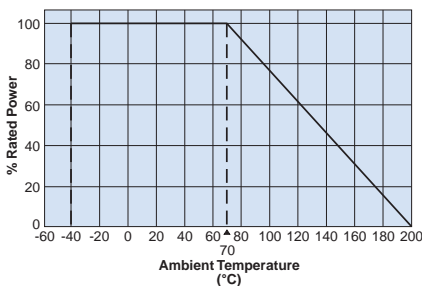

For resistors operated at an ambient temperature of 70°C or above, a power rating shall be derated in accordance with the derating curve.

Performance Characteristics

Parameter	Requirement ΔR ±(% + 0.05Ω)		Test Method																											
	Limit	Typical																												
Resistance	Within regulated to tolerance	—	Resistance 3.3Ω≤R<10Ω 10Ω≤R<100Ω 100Ω≤R<390kΩ	Measurement voltage 0.3V 1.0V 3.0V																										
T.C.R	-500~-1300:3.3Ω≤R<10Ω -600~-1500:10Ω≤R<100Ω -700~-1800:100Ω≤R<1kΩ -900~-1900:1kΩ≤R<100kΩ -900~-2000:100kΩ≤R<200kΩ -900~-2200:200kΩ≤R<390kΩ	—	+25°C/-40°C, +25°C/+75°C and +25°C/+125°C																											
Voltage Coefficient (Apply for over 1kΩ)	0~0.2%/V	—	Rated voltage and rated voltage x 10%																											
Overload	2%	0.4%	Rated voltage x 2.5 or maximum overload voltage for 5s, whichever less																											
Resistance to pulse	Refer to the table on the right	—	The resistor mounted to the test circuit as below is applied with high voltage impulse 10,000 cycles.	<table border="1"> <thead> <tr> <th>Type</th> <th>Test Voltage</th> <th>Performance Requirements ΔR ±(% + 0.05Ω)</th> </tr> </thead> <tbody> <tr> <td rowspan="3">PCF1/2</td> <td>10kV:4.7Ω≤R<10kΩ</td> <td>5</td> </tr> <tr> <td>10kV:10kΩ≤R<33kΩ</td> <td>10</td> </tr> <tr> <td>10kV:33kΩ≤R<100kΩ</td> <td>25</td> </tr> <tr> <td rowspan="3">PCF1</td> <td>4kV:10kΩ≤R<100kΩ</td> <td>5</td> </tr> <tr> <td>14kV:3.3Ω≤R<30kΩ</td> <td>5</td> </tr> <tr> <td>14kV:30kΩ≤R<390kΩ</td> <td>10</td> </tr> <tr> <td rowspan="3">PCF2</td> <td>7kV:30kΩ≤R<390kΩ</td> <td>5</td> </tr> <tr> <td>20kV:3.3Ω≤R<10kΩ</td> <td>5</td> </tr> <tr> <td>20kV:10kΩ≤R<390kΩ</td> <td>10</td> </tr> <tr> <td>11kV:10kΩ≤R<390kΩ</td> <td>5</td> </tr> </tbody> </table>	Type	Test Voltage	Performance Requirements ΔR ±(% + 0.05Ω)	PCF1/2	10kV:4.7Ω≤R<10kΩ	5	10kV:10kΩ≤R<33kΩ	10	10kV:33kΩ≤R<100kΩ	25	PCF1	4kV:10kΩ≤R<100kΩ	5	14kV:3.3Ω≤R<30kΩ	5	14kV:30kΩ≤R<390kΩ	10	PCF2	7kV:30kΩ≤R<390kΩ	5	20kV:3.3Ω≤R<10kΩ	5	20kV:10kΩ≤R<390kΩ	10	11kV:10kΩ≤R<390kΩ	5
Type	Test Voltage	Performance Requirements ΔR ±(% + 0.05Ω)																												
PCF1/2	10kV:4.7Ω≤R<10kΩ	5																												
	10kV:10kΩ≤R<33kΩ	10																												
	10kV:33kΩ≤R<100kΩ	25																												
PCF1	4kV:10kΩ≤R<100kΩ	5																												
	14kV:3.3Ω≤R<30kΩ	5																												
	14kV:30kΩ≤R<390kΩ	10																												
PCF2	7kV:30kΩ≤R<390kΩ	5																												
	20kV:3.3Ω≤R<10kΩ	5																												
	20kV:10kΩ≤R<390kΩ	10																												
11kV:10kΩ≤R<390kΩ	5																													
Resistance to soldering heat	2%	0.8%	350°C±10°C, 3.5s±0.5s																											
Rapid change of temperature	2%	0.4%	-40°C (30 min.)/+85°C (30 min.), 5 cycles																											
Moisture resistance	5%	0.6%	40°C±2°C, 90%~95%RH, 1000 hours, 1.5h ON/0, 5h OFF cycles																											
Load life	5%	0.4%	70°C±2°C, 1000h, 1.5h ON/0, 5h OFF cycles																											
Resistance to Solvent	No abnormality in appearance. Marking shall be easily legible.	—	Dipping in IPA or Xylene for 3 minutes and leaving for 10 minutes after removing drops, then brushing 10 times.																											

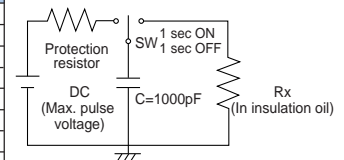

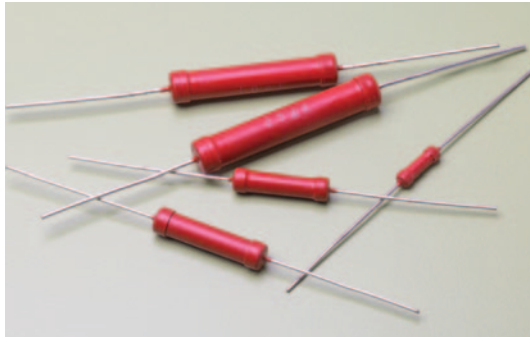

features

- KOA original bulk ceramic resistors
- Excellent in anti-pulse resistance, inrush current and active discharge characteristics
- Higher reliability against disconnection compared to wirewound resistors and film resistors
- Products meet EU RoHS requirements
- Non-inductive resistors
- AEC-Q200 Tested

dimensions and construction

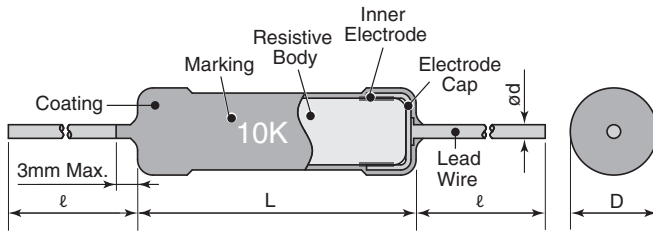

Type	Dimensions inches (mm)			
	L	D	d (nom.)	l*
HPC1/2	.433±.039 (11.0±2.0)	.138±.039 (3.5±1.0)	.031 (0.8)	1.50±.118 (38.0±3.0)
HPC1	.630±.039 (16.0±2.0)	.177±.039 (4.5±1.0)		
HPC2	.827±.039 (21.0±2.0)	.197±.039 (5.0±1.0)		
HPC3	1.02±.039 (26.0±2.0)	.236±.039 (6.0±1.0)	.039 (1.0)	
HPC4	1.50±.039 (38.0±2.0)	.276±.039 (7.0±1.0)		
HPC5	1.73±.039 (44.0±2.0)	.295±.039 (7.5±1.0)		

* Lead length changes depending on taping type

Derating Curve

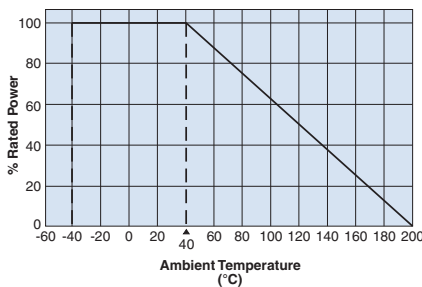

For resistors operated at an ambient temperature of 40°C or above, a power rating shall be derated in accordance with the derating curve.

ordering information

HPC	1	C	T631	R	103	K
Type	Power Rating	Termination Material	Taping	Packaging	Nominal Resistance	Tolerance
HPC	1/2: 0.5W 1: 1W 2: 2W 3: 3W 4: 4W 5: 5W	C: SnCu	See Table Below	A: Ammo R: Reel Nil: Box	2 significant figures + 1 multiplier	K: ±10% M: ±20%

taping

Type	Axial Taping	
	T52	T631
HPC1/2	○	—
HPC1	—	○

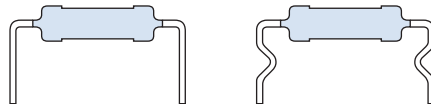

Contact us for lead forming details.

For further information on packaging, please refer to Appendix C.

Specifications given herein may be changed at any time without prior notice. Please confirm technical specifications before you order and/or use.

11/01/23

applications and ratings

Part Designation	Power Rating @ 40°C	Resistance Range (Ω)		T.C.R. (x10 ⁻⁶ /K)	Maximum Working Voltage	Maximum Overload Voltage	Rated Ambient Temp.	Operating Temp. Range
		K: ±10% E-12	M: ±20% E-6					
HPC1/2	0.5W	10 - 390K	3.3 - 330K	-500 ~ -1300: 3.3Ω≤R<10Ω	200V	400V	+40°C	-40°C to +200°C
HPC1	1.0W			-600 ~ -1500: 10Ω≤R<100Ω	300V	600V		
HPC2	2.0W			-700 ~ -1800: 100Ω≤R<1kΩ	400V	800V		
HPC3	3.0W			-900 ~ -1900: 1kΩ≤R<100kΩ	450V	900V		
HPC4	4.0W			-900 ~ -2000: 100kΩ≤R<200kΩ	500V	1000V		
HPC5	5.0W			-900 ~ -2200: 200kΩ≤R<390kΩ	550V	1100V		

Rated voltage = $\sqrt{\text{Power Rating} \times \text{Resistance Value}}$ or Max. working voltage, whichever is lower

environmental applications

Performance Characteristics

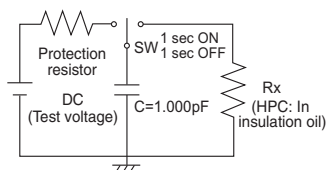
Parameter	Requirement Δ R ±(% + 0.05Ω)		Test Method																													
	Limit	Typical																														
Resistance	Within regulated to tolerance	—	Resistance 3.3Ω≤R<10Ω 10Ω≤R<100Ω 100Ω≤R<390kΩ	Measurement voltage 0.3V 1.0V 3.0V	25°C																											
T.C.R	-500~-1300:3.3Ω≤R<10Ω -600~-1500:10Ω≤R<100Ω -700~-1800:100Ω≤R<1kΩ -900~-1900:1kΩ≤R<100kΩ -900~-2000:100kΩ≤R<200kΩ -900~-2200:200kΩ≤R<390kΩ	—	+25°C/-40°C and +25°C/+125°C																													
Voltage Coefficient (Apply for over 1kΩ)	0~-0.2%/V (HPC1/2) 0~-0.1%/V (HPC1) 0~-0.05%/V (HPC2,3,4,5)	—	Rated voltage and rated voltage x 10%																													
Overload	2%	0.4%	Rated voltage x 2.5 or maximum overload voltage for 5s, whichever less																													
Resistance to pulse	Refer to the table on the right	—	<p>The resistor mounted to the test circuit as below is applied with high voltage impulse 10,000 cycles.</p> <table border="1"> <thead> <tr> <th>Type</th> <th>Test Voltage</th> <th>Performance Requirements R ±(% + 0.05Ω)</th> </tr> </thead> <tbody> <tr> <td rowspan="3">HPC1/2</td> <td>8kV:3.3Ω≤R<30kΩ</td> <td>5</td> </tr> <tr> <td>8kV:30kΩ≤R<390kΩ</td> <td>10</td> </tr> <tr> <td>5kV:30kΩ≤R<390kΩ</td> <td>5</td> </tr> <tr> <td rowspan="3">HPC1</td> <td>15kV:3.3Ω≤R<30kΩ</td> <td>5</td> </tr> <tr> <td>15kV:30kΩ≤R<390kΩ</td> <td>10</td> </tr> <tr> <td>7kV:30kΩ≤R<390kΩ</td> <td>5</td> </tr> <tr> <td rowspan="3">HPC2</td> <td>25kV:3.3Ω≤R<30kΩ</td> <td>5</td> </tr> <tr> <td>25kV:30kΩ≤R<390kΩ</td> <td>10</td> </tr> <tr> <td>15kV:30kΩ≤R<390kΩ</td> <td>5</td> </tr> <tr> <td>HPC3 HPC4 HPC5</td> <td>25kV</td> <td>5</td> </tr> </tbody> </table>		Type	Test Voltage	Performance Requirements R ±(% + 0.05Ω)	HPC1/2	8kV:3.3Ω≤R<30kΩ	5	8kV:30kΩ≤R<390kΩ	10	5kV:30kΩ≤R<390kΩ	5	HPC1	15kV:3.3Ω≤R<30kΩ	5	15kV:30kΩ≤R<390kΩ	10	7kV:30kΩ≤R<390kΩ	5	HPC2	25kV:3.3Ω≤R<30kΩ	5	25kV:30kΩ≤R<390kΩ	10	15kV:30kΩ≤R<390kΩ	5	HPC3 HPC4 HPC5	25kV	5	
Type	Test Voltage	Performance Requirements R ±(% + 0.05Ω)																														
HPC1/2	8kV:3.3Ω≤R<30kΩ	5																														
	8kV:30kΩ≤R<390kΩ	10																														
	5kV:30kΩ≤R<390kΩ	5																														
HPC1	15kV:3.3Ω≤R<30kΩ	5																														
	15kV:30kΩ≤R<390kΩ	10																														
	7kV:30kΩ≤R<390kΩ	5																														
HPC2	25kV:3.3Ω≤R<30kΩ	5																														
	25kV:30kΩ≤R<390kΩ	10																														
	15kV:30kΩ≤R<390kΩ	5																														
HPC3 HPC4 HPC5	25kV	5																														
Resistance to soldering heat	2%	0.8%	350°C±10°C, 3.5s±0.5s																													
Rapid change of temperature	2%	0.4%	-40°C(30min.)/+85°C(30min.), 5 cycles																													
Moisture resistance	5%	0.6%	40°C±2°C, 90%~95%RH, 1000 hours, 1.5h ON/0, 5h OFF cycles																													
Load life	5%	0.4%	40°C±2°C, 1000h, 1.5h ON/0, 5h OFF cycles																													
Resistance to Solvent	No abnormality in appearance. Marking shall be easily legible.	—	Dipping in IPA or Xylene for 3 minutes and leaving for 10 minutes after removing drops, then brushing 10 times.																													
High Temperature Exposure	5%	1.7%	+200°C, 1000 hours																													



features

- Suitable for noise suppression of engine ignition system
- Reliable in pulse/transient applications
- Products meet EU RoHS requirements

leaded resistors

dimensions and construction

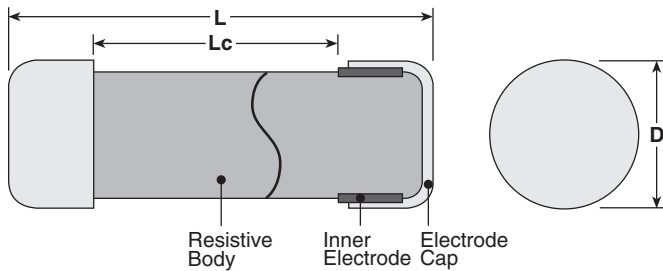

Size Code	Dimensions inches (mm)			Cap Material
	L	Lc (min.)	D	
CPCN1/2	.421±.02 (10.7±0.5)	.213 (5.4)	.138±.004 (3.5±0.1)	Fe(Ni/Cu plating)
CPCN1	.63±.024 (16.0±0.6)	.378 (9.6)	.187±.012 (4.75±0.3)	
CPCN2N	.720±.024 (18.3±0.6)	.452 (11.5)	.187±.012 (4.75±0.3)	
CPCN2NS	.720±.024 (18.3±0.6)	.452 (11.5)	.187±.012 (4.75±0.3)	SUS304
CPCN3	.720±.024 (18.3±0.6)	.394 (10.0)	.283±.012 (7.2±0.3)	Fe(Sn/Cu plating)

ordering information

CPCN	2N	S	502	M
Type	Power Rating Symbol 1/2: 0.5W 1: 1.0W 2N: 1.5W 3: 2.0W	Cap Material Symbol S: SUS304 Nil: Fe (plating)	Nominal Resistance 2 significant figures + 1 multiplier	Tolerance M: ±20%

applications and ratings

Type	Power Rating	Nominal Resistance	Resistance Tolerance	T.C.R. (ppm/°C)	Maximum Working Voltage	Maximum Overload Voltage	Rated Ambient Temperature	Operating Temperature Range
CPCN1/2	0.5W	1kΩ, 5kΩ, 10kΩ, 15kΩ	M: ±20%	-1200±300	86V	215V	+40°C	-40°C to +200°C
CPCN1	1.0W				122V	305V		
CPCN2N CPCN2NS	1.5W	1kΩ, 2kΩ, 5kΩ, 10kΩ, 15kΩ			150V	375V		
CPCN3	2.0W	15kΩ			173V	432V		

Rated Voltage = $\sqrt{\text{Power Rating} \times \text{Resistance Value}}$ or Maximum Working Voltage, whichever is lower.

environmental applications

Derating Curve

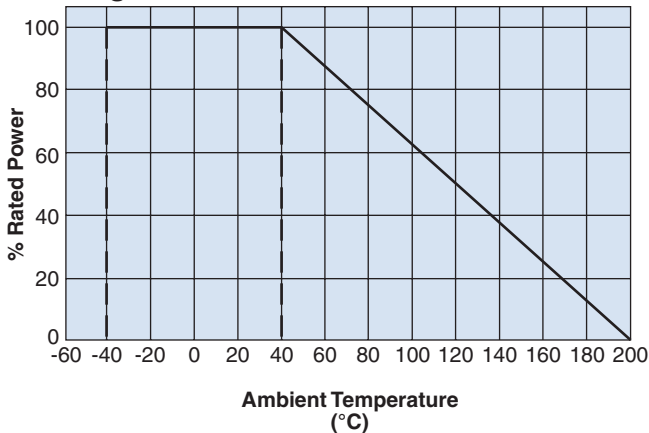

For resistors operated at an ambient temperature of 40°C or higher, the power rating shall be derated in accordance with this derating curve.

Performance Characteristics

Parameter	Requirement $\Delta R \pm(\%+0.05\Omega)$		Test Method			
	Limit	Typical				
Resistance	Within regulated tolerance	—	Resistance	Measurement Voltage		25°C
			1kΩ, 2kΩ, 5kΩ	10V		
			10kΩ, 15kΩ	30V		
T.C.R.	-1200±300ppm/°C	—	+25°C/-40°C and +25°C/+125°C			
Voltage Coefficient	0 ~ -0.2%/V	—	Rated voltage and rated voltage x 10%			
Overload	2	0.3	Rated voltage x 2.5 or max. overload voltage for 5 seconds, whichever is less			
Load Life at High Voltage Pulse	30	—	Continuous 250h high voltage pulse on the test circuit (Refer to JIS D5111) CPCN1/2, CPCN1 in insulation oil			
Resistor Body Strength	No mechanical damages	—	Type	Holding Distance	Time	Force
			CPCN1/2	5.0 ± 0.2mm	10 seconds	98N (10kgf)
			CPCN1	9.0 ± 0.3mm		
			CPCN2N/2NS CPCN3	12.3 ± 0.3mm		
Rapid Change of Temperature	5.0	—	-55°C (15 minutes), +155°C (15 minutes), 500 cycles			
Moisture Resistance	5.0	0.9	40°C ± 2°C, 90 - 95% RH, 1000 hours, 1.5 hr ON, 0.5 hr OFF cycle			
Load Life	5.0	0.7	40°C ± 2°C, 1000 hours, 1.5 hr ON, 0.5 hr OFF cycle			
Low Temperature Operation	5.0	0.7	-40°C, 24 hours			
High Temperature Exposure	5.0	2.0	+200°C, 1000 hours			

The resistance measurement before and after the examination should be performed in room temperature with difference ±1°C.

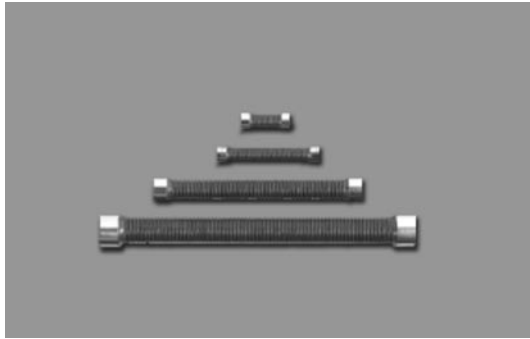

features

- PSN can respond to high voltage and high power with a wide resistance range of 500Ω~6GΩ
- PSO is made completely moisture preventive to be PSN that can be used under high moisture environment
- PN is a non-inductive type and can be used for high frequency
- PWW and PAP type are non-inductive wire wound resistors
- PWW resistors have the same shapes as PSN and can be used for a low resistance area that cannot be produced with PSN resistors
- PAP resistors are non-inductive wirewound resistors with inductance less than PWW can be used for pulse wave measurement, impulse generators, etc. and have the same dimensions as PWW resistors. EU RoHS regulation is not intended for lead in brass.

dimensions and construction

PSN • PV

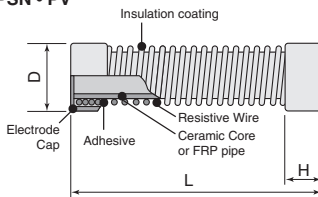

PN, PWW, PAP

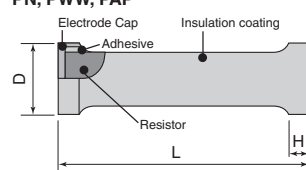

PSO

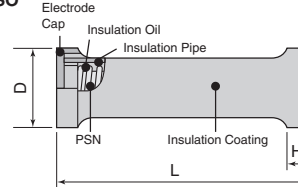

Size Code	Dimensions (mm)			Weight (g)
	L	D±0.5	H (Nominal)	
PSN-0.5	50±2	17.5	10	20
PSN-1	100±2		30	
PSN-2	200±2	24	15	85
PSN-3	300±2	33	20	250
PSN-4	400±3	45		600
PSN-5	500±3	62	25	800
PSN-6	1000±5			1350
PV-0.5	80±2	9.5	8	12
PV-1	150±2			23
PV-2		17.5	10	45
PV-5		24	15	105
PV-8	250±2	33	20	220
PSO-1	105±5	28	10	150
PSO-2	205±5	38		370

Size Code	Dimensions (mm)			Weight (g)	
	L	D±0.5	H (Nominal)		
PSO-3	320±5	46	20	760	
PSO-4	420±5	65		1900	
PSO-5	530±5	80	25	3500	
PSO-6	1050±5			6200	
PN-0.5	50±2	17	8	25	
PN-1	100±2			55	
PN-2	200±2		12	80	
PN-3	300±2			100	
PN-4	400±2	20	20	125	
PWW-3, PAP-3	300±2			33	310 • 250
PWW-4, PAP-4	400±3			45	660 • 510
PWW-5, PAP-5	500±3			62	25
PWW-6, PAP-6	1000±5	2700 • 1850			

ordering information

PSN

PSN-	0.5	CP	F	A	105	J
Product Code	Power Rating	Cap	RoHS	Holder	Nominal Resistance	Resistance Tolerance
	0.5 : 2W 1 : 5W 2 : 10W 3 : 25W 4 : 50W 5 : 125W 6 : 250W	C M CP		Nil: No Holder A B	3 digits	J : ±5% K : ±10% M : ±20%

PSO

PSO-	0.5	C	F	105	J
Product Code	Power Rating	Cap	RoHS	Nominal Resistance	Resistance Tolerance
	1 : 4W 2 : 8W 3 : 20W 4 : 40W 5 : 100W 6 : 200W	C		3 digits	J : ±5% K : ±10% M : ±20%

Specifications given herein may be changed at any time without prior notice. Please confirm technical specifications before you order and/or use.

11/15/22

ordering information

PV

PV-	0.5	CP	F	A	105	J
Product Code	Power Rating	Cap	RoHS	Holder	Nominal Resistance	Resistance Tolerance
	0.5 : 2W 1 : 4W 2 : 7W 5 : 12W 8 : 20W	C M CP		Nil: No Holder A B	3 digits	J : ±5% K : ±10% M : ±20%

PN

PN-	0.5	CP	F	105	J
Product Code	Power Rating	Cap	RoHS	Nominal Resistance	Resistance Tolerance
	0.5 : 1.5W 1 : 3W 2 : 6W 3 : 9W 4 : 12W	C M CP		3 digits	J : ±5% K : ±10% M : ±20%

PWW, PAP

PWW-	3	M	F	A	102	J
Product Code	Power Rating	Cap*	RoHS	Holder	Nominal Resistance	Resistance Tolerance
PWW PAP	3 : 25W 4 : 50W 5 : 100W 6 : 200W	M		Nil: No Holder A B	3 digits	J : ±5% K : ±10% M : ±20%

* Contact us when you have control request for environmental hazardous material other than the substance specified by EU-RoHS. P series resistors use brass for the electrode cap. Lead in brass is a substance not subject to the EU-RoHS (exemption 6(c)), but please note that it exceeds the threshold of the EU-REACH (Reach 19th SVHC list).

applications and ratings

Part Designation	Power Rating (W)	Resistance Range (Ω) J: ±5% K: ±10% M: ±20% (E24**)	T.C.R. (x10 ⁻⁶ /K)	Maximum Working Voltage	Impulse Withstand Voltage	Energy Rating 1 time/5 min.	Operating Temperature Range	
PSN-0.5	2	500~500M	±1500: +25°C/-15°C	15kV	20kV	50J	-30°C~+125°C	
PSN-1	5	1k~1G		30kV	40kV	125J		
PSN-2	10	2k~2G		60kV	80kV	400J		
PSN-3	25	3k~3G		90kV	120kV	1.8kJ		
PSN-4	50	4k~4G		120kV	160kV	4.0kJ		
PSN-5	125	5k~5G		150kV	200kV	9.0kJ		
PSN-6	250	6k~6G	±1000: +25°C/+85°C (R<1GΩ)	300kV	400kV	20.0kJ	-15°C~+60°C	
PV-0.5	2	500~500M		24kV	32kV	45J		
PV-1	4	1k~1G		45kV	60kV	90J		
PV-2	7	1.5k~1.5G		±3000 (R≥1GΩ)	75kV	100kV		270J
PV-5	12	2.5k~2.5G						650J
PV-8	20	2.5k~2.5G						950J
PSO-1	4	1k~1G	30kV				40kV	100J
PSO-2	8	2k~2G	60kV	80kV	320J			
PSO-3	20	3k~3G	90kV	120kV	1.5kJ	-30°C~+125°C		
PSO-4	40	4k~4G	120kV	160kV	3.2kJ			
PSO-5	100	5k~5G	150kV	200kV	7.2kJ			
PSO-6	200	6k~6G	300kV	400kV	16.0kJ			
PN-0.5	1.5	50~500k	±200	—	20kV		35J	
PN-1	3	100~1M		—	40kV		70J	
PN-2	6	200~2M		—	80kV	130J		
PN-3	9	300~3M		—	120kV	200J		
PN-4	12	400~4M		—	160kV	270J		
PWW-3	25	10~800		—	—	120kV	2kJ~5kJ	
PWW-4	50	15~1.5k	160kV			4kJ~12kJ		
PWW-5	100	25~2.5k	200kV			7kJ~20kJ		
PWW-6	200	50~5k	400kV			14kJ~40kJ		
PAP-3	25	10~400	120kV			1kJ~2kJ		
PAP-4	50	10~800	160kV			1.5kJ~4kJ		
PAP-5	100	15~1k	200kV	3.5kJ~10kJ				
PAP-6	200	25~2k	400kV	7kJ~25kJ				

Rated Ambient Temperature: +25°C

Rated voltage=√Power Rating × Resistance value or Max. working voltage, whichever is lower.

** Please ask of us about resistance other than E24 series.

Specifications given herein may be changed at any time without prior notice. Please confirm technical specifications before you order and/or use.

11/03/23

environmental applications

Derating Curve

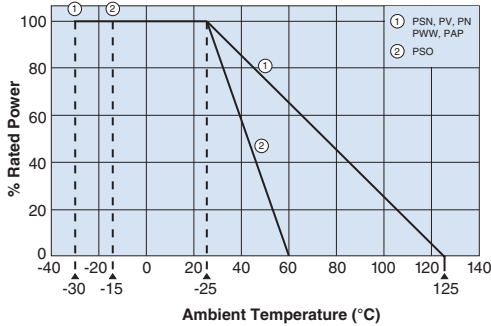

For resistors operated at an ambient temperature of 25°C or above, a power rating shall be rated in accordance with the above derating table.

Holder Dimensions (mm)

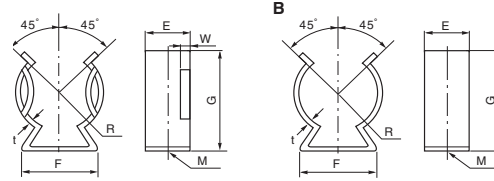

Type	R	E	F	G	M	t	W
PSN-0.5, PSN-1, PV-2	8.5	11	16	24	ø4.2	0.8	1.5±0.5
PSN-2, PV-5	11.5	15	18	32		1.0	1.5±1.0
PSN-3, PV-8, PWW-3, PAP-3	16	18	24	40	ø6.5	1.5	2.0±1.0
PSN-4, PWW-4, PAP-4	22	20	36	59		1.5	
PSN-5, 6, PWW-5, 6, PAP-5, 6	30	25	46	74		1.5	

Cap Dimensions (mm)

Cap Shape	C			M				CP		C			
	D	d	øD	D	M	K	A	d	ℓ	D	M	ℓ ₁	ℓ ₂
PSN-05;PSN-1;PV-2	17.5	7	17.5	3	2	7	1.0	90	—	—	—	—	
PSN-2;PV-5	24	12	24	4	2	10	1.2	120	—	—	—	—	
PSN-3;PV-8;PWW-3;PAP-3	33	14	33	5	4	14	—	—	—	—	—	—	
PSN-4;PWW-4;PAP-4	—	—	45	6	4	16	—	—	—	—	—	—	
PSN-5,6;PWW-5,6;PAP-5,6	—	—	62	8	7	26	—	—	—	—	—	—	
PV-0.5;PV-1	9.5	Without hole	—	—	—	—	0.9	90	—	—	—	—	
PN-0.5	17	Without hole	—	—	—	—	1.0	90	—	—	—	—	
PN-1	—	—	17	4	—	—	1.0	90	—	—	—	—	
PN-2~PN-4	—	—	17	4	—	—	1.2	120	—	—	—	—	
PSO-05,1	—	—	—	—	—	—	—	—	—	28	4	8	—
PSO-2	—	—	—	—	—	—	—	—	—	38	6	10	—
PSO-3	—	—	—	—	—	—	—	—	—	46	8	—	15
PSO-4	—	—	—	—	—	—	—	—	—	65	10	—	20
PSO-5,6	—	—	—	—	—	—	—	—	—	80	12	—	25

reduced size metal oxide power type leaded resistor

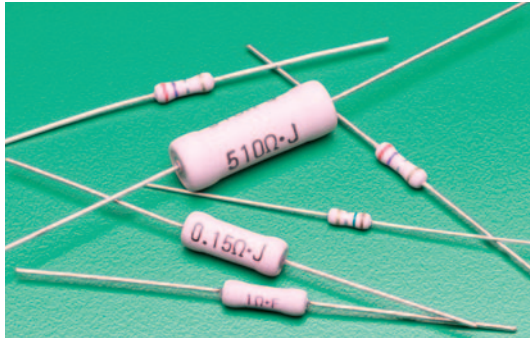

features

- Small size power type resistor
- Coated with UL94V0 equivalent flameproof material
- Suitable for automatic machine insertion
- Products with lead-free terminations meet EU RoHS and China RoHS requirements
- Surface mount style “N” forming is suitable for automatic mounting

leaded resistors

dimensions and construction

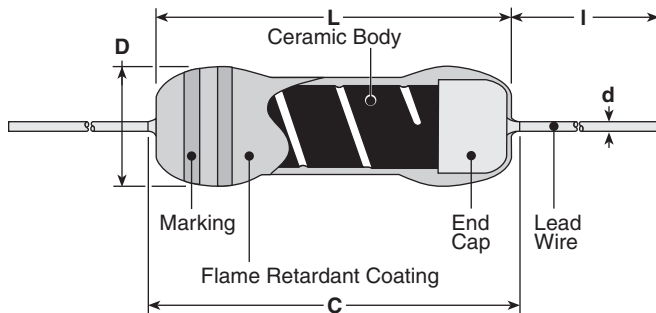

Type	Dimensions inches (mm)				
	L	C (max.)	D	d (nom.) ¹	I*
MOS1/2 MOSX1/2	.244±.02 (6.2±0.5)	.280 (7.1)	.098±.02 (2.5±0.5)	.024 (0.6)	.945 Min. (24.0 Min.)
MOS1 MOSX1	.354±.039 (9.0±1.0)	.437 (11.1)	.118±.02 (3.0±0.5)	.024/.031 (0.6)/(0.8)	
MOS2 MOSX2	.472±.039 (12.0±1.0)	.591 (15.0)	.157±.02 (4.0±0.5)	.031 (0.8)	1.18±.118 (30.0±3.0)
MOS3 MOSX3	.610±.039 (15.5±1.0)	.709 (18.0)	.236±.039 (6.0±1.0)		1.50±.118 (38.0±3.0)
MOS5 MOSX5	.965±.039 (24.5±1.0)	1.10 (28.0)	.354±.039 (9.0±1.0)		

* Lead length changes depending on taping and forming type.

¹ Ex. MOS1C, 1CT52, 1CT526 = 0.6MM

MOS1C8, 1CT528 = 0.8MM

ordering information

MOS	1	C	T52	8	A	103	J
Type	Power Rating	Termination Material	Taping and Forming	Lead Diameter	Packaging	Nominal Resistance	Tolerance
MOS MOSX	1/2: 0.5W 1: 1W 2: 2W 3: 3W 5: 5W	C: SnCu	Axial: T26, T52, T521, T631 Stand-off Axial: L52, L521, L631 Radial: VTP, VTE, GT, GT4, VTF L, U, M, N Forming	MOS(X)1: T52 & Bulk Only: 6: 0.6mm 8: 0.8mm Blank: All others sizes & packaging	A: Ammo R: Reel TEB, TEG: Plastic embossed (N forming)	±2%, ±5%: 2 significant figures + 1 multiplier “R” indicates decimal on value <10Ω ±1%: 3 significant figures + 1 multiplier “R” indicates decimal on value <100Ω	F: ±1% G: ±2% J: ±5%

For further information on packaging, please refer to Appendix C.

applications and ratings

Part Designation	Power Rating @ 70°C	Minimum Dielectric Withstanding Voltage	T.C.R. (ppm/°C) Max.	Resistance Range			Absolute Maximum Working Voltage	Absolute Maximum Overload Voltage	Operating Temperature Range
				E-24, E-96* (F±1%)	E-24* (G±2%)	E-24 (J±5%)			
MOS1/2	0.5W	400V	±300	10Ω - 47kΩ	10Ω - 47kΩ	10Ω - 47kΩ	$E = \sqrt{P \times R}$	600V	-55°C to +200°C
MOS1	1.0W	500V		10Ω - 68kΩ	10Ω - 68kΩ	10Ω - 100kΩ			
MOS2	2.0W			10Ω - 100kΩ	10Ω - 100kΩ		350V	700V	
MOS3	3.0W	700V		—		10Ω - 100kΩ			
MOS5	5.0W	800V			1Ω - 9.1Ω		0.22Ω - 9.1Ω	0.1Ω - 9.1Ω	
MOSX1/2	0.5W	400V		—		0.22Ω - 9.1Ω			
MOSX1	1.0W	500V			—		—	—	
MOSX2	2.0W			700V		—			
MOSX3	3.0W	800V			—		—	—	
MOSX5	5.0W			800V		—			

* Please consult when there is a demand of the resistance besides the 1% and 2% range.

environmental applications

Derating Curve

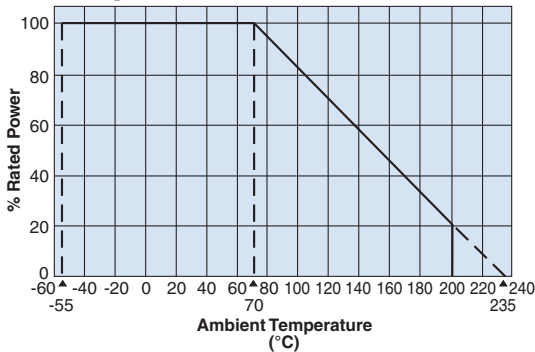

Surface Temperature Rise

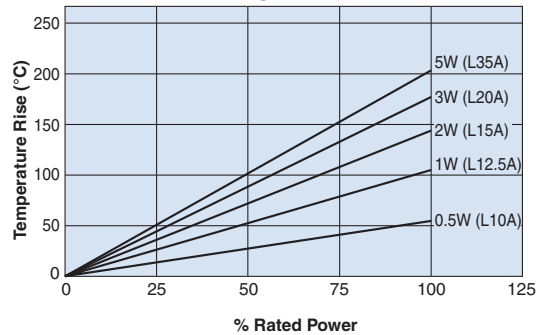

For resistors operated at an ambient temperature of 70°C or above, a power rating shall be derated in accordance with the above derating curve.

Performance Characteristics

Parameter	Requirement $\Delta R \pm(\% + 0.05\Omega)$		Test Method
	Limit	Typical	
Resistance	Within specified tolerance	—	Measuring points are at 10mm ±1mm from the end cap.
T.C.R.	Within specified T.C.R.	—	+25°C/+125°C
Overload (Short time)	±(2% +0.1Ω)	±1%	Rated voltage x 2.5 for 5 seconds
Resistance to Solder Heat	±1%	±0.5%	260°C ± 5°C, 10 seconds ± 1 second, 350°C ± 10°C, 3.5 seconds ± 5 seconds
Terminal Strength	No lead-coming off and loose terminals	—	Twist 360°C, 5 times
Rapid Change of Temperature	±1%	±0.5%	-55°C (30 minutes), +155°C (30 minutes), 5 cycles
Moisture Resistance	±(5%+0.1Ω)	±2.5%	40°C ± 2°C, 90 - 95% RH, 1000 hours, 1.5 hr ON, 0.5 hr OFF cycle
Endurance at 70°C	±(5%+0.1Ω)	±2.5%	70°C ± 2°C, 1000 hours, 1.5 hr ON, 0.5 hr OFF cycle
Resistance to Solvent	No abnormality in appearance. Marking shall be easily legible	—	Ultrasonic washing with isopropyl alcohol for 2 minutes. Power: 0.3W/cm ³ , f: 28kHz, Temp: 35°C ±5°C
Flame Retardant	No evidence of flaming or self-flaming	—	Flame test: the test flame shall be applied and removed for each 15 seconds respectively to repeat the cycle 5 times. Overload flame retardant: AC voltage corresponding to 2, 4, 8, 16 and 32 times the power rating shall be applied for each 1 minute until disconnection occurs. However the applied voltage shall not exceed the value of 4 times of the maximum operating voltage

secondary processed products

L Forming

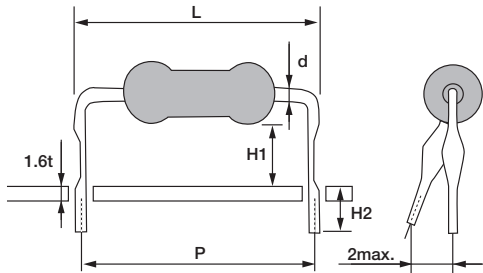

Type	Dimensions millimeters					Substrate Hole Dia.
	P	H1	H2	d (Nom.)	L max.	
1/2CL10A	10.0±1.0	5.3±1.0	4.0	0.6	17.5	ø0.8
1CL12.5A	12.5±1.0	7.0±1.0				
1CL15A	15.0±1.0	6.5±1.0				
2CL15A		7.0±1.0				
2CL15F	4.5±1.0					
2CL20A	20.0±1.0	9.0±1.0		0.8	ø1.0	
2CL20D		4.8±1.0				
3CL20A		8.0±1.0				
3CL20C		10.0±1.0				
3CL20T	4.0±1.0					
3CL25A	25.0±1.0	7.0±1.0				
3CL30A	30.0±1.0	7.0±1.0				
5CL30A		8.5±1.0				
5CL35A	35.0±1.0	5.5±1.0				

M Forming

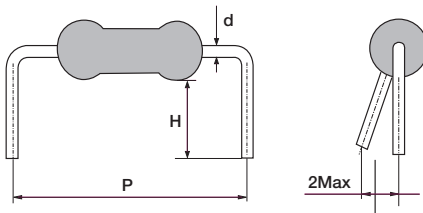

Type	Dimensions millimeters			Substrate Hole Dia.
	P	H	d (Nom.)	
1/2CM10C	10.0±1.0	3.5±1.0	0.6	ø0.8
1/2CM10F	10.0±1.0	5.0±1.0	0.6	
1CM12.5C	12.5±1.0	3.5±1.0	0.8	ø1.0
1CM12.5D	12.5±1.0	4.0±1.0	0.8	
1CM15F	15.0±1.0	5.0±1.0	0.8	
1CM15J	15.0±1.0	6.3±1.0	0.8	
1CM15S	15.0±1.0	11.0±1.0	0.8	
2CM15C	15.0±1.0	3.5±1.0	0.8	
2CM15E	15.0±1.0	4.5±1.0	0.8	
2CM20D	20.0±1.0	4.0±1.0	0.8	
2CM20U	20.0±1.0	13.5±1.0	0.8	
3CM20E	20.0±1.0	4.6±1.0	0.8	
3CM26E	26.0±1.0	4.7±1.0	0.8	
5CM30U	30.0±1.0	13.0±1.0	0.8	

UCL Forming

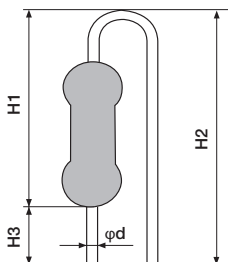

Type	Dimensions millimeters				Insertion Pitch	Substrate Hole Dia.
	H1	H2	H3	d (Nom.)		
1CUCL	13.0±1.0	17.0 max.	3.5±1.0	0.8	5.0	ø1.0
2CUCL	14.5±1.0	18.5 max.	3.5±1.0			
3CUCL	20.0 max.	22.0±1.0	4.0±1.0			

secondary processed products (continued)

VTF Radial Taping

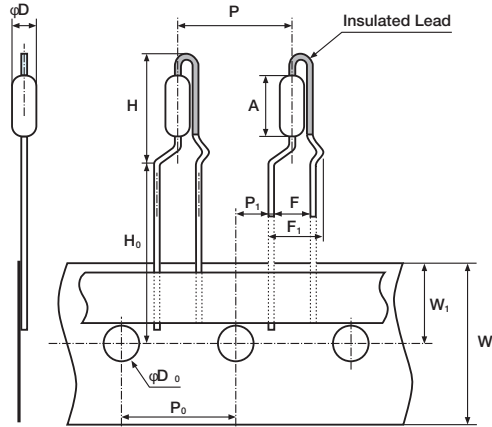

Type	1/2C	1C	2C	2C
	VTP	VTP	VTP	VTF
A	6.2±0.5	9.0±1.0	12.0±1.0	12.0±1.0
øD	2.5±0.5	3.0±0.5	4.0±0.5	4.0±0.5
d (Nom.)	0.6	0.6	0.65	0.8
F	5.0±0.5	5.0±0.5	5.0±0.5	5.0±0.5
F1	—	—	—	7.3 max.
H	13 max.	16 max.	22.5 max.	22.5 max.
H0	16.0+1.0/-0	16.0+1.0/-0	16.0+1.0/-0	16.0+1.0/-0
P	12.7±1.0	12.7±1.0	12.7±1.0	12.7±1.0
P0	12.7±0.3	12.7±0.3	12.7±0.3	12.7±0.3
P1	3.85±0.7	3.85±0.7	3.85±0.7	3.85±0.7
W	18.0±0.5	18.0±0.5	18.0±0.5	18.0±0.5
W1	9.0±0.5	9.0±0.5	9.0±0.5	9.0±0.5
øD0	4.0±0.2	4.0±0.2	4.0±0.2	4.0±0.2
Substrate Hole Dia.	ø0.8	ø0.8	ø0.8	ø1.0

VTP Radial Taping

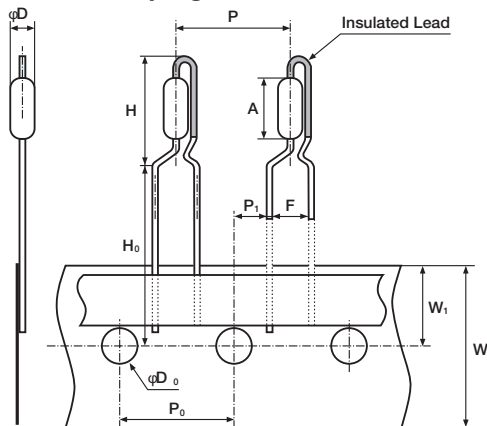

N Forming

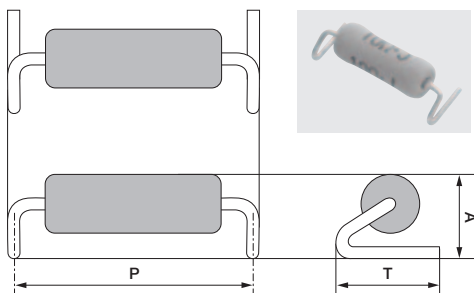

Type	1C	2C	3C
	N14.5TEB	N17TEB	N20TEG
P±1	14.5	17.0	20.0
T±0.5	5.0	6.0	7.5±1.0
A±0.5	4.8	5.8	6.5
d (Nom.)	0.8	0.8	0.8

Recommended Pad Dimensions

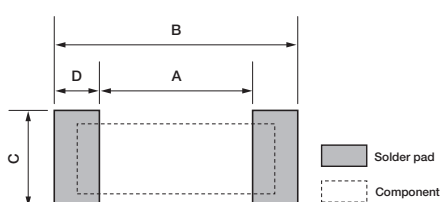

Type	1C	2C	3C
	N14.5TEB	N17TEB	N20TEG
A	12.5	14.6	17.6
B	16.5	19.4	22.4
C	7.0	8.0	9.5
D	2.0	2.4	2.4

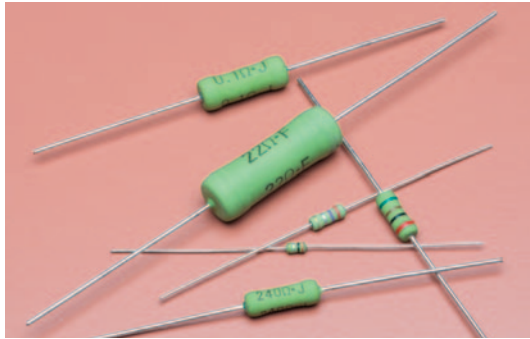

features

- Fixed metal film resistor available (specify “SPRX”)
- Flameproof silicone coating equivalent to (UL94V0)
- High reliability performance
- Suitable for automatic machine insertion
- Products meet EU RoHS requirements
- Surface mount style “N” forming is suitable for automatic mounting

leaded resistors

dimensions and construction

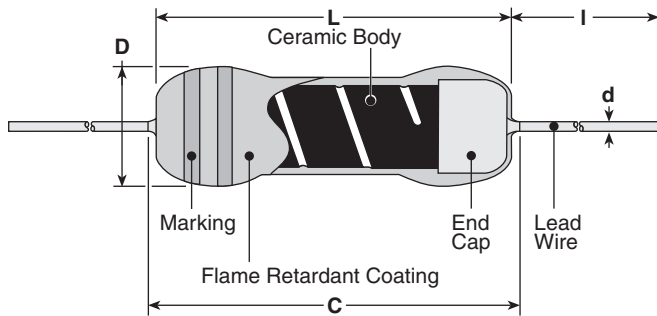

Type	Dimensions inches (mm)				
	L	C (max.)	D	d nominal	I*
SPR1/4 SPRX1/4	.13±.012 (3.3±0.3)	.138 (3.5)	.067±.012 (1.7±0.3)	.018 (0.45)	.787 Min. (20.0 Min.)
SPR1/2 SPRX1/2	.244±.02 (6.2±0.5)	.280 (7.1)	.098±.02 (2.5±0.5)	.024 (0.6)	.945 Min. (24.0 Min.)
SPR1 SPRX1	.354±.039 (9.0±1.0)	.437 (11.1)	.138±.02 (3.5±0.5)	.031 (0.8)	
SPR2 SPRX2	.472±.039 (12.0±1.0)	.591 (15.0)	.165±.031 (4.2±0.8)		
SPR3 SPRX3	.610±.039 (15.5±1.0)	.709 (18.0)	.236±.039 (6.0±1.0)		1.18±.118 (30.0±3.0)
SPR5 SPRX5	.965±.039 (24.5±1.0)	1.10 (28.0)	.354±.039 (9.0±1.0)		1.50±.118 (38.0±3.0)

* Lead length changes depending on taping and forming type.

ordering information

SPR	1/2	C	T52	R	103	J
Type	Power Rating	Termination Material	Taping and Forming	Packaging	Nominal Resistance	Tolerance
SPR SPRX	1/4: 0.25W 1/2: 0.5W 1: 1W 2: 2W 3: 3W 5: 5W	C: SnCu	Axial: T26, T52, T521, T631 Stand-off Axial: L52, L521, L631 Radial: VT, VTP, VTE, GT, VTF L, U, M, N Forming	A: Ammo R: Reel Nil: Box TEB: Embossed plastic (N forming)	±2%, ±5%: 2 significant figures + 1 multiplier “R” indicates decimal on value <10Ω ±1%: 3 significant figures + 1 multiplier “R” indicates decimal on value <100Ω	F: ±1% G: ±2% J: ±5%

Contact us when you have control request for environmental hazardous material other than the substance specified by EU RoHS.

For further information on packaging, please refer to Appendix C.

applications and ratings

Part Designation	Power Rating @ 70°C	Minimum Dielectric Withstanding Voltage	T.C.R. (ppm/°C)	Resistance Range			Absolute Maximum Working Voltage	Absolute Maximum Overload Voltage
				E-24* (F±1%, G±2%)	E-24* (G±2%)	E-24 (J±5%)		
SPR1/4	0.25W	300V	±350	—	—	2.2Ω - 10KΩ	$E = \sqrt{P \times R(V)}$	500V
SPR1/2	0.5W	500V		10Ω - 91KΩ	10Ω - 91KΩ	2.2Ω - 91KΩ		800V
SPR1	1W							1000V
SPR2	2W	700V		10Ω - 100KΩ	10Ω - 100KΩ	2.2Ω - 110KΩ	500V	1200V
SPR3	3W						600V	
SPR5	5W	800V		—	—	0.1Ω - 2.0Ω	$E = \sqrt{P \times R(V)}$	E x 2.5(V)
SPRX1/4	0.25W	300V		1.0Ω - 2.0Ω	0.22Ω - 2.0Ω			
SPRX1/2	0.5W	500V						
SPRX1	1W	700V		—	—			
SPRX2	2W							
SPRX3	3W	800V						

* Please consult when there is a demand of the resistance besides the 1% and 2% range.
 Rated Ambient Temperature: +70°C Operating Temperature Range: -55°C to +200°C

leaded resistors

environmental applications

Derating Curve

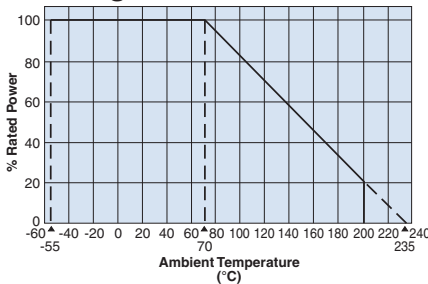

Surface Temperature Rise

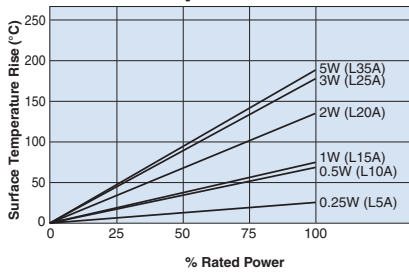

Load Life @ 70°C, 1000 Hr

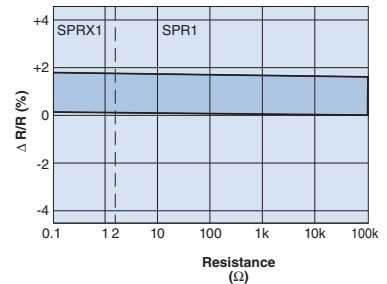

For resistors operated at an ambient temperature of 70°C or above, a power rating shall be derated in accordance with the above derating curve.

Performance Characteristics

Parameter	Requirement Δ R ±(% + 0.05%)		Test Method
	Limit	Typical	
Resistance	Within specified tolerance	—	Measuring points are at 10mm ±1mm from the end cap.
T.C.R.	Within specified T.C.R.	—	+25°C/+125°C
Overload (Short time)	±(1%+0.1Ω)	±0.5%	Rated voltage x 2.5 or max. overload voltage for 5 seconds, whichever is lower
Resistance to Solder Heat	±1%	±0.5%	260°C ±5°C, 10 seconds ± 1 second
Terminal Strength	No lead-coming off and loose terminals	—	Twist 360°C, 5 times
Rapid Change of Temperature	±1%	±0.5%	-55°C (30 minutes), +155°C (30 minutes), 5 cycles
Moisture Resistance	±(3%+0.1Ω):1/4W-2W ±(5%+0.1Ω):3W,5W	1.5: 1/4W-2W 2.5: 3W, 5W	40°C ± 2°C, 90 - 95% RH, 1000 hours, 1.5 hr ON, 0.5 hr OFF cycle
Endurance at 70°C	±(3%+0.1Ω):1/4W-2W ±(5%+0.1Ω):3W,5W	1.5: 1/4W-2W 2.5: 3W, 5W	70°C ± 2°C, 1000 hours, 1.5 hr ON, 0.5 hr OFF cycle
Resistance to Solvent	No abnormality in appearance. Marking shall be easily legible	—	Ultrasonic washing with isopropyl alcohol for 2 minutes. Power: 0.3W/cm ³ , f: 28kHz, Temp: 35°C ±5°C
Flame Retardant	No evidence of flaming or self-flaming	—	Flame test: the test flame shall be applied and removed for each 15 seconds respectively to repeat the cycle 5 times. Overload flame retardant: power (AC) corresponding to 2, 4, 8, 16 and 32 times the power rating shall be applied for each 1 minute until disconnection occurs. However the applied voltage shall not exceed the value of 4 times of the maximum operating voltage

Specifications given herein may be changed at any time without prior notice. Please confirm technical specifications before you order and/or use.

11/14/23

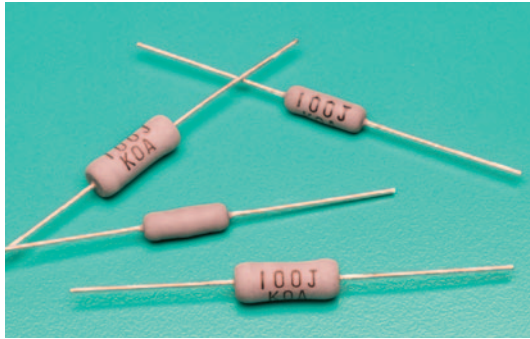

features

- Flameproof retardant coating (equivalent to UL94 V-0)
- Fail-safe mains fusing at AC 250V (CWFS23: 4.7Ω~9.1Ω: AC200V)
- Products with lead-free terminations meet EU RoHS

leadless resistors

dimensions and construction

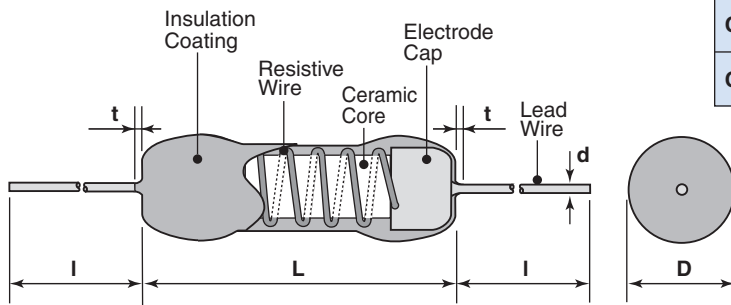

Type	Dimensions inches (mm)				
	L	D	I	d (nom.)	t (max.)
CWFS23	.472±.039 (12.0±1.0)	.157±.039 (4.0±1.0)	1.18±.118 (30.0±3.0)	.031 (0.8)	.118 (3.0)
CWFS35	.591±.039 (15.0±1.0)	.236±.039 (6.0±1.0)	1.18±.118 (30.0±3.0)	.031 (0.8)	.118 (3.0)

ordering information

CFW	S	23	C	T52	A	100	J
Product Code	Type	Power Rating	Termination Material	Taping and Forming	Packaging	Nominal Resistance	Tolerance
	S: Safety Fusing	23: 3W 35: 5W	C: SnCu	23: T52 35: T521	A: Ammo	3 digits	J: ±5%

Contact KOA when you have control request for environmental hazardous material other than the substance specified by EU RoHS.

For further information on packaging, please refer to Appendix C.

Lead length changes depending on taping and forming type.

applications and ratings

Part Designation	Power Rating	Rated Terminal Part Temperature	Resistance Range E-24 (J±5%)	Fusing Characteristics		T.C.R. (×10 ⁻⁶ /K)	Operating Temperature Range
				Fusing Power	Fusing Time		
CWFS23	3W	+120°C	4.7Ω - 100Ω	90W	30s Max.	±100	-55°C to +200°C
CWFS35	5W	+180°C	4.7Ω - 100Ω	150W	30s Max.	±100	

Rated voltage = $\sqrt{\text{Power Rating} \times \text{Resistance value}}$

environmental applications

Derating Curve

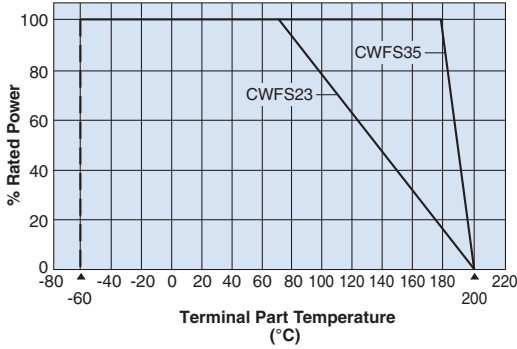

Temperature Rise (Ref.)

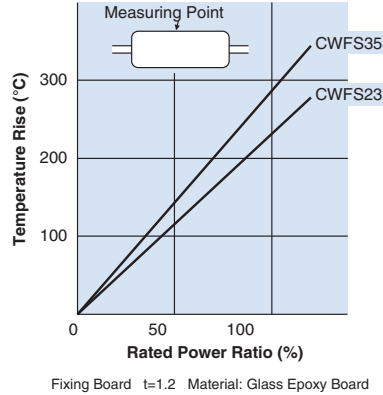

Performance Characteristics

Parameter	Requirement $\Delta R \pm(\% + 0.05\Omega)$		Test Method
	Limit	Typical	
Resistance	Within regulated tolerance	—	25°C
T.C.R.	$\pm 100 \times 10^{-6}/K$	—	+25°C/-55°C and +25°C/+125°C
Melt Time	30 seconds	4 seconds	Power rating x 30
Overload (Short Time)	5%	2%	Rated rating x 10, 5 seconds
Resistance to Solder Heat	1%	0.8%	350°C \pm 10°C for 3.5 seconds or 260°C \pm 5°C for 10 seconds
Moisture Resistance	5%	4%	Power rating x 1/10, 40°C, 90 - 95% RH, 1000 hours, 1.5 hr ON, 0.5 hr OFF cycle
Endurance of Rated Terminal Part Temperature	5%	3%	CWFS23: 120°C \pm 2°C; CWFS35: 180°C \pm 2°C 1000 hours, 1.5 hr ON, 0.5 hr OFF cycle
Resistance to Solvent	No abnormality in appearance such as disappearance of making, etc.	—	On immersing the sample in IPA for 3 min., the resistor surface should be lightly wiped with a dry cloth (velvet or gauze)

Example of Fusing Characteristics

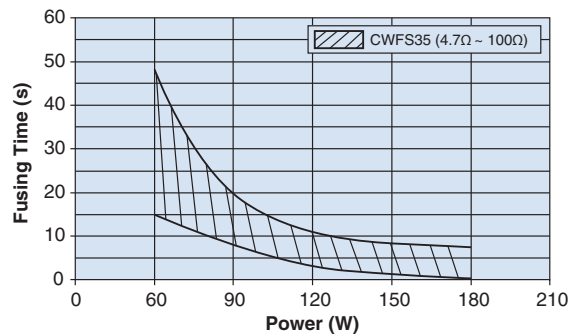
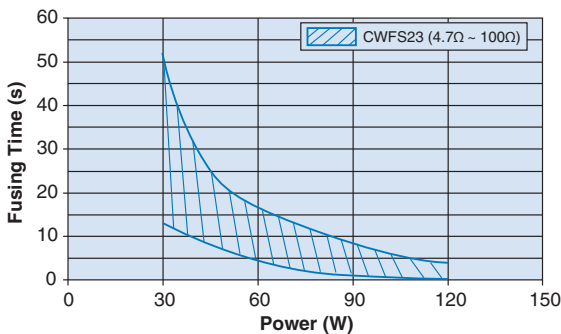

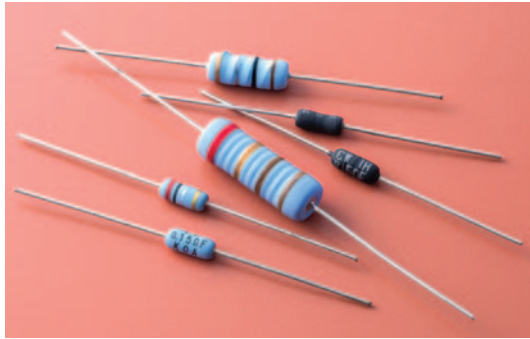

features

- Flameproof silicone coating equivalent (UL94V0)
- CWH resistors meet MIL-PRF-26 (U characteristics)
- CWH high precision resistors with T.C.R. less than $\pm 20 \times 10^{-6}/K$
- Suitable for automatic machine insertion
- Excellent in long time stability
- Products with lead-free terminations meet EU RoHS and China RoHS requirements
- CW1SS has UL1412 approval (File No. E320246)
- Surface mount style "N" forming is suitable for automatic mounting CW, CWP

dimensions and construction

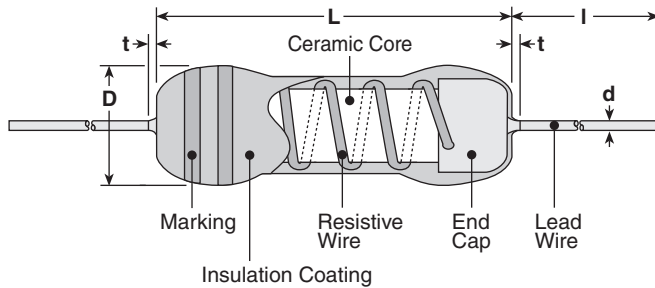

Type	Dimensions inches (mm)				l*
	L	t (max.)	D	d (nom.)	
CW1/4	.13±.012 (3.3±0.3)	.02 (0.5)	.075±.012 (1.9±0.3)	.018 (0.45)	1.18±.118 (30.0±3.0)
CW1/2	.256±.039 (6.5±1.0)	.039 (1.0)	.098±.039 (2.5±1.0)	.024 (0.6)	
CW1	.354±.039 (9.0±1.0)	.118 (3.0)	.138±.039 (3.5±1.0)	.031 (0.8)	
CW1X			.138 ^{+0.006} ₋₀ (3.5 ^{+1.5} ₋₀)		
CW1P			.138±.039 (3.5±1.0)		
CW2	.157±.039 (4.0±1.0)				
CW2X	.472±.039 (12.0±1.0)		.157 ^{+0.006} ₋₀ (4.0 ^{+1.5} ₋₀)		
CW2P	.157±.039 (4.0±1.0)				
CW3	.591±.039 (15.0±1.0)		.236±.039 (6.0±1.0)		
CW3X			.236 ^{+0.006} ₋₀ (6.0 ^{+1.5} ₋₀)		
CW3P			.236±.039 (6.0±1.0)		
CW5	.945±.006 (24.0±1.5)		.354±.006 (9.0±1.5)		1.50±.118 (38.0±3.0)
CW1S	.256±.039 (6.5±1.0)	.039 (1.0)	.098±.039 (2.5±1.0)	.024 (0.6)	1.18±.118 (30.0±3.0)
CW1SS					
CW1H	.354±.039 (9.0±1.0)	.118 (3.0)	.138±.039 (3.5±1.0)	.031 (0.8)	1.18±.118 (30.0±3.0)
CW2H	.472±.039 (12.0±1.0)		.157±.039 (4.0±1.0)		
CW3H	.591±.039 (15.0±1.0)		.236±.039 (6.0±1.0)		

* Lead length changes depending on taping and forming type.

ordering information

CW	1/2	P	C	T52	A	103	F
Type	Power Rating	Style	Termination Material	Taping and Forming	Packaging	Nominal Resistance	Tolerance
	1/4: 0.25W 1/2: 0.5W 1: 1W 2: 2W 3: 3W 5: 5W	H: Stability Nil: Power P: Precision S: Small X: Power SS: Small type, UL Approved	C: SnCu	Axial: T26, T52, T521, T631 Stand-off Axial: L52A, L52B Radial: VTP*, GT L forming: L10A, L12.5A, L15A, L20A, L25A, L30A, L35A N forming: N17, N20	A: Ammo R: Reel TEB: TEG: Embossed plastic (N forming) Nil: Box	±2%, ±5%: 2 significant figures + 1 multiplier "R" indicates decimal on value <10Ω ±1%: 3 significant figures + 1 multiplier "R" indicates decimal on value <100Ω	C: ±0.25% D: ±0.5% F: ±1% G: ±2% J: ±5% K: ±10%

For further information on packaging, please refer to Appendix C.
Contact us when you have control request for environmental hazardous material other than the substance specified by the EU RoHS

* VTP: Applicable to 0.47Ω or over for CW1, CW1P only

applications and ratings

Part Designation	Power Rating	T.C.R. (ppm/°C) Max.	Resistance Range (Ω)					Rated Ambient Temperature	Operating Temperature Range	
			E-24, E-96 (C±0.25%)	E-24, E-96 (D±0.5%)	E-24, E-96 (F±1%)	E-24 (G±2%)	E-24 (J±5%)			E-24 (K±10%)
CW1/4	0.25W	±250	-	-	-	-	0.47 - 15	0.47 - 15	+70°C	-40°C to +155°C
CW1/2	0.5W					0.1 - 100	0.1 - 100			
CW1	1.0W					0.1 - 390	0.1 - 390			
CW2	2.0W					0.1 - 390	0.1 - 390			
CW3	3.0W					0.1 - 390	0.1 - 390			
CW5	5.0W					0.1 - 390	0.1 - 390			
CW1X	1.0W	±500	-	-	-	0.01 - 0.091	0.01 - 0.091			
CW2X	2.0W					0.01 - 0.091	0.01 - 0.091			
CW3X	3.0W					0.01 - 0.091	0.01 - 0.091			
CW1S	1.0W	±250	-	-	-	-	0.1 - 100	0.1 - 100		
CW1SS	1.0W	±100	-	-	-	-	10	-		
CW1P	1.0W	±90: R≥10Ω ±50: R<10Ω	1 - 100	0.47 - 220	0.1 - 430	-	-	-		
CW2P	2.0W	±20: R≥10Ω ±50: R<10Ω	-	0.47 - 220	0.1 - 430	-	-	-	+25°C	-55°C to +275°C
CW2H	2.0W			0.47 - 750	0.1 - 2k					
CW3H	3.0W			0.47 - 1k	0.1 - 3k					

CW_H: Max. Working Voltage: $E = \sqrt{P \times R}$ CW_H: Max. Overload Voltage: $E = \sqrt{P \times R \times 5}$

environmental applications

Derating Curve

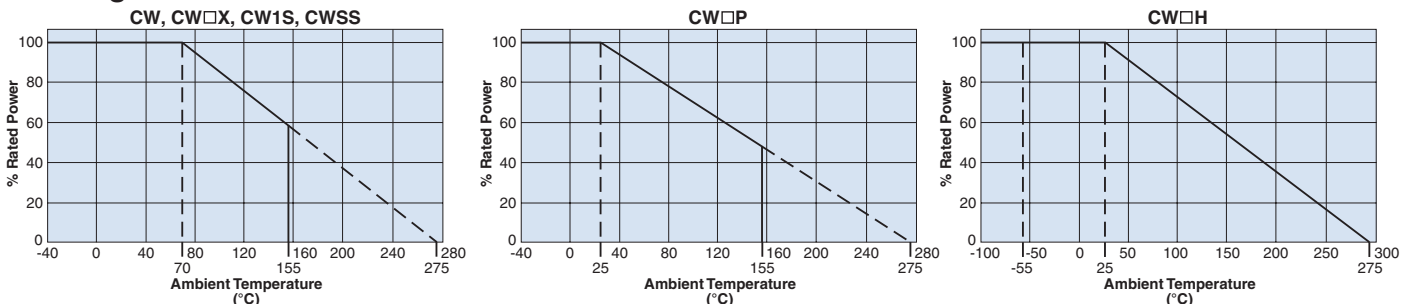

For resistors operated at an ambient temperature of 25°C or above, a power rating shall be derated in accordance with the above derating curve.

Specifications given herein may be changed at any time without prior notice. Please confirm technical specifications before you order and/or use.

11/09/22

environmental applications

Surface Temperature Rise

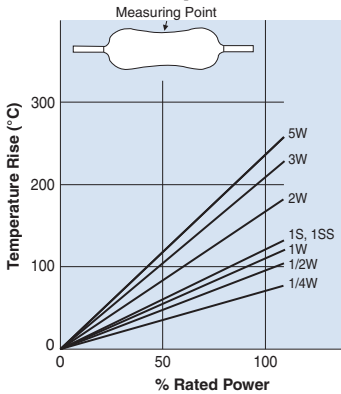

Fixing board: t=1.2
Material: Glass epoxy board

Performance Characteristics

Parameter	Requirement ~ R ±(% + 0.05Ω)		Test Method
	Limit	Typical	
Resistance	Within specified tolerance	—	25°C
T.C.R.	Within specified T.C.R.	—	CW, CW□X, CW1S, CW1SS: +25°C/+125°C CW□P: +25°C/-40°C and +25°C/+155°C CW□H: +25°C/-55°C and +25°C/+125°C
Overload (Short Time)	1%: CW, CWX; 0.5%: CW□P; 2%: CW1S, CW1SS 0.2%: CW□P (R<10Ω)*, CW□H	0.8%: CW, CW□X; 0.4: CW□P 1.8%: CW1S, CW1SS 0.18%: CW□P (R<10Ω) 0.15%: CW□H	CW, CW□X, CW1S, CW1SS: Power rating x 10 for 5 seconds CW□P: Power rating x 6.25 for 5 seconds CW□P (R<10Ω), CW□H: Power rating x 5 for 5 seconds
Resistance to Solder Heat	1%: CW, CW1S, CW1SS, CW□X; 0.5%: CW□P; 0.2%: CW□P (R<10Ω)*, CW□H	0.8%: CW, CW1S, CW1SS, CW□X; 0.4%: CW□P; 0.18%: CW□P (R<10Ω); 0.15%: CW□H	350°C ± 10°C, 3 seconds ± 0.5 second 260°C ± 5°C, 10 seconds ± 1 second
Moisture Resistance	5%: CW, CW1S, CW□X 2%: CW□P 0.5%: CW□P (R<10Ω)*	4%: CW, CW1S, CW□X 1.6%: CW□P 0.45%: CW□P (R<10Ω)	Power rating x 1/10, 40°C, 90 - 95% RH, 1000 hours, 1.5 hr ON, 0.5 hr OFF cycle
Endurance @ 70°C	5%: CW, CW1S, CW1SS, CW□X; 2%: CW□P 0.5%: CW□P (R<10Ω)*	4%: CW, CW1S, CW1SS, CW□X; 1.6%: CW□P 0.45%: CW□P (R<10Ω)	70°C, 1000 hours (CW, CW□X, CW1S, CW1SS), 25°C, 1000 hours (CW□P) 1.5 hr ON, 0.5 hr OFF cycle
Resistance to Solvent	No abnormality in appearance such as disappearance of markings, etc.	—	After immersing the sample in IPA for 3 min., the resistor surface should be lightly wiped with a dry cloth (velvet or gauze)
Low Temperature	0.2%: CW□H	0.15%: CW□H	-55°C, 24 hours
High Temperature	0.5%: CW□H	0.45%: CW□H	+275°C, 250 hours
Thunder Surge	3%: CW1SS	—	Combination wave, +1.5kV 20 seconds 3 cycles
Load Life	0.5%: CW□H	0.45%: CW□H	-25°C, power rating, 1.5 hr ON, 0.5 hr OFF 2000 hours

* Refer to MIL-PRF-26G standard

coat-insulated miniature precision power wirewound resistors



features

- Resistors meeting MIL-R-26E (U and V characteristics) and surface temperature (hot spot) 350°C max.
- Resistors with a wide range of 0.1Ω ~ 62kΩ, covering applications from precision to power
- RW□N type resistors are non-inductive wound and can be used in high frequency applications.
- Products meet EU RoHS requirements

leaded resistors

dimensions and construction

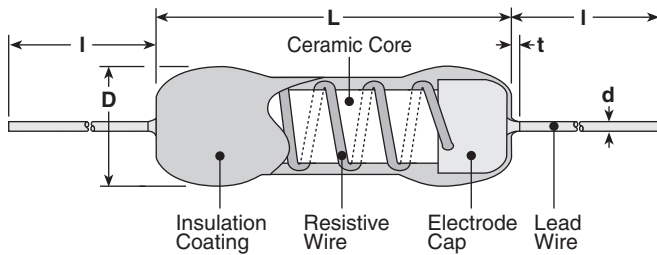

Type	Dimensions inches (mm)			
	L	D	d (nom.)	I
RW1/2, RW1/2N	.315±.039 (8±1.0)	.138 ^{+.039} ₋₀ (1.6 ^{+1.0} ₋₀)	.020 (0.5)	1.50±.118 (38.0±3.0)
RW1, RW1N	.413±.039 (10.5±1.0)	.106±.039 (2.7±1.0)		
RW2, RW2N	.512±.039 (13±1.0)	.205±.039 (5.2±1.0)	.031 (0.8)	
RW3, RW3N	.650±.039 (16.5±1.0)	.252±.039 (6.4±1.0)	.039 (1.0)	
RW5, RW5N	.866±.039 (22±1.0)	.307±.059 (7.8±1.5)		
RW7, RW7N	1.24±.039 (31.5±1.0)			
RW10, RW10N	1.81±.059 (46±1.5)	.366±.089 (9.3±1.5)		

ordering information

Pb Free Type

RW	1/2	N	T	103	J
Type	Power Rating	Winding Method	Termination Material	Nominal Resistance	Tolerance
	1/2: 0.5W 1: 1W 2: 2W 3: 3W 5: 5W 7: 7W 10: 10W	Nil: Standard winding N: Non-inductive winding	T: Sn	±3%, ±5%: 2 significant figures + 1 multiplier "R" indicates decimal on value <10Ω ±0.5%, ±1%: 3 significant figures + 1 multiplier "R" indicates decimal on value <100Ω	D: ±0.5% F: ±1% H: ±3% J: ±5%

Packaging quantity:
RW1/2 ~ RW1: 1,000 pieces
RW2 ~ RW7: 500 pieces
RW10: 300 pieces

applications and ratings

Part Designation	Power Rating		Resistance Range (Ω)				T.C.R. (ppm/ $^{\circ}$ C)	Max. Working Voltage	Max. Overload Voltage
	U	V	D \pm 0.5% (E24 · E96 25x10 ⁰ · 50x10 ⁰)	F \pm 1% (E24 · E96 25x10 ⁰ · 50x10 ⁰)	H \pm 3% (E24 & 25x10 ⁰ · 50x10 ⁰)	J \pm 5% (E24 & 25x10 ⁰ · 50x10 ⁰)			
RW1/2	0.5W	—	10 - 2.61k	10 - 2.61k	0.47 - 2.7k	0.47 - 2.7k	+20/-50: R \geq 10 Ω +50/-70: 1 Ω \leq R<10 Ω +400/-90: R<1 Ω	80V	150V
RW1/2N			—	10 - 2.37k	10 - 2.4k	10 - 2.4k			
RW1	1.0W	—	1 - 5.11k	1 - 5.11k	0.1 - 5.1k	0.1 - 5.1k		130V	300V
RW1N			—	10 - 3.74k	10 - 3.6k	10 - 3.6k			
RW2	2.0W	3.0W	1 - 10k	1 - 10k	0.1 - 10k	0.1 - 10k		140V	500V
RW2N			—	15 - 10k	10 - 10k	10 - 10k			
RW3	3.0W	5.0W	1 - 15k	1 - 15k	0.1 - 15k	0.1 - 15k		200V	600V
RW3N			—	15 - 15k	15 - 15k	15 - 15k			
RW5	5.0W	7.0W	1 - 30.1k	1 - 30.1k	0.1 - 30k	0.1 - 30k		400V	700V
RW5N			—	20 - 29.4k	20 - 30k	20 - 30k			
RW7	7.0W	10W	1 - 45.3k	1 - 45.3k	0.1 - 47k	0.1 - 47k	600V	800V	
RW7N			—	36 - 44.2k	36 - 43k	36 - 43k			
RW10	10W	14W	1 - 60.4k	1 - 60.4k	0.1 - 62k	0.1 - 62k	1000V	1500V	
RW10N			—	62 - 49.9k	62 - 51k	62 - 51k			

Operating Temperature Range: Characteristic U: -55 $^{\circ}$ C ~ +275 $^{\circ}$ C, V: -55 $^{\circ}$ C ~ +350 $^{\circ}$ C

environmental applications

Derating Curve

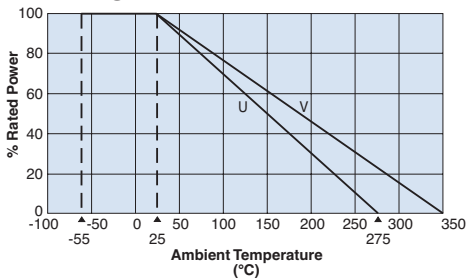

Surface Temperature Rise

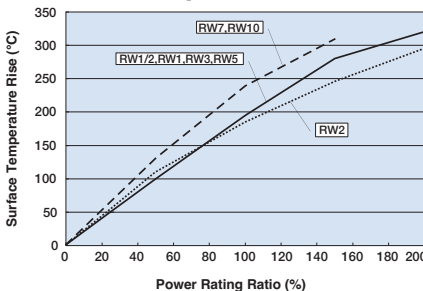

Frequency Characteristics

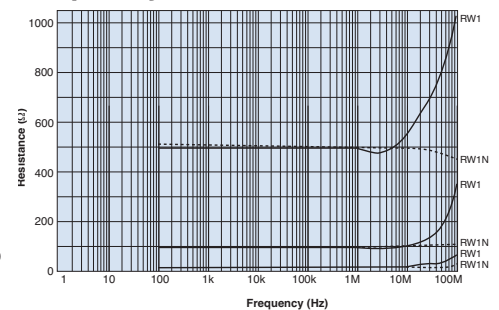

Performance Characteristics

Parameter	Requirement $\Delta R \pm$ (% + 0.05 Ω)	Test Method
Resistance	Within regulated tolerance	25 $^{\circ}$ C
T.C.R.	Within specified T.C.R.	+25 $^{\circ}$ C/-55 $^{\circ}$ C, +25 $^{\circ}$ C/+125 $^{\circ}$ C
Overload (Short time)	0.2%: U	Rated power x 5 or Max. overload voltage, whichever is lower for 5 seconds
	2%: V	Rated power x 10 or Max. overload voltage, whichever is lower for 5 seconds
Resistance to Solder Heat	0.1%	350 $^{\circ}$ C \pm 10 $^{\circ}$ C, 3 seconds \pm 0.5 seconds or 260 $^{\circ}$ C \pm 5 $^{\circ}$ C, 10 seconds \pm 1 second
Moisture Resistance	0.2%: U 2%: V	Power rating x 1/10, 40 $^{\circ}$ C, 90 - 95% RH, 1000 hours, 1.5 hr ON/0.5 hr OFF cycle
Endurance @ 25 $^{\circ}$ C	0.5%: U 3%: V	25 $^{\circ}$ C, 2000 hours 1.5 hr ON/0.5 hr OFF cycle
High Temperature Exposure	0.2%: U	275 $^{\circ}$ C $^{+5}_{-0}$, 250 hours
	2%: V	350 $^{\circ}$ C $^{+5}_{-0}$, 250 hours

rectangular type wirewound resistors with glass core
 rectangular type wirewound resistors with ceramic core
 rectangular type metal oxide film resistors

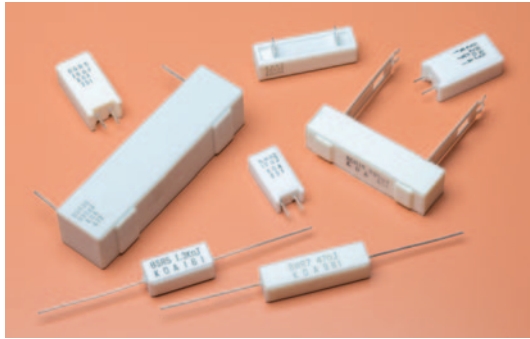

features

- High power resistor
- Use flame-retardant insulated ceramic case
- Products meet EU RoHS requirements
- Excellent with anti-pulse and inrush current



applications and ratings

Type	Power Rating	Resistance Range (Ω) E24				Style & Weight (g/1 piece)													
		F±1%	G±2%	J±5%	K±10%	S	N	E	P	X	Y	YS	Z	H	Q	HA	HB	QA	QB
BWR1	1W	1~56	0.22~75	0.1~75	—	1.3	—	—	—	—	—	—	—	—	—	—	—	—	—
BWR2	2W	1~160	0.22~200	0.1~200	—	2.1	3.9	—	—	—	—	—	—	—	—	—	—	—	—
BWR3	3W	1~300	0.22~390	0.1~390	—	3.9	5.9	—	—	—	—	—	—	—	—	—	—	—	—
BWR5	5W	1~300	0.22~390	0.1~390	—	5.1	7.2	5.7	5.6	—	—	—	—	—	—	—	—	—	—
BWR7	7W	1~360	0.22~390	0.1~390	—	7.5	10.8	—	—	—	—	—	—	—	—	—	—	—	—
BWR10	10W	1~390	0.22~390	0.1~390	—	10.2	15.0	—	—	—	—	—	—	—	—	—	—	—	—
BWR15	15W	1~390	0.22~390	0.1~390	—	18.8	—	—	—	—	—	—	—	—	—	—	—	—	—
BWR20	20W	1~390	0.22~390	0.1~390	—	23.3	—	—	—	—	—	—	—	—	—	—	—	—	—
BGR5	5W	—	—	10~390	0.39~9.1	—	—	—	—	6.1	7.6	6.6	7.6	—	6.2	—	—	—	—
BGR7	7W	—	—	10~390	0.39~9.1	—	—	—	—	8.2	9.1	7.8	9.1	—	7.8	—	—	—	—
BGR10	10W	—	—	10~390	0.39~9.1	—	—	—	—	11.0	12.4	10.4	11.4	9.9	10.7	13.6	—	14.5	—
BGR15	15W	—	—	10~390	0.51~9.1	—	—	—	—	18.8	—	—	20.5	18.4	18.6	24.4	27.5	24.6	27.7
BGR20	20W	—	—	10~390	0.51~9.1	—	—	—	—	22.3	—	—	24.0	21.9	22.1	27.9	31.0	28.1	31.3
BGR30	30W	—	—	10~390	2.2~9.1	—	—	—	—	—	—	—	—	59.3	59.6	73.9	73.5	74.2	73.8
BGR40	40W	—	—	10~390	2.2~9.1	—	—	—	—	—	—	—	—	70.4	70.6	85.0	84.6	85.2	84.8
BSR2	2W	—	—	430~13k	—	2.1	3.8	—	—	—	—	—	—	—	—	—	—	—	—
BSR3	3W	—	—	430~27k	—	3.9	5.9	—	—	—	—	—	—	—	—	—	—	—	—
BSR5	5W	—	—	430~51k	—	5.1	7.2	5.7	—	6.1	7.6	6.6	7.6	—	6.2	—	—	—	—
BSR7	7W	—	—	430~56k	—	7.4	10.8	—	—	8.2	9.1	7.8	9.1	—	7.8	—	—	—	—
BSR10	10W	—	—	430~75k	—	10.2	15.0	—	—	11.0	12.4	10.4	11.4	10.9	10.7	13.7	—	14.5	—
BSR15	15W	—	—	430~56k	—	18.8	—	—	—	18.5	—	—	20.5	18.4	18.6	24.4	27.5	24.6	27.7
BSR20	20W	—	—	430~56k	—	23.3	—	—	—	22.0	—	—	24.0	21.9	22.1	27.9	31.0	28.1	31.3

Type	Power Rating	Max. Working Voltage (V)		Max. Overload Voltage (V)		T.C.R. (x10 ⁻⁶ /K)			Rated Ambient Temperature	Operating Temperature Range					
		BSR	BGR,BWR	BSR	BGR,BWR	BWR	BSR	BGR							
BWR1	1W	—	E=√P•R	—	E=√P•R•10	±100	—	±250	+70°C	-40°C to +155°C					
B□R2	2W	250		500											
B□R3	3W	300		600											
B□R5	5W	350		700											
B□R7	7W	500		1000											
B□R10	10W	700		1400											
B□R15	15W	700		1400											
B□R20	20W	750		1500											
BGR30	30W	—		—			—				—	—	—	+25°C	
BGR40	40W	—		—			—				—	—	—		

Rated voltage=√Power Rating × Resistance value or Max. working voltage, whichever is lower.
 □ Represents the space to designate product type via character G, W, or S.
 Please consult with us in advance about custom-made products.

rectangular type wirewound resistors with glass core
 rectangular type wirewound resistors with ceramic core
 rectangular type metal oxide film resistors

ordering information

BWR	3	C	N	100	J
Type	Power Rating	Termination¹ Material	Style	Nominal Resistance	Tolerance
BGR: Wirewound (glass core) BWR: Wirewound (ceramic core) BSR: Metal oxide film	See table	C: SnCu	Blank: S style ² N: N style E: E style P: P style	+1%: 3 significant figures + 1 multiplier "R" indicates decimal on values <100Ω +2%, +5%, +10%: 2 significant figures + 1 multiplier "R" indicates decimal on values <100Ω	F: ±1% G: ±2% J: ±5% K: ±10%
		T: Sn	X: X style Y: Y style YS: YS style Z: Z style H: H style Q: Q style HA: HA style HB: HB style QA: QA style QB: QB style		

¹ Lead-Free plated terminal symbols.
 C (SnCu) N, E, S and P styles
 T (Sn) X, Y, YS, Z, H, and Q styles

² No indication on style means S style.

Contact us if you have a request for environmentally hazardous materials other than the substance specified by EU RoHS.

leaded resistors

dimensions and construction

S Style

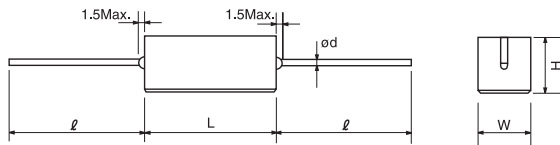

Type	Dimensions millimeters				
	L	W	H	l	d
BWR1C	13.0±1.0	5.5±1.0	5.5±1.0	30.0±3.0	0.6±0.1
BWR2C, BSR2C	18.0±1.5	6.3±1.0	6.3±1.0	35.0±3.0	0.8±0.1
BWR3C, BSR3C	22.0±1.5	8.0±1.0	8.0±1.0		
BWR5C, BSR5C					
BWR7C, BSR7C	35.0±1.5	9.5±1.0	9.5±1.0		
BWR10C, BSR10C	48.0±1.5	12.5±1.2	12.5±1.2		
BWR15C, BSR15C					
BWR20C, BSR20C	63.5±1.5	12.5±1.5	12.5±1.5		

N Style

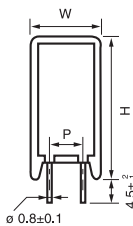

E Style

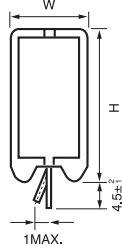

Type	Dimensions millimeters			
	W±1	D±1	H±1.5	P ⁺² ₋₁
BWR2CN, BSR2CN	11	7	20.5	5
BWR3CN, BSR3CN	12	8	25	
BWR5CN, BSR5CN	13	9	25.5	
BWR7CN, BSR7CN			38.5	
BWR10CN, BSR10CN	16	12	35	7.5
BWR5CE, BSR5CE	9.5	9.5	23.5	5

rectangular type wirewound resistors with glass core
 rectangular type wirewound resistors with ceramic core
 rectangular type metal oxide film resistors

dimensions and construction (continued)

X Style (5W, 7W, 10W)

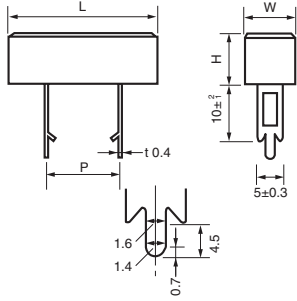

(15W, 20W)

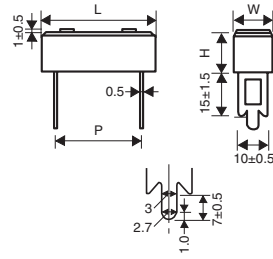

Y Style

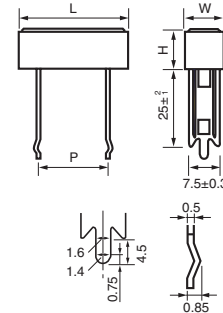

YS Style

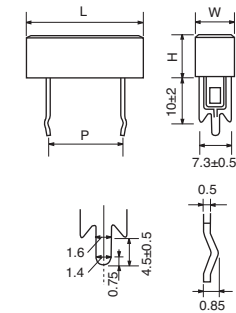

Type	Dimensions millimeters			
	L±1.5	W	H±1.0	P±1.5
BGR5TX, BSR5TX, BGR5TY, BSR5TY, BGR5TYS, BSR5TYS	27	9.5±1	9.5	15
BGR7TX, BSR7TX, BGR7TY, BSR7TY, BGR7TYS, BSR7TYS	35			22.5
BGR10TX, BSR10TX, BGR10TY, BSR10TY, BGR10TYS, BSR10TYS	48	12.5±1.5	12.5	35
BGR15TX, BSR15TX	63.5			32.5
BGR20TX, BSR20TX				47.5

P Style

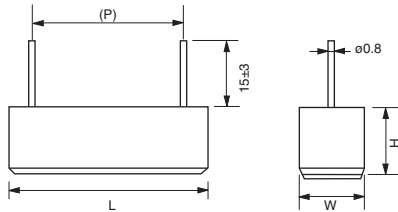

Type	Dimensions millimeters			
	L	W	H	(P)
BWR5CP	23.0±1.5	9.5±1.5	9.5±1.5	20

Parenthesized dimensions are for reference.
 Please refrain from using these parts as a board-insertion type.
 * Soldering only does not allow enough joint strength.
 Additional fixation is recommended.

Z Style (5W, 7W, 10W)

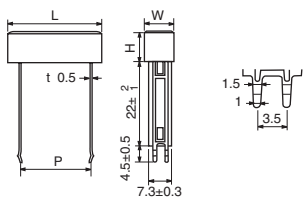

(15W, 20W)

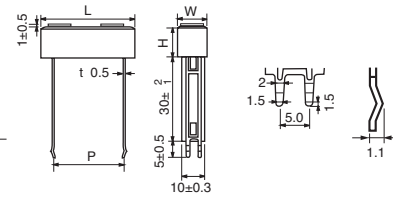

Type	Dimensions millimeters			
	L±1.5	W±1.0	H	P
BGR5TZ, BSR5TZ	27	9.5	9.5±1	15 ⁺⁶ ₋₂
BGR7TZ, BSR7TZ	35			22.5 ⁺⁶ ₋₂
BGR10TZ, BSR10TZ	48	12.5	12.5±1.5	35 ⁺⁶ ₋₂
BGR15TZ, BSR15TZ	63.5			32.5 ⁺⁴ ₋₀
BGR20TZ, BSR20TZ				47.5 ⁺⁴ ₋₀

rectangular type wirewound resistors with glass core
 rectangular type wirewound resistors with ceramic core
 rectangular type metal oxide film resistors

dimensions and construction (continued)

H Style

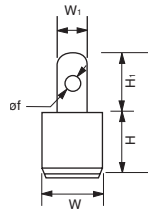
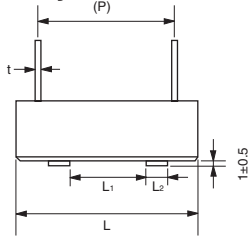

Q Style

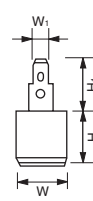
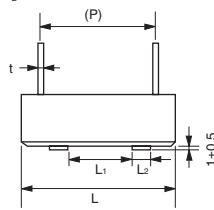

(15W, 20W)

(5W, 7W, 10W, 30W, 40W)

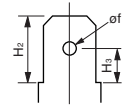
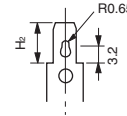

Type	Dimensions millimeters											
	L	L ₁	L ₂	W	W ₁	H	H ₁	H ₂	(H ₃)	(P)	t	(øf)
BGR10TH, BSR10TH	48±1.5	25±1.0	4.5	9.5±1.0	5.0	9.5±1.0	7.0±1.0	—	—	35	0.4	2.0
BGR15TH, BSR15TH			7.0	12.5±1.2	6.0	12.5±1.5	8.5±1.0			34.5		
BGR20TH, BSR20TH			63.5±2	7.0	12.5±1.2	6.0	12.5±1.5			8.5±1.0		
BGR30TH	75±2.5	40±1.2	10.0	19.0±1.5	7.5	19.0±1.5	11.0±1.0	—	—	56	0.5	3.0
BGR40TH	90±2.5									71		
BGR5TQ, BSR5TQ	27±1.5	—	—	9.5±1.0	4.75	9.5±1.0	10.5±1.0	6.5	3.3	15.0	0.5	2.2
BGR7TQ, BSR7TQ	35±1.5									22.5		
BGR10TQ, BSR10TQ	48±1.5									35.0		
BGR15TQ, BSR15TQ	48±1.5	25±1.0	4.5	12.5±1.2	4.75	12.5±1.5	12.0±1.0	6.35	—	34.5	0.5	—
BGR20TQ, BSR20TQ			63.5±2							49.5		
BGR30TQ	75±2.5	40±1.2	10.0	19.0±1.5	6.3	19.0±1.5	12.0±1.0	8.0	4.1	56	0.8	1.7
BGR40TQ	90±2.5									71		

Parenthesized dimensions are for reference.

HA, QA Style

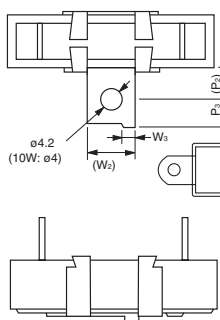

HB, QB Style

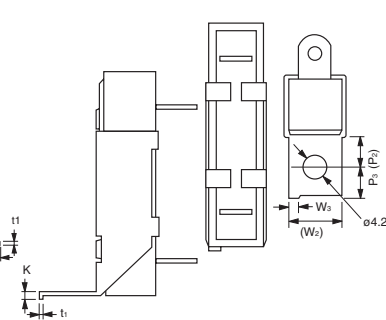

Type	Dimensions millimeters					
	(P ₂)	P ₃	(W ₂)	W ₃	K	t ₁
BGR10THA, BSR10THA, BGR10TQA, BSR10TQA	8.0	6.0±1.0	12.0	3.0±0.3	2.8±0.3	0.6
BGR15THA, BSR15THA, BGR15TQA, BSR15THB, BSR15THB, BGR15TQB, BSR15TQA, BSR15TQB						0.8
BR20THA, BSR20THA, BGR20TQA BGR20THB, BSR20THB, BGR20TQB, BSR20TQA, BSR20TQB						0.8
BGR30THA, BGR30THB, BGR30TQA, BGR30TQB	10.0	8.0±1.0	18.0	3.0±0.3	3.0±0.3	0.8
BGR40THA, BRG40THB, BGR40TQA, BGR40TQB						0.8

Parenthesized dimensions are for reference.

rectangular type wirewound resistors with glass core
 rectangular type wirewound resistors with ceramic core
 rectangular type metal oxide film resistors

Temperature Rise

S Style

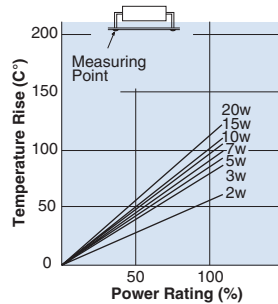
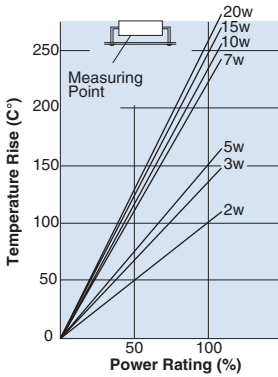

N Style

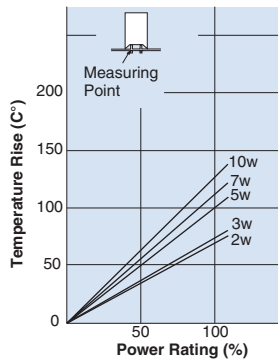

E Style

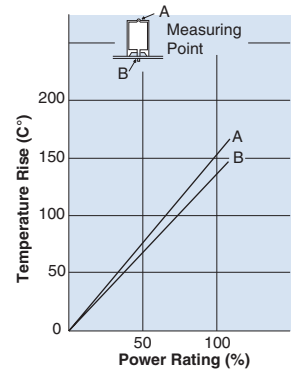

X Style

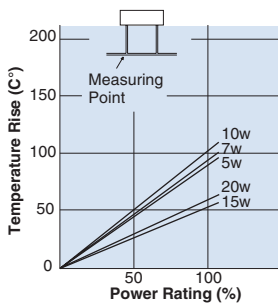

Y Style

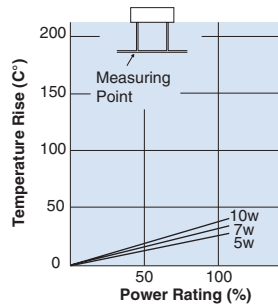

YS Style

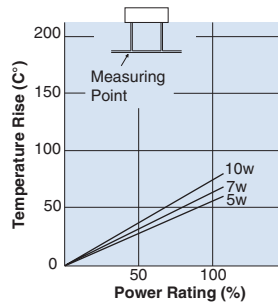

Z Style

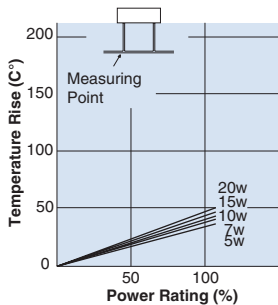

H, Q Style

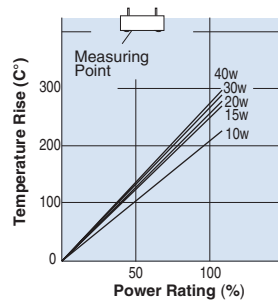

Derating Curve

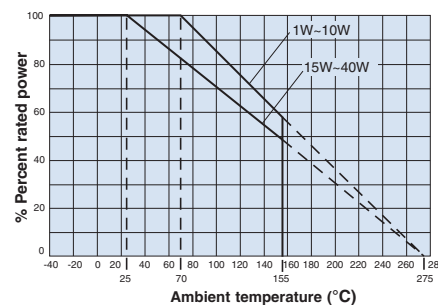

leaded resistors

environmental applications

Performance Characteristics

Parameter	Requirement $\Delta R \pm\%$		Test Method
	Limit	Typical	
Resistance	Within specified tolerance	—	25°C
T.C.R.	Within specified T.C.R.	—	+25°C/+125°C
Resistance to Solder Heat	1%: BWR, BSR 2%: BGR	0.8%: BWR 1.7%: BGR 0.9%: BSR	350°C \pm 10°C for 3.5 seconds 260°C \pm 5°C for 10 seconds
Moisture Resistance	3%: BWR, BGR 5%: BSR	2.4%: BWR 2.55%: BGR 4.5%: BSR	Power rating x 1/10, 40°C, 90 - 95% RH, 1000 hours, 1.5 hr ON, 0.5 hr OFF cycle
Endurance @ 25°C or 70°C	3%: BWR 5%: BGR, BSR	2.4%: BWR 4.25%: BGR 4.5%: BSR	Rated voltage, 25°C or 70°C, 1000 hours, 1.5 hours ON/ 0.5 hours OFF cycle

Specifications given herein may be changed at any time without prior notice. Please confirm technical specifications before you order and/or use.

11/01/23

BGRV: rectangular type wirewound resistors with glass core (for automotive)
BWRV: rectangular type wirewound resistors with ceramic core (for automotive)
BSRV: rectangular type metal oxide film resistors (for automotive)



features

- High power resistors
- Uses flame-retardant insulated ceramic case
- Excellent in anti-pulse and inrush current
- Suitable for high reliability applications like automotive
- AEC-Q200 tested
- Products meet EU RoHS requirements



applications and ratings

Type	Power Rating	Pulse Energy Capacity (J)*	Resistance Range (Ω) E24		Style & Weight (g/1pcs)					
			J±5%	K±10%	S**	N**	Q	QA	QC	QE
BWRV3	3W	11	1~390	—	3.9	5.9	—	—	—	—
BWRV5	5W	17	1~390	—	5.1	7.2	—	—	—	—
BWRV7	7W	52	1~390	—	7.5	10.8	—	—	—	—
BWRV10	10W	100	1~390	—	10.2	15.0	—	—	—	—
BWRV15	15W	100	1~390	—	18.8	—	—	—	—	—
BWRV20	20W	180	1~390	—	23.3	—	—	—	—	—
BWRV40	40W (60W)	549	4.3~220	—	—	—	93.5	—	—	107.5
BGRV5	5W	16	10~390	5.1~9.1	—	—	6.2	—	—	—
BGRV7	7W	31	10~390	5.1~9.1	—	—	7.9	—	—	—
BGRV10	10W	60	10~390	5.1~9.1	—	—	10.7	14.5	—	—
BGRV15	15W	60	10~390	5.1~9.1	—	—	18.6	24.6	—	—
BGRV20	20W	95	10~390	5.1~9.1	—	—	22.1	28.1	—	—
BGRV30	30W	161	10~390	5.1~9.1	—	—	59.6	—	84.6	73.9
BGRV30TQW			10~100	5.1~9.1	—	—				
BGRV40	40W	226	10~390	5.1~9.1	—	—	70.6	—	105.0	95.0
BGRV40TQW			10~100	5.1~9.1	—	—				
BSRV3	3W	—	430~27k	—	3.9	5.9	—	—	—	—
BSRV5	5W	—	430~51k	—	5.1	7.2	6.2	—	—	—
BSRV7	7W	—	430~56k	—	7.5	10.8	7.9	—	—	—
BSRV10	10W	—	430~75k	—	10.2	15.0	10.7	14.5	—	—
BSRV15	15W	—	430~56k	—	18.8	—	18.6	24.6	—	—
BSRV20	20W	—	430~56k	—	23.3	—	22.1	28.1	—	—

* Average value between 10Ω~100Ω

** S Style and N Style lead terminal products are not compatible with the AEC-Q200 vibration test by only soldered PCB mounting.

When using the product, please take into account vibration measures such as fixing the product with silicone resin.

Type	Power Rating	Rated Ambient Temperature	Max. Working Voltage (V)			Max. Overload Voltage (V)			T.C.R. (x10 ⁻⁶ /K)			Operating Temperature Range
			BGRV	BWRV	BSRV	BGRV	BWRV	BSRV	BGRV	BWRV	BSRV	
B□RV3	3W	+70°C	—	E=√P·R	300	—	E=√P·R·10	600	±250	±300	-40°C to +155°C	
B□RV5	5W		350		—	700						
B□RV7	7W		500		—	1000						
B□RV10	10W		700		—	1400						
B□RV15	15W		700		—	1400						
B□RV20	20W	750	—	1500								
BGRV30	30W	+25°C	—	—	—	—	—	—	—	—		
BGRV40	40W		—		—		—					
BWRV40	40W (60W)***		—		E=√P·R		—					E=√P·R·10

Rated voltage= √Power Rating × Resistance value or Max. working voltage, whichever is lower.

Please consult with us in advance about custom-made products.

*** Please note that when used at a rated power of 60W, the surface temperature of the product will reach approximately 300°C.

Specifications given herein may be changed at any time without prior notice. Please confirm technical specifications before you order and/or use.

11/01/23

BGRV: rectangular type wirewound resistors with glass core (for automotive)
BWRV: rectangular type wirewound resistors with ceramic core (for automotive)
BSRV: rectangular type metal oxide film resistors (for automotive)

ordering information

BGRV	30	T	Q		A	300	J
Type	Power Rating	Termination¹ Surface Material	Style²	Dimensional Accuracy³	Mounting Bracket	Nominal Resistance	Resistance Tolerance
BGRV: Wirewound (glass core) BWRV: Wirewound (ceramic core) BSRV: Metal oxide film	See table	C: SnCu T: Sn	Nil: S style N: N style Q: Q style	Nil: Standard W: High precision	Nil: None A: A style C: C style E: E style	3 digits	J: ±5% K: ±10%

¹ Lead-Free plated terminal symbols. C (SnCu): S, N styles T(Sn): Q styles

² No indication on style means S style.

Contact us if you have a request for environmentally hazardous materials other than the substance specified by EU RoHS.

dimensions and construction

S Style³

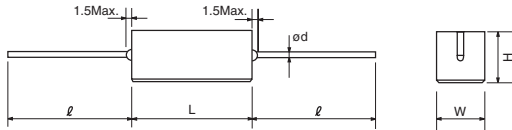

Type	Dimensions millimeters				
	L	W	H	ℓ	d
BWRV3C, BSRV3C	22±1.5	8±1.0	8±1.0	35±3	0.8±0.1
BWRV5C, BSRV5C		9.5±1.0	9.5±1.0		
BWRV7C, BSRV7C					
BWRV10C, BSRV10C	48±1.5				
BWRV15C, BSRV15C	63.5±1.5	12.5±1.5	12.5±1.5		

N Style³

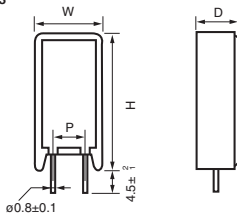

Type	Dimensions millimeters			
	W	D	H	P
BWRV3CN, BSRV3CN	12±1.0	8±1.0	25±1.5	5 ⁺² ₋₁
BWRV5CN, BSRV5CN	13±1.0	9±1.0	25.5±1.5	
BWRV7CN, BSRV7CN			38.5±1.5	
BWRV10CN, BSRV10CN	16±1.0	12±1.0	35±1.5	7.5 ⁺² ₋₁

Q Style

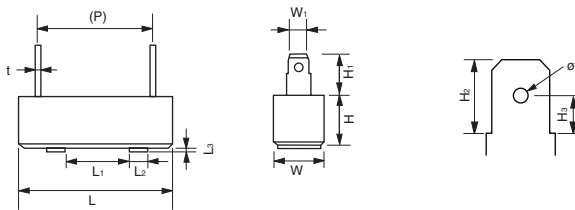

³ S Style and N Style lead terminal products are not compatible with the AEC-Q200 vibration test only by soldered PCB mounting. When using the product, please take into account vibration measures such as fixing the product with silicone resin.

Type	Dimensions millimeters													
	L	L ₁	L ₂	L ₃	W	W ₁	H	H ₁	H ₂	(H ₃)	(P)	t	(øf)	
BGRV5TQ, BSRV5TQ	27±1.5	—	—	—	9.5±1.0	4.75±0.1	9.5±1.0	10.5±1.0	6.5	3.3	(15.0)	0.5	2.2	
BGRV7TQ, BSRV7TQ	35±1.5										(22.5)			
BGRV10TQ, BSRV10TQ	48±1.5	25±1.0	4.5	1.0±0.5	12.5±1.2	6.3±0.1	12.5±1.5	13.0±1.0	6.35	3.15	(35.0)	1.4		
BGRV15TQ, BSRV15TQ			7								(34.5)			
BGRV20TQ, BSRV20TQ	63.5±2	40±1.0	10		19.0±1.0	19.0±1.0	19.0±1.0	12.0±1.0	8.0	4.1	71±0.5	(49.5)	0.8	1.7
BGRV30TQ	75±1.0				(56.0)									
BGRV30TQW ⁴	75±0.5				56±0.5									
BGRV40TQ	90±1.0	40±1.0	19.0±1.0	19.0±0.5	19.0±1.0	19.0±0.5	19.0±1.0	19.0±0.5	19.0±0.5	19.0±0.5	71±0.5			
BGRV40TQW ⁴	90±0.5	40±0.5	19.0±0.5	19.0±0.5	19.0±0.5	19.0±0.5	19.0±0.5	19.0±0.5	19.0±0.5	19.0±0.5	71±0.5			
BWRV40TQ	91±1.0	40±0.5	20.0±0.5	20.0±0.5	20.0±0.5	20.0±0.5	20.0±0.5	20.0±0.5	20.0±0.5	20.0±0.5	71±0.5			

⁴ High-precision products

Parenthesized dimensions are for reference.

Specifications given herein may be changed at any time without prior notice. Please confirm technical specifications before you order and/or use.

11/01/23

BGRV: rectangular type wirewound resistors with glass core (for automotive)
BWRV: rectangular type wirewound resistors with ceramic core (for automotive)
BSRV: rectangular type metal oxide film resistors (for automotive)

dimensions and construction (continued)

QA Style

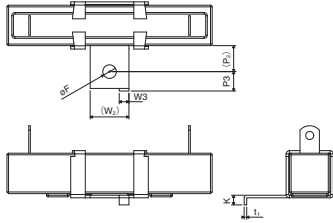

QC Style

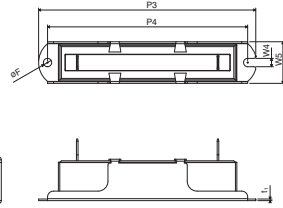

QE Style (BGRV)

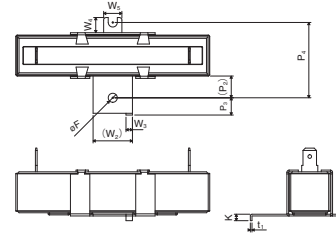

QE Style (BWRV40)

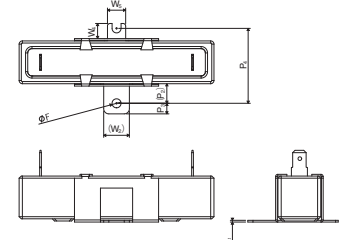

Type	Dimensions millimeters							K	t ₁	øF
	(P ₂)	P ₃	P ₄	(W ₂)	W ₃	(W ₄)	(W ₅)			
BGRV10TQA, BSRV10TQA	8.0	6.0±1.0	—	12.0	3.0±0.3	—	—	2.8±0.3	0.6	4.0
BGRV15TQA, BSRV15TQA								3.0±0.3		
BGRV20TQA, BSRV20TQA								—		
BGRV30TQC, BGRV30TQWC	—	110±1.0	101±1.0	—	—	4.2	21.0	—	0.8	4.2
BGRV40TQC, BGRV40TQWC								—		
BGRV30TQE, BGRV30TQWE	10.0	8.0±1.0	35.0±1.0	18.0	3.0±0.3	7.0	8.5	3.0±0.3	—	—
BGRV40TQE, BGRV40TQWE								—		
BWRV40TQE								8.1		

Parenthesized dimensions are for reference.

Derating Curve

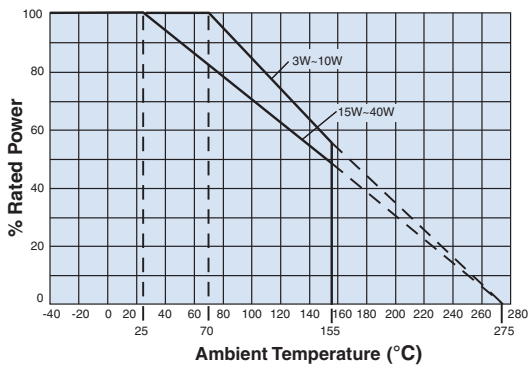

environmental applications

Performance Characteristics

Parameter	Requirement Δ R ±%		Test Method
	Limit	Typical	
Resistance	Within specified tolerance	—	25°C
T.C.R.	Within specified T.C.R.	—	+25°C/+125°C
Resistance to Soldering Heat	1%: BWRV, BSRV 2%: BGRV	0.5%: BWRV, BSRV 1.0%: BGRV	350°C ± 10°C for 3.5 seconds 260°C ± 5°C for 10 seconds
Moisture Resistance	3%: BWRV, BGRV 5%: BSRV	2.0%: BWRV, BGRV 2.5%: BSRV	Power rating x 1/10, 40°C, 90 - 95% RH, 1000 hours, 1.5 hr ON, 0.5 hr OFF cycle
Endurance @ 25°C or 70°C	3%: BWRV 5%: BGRV, BSRV	2.0%: BWRV 2.5%: BGRV, BSRV	25°C or 70°C, rated voltage, 1000 hours, 1.5 hours ON, 0.5 hours OFF cycle

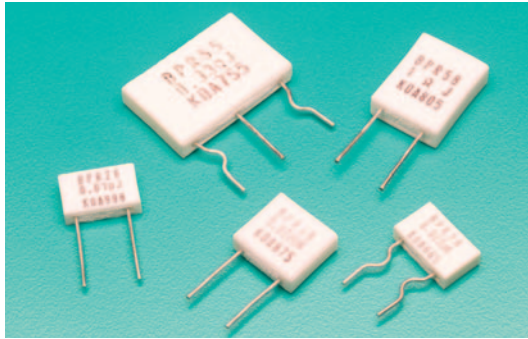

features

- Power type current detecting resistors
- Flame retardant resistors in ceramic case
- Automatic insertion for a 5mm pitch between terminals is applicable (26 type, 58 type)
- Low inductance
- Space saving
- Products with lead-free terminations meet EU RoHS requirements

leaded resistors

dimensions and construction

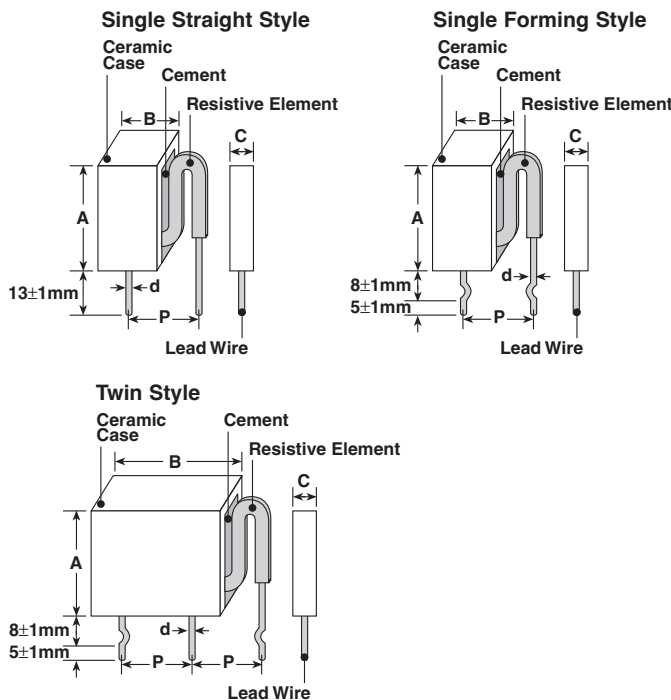

Size Code	Dimensions inches (mm)				
	A	B	C	d	P
BPR26	.335±.04 (8.5±1.0)	.512±.04 (13.0±1.0)	.157±.04 (4.0±1.0)	.024±.004 (0.6±0.1)	.354±.04 (9.0±1.0)
BPR28	.335±.04 (8.5±1.0)	.512±.04 (13.0±1.0)	.157±.04 (4.0±1.0)	.031±.004 (0.8±0.1)	.354±.04 (9.0±1.0)
BPR38	.512±.04 (13.0±1.0)	.551±.04 (14.0±1.0)	.197±.04 (5.0±1.0)	.031±.004 (0.8±0.1)	.354±.04 (9.0±1.0)
BPR58	.709±.04 (18.0±1.0)	.551±.04 (14.0±1.0)		.031±.004 (0.8±0.1)	.354±.04 (9.0±1.0)
BPR108	.669±.06 (17.0±1.5)	1.02±.06 (26.0±1.5)	.197±.04 (5.0±1.0)	.031±.004 (0.8±0.1)	.787±.04 (20.0±1.0)
BPR55	.669±.06 (17.0±1.5)	1.02±.06 (26.0±1.5)		.031±.004 (0.8±0.1)	.394±.04 (10.0±1.0)
BPR77	.787±.07 (20.0±1.8)	1.02±.06 (26.0±1.5)		.031±.004 (0.8±0.1)	.394±.04 (10.0±1.0)

Derating Curve

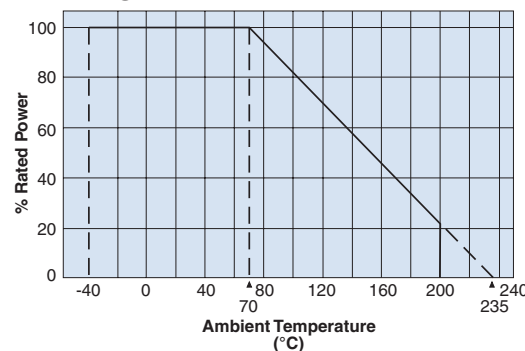

For resistors operated at an ambient temperature of 70°C or above, a power rating shall be derated in accordance with the above derating curve.

ordering information

BPR	5	8	C	F	R10	J
Type	Power Rating	Lead Wire Diameter	Termination Material	Packaging	Nominal Resistance	Tolerance
	2: 2W 3: 3W 5: 5W	6: ø0.6mm 8: ø0.8mm	C: SnCu	Blank: Straight lead (9.0mm pitch) F: Forming (9.0mm pitch) FT: Radial taping (BPR26FT, BPR58FT only, 5.0mm pitch)	2 significant figures +1 multiplier. "R" indicates decimal on value <10Ω. All values less than 0.1Ω are expressed in mΩ with "L" as decimal. Ex: 20mΩ - 20L	J: ±5% K: ±10%
	10: 10W	8: ø0.8mm				
	55: 5W+5W 77: 7W+7W	Blank				

For further information on packaging, please refer to Appendix C.

Specifications given herein may be changed at any time without prior notice. Please confirm technical specifications before you order and/or use.

2/10/21

applications and ratings

Part Designation	Power Rating	T.C.R. (ppm/°C) Max.	Resistance Range		Rated Ambient Temperature	Operating Temperature Range
			J: ±5% (E12)	K: ±10% (E12)		
BPR26	2W	±350*	0.01Ω 0.1Ω - 0.68Ω	0.01Ω - 0.68Ω	+70°C	-40°C to +200°C
BPR28	2W					
BPR38	3W					
BPR58	5W		0.01Ω, 0.1Ω - 1.0Ω	0.01Ω - 1.0Ω		
BPR108	10W		—	0.05Ω, 0.1Ω - 1.0Ω		
BPR55	5W+5W		0.05Ω, 0.1Ω 0.22Ω - 0.47Ω	0.03Ω - 0.47Ω		
BPR77	7W+7W					

* Application range: The straight style of 0.018Ω or over

standard resistance

Resistance	26, 28		38		58		108		55		77	
	J: ±5%	K: ±10%	J: ±5%	K: ±10%	J: ±5%	K: ±10%	J: ±5%	K: ±10%	J: ±5%	K: ±10%	J: ±5%	K: ±10%
0.01	○	○	○	○	○	○	—	—	—	—	—	—
0.012		○		○		○	—	—	—	—	—	—
0.015		○		○		○	—	—	—	—	—	—
0.018		○		○		○	—	—	—	—	—	—
0.02*		○		○		○	—	—				
0.022		○		○		○	—	—				
0.027		○		○		○	—	—				
0.03*		○		○		○	—	—		○		
0.033		○		○		○	—	—				
0.039		○		○		○	—	—				
0.04*		○		○		○	—	—				
0.047		○		○		○	—	—				
0.05*		○		○		○		○		○		○
0.068		○		○		○		○		○		○
0.082		○		○		○		○				
0.1	○	○	○	○	○	○		○	○	○		○
0.12	○	○	○	○	○	○			○	○		
0.15	○	○	○	○	○	○		○	○	○		
0.18	○	○	○	○	○	○		○	○	○		
0.22	○	○	○	○	○	○		○	○	○	○	○
0.27	○	○	○	○	○	○		○	○	○		
0.33	○	○	○	○	○	○			○	○	○	○
0.39	○	○	○	○	○	○			○	○		
0.47	○	○	○	○	○	○			○	○		
0.56	○	○	○	○	○	○						
0.68	○	○	○	○	○	○			—	—	—	—
0.82									—	—	—	—
1.00									—	—	—	—

○ : Available

Blank : Please consult

— : Not available

* Non standard E-12 Decade Value

environmental applications
Performance Characteristics

Parameter	Requirement Δ R%		Test Method
	Limit	Typical	
Resistance	Within regulated tolerance	—	25°C (Measurement position: 10mm under from the case)
T.C.R.	Within specified T.C.R.	—	+25°C/+125°C (Application range: the straight style of 0.018Ω over)
Overload (Short time)	±2.0%	±1.0%	Rated power x 2.5 for 5 seconds (Application range: 0.05Ω & over)
Resistance to Solder Heat	±2.0%	±1.0%	260°C ± 5°C, 10 seconds ± 1 second
Moisture Resistance	±5.0%	±3.0%	40°C ± 2°C, 90 - 95% RH, 1000 hours, 1.5 hr ON, 0.5 hr OFF cycle
Endurance at 70°C	±5.0%	±3.0%	70°C ± 2°C, 1000 hours, 1.5 hr ON, 0.5 hr OFF cycle
High Temperature Exposure	±3.0%	±2.0%	+125°C, 100 hours
Resistance to Solvent	No evidence of damage to protective coating and marking	—	After immersing the sample in I.P.A for 60 seconds ± 10 seconds, the resistor surface should be rubbed with absorbent cotton 10 times

Specifications given herein may be changed at any time without prior notice. Please confirm technical specifications before you order and/or use.

11/09/22



features

- The super low resistance (3mΩ ~) is suitable for high power current sensing
- Pitches and heights adjustable according to mounting conditions
- All custom-made products
- Easy soldering
- Products with lead-free terminations meet EU RoHS requirements. EU RoHS regulation is not intended for Pb-glass contained in electrode, resistor element and glass.

leaded resistors

dimensions and construction

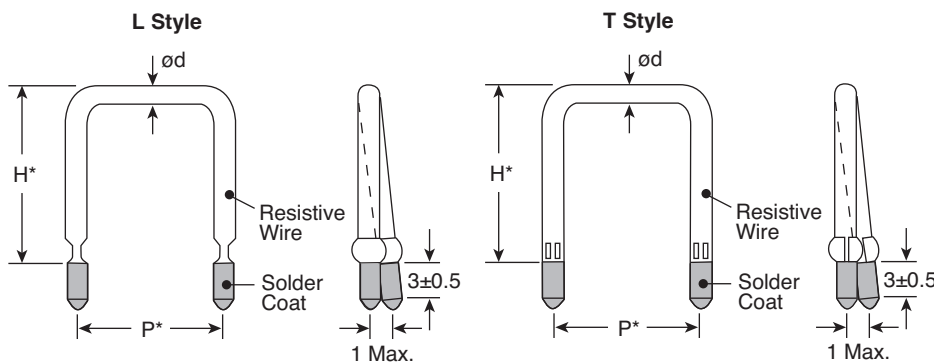

* Please consult with factory about dimensions "P" and "H"
T style is applied for the diameter of ø 2.3 or above

ordering information

LR	09	D	L	10	20L	J
Type	Symbol	Termination Material	Style	Insertion Pitch	Nominal Resistance	Resistance Tolerance
	06~20: L-Style 23~29: T-Style	D: SnAgCu N: No surface treatment	L (06~20) T (23~29)	Insertion Pitch	3 digits "L" indicates the decimal in milliohms	H: ±3% J: ±5%

applications and ratings

Part Designation	Symbol	ød Diameter (mm)	Maximum Current Rating (A)	Resistance Range	Resistance Tolerance	T.C.R. (ppm/°C) Max.	Rated Ambient Temperature	Operating Temperature Range
LR06D	06	0.6	3.0	50mΩ - 100mΩ	H: ±3% J: ±5%	±100	+70°C	-40°C to +180°C
LR07D	07	0.7	4.0	30mΩ - 70mΩ				
LR08D	08	0.8	4.5	28mΩ - 50mΩ				
LR09D	09	0.9	5.0	20mΩ - 40mΩ				
LR10D	10	1.0	5.5	15mΩ - 30mΩ				
LR11D	11	1.1	6.0	15mΩ - 20mΩ				
LR12D	12	1.2	7.0	10mΩ - 20mΩ				
LR13D	13	1.3	7.5	10mΩ - 20mΩ				
LR14D	14	1.4	8.0	10mΩ - 20mΩ				
LR15D	15	1.5	9.0	10mΩ - 20mΩ				
LR16D	16	1.6	9.5	10mΩ - 15mΩ				
LR18D	18	1.8	11	5mΩ - 10mΩ				
LR20D	20	2.0	12	5mΩ - 10mΩ				
LR23D	23	2.3	14	3mΩ - 10mΩ				
LR26D	26	2.6	18	3mΩ - 5mΩ				
LR29D	29	2.9	21	3mΩ - 5mΩ				

* Other diameters and resistances are also available on request

environmental applications

Derating Curve

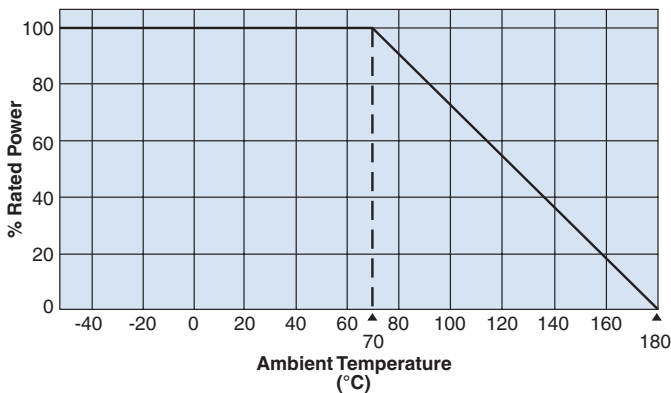

For resistors operated at an ambient temperature of 70°C or above, a power rating shall be derated in accordance with the above derating curve.

Performance Characteristics

Parameter	Requirement Δ R ±%		Test Method
	Limit	Typical	
Resistance	Within specified tolerance	—	25°C
T.C.R.	Within specified T.C.R.	—	+25°C/+125°C
Resistance to Soldering Heat	±2.0%	±1.6%	350°C ± 10°C, 3 seconds
Moisture Resistance	±3.0%	±2.7%	Power rating x 1/10, 40°C, 90% - 95% RH, 1000 hours, 1.5 hr ON, 0.5 hr OFF cycle
Endurance at 70°C	±5.0%	±3.0%	Rated voltage, 70°C, 1000 hours 1.5 hr ON, 0.5 hr OFF cycle

Specifications given herein may be changed at any time without prior notice. Please confirm technical specifications before you order and/or use.

12/13/19

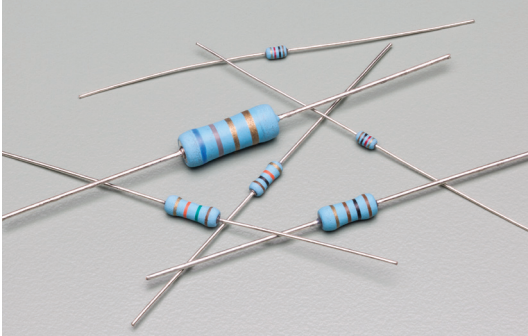

features

- Functions as a resistor in normal condition
- Quick fusing protects circuit from excessive overload at an abnormal time
- Flame-retardant coating equivalent to UL94 V-0
- Eu RoHS regulation is not intended for Pb-glass in insulation coating

dimensions and construction

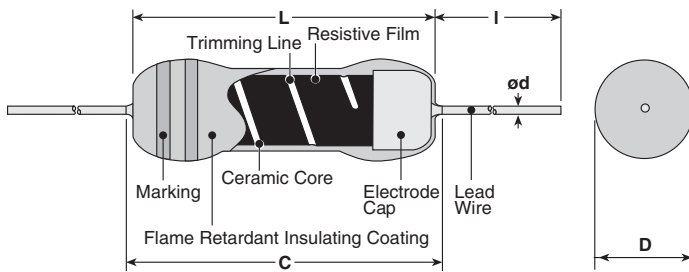

Type	Dimensions inches (mm)				
	L	C Max.	D ^{+0.010} ₋₀	d (Nominal)	ℓ*
RF16	.125±.008 (3.2±0.2)	.134 (3.4)	.461 ^{.25} ₀ (1.7)	.018 (0.45)	1.18±.118 (30±3)
RF25	.248±.020 (6.3±0.5)	.280 (7.1)	.091±.012 (2.3±0.3)	.024 (0.6)	
RF50	.335±.020 (8.5±0.5)	.374 (9.5)	.118±.012 (3.0±0.3)		
RF1	.354±.039 (9.0±1.0)	.437 (11.1)	.138±.020 (3.5±0.5)	.031 (0.8)	
RF2	.610±.039 (15.5±1.0)	.709 (18.0)	.236±.039 (6.0±1.0)		

* Lead length changes depending on taping and forming type.

ordering information

RF	25	C	T52	A	100	J
Product Code	Power Rating	Terminal Surface Material	Taping & Forming	Packaging	Nominal Resistance	Resistance Tolerance
	16: 0.17W 25: 0.25W 50: 0.5W 1: 1W 2: 2W	C: SnCu	T26, T52, T521, T631, MHT, VTP, VTE, VT, GT, L, M Forming	A: Ammo R: Reel	3 digits	J: ±5%

ratings

Type	Power Rating	Resistance Range E24 J: ±5%	Fusing Characteristics						Fusing Time	T.C.R. ×10 ⁻⁶ /K	Dielectric Withstanding Voltage
			Fusing Power								
RF16C	0.17W	1.0 - 1k	—	—	—	3W 1Ω - 4.7Ω	2.5W 5.1Ω - 1kΩ	—	60s Max.	±1000: R≤4.7Ω ±350: R≥5.1Ω	250V
RF25C	0.25W	0.1 - 10k	10W 0.1 - 0.18Ω	7.5W 0.2 - 0.43Ω	6.25W 0.47 - 0.91Ω	—	3.75W 1Ω - 4.7Ω 2.4kΩ - 10kΩ	3W 5.1Ω - 2.2kΩ	30s Max.		
RF50C	0.5W	0.1 - 15k	—	—	12.5W 0.1 - 0.43Ω	—	7.5W 0.47Ω - 2Ω 1.1kΩ - 15kΩ	6W 2.2Ω - 1kΩ			350V
RF1C	1W	0.1 - 10k	—	30W 0.1 - 0.18Ω	25W 0.2 - 0.43Ω	—	15W 0.47Ω - 2Ω 1.1kΩ - 10kΩ	12W 2.2Ω - 1kΩ			600V
RF2C	2W	1.0 - 3k	—	—	—	36W 1Ω - 3.6Ω	30W 1.1kΩ - 3kΩ	24W 3.9Ω - 1kΩ			

Rated Ambient Temperature: +70°C

Operating Temperature Range: -40 -- +155°C

$$\text{Rated voltage} = \sqrt{\text{Power Rating} \times \text{Resistance value}}$$

Specifications given herein may be changed at any time without prior notice. Please confirm technical specifications before you order and/or use.

11/16/22

environmental applications

Derating Curve

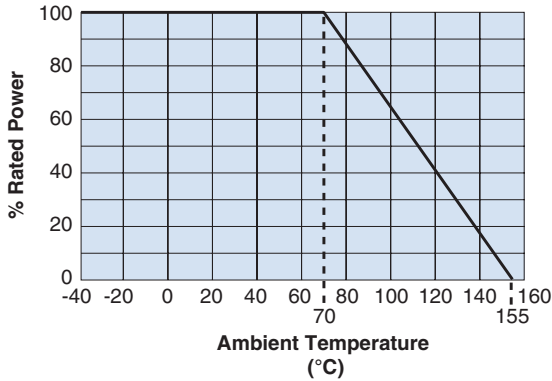

For resistors operated at an ambient temperature of 70°C or above, a power rating shall be derated in accordance with derating curve on the left.

Performance Characteristics

Test Items	Performance Requirements $\Delta R \pm$ (% +0.05 Ω)		Test Methods
	Limit	Typical	
Resistance	Within specified tolerance	—	25°C
T.C.R.	Within specified T.C.R.	—	+25°C/+125°C
Overload (Short Time)	1%	0.5%	Rated voltage \times 2.5 for 5 seconds
Resistance to Soldering Heat	1%	0.5%	350°C \pm 10°C, 3.5s \pm 0.5s or 260°C \pm 5°C, 10s \pm 1s
Rapid Change of Temperature	1%	0.5%	-40°C (30 min.)/ +85°C (30 min.) 5 cycles
Moisture Resistance	5%	2.5%	40°C \pm 2°C, 90% - 95% RH, 1000 hours 1.5h ON/0.5h OFF cycle
Endurance at 70°C	5%	2.5%	70°C \pm 2°C, 1000 hours 1.5h ON/0.5h OFF cycle
Resistance to Solvent	No abnormality in appearance. Marking shall be easily legible.	—	The resistor shall be immersed in IPA for 30 sec.
Flame retardant	No evidence of flaming or self-flaming.	—	— Flame test : The test flame shall be applied and removed for each 15s respectively to repeat the cycle 5 times. Overload flame retardant: A.C. Voltage corresponding to 2, 4, 8, 16 and 32 times the power rating shall be applied for each 1min. until disconnection occurs.

Fusing Characteristics

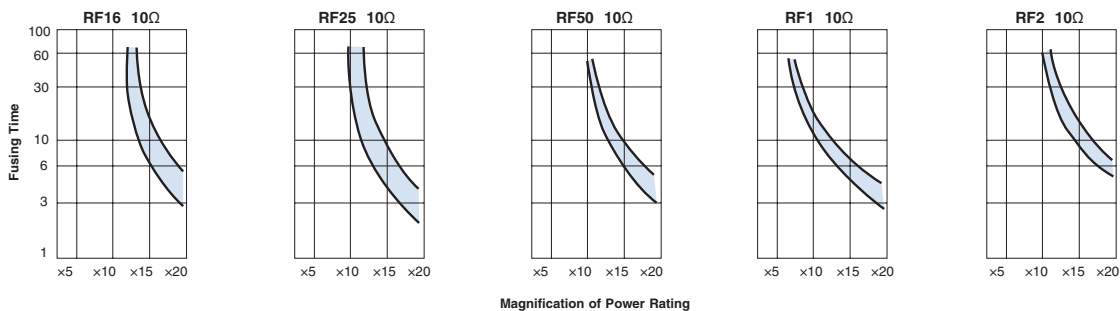

**coat-insulated fusing resistors
(constant current fusing type)**

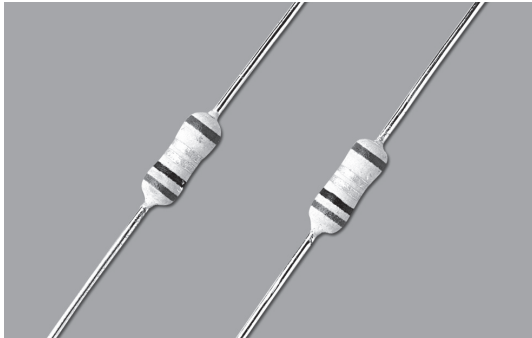

features

- Fuse within 60 seconds in case of over-current
- Constant current fusing type
- Fuse at low magnification at 5 times or 10 times of power rating
- Flame-retardant coating equivalent to UL94 V-0
- Products meet EU RoHS requirements. EU RoHS regulation is not intended for Pb-glass contained in insulation coating.

dimensions and construction

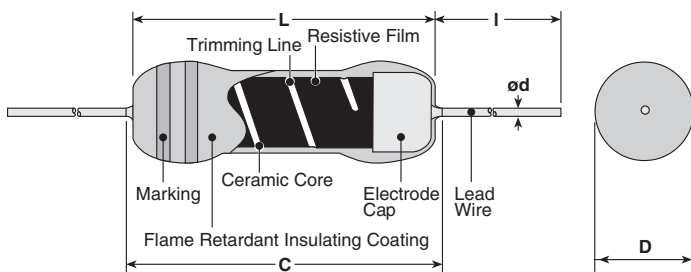

Type	Dimensions inches (mm)				
	L	C Max.	D	d (Nominal)	ℓ*
RF25CC	.248±.020 (6.3±0.5)	.280 (7.1)	.091±.012 (2.3±0.3)	.024 (0.6)	1.18±.118 (30±3)

* Lead length changes depending on taping and forming type.

ordering information

RF	25	C	C	T52	A	R68	K
Product Code	Power Rating	Terminal Surface Material	Constant Current Fusing Type	Taping & Forming	Packaging	Nominal Resistance	Resistance Tolerance
	25: 0.25W	C:SnCu		T26, T52, VTP, VTE, L10A, M10X	A: Ammo R: Reel	3 digits	K:±10%

applications and ratings

Power Rating	Resistance Range(Ω) (E-24)	Resistance Tolerance	Fusing Characteristics			Dielectric Withstanding Voltage	Taping & Q'ty/AMMO (pcs)	
			Fusing Power		Fusing Time		T26A	T52A
0.25W	0.1 - 0.91	K: ±10%	2.5W 0.1Ω	1.25W 0.11Ω - 0.91Ω	60s Max.	250V	2,000	2,000

Rated Ambient Temperature: +70°C
 Operating Temperature Range: -40°C - +155°C
 Rated voltage = √Power Rating×Resistance value

environmental applications

Derating Curve

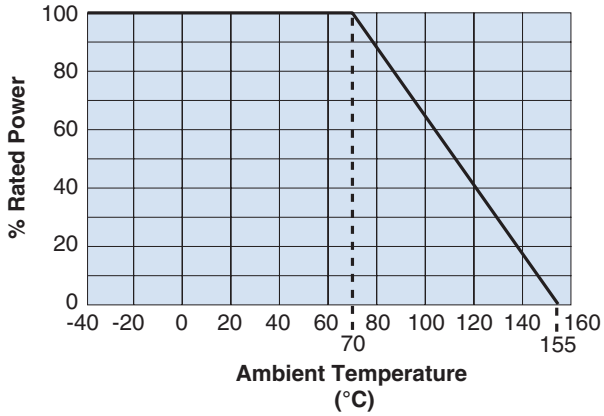

For resistors operated at an ambient temperature of 70°C or above, a power rating shall be derated in accordance with derating curve on the left.

Performance Characteristics

Test Items	Performance Requirements $\Delta R \pm$ (% +0.05 Ω)		Test Methods
	Limit	Typical	
Resistance	Within specified tolerance	—	25°C
Resistance to Soldering Heat	5%	2.5%	350°C \pm 10°C, 3.5s \pm 0.5s or 260°C \pm 5°C, 10s \pm 1s
Humidity	5%	2.5%	40°C \pm 2°C, 90% - 95%RH, 1000h No Load
Endurance at 70°C	5%	2.5%	70°C \pm 2°C, 1000h 1.5h ON/0.5h OFF cycle
Resistance to Solvent	No abnormality in appearance. Marking shall be easily legible.	—	The resistor shall be immersed in IPA for 30 sec.
Flame retardant	No evidence of flaming or self-flaming.	—	Flame test: The test flame shall be applied and removed for each 15s respectively to repeat the cycle 5 times. Overload flame retardant: A.C. Voltage corresponding to 2, 4, 8, 16 and 32 times the power rating shall be applied for each 1min. until dis-connection occurs.

Fusing Characteristics

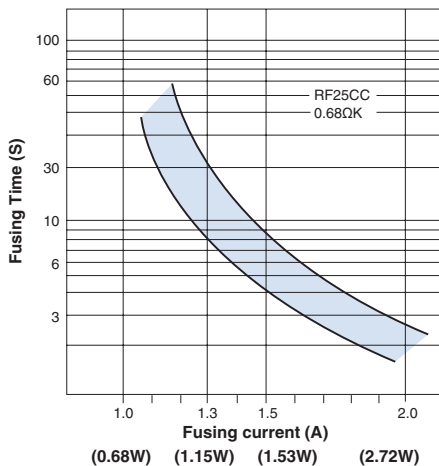

I-R Characteristics

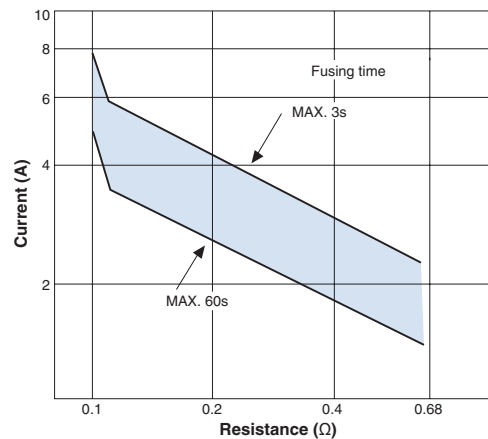

leadless resistors

Precautions for the Thermal Sensors

Refer to the precautions of common matters for all products in the beginning of this catalog.

Particulars Common to Thermal Sensors

- Excessive voltage such as ESD, could damage thermal sensors.
- Water drops from condensation or impure substances that adheres between the electrode wires may cause insulation deficiency and lower the resistance value of the thermal sensors. Be aware when using this product.
- Avoid sudden changes in temperature to maintain the accuracy of the thermal sensors.
- Some of the thermal sensors use special temperature sensing films. Contact us if the sensors are constantly operated under high temperature environment.
- It is necessary to suppress self heating in the design to maintain accuracy of the thermal sensor if rated temperature is set.

Platinum Thin-Film Thermal Sensors

- Welding is recommended to connect the lead wires of SDT101B, SDT310P, SDT310MTM, SDT310AP, SDT310HCTP and SDT310VASP2 since they are heat resistant lead wires. Select the flux for stainless-steel when soldering. Wash the flux with hot water after the soldering to remove the residue completely.
- The 3-wire or 4-wire method is recommended for implementing high precision temperature measuring for both SDT101 and SDT310 series.
- When molded or placed in a metal tube filled with resin, the resistance value may change depending on the kind of resins used.

Terms and Definitions

Platinum Thin Film Thermal Chip Sensors

- Also known as a platinum resistance temperature detector, an electronic component whose resistance value changes with temperature as determined by standards.
- It uses a platinum thin film as a resistor and has excellent environmental resistance, and its resistance value rises almost linearly as the temperature rises.

Linear Positive Temperature Coefficient Resistor

- Unlike the platinum thin film thermal chip sensors, there are many types of resistance value changes with temperature, and there are many types of resistance values, and the resistance value changes with temperature.
- The resistance value change range is narrow compared to the thermistors but the linearity is high.

Thermistor

- Thermally sensitive resistors, constructed from temperature sensitive semi-conductive materials, with predictable, large variation in resistance due to change in temperature. There are two kinds of thermistors characterized by resistance change.
- PTC (Positive Temperature Coefficient): Resistance increases with a rise in temperature.
- NTC (Negative Temperature Coefficient): Resistance decreases with a rise in temperature.

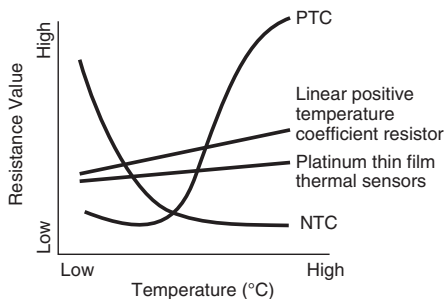

Thermal Time Constant

- Time needed for a sensor's temperature to change 63.2% when the ambient temperature of a sensor is rapidly changed by a condition in which self heat generation can be ignored.

Thermal Dissipation Constant

- The necessary power which is needed to increase the temperature of the element 1°C by self heating and is expressed with the following formula:

$$\delta(W/^{\circ}C) = W/(T1-T)$$

W : Electrical input power (W)
T : Standard Temperature (°C)
T1 : Self heating temperature generated by applied power (°C)

Self-Heating Coefficient

- Self-heating coefficient expressed in °C/mW is values measured at temperature: 0°C in flowing oil with a velocity >0.2m/s, which is value of elements and vary with connecting or fixing methods.

Temperature Coefficient of Resistance (T.C.R.)

- Relative variation of resistance between two given temperatures when temperature is changed by 1K, which is calculated by the following formula.

$$T.C.R. (ppm/^{\circ}C) = \frac{R-R_0}{R_0} \times \frac{1}{T-T_0} \times 10^6$$

R : Resistance value (Ω) at T (°C)
R0 : Resistance value (Ω) at T0 (°C)
T : Measured test temperature (°C)
T0 : Measured base temperature (°C)

Specified Current

- The electricity which it is charged with in the element is moved to the range that rise in temperature due to a self-heat generation can be ignored. Ordinarily recommended measuring currents are 1mA for 100Ω and 0.1mA for 500Ω.

Rated Power

- The maximum wattage which can be continuously applied to a resistor at the rated ambient temperature.

Critical Resistance Value

- The maximum nominal resistance value at which the rated power can be applied without exceeding the maximum working voltage.
- The rated voltage is equal to the maximum working voltage at the critical resistance value.

Maximum Working Voltage

- Maximum D.C. or A.C. voltage (rms) that can be continuously applied to a resistor or a thermosensor. However, the maximum value of the applicable voltage is the rated voltage at the critical resistance value or lower.

Overload Voltage

- Allowable voltage which is applied for 5 sec. according to the short time overload test. Overload voltage shall be 2.5 times of rated voltage or max. overload voltage, whichever is lower.

Rated Ambient Temperature

- Maximum ambient temperature at which the power rating may be applied continuously. The rated ambient temperature refers to the temperature around the resistor mounted inside the equipment, not to the air temperature outside the equipment.

Derating Curve

- Curve that expresses the relation BETWEEN ambient temperature and the maximum allowable power, which is generally expressed in percentage.

External Conductor

- A conductor connected to a temperature sensor that is located outside of the protective body.

Internal Conductor

- A conductor connected to a temperature sensor that is located inside of the protective body.

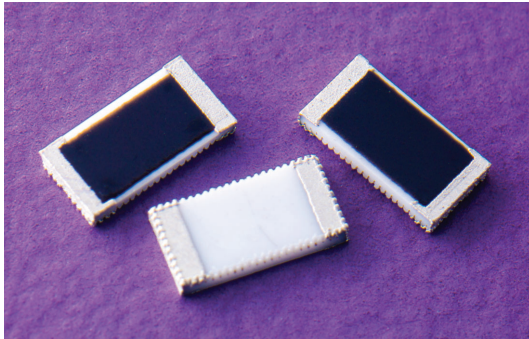

features

- SMD platinum thin film thermal sensors
- T.C.R. is in accordance to JIS-DIN standards IEC
- Suitable for temperature control in various industrial equipment
- Suitable for both flow and reflow solderings
- Products meet EU RoHS requirements

dimensions and construction

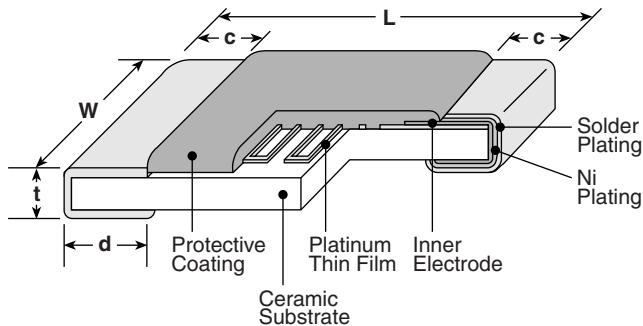

Type (Inch Size Code)	Dimensions inches (mm)				
	L	W	c	d	t
2B (1206)	.126±.008 (3.2±0.2)	.063±.008 (1.6±0.2)	.02±.012 (0.5±0.3)	.02±.012 (0.5±0.3)	.02±.006 (0.5±0.15)

thermal sensors

ordering information

SDT73H	2B	T	TE	100	F	385
Type	Size Code	Termination Material	Packaging	Nominal Resistance	Resistance Tolerance	T.C.R. (x 10⁻⁶/K)
SDT73H 2B SDT73S 2B	2B: 1206	T: Sn	TEK: 4mm pitch plastic embossed (1,000 pieces/reel) TE: 4mm pitch plastic embossed (5,000 pieces/reel)	100: 100Ω 500: 500Ω SDT73S: 100Ω	C: ±0.2% F: ±1% SDT73S: F: ±1%	385: +3850

applications and ratings

Part Designation	Resistance @ 0°C	Resistor Tolerance	Thermal Time Constant ¹	Thermal Dissipation Constant ¹	T.C.R. (ppm/°C) ²	T.C.R. Tolerance (ppm/°C)	Specified Current ⁴	Operating Temperature Range
SDT73H 2B	100Ω 500Ω	C: ±0.2% F: ±1%	6.5 seconds	2.4mW/°C	3850	±50	1mA Max.: 100Ω	-55°C to +155°C
SDT73S 2B	100Ω	F: ±1%					0.1mA Max.: 500Ω	

¹ Thermal time constant and thermal dissipation constant are reference values, which are values of elements and vary with connecting or fixing methods. Thermal dissipation constant is approx. 4mW/°C under the surface mounting condition.

² T.C.R. Measuring Temperature: 0°C/+100°C

³ When always using a SDT73S, 200°C or less is recommended.

⁴ The electricity which it is charged with in the element is moved to the range that rise in temperature due to a self-heat generation can be ignored. Ordinarily recommended measuring currents are 1mA for 100Ω and 0.1mA for 500Ω.

For further information on packaging, please refer to Appendix A.

Specifications given herein may be changed at any time without prior notice. Please confirm technical specifications before you order and/or use.

11/03/23

environmental applications

Temperature Characteristics

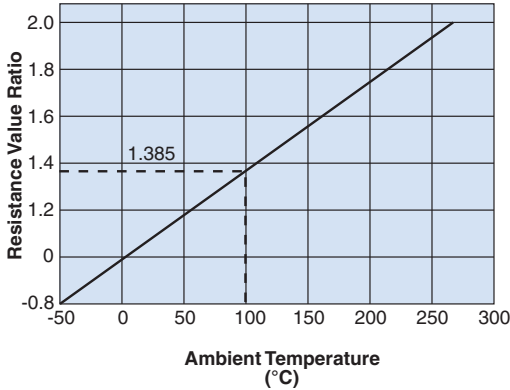

Approximate Expression for Resistance-Temperature Characteristics
 -55°C~0°C : $R_T = R_0 (1 + C_1 T + C_2 T^2 + C_3 (T-100) T^3)$
 0°C~+250°C : $R_T = R_0 (1 + C_1 T + C_2 T^2)$

R_T : Resistance value at T°C
 R_0 : Resistance value at 0°C
 T : Ambient temperature(°C)
 Constants C_1, C_2, C_3 :
 $C_1 = 3.9083 \times 10^{-3} \text{ } ^\circ\text{C}^{-1}$
 $C_2 = -5.775 \times 10^{-7} \text{ } ^\circ\text{C}^{-2}$
 $C_3 = -4.183 \times 10^{-12} \text{ } ^\circ\text{C}^{-4}$

Pt100 Resistance - Temperature Characteristics (JIS C 1604⁻¹⁹⁹⁷)

Temperature (°C)	0	-1	-2	-3	-4	-5	-6	-7	-8	-9
-50	80.31	79.91	79.51	79.11	78.72	78.32	—	—	—	—
-40	84.27	83.87	83.48	83.08	82.69	82.29	81.89	81.50	81.10	80.70
-30	88.22	87.83	87.43	87.04	86.64	86.25	85.85	85.46	85.06	84.67
-20	92.16	91.77	91.37	90.98	90.59	90.19	89.80	89.40	89.01	88.62
-10	96.09	95.69	95.30	94.91	94.52	94.12	93.73	93.34	92.95	92.55
0	100.00	99.61	99.22	98.83	98.44	98.04	97.65	97.26	96.87	96.48
	0	1	2	3	4	5	6	7	8	9
0	100.00	100.39	100.78	101.17	101.56	101.95	102.34	102.73	103.12	103.51
10	103.90	104.29	104.68	105.07	105.46	105.85	106.24	106.63	107.02	107.40
20	107.79	108.18	108.57	108.96	109.35	109.73	110.12	110.51	110.90	111.29
30	111.67	112.06	112.45	112.83	113.22	113.61	114.00	114.38	114.77	115.15
40	115.54	115.93	116.31	116.70	117.08	117.47	117.86	118.24	118.63	119.01
50	119.40	119.78	120.17	120.55	120.94	121.32	121.71	122.09	122.47	122.86
60	123.24	123.63	124.01	124.39	124.78	125.16	125.54	125.93	126.31	126.69
70	127.08	127.46	127.84	128.22	128.61	128.99	129.37	129.75	130.13	130.52
80	130.90	131.28	131.66	132.04	132.42	132.80	133.18	133.57	133.95	134.33
90	134.71	135.09	135.47	135.85	136.23	136.61	136.99	137.37	137.75	138.13
100	138.51	138.88	139.26	139.64	140.02	140.40	140.78	141.16	141.54	141.91
110	142.29	142.67	143.05	143.43	143.80	144.18	144.56	144.94	145.31	145.69
120	146.07	146.44	146.82	147.20	147.57	147.95	148.33	148.70	149.08	149.46
130	149.83	150.21	150.58	150.96	151.33	151.71	152.08	152.46	152.83	153.21
140	153.58	153.96	154.33	154.71	155.08	155.46	155.83	156.20	156.58	156.95
150	157.33	157.70	158.07	158.45	158.82	159.19	159.56	159.94	160.31	160.68
160	161.05	161.43	161.80	162.17	162.54	162.91	163.29	163.66	164.03	164.40
170	164.77	165.14	165.51	165.89	166.26	166.63	167.00	167.37	167.74	168.11
180	168.48	168.85	169.22	169.59	169.96	170.33	170.70	171.07	171.43	171.80
190	172.17	172.54	172.91	173.28	173.65	174.02	174.38	174.75	175.12	175.49
200	175.86	176.22	176.59	176.96	177.33	177.69	178.06	178.43	178.79	179.16
210	179.53	179.89	180.26	180.63	180.99	181.36	181.72	182.09	182.46	182.82
220	183.19	183.55	183.92	184.28	184.65	185.01	185.38	185.74	186.11	186.47
230	186.84	187.20	187.56	187.93	188.29	188.66	189.02	189.38	189.75	190.11
240	190.47	190.84	191.20	191.56	191.92	192.29	192.65	193.01	193.37	193.74
250	194.10	—	—	—	—	—	—	—	—	—

Note: Desired temperature values are obtained by adding temperatures in the vertical and horizontal axes. When calculating a resistance value of 105°C, read the value in the column where 100°C in the vertical axis and 5°C in the horizontal axis cross. The value will be 140.40Ω. The value for 500Ωat 0°C will be the value obtained by multiplying the resistance value in this table by 5.

Performance Characteristics

Parameter	Requirement $\Delta R \pm (\%+0.05\Omega)$		Test Method
	Limit	Typical	
Resistance	Within specified tolerance	—	0°C
T.C.R.	3850±50ppm/°C	—	0°C/ +100°C
Insulation Resistance	100MΩ or more	—	d.c. 100V
Dielectric Withstanding Voltage	±0.5%	-0.019%	a.c. 100V, 60 seconds - 70 seconds
Resistance to Solder Heat	±0.5%	-0.004%	260°C for 10 seconds
Rapid Change of Temperature	±0.5%	-0.033% (SDT73H) -0.048% (SDT73S)	-55°C (30 minutes)/ +25°C (2 - 3 minutes)/ +155°C (30 minutes) (SDT73H, SDT73S)/ +25°C (2 - 3 minutes) (SDT73S), 10 cycles
Moisture Resistance	±0.5%	-0.016%	40°C, 90 - 95% RH, 1000 hours, 1mA, 1.5 hr ON, 0.5 hr OFF cycle
Normal Temperature Load Life	±0.5%	-0.010%	20°C ± 10°C, 1000 hours, 1mA continuous turning on electricity
High Temperature Load Life	±0.5%	-0.017% (SDT73H) -0.020% (SDT73S)	+155°C, 1000 hours (SDT73H), +250°C, 1000 hours (SDT73S) 1mA continuous turning on electricity
High Temperature Exposure	±0.5%	-0.022% (SDT73H) -0.023% (SDT73S)	+155°C, 1000 hours (SDT73H), +250°C, 1000 hours (SDT73S)
Low Temperature Exposure	±0.5%	-0.029%	-55°C, 1000 hours

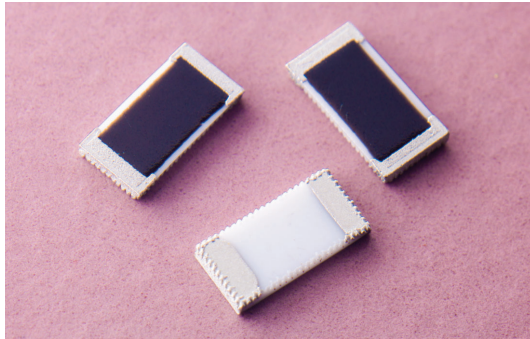

features

- SMD platinum thin film thermal sensors
- T.C.R. is in accordance to JIS IEC standards
- Suitable for both flow and reflow solderings
- Products meet EU RoHS requirements
- AEC-Q200 Tested

dimensions and construction

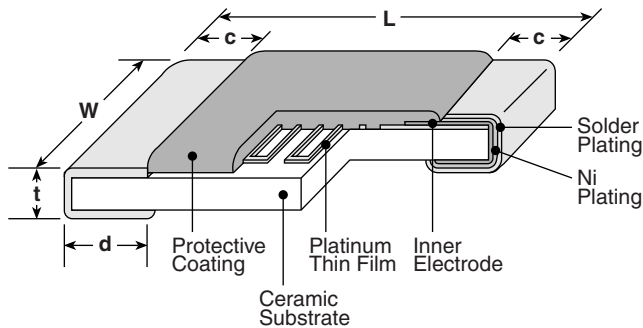

Type (Inch Size Code)	Dimensions inches (mm)				
	L	W	c	d	t
2B (1206)	.126±.008 (3.2±0.2)	.063±.008 (1.6±0.2)	.02±.012 (0.5±0.3)	.02±.012 (0.5±0.3)	.02±.006 (0.5±0.15)

thermal sensors

ordering information

SDT73V	2B	T	TE	100	F	385
Type	Size Code	Termination Material	Packaging	Nominal Resistance	Resistance Tolerance	T.C.R. (x 10 ⁻⁶ /K)
	2B: 1206	T: Sn	TEK: 4mm pitch plastic embossed (1,000 pieces/reel) TE: 4mm pitch plastic embossed (5,000 pieces/reel)	100: 100Ω 500: 500Ω	C: ±0.2% F: ±1%	385: +3850

applications and ratings

Part Designation	Resistance @ 0°C	Resistor Tolerance	Thermal Time Constant ¹	Thermal Dissipation Constant ¹	T.C.R. (ppm/°C) ²	T.C.R. Tolerance (ppm/°C)	Specified Current ³	Operating Temperature Range
SDT73V 2B	100Ω 500Ω	C: ±0.2% F: ±1%	6.5 seconds	2.4mW/°C	3850	±50	1mA Max.: 100Ω 0.1mA Max.: 500Ω	-55°C to +155°C

¹ Thermal time constant and thermal dissipation constant are reference values, which are values of elements and vary with connecting or fixing methods. Thermal dissipation constant is approx. 4mW/°C under the surface mounting condition.

² T.C.R. measuring temperature: 0°C/+ 100°C

³ The electricity which it is charged with in the element is moved to the range that rise in temperature due to a self-heat generation can be ignored. Ordinarily recommended measuring currents are 1mA for 100Ω and 0.1mA for 500Ω.

For further information on packaging, please refer to Appendix A.

environmental applications

Temperature Characteristics

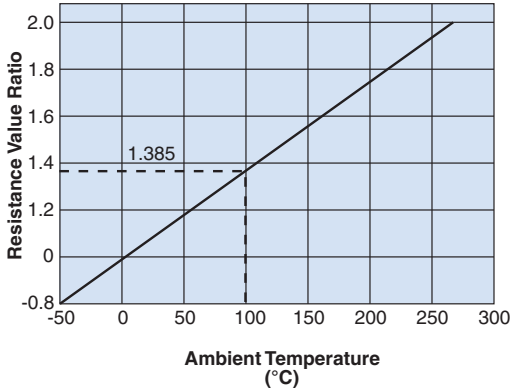

Approximate Expression for Resistance-Temperature Characteristics
 -55°C~0°C : $R_T = R_0 \{1 + C_1 T + C_2 T^2 + C_3 (T-100) T^3\}$
 0°C~+155°C : $R_T = R_0 (1 + C_1 T + C_2 T^2)$

R_T : Resistance value at T°C
 R_0 : Resistance value at 0°C
 T : Ambient temperature(°C)
 Constants C_1, C_2, C_3 :
 $C_1 = 3.9083 \times 10^{-3} \text{ } ^\circ\text{C}^{-1}$
 $C_2 = -5.775 \times 10^{-7} \text{ } ^\circ\text{C}^{-2}$
 $C_3 = -4.183 \times 10^{-12} \text{ } ^\circ\text{C}^{-4}$

Pt100 Resistance - Temperature Characteristic (JIS C 1604⁻¹⁹⁹⁷)

Temperature (°C)	0	-1	-2	-3	-4	-5	-6	-7	-8	-9
-50	80.31	79.91	79.51	79.11	78.72	78.32	—	—	—	—
-40	84.27	83.87	83.48	83.08	82.69	82.29	81.89	81.50	81.10	80.70
-30	88.22	87.83	87.43	87.04	86.64	86.25	85.85	85.46	85.06	84.67
-20	92.16	91.77	91.37	90.98	90.59	90.19	89.80	89.40	89.01	88.62
-10	96.09	95.69	95.30	94.91	94.52	94.12	93.73	93.34	92.95	92.55
0	100.00	99.61	99.22	98.83	98.44	98.04	97.65	97.26	96.87	96.48
	0	1	2	3	4	5	6	7	8	9
0	100.00	100.39	100.78	101.17	101.56	101.95	102.34	102.73	103.12	103.51
10	103.90	104.29	104.68	105.07	105.46	105.85	106.24	106.63	107.02	107.40
20	107.79	108.18	108.57	108.96	109.35	109.73	110.12	110.51	110.90	111.29
30	111.67	112.06	112.45	112.83	113.22	113.61	114.00	114.38	114.77	115.15
40	115.54	115.93	116.31	116.70	117.08	117.47	117.86	118.24	118.63	119.01
50	119.40	119.78	120.17	120.55	120.94	121.32	121.71	122.09	122.47	122.86
60	123.24	123.63	124.01	124.39	124.78	125.16	125.54	125.93	126.31	126.69
70	127.08	127.46	127.84	128.22	128.61	128.99	129.37	129.75	130.13	130.52
80	130.90	131.28	131.66	132.04	132.42	132.80	133.18	133.57	133.95	134.33
90	134.71	135.09	135.47	135.85	136.23	136.61	136.99	137.37	137.75	138.13
100	138.51	138.88	139.26	139.64	140.02	140.40	140.78	141.16	141.54	141.91
110	142.29	142.67	143.05	143.43	143.80	144.18	144.56	144.94	145.31	145.69
120	146.07	146.44	146.82	147.20	147.57	147.95	148.33	148.70	149.08	149.46
130	149.83	150.21	150.58	150.96	151.33	151.71	152.08	152.46	152.83	153.21
140	153.58	153.96	154.33	154.71	155.08	155.46	155.83	156.20	156.58	156.95
150	157.33	157.70	158.07	158.45	158.82	159.19	—	—	—	—

Note: Desired temperature values are obtained by adding temperatures in the vertical and horizontal axes. When calculating a resistance value of 105°C, read the value in the column where 100°C in the vertical axis and 5°C in the horizontal axis cross. The value will be 140.40Ω. The value for 500Ω at 0°C will be the value obtained by multiplying the resistance value in this table by 5.

Performance Characteristics

Parameter	Requirement $\Delta R \pm(\%+0.05\Omega)$		Test Method
	Limit	Typical	
Resistance	Within specified tolerance	—	0°C
T.C.R.	3850±50 (x10 ⁻⁶ /K)	—	0°C/+100°C
Resistance to Solder Heat	±0.5%	-0.004%	260°C for 10 seconds
Solderability	95% Coverage Min.	—	235°C±5°C, 3 seconds ± 0.5 seconds
Terminal Strength	±0.5%	-0.011%	1.8kg force is kept on the samples for 60 seconds
Rapid Change of Temperature	±0.5%	-0.058%	-55°C (30 minutes)/ +25°C (2 - 3 minutes)/ +155°C (30 minutes)/ +25°C (2 - 3 minutes), 1000 cycles
Thermal Shock	±0.5%	-0.032%	-55°C (15 minutes)/ +155°C (15 minutes), 300 cycles
Moisture Resistance	±0.5%	-0.041%	25°C, -65°C (90 - 100% RH), t= 24 hours/cycle. Unpowered. It is carried out 10 times.
Biased Humidity	±0.5%	-0.016%	85°C, 85% RH, 1000 hours, 1mA, 1.5 hr ON, 0.5 hr OFF cycle
High Temperature Exposure	±0.5%	-0.022%	+155°C, 1000 hours
High Temperature Load Life	±0.5%	-0.017%	155°C, 1000 hours, 1mA continuous turning on electricity
Mechanical Shock	±0.5%	-0.001%	100gs Maximum, 6Dms (Standard), 12.3 feet/second
Vibration	±0.5%	-0.009%	Test from 10-2000Hz, 5g's for 20 minutes, 12 cycles each of 3 orientations

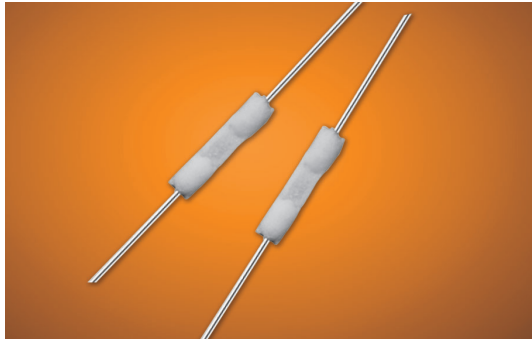

features

- Achieves a thermal time constant of 2.8-seconds due to volume reduction
- Excellent heat-resistance
- Applies axial lead type suitable to use as heater element
- Products with lead-free terminations meet EU RoHS requirements
- AEC-Q200 Tested

dimensions and construction

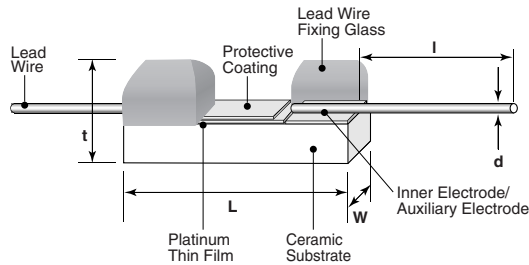

Type	Dimensions inches (mm)				
	W	L	t	l	d
SDT310VASP2	.016 ^{+0.006} _{-.004} (0.4 ^{+0.15} _{-.1})	.079±.004 (2.0±0.10)	.026 max. (0.65 max.)	.394±.079 (10±2.0)	.005±.002 (ø0.12±0.05)

ordering information

SDT310V	AS	P	2	K	20	F	40
Type	Style	Terminal Surface Material P: Pt clad	Generation	Packaging K: Chip Tray B: Bulk	Nominal Resistance 20: 20Ω	Resistance Tolerance F: ±1	T.C.R. Tolerance 40: ±40 x 10 ⁻⁶ /K

applications and ratings

Part Designation	Resistance (Ω at 0°C)	Resistance Tolerance (%)	T.C.R. x 10 ⁻⁶ /K ^{*1}	Thermal Time Constant ^{*2} (s)	Maximum Current (mA)	Power Rating (mW)	Operating Temperature Range ^{*3}
SDT310VASP2	20Ω	±1%	3850±40	2.8	76	0.336	-55°C to +600°C

*1 T.C.R. measuring temperature: 0°C/+100°C.

*2 Thermal time constant is value measured in stationary air and is typical value, which are values of elements and vary with connecting or fixing methods.

*3 Temperature of the device including a self-heating.

Derating Curve

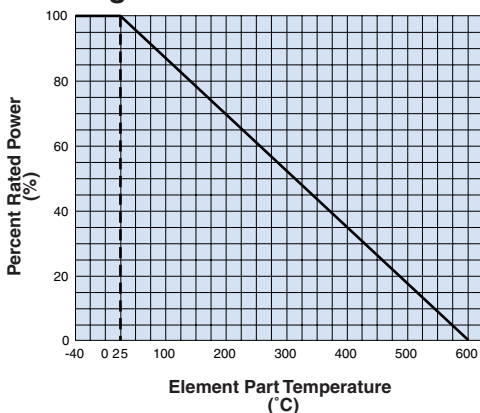

For sensors operated at an element part temperature of 25°C or above, a power rating shall be derated in accordance with the above derating curve.

environmental applications

Temperature Characteristics

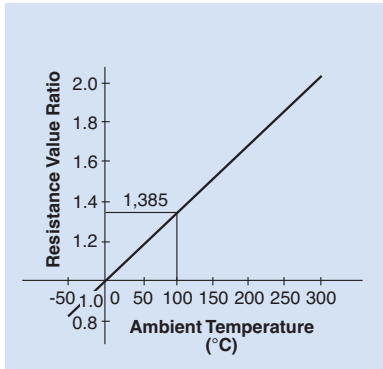

Approximate Expression for Resistance-Temperature Characteristics
 -55°C~0°C : $R_T = R_0 \{1 + C_1 T + C_2 T^2 + C_3 (T-100) T^3\}$
 0°C~+400°C : $R_T = R_0 (1 + C_1 T + C_2 T^2)$

R_T : Resistance value at T°C
 R_0 : Resistance value at 0°C
 T : Ambient temperature(°C)
 Constants C_1, C_2, C_3 :
 $C_1 = 3.908 \times 10^{-3} \text{ } ^\circ\text{C}^{-1}$
 $C_2 = -5.775 \times 10^{-7} \text{ } ^\circ\text{C}^{-2}$
 $C_3 = -4.183 \times 10^{-12} \text{ } ^\circ\text{C}^{-4}$

Pt20 Resistance - Temperature Characteristic 20 at 0°C

Temperature (°C)	0	-1	-2	-3	-4	-5	-6	-7	-8	-9
-50	16.06	15.98	15.90	15.82	15.74	15.66	-	-	-	-
-40	16.85	16.77	16.70	16.62	16.54	16.46	16.38	16.30	16.22	16.14
-30	17.64	17.57	17.49	17.41	17.33	17.25	17.17	17.09	17.01	16.93
-20	18.43	18.35	18.27	18.20	18.12	18.04	17.96	17.88	17.80	17.72
-10	19.22	19.14	19.06	18.98	18.90	18.82	18.75	18.67	18.59	18.51
0	20.00	19.92	19.84	19.77	19.69	19.61	19.53	19.45	19.37	19.30
0	0	1	2	3	4	5	6	7	8	9
10	20.78	20.86	20.94	21.01	21.09	21.17	21.25	21.33	21.40	21.48
20	21.56	21.64	21.71	21.79	21.87	21.95	22.02	22.10	22.18	22.26
30	22.33	22.41	22.49	22.57	22.64	22.72	22.80	22.88	22.95	23.03
40	23.11	23.19	23.26	23.34	23.42	23.49	23.57	23.65	23.73	23.80
50	23.88	23.96	24.03	24.11	24.19	24.26	24.34	24.42	24.49	24.57
60	24.65	24.73	24.80	24.88	24.96	25.03	25.11	25.19	25.26	25.34
70	25.42	25.49	25.57	25.64	25.72	25.80	25.87	25.95	26.03	26.10
80	26.18	26.26	26.33	26.41	26.48	26.56	26.64	26.71	26.79	26.87
90	26.94	27.02	27.09	27.17	27.25	27.32	27.40	27.47	27.55	27.63
100	27.70	27.78	27.85	27.93	28.00	28.08	28.16	28.23	28.31	28.38
110	28.46	28.53	28.61	28.69	28.76	28.84	28.91	28.99	29.06	29.14
120	29.21	29.29	29.36	29.44	29.51	29.59	29.67	29.74	29.82	29.89
130	29.97	30.04	30.12	30.19	30.27	30.34	30.42	30.49	30.57	30.64
140	30.72	30.79	30.87	30.94	31.02	31.09	31.17	31.24	31.32	31.39
150	31.47	31.54	31.61	31.69	31.76	31.84	31.91	31.99	32.06	32.14
160	32.21	32.29	32.36	32.43	32.51	32.58	32.66	32.73	32.81	32.88
170	32.95	33.03	33.10	33.18	33.25	33.33	33.40	33.47	33.55	33.62
180	33.70	33.77	33.84	33.92	33.99	34.07	34.14	34.21	34.29	34.36
190	34.43	34.51	34.58	34.66	34.73	34.80	34.88	34.95	35.02	35.10
200	35.17	35.24	35.32	35.39	35.47	35.54	35.61	35.69	35.76	35.83
210	35.91	35.98	36.05	36.13	36.20	36.27	36.34	36.42	36.49	36.56
220	36.64	36.71	36.78	36.86	36.93	37.00	37.08	37.15	37.22	37.29
230	37.37	37.44	37.51	37.59	37.66	37.73	37.80	37.88	37.95	38.02
240	38.19	38.17	38.24	38.31	38.38	38.46	38.53	38.60	38.67	38.75
250	38.82	38.89	38.96	39.04	39.11	39.18	39.25	39.33	39.40	39.47
260	39.54	39.61	39.69	39.76	39.83	39.90	39.97	40.05	40.12	40.19
270	40.26	40.33	40.41	40.48	40.55	40.62	40.69	40.77	40.84	40.91
280	40.98	41.05	41.12	41.20	41.27	41.34	41.41	41.48	41.55	41.63
290	41.70	41.77	41.84	41.91	41.98	42.05	42.13	42.20	42.27	42.34
300	42.41	42.48	42.55	42.62	42.70	42.77	42.84	42.91	42.98	43.05
310	43.12	43.19	43.26	43.33	43.41	43.48	43.55	43.62	43.69	43.76
320	43.83	43.90	43.97	44.04	44.11	44.18	44.25	44.33	44.40	44.47
330	44.54	44.61	44.68	44.75	44.82	44.89	44.96	45.03	45.10	45.17
340	45.24	45.31	45.38	45.45	45.52	45.59	45.66	45.73	45.80	45.87
350	45.94	46.01	46.08	46.15	46.22	46.29	46.36	46.43	46.50	46.57
360	46.64	46.71	46.78	46.85	46.92	46.99	47.06	47.13	47.20	47.27
370	47.34	47.41	47.48	47.55	47.62	47.69	47.76	47.83	47.90	47.97
380	48.04	48.10	48.17	48.24	48.31	48.38	48.45	48.52	48.59	48.66
390	48.73	48.80	48.87	48.94	49.00	49.07	49.14	49.21	49.28	49.35
400	49.42	49.49	49.56	49.63	49.69	49.76	49.83	49.90	49.97	50.04
410	50.11	50.18	50.24	50.31	50.38	50.45	50.52	50.59	50.66	50.72
420	50.79	50.86	50.93	51.00	51.07	51.13	51.20	51.27	51.34	51.41
430	51.48	51.54	51.61	51.68	51.75	51.82	51.88	51.95	52.02	52.09
440	52.16	52.22	52.29	52.36	52.43	52.50	52.56	52.63	52.70	52.77

Note: Desired temperature values are obtained by adding temperatures in the vertical and horizontal axes. When calculating a resistance value of 105°C, read the value in the column where 100°C in the vertical axis and 5°C in the horizontal axis cross. The value will be 28.08Ω.

environmental applications (continued)

Pt20 Resistance - Temperature Characteristic 20 at 0°C

Temperature (°C)	0	1	2	3	4	5	6	7	8	9
450	52.84	52.90	52.97	53.04	53.11	53.17	53.24	53.31	53.38	53.44
460	53.51	53.58	53.65	53.71	53.78	53.85	53.92	53.98	54.05	54.12
470	54.19	54.25	54.32	54.39	54.46	54.52	54.59	54.66	54.72	54.79
480	54.86	54.93	54.99	55.06	55.13	55.19	55.26	55.33	55.39	55.46
490	55.53	55.60	55.66	55.73	55.80	55.86	55.93	56.00	56.06	56.13
500	56.20	56.26	56.33	56.40	56.46	56.53	56.59	56.66	56.73	56.79
510	56.86	56.93	56.99	57.06	57.13	57.19	57.26	57.32	57.39	57.46
520	57.52	57.59	57.66	57.72	57.79	57.85	57.92	57.99	58.05	58.12
530	58.18	58.25	58.32	58.38	58.45	58.51	58.58	58.64	58.71	58.78
540	58.84	58.91	58.97	59.04	59.10	59.17	59.24	59.30	59.37	59.43
550	59.50	59.56	59.63	59.69	59.76	59.82	59.89	59.96	60.02	60.09
560	60.15	60.22	60.28	60.35	60.41	60.48	60.54	60.61	60.67	60.74
570	60.80	60.87	60.93	61.00	61.06	61.13	61.19	61.26	61.32	61.39
580	61.45	61.52	61.58	61.65	61.71	61.77	61.84	61.90	61.97	62.03
590	62.10	62.16	62.23	62.29	62.36	62.42	62.48	62.55	62.61	62.68
600	62.74	-	-	-	-	-	-	-	-	-

Note: Desired temperature values are obtained by adding temperatures in the vertical and horizontal axes. When calculating a resistance value of 105°C, read the value in the column where 100°C in the vertical axis and 5°C in the horizontal axis cross. The value will be 28.08Ω.

thermal sensors

Performance Characteristics

Parameter	Requirement $\Delta R \pm(\%+0.05\Omega)$		Test Method
	Limit	Typical	
Resistance	Within specified tolerance	—	0°C
T.C.R.	Within specified T.C.R.	—	0°C/ +100°C
Rapid Change of Temperature	±0.5%	-0.15%	-55°C (30 minutes)/ +200°C (30 minutes) 1000 cycles
Moisture Resistance	±0.5%	-0.12%	85°C ± 2°C, 85% RH, 1000 hours, 10mA, 1.5 hr ON, 0.5 hr OFF cycle
Normal Temperature Load Life	±0.5%	±0.10%	25°C ± 10°C, 1000 hours, 76mA, 1.5 hr ON, 0.5 hr OFF cycle
High Temperature Load Life	±0.5%	±0.11%	125°C, 1000 hours, 73mA continuous turning on electricity
Mechanical Shock	±0.5%	±0.04%	100g's maximum, 6Dms (standard), 12.3ft/s
Vibration	±0.5%	-0.03%	Test from 10-1900hz 30g's for 20 minutes, 12 cycles each of 3 orientations
Component Strength	400g and more	—	Pull test

Actual Value (out of guarantee)

Test Items	Reference	Test Method
High Temperature Exposure	0.4%	+600°C, 1000h

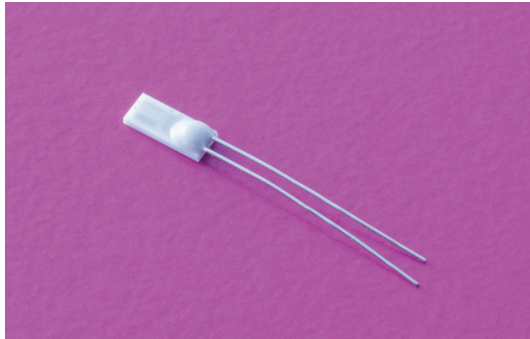

features

- Characteristics are equivalent with IEC 60751⁻²⁰⁰⁸, JISC 1604⁻²⁰¹³
- Small package of 1.2mm x 3mm with 100Ω resistance
- Products meet RoHS requirements. RoHS regulation is not intended for Pb-glass contained in glass.

dimensions and construction

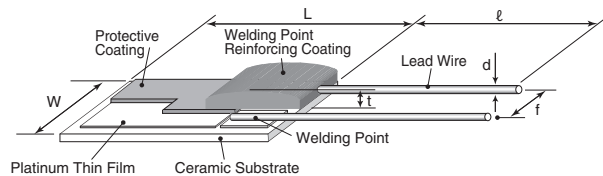

Type	Dimensions inches (mm)					
	W	L	t	f (Nom.)	d	l
SDT310HCTP	.047±.004 (1.2±0.10)	.118±.004 (3.0±0.10)	.043 max. (1.1 max.)	.002 (0.5)	.006±.002 (0.15±0.05)	.315 (8)

ordering information

SDT310	H	CT	P	100	A	3850
Type	Size Code	Operating Temperature	Terminal Surface Material	Nominal Resistance	Class	T.C.R. (x 10 ⁻⁶ /K)
	H: H style	CT: -55°C~400°C	P: Pt clad wire	100: 100Ω	A: F0.15 B: F0.3	

applications and ratings

Part Designation	Resistance (Ω at 0°C)	Tolerance Class		Tolerance	R. Value Tolerance (%)	T.C.R. (x10 ⁻⁶ /K)**	Thermal Time*** Constant (s)	Self-heating Coefficient (°C/mW)****	Specified Current***** (mA) max.	Temperature Range (C°)
		IEC 60751 ⁻²⁰⁰⁸ JIS C 1604 ⁻²⁰¹³	IEC 60751 ⁻²⁰⁰⁸ JIS C 1604 ⁻¹⁹⁹⁷							
SDT310HCTP	100	F0.15	Class A	±(0.15+0.002 [t])*	±0.059	3850	2.8	0.09	1	-55 ~ +300
		F0.3	Class B	±(0.3+0.005 [t])*	±0.12					-55 ~ +400

* [t] is a measuring temperature indicated at °C that is not related to marking * -.

** T.C.R. Measuring Temperature : 0°C/+100°C.

*** Thermal time constant is value measured in stationary air and is typical value, which is value of element and vary with connecting or fixing methods.

**** Self-heating coefficient expressed in °C/mW is values measured at temperature : 0°C in flowing oil with a velocity >0.2m/s, which is value of elements and vary with connecting or fixing methods.

***** Specified current is a current value that is used at reliability test under the condition of self heat-generation that can be disregarded. Recommended measuring currents 1mA for 100Ω.

environmental applications

Temperature Characteristics

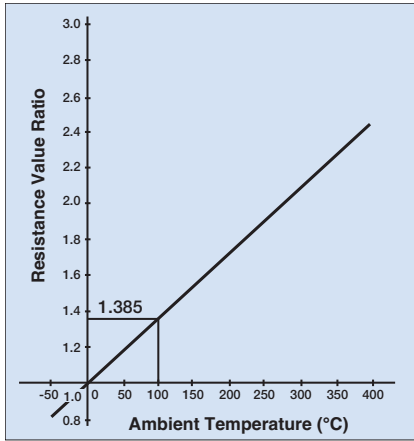

Approximate Expression for Resistance-Temperature Characteristics
 -55°C~0°C : $R_T = R_0 \{1 + C_1 T + C_2 T^2 + C_3 (T-100) T^3\}$
 0°C~+400°C : $R_T = R_0 (1 + C_1 T + C_2 T^2)$

R_T : Resistance value at T°C
 R_0 : Resistance value at 0°C
 T : Ambient temperature(°C)
 Constants C_1, C_2, C_3 :
 $C_1 = 3.908 \times 10^{-3} \text{ } ^\circ\text{C}^{-1}$
 $C_2 = -5.775 \times 10^{-7} \text{ } ^\circ\text{C}^{-2}$
 $C_3 = -4.183 \times 10^{-12} \text{ } ^\circ\text{C}^{-4}$

Pt100 Resistance - Temperature Characteristic (JISC 1604⁻²⁰¹³) 100 at 0°C

Temperature (°C)	0	-1	-2	-3	-4	-5	-6	-7	-8	-9
-50	80.31	79.91	79.51	79.11	78.72	78.32	—	—	—	—
-40	84.27	83.87	83.48	83.08	82.69	82.29	81.89	81.50	81.10	80.70
-30	88.22	87.83	87.43	87.04	86.64	86.25	85.85	85.46	85.06	84.67
-20	92.16	91.77	91.37	90.98	90.59	90.19	89.80	89.40	89.01	88.62
-10	96.09	95.69	95.30	94.91	94.52	94.12	93.73	93.34	92.95	92.55
0	100.00	99.61	99.22	98.83	98.44	98.04	97.65	97.26	96.87	96.48
0	100.00	100.39	100.78	101.17	101.56	101.95	102.34	102.73	103.12	103.51
10	103.90	104.29	104.68	105.07	105.46	105.85	106.24	106.63	107.02	107.40
20	107.79	108.18	108.57	108.96	109.35	109.73	110.12	110.51	110.90	111.29
30	111.67	112.06	112.45	112.83	113.22	113.61	114.00	114.38	114.77	115.15
40	115.54	115.93	116.31	116.70	117.08	117.47	117.86	118.24	118.63	119.01
50	119.40	119.78	120.17	120.55	120.94	121.32	121.71	122.09	122.47	122.86
60	123.24	123.63	124.01	124.39	124.78	125.16	125.54	125.93	126.31	126.69
70	127.08	127.46	127.84	128.22	128.61	128.99	129.37	129.75	130.13	130.52
80	130.90	131.28	131.66	132.04	132.42	132.80	133.18	133.57	133.95	134.33
90	134.71	135.09	135.47	135.85	136.23	136.61	136.99	137.37	137.75	138.13
100	138.51	138.88	139.26	139.64	140.02	140.40	140.78	141.16	141.54	141.91
110	142.29	142.67	143.05	143.43	143.80	144.18	144.56	144.94	145.31	145.69
120	146.07	146.44	146.82	147.20	147.57	147.95	148.33	148.70	149.08	149.46
130	149.83	150.21	150.58	150.96	151.33	151.71	152.08	152.46	152.83	153.21
140	153.58	153.96	154.33	154.71	155.08	155.46	155.83	156.20	156.58	156.95
150	157.33	157.70	158.07	158.45	158.82	159.19	159.56	159.94	160.31	160.68
160	161.05	161.43	161.80	162.17	162.54	162.91	163.29	163.66	164.03	164.40
170	164.77	165.14	165.51	165.89	166.26	166.63	167.00	167.37	167.74	168.11
180	168.48	168.85	169.22	169.59	169.96	170.33	170.70	171.07	171.43	171.80
190	172.17	172.54	172.91	173.28	173.65	174.02	174.38	174.75	175.12	175.49
200	175.86	176.22	176.59	176.96	177.33	177.69	178.06	178.43	178.79	179.16
210	179.53	179.89	180.26	180.63	180.99	181.36	181.72	182.09	182.46	182.82
220	183.19	183.55	183.92	184.28	184.65	185.01	185.38	185.74	186.11	186.47
230	186.84	187.20	187.56	187.93	188.29	188.66	189.02	189.38	189.75	190.11
240	190.47	190.84	191.20	191.56	191.92	192.29	192.65	193.01	193.37	193.74
250	194.10	194.46	194.82	195.18	195.55	195.91	196.27	196.63	196.99	197.35
260	197.71	198.07	198.43	198.79	199.15	199.51	199.87	200.23	200.59	200.95
270	201.31	201.67	202.03	202.39	202.75	203.11	203.47	203.83	204.19	204.55
280	204.90	205.26	205.62	205.98	206.34	206.70	207.05	207.41	207.77	208.13
290	208.48	208.84	209.20	209.56	209.91	210.27	210.63	210.98	211.34	211.70
300	212.05	212.41	212.76	213.12	213.48	213.83	214.19	214.54	214.90	215.25
310	215.61	215.96	216.32	216.67	217.03	217.38	217.74	218.09	218.44	218.80
320	219.15	219.51	219.86	220.21	220.57	220.92	221.27	221.63	221.98	222.33
330	222.68	223.04	223.39	223.74	224.09	224.45	224.80	225.15	225.50	225.85
340	226.21	226.56	226.91	227.26	227.61	227.96	228.31	228.66	229.02	229.37
350	229.72	230.07	230.42	230.77	231.12	231.47	231.82	232.17	232.52	232.87
360	233.21	233.56	233.91	234.26	234.61	234.96	235.31	235.66	236.00	236.35
370	236.70	237.05	237.40	237.74	238.09	238.44	238.79	239.13	239.48	239.83
380	240.18	240.52	240.87	241.22	241.56	241.91	242.26	242.60	242.95	243.29
390	243.64	243.99	244.33	244.68	245.02	245.37	245.71	246.06	246.40	246.75
400	247.09	247.44	247.78	248.13	248.47	248.81	249.16	249.50	249.85	250.19

Note: Desired temperature values are obtained by adding temperatures in the vertical and horizontal axes.
 When calculating a resistance value of 105°C, read the value in the column where 100°C in the vertical axis and 5°C in the horizontal axis cross. The value will be 140.40Ω.

environmental applications (continued)

Performance Characteristics

Parameter	Requirement $\Delta R \pm(\%)$		Test Method
	Limit	Typical	
Resistance	Within specified tolerance	—	0°C
T.C.R.	Within specified T.C.R.	—	0°C/ +100°C
Insulation Resistance	100M Ω or more	—	d.c. 100V
Dielectric Withstanding Voltage	$\pm 0.06\%$	-0.003%	a.c. 100V, 60 seconds - 70 seconds
Rapid Change of Temperature	± 0.06 (F0.15 at 300°C) ± 0.12 (F0.3 at 400°C)	-0.002% +0.013%	-55°C (30 minutes)/ +25°C (2 - 3 minutes)/ +300°C or +400°C (30 minutes)/ +25°C (2 - 3 minutes), 10 cycles
Moisture Resistance	$\pm 0.06\%$	-0.002%	60°C \pm 2°C, 90 - 95% RH, 1000 hours, 1mA, 1.5 hr ON, 0.5 hr OFF cycle
High Temperature Load Life	± 0.06 (F0.15 at 300°C) ± 0.12 (F0.3 at 400°C)	-0.016% -0.022%	300°C or 400°C, 1000 hours, 1mA continuous turning on electricity
High Temperature Exposure	± 0.06 (F0.15 at 300°C) ± 0.12 (F0.3 at 400°C)	+0.004% +0.014%	+300°C or +400°C, 1000 hours
Low Temperature Exposure	$\pm 0.06\%$	+0.010%	-55°C, 1000 hours

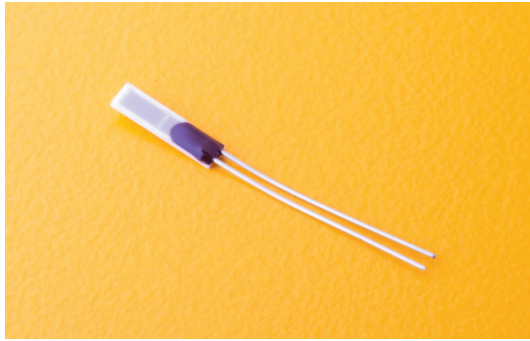

features

- T.C.R. is in accordance to JIS-DIN IEC standards
- The small package with a real ability of 1kΩ resistance
- Thermal time constant is improved with the small package
- Products meet EU RoHS requirements. EU RoHS regulation is not intended for Pb-glass contained in glass.

dimensions and construction

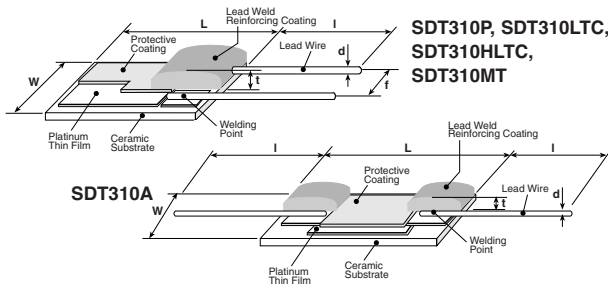

Type	Dimensions inches (mm)								
	L	W	t	f	d (Nom.)	l			
SDT310AP	.118±.010 (3.0±0.25)	.031±.008 (0.8±0.2)	.047 max. (1.2 max.)	.043±.010 (1.1±0.25)	.008±.002 (ø0.2±0.05)	.315±.079 (8±2)			
SDT310LTC		.079±.010 (2.0±0.25)				.394 ^{+0.179} _{-.079} (10 ⁺³ ₋₂)			
SDT310P						.315±.079 (8±2)			
SDT310MTM						.197±.004 (5.0±0.10)	.047±.004 (1.2±0.10)	.043 max. (1.1 max.)	.012±.004 (0.3±0.10)
SDT310HLTC									

ordering information

SDT310		LT	C	100	A	3850
Type	Size Code	Temperature Range	Terminal Surface Temperature	Nominal Resistance	Class	T.C.R. (x 10 ⁻⁶ /K)
	Nil: Standard A H	LT: -55°C~+155°C Nil: -55°C~+400°C MT: -55°C~+650°C	C: SnCu (SDT310LT, SDT310HLT) P: Pt clad wire (SDT310, SDT310A) M: PtIr (SDT310MT)	100: 100Ω 500: 500Ω 1K: 1kΩ 10: 10Ω (SDT310AP)	A: ±(0.15+0.002[t]) B: ±(0.3+0.005[t]) C: ±(1.0+0.01[t]) K: ±10%(SDT310A)	

applications and ratings

Part Designation	Resistance Range (Ω @ 0°C)	Tolerance Class (°C)	Resistance Tolerance	Thermal Time Constant**	Thermal Dissipation Constant**	T.C.R. (ppm/°C)*	Specified Current***	Operating Temperature Range		
SDT310LTC	100, 500, 1k	A:±(0.15+0.002 [t])	±0.059%	7 seconds in stationary air	0.9mW/°C	3850	10Ω, 100Ω 1mA Max. 500Ω, 1KΩ 0.1mA Max.	-55°C to +155°C		
		B:±(0.3+0.005 [t])	±0.12%							
		C:±(1.0+0.01 [t])	±0.39%							
SDT310P	100, 500, 1k	A:±(0.15+0.002 [t])	±0.059%							
		B:±(0.3+0.005 [t])	±0.12%							
		C:±(1.0+0.01 [t])	±0.39%							
SDT310MTM	100	B:±(0.3+0.005 [t])	±0.12%							
		C:±(1.0+0.01 [t])	±0.39%							
SDT310HLTC	1k	A:±(0.15+0.002 [t])	±0.059%	2.8 seconds in stationary air	1.0mW/°C	3850±2%		-55°C to +155°C		
		B:±(0.3+0.005 [t])	±0.12%							
		C:±(1.0+0.01 [t])	±0.39%							
SDT310AP	10	—	±10%	6 seconds in stationary air	1.0mW/°C					-55°C to +400°C

* T.C.R. measuring temperature: 0°C/+100°C.

** Thermal time constant and thermal dissipation constant are values measured in stationary air and are typical values, which are values of elements and vary with connecting or fixing methods.

*** The electricity which it is charged with in the element is moved to the range that rise in temperature due to a self-heat generation can be ignored. Recommended measuring currents are 1mA for 100Ω and 0.1mA for 500Ω or 1kΩ. SDT310AP can be used as hot-film sensor. Maximum specified current is 100mA when using under self-heating condition.

Specifications given herein may be changed at any time without prior notice. Please confirm technical specifications before you order and/or use.

environmental applications

Temperature Characteristics

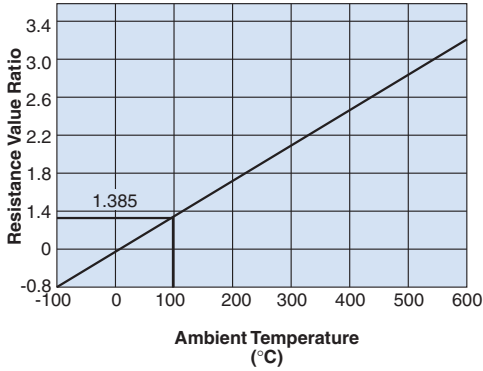

Approximate Expression for Resistance-Temperature Characteristics

$$-55^{\circ}\text{C}\sim 0^{\circ}\text{C} : R_T = R_0 \{1 + C_1 T + C_2 T^2 + C_3 (T-100) T^3\}$$

$$0^{\circ}\text{C}\sim +650^{\circ}\text{C} : R_T = R_0 (1 + C_1 T + C_2 T^2)$$

R_T : Resistance value at $T^{\circ}\text{C}$

R_0 : Resistance value at 0°C

T : Ambient temperature ($^{\circ}\text{C}$)

Constants C_1, C_2, C_3 :

$$C_1 = 3.9083 \times 10^{-3} \text{ } ^{\circ}\text{C}^{-1}$$

$$C_2 = -5.775 \times 10^{-7} \text{ } ^{\circ}\text{C}^{-2}$$

$$C_3 = -4.183 \times 10^{-12} \text{ } ^{\circ}\text{C}^{-4}$$

Pt100 Resistance - Temperature Characteristic (JIS C1604⁻¹⁹⁹⁷) 100 at 0°C

Temperature ($^{\circ}\text{C}$)	0	-1	-2	-3	-4	-5	-6	-7	-8	-9
-50	80.31	79.91	79.51	79.11	78.72	78.32	—	—	—	—
-40	84.27	83.87	83.48	83.08	82.69	82.29	81.89	81.50	81.10	80.70
-30	88.22	87.83	87.43	87.04	86.64	86.25	85.85	85.46	85.06	84.67
-20	92.16	91.77	91.37	90.98	90.59	90.19	89.80	89.40	89.01	88.62
-10	96.09	95.69	95.30	94.91	94.52	94.12	93.73	93.34	92.95	92.55
0	100.00	99.61	99.22	98.83	98.44	98.04	97.65	97.26	96.87	96.48
	0	1	2	3	4	5	6	7	8	9
0	100.00	100.39	100.78	101.17	101.56	101.95	102.34	102.73	103.12	103.51
10	103.90	104.29	104.68	105.07	105.46	105.85	106.24	106.63	107.02	107.40
20	107.79	108.18	108.57	108.96	109.35	109.73	110.12	110.51	110.90	111.29
30	111.67	112.06	112.45	112.83	113.22	113.61	114.00	114.38	114.77	115.15
40	115.54	115.93	116.31	116.70	117.08	117.47	117.86	118.24	118.63	119.01
50	119.40	119.78	120.17	120.55	120.94	121.32	121.71	122.09	122.47	122.86
60	123.24	123.63	124.01	124.39	124.78	125.16	125.54	125.93	126.31	126.69
70	127.08	127.46	127.84	128.22	128.61	128.99	129.37	129.75	130.13	130.52
80	130.90	131.28	131.66	132.04	132.42	132.80	133.18	133.57	133.95	134.33
90	134.71	135.09	135.47	135.85	136.23	136.61	136.99	137.37	137.75	138.13
100	138.51	138.88	139.26	139.64	140.02	140.40	140.78	141.16	141.54	141.91
110	142.29	142.67	143.05	143.43	143.80	144.18	144.56	144.94	145.31	145.69
120	146.07	146.44	146.82	147.20	147.57	147.95	148.33	148.70	149.08	149.46
130	149.83	150.21	150.58	150.96	151.33	151.71	152.08	152.46	152.83	153.21
140	153.58	153.96	154.33	154.71	155.08	155.46	155.83	156.20	156.58	156.95
150	157.33	157.70	158.07	158.45	158.82	159.19	159.56	159.94	160.31	160.68
160	161.05	161.43	161.80	162.17	162.54	162.91	163.29	163.66	164.03	164.40
170	164.77	165.14	165.51	165.89	166.26	166.63	167.00	167.37	167.74	168.11
180	168.48	168.85	169.22	169.59	169.96	170.33	170.70	171.07	171.43	171.80
190	172.17	172.54	172.91	173.28	173.65	174.02	174.38	174.75	175.12	175.49
200	175.86	176.22	176.59	176.96	177.33	177.69	178.06	178.43	178.79	179.16
210	179.53	179.89	180.26	180.63	180.99	181.36	181.72	182.09	182.46	182.82
220	183.19	183.55	183.92	184.28	184.65	185.01	185.38	185.74	186.11	186.47
230	186.84	187.20	187.56	187.93	188.29	188.66	189.02	189.38	189.75	190.11
240	190.47	190.84	191.20	191.56	191.92	192.29	192.65	193.01	193.37	193.74
250	194.10	194.46	194.82	195.18	195.55	195.91	196.27	196.63	196.99	197.35
260	197.71	198.07	198.43	198.79	199.15	199.51	199.87	200.23	200.59	200.95
270	201.31	201.67	202.03	202.39	202.75	203.11	203.47	203.83	204.19	204.55
280	204.90	205.26	205.62	205.98	206.34	206.70	207.05	207.41	207.77	208.13
290	208.48	208.84	209.20	209.56	209.91	210.27	210.63	210.98	211.34	211.70
300	212.05	212.41	212.76	213.12	213.48	213.83	214.19	214.54	214.90	215.25
310	215.61	215.96	216.32	216.67	217.03	217.38	217.74	218.09	218.44	218.80
320	219.15	219.51	219.86	220.21	220.57	220.92	221.27	221.63	221.98	222.33
330	222.68	223.04	223.39	223.74	224.09	224.45	224.80	225.15	225.50	225.85
340	226.21	226.56	226.91	227.26	227.61	227.96	228.31	228.66	229.02	229.37
350	229.72	230.07	230.42	230.77	231.12	231.47	231.82	232.17	232.52	232.87
360	233.21	233.56	233.91	234.26	234.61	234.96	235.31	235.66	236.00	236.35
370	236.70	237.05	237.40	237.74	238.09	238.44	238.79	239.13	239.48	239.83
380	240.18	240.52	240.87	241.22	241.56	241.91	242.26	242.60	242.95	243.29
390	243.64	243.99	244.33	244.68	245.02	245.37	245.71	246.06	246.40	246.75
400	247.09	247.44	247.78	248.13	248.47	248.81	249.16	249.50	249.85	250.19
410	250.53	250.88	251.22	251.56	251.91	252.25	252.59	252.93	253.28	253.62
420	253.96	254.30	254.65	254.99	255.33	255.67	256.01	256.35	256.70	257.04
430	257.38	257.72	258.06	258.40	258.74	259.08	259.42	259.76	260.10	260.44
440	260.78	261.12	261.46	261.80	262.14	262.48	262.82	263.16	263.50	263.84

Note: Desired temperature values are obtained by adding temperatures in the vertical and horizontal axes. When calculating a resistance value of 105°C , read the value in the column where 100°C in the vertical axis and 5°C in the horizontal axis cross. The value will be 140.40Ω . The value for 500Ω at 0°C will be the value obtained by multiplying the resistance value in this table by 5. Similarly, the value for $1\text{K}\Omega$ at 0°C will be the value obtained by multiplying the resistance value by 10.

environmental applications (continued)
Pt100 Resistance - Temperature Characteristic (JIS C1604⁻¹⁹⁹⁷)
100 at 0°C

Temperature (°C)	0	1	2	3	4	5	6	7	8	9
450	264.18	264.52	264.86	265.20	265.53	265.87	266.21	266.55	266.89	267.22
460	267.56	267.90	268.24	268.57	268.91	269.25	269.59	269.92	270.26	270.60
470	270.93	271.27	271.61	271.94	272.28	272.61	272.95	273.29	273.62	273.96
480	274.29	274.63	274.96	275.30	275.63	275.97	276.30	276.64	276.97	277.31
490	277.64	277.98	278.31	278.64	278.98	279.31	279.64	279.98	280.31	280.64
500	280.98	281.31	281.64	281.98	282.31	282.64	282.97	283.31	283.64	283.97
510	284.30	284.63	284.97	285.30	285.63	285.96	286.29	286.62	286.95	287.29
520	287.62	287.95	288.28	288.61	288.94	289.27	289.60	289.93	290.26	290.59
530	290.92	291.25	291.58	291.91	292.24	292.56	292.89	293.22	293.55	293.88
540	294.21	294.54	294.86	295.19	295.52	295.85	296.18	296.50	296.83	297.16
550	297.49	297.81	298.14	298.47	298.80	299.12	299.45	299.78	300.10	300.43
560	300.75	301.08	301.41	301.73	302.06	302.38	302.71	303.03	303.36	303.69
570	304.01	304.34	304.66	304.98	305.31	305.63	305.96	306.28	306.61	306.93
580	307.25	307.58	307.90	308.23	308.55	308.87	309.20	309.52	309.84	310.16
590	310.49	310.81	311.13	311.45	311.78	312.10	312.42	312.74	313.06	313.39
600	313.71	314.03	314.35	314.67	314.99	315.31	315.64	315.96	316.28	316.60
610	316.92	317.24	317.56	317.88	318.20	318.52	318.84	319.16	319.48	319.80
620	320.12	320.43	320.75	321.07	321.39	321.71	322.03	322.35	322.67	322.98
630	323.30	323.62	323.94	324.26	324.57	324.89	325.21	325.53	325.84	326.16
640	326.48	326.79	327.11	327.43	327.74	328.06	328.38	328.69	329.01	329.32
650	329.64	—	—	—	—	—	—	—	—	—

Note: Desired temperature values are obtained by adding temperatures in the vertical and horizontal axes. When calculating a resistance value of 105°C, read the value in the column where 100°C in the vertical axis and 5°C in the horizontal axis cross. The value will be 140.40Ω. The value for 500Ω at 0°C will be the value obtained by multiplying the resistance value in this table by 5. Similarly, the value for 1KΩ at 0°C will be the value obtained by multiplying the resistance value by 10.

Performance Characteristics

Parameter	Requirement Δ R (%+0.05Ω)		Test Method
	Limit	Typical	
Resistance	Within specified tolerance	—	0°C
T.C.R.	Within specified T.C.R.	—	0°C/ +100°C
Insulation Resistance	100MΩ or more	—	d.c. 100V
Dielectric Withstanding Voltage	±0.12%	±0.010%	a.c. 100V, 60 seconds - 70 seconds
Resistance to Solder Heat	±0.5%	±0.014%	350°C for 3.5 seconds
Rapid Change of Temperature	±0.12%	-0.026%	-55°C (30 minutes)/ +25°C (2 - 3 minutes)/ +155°C (30 minutes)/ +25°C (2 - 3 minutes), 10 cycles (SDT310LTC, SDT310HLTC); -55°C (30 minutes)/ +25°C (2 - 3 minutes)/ +400°C (30 minutes)/ +25°C (2 - 3 minutes), 10 cycles (SDT310P, SDT310A); +25°C (30 minutes)/ +650°C (30 minutes) 10 cycles (SDT310MTM)
Moisture Resistance	±0.5%	-0.004%	60°C ± 2°C, 90 - 95% RH, 1000 hours, 1mA, 1.5 hr ON, 0.5 hr OFF cycle
Normal Temperature Load Life	±0.5%	-0.017%	20°C ± 10°C, 1000 hours, 1mA continuous turning on electricity
High Temperature Load Life	±0.5%	-0.022%	155°C ± 2°C (SDT310LTC, SDT310HLTC), 400°C ± 8°C (SDT310P, SDT310AP), 1000 hours, 650°C ± 13°C (SDT310MTM), 250 hours, 1mA continuous turning on electricity
High Temperature Exposure	±0.12%, ±0.5% (SDT310MTM)	-0.027%, -0.060% (SDT310MTM)	+155°C (SDT310LTC, SDT310HLTC), +400°C (SDT310P, SDT310AP), +650°C (SDT310MTM), 250 hours
Low Temperature Exposure	±0.12%	-0.036%	-55°C, 250 hours

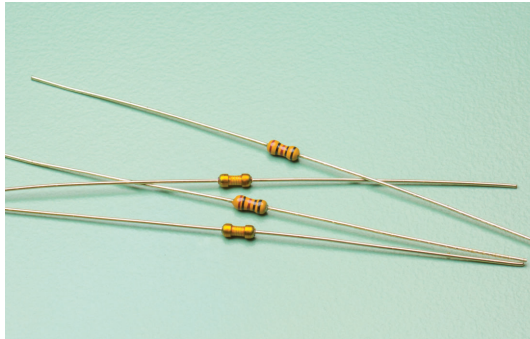

features

- SDT101SA is ultra-compact sensor element and offers 1kΩ
- Simple structure for lead forming
- STD101A and SDT101SA can be easily soldered
- Ideal for low directivity heat flow sensor elements
- Products meet EU RoHS requirements
- AEC-Q200 Tested (SDT101B 500Ω, SDT101SA)

dimensions and construction

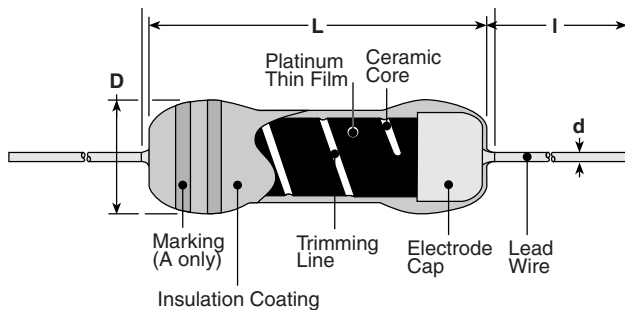

Type	Dimensions inches (mm)				
	L	C	D	d (Nom.)	I
SDT101A	.157±.031 (4.0±0.8)	—	.063±.008 (1.6±0.2)	.016±.003 (0.4±0.08)	1.18±.118 (30±3)
SDT101SA	—	.157±.031 (4.0±0.8)	.063±.008 (1.6±0.2)	.016±.003 (0.4±0.08)	1.18±.118 (30±3)
SDT101B	.157±.031 (4.0±0.8)	—	.059±.008 (1.5±0.2)	.016±.003 (0.4±0.08)	1.18±.118 (30±3)

ordering information

SDT101	A	X	C	T26	A	100	D	F
Type	Temperature Range	Reference Temperature*	Terminal Surface Material	Taping	Packaging	Nominal Resistance	Resistance Tolerance	T.C.R. Tolerance
SDT101 SDT101S	A: -55°C~+150°C B: -55°C~+300°C	X: 0°C	C: SnCu (A, SA only) N: Ni (B only)	Nil: Bulk T26: 26mm taping (A only) T52: 52mm taping	Nil: Bulk A: AMMO (A only) R: Reel (B only)	10: 10Ω 100: 100Ω 500: 500Ω 1K: 1kΩ (SA only)	D: ±0.5% F: ±1% G: ±2% (SA only)	F: ±1% G: ±2%

* There is also a product that has a standard temperature of 25°C (symbol: Y) for custom support.
(However, the temperature coefficient of resistance is measured at 0°C/100°C.) Please contact us.
Contact us when you have control request for environmental hazardous material other than the substance specified by EU RoHS.
For further information on taping, please refer to Appendix C on the back pages.

applications and ratings

Part Designation	Power Rating @ 70°C*	Thermal Time Constant*	Thermal Dissipation Constant*	Resistance Range	Resistance Tolerance	T.C.R. (ppm/°C)	T.C.R. Tolerance (ppm/°C)	Rated Ambient Temperature	Operating Temperature Range
SDT101A	0.125W	6 seconds	2.8mW/°C	10Ω, 100Ω, 500Ω	D: ±0.5% F: ±1%	3500	F: ±1% G: ±2%	+70°C	-55°C to +150°C
SDT101SA				1kΩ	G: ±2%		G: ±2%		
SDT101B		9 seconds	1.8mW/°C	10Ω, 100Ω, 500Ω	D: ±0.5% F: ±1%		F: ±1% G: ±2%	+200°C	-55°C to +300°C

* Thermal time constant and thermal dissipation constant are reference values, which are values of elements and vary with connecting or fixing methods. T.C.R. measuring temperature: 0°C/+100°C

environmental applications

Derating Curve

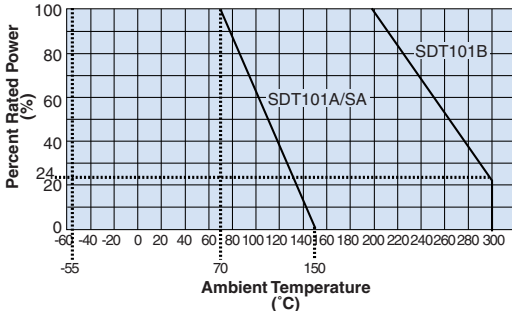

For sensors operated at an ambient temperature or above, a power rating shall be derated in accordance with the above derating curve.

Example of Temperature Characteristics of Resistance

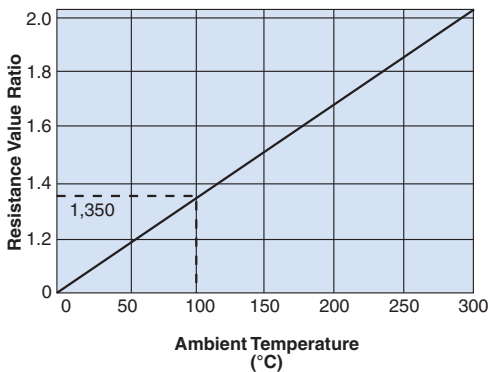

Approximate Expression for Resistance-Temperature Characteristics

R_T : Resistance value at $T^\circ\text{C}$

R_0 : Resistance value at 0°C

T : Ambient temperature ($^\circ\text{C}$)

Constants C_1, C_2 :

$$C_1 = 0.356297 \times 10^{-2} \quad C_2 = 0.617945 \times 10^{-6}$$

Resistance - Temperature Characteristic (Typical Value)

Temperature (°C)	0	-1	-2	-3	-4	-5	-6	-7	-8	-9
-50	82.04	81.67	81.31	80.94	80.58	80.22	—	—	—	—
-40	85.66	85.29	84.93	84.57	84.21	83.85	83.49	83.12	82.76	82.40
-30	89.26	88.90	88.54	88.18	87.82	87.46	87.10	86.74	86.38	86.02
-20	92.85	92.49	92.13	91.78	91.42	91.06	90.70	90.34	89.98	89.62
-10	96.43	96.07	95.72	95.36	95.00	94.64	94.29	93.93	93.57	93.21
0	100.00	99.64	99.29	98.93	98.57	98.22	97.86	97.50	97.15	96.79
10	103.56	103.20	102.84	102.48	102.12	101.76	101.40	101.04	100.68	100.32
20	107.10	106.74	106.38	106.02	105.66	105.30	104.94	104.58	104.22	103.86
30	110.63	110.27	109.91	109.55	109.19	108.83	108.47	108.11	107.75	107.39
40	114.15	113.79	113.43	113.07	112.71	112.35	111.99	111.63	111.27	110.91
50	117.65	117.29	116.93	116.57	116.21	115.85	115.49	115.13	114.77	114.41
60	121.15	120.79	120.43	120.07	119.71	119.35	118.99	118.63	118.27	117.91
70	124.63	124.27	123.91	123.55	123.19	122.83	122.47	122.11	121.75	121.39
80	128.10	127.74	127.38	127.02	126.66	126.30	125.94	125.58	125.22	124.86
90	131.56	131.20	130.84	130.48	130.12	129.76	129.40	129.04	128.68	128.32
100	135.00	134.64	134.28	133.92	133.56	133.20	132.84	132.48	132.12	131.76
110	138.43	138.07	137.71	137.35	136.99	136.63	136.27	135.91	135.55	135.19
120	141.85	141.49	141.13	140.77	140.41	140.05	139.69	139.33	138.97	138.61
130	145.26	144.90	144.54	144.18	143.82	143.46	143.10	142.74	142.38	142.02
140	148.65	148.29	147.93	147.57	147.21	146.85	146.49	146.13	145.77	145.41
150	152.04	151.68	151.32	150.96	150.60	150.24	149.88	149.52	149.16	148.80
160	155.41	155.05	154.69	154.33	153.97	153.61	153.25	152.89	152.53	152.17
170	158.77	158.41	158.05	157.69	157.33	156.97	156.61	156.25	155.89	155.53
180	162.11	161.75	161.39	161.03	160.67	160.31	159.95	159.59	159.23	158.87
190	165.45	165.09	164.73	164.37	164.01	163.65	163.29	162.93	162.57	162.21
200	168.77	168.41	168.05	167.69	167.33	166.97	166.61	166.25	165.89	165.53
210	172.08	171.72	171.36	171.00	170.64	170.28	169.92	169.56	169.20	168.84
220	175.37	175.01	174.65	174.29	173.93	173.57	173.21	172.85	172.49	172.13
230	178.66	178.30	177.94	177.58	177.22	176.86	176.50	176.14	175.78	175.42
240	181.93	181.57	181.21	180.85	180.49	180.13	179.77	179.41	179.05	178.69
250	185.19	184.83	184.47	184.11	183.75	183.39	183.03	182.67	182.31	181.95
260	188.44	188.08	187.72	187.36	187.00	186.64	186.28	185.92	185.56	185.20
270	191.67	191.31	190.95	190.59	190.23	189.87	189.51	189.15	188.79	188.43
280	194.90	194.54	194.18	193.82	193.46	193.10	192.74	192.38	192.02	191.66
290	198.11	197.75	197.39	197.03	196.67	196.31	195.95	195.59	195.23	194.87
300	201.31	—	—	—	—	—	—	—	—	—

Note: Desired temperature values are obtained by adding temperatures in the vertical and horizontal axes. When calculating a resistance value of 105°C, read the value in the column where 100°C in the vertical axis and 5°C in the horizontal axis cross. The value will be 136.72Ω. The value for 500Ω at 0°C will be the value obtained by multiplying the resistance value in this table by 5. Similarly, the value for 10Ω at 0°C will be the value obtained by dividing the resistance value by 10.

Performance Characteristics

Parameter	Requirement $\Delta R \pm(\%+0.05\Omega)$		Test Method
	Limit	Typical	
Resistance	Within specified tolerance	—	0°C
T.C.R.	Within specified T.C.R.	—	0°C/ +100°C
Overload (Short Time)	±0.5%	±0.2%	Rated voltage x 2.5 for 5 seconds
Resistance to Solder Heat (SDT101A)	±0.3%	±0.1%	350°C, 1 second (SDT101A/SA)
Rapid Change of Temperature	±0.5%	±0.2%	-55°C (30 minutes)/ +25°C (10 minutes)/ +150°C (30 minutes)/ +25°C (10 minutes), 5 cycles
Moisture Resistance	±1%	±0.3%	80°C ± 2°C, 90 - 95% RH, 1000 hours, 1.5 hr ON, 0.5 hr OFF cycle
Endurance at 70°C	±1%	±0.2%	70°C ± 3°C (SDT101A/SA), 200°C ± 3°C (SDT101B), 1000 hours, 1.5 hr ON, 0.5 hr OFF cycle
High Temperature Exposure	±1%	±0.7%	+150°C (SDT101A/SA), +300°C (SDT101B), 1000 hours
Shelf Life	±0.3%	±0.1%	Left for 1 year on shelf in natural condition

Specifications given herein may be changed at any time without prior notice. Please confirm technical specifications before you order and/or use.

11/27/23

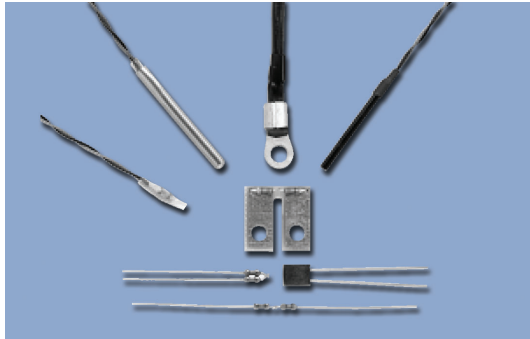

features

- All ST-series thermal sensors are custom-made products. ST-series thermal sensors are designed in various shapes in accordance with your application using a platinum thin-film thermal sensor (SDT101, SDT310 series) as an element. Shapes of sensor parts can be designed flexibly to meet your shapes and dimensional needs, from simple resin mold parts to sensor parts sealed in metal protective tubes made of SUS316.
- Products with Pb Free symbol “F” meet EU RoHS requirements

ordering information

ST3000 Series

ST	31050201	F	A	X	1K	B	D
Type	Type Number	Pb Free Symbol	Element Type	Reference Temperature*	Nominal Resistance**	Resistance Tolerance**	T.C.R. Tolerance**
			A: SDT101	X: 0°C	100: 100Ω 500: 500Ω 1K: 1kΩ	B: ±0.1% C: ±0.2% D: ±0.5% F: ±1%	D: ±0.5% F: ±1% G: ±2%

ST8100 Series

ST	8102201	F	B	X	1K	B
Type	Type Number	Pb Free Symbol	Element Type	Reference Temperature	Nominal Resistance**	Class**
			B: SDT310LTC C: SDT310P	X: 0°C	100: 100Ω 500: 500Ω 1K: 1kΩ	B: ±(0.3+0.005 [t]) C: ±(1.0+0.01 [t])

* ST3000 series products with a reference temperature of 25°C (T.C.R. will be calculated between 0°C/100°C.) are also available. Contact us.

**These are specified for inner element only. Contact us when you have control request for environmental hazardous material other than the substance specified by EU RoHS.

applications and ratings

Part Designation	Element	Resistance Value at 0°C	Class: Tolerance to Measuring Temperature	Resistance Tolerance	T.C.R. (x 10 ⁻⁶ /K)	T.C.R. Tolerance (ppm/°C)
ST3000	SDT101A SDT101B	100Ω 500Ω 1kΩ	—	B: ±0.1% C: ±0.2% D: ±0.5% F: ±1%	3500	D: ±0.5% F: ±1% G: ±2%
ST8100	SDT310LTC SDT310P	100Ω 500Ω 1kΩ	B: ±(0.3+0.005[t]) C: ±(1.0+0.01[t])	—	3850	—

ST3000 Series, 1kΩ, resistance tolerance B • C are produced in pair of SDT101Series. The combination of ST3000 series, resistance tolerance B-T.C.R. and tolerance D is equivalent to class B of SDT310 tolerance to the measuring temperature.

In the above table specification there are restrictions on manufacturing range depending on part number. Please refer to the Performance list.

environmental applications

Example of	Material	Example of	Material	Example of	Form
Processing Protective Tubes	PPS	Processing External Conductors	Polyurethane coated wire	Processing of Terminals	Processing of connecting terminals
	Epoxy resin coating		Parallel heat-resistant vinyl chloride wire		
	Fluorine resin shrinkage tube		Fluorine resin coated wire	Others	Mounting on printed circuit board
	Polyimide				
	SUS304				
	SUS316				
Cu					
			Form		
			2-wire system		
			3-wire, 4-wire system		
			Shielded wire		

environmental applications
Performance Characteristics - ST3000 series (A part extract)

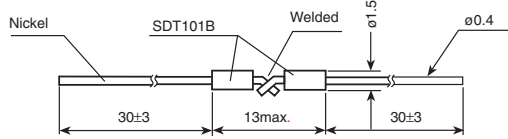
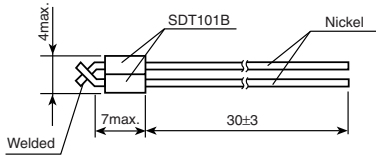
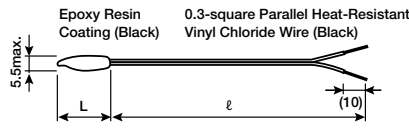
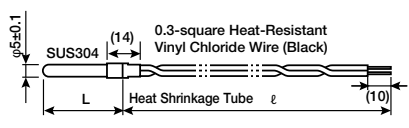
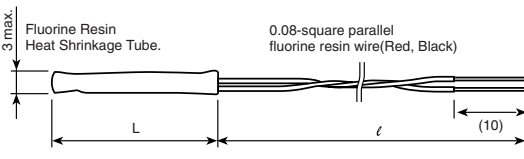
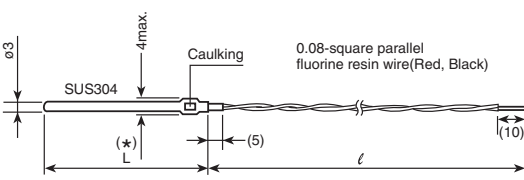
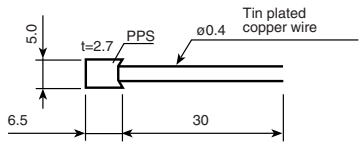
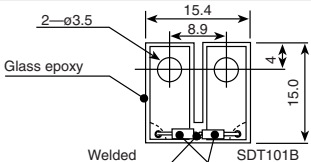
Shape	Unit: mm	Product Number	L (mm)	ℓ (m)	Measurement Temp. Range
 <p>Nickel SDT101B Welded ø1.5 ø0.4 30±3 13max. 30±3</p>		31011 Lead wire without solder plating	—	—	-50°C ~ +300°C
		31012 Lead wire with solder plating	—	—	-40°C ~ +120°C
 <p>4max. SDT101B Nickel Welded 7max. 30±3</p>		31021 Lead wire without solder plating	—	—	-50°C ~ +300°C
		31022 Lead wire with solder plating	—	—	-40°C ~ +120°C
 <p>5.5max. Epoxy Resin Coating (Black) 0.3-square Parallel Heat-Resistant Vinyl Chloride Wire (Black) L ℓ (10)</p>		31030201	30 max.	0.1	-40°C ~ +100°C
		31030205		0.5	
		31030210		1.0	
		31030230		3.0	
 <p>ø5±0.1 SUS304 (14) 0.3-square Heat-Resistant Vinyl Chloride Wire (Black) Heat Shrinkage Tube L ℓ (10)</p>		31040301	35	0.1	-40°C ~ +100°C
		31040305		0.5	
		31040310		1.0	
		31040330		3.0	
 <p>3 max. Fluorine Resin Heat Shrinkage Tube. 0.08-square parallel fluorine resin wire (Red, Black) L ℓ (10)</p>		31050201	23 max.	0.1	-40°C ~ +220°C
		31050205		0.5	
		31050210		1.0	
		31050230		3.0	
 <p>ø3 4max. SUS304 Caulking 0.08-square parallel fluorine resin wire (Red, Black) L ℓ (10) *</p> <p>* For product of resistance 1kΩ or product of resistance tolerance B, C, L=50mm is only available.</p>		31060301	30	0.1	-40°C ~ +220°C
		31060305		0.5	
		31060310		1.0	
		31060330		3.0	
		31060501	50	0.1	
		31060505		0.5	
		31060510		1.0	
		31060530		3.0	
 <p>5.0 t=2.7 PPS ø0.4 Tin plated copper wire 6.5 30</p>		3201	—	—	-20°C ~ +120°C
 <p>2-ø3.5 15.4 8.9 15.0 Glass epoxy Welded SDT101B</p>		3202	—	—	-40°C ~ +140°C

Specifications given herein may be changed at any time without prior notice. Please confirm technical specifications before you order and/or use.

11/21/18

environmental applications (continued)
Performance Characteristics - ST3000 series (A part extract)

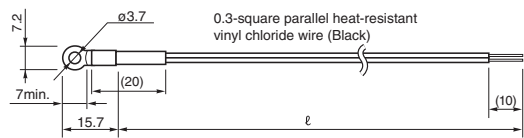
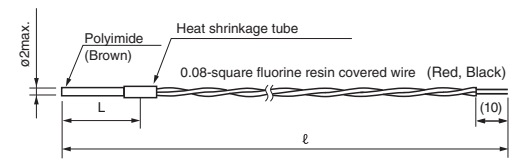
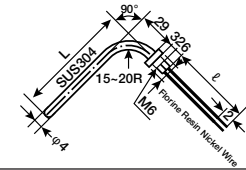
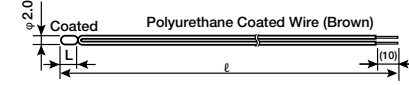
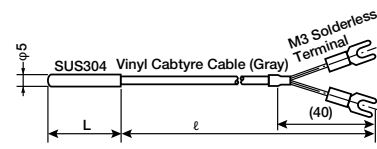
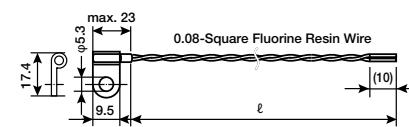
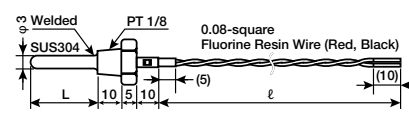
Shape	Unit: mm	Product Number	L (mm)	ℓ (m)	Measurement Temp. Range
 <p>0.3-square parallel heat-resistant vinyl chloride wire (Black)</p> <p>* With the round terminals fixed, handle the wire without applying tensile stress or bending stress.</p>		32050001	—	0.1	-20°C ~ +80°C
		32050005		0.5	
		32050010		1.0	
		32050030		3.0	
 <p>0.08-square fluorine resin covered wire (Red, Black)</p>		32090201	24	0.1	-40°C ~ +120°C
		32090205		0.5	
		32090210		1.0	
		32090230		3.0	
 <p>SUS304</p> <p>Forme Resin Heat Resistant Wire</p>		32120907	90	0.7	-40°C ~ +300°C Only top of protective tubes
		32121207	120	0.7	
		32121707	175	0.7	
		32121202	120	0.2	
 <p>Polyurethane Coated Wire (Brown)</p> <p>Products with resistance value 1K or resistance tolerance B, C are not manufactured</p>		33010004	(8)	0.4	-20°C ~ +80°C
 <p>SUS304 Vinyl Cabtyre Cable (Gray)</p> <p>M3 Solderless Terminal</p>		33040305	35	0.5	-40°C ~ +60°C
		33040310		1.0	
		33040330		3.0	
 <p>0.08-Square Fluorine Resin Wire</p>		33060001	—	0.1	-20°C ~ +120°C
		33060005		0.5	
		33060010		1.0	
		33060030		3.0	
 <p>0.08-square Fluorine Resin Wire (Red, Black)</p>		33110305	30	0.5	-40°C ~ +220°C
		33110310		1.0	
		33110330		3.0	

thermal sensors

environmental applications (continued)

Performance Characteristics - ST8100 series

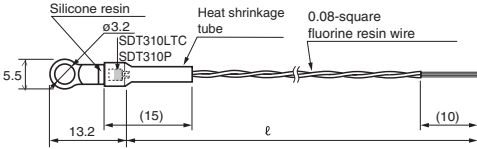
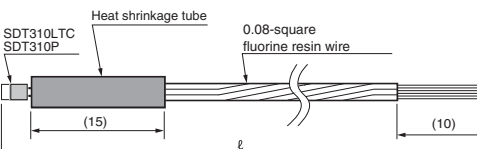
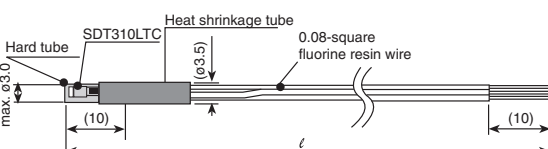
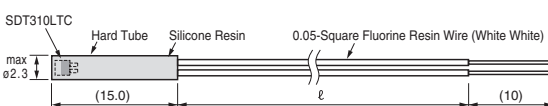
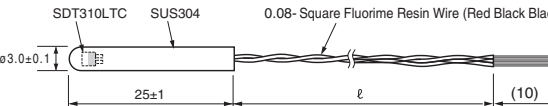
Shape	Unit: mm	Product Number	Lead Wire Number	ℓ (m)	Measurement Temp. Range
 <p>2 wire: Red Black 3 wire: Red Black Black</p>		8102201	2	0.1	SDT310LTC: -40°C ~ +105°C SDT310P: -40°C ~ +200°C
		8102205		0.5	
		8102210		1.0	
		8102301	3	0.1	
		8102305		0.5	
		8102310		1.0	
 <p>2 wire: Red Black 3 wire: Red Black Black</p>		8103201	2	0.1	SDT310LTC: -40°C ~ +105°C SDT310P: -40°C ~ +200°C
		8103205		0.5	
		8103210		1.0	
		8103301	3	0.1	
		8103305		0.5	
		8103310		1.0	
 <p>2 wire: Red Black 3 wire: Red Black Black</p>		8104201	2	0.1	SDT310LTC Only: -40°C ~ +105°C
		8104205		0.5	
		8104210		1.0	
		8104301	3	0.1	
		8104305		0.5	
		8104310		1.0	
		8106201	2	0.1	SDT310LTC Only: -40°C ~ +125°C
		8106205		0.5	
		8106210		1.0	
		8107301	3	0.1	SDT310LTC Only: -40°C ~ +150°C
		8107305		0.5	
		8107310		1.0	

thermal sensors

guarantee of product

The guaranteed term of the product is one year after delivery. However, when trouble occurs during the guaranteed term because of our responsibility, the product is exchanged or is repaired. We guarantee the product itself, any damages caused by this product shall be excused.

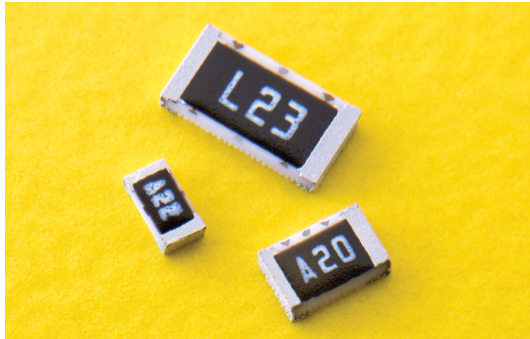

features

- Thin film thermal sensors of SMD type
- Resistance tolerance $\pm 1\%$, a wide range of TCRs $+3000 \times 10^{-6}/K \sim +5000 \times 10^{-6}/K$ with the standard products
- Suitable for control of temperatures in various industrial equipment
- Suitable for both flow and reflow soldering
- Products with lead-free terminations meet EU RoHS and China RoHS requirements

dimensions and construction

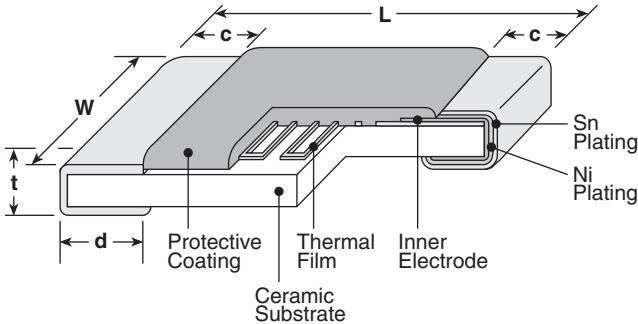

Type (Inch Size Code)	Dimensions inches (mm)				
	L	W	c	d	t
1J (0603)	.063 \pm .008 (1.6 \pm 0.2)	.031 \pm .008 (0.8 \pm 0.2)	.012 \pm .008 (0.3 \pm 0.2)	.012 \pm .008 (0.3 \pm 0.2)	.02 \pm .004 (0.5 \pm 0.1)
2A (0805)	.079 \pm .008 (2.0 \pm 0.2)	.049 \pm .008 (1.25 \pm 0.2)	.016 \pm .008 (0.4 \pm 0.2)	.016 \pm .008 (0.4 \pm 0.2)	.02 \pm .006 (0.5 \pm 0.15)
2B (1206)	.126 \pm .008 (3.2 \pm 0.2)	.063 \pm .008 (1.6 \pm 0.2)	.02 \pm .012 (0.5 \pm 0.3)	.02 \pm .012 (0.5 \pm 0.3)	.02 \pm .006 (0.5 \pm 0.15)

ordering information

LP73	2B	T	TE	103	J	3600
Product Code	Size Code	Termination Material	Packaging	Resistance Value	Tolerance	T.C.R.
	1J: 0603 2A: 0805 2B: 1206	T: Sn	TE: 4mm embossed pitch plastic (5,000 pieces/reel)	2 significant figures + 1 multiplier 3 digits	F: $\pm 1\%$ G: $\pm 2\%$ J: $\pm 5\%$	

applications and ratings

Part Designation	Power Rating	Thermal Time Constant (sec.)*	Thermal Dissipation Constant (mW/°C)*	Rated Ambient Temp.	Operating Temp. Range
LP731J	0.016W	2	1.2	+70°C	-55°C to +125°C
LP732A	0.031W	4	1.8		
LP732B	0.063W	6.5	2.4		

* Thermal Time Constant and Dissipation Constant are reference values, which are values of elements and vary with connecting or fixing methods.

For further information on packaging, please refer to Appendix A.

applications and ratings (continued)

T.C.R. (ppm/°C) Max.	T.C.R. Tolerance	Resistance Range E-24			Resistance Tolerance
		1J	2A	2B	
3000	±5%	100Ω-1kΩ	100Ω - 2kΩ	100Ω - 10kΩ	F: ±1%, G: ±2% J: ±5%
3300					
3600					100Ω-300Ω
4000		330Ω-1kΩ			F: ±1% G: ±2% J: ±5%
4500		100Ω - 1kΩ			
5000					

environmental applications

Derating Curve

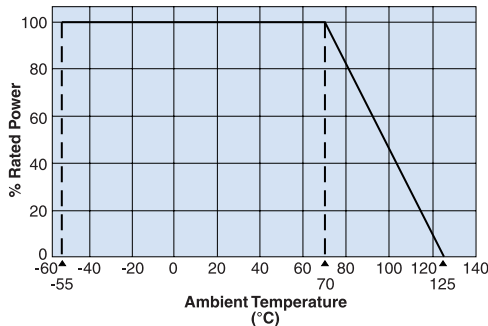

For sensors operated at an ambient temperature of 70°C or above, a power rating shall be derated in accordance with the above derating curve.

Temperature Characteristics

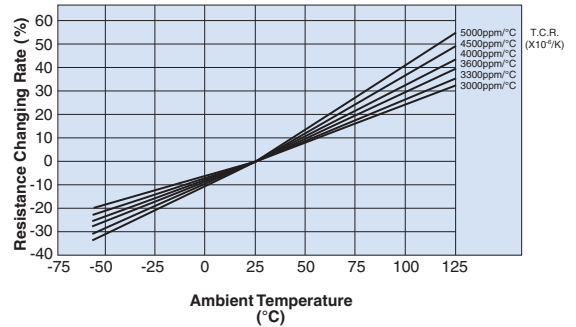

Approximate Expression for Resistance-Temperature Characteristics

T.C.R. (x10 ⁻⁶ /K)	C ₀	C ₁	C ₂
3000	0.931258	0.00265213	3.90112 x 10 ⁻⁶
3300	0.924355	0.00292569	4.00516 x 10 ⁻⁶
3600	0.916356	0.00323714	4.34428 x 10 ⁻⁶
4000	0.907039	0.00361006	4.33457 x 10 ⁻⁶
4500	0.897412	0.00395222	6.05201 x 10 ⁻⁶
5000	0.886014	0.00437224	7.48809 x 10 ⁻⁶

(Values are not guaranteed but typical)

$$R_T = R_{25} (C_0 + C_1 T + C_2 T^2)$$

R_T: Resistance value at T°C
R₂₅: Resistance value at 25°C
T: Ambient temperature (°C)
C₀, C₁, C₂: Constants

Performance Characteristics

Parameter	Requirement Δ R ±(%+0.05Ω)		Test Method
	Limit	Typical	
Resistance	Within regulated tolerance	—	25°C
T.C.R.	Within specified T.C.R.	—	+25°C/+65°C
Overload	±0.5%	±0.3%	Rated voltage x 2.5 for 5 seconds
Resistance to Solder Heat	±0.5%	±0.3%	260°C ± 5°C, 10 seconds + 1 second/- 0 second
Rapid Change of Temperature	±0.5%	±0.3%	-55°C (30 minutes), +25°C (2-3 minutes), +125°C (30 minutes), +25°C (2-3 minutes), 5 cycles
Moisture Resistance	±2.0%	±1.5%	40°C ± 2°C, 90 - 95% RH, 1000 hours, 1.5 hours ON, 0.5 hours OFF cycle
Endurance at 70°C	±2.0%	±1.5%	70°C ± 2°C, 1000 hours, 1.5 hours ON, 0.5 hours OFF cycle

Confirming resistance drift is recommended since this product has a tendency to have bigger resistance change than general flat chip over 70°C. Please pay attention not to be applied ESD, it may cause of resistance change.

Actual Value (Out of Guarantee)

Test Items	Reference	Test Method
High Temperature Exposure	±8.0%	125°C, 1000 hours
ESD	500V	Human model, 100 pF 1.5 kΩ

Specifications given herein may be changed at any time without prior notice. Please confirm technical specifications before you order and/or use.

1/02/14

linear positive temperature coefficient flat chip resistors (for automotive)



features

- SMD thin film resistors with thermo-perceptivity
- Various TCRs $+150 - +4500 \times 10^{-6}/K$ are available
- Operating temperature range $-155^{\circ}C$
Rated ambient temperature: $85^{\circ}C$
- Products meet EU RoHS requirements
- AEC-Q200 Tested

dimensions and construction

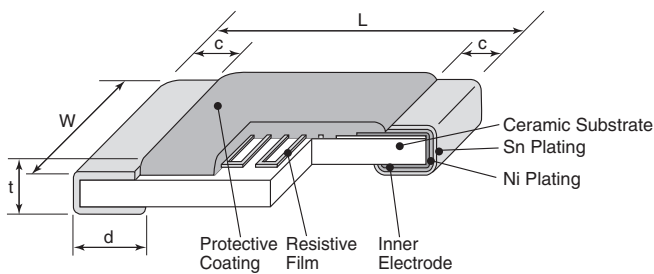

Type	Dimensions inches (mm)				
	L	W	c	d	t
2A (0805)	.079±.008 (2.0±0.2)	.049±.008 (1.25±0.2)	.016±.008 (0.4±0.2)	.012 ^{+.008} _{-.004} (0.3 ^{-.02} _{-0.1})	.020±.004 (0.5±0.1)
2B (1206)	.126±.008 (3.2±0.2)	.063±.008 (1.6±0.2)	.020±.012 (0.5±0.3)	.016 ^{+.008} _{-.004} (0.4 ^{-.02} _{-0.1})	.024±.004 (0.6±0.1)

ordering information

LT73V	2B	T	TD	102	J	0900
Type	Power Rating	Termination Material	Taping	Nominal Resistance	Resistance Tolerance	T.C.R. ($\times 10^{-6}/K$)
	2A:0.1W 2B:0.125W	T:Sn	TD:4mm pitch paper TE:4mm pitch plastic embossed	3 digits	G:±2% J:±5%	4 digits

For further information on packaging, please refer to Appendix A.

applications and ratings

Type	Power Rating	Max. Working Voltage	Max. Overload Voltage	Thermal Time Constant*	Thermal Dissipation Constant*	Rated Ambient Temperature	Operating Temperature Range	Taping & Q'ty/Reel (pcs)	
								TD	TE
2A	0.1W	50V	100V	1.0s	1.37mW/°C	+85°C	-55°C - +155°C	5,000	4,000
2B	0.125W	75V	150V	1.5s	1.47mW/°C			5,000	4,000

* Thermal time constant and dissipation constant are reference values, which are values of elements and vary with connecting or fixing methods.

T.C.R. ($\times 10^{-6}/K$)	T.C.R. Tolerance	(Ω) Resistance Range (E24)		Resistance Tolerance
		2A	2B	
150, 250, 350, 450, 500	±100×10 ⁻⁶ /K	2k - 15k	2k - 22k	G: ±2% J: ±5%
600, 700, 800, 900	±150×10 ⁻⁶ /K	1k - 8.2k	1k - 15k	
1000, 1200, 1400	±15%	1k - 6.8k	1k - 8.2k	
1600, 1800		510 - 4.7k	1k - 6.8k	
2000, 2200, 2400	±10%	510 - 4.7k	510 - 6.8k	
2600, 2800, 3000		510 - 3k	510 - 6.2k	
3300, 3600, 3900		100 - 1k	100 - 2k	
4200		51 - 510	51 - 510	
4500				

T.C.R. Measuring Temperature: $+25^{\circ}C - +75^{\circ}C$

Rated voltage = $\sqrt{\text{Power Rating} \times \text{Resistance value}}$ or Max. working voltage, whichever is lower.

Specifications given herein may be changed at any time without prior notice. Please confirm technical specifications before you order and/or use. 10/26/21

linear positive temperature coefficient flat chip resistors (for automotive)

environmental applications

Derating Curve

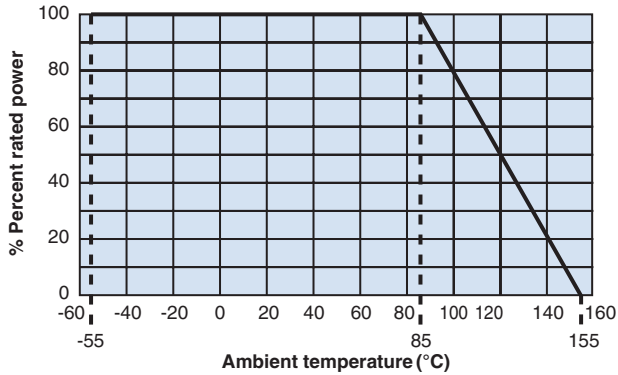

For resistors operated at an ambient temperature of 85°C or above, a power rating shall be derated in accordance with the above derating curve.

Temperature Characteristics of Resistance

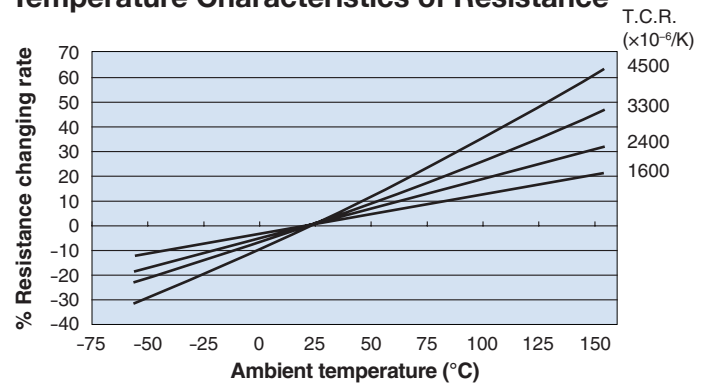

Approximate Expression for Resistance- Temperature Characteristics

Values are not guaranteed but typical.

$$R_T = R_{25} (C_0 + C_1 T + C_2 T^2) \quad R_T: T^\circ\text{C}$$

R_{25} : 25°C

T: (°C)

C_0, C_1, C_2 :

R_T : Resistance value at T°C

R_{25} : Resistance value at 25°C

T: Ambient temperature (°C)

C_0, C_1, C_2 : Constants

T.C.R. ($\times 10^{-6}/\text{K}$)	C_0	C_1	C_2
3000	0.9288	0.0028	1.9983×10^{-6}
3300	0.9232	0.0030	2.9980×10^{-6}
3600	0.9175	0.0032	4.0000×10^{-6}
3900	0.9099	0.0035	4.0064×10^{-6}
4200	0.9026	0.0038	3.9964×10^{-6}
4500	0.8948	0.0041	4.0064×10^{-6}

Performance Characteristics

Parameters	Performance Requirements $\Delta R \pm (\% + 0.05\%)$		Test Methods
	Limit	Typical	
Resistance	Within specified tolerance	-	25°C
T.C.R.	Within specified T.C.R.	-	+25°C/+75°C
Overload (Short Time)	1%	0.02%	Rated voltage \times 2.5 or Max. overload Vol., whichever is lower, for 5 seconds
Resistance to Soldering Heat	1%	0.10%	260°C \pm 5°C, 10 seconds \pm 1 second
Rapid Change of Temperature	2% : $\text{TCR} \leq +3300$ 5% : $\text{TCR} \geq +3600$	0.53% 2.59%	-55°C (30min.)/+155°C (30min.), 1000 cycles
Moisture Resistance	3%	0.15%	85°C \pm 2°C, 85% \pm 5% RH, 1/10 rated power, 1.5h ON/0.5h OFF cycle. 1000 hours
Endurance at 85°C	2% : $\text{TCR} \leq +3300$ 5% : $\text{TCR} \geq +3600$	0.30% 0.76%	85°C \pm 2°C, 1000 hours 1.5h ON/0.5h OFF cycle.
High Temperature Load Life	2% : $\text{TCR} \leq +3300$ 5% : $\text{TCR} \geq +3600$	0.40% 2.17%	125°C, Rated voltage, 1000 hours
High temperature Exposure	2% : $\text{TCR} \leq +3300$ 5% : $\text{TCR} \geq +3600$	0.81% 3.20%	155°C, 1000h
Low Temperature Exposure	2%	-0.10%	-55°C, 1000h

Please pay attention not to be applied ESD, it may cause of resistance change.

Actual Value (Out of guarantee)

Test Items	Reference	Test Methods
ESD	500V	Human Body Model, 100pF, 1.5kV

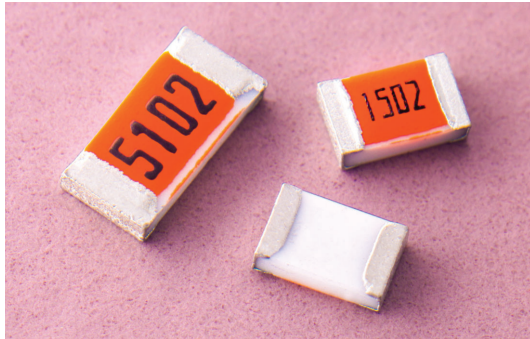

features

- Anti-leaching nickel barrier terminations
- Twenty-five specifiable temperature characteristics
- SMD thin film resistor with thermo-perceptivity
- Products with lead-free terminations meet EU RoHS and China RoHS requirements

dimensions and construction

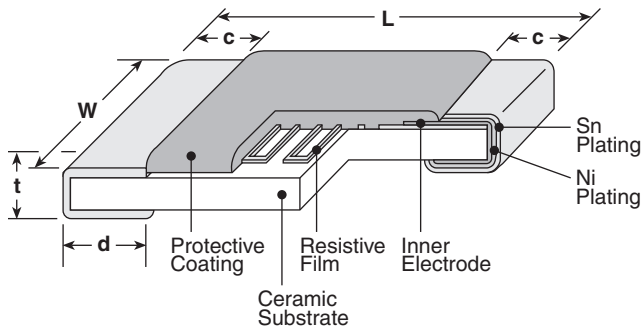

Type (Inch Size Code)	Dimensions inches (mm)				
	L	W	c	d	t
2A (0805)	.079±.008 (2.0±0.2)	.049±.008 (1.25±0.2)	.016±.008 (0.4±0.2)	.012 ^{+0.008} _{-.004} (0.3 ^{+0.2} _{-0.1})	.02±.004 (0.5±0.1)
2B (1206)	.126±.008 (3.2±0.2)	.063±.008 (1.6±0.2)	.02±.008 (0.5±0.3)	.016 ^{+0.008} _{-.004} (0.4 ^{+0.2} _{-0.1})	.024±.004 (0.6±0.1)

thermal sensors

ordering information

LT73	2B	T	TD	101	J	1000
Type	Size Code 2A: 0805 2B: 1206	Termination Material T: Sn	Packaging TD: 7" paper taping (5,000 pieces/reel) TE: 7" embossed plastic (4,000 pieces/reel)	Resistance Value 2 significant figures + 1 multiplier	Tolerance G: ±2% J: ±5%	T.C.R.

applications and ratings

Part Designation	Power Rating	Maximum Working Voltage	Maximum Overload Voltage	Thermal Time Constant	Thermal Dissipation Constant	Rated Ambient Temperature	Operating Temperature Range
LT732A	0.1W	50V	100V	1.0s	1.37mW/°C	+70°C	-40°C to +125°C
LT322B	0.125W	75V	150V	1.5s	1.47mW/°C		

Thermal time constant and dissipation constant are reference values, which are values of elements and vary with connecting or fixing methods.

For further information on packaging, please refer to Appendix A.

Specifications given herein may be changed at any time without prior notice. Please confirm technical specifications before you order and/or use.

10/26/21

applications and ratings

T.C.R. (x10 ⁻⁶ /K)	T.C.R. Tolerance	Resistance Range E-24		Resistance Tolerance
		LT732A	LT732B	
150, 250, 350, 450, 500	±100x10 ⁻⁶ /K	2kΩ - 24kΩ	2kΩ - 51kΩ	G: ±2%
600, 700, 800, 900	±150x10 ⁻⁶ /K	1kΩ - 20kΩ	1kΩ - 43kΩ	J: ±5%
1000, 1200, 1400	±15%	1kΩ - 13kΩ	1kΩ - 27kΩ	
1600, 1800		510Ω - 4.7kΩ	1kΩ - 10kΩ	
2000, 2200, 2400	±10%	510Ω - 4.7kΩ	510Ω - 9.1kΩ	
2600, 2800, 3000		510Ω - 3.0kΩ	510Ω - 6.2kΩ	
3300, 3600, 3900		510Ω - 3.0kΩ	510Ω - 6.2kΩ	
4200		100Ω - 1kΩ	100Ω - 2kΩ	
4500		51Ω - 510Ω	51Ω - 510Ω	

T.C.R. Measuring Temperature: +25°C ~ +75°C

Rated voltage = $\sqrt{\text{Power Rating} \times \text{Resistance value}}$ or Max. working voltage, whichever is lower.

environmental applications

Derating Curve

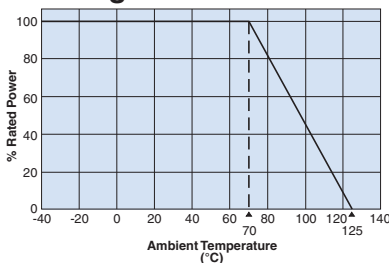

For resistors operated at an ambient temperature of 70°C or above, a power rating shall be derated in accordance with the above derating curve.

Examples of Temperature Characteristics of Resistance

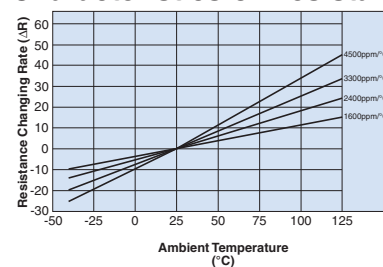

Approximate Expression for Resistance-Temperature Characteristics

Values are not guaranteed but typical.

$R_T = R_{25} (C_0 + C_1 T + C_2 T^2)$ R_T : T°C R_T : Resistance value at T°C
 R_{25} : 25°C R_{25} : Resistance value at 25°C
 T: (°C) T: Ambient temperature (°C)
 C₀, C₁, C₂: C₀, C₁, C₂: Constants

T.C.R. (x10 ⁻⁶ /K)	C ₀	C ₁	C ₂
3000	0.9288	0.0028	1.9983 x 10 ⁻⁶
3300	0.9232	0.0030	2.9980 x 10 ⁻⁶
3600	0.9175	0.0032	4.0000 x 10 ⁻⁶
3900	0.9099	0.0035	4.0064 x 10 ⁻⁶
4200	0.9026	0.0038	3.9964 x 10 ⁻⁶
4500	0.8948	0.0041	4.0064 x 10 ⁻⁶

Performance Characteristics

Parameter	Requirement ΔR ±(% + 0.05Ω)		Test Method
	Limit	Typical	
Resistance	Within specified tolerance	—	25°C
T.C.R.	Within specified T.C.R.	—	+25°C/+75°C
Overload (Short time)	±1.0%	±0.23%	Rated voltage x 2.5 or maximum overload volume for 5 seconds, whichever is lower
Resistance to Solder Heat	±1.0%	±0.1%	260°C ± 5°C, 10 seconds ± 1 second
Rapid Change of Temperature	±1.0%	±0.1%	-40°C (30 minutes)/ +125°C (30 minutes), 5 cycles
Moisture Resistance	±3.0%	±0.54%	40°C ± 2°C, 90 - 95% RH, 1000 hours, 1.5 hr ON, 0.5 hr OFF cycle
Endurance at 70°C	±3.0%	±0.62%	70°C ± 2°C, 1000 hours, 1.5 hr ON, 0.5 hr OFF cycle

Confirming resistance drift is recommended since this product has a tendency to have bigger resistance change than general flat chip over 70°C. Please pay attention not to be applied ESD, it may cause of resistance change.

Actual Value (Out of Guarantee)

Test Items	Reference	Test Method
Low Temperature Exposure	±0.05%	-40°C, 45 minutes
High Temperature Exposure	±0.6%	125°C, 1000 hours
ESD	500V	Human Body Model, 100 pF 1.5 kΩ

Specifications given herein may be changed at any time without prior notice. Please confirm technical specifications before you order and/or use.

3/16/17



features

- LP series is thin-film thermal sensors and accomodates resistance tolerance $\pm 1\%$ and high T.C.R. $+5000 \times 10^{-6}/K$ with the standard products
- Suitable for control of temperatures for various industrial equipment
- Products meet EU RoHS requirements

dimensions and construction

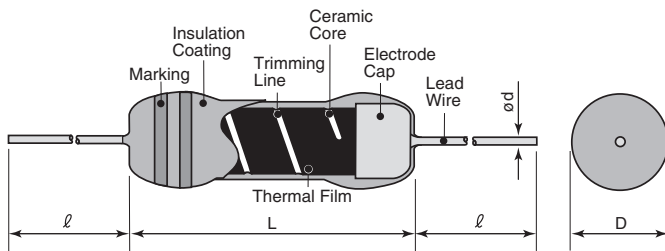

Type	Dimensions inches (mm)			
	L	D	d (Nom.)	ℓ
LP 1/16	.138 ^{+0.006} _{-.016} (3.5 ^{+0.2} _{-0.4})	.067±.008 (1.7±0.2)	.020±.002 (0.5±0.05)	1.18±.118 (30±3)
LP 1/8	.25±.031 (6.35±0.8)	.090±.008 (2.3±0.2)	.026±.002 (0.65±0.05)	1.50±.118 (38±3)

ordering information

LP	1/8	C	T26	A	103	J	362
Product Code	Power Rating	Termination Surface Material	Taping	Packaging	Nominal Resistance	Resistance Tolerance	Symbol of T.C.R.
	1/16: 0.063W 1/8: 0.125W	C: SnCu	Nil: Bulk T26: 26mm Taping T52: 52mm Taping	Nil: Bulk A: AMMO	3 digits	F: ±1% G: ±2% J: ±5%	3 digits 151: 150 362: 3600

applications and ratings

Type	Power Rating	Thermal Time Constant	Thermal Dissipation Constant*	Rated Ambient Temperature	Operating Temperature Range
LP1/16C	0.063W	8s	2.5mW/°C	+70°C	-55°C~150°C
LP1/8C	0.125W	14s	4.5mW/°C		

* Thermal time constant and dissipation constant are reference values, which are values of elements and vary with connecting or fixing methods.

T.C.R. ($\times 10^{-6}/K$)	T.C.R. Tolerance	(Ω) Resistance Range (E24 & 2.5, 5.0×10 ⁿ)					
		LP1/16			LP1/8		
		F:±1%	G:±2%	J:±5%	F:±1%	G:±2%	J:±5%
150, 250, 350 450	±50×10 ⁻⁶ /K	-	150-10k	150-10k	-	150-51k0	150-51k0
550, 650, 750, 850 950, 1000, 1200 1400, 1600, 1800 2000, 2200, 2400			150-30k	150-30k		150-100k	150-100k
2500 3000 3300 3600	±5%	100-30k	10-30k	1-30k	100-100k	10-100k	1-100k
4000, 4500, 5000		100-10k	10-10k	1-10k	100-51k	10-51k	1-51k
					100-20k	10-20k	1-20k

T.C.R. Measuring Temperature: +25°C/+65°C. T.C.R. is guaranteed by random inspections.

Specifications given herein may be changed at any time without prior notice. Please confirm technical specifications before you order and/or use. 11/30/17

environmental applications

Derating Curve

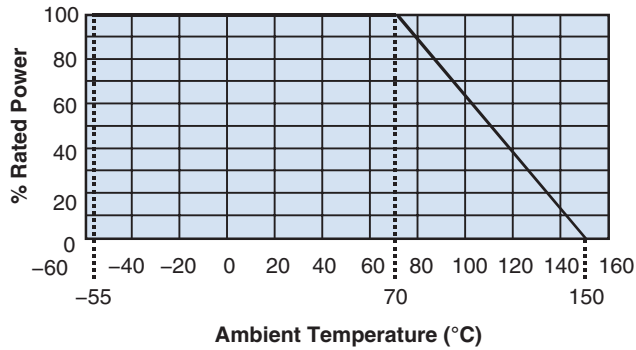

Examples of Temp. Characteristics of Resistance

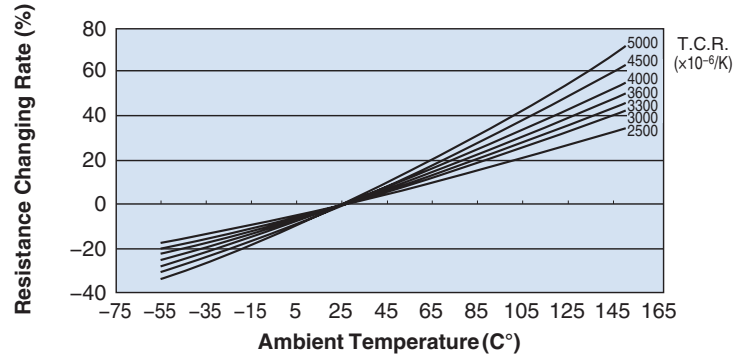

Approximate Expression for Resistance- Temperature Characteristics

Values are not guaranteed but typical.

$$R_T = R_{25} (C_0 + C_1 T + C_2 T^2)$$

R_T : T°C

R_{25} : 25°C

T: (°C)

C_0, C_1, C_2 :

R_T : Resistance value at T°C

R_{25} : Resistance value at 25°C

T: Ambient temperature (°C)

C_0, C_1, C_2 : Constants

T.C.R. ($\times 10^{-6}/K$)	C_0	C_1	C_2
3000	0.931258	0.00265213	3.90112×10^{-6}
3300	0.924355	0.00292569	4.00516×10^{-6}
3600	0.916356	0.00323714	4.34428×10^{-6}
4000	0.907039	0.00361006	4.33457×10^{-6}
4500	0.897412	0.00395222	6.05201×10^{-6}
5000	0.886014	0.00437224	7.48809×10^{-6}

Performance Characteristics

Test Items	Performance Requirements $\Delta R \pm$ (%+0.05 Ω)		Test Methods
	Limit	Typical	
Resistance	Within specified tolerance	—	25°C
T.C.R.	Within specified T.C.R.	—	+25°C/+65°C
Overload (Short time)	0.5%	0.2%	Rated voltage \times 2.5 for 5 seconds
Resistance to Soldering Heat	0.5%	0.2%	350°C \pm 10°C, 1 second
Rapid Change of Temperature	0.5%	0.2%	-55°C (30min.) /+25°C (10min.) /+150°C (30min.) /+25°C (10min.) 5 cycles
Moisture Resistance	2%	0.3%	40°C \pm 2°C, 90%–95%RH, 1000h 1.5h ON/0.5h OFF cycle
Endurance at 70°C	2%	0.5%	70°C \pm 3°C, 1000h 1.5h ON/0.5h OFF cycle

Precautions for the Inductors

Refer to the precautions of common matters for all products in the beginning of this catalog for the matters common to all products.

Inductors in General

- Characteristics such as the inductance, Q value etc. are frequency dependent.
- The stress from resin coating and molding can result in change of inductance.
- Since the inductors use ceramic materials, chipping and cracking can occur. Please be careful when handling. Excessive vibration and impact could destroy the parts.
- Keep magnetic tweezers and other magnets away from the inductors to avoid change of inductance caused by magnetization. Do not press the wire wound part of the chip inductor with sharp objects.
- The inductance could decrease according to magnetic saturation when the inductor is used exceeding the allowable current. There is also a possibility of disconnection and short-circuit or emitting smoke and ignition caused by the heat generation of the inductor.
- There is a risk of disconnection when excessive current (inrush current) is applied. Change of the characteristics may occur by the magnetization of the core when excessive current is applied to a DC circuit.
- When the parts are used at high-frequency, the heat generation will be larger and the part temperature will be higher compared with DC or low-frequency. This is caused by increasing iron loss and copper loss. Please be careful not to exceed the operating temperature rise by high frequency.

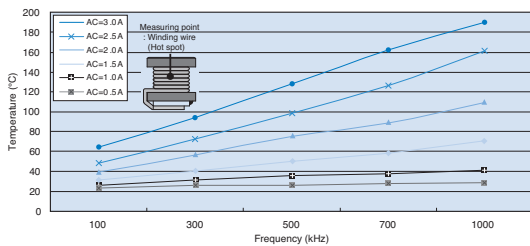

Ex. Temperature rise by high frequency

- The electrical characteristics change from the variation of frequency of the parts. When the part is used above the frequency band of the SRF (self-resonant frequency), it will function as a capacitor. Please do not use the parts above the SRF.

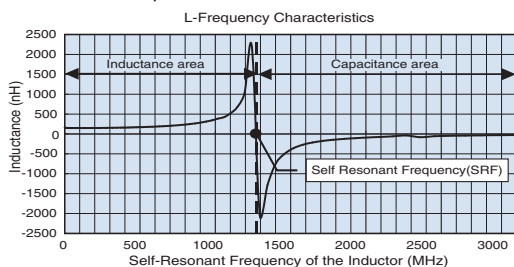

Mounting

- Some of the inductors have magnetic polarity to which attention should be paid when mounting.
- The inductance and Q values of a non-magnetically-shielded inductor could change from magnetic coupling affected by other components, chassis, patterns, etc. When mounting in high density, check the characteristic in advance with the actual equipment. Additionally, take care of the positioning of the components since closely mounted inductors may cause magnetic coupling. Do not place large magnetic materials like audio speakers, etc. near the inductors.
- Do not expose the inductors to the heat radiation from other high temperature parts.

Reference

- For basic precautions, please refer to the Technical report of JEITA RCR-2501C Safety application guide for inductors for use in electronic equipment.

Terms and Definitions

Nominal Inductance

- Inductance that the inductor is designed to have and generally indicated on the body.

Q Value (Quality factor)

- A coefficient that shows the quality of the inductors. It is calculated from the following formula shown below.

$$Q = \frac{\omega L}{R}$$

ω = Angular Frequency ($\omega=2\pi f$)
 L = Inductance
 R = Resistance

Self-Resonant Frequency

- Frequency that resonance occurs by the distribution capacity and inductance of the inductor.

DC Resistance Value

- Resistance value at DC.

Allowable DC Current

- Upper limit of the current which is set to assure the safe use of the inductor.
- It is defined as the smaller DC current value of either the DC superposition or the surface temperature rise characteristics.
- DC superposition characteristic is a phenomenon which occurs when the inductors, made with magnetic materials such as ferrite, have a large DC current applied. When this occurs, the inductance drops because of the magnetic saturation.
- The plot below shows the relationship between the DC superposition and the surface temperature rise.

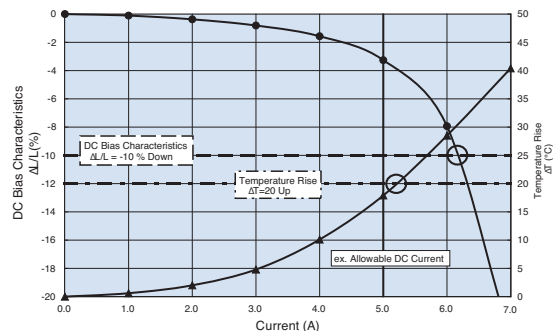

Iron Loss

- Electrical energy that is lost when the wire wound magnetic material is magnetized by the applied AC. It is calculated by the sum of hysteretic loss and eddy-current loss.

Copper Loss

- Energy that is transformed into Joule heat by the resistance of the wound wire. The Copper loss increases in the high frequency band from the skin effect.



features

- Monolithic structure provides high reliability in a wide temperature and humidity range
- High quality ceramic material and unique manufacturing process provides high Q at high frequency
- Nickel barrier with solder overcoat for excellent solderability
- Products with lead-free terminations meet EU RoHS requirements

dimensions and construction

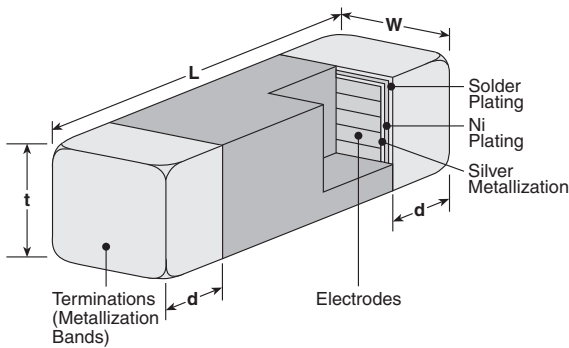

Size Code	Dimensions inches (mm)			
	L	W	t	d
1E (0402)	.039±.004 (1.0±0.1)	.02±.004 (0.5±0.1)	.02±.004 (0.5±0.1)	.01±.004 (0.25±0.1)
1J (0603)	.063±.006 (1.6±0.15)	.031±.006 (0.8±0.15)	.031±.006 (0.8±0.15)	.012±.008 (0.3±0.20)

Inductors

ordering information

MHL	1E	C	T	TP	3N9	S
Type	Size Code	Material	Termination Material	Packaging	Nominal Inductance	Tolerance
	1E 1J	Permeability Code: C	T: Sn	TP: 7" paper tape 2 mm pitch (1E only - 10,000 pieces/reel) TD: 7" paper tape (1J - 4,000 pieces/reel)	3N9 = 3.9nH R10 = 100nH	S: ±0.3nH J: ±5%

For further information on packaging, please refer to Appendix A.

applications and ratings

Part Designation	Inductance L (nH)	Inductance Tolerance	Q Minimum (100MHz)	Self Resonant Frequency Typical (MHz)	DC Resistance Maximum (Ω)	Allowable DC Current Maximum (mA)	Operating Temperature Range**
MHL1ECTTP1N0*	1.0	S: ±0.3nH	8	10000	0.12	300	-55°C to +125°C
MHL1ECTTP1N2*	1.2				0.16		
MHL1ECTTP2N2*	2.2				0.19		
MHL1ECTTP3N3*	3.3			4000	0.22		
MHL1ECTTP3N9*	3.9				0.24		
MHL1ECTTP4N7*	4.7				0.27		
MHL1ECTTP5N6*	5.6						

applications and ratings (continued)

Part Designation	Inductance L (nH)	Inductance Tolerance	Q Minimum (100MHz)	Self Resonant Frequency Typical (MHz)	DC Resistance Maximum (Ω)	Allowable DC Current Maximum (mA)	Operating Temperature Range**				
MHL1ECTTP6N8*	6.8	J: ±5%	8	3900	0.32	300	-55°C to +125°C				
MHL1ECTTP8N2*	8.2			3500	0.37						
MHL1ECTTP10N*	10			3200	0.42						
MHL1ECTTP12N*	12			2600	0.50						
MHL1ECTTP15N*	15			2300	0.55						
MHL1ECTTP18N*	18			2000	0.65						
MHL1ECTTP22N*	22			1600	0.8						
MHL1ECTTP27N*	27			1400	0.9	200					
MHL1ECTTP39N*	39			1100	1.2						
MHL1ECTTP47N*	47			900	1.3						
MHL1ECTTP56N*	56			J: ±5%	8	750		1.4	100		
MHL1ECTTP82N*	82					600		1.6			
MHL1ECTTPR10*	100					600		2.0			
MHL1JCTTD1N5*	1.5					S: ±0.3nH		8	6000	0.10	600
MHL1JCTTD1N8*	1.8										
MHL1JCTTD2N2*	2.2										
MHL1JCTTD2N7*	2.7										
MHL1JCTTD3N3*	3.3	10	5200	0.13							
MHL1JCTTD3N9*	3.9		5000	0.15							
MHL1JCTTD4N7*	4.7		4000	0.20							
MHL1JCTTD5N6*	5.6		4000	0.23							
MHL1JCTTD6N8*	6.8	J: ±5%	12	3500	0.25		600				
MHL1JCTTD8N2*	8.2			3200	0.28						
MHL1JCTTD10N*	10			2600	0.30						
MHL1JCTTD12N*	12			2300	0.35						
MHL1JCTTD15N*	15			2000	0.40						
MHL1JCTTD18N*	18			1600	0.45						
MHL1JCTTD22N*	22			1400	0.50						
MHL1JCTTD27N*	27			1200	0.55						
MHL1JCTTD33N*	33			1100	0.60						
MHL1JCTTD39N*	39			900	0.65	500					
MHL1JCTTD47N*	47			700	0.70						
MHL1JCTTD68N*	68			600	0.80	400					
MHL1JCTTD82N*	82			600	1.0						
MHL1JCTTDR12*	120			8***	8***	500	1.3	300			
MHL1JCTTDR15*	150	500	1.7								
MHL1JCTTDR22*	220	400	2.0			250					

*Add tolerance character (S, J)

** The operating temperature range of the coil (ambient temperature + self heating) must remain at +125°C or less

*** 50MHz

Inductors

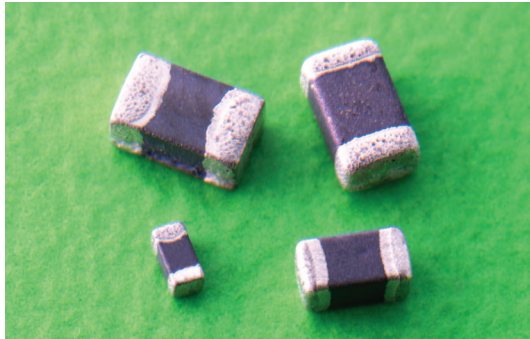

features

- Designed to reduce noise at high frequencies
- Standard EIA packages: 1E, 1J, 2A, 2B
- Nickel barrier with solder overcoat for excellent solderability
- Marking: Black body color with no marking
- Products with lead-free terminations meet EU RoHS requirements

dimensions and construction

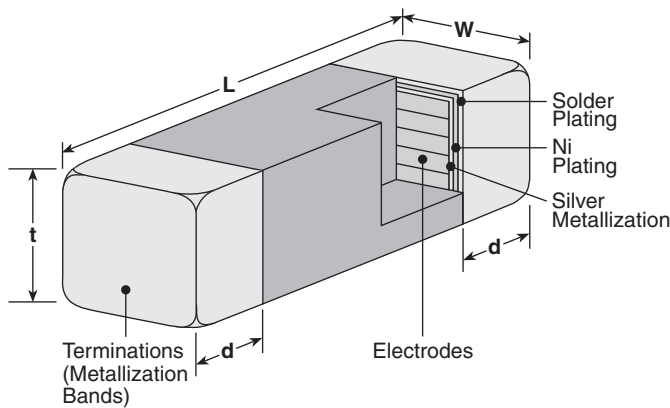

Type (Inch Size Code)	Dimensions inches (mm)			
	L	W	t	d
1E (0402)	.039±.004 (1.0±0.1)	.02±.004 (0.5±0.1)	.02±.004 (0.5±0.1)	.01±.004 (0.25±0.1)
1J (0603)	.063±.006 (1.6±0.15)	.031±.006 (0.8±0.15)	.031±.006 (0.8±0.15)	.014±.006 (0.36±0.15)
2A (0805)	.079±.008 (2.0±0.2)	.049±.008 (1.25±0.2)	.035±.008 (0.9±0.2)	.020±.012 (0.51±0.30)
2B (1206)	.126±.008 (3.2±0.2)	.063±.008 (1.6±0.2)	.043±.008 (1.1±0.2)	.020±.012 (0.51±0.30)

ordering information

CZB	1E	G	T	TP	100	P
Type	Size	Permeability Code	Termination Material	Packaging	Impedance	Tolerance
	1E 1J 2A 2B	F G S	T: Sn	TP: 7" paper tape (1E only - 10,000 pieces/reel) TD: 7" paper tape (1J, 2A - 4,000 pieces/reel) TE: 7" embossed plastic (2B - 3,000 pieces/reel)	2 significant figures + 1 multiplier	P: ±25%

For further information on packaging, please refer to Appendix A.

applications and ratings

Part Designation	Impedance @ 100MHz † (Ω)	DC Resistance Maximum †† (Ω)	Allowable DC Current Maximum (mA)	Operating Temperature Range
CZB1EGTTP100P	10	0.05	600	-55°C to +125°C
CZB1EGTTP700P	70	0.40	350	
CZB1EGTTP121P	120	0.50	300	
CZB1EGTTP221P	220	0.70	200	
CZB1EGTTP301P	300	0.80		
CZB1EGTTP601P	600	1.00	150	
CZB1EGTTP102P	1000	1.50	100	
CZB1JGTTD300P	30	0.10	600	-55°C to +125°C
CZB1JGTTD600P	60	0.20		
CZB1JGTTD800P	80			
CZB1JGTTD101P	100	0.25	400	
CZB1JGTTD121P	120			
CZB1JGTTD141P	140	0.30	300	
CZB1JGTTD221P	220			
CZB1JGTTD301P	300	0.35	250	
CZB1JGTTD451P	450	0.40		
CZB1JGTTD601P	600	0.45	150	
CZB1JGTTD102P	1000	0.60		
CZB1JGTTD152P	1500	0.70	300	
CZB1JGTTD202P	2000	1.20		
CZB2AFTTD500P	50	0.10	800	
CZB2AGTTD101P	100	0.15	600	
CZB2AGTTD121P	120	0.25	600	
CZB2AGTTD301P	300	0.30	400	
CZB2AGTTD601P	600			
CZB2AGTTD601PV	600	0.25	500	
CZB2AGTTD102P	1000	0.40	300	
CZB2BFTE300P	30	0.10	800	-55°C to +125°C
CZB2BFTE600P	60			
CZB2BFTE800P	80			
CZB2BFTE101P	100	0.20	600	
CZB2BFTE121P	120			
CZB2BFTE201P	200	0.20	500	
CZB2BFTE301P	300	0.30		
CZB2BFTE601P	600	0.40	400	

† Impedance test method: HP4291A

†† DCR test method: Keithley 580

For complete environmental specifications, please refer to www.koaspeer.com

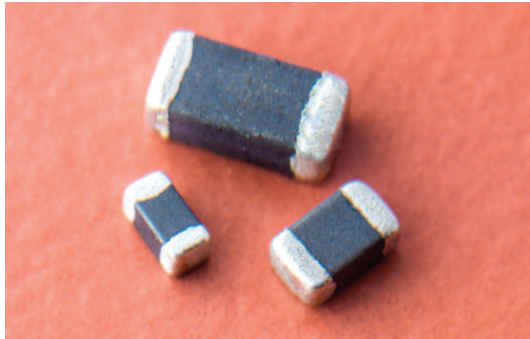

features

- Designed to reduce noise at high frequencies
- Standard EIA packages: 1J, 2A, 2B
- Nickel barrier with solder overcoat for excellent solderability
- Marking: Black body color with no marking
- Products with lead-free terminations meet EU RoHS requirements

dimensions and construction

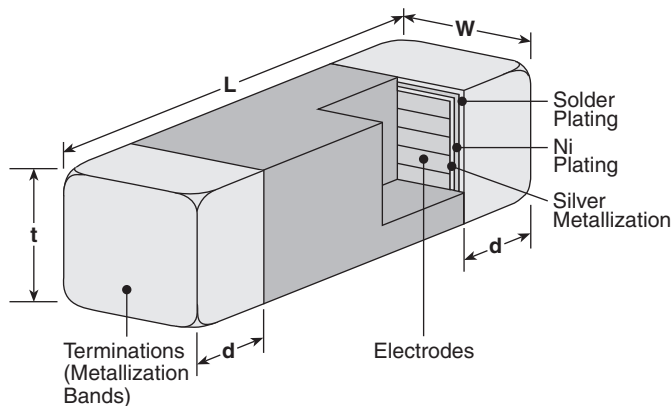

Type (Inch Size Code)	Dimensions inches (mm)			
	L	W	t	d
1J (0603)	.063±.006 (1.6±0.15)	.031±.006 (0.8±0.15)	.031±.006 (0.8±0.15)	.014±.006 (0.36±0.15)
2A (0805)	.079±.008 (2.0±0.2)	.047±.008 (1.20±0.2)	.035±.008 (0.9±0.2)	.02±.012 (0.51±0.30)
2B (1206)	.126±.008 (3.2±0.2)	.063±.008 (1.6±0.2)	.043±.008 (1.1±0.2)	.02±.012 (0.51±0.30)

ordering information

CZP	2A	F	T	TD	300	P
Type	Size	Permeability Code	Termination Material	Packaging	Impedance	Tolerance
	1J 2A 2B	F P	T: Sn	TD: 7" paper tape (1J, 2A - 4,000 pieces/reel) TE: 7" embossed plastic (2B - 3,000 pieces/reel)	2 significant figures + 1 multiplier	P: ±25%

For further information on packaging, please refer to Appendix A.

applications and ratings

Part Designation	Impedance @ 100MHz (Ω)	DC Resistance Maximum (Ω)	Allowable DC Current Maximum (mA)	Operating Temperature Range	
CZP1JFTTD300P	30	0.03	3000	-55°C to +125°C	
CZP1JFTTD600P	60	0.04			
CZP1JFTTD121P	120	0.10	2000		
CZP1JFTTD181P	180				
CZP1JFTTD221P	220				
CZP1JFTTD301P	300				
CZP1JFTTD601P	600	0.20	1000		
CZP2AFTTD300P	30	0.015	4000		-55°C to +125°C
CZP2AFTTD600P	60	0.04	3000		
CZP2AFTTD800P	80				
CZP2AFTTD221P	220				
CZP2AFTTD301P	300	0.15	2000		
CZP2AFTTD601P	600	0.20			
CZP2AFTTD102P	1000			1000	
CZP2BFTTE190P	19	0.02	4000	-55°C to +125°C	
CZP2BFTTE300P	30				
CZP2BFTTE500P	50	0.025	3000		
CZP2BFTTE800P	80	0.03			
CZP2BFTTE101P	100	0.08			2500
CZP2BFTTE121P	120				
CZP2BFTTE601P	600		0.20		
CZP2BPTTE600P	60	0.02	6000		
CZP2BPTTE101P	100	0.03	3000		
CZP2BPTTE121P	120	0.04			
CZP2BPTTE601P	600	0.10			1500

For complete environmental specifications, please refer to www.koaspeer.com

Precautions for the Fusing Components

Refer to the precautions in the beginning part of this catalog for the matters common to all products.

Safety Standards

- KOA's fuse components comply with the following safety standards:
 - U.S.A. UL (Underwriters Laboratories Inc.) UL248
 - CANADA CSA (Canadian Standards Association) C22.2 No.248
c-UL (Underwriters Laboratories Inc.) UL248
*c-UL is equivalent to CSA in recognition
 - INTERNATIONAL IEC (International Electrotechnical Commission) 60127-1, -4
 - JAPAN Electrical Appliances and Materials Safety Act (PSE) Class-B

Rated Current

- Specified amperage that conforms to safety standards, such as fusing time. This is not to be confused with the steady-state (stationary) current, which is calculated using the following equation:
Stationary Current ≤ Rated Current x Stationary Derating Coefficient x Ambient Temperature Derating
The table below indicates deratings for each type of products.

Type	Stationary Derating Coefficient
CCF1N, CCF1F	0.7
TF16AT	0.75
TF10BN, TF16SN, TF16VN	1.0

Deratings for Ambient Temperatures

The following Deratings for Ambient Temperatures are required:

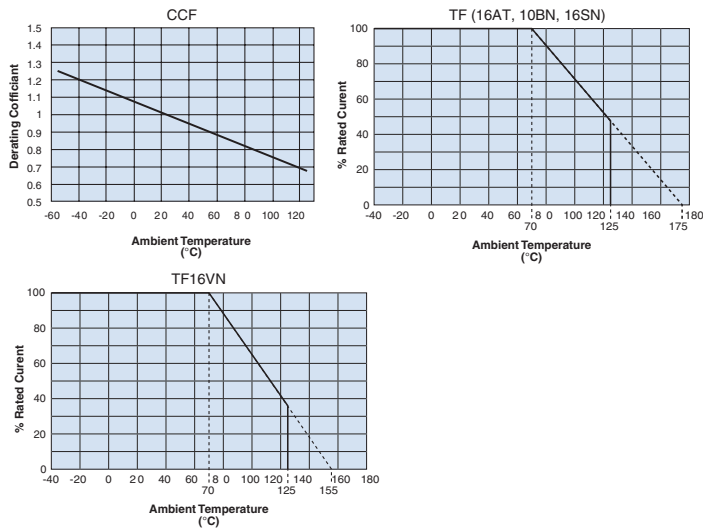

- If the current waveform is a repeated pulse or AC waveform, the peak current shall be both the rated current and stationary current. Do not use the effective value of the current waveform.

Rated Voltage

- A rated voltage indicates the voltage that does not run through electrodes after the fuse blows. In case of exceeding the rated voltage, the circuit voltage should be applied at voltage not higher than the rated voltage because the current may run again or may break the elements.

Interrupting Capacity

- Maximum current and voltage that can be interrupted when an abnormal situation arises. Make sure beforehand that voltage and current at the time of abnormality occurring in the circuit are within the interrupting capacity.

Type	Fusing Current	Fusing Time
CCF1N (0.4~10)	Rated Current x 2 or Over	1 second
TF16SN	Rated Current x 2 or Over	1 second
TF10BN	Rated Current x 2 or Over	5 seconds
TF16AT	Rated Current x 2 or Over	5 seconds
TF16VN	Rated Current x 2.5 or Over	5 seconds
CCF1N (12~30)	Rated Current x 2 or Over	60 seconds
CCF1F	Rated Current x 2 or Over	120 seconds

Fusing Current

- Minimum current needed to break fusing element. Refer to the following list to quickly interrupt if an abnormal current occurred in the circuit:
If fusing time is within 1 second, the variance in the fusing time is largely affected by the surroundings (temperature, mounting pad dimensions, substrate material, etc.). If the fusing time is not less than 1 second, the verification should be made with an actual circuit.

Anti-Surge Characteristics

Be careful of the short time over current (inrush current, reversible current at motor-lock etc.) that is generated in the circuit.

- Inrush current will differ according to the ambient temperature and the charging/discharging condition of the capacitor etc. Check the current wave form with the condition which will be the maximum current.
- When components that are highly dependent on temperatures such as thermistors are used within the circuit, check the current wave form with the condition which will be the maximum current.
- Set the sampling frequency at a level which the peak current can be detected when measuring the surge current with a digital oscilloscope.
- Generally, current probes are used for current measurement. When shunt resistors are used, be sure to use the lowest resistance value as possible according to the impedance in the circuit.

Operation Check

- Before you decide which fuse product you use, please mount the selected fuse on actual device and confirm that rush current and surge current have enough margin and that the product has performance that enables it to interrupt the abnormal current quickly.

Soldering

- This product is suitable both for reflow-soldering and for flowsoldering, but excessive heat may cause an open-circuit and change its characteristics.
- The part shall be soldered at the maximum temperature of 260°C or less.
- If a soldering iron is used, it shall be at 350°C or less and should be soldered in a short time. Further, pay attention that the products are not touched directly by the top of the iron. It may cause disconnection or characteristic change.

Placement

- Please confirm sufficiently the evaluation of reliability and use those that have small contractile stress at a resin stiffening time. By contractile stress at the resin stiffening time, fuses might be broken, resistance value may be changed and disconnection might occur in case of resin coating/potting or molded sealing. There is a possibility that heat may fill the surrounding of the fuses by shielding and may cause the fusing characteristics to change so, please check with the actual circuit.
- The fusing characteristics may change when there are components that generate heat around the fuses. Keep fuses away from those parts.

Storage

- Avoid storing components under the condition of high temperature/high humidity (40°C/70%RH or more) which may deteriorate solderability.
- Also avoid direct sun light which may deteriorate solderability and induce changes in taping strength.se parts.

Parts Selection

- If you have any questions about fuse selection, please do not hesitate contacting us.

Reference

- For basic precautions, refer to JEITA technical report "JEITA RCR-4800 Safety application guide on fuse for use in electronic and electrical equipment".



features

- Small, lightweight design
- Special manufacturing method stabilizing fusing characteristics and occupying less area
- Low power consumption and less voltage drop due to low internal resistance
- Suitable for overcurrent protection of circuit block in electronic devices
- Suitable for flow and reflow soldering
- Products meet EU RoHS requirements

dimensions and construction

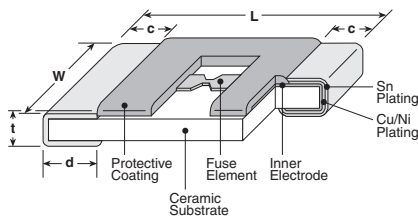

Type (Inch Size Code)	Dimensions inches (mm)				
	L	W	c	d	t
TF10BN (0402)	.04±.004 (1.0±0.1)	.02±.002 (0.5±0.05)	.008±.004 (0.2±0.1)	.01±.004 (0.25±0.1)	.015±.002 (0.4±0.05)
TF16AT (0603)	.063±.004 (1.6±0.1)	.031±.003 (0.8±0.08)	.012±.004 (0.3±0.1)	.012±.004 (0.3±0.1)	.018±.002 (0.45±0.05)
TF16SN (0603)	.063±.008 (1.6±0.2)	.031±.004 (0.8±0.1)	.012±.004 (0.3±0.1)	.012±.004 (0.3±0.1)	.015+ ^{+0.04} -.002 (0.4+ ^{+0.1} -0.05)

ordering information

TF	16S	N	1.25	T	TD
Type	Size	Fusing Characteristic	Rated Current	Termination Material	Packaging
	10B: 0402 16A: 0603 16S: 0603	N: Normal blow T: Anti pulse (16A only)	Reference rating chart	T: Sn	TB: 2mm pitch punched paper (TF10BN only, 10,000 pieces/reel) TD: 4mm pitch punched paper (TF16 only, 5,000 pieces/reel)

applications and ratings

Part Designation	Marking	Rated Current	Fusing Time	Internal R. Maximum (mΩ)	Rated Voltage	Rated Ambient Temperature	Operating Temperature Range
TF10BN0.20	A	0.20A	Open within 5 sec. at 200% rated current (Refer to Fusing Characteristics graph)	1990	DC 32V	+70°C	-55°C to +125°C
TF10BN0.25	C	0.25A		1270			
TF10BN0.315	D	0.315A		850			
TF10BN0.50	F	0.50A		320			
TF10BN0.63	I	0.63A		200			
TF10BN0.80	K	0.80A		135			
TF10BN1.00	L	1.00A		115			
TF10BN1.25	M	1.25A		90			
TF10BN1.60	N	1.60A		58			
TF10BN2.00	S	2.00A		42			
TF10BN2.50	T	2.50A		35			
TF10BN3.00	V	3.00A		30			
TF10BN3.50	R	3.50A		27			
TF10BN4.00	X	4.00A		23			
TF10BN5.00	Y	5.00A		19			
TF16AT0.25	C	0.25A	Open within 5 sec. at 200% rated current (Refer to Fusing Characteristics graph)	498	DC 32V	+70°C	-55°C to +125°C
TF16AT0.315	D	0.315A		384			
TF16AT0.50	F	0.50A		198			
TF16AT0.63	I	0.63A		143			
TF16AT0.80	K	0.80A		120			
TF16AT1.00	L	1.00A		94			
TF16AT1.25	M	1.25A		73			
TF16AT1.60	N	1.60A		59			
TF16AT2.00	S	2.00A		42			
TF16AT2.50	T	2.50A		32			

For further information on packaging, please refer to Appendix A.

Specifications given herein may be changed at any time without prior notice. Please confirm technical specifications before you order and/or use.

11/15/23

applications and ratings (continued)

Part Designation	Marking	Rated Current	Fusing Time	Internal R. Maximum (mΩ)	Rated Voltage	Rated Ambient Temperature	Operating Temperature Range
TF16AT3.15	U	3.15A	Open within 5 sec. at 200% rated current (Refer to Fusing Characteristics graph)	24	32V	+70°C	-55°C to +125°C
TF16AT4.00	X	4.00A		17			
TF16AT5.00	Y	5.00A		14			
TF16SN0.20	A	0.20A	Open within 1 sec. at 200% rated current (Refer to Fusing Characteristics graph)	1500	32V	+70°C	-40°C to +125°C
TF16SN0.25	C	0.25A		960			
TF16SN0.315	D	0.315A		600			
TF16SN0.40	H	0.40A		440			
TF16SN0.50	F	0.50A		300			
TF16SN0.63	I	0.63A		190			
TF16SN0.70	J	0.70A		170			
TF16SN0.80	K	0.80A		135			
TF16SN1.00	L	1.00A		103			
TF16SN1.25	M	1.25A		78			
TF16SN1.60	N	1.60A		58			
TF16SN2.00	S	2.00A		47			
TF16SN2.50	T	2.50A		38			
TF16SN3.15	U	3.15A		28			

environmental applications

Derating Curve

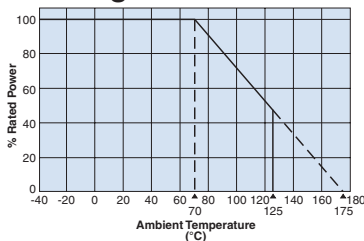

Stationary Current: Regard the peak of stationary current waveform as stationary current value when the stationary current is repeated pulse.

Temperature Derating: Rated current needs to be derated if used at an ambient temperature 70°C or above. Refer to the derating coefficient on the left figure.

Fusing Characteristics

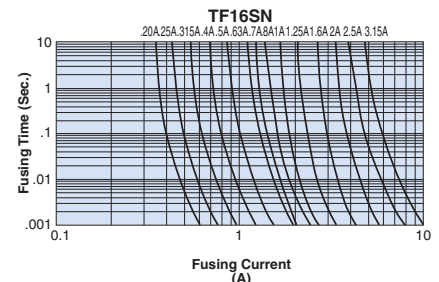
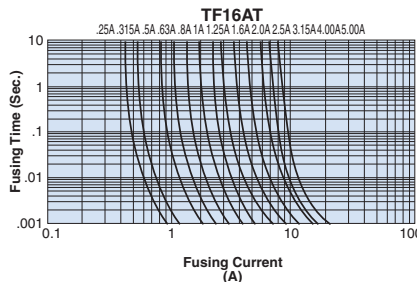
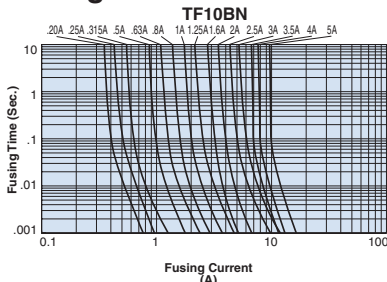

Performance Characteristics

Parameter	Requirement		Test Method
	Limit	Typical	
Fusing Characteristics	Within 1 second (16SN) Within 5 seconds (10BN, 16AT)	—	200% of rated voltage shall be carried (@25°C)
Bending Test	No mechanical damages	—	Distance between holding points: 90mm, Bending: 3mm, 1 time (BN, AT), 2mm, 1 time (SN)
Resistance to Solder Heat	±10%	±4.5% (16SN) ±5% (10BN, 16AT)	260°C ± 5°C, 10 seconds ± 0.5 [±] second
Solderability	95% coverage minimum	—	245°C ± 3°C, 3 seconds ± 0.5 second
Load Life	±10%	±4.5% (16SN) ±5% (10BN, 16AT)	70°C ± 2°C, 1000 hours, rated current x 100%, 1.5 hr ON, 0.5 hr OFF cycle
Load Life Moisture	±10%	±3% (10BN) ±4.5% (16SN), 5% (16AT)	40°C ± 2°C, 90 - 95% RH, 1000 hours, rated current x 100% (10BN, 16SN), x 75% (16AT), 1.5 hr ON, 0.5 hr OFF cycle
Rapid Change of Temperature	±10%	±4% (16SN) ±5% (10BN, 16AT)	16SN: -40°C ± 2°C (30 minutes), 10BN, 16AT: -55°C ± 2°C, +125°C (30 minutes), 10 cycles
Resistance to Solvent	No evidence of damages to protective coating and marking	—	Conforming to MIL-STD-202F
Residual Resistance	10kΩ and more	—	Measure DC resistance after fusing

Specifications given herein may be changed at any time without prior notice. Please confirm technical specifications before you order and/or use.

11/15/23



features

- Small and light chip current fuses for the secondary circuit
- Temperature cycle (-55°C ~ 125°C), 1000 cycle
- Original construction and manufacturing method stabilize fusing characteristics
- Suitable for overcurrent protection of circuit block in small electronic devices
- Suitable for reflow solderings
- Products meet EU RoHS requirements

dimensions and construction

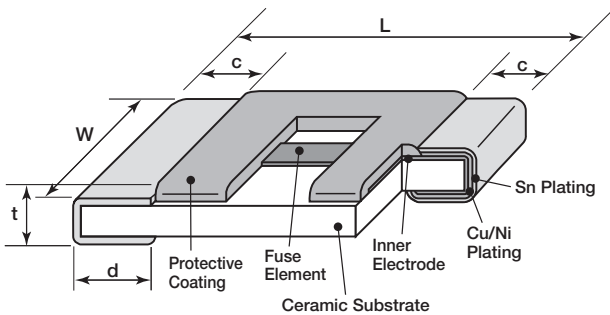

Type	Dimensions inches (mm)				
	L	W	c	d	t
TF16VN (0603)	.063±.004 (1.6±0.1)	.031±.004 (0.8±0.1)	.014±.004 (0.35±0.1)	.012±.004 (0.3±0.1)	.018±.004 (0.45±0.1)

ordering information

TF	16V	N	2.50	D	T	TD
Product Code	Size	Fusing Characteristics	Rated Current	Rated Voltage	Terminal Surface Material	Taping
	16V: 0603	N: Normal blow		Nil: DC 32V D: DC 125V DC 70V DC 50V	T: Sn	TD: 4mm pitch punch paper

For further information on packaging, please refer to Appendix A.

ratings

Type	Marking	Rated Current	Fusing Time	Internal R. (mΩ)Max.	Rated Voltage	Rated Ambient Temp.	Operating Temperature Range
TF16VN0.40	H	0.40A	Open within 5 sec. at 250% rated current. Refer to the graph of fusing characteristics.	760	DC 32V (DC125V)	+70°C	-55°C ~ 125°C
TF16VN0.50	F	0.50A		520			
TF16VN0.63	I	0.63A		370	DC 32V (DC70V)		
TF16VN0.80	K	0.80A		200			
TF16VN1.00	L	1.00A		160			
TF16VN1.25	M	1.25A		130			
TF16VN1.60	N	1.60A		100			
TF16VN2.00	S	2.00A		80			
TF16VN2.50	T	2.50A		60	DC 32V (DC50V)		
TF16VN3.15	U	3.15A		40			

High rated voltage products (DC 125V: 0.4A to 0.5A, DC 70V: 0.63A to 2.5A, DC 50V: 3.15A) are available. Please ask KOA sales.

environmental applications

Derating Curve

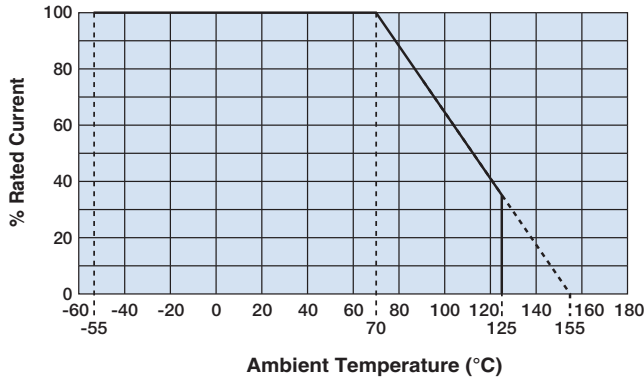

Stationary current: Regard the peak of stationary current waveform as stationary current value when the stationary current is repeated pulse.

Temperature Derating: Rated Current needs to be derated if used at an ambient temperature of 70°C or more. Refer to the derating coefficient on the left figure.

Fusing Characteristics (Average Fusing Time)

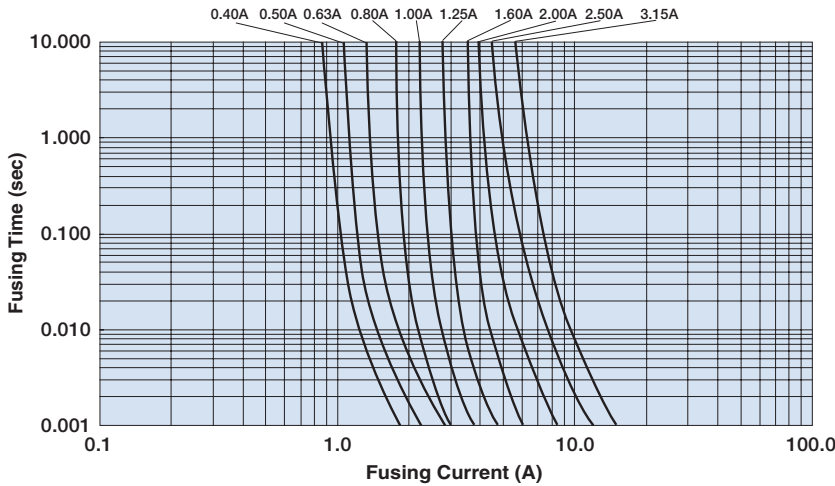

Performance Characteristics

Test Items	Performance Requirements $\Delta R \pm \%$		Test Methods
	Limit	Typical	
Fusing Characteristics	Within 5 seconds	—	250% of rated current shall be carried (@25°C)
Bending Test	No mechanical damages	—	Distance between holding points 90mm, bending width 2mm, 1 time.
Resistance to Soldering Heat (Reflow Soldering)	10	5	Preheating: 150+30°C, 90 ± 30 seconds Heating: 230°C or more, 30 ± 10 seconds, max. 260°C
Solderability	95% coverage min.	—	245°C±3°C, 3 seconds ± 0.5 seconds
Load Life	10	5	70°C±2°C, 1000h, Rated current × 100%, 1.5h ON/0.5h OFF cycle
Load Life Moisture	10	5	85°C±2°C, 85%±5%RH, 1000h, Rated current × 10%, 1.5h ON/0.5h OFF cycle
Rapid Change of Temperature	10	5	-55°C (30min.)/+125°C (30min.) 1000 cycles
Resistance to Solvent	No evidence of damages to protective coating and marking.	—	Conforming to MIL-STD-202F
Residual Resistance	10kΩ or more	—	Measure DC resistance after fusing

Specifications given herein may be changed at any time without prior notice. Please confirm technical specifications before you order and/or use.

10/17/18



features

- Surface mount fuse suitable for primary and secondary circuits
- Ceramic case provides excellent mechanical strength
- Suitable for flow and reflow soldering
- Stable fusing characteristics due to the original technology
- Excellent Anti-Surge characteristics
- Products with lead-free terminations meet EU RoHS and China RoHS requirements

dimensions and construction

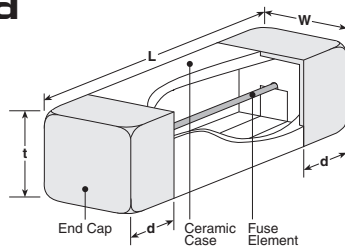

Type	Dimensions inches (mm)			
	L	W	t	d
CCF	.236±.008 (6.0±0.2)	.098±.008 (2.5±0.2)	.098±.008 (2.5±0.2)	.055±.008 (1.4±0.2)

ordering information

CCF	1	N	1		T	TE
Type	Style	Characteristic	Rated Current	Rated Voltage (UL)	Termination Material	Packaging
		N: Normal blow	Reference rating chart	Nil: 125Va.c./60Vd.c. or 65Va.c./65Vd.c. D: 125Va.c./160Vd.c.	T: Sn	TE: 4mm pitch embossed plastic (1,000 pieces/reel)

For further information on packaging, please refer to Appendix A.

applications and ratings

Part Designation	Current Rating	Voltage Rating	Operating Temperature Range	Interrupting Capacity	Fusing Characteristics		Internal R. (mΩ) Max.	Normal Melting Pt (A ² , seconds)	
					Rated Current	Fusing Time			
CCF1N0.4	400mA	UL (c-UL) AC 125V DC 60V (DC 160V)	-55°C to +125°C	UL (c-UL) AC 125V 50A DC 60V 50A (DC 160V)	UL (c-UL) 100% 200%	4 hour min. 1 second max.	650	0.024	
CCF1N0.5	500mA						510	0.030	
CCF1N0.63	630mA						390	0.052	
CCF1N0.8	800mA						250	0.125	
CCF1N1	1A	PSE AC 100V			PSE AC 100V 100A	PSE 130% 160% 200%	4 hour min. 1 hour max. 1 second max.	90.4	0.156
CCF1N1.25	1.25A							75.9	0.220
CCF1N1.6	1.6A							59.3	0.513
CCF1N2	2A							42.9	0.814
CCF1N2.5	2.5A							36.6	1.31
CCF1N3.15	3.15A							26	2.37
CCF1N4	4A							20.1	3.85
CCF1N5	5A							15.3	6.5
CCF1N6.3	6.3A	(DC 160V)		(DC 160V)			4 hour min. 1 second max.	11.4	10.6
CCF1N7	7A							10.6	12.8
CCF1N8	8A							9.5	17.0
CCF1N10	10A							7.5	27.7
CCF1N12	12A	UL (c-UL) AC 65V DC 65V		UL (c-UL) AC 65V 50A DC 65V 50A	UL (c-UL) 100% 200%	4 hour min. 60 seconds max.	4.5	73.5	
CCF1N15	15A	DC 65V		DC 65V 100A	100% 200%	4 hour min. 60 seconds max.	3.5	125.5	
CCF1N30	30A						1.7	527.5	

Operating Temp. Range: -55°C ~ +125°C

Specifications given herein may be changed at any time without prior notice. Please confirm technical specifications before you order and/or use.

11/01/23

environmental applications

Deratings

- Stationary current
Regard the peak of stationary current waveform as stationary current value when the stationary current is repeated pulse.
- Normal derating
Normal derating of this product should be 0.7max. as standards.
- Deratings by ambient temperatures
When using the products at the temperatures other than normal temperature (25°C ±5°C), temperature adjustment will be required. Please refer to the derating coefficient as shown in the figure.

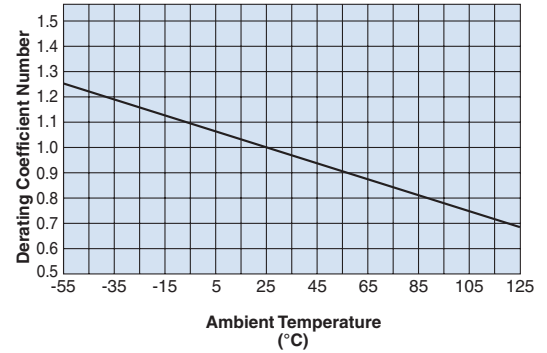

Fusing Characteristics

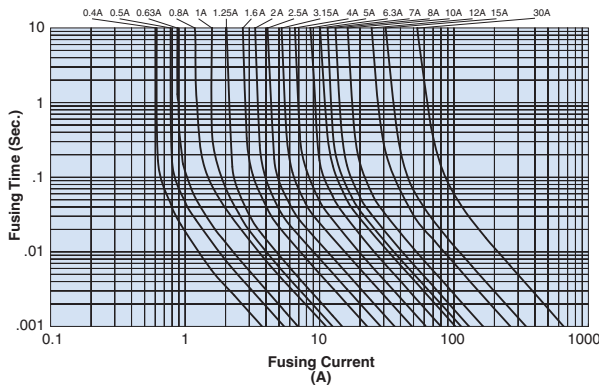

Performance Characteristics

Parameter	Requirement Δ R±%		Test Method
	Limit	Typical	
Fusing Characteristics	Within specified time. No restrike	—	Fusing time measured under rated current x 160% and 200%
Surface Temperature Rise	Max. Temp. Rise 140°C	—	Surface temperature should be measured by rated current x 115%
	Max. Temp. Rise 75°C	—	Surface temperature should be measured by rated current x 100%
Bending Test	No mechanical damages	—	Distance between holding points 90mm, bent by 3mm at rate of 1mm/s
Resistance to Soldering Heat	±10%	±3%	260°C ±5°C, 10 seconds ± 0.5 seconds
Solderability	±95% coverage min.	—	235°C ±5°C, 3 seconds ± 0.5 seconds
Load Life	±10%	±5%	70°C ± 2°C, 1000 hours, rated current x 70%, 1.5 hr ON, 0.5 hr OFF cycle
Load Life Moisture	±10%	±5%	40°C ± 2°C, 90 - 95% RH, 1000 hours, rated current x 70%, 1.5 hr ON, 0.5 hr OFF cycle
Rapid Change of Temperature	±10%	±5%	-55°C (30 minutes), +125°C (30 minutes), 100 cycles



features

- Meets IEC60127-4 specifications (7A or less)
- Stable fusing characteristics due to original technology
- Suitable for reflow and flow soldering
- Products meet EU RoHS requirements
- Excellent anti-sulfuration characteristics due to using high sulfuration-proof material

dimensions and construction

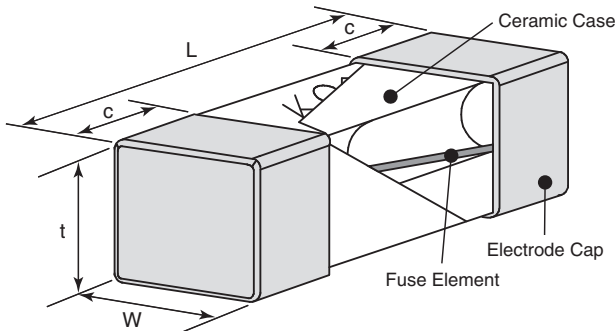

Type	Dimensions inches (mm)			
	L	W	t	c
CCF1F (2410)	.236±.008 (6.0±0.2)	.098±.008 (2.5±0.2)	.098±.008 (2.5±0.2)	.055±.008 (1.4±0.2)

ordering information

CCF	1	F	1	T	TE
Type	Style	Fusing Characteristic F: Fast-acting	Rated Current	Termination Surface Material T: Sn	Packaging TE: 4mm pitch plastic embossed BK: Bulk

applications and ratings

Part Designation	Current Rating	Voltage Rating	Interrupting Capacity	Fusing Characteristics		Internal R. (mΩ) Max.	Normal Melting Pt (A ² , sec.)	Operating Temperature Range
				Rated Current	Fusing Time			
CCF1F0.4	0.4A	UL(c-UL) AC 125V DC 125V	UL(c-UL) AC125V 50A DC125V 50A	UL(c-UL) 100% 200%	4 hour min. 60 sec. max.	650	0.024	-55°C to +125°C
CCF1F0.5	0.5A					510	0.030	
CCF1F0.63	0.63A					390	0.052	
CCF1F0.8	0.8A					250	0.125	
CCF1F1	1A					90.4	0.156	
CCF1F1.25	1.25A					75.9	0.220	
CCF1F1.6	1.6A					59.3	0.513	
CCF1F2	2A					42.9	0.814	
CCF1F2.5	2.5A					36.6	1.31	

For further information on packaging, please refer to Appendix A.

applications and ratings (continued)

Part Designation	Current Rating	Voltage Rating	Interrupting Capacity	Fusing Characteristics		Internal R. (mΩ) Max.	Normal Melting Pt (A ² , sec.)	Operating Temperature Range
				Rated Current	Fusing Time			
CCF1F3.15	3.15A	UL(c-UL) AC 125V DC 125V	UL(c-UL) AC125V 50A DC125V 50A	UL(c-UL) 100% 200%	4 hour min. 60 sec. max.	26.0	2.37	-55°C to +125°C
CCF1F4	4A					20.1	3.85	
CCF1F5	5A					15.3	6.5	
CCF1F6.3	6.3A					11.4	10.6	
CCF1F7	7A					10.6	12.8	
CCF1F8	8A					9.5	17.0	
CCF1F10	10A					7.5	27.7	
CCF1F12	12A	UL(c-UL) AC 65V DC 65V	UL(c-UL) AC65V 50A DC65V 50A	4.5	73.5			
CCF1F15	15A			3.5	125.5			

environmental applications

Derating Curve

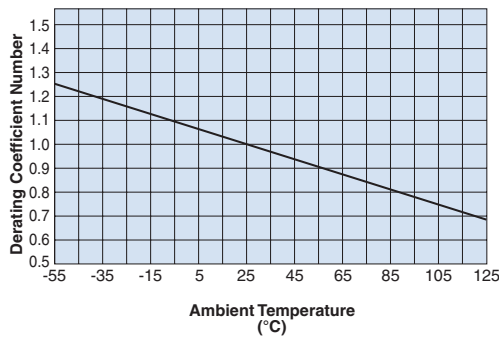

Fusing Characteristics

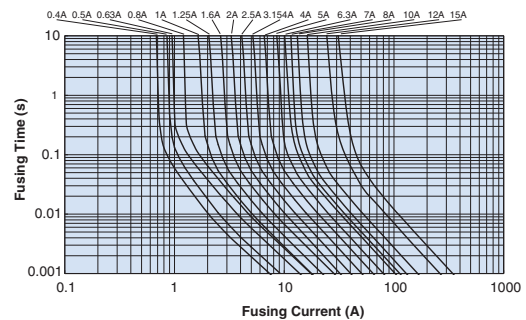

Stationary Current: Regard the peak of stationary current waveform as stationary current value when the stationary current is repeated pulse. Normal derating of this product should be 0.7max. as standards.

Deratings by ambient temperatures. When using the products at the temperatures other than normal temperature (25°C ± 5°), temperature adjustment will be required. Please refer the derating coefficient as shown in the figure.

Performance Characteristics

Parameter	Requirements		Test Method
	Limit	Typical	
Fusing Characteristics	Within specified time. Insulation resistance shall not be less than 0.1MΩ	—	Fusing time measured under rated current x 200%) (at 25°C)
Surface Temperature Rise	Maximum temperature rise 75°C and not fusing (all the rating)	—	Surface temperature should be measured by 1.00/n
Bending Test	No mechanical damage	—	Distance between holding points 90mm, bent by 3mm at rate of 1mm/second
Resistance to Soldering Heat	ΔR±10%	±3%	260°C ± 5°C, 10 seconds ± 0.5 seconds
Solderability	95% coverage minimum	—	235°C ± 5°C, 3 seconds ± 0.5 seconds
Load Life	ΔR±10%	±5%	70°C ± 2°C, 1000 hours, rated current x 70%, 1.5 hr ON, 0.5 hr OFF cycle
Load Life Moisture	ΔR±10%	±5%	40°C ± 2°C, 90 - 95% RH, 1000 hours, rated current x 70%, 1.5 hr ON, 0.5 hr OFF cycle
Rapid Change of Temperature	ΔR±10%	±5%	-55°C (30 minutes), +125°C (30 minutes), 100 cycles
Sulfuration Test	ΔR±10%	—	Soaked in industrial oil with 3.5% sulfur concentration, 105°C±3°C, 500 hours

Precautions for the Varistors

The reliability of the metal oxide varistors are dependant on the ways of their use and could lead to accidents so please be aware.

Selection and Protection

- It is recommended that the steady-state circuit voltage which remains at 80% or less of the max. allowable circuit voltage. Exceeding the specification will cause deterioration, short-circuits, etc.
- Select proper parts according to the surge energy and the number of the impressions if the varistors are used to absorb the surge for an inductive loading.
- The rated surge endurance is defined in terms of shock wave current waveform (starting up 8 μ s/wave-tail length 20 μ s).
- Insert fuses or thermal fuses in series with varistors if the size of the surge power cannot be estimated, in order to prevent varistors from bursting due to an excessive surge over the rating.
- Give consideration on the layout to combustible materials and to take measurements on the circuits (fuses or thermal fuses) since there may be smoking or flaming if the varistor short-circuits due to an excessive surge over the rating.
- Upon mold sealing, fully confirm the reliability and use the resin which has small contractile stress at stiffening since the protection coat may peel off, cracks may occur at the solder connection, and the characteristics of the varistor may change.
- Perform the withstand voltage test and the insulation resistance test with the varistors removed from the circuit since the test voltage may exceed the varistor voltage.

Failure Mode

- Varistor voltage will drop and the leakage current will increase when excessive surge which is above the rating is applied to the varistor. Temperature will increase due to Joule heating as the leakage current increases, which will cause thermal runaway and short circuit.

Reference

- For basic precautions, please refer to the technical report of EMAJ-R039 Safety application guide for varistors.

Terms and Definitions

Maximum Allowable Circuit Voltage

- The maximum commercial frequency sinusoidal voltage effective value or maximum D.C. voltage or A.C. voltage (rms) that can be continuously applied.

Maximum Energy (E)

- The maximum energy within the varistor voltage change rate of $\pm 10\%$ when a single impulse of 2ms is applied.

Maximum Peak Current (Ip)

- The maximum peak current within the varistor voltage change rate of $\pm 10\%$, when a single standard impulse of 8/20 μ s is applied.

Operating Temperature (T_{opt})

- The allowable ambient temperature range while the device is operating.

Storage Temperature (T_{stg})

- The temperature range in which the elements do not deteriorate.

Varistor Voltage (Vc)

- The terminal voltages on both ends of the varistor when the specified current is applied.

Clamping Voltage (Vp)

- The peak value of the voltage between two terminals of the varistor when the specified standard waveform impulse current (8/20 μ s) is applied.

Recommended value of varistor voltage for the power supply voltage

Voltage of Power Line	Varistor Voltage
3.3V d.c.	8.2V
5V d.c.	8.2V, 12V
12V d.c.	24V, 27V
24V d.c.	47V, 56V
48V d.c.	82V, 100V

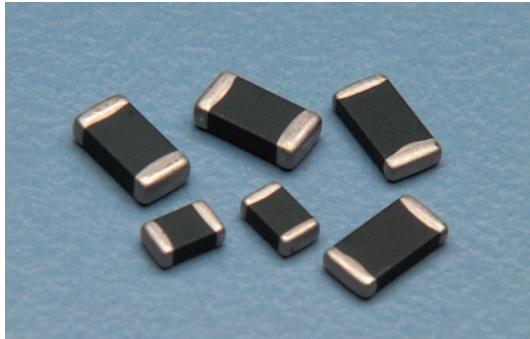

features

- Varistors own two-way symmetries and can absorb positive and negative surges
- SMD type metal oxide varistors (0201 and 0402 inch size)
- Multilayer construction allows its small size to absorb a large surge
- Small space and high density mounting available due to the small package
- Suitable for both flow and reflow solderings
- Products with lead free termination meet EU RoHS requirements

dimensions and construction

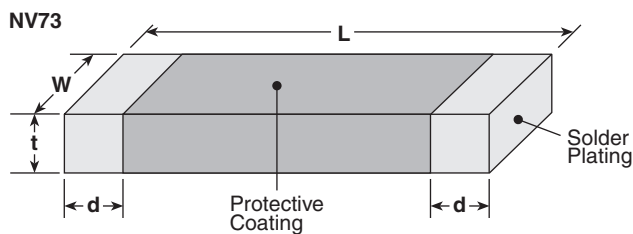
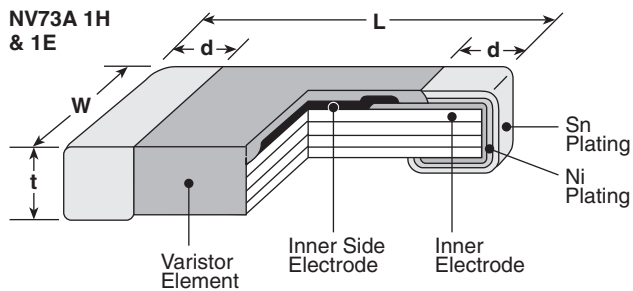

Type (Inch Size Code)	Dimensions inches (mm)			
	L	W	t	d
1H (0201)	.024±.001 (0.6±0.03)	.012±.001 (0.3±0.03)	.012±.001 (0.3±0.03)	.004 min. (0.1 min.)
1E (0402)	.023±.004 (1.0±0.1)	.02±.004 (0.5±0.1)	.023 max. (0.6 max.)	.01±.006 (0.25±0.15)
1J (0603)	.063±.006 (1.6±0.15)	.031±.006 (0.8±0.15)	.031±.006 (0.8±0.15)	.016 ^{+0.006} _{-.008} (0.4 ^{+0.15} _{-0.2})
2A (0805)	.079±.008 (2.0±0.2)	.049±.008 (1.25±0.2)	.051 max. (1.3 max.)	.02±.010 (0.5±0.25)
2B (1206)	.126±.008 (3.2±0.2)	.063±.008 (1.6±0.2)	.065 max. (1.65 max.)	.02 ^{+0.014} _{-.010} (0.5 ^{+0.35} _{-0.25})

ordering information

NV73	A		1J	T	TE	12
Type	Energy Code	Capacitance Type	Size	Termination Material	Packaging	Varistor Voltage
	A B C	Blank: Standard L: Low Capacitance (1E only)	1H: 0201 1E: 0402 1J: 0603 2A: 0805 2B: 1206	T: Sn	TBM: 2mm press paper (1H: 15,000 pieces/reel) TP: 2mm pitch paper (1E: 10,000 pieces/reel) TE: 7" embossed plastic (1J, 2A, 2B: 2,500 pieces/reel)	8: 8V 12: 12V 120: 120V

The terminal surface material lead free is standard.
Contact us when you have control request for environmental hazardous material other than the substance specified by EU-RoHS.
For further information on packaging, please refer to Appendix A.

applications and ratings

Part Designation	Varistor Voltage V _{1mA} (V)	Varistor Voltage Tolerance (V)	Maximum Allowable Voltage d.c. (V)	Clamping Voltage I _c =1A (V) 8/20μs	Maximum Energy (J) 10/1000μs	Maximum Peak Current (A) 2 times 8/20μs	Capacitance (Typ) 1kHz (pF)	Operating Temp. (°C)	Storage Temp. (°C)
NV73A1HTTB12	12	10 - 15.6	6.5	35	0.01	1	33	-40°C to +85°C	-40°C to +125°C
NV73A1ETTP8	8	6.4 - 9.6	5.5	20	0.05	20	480		
NV73A1ETTP18	18	16.2 - 19.8	14.0	35			160		
NV73AL1ETTP12	12	10 - 14	5.5	30	0.03	5	50		
NV73AL1ETTP21	21	18 - 24	14.0	50			50		
NV73AL1ETTP28	28	24 - 32	18.0	65	0.005	2	15		
NV73AL1ETTP120	120	90 - 150		350 (1C=0.5A)			0.5		

Part Designation	Varistor Voltage V _c	Maximum Allowable Voltage		Clamping Voltage		Maximum Energy E (J)	Maximum Peak Current I _P (A) (2 times)	Operating Temp. T _{opt} (°C)	Storage Temp. T _{stg} (°C)
	I _c = 1mA (V)	a.c rms (V)	d.c (V)	V _{1A}	V _{2A}				
NV73A1JTTE8.2	6.8 - 9.8	4.2	6.0	—	21	0.1	30	-40°C to +85°C	-40°C to +125°C
NV73A1JTTE12	10 - 14.4	6.1	8.6	—	29				
NV73A1JTTE15	12.5 - 18	7.6	10.8	—	35				
NV73A1JTTE18	16 - 20	9.1	12.8	—	37				
NV73A1JTTE20	18 - 22	10.6	15.0	—	40				
NV73A1JTTE22	19 - 24	12.0	16.5	—	42				
NV73A1JTTE24	21.8 - 26.5	14.0	18.0	—	46				
NV73A1JTTE27	25 - 32	17.0	22.0	—	49				
NV73A2ATTE8.2	6.8 - 9.8	4.2	6.0	18	—	0.01	10		
NV73A2ATTE12	10 - 14.4	6.1	8.6	24	—	0.03	20		
NV73A2ATTE15	12.5 - 18	7.6	10.8	29	—	0.04			
NV73A2ATTE18	16 - 20	9.1	12.8	29	—				
NV73A2ATTE20	18 - 22	10.6	15.0	33	—	0.05			
NV73A2ATTE22	19 - 24	12.0	16.5	39	—				
NV73A2ATTE24	21.8 - 26.5	14.0	18.0	42	—	0.06			
NV73A2ATTE27	25 - 32	17.0	22.0	50	—	0.07			
NV73A2ATTE33	30 - 39	20.0	26.0	60	—	0.12	25		
NV73A2ATTE39	37 - 47	25.0	31.0	72	—	0.14			
NV73A2ATTE47	45 - 54	30.0	38.0	86	—	0.16			
NV73B2ATTE8.2	6.8 - 9.8	4.2	6.0	—	18	0.03	20		
NV73B2ATTE12	10 - 14.4	6.1	8.6	—	24	0.05	35		
NV73B2ATTE15	12.5 - 18	7.6	10.8	—	30	0.07			
NV73B2ATTE18	16 - 20	9.1	12.8	—	32	0.08			
NV73B2ATTE20	18 - 22	10.6	15.0	—	36	0.09			
NV73B2ATTE22	19 - 24	12.0	16.5	—	40	0.11			
NV73B2ATTE24	21.8 - 26.5	14.0	18.0	—	42	0.12			
NV73B2ATTE27	25 - 32	17.0	22.0	—	58	0.24			
NV73B2ATTE33	30 - 39	20.0	26.0	—	66	0.25	50		
NV73C2ATTE8.2	6.8 - 9.8	4.2	6.0	—	18	0.04	25		
NV73C2ATTE12	10 - 14.4	6.1	8.6	—	24	0.09	50		
NV73C2ATTE15	12.5 - 18	7.6	10.8	—	29	0.11			
NV73C2ATTE18	16 - 20	9.1	12.8	—	32	0.13			
NV73C2ATTE20	18 - 22	10.6	15.0	—	35	0.14			
NV73C2ATTE22	19 - 24	12.0	16.5	—	40	0.17			
NV73C2ATTE24	21.8 - 26.5	14.0	18.0	—	42	0.18			
NV73A2BTTE27	25 - 32	17.0	22.0	—	55	0.13		40	
NV73A2BTTE33	30 - 39	20.0	26.0	—	60	0.15			
NV73A2BTTE39	37 - 47	25.0	31.0	—	72	0.18			
NV73A2BTTE47	45 - 54	30.0	38.0	—	85	0.22			
NV73A2BTTE56	52 - 62	35.0	45.0	—	100	0.26			

Specifications given herein may be changed at any time without prior notice. Please confirm technical specifications before you order and/or use.

11/24/14

applications and ratings (continued)

Part Designation	Varistor Voltage Vc	Maximum Allowable Voltage		Clamping Voltage		Maximum Energy E (J)	Maximum Peak Current I _P (A) (2 times)	Operating Temp. T _{opt} (°C)	Storage Temp. T _{stg} (°C)		
	I _c = 1mA (V)	a.c rms (V)	d.c (V)	V _{1A}	V _{2A}						
NV73B2BTTE8.2	6.8 - 9.8	4.2	6.0	—	18	0.03	50	-40°C to +85°C	-40°C to +125°C		
NV73B2BTTE12	10 - 14.4	6.1	8.6	—	24	0.07					
NV73B2BTTE15	12.5 - 18	7.6	10.8	—	29	0.09					
NV73B2BTTE18	16 - 20	9.1	12.8	—	32	0.1					
NV73B2BTTE20	18 - 22	10.6	15.0	—	35	0.11					
NV73B2BTTE22	19 - 24	12.0	16.5	—	40	0.12					
NV73B2BTTE24	21.8 - 26.5	14.0	18.0	—	42	0.14					
NV73B2BTTE27	25 - 32	17.0	22.0	—	52	0.16					
NV73C2BTTE8.2	6.8 - 9.8	4.2	6.0	—	18	0.06	40				
NV73C2BTTE12	10 - 14.4	6.1	8.6	—	24	0.1	70				
NV73C2BTTE15	12.5 - 18	7.6	10.8	—	29	0.13					
NV73C2BTTE18	16 - 20	9.1	12.8	—	29	0.15					
NV73C2BTTE20	18 - 22	10.6	15.0	—	31	0.17					
NV73C2BTTE22	19 - 24	12.0	16.5	—	35	0.19					
NV73C2BTTE24	21.8 - 26.5	14.0	18.0	—	38	0.2					
NV73C2BTTE27	25 - 32	17.0	22.0	—	48	0.24					

environmental applications

Performance Characteristics

Parameter	Requirement Δ V±%	Test Method
Varistor Voltage	Within specified tolerance	Voltage between terminals when 1mA is flowed
Solderability	95% coverage minimum	230°C ± 5°C, 4 seconds ± 1 second
Resistance to Solder Heat	±10%	260°C ± 5°C, 10 seconds ± 0.5 second*; 270°C ± 5°C, 3 seconds ± 0.5 second**
Rapid Change of Temperature	±10%	-40°C (30 minutes), +125°C (30 minutes), 30 cycles**; 5 cycles*
Maximum Peak Current	±10%	A single standard impulse of 8/20μ seconds, positive/negative applied once each
Maximum Energy	±10%	A single standard impulse of 10/1000μs, once*; A single standard impulse of 2ms, once**
High Temperature Life with d.c. Bias	±10%	85°C ± 5°C, 1000h, Load: Maximum allowable circuit voltage (d.c.)
High Temperature Life with a.c. Bias**	±10%	85°C ± 5°C, 1000h, Load: Maximum allowable circuit voltage (V _{a.c.r.m.s.})**
High Temperature & High Humidity Life with d.c. Bias	±10%	40°C ± 5°C, 95% RH, 500h, Load: Maximum allowable voltage (d.c.)
Capacitance*	Typical	1kHz: Others, 1MHz: Varistor voltage 120V
High Temperature Storage Life	±10%	125°C ± 5°C, 1000h
Low Temperature Storage Life	±10%	-40°C ± 5°C, 1000h

* 1H, 1E ** 1J, 2A, 2B

For Voltage Current Curves Graphs see Environmental Applications. Additional environmental applications can also be found at www.koaspeer.com

environmental applications (continued)

Voltage-Current Curves (Ta = 25°C)

NV73A 1E

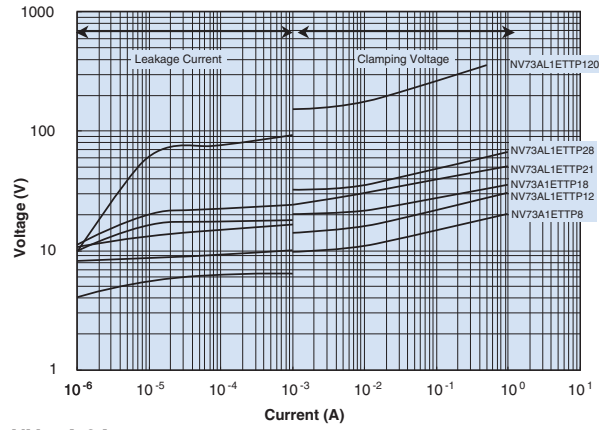

NV73A 1J

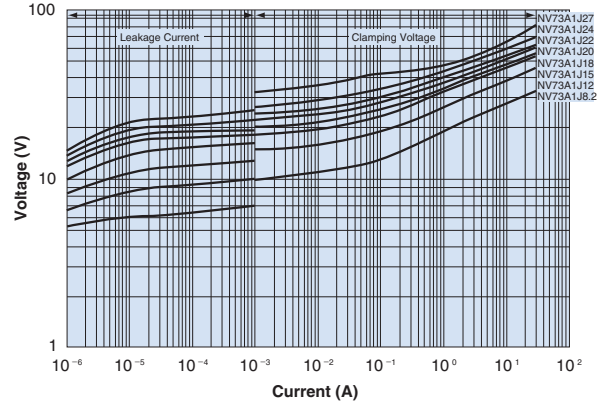

NV73A 2A

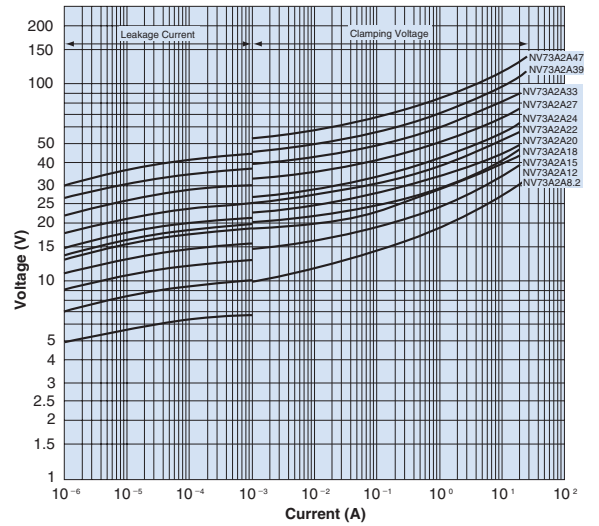

NV73B 2A

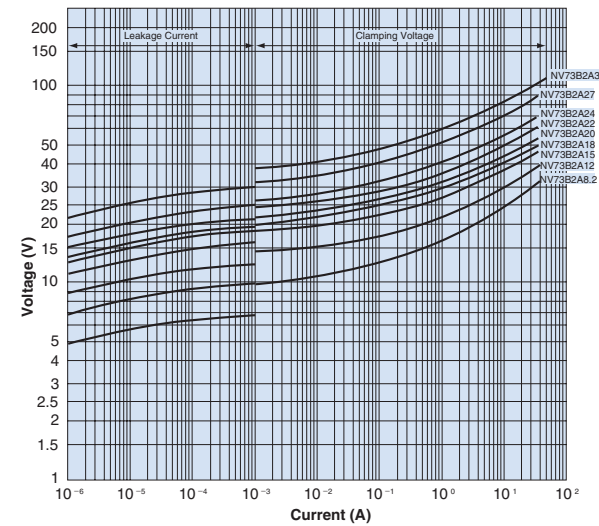

NV73C 2A

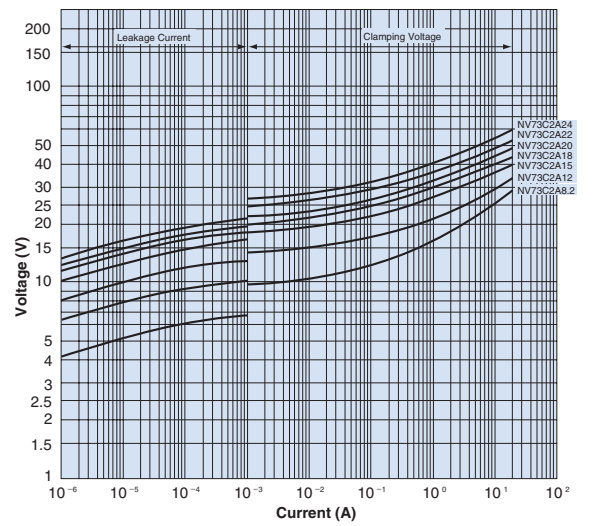

NV73A 2B

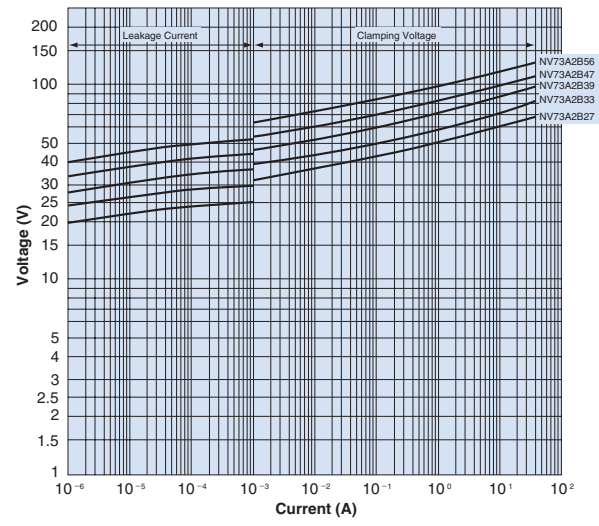

Specifications given herein may be changed at any time without prior notice. Please confirm technical specifications before you order and/or use. 12/08/16

circuit protection

environmental applications (continued)

Voltage-Current Curves (Ta = 25°C)

NV73B 2B

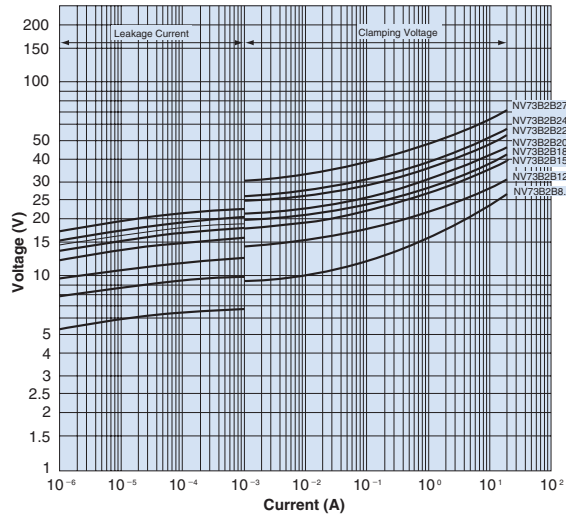

NV73C 2B

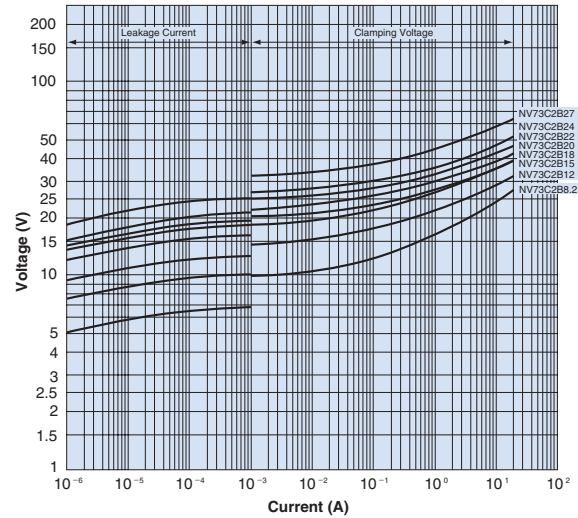

circuits
protection

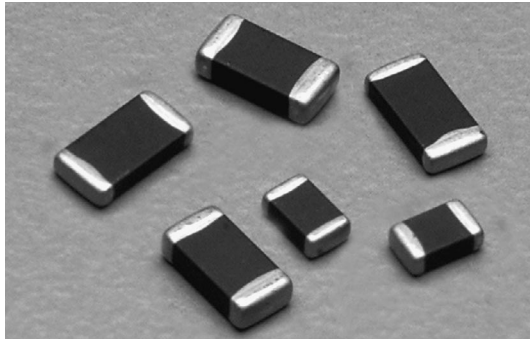

features

- SMD type metal oxide varistors
- Ideal for countermeasures against ESD (Conforming to IEC61000-4-2)
- Symmetrical non-linearity V-I characteristics absorb positive and negative surge
- High maximum energy type
- Low leakage current
- High resistance to cyclic temperature stress
- Suitable for both flow and reflow soldering
- Products meet EU RoHS requirements
- AEC-Q200 Tested

dimensions and construction

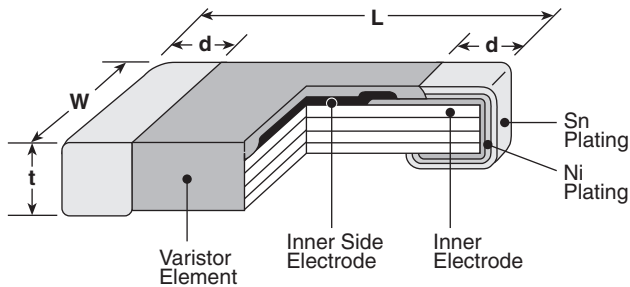

Type (Inch Size Code)	Dimensions inches (mm)			
	L	W	t	d
1J (0603)	.063±.006 (1.6±0.15)	.031±.006 (0.8±0.15)	.039 max. (1.0 max.)	.016±.006 (0.4±0.15)
2A (0805)	.079±.010 (2.0±0.25)	.049±.008 (1.25±0.2)	.051 max. (1.30 max.)	.020±.010 (0.5±0.25)
2B (1206)	.126±.012 (3.2±0.3)	.063±.012 (1.6±0.3)	.057 max. (1.45 max.)	.022±.012 (0.55±0.3)

ordering information

NV73	DL	2A	T	TE	27
Type	Energy Code	Size	Termination Material	Packaging	Varistor Voltage
		1J: 0603 2A: 0805 2B: 1206	T: Sn	TE: 7" embossed plastic	

applications and ratings

Part Designation	Varistor Voltage (V)	Maximum Allowable Voltage		Maximum Clamping Voltage (V)		Maximum Energy (J)	Maximum Peak Current 8/20µs (A) 1 time	Short-Time Applied Voltage (5 min) (VDC)	Capacitance (Typ) 1kHz (pF)
	V _{1mA}	A.C. (V _{r.m.s.})	D.C. (V)	V _{1A}	V _{2A}				
NV73DL1JTTE12	10~14.4	6.1	8.6	24	—	0.1	80	10	630
NV73DL1JTTE22	22~27	14	16	42	—	0.2	100	24.5	390
NV73DL1JTTE27	24~32	17	22	50	—	0.2	100	24.5	320
NV73DL1JTTE33	33~39	20	26	60	—	0.3	100	24.5	200
NV73DL1JTTE47	40~54	30	34	81	—	0.3	100	42	130
NV73DL2ATTE12	10~14.4	6.1	8.6	24	—	0.1	120	10	1070
NV73DL2ATTE22	22~27	14	16	42	—	0.3	160	24.5	610
NV73DL2ATTE27	24~32	17	22	50	—	0.3	160	24.5	580
NV73DL2ATTE33	33~39	20	26	60	—	0.3	160	24.5	380
NV73DL2ATTE47	40~54	30	34	81	—	0.3	160	42	260
NV73DL2ATTE68	62~72	45	56	108	—	0.3	160	64	190
NV73DL2ATTE82	74~90	50	65	135	—	0.3	160	75	105

For further information on packaging, please refer to Appendix A.

Specifications given herein may be changed at any time without prior notice. Please confirm technical specifications before you order and/or use.

11/27/23

applications and ratings (continued)

Part Designation	Varistor Voltage (V) V_{1mA}	Maximum Allowable Voltage		Maximum Clamping Voltage (V)		Maximum Energy (J)	Maximum Peak Current 8/20 μ s (A) 1 time	Short-Time Applied Voltage (5 min) (V _{DC})	Capacitance (Typ) 1kHz (pF)
		A.C. (V _{r.m.s.})	D.C. (V)	V _{1A}	V _{2A}				
NV73DL2BTTE22	22~27	14	16	—	42	1	300	24.5	1600
NV73DL2BTTE27	24~32	17	22	—	50	1	300	24.5	1360
NV73DL2BTTE33	33~39	20	26	—	60	1	300	24.5	870
NV73DL2BTTE68	62~72	45	56	—	108	1.5	300	64	380
NV73DL2BTTE82	74~90	50	65	—	135	1.5	300	75	250

Operating temperature range: -40°C to +125°C
Storage temperature range: -40°C to +150°C

environmental applications

Voltage Current Curves (Ta = +25°C)

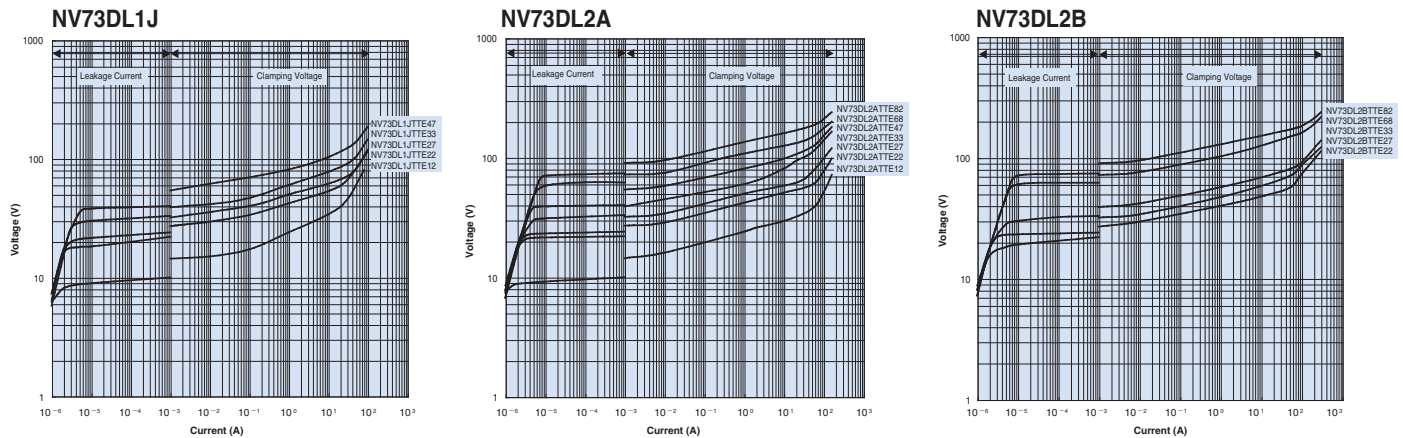

Performance Characteristics

Parameter	Requirement $\Delta V_{1mA} \pm \%$	Test Method
Varistor Voltage	Within specified tolerance	Voltage between terminals when 1mA and 10mA are flowed
Solderability	95% coverage minimum	230°C \pm 5°C, 5 seconds \pm 0.5 second
Resistance to Solder Heat	$\pm 10\%$	260°C \pm 5°C, 10 seconds \pm 0.5 second
Rapid Change of Temperature	$\pm 10\%$	-40°C (30 minutes)/ +125°C (30 minutes), 1000 cycles
Short-Time Applied Voltage	$\pm 10\%$	Maximum value of D.C. voltage that can be applied for a short period of time (5 min.)
Maximum Peak Current	$\pm 10\%$	A single standard impulse current of 8/20 μ seconds is applied
Maximum Energy	$\pm 10\%$	A single standard impulse of 2m second, once
Electrostatic Discharge	$\pm 10\%$	25kV (Non contact) (NV73DL1J12, NV73DL2A12: 15kV (Non contact))
Vibration Resistance	No visible damage. No remarkable mechanical damage	Vibration frequency: 10Hz~2000Hz; Full amplitude: 1.5mm, 10Hz~2000Hz~10Hz 20 min. XYZ direction 4 hrs for each total 12 hrs
High Temperature Life with d.c. Bias	$\pm 10\%$	125°C \pm 2°C, 1000h, Applied voltage: Varistor voltage (V_{1mA}) x 0.85
High Temperature & High Humidity Life with Bias	$\pm 10\%$	85°C \pm 2°C, 85% RH, 1000h, Applied voltage: Varistor voltage (V_{1mA}) x 0.85
Thermal Shock	$\pm 10\%$	-55°C (15 min.)/ +125°C (15 min.) 300 cycles
Shock	$\pm 10\%$	Half sine wave, Applied time: 1m second, Applied cycle: 500m/s ² , 5 cycles
High Temperature Storage	$\pm 10\%$	150°C, 1000h
Low Temperature Storage	$\pm 10\%$	-40°C, 1000h

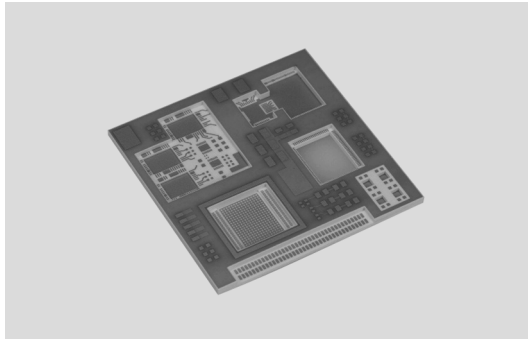

construction

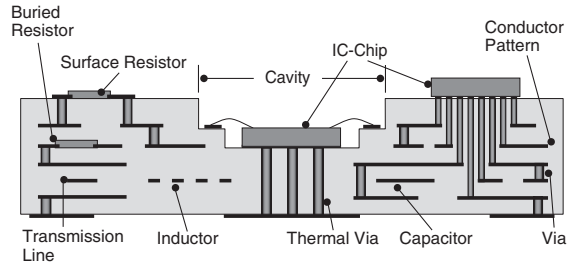

ordering information

New Part #	KLC	AB1
	Type	KOA Ref. Number

features

- Suitable for bare chip mounting as it has thermal expansion coefficient close to that of silicon and excellent dimensional accuracy and flatness.
- Excellent high frequency characteristics are achieved by the low-loss dielectric ceramic and the low-loss conductor.
- Downsizing and high integration density can be achieved by the multilayer wiring, the multi-cavity structure and the surface/buried resistor printing.
- The substrate and the cavity can be formed in round, polygonal, concave or convex shape.
- Thermal vias can be placed in the bare chip mounting area to improve the thermal conductivity of the substrate.
- The use of ceramic material contribute to the excellent heat and humidity resistance and prevents outgas and dust generation.
- Products meet EU RoHS requirements

what is LTCC ?

LTCC stands for Low Temperature Co-fired Ceramics.

LTCCs are multilayer ceramic substrates that can be fired simultaneously with low-resistance conductors since the glass-based material is added to the alumina material to lower the firing temperature compared to the general ceramic firing process.

On KOA's LTCC, silver (Ag) based paste that has low conductor resistance is co-fired to create the conductor patterns on each layer of the ceramic substrate.

It realizes the multilayer substrate with excellent low-loss electrical characteristics as well as high dimensional accuracy.

KOA's LTCC also provides downsizing by integrating resistors and transmission lines in the inner and surface layers of the substrate. In addition, the thermal expansion coefficient close to silicon enhances the reliability of the bare chip mounting, and the cavity structure contributes to the lower profile package.

high-precision specification

Substrates with higher precision based on the LTCC multilayer substrate are available.

- High-precision pad positioning and excellent flatness.
- High-density wiring structure by utilizing LTCC multilayer substrate.

Please contact us for details.

environmental applications

Characteristics of Substrate Material

Parameter	Characteristics
Bending Strength (MPa)	250
Thermal Expansion Coefficient ($\times 10^{-6}/K$)	5.5
Thermal Conductivity ($W/m \cdot K$)	3
Insulation Resistance ($\Omega \cdot cm$)	$>10^{13}$
Dielectric Constant at 1GHz	6.6
Dielectric Loss at 1GHz	0.004
Density (g/cm^3)	2.8
Surface Roughness Ra (μm)	<0.4
Withstanding Voltage (kV/mm)	>15
Substrate Thickness (mm)	0.4~2.0 Standard
Layer Thickness ($\mu m/$ Layer)	80, 100, 125 Standard

Standard Design Rules

Symbol	Parameter	Design Value
A	Line Width	0.06mm Min.
B	Line to Line Spacing	0.06mm Min.
C	Via Diameter	0.1mm, 0.15mm, 0.2mm
D	Via Pad Diameter	Via diameter +0.05mm Min.
E	Via to Via Spacing	0.2mm Min.
F	Via pad to Line Spacing	0.125mm Min.
G	Part Edge to Conductor Spacing	0.2mm Min.
H	Part Edge to Via Spacing	0.3mm Min.
J1, J2	Cavity Width	0.6mm Min.
K1, K2	Cavity Depth	0.1mm Min.
L	Wall Width of Cavity	0.5mm Min.
M	Shelf Width in the Cavity	0.5mm Min.

Conductor

Parameter	Characteristics
Material of Conductor	Ag
Resistivity of Conductor ($\mu\Omega \cdot cm$)	2.5
Surface Plating	Ni-Au, Ni-Pd-Au

Surface/Buried Printed Resistor

Parameter	Surface Resistor	Buried Resistor
Resistance Range (Ω)	10 ~ 100k	10 ~ 200k
Resistance Tolerance (%)	± 5	$\pm 20 \sim 50$

Surface layer - Inner layer

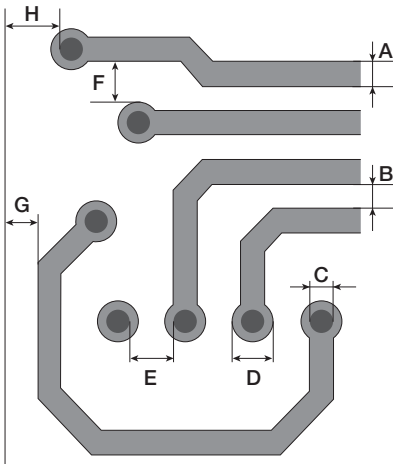

Cavity

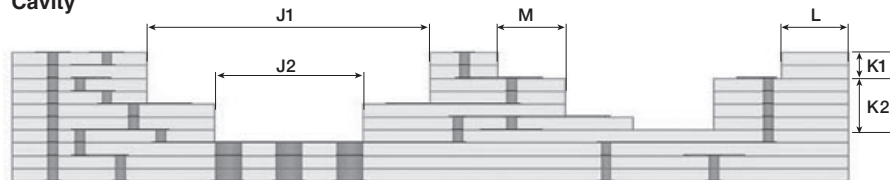

* Please contact us for the use out of the standard design rules, and detailed design rules.

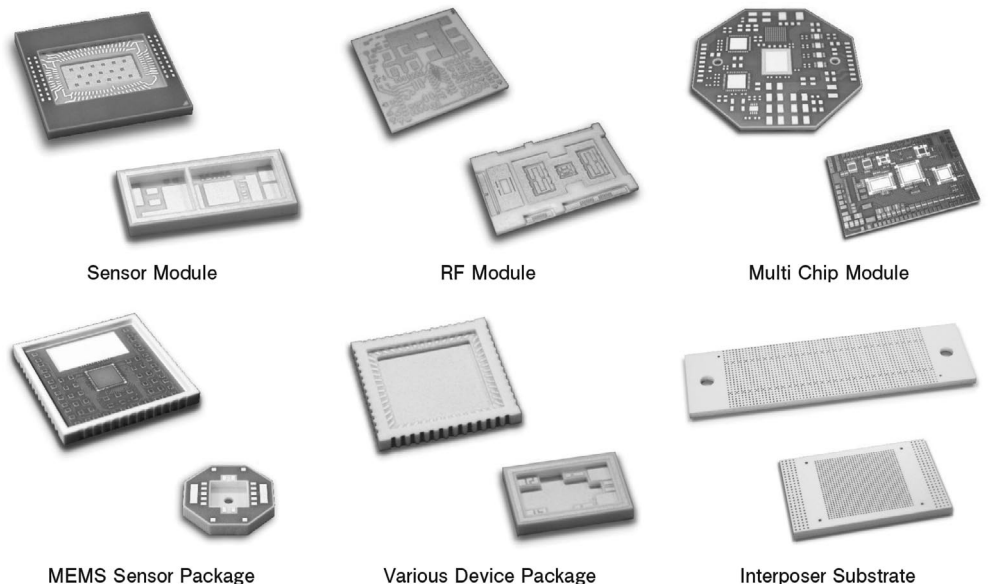

Specifications given herein may be changed at any time without prior notice. Please confirm technical specifications before you order and/or use.

11/01/23

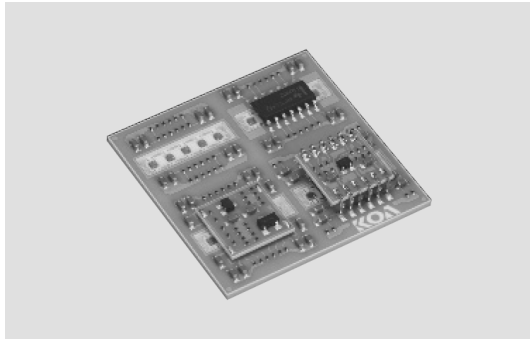

features

- Plural semiconductors in one package offers downsized system with high performance and standardization
- Wiring space saving by multilayer fine patterns on build-up substrate. No signal delay by shortened wiring distance
- Less mounting problem because of the decreasing number of the terminals

construction

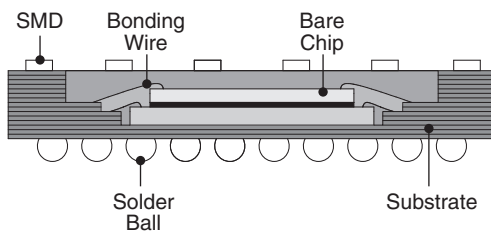

Package Specifications

Item	Content
Terminal Pitch	0.8mm~
Mountable Device	<ul style="list-style-type: none"> • SMD • Bare Chip • Printed Resistor
Package	<ul style="list-style-type: none"> • SON • BGA • LGA
Substrate for Package	• LTCC

Mounting Specifications

Item	Unit	Min.	Std.	Max.	Note
Substrate Dimension	mm	—	—	100 x 100	
Substrate Thickness	mm	0.4	—	2.0	
Bare Chip Pad Pitch	μm	100	—	—	
Bare Chip Pad Dimension	μm	70	—	—	
Bare Chip Thickness	mm	0.1	0.2	—	
Molding Height	mm	0.3	1.0	1.2	Height from chip surface
Wire Length	mm	0.3	—	3.0	
Wire Loop Height	μm	100	200	—	
Wire Diameter	Au	20	25	40	
Plating	Nonelectrical Au Plating				
Substrate	• LTCC				

Molding

Material	Color
Epoxy	Black

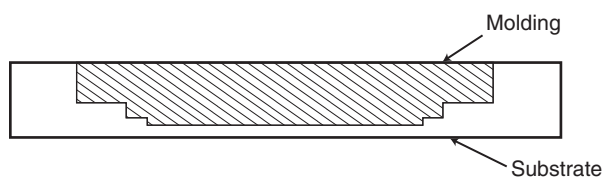

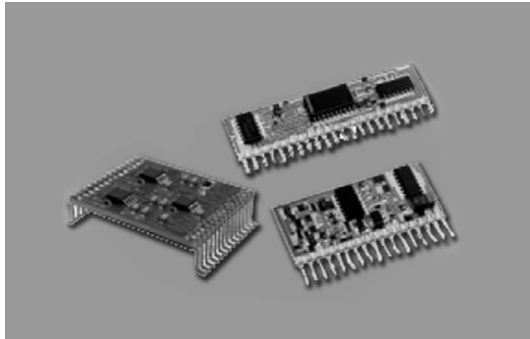

features

- Adjustment processes are decreased by function and ratio trimmings
- Various types of package are available
- High reliability achieved by KOAs original thick film technology

ordering information

KA	7777	D
Product Code	KOA Ref. Number	Terminal Surface Material
KA: Hybrid IC		D: SnAgCu T: Sn Nil: Sn/Pb

Component - KA Series

Substrate Materials	Item	Printing	Mounting	Bonding
	Al ₂ O ₃ Alumina	o	o	o
	Glass epoxy	x	o	o
Conductors, Resistors	Item	Ag-Pd	Ag-Pt	
	Conductor resistance	18mΩ/□/15μm	5mΩ/□/10μm	
	Heat shock	-55°C~+125°C 300 Cycles	-55°C~+125°C 500 Cycles	
	Printed Resistor	5Ω~10MΩ ±100x10 ⁻⁶ /K		
Mounting	Item	Specifications		
	BGA	0.5mm Pitch~		
	QFP	0.4mm Pitch~		
	Chip	0.4mm x 0.2mm		
Package, Outside Terminals	Package	Lead Pitch		
	SIP	1.8mm, 2.0mm, 2.5mm, 2.54mm		
	DIP, SOP	1.27mm, 1.8mm, 2.54mm		
	ZIP	2.54mm		
	BGA, LGA	1.0mm~		
Over Coating, Plating	Over Coating	Color		UL Standard
	Epoxy metamorphic phenol	Black		94 V0 Approved
	Epoxy	Black		94 V1 Approved

o= Available x= Not available

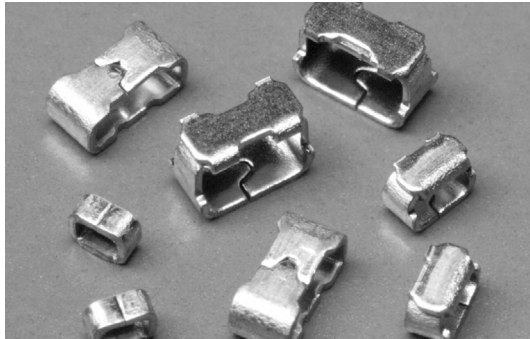

features

- Surface-mountable chip type test terminal
- Automatic machine insertable
- Suitable for reflow and wave soldering
- Available in three standard sizes: 0603, 0805 or 1206
- Products with lead-free terminations meet EU RoHS and China RoHS requirements
- AEC-Q200 Tested (RCU only)

dimensions and construction

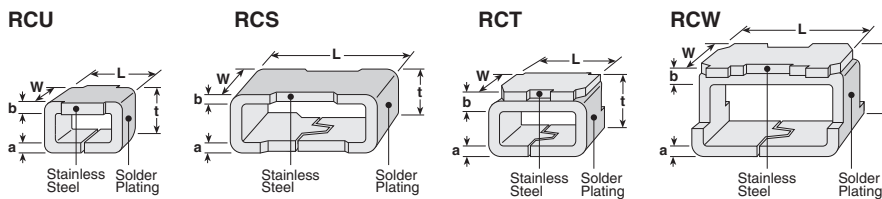

Note: Top surfaces of RCT and RCW are not solderable.

Type (Inch Size Code)	Dimensions inches (mm)				
	L	W	t	a	b
RCU (0603)	.063 (1.6)	.031 (0.8)	.045 (1.15)	.009 (0.23)	.009 (0.23)
RCT (0805)	.079 (2.0)	.049 (1.25)	.057 (1.45)	.009 (0.23)	.018 (0.45)
RCS (1206)	.126 (3.2)	.063 (1.6)	.049 (1.25)	.009 (0.23)	.009 (0.23)
RCW (1206)			.079 (2.0)	.009 (0.23)	.018 (0.45)

ordering information

RCU	C	TE
Type	Termination Material	Packaging
RCU RCT RCS RCW	C: SnCu	TE: 7" embossed plastic (2,000 pieces/reel) TED: 10" embossed plastic (5,000 pieces/reel) RCW not available in TED

For further information on packaging, please refer to Appendix A.

applications and ratings

Part Designation	Rated Current	Standard Resistance	Rated Ambient Temperature	Operating Temperature Range
RCU RCT RCS RCW	2 Amps	50mΩ or less	+70°C	-55°C to +125°C

environmental applications

Performance Characteristics

Parameter	Requirement Real R		Test Method
	Limit	Typical	
Resistance	50mΩ Max. after the test	10mΩ Max. after the test	25°C
Resistance to Solder Heat			260°C ± 5°C, 10 seconds ± 1 second
Rapid Change of Temperature			-55°C (30 minutes), +125°C (30 minutes), 100 cycles
High Temperature Exposure			+125°C, 240 hours

Specifications given herein may be changed at any time without prior notice. Please confirm technical specifications before you order and/or use.

1/06/14

For Product Specific packaging, please refer to the individual product data sheets.

Type		Component Size (mm)			Carrier Tape	Quantity/ Reel (Pieces)	Taping (mm)					Reel Size øa (mm)	
		L	W	T			A	B	W	P1	T1		
RK73B RK73H RK73G RK73Z RS73 HSG73P HV73 SG73 SG73P SG73S SR73 RF73	1F	0.4	0.2	0.13	TX	40,000	0.25±0.04	0.45±0.04	4	1	0.40±0.1	180	
	1H	0.6	0.3	0.23	TBL	20,000	0.25±0.04	0.45±0.04	8	2	0.31±0.1	180	
					TCM	15,000	0.37±0.05	0.67±0.05	8	2	0.42±0.1	180	
	1E	1.0	0.5	0.35	TPL	20,000	0.65±0.10	1.15±0.10	8	2	0.42 + 0.2/-0	180	
					TP	10,000							
	1J	1.6	0.8	0.45	TP	10,000	1.1±0.1	1.9±0.1	8	2	0.6 + 0.2/-0	180	
					TD	5,000	1.1±0.1	1.9±0.1	8	4	0.6 + 0.2/-0	180	
	2A	2.0	1.25	0.5	TP	10,000	1.65±0.20	2.4±0.2	8	2	0.75 + 0.2/-0	180	
					TD	5,000	1.65±0.20	2.4±0.2	8	4	0.75 + 0.2/-0	180	
	2B	3.2	1.6	0.6	TE	4,000	1.6±0.2	2.4±0.2	8	4	0.9±0.1	180	
					TD	5,000	2±0.2	3.5±0.2	8	4	0.75 + 0.2/-0	180	
	2E1	3.2	2.6	0.6	TE	4,000	1.9±0.2	3.5±0.2	8	4	1.0±0.1	180	
TD					5,000	2.85±0.20	3.5±0.2	8	4	0.75 + 0.2/-0	180		
W2H, 2H	5.0	2.5	0.6	TE	4,000	2.9±0.2	5.35±0.20	12	4	1.0±0.15	180		
				TE	4,000	3.44±0.20	6.65±0.20	12	4	1.0±0.15	180		
RN73H RN73R LT73 LT73V	1E	1.0	0.5	0.35	TP	10,000	0.65±0.10	1.15±0.10	8	2	0.42 + 0.2/-0	180	
	1J	1.6	0.8	0.45	TD	5,000	1.1±0.1	1.9±0.1	8	4	0.6 + 0.2/-0	180	
					TD	5,000	1.65±0.20	2.4±0.2	8	4	0.75 + 0.2/-0	180	
	2A	2.0	1.25	0.5	TE	4,000	1.6±0.2	2.4±0.2	8	4	1.0±0.15	180	
					TD	5,000	2±0.2	3.5±0.2	8	4	0.75 + 0.2/-0	180	
	2B	3.2	1.6	0.6	TE	4,000	1.9±0.2	3.5±0.2	8	4	1.0±0.15	180	
					TD	5,000	2.85±0.20	3.5±0.2	8	4	0.75 + 0.2/-0	180	
	2E	3.2	2.5	0.6	TE	4,000	2.85±0.20	3.5±0.2	8	4	1.0±0.15	180	
					TD	5,000	2.85±0.20	3.5±0.2	8	4	0.75 + 0.2/-0	180	
	UR73 UR73V	D1E	1.0	0.5	0.4	TP	10,000	0.65±0.10	1.15±0.10	8	2	0.5 + 0.2/-0	180
		D1J	1.6	0.8	0.5	TD	5,000	1.1±0.1	1.9±0.1	8	4	0.68 + 0.2/-0	180
						TD	5,000	1.65±0.2	2.4±0.2	8	4	0.75 + 0.2/-0	180
2A		2.0	1.25	0.55	TD	5,000	1.65±0.2	2.4±0.2	8	4	0.75 + 0.2/-0	180	
					TD	5,000							
2B		3.2	1.6	0.6	TD	5,000	2±0.2	3.5±0.2	8	4	0.75 + 0.2/-0	180	
					TD	5,000							
D2H		5.0	2.5	0.65	TE	4,000	2.9±0.2	5.35±0.20	12	4	1.0±0.15	180	
					TE	4,000	3.44±0.20	6.65±0.20	12	4	1.0±0.15	180	
WK73 WU73 WG73		1E	0.5	1.0	0.35	TP	10,000	0.65±0.10	1.15±0.10	8	2	0.42 + 0.2/-0	180
		1J	0.8	1.6	0.45	TD	5,000	1.1±0.1	1.9±0.1	8	4	0.6 + 0.2/-0	180
						TD	5,000	1.65±0.20	2.4±0.2	8	4	0.75 + 0.2/-0	180
	2A	1.25	2.0	0.55	TD	5,000	1.65±0.20	2.4±0.2	8	4	0.75 + 0.2/-0	180	
					TD	5,000	2.0±0.2	3.5±0.2	8	4	0.75 + 0.2/-0	180	
	2H2, 2H	2.5	5.0	0.6	TE	4,000	2.9±0.2	5.35±0.20	12	4	1.0±0.15	180	
					TE	4,000	3.44±0.20	6.65±0.20	12	4	1.0±0.15	180	
	3A3, 3A	3.1	6.3	0.6	TE	4,000	3.44±0.20	6.65±0.20	12	4	1.0±0.15	180	
					TD	5,000	1.1±0.1	1.9±0.1	8	4	0.6 + 0.2/-0	180	
	WN73H	1J	0.8	1.6	0.35	TD	5,000	1.1±0.1	1.9±0.1	8	4	0.6 + 0.2/-0	180
						TD	5,000	2±0.2	3.5±0.2	8	4	0.75 + 0.2/-0	180
	SLR	1	6.3	3.1	1.9	TE	1,000	3.6±0.1	6.8±0.1	12	8	2.35±0.1	180
TE						2,000	255						
MWS	5	16.9	8.6	4.8	TEG	1,500	8.90±0.10	17.3±0.10	24	12	5.1±0.10	380	
					TEB	5,000	3.45±0.1	6.60±0.1	12	8	1.6±0.1	330	
PS	L (0.2mΩ)	6.3	3.15	1.40	TEB	5,000	3.45±0.1	6.60±0.1	12	8	1.6±0.1	330	
	L (0.3mΩ)	6.3	3.15	1.32	TEB	5,000	3.45±0.1	6.60±0.1	12	8	1.6±0.1	330	
	L (0.5mΩ)	6.3	3.15	1.12	TEB	5,000	3.45±0.1	6.60±0.1	12	8	1.6±0.1	330	
	F (0.5mΩ)	3.0	3.8	1.8	TEB	3,000	3.25±0.1	4.25±0.1	12	8	2.2±0.1	330	
	F (1mΩ)	3.0	3.8	1.8	TEB	3,000	3.25±0.1	4.25±0.1	12	8	2.2±0.1	330	
TLR	2A	2.0	1.25	0.25	TD	5,000	1.65±0.1	2.4±0.1	8	4	0.42 + 0.2/-0	178	
	2BN, 2B, 2BW, 2BP	3.2	1.6	0.6	TD	5,000	2.0±0.10	3.5±0.10	8	4	0.75±0.05	180	
	2H, 2HW	5.0	2.5	0.6	TE	4,000	2.9±0.10	5.35±0.10	12	4	0.77±0.1	180	
	3AW, 3AP, 3APS	6.4	3.2	0.6	TE	2,000	3.55±0.10	6.75±0.10	12	8	1.0±0.1	180	

RK73 series fit for ø255 and ø330 reels, and RN73 series for ø255 reel. For further details, please refer to individual specification sheets.

Packaging specifications

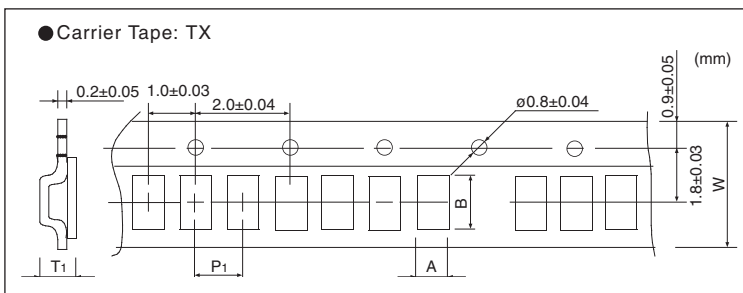
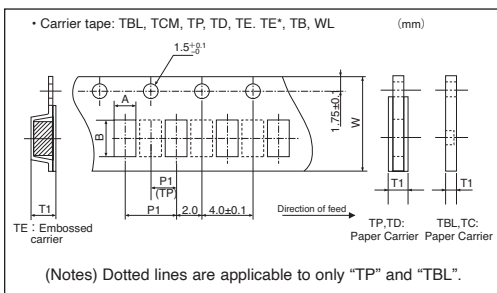

Specifications given herein may be changed at any time without prior notice. Please confirm technical specifications before you order and/or use.

5/08/24

For Product Specific packaging, please refer to the individual product data sheets.

Type	Component Size (mm)			Carrier Tape	Quantity/ Reel (Pieces)	Taping (mm)					Reel Size øa (mm)	
	L	W	T			A	B	W	P1	T1		
TLRZ	1E	1.0	0.5	0.4	TB	10,000	0.65±0.1	1.15±0.1	8	2	0.6±0.03	180
	1J	1.6	0.8	0.5	TD	5,000	1.10±0.1	1.90±0.1	8	4	0.6±0.05	180
	2A	2.0	1.25	0.5	TD	5,000	1.65±0.2	2.40±0.1	8	4	0.75±0.05	180
	2B	3.2	1.6	0.5	TD	5,000	2.0±0.10	3.5±0.10	8	4	0.75±0.05	180
TLRH	2A	2.0	1.25	0.25	TD	5,000	1.65±0.1	2.4±0.1	8	4	0.42+0.2/-0	178
	3AW, 3AP	6.3	3.2	0.5	TE	2,000	3.55±0.20	6.75±0.20	12	8	1.0±0.1	178
SL	07, W07	5.0	2.5	1.7	TE	2,000	3.1±0.1	5.5±0.1	12	4	2.25±0.10	180
	1, W1	6.3	3.1	1.9	TE	1,000	3.6±0.1	6.8±0.1	12	8	2.35±0.10	180
	2	11.5	7.0	2.5	TED	1,000	7.7±0.1	12.2±0.10	24	12	3.1±0.1	255
SLN	2, 3	11.5	7.0	2.4	TED	1,000	7.7±0.1	12.2±0.10	24	12	3.1±0.1	255
	5	11.5	7.0	2.5	TED	1,000	7.7±0.1	12.2±0.10	24	12	3.1±0.1	255
TSL	1	6.3	3.1	1.0	TE	3,000	3.4±0.1	6.6±0.1	12	4	1.3±0.1	180
CSR	1	10.8	6.2	2.1	TE	1,000	6.7±0.1	11.1±0.10	24	12	2.60±0.10	255
	2	12.8	8.2	3.1	TE	1,000	9±0.1	13±0.10	24	12	4.35±0.10	330
LP73	1J	1.6	0.8	0.5	TE	5,000	1.1±0.1	1.9±0.1	8	4	0.6±0.1	180
	2A	2.0	1.25	0.5	TE	5,000	1.6±0.1	2.4±0.1	8	4	0.85+0.2/-0	180
	2B	3.2	1.6	0.5	TE	5,000	2.0±0.1	3.6±0.1	8	4	0.85+0.2/-0	180
SDT73H SDT73S SDT73V	2B	3.2	1.6	0.5	TEK/TE	1,000/5,000	2.0±0.1	3.6±0.1	8	4	0.85+0.2/-0	180
RD41	2ES, 12M	3.5	1.4	—	TE	3,000	1.7±0.1	3.7±0.1	8	4	2.0 max.	178
RN41, CC	2E, 25, 3AS	5.9	2.2	—	TE	1,500	2.4±0.1	6.2±0.1	12	4	2.9 max.	178
RCU		1.6	0.8	1.15	TE/TED	2,000/5,000	1.05±0.15	1.85±0.15	8	4	1.25±0.1	178/260
RCT		2.0	1.25	1.45	TE/TED	2,000/5,000	1.65+0.1/-0.2	2.45±0.15	8	4	1.70±0.1	178/260
RCS		3.2	1.6	1.25	TE/TED	2,000/5,000	2.0±0.2	3.6±0.2	8	4	1.45±0.15	178/260
RCW		3.2	1.6	2.0	TE	2,000	1.95+0.1/-0.05	3.4+0.1/-0.05	8	4	2.2±0.1	178
CNN	2A2	2.54	2.0	0.5	TE	4,000	2.4±0.2	2.9±0.2	8	4	1±0.15	180
KPC	Q16	4.9	5.99	1.6	TE	2,500	6.5±0.1	5.3±0.1	12	8	2.1±0.1	330
	Q20	8.66	5.99	1.6	TE	2,500	6.5±0.1	9.0±0.1	16	8	2.1±0.1	330
	Q24	8.66	5.99	1.6	TE	2,500	6.5±0.1	9.0±0.1	16	8	2.1±0.1	330
	N08	4.83	5.99	1.6	TE	2,500	6.5±0.1	5.3±0.1	12	8	2.1±0.1	330
	N14	8.66	5.99	1.6	TE	2,500	6.5±0.1	9.0±0.1	16	8	2.1±0.1	330
	N16	9.91	5.99	1.6	TE	2,500	6.5±0.1	10.3±0.1	16	8	2.1±0.1	330
	S03	2.92	2.30	0.95	TE	3,000	3.15±0.1	2.77±0.1	8	4	1.22±0.1	180
HVDP08		8.66	5.99	1.6	TE	2,500	6.5±0.1	9.0±0.1	16	8	2.1±0.1	330
NV73 NV73DL	1H	0.6	0.3	0.3	TBM	15,000	0.38±0.02	0.68±0.02	8	2	0.42±0.02	180
	1E	1.0	0.5	0.5	TP	10,000	0.65±0.1	1.15±0.1	8	2	0.6+0.2/-0	180
	1J	1.6	0.8	0.8	TE	2,500	1.2±0.1	1.9±0.1	8	4	1.75 max.	178
	2A	2.0	1.25	1.3 max.	TE	2,500	1.6±0.1	2.4±0.1	8	4	1.75 max.	178
	2B	3.2	1.6	1.65 max.	TE	2,500	2.0±0.1	3.6±0.1	8	4	1.75 max.	178
	2E	3.2	2.5	1.5 max.	TE	2,000	2.85±0.1	3.50±0.1	8	4	1.55 max.	178
NV73S	2E	3.2	2.5	1.3	TE	2,000	2.85±0.1	3.50±0.1	8	4	1.55 max.	178
	2J	4.5	3.2	1.3	TE	1,000	3.60±0.1	4.90±0.1	12	8	2.05 max.	180
	2L	5.7	4.7	1.3	TE	1,000	5.40±0.1	6.00±0.1	12	8	2.60 max.	180
	2L H	5.7	4.7	2.5	TE	1,000	5.40±0.1	6.00±0.1	12	8	2.60 max.	180
TF	10B	1.0	0.5	0.45	TB	10,000	0.65±0.05	1.15±0.05	8	2	0.6±0.04	180
	16S,16A,16V	1.6	0.8	0.4	TD	5,000	1.1±0.1	1.9±0.1	8	4	0.6+0.2/-0	180
CCF	1N, 1F	6.0	2.5	2.5	TE	1,000	2.7±0.2	6.4±0.2	12	4	2.9±0.2	180
CZB CZP	1J	1.6±0.15	0.8±0.15	0.8±0.15	TD	4,000	1.1±0.1	1.8±0.1	8.1±0.1	4.0±0.1	1.1±0.1	178
	2A	2.0±0.2	1.25±0.2	0.9±0.2	TD	2,000/4,000*	1.6±0.1	2.4±0.1	8.1±0.1	4.0±0.1	1.2±0.1	178
	2B	3.2±0.2	1.6±0.2	0.51±0.25	TE	3,000	1.8±0.1	3.5±0.1	8.1±0.1	4.0±0.1	1.8±0.1	178
MHL	1E	1.0±0.1	0.5±0.1	0.5±0.1	TP	10,000	0.67±0.1	1.17±0.1	8.0±0.22	2.0±0.23	0.63±0.1	178
	1J	1.6±0.15	0.8±0.15	0.8±0.15	TD	4,000	1.15±0.1	1.85±0.1	8.0±0.1	4.0±0.1	1.1±0.1	178

* CZB2A: <2200Ω=TD:4,000; 2200Ω=TD: 2,000 pcs/reel

Packaging specifications

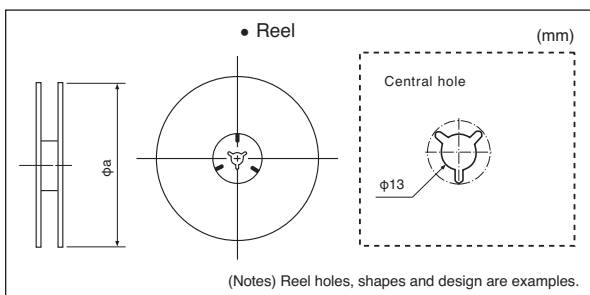

Specifications given herein may be changed at any time without prior notice. Please confirm technical specifications before you order and/or use.

5/08/24

standard soldering pad dimensions

The optimum soldering pad dimensions may differ depending on soldering conditions, however, the following land dimensions are generally recommended.

Flat Type Components - For Reflow Soldering

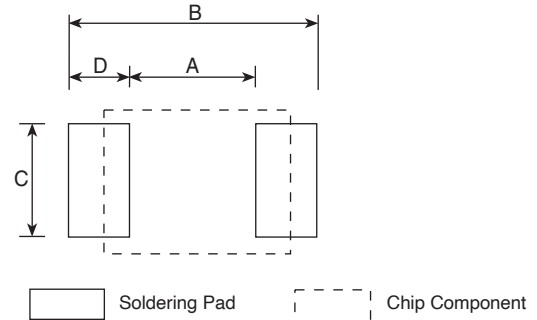

For Reflow Soldering

Type	Style	Dimensions millimeters				
		Component Size	A	B	C	D
	1F	0.4x0.2	0.12	0.48	0.18	0.18
RK73	1H	0.6x0.3	0.25	0.7	0.3	0.225
RS73	1E	1.0x0.5	0.5	1.3	0.3	0.4
SG73	1J	1.6x0.8	1.0	2.0	0.6	0.5
RN73	2A	2.0x1.25	1.3	2.5	1.05	0.6
HSG73P	2B	3.2x1.6	2.2	4.0	1.4	0.9
SR73	2E, 2E1	3.2x2.5	2.2	4.0	2.3	0.9
LT73	W2H/2H	5.0x2.5	3.3/3.5	6.1/6.3	2.3	1.4
LP73	W3A2, W3A, 3A	6.3x3.1	4.6	8.0	3.0	1.7
SDT73						
RF73						
RK73 AT	1E	1.0x0.5	0.5	1.7	0.53	0.6
SG73 AT	1J	1.6x0.8	1.0	2.5	0.85	0.75
HV73 AT	2A	2.0x1.25	1.2	3.0	1.33	0.9
HSG73P AT	2B	3.2x1.6	2.05	4.4	1.7	1.175
UR73	2A	2.0x1.25	1.3	2.6	1.1	0.65
	2B	3.2x1.6	2.2	4.2	1.6	1.0
UR73D	1E	1.0x0.5	0.4	1.7	0.5	0.65
	1J	1.6x0.8	0.5	2.5	0.9	1.0
	2A	2.0x1.25	0.8	3.4	1.3	1.3
	2B	3.2x1.6	1.2	4.6	1.8	1.7
	2H (10mΩ-30mΩ)	5.0x2.5	1.8	6.1	2.6	2.15
	2H (33mΩ-100mΩ)		3.3	6.1	2.5	1.4
	3A (10mΩ-30mΩ)	6.3x3.1	2.3	8.0	3.3	2.85
	3A (33mΩ-100mΩ)		4.6	8.0	3.2	1.7
UR73V	2A	2.0x1.25	1.2	3.4	1.3	1.1
UR73VH	2B	3.2x1.6	2.2	4.2	1.6	1.0
UR73VD	2A (10mΩ-18mΩ)	2.0x1.25	0.6	3.4	1.3	1.4
	2A (20mΩ-36mΩ)		0.8	3.4	1.3	1.3
	2B (10mΩ-13mΩ)	3.2x1.6	0.7	4.4	1.6	1.85
	2B (15mΩ-16mΩ)		0.9	4.4	1.6	1.75
	2B (18mΩ-20mΩ)		1.0	4.4	1.6	1.7
	2B (18mΩ-20mΩ)		1.0	4.4	1.6	1.7
	2B (22mΩ-27mΩ)		1.2	4.4	1.6	1.6

Type	Style	Dimensions millimeters					
		Component Size	A	B	C	D	
WK73	1E	0.5x1.0	0.2	1.1	1.0	0.45	
	1J	0.8x1.6	0.4	1.7	1.6	0.65	
	2A	1.25x2.0	0.55	2.35	2.0	0.9	
	WU73	2B15, 2B	1.6x3.2	0.7	2.3	3.2	0.8
		2H2, 2H	2.5x5.0	1.0	3.5	5.0	1.25
WG73	3A3, 3A	3.1x6.3	1.6	3.9	6.3	1.15	
	WN73H	1J	0.8x1.6	0.4	1.7	1.6	0.65
	2B	1.6x3.1	0.7	2.3	3.2	0.8	
SLR	1	6.3x3.1	3.4	8.0	3.0	2.3	
TF	10B	1.0x0.5	0.5	1.3	0.3	0.4	
	16S,16A,16V	1.6x0.8	1.0	2.0	0.6	0.5	
PS	L	6.3x3.15	3.4	7	3.4	1.8	
	F	3.0x3.8	Described on the product page				
TLR	2A	2.0x1.25	0.5	2.5	1.3	1.0	
	2BW, 2BP (0.5mΩ)	3.2x1.6	0.6	4.0	1.8	1.7	
	2BN, 2B, 2BW, 2BP (1mΩ, 1.5mΩ)		0.8	4.0	1.8	1.6	
	2BN, 2B, 2BW, 2BP (2mΩ-20mΩ)		1.4	4.0	1.8	1.3	
	2H, 2HW (0.5mΩ-1.5mΩ)	5.0x2.5	1.0	6.1	3.0	2.55	
	2H, 2HW (2mΩ-6mΩ)		1.3	6.1	3.0	2.4	
	2H, 2HW (7mΩ-10mΩ)		3.3	6.1	3.0	1.4	
	3AW (0.5mΩ-0.82mΩ)	6.35x3.18	0.8	7.55	3.83	3.375	
	3AW (1mΩ-4mΩ)		1.45	7.55	3.83	3.05	
	3AW (5mΩ-8mΩ)		3.45	7.55	3.83	2.05	
3AW (9mΩ, 10mΩ)	4.4		7.55	3.83	1.575		

standard soldering pad dimensions (continued)

The optimum soldering pad dimensions may differ depending on soldering conditions, however, the following land dimensions are generally recommended.

For Reflow Soldering

Type	Style	Dimensions millimeters				
		Component Size	A	B	C	D
TLR	3AP (0.5mΩ-0.82mΩ)	6.35x3.18	0.8	7.55	3.83	3.375
	3AP (1mΩ, 1.5mΩ)		1.45	7.55	3.83	3.05
	3AP (2mΩ)		1.05	7.55	3.83	3.25
	3AP (3mΩ-4mΩ)		1.45	7.55	3.83	3.05
	3AP (5mΩ-8mΩ)	6.35x3.18	3.45	7.55	3.83	2.05
	3AP (9mΩ, 10mΩ)		4.4	7.55	3.83	1.575
	3APS		3.45	7.55	3.83	2.05
TLRH	2A	2.0x1.25	0.5	2.5	1.3	1.0
	3AW	6.3x3.2	4.4	7.5	3.7	1.55
	3AP	6.3x3.2	2.15	7.55	3.83	2.7
TLRZ	1E	1.0x0.5	0.5	1.3	0.6	0.4
	1J	1.6x0.8	0.5	2.0	0.9	0.75
	2A	2.0x1.25	0.5	2.5	1.45	1.0
	2B	3.2x1.6	2.2	3.8	1.8	0.8
SL	07, W07	5.0x2.5	2.3	7.0	2.6	2.35
	1, W1	6.3x3.1	3.4	8.0	3.0	2.3
	2	11.5x7.0	5.4	15.0	5.0	4.8
SLN	2, 3, 5	11.5x7.0	5.0	15.0	6.0	5.0
TSL	1	6.3x3.1	3.4	8.0	3.0	2.3
CCF	1N, 1F	6.0x2.5	3.0	7.2	2.8	2.1
NV73 NV73DL	1H	0.6x0.3	0.25-0.35	0.65-0.95	0.25-0.35	0.2-0.3
	1E	1.0x0.5	0.51	1.73	0.51	0.61
	1J	1.6x0.8	1.0	3.0	1.0	1.0
	2A	2.0x1.25	1.2	4.0	1.2	1.4
	2B	3.2x1.6	2.2	5.0	1.3	1.4
NV73S	2E	3.2x2.5	2.2	5.0	2.3	1.4
	2J	4.5x3.2	3.0	6.6	3.2	1.8
	2L	5.7x4.7	4.2	7.8	5.0	1.8

Flat Type Components - For Reflow Soldering

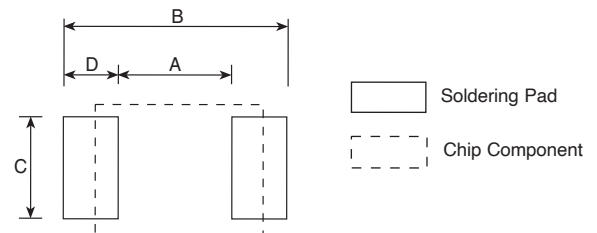

standard soldering pad dimensions (continued)

The optimum soldering pad dimensions may differ depending on soldering conditions, however, the following land dimensions are generally recommended.

Flat Type Components - For Flow Soldering

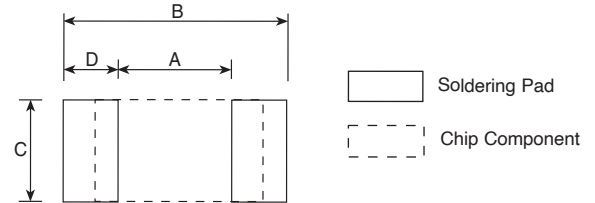

For Flow Soldering

Type	Style	Dimensions millimeters				
		Component Size	A	B	C	D
RK73	1E	1.0x0.5	0.5	1.5	0.5	0.5
RS73	1J	1.6x0.8	1.0	2.4	0.8	0.7
HV73	2A	2.0x1.25	1.3	3.1	1.25	0.9
SG73	2B	3.2x1.6	2.2	4.4	1.6	1.1
RN73	2E, 2E1	3.2x2.5	2.2	4.4	2.5	1.1
HSG73P	W2H/2H	5.0x2.5	3.3/3.5	6.1/6.3	2.5	1.4
SR73	W3A2, W3A, 3A	6.3x3.1	4.6	8.0	3.2	1.7
LT73	1E	1.0x0.5	0.5	1.7	0.53	0.6
LP73	1J	1.6x0.8	1.0	2.5	0.85	0.75
SDT73	2A	2.0x1.25	1.2	3.0	1.33	0.9
RF73	2B	3.2x1.6	2.05	4.4	1.7	1.175
RK73 AT	2A	2.0x1.25	1.3	2.6	1.1	0.65
SG73 AT	2B	3.2x1.6	2.2	4.2	1.6	1.0
HV73 AT	1E	1.0x0.5	0.4	1.7	0.5	0.65
HSG73P AT	1J	1.6x0.8	0.5	2.5	0.9	1.0
UR73	2A	2.0x1.25	0.8	3.4	1.3	1.3
	2B	3.2x1.6	1.2	4.6	1.8	1.7
	2H (10mΩ-30mΩ)	5.0x2.5	1.8	6.1	2.6	2.15
	2H (33mΩ-100mΩ)		3.3	6.1	2.5	1.4
	3A (10mΩ-30mΩ)	6.3x3.1	2.3	8.0	3.3	2.85
	3A (33mΩ-100mΩ)		4.6	8.0	3.2	1.7
	UR73V	2A	2.0x1.25	1.2	3.4	1.3
UR73VH	2B	3.2x1.6	2.2	4.2	1.6	1.0
UR73VD	2A (10mΩ-18mΩ)	2.0x1.25	0.6	3.4	1.3	1.4
	2A (20mΩ-36mΩ)		0.8	3.4	1.3	1.3
	2B (10mΩ-13mΩ)	3.2x1.6	0.7	4.4	1.6	1.85
	2B (15mΩ-16mΩ)		0.9	4.4	1.6	1.75
	2B (18mΩ-20mΩ)		1.0	4.4	1.6	1.7
	2B (22mΩ-27mΩ)		1.2	4.4	1.6	1.6
TF	10B	1.0x0.5	0.5	1.5	0.5	0.5
	16S, 16A	1.6x0.8	1.0	2.4	0.8	0.7

Type	Style	Dimensions millimeters				
		Component Size	A	B	C	D
NV73	1J	1.6x0.8	1.0	3.0	1.0	1.0
	2A	2.0x1.25	1.2	4.0	1.2	1.4
	2B	3.2x1.6	2.2	5.0	1.3	1.4
NV73DL	2E	3.2x2.5	2.2	5.0	2.3	1.4
	2J	4.5x3.2	3.0	6.6	3.2	1.8
	2L	5.7x4.7	4.2	7.8	5.0	1.8
CCF	1N, 1F	6.0x2.5	3.0	7.2	2.8	2.1

melf type components—RD41, RN41, MLT, CC

Reflow Soldering

Type	Style	Dimensions millimeters			
		Component Size	A	C	D
RD41	2ES 12M	3.5 X 1.40	1.5	1.3	1.7
RN41	2E 25	5.9 X 2.2	2.2	2.2	3.0
CC	3AS	5.9 X 2.2	15.0	15.0	4.0

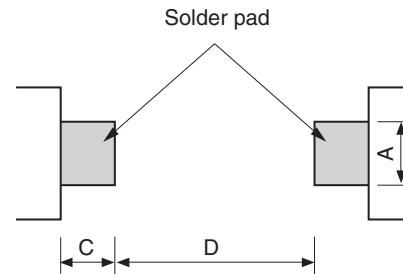

Flow Soldering

Type	Style	Dimensions millimeters				
		Component Size	A	B	C	D
RD41	2ES 12M	3.5 X 1.40	1.5	2.2	1.5	2.0
RN41	2E 25	5.9 X 2.2	2.0	3.0	3.0	4.0
CC	3AS	5.9 X 2.2	15.0	3.0	15.0	4.0

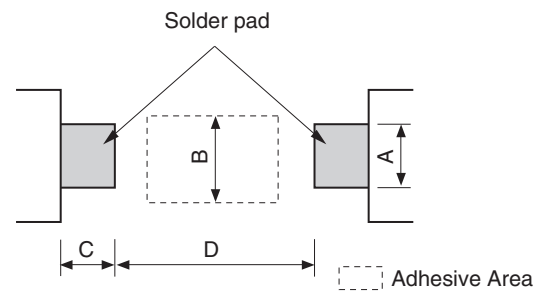

resistor arrays—CN

- For Reflow Soldering

Type	Style	Dimensions millimeters					
		Component Size	A	B	C	D	E
CNN	2A2	2.54 X 2.0	1.2	2.8	0.6	0.8	1.27

Chip Networks

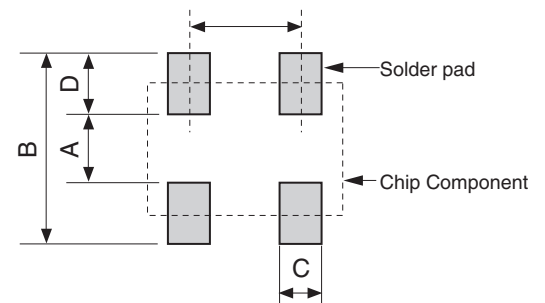

MWS

- For Reflow and Flow Soldering

Type	Style	Dimensions millimeters					
		Component Size	A	B	C	D	E
MWS	5	16.9 X 8.6	2.2	6.2	2.5	2.0	14.1

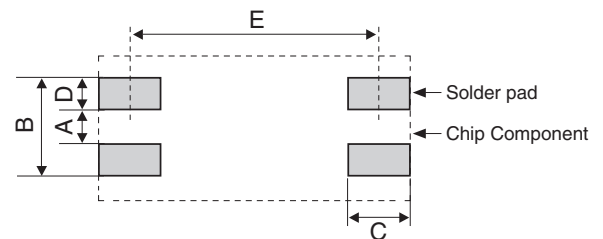

other chips—RCS, RCT, RCU, RCW

- For Reflow Soldering

Type	Dimensions millimeters	
	A	B
RCU	2.5~2.7	0.6~0.8
RCT	2.9~3.1	1.05~1.25
RCS	4.1~4.3	1.4~1.6
RCW		

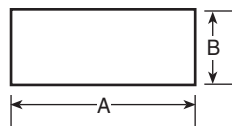

axial tapings

Straight Type Name	Taping Type Name	Lead ød (mm)	Packaging Style	Packaging & Q'ty (pcs)		Weight (g)		
				AMMO	Reel	AMMO	Reel	Net 1000pcs
MOS1/2 ¹	MOS1/2CT26	0.6	T26	2000	—	350	—	140
MOS1/2	MOS1/2CT52	0.6	T52	2000	5000	590	1400	250
MOS1	MOS1CT52	0.6	T52	2000	4000	810	1550	350
MOS1	MOS1CT526	0.6	T52	2000	4000	810	1550	350
MOS1C8	MOS1CT528	0.8	T52	2000	4000	810	1550	350
MOS1	MOS1CL52	0.8	L52	2000	4000	810	1550	350
MOS2	MOS2CT52	0.8	T52	1000	2000	910	1750	800
MOS2	MOS2CT521	0.8	T521	1000	1000	910	950	800
MOS2	MOS2CL521	0.8	L521	1000	1000	910	950	800
MOS3	MOS3CL521	0.8	L521	500	—	775	—	1350
MOS3	MOS3CT521	0.8	T521	500	1000	775	1500	1350
MOS3	MOS3CT631	0.8	T631	1000	1000	1580	1600	1400
MOS3	MOS3CL631	0.8	L631	500	1000	775	1600	1400
SPR1/4 ²	SPR1/4CT26	0.45	T26	2000	—	250	—	90
SPR1/4	SPR1/4CT52	0.45	T52	2000	5000	340	850	140
SPR1/2	SPR1/2CT26	0.6	T26	2000	—	350	—	140
SPR1/2	SPR1/2CT52	0.6	T52	2000	5000	590	1400	250
SPR1/2	SPR1/2CL52	0.65	L52	2000	5000	590	1400	250
SPR1	SPR1CT52	0.8	T52	2000	4000	1140	2150	500
SPR1	SPR1CL52	0.8	L52	2000	4000	1140	2150	500
SPR2	SPR2CT52	0.8	T52	1000	2000	910	1750	800
SPR2	SPR2CT521	0.8	T521	1000	1000	910	950	800
SPR2	SPR2CL521	0.8	L521	1000	1000	910	950	800
SPR3	SPR3CT521	0.8	T521	500	1000	775	1500	1350
SPR3	SPR3CL521	0.8	L521	500	—	775	—	1350
SPR3	SPR3CT631	0.8	T631	1000	1000	1580	1600	1400
SPR3	SPR3CL631	0.8	L631	500	1000	775	1600	1400
RF16	RF16CT26	0.45	T26	2000	—	220	—	90
RF16	RF16CT52	0.45	T52	2000	5000	340	800	150
RF25	RF25CT26	0.6	T26	2000	—	330	—	140
RF25	RF25CT52	0.6	T52	2000	5000	500	1300	230
RF50	RF50CT52	0.6	T52	2000	4000	660	1320	310
RF1	RF1CT52	0.8	T52	2000	4000	1080	2050	500
RF2	RF2CT521	0.8	T521	500	1000	700	1420	1300
RF2	RF2CT631	0.8	T631	1000	—	1410	—	1350
Z16	Z16CT26	0.45	T26	5000	—	615	—	110
Z16	Z16CT52	0.45	T52	3000	5000	530	920	150
Z25	Z25CT26	0.6	T26	2000	—	410	—	180
Z25	Z25CT52	0.6	T52	2000	5000	530	1400	240
J1/6Z	J1/6ZCT26	0.5	T26	2000	—	230	—	90
J1/6Z	J1/6ZCT52	0.5	T52	2000	5000	320	950	130
J1/4Z	J1/4ZCT26	0.6	T26	2000	—	320	—	130
J1/4Z	J1/4ZCT52	0.6	T52	2000	5000	460	1310	190
JL5	JL5CT26	0.5	T26	5000	—	420	—	75
JL5	JL5CT52	0.5	T52	5000	—	680	—	120
JL6	JL6CT26	0.6	T26	5000	—	515	—	100
JL6	JL6CT52	0.6	T52	5000	—	815	—	160
JL8	JL8CT52	0.8	T52	—	10000	—	3054	305
LP1/8	LP1/8CT26	0.65	T26	2000	—	410	—	170
LP1/8	LP1/8CT52	0.65	T52	2000	—	580	—	260
LP1/16	LP1/16CT26	0.5	T26	4000	—	450	—	100
LP1/16	LP1/16CT52	0.5	T52	4000	—	630	—	150
SDT101A	SDT101AXCT26	0.4	T26	2000	—	350	—	75
SDT101A	SDT101AXCT52	0.4	T52	2000	—	470	—	150
SDT101B	SDT101BXNT52	0.4	T52	—	2000	—	410	150
CFS1/4	CFS1/4 CT26	0.45	T26	5000	—	615	—	110
CFS1/4	CFS1/4 CT52	0.45	T52	3000	5000	530	920	150
CF1/4	CF1/4 CT26	0.6	T26	2000	—	410	—	180
CF1/4	CF1/4 CT52	0.6	T52	2000	5000	530	1400	240
CFB1/2	CFB1/2 CT52	0.7	T52	2000	4000	1110	2280	520
CFS1/2	CFS1/2 CT26	0.6	T26	2000	—	525	—	230
CFS1/2	CFS1/2 CT52	0.6	T52	2000	4000	640	1500	290
CFPS1/4	CFPS1/4 CT26	0.45	T26	5000	—	615	—	100
CFPS1/4	CFPS1/4 CT52	0.45	T52	3000	—	530	—	150
CFP1/4	CFP1/4 CT26	0.6	T26	2000	—	410	—	180
CFP1/4	CFP1/4 CT52	0.6	T52	2000	5000	530	1400	240

Packaging

(1) AMMO Pack
(Symbol:A) Standard

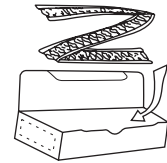

(2) Reel (Symbol: R)

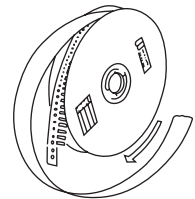

*1: The same taping applicable also to MOSX.

*2: The same taping applicable also to SPRX.

Specifications given herein may be changed at any time without prior notice. Please confirm technical specifications before you order and/or use. 11/10/23

axial tapings

Straight Type Name	Taping Type Name	Lead ød (mm)	Packaging Style	Packaging & Q'ty (pcs)		Weight (g)		
				AMMO	Reel	AMMO	Reel	Net 1000pcs
CFP1/4	CFP1/4 CL52	0.65	L52	2000	—	530	—	240
CFPB1/2	CFPB1/2 CT52	0.7	T52	2000	4000	1110	2280	520
CFPB1/2	CFPB1/2 CL52	0.65	L52	2000	—	1110	—	520
CFPS1/2	CFPS1/2 CT26	0.6	T26	2000	—	525	—	230
CFPS1/2	CFPS1/2 CT52	0.6	T52	2000	4000	640	1500	290
MFS1/4**	MFS1/4 □CT26	0.45	T26	3000	—	350	—	90
MFS1/4	MFS1/4 □CT52	0.45	T52	3000	—	500	—	120
MFS1/2	MFS1/2 □CT26	0.6	T26	2000	—	360	—	160
MFS1/2	MFS1/2 □CT52	0.6	T52	2000	5000	500	1300	215
MF1/4	MF1/4 □CT26	0.6	T26	2000	—	360	—	160
MF1/4	MF1/4 □CT52	0.6	T52	2000	5000	500	1300	215
MF1/2	MF1/2 □CT52	0.6	T52	2000	4000	900	2000	360
SNF 2C	SNF 2CCT26	0.45	T26	3000	—	500	—	110
SNF 2C	SNF 2CCT52	0.45	T52	3000	—	430	—	150
SNF 2E	SNF 2ECT26	0.6	T26	2000	—	450	—	180
SNF 2E	SNF 2ECT52	0.6	T52	2000	5000	470	1400	240
SNF 2H	SNF 2HCT52	0.7	T52	2000	4000	950	2010	520
RNS1/4	RNS1/4 □CT52	0.6	T52	2000	4000	600	1550	440
RNS1/8	RNS1/8 □CT26	0.6	T26	2000	—	400	—	180
RNS1/8	RNS1/8 □CT52	0.6	T52	2000	5000	600	1550	260
RNS1/2	RNS1/2 □CT52	0.6	T52	2000	4000	1100	2150	500
RNS1	RNS1 □CT521	0.8	T521	500	1000	750	2100	1500
RCR16	RCR16 CT26	0.45	T26	5000	—	500	—	100
RCR16	RCR16 CT52	0.45	T52	3000	—	450	—	150
RCR25	RCR25 CT26	0.6	T26	2000	—	390	—	180
RCR25	RCR25 CT52	0.6	T52	2000	—	520	—	240
RCR25EN	RCR25EN CT26	0.6	T26	2000	—	390	—	180
RCR25RN	RCR25EN CT52	0.6	T52	2000	—	520	—	240
RCR50 (+)	RCR50(+) CT52	0.7	T52	2000	3000	1050	1630	520
RCR50EN	RCR50ENCT52	0.7	T52	2000	3000	1050	1630	520
RCR60	RCR60 CT52	0.7	T52	2000	3000	1050	1630	520
RCR75	RCR75 CT52	0.8	T52	1000	—	830	—	800
RCR100	RCR100 CT521	0.8	T521	500	—	750	—	1400
RCR100	RCR100 CT631	0.8	T631	1000	—	1450	—	1400
RK1/4	RK1/4 □CT26	0.6	T26	2000	—	360	—	250
RK1/4	RK1/4 □CT52	0.6	T52	2000	5000	500	1300	250
RK1/2	RK1/2 □CT52	0.6	T52	2000	4000	900	—	380
RK1	RK1 □CT521	0.8	T521	500	—	700	—	1340
PCF1/2	PCF1/2 CT52	0.7	T52	—	2000	—	1140	450
PCF1	PCF1 CT631	0.8	T631	—	1000	—	1530	1270
PCF2	PCF2 CT631	0.8	T631	—	500	—	1340	2160
HPC1/2	HPC1/2 CT52	0.8	T52	1000	2000	800	1440	600
HPC1	HPC1 CT631	0.8	T631	—	1000	—	1440	1170
CW1/4	CW1/4 CT26	0.45	T26	2000	—	460	—	150
CW1/4	CW1/4 CT52	0.45	T52	3000	—	690	—	150
CW1/2	CW1/2 CT52	0.6	T52	2000	—	570	—	250
CW1 ⁴	CW1 CT52	0.8	T52	1000	—	580	—	650
CW2 ⁴	CW2 CT52	0.8	T52	1000	—	780	—	950
CW2 ⁴	CW2 CT521	0.8	T521	1000	—	790	—	950
CW3 ⁴	CW3 CT521	0.8	T521	500	—	740	—	1780
CW3 ⁴	CW3 CT631	0.8	T631	500	—	750	—	1780
CW1S	CW1S CT52	0.6	T52	2000	—	570	—	250
CWFS23	CWFS23 CT52	0.8	T52	1000	—	780	—	950
CWFS23	CWFS23 CT521	0.8	T521	1000	—	790	—	950
CWFS35	CWFS35 CT521	0.8	T521	500	—	740	—	1780

Packaging

(1) AMMO Pack
(Symbol:A) Standard

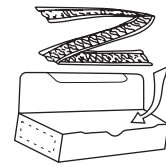

(2) Reel (Symbol: R)

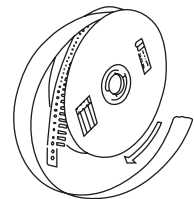

T-Type

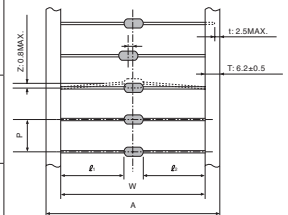

L-Type

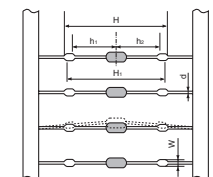

□ T.C.R. * 4 The same taping applicable also to CW-P, CW-X and CW-H
** ±0.1% and ±0.25% not available in reel packaging

T-Type

Packaging Style	Dimensions (mm)				
	W	P	A	l l ₁ -l ₂ l	Accumulated Tolerance
T26 ⁶	26 ^{+0.2} ₋₀	5.00±0.3	39±1.0	0.2Max. ⁵	250.0±3mm/P×50
	26 ⁺¹ ₋₀	5.00±0.3	39±1.0	1.0Max.	100.0±2mm/P×20
T52 ⁶	52±1	5.08±0.38	64.5±1.0	1.0Max.	101.6±2mm/P×20
T521	52±1	10.16±0.80	64.5±1.0	1.0Max.	203.2±3mm/P×20
T631	63±1	10.16±0.80	—	1.0Max.	203.2±3mm/P×20

⁵ Applied to CFS1/4 (CFPS1/4) T26 Only

⁶ Contact us for LP and SDT series

Specifications given herein may be changed at any time without prior notice. Please confirm technical specifications before you order and/or use.

11/10/23

L-Type

Type	Dimensions (mm)			
	H±1	W	d	h ₁ , h ₂
MOS ²	1 □L52	25.5	1.20~1.45	0.8
	2 □L521	36.0		0.8
	3 □L631	42.5		0.8
SPR ³	1/2 □L52	26.0	1.17~1.40	0.65
	1 □L52	25.5		0.8
	2 □L521	36.0		0.8
	3 □L631	42.5	1.20~1.45	0.8
CFP	1/4 □L52	H1: 24.5±1	1.17~1.4	0.65
CFPB	1/2 □L52	H1: 27.5±1		0.65
CW	1/2 □L52	26.0	1.05~1.35	0.6
CW	1 □L52	27.5	1.20~1.40	0.8

radial tapings

(mm)

VT					VT					VTE				
Radial Type Name	Radial Lead ød	AMMO (pcs)	Reel (pcs)	Weight g/AMMO	Radial Type Name	Radial Lead ød	AMMO (pcs)	Reel (pcs)	Weight g/AMMO	Radial Type Name	Radial Lead ød	AMMO (pcs)	Reel (pcs)	Weight g/AMMO
MFS1/2 CVT	0.6	2000	2500	750	MFS1/4 CVT	0.45	3000	3000	620	MFS1/2 CVTE	0.6	2000	2500	750
MF1/4 CVT	0.6	2000	2500	750	CFS1/4 CVT	0.45	3000	3000	720	MF1/4 CVTE	0.6	2000	2500	750
RNS1/8 CVT	0.6	2000	2500	750	SPR1/4 CVT*	0.45	3000	3000	720	RNS1/8 CVTE	0.6	2000	2500	750
J1/4Z CVT*	0.6	2000	2500	670						MOS1/2 CVTE	0.6	2500	2500	930
CF1/4 CVT	0.6	2000	2500	720						SPR1/2 CVTE	0.6	2500	2500	930
CFS1/2 CVT	0.6	2000	2500	800						CF1/4 CVTE	0.6	2500	2500	900
CFP1/4 CVT*	0.6	2000	2500	720						CFS1/2 CVTE	0.6	2500	2500	1000
CFPS1/2 CVT*	0.6	2000	2500	800						RF25 CVTE	0.6	2000	2500	750
RF25 CVT*	0.6	2000	2500	750										
VTP					VTF									
Radial Type Name	Radial Lead ød	AMMO (pcs)	Reel (pcs)	Weight g/AMMO	Radial Type Name	Radial Lead ød	AMMO (pcs)	Reel (pcs)	Weight g/AMMO	Radial Type Name	Radial Lead ød	AMMO (pcs)	Reel (pcs)	Weight g/AMMO
CW1/2 CVTP*	0.6	2000	—	750	J1/4Z CVTP*	0.6	2000	2500	670	SPR2CVTF	0.8	1000	—	1080
CW1 CVTP*	0.8	1000	—	740	MF1/4 CVTP	0.6	2000	2500	750	MOS2CVTF	0.8	1000	—	1060
CW2 CVTP*	0.8	1000	—	1080	RNS1/8 CVTP	0.6	2000	2500	750					
					CF1/4 CVTP	0.6	2000	2500	740					
					CFS1/2 CVTP	0.6	2000	2500	800					
					CFP1/4 CVTP	0.6	2000	2500	740					
					CFPS1/2 CVTP	0.6	2000	2500	800					
					RF25 CVTP	0.6	2000	2500	750					
					RCR75 CVTP**	0.65	1000	—	1080					
MT					MHT					FT				
Radial Type Name	Radial Lead ød	AMMO (pcs)	Reel (pcs)	Weight g/AMMO	Radial Type Name	Radial Lead ød	AMMO (pcs)	Reel (pcs)	Weight g/AMMO	Radial Type Name	Radial Lead ød	AMMO (pcs)	Reel (pcs)	Weight g/AMMO
MFS1/4 CMT	0.45	3000	—	620	CFS1/4 CMHT	0.45	3000	—	630	BPR26 CFT	0.6	500	—	790
CFS1/4 CMT	0.45	3000	3000	630	CFPS1/4 CMHT	0.6	3000	—	720	BPR58 CFT	0.8	500	—	1940
CFPS1/4 CMT	0.45	3000	3000	630	RF16 CMHT	0.45	3000	—	240					
J1/6Z CMT	0.5	2000	—	450										

□ T.C.R. * The insulated coating on the lead wire is not available.
 Also for MOSX, SPRX types, radial taping in the same shape as MOS, SPR types is applicable.
 ** Surge resistance is not guaranteed. Rating specifications are different. Please contact KOA for details.

Specifications given herein may be changed at any time without prior notice. Please confirm technical specifications before you order and/or use. 11/30/22

radial tapings

(mm)

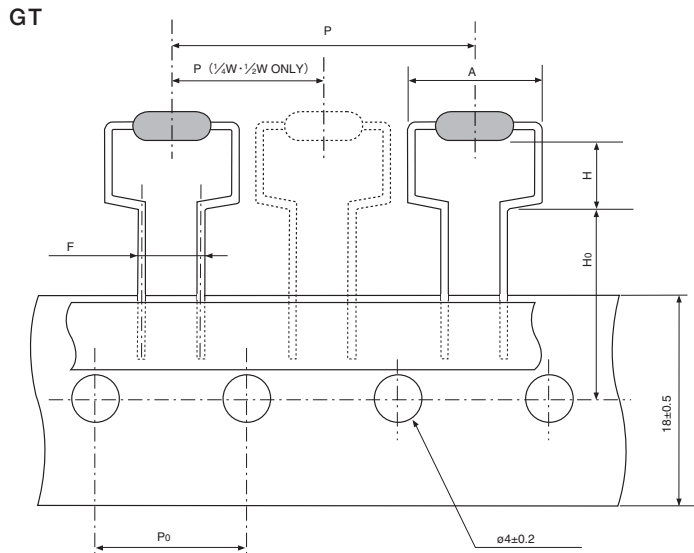





Radial Type Name	Radial Lead ød	AMMO (pcs)	Weight g/AMMO	F	P	P0	H	H0	AMax.
MOS1/2CGT	0.6	2000	740	5±0.5	12.7±1.0	12.7±0.3	6.5 ^{+0.6} ₋₀	16±0.5	12
MOS1CGT	0.8	1000	730	7.5 ^{+0.8} _{-0.2}	30±1.0	15±0.3	6.5 ^{+1.0} ₋₀	19±0.7	14.5
MOS1CGT4	0.8	1000	700				4.0 ^{+1.0} ₋₀		17.5
MOS2CGT	0.8	500	580				7.5 ^{+1.0} ₋₀		21
MOS2CGT4	0.8	500	560				4.0 ^{+1.0} ₋₀		
MOS3CGT	0.8	500	910				8.5 ^{+1.0} ₋₀		
MOS3CGTS ¹	0.8	500	910	7.5±0.5			5.5±1.0	19±1.0	
SPR1/2CGT	0.6	2000	740	5±0.5	12.7±1.0	12.7±0.3	6.5 ^{+0.6} ₋₀	16±0.5	12
SPR1CGT	0.8	1000	770	7.5 ^{+0.8} _{-0.2}	30±1.0	15±0.3	6.5 ^{+1.0} ₋₀	19±0.7	14.5
SPR2CGT	0.8	500	540				7.5 ^{+1.0} ₋₀		17.5
SPR3CGT	0.8	500	910				8.5 ^{+1.0} ₋₀		
CFP1/4CGT	0.65	2000	720	5±0.5	12.7±1.0	12.7±0.3	6.5 ^{+0.6} ₋₀	16±0.5	12
CFPS1/2CGT	0.8	1500	600	5±0.5	12.7±1.0	12.7±0.3	6.5 ^{+0.6} ₋₀	16±0.5	12
CW1HCGT	0.8	1000	920	7.5 ^{+0.8} _{-0.2}	30±1.0	15±0.3	6.5 ^{+1.0} ₋₀	19±0.7	14.5
RF50CGT	0.8	1000	730				8.5 ^{+1.0} ₋₀		21
RF1CGT	0.8	1000	770				7.5 ^{+1.0} ₋₀		17.5
RF2CGT	0.8	500	1820				7.5 ^{+1.0} ₋₀		
CW2CGT	0.8	500	1080				8.5 ^{+1.0} ₋₀		21
CW3CGT	0.8	500	1820						

□ T.C.R.

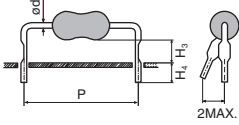
Also for MOSX, SPRX types, radial tapping in the same shape as MOS, SPR types is applicable.

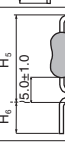
forming (not available taping)

Forming Style	Forming Type Name	Forming Dimension (mm)				Weight g/100pcs	Basic Unit (pcs)	Straight Type Name
		P±1	H3±1orH5	H4±1orH6	d			
L Forming 	CW1/2CL10A (CW1SCL10A)	10.0	5.3	4.5	0.6	24	2000	CW1/2 (CW1S)
	CW1CL12.5A (CW1PCL12.5A) (CW1HCL12.5A)	12.5	6.5	4.0	0.8	56	1000	CW1 (CW1P) (CW1H)
	CW1CL15A (CW1PCL15A) (CW1HCL15A)	15.0	5.3	4.5	0.8	56	1000	CW1 (CW1P) (CW1H)
	CW2CL15A (CW2PCL15A) (CW2HCL15A)	15.0	7.0	4.5	0.8	84	1000	CW2 (CW2P) (CW2H)
	CW2CL20A (CW2PCL20A) (CW2HCL20A)	20.0	8.0	4.5	0.8	84	1000	CW2 (CW2P) (CW2H)
	CW3CL20A (CW3PCL20A) (CW3HCL20A)	20.0	8.0	4.0	0.8	160	1000	CW3 (CW3P) (CW3H)
	CW3CL25A (CW3PCL25A) (CW3HCL25A)	25.0	7.0	4.5	0.8	160	1000	CW3 (CW3P) (CW3H)
	CW5CL30A	30.0	8.5	4.5	0.8	524	500	CW5
	CW5CL35A	35.0	5.5	4.5	0.8	524	500	CW5
	MOS1/2CL10A (MOSX1/2CL10A)	10.0	5.3±1.0	4.0±1.0	0.6	23	2000	MOS1/2 (MOSX1/2)
	MOS1CL12.5A (MOSX1CL12.5A)	12.5	7.0±1.0	4.0±1.0	0.8	31	2000	MOS1 (MOSX1)
	MOS1CL15A (MOSX1CL15A)	15.0	6.5±1.0	4.0±1.0	0.8	31	2000	MOS1 (MOSX1)
	MOS2CL15A (MOSX2CL15A)	15.0	7.0±1.0	4.0±1.0	0.8	71	2000	MOS2 (MOSX2)
	MOS2CL15F (MOSX2CL15F)	15.0	4.5±1.0	4.0±1.0	0.8	71	2000	MOS2 (MOSX2)
	MOS2CL20A (MOSX2CL20A)	20.0	9.0±1.0	4.0±1.0	0.8	71	2000	MOS2 (MOSX2)
	MOS2CL20D (MOSX2CL20D)	20.0	4.8±1.0	4.0±1.0	0.8	71	2000	MOS2 (MOSX2)
	MOS3CL20A (MOSX3CL20A)	20.0	8.0±1.0	4.0±1.0	0.8	130	1000	MOS3 (MOSX3)
	MOS3CL20C (MOSX3CL20C)	20.0	10.0±1.0	4.0±1.0	0.8	130	1000	MOS3 (MOSX3)
	MOS3CL20T (MOSX3CL20T)	20.0	4.0±1.0	4.0±1.0	0.8	130	1000	MOS3 (MOSX3)
	MOS3CL25A (MOSX3CL25A)	25.0	7.0±1.0	4.0±1.0	0.8	130	1000	MOS3 (MOSX3)
	MOS3CL30A (MOSX3CL30A)	30.0	7.0±1.0	4.0±1.0	0.8	130	1000	MOS3 (MOSX3)
	MOS5CL30A (MOSX5CL30A)	30.0	8.5±1.0	4.0±1.0	0.8	524	500	MOS5 (MOSX5)
	MOS5CL35A (MOSX5CL35A)	35.0	5.5±1.0	4.0±1.0	0.8	524	500	MOS5 (MOSX5)
	SPR1/2CL10A (SPRX1/2CL10A)	10.0	5.3	4.0	0.6	23	2000	SPR1/2 (SPRX1/2)
	SPR1CL12.5A (SPRX1CL12.5A)	12.5	6.5	4.0	0.8	54	2000	SPR1 (SPRX1)
	SPR1CL15A (SPRX1CL15A)	15.0	5.3	4.0	0.8	54	2000	SPR1 (SPRX1)
	SPR2CL15A (SPRX2CL15A)	15.0	7.0	4.0	0.8	71	2000	SPR2 (SPRX2)
	SPR2CL20A (SPRX2CL20A)	20.0	9.0	4.0	0.8	71	2000	SPR2 (SPRX2)
	SPR3CL20A (SPRX3CL20A)	20.0	8.0	4.0	0.8	141	1000	SPR3 (SPRX3)
	SPR3CL25A (SPRX3CL25A)	25.0	7.0	4.0	0.8	141	1000	SPR3 (SPRX3)
	SPR5CL30A (SPRX5CL30A)	30.0	8.5	4.0	0.8	456	500	SPR5 (SPRX5)
	SPR5CL35A (SPRX5CL35A)	35.0	5.5	4.0	0.8	456	500	SPR5 (SPRX5)
	RCR50(+)/CL15A	15.0	5.3	4.5	0.7	34	2000	RCR50 (+)
	RCR50ENCL15A	15.0	5.3	4.5	0.7	34	2000	RCR50EN
	RCR60CL15A	15.0	5.3	4.5	0.7	34	2000	RCR60
	RCR75CL15A	15.0	7.0	4.5	0.8	69	2000	RCR75
	RCR100CL20A	20.0	8.0	4.0	0.8	142	1000	RCR100
	RCR100CL25A	25.0	7.0	4.0	0.8	142	1000	RCR100
	RK1/4□CL10A	10.0	5.3	4.5	0.6	23	1000	RK1/4
	RK1□CL20A	20.0	8.8	4.5	0.8	146	1000	RK1
	CFP1/4CL10A	10.0	6.5	4.5	0.65	23	1000	CFP1/4
	CFPB1/2CL12.5A	12.5	6.5	4.5	0.65	44	1000	CFPB1/2
	RF25CL10A	10.0	5.35	5.0	0.6	23	2000	RF25
	RF50CL12.5A	12.5	6.0	5.2	0.6	29	2000	RF50
	RF50CL15A	15.0	6.0	5.3	0.6	29	2000	RF50
RF1CL12.5A	12.5	6.5	4.8	0.8	46	2000	RF1	
RF1CL15A	15.0	5.3	4.5	0.8	46	2000	RF1	
RF1CL20A	20.0	5.3	4.5	0.8	46	2000	RF1	
RF2CL20A	20.0	8.0	5.0	0.8	141	1000	RF2	
RF2CL25A	25.0	7.0	4.5	0.8	141	1000	RF2	
U Forming 	MFS1/4□CU	-	5.5Max.	15.0±1.0	0.45	14	2000	MFS1/4
	CFS1/4CU	-	5.5Max.	15.0±1.0	0.45	12	2000	CFS1/4
U Forming 	MF1/4□CU	-	9.5Max.	28.0±3.0	0.6	23	1000	MF1/4
	RK1/4□CU	-	9.5Max.	30.0±3.0	0.6	23	1000	RK1/4
	CF1/4CUCL	-	10.0Max.	10.0±1.0	0.6	23	1000	CF1/4
	CFS1/2CU	-	9.5Max.	30.0±3.0	0.6	44	1000	CFS1/2
U Forming 	MOS1CU (MOSX1CU)	-	21.0Max.	15.0Min.	0.8	55	1000	MOS1 (MOSX1)
	MOS2CU (MOSX2CU)	-	23.5Max.	15.0Min.	0.8	85	1000	MOS2 (MOSX2)
	MOS3CU (MOSX3CU)	-	26.0Max.	15.0Min.	0.8	150	1000	MOS3 (MOSX3)
	SPR1CU (SPRX1CU)	-	21.0Max.	15.0Min.	0.8	54	1000	SPR1 (SPRX1)
	SPR2CU (SPRX2CU)	-	23.5Max.	15.0Min.	0.8	93	1000	SPR2 (SPRX2)
	SPR3CU (SPRX3CU)	-	26.0Max.	15.0Min.	0.8	141	1000	SPR3 (SPRX3)
UCL Forming 	MOS1CUCL (MOSX1CUCL)	-	13.0±1.0	3.5±1.0	0.8	30	1000	MOS (X)1
	MOS2CUCL (MOSX2CUCL)	-	14.5±1.0	3.5±1.0	0.8	60	1000	MOS (X)2
	MOS3CUCL (MOSX3CUCL)	-	20.0Max.	4.0±1.0	0.8	130	1000	MOS (X)3

□ T.C.R.

Specifications given herein may be changed at any time without prior notice. Please confirm technical specifications before you order and/or use. 11/10/23

forming (not available taping)

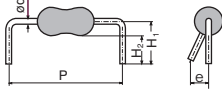
Forming Style	Forming Type Name	Forming Dimension (mm)					Weight g/100pcs	Basic Unit (pcs)	Straight Type Name
		P±1	H1	H2	e Max.	d			
 <p>M Forming</p>	MFS1/4□CM5F	5.0	-	5.0±1.0	2.0	0.45	14	2000	MFS1/4
	MFS1/4□CM5R	5.0	10.0±1.0	-	2.0	0.45	14	2000	MFS1/4
	MFS1/4□CM5W	5.0	-	15.0±1.0	2.0	0.45	14	1000	MFS1/4
	MFS1/2□CM10R	10.0	10.0±1.0	-	2.0	0.6	23	2000	MFS1/2
	MF1/4□CM10F	10.0	-	5.0±1.0	2.0	0.6	23	2000	MF1/4
	MF1/4□CM12.5R	12.5	10.0±1.0	-	2.0	0.6	23	2000	MF1/4
	MF1/2□CM12.5R	12.5	10.0±1.0	-	2.0	0.6	41	1000	MF1/2
	MF1/2□CM15R	15.0	10.0±1.0	-	2.0	0.6	41	1000	MF1/2
	SNF 2CCM5F	5.0	-	5.0±1.0	1.5	0.45	14	2000	SNF 2C
	SNF 2ECM10F	10.0	-	5.0±1.0	1.7	0.6	24	2000	SNF 2E
SNF 2ECM12.5R	12.5	10.0±1.0	-	1.7	0.6	24	2000	SNF 2E	
SNF 2HCM12.5K	12.5	7.0±1.0	-	2.0	0.7	41	2000	SNF 2H	
SNF 2HCM15K	15.0	7.0±1.0	-	2.0	0.7	41	2000	SNF 2H	
RCR16CM5F	5.0	-	5.0±1.0	2.0	0.45	14	2000	RCR16	
RCR25CM10F	10.0	-	5.0±1.0	2.0	0.6	23	2000	RCR25	
RCR25ENCM10F	10.0	-	5.0±1.0	2.0	0.6	23	2000	RCR25EN	
RCR50(+)CM15F	15.0	-	5.0±1.0	2.0	0.7	40	2000	RCR50	
RCR50CM15F	15.0	-	5.0±1.0	2.0	0.7	40	2000	RCR50+	
RCR60CM15F	15.0	-	5.0±1.0	2.0	0.7	40	2000	RCR60	
RCR100CM20E	20.0	-	4.6±1.0	2.0	0.8	120	1000	RCR100	
RK1/4□CM10F	10.0	-	5.0±1.0	1.7	0.6	21	1000	RK1/4	
RK1/4□CM10R	10.0	-	10.0±1.0	1.7	0.6	21	1000	RK1/4	
RK1/4□CM12.5R	12.5	-	10.0±1.0	1.7	0.6	23	1000	RK1/4	
RK1/2□CM15F	15.0	-	5.0±1.0	2.0	0.6	40	1000	RK1/2	
RK1/2□CM12.5F	12.5	-	5.0±1.0	2.0	0.6	37	1000	RK1/2	
RK1/2□CM15R	15.0	-	10.0±1.0	2.0	0.6	37	1000	RK1/2	
CFS1/4CM5F	5.0	5.9±1.0	5.0±1.0	1.5	0.45	12	2000	CFS1/4	
CF1/4CM10H	10.0	6.0±1.0	4.8±1.0	1.7	0.6	23	1000	CF1/4	
CF1/4CM12.5H	12.5	6.0±1.0	4.8±1.0	1.7	0.6	23	2000	CF1/4	
CFB1/2CM12.5K	12.5	7.0±1.0	5.0±1.0	1.7	0.7	44	1000	CFB1/2	
CFS1/2CM10H	10.0	6.0±1.0	4.8±1.0	1.7	0.6	26	1000	CFS1/2	
CFPS1/4CM5F	5.0	5.9±1.0	5.0±1.0	1.5	0.45	12	2000	CFPS1/4	
CFP1/4CM10H	10.0	6.0±1.0	4.8±1.0	1.7	0.6	23	1000	CFP1/4	
CFPB1/2CM12.5K	12.5	7.0±1.0	5.0±1.0	2.0	0.7	44	1000	CFPB1/2	
J1/6ZCM7.5H	7.5	-	5.0 ^{+2.0} _{-2.0}	1.5	0.5	5	1000	J1/6Z	
J1/4ZCM10H	10.0	-	5.0 ^{+2.0} _{-2.0}	1.5	0.6	9	1000	J1/4Z	
RF16CM5F	5.0	-	5.0±1.0	2.0	0.45	12	2000	RF16	
RF25CM10X	10.0	16.0±1.0	14.8±1.0	1.5	0.6	23	2000	RF25	
RF50CM12.5E	12.5	-	4.5±1.0	1.5	0.6	29	1000	RF50	
RF1CM15F	15.0	-	5.0±1.0	1.5	0.8	46	2000	RF1	
MOS1/2CM10C (MOSX1/2CM10C)	10.0	-	3.5±1.0	2.0	0.6	23	2000	MOS (X) 1/2	
MOS1/2CM10F (MOSX1/2CM10F)	10.0	-	5.0±1.0	2.0	0.6	23	2000	MOS (X) 1/2	
MOS1CM12.5C (MOSX1CM12.5C)	12.5	-	3.5±1.0	2.0	0.8	31	2000	MOS (X) 1	
MOS1CM12.5D (MOSX1CM12.5D)	12.5	-	4.0±1.0	2.0	0.8	31	2000	MOS (X) 1	
MOS1CM15F (MOSX1CM15F)	15.0	-	5.0±1.0	2.0	0.8	31	2000	MOS (X) 1	
MOS1CM15J (MOSX1CM15J)	15.0	-	6.3±1.0	2.0	0.8	31	2000	MOS (X) 1	
MOS1CM15S (MOSX1CM15S)	15.0	-	11.0±1.0	2.0	0.8	31	2000	MOS (X) 1	
MOS2CM15C (MOSX2CM15C)	15.0	-	3.5±1.0	2.0	0.8	71	2000	MOS (X) 2	
MOS2CM15E (MOSX2CM15E)	15.0	-	4.5±1.0	2.0	0.8	71	2000	MOS (X) 2	
MOS2CM20D (MOSX2CM20D)	20.0	-	4.0±1.0	2.0	0.8	71	2000	MOS (X) 2	
MOS2CM20U (MOSX2CM20U)	20.0	-	13.5±1.5	2.0	0.8	71	2000	MOS (X) 2	
MOS3CM20E (MOSX3CM20E)	20.0	-	4.6±1.0	2.0	0.8	120	1000	MOS (X) 3	
MOS3CM26E (MOSX3CM26E)	26.0	-	4.7±1.0	2.0	0.8	120	1000	MOS (X) 3	
MOS5CM30U (MOSX5CM30U)	30.0	-	13.0±1.0	2.0	0.8	456	500	MOS (X) 5	
SPR1/2CM10F (SPRX1/2CM10F)	10.0	-	5.0±1.0	2.0	0.6	23	2000	SPR1/2	
SPR1CM12.5D (SPRX1CM12.5D)	12.5	-	4.0±1.0	2.0	0.8	44	2000	SPR1	
SPR1CM15F (SPRX1CM15F)	15.0	-	5.0±1.0	2.0	0.8	44	2000	SPR1	
SPR2CM15E (SPRX2CM15E)	15.0	-	4.5±1.0	2.0	0.8	71	2000	SPR2	
SPR3CM20E (SPRX3CM20E)	20.0	-	4.6±1.0	2.0	0.8	120	1000	SPR3	

□ T.C.R.

minimum ordered quantity

Chip Components

Type	Basic Unit/Bag	Quantity /Box	Taping
RK73B, RK73H	1F~W3A2	1,000	—
RK73G	1H~2B	1,000	—
RK73Z	1F~W3A	1,000	—
RS73	1J~2B	1,000	—
HSG73P	1E~2B	1,000	—
RN73R, RN73H	1E~2E	200	—
WK73, WU73 WG73	1E~3A3	1,000	—
WN73H	1J, 2B	200	—
SR73	1H~W3A2	1,000	—
UR73, UR73D, UR73V, UR73VH, UR73VD	1E~3A	1,000	—
HV73, HV73V	1J~3A	1,000	—
SG73, SG73P, SG73S, SG73G	1E~W3A	1,000	—
SLR	1	100	—
MWS	5	—	1,500
PSF, PSL		100	—
TLR, TLRH	1J, 2A, 2BP, 2B, 2H, 3AW, 2BW, 2HW, 3AP, 3APS	100	—
SL, SLN	07, 1, 2, W07, W1, 3, 5	100	—
TSL	1	100	—
CSR	1, 2	100	—
RD41	2ES	2,000	40,000
	2E	2,000	10,000
RN41	2ES	2,000	40,000
	3AS	2,000	10,000
CC	12M	2,000	40,000
	25	2,000	10,000
CPCN	1/2	1,000	10,000
	1, 2N, 2NS	1,000	5,000
	3	500	2,000
RF73	1J~3A	200	—
LT73, LT73V	2A, 2B	200	—
LP73	1J	1,000	—
	2A, 2B	500	—
SDT73H, SDT73S, SDT73V	2B	100	—
CNN	2A	100	—
TF	10B, 16S, 16A, 16VN	100	—
CCF	1N, 1F	100	—
NV73	1H~1E	—	—
NV73, NV73DL	1J~2B	1,000	—
NV73DS	2L	500	—
RCU		100	—
RCT		100	—
RCS		100	—
RCW		100	—

() is flat container

*1 MOQ may vary depending on the country of purchase. Please contact our sales office in charge.

*2 Please contact us for other lug terminals.

Discrete Components

Type	Basic Unit/Bag	Taping
CF (CFP)	S1/4CS, S1/4	2,000
	1/4, B1/2, S1/2, 1/4CS	1,000
MF (MFP)	S1/4	2,000
	S1/2, 1/4, 1/2	1,000
SN	3A	1,000
	3D	500
SNF	2C	2,000
	2E, 2H	1,000
RNS	1/8~1	100
RK	1/4~1	1,000
RCR	16, 25	2,000
	50, 50+, 60, 75	2,000
	100	1,000
HPC	1/2	3,000
	1	1,000
	2, 3	1,000
	4, 5	500
PCF	1/2	2,000
	1	1,000
RF	2	500
	16~1	2,000
RF25CC		2,000
MOS (MOSX)	1/2~2	2,000
	3, 1U, 2U	1,000
	5	500
SPR (SPRX)	1/4	2,000
	1/2~2	2,000
	3, 1U, 2U	1,000
	5	500
CW	1/2~3	1,000
	5	500
BPR **	26, 28	(1,000)
	38	(1,000)
	58	(1,000)
	108, 55, 77	(400)
LR	6~29	1,000
BGR, BWR, BSR	2N, 3N, 5N	(1500)
	7N	(700)
	10N	(600)
BGR, BWR, BSR (Straight type)	5E, 5P	500
	1	500
	2, 3	(1000)
	5	(700)
	7, 10	(500)
	15	(320)
BGR, BSR (Lug terminal *)	20	(300)
	15, 20	500
	10~20HA, 10~20QA	400
	30 (BGR)	180
	40 (BGR)	150
	30HA, 30QA	180
BWRV, BSRV	40HA, 40QA	144
	3N, 5N	(1500)
	7N	(700)
	10N	(600)

Please refer to product pages for taping quantities.

Specifications given herein may be changed at any time without prior notice. Please confirm technical specifications before you order and/or use.

11/14/23

Discrete Components (continued)

Type	Basic Unit/Bag	Taping	
BWRV, BSRV (Straight type)	3	(1000)	—
	5	(700)	—
	7, 10	(500)	—
	15	(320)	—
	20	(300)	—
BGRV, BSRV (Lug terminal *)	15, 20	500	—
	10~20QA	400	—
	30, 40	150	—
	30~40QC	20	—
	30~40QE	75	—
BWRV (Lug terminal)	40	135	—
	40QE	75	—
Z	16	2,000	O
	25	1,000	O
J1/6Z, J1/4Z	1,000	O	
JLT	—	O	

() is flat container * Please contact us for other lug terminals.

Type	Basic Unit/Bag	Quantity /Box	Taping
GS	1/4	100	1,000 *3
	1/2	50	2,000 *3
	1	50	2,000
	2, 5, 3	10	250
	7, 10, 12	10	100
LP	1/16	100	2,000 O
	1/8	100	1,000 O
SDT101	A	100	2,000 O
	B	100	2,500 O
SDT101S	A	100	2,500 —
SDT310	HCTP,LTC,P, MTM,HLTC,AP	100	1,000 —
	VASP2B (Bulk)	100	1,000 —
	VASP2K (Tray)	200	1,000 —
PSN•PV•PSO•PN•PWW•PAP		1	—
RW	1/2	20	1000 —
	1	20	1000 —
	2~7	20	500 —
	10	20	300 —
HS	4015	—	Box (324) —
	4022	—	Box (216) —
	8018	—	Box (180) —
	8022	—	Box (120) —

Please refer to product pages for taping quantities.

*1 Custom taping for GS1/4, GS1/2 are available on request.

surface mounted device style lead forming

Ratings

Type	Forming Type Name	Carrier Type	Forming Dimensions (mm)				Quantity/Reel (pcs)	Weight (g)	
			P	T	A	d		Reel	NET/1000pcs
MOS (X) 1C	N14.5	TEB	14.5 ± 1	5.0 ± 0.5	4.8 ± 0.5	0.8	1000	700	350
MOS (X) 2C SPR(X) 2C RCR75C CW2C	N17	TEB	17.0 ± 1	6.0 ± 0.5	5.8 ± 0.5	0.8	1000	900	600
MOS (X) 3 SPR(X) 3 RCR100 CW3C	N20	TEG	20.0 ± 1	7.5 ± 1	6.5 ± 0.5	0.8	900	1,800	1,400

Forming Style

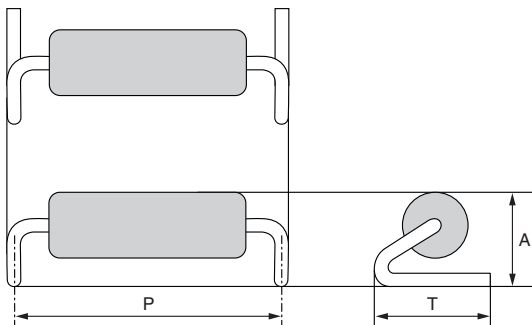

Packaging Specifications

Carrier tape: TEB (N14.5, N17)

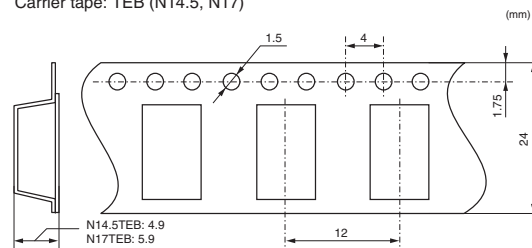

Carrier tape: TEG (N20)

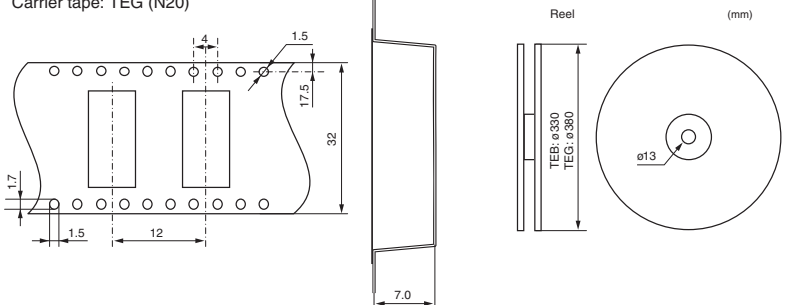

Recommended Pad Dimensions

Type	Forming Type Name	Forming Dimensions (mm)			
		A	B	C	D
MOS (X) 1C	N14.5TEB	12.5	16.5	7.0	2.0
MOS (X) 2C SPR(X) 2C RCR75C CW2C	N17TEB	14.6	19.4	8.0	2.4
MOS (X) 3 SPR(X) 3 RCR100 CW3C	N20TEG	17.6	22.4	9.5	2.4

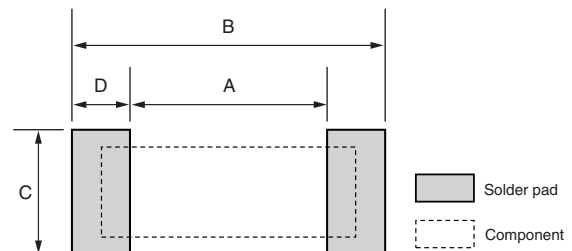

- Need a dedicated nozzle for automatic mounting. Please ask us before use.

marking

KSE Part Designation		Color		Marking Type
		Body	Marking	
BGR, BSR BWR, BGRV BSRV, BWRV	1-40	White	Black	Alphanumeric
BPR	2-77	White	Black	Alphanumeric
CC	12M-25	Blue	Black	1 Color Band
CCF	1N-1F	White	Black	Alphanumeric
CF	1/4	Venetian Red	Various	4 Color Bands
CFB, CFS	1/2	Venetian Red	Various	4 Color Bands
CFP, CFPS	1/4-1/2	Green	Various	4 Color Bands
CFS	1/4	Ivory	Various	4 Color Bands
CNN	2A	Green	Yellow	Dot + 2 Digits
CPCN	1/2-3	Gray	None	None
CSR	1-2	Black	White	Alphanumeric
CW, CW_X	1/2-5	Blue	Various	4 Color Bands
	1/4	Green	Various	4 Color Bands
CW_H	1-3	Black	Silver	Alphanumeric
CW_P	1-3	Blue	Black	Alphanumeric
CW_S	1	Black	Silver	Alphanumeric
CW_SS	1	Black	Silver	2 Color Bands
CWFS	23-35	Gray	Black	Alphanumeric
GS	1/4-12	Brown	Silver	Alphanumeric
HPC	1/2-5	Reddish Brown	White	Alphanumeric
HS	4015-8022	Copper	Laser	QR Code (optional)
HSG73P HSG73P-RT	1E-2B	Black	None	None
HV73 HV73-RT HV73V HV73V-RT	1J 2A-3B	Black	White	3 Digits (E-24) None (E-96)
HVD	P08	Black	Laser	Alphanumeric
JL	5-8	Silver	None	None
J-Z	1/6-1/4	Black	None	None
LP	1/16	Ivory	Various	5 Color Bands
	1/8	Brown	Various	5 Color Bands
LP73	1J-2B	Black	White	Alphanumeric
LR	06-29	Silver	None	None
LR72	2A-2C	Silver	Stamped	Alphanumeric
LT73, LT73V	2A-2B	Orange	Black	4 Digits
MF MFS RK	1/4-1	Light Gray	Various	5 Color Bands (0.5%-1%)
				4 Color Bands (2%-5%)
MHL	1E-1J	Black	None	None
MOS MOSX	1/2-1	Lavender	Various	5 Color Bands (1%) 4 Color Bands (2%-5%)
	2-5	Lavender	Black	Alphanumeric
MWS	5	Black	Laser	Alphanumeric
NV73 NV73DL	1E-2B	Black	None	None
NV73S	2E-2LH	Black	None	None
PAP, PN PSN, PSO PV, PWW	0.5-8	Red	Black	Alphanumeric
PCF	1/2-2	Light Green	Various	4 Color Bands
PSF	4	Copper	None	None
PSL	2	Copper	None	None

KSE Part Designation		Color		Marking Type
		Body	Marking	
RB(X), RD(X) RIA, RNX RTX, RTY	S03-Q24	Black	Laser	Alphanumeric
RC	U-W	Silver	None	None
RCR	16	Blue Gray	Various	5 Color Bands (1%) 4 Color Bands (5%)
	25, 25EN 75, 100	Blue Gray	Various	5 Color Bands (1%) 4 Color Bands + 1 Black Color Band (5%)
	50	Blue Gray	Various	4 Color Bands + 1 Black Color Band (E-24 Values) 5 Color Bands (E-96 Values)
	50+, 50EN	Blue Gray	Various	4 Color Bands + 1 Green Color Band (E-24 Values) 5 Color Bands (E-96 Values)
RD41	2ES-2E	Ivory	Various	3 Color Bands
	16-2	Blue	Various	4 Color Bands
RF	25CC	Blue	Various	4 Color Bands + 1 Green Color Band
	1J	Brown	None	None
RF73	2A-3A	Brown	Black	3 Digits
	1F-1E	Black	None	None
RK73B RK73B-RT	1J-W3A2	Black	White	3 Digits
	1E-2B	Black	None	None
RK73B-AT	1H-1E	Black	None	None
RK73G RK73G-RT	1J	Dark Blue	White	3 Digits (E-24) None (E-96)
	2A-2B	Dark Blue,	White	4 Digits
RK73G-AT	1E-2B	Dark Blue	None	None
RK73H RK73H-RT	1F, 1H	Black	None	None
	1E	Blue	None	None
	1J	Blue	Black	3 Digits (E-24) None (E-96)
RK73H-AT	2A-W3A2	Blue	Black	4 Digits
	1E-2B	Blue	None	None
RK73Z RK73Z-RT	1F	Black	None	None
	1H-1E	Green	None	None
	1J	Black	White	0
RK73Z-AT	2A-W3A	Black	White, None (AT)	000
	1E-2B	Black	None	None
RN41	2ES-3AS	Blue	Various	5 Color Bands (0.1%-1%) 4 Color Bands (5%)
	1E	Black	None	None
RN73H	1J	Black	Red (5ppm, 10ppm)	3 Digits (E-24) [None above 360kΩ] None (E-96, E-192)
			Yellow (25ppm, 50ppm, 100ppm)	

marking (continued)

KSE Part Designation		Color		Marking Type
		Body	Marking	
RN73H	2A	Black	Red (5ppm, 10ppm) Yellow (25ppm, 50ppm, 100ppm)	4 Digits (E-24, E-96) [None above 1MΩ] None (E-192)
	2B-2E	Black	Red (5ppm, 10ppm) Yellow (25ppm, 50ppm, 100ppm)	4 Digits (E-24, E-96) None (E-192)
RN73R	1E-2E	Black	None	None
RNS	1/8-1	Light Gray	Black	Alphanumeric
RS73 RS73-RT	1E-2B	Black	None	None
RW	1/2-10	Black	Silver	Alphanumeric
SDT101	A	Ivory	Various	5 Color Bands
	B	Transparent Brown	None	None
	SA	Ivory	None	None
SDT310	AP, HCTP HLTC, LTC MTM, P VASP2	White	None	None
SDT73H SDT73V	2B	Black	None	None
SDT73S	2B	Milky White	None	None
SG73 AT	1J- 2B	Wine Red	None	None
SG73 SG73-RT	1J-W3A	Wine Red	White	3 Digits
SG73G	1J-2B	Green	None	None
SG73G-AT	1J-2B	Green	None	None
SG73P AT	1J- 2B	Green	None	None
SG73P SG73P-RT	1E	Black	None	None
	1J	Green	None	None
SG73S AT	2A-2E1	Green	Black	3 Digits (E-24) None (E-96)
SG73S SG73S-RT	1J- 2B	Green	None	None
	1E	Black	None	None
	1J	Green	None	None
SL	07	Black	White	4 Digits (1%) 3 Digits (5%)
	1-3	Black	White	Alphanumeric
SLN	2-5	Black	Laser	Alphanumeric
SLR	1	Black	Laser	Alphanumeric
SLW	07	Black	White	4 Digits (1%) 3 Digits (5%)
	1	Black	White	Alphanumeric
SLZ	1	Black	White	0Ω
SN	3A-3D	Light Gray	Various	5 Color Bands (0.5%-1%) 4 Color Bands (2%)
SNF	2C-2H	Light Blue	Various	4 Color Bands
SPR SPRX	1/4-1	Light Green	Various	5 Color Bands (1%) 4 Color Bands (2%-5%)
	2-5	Light Green	Black	Alphanumeric

KSE Part Designation		Color		Marking Type	
		Body	Marking		
SR73	1E	Indigo	None	None	
	1H	Black	None	None	
	1J	Indigo	White	None (1%) 3 Digits (2%-5%)	
	2A-W3A2	Indigo	White	4 Digits (0.5%-1%) 3 Digits (2%-5%)	
SR73-RT	1E	Black	None	None	
	1J	Black	White	None (1%) 3 Digits (2%-5%)	
	2A-2E	Black	White	4 Digits	
TF	10BN 16SN 16VN	Black	White	1 Letter (Rating Code)	
	16AT	Black	Blue	1 Letter (Rating Code)	
TLR	2A 2BP (1mΩ-1.5mΩ) 2BW (1mΩ-1.5mΩ) 3AP (0.5mΩ-1.5mΩ) 3APS (2mΩ)	Black	None	None	
	2B (1mΩ-1.5mΩ) 2BN (1mΩ-1.5mΩ)	Black	White	4 Digits	
	2B (2mΩ-20mΩ) 2BN (2mΩ-20mΩ) 2H, 3AW (2mΩ-10mΩ)	Silver	Black	4 Digits	
	2BP (0.5mΩ, 2mΩ-20mΩ) 2BW (0.5mΩ, 2mΩ-20mΩ) 2HW, 3AP (2mΩ-10mΩ) 3APS (3mΩ)	Silver	None	None	
	3AW (0.5mΩ-1.5mΩ)	Black	Laser	4 Digits	
	2A	Black	None	None	
	3AW-3AP	Black	Laser	4 Digits	
	TLRH	1E-2B	Silver	None	None
	TSL	1	Black	White	Alphanumeric
	UR73	2A-2B	Indigo	White	4 Digits
UR73D	1E-1J	White	None	None	
	2A-3A	White	Black	4 Digits	
UR73V UR73VH	2A-2B	Black	None	None	
UR73VD	2A-2B	White	None	None	
WG73	2B, 3A	Wine Red	None	None	
	2H	Wine Red	White	3 Digits	
WK73R WK73R-RT WK73S WK73S-RT	1E-2A 2B-3A3	Black	White	3 Digits (E-24) None (E-96)	
WN73H	1J, 2B	Black	None	None	
WU73	2B-2B15	Black	None	None	
Z	16, 25Y	Ivory	Black	1 Color Band	
	25	Venetian Red	Black	1 Color Band	

significant figures of nominal resistance

E-12 Decade Values					
10	12	15	18	22	27
33	39	47	56	68	82
E-24 Decade Values					
10	11	12	13	15	16
18	20	22	24	27	30
33	36	39	43	47	51
56	62	68	75	82	91
E-96 Decade Values					
100	102	105	107	110	113
115	118	121	124	127	130
133	137	140	143	147	150
154	158	162	165	169	174
178	182	187	191	196	200
205	210	215	221	226	232
237	243	249	255	261	267
274	280	287	294	301	309
316	324	332	340	348	357
365	374	383	392	402	412
422	432	442	453	464	475
487	499	511	523	536	549
562	576	590	604	619	634
649	665	681	698	715	732
750	768	787	806	825	845
866	887	909	931	953	976
E-192 Decade Values					
100	101	102	104	105	106
107	109	110	111	113	114
115	117	118	120	121	123
124	126	127	129	130	132
133	135	137	138	140	142
143	145	147	149	150	152
154	156	158	160	162	164
165	167	169	172	174	176
178	180	182	184	187	189
191	193	196	198	200	203
205	208	210	213	215	218
221	223	226	229	232	234
237	240	243	246	249	252
255	258	261	264	267	271
274	277	280	284	287	291
294	298	301	305	309	312
316	320	324	328	332	336
340	344	348	352	357	361
365	370	374	379	383	388
392	397	402	407	412	417
422	427	432	437	442	448
453	459	464	470	475	481
487	493	499	505	511	517
523	530	536	542	549	556
562	569	576	583	590	597
604	612	619	626	634	642
649	657	665	673	681	690
698	706	715	723	732	741
750	759	768	777	787	796
806	816	825	835	845	856
866	876	887	898	909	920
931	942	953	965	976	988



surface mount resistors

Anti-Sulfur Precision Flat Chip Resistors

RK73H1ERT-Kit1 (0402 chip size)
122 values, 100 pcs each

RK73H1JRT-Kit1 (0603 chip size)
122 values, 100 pcs each

Precision Flat Chip Resistors

RK73H1FTK001Kit (01005 chip size)
38 values, Lead-free, 25 pcs each (10R0 ~ 620K = $\pm 1\%$)

RK73H1HTK001Kit (0201 chip size)
217 values, Lead-free, 50 pcs each (0, 10R0 ~ 1M00 = $\pm 1\%$)

RK73H1ETK001 (0402 chip size)
122 values, Lead-free, 100 pcs each (0, 10R0 ~ 1M00 = $\pm 1\%$) E-24

RK73H1JTK001 (0603 chip size)
122 values, Lead-free, 100 pcs each (0, 10R0 ~ 1M00 = $\pm 1\%$) E-24

RK73H2ATK001 (0805 chip size)
122 values, Lead-free, 100 pcs each (0, 10R0 ~ 1M00 = $\pm 1\%$)

RK73H2BTK001 (1206 chip size)
122 values, Lead-free, 100 pcs each (0, 10R0 ~ 1M00 = $\pm 1\%$)

General Purpose Flat Chip Resistors

RK73B1FTK001Kit (01005 chip size)
51 values, Lead-free, 25 pcs each (0, 10 ~ 1M = $\pm 5\%$)

RK73B1HTK001Kit (0201 chip size)
139 values, Lead-free, 50 pcs each (0, 2R2 ~ 2M2 = $\pm 5\%$)

High Voltage Flat Chip Resistors

HV73TK001Kit (0603, 0805, 1206, 2010 chip sizes)
156 values, Lead-free, 25 pcs each (10k ~ 10M = $+1\%$)

Surge Current Flat Chip Resistors

SG73TK001Kit (0603, 0805, 1206, 1210, 2010, 2512 chip sizes)
204 values, $\pm 10\%$, Lead-free, 25 pcs each

SG73STK001Kit (0603, 0805, 1206, 1210 chip sizes)
101 values, $\pm 1\%$, Lead-free, 25 pcs each

SG73PTK001Kit (0603, 0805, 1206, 1210 chip sizes)
97 values, $\pm 1\%$, Lead-free, 25 pcs each

Wide Terminal Flat Chip Resistors

NEW WK731JT-Kit1 (0306 chip size)
73 values, lead-free, 100 pcs each ($\pm 1\%$)

NEW WK732AT-Kit1 (0508 chip size)
138 values, lead-free, 100 pcs each ($\pm 1\%$)

WK73TK001Kit (0612, 1020 & 1225 chip sizes)
64 values, Lead-free, 25 pcs each ($\pm 1\%$, $\pm 5\%$)

WU73TK001Kit (0612 chip sizes)
27 values, 20 pcs each ($\pm 1\%$)

Circuit Protection - Fuses

CCFTK001Kit (2410 chip size)
18 values, Lead-free, 20 pcs each

FuseKit-TF10BN (0402 chip size)
12 values, Lead-free, 100 pcs each

FuseKit-TF16SN (0603 chip size)
14 values, Lead-free, 100 pcs each

FuseKit-TF16AT (0603 chip size)
13 values, Lead-free, 100 pcs each

Ultra Precision Flat Chip Resistor

RN73H1ET-Kit (0402 chip size)
49 values, Lead-free, 50 pcs each ($\pm 0.1\%$, 25ppm $^{\circ}$ C)

RN73H1JT-Kit (0603 chip size)
67 values, Lead-free, 50 pcs each ($\pm 0.1\%$, 25ppm $^{\circ}$ C)

RN73H2AT-Kit (0805 chip size)
73 values, Lead-free, 50 pcs each ($\pm 0.1\%$, 25ppm $^{\circ}$ C)

RN73R1ET-Kit1 (0402 chip size)
49 values, Lead-free, 100 pcs each ($\pm 0.1\%$, 25ppm $^{\circ}$ C)

RN73R1JT-Kit1 (0603 chip size)
67 values, Lead-free, 100 pcs each ($\pm 0.1\%$, 25ppm $^{\circ}$ C)

RN73R2AT-Kit1 (0805 chip size)
73 values, Lead-free, 100 pcs each ($\pm 0.1\%$, 25ppm $^{\circ}$ C)

RN73R2BT-Kit1 (1206 chip size)
74 values, Lead-free, 100 pcs each ($\pm 0.1\%$, 25ppm $^{\circ}$ C)

NEW RS73F1ET-Kit1 0402 chip size)
86 values, Lead-free, 100 pcs each ($\pm 0.1\%$, 25ppm $^{\circ}$ C)

RS73F1JT-Kit1 (0603 chip size)
121 values, Lead-free, 100 pcs each ($\pm 0.1\%$, 25ppm $^{\circ}$ C)

NEW RS73F2AT-Kit1 (0805 chip size)
121 values, Lead-free, 100 pcs each ($\pm 0.1\%$, 25ppm $^{\circ}$ C)

NEW RS73F2BT-Kit1 (1206 chip size)
121 values, Lead-free, 100 pcs each ($\pm 0.1\%$, 25ppm $^{\circ}$ C)

NOTE: Reference product data pages for available values.

current sense resistors

Surface Mount Molded

SLW07TK001Kit (2010, 1W size)

27 values, 20 pcs each ($\pm 1\%$).

SLW1TK001Kit (2512, 1.5W size)

25 values, 20 pcs each ($\pm 0.5\%$).

SL1TK001Kit (2512, 1W size)

33 values, 20 pcs each ($\pm 1\%$).

SL2TK001Kit (4528, 2W size)

45 values, 20 pcs each ($\pm 1\%$).

SL3TK001Kit (4528, 3W size)

33 values, 20 pcs each ($\pm 1\%$).

SLN3TK001Kit (4528, 3W size)

32 values, 20 pcs each ($\pm 0.5\%$).

SLN5TK001Kit (4528, 5W size)

21 values, 10 pcs each ($\pm 0.5\%$).

TSL1TK001Kit (2512, 1W size)

33 values, Lead-free, 20 pcs each ($\pm 1\%$).

SLRTK001Kit (2513, 1W size)

40 values, 15 pcs each ($\pm 1\%$).

Metal Plate

TLR2ATK001Kit (0805 chip size)

6 values, complete range, 20 pcs each ($\pm 1\%$).

TLR2BWD-Kit (1206 chip size)

17 values, 15 pcs each ($\pm 1\%$).

TLR2HW-Kit (2010 chip size)

10 values, 15 pcs each ($\pm 1\%$).

TLR3APD-Kit (2512 chip size)

10 values, 20 pcs each ($\pm 1\%$).

TLRDK001Kit (1206, 1210, 2512 chip sizes)

36 values, Lead-free, complete range, 20 pcs each ($\pm 1\%$).

TLR2BP-Kit (1206 chip size)

17 values, 15 pcs each ($\pm 1\%$).

Chip Resistors

UR73TK001Kit (0402, 0603, 0805, 1206, 2512 chip sizes)

144 values, Lead-free, 20 pcs each ($\pm 1\%$).

UR73VTK001Kit (1206 chip sizes)

8 values, 20 pcs each ($\pm 1\%$).

Thick Film

SR731HTK001Kit (0201 chip size)

29 values, Lead-free, 50 pcs each (R47 ~ 10R0, $\pm 1\%$, $\pm 5\%$)

SR731ETK001Kit (0402 chip size)

25 values, Lead-free, 50 pcs each (R100 ~ 1R00, $\pm 1\%$)

SR731JTK001Kit (0603 chip size)

49 values, Lead-free, 50 pcs each (R100 ~ 10R0, $\pm 1\%$)

SR732ATK001Kit (0805 chip size)

49 values, Lead-free, 50 pcs each (R100 ~ 10R0, $\pm 1\%$)

SR732BTK001Kit (1206 chip size)

49 values, Lead-free, 50 pcs each (R100 ~ 10R0, $\pm 1\%$)

SR732ETK001Kit (1210 chip size)

49 values, Lead-free, 50 pcs each (R100 ~ 10R0, $\pm 1\%$)

SR732HTK001Kit (2010 chip size)

49 values, Lead-free, 50 pcs each (R100 ~ 10R0, $\pm 1\%$)

SR733ATK001Kit (2512 chip size)

49 values, Lead-free, 50 pcs each (R100 ~ 10R0, $\pm 1\%$)

Power Shunt

PSF4-Kit (1216 chip size)

2 values, Lead-free, 10 pcs each ($\pm 1\%$).

PSL2-Kit (2512 chip size)

3 values, Lead-free, 10 pcs each ($\pm 1\%$).

NOTE: Reference product data pages for available values.

APM Naltron

1100 Town Plaza Court
(Suite 1020-B)
Winter Springs, FL 32708
PH: 813-886-2457

Carlberg & Associates

425 E. 11th Ave
Mesa, AZ 85204
PH: 602-909-8066
FX: 480-460-1123

CBA Empire

144 North Beverwyck Road
Lake Hiawatha, NY 07034
PH: 508-820-0800
FX: 508-820-4607

DL Marketing

405 Ave Esmeralda
Guaynabo, PR 00969
PH: 787-640-0488 (Cell)

Fastec Mexico SA DE CV

Ontario #1791-9
Col. Colomos Providencia
Guadalajara, Jalisco 44660
Mexico
PH: 011-52-33-3641-5051
FX: 011-52-33-3641-5052

FH Sales

6800 W. 107th Street (Suite 200)
Overland Park, KS 66212
PH: 913-648-6811
FX: 913-648-6823

Greenslade Sales, Inc.

505 E. Golf Road (Suite A)
Arlington Heights, IL 60005
PH: 847-593-3450
FX: 847-593-3468

Halbar – RTS

1110 8th St
Kirkland, WA 98033
PH: 425-893-8400
FX: 425-893-8500

Halbar – RTS

8196 SW Hall Blvd. (Suite 115)
Beaverton, OR 97008
PH: 503-624-5741
FX: 503-684-1803

Hughes Cain & Associates

2221 Justin Rd (#119-329)
Flower Mound, TX 75028
PH: 214-995-1034

Hughes Cain & Associates

108 Timberlake Drive
Kingsland, TX 78639
PH: 512-826-3039

JLT & Associates

22 Shaver Ave. N.
Toronto, ON M98 4N4
Canada
PH: 416-207-9788

John F. Kilfoil Company

9200 Montgomery Rd
(Suite 3A/4A)
Cincinnati, OH 45209
PH: 513-791-6150
FX: 513-791-6153

John F. Kilfoil – Michigan

37875 West Twelve Mile Road
Farmington Hills, MI 48331
PH: 513-791-6150

Meridian Marketing

10800 E. Bethany Dr.
(Suite 264)
Aurora, CO 80014
PH: 303-790-7171

Metz-Jade Associates, Inc.

Paoli Executive Green II
(Suite 201)
43 Leopard Rd
Paoli, PA 19301
PH: 484-318-7779
FX: 484-318-7842

Northeast Representatives

PO Box 447
570 Pleasant St (Shipments)
Marshfield, MA 02051
PH: 781-837-8788
FX: 781-837-9342

Rep One Associates, Inc.

3 Turnbridge Lane
Huntsville, AL 35802
PH: 256-539-7371

Straube Associates (SAI)

333 W. Maude Ave. (Suite 205)
Sunnyvale, CA 94085
PH: 650-969-6060

Tradecom

Rua Sansao Alves dos Santos
433-CJ 61 - Brooklin Novo
Sao Paulo - SP
Brazil - 04571-090
PH: (55) 11 5507-2627
FX: (55) 11 5505-7905

Tri-Tech Electronics, Inc.

2200 West Ridge Rd
(Suite 100)
Rochester, NY 14626
PH: 585-385-6500

Victory Sales America, Inc.

4600 W. 77th St. (Suite 205)
Edina, MN 55435
PH: 612-615-9777
FX: 651-994-6978

Westrep CA

400 N. Tustin Ave (Suite 130)
Santa Ana, CA 92705
PH: 714-527-2822
FX: 714-527-3868

corporate information

Name	Branch Location	Street	City/Zip	State	Phone
Arrow Electronics	See Below	9201 East Dry Creek Road	Centennial	CO	303-824-4000
Brevan Electronics, Inc.	Corporate	109 Northeastern Boulevard	Nashua	NH	603-429-1900
Carlton-Bates	Corporate	3600 W. 69th Street	Little Rock	AR	844-284-3700
Digi - Key	Corporate	701 Brooks Avenue South	Thief River Falls	MN	800-344-4539
GW Electronics	Corporate	1833 Executive Drive	Oconomowoc	WI	262-567-9445
Hughes-Peters	See Below	8000 Technology Boulevard	Huber Heights	OH	973-586-9000
Justin Electronics	Corporate	400 Oser Avenue, Suite #800	Hauppauge	NY	631-951-4900
M3 Technology	Corporate	58 Sawgrass Drive	Bellport	NY	631-205-0005
Mouser	Corporate	1000 N Main St	Mansfield	TX	817-804-3800
REM Electronics	See Below	525 S. Park Avenue	Warren	OH	330-373-1300
Rutronik	See Below	2745 N. Dallas Parkway	Plano	TX	469-782-0900
TTI	See Below	2441 Northeast Parkway	Fort Worth	TX	817-740-9000
Verical	Corporate	9201 East Dry Creek Road	Centennial	CO	303-824-4000

branch locations

State	City/Zip	Name	Street	Phone
AL	Huntsville	Arrow Electronics	1300 Meridian Street (Ste 200)	256-864-3300
	Huntsville	TTI, Inc.	4725 Whitesburg Drive (Ste 201)	256-721-1597
AR	Little Rock	Carlton-Bates	3600 W. 69th Street	501-562-9100
AZ	Phoenix	Arrow Electronics	1955 East Sky Harbor Circle N	602-256-2290
	Tempe	TTI, Inc.	2151 East Broadway Road (Ste 211)	480-638-1590
CA	Foothill Ranch	Arrow Electronics	26632 Towne Centre Drive (Ste 100)	949-380-4700
	San Diego	Arrow Electronics	10089 Willow Creek Road (Ste 225)	858-536-7600
	San Jose	Arrow Electronics	1650 Technology Drive (Ste 200)	669-342-3800
	Woodland Hills	Arrow Electronics	20935 Warner Center Lane	818-932-1000
	Chatsworth	TTI, Inc.	9121 Oakdale Avenue (Ste 200)	818-407-8000
	Fremont	TTI, Inc.	48371 Fremont Blvd. (Ste 107)	510-668-0830
	Poway	TTI, Inc.	13475 Danielson Street (Ste 210)	858-748-2025
	Tustin	TTI, Inc.	14511 Myford Road (Ste 210)	714-505-4857
CO	Centennial	Arrow Electronics	9201 East Dry Creek Road	303-824-4000
	Westminster	TTI, Inc.	9035 Wadsworth Pkwy (Ste 1600)	303-427-0241
CT	Wallingford	TTI, Inc.	8 Fairfield Blvd. (Ste 109)	203-949-6262
FL	Lake Mary	Arrow Electronics	100 Colonial Center Pkwy (Ste 250)	321-233-8800
	Coral Springs	Rutronik	3111 N. University Drive (Ste 1050)	954-799-8430
	Boca Raton	Hughes-Peters	2255 Glades Rd (Ste 324A)	954-973-7103
	Orlando	Hughes-Peters	4494 North John Young Parkway	407-849-6060
	Orlando	TTI, Inc.	5810 Hoffner Avenue (Ste 801)	407-273-6977
GA	Alpharetta	Arrow Electronics	Deerfield Corporate Center One 13010 Morris Road (Ste 600)	770-495-5200
IL	Itasca	Arrow Electronics	1160 Springlake Drive	630-250-0500
	Downers Grove	Hughes-Peters	5221 Thatcher Road	847-768-7452
	Schaumburg	TTI, Inc.	915 National Parkway (Ste 30 Entrance D)	847-884-6500
IN	Indianapolis	Arrow Electronics	3077 E. 98th Street (Ste 160)	317-810-6250
	Indianapolis	Hughes-Peters	5333 Commerce Square Drive (Unit B)	317-882-1188
KS	Mission	TTI, Inc.	6405 Metcalf Ave (Ste 105)	913-789-6427
MA	Peabody	Arrow Electronics	4 Technology Drive	978-538-8500
	Tewksbury	TTI, Inc.	Three Highwood Drive	978-851-2000

branch locations (continued)

State	City/Zip	Name	Street	Phone
MD	Columbia	Arrow Electronics	7067 Columbia Gateway Drive	410-312-4600
	Columbia	TTI, Inc.	6304 Woodside Court (Ste 115)	410-995-6627
MI	Plymouth	Arrow Electronics	44760 Helm Street	734-335-9260
MN	Bloomington	Arrow Electronics	10900 Hampshire Ave. S	952-828-5350
	Thief River Falls	Digi - Key	701 Brooks Avenue South	800-344-4539
	Minnetonka	Hughes-Peters	13911 Rignedale Drive (Ste 402)	952-544-0969
	Minneapolis	TTI, Inc.	7825 Washington Avenue South (Ste 800)	952-829-7200
MO	Earth City	Arrow Electronics	514 Earth City Expressway (Ste 321)	314-725-4164
NC	Raleigh	TTI, Inc.	220 Horizon Drive (Ste 203)	919-876-8922
NH	Nashau	Brevan Electronics, Inc.	109 Northeastern Blvd.	603-429-1900
NJ	Parsippany	Hughes-Peters	7 Campus Drive (Ste 100)	973-586-9000
	Mount Laurel	TTI, Inc.	305 Fellowship Road (Ste 100)	856-234-6400
NY	Islandia	Arrow Electronics	2950 Expressway Drive North	631-851-2300
	Pittsford	Arrow Electronics	1000 Pittsford-Victor Rd (2nd Floor)	585-427-0300
	Bellport	M3 Technology	58 Sawgrass Drive	631-205-0005
	Ronkonkoma	TTI, Inc.	3281 Veterans Highway (Ste E-3)	631-737-2000
	Victor	TTI, Inc.	7640 Omnitech Pl (Ste 5-C)	203-949-6262
OH	Huber Heights	Hughes-Peters	8000 Technology Blvd.	937-235-7100
	Warren	REM Electronics	525 S. Park Avenue	330-373-1300
	Dayton (Centerville)	TTI, Inc.	10564 Success Lane (Ste B)	937-885-6270
	Independence	TTI, Inc.	Corporate Plaza 2 6480 Rockside Woods Blvd. (Ste 110)	216-524-2810
OR	Beaverton	Arrow Electronics	6600 SW 105th Avenue (Ste 100)	503-629-1400
	Beaverton	TTI, Inc.	8700 SW Nimbus Avenue (Ste B)	503-644-4560
PA	McKean	Hughes-Peters	9003 Main Street (Ste 5) McKean Plaza	814-476-1025
	Erie	REM Electronics Inc.	2126 Filmore Avenue (#5)	814-453-5626
TX	Plano	Arrow Electronics	1820 Preston Park Blvd.	972-985-6600
	Stafford	Hughes-Peters	10701 Corporate Drive (Ste 244)	281-565-1181
	Mansfield	Mouser Electronics, Inc.	1000 N. Main Street	817-804-3800
	Houston	TTI, Inc.	7102 N Sam Houston Pkwy (Ste 130)	713-339-2700
	Irving	TTI, Inc.	4600 Fuller Drive (Ste 100)	972-594-5900
	Fort Worth	TTI, Inc. (Mexico & Latin America)	5050 Mark IV Parkway	817-624-6380
	Fort Worth	TTI, Inc. (Telemarketing)	2441 Northeast Parkway	817-624-6380
	Fort Worth	TTI, Inc. (Teleservices & BDG)	2441 Northeast Parkway	817-624-6380
	Fort Worth	TTI, Inc.	2441 Northeast Parkway	817-624-6380
WA	Bellevue	Arrow Electronics	3380 146th Pl SE	425-643-9992
	Redmond	TTI, Inc.	11121 Willows Road NE (Ste 130)	425-882-0291
WI	Brookfield	Arrow Electronics	400 N. Executive Drive (Ste 112)	262-879-0434
	Oconomowoc	GW Electronics	1833 Executive Drive	262-567-9445
	Brookfield	Hughes-Peters	325 N Corporate Drive (Ste 250)	262-505-5841
	Brookfield	TTI, Inc.	175 North Patrick Blvd (Ste 160)	262-797-9233
Canada				
Ontario	Mississauga	Arrow Electronics	171 Superior Boulevard (Unit 2)	905-670-7769
	Woodbridge	TTI, Inc.	261 Milani Blvd. (Ste 201)	905-850-3003
Quebec	Dorval	Arrow Electronics	1255 Route Transcanadienne	418-871-9008
	Pointe-Claire	TTI, Inc.	52 Hymus Boulevard (Ste 102)	514-426-1212

Specifications given herein may be changed at any time without prior notice. Please confirm technical specifications before you order and/or use.

11/30/23

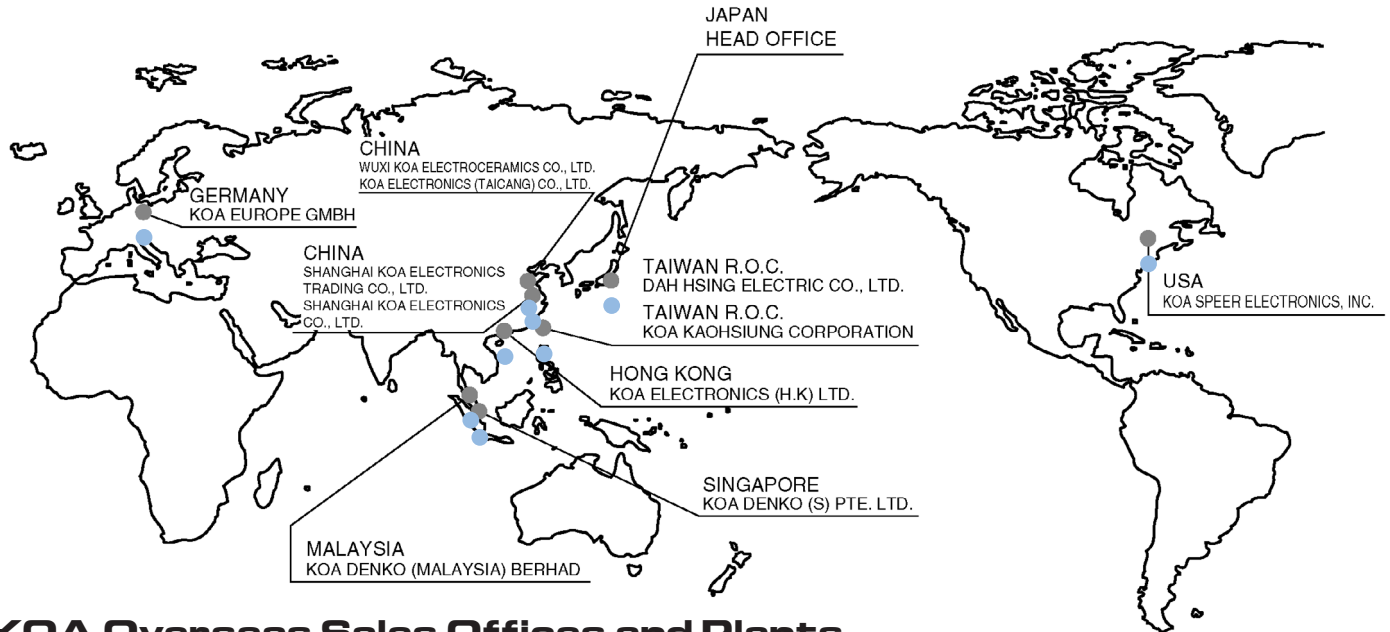

KOA Overseas Sales Offices and Plants

Office Name	Address	
Global Sales Center	2-17-2 Midori-Cho, Fuchu-Shi, Tokyo 183-0006 Japan	(Tel) (+81)42-336-5755 (Fax) (+81)42-336-5353
USA		
KOA Speer Electronics, Inc.	199 Bolivar Drive, Bradford, PA 16701, USA http://www.koaspeer.com/	(Tel) 1-814-362-5536 (Fax) 1-814-362-8883
Germany		
KOA Europe Gmbh	Kaddenbusch 6, D-25578 Dageling Itzehoe, Germany http://www.koaeurope.de/	(Tel) 49-4821-8989-0 (Fax) 49-4821-8989-89
Via Electronic Gmbh	Robert-Friese-Straße3, D-07629 Hermsdorf, Germany https://via-electronic.de/	(Tel) (49) 036601-9298-0 (Fax) (49) 036601-9298-110
Singapore		
KOA Denko (S) Pte., Ltd	80 Bendemeer Road #03-01 Luzerne, Singapore 339949 http://www.koaspore.com.sg/	(Tel) 65-63395151 (Fax) 65-63398556
Thailand		
KOA Denko (S) Pte., Ltd Thailand Representative Office	319 Chamchuri Square Building 24th Floor, Room 24101, Phayathai Road, Pathumwan Bangkok 10330 Thailand	(Tel) (+66) 2007-2427
Malaysia		
KOA Denko (Malaysia) Sdn.Bhd.	Lot 7.8&9 Batu Berendam (Ftz) 75350 Melaka, Malaysia.	(Tel) 60-6-2328031 (Fax) 60-6-2313171
China		
Shanghai KOA Electronics Co., Ltd.	No.581 Guiping Road,Cao He Jing, Shanghai, China	(Tel) 86-21-64850723 (Fax) 86-21-64852960
Shanghai KOA Electronics Trading Co., Ltd.	No.581 Guiping Road,Cao He Jing, Shanghai, China http://www.koaglobal.com.cn/	(Tel) 86-21-64320101 (Fax) 86-21-64320083
Shanghai KOA Electronics Trading Co., Ltd. Tianjin Branch	Rm 823, No.219, Nanjing Rd, Heping District Tianjin, China	(Tel) 86-21-64320101 (Fax) 86-21-64320083
KOA Electronics (Taicang) Co., Ltd.	No.77 Luoyang East Road, Taicang Economy Development Area, Taicang, Jiangu Province, China	(Tel) 86-512-53561111 (Fax) 86-512-53561600
Wuxi KOA Electroceramics Co., Ltd.	Heqiao, Yixing City, Jiangu Province, China http://www.wuxkoa.com/	(Tel) 86-510-87871645 (Fax) 86-510-87871626
KOA Electronics (H.K.) Ltd.	Unit 2315, Metropolis Tower, 10 Metropolis Drive, Hunghom, Kowloon, Hong Kong http://www.hk.koaglobal.com/	(Tel) 85-2-24926918 (Fax) 85-2-24927398
Taiwan		
Dah Hsing Electric Co., Ltd.	11th Floor Ping-An Mansion, No.34 Sec.1, Nan-King East Road, Taipei, Taiwan http://www.koadah.com/	(Tel) 88-6-2-2521-4166 (Fax) 88-6-2-2564-1859
KOA Kaohsiung Corporation	17-2 Kai-Fa Road,N.E.P.Z. Kaohsiung, Taiwan http://www.koaglobal.com.Tw/	(Tel) 88-6-7-363-4157 (Fax) 88-6-7-363-4543

Specifications given herein may be changed at any time without prior notice. Please confirm technical specifications before you order and/or use. 10/30/20

world class quality

Successful companies recognize the value in selecting suppliers committed to total quality. KOA Speer has long embraced the principals of continuous improvement to attain new performance levels in every aspect of customer support. Our manufacturing programs redefine industry standards with defect levels measured in parts per billion. This organization-wide focus on quality resulted in our receiving ISO 9001:2015 certification. In addition, our quality program has received the more stringent IATF 16949:2016 certification required to be a tier one supplier in the automotive industry.

customer programs

KOA Speer can play a vital role in helping your operation achieve maximum efficiency. Our sales/customer service representatives will meet with your design, production and purchasing teams to create a program that makes sense for your organization. Among the areas we regularly address are data entry and access through customized EDI, and inventory management through dock-to-stock and JIT programs. Our willingness to not only develop these programs but to execute them as promised, makes KOA Speer a dependable partner worth integrating into your operation.

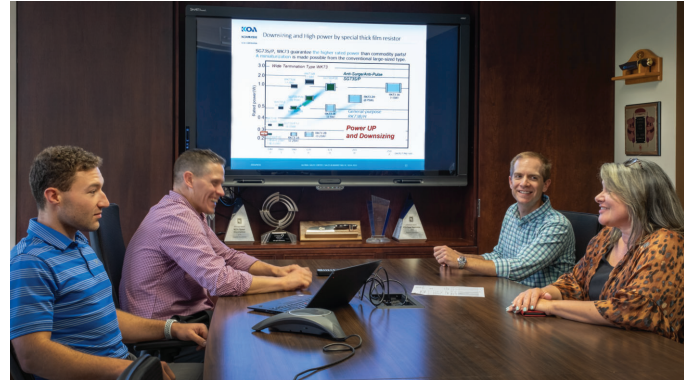

responsive service

Providing products and answers when you need them is a fundamental policy at KOA Speer. Our 185,000 square foot warehouse features an automated material handling system based upon bar coding and radio frequency data communication (RFDC) to maintain an inventory of billions of components, while shipping millions of components per day. Standard product availability, the industry's most extensive electronic data interchange (EDI) program and a willingness to inventory to customer requirements, make KOA Speer JIT delivery an integral part of our customer's efforts at improving efficiency.



a global presence

North America

KOA Speer Electronics, Inc.
Bradford, PA 16701 USA
(814) 362-5536

Europe

KOA Europe GmbH
Dageling, Germany
(49) 4821-89890

China

Shanghai KOA Electronics
Shanghai, China
(86) 21-64855477

Japan

KOA Corporation
Tokyo, Japan
(81) 4233-65755

Singapore

KOA Denko Singapore
(65) 339-5151



199 Bolivar Drive
Bradford, PA 16701
Phone: 814-362-5536
Fax: 814-362-8883
www.koaspeer.com