

features

- Flame retardant coating (UL94V0)
- Excellent transient voltage suppression characteristics
- Higher surge current
- Wide varistor voltage
- V-I characteristics are the same in both polarity
- Products with lead-free terminations meet EU RoHS requirements

Approval Awarded and Varistor Vol..rang

Type	UL1449 (File No. E328032) (Units (V))	
	S Series	U Series
NVD05	82 - 470	100 - 470
NVD07	82 - 470	100 - 470
NVD10	82 - 1100	100 - 1100
NVD14	82 - 910	120 - 910
NVD20	—	200 - 910

S Series: does not apply to 330 and 510. The VDE acquisition products apply individually. c-UL acquisition products apply individually.

dimensions and construction

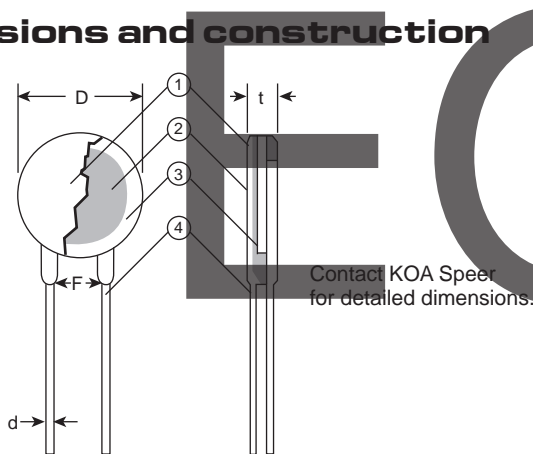

Type	Dimensions inches (mm)			
	øD (max.)*	ød	F	t (max.)*
05U	.276 - .295 (7.0 - 7.5)	.024 (0.6)	.197±.039 (5.0±1.0)	.169±.232 (4.3 - 5.9)
07U	.276 - .374 (9.0 - 9.5)			
10U	.472 - .531 (12.0 - 13.5)	.031 (0.8)	.295±.039 (7.5±1.0)	.169±.567 (4.3 - 14.4)
10UB	.472 (12.0)	.024 (0.6)	.197±.039 (5.0±1.0)	.169±.209 (4.3 - 5.3)
14U	.630 - .669 (16.0 - 17.0)	.031 (0.8)	.295±.039 (7.5±1.0)	.169±.567 (4.3 - 14.4)
20U	.91 - .94 (23.0 - 24.0)	.039 (1.0)	.394±.039 (10±1.0)	.205±.354 (5.2 - 9.0)

* D max. and t ma. vary according to the varistor voltage

ordering information

NV	D	05	U	C	D	MHT	A	220
Type	Style	Diameter	Series	Termination Material	Inner Connect Solder Material	Taping	Packaging	Varistor Voltage
	Disc	05 07 10 14 20	S: S series U: U series UB: U series 5mm pitch (D10 only)	C: Sn-Cu	D: SnAgCu Blank: SnPb	MT:5mm straight taping MHT:5mm inside kink taping 10UB: GHT: 7.5mm straight taping GJT: 7.5mm outside kink taping MJT:5mm outside kink taping 10UC: MJT: 7.5mm outside kink taping	A: Ammo	22V 022 220V 220 1800V 1800

For further information on packaging, please refer to Appendix C.

applications and ratings

Type	Varistor Voltage Vc Ic = 0.1mA (V)	Maximum Allowable Voltage		NVD05UC			NVD07UC				
		a.c. r.m.s. (V)	d.c. (V)	Maximum (2ms) Energy	Max. Peak Current (2 pulses)	Clamping Voltage	Maximum (2ms) Energy	Max. Peak Current (2 pulses)	Clamping Voltage		
				E (J)	Ip (A)	V1A V5A	E (J)	Ip (A)	V2.5A V10A		
NVD□SCD018	16 - 22	11	14	0.3	50	40	—	—	—	—	—
NVD□UCD022	20 - 27	14	18	0.5	125	48	—	1.1	250	43	—
NVD□UCD027	25 - 32	17	22	0.7		60	—	1.3		53	—
NVD□UCD033	30 - 39	20	26	0.8		73	—	1.6		65	—
NVD□UCD039	37 - 47	25	31	0.9		86	—	1.9		77	—
NVD□UCD047	45 - 54	30	38	1.1		104	—	2.3		93	—
NVD□UCD056	52 - 62	35	45	1.3		123	—	2.7		110	—
NVD□UCD068	60 - 76	40	56	1.6		150	—	3.3		135	—
NVD□SCD082	74 - 90	50	65	1.7		200	—	145		3.5	600
NVD□UCD100	90 - 110	60	85	3.0	600	—	175	6.0	1250	—	165
NVD□UCD120	108 - 132	75	100	3.5		—	210	7.0		—	200
NVD□UCD150	135 - 165	95	125	4.5		—	260	9.0		—	250
NVD□UCD200	185 - 225	130	170	6.0		—	355	12.5		—	340
NVD□UCD220	198 - 242	140	180	6.5		—	380	13.5		—	360
NVD□UCD240	216 - 264	150	200	7.5		—	415	15.0		—	395
NVD□UCD270	247 - 303	175	225	8.0		—	475	17.0		—	455
NVD□UCD330	297 - 363	210	270	9.5		—	570	20.0		—	545
NVD□UCD360	342 - 396	230	300	11.0		—	620	23.0		—	595
NVD□UCD390	367 - 429	250	320	12.0		—	675	25.0		—	650
NVD□UCD430	407 - 473	275	350	13.5		—	745	27.5		—	710
NVD□UCD470	437 - 517	300	385	15.0		—	810	30.0		—	775

□ Add disk diameter

Type	Varistor Voltage Vc Ic = 0.1mA (V)	Maximum Allowable Voltage		NVD10UC - NVD10UCB*				NVD14UC				NVD20UC			
		a.c. r.m.s. (V)	d.c. (V)	Max. (2ms) Energy	Max. Peak Current (2 pulses)	Clamping Voltage		Max. (2ms) Energy	Max. Peak Current (2 pulses)	Clamping Voltage		Max. (2ms) Energy	Max. Peak Current (2 pulses)	Clamping Voltage	
				E (J)	Ip (A)	V5A V25A	E (J)	Ip (A)	V10A V50A	E (J)	Ip (A)	V100A			
NVD□SCD018	16 - 22	11	14	—	—	—	—	—	—	—	—	—	—	—	
NVD□UCD022	20 - 27	14	18	2.6	500	43	—	5.3	1000	43	—	—	—	—	
NVD□UCD027	25 - 32	17	22	3.2		53	—	6.5		53	—	—	—	—	
NVD□UCD033	30 - 39	20	26	4.0		65	—	7.9		65	—	—	—	—	
NVD□UCD039	37 - 47	25	31	4.4		77	—	9.4		77	—	—	—	—	
NVD□UCD047	45 - 54	30	38	5.7		93	—	11.0		93	—	—	—	—	
NVD□UCD056	52 - 62	35	45	6.7		110	—	13.0		110	—	—	—	—	
NVD□UCD068	60 - 76	40	56	8.2		135	—	16.0		135	—	—	—	—	
NVD□SCD082	74 - 90	50	65	8.0		1250	—	135		14.0	2500	—	135	—	—
NVD□UCD100	90 - 110	60	85	12.0	2500	—	165	—	—	—	—	—	—		
NVD14SCD100	90 - 110	—	—	—	—	—	—	18.0	2500	—	165	—	—		
NVD□UCD120	108 - 132	75	100	14.5	2500	—	200	30.0	5000	—	200	—	—	—	
NVD□UCD150	135 - 165	95	125	18.0		—	250	37.5		—	250	—	—	—	—
NVD□UCD200	185 - 225	130	170	25.0		—	340	50.0		—	340	100	—	—	340
NVD□UCD220	198 - 242	140	180	27.5		—	360	55.0		—	360	110	—	—	360
NVD□UCD240	216 - 264	150	200	30.0		—	395	60.0		—	395	120	7000	—	395
NVD□UCD270	247 - 303	175	225	35.0		—	455	70.0		—	455	135	—	—	455
NVD□UCD330	297 - 363	210	270	42.0		—	545	80.0		—	545	—	—	—	—
NVD□UCD360	342 - 396	230	300	45.0		—	595	90.0		—	595	180	—	—	595
NVD□UCD390	367 - 429	250	320	50.0		—	650	100.0		4500	—	650	195	6500	650
NVD□UCD430	407 - 473	275	350	55.0		—	710	110.0		—	710	215	—	—	710
NVD□UCD470	437 - 517	300	385	60.0		—	775	125.0		—	775	250	—	—	775

□ Add disk diameter

* Manufacturing range of NVD10UCB is varistor voltages 22 - 270

Specifications given herein may be changed at any time without prior notice. Please confirm technical specifications before you order and/or use.

12/20/17

applications and ratings (continued)

Type	Varistor Voltage Vc Ic = 0.1mA (V)	Maximum Allowable Voltage		NVD10UC - NVD10UCB*			NVD14UC**			NVD20UC					
		a.c. r.m.s. (v)	d.c. (v)	Max. (2ms) Energy	Max. Peak Current (2 pulses)	Clamping Voltage	Max. (2ms) Energy	Max. Peak Current (2 pulses)	Clamping Voltage	Max. (2ms) Energy	Max. Peak Current (2 pulses)	Clamping Voltage			
				E (J)	Ip (A)	V5A	V25A	E (J)	Ip (A)	V10A	V50A	E (J)	Ip (A)	V100A	
NVD□UCD510	474 - 561	320	410	67.0	2500	—	845	136.0	4500	—	845	—	6500	—	
NVD□UCD620	577 - 682	385	505	67.0		—	1025	136.0		—	1025	273		—	1025
NVD□UCD680	637 - 748	420	560	67.0		—	1120	136.0		—	1120	273		—	1120
NVD□UCD750	697 - 825	460	615	70.0		—	1240	150.0		—	1240	300		—	1240
NVD□UCD780	737 - 858	485	640	70.0		—	1290	150.0		—	1290	300		—	1290
NVD□UCD820	767 - 902	510	670	80.0		—	1355	165.0		—	1355	325		—	1355
NVD□UCD910	857 - 1000	550	745	90.0		—	1500	180.0		—	1500	360		—	1500
NVD□UCD1100	1070 - 1210	680	895	110.0		—	1815	—		—	1815	—		—	—
NVD□UCD1800	1700 - 1980	1000	1465	183.0		—	2970	360.0		—	2970	—		—	—

□ Add disk diameter

* Manufacturing range of NVD10UCB is varistor voltages 22 - 270

** NVD14SCD100 is applied

environmental applications

Performance Characteristics

Parameter	Requirement Δ V±%	Test Method						
Varistor Voltage	Within specified tolerance	Voltage between terminals when the specified current is flowed <table border="1"> <tr> <th>Ic</th> <th>Type</th> </tr> <tr> <td>0.1mA</td> <td>NVD05UCD</td> </tr> <tr> <td>1mA</td> <td>NVD07UCD - NVD20UCD</td> </tr> </table>	Ic	Type	0.1mA	NVD05UCD	1mA	NVD07UCD - NVD20UCD
Ic	Type							
0.1mA	NVD05UCD							
1mA	NVD07UCD - NVD20UCD							
Solderability	95% coverage minimum	230°C ± 5°C, 5 seconds ± 0.5 second / 250°C ± 5°C, 5 seconds ± 0.5 second (Pb free)						
Resistance to Solder Heat	±5% no abnormality in appearance	260°C ± 5°C, 10 seconds ± 1 second						
Rapid Change of Temperature	±5% no abnormality in appearance	-40°C (30 minutes) / +125°C (30 minutes), 5 cycles, except NVD20UCD -40°C (30 minutes) / +85°C (30 minutes), 5 cycles: NVD20UCD						
Maximum Peak Current	±10% no abnormality in appearance	Rated impulse current of (T=8/20μs), positive/negative applied once each						
Maximum Energy	±10% no abnormality in appearance	A single standard impulse of 2ms, once						
High Temperature Life with d.c. Bias	±10% no abnormality in appearance	85°C ± 5°C, Vc=(Vd.c.) 1000h Load: maximum allowable circuit voltage (d.c.)						
High Temperature Life with a.c. Bias	±10% no abnormality in appearance	85°C ± 5°C, Vc=(Va.c.r.m.s.) 1000h Load: maximum allowable circuit voltage (d.c.)						
High Temperature & High Humidity Life with Bias	±5% no abnormality in appearance	80°C ± 5°C, 95% RH, 1000h						
High Temperature Storage Life	±5% no abnormality in appearance	125°C ± 5°C, 1000h						
Low Temperature Storage Life	±5% no abnormality in appearance	-40°C ± 5°C, 1000h						

Voltage Current Curves (Ta = +25°C)

NVD05SCD018 - NVD05UCD068

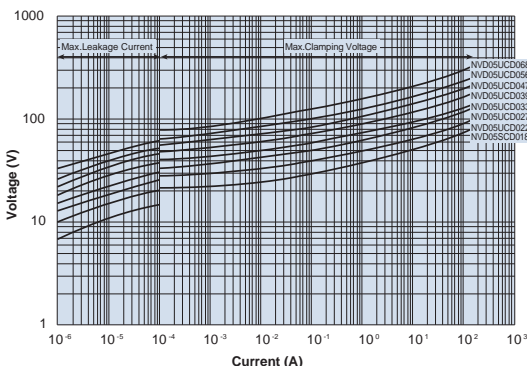

NVD05SCD082 - NVD05UCD470

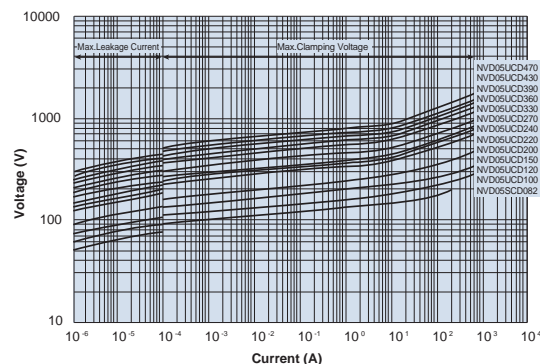

For Typical Characteristics Graphs see Environmental Applications. Additional environmental applications can also be found at www.koaspeer.com

Specifications given herein may be changed at any time without prior notice. Please confirm technical specifications before you order and/or use.

12/20/17

environmental applications (continued)

Voltage Current Curves (Ta = +25°C)

NVD07UCD022 - NVD07UCD068

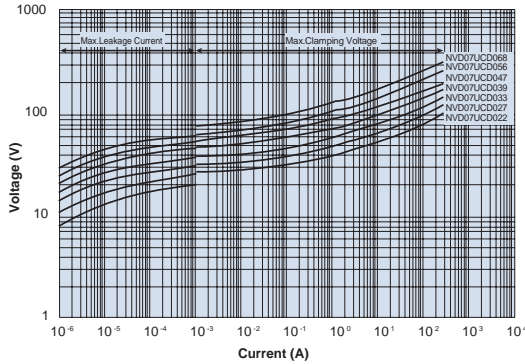

NVD07SCD082 - NVD07UCD470

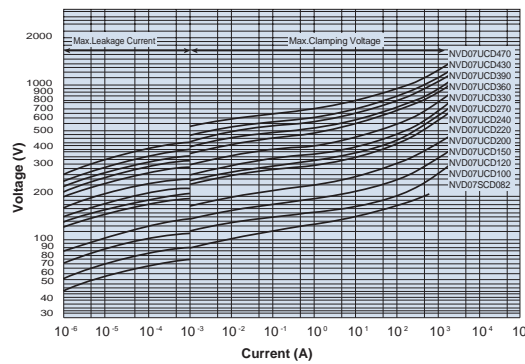

NVD10UCD022 - NVD10UCD068
NVD10UBCD022 - NVD10UBCD068

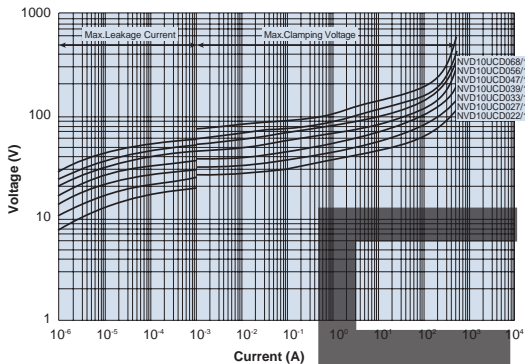

NVD10SCD082 - NVD10UCD1800
NVD10SBCD082 - NVD10UBCD270

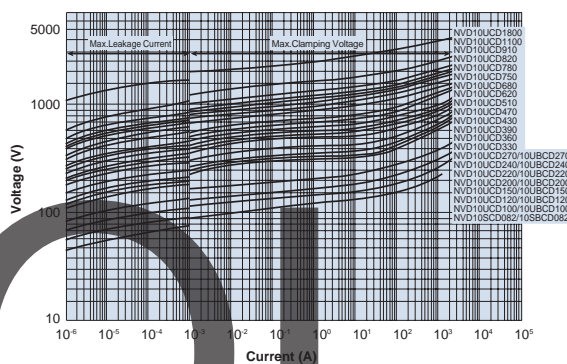

NVD14UCD022 - NVD14UCD068

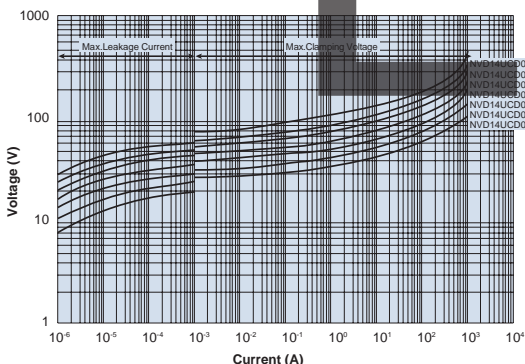

NVD14SCD082 - NVD14UCD1800

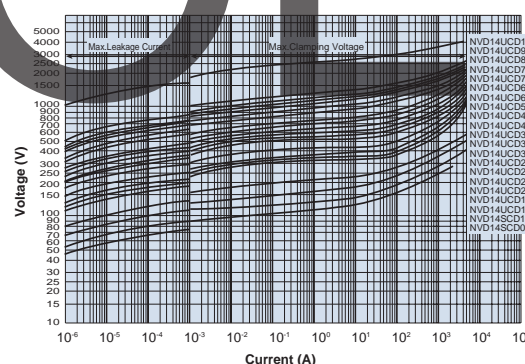

NVD20UCD200 - NVD20UCD470

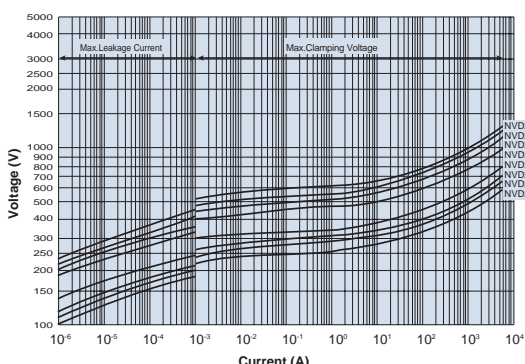

NVD20UCD620 - NVD20UCD910

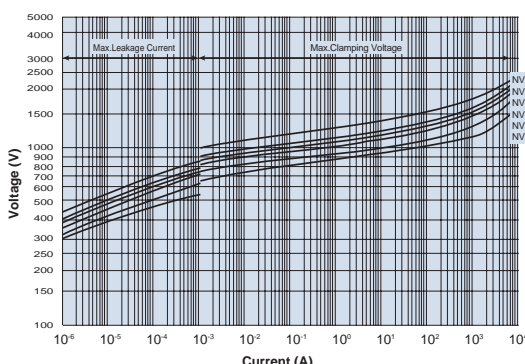

Specifications given herein may be changed at any time without prior notice. Please confirm technical specifications before you order and/or use.

12/20/17