

BUFFALO LODGE



PEPPERMINT PINWHEEL
TABLE RUNNER • PLACEMAT • TREE SKIRT



This block finishes at an 8½" hexagon and can be used in place of the tree block in the Buffalo Lodge pattern available at kristamoser.com



FABRIC REQUIREMENTS

You will need (1) 2½" strip of red and white striped fabric and (1) 2½" strip of white background fabric for each block.



2½"



2½"

CUTTING

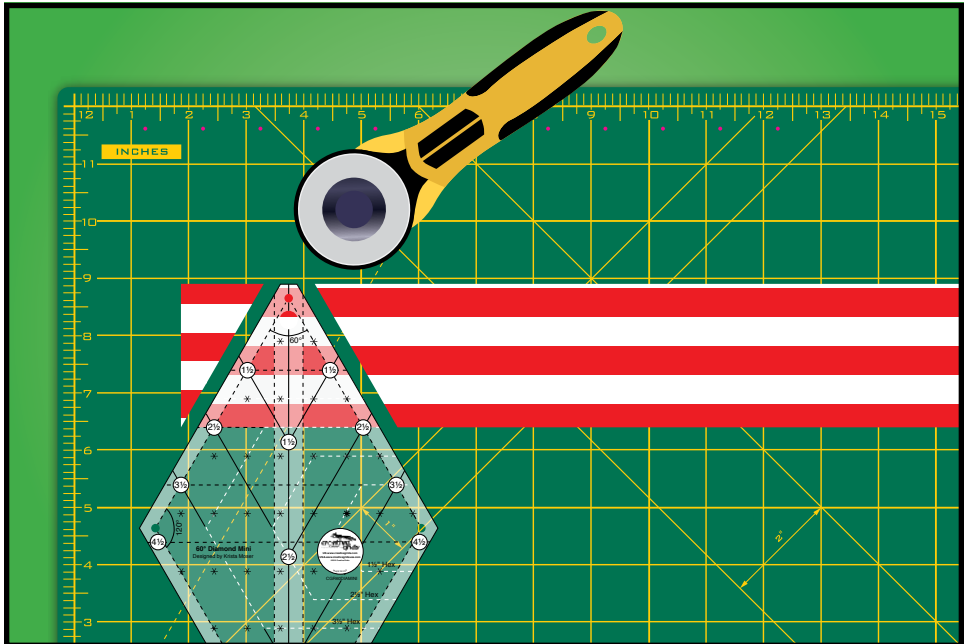

1. From the red and white striped fabric, cut (8) 2½" triangles. Using the triangle lines on the ruler, align the 2½" line with one edge of the strip and the flat tip with the other.

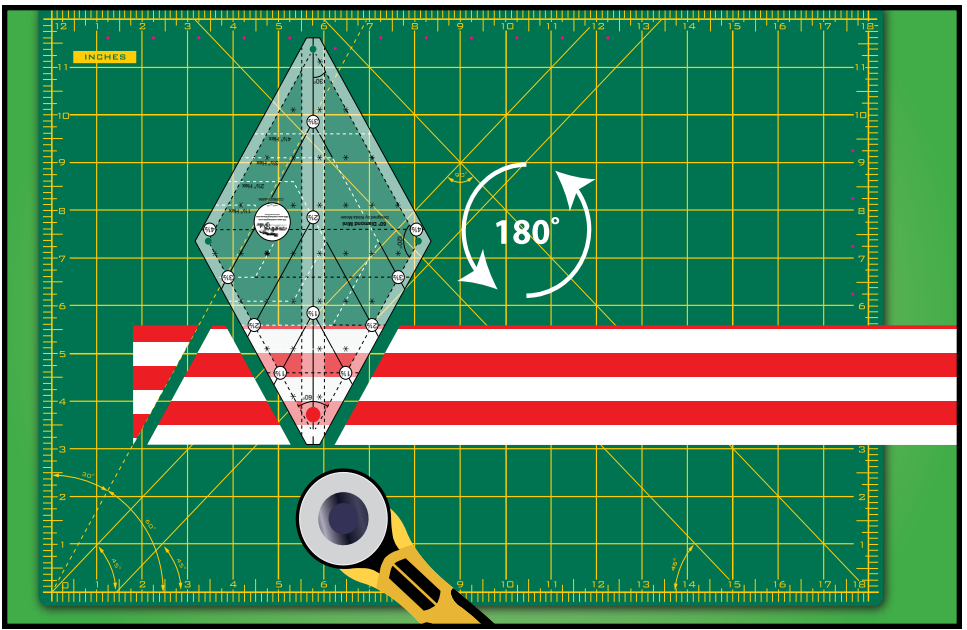

2. Cut on both sides of the ruler, then rotate the ruler 180° to make the next cut.

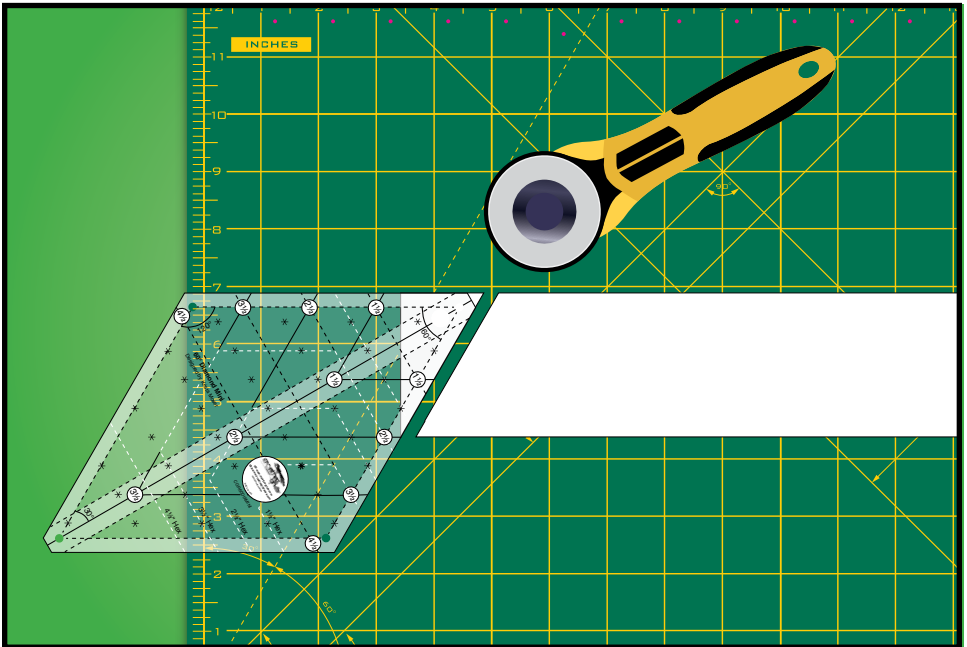

3. From the white background strip, make the following cuts with the strip folded right sides together. Trim the selvage end off the strip at the 60° angle.

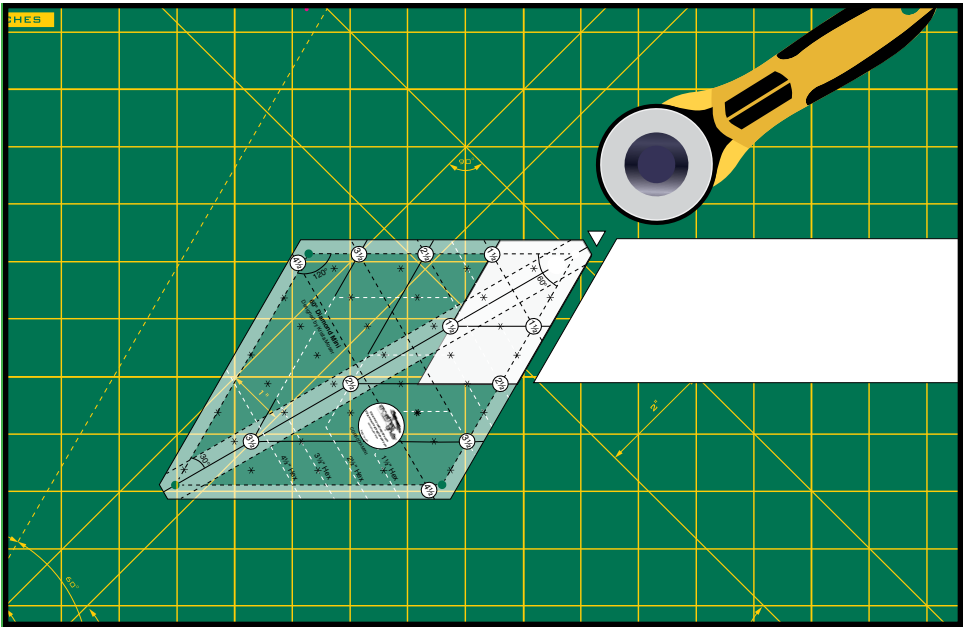

4. Move the ruler down the strip until the cut edge lines up with the $1\frac{1}{2}$ " diamond line. Cut along the edge of the ruler, and use the flat tip to remove the corner from the fabric (this will help with piecing accuracy later).

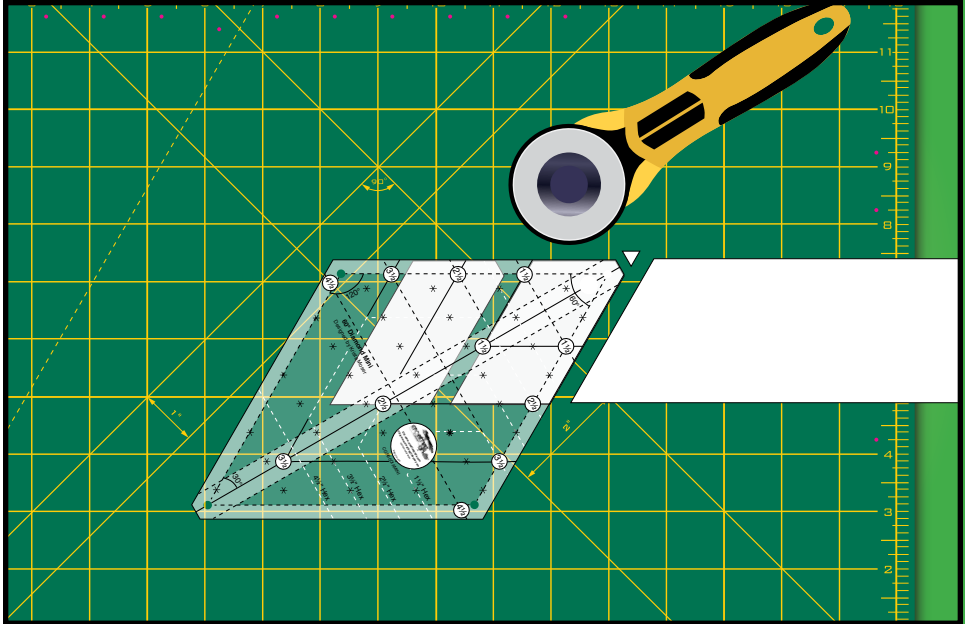

5. Make a second cut just like the first, this will get you two sets of mirror image $1\frac{1}{2}$ " x $2\frac{1}{2}$ " parallelograms.

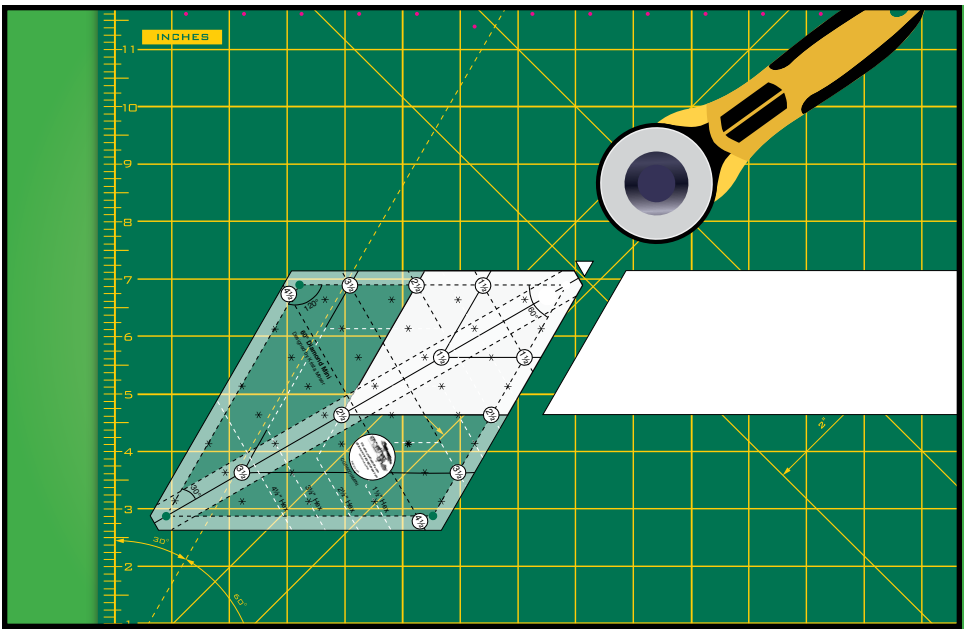

6. Move the ruler down the strip until the 2½" diamond line meets the cut edge. Cut along the edge of the ruler, and use that flat tip to remove the fabric corner. This will get you two 2½" diamonds.

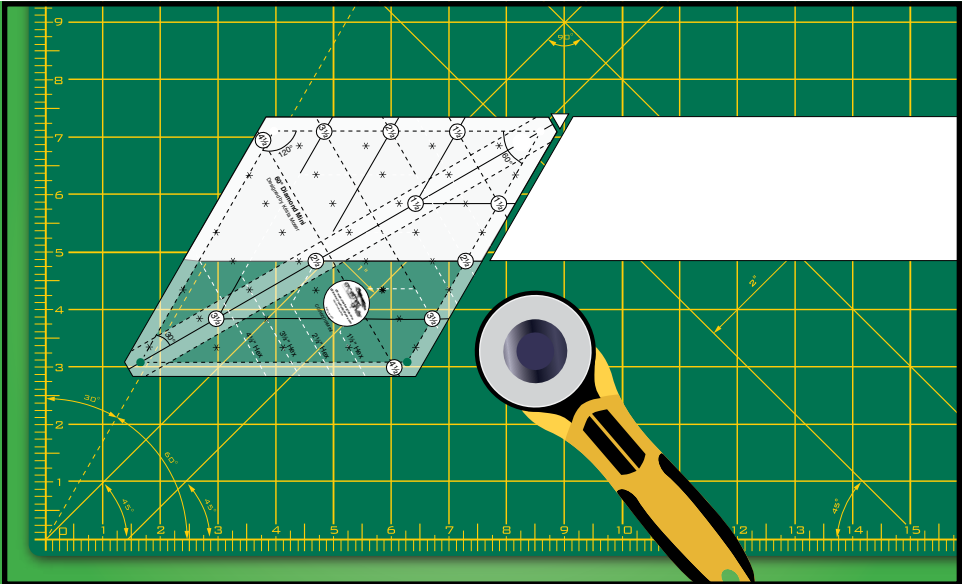

7. Open the strip and cut through a single layer to cut two 4½" parallelograms. Move the ruler to cover the strip from edge to edge. Align the cut edge, with the edge of the ruler, and cut along the opposite edge to get a 4½" parallelogram.

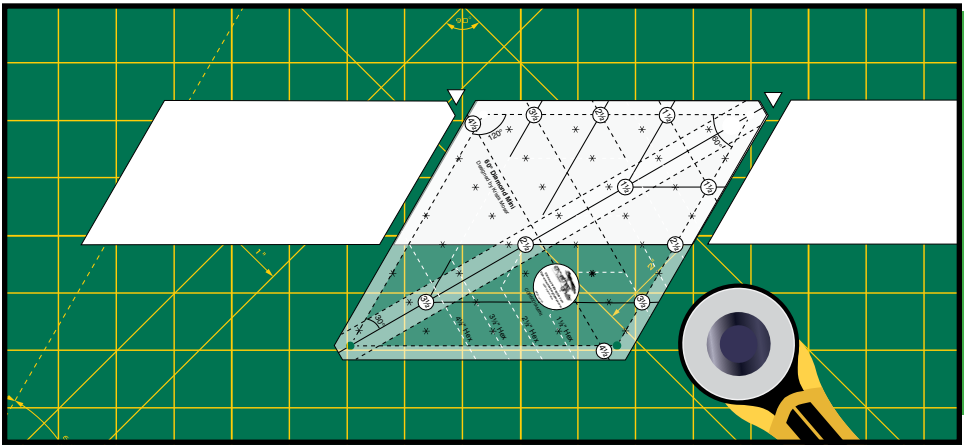

7. Make two cuts like this.

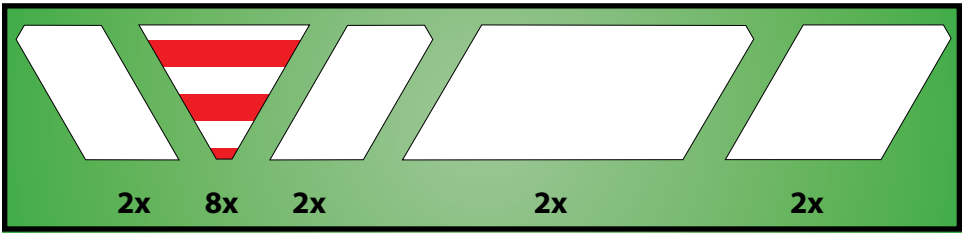

MAKING THE PEPPERMINT BLOCK

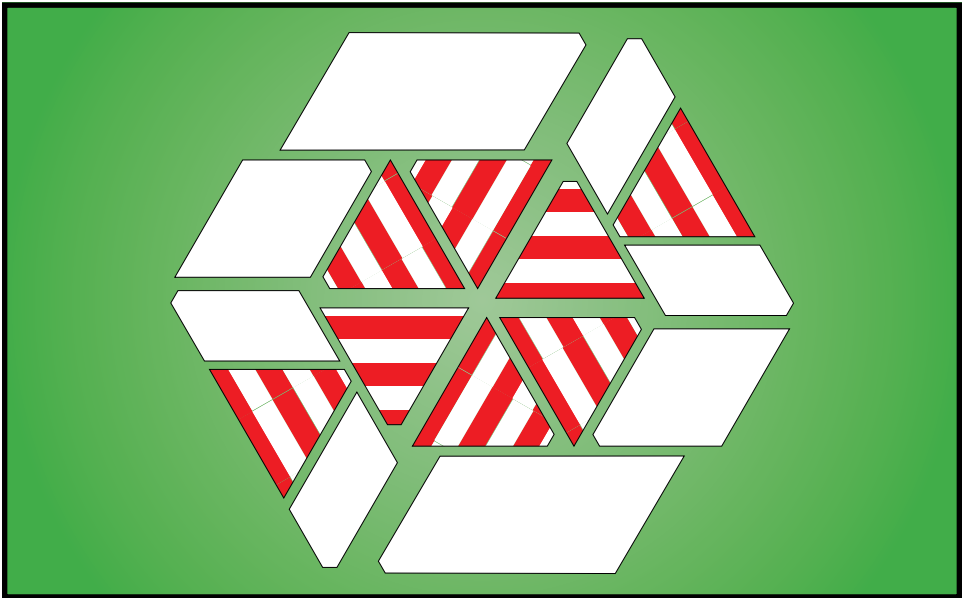

8. Arrange all the pinwheel block pieces as shown. Pay close attention to the direction you place your red and white striped triangles. You want these to look like they are spiralling out.

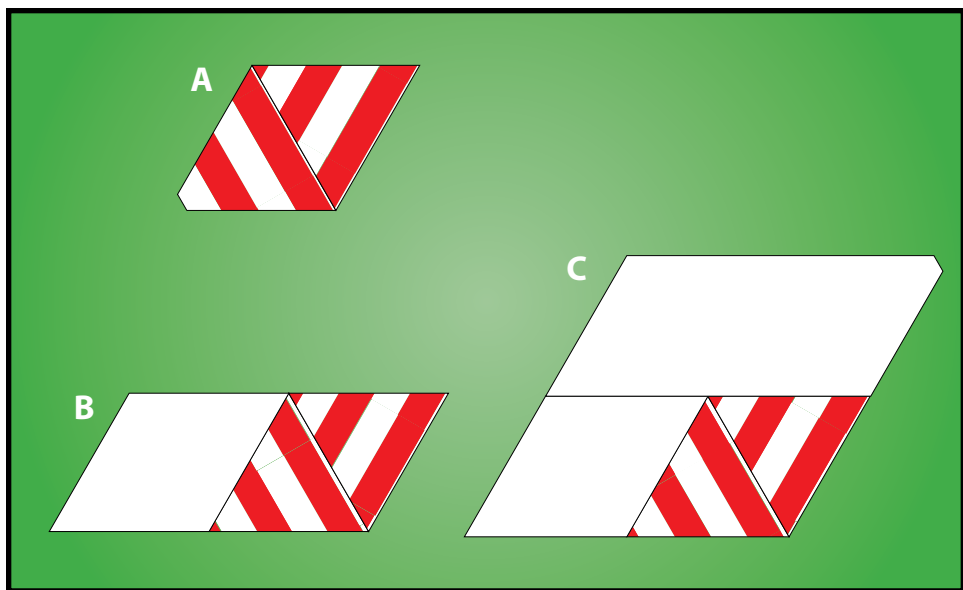

9. Sew two of the red and white striped triangles together (A). Press that seam open, then sew the $2\frac{1}{2}$ " diamond to them (B). Press that seam open before adding the $4\frac{1}{2}$ " parallelogram (C). Use the flat tips as a guide to help line up your pieces.

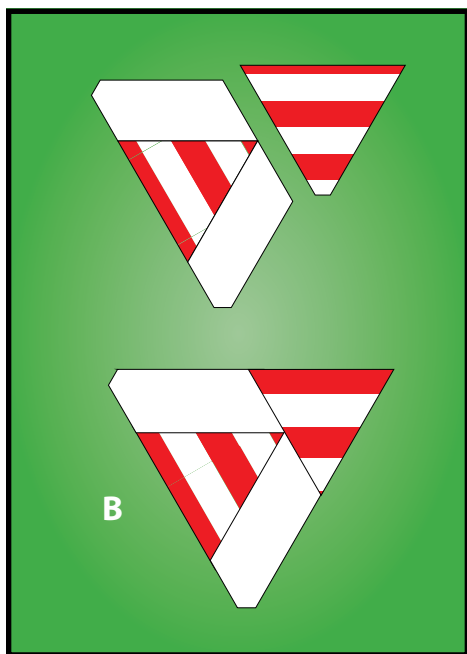
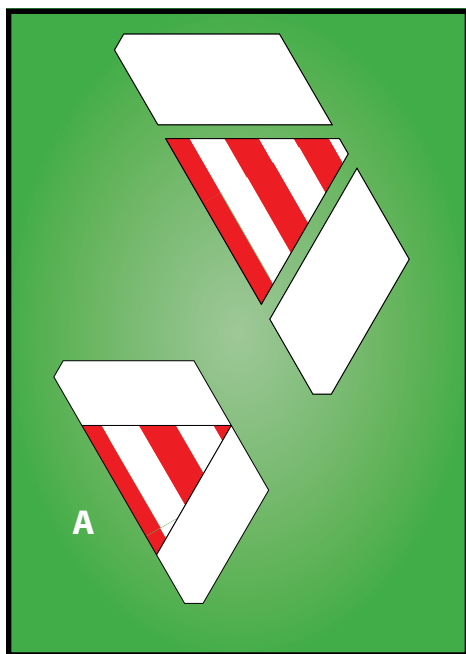

10. Sew one $1\frac{1}{2}$ " x $2\frac{1}{2}$ " parallelogram to each side of a $2\frac{1}{2}$ " triangle. Press the seams open between each piece as you go (A). Sew one more red and white striped triangle to this unit (B).

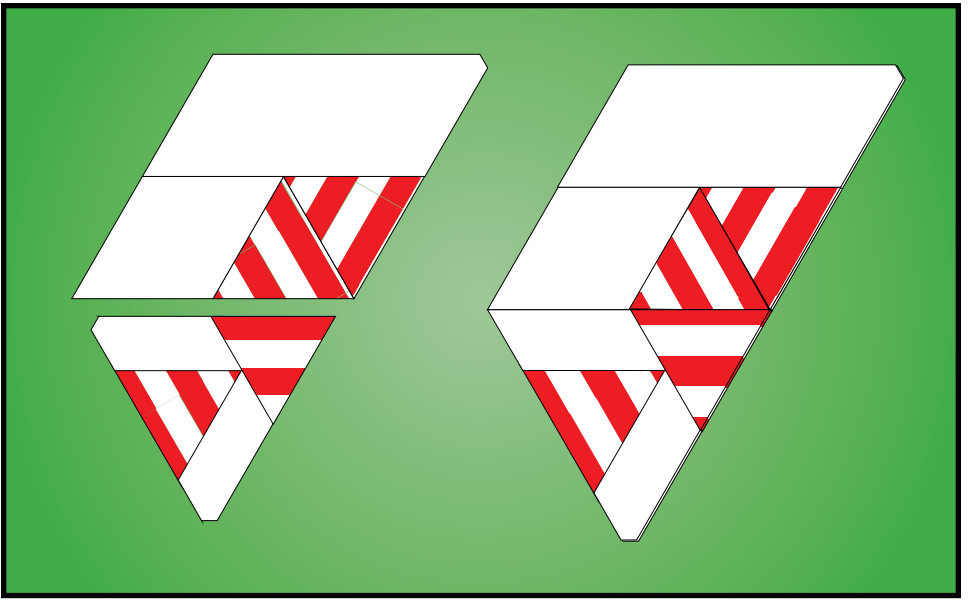

11. Sew these two larger units together to make one half of the pinwheel block. Repeat steps 9 -11 for the other half of the block.

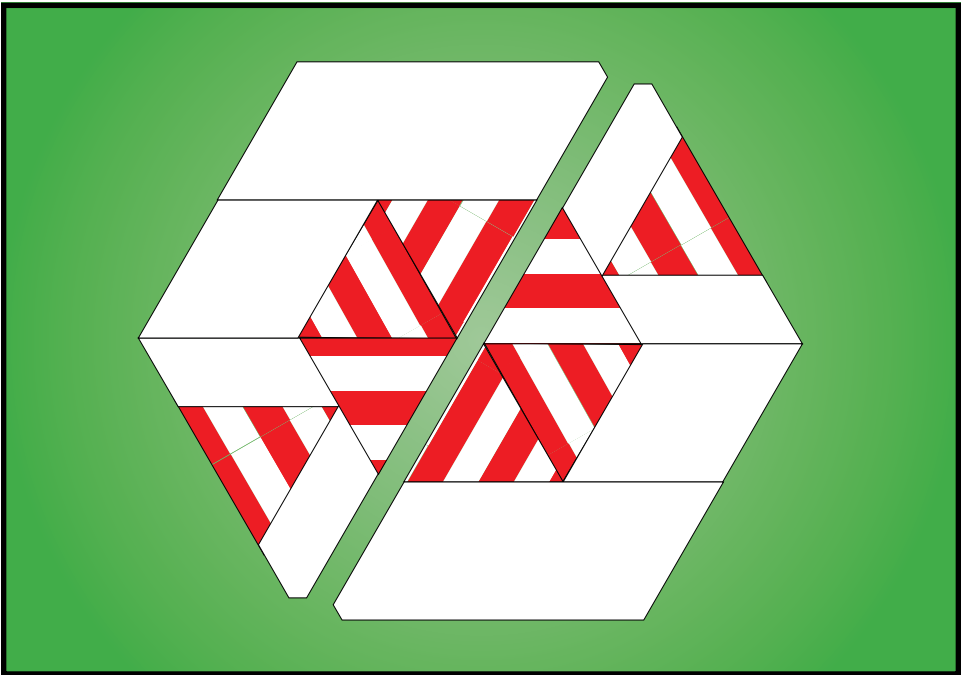

12. Sew the two halves of the block together with a seam down the middle. Press this seam open.