

\$2.00 • 2018/2019 Edition

*Larry's* THUNDERBIRD  
& MUSTANG  
PARTS



Featuring  
Outstanding  
Prices &  
More Parts  
Than Ever!

1958-'66

# Thunderbirds



Restoration Parts and Accessories



# WELCOME TO LARRY'S THUNDERBIRD & MUSTANG PARTS



## Ordering

(U.S.) 800 854-0393

951-270-3223

(24 Hr. FAX) 951-270-3224

Web Site

[www.larrystbird.com](http://www.larrystbird.com)

e-mail: [info@larrystbird.com](mailto:info@larrystbird.com)

## Our Address

1180 California Ave. #B  
Corona, California 92881

## Store Hours:

Monday - Friday: 7am to 5pm



## After More Than 45 Years, We Are Still Recognized as The Leader in the Industry!

We'd like to thank you for requesting our latest Parts & Accessories Catalog for '58-66 Thunderbirds. We think you'll find this latest edition to be better than ever, with many new parts added to help your restoration project move forward. We continually strive to offer enthusiasts the finest selection of Thunderbird parts and accessories available so that each restoration project is an enjoyable experience. Because of your continued patronage, we are able to offer great prices on every item we sell. In fact, we have reduced prices on a number of parts, which means greater buying power for you, our valued customer.

## The Biggest Selection of Parts! And We're Still Growing!

Whether it's a hard to find part or a standard Thunderbird replacement part, Larry's has what you're looking for. Our inventory of parts is concours-quality, and growing all of the time! Give us a call if you can't find the parts you need. Our knowledgeable parts specialists will be happy to help you find them!

## Ordering Is As Easy as a Phone Call Away!

And Now Find Us On the Internet at [www.larrystbird.com](http://www.larrystbird.com)

We offer a number of different ways for you to place your order. You may send in your order on the form enclosed, call in your order using our Toll-Free lines, FAX an order, or order from our website at [www.larrystbird.com](http://www.larrystbird.com). If you need more information via e-mail, contact us at: [info@larrystbird.com](mailto:info@larrystbird.com). Whichever route you choose, we'll process and ship your order as soon as possible.

## A Guarantee Goes Along with Everything We Sell!

Our goal is to make sure each customer is 100% satisfied with every purchase from Larry's Thunderbird & Mustang Parts! If you are not happy with your purchase, for any reason, let us know! We'll be happy to either refund, credit, or exchange the amount. Please take a moment to refer to the Ordering Information page in the center of this catalog for complete details on returns, damaged parts, or any other shipping questions.

## Speedy & Efficient Shipping

Every order we receive gets special attention from the time it comes in to the moment it leaves our warehouse. Need special shipping arrangements? We offer Fed-Ex One Day, Two Day & Three Day Service when requested, as well as regular Fed-Ex Ground Service. Count on our efficient shipping department to get your order to you on time!



Owner: John Tighe  
1966 Thunderbird

# What's **NEW** for 1958/66 Thunderbirds!

**Vacuum Diagram Manual**

**See Page 108**



**We Also Sell Used Parts**



**Thunderbird Customers Please Note:** Throughout the catalog you will notice a number of parts that are underlined. This designates the part as being obsolete and is limited in quantities. If you are interested in purchasing that particular part, we advise you to call and check on it's availability. A number of these parts are in demand so it's often wise to place your order as soon as possible.

**About Our Pricing:** At Larry's we strive to maintain the lowest prices possible. However, due to constantly changing market conditions, we are not always able to maintain prices listed in this catalog. We reserve the right to change prices without prior notice. Thank you for your understanding.

## Table of Contents

Upholstery & Related trim.....	2
Wheel & Wheel Covers.....	14
Spare Wheel.....	15
Brakes.....	16
Suspension.....	22
Rear Axle & Drive Train.....	29
Exhaust System.....	31
Engine Compartment.....	32
Transmission.....	36
Cooling System & Grille.....	39
Fuel & Carburetor System.....	42
Windshield, Windwing & Visor.....	46
Dash, Console & Underdash Area..	47
Generator & Alternator.....	50
Battery.....	51
Starter.....	52
Ignition & Distributor.....	53
Exterior Lamps.....	55
Turn Signal & Horn.....	59
Bulb & Fuses.....	60
Wiring.....	62
Power Windows & Seats.....	64
Fenders & Hood Area.....	65
Instruments & Gauges.....	67
Windshield Wiper & washer.....	68
Mirror.....	70
Bumpers.....	71
Heating, Ventilation & A/C.....	72
Doors & Windows.....	74
Rear Quarter Panel Area.....	82
Trunk & Rear Body Area.....	83
Hard & Soft Top Parts.....	86
Seat Hardware.....	90
Plugs, Grommets & Bumpers.....	91
Body Weatherstripping.....	92
Body Panels.....	94
Hardware & Attatching Parts.....	96
Emblems.....	98
Radio.....	102
Accessories.....	104
Car Care.....	107
Literature & Manuals.....	108
Decals.....	110
Paints.....	112

# When You Are ready For Concours-Quality Upholstery, You Are Ready for Larry's Upholstery!

*Our Personal Commitment to Quality,  
Authenticity and Your Satisfaction are a  
part of Every Upholstery Item We Supply.*

- ✓ Naugahyde Vinyls, which are the same fabrics that were used originally.
- ✓ American-Made Bonded Dacron Polyester Thread. It wears like iron and won't fade, fray or come apart like cheaper threads!
- ✓ All items are Color-Matched to original factory specifications.
- ✓ We use the Best Foam Rubber Available in Seat Inserts, which guarantee a long-lasting wrinkle-free pleat.
- ✓ Heavy Backing for Underside of Seat Inserts.
- ✓ Correct Number of Pleats on Seat Inserts, with Evenly Spaced Stitching for Consistency in Look in Construction.
- ✓ All French Seams are sewn with a Double-Needle Machine to achieve a Straight, Parallel Seam.
- ✓ The Best Seamstresses in the Business! We take Pride in our work and make sure each upholstery item is The Very Best!
- ✓ Each Upholstery item that Larry's sends out has Our Guarantee that you will be Completely Satisfied. Period.

The interior of your Thunderbird can sometimes be more difficult to restore and care for than the exterior. For that reason, the interior portion of your restoration project is crucial and will usually need for the most attention.

Because you are paying this much attention to detail you don't have the time to worry about upholstery that doesn't match in color, vinyl that doesn't have the right grain, or stitching that is not straight and uniform. Getting the correct upholstery items the first time around saves heartache, headaches, and money in the long run.

There is an ultimate benefit in restoring your Thunderbird's interior correctly-increased value of your car! A properly restored interior not only looks good but it can make you money too. It adds untold dollars to the resale value of your vehicle.

At Larry's we offer only concours-quality upholstery, made from the finest materials available to you.

There really is more to the construction of quality upholstery than meets the eyes, but with features like these and a surefire guarantee going into each piece, you can be assured that your interior will be first-class. Your reward will be your own satisfaction from doing the job right as well as the admiration of everyone who sees your restored Thunderbird.



# Upholstery Trim Kits

## The Most Economical Way to Purchase Your Upholstery!

When you are ready to replace the upholstery in your Thunderbird, it is always best to buy items at the same time to ensure dye lot consistency in vinyls. Your time is also a valuable commodity these days. Each trip to the phone or the store to order more parts means more down time!

Wouldn't you rather spend that time working on your car? Our Upholstery Trim Kits will save you time, money, and the inevitable 'forgetting things that I needed' syndrome!

**Each Upholstery Trim Kits Includes: Door Panels, Kick panels, Quarter Trim Panels & Rear Arm Rest Covers.**

*Please Note—If you are ordering for a leather interior, be sure to order a Leather Look Trim Kit.*

1960 Red & White Rear Arm Rest Cover



1960 White Quarter Panel Set



1960 Red & White Kick Panel Set

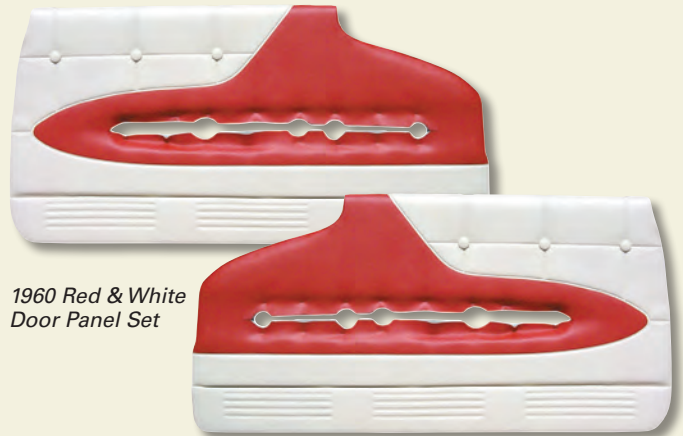

1960 Red & White Door Panel Set

## Vinyl Interior Trim Kits

BTK A58BU	58	Blue & White.....	Each	749.70
BTK A58TQ	58	Turquoise & White .....	Each	749.70
BTK A58BK	58/59	Black & White .....	Each	749.70
BTK A58GN	58	Green & White.....	Each	749.70
BTK A58RD	58/59	Red & White.....	Each	749.70
BTK A58PO	58/59	Palomino & White .....	Each	749.70
BTK A59BU	59	Blue & Blue.....	Each	749.70
BTK A59TQ	59	Turquoise & White .....	Each	749.70
BTK B60BK	60	Black & White .....	Each	867.00
BTK B60BU	60	Blue & Blue.....	Each	867.00
BTK B60RD	60	Red & White.....	Each	867.00
BTK B60TN	60	Dk. Beige & Lt. Beige .....	Each	867.00
BTK B60TQ	60	Turquoise & Turquoise.....	Each	867.00
BTKC B60BK	60	Black & White Conv.....	Each	867.00
BTKC B60BU	60	Blue & Blue Conv .....	Each	867.00
BTKC B60RD	60	Red & White Conv .....	Each	867.00
BTKC B60TN	60	Dk. Beige & Lt. Beige Conv .....	Each	867.00
BTKC B60TQ	60	Turquoise & Turquoise Conv ...	Each	867.00

## Leather Look Trim Kits

BTKL 58BK	58/59	Black.....	Each	867.00
BTKL 58TQ	58/59	Turquoise.....	Each	867.00
BTKL 58RD	58/59	Red .....	Each	867.00
BTKL 58BG	58/59	Beige.....	Each	867.00
BTKL 60BK	60	Black.....	Each	867.00
BTKL 60RD	60	Red .....	Each	867.00
BTKL 60BG	60	Beige .....	Each	867.00
BTKL 60TQ	60	Turquoise.....	Each	867.00
BTKCL 60BK	60	Black (Convertible).....	Each	867.00
BTKCL 60RD	60	Red (Convertible) .....	Each	867.00
BTKCL 60BG	60	Beige (Convertible) .....	Each	867.00
BTKCL 60TQ	60	Turquoise (Convertible).....	Each	867.00

# UPHOLSTERY & RELATED TRIM

**Seat Cover Sets** For the best in completely original-Style Seat Cover Sets for your 1958-66 T-Bird, look no further! Larry's offers the finest in craftsmanship & authenticity. Each set is constructed with the sturdiest vinyls available, with correct grain and colors. Each Seat Cover is carefully crafted with welts and seams finished to original specifications. You won't find any better!

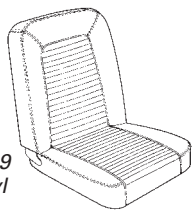
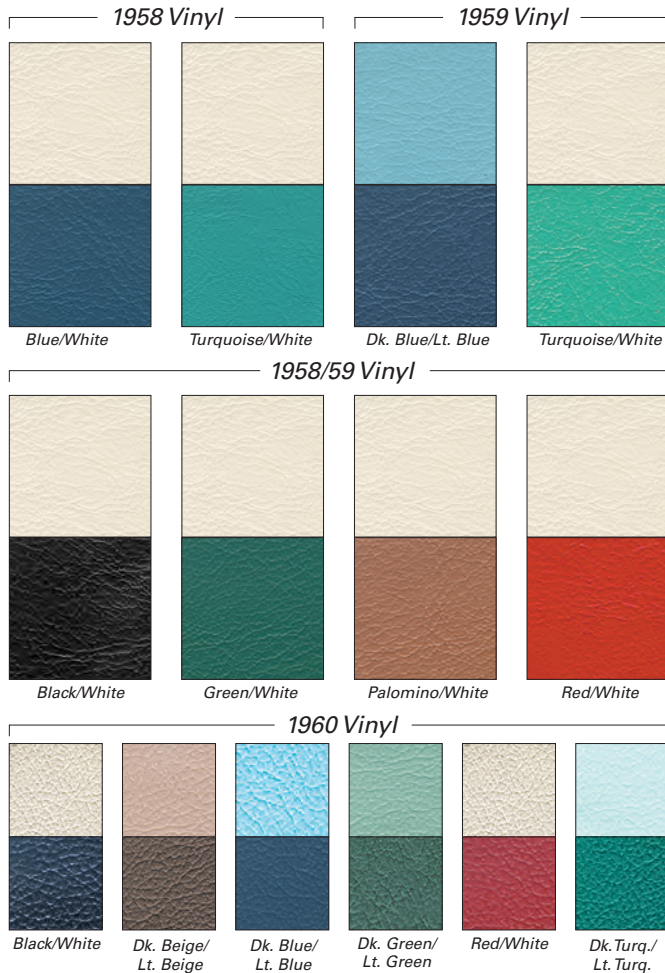

## 58/60 Vinyl Seat Cover Sets

(Front & Rear)



BSC FR58TQ	58	Turquoise/White	Set	499.95
BSC FR58BU	58	Blue/White	Set	499.95
BSC FR58BK	58/59	Black/White	Set	499.95
BSC FR58GN	58/59	Green/White	Set	499.95
BSC FR58PO	58/59	Palomino/White	Set	499.95
BSC FR58RD	58/59	Red/White	Set	499.95
BSC FR59DKBU	59	Dk. Blue/Lt. Blue	Set	499.95
BSC FR59TQ	59	Turquoise/White	Set	499.95
BSC FR60BK	60	Black/White	Set	499.95
BSC FR60BN	60	Dk. Beige/Lt. Beige	Set	499.95
BSC FR60BU	60	Dk. Blue/Lt. Blue	Set	499.95
BSC FR60GN	60	Dk. Green/Lt. Green	Set	499.95
BSC FR60RD	60	Red/White	Set	499.95
BSC FR60TQ	60	Dk. Turq/Lt. Turq	Set	499.95

## 58/66 Leather Seat Cover Sets

(Front & Rear) Our leather Seat Cover Sets feature premium-grade vat dyed leathers designed to improve the appearance and value of your Thunderbird. Covers are hand-made with complete attention to detail, offering out-standing fit, finish and comfort year 'round.

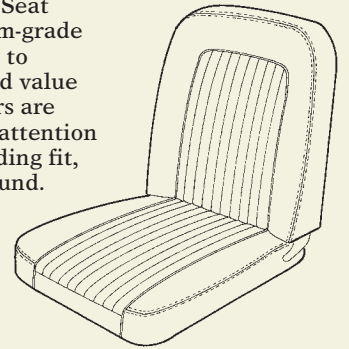

Be sure to Replace Seat Foam when restoring your T-Bird's Seats! See page 8 for Our Complete Selection!

BSC FR58LBK	58/59	Black	Set	1604.95
BSC FR58LRD	58/59	Red	Set	1604.95
BSC FR58LBG	58/59	Beige	Set	1604.95
BSC FR58LTQ	58/59	Turquoise	Set	1604.95
BSC FR60LBK	60	Black	Set	1604.95
BSC FR60LRD	60	Red	Set	1604.95
BSC FR60LBG	60	Beige	Set	1604.95
BSC FR60LTQ	60	Turquoise	Set	1604.95
BSC FR61LAQ	61/62	Aqua	Set	1604.95
BSC FR61LBK	61/62	Black	Set	1604.95
BSC FR61LBG	61/62	Beige	Set	1604.95
BSC FR61LBU	61/62	Blue	Set	1604.95
BSC FR61LRD	61/62	Red	Set	1604.95
BSC FR63LAQ	63	Aqua	Set	1604.95
BSC FR63LBK	63	Black	Set	1604.95
BSC FR63LBG	63	Beige	Set	1604.95
BSC FR63LBU	63	Blue	Set	1604.95
BSC FR63LRD	63	Red	Set	1604.95
BSC FR64LAQ	64/65	Aqua	Set	1604.95
BSC FR64LAQRC	64/65	Recliner Aqua	Set	1604.95
BSC FR64LBK	64/65	Black	Set	1604.95
BSC FR64LBKRC	64/65	Recliner Black	Set	1604.95
BSC FR64LBU	64/65	Blue	Set	1604.95
BSC FR64LBURC	64/65	Recliner Blue	Set	1604.95
BSC FR64LBG	64/65	Beige	Set	1604.95
BSC FR64LBGRC	64/65	Recliner Beige	Set	1604.95
BSC FR64LRD	64/65	Red	Set	1604.95
BSC FR64LRDRC	64/65	Recliner Red	Set	1604.95
BSC FR64LWT	64/65	White	Set	1604.95
BSC FR64LRDWT	64/65	Recliner White	Set	1604.95
BSC FR66LBK	66	Black	Set	1604.95
BSC FR66LBKRC	66	Recliner Black	Set	1604.95
BSC FR66LBG	66	Beige	Set	1604.95
BSC FR66LBGRC	66	Recliner Beige	Set	1604.95
BSC FR66LBU	66	Blue	Set	1604.95
BSC FR66LBURC	66	Recliner Blue	Set	1604.95
BSC FR66LRD	66	Red	Set	1604.95
BSC FR66LRDRC	66	Recliner Red	Set	1604.95
BSC FR66LTQ	66	Turquoise	Set	1604.95
BSC FR66LRDWT	66	Recliner Turquoise	Set	1604.95

# UPHOLSTERY & RELATED TRIM

## 61/63 Vinyl Seat Cover Sets (Front & Rear)



BSC EM Correct Emblem for 61/63 Seatback. State Qty. & Color Required ..... 29.95

### Emblem, Rear Seat & Tri-Power Air Cleaner

B 60608A 61/62; Rear Seat, 62/63; Tri-Power Intake Manifold..... Each 35.65

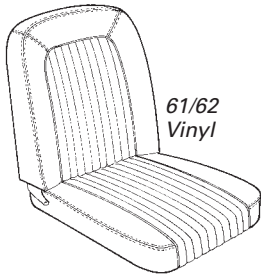

61/62 Vinyl

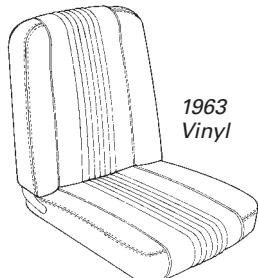

1963 Vinyl

### 1961/62 Vinyl Colors

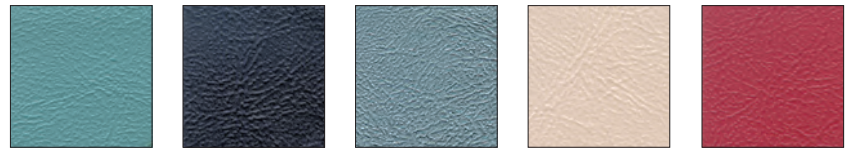

Aqua

Black

Blue

Lt. Beige

Red

### 1963 Vinyl Colors—(With Vachette Inserts)

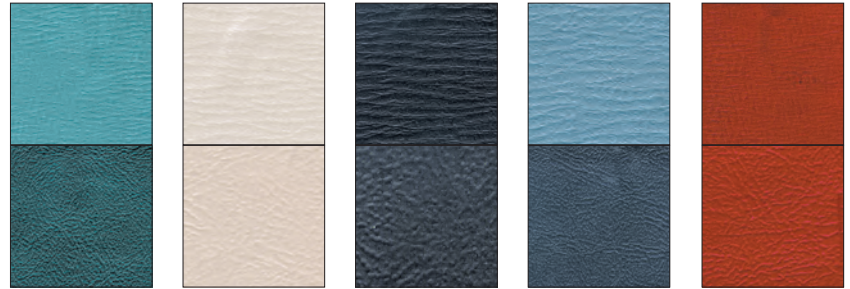

Aqua (With Vachette Insert)

Beige (With Vachette Insert)

Black (With Vachette Insert)

Blue (With Vachette Insert)

Red (With Vachette Insert)

BSC FR61AQ	61/62	Aqua	Set	499.95
BSC FR61BK	61/62	Black	Set	499.95
BSC FR61BU	61/62	Blue	Set	499.95
BSC FR61BG	61/62	Lt. Beige	Set	499.95
BSC FR61RD	61/62	Red	Set	499.95
BSC F		Front Buckets in Above Colors	Set	299.95

BSC FR63AQ	63	Aqua (w/Vachette Inserts)	Set	499.95
BSC FR63BK	63	Black (w/Vachette Inserts)	Set	499.95
BSC FR63BU	63	Blue (w/Vachette Inserts)	Set	499.95
BSC FR63BG	63	Lt. Beige (w/Vachette Inserts)	Set	499.95
BSC FR63RD	63	Red (w/Vachette Inserts)	Set	499.95
BSC F		Front Buckets in Above Colors	Set	299.95

## 64/66 Vinyl Seat Cover Sets (Front & Rear)

### 1964/65 Vinyl Colors

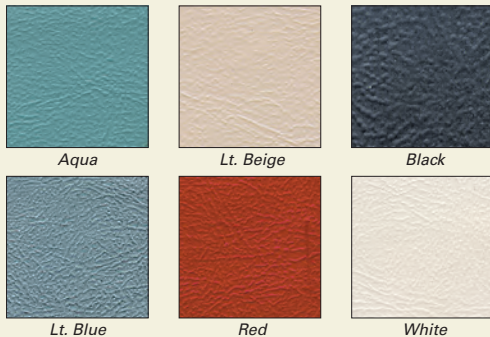

Aqua

Lt. Beige

Black

Lt. Blue

Red

White

64 Vinyl

Palomino

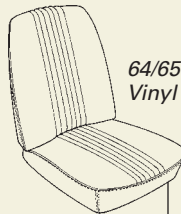

64/65 Vinyl

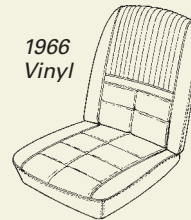

1966 Vinyl

### 65 Vinyl

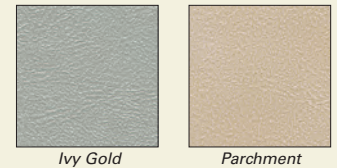

Ivy Gold

Parchment

### 1966 Vinyl

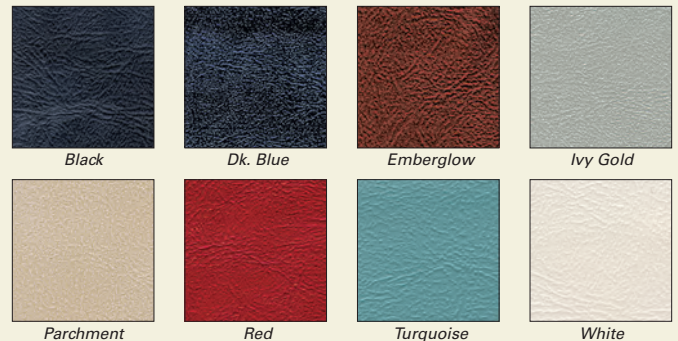

Black

Dk. Blue

Emberglow

Ivy Gold

Parchment

Red

Turquoise

White

BSC FR64PO	64	Palomino	Set	499.95
BSC FR64PORC	64	Palomino w/Recliner	Set	499.95
BSC FR64AQ	64/65	Aqua	Set	499.95
BSC FR64AQR	64/65	Aqua w/Recliner	Set	499.95
BSC FR64BG	64/65	Lt. Beige	Set	499.95
BSC FR64BGRC	64/65	Lt. Beige w/Recliner	Set	499.95
BSC FR64BK	64/65	Black	Set	499.95
BSC FR64BKRC	64/65	Black w/Recliner	Set	499.95
BSC FR64LTBU	64/65	Lt. Blue	Set	499.95
BSC FR64LTBURC	64/65	Lt. Blue w/Recliner	Set	499.95
BSC FR64RD	64/65	Red	Set	499.95
BSC FR64RDRC	64/65	Red w/Recliner	Set	499.95
BSC FR64WT	64/65	White	Set	499.95
BSC FR64WTRC	64/65	White w/Recliner	Set	499.95
BSC FR64IG	65	Ivy Gold	Set	499.95
BSC FR64IGRC	65	Ivy Gold w/Recliner	Set	499.95
BSC FR64PT	65	Parchment	Set	499.95
BSC FR64PTRC	65	Parchment w/Recliner	Set	499.95

BSC FR66BK	66	Black	Set	499.95
BSC FR66BKRC	66	Black w/Recliner	Set	499.95
BSC FR66DKBU	66	Dark blue	Set	499.95
BSC FR66DKBURC	66	Dark Blue w/Recliner	Set	499.95
BSC FR66EG	66	Emberglo	Set	499.95
BSC FR66EGRC	66	Emberglo w/Recliner	Set	499.95
BSC FR66IG	66	Ivy Gold	Set	499.95
BSC FR66IGRC	66	Ivy Gold w/Recliner	Set	499.95
BSC FR66PT	66	Parchment	Set	499.95
BSC FR66PTRC	66	Parchment w/Recliner	Set	499.95
BSC FR66RD	66	Red	Set	499.95
BSC FR66RDRC	66	Red w/Recliner	Set	499.95
BSC FR66TQ	66	Turquoise	Set	499.95
BSC FR66TQRC	66	Turquoise w/Recliner	Set	499.95
BSC FR66WT	66	White	Set	499.95
BSC FR66WTRC	66	White w/Recliner	Set	499.95

## Our Concours-Quality Carpet Sets are Authentic in Appearance, Fit & Finish!

When it comes to finding the best carpet for your 1958/66 Thunderbird, our Carpet Sets (BMC) can't be beat! Thunderbird carpet Sets are cut, sewn and bound for a proper fit. Each set features tough Nylon-Loop construction for a long-lasting resistance to fading and wear, Cloth or Serge-Bound Edges and Correct Original Colors.

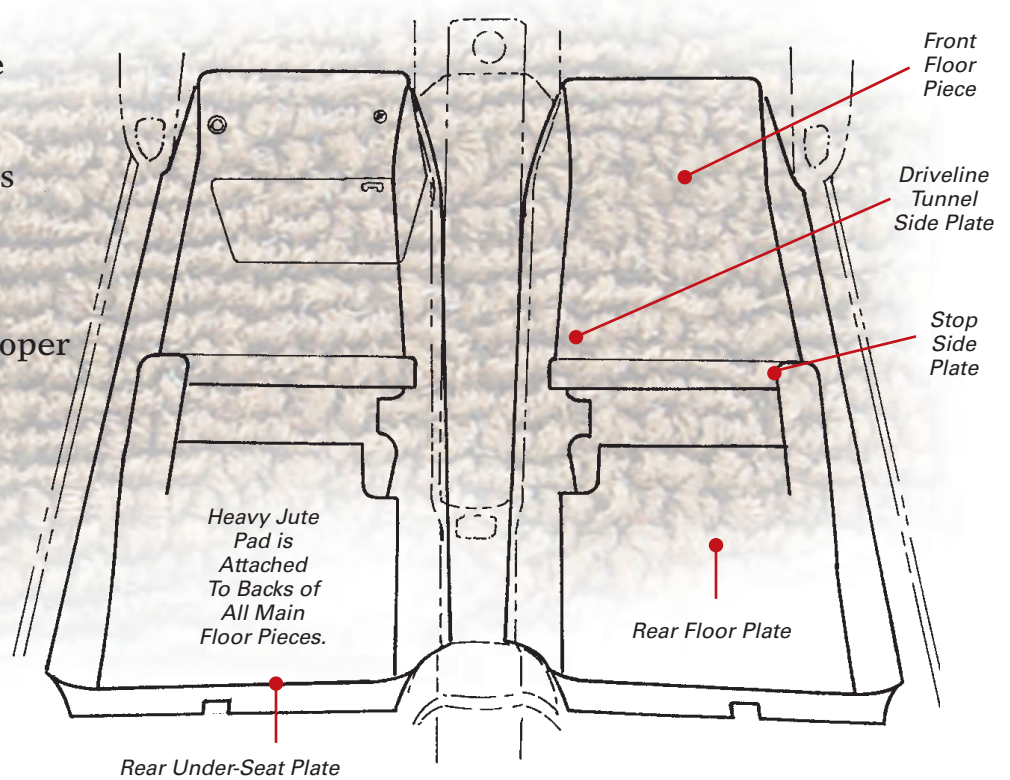

### 1958 Carpet 1958 Carpet is Cloth-bound.

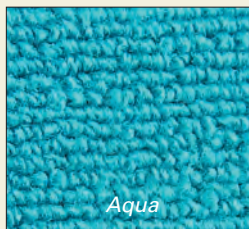

Aqua



Black

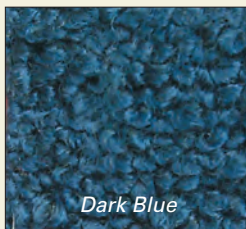

Dark Blue



Dark Brown

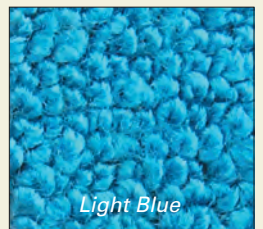

Light Blue



Dark Green

#### Current Carpet Colors Available for 1958 Thunderbirds:

BMC 58AQ	58	Aqua	Cloth Bound	.....	Each	149.95
BMC 58BK	58	Black	Cloth Bound	.....	Each	149.95
BMC 58DKBU	58	Dk. Blue	Cloth Bound	.....	Each	149.95
BMC 58DKBN	58	Dk. Brown	Cloth Bound	.....	Each	149.95
BMC 58DKGN	58	Dk. Green	Cloth Bound	.....	Each	149.95
BMC 58LTBU	58	Lt. Blue	Cloth Bound	.....	Each	149.95
BMC 58LTSD	58	Lt. Saddle	Cloth Bound	.....	Each	149.95
BMC 58RD	58	Red	Cloth Bound	.....	Each	149.95



Light Saddle

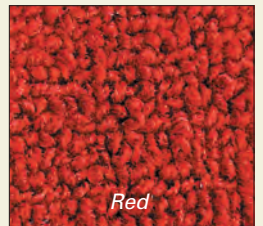

Red



## 1959/60 Carpet



**(1959/60 Carpet is Serge-Bound)**

BMC 59AQ	59/60	Aqua	Serge Bound ....	Each	149.95
BMC 59BK	59/60	Black	Serge Bound ....	Each	149.95
BMC 59DKBN	59/60	Dk. Brown	Serge Bound ....	Each	149.95
BMC 59DKBU	59/60	Dk. Blue	Serge Bound ....	Each	149.95
BMC 59DKGN	59/60	Dk. Green	Serge Bound ....	Each	149.95
BMC 59LTBU	59/60	Lt. Blue	Serge Bound ....	Each	149.95
BMC 59LTSD	59/60	Lt. Saddle	Serge Bound ....	Each	149.95
BMC 59RD	59/60	Red	Serge Bound ....	Each	149.95

## 1961/63 Carpet



**Color-Matched for Your 'Bird's Restoration!**

BMC 61AQ	61/63	Aqua	Serge Bound.....	Each	149.95
BMC 61BK	61/63	Black	Serge Bound.....	Each	149.95
BMC 61BN	61/63	Dk. Brown	Serge Bound.....	Each	149.95
BMC 61DKBU	61/63	Dk. Blue	Serge Bound.....	Each	149.95
BMC 61MDBU	61/63	Lt. Blue	Serge Bound.....	Each	149.95
BMC 61LTSD	61/63	Lt. Saddle	Serge Bound.....	Each	149.95
BMC 61RD	61/63	Red	Serge Bound.....	Each	149.95

## 1964/66 Carpet



**Carpet Kits 1964 thru 1966**  
Thunderbirds are moulded to match factory floorboard contours for a wrinkle-free fit!

BMC 64AQ	64/66	Aqua	Moulded.....	Each	198.90
BMC 64BK	64/66	Black	Moulded.....	Each	198.90
BMC 64BU	64/66	Dk. Blue	Moulded.....	Each	198.90
BMC 64DKGN	64/66	Dk. Green	Moulded.....	Each	198.90
BMC 64DKSD	64/66	Dk. Saddle	Moulded.....	Each	198.90
BMC 64EMG	64/66	Emberglow	Moulded.....	Each	198.90
BMC 64IG	64/66	Ivy Gold	Moulded.....	Each	198.90
BMC 64LTBU	64/66	Lt. Blue	Moulded.....	Each	198.90
BMC 64LTSD	64/66	Lt. Saddle	Moulded.....	Each	198.90
BMC 64MN	64/66	Maroon	Moulded.....	Each	198.90
BMC 64MSGN	64/66	Moss Green	Moulded.....	Each	198.90
BMC 64RD	64/66	Red	Moulded.....	Each	198.90



## Special Trim Adhesives

Secure your new carpet with 3M® Special Adhesives.

B 19552A	Black cement, 2 oz. tube ...	10.97
B 19552B	Yellow cement, 2 oz. tube...	8.93
B 19552C	Spray Adhesive, 16.75 oz. can .....	26.50

# UPHOLSTERY & RELATED TRIM

## Seat Foam Sets

Is your seat looking tired? Seating restoration is incomplete without new foam and its revitalizing characteristics.

BSF 58	1958/60; 1 Bucket.....	Each	149.95
BSF 61	1961/62; 1 Bucket.....	Each	149.95
BSF 63	1963; 1 Bucket.....	Each	149.95
BSF 66	1966; 1 Bucket.....	Each	149.95
BSF R58	1958/60; Rear Seat Foam.....	Set	392.70
BSF R61	1961/62; Rear Seat Foam.....	Set	392.70
BSF R58	1963; Rear Seat Foam.....	Set	392.70
BSF R64	1964/66; Rear Seat Foam.....	Set	392.70
BSF 64R	1964/65; Recliner, 1 Bucket.....	Each	149.95
BSF 66R	1966; Recliner, 1 Bucket.....	Each	149.95

## Upholstery Installation Kit



Our Upholstery Installation Kit includes one Hog Ring Plier Set & 250 Hog Rings. Enough to do a complete interior.

MAC 8 Complete Hog Ring Kit ..... Each 13.77

## Original-Style Rubber Floor Mats. Correct Pattern Logos!

A great way to keep your Thunderbird's carpet fresh and clean is with a set of Original-Style Floor Mats. These are high grade rubber and feature the proper Thunderbird logo and/or script for each particular year. We sell them in perfect-fit Front & Rear sets only.

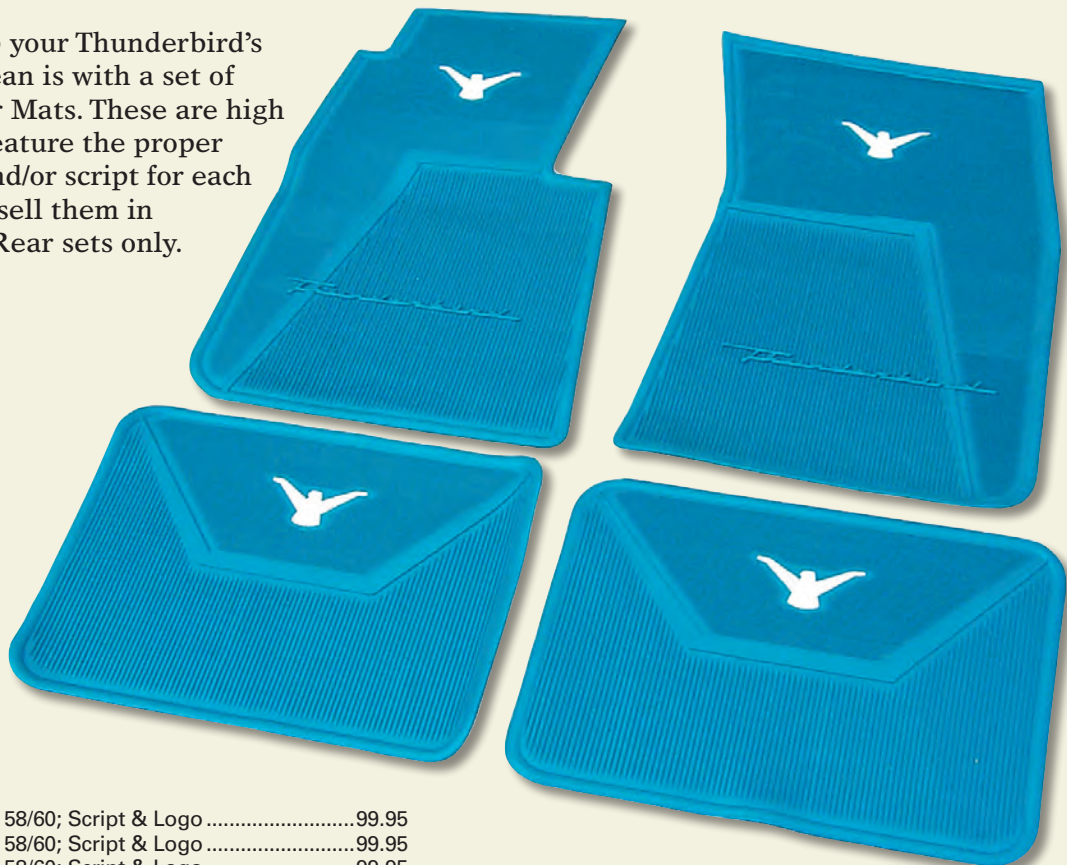

B 13106A	Black	58/60; Script & Logo .....	99.95
B 13106C	Red	58/60; Script & Logo .....	99.95
B 13106D	Blue	58/60; Script & Logo .....	99.95
B 13106E	Turquoise	58/60; Script & Logo .....	99.95
B 13106F	Black	61/63; Script & Logo .....	99.95
B 13106H	Red	61/63; Script & Logo .....	99.95
B 13106I	Blue	61/63; Script & Logo .....	99.95
B 13106J	Turquoise	61/63; Script & Logo .....	99.95

B 13106K	Black	64/66; Logo Only .....	99.95
B 13106M	Red	64/66; Logo Only .....	99.95
B 13106N	Blue	64/66; Logo Only .....	99.95
B 13106O	Aqua	64/66; Logo Only .....	99.95
B 13106P	Burgundy	64/66; Logo Only .....	99.95

# UPHOLSTERY & RELATED TRIM

## Windlace Retainer Clip

B 02614A 58/60 ..... Each 4.03

## Dash End Plates

B 04564A 61/63; Black Vinyl ..... Pair 45.00

## Color-Matched Windlace

BWL 58BK	58/60	Black; Cloth	Set	39.95
BWL 58BU	58/60	Blue; Cloth	Set	39.95
BWL 58GN	58/60	Green; Cloth	Set	39.95
BWL 58RD	58/60	Red; Cloth	Set	39.95
BWL 58TQ	58/60	Turquoise; Cloth	Set	39.95
BWL 58PO	58/60	Palomino; Cloth	Set	39.95
BWL 60BG	60	Dk Beige; Cloth	Set	39.95

## Protect Your Dash! Use a Dash Mat



If you've got a brand new dash pad that you want to protect, or an original that is in need of special attention, you need a custom fit Dash Mat to help deter the effects of the sun and its strong UV rays. Each mat is sewn and fit specifically for Thunderbirds. Attaches to the dash area via velcro and tape for a great fit.

BDM 58BK	58/60	Black	Each	42.95
BDM 58DKBU	58/60	Dark Blue	Each	42.95
BDM 58TN	58/60	Tan	Each	42.95
BDM 61BK	61/63	Black	Each	42.95
BDM 61DKBU	61/63	Dark blue	Each	42.95
BDM 61DKGN	61/63	Dark Green	Each	42.95
BDM 61GY	61/63	Gray	Each	42.95
BDM 61LTBU	61/63	Light blue	Each	42.95
BDM 61TN	61/63	Tan	Each	42.95
BDM 64BK	64/66	Black	Each	42.95
BDM 64DKBU	64/66	Dark blue	Each	42.95
BDM 64DKGN	64/66	Dark Green	Each	42.95
BDM 64GY	64/66	Gray	Each	42.95
BDM 64LTBU	64/66	Light blue	Each	42.95
BDM 64RD	64/66	Dark Red	Each	42.95

## Original-Style Step Plates

When replacing your carpet and other upholstery items you'll want to install new step plates to finish off the job with complete attention to detail. Manufactured to exacting standards for an original appearance. Easy to install.

B 13208B	61/62	Each	78.95
B 13208D	64/66	Pair	109.95
B 13208E	58/60	Each	66.30
B 13208F	63	Each	54.95

## Quarter Panel Trim

BQTC 58WT	58/59	White	Pair	56.10
BQTC 59BU	59	Lt. Blue	Pair	56.10
BQTC 60BU	60	Lt. Blue	Pair	138.95
BQTC 60BUC	60	Blue (Convertible)	Pair	138.95
BQTC 60TN	60	Lt. Tan	Pair	138.95
BQTC 60TNC	60	Lt. Tan (Convertible)	Pair	138.95
BQTC 60TQ	60	Lt. Turquoise	Pair	138.95
BQTC 60TQC	60	Lt. Turquoise (Conv.)	Pair	138.95
BQTC 60WT	60	White	Pair	138.95
BQTC 60WTC	60	White (Convertible)	Pair	138.95

## Rear Arm Rest Covers



BRAC 58BU	58	Blue	Pair	58.09
BRAC 58TQ	58	Turquoise	Pair	58.09
BRAC 58BK	58/59	Black	Pair	58.09
BRAC 58GN	58/59	Green	Pair	58.09
BRAC 58RD	58/59	Red	Pair	58.09
BRAC 58TN	58/59	Tan	Pair	58.09
BRAC 59BU	59	Dark Blue	Pair	58.09
BRAC 59TQ	59	Turquoise	Pair	58.09
BRAC 60BK	60	Black	Pair	58.09
BRAC 60BU	60	Blue	Pair	58.09
BRAC 60RD	60	Red	Pair	58.09
BRAC 60TN	60	Tan	Pair	58.09
BRAC 60TQ	60	Turquoise	Pair	58.09



## Create a New Looking Dash!

Tired of looking at that cracked and faded dash in front of you each time you take a drive in your Thunderbird? Install a Dash Pad to help make your dash area look new again. Each pad is manufactured to original Ford details, with some trimming required for a great fit. Limited Quantities Available!

B 04290A	61/62 (to 4/16/62); Black	475.00
B 04290G	58/60; Black	485.00

### Related Attaching Parts Kits For Dash Area

BHK 263	Dash End Caps, 61/63, 2 Sides (8 Pieces)	2.81
BHK 265	Instrument Bezel Covers, 61/63, (3 Pieces)	1.74
BHK 266	Instrument Housing Bezel, 64/66, (15 Pieces)	4.62
BHK 268	Instrument Housing Ret. Plate, 64/66, (6 Pieces)	2.18
BHK 273	Lower Dash trim—LH, 64/66, (3 Pieces)	1.74
BHK 274	Lower Dash trim—RH, 64/66, (3 Pieces)	1.74
BHK 275	Under Dash Panel, 58/60, (12 Pieces)	5.24
BHK 276	Under Dash Panel Moulding - Lower, 58/60, (16 Pieces)	12.48
BHK 277	Under Dash Panel Moulding - Upper, 58/60, (4 Pieces)	1.56
BHK 278	Under Dash Panel & Mould., 58/60, (32 Pcs)	18.73

## Deluxe Door Panels

Larry's Deluxe Door Panels are a semi-complete panel that features a sturdy plastic backing as well as correct contours and are moulded to original specifications, then covered with correct vinyl material. Sold In Pairs Only.

**1958/59 Must use existing trim items.**

BDP C58BK	58/59	Black/White .....	Pair	645.00
BDP C58BU	58	Blue/White .....	Pair	645.00
BDP C58GN	58/59	Green/White.....	Pair	645.00
BDP C58PO	58/59	Palomino/White.....	Pair	645.00
BDP C58RD	58/59	Red/White.....	Pair	645.00
BDP C58TQ	58	Turquoise/White .....	Pair	645.00
BDP C59BU	59	Blue/White .....	Pair	645.00
BDP C59TQ	59	Turquoise/White .....	Pair	645.00

**1960 Vinyl design with squares. Must use existing trim items**

BDP C60BK	60	Black/White .....	Pair	645.00
BDP C60BU	60	Blue/Blue.....	Pair	645.00
BDP C60RD	60	Red/White.....	Pair	645.00
BDP C60TN	60	Dk. Brown/Lt. Brown.....	Pair	645.00
BDP C60TQ	60	Turquoise/Turquoise .....	Pair	645.00

**1961/62 (early '62 - Before 4/16/62) With recess to mate with original dash and detachable arm rest(not included).**

BDP C61BK	61 (early 62)	Black .....	Pair	675.00
BDP C61WT	61 (early 62)	White.....	Pair	675.00
BDP C62BK	(late) 62/63	Black.....	Pair	675.00
BDP C62WT	(late) 62/63	White .....	Pair	675.00



BDP C58TQ 1958 Door Panel



BDP C60RD 1960 Door Panel

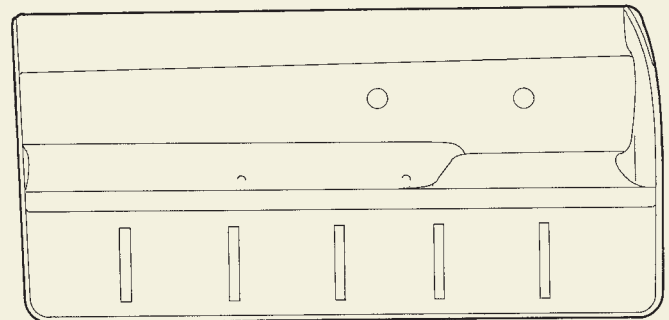
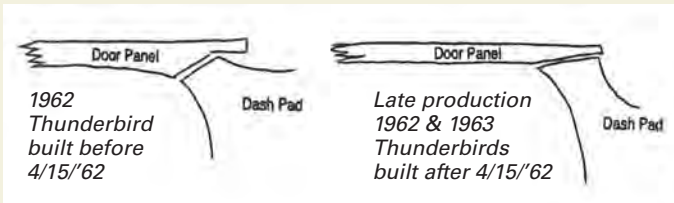

1962/63 Door Panel

## Combination Door Panel

Features Ford's late 62/63 style, except it has the recessed area in the upper front corner where it meets the dash like 61/early 62 panel. To be used with 61/62 Dash Pad. Sold In Pairs Only. Moulded armrest. Special Order Item Only.

BDP C63BK	(late) 62/3	Black	(combo).....	Pair	675.00
BDP C63WT	(late) 62/3	White	(combo).....	Pair	675.00

**1964 Standard: (Will not accept Woodgrain) \*These are a special order item. Landau: Must use existing woodgrain panel.**

BDP C64BK	64	Black	(Standard) .....	Pair	675.00
BDP C64LBK	64	Black	(Landau) .....	Pair	675.00
BDP C64WT	64	White	(Standard) .....	Pair	675.00
BDP C64LWT	64	White	(Landau) .....	Pair	675.00

**1965 Standard: (Will not accept Woodgrain) \*These are a special order item. Landau: Must use existing woodgrain panel.**

BDP C65BK	65	Black	(Standard) .....	Pair	675.00
BDP C65LBK	65	Black	(Landau) .....	Pair	675.00
BDP C65WT	65	White	(Standard) .....	Pair	675.00
BDP C65LWT	65	White	(Landau) .....	Pair	675.00

**1966 Standard: (Will not accept Woodgrain) \*These are a special order item.**

BDP C66BK	66	Black	(Standard) .....	Pair	675.00
BDP C66WT	66	White	(Standard) .....	Pair	675.00

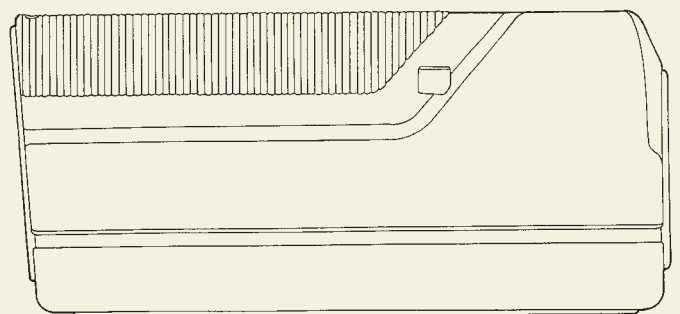

1964/65 Door Panel (Not Landau)

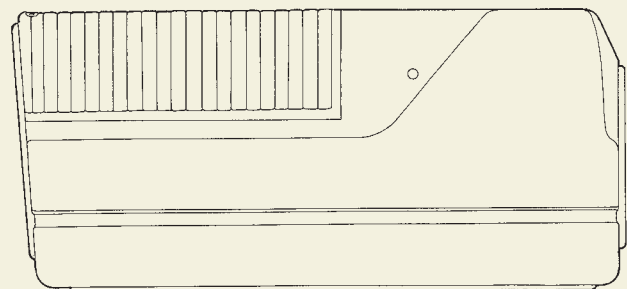

1966 Door Panel

# UPHOLSTERY & RELATED TRIM

## Door Pull Cup Brackets

B 24110A 65/66; Door Pull Cup Brackets ..... Pair 16.25

## Door Panel Armrests

Larry's Deluxe Door Panels are semi-complete panels that feature a sturdy plastic backing (an improvement over the original!), correct contours, and are moulded to original specifications, then covered with correct vinyl material.

B 24140A 61/62; RH..... Each 81.55  
 B 24141A 61/62; LH ..... Each 81.55  
**BHK 167 Dr. Panel Armrest Cup, 61/63, 2 Sides (4 Pieces) 1.98**

## Door Panel Pull Cups



B 24142A 58/60 & Late 62/63..... Pair 21.95

## Door Handle Removal Tool



One simple slip is all it takes to damage the trim on your Thunderbird's door. Our special Door Handle Removal Tool is the way to safely remove your door handle. Add it to your T-Bird tool kit.

B 22601T '58-66 ..... 8.67

## Door Panel Carpet 1964/66 Thunderbirds



BDC AQ	64/66	Aqua .....	Pair	50.95
BDC BK	64/66	Black .....	Pair	50.95
BDC BU	64/66	Dark Blue.....	Pair	50.95
BDC DKGN	64/66	Dark Green.....	Pair	50.95
BDC DKSD	64/66	Dark Saddle .....	Pair	50.95
BDC EMB	64/66	Emberglo .....	Pair	50.95
BDC IG	64/66	Ivy Gold.....	Pair	50.95
BDC LTBU	64/66	Light Blue.....	Pair	50.95
BDC MDSD	64/66	Medium Saddle.....	Pair	50.95
BDC MN	64/66	Maroon.....	Pair	50.95
BDC MSGN	64/66	Moss Green .....	Pair	50.95
BDC RD	64/66	Red.....	Pair	50.95

## Quarter Trim Caps

B 31490A 64/66; Rear Upper Convertible ..... Pair 30.55

**Note: These parts come primed and must be painted to match your interior.**

## Door/Trim Attaching Hardware

BHK 130	Dr. Hinge To Door, 2 Hinges, 61/63, 1 Door (8 Pieces) .....	5.37
BHK 131	Dr. Hinge To Door, 2 Hinges, 64/66, 1 Door (12 Pieces) .....	11.49
BHK 133	Dr. Hinge To Body, 2 Hinges, 64/66, 1 Side (16 Pieces) .....	9.92
BHK 155	Door Belt Cap-Front, (20360/1), 61/63, 2 Sides (4 Pieces) .....	2.00
BHK 156	Door Belt Cap-Rear, (20362/3), 61/63, 2 Sides (10 Pieces) .....	3.50
BHK 157	Door Panels, 58/60, (18 Pieces).....	10.36
BHK 158	Door Trim Panel Retainer-Front, (237A24/5), 61/63, 2 Sides (8 Pieces) .....	3.00
BHK 159	Door Trim Panel Retainer-Rear, (237A26/7), 61/63, 2 Sides (4 Pieces) .....	2.06
BHK 160	Inside Stainless Above Door, 58/60, (8 Pieces) .....	2.88
BHK 161	Inside Moulding Over Door, 64/66, 2 Sides (6 Pieces) .....	2.38
BHK 162	Rear Of Door Top Protective Moulding, 64/66, 2 Sides (4 Pieces) .....	2.06
BHK 163	Stainless Steel Moulding, 64/66, 2 Sides (8 Pieces) .....	3.00
BHK 169	Door Light Bezel, 61/63, 2 Sides (4 Pieces) .....	2.31

# UPHOLSTERY & RELATED TRIM

## Landau Vinyl Top

Has your original landau top finally gotten to the point where it seems to be a better air scoop than a cover for your hardtop? We've seen many a top deteriorated so badly that they look like they've got a disease! If you are one of those special owners, why not replace the old worn out original with our Vinyl Landau Top that is hand-crafted to fit your Thunderbird perfectly! Made to fit 1961 thru 1966 Thunderbirds, from original Cobra Grain Vinyl fabric. The Best!

BLD 61BK	61/63; Black Only .....	259.95
BLD 64BK	64/66; Black Lavant .....	235.00
BLD 64WT	64/66 White Lavant .....	235.00

## The Finest Convertible Tops Available!

Isn't it about time you replaced that worn out soft top on your pride and joy? There really isn't any need to put up with the elements intruding on your outing to the car show, etc. Larry's offers the highest-quality convertible top available for classic Thunderbirds. Each convertible top includes a plastic window and is made with original patterns and tough top quality vinyl. Manufacturer guarantees each top against defects in workmanship and materials for 3 years (except plastic window).

BST 58BK	58/60	Black w/black Underside.....	315.95
BST 58WT	58/60	White w/black Underside .....	315.95
BST 61BK	61/63	Black w/black Underside.....	315.95
BST 61WT	61/63	White w/black Underside .....	315.95
BST 64BK	64/66	Black w/black Underside.....	315.95
BST 64WT	64/66	White w/black Underside .....	315.95

**\*\*Note: Soft Top Does Not Include Top Pad.**

BHK 291	Conv. Center equalizer, 58/60, (8 Pieces) .....	2.00
BHK 292	Conv. Rear Cyl. Hinges to Lid, 58/60, (6 Pieces) .....	6.00
BHK 293	Conv. Rear Cyl. Hinges to Body, 58/60, (16 Pieces) .....	7.74
BHK 294	Conv. Trunk Lid to Body Hinge, 58/60, (16 Pieces) .....	6.62
BHK 295	Conv. Soft Top Foot to Body, 58/60, (36 Pieces) .....	12.98
BHK 296	Soft Top Mechanism to Foot, 58/60, (32 Pieces) .....	13.23
BHK 297	Soft Top Arms to Package Tray, 58/60, (26 Pieces) .....	8.86

## Convertible Top Pad

As with all upholstery items, complete care is taken to ensure a proper fit and finish when your Convertible Top Pad is installed. Manufactured from the finest materials!

B 52874A	58/66; Black Only .....	Pair	65.95
----------	-------------------------	------	-------



## Wing Screw & Retainer for Tonneau Cover

B 50136A	58/66; (2) required .....	Each	14.33
----------	---------------------------	------	-------

## Original-Style Sun Visors



Replace Worn and faded original sun visors with our high-quality Original-Style Sun Visors, manufactured to correct size and correct vinyl.

B 04104A	58/59	White .....	Pair	135.00
B 04104B	60	White .....	Pair	135.00
B 04104C	60	Black .....	Pair	135.00
B 04104D	60	Dark Blue.....	Pair	135.00
B 04104E	60	Dark Green.....	Pair	135.00
B 04104F	60	Dark Turquoise.....	Pair	135.00
B 04104G	60	Light Beige.....	Pair	135.00
B 04104H	60	Red.....	Pair	135.00

## Sun Visor Anchor Pins

B 04114A	64/65	.....	Each	3.59
----------	-------	-------	------	------

## Sun Visor Rubber Tip

B 04115A	61/66	.....	Each	1.04
----------	-------	-------	------	------

## Sun Visor Rod Clip

B 04131A	58/60	Chrome, 2 Required.....	Each	15.25
B 04131B	61/63	Chrome .....	Each	16.95



B 04144A  
Sun Visor Brackets

## Sun Visor Arm & Bracket

B 04144A	58/60; RH .....	Each	51.00
B 04145A	58/60; LH.....	Each	51.00
B 04144C	61/63; RH.....	Each	51.00
B 04145C	61/63; LH.....	Each	51.00
B 04144D	64/66; RH, Convertible .....	Each	56.10
B 04145D	64/66; LH, Convertible.....	Each	56.10
BHK 110	Visor Brackets, 58/60, (8 Pieces) .....		3.56
BHK 113	Visor Brackets, Center, 58/60, (8 Pieces) .....		1.88
BHK 114	Center Visor Bracket, 64/66, (2 Pieces) .....		1.74

# UPHOLSTERY & RELATED TRIM



## Kick Panels

Larry's reproduction Kick Panels bring new life to the floor/firewall area and are easy to install. Quality crafted for years of extended use. Don't forget these when replacing carpet and door panels!

BKP 58WT	58/59	White	Pair	89.95
BKP 59BU	59	Light Blue	Pair	89.95
BKP 60BK	60	Black/White	Pair	85.00
BKP 60BU	60	Blue/Blue	Pair	85.00
BKP 60RD	60	Red/White	Pair	85.00
BKP 60TN	60	Brown/Brown	Pair	85.00
BKP 60TQ	60	Turquoise/Turquoise	Pair	85.00
B 02344A	64/66	Black (Coupe)	Pair	109.25
B 02344B	64/66	Black (Conv.)	Pair	109.25
B 02344C	61/62	Black Only	Pair	105.00
B 02344D	63	Black Only	Pair	101.49
BHK 231	Kick Panels, 58/60, 2 Sides (4 Pieces)			1.81
BHK 232	Kick Panels, 61/63, 2 Sides (8 Pieces)			3.37
BHK 233	Kick Panels, 64/66, 2 Sides (6 Pieces)			2.88

### B 31002/3 Rear Seat Quarter Trim Aluminum Panel

B 31002A	61/63 RH	Each	27.49
B 31003A	61/63 LH	Each	27.49

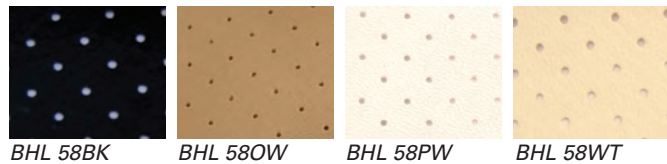

## Headliners

BHL 58BK	58/60; Black	65.00
BHL 58WT	58/60; Off White	65.00
BHL 61WT	61/63; Off White (Fits all 2-Door Hdtops)	65.00
BHL 61BK	61/63 Black	65.00
BHL 64BK	64/66 Black (Non Landau)	65.00
BHL 64WT	64/66; Off White (Fits all 2-Door Hdtops, Exc. '66 Landau)	65.00
BHL 58PW	58/60; Pure White	65.00
BHL 61PW	61/63; Pure White	65.00
BHL 64PW	64/66; Pure White (Non Landau)	65.00

### Dome Lamp Assembly

#### Dome Lamp Lens Gasket

B 13706A	58/60	Each	6.35
----------	-------	------	------

#### Pillar/Dome Lamp Lens

B 13783A	61/66	Each	3.59
B 13783B	58/60	Each	5.94
B 13783C	66 Landau	Each	10.56

#### Dome Lamp Body

B 13787A	58/60	Each	17.64
----------	-------	------	-------

## Seat Belt Sets



### Front Seat Belts 74"

BSB 74BK	58/66; Black	Each	36.67
BSB 74DKBU	58/66; Dark Blue	Each	36.67
BSB 74DKGN	58/66; Dark Green	Each	36.67
BSB 74DKIG	58/66; Dark Ivy Gold	Each	36.67
BSB 74MN	58/66; Maroon	Each	36.67
BSB 74PO	58/66; Palomino/Saddle	Each	36.67
BSB 74PT	58/66; Parchment	Each	36.67
BSB 74RD	58/66; Red	Each	36.67
BSB 74SIBU	58/66; Silver Blue	Each	36.67
BSB 74TQ	58/66; Turquoise	Each	36.67
BSB 74WT	58/66; White	Each	36.67

### Rear Seat Belts 54"

BSB 54BK	58/66; Black, Rear	Each	34.63
BSB 54DKBU	58/66; Dark Blue, Rear	Each	34.63
BSB 54DKGN	58/66; Dark Green, Rear	Each	34.63
BSB 54DKIG	58/66; Dark Ivy Gold	Each	34.63
BSB 54MN	58/66; Maroon, Rear	Each	34.63
BSB 54PO	58/66; Palomino/Saddle, Rear	Each	34.63
BSB 54PT	58/66; Parchment, Rear	Each	34.63
BSB 54RD	58/66; Red, Rear	Each	34.63
BSB 54SIBU	58/66; Silver Blue, Rear	Each	34.63
BSB 54TQ	58/66; Turquoise, Rear	Each	34.63
BSB 54WT	58/66; White, Rear	Each	34.63

### Retactable Front Seat Belts

BSB RBK	64/66; Black	Each	74.41
BSB RDKBU	64/66; Dark Blue	Each	74.41
BSB RDKGN	64/66; Dark Green	Each	74.41
BSB RDKIG	64/66; Dark Ivy Gold	Each	74.41
BSB RMN	64/66; Maroon, Rear	Each	74.41
BSB RPO	64/66; Palomino/Saddle	Each	74.41
BSB RPT	64/66; Parchment	Each	74.41
BSB RRD	64/66; Red	Each	74.41
BSB RSIBU	64/66; Silver Blue	Each	74.41
BSB RTQ	64/66; Turquoise	Each	74.41
BSB RWT	64/66; White	Each	74.41

## Upholstery Section Attaching Hardware

BHK 138	Step Plates, 61/62, 2 Sides (18 Pieces)	5.12
BHK 139	Step Plates, 58/60, 2 Sides (20 Pieces)	5.12
BHK 140	Step Plates, 61/63, 2 Sides (18 Pieces)	5.12
BHK 141	Step Plates, 64/66, 2 Sides (12 Pieces)	3.80
BHK 190	Rear Seat Arm Rest, 64/66, 2 Sides (4 Pieces)	2.18
BHK 193	Rear Arm Rest Top Cap, 64/66, 2 Sides (4 Pieces)	2.24
BHK 231	Kick Panels, 58/60, 2 Sides (4 Pieces)	1.81
BHK 232	Kick Panels, 61/63, 2 Sides (8 Pieces)	3.37
BHK 233	Kick Panels, 64/66, 2 Sides (6 Pieces)	2.88
BHK 235	Door Courtesy Light Cover, 61/63, (2 Pieces)	1.74
BHK 236	Coat Hooks, 58/60, 2 Sides (2 Pieces)	1.12
BHK 237	Coat Hooks, 64/66, 2 Sides (2 Pieces)	1.74
BHK 238	Inside Rear Quarter Panel-Lower Armrest, 58/60 (6 Pieces)	3.37
BHK 239	Inside Rear Quarter Panel, 61/63, 2 Sides (4 Pieces)	2.18
BHK 240	Inside Rear Quarter Moulding, 64/66, 2 Sides (4 Pieces)	1.94
BHK 241	Inside Rear Quarter Panel, Upper, 58/60 (6 Pieces)	2.88
BHK 242	Rear Window Inside Top Moulding, 58/60, (9 Pieces)	3.12
BHK 243	Inside Stainless-Back of Qtr. Window, 58/60, (4 Pieces)	1.56
BHK 244	Inside Rear Window Top Moulding, 64/66, (3 Pieces)	1.74
BHK 245	Inside Rear Window Side Moulding, 64/66, 2 Sides (6 Pieces)	2.44
BHK 246	Panel Behind Rear Seat, 58/60, (6 Pieces)	2.24
BHK 247	Quarter Window-Front Corner Stainless, 58/60, (4 Pieces)	1.50
BHK 249	Package Tray, 64/66, (10 Pieces)	2.81
BHK 365	Courtesy Light-Landau Only, 1966, (4 Pieces)	1.74

# WHEELS & WHEEL COVERS

## Wheel Covers



B 1130A '59/60 Full Cover  
Each ..... 79.95

## SunRay Deluxe Wheel Cover

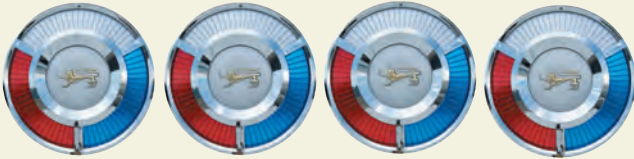

B 1130B 59/60; SunRay with Retainers..... Set of 4 280.35

\* Note: Works with B 1130A Wheel Cover

## Wire Wheel Spinner Center

B 1130C	58/66; Black.....	Each	30.55
B 1130D	58/66; Blue.....	Each	30.55
B 1130E	58/66; Green.....	Each	30.55
B 1130F	58/66; Red.....	Each	30.55

## Replacement Road Wheel

B 1007A	58/63; 14".....	Each	132.55
B 1007B	65/66; 15".....	Each	169.95

## Wire Wheel with Pan and Center



B 1015ABU	58/64; 14" With Blue Center .....	Each	550.75
B 1015ABK	58/64; 14" With Black Center .....	Each	550.75
B 1015ARD	58/64; 14" With Red Center .....	Each	550.75
B 1015GN	58/64; 14" With Green Center .....	Each	550.75
B 1015BBU	64; 15" With Blue Center .....	Each	550.75
B 1015BBK	64; 15" With Black Center .....	Each	550.75
B 1015BRD	64; 15" With Red Center .....	Each	550.75
B 1015BGN	64; 15" With Green Center .....	Each	550.75
B 1015CBU	65/66 15" Front, w/Blue Center .....	Each	550.75
B 1015CBK	65/66 15" Front, w/Black Center .....	Each	550.75
B 1015CGN	65/66 15" Front, w/Green Center .....	Each	550.75
B 1015CRD	65/66 15" Front, w/Red Center .....	Each	550.75
B 1015CGN	65/66 15" Front, w/Green Center .....	Each	550.75
B 1015DBU	65/66 15" Rear, w/Blue Center .....	Each	550.75
B 1015DBK	65/66 15" Rear, w/Black Center .....	Each	550.75
B 1015DRD	65/66 15" Rear, w/Red Center .....	Each	550.75
B 1015DGN	65/66 15" Rear, w/Green Center .....	Each	550.75

<b>B 1001</b>	<b>Rear Wheel Bearing Gasket</b>		
B 1001A	58/60 & 62/66 .....	Each	.89

## Spinner Assembly For Wire Wheel



B 1130BK B 1130BU B 1130GN B 1130RD

B 1130BK	58/66; Black Center.....	Each	76.45
B 1130BU	58/66; Blue Center.....	Each	76.45
B 1130GN	58/66; Green Center.....	Each	76.45
B 1130RD	58/66; Red Center.....	Each	76.45

Note: Each Assembly Includes (1) Pan, (1) Spinner & (1) Colored Center.  
Each Spinner Comes Assembled and Ready to Install.

<b>B 1012</b>	<b>Hub Bolt Nut</b>		
B 1012A	58/60 & 64/66; Wheel Hub Bolt, 1/2" x 20" zinc plated .....		.79
<b>B 1107</b>	<b>Front &amp; Rear Bolt</b>		
B 1107A	58/66; 1/2" x 20 x 1 5/8" serrations, diameter- .618/.628 .....		1.99
<b>B 1131</b>	<b>Hub Grease Cap</b>		
B 1131A	58/62; Front .....		2.81
B 1131B	63/66; Front, 1 31/32" O.D. ....		3.95
<b>B 1177</b>	<b>Rear Axle Bearing Inner Oil Seal</b>		
B 1177A	58/61; 1 3/8" I.D.—2 3/8" O.D. ....		8.06
B 1177B	62/64; 1 1/2" I.D.—2 1/2" O.D. ....		5.72
B 1177C	65/66; Rear Axle .....		5.15
<b>B 1104</b>	<b>Wheel Hub</b>		
B 1104A	58/62; 5 Stud .....		101.95
B 1104B	63/64; 5 Stud .....		101.95
<b>B 1190</b>	<b>Front Wheel Grease Retainer</b>		
B 1190A	58/62; (Before 5/21/62) Drum Brakes 2 1/2" O.D.—1 15/16" - I.D. - 9/32" Thick .....		4.11
B 1190B	62/66 (After 5/21/62) 2 27/32" major O.D. - 2 37/64" minor O.D. - 1 15/16" I.D. ....		8.11
<b>B 1193</b>	<b>Front Brake Backing Plate Gasket</b>		
B 1193A	61/64 .....	Each	.99
<b>B 1195</b>	<b>Front Spindle Nut Washer</b>		
B 1195A	58/66; 1 21/32" O.D.—3/32" thick .....		14.53
<b>B 1201</b>	<b>Differential Bearing</b>		
B 1201A	58/64; 1 1/4" I.D.—2 1/64 O.D. (Stamped 62048).....		10.35
B 1201B	65/66; 1 5/8 I.D.—2 9/16" O.D., LM48548 .....		10.35
<b>B 1201</b>	<b>Front Wheel Inner Bearing</b>		
B 1201C	66; Differential 1 13/16" I.D., 25590 .....		21.80
B 1202C	66; Differential Cup, 25520 .....		12.43
<b>B 1202</b>	<b>Front Wheel Bearing Inner Cup</b>		
B 1202A	58/64; (Stamped 67010).....		5.72
B 1202B	65/66; LM48510 .....		5.72
<b>B 1216</b>	<b>Front Wheel Bearing • Outer</b>		
B 1216A	58 thru Early 63; (Stamped 11949) .....		7.23
B 1216B	Late 63/66; M12649 .....		9.31
<b>B 1217</b>	<b>Front Wheel Bearing Cup • Outer</b>		
B 1217A	63/66; M12610 .....		4.68
B 1217B	58/62; (Stamped 11910) .....		5.72
<b>B 1225</b>	<b>Rear Axle Bearing Assembly</b>		
B 1225A	61; 1 3/8" I.D. - 2 53/64" O.D., Small .....		22.37
B 1225B	58/60 & 62/66; 1 17/32" I.D.—3 5/32" O.D. Large; Includes Retainer .....		28.95

## Wheels & Wheel Covers Attaching Hardware

BSP 374504 Nut, Front Spindle .....	Each	3.89
BSP 374536 Retainer, Front Spindle Nut .....	Each	2.50



## Larry's Illustration Manuals

Illustrated Parts Manuals for 1958/60 and 1961/66 are an in-depth compilation of full-page illustrations that cover all systems in your Thunderbird. These manuals are a "must have" item for those who work on their own car, or if you need to have an idea of what your mechanic is doing on your vehicle. Probably one of the best investments you can make when it comes to restoring your T-Bird properly!

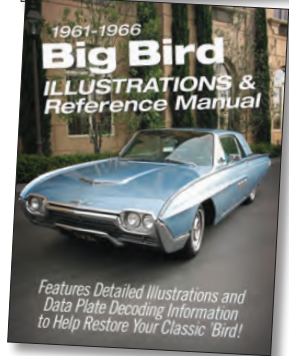

Order Part—BLT 18 (58/60) ..... 13.50  
 Order Part—BLT 19 (61-66) ..... 13.50

## Spare Tire Hold Down Bolt

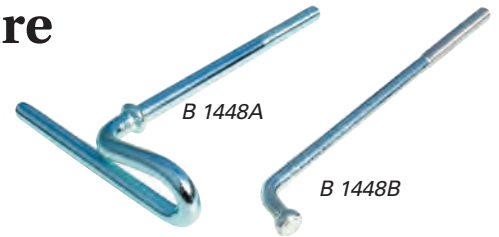

<b>B 1446</b>	<b>Spare Tire Hold Down Plate</b>	
B 1446A	58/59 & 62/66 With Wire Wheels .....	4.11
<b>B 1448</b>	<b>Spare Tire Hold Down Bolt</b>	
B 1448A	58/63; T-Type Bolt .....	14.98
B 1448B	64; 3/8" - 16 x 7 7/8" .....	10.15
B 1448C	64/66; 3/8" -16 x 9 3/16" with 3 1/4" Thread Length	5.15
<b>B 1462</b>	<b>Spare Wheel Carrier Bolt Nut</b>	
B 1462A	61/66; 3/8" x 16" Wing Nut .....	3.95
<b>B 17032</b>	<b>Jack Handle</b>	
B 17032C	58/66; Jack Handle.....	34.63



# Join the Club that Celebrates Ownership of 1955-Present Thunderbirds!

## "For Owners and Lovers of Ford Thunderbirds 1955 - Present"

### The Pride of Ownership

As an owner or fan of a 1955-newer Thunderbird, you already know about the qualities that make it special— Styling, Power, Prestige... Things that others take notice of. These timeless, classic qualities add up to a thrilling package that others clamor to have. Nostalgia, Excitement, Pride of Ownership— things you have in common with a group that shares the same love for the four-seat Thunderbird.

### The Privileges of Membership

This same pride is shared by the thousands of members of the Vintage Thunderbird Club International. VTCI members are a part of an automotive-loving fraternity that is among the best in the world. VTCI members are special— They love their cars, and help others who share the same desire to own a piece of motoring history. That's why there is VTCI— To preserve 1955-present Thunderbirds, and help them keep going well into the 21st Century!

### "Why Not Just Go It Alone?"

Sure, you could get by on your own, buying parts, performing repairs, and get frustrated when things don't go right or cost too much. Wouldn't it be nice to know others who have "been there" before you and benefit from their knowledge? Think of

the time and money you'd save by having such a resource at your fingertips. VTCI members have recovered their dues time and again, thanks to members networking to find hard-to-get parts, specialized technical information, and perhaps the most priceless benefit of all— friendships that last a lifetime. It's something you can't find just anywhere.

### "What Do I Get from VTCI?"

We've already given you an idea of what VTCI can provide from a personal level. Check out more benefits VTCI has to offer:

- "Thunderbird Scoop" Bi-Monthly Magazine
- Activities - Find out about local and regional car shows and concours events.
- Technical Assistance - Get your questions answered,
- Concours Rulebook - Do it right the first time.
- Membership Roster - Your future friends.
- Windshield Decal & Membership Card Sound like Fun? Join Us Soon! You'll Be Glad You Did!

### Vintage Thunderbird Club International

1304 Greenwood • Shertz, TX • 78154  
 (210) 566-2118  
[www.vintagethunderbirdclub.org](http://www.vintagethunderbirdclub.org)

# BRAKES

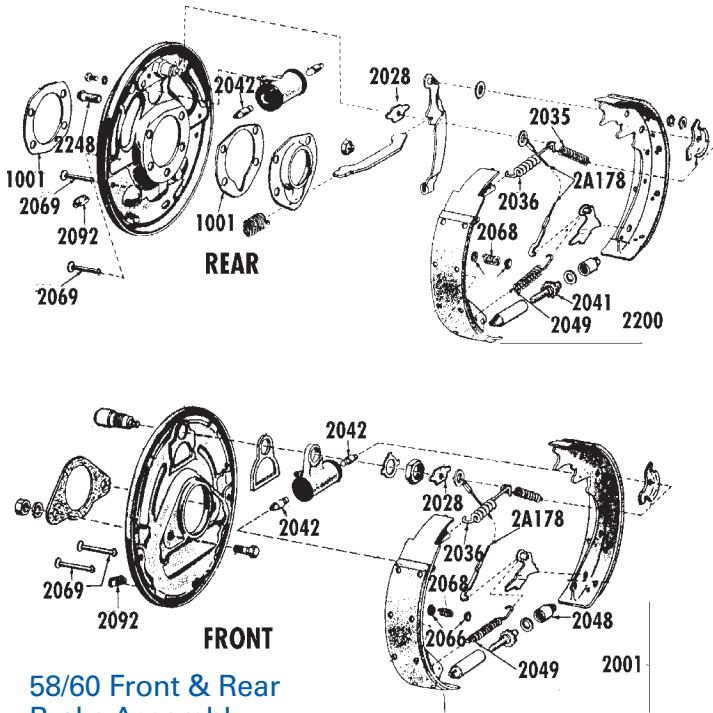

58/60 Front & Rear Brake Assembly

<b>B 1012</b>	<b>Hub Bolt Nut</b>	
B 1012A	58/60 & 64/66; Wheel Hub Bolt, 1/2" x 20" zinc plate .....	.79
<b>Disc Brake Rotor</b>		<b>B 1102A</b>
B 1102A	65/67; Rotor Only, No Hub .....	147.90
<b>B 1107</b>	<b>Wheel Stud</b>	
B 1107A	58/66; 1/2" x 20 x 1 5/8" serrations dia. .618/.628 ..	1.99
<b>B 1125</b>	<b>Front Brake Drum</b>	
B 1125A	61/62; Less Hub.....	137.65
B 1125B	63/64; Less Hub .....	139.95
B 1125C	59/60; Less Hub .....	94.65
<b>B 1126</b>	<b>Rear Brake Drum</b>	
B 1126A	58 Only .....	105.00
B 1126B	63/66 .....	149.95
B 1126C	61/62 .....	105.00
<b>B 1131</b>	<b>Hub Grease Cap</b>	
B 1131A	58/62; Front .....	2.81
B 1131B	63/66; Front, 1 31/32" O.D. ....	3.95
<b>B 1190</b>	<b>Front Wheel Grease Retainer</b>	
B 1190A	58/62; (Before 5/21/62) Drum Brakes 2 1/2" O.D.—1 15/16"—I.D.—9/32" Thick .....	4.11
B 1190B	62/66 (After 5/21/62) 2 27/32" major O.D.—2 37/64" minor O.D. 1 15/16" I.D. ....	8.11
<b>B 1193</b>	<b>Front Brake Backing Plate Gasket</b>	
B 1193A	61/64 .....	Each .99
<b>B 1195</b>	<b>Front Spindle Nut Washer</b>	
B 1195A	58/66; 1 21/32" OD—3/32" thick .....	14.53



61/63 Brake System—Typical

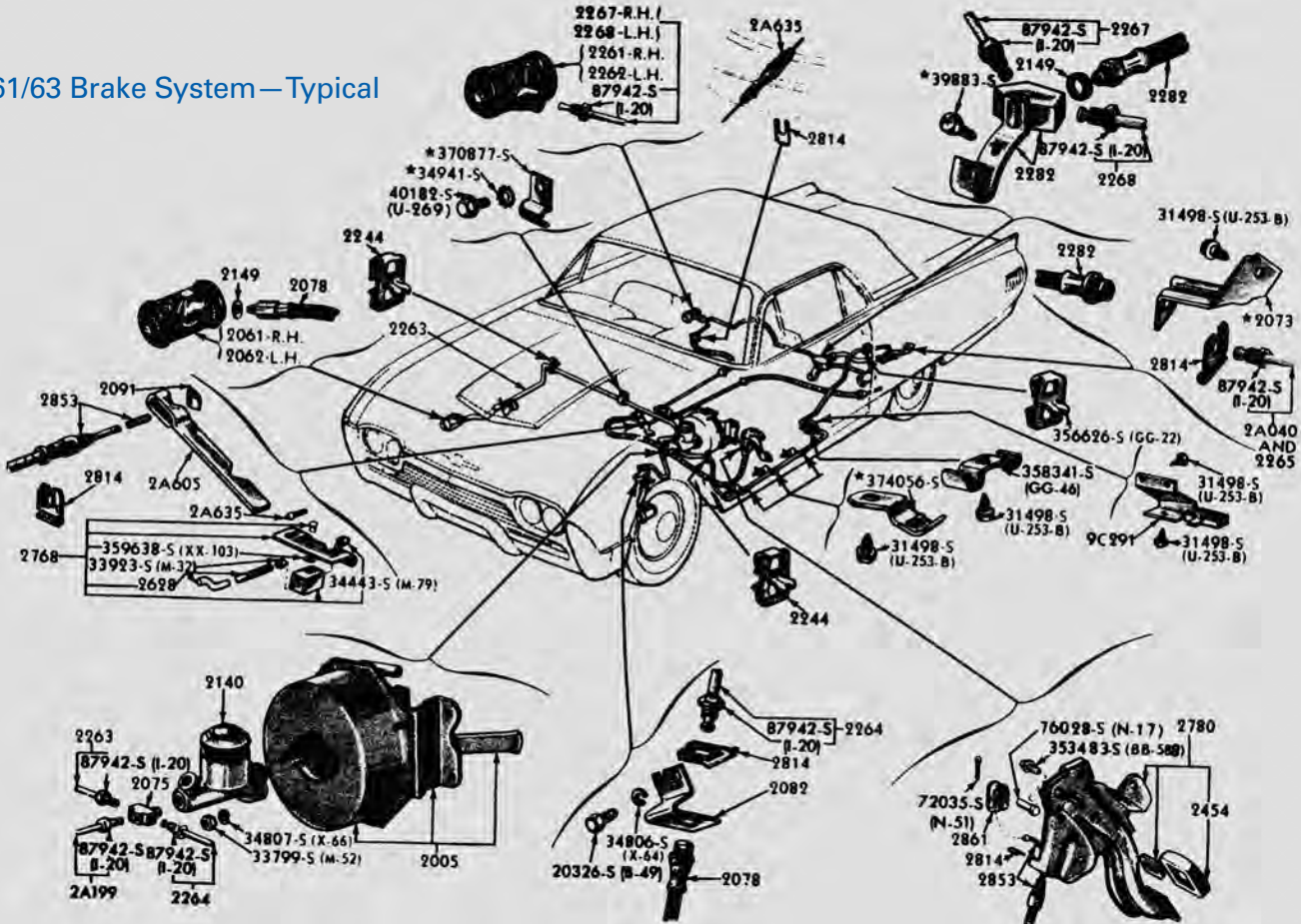

## Front Brake Shoe



B 2001A	65/66; Pad, Disc Brake .....	29.53
B 2001B	58/60; Front & 59/62, Rear .....	63.75
B 2001D	61/62; Front .....	58.09
B 2001E	63/64; Front .....	61.15

## Rebuilt Brake Boosters

*Note: Please Remove Any Extra Brackets, Check Valves or Spacers Before Sending in Core.*

*Core Return or Boosters Sent in For Rebuild Must Have Pedal Rod And Cylinder Rod.*

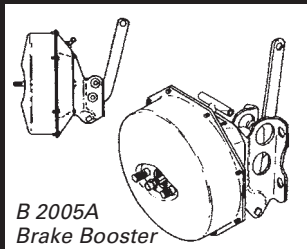

B 2005A  
Brake Booster

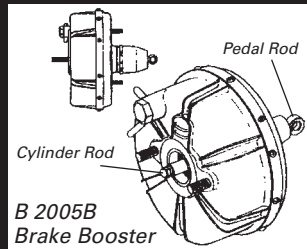

B 2005B  
Brake Booster

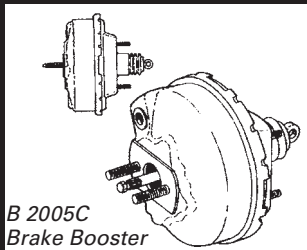

B 2005C  
Brake Booster

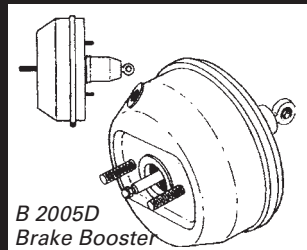

B 2005D  
Brake Booster

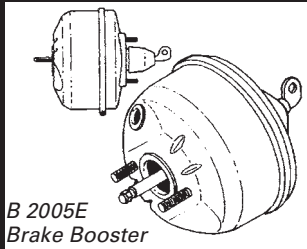

B 2005E  
Brake Booster

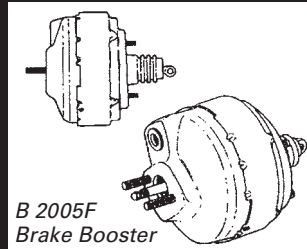

B 2005F  
Brake Booster

## Rebuilt Thunderbird Brake Boosters

B 2005A	59/60 .....	219.30
B 2005B	61/Early 64 .....	219.30
B 2005C	63/64; Bendix .....	219.30
B 2005D	63/64; Midland .....	219.30
B 2005E	65/66; Midland .....	219.30
B 2005F	65/66; Bendix .....	219.30
B 2005G	58/60; Booster-Under Dash .....	290.70
	Core Charge .....	250.00

*\*Note: It May Be necessary To Rebuild Your Booster Due To Current Shortage Of Cores. Please Call For Info.*

## Master Cylinder Rebuilt Kit



B 2004A	58/60; w/o Power Brakes, 1" .....	24.99
B 2004B	58; w/ Power Brakes 59/60; w/ Power Brakes, w/ Factory A/C, 1 1/8" .....	40.75
B 2004C	59/60; w/ Power Brakes, w/o Factory A/C 61; All (Before 6/9/61) 1" .....	24.99
B 2004D	61/64; All (After 6/9/61) 66; (From 1/3/66 To 4/1/66) 7/8" .....	29.53
B 2004E	65/66; (Before 1/3/66) 15/16" .....	25.26

## Brake Booster Spacer Plate

B 2006A	61/63; Nylon Screw Type .....	Pair	20.35
B 2006B	64/66; Metal, Midland Type Booster .....	Each	25.45
B 2006C	64/66; Nylon, Midland Type Booster .....	Each	25.45
B 2006D	61/63; Clip, Booster to Plastic Ring .....	Each	25.45

## B 2035 Brake Shoe Return Spring

B 2035A	58/60; All .....	Each	2.65
B 2036A	61; Front, Primary .....	Each	3.13

## B 2041 Brake Shoe Adjusting Screw Kit

B 2041A	61/66; RH .....	13.47
B 2041B	61/66; LH .....	13.47

## Brake System Master Cylinder Assembly—Typical

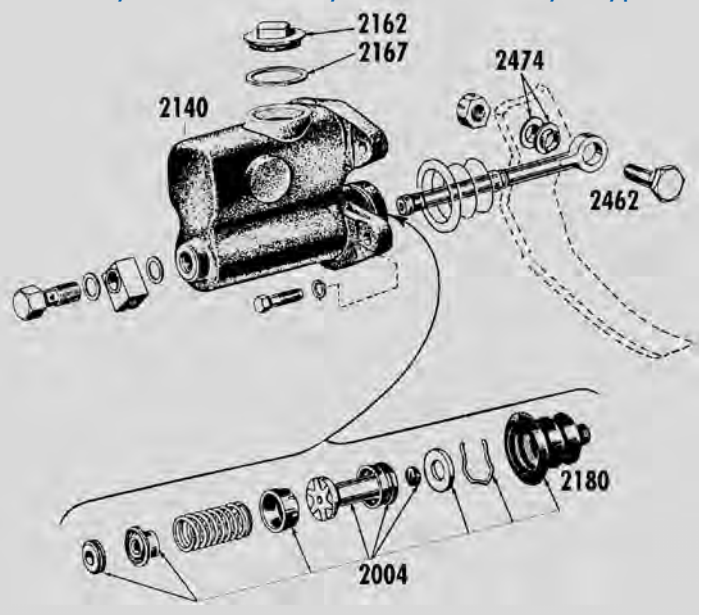

# BRAKES

<b>B 2049</b>	<b>Adjusting Spring—Brake Shoe</b>		
B 2049A	61/62; Front/RR .....	Each	2.93
B 2049B	58/60 .....	Each	2.65

## Front Brake Cylinder



B 2061B



B 2062B

B 2061A	59/60; RH, 1 3/32" .....	39.73
B 2062A	59/60; LH, 1 3/32" .....	39.73
B 2061B	58; RH, 1 1/8" .....	39.73
B 2062B	58; LH, 1 1/8" .....	39.73
*B 2061C	61/64; Front RH.....	37.69
*B 2062C	61/64; Front LH .....	37.69

\* Bleeder Screw May Need Modification

<b>B 2066</b>	<b>Spring Cup—Brake Shoe Hold Down</b>		
B 2066A	58/66; FR/RR.....	Each	.59

## Master Cylinder Brass Block

B 2075A	58/60 .....	Each	20.35
B 2075B	61/64 .....	Each	24.43
B 2075C	65/66 .....	Each	20.35

**Big Selection of Parts! Whether it's a hard to find part or a standard Thunderbird replacement part, Larry's has what you're looking for. Our inventory of parts is concours-quality. Give us a call if you can't find the parts you need. Our knowledgeable parts specialists will be happy to help!**

## Front Brake Hose



B 2078B

<b>B 2078</b>	<b>Hose Assembly—Front Brake</b>		
B 2078A	58; Front & 59/60 Rear		
	62/64; Drum .....		16.27
B 2078B	65/66; Disc .....		20.35
B 2078C	59/60; Drum, Front .....		15.25
B 2078D	61; Drum, Front .....		17.29
<b>B 2079</b>	<b>Brake Hose Banjo Bolt</b>		
B 2079A	65/66; Disc Brake .....	Each	8.93
<b>B 2091</b>	<b>Brake Proportioning Valve Kit</b>		
B 2091K	65/66 .....	Each	15.95
<b>B 2092</b>	<b>Plug—Brake Adjusting Hole</b>		
B 2092A	58/66; Front & Rear .....		.60
<b>B 2106</b>	<b>Retainer—Parking Brake Lever Pin</b>		
B 2106A	58/66; "C" Clip .....		1.19



B 2120A

<b>B 2120/1</b>	<b>Caliper Assembly—Disc Brake • New</b>		
B 2120A	65/66; RH .....		132.55
B 2121A	65/66; LH .....		132.55

## 1965/66 Brake Booster Assembly

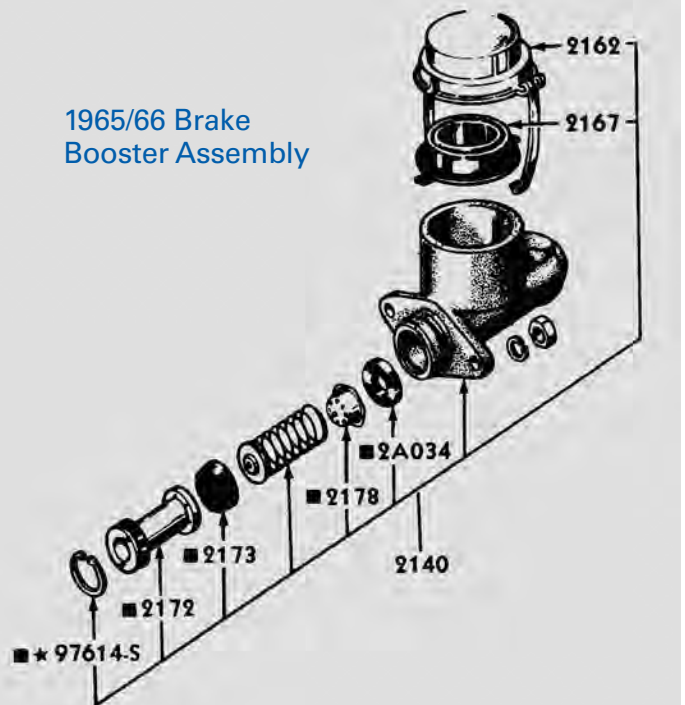

# BRAKES

## Brake Spring Kits



B 2095AK Brake Spring Kit



B 2095BK Brake Spring Kit



B 2095CK Brake Spring Kit



B 2095DK Brake Spring Kit

Count on Larry's to supply you with the finest components for rebuilding your Thunderbird's Brakes!



B 2095EK Brake Spring Kit

B 2095AK	56/60; Front	23.88
B 2095BK	61; Front	23.88
B 2095CK	62; Front	23.88
B 2095DK	63/64; Front	23.88
B 2095EK	58; Rear	23.88
B 2095FK	59/60; Rear	23.88
B 2095GK	61/62; Rear	23.88
B 2095HK	63/66; Rear	23.88

## Disc Brake Kits

B 2123A	58/60 Front	Kit	1014.39
B 2123B	61/62 Front	Kit	1014.39
B 2123C	63/64 Front	Kit	1014.39
B 2124A	58/60; Rear	Kit	782.85
B 2124B	61/64; Rear	Kit	782.85

<b>B 2125</b>	<b>Brake Caliper Fluid Transfer Line</b>		
B 2125A	65/66; RH	Each	13.21
<b>B 2126</b>	<b>Connection line—Brake Caliper</b>		
B 2126A	65/66; LH	Each	13.21
<b>B 2127</b>	<b>Disc Brake Pad Retainer</b>		
B 2127A	65/66	Each	13.74
<b>B 2128</b>	<b>Kit—Rear Brake Cylinder Repair</b>		
B 2128A	58 & 61/62; 2 Cups & 2 Boots; 7/8" diameter		9.29
B 2128B	63/66; 2 Cups & 2 Boots; 15/16" diameter		8.44
B 2128C	59/60; 2 Cups & 2 Boots; 29/32" diameter		10.46

*Be Sure to Ask About Larry's Gift Certificates!*

## Brake Master Cylinder



B 2140B

B 2140A	58; w/o Power Brakes; 59/60; w/o Power Brakes, w/o A/C	91.75
B 2140B	61/64; (after 6/9/61), 7/8" Diameter, Drum Brakes	81.55
B 2140C	65/66; (before 1/3/66), 15/16" Diameter, Disc Brakes	137.65
<b>B 2149</b>	<b>Gasket—Brake Line</b>	
B 2149A	58/66; Also used on differential cover bolt	.91

## Master Cylinder Caps



B 2162A



B 2162B



B 2162BC

<b>B 2162</b>	<b>Cup—Brake Master Cylinder</b>		
B 2162A	61/64; Drum Type, Screw-On, With Gasket		15.87
B 2162B	65/66; Disc Type, Clip-On		22.39
B 2162C	58/60; Drum Type, Screw-On		13.21
B 2162AC	61/64; Drum Type, Chrome Screw-On, With Gasket		20.35
B 2162BC	65/64; Disc Type, Chrome Clip-On		25.45

## Master Cylinder Filler Cap Gaskets



B 2167B



B 2167C

<b>B 2167</b>	<b>Gasket—Brake Master Cylinder Filler Cap</b>		
B 2167B	65/66; Disc Brakes		8.11
B 2167C	58/60; Drum Type		1.15

# BRAKES

<b>B 2180</b>	<b>Brake Master Cylinder Boot</b>	
B 2180A	58/60 .....	5.58
<b>B 2196</b>	<b>Brake Cylinder Piston</b>	
B 2196A	65/66; Disc Brake Caliper .....	Each 15.87



B 2200A

<b>B 2200</b>	<b>Rear Brake Shoe</b>	
B 2200A	63/66 .....	45.00
B 2200B	58 .....	54.01

\*Note: For 59/62, See Part #2001-B.

<b>B 2208</b>	<b>Bleeder Screw</b>	
B 2208A	58/66; 3/8" - 24 x 1 11/64" .....	5.95



B 2208A

<b>B 2221</b>	<b>Front Brake Cylinder Repair Kit</b>	
B 2221A	59/64; 2 Cups & 2 Boots; 1 3/32 .....	8.62
B 2221C	58; 2 Cups & 2 Boots; 1 1/8" .....	7.96
B 2221D	65/66; (Before 10/1/66), (2 Kits Req. Per Car) ..	Each 18.57
B 2221E	66; (After 10/1/66), (2 Kits Required Per Car) .	Each 20.15

## Rear Brake Cylinder

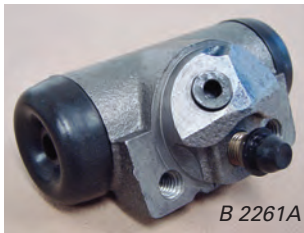

B 2261A



B 2262A

B 2261A	58 & 61/62; RH; 7/8" cup .....	20.76
B 2262A	58 & 61/62; LH; 7/8" cup .....	22.84
B 2261B	63/66; RH; 15/16" cup .....	20.76
B 2262B	63/66; LH; 15/16" cup .....	22.84
B 2262C	59/60; LH; 29/32" cup .....	27.49
B 2261D	59/60; RH; 29/32" cup .....	27.49

## Brake Line Kits (Original Steel Type)

B 2269AK	58; Manual or Power Brakes w/underdash booster .....	168.30
B 2269BK	59/60; Manual or Power Brakes w/underdash booster .....	168.30
B 2269CK	59/60; Power Brakes w/firewall booster .....	168.30
B 2269DK	61/62; Rear Brake Hose mounted to frame rail, early crossover line .....	168.30
B 2269EK	61/62; Rear Brake Hose mounted to frame rail, late crossover line .....	168.30
B 2269FK	62/63; Rear Brake Hose mounted to floor pan, early crossover line .....	168.30
B 2269GK	62/63; Rear Brake Hose mounted to floor pan, late crossover line .....	168.30
B 2269HK	64; All .....	178.50
B 2269IK	65/66; Without caliper lines .....	178.50



B 2282A

## Rear Brake Hose

<b>B 2282</b>	<b>Rear Brake Hose</b>	
B 2282A	58 .....	20.15
B 2282B	64/66 .....	37.69
B 2282C	61/62 .....	20.76
B 2282D	63 .....	35.65

## 58 Brake System

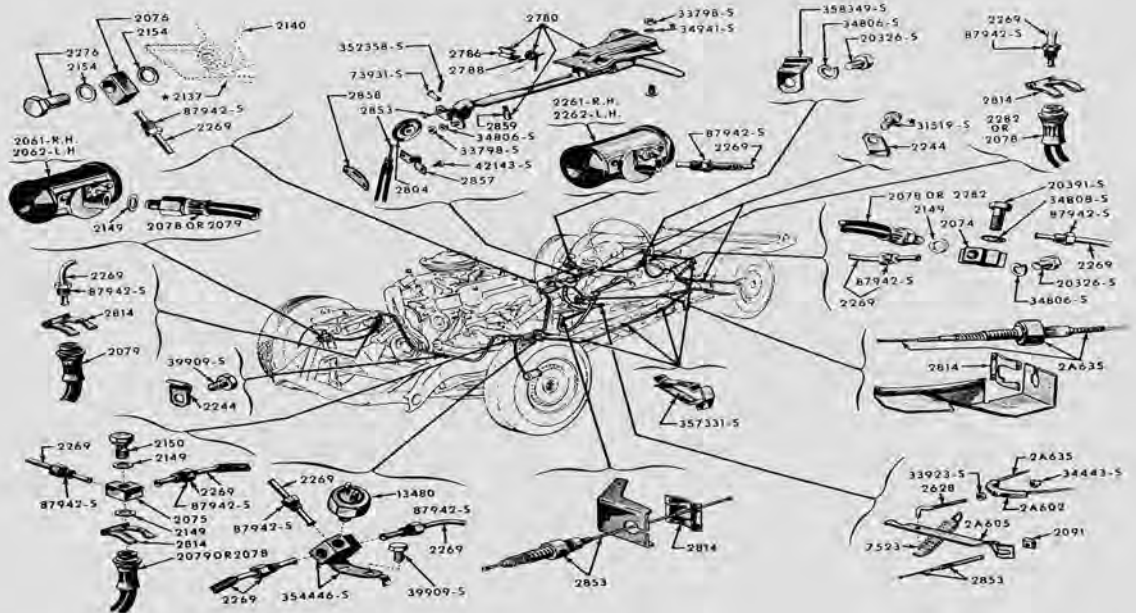

# BRAKES

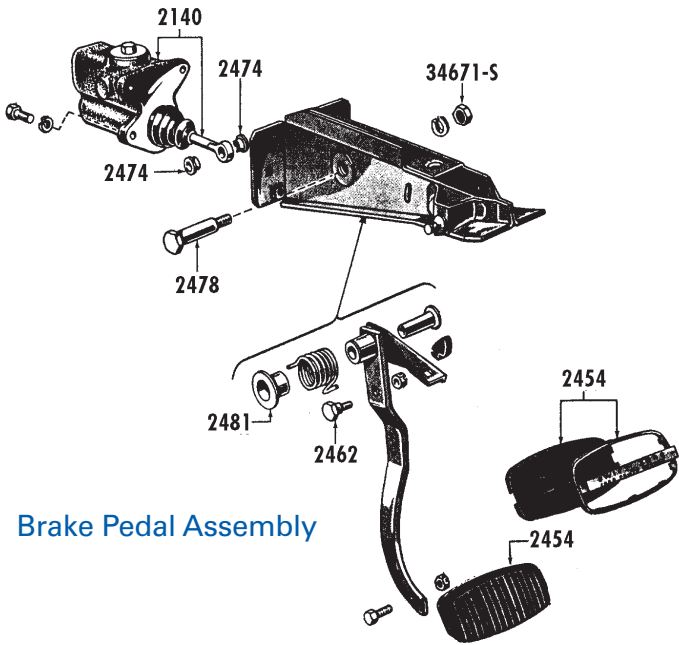

Brake Pedal Assembly

<b>B 2342</b>	<b>Power Brake Booster Hose Clamp</b>	
B 2342A	61/66 .....	2.04
<b>B 2365</b>	<b>Power Brake Booster Check Valve</b>	
B 2365A	Late 64/66 .....	22.39
B 2365B	61/Early 64 .....	35.65
<b>B 2369</b>	<b>Manifold To Brake Booster Vacuum Line</b>	
B 2369A	58/60 .....	11.62
B 2369B	61 .....	9.50
B 2369C	66 .....	6.38
<b>B 2462</b>	<b>Brake Master Cylinder Link Rod Bolt</b>	
B 2462A	58/62; 3/8" - 24 x 1 11/32" .....	17.00
<b>B 2471</b>	<b>Brake &amp; Clutch Pedal Mounting Bushing</b>	
B 2471A	60/61; Plastic; (before 3/21/61) .....	1.48
B 2474A	58/64; Brake Master Cylinder Push Rod Bushing 62" long .....	6.07
<b>B 2481</b>	<b>Brake Pedal Spring Bushing</b>	
B 2481A	58/60 .....	24.95

<b>B 2493</b>	<b>Brake Booster Seal</b>	
B 2493A	58/66; Square cut O-ring goes between the booster and master cylinder .....	2.93
<b>B 2628</b>	<b>Parking Brake Equalizer Rod</b>	
B 2628B	58/66; Universal- Cut from threaded end to length .....	13.21
<b>B 2635</b>	<b>Rear Parking Brake Cable Assembly</b>	
B 2635A	61/62; 2 Required Per Car .....	Each 36.67
B 2635B	63; 2 Required Per Car .....	Each 38.71
B 2635C	64/66; 2 Required Per Car .....	Each 36.67
B 2635E	60 .....	Each 39.73
B 2635F	58; 1 Required Per Car .....	Each 39.73
B 2635G	59 .....	Each 39.27



**B 2780** **Parking Brake Release Vacuum Canister**  
B 2780A 64/66 ..... 50.95

<b>B 2786</b>	<b>Parking Brake Ratchet Pawl</b>	
B 2786A	58/60 .....	8.44
<b>B 2788</b>	<b>Parking Brake Ratchet Spring</b>	
B 2788A	58/60 .....	3.13
<b>B 2804</b>	<b>Parking Brake Cable Pulley</b>	
B 2804A	58/60 .....	24.43
<b>B 2814</b>	<b>Brake Hose &amp; Park Brake Cable Clip</b>	
B 2814A	58/66; .....	1.58
B 2814B	58/61; Park Brake .....	1.99
<b>B 2853</b>	<b>Front Parking Brake Cable Assembly</b>	
B 2853A	61/66 .....	40.75
B 2853B	58/60; 42" long .....	40.75
<b>B 4090</b>	<b>Power Brake Booster Hose</b>	
B 4090G	58/60; 3/8" ID (3 Ft. Required) .....	Per Foot 4.03
<b>B 13480</b>	<b>Stop Lamp Switch</b>	
B 13480A	58/64 .....	10.50
B 13480B	65/66 .....	37.94

## Brake System Attaching Hardware

BHK 264	Emer. Brake Release Bracket, 58/60, (4 Pieces).....	1.38
---------	---	------

## Brake Pad Covers



B 2454C



B 2454E



B 2454F



B 2454G



B 2454H

<b>B 2454</b>	<b>Brake Pedal Pad</b>	
B 2454B	58/61; Manual Drum Brake, Without Power - A/T ..	18.31
B 2454C	65/66; Parking Brake .....	4.54
B 2454D	58/62; "Swift Sure" Type Pedal. See Parts 2454E & 2454F for "Swift Sure" Pedal Components.	
B 2454E	58/62; "Swift Sure" Type Pedal; Without Band .....	30.17
B 2454F	58/62; "Swift Sure" Type Pedal; Stainless Band ....	15.56
B 2454G	63/64; Power Brakes, w/Stainless Trim .....	50.95
B 2454H	65/66; Power Brakes, w/Stainless Trim .....	50.95
<b>B 2457</b>	<b>Brake &amp; Clutch Pad</b>	
B 2457A	58/60; Standard Transmission .....	5.95

## Suspension Bumpers

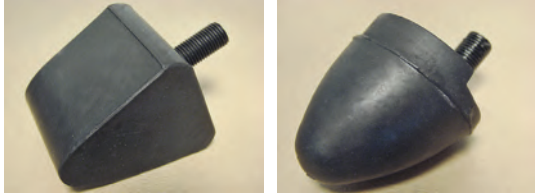

B 3019A

B 3020A

### Lower Arm Bumper

B 3019A 58/60 ..... 9.13

### Front Suspension Bumper

B 3020A 58/60; Upper ..... 7.65

## Upper A Arm Shaft Kit



B 3047A

### B 3047 Upper A Arm Shaft Kit

B 3047A 61/66 ..... Each 66.25  
 B 3047B 58/60 ..... Each 159.86

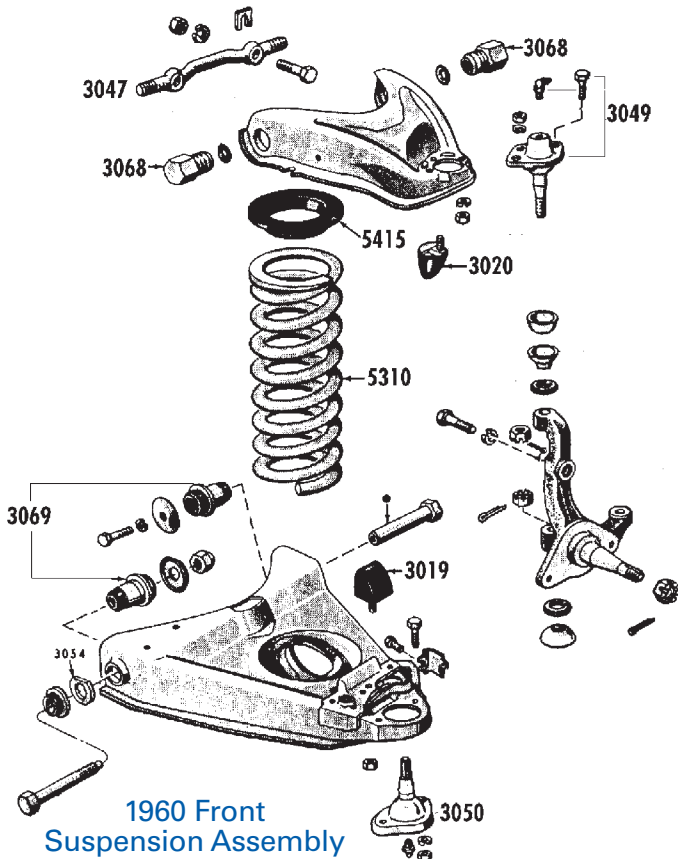

1960 Front Suspension Assembly

## Upper Ball Joint



B 3049A

### B 3049 Upper Ball Joint

B 3049A 61/62; RH ..... Each 91.75  
 B 3049B 61/62; LH ..... Each 91.75  
 B 3049C 63/66 ..... Each 59.95  
 B 3049D 58/60; Bolt-On Type ..... Each 40.75

## Lower Ball Joint



B 3050A

### B 3050 Ball Joint [Lower]

B 3050A 61/66; RH ..... Each 59.95  
 B 3050B 61/66; LH ..... Each 59.95  
 B 3050C 58/60; Bolt-On Type ..... Each 101.95

### B 3054 Front Alignment Shim

B 3054B 61/66; 1/16" ..... Each 3.74  
 B 3054C 61/66-1/8" ..... Each 3.96  
 B 3054D 61/66; 1/32" ..... Each 3.44



B 3054B

## Front Suspension Upper Arm Shaft Bushing

B 3068A 62/66; 1/4" x 28; Lube Fitting Hole ..... Each 15.81  
 B 3068B 58/60 ..... Each 5.92  
 BSP 374269 62/66; O-Ring For Part #B 3069A ..... Each 1.04

\*For 1961, See Part Number B 3047A.

## Front Suspension Lower Arm Bushings



B 3069A

B 3069B

B 3069C

B 3069A 58/60; Bushing Only ..... Each 6.14  
 B 3069B 58/60; Lower Shaft Kit, 2 Required Per Car ..... Set 124.95  
 B 3069C 61/66; 1/2" Diameter ..... Each 15.00

### B 3187 Strut Rod Bushing & Washer Kit

B 3187A 62/66 ..... Each 22.35  
 B 3187B 61 ..... Set Of 4 19.95



## Rear Axle to Spring Bumper

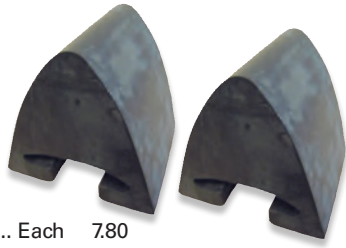

**B 4730B**  
58/64; (2 Required) ..... Each 7.80

## Coil Spring Saddle Bushing Bracket

**B 5308A** 61/62 ..... Pair 30.55

## Front Coil Spring



B 5310A

B 5310A	58/60	.....	Pair	188.70
B 5310B	61/62; With Air Conditioning	.....	Pair	188.70
B 5310C	63; With Air Conditioning	.....	Pair	188.70
B 5310D	64/65; With Air Conditioning	.....	Each	99.50
B 5310E	66; With Air Conditioning	.....	Pair	190.96

## Spring Saddle Bushing Kit



B 5322AK

**B 5322 Spring Saddle Bushing Kit**  
B 5322AK 61/62 ..... Pair 51.97

## Front Coil Spring Insulator



B 5415B

B 5415A	58/60; Rubber	.....	Each	7.40
B 5415B	61/66; Rubber, Upper & Lower; Set Of 2	.....		14.25

## Rear Leaf Spring

B 5560A	61; 4-Leaf; (Hardtop & Convertible)	.....	Each	163.15
B 5560B	62/63; 4-Leaf; (Hardtop & Convertible)	.....	Each	142.75
B 5560C	64/66; 5-Leaf; (Hardtop & Convertible)	.....	Each	137.65
B 5560D	59/60; 5-Leaf; (Hardtop & Convertible)	.....	Each	132.55

## Leaf Spring Anti-Squeak Pad

B 5586A 59/60 ..... Each 1.56

## Stabilizer Bar Kits

*A great way to increase safety and improve your Thunderbird's handling and performance!*

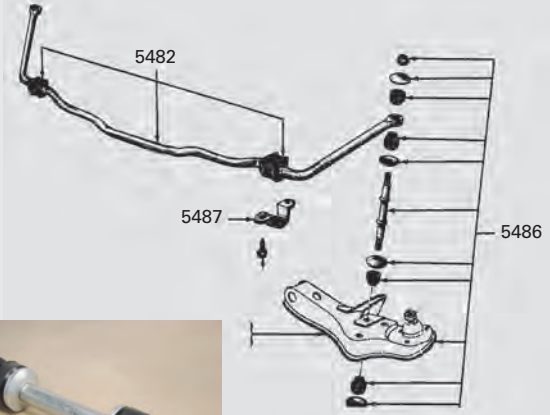

B 5486A



B 5482D



B 5493A



B 5486B

Stabilizer Bars (Sway Bar) are an integral component of your Thunderbird's suspension system, providing increased handling and safety during most driving conditions. Larry's Stabilizer Bar Kits include all necessary bushings and hardware for easy installation. To optimize your suspension system restoration, you will want to install front and rear stabilizer bars, keeping your Thunderbird 'flat' during normal cornering. A great investment to improve your car's suspension system.

**B 5482 Stabilizer Bar Kit**

B 5482A	58/60; Front; 1 1/8" diameter	.....	Per Kit	259.95
B 5482B	58/60; Rear; 1 1/8" diameter	.....	Per Kit	259.95
B 5482C	61/63; Front; 1 1/8" diameter	.....	Per Kit	259.95
B 5482D	61/63; Rear; 1" diameter	.....	Per Fit	259.95
B 5482E	64/66; Front; 1 1/8" diameter	.....	Per Fit	259.95
B 5482F	64/66; Rear; 1" diameter	.....	Per Kit	259.95

*Note: Sway Bar Kits Include all mounting hardware and bushings.*

**B 5486 Stabilizer End (Sway Bar) Repair Kit**

B 5486A	61/66; 2 Required (Replacement Type)	.....	Each	8.75
B 5486B	58/60; 2 Required	.....	Each	13.01

**B 5487 Sway Bar Bracket**

B 5487A	58/60; Center Insulator Bracket	.....	Pair	38.95
---------	---------------------------------	-------	------	-------

**B 5493 Sway Bar Insulator Bushing**

B 5493A	61/66; Center	.....	Each	6.89
B 5493B	58/60; Center	.....	Each	6.89

## Leaf Spring Shackle Kit



B 5630C

<b>B 5630</b>	<b>Leaf Spring Shackle Kit</b>		
B 5630A	61/63; Rear of Leaf .....	Each	34.95
B 5630B	64/66; Rear Leaf—Rear .....	Each	45.58
B 5630C	59/60; Rear Spring—Rear .....	Each	15.25

<b>B 5724</b>	<b>Leaf Spring Clamp Kit</b>		
B 5724A	59/66; Use With 2 1/2" Spring .....	Each	9.95

<b>B 5741</b>	<b>Rear Spring Center Mounting Insulator</b>		
B 5741A	59/60 .....		7.40
B 5741B	62/66; (After 2/1/61) .....		9.31
B 5741C	61; (Before 2/1/61) .....	Each	17.29

## Rear Spring Bushing

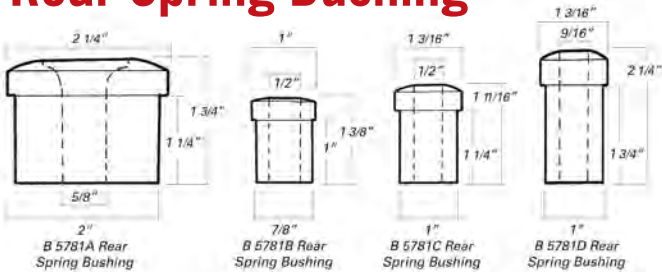

B 5781A	62/66; (Front) .....	Each	10.50
B 5781B	59/60; (Rear) .....	Each	2.03
B 5781C	61/63; (Rear) All .....		
	64/66; (Rear—Lower) .....	Each	5.25
B 5781D	64/66; (Rear—Upper) .....	Each	4.35
B 5781E	59/60; (Front) .....	Each	20.76
B 5781G	61; (Front) .....	Each	3.64

## Spring or Rear Axle Bumper



B 5783A	58/64; (58/60, 3 Required) & (61/64, 2 Required) .....	6.19
---------	--	------

## Leaf Spring Mounting Bolt

B 5904C	62/66; Front of Rear Leaf .....	Each	20.35
---------	---------------------------------	------	-------



Give us a call if you can't find what you need. Our knowledgeable parts specialists will be happy to help!



B 18124A

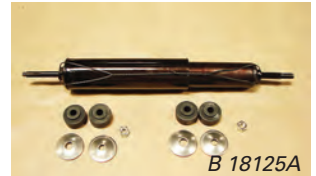

B 18125A



B 18124B



B 18125B



B 18124D

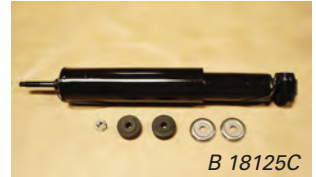

B 18125C



B 18124F



B 18125D

## Shock Absorbers & Related Parts

New shocks will dramatically improve your 'Bird's handling!



<b>B 18085</b>	<b>Front Shock Absorber Bumper</b>		
B 18085A	64/66 .....	10.15	



B 18085A

<b>B 18116</b>	<b>Shock Absorber Upper Bushing</b>		
B 18116A	64/66 .....	10.61	



B 18116A

<b>B 18124/5</b>	<b>Shock Absorbers</b>		
B 18124A	61/62; Front .....	70.14	
B 18125A	61/63; Rear .....	70.14	
B 18124B	64/66; Front .....	70.14	
B 18124C	63; Front .....	70.14	
B 18125C	64/66; Rear .....	70.14	
B 18124F	59/60; Front .....	70.14	
B 18125B	59/60; Rear .....	70.14	
B 18125D	58; Rear .....	70.14	

<b>B 18183</b>	<b>Shock Absorber Mount Bracket</b>		
B 18183C	63/66; Front Lower (2 req.) .....	Each	22.39

<b>B 18198</b>	<b>Shock Absorber Bushing Repair Kit</b>		
B 18198A	63; Lower .....	Each	14.80

## Suspension System Attaching Hardware

BHK 508	Sway Bar Brackets, 58/60, Front	Each.....	1.44
BSP 374269	"O" Ring, Upper Cntrl Arm Bushing, 61/66.....		1.04

# STEERING

## 1960 Front Steering Linkage

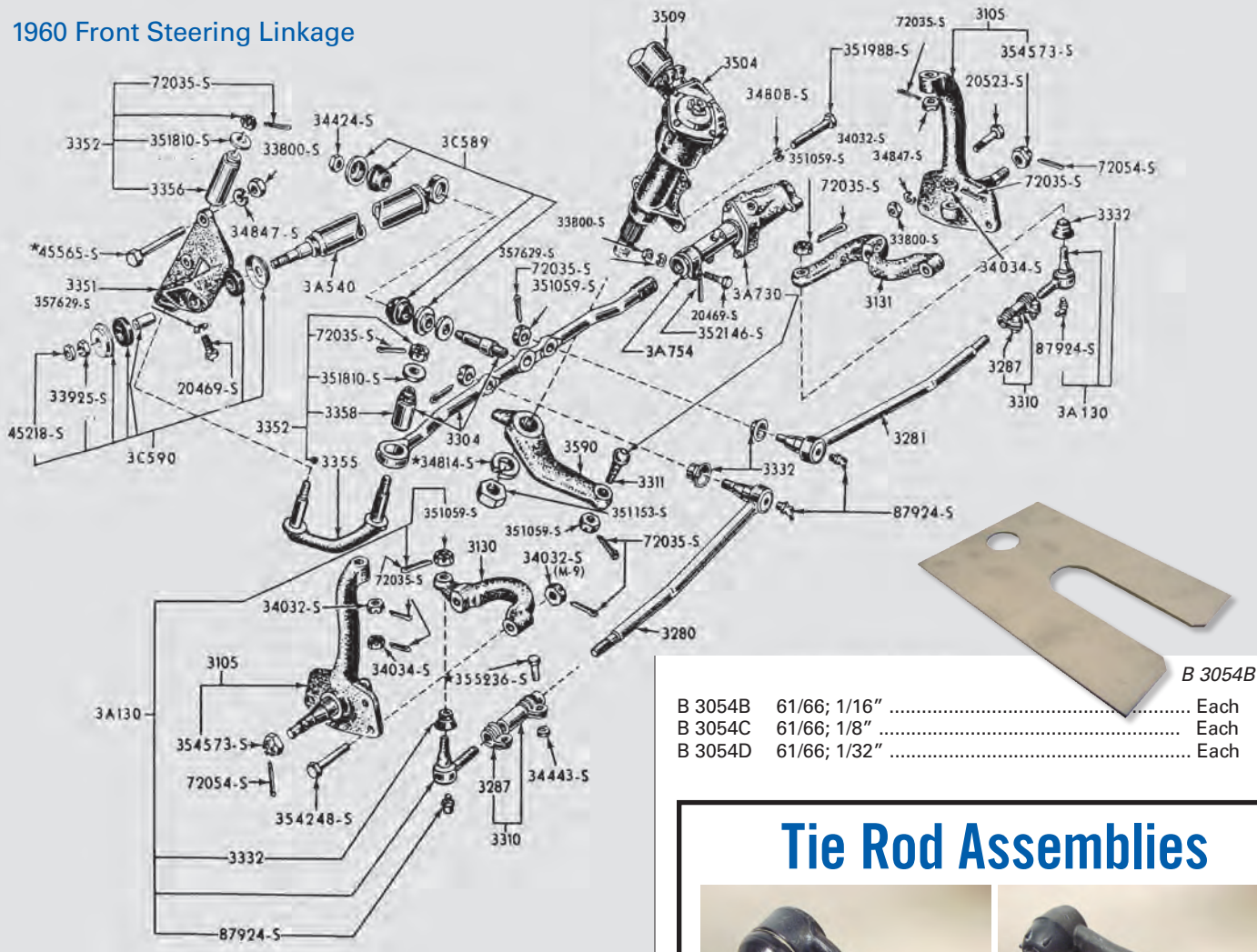

B 3054B	61/66; 1/16"	.....	Each	3.74
B 3054C	61/66; 1/8"	.....	Each	3.96
B 3054D	61/66; 1/32"	.....	Each	3.44

- B 2344 Power Steering Return Line to Pump Clamp**  
B 2344A 58/66;  
60 Sliding Roof Front Drain Hose. (2 Required);  
63/66, Lower Return Tube To Windshield Wiper Motor  
(1 Required) ..... Each 1.79
- B 2525 Brake Booster Push Rod Clip**  
B 2525A 61/66; Push Rod to Operating Lever ..... Each 5.05
- B 3006 Power Steering Oil Reservoir Filler Cap**  
B 3006A 58/65; P/S Reservoir Cap Seal ..... Each 1.54  
B 3006B 58/66; With out A/C, Cap & Stick ..... Each 20.35  
B 3006C 65/66; Ford Pump ..... Each 13.77
- B 3054 Front Alignment Shim**



## Tie Rod Assemblies



B 3131A	61/66; RH & LH; Outer	.....	Each	49.92
B 3131B	65/66; RH & LH; Inner	.....	Each	49.89
B 3130C	58/60; RH & LH; Outer	.....	Each	23.95
BSP 72035	58/66; Cotter Pin - 1/8" x 1"	.....	Each	.28
BSP 87924	58/66; Fitting; Lubricator 1/4" x 20 x 90°	.....	Each	2.07
*Note: See Also Part Number B 3280/1.				
B 3280A	61/64; RH & LH; Inner	.....	Each	50.95
B 3280B	58; RH; Inner	.....	Each	93.59
B 3281A	58; LH; Inner	.....	Each	59.95
B 3280C	59/60; RH; Inner	.....	Each	80.53
B 3281B	59/60; LH; Inner	.....	Each	80.53
*Note: See Also Part Number B 3130/1				

## Power Steering Reservoir Lid

B 3582A	58/64 With Out A/C.....	Each	23.41
---------	-------------------------	------	-------

**Cap Does Not Come With Lid**



# STEERING

<b>B 3304</b>	<b>Steering Arm to Idler Arm Rod Assembly</b>	
B 3304B	61/64; (Drag link) .....	117.25
<b>B 3310</b>	<b>Adjusting Sleeve Tie Rod</b>	
B 3310B	58/66; RH & LH; 11/16" x 18 x 4 1/2" ..	Each 10.50
<b>B 3332</b>	<b>Tie Rod End Seal</b>	
B 3332A	58/60 .....	Each 2.03
<b>B 3351</b>	<b>Idler Arm Bracket</b>	
B 3351C	64/66 .....	Each 91.75

## Idler Arm Kit



B 3352A	58/60; (With Power Steering)	
	Includes Bushing .....	57.25
	<i>*Note: Also See Part Number B 3734 On Page 28.</i>	

<b>B 3356/8</b>	<b>Idler Arm Bushing</b>	
B 3356A	61/62; (from 4/4/61 to 3/15/62) .....	15.25
B 3356B	58/60; Manual Steering .....	10.15
B 3356C	64/66; Upper; . 884" I.D. x 1.42" O.D. .	30.55
B 3356D	58/60; Power Steering; Upper .....	7.09
<b>B 3358</b>	<b>Power Steering; Lower</b>	
B 3358A	58/60; Power Steering; Lower .....	7.09
	<i>*Note: Also See Part Number 3352 &amp; 3734 For Idler Arms.</i>	
<b>B 3359</b>	<b>Idler Arm Seal</b>	
B 3359C	58/60; (Manual Steering), 2 Required Per Car Each	1.51
<b>B 3494</b>	<b>Power Steering Pump to Hose Tube</b>	
B 3494A	65/66; Steel .....	16.93
<b>B 3502</b>	<b>Steering Gear Bearing Seal Kit</b>	
B 3502A	65/66; Seal Kit .....	25.45
<b>B 3512</b>	<b>Steering Column Seal</b>	
B 3512A	58/60; Grommet Type .....	Each 8.11
B 3512B	61/64; Seal Type .....	Each 30.18
<b>B 3513</b>	<b>Steering Column at Firewall Seal</b>	
B 3513A	58/60 .....	Each 6.07
<b>B 3517</b>	<b>Steering Column Upper Bearing Assembly</b>	
B 3517A	60; 1.44" O.D. ....	11.95
B 3517B	61/66 .....	23.50
<b>B 3518</b>	<b>Steering Column Upper Bearing Sleeve</b>	
B 3518A	65/66; Fixed Wheel; 1 3/8" O.D. x 1 1/16" I.D. x 1/4" Thick; 8 Ribs .....	9.92
B 3518B	60; Plastic .....	8.84
<b>B 3525</b>	<b>Steering Shaft Coupling Insulator Kit</b>	
B 3525A	61/66; Insulator Kit .....	20.76
<b>B 3526</b>	<b>Power Steering Gear Input Shaft Bearing</b>	
B 3526A	65/66 .....	7.12
<b>B 3533</b>	<b>Power Steering Control Valve Ball Stud Kit</b>	
B 3533A	58/62 .....	37.69



B 3525A



B 3538A

<b>B 3538</b>	<b>Power Steering Pump Filter</b>	
B 3538A	58/64 .....	13.50

<b>B 3538</b>	<b>Seal &amp; Gasket Kit</b>	
	Power Steering Gear - Integral (Ford Gear)	
B 3538B	61/64 P/S Gear Seal/Gasket Kit .....	61.15
B 3538K	65/66 .....	40.75

## Power Steering Cylinder

(Rebuilt)



B 3540A

B 3540A	59 (Rebuilt) .....	270.30
	*Core Charge .....	350.00
B 3540B	60 (Rebuilt) .....	270.30
	*Core Charge .....	350.00
B 3540C	58 (Rebuilt) .....	270.30
	*Core Charge .....	350.00
B 3540D	58/59 (New Part).....	331.50
	(Made For 58, Will Work On 59)	
B 3540E	59 352 & 59/60 430 (New Part).....	331.50
B 3540F	60 352 (New Part).....	331.50

*\*Note: Cores Must Be Drained Of ALL FLUID To Receive A Full Core Refund! No Exceptions!*

<b>B 3547</b>	<b>P/S Pump Reservoir Orifice O Ring Seal</b>	
B 3547A	58/60 & 64/66; 5 3/64" I.D. ....	7.56

## Power Steering Box (Rebuilt)



B 3548A

B 3548A	61 & Early 62; Pin-Type Shaft .....	402.90
B 3548B	Late 62 thru 64; Bolt-Type Shaft .....	402.90
B 3548C	65/66 .....	402.90
	*Core Charge .....	250.00

*\*Note: Cores Must Be Drained Of ALL FLUID To Receive A Full Core Refund! No Exceptions!*

*\*Note: Steering Boxes Do Not Come With Lower Insulators. 3 Required Part # B3716B. Page 27*

<b>B 3552</b>	<b>Steering Worm Bearing Cup</b>	
B 3552A	58/66; Upper & Lower .....	23.97
<b>B 3571</b>	<b>Steering Worm Thrust Bearing Ball &amp; Cage Assembly</b>	
B 3571A	58/66 .....	27.49
<b>B 3584</b>	<b>Power Steering Pump Seal Kit</b>	
B 3584A	58/65; For Eaton Plump .....	15.87
B 3584B	65/66; For Ford Pump .....	15.95
<b>B 3589</b>	<b>Power St. Ram Cylinder Bushing &amp; Washer Kit</b>	
B 3589K	58/60; Bushing & Washer Kit For Eyelet End .....	7.95
<b>B 3590</b>	<b>Pitman Arm</b>	
B 3590A	65/66 .....	127.45
<b>B 3590</b>	<b>Ram Cylinder Rod End Mount Kit</b>	
B 3590BK	58/60 .....	Kit 13.47
<b>B 3591</b>	<b>Steering Sector Shaft Housing Oil Seal</b>	
B 3591A	58/60; 1 5/64 ID x 1 9/16" O.D. ....	16.58
<b>B 3592</b>	<b>P/S Pump Shaft Oil Seal Assembly</b>	
B 3592A	58/66; Eaton, Belt-Driven Side-Mount Plump .....	9.78



B 3600A

## Steering Wheel

B 3600A	58/60; White .....	Each 305.95
---------	--------------------	-------------

# STEERING

## 61/63 Front Power Steering System

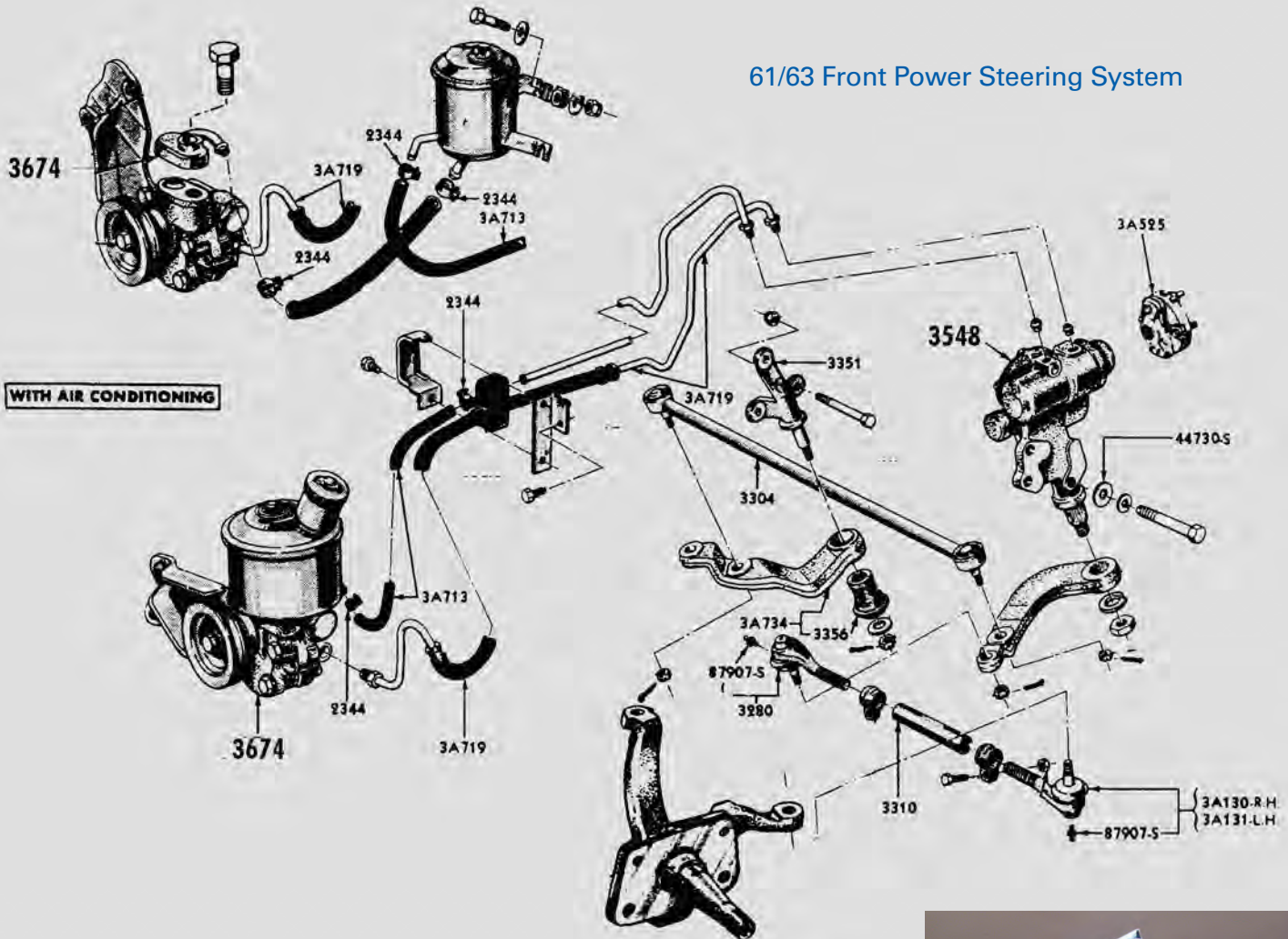

<b>B 3642</b>	<b>Power Steering Reservoir Lid Gasket</b>	
B 3642A	58/64; With Air Conditioning .....	2.35
B 3642B	58/64; Without Air Conditioning .....	2.35
<b>B 3650</b>	<b>Power Steering Control Valve Repair Kit</b>	
B 3650A	58; 2 Seals .....	14.19
B 3650C	59/60; 2 Seals .....	11.94
B 3672	Horn Button Pad	
B 3672A	58/60 .....	3.03



B 3674A

<b>B 3674</b>	<b>Rebuilt Power Steering Pump</b>	
B 3674A	58/65; Eaton; Front Mounted, Less Reservoir .....	137.70
	*Core Charge .....	150.00
B 3674B	61/65; Eaton; Rear Mounted, Less Reservoir .....	137.70
	*Core Charge .....	150.00
B 3674C	65/66; Ford .....	137.70
	*Core Charge .....	150.00
B 3674X	58/60; Lower Steering Column Bushing .....	13.21

\*Note: Cores Must Be COMPLETELY DRAINED OF ALL FLUID To Receive A Full Core Refund! No Exceptions!  
 \*For Grommet Used On Eaton Pump Reservoir Cover Stud, See Part Number B 6570A.



B 3680A

<b>B 3680</b>	<b>Steering Wheel Chrome Inserts</b>	
B 3680A	58/60; Set of 3 Pieces .....	Set 40.75
<b>B 3713</b>	<b>Power Steering Return Hose</b>	
B 3713A	58/62; Gear To Pump Return .....	26.95
<b>B 3714</b>	<b>P/S Control Valve to Cylinder Hose</b>	
B 3714A	58/59; 2 Required Per Car .....	Each 22.24
<b>B 3714</b>	<b>Control Valve to Cylinder Line</b>	
B 3714BK	60; 4-Piece Set .....	34.97
<b>B 3716</b>	<b>Steering Gear Insulator Assembly</b>	
B 3716B	63/66; 7/16" x 2 3/4" O.D. ...	Each 59.95
		<b>B 3716B</b>
<b>B 3719</b>	<b>Power Steering Pressure Hose</b>	
B 3719A	61/63; All .....	37.69
B 3719B	65; With Air Conditioning .....	33.61
	66; All, With Ford Pump .....	37.09
B 3719C	58/60; (Except 430 engine) .....	56.05
B 3719D	64; 65 with Eaton Plump .....	



# STEERING

## 65/66 Power Steering System

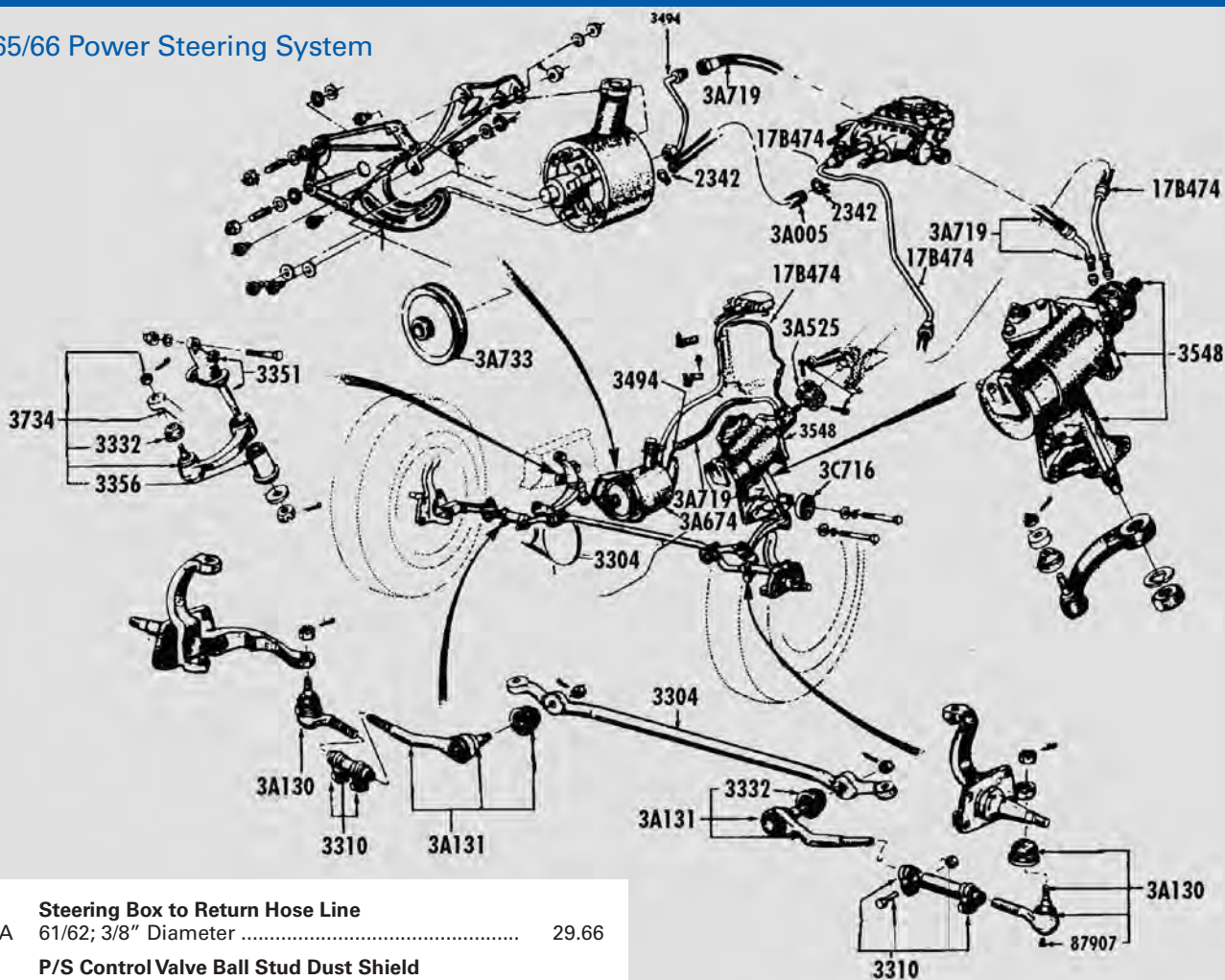

<b>B 3721</b>	<b>Steering Box to Return Hose Line</b>	
B 3721A	61/62; 3/8" Diameter .....	29.66
<b>B 3728</b>	<b>P/S Control Valve Ball Stud Dust Shield</b>	
B 3728A	58/60 .....	4.88



**Power Steering Control Valve (Rebuilt)**

<b>B 3730</b>	<b>Power Steering Control Valve • Rebuilt</b>	
B 3730A	58/59 .....	188.70
	*Core Charge .....	250.00
B 3730B	60 .....	198.90
	*Core Charge .....	250.00

\*Note: Cores MUST BE DRAINED OF ALL FLUID to Receive a Full Core Refund!

<b>B 3730</b>	<b>Power Steering Control Valve • New</b>	
B 3730F	58/59; .....	Each 448.75

Note: These Are New Valves With All New Internal Parts. NO CORE DEPOSIT REQUIRED.



<b>B 3734</b>	<b>Steering Idler Arm</b>	
B 3734A	61/63; includes Bushing, Washer & Bracket .....	234.60
B 3734C	65/66; Includes Bushing .....	210.95

\*Note: See Also Part Number B 3352 On Page 26.

<b>B 3754</b>	<b>Control Valve to Drag Link Clamp</b>	
B 3754A	58/60 .....	Each 12.75
<b>B 3764</b>	<b>Power Steering Cylinder Seal Kit</b>	
B 3764A	58/60 .....	15.56
<b>B 3773</b>	<b>Steering Column Dust Cover</b>	
B 3773A	63/66; Fits At Bottom Of Steering Column .....	14.23
<b>B 3805</b>	<b>Power Steering Gear Piston Seal</b>	
B 3805A	65/66; 3 1/32" LD . .....	7.65
<b>B 17474</b>	<b>Steering Box to Wiper Motor Hose</b>	
B 17474A	64/66 .....	45.58
B 17474B	63 .....	45.58

## Engine Compartment Belts

See Page 41 for a complete listing of belts for your Thunderbird.

## Steering System Attaching Hardware

BHK 261	Steering Wheel Side Boot, 61/63, (4 Pieces) ...	1.74
BHK 503	Power St. Pump to Bracket, 58/60, (2 Pieces) .	1.50
BHK 504	Power Steering Pump Bracket to Water Pump, 58/60, (4 Pieces) .....	2.68
BSP 87036	Cap Seal, Control Valve . .....	Each 2.40
BSP 87147	Seal, Rubber "O" Ring, Power Steering Pump Cover, Use w/Roll-type pump, 58/60, 2 5/8" x 2 53/64" .....	1.26

# REAR AXLE & DRIVE TRAIN

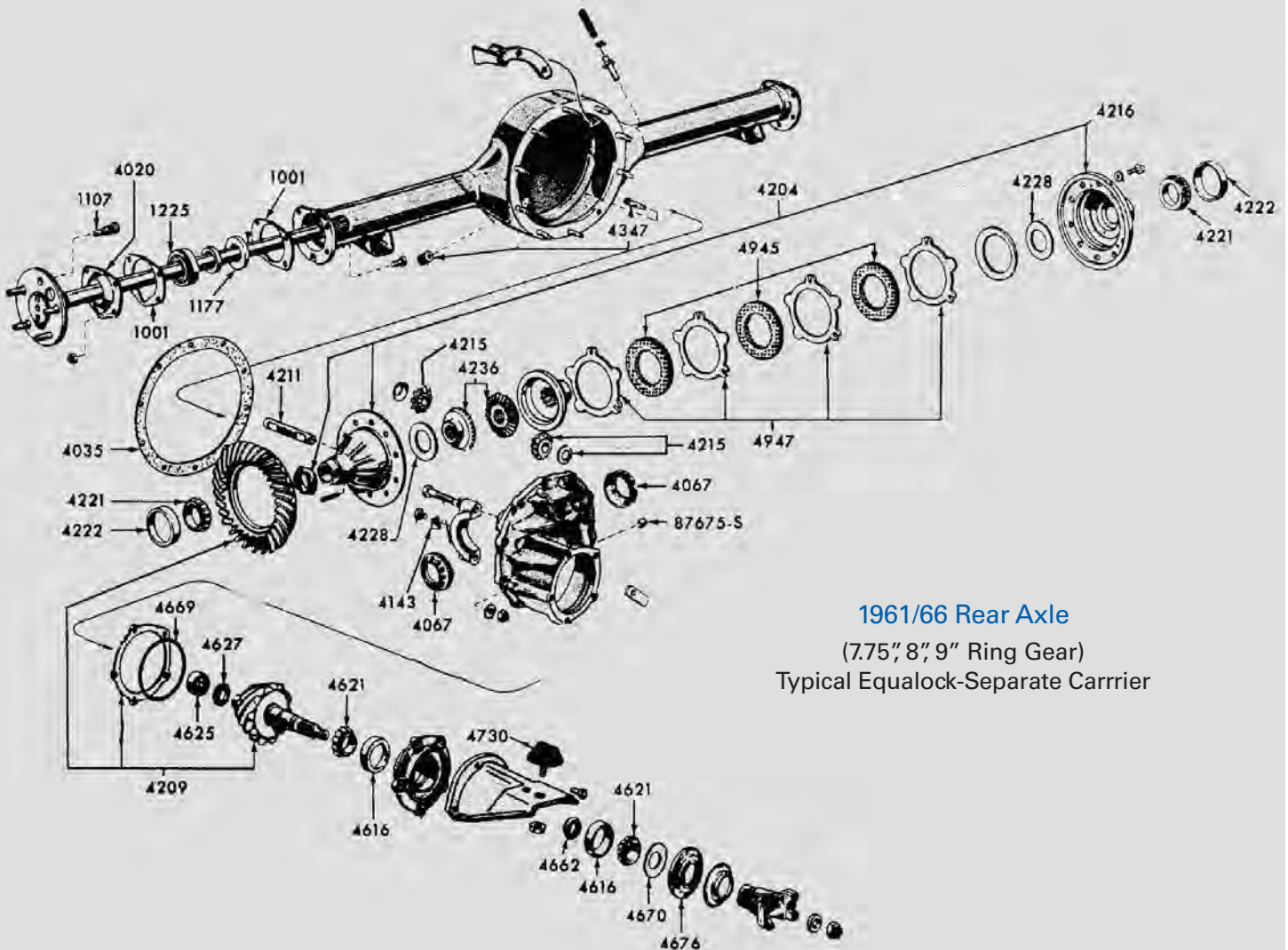

**1961/66 Rear Axle**  
(7.75", 8", 9" Ring Gear)  
Typical Equallock-Separate Carrier

<b>B 1001</b>	<b>Rear Wheel Bearing Gasket</b>		
B 1001A	58/60 & 62/66	Each	.89
<b>B 1177</b>	<b>Rear Axle Bearing Inner Oil Seal</b>		
B 1177A	58/61; 1 3/8" I.D. - 2 3/8" O.D.		8.06
B 1177B	62/64; 1 1/2" I.D. - 2 1/2" O.D.		5.72
B 1177C	65/66; Rear Axle		5.15
<b>B 1201</b>	<b>Differential Bearing</b>		
B 1201C	66; Differential 1 13/16" I.D., 25590		21.80
B 1202C	66; Differential Cup, 25520		12.43
<b>B 4221</b>			
B 4221B	58/66; 1 25/32" I.D.; (Stamped 603049)		17.64
<b>B 1225</b>	<b>Rear Axle Bearing Assembly</b>		
B 1225A	61; 1 3/8" I.D. - 2 53/64" O.D., Small		22.37
B 1225B	58/60 & 62/66; 1 17/32" I.D. - 3 5/32" O.D. Large; Includes Retainer		28.95

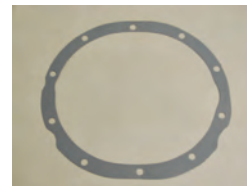

B 4035B

<b>B 4035</b>	<b>Rear Axle Carrier Gasket</b>		
B 4035B	58/66		5.87

## Spider Gear Kit

B 4215K	58/66; Ford 9" Ring Gear	Each	253.93
---------	--------------------------	------	--------

*This Kit Includes, New Shims, Side Gears, Spider Gears And The Shaft.*

<b>B 4222</b>	<b>Differential Bearing Cup</b>		
B 4222A	58/64; 2 57/64" O.D.; (Stamped 501310)		8.27
B 4222B	58/66; 3 1/16" O.D.; (Stamped 603011)		9.88

*Can't make a decision on the best gift?  
Larry's gift certificates are the solution! Ask  
our Sales Specialists for complete details*

# REAR AXLE & DRIVE TRAIN

<b>B 4347</b>	<b>Differential Carrier to Rear Axle Housing Bolt</b>	
B 4347B	61/66 .....	5.05
<b>B 4529</b>	<b>Universal Joint U-Bolt</b>	
B 4529C	58/66; 5/16" x 24 .....	14.23
<b>B 4616</b>	<b>Drive Pinion Bearing</b>	
B 4616A	58/66; Cup, Front& Rear; (Stamped 88010) .....	8.12
<b>B 4621</b>	<b>Pinion Bearing Cone &amp; Roller Drive</b>	
B 4621A	58/66; (Stamped 88048) .....	13.47
<b>B 4625</b>	<b>Bearing Assembly - Drive Pinion Pilot</b>	
B 4625B	58/66; 8 3/8" & 9" R/G, 1.10" I.D. x 1.85" O.D. x 21/32" Thick .....	37.40
<b>B 4627</b>	<b>Drive Pinion Pilot Bearing Retainer</b>	
B 4627A	58/66; 8 3/4" & 9" Ring Gear .....	20.37

<b>B 4669</b>	<b>Driving Axle Pinion Bearing Retainer "0" Ring</b>	
B 4669B	58/66; 4 3/4" I.D. ....	2.50
<b>B 4670</b>	<b>Driving Pinion Shaft Oil Slinger</b>	
B 4670A	58/66 .....	2.35



<b>B 4676</b>	<b>Rear Pinion Seal</b>	
B 4676B	58/66 .....	8.84

## Rear Axle Bumper

B 4730B



<b>B 4730</b>	<b>Rear Axle to Spring Bumper</b>	
B 4730B	58/64; (2 Required) .....	Each 7.80
<b>B 5783</b>	<b>Spring or Rear Axle Bumper</b>	
B 5783A	58/60; 3 Required 61/64; 2 Required .....	6.19

## U-Joint Kit



B 4635E

B 4635A	61; Front & Rear .....	11.95
B 4635B	62; Front 63-66; Front & Rear .....	13.95
B 4635C	62; Rear .....	29.53
B 4635E	58/60; Front & Rear .....	14.75

## Rear Axle Pinion Yoke

B 4851D	58/66; Ford 9" Ring Gear .....	Each 99.91
---------	--------------------------------	------------

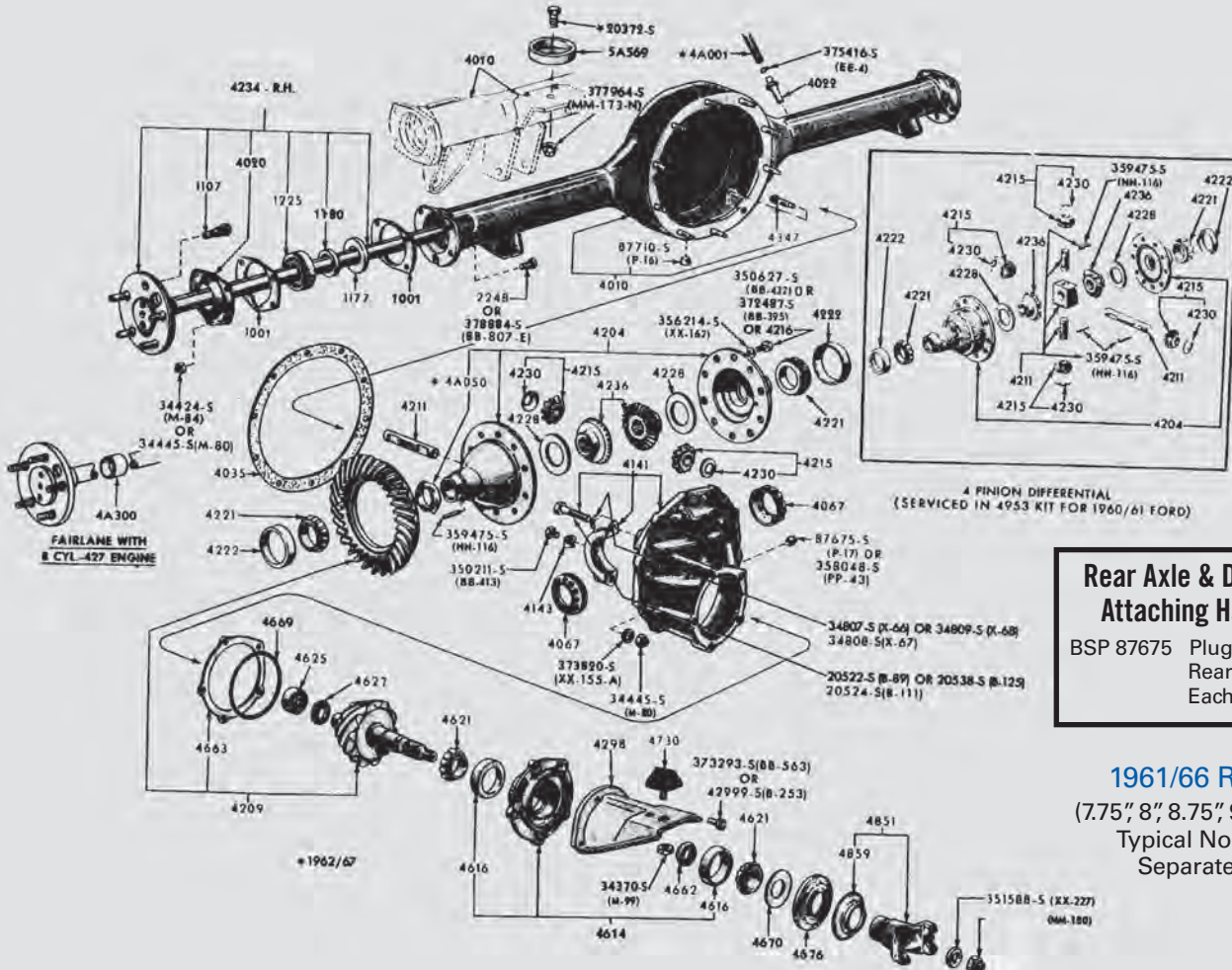

### Rear Axle & Drive Train Attaching Hardware

BSP 87675	Plug, Rear Axle Housing	
Each	.....	3.93

### 1961/66 Rear Axle

(7.75" 8"; 8.75" 9" Ring Gear)  
Typical Non-Locking  
Separate Carrier



# EXHAUST EXHAUST MUFFLERS

## 1964/66 Exhaust System

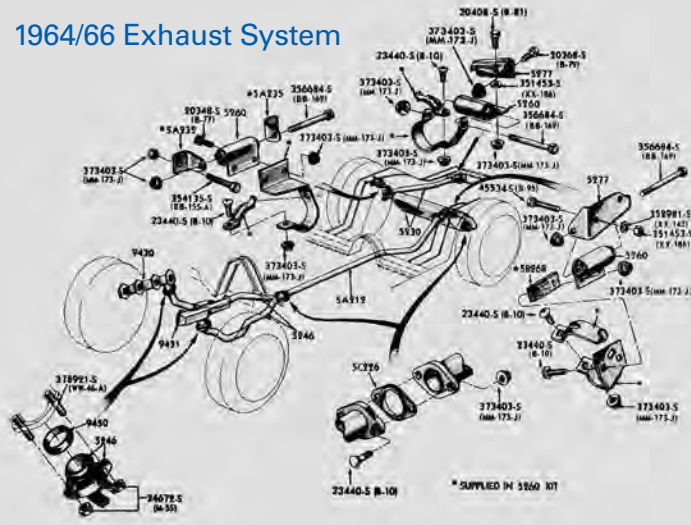

## Exhaust Mufflers

B 5230A	61/62 (Early); RH	84.15
B 5230B	61,62 (Early); LH	84.15
B 5230C	62 (Late); RH	86.65
B 5230D	62 (Late); LH	86.65
B 5230E	58/60; 352 V8, RH or LH	Each 76.45

## Exhaust Pipe Set

B 5256AK	58/60; 352	Set 425.00
B 5256BK	58/60; 430	Set 418.20
B 5256CK	61/ Early 62; 2" Pipes	Set 428.40
B 5256DK	62 Late; 1 3/4" Pipes	Set 428.40
B 5256EK	63; 2 1/4" Pipes Single Exhaust	Set 335.00
B 5256FK	63; (For conversion to dual Exhaust) 2" Pipes	Set 450.00
B 5256GK	64/65; With Resonators	Set 535.50
B 5256HK	64/65; With Out Resonators	Set 433.50
B 5256JK	66; With Resonators	Set 535.50
B 5256KK	66; With Out Resonators	Set 423.30

Note: Clamps and gaskets are not included and must be purchased separately. These exhaust systems are drop shipped direct from the manufacture, and must be paid for in advance or with credit card, no cods!! Due to the size and weight of the system, actual freight cost will be charged.

## Exhaust Pipe Clamp



B 5231A



B 5231C

<b>B 5231</b>	<b>Exhaust Pipe Clamp</b>		
B 5231A	63; 2 1/4"	Each	2.09
B 5231B	58/62; 1 3/4"	Each	2.09
B 5231C	58/66; 2"	Each	2.09

## Exhaust Heat Riser Spacer



<b>B 9427</b>	<b>Exhaust Heat Riser Spacer</b>	
B 9427A	58/60; with flapper	84.95
B 9427AS	58/60; spacer only	29.95
B 9427D	66; 390, with flapper	90.78
B 9427DS	66; 390, spacer only	39.95

## Exhaust Manifolds

B 9430A	58/60; 352, Cast #575204, Flat Flange, RH	Each 280.50
B 9430B	58/60; 430, Cast #B9EM-9430-A, Flat Flange, RH	Each 280.50
B 9430C	61/62; 390, Cast #C1SE-9430-B, Flat Flange, RH	Each 280.50
B 9430D	63/64; 390, Cast #C3SE-9430-B, Tapered Flange, RH	Each 280.50
B 9430E	65; 390, Cast #C5SZ-9430-C, Tapered Flange, RH	Each 280.50
B 9430F	66; 428, Cast #C6AE-9430-A, Tapered Flange, RH	Each 280.50
B 9431A	58/60; 352, Cast #5750730, Flat Flange, LH	Each 280.50
B 9431B	59/60; 430, Cast #B9EL-9431-A, Flat Flange, LH	Each 280.50
B 9431C	61/62; 390, Cast #C1SE-9431-A, v Flat Flange	Each 280.50
B 9431D	63/66; 390, 428, Cast #C3SE-9431-B, Tapered Flange	Each 280.50
B 9431LK	58/66; Exhaust Manifold Bolt Lock Kit, Both Sides	Set 16.50

## Exhaust Manifold Gasket



<b>B 9448</b>	<b>Exhaust Manifold Gasket</b>	
B 9448F	61/66; RH & LH Heat Shield	Pair 19.89



<b>B 9450</b>	<b>Exhaust Manifold to Outlet Pipe Gasket</b>	
B 9450A	58/63 & 66	Each 2.65
B 9450D	63/66	Each 4.68

# ENGINE

<b>B 6008</b>	<b>Cylinder Head to Block Dowel or Guide</b>		
B 6008A	58/66; 390 Engine .....	Each	3.32
<b>B 6020</b>	<b>Cylinder Block Timing Cover Gasket Kit</b>		
B 6020C	58/66; Use with aluminum cover .....		17.29
<b>B 6026</b>	<b>Freeze Plug Kit</b>		
B 6026A	58/66; 352, 390, 428, Steel .....		11.17
B 6026B	58/66; 352, 390, 428, Brass .....		26.47
<b>B 6028/9</b>	<b>Motor Mount Support Bracket</b>		
B 6028A	59/60; 430 RH or LH .....	Each	45.90
B 6028B	61/63; RH .....	Each	37.09
B 6029B	61/63; LH .....	Each	37.09
B 6028C	64/66; RH .....	Each	37.09
B 6029C	64/66; LH .....	Each	37.09
<b>B 6035</b>	<b>Motor Mount Heat Shield</b>		
B 6035A	58/66; For LH side only .....		15.04

## Motor Mount



B 6038C

B 6038D

B 6038E

B 6038A	59/60; 430 .....		45.85
B 6038C	64/66; (Except 66 C6Trans.), 390, RH CM-MX .....		39.95
B 6038D	64/66; (Except 66 C6Trans.), 390, LH CM-MX .....		39.95
B 6038E	58/60; RH or LH, (Except 430 Engine) 61/63; 390 66; 390 C6 - CM & 428, RH or LH .....		26.99

<b>B 6039</b>	<b>Motor Mount Insulator</b>		
B 6039A	59/60; RH or LH .....		7.37

## Cylinder Head Gasket

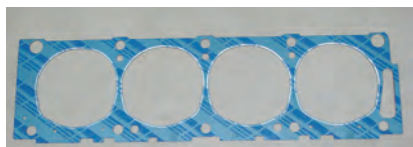

B 6051A

<b>B 6051</b>	<b>Cylinder Head Gasket</b>		
B 6051A	58/66; (Except 430) .....		23.97



## Cast Blast

High-Performance coating suitable for heads, blocks, or other cast iron parts, restoring them to their original lustre. CastBlast prevents rust, and is quick-drying and durable.

TPT-CB	16 oz. can .....	Each	10.35
--------	------------------	------	-------



## Engine Compartment Spray Paints



BPT 60WT



BPT 60YL



BPT 1612



BPT 19000



BPT 1923

<b>White</b>			
BPT 60WT	'60Thunderbirds. Air Filter & Fan, 352 Engine 13 oz. Can .....		8.95
<b>Yellow</b>			
BPT 60YL	'60Thunderbirds Valve Covers, 352 Engine, 13 oz. Can .....		8.95
<b>Black</b>			
BPT 1612	'61/65—Engine Block, Heads, Intake Manifold, Oil Pan. '59/60—Engine Block '58—Valve Covers. 13 oz. can .....		6.75
<b>Argent (Silver)</b>			
BPT 19000	'61/62—Valve Covers & Air Cleaner. 13 Oz. Can .....		9.50
<b>Gold</b>			
BPT 1705	'65Thunderbirds Valve Covers & Air Cleaner. 13 oz. Can .....		8.93
<b>Ford Dark Blue</b>			
BPT 1923	'66Thunderbirds—Complete Engine '58Thunderbirds—Engine Block. '59Thunderbirds—Valve Covers 13 Oz. Can .....		6.75

## Complete Engine Gasket Set

B 6078R 58/66 (Except 430), Full Set ..... 148.87

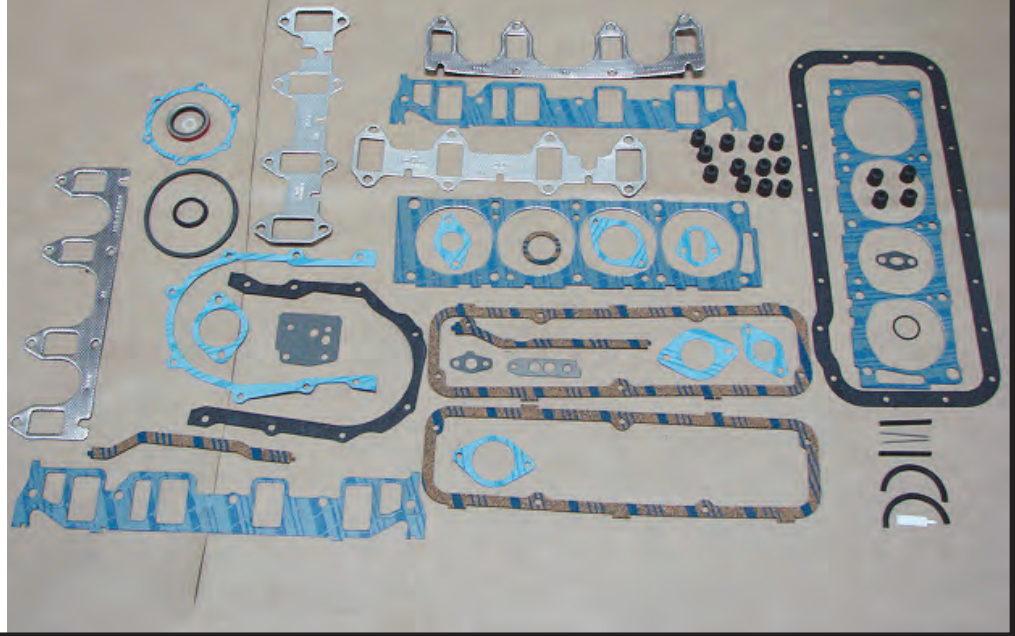

<b>B 6079</b>	<b>Valve Grind Engine Gasket Set</b>		
B 6079A	61/66 .....	Set	100.93
<b>B 6212</b>	<b>Connecting Rod Nut</b>		
B 6212B	58/60 .....	Each	2.27
<b>B 6214</b>	<b>Connecting Rod Bolt</b>		
B 6214A	58/60 .....	Each	7.80
<b>B 6256</b>	<b>Camshaft Sprocket</b>		
B 6256A	63/66; 390 & 428 Engines, 36-Tooth, Spacer is not required with this sprocket		18.87
B 6256B	58/60; 352 Engine, 36-Tooth .....		55.00
<b>B 6268</b>	<b>Timing Chain</b>		
B 6268A	58/66; 352, 390 & 428 Engines, 48 Links .....		33.15
<b>B 6306</b>	<b>Crankshaft Sprocket</b>		
B 6306A	64/66; 390 & 428 Engines, 18Teeth .....		7.91
B 6306B	58/63; 18Teeth.....		15.92
<b>B 6312</b>	<b>Harmonic Balancer Pulley</b>		
B 6312A	58/66; 390 Engine .....		101.49



B 6312A

<b>B 6321</b>	<b>Rear Crankshaft Bearing Seal</b>		
B 6321C	58/66; 352, 390 & 428 Engines, Rope Seal .....		25.25
	Also See Part No.6336-B (Below)		

## Flywheel & Ring Gear Assembly



B 6375A

B 6375A	58/64; All Engines/Auto Trans. 153 Tooth .....		101.83
B 6375B	66/67; 428, Auto Trans. 186 Tooth .....		158.10
B 6375D	65/66; 390, 184 Tooth .....		92.50
<b>B 6378</b>	<b>Crankshaft Pulley Washer</b>		
B 6378A	58/66; 390 & 428 Engines; 1.76" O.D. — .66" I.D. -.212" Thick .....		3.83
<b>B 6384</b>	<b>Flywheel Ring Gear</b>		
B 6384A	65/66; 390 Engine, 184-Tooth .....		84.66



B 6436A

<b>B 6436</b>	<b>Starter to Flywheel Housing Seal</b>		
B 6436A	58/62 .....		13.47

*Big Selection of Parts! Whether it's a hard to find part or a standard Thunderbird replacement part, Larry's has what you're looking for. Our inventory of parts is concours-quality. Give us a call if you can't find the parts you need. Our knowledgeable parts specialists will be happy to help!*

**B 6570 Power Steering Reservoir Cover Grommet**  
 B 6570A 58/65; Eaton Type Pump ..... 1.83



B 6582A

## Engine Valve Cover

B 6582A 61/66; 390, 428, Chromed, Stamped  
 (Power by Ford).....Pair 198.85  
 M 6892A PVC Grommet Used With Chrome  
 Valve Covers ..... 3.69

## Valve Cover Gasket

B 6584C Valve  
 Cover Gasket



**Valve Rocker Arm Cover Gasket**  
 B 6584C 58/66; (Except 430 Engine) ..... Each 7.95

## Oil Pump



B 6600A 58/66; 352, 390 & 428 Engines ..... 78.49

**B 6618 Oil Pump Intermediate Drive Shaft**  
 B 6618A 58/66; 352, 390 & 428 Engines ..... 10.15

## Oil Pump Gasket



B 6626A

**B 6626 Oil Pump Inlet Tube Gasket**  
 B 6626A 58/66 ..... 1.90

## Oil Filter Adaptor to Engine Block Gasket



B 6636B

B 6636B 58/66; 8 Cylinder, All ..... 1.97

**B 6664 Crankcase Ventilation Hose**  
 B 6664A 61/66; 390 & 428 Engines; 15/32" I.D. ....Per Foot 5.56  
 B 6664B 61/66; 390 & 428 Engines; 5/8" I.D.. ....Per Foot 4.26

## PCV Valve



B 6666A



B 6666B

B 6666A 62/64; 390 & 428 Engines, 2 7/8"  
 Long 1/4" x 18 Male Threads One End ..... 8.62  
 B 6666B 65/66..... 5.84



*We carry a large inventory of  
 concours-quality parts. Give us  
 a call if you can't find what you  
 need. Our knowledgeable parts  
 specialists will be happy to help!*

## Engine Oil Pan



B 6675A



B 6710A



B 6730A



B 6734A

B 6675A	58/66; 352, 390 & 428 Engines .....	66.30
Engine Oil Pan Gasket		
B 6710A	58/66; All, 8 Cylinder .....	17.85
Engine Oil Drain Plug		
B 6730A	58/66; All, 8 Cylinder .....	5.97
Oil Drain Plug Gasket		
B 6734A	58/66; All, 8 Cylinder • Nylon .....	1.89

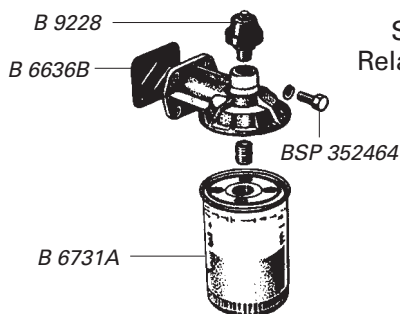

## Spin-On oil Filter & Related Parts 390 Engine



B 6731A

<b>B 6700</b>	<b>Engine Front Timing Cover Oil Seal</b>		
B 6700A	58/66; 8 Cylinder, All .....	Each	13.50
<b>B 6701</b>	<b>Engine Crankcase Rear Oil Seal Packing</b>		
B 6701A	61/66; 390 & 428 Engines, Rubber Formed Seal; 3.40" Diameter split-Lip Type.....	Each	29.53
B 6701B	58/66 (Except 430) .....	Each	24.75
<b>B 6731</b>	<b>Engine Oil Filter</b>		
B 6731A	58/66; All, 8 Cylinder, Spin-On Type .....		7.09
<b>B 6750</b>	<b>Engine Oil Dipstick</b>		
B 6750A	58/60; 352 Engine (Note*).....	Each	21.37
B 6750C	61/64 .....	Each	21.37
B 6750D	65 .....	Each	21.37
B 6750E	66 .....	Each	21.37



B 6754D

\* Dipstick only work with B 6754A

<b>B 6754</b>	<b>Oil Level Indicator Tube</b>		
B 6754A	58/60; If car built before April 1, 1960, purchase item B 6750A in addition to the dipstick tube .....		21.37
B 6754C	61/64; If car built after Oct. 1961, purchase item B 6750C in addition to the dipstick tube .....		21.37
B 6754D	65; All.....		21.37
B 6754E	66; All.....		21.37

## Engine Breather Caps



B 6766E



B 6766F

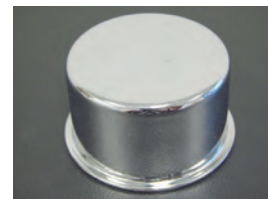

B 6766G

B 6766E	65/66; 390 & 428; Open Systems, Chrome Finish.....	13.21
B 6766F	61/66; 390 & 428; Open System, Push-On Correct Type, Black Finish.....	11.25
B 6766G	61/66; 390 & 428; Open System, Push-On Correct Type, Chrome Finish.....	11.95



B 6868A



B 6881A



B 9278A

<b>B 6868</b>	<b>Oil Filter Adaptor</b>		
B 6868A	65/66; 390 & 428, Fits On Valve Cover .....		15.25
	Converts a Twist-on Type Breather Cap to a Push-On Type.		
B 6881A	58/66; 352, 390 & 428 Oil Filter Adaptor .....		50.95
<b>B 9278</b>	<b>Oil Pressure Sender</b>		
B 9278A	58/63 .....		22.39
B 9278B	64/66 .....		23.50
<b>B 10884</b>	<b>Water Temp Sender</b>		
B 10884A	58/61 .....		13.01
B 10884C	63/64; (After 11/15/62 - Will work for 62 & early 63 if used with part #10911A) .....		15.25
B 10884D	66; With Gauges .....		9.95

<b>B 60608</b>	<b>Emblem, Rear Seat &amp; Tri-Power Air Cleaner</b>		
B 60608A	Rear Seat, 62/63; Tri-Power Intake Manifold ..	Each	35.65

## Engine Compartment Attaching Hardware

BHK 497	Bell Crank to Engine, 58/60, (2 Pieces) .....	1.24	
BHK 499	Valve Cover Bolts, 58/60, (10 Pieces) .....	6.00	
BSP 370383	Washer, Special, 13/32" — 3/4" wide, 5 prongs steel .....	Each	2.30

# TRANSMISSION

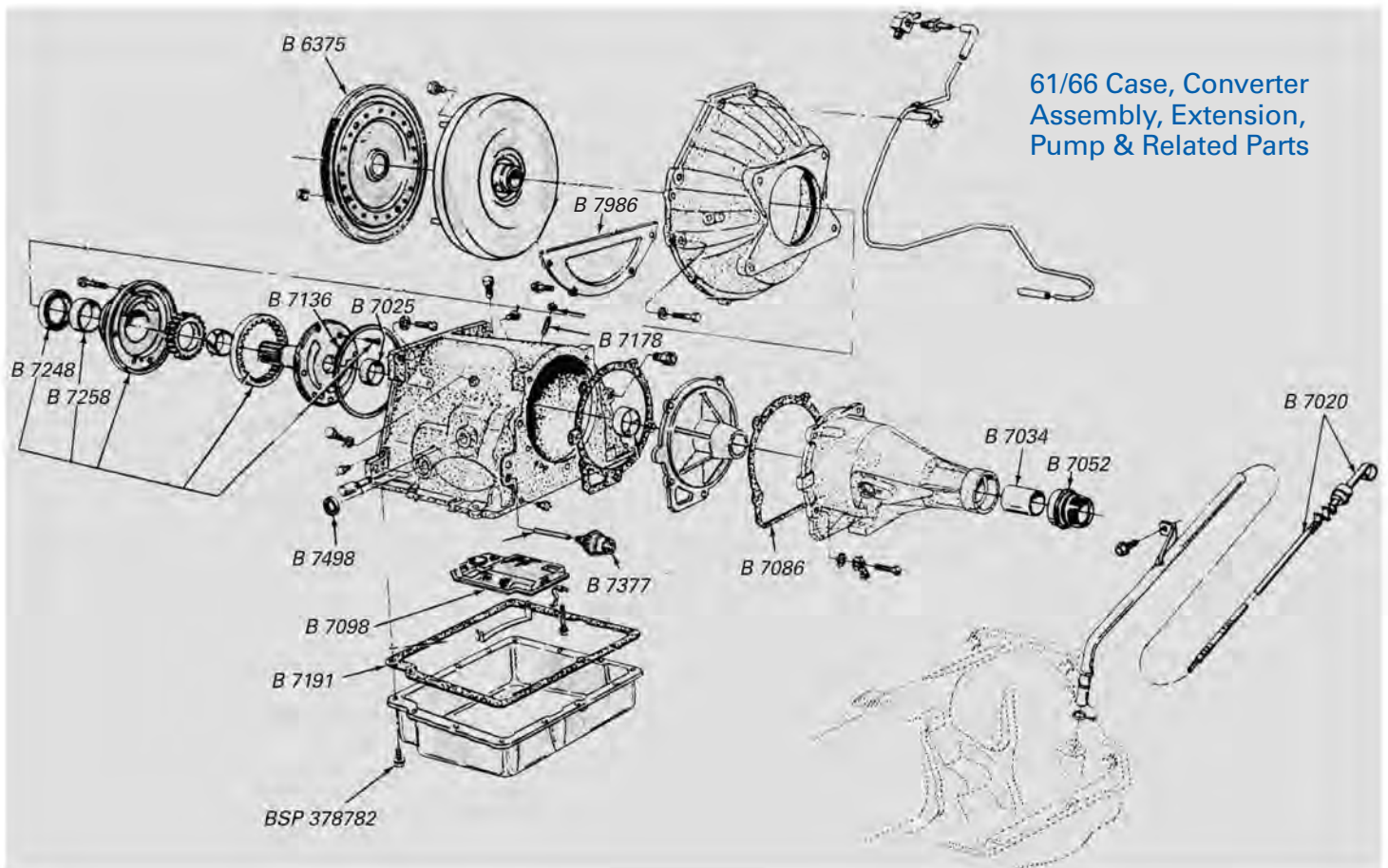

61/66 Case, Converter Assembly, Extension, Pump & Related Parts

## Brake & Clutch Pedal Pad



B 2457A 58/60 Standard Transmission ..... Each 5.95

<b>B 7020</b>	<b>Transmission Indicator Oil Level</b>	
B 7020D	58/59; (Before 6/15/59) .....	27.54
B 7020E	61; .....	26.48
B 7020F	62; (Before 2/22/62).....	26.48
B 7020G	62/65; (After 2/22/62) .....	26.48
B 7020H	66; CM .....	35.65
B 7020J	66; C6.....	27.54



B 7032A

## Transmission Mount



B 6068A                      B 6068B                      B 6068C

<b>B 6068</b>	<b>Transmission Mount</b>	
B 6068A	61/63; 390, Support Assembly .....	24.95
B 6068B	64/66; 390 (except '66 with C6 Transmission) .....	21.95
B 6068C	58/60; (except 430) .....	20.76
B 6068D	66; 390 & 428 (C6 Transmission) .....	21.95

<b>B 7032</b>	<b>Transmission Cooler Lines</b>	
B 7032A	58/59 .....	64.95
B 7032B	60 .....	64.95
B 7032C	61; FMX .....	58.36
B 7032D	62/63; FMX .....	58.36
B 7032E	64/66; FMX .....	58.36
B 7032F	66; C-6 Transmission .....	58.36

<b>B 7034</b>	<b>Transmission Extension Housing</b>	
	Standard Or Automatic Transmission Bushing	
B 7034B	58/60; 332 Engine; 1 1/2" I.D. x 1 5/8" O.D.; .....	16.58



# TRANSMISSION

<b>B 7052</b>	<b>Extension Housing Seal</b>	
B 7052A	58/60; Standard Transmission .....	10.67
B 7052B	58/60; A/T & 3-Speed Overdrive .....	22.19
<b>B 7071</b>	<b>Forward Clutch Piston Spring</b>	
B 7071D	66; 1 13/16" Long x 1/2" Diameter, (C6Trans.) .....	7.50
<b>B 7078</b>	<b>Neutral Safety Switch Wire Loom</b>	
B 7078A	66; (C/M) .....	Each 20.35
<b>B 7090</b>	<b>Forward Clutch Hub Thrust Washer</b>	
B 7090A	66; 2 7/8" O.D. x 2 3/16" I.D., (C6Transmission) ....	5.51



B 7098B

<b>B 7098</b>	<b>A/T Filter Screen</b>	
B 7098B	66; (C6Transmission) .....	10.15
B 7098C	58/66; (C/M) With Gasket .....	13.21
<b>B 7146</b>	<b>Kickdown Return Spring</b>	
B 7146A	61/66 .....	4.95
<b>B 7187</b>	<b>Auto Transmission Kick Down Rod</b>	
B 7187C	61/64 .....	Each 50.95
B 7187D	65/66; For Cruise-O-Matic Trans Type .....	Each 50.95
<b>B 7191</b>	<b>Transmission Oil Pan to Case Gasket</b>	
B 7191A	58/66; (C/M) .....	4.95
B 7191B	66; (C6Transmission) .....	8.97



B 7213A



B 7213C



B 7213D



B 7213E

<b>B 7213</b>	<b>Shifter Lens</b>	
B 7213A	60; Shifter Lens With Wire .....	50.95
B 7213B	61; With Moveable Column (Will also work on 62/63) .....	50.95
B 7213C	64; Cruise-O-Matic (Will also work on 64/66) .....	25.45
B 7213D	58 .....	50.95
B 7213E	59 .....	50.95



B 7228A



B 7228B

<b>B 7228</b>	<b>Shift Collar</b>	
B 7228A	58/60; Includes Access Door and Spring Clip.....	112.15
B 7228B	61/63 .....	112.15

## Transmission Shift Lever (Auto. Trans.)

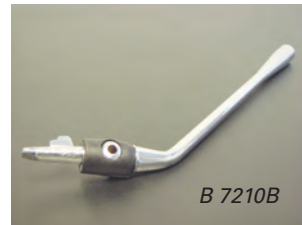

B 7210B



B 7210E

B 7210B	61/63; Includes Bushing .....	50.95
B 7210C	64/66; Includes Bushing .....	50.95
B 7210D	58; Black knob, silver center, includes bushing .....	39.73
B 7210E	59; White knob, gold center, includes bushing .....	39.73
B 7210F	60; White knob, silver center, includes bushing .....	39.73

## Transmission Shift Detent Plate



B 7216R

<b>B 7216</b>	<b>Shift Detente Plate</b>	
B 7216A	58/60 .....	26.95
B 7216B	61/63 .....	26.95
B 7216R	64/66 .....	16.27

<b>B 7246</b>	<b>Transmission Gear Shift Insulator</b>	
B 7246A	58/65; (C/M) .....	3.05



B 7247A

<b>B 7247</b>	<b>Neutral Safety Switch</b>	
B 7247A	58/60 .....	49.93
<i>(Note-wire connectors may need to be modified)</i>		
B 7247B	61/63 .....	55.36
B 7247C	64/66 .....	61.15
B 7247D	66; C6, 390, 428 .....	81.55
<b>B 7248</b>	<b>Front Oil Pump Seal</b>	
B 7248A	58/66; 2 11/16" O.D. x 1 15/16" x 3/8" Thick, (C/M)..	11.07
B 7248C	66; Small—2 3/4" O.D. x 2" I.D. (C/6Trans.), (C/M)..	5.57
<b>B 7288</b>	<b>Shift Shaft Lever Oil Seal</b>	
B 7288A	58/60; Standard & O/D Transmissions .....	Each 1.48

# TRANSMISSION

## 61 Fixed Steering Column & Shift Control Selector Mechanism

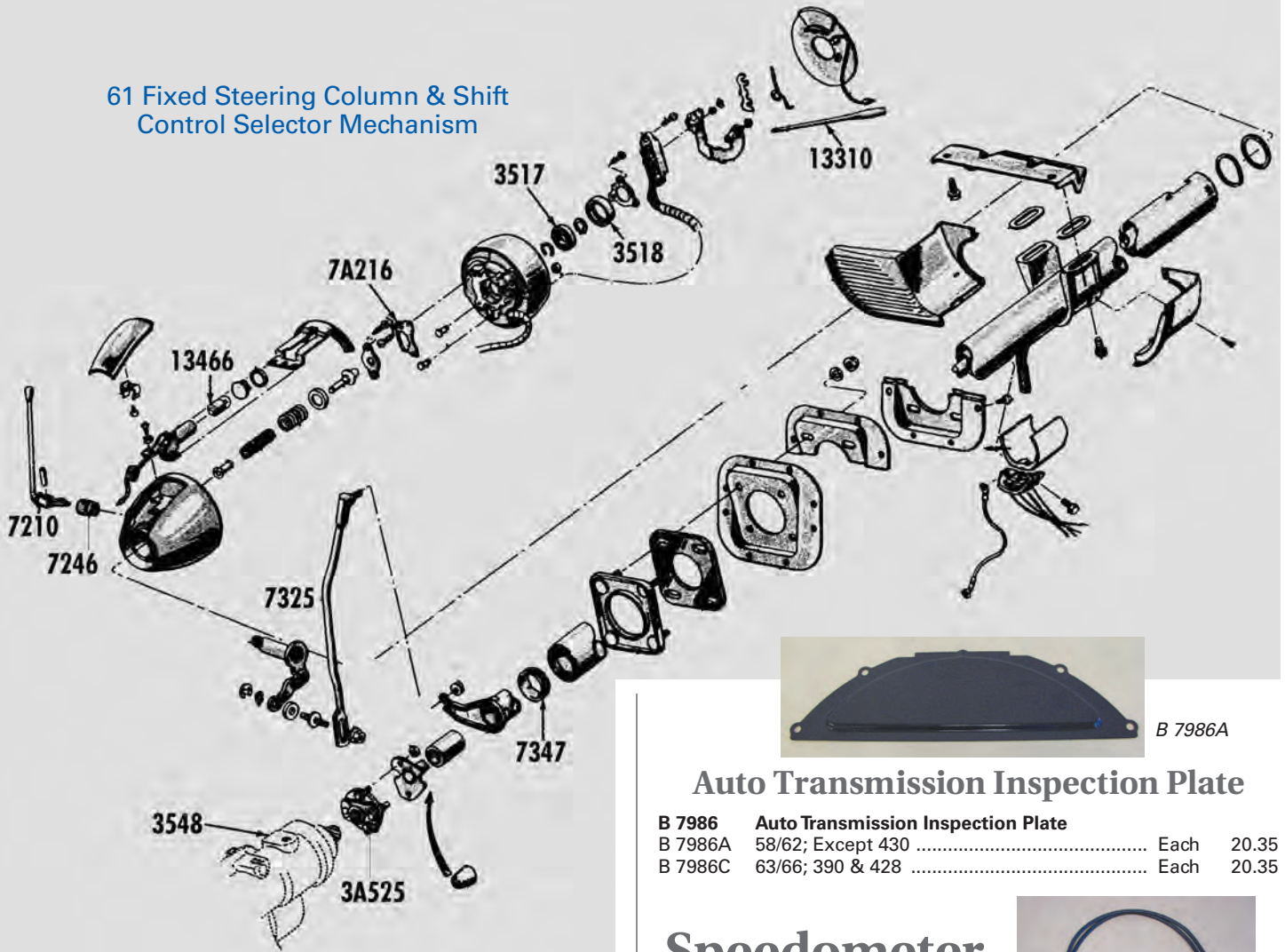

## Auto Transmission Inspection Plate

B 7986	Auto Transmission Inspection Plate		
B 7986A	58/62; Except 430	Each	20.35
B 7986C	63/66; 390 & 428	Each	20.35

## Shift Tube Selector Arm



B 7302A	58/60; Repairs The Sloppy Gear Selection	Each	33.41
---------	--	------	-------

<b>B 7343</b>	<b>Selector Arm Bushing &amp; Insulator Control</b>		
B 7343A	64/66; Kit—Bushings & Insulator, (C/M)	9.13	
<b>B 7347</b>	<b>Transmission Control Selector Tube Bearing</b>		
B 7347A	61/66; (C/M)	10.57	



B 7377B

<b>B 7377</b>	<b>Shift Control Vacuum Diaphragm</b>		
B 7377B	61/66; (C/M)	37.69	
<b>B 7513</b>	<b>Clutch Fork Dust Boot</b>		
B 7513A	58/60; Standard Transmission	21.18	
<b>B 7517</b>	<b>Clutch Equalizer Shaft Bushing</b>		
B 7517A	58/60; Standard & O/D	Each 3.66	

## Speedometer Cable



B 17260A

B 17260	Speedometer Cable		
B 17260A	58/60 & 64/65; (Before 11/13/64), (Exc. W/Spd. Control) 58.80" Long; LH Wind	49.95	
B 17260C	61/63	50.95	
BSP 87036	66; "0" Ring- 11/32" LD	2.40	

## Speedometer Gear



B 17271A

B 17271	Speedometer Driven Gear		
B 17271A	64/66; 16Teeth, Axle Ratio 3.0	8.01	
B 17271B	65/66; 20Teeth, Axle Ratio 3.90	8.01	
B 17271C	64/66; 17Teeth, Axle Ratio 3.25	8.01	
B 17271D	58/63; 19Teeth	21.18	
B 17271K	58/63; 18Teeth	21.18	

## Speedometer Drive Gear Retainer



B 17292A

B 17292	Speedometer Drive Gear Retainer		
B 17292A	58/66; U-Shape	2.91	



# COOLING SYSTEM & GRILLE

## 58/60 Cooling System

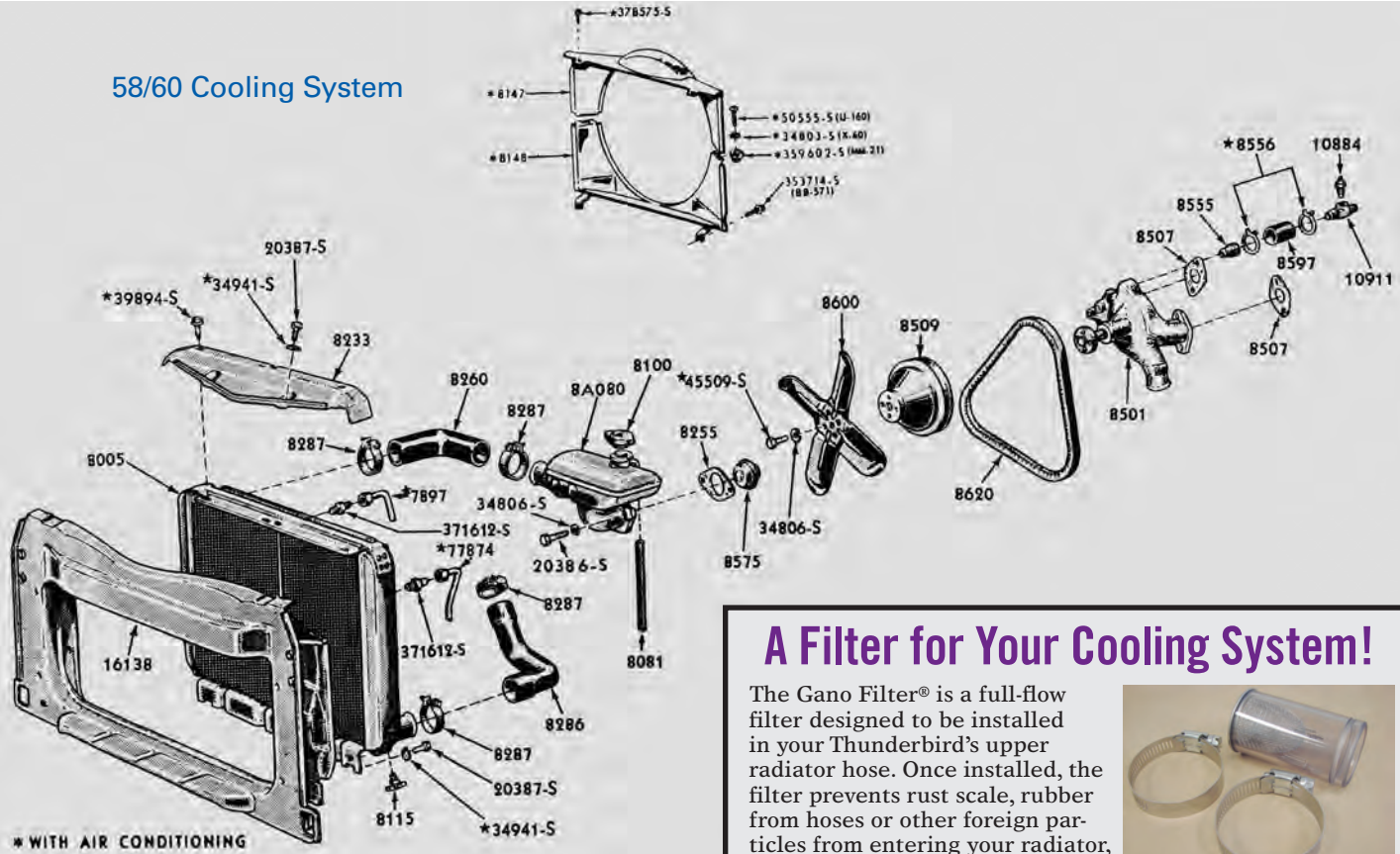

\* WITH AIR CONDITIONING

## A Filter for Your Cooling System!

The Gano Filter® is a full-flow filter designed to be installed in your Thunderbird's upper radiator hose. Once installed, the filter prevents rust scale, rubber from hoses or other foreign particles from entering your radiator, thereby avoiding the necessity of repair or replacement. And it's easy to install!



B 8288B

B 8288B	58/66; Medium 1 1/2" - 1 3/4"	45.85
B 8288C	58/66; Large 1 7/8" - 2 1/8"	45.85

## Heavy Duty Radiator



B 8005E

<b>B 8005</b>			
B 8005A	58/60	Each	445.00
B 8005B	61	Each	445.00
B 8005C	62/63	Each	445.00
B 8005D	64; Early, Req's 90 Degree Fitting At Cooler Lines	Each	445.00
B 8005E	64/66; Late, 17" Core & Uses 90 Degree Tube With Inverted Flare Fitting	Each	445.00
B 8005F	66; 19" Core	Each	445.00

## Surge Tank



B 8008C

<b>B 8080</b>			
B 8080A	58/60	203.95	Except 430
B 8080B	59/60	203.95	430
B 8080C	61/64	203.95	RH Fill
B 8080D	65/66	203.95	LH Fill

## B 8093 Radiator Support to Hood Seal

B 8093R	62/63	6.78
B 8093SK	Staples (16 Included)	
	For Part #8093-R Listed Above	1.31
B 16238A	64/66	6.19
B 16238AK	64/66; Seal w/Pins	Per Kit 8.84

## Radiator Caps



B 8100A

B 8100C

B 8100D

<b>B 8100</b>			
B 8100A	58/66; 12 lbs.; Pressure Relief Top	17.85	
B 8100B	58/66; 7 lbs.; Pressure Relief Top	11.48	
B 8100C	58/66; 13 lbs.; Bright Finish	10.17	
B 8100D	58/66; 13 lbs.; Natural Finish	11.07	

## Hardware

BSP 371612A	58/60; Radiator to Trans Cooling Line, 2 Required	Each	4.69
BSP 371612B	62/64 Early; Radiator to Trans Cooling Line, 1 Required	Each	13.21
BSP 371612C	62/64; Radiator to Trans Cooling Line, 1 Required	Each	18.31

# COOLING SYSTEM & GRILLE

## Radiator Drain Valve

B 8115A 58/66; 1/4" x 18 Pipe Thread ..... 5.08



## Radiator Fan Shrouds



B 8146A

B 8146A	66; 17" With Smog.....	178.45
B 8146B	66; 19" Without Smog.....	178.45
B 8146C	61/65; 2-Piece, like original .....	Set 112.15
B 8146D	58/60; 352 .....	189.95



B 8213A

<b>B 8213</b>	<b>Grille Emblem</b>	
B 8213A	66; Complete with 3 Plastic Inserts .....	Each 152.95
<b>B 8242/3</b>	<b>Grille Corner Moulding</b>	
B 8242A	66; RH .....	63.62
B 8243A	66; LH .....	63.62
<b>B 8255</b>	<b>Thermostat Housing to Block Gasket</b>	
B 8255A	58/66; (Except 430) .....	1.45

## Radiator Hoses



B 8260A

<b>B 8260</b>	<b>Radiator Hose • Upper [Without Script]</b>	
B 8260A	58/60; 352 & 430 Engines .....	18.31
B 8260C	61/63 .....	22.95



B 8260H



B 8286A

<b>B 8260</b>	<b>Radiator Hose with Correct Numbers &amp; Logo</b>	
B 8260F	58/60; 352 Engine—Upper .....	26.47
B 8260G	58/60; 430 Engine—Upper .....	26.47
B 8260H	61/63; Upper .....	26.47
B 8260I	64/65; Upper .....	26.47
B 8260J	66; Upper .....	26.47
<b>B 8286</b>	<b>Radiator Hose with Correct Numbers &amp; Logo</b>	
B 8286A	58/60; 352 Engine—Lower .....	26.47
B 8286B	58/60; 430 Engine—Lower .....	26.47
B 8286D	61/63; Lower .....	26.47
B 8286E	64/65; Lower .....	26.47
B 8286H	66; Lower .....	26.47

## Nose & Continental Kit Ornament



B 8259A



B 8259B

B 8259A	60; Nose Panel.....	43.00
B 8259B	58/59 .....	31.78

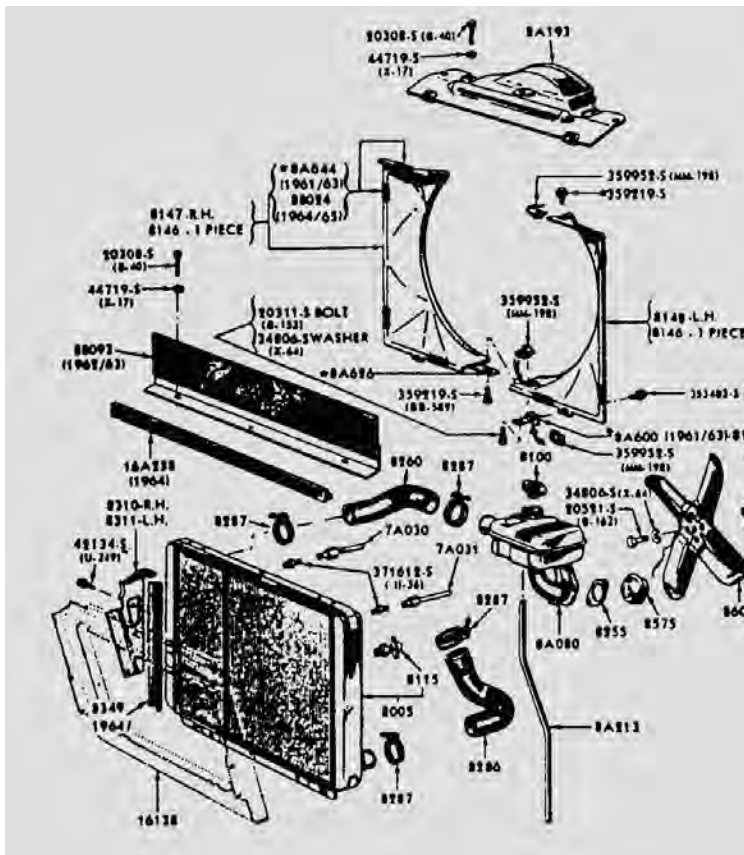

61/63 Cooling System

# COOLING SYSTEM & GRILLE

## Radiator Side Seals

- B 8348/9 Radiator Side Seals**  
**B 8348A 64/66** ..... Pair 10.15

## Water Pumps

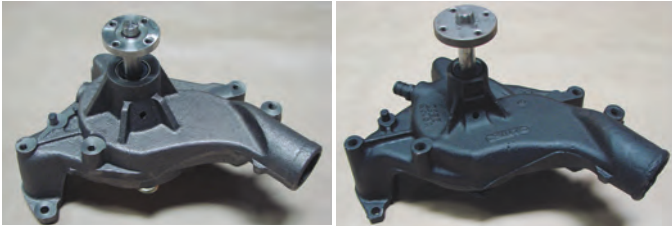

B 8501A

B 8501R

- B 8501A 58/60; Long Shaft Style, New ..... 152.95  
 B 8501B 61/64; 390, With Generator, New ..... 101.95  
 B 8501H 63/66; 390 & 428, With Alternator, New ..... 77.47  
 B 8501R 58/60; 332 & 352 Engines, Rebuilt ..... 209.95  
 Core Charge ..... 100.00  
 B 8501U 58/60; 430 Engine, Rebuilt ..... 209.95  
 Core Charge ..... 100.00

- B 8507 Water Pump to Block Gasket**  
**B 8507A 58/66; (Except 430) (2 Required)** ..... Each 1.93

- B 8513 Water Pump Cover Gasket**  
**B 8513A 61/66** ..... 3.01

- B 8546 Water Pump Pulley to Fan Spacer**  
**B 8546A 58/60;**  
**61/63; 390, Without Air Conditioning, 1.28" Thick** .. 14.23



B 8555B

- B 8555 Water By-Pass Tube**  
**B 8555B 58/66; Steel, 5/8" O.D. x 2.5" Long** ..... 5.87

- B 8556 Water By-Pass Clamp**  
**B 8556K 61/66** ..... 1.54



B 8575B

## Thermostat

- B 8575B 58/66; 180° (Except 430 engine)**..... 9.82  
**B 8575D 58/66; 160° (Except 430 engine)** ..... 7.40

- B 8597 Water By-Pass Hose**  
**B 8597D 61/66; 390** ..... 6.07



B 8600A

- B 8600 Fan Blade**  
**B 8600A 58/60; 6-Blade Fan** ..... 66.25

## Grille Bar Kit

- B 8666K 60; Includes Bars & Retaining Clips** ..... Kit 202.47

- B 16137 Radiator Support to Radiator Seal**  
**B 16137A 58/60** ..... Pair 4.68

- B 16238 Radiator Support to Hood Seal**  
**B 16238A 64/66** ..... 6.19  
**B 16238AK 64/66; Seal Kit w/Pins** ..... Per Kit 8.84

## Cooling System Attaching Hardware

- BHK 300 Grille, 63, (20 Pieces) ..... 13.36  
 BHK 300A Front Grille, 60, (20 Pieces) ..... 61.49  
 BHK 300B Front Grille, 58/59, (20 Pieces) ..... 56.50  
 BHK 301 Grille, 64/65 (20 Pieces) ..... 14.17  
 BHK 302 Grille, 66, (38 Pieces) ..... 26.71  
 BHK 303 Grille Bar to Grille 60 (36 Pieces) ..... 7.24  
 BHK 304 Grille Guard, 61/63 (4 Pieces) ..... 2.31  
 BHK 305 Grille to Brackets 58/60 (21 Pieces) ..... 4.30  
 BHK 306 Grille Moulding - Top, 66, 2 Sides (12 Pieces) ..... 4.80  
 BHK 307 Grille Moulding Under Light (Eyebrow),  
 66, 2 Sides (8 pieces) ..... 5.30  
 BHK 308 Grille Moulding—Center Clip, 66 (4 Pieces) ..... 2.31  
 BHK 309 Grille Moulding Complete, 66 (27 Pieces) ..... 14.92  
 BHK 310 Grille Moulding to Bumper, Lower ..... 46.38  
 BHK 311 Grille to Lower Moulding, 58/60 (16 Pieces) ..... 5.37  
 BHK 312 Grille Center Ornament, 66 (3 Pieces) ..... 1.74  
 BHK 313 Bumper to Grille Bracket, 58/60, (14 Pieces) ..... 4.37  
 BHK 366 Rad. Side Air Deflectors, 58/60 ..... 2.88  
 BHK 367 Lower Rad. Support Bracket, 58/60 ..... 5.50  
 BHK 468 Radiator Shield—Top Cover to Hose Panel, 58/60 (2 Pcs) 3.00  
 BHK 469 Rad. Side Rubber Shield Brkt, 58/60, (8 Pieces) ..... 1.88  
 BHK 470 Radiator Top Cover, 58/60, (3 Pieces) ..... 2.24  
 BHK 471 Rad. Side Rubber Shield to Brkts, 58/60, (8 Pcs) ..... 2.88  
 BHK 472 Radiator Cover (8A193), 61/63 (20 Pieces) ..... 5.68  
 BHK 473 Radiator Shield, 64/66 (16 Pieces) ..... 12.36  
 BHK 474 Support For Radiator To Hood Seal, 62/63 (4 Pieces) ..... 3.00  
 BHK 505 Water Pump, 58/60 (4 Pieces) ..... 2.68

## Engine Compartment Belt Application Chart

- |         |      |         |      |
|---------|------|---------|------|
| B 8620A | 9.95 | B 8620J | 9.95 |
| B 8620B | 9.95 | B 8620K | 9.95 |
| B 8620C | 9.95 | B 8620L | 9.95 |
| B 8620D | 9.95 | B 8620M | 9.95 |
| B 8620E | 9.95 | B 8620N | 9.95 |
| B 8620F | 9.95 | B 8620O | 9.95 |
| B 8620G | 9.95 | B 8620P | 9.95 |
| B 8620H | 9.95 | B 8620Q | 9.95 |
| B 8620I | 9.95 |         |      |

## Engine Compartment Belt Application Chart

Year	1958			1959			1960		1961		1962		1963		1964		1965		1966	
Engine Sizes	352	352	430	352	430	390	390	390	390	390	390	390	390	390	390	390	390	390	390	428
Water Pump/Generator	E	E	D	E	D	C	C	B	D	D	D	D	D	D	D	D	D	D	D	D
Power Steering Pump	H	H	A	H	A	I	I	I	F	G	G	G								
Eaton Pump with A/C								Q	Q	Q	Q									
Ford Pump with A/C										P	P	P								
Air Conditioner	K	K	L	K	L	J	J	J	M	N										
With Smog																			Q	Q
Without Smog																			N	N

# FUEL & CARBURETOR SYSTEM

## 58/60 Thunderbird Fuel System

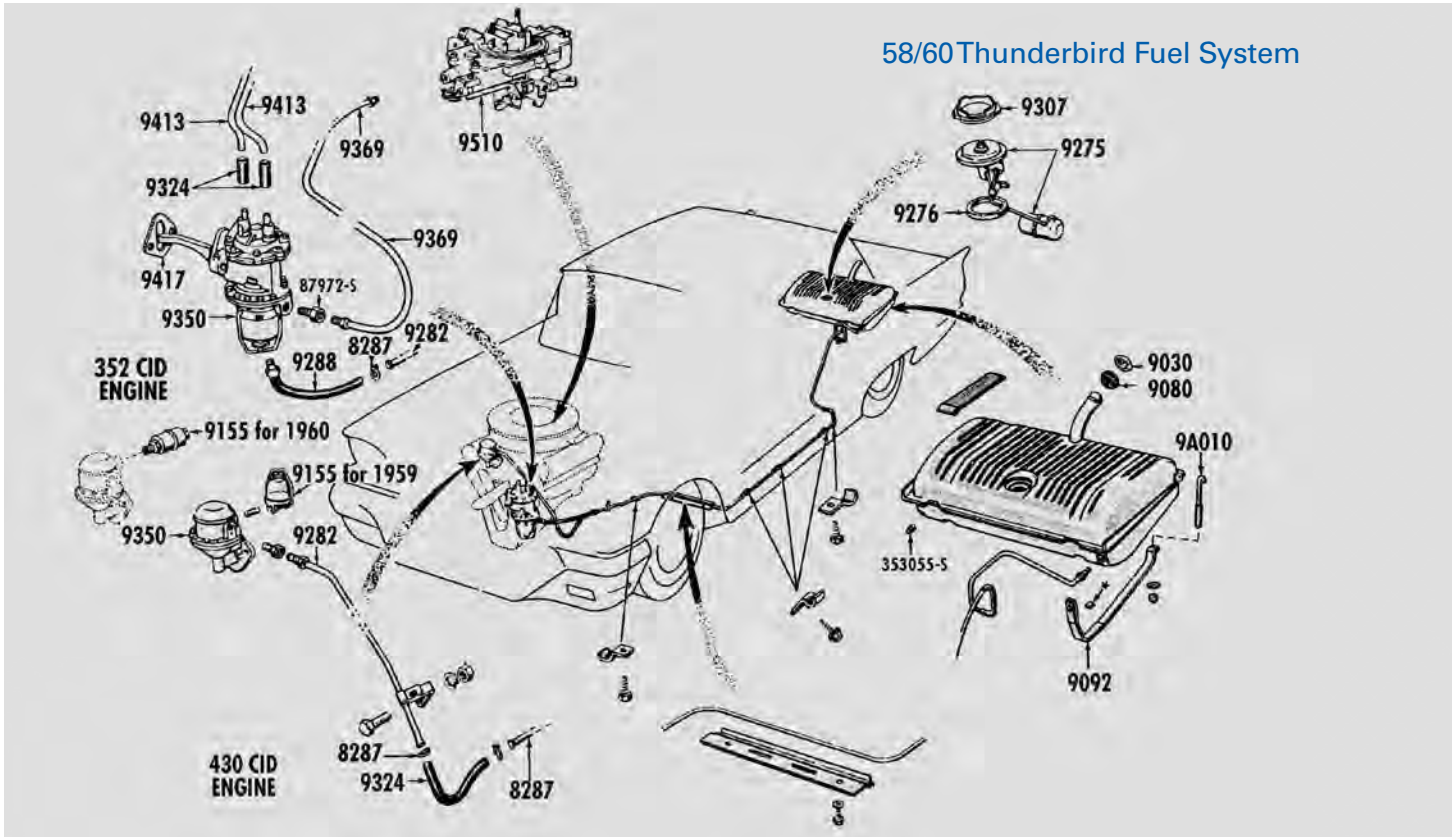

## Fuel Tank

Highest Quality Fuel Tank Available



B 9002A



B 9002B



B 9002C

B 9002A	58/60	264.18
B 9002B	61	264.18
B 9002C	62/63	264.18
B 9002D	64/66	264.18

## Fuel Tank Strap Bolts

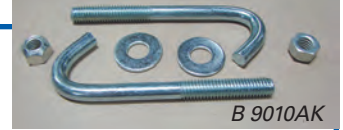

B 9010AK

B 9010AK	58/60; Includes Bolts, Washers & Nuts	Pair	15.25
B 9010BK	61/63; Includes Bolts, Washers & Nuts	Pair	21.95
B 9010CK	64/66; Includes Bolts, Washers & Nuts	Pair	22.39

*See page 43 for Straps.*

## Fuel Tank Caps



B 9030B

B 9030A	61/66; Non-Locking, Vented	7.09
B 9030B	61/66; Locking, Vented	15.87
B 9030C	58/60; Non-Locking	7.09
B 9030D	58/60; Locking	15.15

## Fuel Filler Pipe



B 9034C

B 9034C	62/63	50.95
B 9034D	64/66	86.65

Note: B 9034C will work on a 1961 if a 62/63 gas tank is installed

## Fuel Filler Hose



B 9047B

B 9047B	1961; Fuel Neck Filler Hose	17.29
---------	-----------------------------	-------

# FUEL & CARBURETOR SYSTEM

<b>B 9072</b>	<b>Gas Tank "O" Ring</b>		
B 9072A	61/66	Each	2.10
<b>B 9076</b>	<b>Fuel Filler Neck Seal</b>		
B 9076A	64/66; Neck to body seal		5.36

## Fuel Tank Filler Grommet



B 9080B

<b>B 9080</b>	<b>Gas Filler Neck Grommet</b>		
B 9080B	58/60		10.95
<b>B 9092</b>	<b>Gas Tank Strap</b>		
B 9092A	58/60	Pair	39.95
B 9092B	61/63	Pair	39.95
B 9092C	64/66	Pair	39.95

## Fuel Filters



B 9155A



B 9155C

B 9155A	61/66; In-Line Filter	5.36
B 9155C	58/59; 352 Engine	27.25
B 9180K	58/59; Bracket—Fuel Filter 352 Engine, Includes Clip	6.71



B 9202B

<b>B 9202</b>	<b>Fuel Tank Sender Float Assembly</b>		
B 9202B	58/66		9.13

## Fuel Tank Sender



B 9275C

B 9275A	58/60	59.95
B 9275B	61/63	76.50
B 9275C	64/66;	
	Without "Low Fuel Level" Warning	85.64
B 9275D	64/66; With "Low Fuel Level" Warning.	96.85

<b>B 9276</b>	<b>Fuel Sender Gasket</b>		
B 9276A	61/66	1.21	
B 9276B	58/60	Each 1.56	

<b>B 9280</b>	<b>Fuel Log</b>		
B 9280A	61/66; 390, For Use With 3 2Bbl. Carbs		50.95

<b>B 9282</b>	<b>Tank to Fuel Pump Fuel Line</b>		
B 9282A	58/60; 15/16", 1 Piece		101.95
B 9282B	61; 15/16", 2 Piece		101.95
B 9282C	62; 15/16", 2 Piece		101.95
B 9282D	63; 3/8", 2 Piece		101.95
B 9282E	64; 3/8", 2 Piece		101.95
B 9282F	65/66; 3/8", 2 Piece		101.95
BSP 87972	Fuel Pump To Fuel Line Fitting		5.41



B 9288A

<b>B 9288</b>	<b>Fuel Pump to Fuel Tank Flex Line</b>		
B 9288A	58		7.40
B 9288B	58; 430		8.01



B 9307A

<b>B 9307</b>	<b>Fuel Tank Sender Retainer</b>		
B 9307A	58/60		10.56
B 9307B	61/66		7.09

<b>B 9324</b>	<b>Fuel Hose</b>		
B 9324A	58/66; 3/8" I.D.	Per Foot	2.55

## Fuel Pumps



B 9350A



B 9350E

B 9350A	63/66; 390 Engine (After 7/15/63) & 428 Engine, All	45.85
B 9350B	62/63; 390 Engine (Before 7/15/63)	50.95
B 9350C	61	98.50
B 9350D	58/60; 352 Engine, Double-Action with Glass Bowl	99.75
B 9350E	59/60; 430 Engine	117.25
BSP 87972	Fuel Pump to Fuel Line Fitting	5.41

## Fuel Pump Parts



B 9365A



B 9364A



B 9365B

<b>B 9364</b>	<b>Fuel Bowl Gasket</b>		
B 9364A	58/60		1.51

<b>B 9365</b>	<b>Fuel Pump Filter Strainer Assembly</b>		
B 9365A	62/66		8.11
B 9365B	58/60		6.99

<b>B 14406</b>	<b>Low Fuel Sender Wire Harness</b>		
B 14406D	64/66; With Plug & Boot		41.95

# FUEL & CARBURETOR SYSTEM

<b>B 9369</b>	<b>Fuel Pump to Carburetor Fuel Line</b>	
B 9369A	58/60; 352, 1 Piece .....	23.30
BSP 87972	58/60; Fitting—Fuel Pump To Fuel Line .....	5.41
B 9369B	61; 390, 2 Piece .....	23.30
B 9369C	62/63; 390, 1 Piece .....	23.30
B 9369D	64; 390, 1 Piece .....	23.30
B 9369E	65/66; 390, 1 Piece .....	23.30
B 9369F	66; 428, 1 Piece .....	23.30
<b>B 9413</b>	<b>Vacuum Line</b>	
B 9413A	58/60; Fuel Pump To Manifold .....	12.95
B 9413B	58/60; Fuel Pump To Wiper Motor .....	16.95

## Fuel Pump Gasket



B 9417A

<b>B 9417</b>	<b>Fuel Pump to Block Gasket</b>	
B 9417A	61/62; Use With Part B8A-6019-B & coAE-6019-A Steel Stamped Covers .....	1.79
B 9417C	58/66 .....	.98

## Carburetor Mounting Gaskets

<b>B 9447</b>	<b>Carburetor Mounting Gasket</b>	
B 9447A	66; .018/.024" Thick 4 Bbl.....	1.59
B 9447F	58/60; 4 Bbl .....	3.72
<b>B 9447</b>	<b>Carburetor Spacer to Intake Gasket</b>	
B 9447B	62/65; 4 Bbl .....	5.85

<b>B 9496</b>	<b>Smog Pump Filter</b>	
B 9496A	66 .....	9.69
<b>B 9503</b>	<b>Secondary Diaphragm</b>	
B 9503A	58/66; Autolite 4 Bbl. ....	Each 17.29

<b>B 9510</b>	<b>Carburetor Assembly</b>	
B 9510A	61/66; 390, 428 Rebuilt, Ford Type .....	Each 281.74
	Core Charge.....	250.00
B 9510B	61/66; Holley V8 Rebuilt, Holley Replacement .....	Each 325.00
	(Need Core in Advance)	
	Core Charge.....	150.00

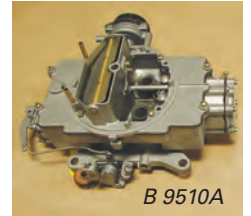

B 9510A

<b>B 9550</b>	<b>Carburetor Float</b>	
B 9550C	58/66; Ford 4Bbl . ....	Each 24.74
<b>B 9577</b>	<b>Fast Idle Cam Lever</b>	
B 9577B	63/64; Dog Leg Style For Autolite . ....	Each 20.35
	2100 & 4100 Carburetor	



B 9586B

<b>B 9586</b>	<b>Carburetor Rebuild Kit</b>	
B 9586B	66; 428 .....	31.78
9586D	58/60; Ford 4Bbl.	
	61/65; 390 Engine, Holley Type .....	39.95
	61/66; 390 Engine, Ford Type .....	39.95
B 9586E	58/60; All & 66; 390 Engine, Holley 4Bbl . ....	50.95

## Carburetor Spacer



B 9589A

<b>B 9589</b>	<b>Carburetor Spacer</b>	
B 9589A	58/61 .....	Each 60.13
B 9589B	66 .....	Each 60.13

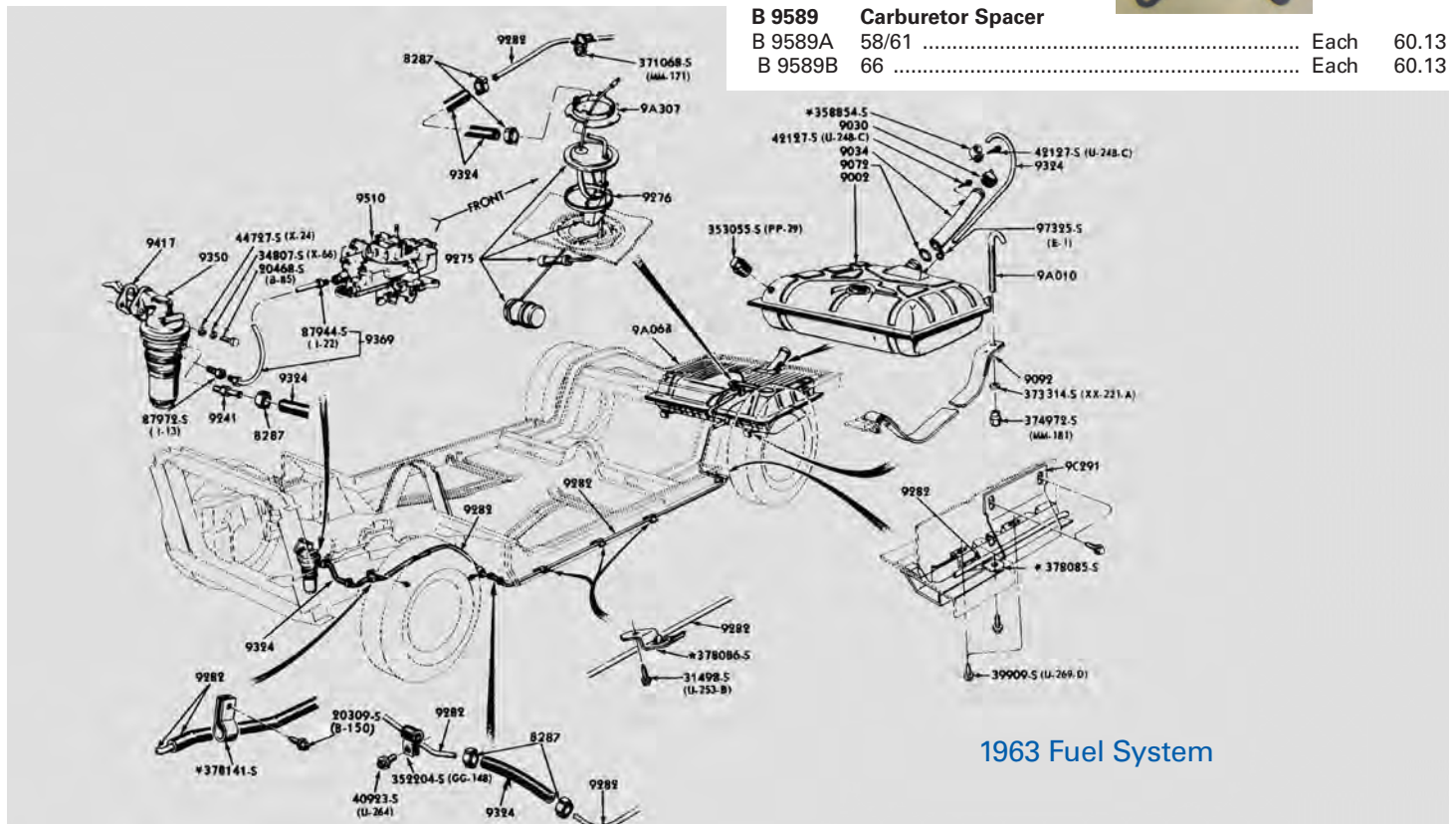

# FUEL & CARBURETOR SYSTEM

## Air Cleaner Elements

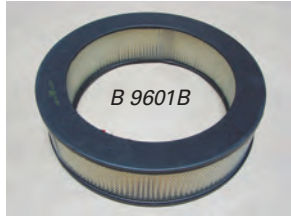

<b>B 9601</b>	<b>Carburetor Air Cleaner Element Assembly</b>	
B 9601A	61/64; Oval, 6v	29.95
B 9601B	64	14.23
B 9601C	65/66	15.25
B 9601D	61/63	16.75
B 9601E	58/60	18.87
	<b>BHK 485 Air Cleaner Nut, 61/63 (1 Piece).....</b>	<b>1.74</b>

## Carburetor Linkage Kit



<b>B 9700</b>	<b>Carburetor Linkage Kit</b>	
B 9700A	61/66; Incl. All Linkage Parts For A 3-2Bbl. Setup	71.35

## Exhaust Manifold Choke Plate Kit

B 9705AK	58/66; All, Except 430, Includes Plate, Gasket & Screw	Kit	10.15
----------	--	-----	-------

## Throttle Stop Bumper

<b>B 9720</b>	<b>Throttle Stop Bumper</b>		
B 9720B	61/66	Each	3.32

## Gas Pedal Rod

<b>B 9727</b>	<b>Gas Pedal Rod</b>		
B 9727A	58/60	Each	5.25

## Gas Pedals



	<b>B 9735A</b>		
	<b>B 9735D</b>		
	<b>B 9735E</b>		
B 9735A	58/66; Ford Replacement		15.87
B 9735D	63/64; With stainless trim		53.01
B 9735E	65/66; With stainless trim		53.01

## Throttle Stop Bracket

<b>B 9853</b>	<b>Throttle Stop Bracket</b>		
B 9853A	61/64; Throttle Stop Bracket	Each	19.05
B 9853B	65/66; C 6 Transmission	Each	24.36
B 9853C	66; CM Transmission	Each	30.55

## Choke Tube Insulator

<b>B 9865</b>	<b>Choke Tube Insulator</b>		
B 9865A	58/60; 14.5"	Each	14.53
B 9865B	61/63; 16"	Each	14.53
B 9865C	64/66; 17.5"	Each	14.53

## Cruise Control Bellows



<b>B 9735</b>	<b>Cruise Control Bellows</b>		
B 9735C	64/66; 3"		38.15

<b>B 9737</b>	<b>Accelerator Return Spring</b>		
B 9737A	58/66; 2Bbl. & 4Bbl.		4.77

<b>B 9741</b>	<b>Accelerator Return Spring Bracket</b>		
B 9741A	61/66; Mounts to Transmission Bell Housing	Each	21.18

<b>B 9742</b>	<b>Kickdown Return Spring Bracket</b>		
B 9742A	61/66; Mounts to Carburetor Stud	Each	10.35

<b>B 9772</b>	<b>Bell Crank &amp; Accelerator Rod Kit</b>		
B 9772AK	61/66;	Set	31.78

## Accelerator Rod Seal



<b>B 9793</b>	<b>Firewall to Accelerator Rod Seal</b>		
B 9793A	61/66		5.45

<b>B 9819</b>	<b>Choke Tube</b>		
B 9819A	58/62; Complete And Correct Replacement Kit		28.05
B 9819C	63/64; Correct Replacement		28.05

<b>B 9825/6</b>	<b>Rod End Carburetor Linkage Clip</b>		
B 9825B	58/66; RH		.63
B 9826A	58/66; LH		.77

<b>B 9853</b>	<b>Throttle Stop Bracket</b>		
B 9853A	61/64		19.05
B 9853B	66; C6 Transmission		24.36

<b>B 9857</b>	<b>Accelerator Rod Clip</b>		
B 9857A	61/66; This Clip Is Also Included In Part # B 9772AK	Each	9.46



<b>B 18663</b>	<b>"Y" Pipe For Heater Hose to Carburetor Clip</b>		
B 18663B	Late 62/63; 2 3/4"	Each	13.21
B 18663C	64/66; 2 5/8"	Each	13.21

<b>B 40560</b>	<b>Gas Filler Door</b>		
B 40560B	61/63; Chrome	Each	81.55

## Fuel & Carburetor System Attaching Hardware

BHK 234	Gas Pedal to Floor, 58/60, (2 Pieces)		1.38
BHK 485	Air Cleaner Nut, 61/63, (1 Piece)		1.74
BHK 498	Carburetor Mounting, 58/60, (12 Pieces)		3.68
BSP 87972	Fuel Pump to Fuel Line Fitting	Each	5.30

<b>BSP 375838</b>	<b>Gas Door Bumpers 64/66</b>		
	Front Licence Plate Bracket Bumper	Each	2.65

# WINDSHIELD, WINDWINGS & VISORS

## Firewall Pad Retainer

B 01670A 58/60; Steel ..... Each 4.19

## Front Cowel Drain Hoses



B 02207A

B 02207A 61/63 ..... Pair 35.65  
 B 02207B 64/66 ..... Pair 35.65

## Front Cowel Drain Tube Clamps

B 02208A 61/66; Stamped Wittek Chicago Like Original ..... Pair 21.18



## B 02626/7 Windshield Pillar Seal

B 02626/7A 64/66; Conv., Weatherstrip For Windshield Pillar .. Pair 46.82  
 B 02626/7B 58/60; Conv., Weatherstrip For Windshield Pillar... Pair 49.83  
 B 02626/7C 58/60; Hardtop..... Pair 15.87  
 B 02626/7D 61/63; Convertible..... Pair 56.19

## Windshields

B 03100A 58/60; Green Tint with Blue Shade at Top ..... Each 610.98  
 B 03100C 61/63; Green Tint with Blue Shade at Top ..... Each 402.39  
 B 03100D 61/63; Clear ..... Each 402.39  
 B 03100E 64/66; Green Tint with Blue Shade at Top ..... Each 229.50

## B 03110 Windshield Weatherstrip

B 03110A 61/63; Coupe Only ..... 79.54  
 B 03110B 64/66; Coupe & Convertible Only..... 74.50  
 B 03110C 61/63; Convertible Only..... 124.39  
 B 03110D 58/60; All Models..... 79.54

## Sun Visor & Related Parts



B 04115A



B 04104A

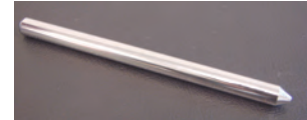

B 04114A

## B 04104 Sun Visor

B 04104A 58/59; White ..... Pair 135.00  
 B 04104B 60; White ..... Pair 135.00  
 B 04104C 60; Black ..... Pair 135.00  
 B 04104D 60; Dark Blue ..... Pair 135.00  
 B 04104E 60; Dark Green ..... Pair 135.00  
 B 04104F 60; Dark Turquoise..... Pair 135.00  
 B 04104G 60; Light Beige ..... Pair 135.00  
 B 04104H 60; Red ..... Pair 135.00

## B 04114 Sun Visor Pins

B 04114A 64/65 ..... Each 3.59

## B 04115 Sun Visor Tips

B 04115A 61/66 ..... Each 1.04

## B 04115 Sun Visor Rod Clip

B 04131A 58/60; Chrome, 2 Required ..Each 15.25  
 B 04131B 61/63; Chrome, .....Each 17.29

## B 04144/5 Sun Visor Arm

B 04144A 58/60; RH .....Each 51.00  
 B 04145A 58/60; LH ..... Each 51.00  
 B 04144C 61/63; RH ..... Each 51.00  
 B 04145C 61/63; LH ..... Each 51.00  
 B 04144D 64/66; RH Convertible ..... Each 56.10  
 B 04145D 64/66; LH Convertible ..... Each 56.10  
 BHK 110 Visor Brackets, 58/60 (8 Pieces) ..... 3.56  
 BHK 113 Visor Brackets, Center, 58/60 (8 Pieces) ..... 1.88  
 BHK 114 Center Visor Bracket, 64/66 (2 Pieces) ..... 1.74



B 04144A

## Windshield Area Attaching Hardware

BHK 100 Top Of Windshield Chrome, Exterior—Conv, 64/66, (3 Pieces) ..... 1.74	BHK 114 Center Visor Bracket, 64/66, (2 Pieces) ..... 1.74
BHK 101 Top Of Windshield Chrome, Exterior—Conv, 58/60, (4 Pieces) ..... 1.62	BHK 116 Windshield Inside Verticle—Convertible, 61/63, 2 Sides, (4 Pieces) ..... 1.74
BHK 102 Windshield Outside Upper Corner Cap, Conv., 58/60, (4 Pieces) ..... 1.74	BHK 117 Windshield Outside Verticle Weatherstrip Retainer Convertible, 61/63, 2 Sides, (10 Pieces) ..... 3.18
BHK 103 Windshield Inside Upper Corner—Coupe, 61/63, 2 Sides (4 Pieces) ..... Each 1.94	BHK 118 Windshield Verticle, Outside—Coupe, 58/60 (10 Pieces) ..... 2.12
BHK 104 Windshield Outside Upper Corner Cap—Convertible, 61/63, 2 Sides (4 Pieces) ..... Each 1.81	BHK 120 Windshield Inside Verticle—Coupe, 61/63, 2 Sides (12 Pieces) ..... 3.50
BHK 105 Windshield Outside Upper Corner Cap—Convertible, 64/66, 2 Sides (2 Pieces) ..... Each 1.74	BHK 121 Windshield Verticle, Inner—Coupe, 61/63, 2 Sides (4 Pieces) ..... 1.94
BHK 106 Windshield Outside Upper Corner Cap—Coupe, 58/60, (2 Pieces) ..... 1.50	BHK 122 Windshield Inside Side Post, 64/66, 2 Sides (2 Pieces) ..... 1.74
BHK 107 Windshield Upper Inside Stainless, 58/60 (2 Pieces) ..... 1.24	BHK 123 Windshield Inside Verticle—Coupe, 58/60, (4 Pieces) ..... 1.94
BHK 108 Upper Inside W/S, Stainless—Coupe & Conv., 61/63 (3 Pieces) ..... 1.81	BHK 124 Windshield Inside Lower Mlding, Side (2), 58/60, (4 Pieces) ..... 1.62
BHK 109 Upper Inside W/S Moulding & Visor Brackets, 64/66 (14 Pieces) ..... 4.44	BHK 125 Windshield Rain Gutter—Convertible, 61/63, 2 Sides (6 Pieces) ..... 2.12
BHK 110 Visor Brackets, 58/60, (8 Pieces) ..... 3.56	BHK 126 Windshield Rain Gutter—Convertible, 64/66, 2 Sides (8 Pieces) ..... 11.55
BHK 111 Windshield Upper Inside Stainless & Visor Brackets, 58/60, (18 Pieces) ..... 4.50	BHK 127 Windshield Inside Lower Moulding—Center, 58/60, (3 Pieces) ..... 1.38
BHK 112 Visor Brackets, 61/66, 2 Sides (8 Pieces) ..... 3.56	BHK 334 Cowl Cover, 58/60, (6 Pieces) ..... 1.68
BHK 113 Visor Brackets, Center, 58/60, (8 Pieces) ..... 1.88	BHK 335 Cowl Cover, 61/63, (24 Pieces) ..... 4.30
	BHK 336 Cowl Cover, 64/66, (22 Pieces) ..... 4.00



# DASH, CONSOLE & UNDERDASH AREA

<b>B 2462</b>	<b>Brake Master Cylinder Link Rod Bolt</b>	
B 2462A	58/62; 3/8" - 24 x 1 11/32" .....	17.00
<b>B 2471</b>	<b>Brake &amp; Clutch Pedal Mounting Bushing</b>	
B 2471A	60/61; Plastic; (before 3/21/61) .....	1.48
<b>B 2474</b>	<b>Brake Master Cylinder Push Rod Bushing</b>	
B 2474A	58/64; .62" long .....	6.07
<b>B 2481</b>	<b>Brake Pedal Spring Bushing</b>	
B 2481A	58/60 .....	24.95
<b>B 2786</b>	<b>Parking Brake Ratchet Pawl</b>	
B 2786A	58/60 .....	8.44
<b>B 2788</b>	<b>Parking Brake Ratchet Spring</b>	
B 2788A	58/60 .....	3.13
<b>B 2804</b>	<b>Parking Brake Cable Pulley</b>	
B 2804A	58/60 .....	24.43

## Kick Panels

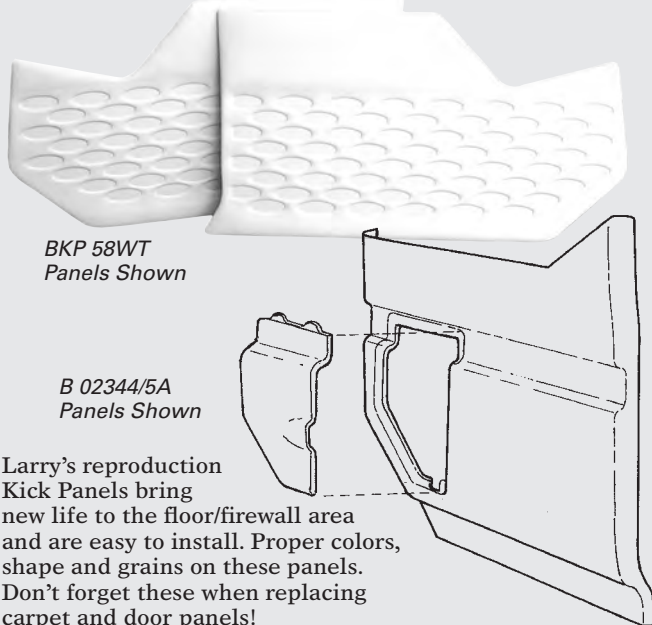

BKP 58WT  
Panels Shown

B 02344/5A  
Panels Shown

Larry's reproduction Kick Panels bring new life to the floor/firewall area and are easy to install. Proper colors, shape and grains on these panels. Don't forget these when replacing carpet and door panels!

BKP 58WT	58/59	White .....	Pair	89.95
BKP 59BU	59	Light Blue .....	Pair	89.95
BKP 60BK	60	Black/White .....	Pair	89.95
BKP 60BU	60	Blue/Blue .....	Pair	85.00
BKP 60RD	60	Red/White .....	Pair	85.00
BKP 60TN	60	Brown/Brown .....	Pair	85.00
BKP 60TQ	60	Turquoise/Turquoise .....	Pair	85.00
B 02344/5A	64/66	Black (Coupe) .....	Pair	109.25
B 02344/5B	64/66	Black (Convertible) .....	Pair	109.25
B 02344/5C	61/62	Black Only .....	Pair	105.00
B 02344/5D	63	Black Only .....	Pair	101.49
BHK 231		Kick Panels, 58/60, 2 Sides (4 Pieces) .....		1.81
BHK 232		Kick Panels, 61/63, 2 Sides (8 Pieces) .....		3.37
BHK 233		Kick Panels, 64/66, 2 Sides (6 Pieces) .....		2.88

### Firewall Pad Retainer

B 01670A	58/66; Steel .....	Each	4.19
----------	--------------------	------	------

<b>B 02207</b>	<b>Front Cowel Drain Hoses</b>		
B 02207A	61/63 .....	Pair	35.65
B 02207B	64/66 .....	Pair	35.65

### Front Cowel Drain Tube Clamps

B 02208A	61/66; Stamped Wittek Chicago Like Original .....	Pair	21.18
----------	---	------	-------



B 04290A

B 04290G

## Create a New Looking Dash for Your 'Bird!

Install a Dash Pad to help make your dash area look new again. Some trimming required for a great fit.

B 04290A	61/62; Black .....	475.00
B 04290G	58/60; Black .....	485.00

### Related Attaching Parts Kits For Dash Area

BHK 263	Dash End Caps, 61/63, 2 Sides (8 Pieces) .....	2.81
BHK 265	Instrument Bezel Covers, 61/63, (3 Pieces) .....	1.74
BHK 266	Instrument Housing Bezel, 64/66, (15 Pieces) .....	4.62
BHK 268	Instrument Housing Ret. Plate, 64/66, (6 Pieces) .....	2.48
BHK 269	Radio Bracket to Dash, 58/60, (2 Pieces) .....	.74
BHK 270	Radio Speaker Grille, 64/66, (2 Pieces) .....	1.74
BHK 273	Lower Dash Trim - LH, 64/66, (3 Pieces) .....	1.74
BHK 274	Lower Dash Trim - RH, 64/66, (3 Pieces) .....	1.74
BHK 275	Under Dash Panel, 58/60, (12 Pieces) .....	5.24
BHK 276	Under Dash Panel Moulding - Lower, 58/60, (16 Pieces) .....	12.48
BHK 277	Under Dash Panel Moulding - Upper, 58/60, (4 Pieces) .....	1.56
BHK 278	Under Dash Panel & Mould., 58/60, (32 Pcs.) .....	18.73

### B 04406 Dash Aluminum

B 04406A	61/63; Upper No A/C, RH .....	Each	132.65
B 04406B	61/63; Upper With A/C, RH .....	Each	100.82

### B 04407 Dash Aluminum

B 04407A	61/63; LH .....	Each	47.76
----------	-----------------	------	-------

### B 04408 Dash Aluminum

B 04408A	61/63; Center with A/C .....	Each	51.00
----------	------------------------------	------	-------

### B 04426 Dash Trim Clip

B 04426A	61/66 .....	Each	.97
----------	-------------	------	-----

### B 04460 Dash Script "Thunderbird"

B 04460	61/63 .....	Each	25.96
---------	-------------	------	-------



## Console Switch Plate Insert

### B 04567 Console Switch Plate Insert

Thin foil plate with letters showing and adhesive-backed.			
B 04567A	64/66; Front & Rear Switches w/Lockout .....	Each	13.74
B 04567B	65/66; Front & Rear Switches, w/Vents & Lockout .....	Each	13.74
B 04567C	66; Landau & Town Coupe, w/Power Vents .....	Each	13.74

## Dash End Plates

B 04564A	61/63; Black Vinyl .....	Pair	45.00
<b>B 04567 Console Aluminum</b>			
B 04567D	61/62 All; 63 With Manual Windows .....	Each	80.02
B 04567E	63; Power Windows .....	Each	80.02
<b>B 04814 Ash Tray Aluminum</b>			
B 04814A	61/62 .....	Each	28.05

## Glove Box Inserts

### B 06010 Glove Compartment

B 06010A	58/60 .....	Each	19.95
B 06010B	61/63; Center Console .....	Each	61.15
B 06010C	64; Center Console .....	Each	50.95
B 06010D	65/66; Center Console .....	Each	50.95
<b>BHK 251</b>	<b>Glove Box Door to Hinge, 58/60, (8 Pieces) ...</b>		<b>2.24</b>
<b>BHK 252</b>	<b>Glove Box Hinge to Dash, 58/60, (5 Pieces) ....</b>		<b>1.38</b>
<b>BHK 253</b>	<b>Glove Box, 58/60, (7 Pieces) .....</b>		<b>3.74</b>
<b>BHK 254</b>	<b>Glove Box Latch, 58/60, (4 Pieces) .....</b>		<b>1.00</b>

# DASH, CONSOLE & UNDERDASH AREA

## Glove Box Lock Plastic Bezel

B 06082A	58; Black	.....	Each	13.74
B 06082B	59/60; White	.....	Each	13.74

## Outer Dash Bezel

B 10844A	Outer Bezel For Oil & Generator	.....	Each	14.23
----------	---------------------------------	-------	------	-------

## Dash Chrome Bezels

B 10852A	60; Headlight, Clear Letters	... Each	21.18
B 10852B	60; Headlight, Green Letters	.. Each	21.18
B 10852C	60; Wiper, Clear Letters	.....	Each 21.18
B 10852D	60; Wiper, Green Letters	.....	Each 21.18
B 10852H	58/59; Lights	.....	Each 16.07
B 10852J	58/59; Wipers	.....	Each 16.07
B 10852K	58/59; Lighter	.....	Each 16.07

B 10852A



## Dash Knob Bezel

B 10853A	58/60; For Wipers, Lights & Ignition, Chrome	.....	Each	13.74
<i>*Note: For Rubber Insert See Part Number 10868 Below.</i>				
B 10853B	61/63; Headlight & Wiper Switch Bezel, Chrome	.....	Each	15.75
B 10868	<b>Rubber Insert - (Use with Dash Knob Bezel)</b>			
B 10868A	58/60; (Use With Dash Knob Bezel 10853-A)	.....	Each	1.59



B 10853A

## Ignition Switch



B 11572A

B 11572C

B 11572A	61/64	.....	24.23
B 11572B	65/66	.....	50.95
B 11572C	58/60	.....	39.73

## Ignition Switch Bezel

B 11580A	58/59; Off-On-Start, Plastic	.....	Each	19.33
B 11580C	60; Chrome With Clear Letters	....	Each	21.18
B 11580E	60; Chrome With Green Letters	..	Each	21.18



B 11580A

## Ignition Switch Cylinder & Keys



B 11582A

B 11582B

B 11582C

B 11582A	61/64	.....	13.21
B 11582B	65/66	.....	27.80
B 11582C	58/60	.....	13.90

## B 11584 Ignition Switch Bezel

B 11584A	61/63	.....	31.50
B 11584B	64; Chrome	.....	31.50
B 11584C	65/66; Chrome	.....	31.50

## B 11585 Ignition Switch Bezel Retainer Nut

B 11585A	58/60	.....	13.47
----------	-------	-------	-------

## B 11650 Headlight Switch Bezel Nut

B 11650B	58/60; Inner	.....	15.25
B 11650C	61/63; Includes Both Bushings	.....	15.25

## B 11654 Headlight Switch

B 11654A	61/63	.....	42.40
B 11654B	58/60	.....	50.95
B 11654C	65/66	.....	69.95
B 11654D	64	.....	76.45



B 11654A

## Headlamp Switch Knobs



B 11661A

B 11661B

B 11661C

## B 11661 Headlamp Switch Knob & Shaft

B 11661A	58; Black w/Silver	.....	9.95
B 11661B	59; White w/Gold	.....	10.61
B 11661C	60; White w/Silver	.....	9.55
B 11661D	61/63	.....	21.50

## Courtesy & Map Lamp Switch

B 13713A



## B 13713 Courtesy & Map Lamp Switch Assembly

B 13713A	58/66	.....	7.24
----------	-------	-------	------

## B 13761 Dash Courtesy Light Lens

B 13761A	58/63	.....	10.08
B 13761C	64/66; Mount on console	.....	Pair 10.56

## B 13786 Door Lamp Housing

B 13786B	63/64; With Red & White Lenses	.....	Each 31.78
----------	--------------------------------	-------	------------

## Dash Mats



BDM 58RD

BDM 58BK	58/60	Black	.....	Each	42.95
BDM 58DKBU	58/60	Dark Blue	.....	Each	42.95
BDM 58TN	58/60	Tan	.....	Each	42.95
BDM 61BK	61/63	Black	.....	Each	42.95
BDM 61DKBU	61/63	Dark Blue	.....	Each	42.95
BDM 61DKGN	61/63	Dark Green	.....	Each	42.95
BDM 61LTBU	61/63	Light Blue	.....	Each	42.95
BDM 64BK	64/66	Black	.....	Each	42.95
BDM 64DKBU	64/66	Dark Blue	.....	Each	42.95
BDM 64DKGN	64/66	Dark Green	.....	Each	42.95
BDM 64LTBU	64/66	Light Blue	.....	Each	42.95
BDM 64RD	64/66	Dark Red	.....	Each	42.95
BDM 64TN	64/66	Tan	.....	Each	42.95

## Interior Pillar Lamp



B 13776A



B 13776B

B 13776A	61/63;		
	Roof Courtesy Lamp	.....	Each 33.61
B 13776B	64/66	.....	Each 43.81

## B 14289 Dash to Engine Gauge Feed

B 14289A	58/59; Non A/C	.....	Each	91.75
B 14289B	58/59; With A/C	.....	Each	142.75
B 14289C	60; With A/C	.....	Each	139.95

## B 14290 Dash to Headlamp Junction

B 14290B	59	.....	Each	165.00
B 14290C	60	.....	Each	165.00

# DASH, CONSOLE & UNDERDASH AREA

<b>B 14401 Underdash Wire Loom</b>		
B 14401A 58	Each	530.00
B 14401B 59	Each	530.00
B 14401C 60	Each	530.00

<b>B 14528 Window Switch Housing</b>		
B 14528C 61/62; LH Door	Each	53.01
B 14528D 63; Console	Each	16.93
B 14528E 64/66; Console 5 Hole	Each	42.40
B 14528F 66; Lockout Cover Plate	Each	13.74
B 14528G 64/66; Quarter Window	Each	19.05

<b>B 14528 Power Window Switch Assembly Kit</b>		
B 14528DK 64/66; 5 Switch Style	Set	224.35
B 14528EK 66; 4 Switch Style For Landaus & Coupes	Set	224.35
B 14528FK 65/66; 7 Switch Style	Set	305.95

Note: These switch and housing assemblies are complete and ready to install.

<b>B 14540 Power Window Lockout Switch</b>		
B 14540A 61/62; Chrome	Each	46.48
B 14540B 64/66; Chrome	Each	46.48
<b>B 15050 Cigar Lighter Knob</b>		
B 15050A 58	Each	5.30
B 15050B 59	Each	6.36
B 15050C 60	Each	5.30



B 14540B

<b>B 15051 Cigar Lighter Shaft</b>		
B 15051A 58/59	Each	2.19
B 15051B 60	Each	2.19
<b>B 15052 Cigar Lighter Knob &amp; Element Assembly</b>		
B 15052B 60; Chrome With Clear Letters	Each	34.97
B 15052C 60; Chrome With Green Letters	Each	34.97
<b>B 15053 Cigar Lighter Bezel</b>		
B 15053C 60; Chrome With Clear Letters	Each	21.18
B 15053D 60; Chrome With Green Letters	Each	21.18
<b>B 15054 Cigar Lighter Element Assembly</b>		
B 15054B 58/66		13.52



B 15052C

<b>B 15056 Cigar Lighter Washer</b>		
B 15056A 60; Chrome	Each	2.55
B 15674A 60; Convert. Top Switch Handle, Chrome Finish	Each	19.64
<b>B 15059 Cigar Lighter Bezel</b>		
B 15059A 60; Outer Chrome Bezel	Each	21.18
<b>B 15668 Convertible Top Control Switch</b>		
B 15668B 61/62	Each	39.95
B 15668D 64/66	Each	71.35

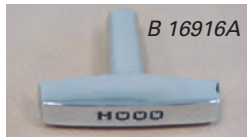

B 16916A

## Hood Pull Handle

<b>B 16916 Hood Pull Handle</b>		
B 16916A 58/60		17.51
B 16916B 61/62; Includes Cable		50.95

<b>B 17512 Wiper Inner Bezel Nut</b>		
B 17512A 58/60		15.25
B 17512B 61/63		15.25

## Windshield Wiper Knobs

B 17513A 58; Black w/Silver	Each	9.55
B 17513B 59; White w/Gold	Each	10.61
B 17513C 60; White w/Silver	Each	9.55
B 17513D 61/63	Each	20.35



B 17513A

## Windshield Wiper Switch Assembly

B 17625D 64/65	Each	23.41
----------------	------	-------

<b>B 18513 Heater Blower Switch Knob</b>		
B 18513A 58; Black	Each	5.30
B 18513B 59/60; White	Each	6.36

<b>B 18518 Heater Temperature Control Cable Assembly</b>		
B 18518B 58; Heater Temp Control Cable		22.90
B 18518C 59/60; Heater Temp Control Cable		22.70

## Heater Control Knobs

B 18519A 58; Black	Each	5.46
B 18519B 59/60; White	Each	6.36



B 18556A

<b>B 18556 Fresh Air Inlet Seal</b>		
B 18556A 61/66		47.43

<b>B 18556 Windshield Defroster Hose</b>		
B 18556C 61/66; 2 1/2" I.D. x 36" Long- Cut To Length; RH Or LH		18.68

## Radio Knobs



B 18805A

B 18805B

B 18805C

<b>B 18805 Radio Knob</b>		
B 18805A 58; Black w/Silver	Each	5.36
B 18805B 59; White w/Gold	Each	6.38
B 18805C 60; White w/Silver	Each	5.36

## Dash, Console, Underdash Attaching Hardware

BHK 200	Air Conditioning Vent In Console, 61/63 (3 Pieces).....	1.74
BHK 201	Console Trim - Upper, 61/63, 2 Sides (9 Pieces).....	4.62
BHK 202	Console Side Pieces, 61/63, 2 Sides (10 Pieces).....	3.30
BHK 203	Ash Tray, 61/63, (4 Pieces).....	2.06
BHK 204	Ash Tray Cover Handle, 61/63, (2 Pieces).....	1.74
BHK 205	Console Trim & Dash Trim - Lower, 61/63, 2 Sides (24 Pcs)	6.36
BHK 206	A/C Dial Housing, 58/60, (10 Pieces).....	4.00
BHK 207	A/C Dial Lower Plate, 58/60, (2 Pieces).....	.74
BHK 208	Ash Tray, Front, 58/60, (2 Pieces).....	.82
BHK 209	Ash Tray, Rear, 58/60, (2 Pieces).....	.82
BHK 210	Console Window Switch Retainer, 64/66, (8 Pieces) ..	2.56
BHK 211	Console Lower Moulding, 64/66, 2 Sides (10 Pieces)	3.50
BHK 212	Glove Box, 64/66, (5 Pieces).....	1.81
BHK 213	Casting Around Glove Box, 64/66 (4 Pieces).....	2.24
BHK 214	Lid Check Strap, 64/66, (2 Pieces).....	1.74
BHK 215	Catch, 64/66, (2 Pieces).....	1.74
BHK 216	Console Cigar Lighter & Ash Tray Case, 64/66 (10 Pieces)	2.38
BHK 217	Lid Hinge, 64/66 (8 Pieces).....	2.56
BHK 218	Latch, 64/66 (8 Pieces).....	1.94
BHK 219	Rear Console Ash Tray Retainer, 64/66, (3 Pieces).....	1.74
BHK 220	Console, 58/60, (8 Pieces).....	2.88
BHK 221	Console Trim—Lower, 58/60, (12 Pieces).....	2.62
BHK 222	Console Trim—Top, 58/60, (9 Pieces).....	2.74
BHK 223	Console & Trim—Upper and Lower, 58/60, (29 Pieces)	7.62
BHK 224	Radio Speaker, 58/60, (4 Pieces).....	1.12
BHK 230	Front Air Vent Brackets, 61/63, 2 Sides (6 Pieces).....	4.12
BHK 231	Kick Panels, 58/60, (2 Sides), (4 Pieces).....	1.81
BHK 232	Kick Panels, 61/63, 2 Sides, (8 Pieces).....	3.37
BHK 233	Kick Panels, 64/66, 2 Sides, (6 Pieces).....	2.88
BHK 251	Glove Box Door to Hinge, 58/60, (8 Pieces).....	2.24
BHK 252	Glove Box Hinge to Dash, 58/60, (5 Pieces).....	1.38
BHK 253	Glove Box, 58/60, (7 Pieces).....	3.74
BHK 254	Glove Box Latch, 58/60, (4 Pieces).....	1.00
BHK 256	Glove Box Stop Arm, 58/60, (8 Pieces).....	1.32
BHK 261	Steering Wheel Side Boot, 61/63, (4 Pieces).....	1.74
BHK 263	Dash End Caps, 61/63, 2 Sides (8 Pieces).....	2.81
BHK 269	Radio Bracket to Dash, 58/60, (2 Pieces).....	.74
BHK 270	Radio Speaker Grille, 64/66, (2 Pieces).....	1.74
BHK 273	Lower Dash Trim—Left Hand, 64/66, (3 Pieces).....	1.74
BHK 274	Lower Dash Trim—Right Hand, 64/66, (3 Pieces).....	1.74
BHK 275	Under Dash Panel, 58/60, (12 Pieces).....	5.24
BHK 276	Under Dash Panel Moulding—Lower, 58/60, (16 Pieces)	12.48
BHK 277	Under Dash Panel Moulding—Upper, 58/60, (4 Pieces)	1.56
BHK 278	Under Dash Panel & Moulding, 58/60, (32 Pieces).....	18.73
BHK 279	Inside Panel in Front of Door, 58/60, (4 Pieces).....	1.62
BSP 359422	Bumper, Glove Box Door - 58/60.....	Pair 2.12

# GENERATOR & ALTERNATOR

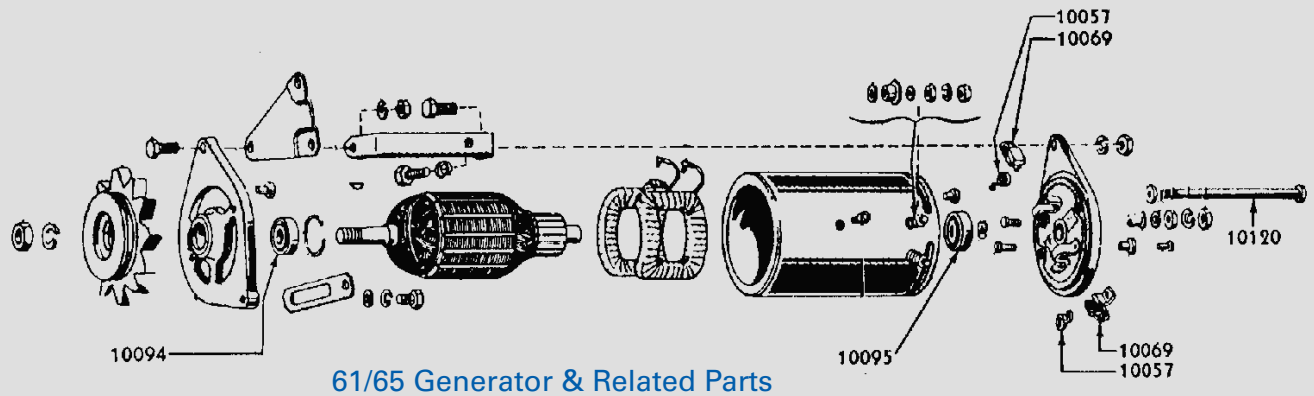

B 8652B Alternator Spacer WO/AC, Cut to Fit ..... 6.89

*See Belt Pricing Page 41*

**B 10002 Rebuilt Generator**  
 B 10002A\* 61; Ford, Without Air Conditioning;  
 (352 Engine)..... 152.95



B 10002B

B 10002B\* 58/62; With Air Conditioning;  
 (Except 430 Engine)..... 152.95  
 \*Core Charge On All Generators ..... 100.00

**B 10057 Generator Brush Spring**  
 B 10057A 58/61 ..... Each 3.46

**B 10069 Generator Brush Set**  
 B 10069A 58/61 ..... 13.21

**B 10094 Generator Or Alternator Bearing**  
 B 10094A 58/64; Front Plate  
 63/66; Alternator, Front ..... 16.95

**B 10095 Generator Rear Bearing**  
 B 10095B 58/64 ..... 11.50

**B 10170 Splash Shield - Generator**  
 B 10170A 61/62; Rubber ..... 23.41



B 10316A

**B 10316 Alternator Voltage Regulator**  
 B 10316A 63/66; Black Replacement Type ..... 27.49

## Alternator



B 10346A

**B 10346 Alternator Rebuilt**  
 B 10346A 63/64 ..... 86.60  
 B 10346B 65/66 ..... 81.55

**Alternator Conversion Kit**  
 B 10346AK 58/60 ..... 203.95  
*This kit includes the lower mount bracket, spacers, electr plug and the lower mount bracket bolt. This kit is by far the easiest generator to alternator conversion kit to install. Just follow the included installation instructions.*

**Alternator New**  
 B 10346N 58/66; Alternator ..... 201.96

## Generator Voltage Regulator



B 10505B

B 10505A 62/64; 15 Volt—30 Amp;  
 Replacement Type Only ..... 84.95  
 B 10505B 58/61; 15 Volt—30 Amp;  
 Replacement Type Only ..... 74.95

## Generator & Alternator Attaching Hardware

BHK 490 Voltage Regulator, 58/60, (3 Pieces) ..... 1.50  
 BHK 506 Generator to Bracket, 58/60, (9 Pieces) ..... 4.74  
 BHK 507 Generator Bracket to Body, 58/60, (3 Pieces) ..... 1.94

# BATTERY

## Battery Tray & Related Parts

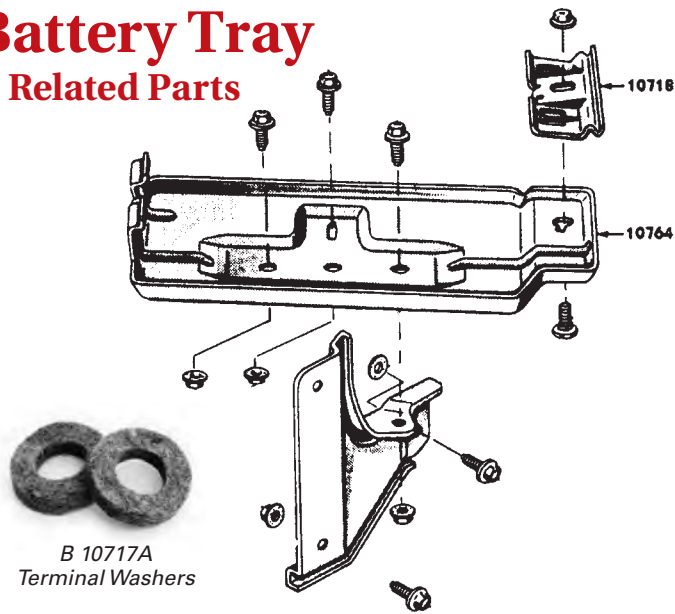

- B 10717 Battery Terminal Corrosion Arrester Washer**  
 B 10717A 58/66; Oil Impregnated Felt; 11/16" I.D.) . . . . . Pair 3.16

## Battery Hold-Down Clamp Kits

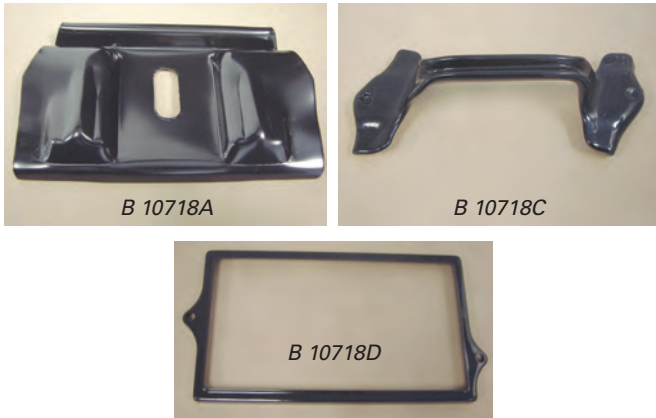

- B 10718A 61/64 ..... 4.19  
 B 10718C 66; (After 12/1/65) ..... 6.63  
 B 10718D 58/60; Like OEM ..... 31.78

## Battery Bolt Clamp



- B 10756 Battery Clamp Bolt**  
 B 10756A 58/60 & 65/66 ..... Each 2.25



- B 10757 Battery Shield**  
 B 10757A 58/59 ..... 41.57

## Battery Tray



B 10764A

- B 10764 Battery Tray**  
 B 10764A 61/66; (Before 12/1/65) ..... 38.95  
 B 10764C 58/60 ..... 50.95  
 BHK 487 Battery Tray, 61/63 (3 Pieces) ..... 3.68  
 BHK 488 Battery Tray, 64/65 (8 Pieces) ..... 6.18  
 BHK 489 Battery Tray, 66 (6 Pieces) ..... 5.06

- B 14300 Battery to Starter Relay Cable Assembly**  
 B 14300D 58/60; 13" Long ..... 15.25  
 B 14300H 65/66; Battery To Ground ..... 21.75



## Larry's Original Style Battery Cable Sets

Larry's Original-Style Battery Cable Sets are manufactured from the same materials that Ford originally used to produce the factory cable sets. Each reproduction set features correct Ink-Stamped Part Numbers, Terminals, Boots, Heads & Mouldings. Wire insulation is manufactured from original-type neoprene rubber for heat resistance. Our battery cable sets include Positive (+), Negative (-) and Starter Cables. Our Cable Sets are The Finest Available for your Thunderbird!

- B 14301AK 58 ..... 69.95  
 B 14301BK 59/60 ..... 69.95  
 B 14301CK 61 ..... 69.95  
 B 14301DK 62 ..... 69.95  
 B 14301EK 63 ..... 69.95  
 B 14301FK 64/65 ..... 69.95  
 B 14301GK 66 ..... 69.95

- B 14302 Starter Cable Grommet**  
 B 14302B 58/60 ..... Each 4.21

## Starter Cable Brackets



- B 14304D 58/60; Small, 1/4" Bolt Hole ..... 5.15  
 B 14304E 58/60; Large, 7/8" Bolt Hole ..... 5.15

## Battery Attaching Hardware

- BHK 487 Battery Tray, 61/63 (3 Pieces) ..... 3.68  
 BHK 488 Battery Tray, 64/65 (8 Pieces) ..... 6.18  
 BHK 489 Battery Tray, 66 (6 Pieces) ..... 5.06  
 BSP 700045 Battery Hold-Down Grommet  
 58/60 ..... Each .79

# STARTER

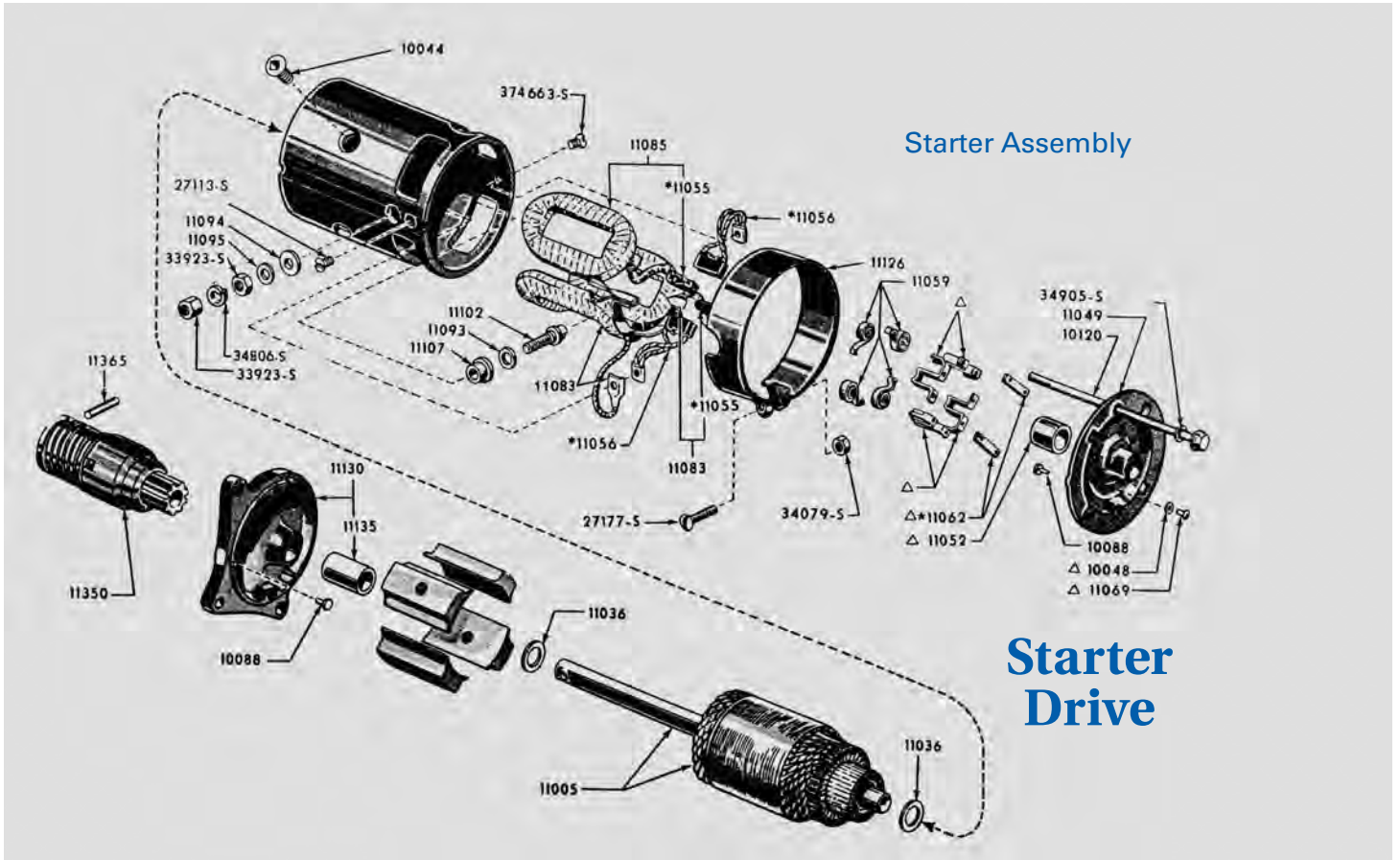

## Rebuilt Starters

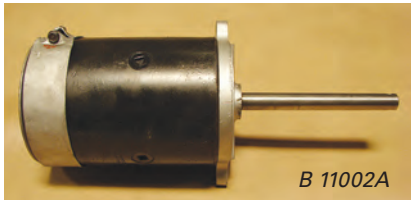

B 11002A	58/61	147.90
	Core Charge	75.00
B 11002B	62/64	169.95
	Core Charge	75.00
B 11002C	65/66	145.00
	Core Charge	75.00

## Starters

B 11002D	58/62; "New"	183.55
B 11002E	65/66; 360 CBI "New"	173.35

### B 11057 Starter Motor Brush Set

B 11057A	61/64	12.50
B 11057B	58/60 & 65/66	8.50



B 11350A

### B 11350 Drive Starter

B 11350A	58/61	61.15
B 11350C	62/64	96.85

### B 11450 Starter Relay Solenoid Assembly

B 11450A	58/66	13.01
----------	-------	-------

## Starter Cable Brackets



B 14304D      B 14304E

B 14304D	58/60; Small, 1/4" Bolt Hole	5.15
B 14304E	58/60; Large, 7/8" Bolt Hole	5.15

## Starter Attaching Hardware

BHK 491	Starter Solenoid, 58/60, (2 Pieces)	1.12
BHK 494	Starter Cable Brackets, 58/60, (2 Pieces)	1.06



Your Number One Source for  
T-Bird Restoration Parts!

## Ignition Switch & Related Parts

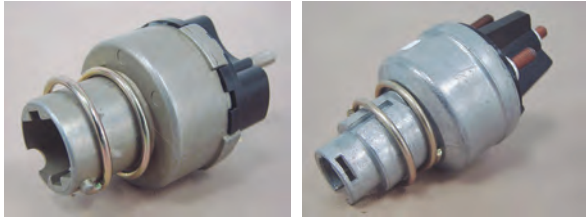

B 11572A

B 11572C

B 11572A	61/64	.....	24.23
B 11572B	65/66	.....	50.95
B 11572C	58/60	.....	39.73



B 11582A

B 11582B

B 11582C

<b>B 11582</b>	<b>Ignition Switch Cylinder &amp; Key</b>		
B 11582A	61/64	.....	13.21
B 11582B	65/66	.....	27.80
B 11582C	58/60	.....	13.90

<b>B 11584</b>	<b>Ignition Switch Bezel</b>		
B 11584A	61/63	.....	31.50
B 11584B	64; Chrome	.....	31.50
B 11584C	65/66; Chrome	.....	31.50

<b>B 11585</b>	<b>Ignition Switch Bezel Retainer Nut</b>		
B 11585A	58/60	.....	13.74

## HiPo Ignition Coil



B 12029A



T 12029B



B 12029C

## Pertronix "Flame Thrower"

Maximizes energy and reliability over the full RPM range, delivering 15% more spark energy and voltage. Enables larger plug gaps for greater fuel efficiency, more power. Legal in all 50 states (CARB E.O. D57-3).

B 12029A	58/66; Black	.....	40.75
B 12029B	58/66; 12V. Yellow Top Coil	.....	30.55
B 12029C	58/66; Chrome	.....	40.75

## Ignition Switch Bezel



B 11580A

B 11580A	58/59; Off-On-Start, Plastic	..... Each	19.33
B 11580C	60; Chrome With Clear Letters	..... Each	21.18
B 11580E	60; Chrome With Green Letters	..... Each	21.18

## Pertronix Solid-State Electronic Ignition System



Increase your Thunderbird's performance! Pertronix Ignition Kits increase horsepower and improve fuel economy. Fits entirely in distributor. Tests have shown the ignitor delivers twice the voltage to the spark plugs.



<b>B 12000BK</b>			
B 12000BK	58/66	.....	86.70

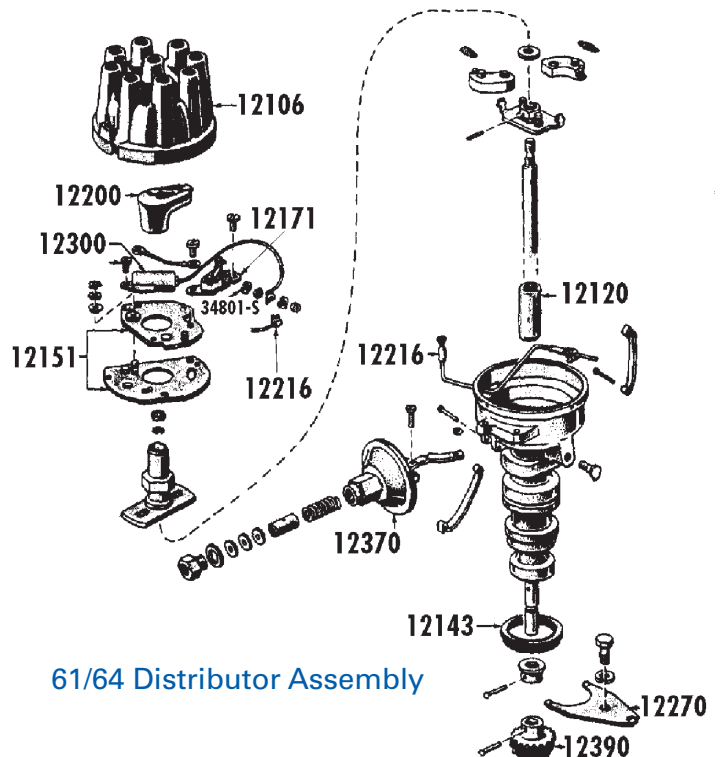

61/64 Distributor Assembly

# IGNITION & DISTRIBUTOR

## Rebuilt Distributor

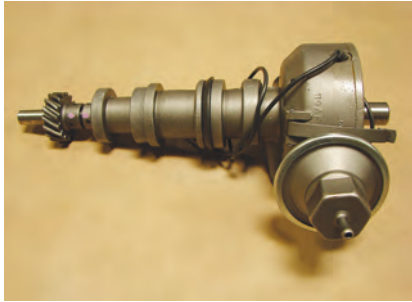

B 12127	Rebuilt Distributor	
B 12127A	58/66 .....	193.75
	Core Charge .....	75.00

## New Distributor

B 12127N	58/66; All, Except 430 "New" .....	Each	245.00
----------	------------------------------------	------	--------

## Distributor Rebuilt Parts



B 12171A



B 12106A



B 12200A

<b>B 12106</b>	<b>Distributor Cap</b>	
B 12106A	58/66; 8 Cylinder .....	16.95

<b>B 12171</b>	<b>Distributor Points</b>	
B 12171A	58/66 .....	7.89

<b>B 12200</b>	<b>Distributor Rotor</b>	
B 12200A	58/66 .....	5.95

## Pertronix Plug Wires



B 12259A



B 12259D

<b>B 12259A</b>	<b>58/66; 7.0mm "Stock Look"</b>	
	custom wires .....	Set 56.05

<b>B 12259D</b>	<b>58/66; (Except 430 Engine)</b> .....	Set 50.95
-----------------	---	-----------

## Plug Wire Separators



B 12297A



B 12297B

<b>B 12297</b>	<b>Ignition Wire Separator</b>	
B 12297A	58/66; Comb Shape, 8 Prongs, .09" Thick .....	.52

B 12297B	58/66; Comb Shape, On Valve Cover, 2.18" Long .....	3.07
----------	---	------

<b>B 12405</b>	<b>Spark Plug</b>	
B 12405A	58/66; Motorcraft .....	Each 3.78

<b>B 12300</b>	<b>Distributor Condenser Assembly</b>	
B 12300C	58/66 (Except transistorized ignition) .....	7.95

<b>B 12371</b>	<b>Distributor Vacuum Line</b>	
B 12371A	58/61 .....	27.54
B 12371B	62/63 .....	27.54
B 12371C	64/66 .....	27.54

## Door & Ignition Lock Cylinder & Key Set



B 22050A

<b>B 22050</b>	<b>Door &amp; Ignition Lock Cylinder &amp; Key Set</b>	
B 22050A	61/64; (Less Lever) .....	51.97
B 22050B	65/66; .....	57.17
B 22050C	58/60 .....	81.55



B 22051CK

<b>B 22051</b>	<b>Key Blank Set - Door &amp; Trunk Locks</b>	
B 22051CK	58/64; Ignition & Trunk Keys, As Original ...	Per Set 3.75

## Ignition & Distributor Attaching Hardware

BHK 490	Voltage Regulator, 58/60, (3 Pieces) .....	1.50
BHK 491	Starter Solenoid, 58/60, (2 Pieces) .....	1.12



# EXTERIOR LIGHTS

## Headlamp & Related Parts

B 10853B



<b>B 10853</b>	<b>Chrome Headlight &amp; Wiper Bezel</b>		
B 10853B	61/63; Headlight & Wiper Switch Bezel, Chrome	Each	15.75

## Headlight Switch Bezel Nut

<b>B 11650</b>	<b>Headlight Switch Bezel Nut</b>		
B 11650B	58/60; Inner	Each	15.25
B 11650C	61/63; Includes Both Bushings	Each	15.25

### 58/60 Headlamp Assembly

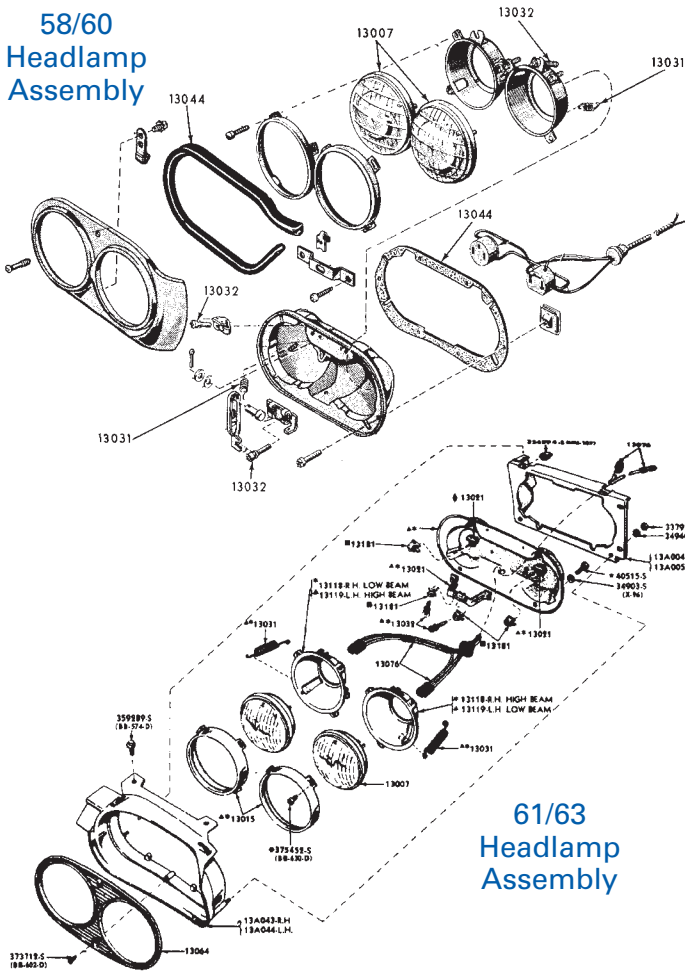

### 61/63 Headlamp Assembly

## Headlamp Switch Knobs



<b>B 11661</b>	<b>Headlamp Switch Knob &amp; Shaft</b>		
B 11661A	58; Black w/Silver	.....	9.55
B 11661B	59; White w/Gold	.....	10.61
B 11661C	60; White w/Silver	.....	9.55
B 11661D	61/63	.....	21.50
<b>B 11654</b>	<b>Headlight Switch</b>		
B 11654A	61/63	.....	42.40
B 11654B	58/60	.....	50.95
B 11654C	65/66	.....	69.95
B 11654D	64	.....	76.45

B 13007A



B 13024A



<b>B 13007</b>	<b>Headlamp Bulb</b>		
B 13007A	58/66; Low Beam, With FoMoCo Script	.....	19.89
B 13007B	61/66; High Beam, With FoMoCo Script	.....	18.31
<b>B 13024</b>	<b>Headlamp Dimmer Switch</b>		
B 13024A	61/66	.....	15.04
B 13024B	58/60	.....	35.65
<b>B 13031</b>	<b>Headlamp Ring Spring</b>		
B 13031A	61/63	.....	2.03
<b>B 13032</b>	<b>Headlamp Adjusting Screw</b>		
B 13032A	58/60; Adjusting Screw	.....	1.01
B 13032B	66; Screw & Nut Assembly	.....	3.03
<b>B 13044</b>	<b>Headlamp Bucket Gasket</b>		
B 13044A	58/60; Inner Gasket	.....	3.45
B 13044B	58/60; Outer Gasket	.....	9.02

## Headlamp Door

B 13064A



<b>B 13064</b>	<b>Headlamp Door</b>		
B 13064A	61/63	.....	41.57
B 13064B	64/65; RH	.....	91.21
B 13064C	64/65; LH	.....	91.21
BHK 344	Headlight Doors, 61/63, 2 Sides (4 Pieces)....	Each	2.00

## Lamp Gasket Kits

Your best pricing on replacement gaskets for exterior lamps!



B 13000AK

<b>B 13000AK</b>	58/59; Includes the following Gaskets: Headlamp Buckets, Signal Lamps & Tail Lamps	Set	29.08
<b>B 13000BK</b>	60; Includes the following Gaskets: Headlamp Buckets, Signal Lamps & Tail Lamps	Set	31.16

<b>B 13000CK</b>	61; Includes the following Gaskets: Signal Lamps, Tail Lamps & Back-Up Lamps	Set	13.47
<b>B 13000DK</b>	62/63; Includes the following Gaskets: Signal Lamps, Tail Lamps & Back-Up Lamps	Set	24.92
<b>B 13000EK</b>	64/65; Includes the following Gaskets: Signal Lamps, Tail Lamps, Back-Up Lamps & Rear License Plate Lamp	Set	20.76
<b>B 13000FK</b>	66; Includes The Following Gaskets: Signal Lamps, Tail Lamps (For All 3 Lenses), Back-Up Lamps & Rear License Plate Lamp	Set	25.96

# EXTERIOR LIGHTS

<b>B 13076</b>	<b>Headlamp Wire &amp; Socket</b>		
B 13076A	58; Includes grommet .....	Each	30.55
B 13076B	59; Includes grommet .....	Each	30.55
B 13076C	60/63; Includes grommet .....	Each	30.55
<b>B 13181</b>	<b>Headlamp Adjusting Nut</b>		
B 13181A	62/63; Nylon Only .....	Each	2.81
<b>B 14290</b>	<b>Dash to Headlamp Junction</b>		
B 14290B	59 .....	Each	165.00
B 14290C	60 .....	Each	165.00
B 14290A	62 .....	Each	275.35

## 58/59 Parking Lamp Assembly

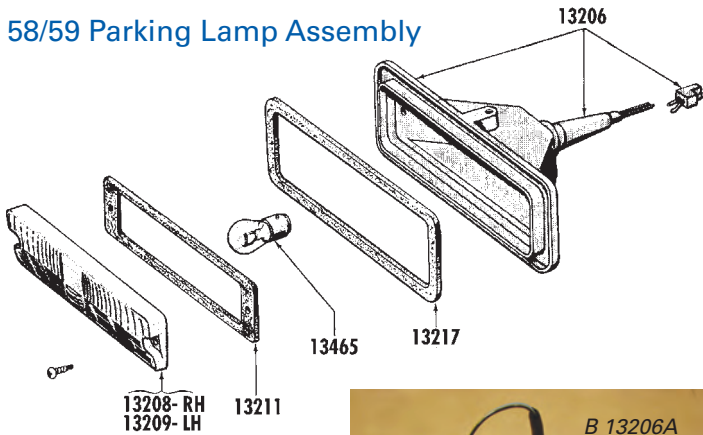

## Parking Lamp Body

<b>B 13206</b>	<b>Parking Lamp</b>		
B 13206A	58/60; Body, With Correct Wiring Pigtail .....	Each	63.62

## Parking Lamp Lens

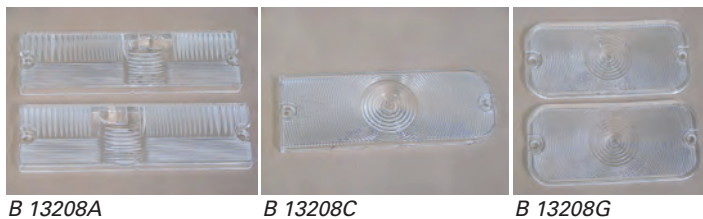

<b>B 13208</b>	<b>Parking Lamp Lens</b>		
B 13208A	58/60; Clear, RH & LH .....	Pair	13.77
B 13208C	61/63; Clear .....	Each	8.01
B 13208G	64/65 .....	Pair	13.21
B 13208H	66; RH .....	Each	31.78
B 13208I	66; LH .....	Each	31.78
B 13208J	63; Amber .....	Each	8.11
<b>B 13211</b>	<b>Parking Lamp Lens Gasket</b>		
B 13211A	58/60 .....	Each	1.66
B 13211B	61/63 .....	Each	3.00
B 13211C	64/65 .....	Each	3.00
B 13211D	66 .....	Each	3.00
<b>B 13217</b>	<b>Parking Lamp Body to Fender Pad</b>		
B 13217A	58/60 .....	Each	1.85

## Turn Signal Flasher (Under Dash)



<b>B 13350A</b>	65/66; Emergency Warning .....	5.00
<b>B 13350B</b>	63/64; Standard Turn Signal .....	6.14
<b>B 13350C</b>	58/62; #223 .....	5.15

## Fender Mounted Turn Signal Lamps



<b>B 13355A</b>	64/65 .....	Pair	86.65
<b>B 13355B</b>	66 .....	Pair	86.65

## Emergency Flasher Switch



<b>B 13530</b>	<b>Emergency Flasher Switch</b>		
B 13530A	66; 2 Wire, Fits in the Roof Console .....	Each	40.75

## Turn Signal Sequencer Assembly

This Electronic Sequential Unit Replaces All Of The Original Mechanical Parts. Includes Flasher & Motor, Directional Relay And Stop Lamp Relay. Plugs In With No Modifications Required!



<b>B 13367B</b>	65/66; (Before 11/18/65) .....	235.00
<b>B 13367C</b>	66; (After 11/18/65) .....	235.00

## 1958 Rear/Backup Lamp Assembly

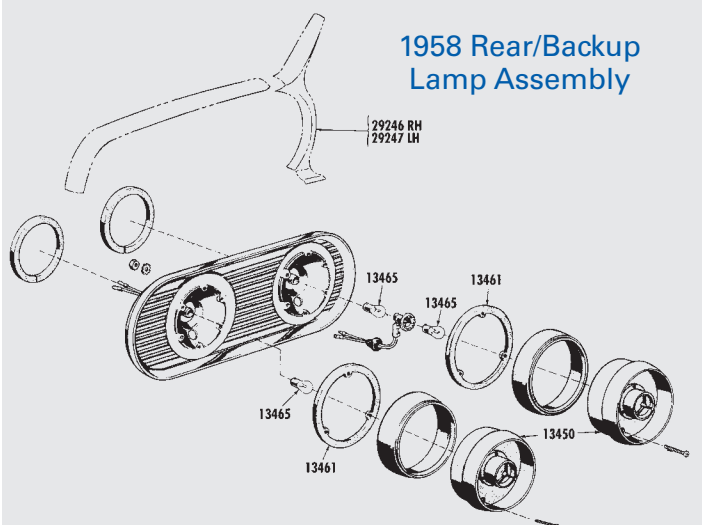

# EXTERIOR LIGHTS

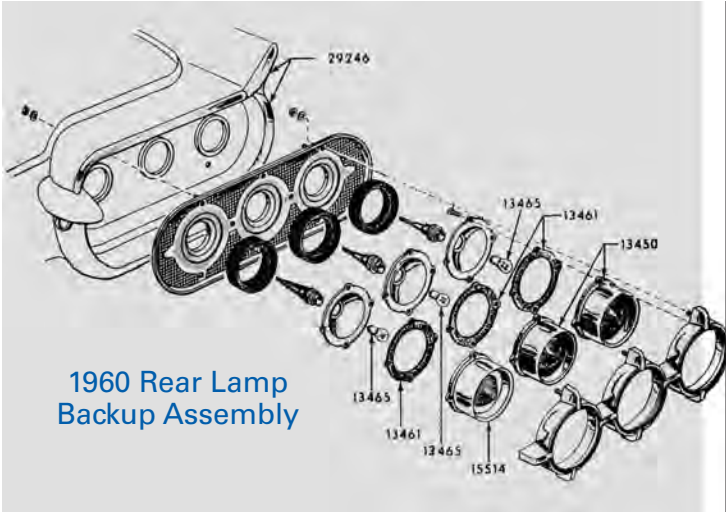

1960 Rear Lamp Backup Assembly

## Rear Tail Lamp Lenses



B 13450A

(does not include chrome center bezel)

B 13450B



B 13450C



B 13450D



## Parking Lamp Socket



B 13410A

### B 13410 Parking Lamp Socket

B 13410A 58/60; With Correct Wiring Pigtail ..... Each 33.61



B 13450F



B 13450H

## Rear Lamp Mounting Pad

B 13420A 62/63; White color like original ..... Each 6.19  
 B 13420C 60; 6 required per car ..... Each 8.44

### B 13450 Rear Tail Lamp Lens

B 13450A	62/63	.....	Each	43.81
B 13450B	64	.....	Each	66.59
B 13450C	65	.....	Each	4.07
B 13450D	66; Outer Lens	.....	Each	65.55
B 13450E	66; Center Lens	.....	Each	71.35
B 13450F	60; Red	.....	Each	25.45
B 13450G	58/59	.....	Each	40.75
B 13450H	61	.....	Each	34.95
BHK 368	Tail Light Body, 64/66, 2 Sides (12 Pieces)	.....		5.62
BHK 369	Tail Light Lens, 64/66, 2 Sides (8 Pieces)	.....		2.24

## Tail Light Housing



B 13434A



B 13434B

### B 13434 Tail Light Housing

B 13434A 61; (Reflection Pan) ..... Each 69.99  
 B 13434B 62/63; (Reflection Pan) ..... Each 94.50

### B 13435 Trailer Lighting Relay Assembly

B 13435A 65/66 ..... 30.55

### B 13489 Tail Lamp Lens Bezel

B 13489E '65 ..... Each 91.75

## Rear Tail Lamp Mounting Gasket

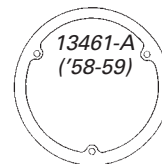

13461-A ('58-'59)

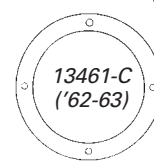

13461-C ('62-'63)

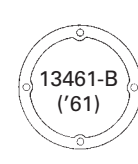

13461-B ('61)

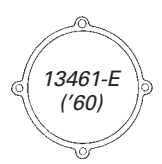

13461-E ('60)

B 13461A	58/59	.....	Each	3.00
B 13461B	61	.....	Each	3.00
B 13461C	62/63	.....	Each	3.00
B 13461D	64/65	.....	Each	4.11
B 13461E	60	.....	Each	3.00
B 13461F	66; Outer	.....	Each	4.43
B 13461G	66; Center Lens	.....	Each	4.43

# EXTERIOR LIGHTS

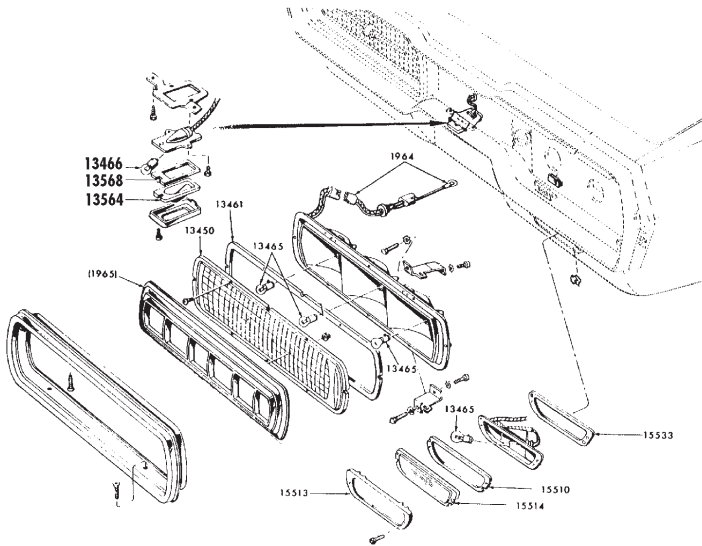

1965 Rear Lamp/Backup Lamp

## Stop Lamp Switch



B 13480A

B 13480	Stop Lamp Switch Assembly	
B 13480A	58/64	10.50
B 13480B	65/66	37.94
B 13480	Tail Lamp Bucket Retainer	
B 13480D	61	26.75
B 13480E	62/63	26.75
B 13482	Turn Signal Relay	
B 13482A	(Late) 65/66; Mounts on sequential pack in trunk...	66.25

## Rear Tail Lamp Lens Bezel



B 13489B



B 13489D



B 13489E

B 13489B	63	Each	50.95
B 13489C	58/59	Each	29.95
B 13489D	62	Each	10.56
B 13489E	65	Each	91.75
BSP 37285663; Screw For Tail Lamp Bezel;			
	(4) Required	Each	.99

<b>B 13564</b>	<b>Rear License Plate Lamp Lens</b>	
B 13564A	64/66	9.07
BHK 377	Rear License Plate Light, 64/66, (2 Pieces)	1.74
<b>B 13568</b>	<b>Rear License Plate Lamp Lens Gasket</b>	
B 13568A	64/66	1.10



B 13616B

<b>B 13616</b>	<b>Center Tail Lamp Lens Emblem</b>		
B 13616B	66	Each	48.77
<b>B 14405</b>	<b>Tail Light Loom</b>		
B 14405A	58/60; Hard Top, Includes turn signal wires ..	Each	175.00
<b>B 14512</b>	<b>Convertible Top &amp; Stop Lamp Relay</b>		
B 14512A	63/66; Convertible Top		
	64; Stop Lamp		53.01
<b>B 15510</b>	<b>Back-Up Lamp Lens Gasket</b>		
B 15510A	64/65	Each	3.00
B 15510B	61/63	Each	3.00

## Backup Lamp Bezel

<b>B15513</b>	<b>Back-Up Lamp Bezel</b>		
B 15513B	64/65	Each	23.30

## Backup Lamp Lenses



B 15514C

<b>B 15514</b>	<b>Back-Up Lamp Lens</b>		
B 15514A	61/63	Each	9.13
B 15514B	64/65; (From 1/6/64)	Each	21.18
B 15514C	60; Red With White Center	Each	34.76
BHK 374	Back-Up Light Body & Lens, 64/66, 2 Sides (8 Pieces)		2.81
<b>B 15533</b>	<b>Back-Up Lamp to Body Pad</b>		
B 15533B	64/66	Each	2.08

## Exterior Lights Area Attaching Hardware

BHK 337	Headlight Door, 58/60, (4 Pieces)	1.38	
BHK 338	Headlight Bulb Ring, 58/60, (12 Pieces)	3.24	
BHK 339	Headlight Bucket, 58/60, (12 Pieces)	3.24	
BHK 340	Headlight Bucket, 61/63, 2 Sides (4 Pieces)	3.62	
BHK 341	Headlight Bucket, 64/65, 2 Sides (16 Pieces)	5.43	
BHK 342	Headlight Bucket, 1966, 2 Sides (18 Pieces)	9.86	
BHK 344	Headlight Doors, 61/63, 2 Sides (14 Pieces)	2.00	
BHK 345	Headlight Chrome Door, 64/65, 2 Sides (12 Pieces) ..	4.80	
BHK 346	Headlight Retainer Ring, 64/65, 2 Sides (6 Pieces) ....	1.74	
BHK 347	Headlight Door, 1966, 2 Sides (8 Pieces)	5.80	
BHK 352	Parking Light, 58/60, (12 Pieces)	3.24	
BHK 353	Parking Light Body, 61/63, 2 Sides (4 Pieces)	1.74	
BHK 354	Parking Light Body, 64/66, 2 Sides (4 Pieces)	2.24	
BHK 355	Parking Light Lens, 58/60, (4 Pieces)	1.18	
BHK 356	Parking Light Lens, 61/63, 2 Sides (4 Pieces)	1.74	
BHK 358	Parking Light Lens, 1966, 2 Sides, (8 Pieces)	2.24	
BHK 368	Tail Light Body, 64/66, 2 Sides (12 Pieces).....	5.62	
BHK 369	Tail Light Lens, 64/66, 2 Sides (8 Pieces)	2.24	
BHK 371	Headlamp Adjusting Kit 61/63 (1 Side Only)	22.91	
BHK 374	Back-Up Light Body & Lens, 64/66, 2 Sides (8 Pieces)	2.81	
BHK 377	Rear License Plate Light, 64/66, (2 Pieces)	1.74	
BHK 426	Tail Lamp Door, 58/60	2.68	
BHK 427	Tail Lamp Bezel, 58/60	5.12	
BSP 354899	Screw - Stainless; Parklight Lens, 58/60	Each	1.01
BSP 358898	Screw - Stainless; Tail Lamp Lens, 64/65	Each	1.01
BSP 371476	Screw - Stainless; Park Light Lens, 61/65 & Tail Light Lens, 61	Each	1.01
BSP 372856	Screw, for '63 Tail Lamp Bezel (4 Required)	Each	.99

# TURN SIGNAL & HORN

- B 3672 Horn Button Pad**  
 B 3672A 58/60 ..... Each 3.03

## Turn Signal Lever



B 13310A

- B 13305A 63/66 Large Thread End ..... 17.29  
 B 13305B 58 ..... 17.29  
 B 13305C 59 ..... 17.29  
 B 13305D 60 ..... 17.29  
 B 13305E 61/62 Small Thread End ..... 17.29

- B 13309 Turn Indicator Pawl**  
 B 13309A 58/63 ..... 7.40

- B 13318 Turn Indicator Cam**  
 B 13318A 58/60; Switch To Pawl ..... 10.92

## Turn Signal Switch



B 13341E

- B 13341 Turn Indicator Switch & Mounting Plate**  
 B 13341A 58/60 ..... 101.95  
 B 13341C 61/63 ..... 67.50  
 B 13341D 64 ..... 127.50  
 B 13341E 65/66 ..... 101.95
- B 13343 Turn Indicator Spring**  
 B 13343A 58/60; Switch To Pawl ..... 3.17

## Turn Signal Flasher (Under Dash)



- B 13350A ..... B 13350B ..... B 13350C .....
- B 13350A 65/66; Emergency Warning ..... 5.00  
 B 13350B 63/64; Standard Turn Signal ..... 6.14  
 B 13350C 58/62; #223 ..... 5.15

## Fender Mounted Turn Signal Lamps



- B 13355A 64/65 ..... Pair 86.65  
 B 13355B 66 ..... Pair 86.65

## B 13367 Turn Signal Sequencer Assembly

This Electronic Sequential Unit Replaces All Of The Original Mechanical Parts Includes Flasher & Motor, Directional Relay And Stop Lamp Relay. Plugs In With No Modifications Required!



B 13367C

- B 13367B 65/66; (Before 11/18/65) ..... 235.00  
 B 13367C 66; (After 11/18/65) ..... 235.00

- B 13482 Turn Signal Relay**  
 B 13482A (Late) 65/66; mounts on sequential pack in trunk .. 66.25

## Emergency Flasher Switch

- B 13530 Emergency Flasher Switch**  
 B 13530A 66; 2 Wire, Fits in the Roof Console ..... Each 40.75

- B 13807 Horn Ring Spring**  
 B 13807A 58/60 ..... Each 4.03

## Horn Ring Medallions



B 13809A

B 13809B

- B 13809A 58/60; Black, With Power Steering ..... 25.45  
 B 13809B 58/60; White, With Power Steering ..... 25.45

## Horn Assembly



B 13832A

- B 13821 Repair Kit Horn Brush Insulator**  
 B 13821A 64/66 ..... 8.07  
 B 13821B 61/62 ..... 14.23

- B 13832/33 Horn Assembly**  
 B 13832A 58/66; High Pitch; Ford Replacement ..... 16.58  
 B 13833A 58/66; Low Pitch; Ford Replacement ..... 16.58

- B 13853 Horn Relay & Bracket Assembly**  
 B 13853A 58/63 & 66 ..... 23.41  
 B 13853B 64 ..... 22.39



B 13583A

## Turn Signal / Horn Area Attaching Hardware

- BHK 359 Horn, 61/63, (2 Pieces) ..... 2.06  
 BHK 360 Horn, 64/65, 2 Sides (4 Pieces) ..... 4.50  
 BHK 361 Horn, 66, 2 Sides, (2 Pieces) ..... 2.50  
 BHK 495 Horn Relay, 58/60, (2 Pieces) ..... 1.06  
 BHK 501 Horns to Brackets, 58/60, (8 Pieces) ..... 1.50  
 BHK 502 Horn Brackets to Fender, 58/60, (6 Pieces) ..... 4.24

# BULBS & FUSES

## Light Bulb Chart

Description	Quantity	Model Year	Body Style	Part Number	Price Each
Oil Indicator	1	58/62	All	B 13465B	.91
	1	63 & 66	All	B 13465U	.86
	1	64/65	All	B 13465Q	1.01
Generator	1	58/62	All	B 13465B	.91
	1	63	All	B 13465U	.86
Amp Gauge	1	64/65	All	B 13465Q	1.01
	1	66	All	B 13465U	.86
Low Fuel Lamp	1	64/66	All	B 13465A	1.06
Fuel Gauge Temperature	1	58/60	All	B 13465B	.91
	2	61/62	All	B 13465B	.91
	2	63	All	B 13465U	.86
	1	64/65	All	B 13465Q	1.01
	1	66	All	B 13465U	.86
Ignition Lamp	1	58/62	All	B 13465B	.91
	1	63	All	B 13465U	.86
	1	64/65	All	B 13465A	1.06
Speedometer/Odometer	2	58/60	All	B 13465B	.91
	2	61/63	All	B 13465Q	1.01
	6	64/65	All	B 13465U	.86
	6	66	All	B 13465P	1.01
Headlamp Switch	1	58/62	All	B 13465B	.91
	1	63	All	B 13465U	.86
High Beam indicator	1	58/62	All	B 13465B	.91
	1	63/66	All	B 13465U	.86
Turn Indicator-(Interior)	2	60	All	B 13465B	.91
	2	61/62	All	B 13465Q	1.01
	2	63/66	All	B 13465U	.86
Window Wiper	1	58/62	All	B 13465B	.91
	1	63/65	All	B 13465U	.86
	1	66	All	B 13465R	.86
Seat Belt	1	64/65	All	B 13465U	.86
	1	66	All	B 13465A	1.06
Cigar Lighter	1	58/60	All	B 13465B	.91
Ashtray	1	60, 63/66	All	B 13465A	1.06
	1	61/62	All	B 13465B	.91
Glove Box	1	58/62	All	B 13465B	.91
	1	63/64	All	B 13465A	1.06
	1	66	All	B 13465H	2.95

# BULBS & FUSES

## Light Bulb Chart

Description	Quantity	Model Year	Body Style	Part Number	Price Each
Radio— (AM Only)	1	58/60	All	B 13465B	.91
	1	61/63	All	B 13465T	1.01
	1	64/66	All	B 13465R	.86
Radio— (AM/FM)	1	64/66	All	B 13465S	1.01
Clock	1	58/65	All	B 13465Q	1.01
	1	66	All	B 13465U	.86
Map Light	1	61/62	All	B 13465D	1.01
	1	63	All	B 13465H	2.95
	2	64/66	All	B 13465H	2.95
Heater Panel	1	61/62	All	B 13465B	.91
	1	63/65	All	B 13465U	.86
	1	66	All	B 13465A	1.06
Air Conditioning Panel	1	58/60	All	B 13465B	.91
	1	65	All	B 13465M	1.01
	1	66	All	B 13465R	.86
Shift Dial Lamp	1	58/65	All	B 13465A	1.06
	1	66	All	B 13465E	1.34
Courtesy Lamp—Door	2	63/65	All	B 13465J	1.48
	2	66	Calif.	B 13465H	2.95
	2	66	All (Exc. Calif.)	B 13465I	1.34
Trunk Lamp	1	60/62	All	B 13465D	1.01
	1	63/66	All	B 13465H	2.95
Tail Lamp/Stop Lamp	2	58/59	All	B 13465K	1.44
	4	60/62	All	B 13465K	1.44
	2	63	All	B 13465N	1.01
	6	64/65	All	B 13465N	1.01
	8	66	All	B 13465N	1.01
Parking Lamp Blinker	2	58/62	All	B 13465K	1.44
	2	63	All	B 13465N	1.01
	2	64/66	All	B 13465O	2.07
Parking Brake	1	61/62	All	B 13465B	.91
	1	63	All	B 13465G	1.59
	1	64/66	All	B 13465U	.86
Back-Up Lamp	2	58/63	All	B 13465L	1.39
	2	64/66	All	B 13465F	1.87
License Plate Lamp	1	58/62	All	B 13465C	1.01
	1	63/66	All	B 13465M	1.01
Interior Dome Lamp	1	58/63	Coupe	B 13465I	1.34
	1	65/66	Coupe	B 13465I	1.34
Pillar Lamp	2	64 & 66	Coupe	B 13465I	1.34
Fender Turn Signal	2	64/66	All	B 13465A	1.06





# WIRING

<b>B 14240</b>	<b>Wiring Conduit Insulator</b>		
B 14240A	58/60; .....	Per Foot	1.52
<b>B 14289</b>	<b>Dash to Engine Gauge Feed</b>		
B 14289A	58/59; Non A/C .....	Each	91.75
B 14289B	58/59; With A/C .....	Each	142.75
B 14289C	60; With A/C .....	Each	139.95
B 14289D	60; With Out A/C .....	Each	132.55
<b>B 14290</b>	<b>Dash to Headlight Junction</b>		
B 14290A	62 .....	Each	275.35
B 14290B	59 .....	Each	165.00
B 14290C	60 .....	Each	165.00
B 14300D	58/60; 13" Long .....		15.25
B 14300H	65/66; Battery To Ground .....		21.75

<b>B 14651</b>	<b>Inner Fender Apron Grommet</b>		
B 14651A	58/60 .....		3.13

## Larry's Original Style Battery Cable Sets



B 14301AK

Larry's Original-Style Battery Cable Sets are manufactured from the same materials that Ford originally used to produce the factory cable sets. Each reproduction set features correct Ink-Stamped Part Numbers, Terminals, Boots, Heads & Mouldings. Wire insulation is manufactured from original-type neoprene rubber for heat resistance. Our battery cable sets include Positive (+), Negative (-) and Starter Cables. Our Cable Sets are The Finest Available for your Thunderbird!

B 14301AK	58 .....	69.95
B 14301BK	59/60 .....	69.95
B 14301CK	61 .....	69.95
B 14301DK	62 .....	69.95
B 14301EK	63 .....	69.95
B 14301FK	64/65 .....	69.95
B 14301GK	66 .....	69.95

<b>B 14303</b>	<b>Firewall to Engine Ground Cable</b>		
B 14303B	58/62 .....		12.20
<b>B 14401</b>	<b>Underdash Wire Loom</b>		
B 14401A	58 .....	Each	530.00
B 14401B	59 .....	Each	530.00
B 14401C	60 .....	Each	530.00
<b>B 14405</b>	<b>Tail Light Loom</b>		
B 14405A	58/60; Hard Top, includes turn signal wires .....	Each	175.00
<b>B 14406</b>	<b>Low Fuel Sender Wire Harness</b>		
B 14406D	64/66; With Plug & Boot .....		41.95
<b>B 14608</b>	<b>Wiring Retainer On Firewall</b>		
B 14608B	58/60 .....		9.50

## Electrical System Manuals for "Do-It-Yourselfers"



BLT AM93

### Electrical Assembly Manuals

BLT AM93	1962; Electrical Assembly .....	15.81
BLT AM53	1964; Electrical Assembly .....	15.81
BLT AM58	1965; Electrical Assembly .....	15.81
BLT AM63	1966; Electrical Assembly .....	15.81



BLT WD63

### Wiring Diagram Manuals

BLT WD58	1958 .....	7.65
BLT WD59	1959 .....	7.65
BLT WD60	1960 .....	7.65
BLT WD61	1961 .....	7.65
BLT WD62	1962 .....	7.65
BLT WD63	1963 .....	7.65
BLT WD64	1964 .....	7.65
BLT WD65	1965 .....	7.65
BLT WD66	1966 .....	7.65

### Wiring Area Attaching Hardware

BHK 362	Engine Compartment Wire Loom— LH, 61/63 (16 Pcs.) .....	7.62
BHK 363	Engine Compartment Wire Loom, 64/66, 2 Sides (32 Pcs.) .....	12.36
BSP 376914	Plastic Wrap to Attach Wire Loom .....	Each .57

# POWER WINDOWS & SEATS

- B 04567 Console Switch Plate Insert**  
*Thin foil plate with letters showing and adhesive-backed.*
- B 04567A 64/66; Front & Rear Switches w/Lockout ..... 13.47  
 B 04567B 65/66; Front & Rear Switches  
 w/Vents & Lockout ..... 13.47  
 B 04567C 66; Landau & Town Coupe, w/Power Vents..... 13.47

## Console Aluminum

- B 04567D 61/62 All; 63 With  
 Manual Windows ..... Each 80.02  
 B 04567E 63; Power Windows ..... Each 80.02
- B 14033 Window Switch Power Bar**
- B 14033A 58/60; Console ..... Each 3.01  
 B 14033B 61/62; LH Door ..... Each 4.03  
 B 14033C 63/66; Console ..... Each 3.57

## Window Switch Housing Finish Plate

- B 14307B 64/66; Front & Rear  
 With Lockout ..... Each 15.25  
 B 14307C 64/66; Front & Rear  
 With Lockout & Vent ..... Each 15.25  
 B 14307D 66; Front & Vent Only ..... Each 15.25

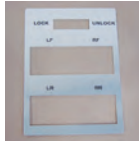

B 14307B

## Power Window & Top Control Switch Bezel



B 14183A

- B 14183A 61/62; Front Window**  
 61/63; Rear Quarter Window  
 61/62; Top Control Switch..... Each 10.35  
 Note: See Page 80 Part #B 30320A & B
- B 14524 Window Switch Housing Plate**
- B 14524C 61/62; LH Door ..... Each 13.21  
 B 14524D 61/62; RH Door, 63/66 Quarter Window ..... Each 7.37

## Window Switch Housing



14528A

14528B

- B 14528A 61/62; Rear Qtr. Window &  
 Convertible Top Control ..... 22.39  
 B 14528B 58/60; Console Switch Housing ..... 25.50  
 B 14528C 61/62; LH Door ..... 53.01  
 B 14528D 63; Console ..... 16.93  
 B 14528E 64/66; Console 5 Hole ..... 42.40  
 B 14528F 66, Lockout Cover Plate..... 13.74  
 B 14528G 64/66; Quarter Window ..... 19.05  
 B 14528H 63; Rear Quarter Window Switch ..... 22.39

- B 14528 Power Window Switch Assembly Kit**
- B 14528DK 64/66; 5 Switch Style ..... Set 224.35  
 B 14528EK 66; 4 Switch Style For Landaus & Coupes ..... Set 224.35  
 B 14528FK 65/66; 7 Switch Style ..... Set 305.95  
 Note: These switch and housing assemblies are complete and ready to install.

## Master Console Window Switch Retainer Clip

Application	B 14570A	B 14570B	B 14570C
58/60	(4)	(0)	(4)
61/62	(4)	(0)	(6)
63		(0)	(8)
64/66 (4 window w/lock out)		(3)	(8)
64/66 (6 window w/lock out)		(3)	(12)
66 Landau		(3)	(8)

- B 14570 Window & Seat Switch Retainer Clip**
- B 14570A & B Years & Applications as listed above Each.....2.60  
 B 14570C Years & Applications as listed above Each.....2.60

## Window Regulator Switch & Wiring



B 14529D

B 14632F

B 14632G

- B 14529 Power Window Switches**
- B 14529A 58, Black, RH Front & LH Rear ..... Each 38.03  
 B 14529B 58, Black, LH Front & RH Rear ..... Each 38.03  
 B 14529C 59; White, RH Front & LH Rear,  
 60; White, LH Front & RH Rear ..... Each 38.03  
 B 14529D 59; White, LH Front & RH Rear  
 60; White, RH Front & LH Rear ..... Each 38.03  
 B 14529E 61/62; Chrome ..... Each 38.03  
 B 14529F 63, Chrome ..... Each 38.03  
 Fits in the Quarter Trim panel

- B 14540 Power Window Lockout Switch**
- B 14540A 61/62; Chrome ..... Each 46.48  
 B 14540B 64/66; Chrome ..... Each 46.48

- B 14553 Window Motor**
- B 14553A 58/60; All Windows ..... Each 178.45  
 B 14553B 61 & Early 62; All Windows . Each 178.45  
 B 14553C Late 62 & 63; All Window & 64 Doors ..... Each 178.45  
 B 14553E 64/66; Door Window Motor RH ..... Each 178.45  
 B 14553F 64/66; Door Window Motor LH ..... Each 178.45  
 B 14553G 64/66; Quarter Window Motor RH ..... Each 178.45  
 B 14553H 64/66; Quarter Window Motor LH ..... Each 178.45



B 14553E

Note: These Motors Are New, NOT Rebuilt.

- B 14632 Window Regulator Switch & Wiring**
- B 14632D 63, Rear, RH or LH ..... Each 40.75  
 B 14632E 63, Front, RH or LH ..... Each 40.75  
 B 14632F 64/66; Switch & Wiring In Console  
 RH or LH, Rear Qtr. Window or  
 Frt Vent Window ..... Each 32.85  
 B 14632G 64/66; Switch & Wiring In Console  
 RH or LH, Front Door Window ..... Each 32.85
- B 14691 Power Seat Switch Retainer**
- B 14691A 61/63; ..... Each 6.31
- B 14677 Electric Window Safety Relay Assembly**
- B 14677A 61/66 ..... 53.01

## Power Seat Switch

B 14701D

- B 14701A 58/66; Includes lever,  
 knob & lever housing  
 repair kit..... 27.49
- B 14701 Power Seat Switch-Complete**
- B 14701B 58, Black Knob ..... Each 78.49  
 B 14701C 59/60; White Knob ..... Each 78.49  
 B 14701D 61/62; Chrome (4 Wire-3 Wire) ..... Each 78.49  
 B 14701E 62/63; Chrome (3 Wire-2 Wire) ..... Each 78.49  
 B 14701F 64/65; Chrome Knob ..... Each 78.49



- B 23395 Gears For Power Window Motor Gear Housing**
- B 23395D 61/64 Door &  
 61/63 Quarter Window, "Flat Gear" ..... 25.45  
 B 23395E 61/64 Door &  
 61/63 Quarter Window, "Worm Gear" ..... 25.45
- B 23396 Window Motor to Housing Gasket**
- B 23396A 65/66 ..... Each 2.03
- B 23396 Power Window Gear Housing Plate**
- B 23396B 64/66; ..... Each 5.25
- B 23440 Window Motor Drive Coupler**
- B 23440A 61/64; Door & Rear Quarter Window Motors Each 11.39  
 B 23440R 58/60; Window  
 61/66; seat ..... 10.87

## Power Windows & Seats Attaching Hardware

- BHK 210 Console Window Switch Retainer,  
 64/66, (8 Pieces) ..... 2.56

# FENDERS & HOOD AREA

## Nose & Continental Kit Ornament



B 8259A	60; Nose Panel	.....	43.00
B 8259B	58/59	.....	31.79

### B 13064 Headlamp Door

B 13064A	61/63	.....	Each	41.57
B 13064B	64/65; RH	.....	Each	91.21
B 13064C	64/65; LH	.....	Each	91.21

B 13355B



### B 13355 Fender Mounted Turn Signal Lamps

B 13355A	64/65	.....	Pair	86.65
B 13355B	66	.....	Pair	86.65

### B 14651 Inner Fender Apron Grommet

B 14651A	58/60	.....	Each	3.13
----------	-------	-------	------	------

### B 16036/7 Top Fender Moulding

B 16036A	61/63; RH	.....	121.99
B 16037A	61/63; LH	.....	121.99

\*Note: See Page 82 For Part Number 29144 For Clip Only.

### B 16076 Fender & Quarter Top Mouldings Clip

B 16076A	61/63; "Y" Style	.....	Each	4.34
----------	------------------	-------	------	------

\*Note: Also See Page 82 For Part Number B 29144.

## Front Fender Nameplate



B 16098A	58; Fender	.....	25.00
	59; Door	.....	
	58/60; Spare Wheel Carrier	.....	
	61/62; "Thunderbird"	.....	

### B 16102/3 Front Fender Splash Shield

B 16102B	58/60; RH, Rear	.....	Each	100.82
B 16103B	58/60; LH, Rear	.....	Each	100.82

### B 16137 Radiator Support to Radiator Seal

B 16137A	59/60	.....	Pair	4.68
----------	-------	-------	------	------

### B 16160 Fender to Bumper Seal

B 16160A	58/60	.....	Pair	16.93
----------	-------	-------	------	-------

### B 16170C Splash Shield Rubber Kit

B 16170C	61/63	.....	Set	59.16
B 16170D	64/66	.....	Set	59.16

## Fender Top Ornaments



B 16178A	60; RH or LH;	.....	Each	66.30
B 16178B	59; RH or LH;	.....	Each	66.30
B 16178C	58; RH or LH;	.....	Each	66.30

## Roadster Emblem



B 16228A	61/63; For Front Fender	.....	Each	26.28
----------	-------------------------	-------	------	-------

## Fender Emblems

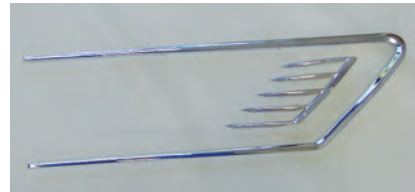

B 16228B

B 16228B	65; "C" and Feather Set, RH	.....	Set	90.47
B 16229B	65; "C" and Feather Set, LH	.....	Set	90.47

### B 16238 & 8093 Radiator Support to Hood Seal

B 8093R	62/63	.....	6.78	
B 8093SK	Staples For 8093-R; (16 Staples Per Package)	.....	1.31	
B 16238A	65/66	.....	6.19	
B 16238AK64/66;	Seal w/Pins	.....	Per Kit	8.84

### B 16298 Cowel Braces

B 16298C	64/66; Convertible, Cowel to Shock Tower	.....	Pair	71.35
----------	--	-------	------	-------

### B 16311 Front Fender to Bumper Seal Retainer

B 16311A	58/60; Use With Part Number B 16160A	.....	Each	7.23
----------	--------------------------------------	-------	------	------

## Hood Letters



B 16606A	64; Letters, Complete Set	.....	Set	34.28
----------	---------------------------	-------	-----	-------

### B 16607 Hood Emblem Insert

B16607A	61/63; Plastic	.....	.....	27.49
---------	----------------	-------	-------	-------

# FENDERS & HOOD AREA

## Hood Emblem



B 16637B

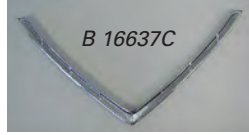

B 16637C



B 16644A

<b>B 16637 Hood Emblem</b>		
B 16637B 65	Each	49.93
B 16637C 66	Each	76.50
<b>B 16644 Hood Emblem</b>		
B 16644A 61/63		37.71
<b>B 16738 Hood Insulation &amp; Sound Deadener</b> (Fiberglass Sound Deadening Hood Pads)		
B 16738AR61/63	Set	46.82
B 16738BR64	Set	46.82
B 16738CR65	Set	46.82
B 16738DR66	Set	46.82
<b>B 16740 Hood to Firewall Seal</b>		
B 16740AR 61/66	Each	8.95
B 16740C 58/60	Each	8.21

## Hood Bumper



B 16758AK B 16763A B 16763B B 16763C

<b>B 16758 Hood Bumper</b>		
B 16758AK 58/60; (1) Set of 4, on fender	Set	9.95
B 16758C 58/60; Door & Fuel Filler Door, Front/Rear License Plates	Each	2.60
<b>B 16763 Hood Bumper</b>		
B 16763A 61/66; On Fender, Wedge-Shape, (4 required) Each		3.25
B 16763B 58/65; On Radiator Support 5/16-18 Thread	Each	5.15
B 16763C 66; On Radiator Support 5/16-18 Thread	Each	5.15
B 16763D 66; On Radiator Support 3/8-18 Thread	Pair	9.69

<b>B 16789 Hood Hinge Spring</b>		
B 16789B 61/66	Each	18.62

## Original Type Hood Hinge



B 16796A

B 16796A 61/66; RH, Gold Cadmium Plated Like Original!	Each	112.15
B 16797A 61/66; LH, Gold Cadmium Plated Like Original!	Each	112.15

## "Eyebrow" Hood Moulding



B 16857A

<b>B 16856/7 Moulding—Hood Eyebrow</b>		
B 16856A 61/63; RH		49.47
B 16857A 61/63; LH		49.47

## Hood Pull Handle



B 16916A

B 16916A 58/60;	17.51
B 16916B 61/62; Includes Cable	50.95

## Hood Latch Cross Over Cable

B 16917A 58/60	Each	16.95
----------------	------	-------

## Hood Moulding



B 16958A

<b>B 16958 Hood Moulding</b>		
B 16958A 61/63; Center		66.80
<b>B 29040 Side Body Moulding Kit</b>		
B 29040A 61/62; 10-Piece Kit	Full Set	275.91
B 29040B 64 or 66; 8-Piece Kit	Full Set	297.14
B 29040C 65; 8-Piece Kit	Full Set	297.14
<b>BPP 16005/6 Lower Rear Front Fender Repair Panel</b>		
BPP 16005LR	58/60; RH Side	112.15
BPP 16006LR	58/60; LH Side	112.15
BPP 16005ALR	61/63; RH Side	91.75
BPP 16006ALR	61/63; LH Side	91.95
BPP 16005BLR	64/66; RH Side	86.70
BPP 16006BLR	64/66; LH Side	86.70
<b>BPP 16054 Battery Box Apron Repair Panel</b>		
BPP 16054A	64/66	162.82
BPP 16054B	61/63	162.82

## Side Body Moulding Kit

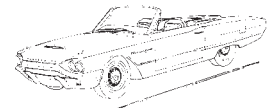

B 29040A 61/62; 10-Piece Kit	Full Set	275.91
B 29040B 64 or 66; 8-Piece Kit	Full Set	297.14
B 29040C 65; 8-Piece Kit	Full Set	297.14
B 29040ACK 61/62; Clip Kit	Set	48.96
B 29040BCK 64 or 66; Clip Kit	Set	48.96
B 29040CCK 66; Clip Kit	Set	49.93

## Fenders & Hood Area Attaching Hardware

BHK 325	Front Valance - Side, 1966, 2 Side (28 Pieces)	30.47
BHK 326	Front Valance - Side, Bracket, 1966, 2 Sides (4 Pieces)	2.24
BHK 332	Front Fender to Bumper Seal, 58/60	2.62
BHK 334	Cowl Cover, 58/60, (6 Pieces)	1.68
BHK 335	Cowl Cover, 61/63, (24 Pieces)	4.30
BHK 336	Cowl Cover, 64/66, (22 Pieces)	4.00
BHK 378	Hood Vent Casting, 58/60, (6 Pieces)	2.24
BHK 379	Hood Vent Grille, 58/60, (3 Pieces)	1.32
BHK 380	Hood Hinge To Hood, 61/63, 2 Sides (8 Pieces)	4.93
BHK 381	Hood Hinge To Hood, 64/66, 2 Sides (8 Pieces)	4.68
BHK 382	Hood Hinge to Hood, 58/60, (4 Pieces)	4.12
BHK 383	Hood Hinge To Inner Fender Brace, 61/63, 2 Sides (12 Pieces)	5.06
BHK 384	Hood Hinge To Inner Fender Brace, 64/66, 2 Sides (6 Pieces)	6.18
BHK 385	Hood Hinge to Body, 58/60, (16 Pieces)	11.61
BHK 386	Hood Vent Casting, 61/63, (10 Pieces)	3.12
BHK 387	Hood Ornament, 61/63, (3 Pieces)	1.88
BHK 388	Hood Center Ornament, 1966, (5 Pieces)	1.88
BHK 390	Hood Guide Latch, 61/63, (16 Pieces)	8.86
BHK 391	Hood Latch On Need, 61/63, (4 Pieces)	3.00
BHK 392	Hood Latch, 64/65, (2 Pieces)	2.81
BHK 393	Hood Latch, 1966, (3 Pieces)	3.30
BHK 394	Hood Latch - Side, 58/60, (4 Pieces)	1.18
BHK 395	Hood Catch, 61/63, (6 Pieces)	4.00
BHK 396	Hood Catch, 64/65, (1 Pieces)	4.93
BHK 397	Hood Catch, 1966, (4 Pieces)	2.94
BHK 398	Hood Catch - Side, 58/60, (4 Pieces)	1.62
BHK 399	Hood Release Bar, 61/63, (10 Pieces)	5.43
BHK 400	Fenders, Complete Set, 61/63, 2 Sides (72 Pieces)	58.86
BHK 401	Hood Release Catch, 58/60, (26 Pieces)	8.12
BHK 403	Fenders - Bolts Only, 61/63, 1 Side (16 Pieces)	8.86
BHK 404	Fenders Only, 64/66, 1 Side (18 Pieces)	18.73
BHK 406	Front Fender Splash Shields, 58/60, (28 Pieces)	22.09
BHK 407	Fender Splash Shield - Rear, 64/66, 1 Side (8 Pieces)	5.12
BHK 408	Top Fender Ornament, 58/60, (4 Pieces)	3.00
BHK 477	Expert Braces - Firewall To Shock Tower, 61/63, 2 Side, (24 Pieces)	12.17
BHK 478	Export Brace, 64/66, (28 Pieces)	12.80

# INSTRUMENTS & GAUGES

## Fuel Tank Sender



B 9275C

B 9275A	58/60 .....	59.95
B 9275B	61/63 .....	76.50
B 9275C	64/66; Without "Low Fuel Level" Warning .....	85.64
B 9275D	64/66; With "Low Fuel Level" Warning. ....	96.85

## Oil Pressure Sender

B 9278A	58/63 .....	22.39
B 9278B	64/66 .....	23.50

## Instrument Cluster Voltage Regulator



B 10804C

<b>B 10804</b>	<b>Instrument Cluster Voltage Regulator</b>	
B 10804B	58/59 .....	29.53
B 10804C	60/66 .....	22.68

<b>B 10823</b>	<b>Dash Engine Indicators Plastic Bezel</b>	
B 10823A	60, "Oil" Lens and Inner Bezel.....	Each 23.30
B 10823B	60, "Generator" Lens and Inner Bezel.....	Each 23.30

## Water Temp. Sender



B 10884A

B 10884C



B 10884A	58/61 .....	13.01
B 10884C	63/64; (After 11/15/62 - Will work for 62 & early 63 if used w/part T 10911A) .....	15.25
B 10884D	66; With Gauges .....	9.95

## Speedometer Cable



<b>B 17260</b>	<b>Speedometer Cable</b>	
B 17260A	58/60 & 64/65; (Before 11/13/64), (Exc. W/Spd. Control) 58.80" Long; LH Wind .....	49.95
B 17260C	61/63 .....	50.95
BSP 87036	66; "0" Ring- 11/32" LD . ....	2.40

## Speedometer Gear

<b>B 17271</b>	<b>Speedometer Driven Gear</b>	
B 17271A	64/66; 16 Teeth, Axle Ratio 3.0 .....	8.01
B 17271B	65/66; 20 Teeth, Axle Ratio 3.90 .....	8.01
B 17271C	64/66; 17 Teeth, Axle Ratio 3.25 .....	8.01
B 17271D	58/63; 19 Teeth .....	21.18
B 17271K	58/63; 18 Teeth .....	21.18

<b>B 17292</b>	<b>Speedometer Drive Gear Retainer</b>	
B 17292A	58/66; U-Shape .....	2.91

## Clock Assembly

We Can Rebuild Any Year Clock.  
Call for availability for exchange. Cores on hand vary.



B 18375E



B 18375C



B 18375D



B 18375F

B 18375A	58 .....	Each	149.95
B 18375B	59 .....	Each	149.95
B 18375C	65/66 .....	Each	149.95
B 18375D	60 .....	Each	149.95
B 18375E	61/63 .....	Each	149.95
B 18375F	64 .....	Each	149.95

**Note: Core Deposit on All Clocks is 100.00**  
61/63 Clocks Must Have The Chrome Bezel & The Knob Removed.  
They Are Not Part of The Rebuild Service.

## Instrument & Gauges Attaching Hardware

BHK 250	Instrument Bezel - Bottom, 58/60, (2 Pieces) .....	1.12
BHK 265	Instrument Bezel Covers, 61/63, (3 Pieces) .....	1.74
BHK 266	Instrument Housing Bezel, 64/66, (15 Pieces) .....	4.62
BHK 268	Instrument Housing Retainer Plate, 64/66, (6 Pieces) .....	2.18

# WINDSHIELD WIPER & WASHER

## 1958/60 Windshield Wiper & Related Parts

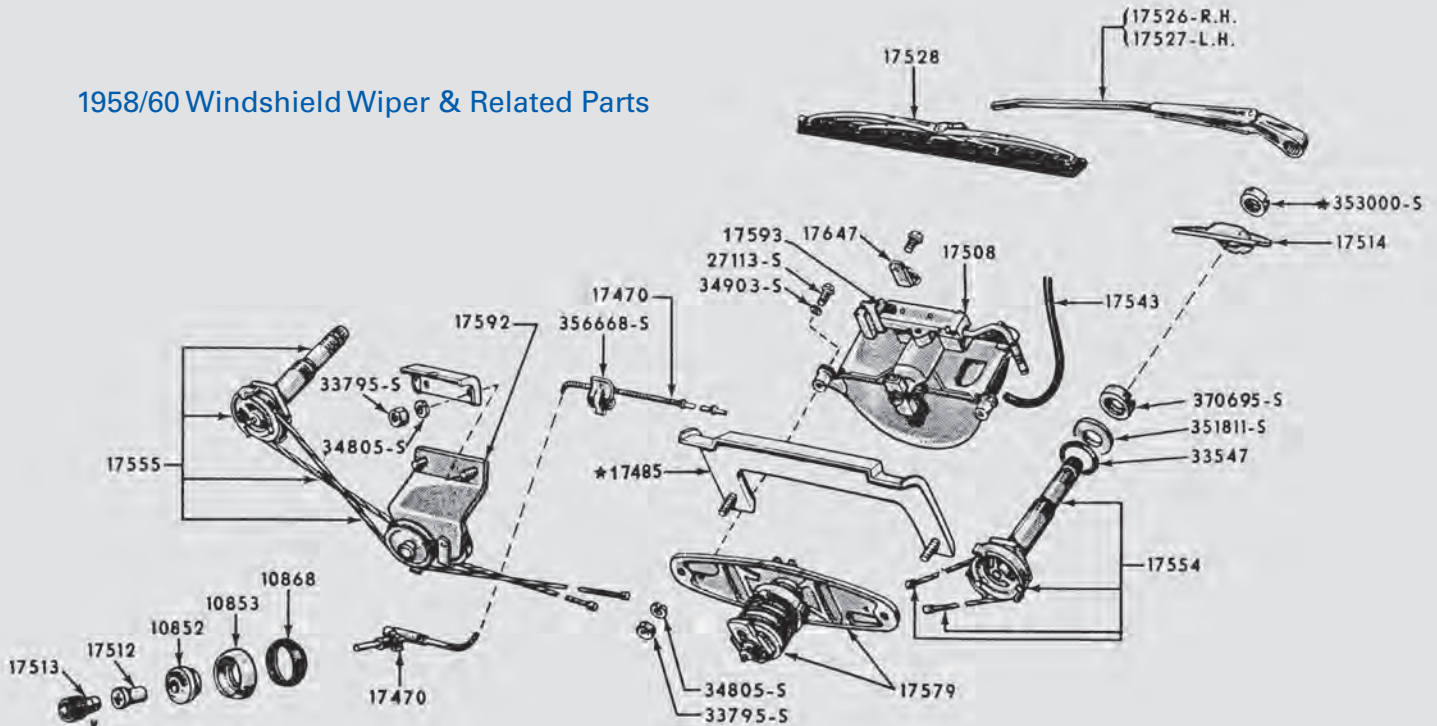

## Larry's Illustrations Manuals

Larry's Illustrated Parts Manuals for 1958/60 and 1961/66 are an in-depth compilation of full-page illustrations that cover all systems in your Thunderbird. These manuals are a "must have item" for those who work on their own car, or if you need to have an idea of what your mechanic is doing on your vehicle. Probably one of the best investments you can make when it comes to restoring your T-Bird properly!



Order Part—BLT 18  
[58/60] ..... 13.50

Order Part—BLT 19  
[61-66] ..... 13.50

<b>B 9413</b>	<b>Vacuum Line</b>		
B 9413A	58/60; Fuel Pump to Manifold .....		12.95
B 9413B	58/60; Fuel Plump to Wiper Motor .....		16.93
<b>B 10853</b>	<b>Chrome Headlight &amp; Wiper Bezel</b>		
B 10853B	61/63; Headight & Wiper Switch Bezel, Chrome .....	Each	15.75
<b>B 17474</b>	<b>Steering Box to Wiper Motor Hose</b>		
B 17474A	64/66 .....		45.58
B 17474B	63 .....		45.58
<b>B 17478</b>	<b>Windshield Washer Switch Housing</b>		
B 17478R	64/66; Plastic Housing .....		12.20

## Windshield Motor Conversion Kit

B 17508AK	58/60; To Convert The Vacuum.....	Each	319.95
	Motor To Electric		
B 17508B	58/60; Vacuum Wiper Motor (Rebuilt) .....		127.50
	Core Charge .....		200.00

<b>B 17512</b>	<b>Wiper Inner Bezel Nut</b>		
B 17512A	58/60 .....		15.25
B 17512B	61/63 .....		15.25

## Windshield Wiper Knob



B 17513A	58; Black w/Silver Center .....	Each	9.55
B 17513B	59; White w/Gold Center .....	Each	10.61
B 17513C	60; White w/Silver Center .....	Each	9.55
B 17513D	61/63 .....	Each	20.35

<b>B 2344</b>	<b>Power Steering Retainer Hose Clump</b>		
B 2344A	58/66 .....	Each	1.79

# WINDSHIELD WIPER & WASHER

## Windshield Washer Reservoir



B 17618AR



B 17618BR



B 17618CR



B 17618F

### B 17618 Reservoir Windshield Washer

B 17618AR 61/63; As Original .....	30.55
B 17618BR 64/65; As Original .....	30.55
B 17618CR 66; As Original .....	30.55
B 17618F 58/60; As Original .....	30.55
BHK 480 Washer Bag Bracket, 61/63, (2 Pieces) .....	1.74
BHK 481 Washer Bag Bracket, 64/66, (2 Pieces) .....	1.74

### B 17651 Windshield Washer Bag Bracket

B 17651A 61/63 .....	13.74
B 17651B 58/60 .....	13.74
B 17651C 64/66 .....	13.74

### B 17514/5 Wiper Arm Bezel

B 17514C 64/65; RH .....	Each	15.25
B 17515C 64/65; LH .....	Each	15.25

## Wiper Arms, Blades & Related Parts



B 17528B  
Windshield Wiper  
Blade Assembly

<b>B 17528</b> Windshield Wiper Blade Assembly	
B 17528A 61/62 .....	13.77
<b>B 17531</b> Clip Wind. Wiper Adapter & Connecting Arm	
B 17531B 66; Also Used To Attach Headlamp Cover Motor .....	4.34

<b>B 17593</b> Wiper Motor Return Line	
B 17593A 63; 2 Pieces .....	Set 29.81

<b>B 17601</b> Windshield Washer Hose Tee	
B 17601A 58/66 .....	1.51

<b>B 17602</b> Washer Nozzle Rubber Tip	
B 17602A 64/66 .....	Pair 5.05

## Windshield Wiper Switch Assembly

B 17625D 64/65 .....	Each	23.41
----------------------	------	-------

## Windshield Washer Pump



B 17664B 61/66; Reproduction of original pump.....	33.57
--	-------

## Windshield Washer Nozzels

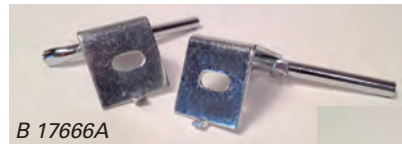

B 17666A



B 17666B

B 17666A 58/60 .....	Pair	25.45
B 17666B 61/63 .....	Pair	25.45

## Wiper & Washer System Attaching Hardware

BHK 479 Windshield Washer Nozzle, 58/60, (2 Pieces) .....	.88
BHK 480 Washer Bag Bracket, 61/63, (2 Pieces) .....	1.74
BHK 481 Washer Bag Bracket, 64/66, (2 Pieces) .....	1.74
BHK 482 Washer Bag Bracket, 58/60, (2 Pieces) .....	.88
BHK 492 Wiper Motor Relay, 58/60, (2 Pieces) .....	1.06

# MIRRORS

## Exterior Rear View Mirrors

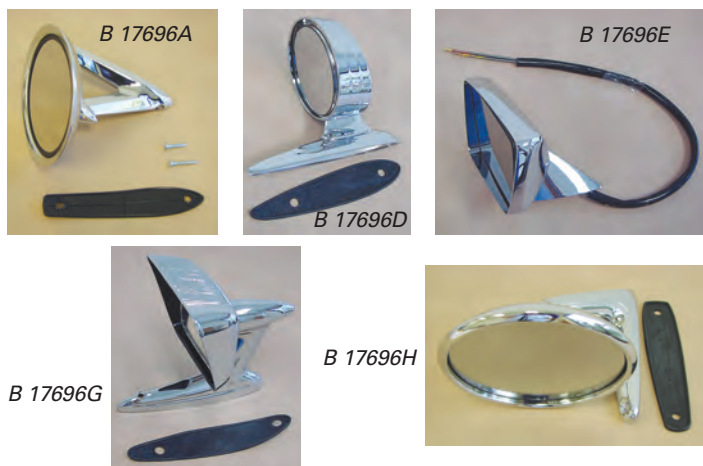

<b>B 17530</b>	<b>Remote Control Mirror Bezel</b>	
B 17530C	64/66 .....	11.62
<b>B 17696</b>	<b>Outside Rear View Mirror Assembly</b>	
B 17696A	61/66; Universal Mirror, Replacement Type .....	36.36
B 17696B	58/59; RH, Convex Type .....	148.95
B 17696C	58; Original Type; Can use on 59 & 60, but it may be necessary to drill new hole .....	37.40
B 17696D	58/59; Adjust-O-Ring .....	Each 148.95
B 17696E	64/66; LH, Remote type (less Bird emblem*) .....	179.95
B 17696F	64/66; RH, Companion to Remote type (less emblem*) .....	159.95
*Note: For Bird Emblem, see Part 17686 listed above.		
B 17696G	60; Hooded, like original! .....	Each 139.00
B 17696H	61/62; RH or LH STD Type .....	Each 79.95
B 17696J	61/62; RH, Convex Type .....	79.95

## Mirror Emblem

B 17686A	64/66; For back of mirror .....	23.21
----------	---------------------------------	-------



<b>B 17696</b>	<b>Outside Rear View Mirror</b>	
B 17696K	63; LH Remote Type, With Gasket .....	159.95
B 17696L	63; RH Companion to Remote, With Gasket .....	149.95

<b>B 17718</b>	<b>Remote Mirror Control Lever</b>	
B 17718A	63/66 .....	40.75

<b>B 17719</b>	<b>Remote Mirror Control Lever Nut</b>	
B 17719A	63; .....	13.77
B 17719B	64/66 .....	10.56

## Mounting Plate & Pads



<b>B 17717</b>	<b>Outside Rear View Mirror Mounting Plate</b>	
B 17717R	64/66 .....	11.17

<b>B 17724</b>	<b>Outside Mirror Mounting Pad</b>	
B 17724A	61/66; Used With Mirror #B 17696A .....	2.60
B 17724B	64/66 .....	6.19
B 17724C	58/60; Used With Mirror #B 17696C .....	.99
B 17724D	58/59; Use With Adjust-O-Ring Mirror .....	7.09
B 17724E	58/60; Use With Hooded Mirror .....	7.09
B 17724F	58/60; Use With Original Mirror .....	7.09
B 17724G	63; LH "Rubber" .....	Each 6.07
B 17724H	63; LH "Rubber" .....	Each 6.07
B 17724I	64; RH or LH "Rubber" Std Mirror Only.....	Each 6.07

## Mirror Attaching Hardware

BHK 129	Inside Rear View Mirror, 58/66, (5 Pieces) .....	1.88
BHK 150	Remote Mirror to Body, 63, (2 Pieces) .....	1.74
BHK 151	Outside Mirror - Early 64, (2 Pieces) .....	2.00
BHK 152	Outside Mirror - LH, 64/66, (2 Pieces) .....	1.74
BSP 378213	Set Screw, Remote Control Mirror, 64/66.....	Each 1.01

## Original-Style Inside Rear View Mirror



B 17698C



B 17698A



B 17690F



B 17700R

<b>B 17700</b>	<b>Inside Rear View Mirror - "Day/Nite"</b>	
B 17700A	61/64; Push-Button Type .....	49.95
B 17700B	58/59; .....	29.95
B 17700C	60; Day/Night.....	77.25
B 17700R	"Day/Nite" Mirror Assembly 64/66; (*Does Not include Mounting Bracket) .....	45.90
*See Part Number B 17690F For Mounting Arm.		

<b>B 17690</b>	<b>Inside Rear View Mirror Arm</b>	
B 17690F	61/66 .....	Pair 15.25

<b>B 17698</b>	<b>Inside Rear View Mirror Bracket</b>	
B 17698A	58/60 .....	20.35
B 17698C	61/66; Chrome Finish; Cement-On Type .....	10.35



# BUMPERS

<b>B 40340</b>	<b>Rear Bumper Stone Deflector</b>		
B 40340A	64/66	Pair	15.87
<b>B 16160</b>	<b>Fender To Bumper Seal</b>		
B 16160A	58/60	Pair	16.93
<b>B 17120</b>	<b>Front Bumper Guard Pad</b>		
B 17120A	66; 2 Required	Each	15.25

## License Plate Bracket

B 17385A	58/60; Front	21.18
B 17385B	61/63; Front	21.18
B 17385C	64/65; Front	28.60
B 17385D	66; Front	20.35

<b>B 17758</b>	<b>Bumper Bolt</b>		
B 17758A	58/66; Chrome; 7/16" x 1 3/4"	1.68	
BSP 44730	64/66; Washer- 7/16"	Each	.28

<b>B 17832</b>	<b>Rear Bumper Deflector</b>		
17832A	58/60	Pair	19.64

## Rear Bumper Emblem & Related Parts



B 17850A



B 17850B

<b>B 17847</b>	<b>Rear Bumper Emblem Housing</b>		
B 17847A	64/65; Chrome	Each	88.03
<b>B 17850</b>	<b>Rear Bumper Name Plate</b>		
B 17850A	64	Each	47.71
B 17850B	65; With Thunderbird Wing Span	Each	47.71
<b>B 17851</b>	<b>Rear Bumper Emblem Retainer Plate</b>		
B 17851A	64/65	Each	12.75
<b>B 17852</b>	<b>Rear Bumper Center Emblem Pad</b>		
B 17852A	64/65		4.77

## Rear Bumper Ends



B 17864A

<b>B 17864/5</b>	<b>Rear Bumper Ends</b>		
B 17864A	61/63; RH		377.35
B 17865A	61/63; LH		377.35
BHK 419	RearBumper Q's, 61/63, 2 Sides (30 Pieces)		7.74

## Rear Bumper to Lower Back Panel Filler



B 17888A

<b>B 17888/9</b>	<b>Rear Bumper to Lower Back Panel Filler</b>		
B 17888A	58/60	Pair	29.08
<b>B 17970</b>	<b>Rubber Bumper Impact</b>		
B 17970A	61/63; Front & Rear Bumper Impact	Set of 4	219.30

## Center Bumper Guard

B 17996B	61/63; Front	301.87
----------	--------------	--------

<b>B 40334</b>	<b>Lower Back Panel to Bumper Splash Shield</b>		
B 40334A	61/63, Rubber Seal, Hard Top	Pair	11.89
<b>B 40334</b>	<b>Body to Bumper Splash Shield</b>		
B 40334B	64/66; Convertible		132.60
<b>B 40340</b>	<b>Rear Bumper Stone Deflector</b>		
B 40340A	64/66;	Pair	15.87



B 40560B

## Gas Filler Door

<b>B 40560</b>	<b>Gas Filler Door</b>		
B 40560B	61/63; Chrome	Each	81.55

## Bumper Area Attaching Hardware

BHK 313A	Front Bumper, 58/60	107.50	
BHK 313	Bumper to Grille Bracket, 58/60, (14 Pieces)	4.37	
BHK 314	Front Bumper, 61/63, (24 Pieces)	25.47	
BHK 315	Front Bumper, 64/66, (50 Pieces)	23.29	
BHK 316	Front Bumper Brackets to Frame, 58/60, 2 Sides (24 Pcs)	20.10	
BHK 317	Front Bumper Extension, 61/63, (4 Pieces)	2.74	
BHK 318	Front Bumper Guard, 64/65, (12 Pieces)	9.74	
BHK 319	Front Bumper Brackets to Frame, 64/65, 2 Sides (24 Pcs)	8.99	
BHK 320	Front Bumper Bracket, 1966, 2 Sides (32 Pieces)	12.86	
BHK 321	Front Bumper to Bracket, 58/60, Upper	3.62	
BHK 322	Front Bumper Bracket to Frame, 58/60, Lower	17.48	
BHK 327	Front Bumper Bracket to Frame, 58/60, Lower	12.92	
BHK 328	Front Bumper to Bracket, 58/60, Side	9.12	
BHK 329	Front Bumper Side Bracket to Frame, 58	7.24	
BHK 330	License Plate Holder - Front, 61/63 (4 Pieces)	1.74	
BHK 331	License Plate Holder -Front, 64/65 (8 Pieces)	4.50	
BHK 332	Front Fender to Bumper Seal, 58/60	2.62	
BHK 333	License Bracket - Front, 1966 (2 Pieces)	2.18	
BHK 409	RearBumper Guard to Upper Bumper, 65	4.50	
BHK 410	Rear Bumper to Back Panel Filler	1.38	
BHK 415	Rear Bumper, 58/60	80.15	
BHK 416	Rear Bumper, 61/63, (30 Pieces)	28.65	
BHK 417	Rear Bumper, 64/66, (40 Pieces)	18.41	
BHK 418	Rear Bumper to Brackets, 58/60	51.74	
BHK 419	Rear Bumper Q's, 61/63, 2 Side (30 Pieces)	7.74	
BHK 420	Rear Bumper Support, 64/66, (16 Pieces)	9.92	
BHK 421	Rear Bumper Center, 64/66, (41 Pieces)	4.06	
BHK 422	Rear Bumper Bracket to Frame, 64/66, 2 Sides (12 Pcs)	6.12	
BHK 423	Rear Bumper Bracket to Frame, 58/60	40.82	
BHK 424	Rear Upper Bumper to Lower Bumper	9.61	
BSP 44730	Flat Washer, 7/16" x 1 1/8"	Each	.28

# HEATING, VENTILATION & A/C

## A/C Compressor Support Brace Spacer

<b>B 2887</b>	<b>A/C Compressor Support Brace Spacer</b>		
B 2887A	65; 49/64".....	Each	4.03
B 2887B	66; 1 1/4".....	Each	4.03

## Air Compressor Support Bracket

<b>B 2888/89</b>	<b>Air Compressor Support Bracket</b>		
B 2889A	65; Rear.....	Each	30.55
B 2889B	66; Rear.....	Each	30.55
B 2889C	64; Rear.....	Each	30.55

## A/C Clutch Brush & Wire

<b>B 2979</b>	<b>A/C Clutch Brush &amp; Wire</b>		
B 2979A	63/66;.....	Each	47.89

## Vent Cable

<b>B 01890/1</b>	<b>Vent Cable</b>		
B 01890D	61/63; With Knob, RH.....	Each	50.95
B 01891D	61/63; RH Without Knob, RH.....	Each	20.35

## Vent Cable Bezel Nut

<b>B 01910</b>	<b>Vent Cable Bezel Nut</b>		
B 01910A	61/63; LH.....	Each	15.25

## A/C & Heater Control Motor Assembly



<b>B 18318B</b>	<b>58/66</b>		
	Arm Length 4 11/16" Long.....		66.25

<b>B 18472</b>	<b>Heater Hose</b>		
B 18472E	58/66; 518" LD.....	Per Foot	1.89

## Heater Core

Get your heater up to proper operating standards!

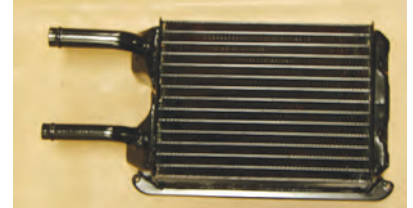

B 18476H

B 18476B	62/63; 1 Pipe With 3 Studs.....	Each	125.41
B 18476D	58/60; 1 Pipe With 3 Tabs.....	Each	125.41
B 18476E	61/Early 62; 1 Pipe With 2 Studs.....	Each	125.41
B 18476G	64/66; W/O A/C, 2 Long Pipes.....	Each	125.41
B 18476H	64/66; With A/C.....	Each	125.41

## Heater Blower Motor Switch



B 18478D	64.....	Each	81.55
B 18478E	65/66.....	Each	81.55

## A/C Idler Pulley

<b>B 8678</b>	<b>A/C Idler Pulley</b>		
B 8678B	64/66; Complete Pulley, Bearing & Shaft.....	Each	71.35

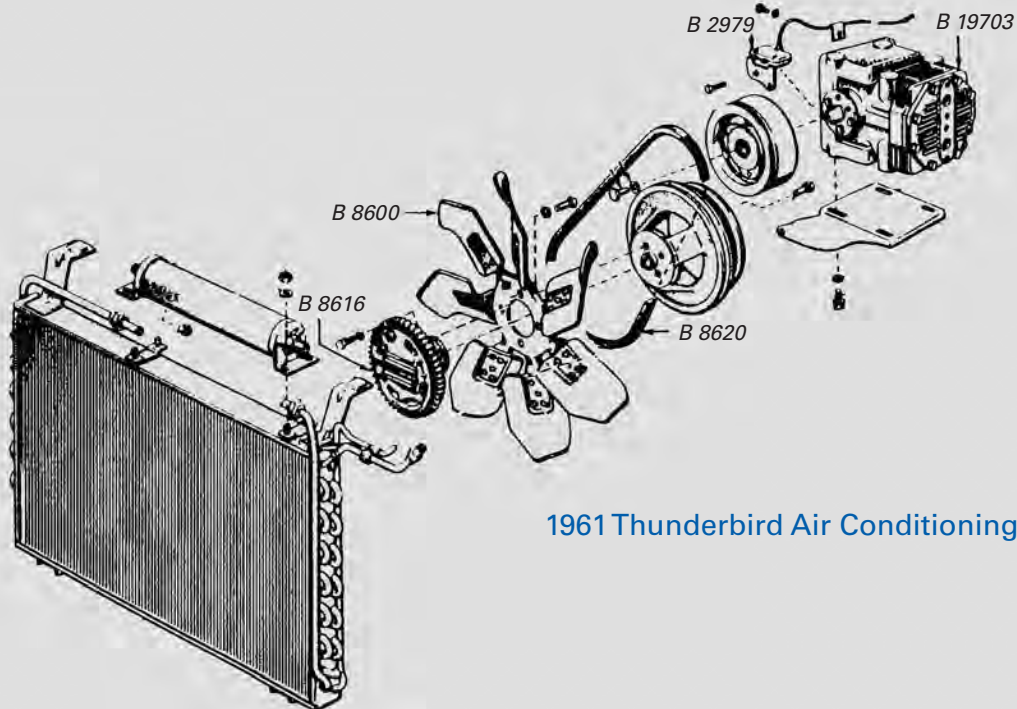

1961 Thunderbird Air Conditioning Systems

# HEATING, VENTILATION & A/C

<b>B 18481</b>	<b>Heater Hose Bracket</b>		
B 18481A	58/63; Dual Type	Each	10.43
B 18481B	64/66; Single Type	Each	5.05

## Heater Core Valve Kit



B 18495A	58/60; Replacement type	76.45
B 18495B	61/63; Replacement type	80.53
B 18495C	61/63; Original Style	58.09

## Heater Blower Switch Knob

B 18513A	58;		
	Black	Each	5.30
B 18513B	59/60;		
	White	Each	6.36



<b>B 18518</b>	<b>Heater Control Cable</b>		
B 18518B	58 Heater Temperature	Each	22.70
B 18518C	58/60 Heater Temperature	Each	22.70
B 18518D	61/63 Heater Temperature	Each	22.70
B 18518E	64/64 Off/Heater Defrost	Each	22.70

## Heater Control Knob

B 18519A	58; Black	Each	5.46
B 18519B	59/60; White	Each	6.36



<b>B 18527</b>	<b>Heater Blower Motor Assembly</b>		
B 18527A	64/66		112.15



<b>B 18556</b>	<b>Fresh Air Inlet Seal</b>		
B 18556A	61/66		47.43

<b>B 18548</b>	<b>Defroster Control Cable</b>		
B 18548A	58 Heater/Defroster	Each	21.93
B 18548B	59/60 Defroster	Each	21.93
B 18548C	61/63 Off/Heater/Defroster	Each	21.93
B 18548E	58/63 Control Cable Clip	Each	2.55

<b>B 18552</b>	<b>Air Heater Control Cable</b>		
B 18552A	58 RH Air	Each	21.93
B 18552B	59/60 Off/Heater	Each	21.93
B 18552D	64/66 Heater Temperature	Each	21.93

## Windshield Defroster Hose

<b>B 18556</b>	<b>Windshield Defroster Hose</b>		
B 18556C	61/66; 2 1/2" I.D. x 36" Long- Cut To Length; RH Or LH		18.68



<b>B 18596</b>	<b>Heater Core Tube Seal</b>		
B 18596D	64/66; Without A/C		3.01



<b>B 18599</b>	<b>Water Pump or Block Elbow</b>		
B 18599A	58/64; Nipple, Straight 3/8"		10.15
B 18599B	58/60; Elbow Heater Hose, 90 deg.		16.07

<b>B 18663</b>	<b>"Y" Pipe For Heater Hose to Carburetor Clip</b>		
B 18663B	Late 62/63; 2 3/4"	Each	13.21
B 18663C	Late 64/66; 2 5/8"	Each	13.21

<b>B 19460</b>	<b>Heater Water Valve to Core Seal</b>		
B 19460A	58/63		1.99

## Vacuum Canister



B 19566A	61/65	Each	61.15
B 19566B	66	Each	61.15

## A/C Hose Firewall Grommet

<b>B 19588</b>	<b>A/C Hose Firewall Grommet</b>		
B 19588A	61/64	Each	12.19
B 19588B	65/66	Each	12.19



<b>B 19596</b>	<b>Self Sealing Air Conditioner Coupling Assembly</b>		
B 19596A	61/64; internal-Female; includes Check Valve		17.81

<b>B 19703</b>	<b>Air Conditioner Compressor Assembly</b>		
B 19703B	63/66		304.51

<b>B 19786</b>	<b>Heater Motor Hose</b>		
B 19786A	61/66; inlet Hose, Double 90° Bend		9.44
B 19786B	61/66; Drain Hose, Single 90° Bend		5.25

## Blower Motor Cover Seal

B 19797B	61/66	Each	10.15
----------	-------	------	-------

## A/C Receiver/Dryer

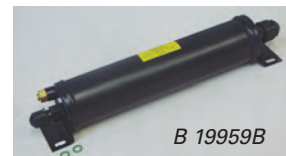

<b>B 19959</b>	<b>A/C Receiver/Dryer</b>		
B 19959A	58/60	Each	132.55
B 19959B	61/65	Each	132.55
B 19959C	66	Each	132.55

## Heating & Ventilation Attaching Hardware

BHK 200	Air Conditioning Vent in Console, 61/63 (3 Pieces)	1.74
BHK 206	Air Conditioning Dial Housing, 58/60 (10 Pieces)	4.00
BHK 207	Air Conditioning Dial Lower Plate, 58/60 (2 Pieces)	.74
BHK 230	Front Air Vent Brackets, 61/63, 2 Sides (6 Pieces)	4.12
BHK 483	Vacuum Storage Tank Brackets, 61/63 (2 Pieces)	1.74
BHK 493	Heater Fan Relay, 58/60 (2 Pieces)	1.06
BHK 496	Heater Blower, 58/60 (10 Pieces)	3.12

# DOORS & WINDOWS

## 1958/60 Front Window & Related Parts

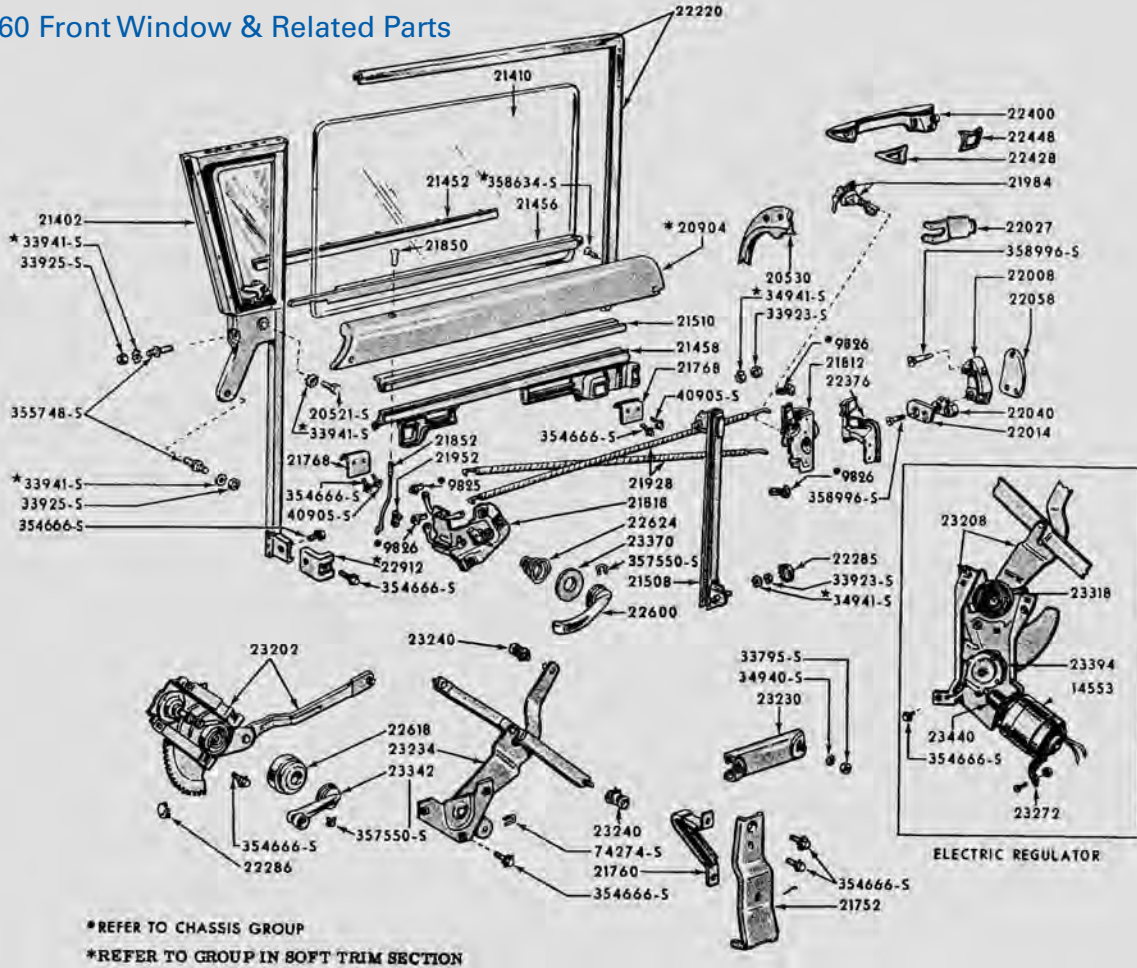

## Door Scuff Plates

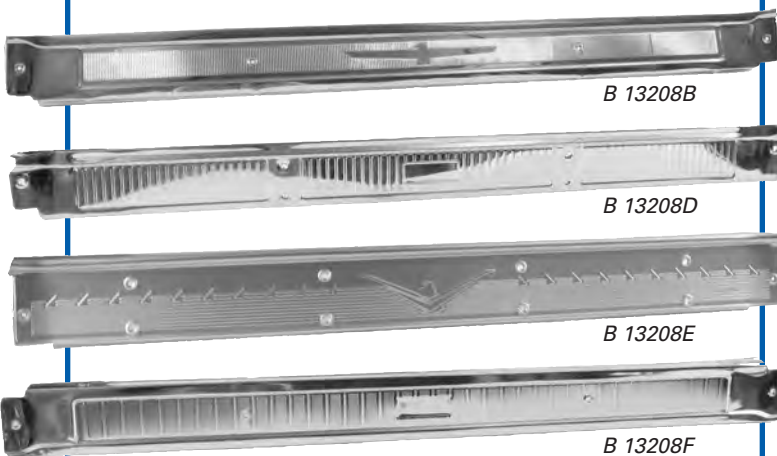

B 13208	Door Scuff Plate		
B 13208B	61/62	Each	78.95
B 13208D	64/66; RH & LH	Pair	109.95
B 13208E	58/60	Each	66.30
B 13208F	63	Each	54.95
BHK 138	Step Plates, 61/62, 2 Sides (18 Pieces)		5.12

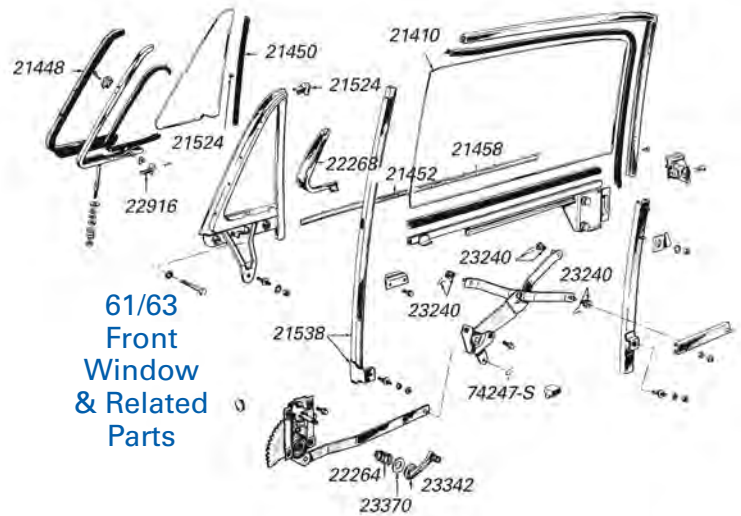

61/63  
Front  
Window  
& Related  
Parts

## Door & Window Handle Removal Tool

Use this special tool to safely remove door and window handles. A must if you are doing the work yourself!



B 22601T ..... 8.67

# DOORS & WINDOWS

## Courtesy Lamp & Related Parts



B 13713A



B 13776B



B 13786A

<b>B 13713</b>	<b>Courtesy &amp; Map Lamp Switch Assembly</b>		
B 13713A	58/66 .....	7.24	
<b>B 13761</b>	<b>Dash Courtesy Light Lens</b>		
B 13761A	58/63 .....	10.08	
<b>B 13776</b>	<b>Interior Pillar Lamp Assembly</b>		
B 13776A	61/63; Roof Courtesy Lamp .....	Each	33.61
B 13776B	64/66 .....		43.81
<b>B 13786</b>	<b>Door Courtesy Lamp Switch Actuator</b>		
B 13786A	64/66 .....	Each	10.56

## Door Lamp Housing

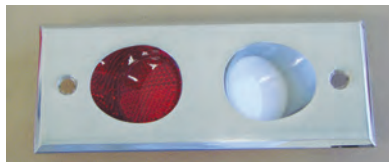

<b>B 13786</b>	<b>Door Lamp Housing</b>		
B 13786B	63/64; With Red & White Lenses .....	Each	31.78

<b>B 14033</b>	<b>Window Switch Power Bar</b>		
B 14033A	58/60; Console .....	Each	3.01
B 14033B	61/62; LH Door .....	Each	4.03
B 14033C	63/66; Console .....	Each	3.57

## Power Window & Top Control Switch Bezel

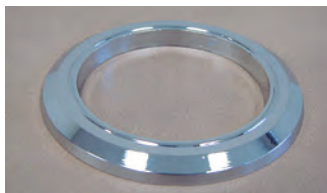

<b>B 14183A</b>	<b>61/62; Front Window</b>		
	61/63; Rear Quarter Window		
	61/62; Top Control Switch .....	Each	10.35

*Note: See Part #B 30320A & B*

## Window Switch Housing Finish Plate

B 14307B	64/66; Front & Rear With Lockout .....	Each	15.25
B 14307C	64/66; Front & Rear With Lockout & Vent .....	Each	15.25
B 14307D	66; Front & Vent Only .....	Each	15.25

<b>B 14524</b>	<b>Window Switch Housing Plate</b>		
B 14524C	61/62; LH Door .....	Each	13.21
B 14524D	61/62; RH Door, 63/66 Quarter Window .....	Each	7.37

## Window Switch Housing



B 14528A



B 14528B

B 14528A	61/62; Rear Quarter Window & Convertible Top Control .....	22.39
B 14528B	58/60; Console Switch Housing .....	25.50
B 14528C	61/62; LH Door .....	53.01
B 14528D	63; Console .....	16.93
B 14528E	64/66; Console 5 Hole .....	42.40
B 14528F	66; Lockout Cover Plate .....	13.74
B 14528G	64/66; Quarter Window .....	19.05
B 14528H	63; Rear Quarter Window .....	Set 22.39

## B 14528 Power Window Switch Assembly Kit

B 14528DK	64/66; 5 Switch Style .....	Set	224.35
B 14528EK	66; 4 Switch Style For Landaus & Coupes .....	Set	224.35
B 14528FK	65/66; 7 Switch Style .....	Set	305.95

*Note: These switch and housing assemblies are complete and ready to install.*

## Power Window Switches



B 14529D

### B 14529 Power Window Switches

B 14529A	58, Black, RH Front & LH Rear .....	Each	38.03
B 14529B	58, Black, LH Front & RH Rear .....	Each	38.03
B 14529C	59; White, RH Front & LH Rear, 60; White, LH Front & RH Rear .....	Each	38.03
B 14529D	59; White, LH Front & RH Rear 60; White, RH Front & LH Rear .....	Each	38.03
B 14529E	61/62; Chrome .....	Each	38.03
B 14529F	63, Chrome .....	Each	38.03

Fits in the Quarter Trim panel

### B 14540 Power Window Lockout Switch

B 14540A	61/62; Chrome .....	Each	46.48
B 14540B	64/66; Chrome .....	Each	46.48

### B 14553 Window Motor

B 14553A	58/60; All Windows .....	Each	178.45
B 14553B	61 & Early 62; All Windows ..	Each	178.45
B 14553C	Late 62 & 63; All Window & 64 Doors .....	Each	178.45
B 14553E	64/66; Door Window Motor RH .....	Each	178.45
B 14553F	64/66; Door Window Motor LH .....	Each	178.45
B 14553G	64/66; Quarter Window Motor RH .....	Each	178.45
B 14553H	64/66; Quarter Window Motor LH .....	Each	178.45



B 14553F

*Note: These Motors Are New, NOT Rebuilt.*

### B 14570 Power Window & Seat Switch Clip

B 14570A	58/62 .....	Each	2.60
----------	-------------	------	------

### B 14570 Window Switch Clip

B 14570B	58/66 .....	Each	2.60
B 14570C	64/66 .....	Each	2.60

## Window Regulator Switch & Wiring



B 14632F



B 14632G

### B 14632 Window Regulator Switch & Wiring

B 14632D	63, Rear, RH or LH .....	Each	40.75
B 14632E	63, Front, RH or LH .....	Each	40.75
B 14632F	64/66; Switch & Wiring In Console RH Or LH, Rear Qtr. Window or Frt Vent Window .....	Each	32.85
B 14632G	64/66; Switch & Wiring In Console RH Or LH, Front Door Window .....	Each	32.85

# DOORS & WINDOWS

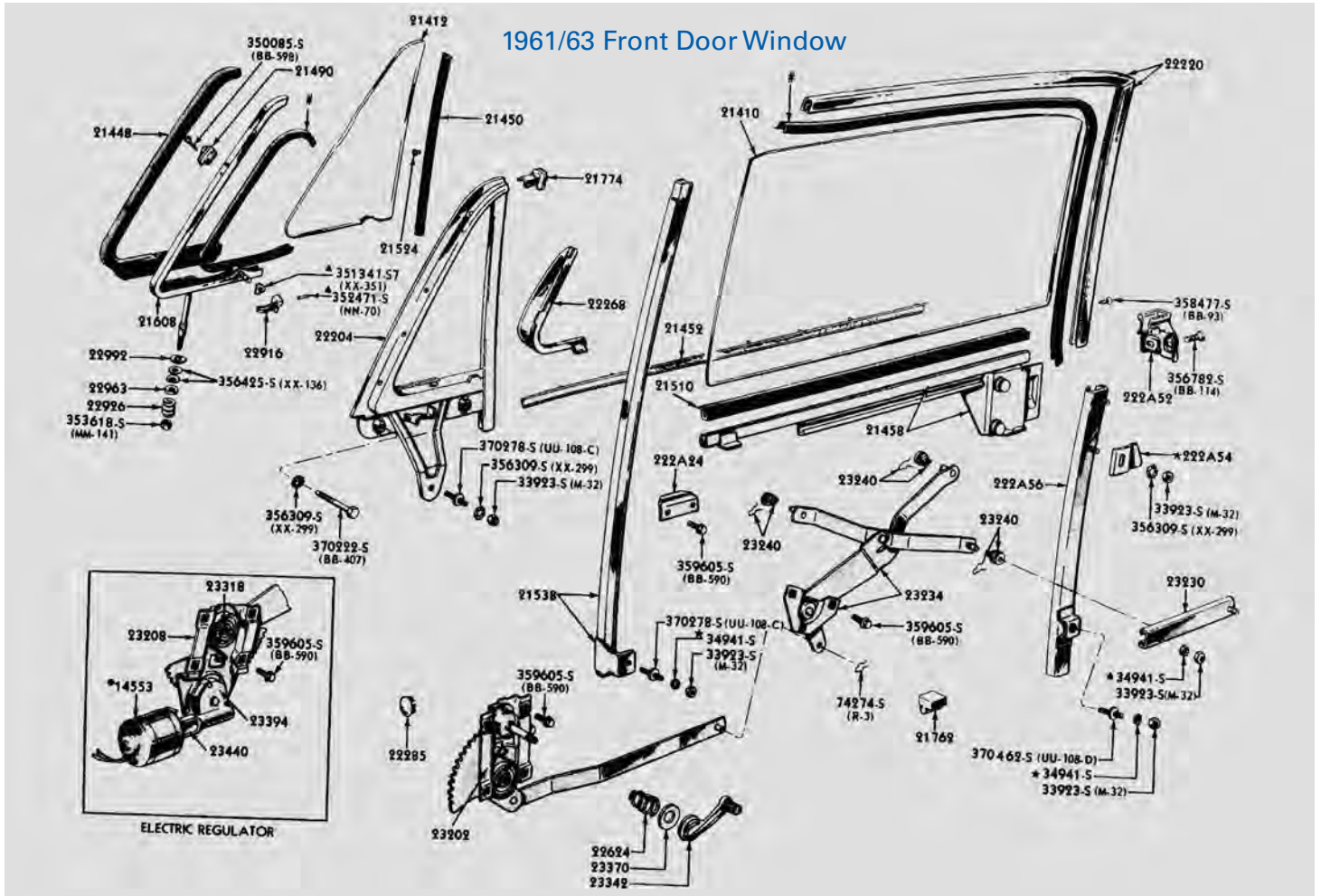

## Electric Window Safety Relay Assembly

B 14677A



Electric Window Safety Relay Assembly  
B 14677A 61/66 ..... 53.01

**B 16758 Door & License Plate Bumper**  
B 16758C 58/60; Door & Fuel Filler Door,  
Front/Rear License Plates ..... Each 2.60

**B 20126 Lower Door Drain Seal**  
B 20126A 61/66; Fits on bottom of Door, 3 per door ..... Each 2.93

**B 20530 Front Door Weatherstrip**  
B 20530A 58/60; RH & LH ..... Pair 88.69  
B 20530B 61/62; RH & LH ..... Pair 80.53  
B 20530C 64/65; RH & LH ..... Pair 91.75  
B 20530D 66; RH & LH ..... Pair 90.78  
B 20530E 63; RH & LH ..... Pair 80.53

B 20580A



**B 20580 Front Door at Belt Weatherstrip**  
B 20580A 58/60 ..... Pair 20.11

**B 20586 Weatherstrip Retainer**  
B 20586A 66; RH & LH ..... Each .52

## Door Wiring Guide

B 20768A



**B 20768 Door Wiring Guide**  
B 20768A 58/60; RH ..... 34.68  
B 20769A 58/60; LH ..... 34.68

## 1961/63 Door Lock & Related Parts

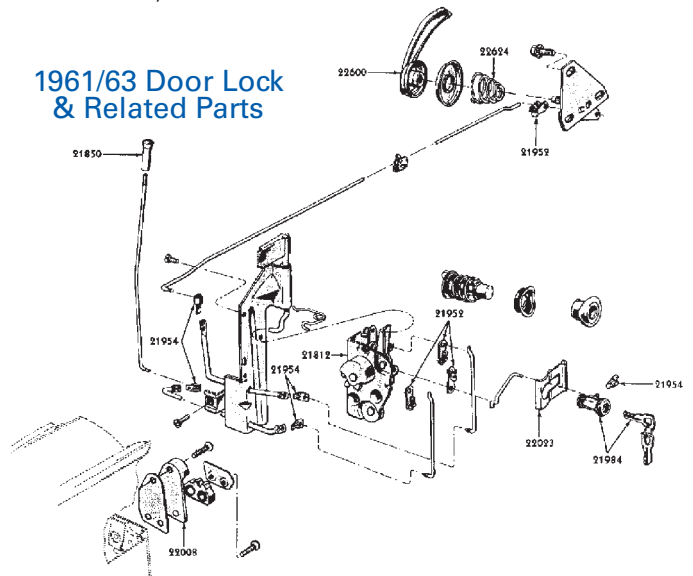

# DOORS & WINDOWS

- B 20910 Door Edge Guards**  
 B 20910B 61/63; Stainless ..... Pair 26.48

## Outside Door Ornament

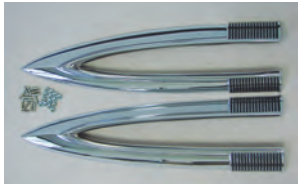

B 20980C



B 20980B



B 20980A



B 20981A

- B 20980/1 Outside Door Ornament  
 B 20980A 63; RH, (3 Required Per Door) ..... Each 21.37  
 B 20981A 63; LH, (3 Required Per Door) ..... Each 21.37  
 B 20980B 58; (5 Required Per Door) ..... Each 19.05  
 B 20980C 59; Chrome Spear Head ..... Pair 195.50

- B 21032 Door Panel Retainer**  
 B 21032A 58/60; Lower ..... Each 20.35  
 B 21032B 61/63; Lower ..... Each 20.35

- B 21402 Vent Window Glass**  
 B 21402A 58/60; Clear ..... Each 22.39  
 B 21402B 58/60; Tint ..... Each 22.39

- B 21410 Door Window Glass**  
 B 21410A 58/60; Clear ..... Each 64.21  
 B 21410B 58/60; Tint ..... Each 66.25  
 B 21410CC 61/63; RH Clear ..... Each 208.03  
 B 21410CT 61/63; RH Tint ..... Each 220.27  
 B 21411CC 61/63; LH Clear ..... Each 208.03  
 B 21411CT 61/63; LH Tint ..... Each 220.27

- B 21448 Vent Window Seal**  
 B 21448A 58/60 ..... Pair 109.95  
 B 21448B 61/63 ..... Pair 90.78  
 B 21448C 64/66 ..... Pair 86.70

- B 21450 Vent Window e Rear Seal**  
 B 21450A 58/60 ..... Pair 19.98  
 B 21450B 61/63 ..... Pair 19.98  
 B 21450C 64/66 ..... Pair 19.98

- B 21458 Door & Quarter Beltline Weatherstrip Set (Inside & Outside)**  
 B 21458A 61/63; (Coupe) 8-Piece Set ..... 95.46  
 B 21458B 61/63; (Convertible) 10-Piece Set ..... 101.95  
 B 21458C 64/66; (Coupe) 8-Piece Set ..... 95.46  
 B 21458D 58/60; (Hardtop) 8-Piece Set ..... 86.70  
 B 21458E 58/60; (Convertible) 8-Piece Set ..... 86.70  
 B 21458F 64/66; (Convertible) 8-Piece Set ..... 112.15

- B 21538 Front Vent Window Division Frame Channel**  
 B 21538B 58/60 ..... Pair 48.85  
 B 21538C 64/66 ..... Pair 48.85

## Front Vent Upper Bumper

- B 21774A 58/60 ..... Pair 14.97  
 B 21774B 61/63 ..... Pair 23.29  
 B 21774C 64/66 ..... Pair 23.29

- B 21801 Door Lock Pawl (includes Washers) Bushing**  
 B 21801B 64 ..... 3.75

## Door Latch Assembly



B 21812C

- B 21812C 64; RH, Without Vacuum Door Lock ..... 68.93  
 B 21813C 64; LH, Without Vacuum Door Lock ..... 68.93  
 BHK 147 Door Latch, 64/66, 2 Sides (6 Pieces) ..... 4.44

## Inside Door Handle Actuator

- B 21818B 61/63; RH ..... Each 45.85  
 B 21818C 64/66; RH ..... Each 45.85  
 B 21819B 61/63; LH ..... Each 45.85  
 B 21819C 64/66; LH ..... Each 45.85

## Door Lock Knob



B 21850A



B 21850B

- B 21850 Door Lock Knob**  
 B 21850A 65/66; Chrome Finish ..... Each 4.15  
 B 21850B 61/63; Chrome Finish, die-cast ..... Each 6.90  
 B 21850C 64; Chrome Finish, die-cast ..... Each 6.90  
 B 21850D 58/60; Black ..... Each 6.90

- B 21910 Door Latch Remote Spring**  
 B 21910A 58/60 ..... 5.83

- B 21952 Door Lock Rod Clip**  
 B 21952A 64; (From 3/1/64) ..... 4.95  
 B 21954A 65/66 ..... 6.89



B 21952A

## Front Door Lever



21970C

- B 21970 Front Door Operating Lever**  
 B 21970C 58/60; RH ..... 15.87  
 B 21971A 58/60; LH ..... 15.87

## Door Lock Knob Grommet



B 21999D

- B 21999A 58/63; Black ..... Each 4.77  
 B 21999B 58/63; White ..... Each 4.77  
 B 21999C 64 ..... Each 7.37  
 B 21999D 65/66 ..... Each 7.37

## Deluxe Door Panels

Larry's Deluxe Door Panels are a semi-complete panel that features a sturdy plastic backing (an improvement over the original!) and feature correct contours and are moulded to original specifications, then covered with correct vinyl material. Sold In Pairs Only.

### 1958/59 *Must use existing trim items.*

BDP C58BK	58/59	Black/White .....	Pair	645.00
BDP C58BU	58	Blue/White .....	Pair	645.00
BDP C58GN	58/59	Green/White .....	Pair	645.00
BDP C58PO	58/59	Palomino/White.....	Pair	645.00
BDP C58RD	58/59	Red/White .....	Pair	645.00
BDP C58TQ	58	Turquoise/White.....	Pair	645.00
BDP C58BK	58/59	Black/White .....	Pair	645.00
BDP C59BU	59	Blue/White .....	Pair	645.00
BDP C59TQ	59	Turquoise/White.....	Pair	645.00

### 1960 *Vinyl design with squares. Must use existing trim items*

BDP C60BK	60	Black/White .....	Pair	645.00
BDP C60BU	60	Blue/Blue.....	Pair	645.00
BDP C60RD	60	Red/White .....	Pair	645.00
BDP C60TN	60	Dk. Brown/Lt. Brown.....	Pair	645.00
BDP C60TQ	60	Turquoise/Turquoise.....	Pair	645.00

### 1961/62 (early '62 - Before 4/16/62) *With recess to mate with original dash and detachable arm rest(not included).*

BDP C61BK	61 (early 62)	Black .....	Pair	675.00
BDP C61WT	61 (early 62)	White .....	Pair	675.00
BDP C62BK	(late) 62/63	Black .....	Pair	675.00
BDP C62WT	(late) 62/63	White.....	Pair	675.00

## 1962/63 Combination Door Panel

Features Ford's late 62/63 style, except it has the recessed area in the upper front corner where it meets the dash like 61/early 62 panel. To be used with 61/62 Dash Pad. Sold In Pair Only. Moulded armrest. Special Order Item Only.

BDP C63BK	(late) 62/3	Black	(combo).....	Pair	675.00
BDP C63WT	(late) 62/3	White	(combo).....	Pair	675.00

### 1964 Standard: (Will not accept Woodgrain) \*These are a special order item. *Landau: Must use existing woodgrain panel.*

BDP C64BK	64	Black	(Standard) .....	Pair	675.00
BDP C64LBK	64	Black	(Landau) .....	Pair	675.00
BDP C64WT	64	White	(Standard) .....	Pair	675.00
BDP C64LWT	64	White	(Landau) .....	Pair	675.00

### 1965 Standard: (Will not accept Woodgrain) \*These are a special order item. *Landau: Must use existing woodgrain panel.*

BDP C65BK	65	Black	(Standard) .....	Pair	675.00
BDP C65LBK	65	Black	(Landau) .....	Pair	675.00
BDP C65WT	65	White	(Standard) .....	Pair	675.00
BDP C65LWT	65	White	(Landau) .....	Pair	675.00

### 1966 Standard: (Will not accept Woodgrain) \*These are a special order item.

BDP C66BK	66	Black	(Standard) .....	Pair	675.00
BDP C66WT	66	White	(Standard) .....	Pair	675.00

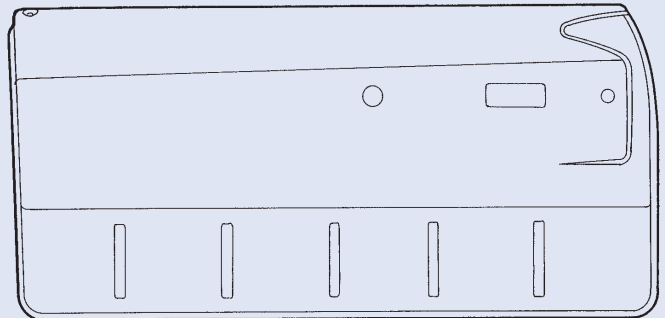

1961/Early 1962

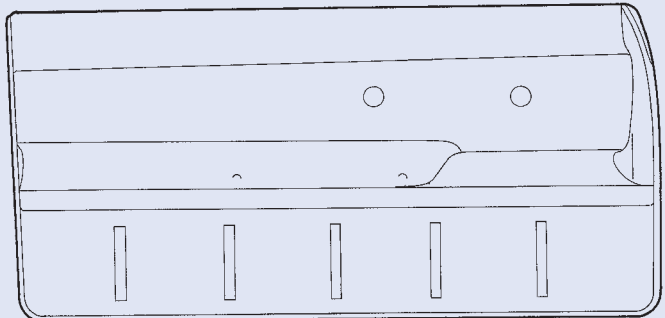

1962/63 Door Panel

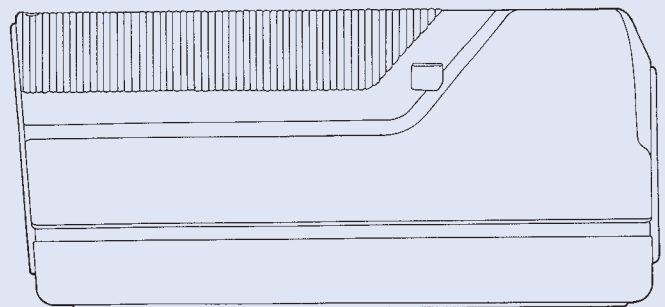

1964/65 Door Panel (Not Landau)

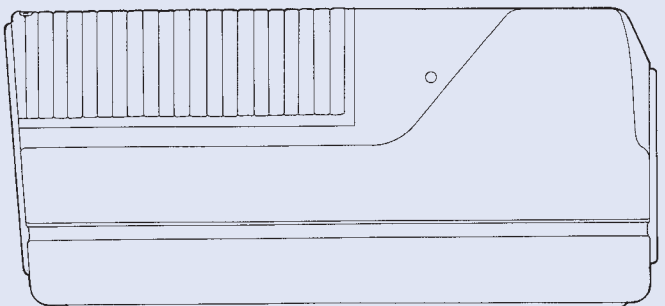

1966 Door Panel



# DOORS & WINDOWS

## Door Pull Cup Brackets

B 24110A 65/66; Door Pull Cup Brackets ..... Pair 16.25

## Door Panel Armrests



B 24140A

B 24140A 61/62; RH..... Each 81.55  
 B 24141A 61/62; LH..... Each 81.55  
 BHK 167 Door Panel Armrest Cup, 61/63, 2 Sides  
 (4 Pieces)..... 2.06

## Door Panel Pull Cups



B 24142A 58/60 & Late 62/63..... Pair 21.95

## Door/Trim Attaching Hardware

BHK 130 Dr. Hinge To Door, 2 Hinges, 61/63,  
 1 Door (8 Pieces)..... 5.37  
 BHK 131 Dr. Hinge To Door, 2 Hinges, 64/66,  
 1 Door (12 Pieces)..... 11.49  
 BHK 133 Dr. Hinge To Body, 2 Hinges, 64/66,  
 1 Side (16 Pieces)..... 9.92  
 BHK 138 Step Plates, 61/62, 2 Sides (18 Pieces)..... 5.12  
 BHK 155 Door Belt Cap-Front, (20360/1), 61/63,  
 2 Sides (4 Pieces)..... 2.00  
 BHK 156 Door Belt Cap-Rear, (20362/3), 61/63,  
 2 Sides (10 Pieces)..... 3.50  
 BHK 157 Door Panels, 58/60, (18 Pieces)..... 10.36  
 BHK 158 Door Trim Panel Retainer-Front, (237A24/5),  
 61/63, 2 Sides (8 Pieces)..... 3.00  
 BHK 159 Door Trim Panel Retainer-Rear, (237A26/7),  
 61/63, 2 Sides (4 Pieces)..... 2.06  
 BHK 160 Inside Stainless Above Door,  
 58/60, (8 Pieces) ..... 2.88  
 BHK 161 Inside Moulding Over Door,  
 64/66, 2 Sides (6 Pieces)..... 2.38  
 BHK 162 Rear Of Door Top Protective Moulding,  
 64/66, 2 Sides (4 Pieces)..... 2.06  
 BHK 163 Stainless Steel Moulding,  
 64/66, 2 Sides (8 Pieces)..... 3.00  
 BHK 169 Door Light Bezel,  
 61/63, 2 Sides (4 Pieces)..... 2.31

## Door Skin Repair Panel

BPP 20124BH 64/66; RH..... Each 91.75  
 BPP 20125BH 64/66; LH..... Each 91.75

## Door Panel Carpet

BDC AQ 64/66 Aqua ..... Pair 50.95  
 BDC BK 64/66 Black ..... Pair 50.95  
 BDC BU 64/66 Dark Blue ..... Pair 50.95  
 BDC DKGN 64/66 Dark Green ..... Pair 50.95  
 BDC DKSD 64/66 Dark Saddle ..... Pair 50.95  
 BDC EMB 64/66 Emberglo ..... Pair 50.95  
 BDC IG 64/66 Ivy Gold ..... Pair 50.95  
 BDC LTBU 64/66 Light Blue ..... Pair 50.95  
 BDC MDSD 64/66 Medium Saddle ..... Pair 50.95  
 BDC MN 64/66 Maroon ..... Pair 50.95  
 BDC MSGN 64/66 Moss Green ..... Pair 50.95  
 BDC RD 64/66 Red ..... Pair 50.95



B 22023A

B 22023 Door Lock Cylinder Retainer  
 B 22023A 65/66 ..... Each 4.59  
 B 22023B 58/60 ..... Pair 8.44

## Quarter Trim Caps

B 31490A 64/66; Rear Upper Convertible..... Pair 30.55  
**Note: These parts come primed and must be painted to match your interior.**



*Big Selection of Parts! Whether it's a hard to find part or a standard Thunderbird replacement part, Larry's has what you're looking for. Our inventory of parts is concours-quality. Give us a call if you can't find the parts you need. Our knowledgeable parts specialists will be happy to help!*

# DOORS & WINDOWS

## Door Lock Cylinder & Key Set



B 22050A

B 22050A	61/64; (Less Lever)	51.97
B 22050B	65/66;	57.17
B 22050C	58/60	81.55

## Key Blank Set Door & Trunk Locks



B 22051CK 58/64; Ignition & Trunk Keys, As Original ... Per Set 3.75

B 22051CK

<b>B 22075</b>	<b>Door Lock Lever Retainer Spring</b>	
B 22075A	58/60	.67
<b>B 22268</b>	<b>Vent Window Deflector</b>	
B 22268A	61/63; Vent Window Air Deflector, Plastic	Pair 33.15

## Vent Window Frame Seal

<b>B 22380</b>	<b>Vent Window Frame Seal</b>	
B 22380B	64/66; Fits on Vent Window Frame to Door Panel Inner Extension	Pair 21.87

## Exterior Door Handle & Related Parts



<b>B 22400/1/4/5</b>	<b>Outside Door Handle</b>	
* B 22400AK	58/60;	Pair 137.90
* B 22400A	58/60; RH	Each 74.24
* B 22401A	58/60; LH	Each 74.24
* Includes The Buttons & Attaching Hardware.		
B 22404A	64/66; RH, (Button not included)	Each 74.95
B 22405A	64/66; LH, (Button not included)	Each 74.95
<b>B 22406</b>	<b>Outside Door Button Bezel</b>	
B 22406A	61/63; Chrome	Each 21.50
<b>B 22428</b>	<b>Outside Door Handle Pad</b>	
B 22428A	58/60;	Per Set 8.44
B 22428B	64/66;	Per Set 10.56
<b>B 22454/5</b>	<b>Door Handle Button Assembly</b>	
B 22454A	61/63	Each 38.32
B 22454B	58/60; RH	Each 18.57
B 22455B	58/60; LH	Each 18.57
B 22454C	64/66	Each 18.95

## Trim Adhesives

Use on weatherstripping and other areas of the car.



B 19552A

B 19552A Black cement, 2 oz. tube ..... 10.97



B 19552B

B 19552B Yellow cement, 2 oz. tube .... 8.93

B 19552C Spray Adhesive, 16.75 oz. can ..... 26.50

B 19552C

## Interior Door Handle & Related Parts

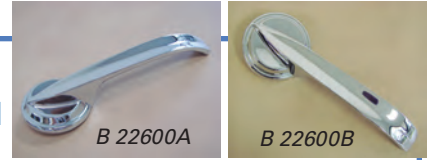

B 22600A

B 22600B

B 22600A	58/63	25.45
B 22600B	64/66; RH	20.76
B 22601A	64/66; LH	20.76
BHK 148	Door Handle Regulator, 58/60 (12 Pieces)	4.24
BHK 171	Inside Door Handles, 64/66, 2 Sides (4 Pieces)	1.94

### Escutcheon

B 22620A	64/66; Chrome, RH	7.25
B 22621A	64/66; Chrome, LH	7.25

<b>B 22601</b>	<b>Door Handle Removal Tool</b>	
B 22601T	All Years [See Page 74 for photo and more details]	Each 8.67
<b>B 22624</b>	<b>Door &amp; Window Handles Spring</b>	
B 22624A	58/63	Each .85
<b>B 22841</b>	<b>Door Hinge Bushing</b>	
B 22841B	61/66; Front Doors. Also Used On 61/63 Convertible Trunk Lid Hinge (4 Required)	Each 1.46

## Vent Window Handle & Related Parts

<b>B 22916/7</b>	<b>Vent Window Handle</b>	
B 22916A	58/60; RH	Each 19.05
B 22917A	58/60; LH	Each 19.05
B 22916B	61/63; RH	Each 16.93
B 22917B	61/63; LH	Each 16.93
<b>B 22926</b>	<b>Door Ventilating Window Pivot Spring</b>	
B 22926A	61/64	15.25

<b>B 23030</b>	<b>Door Bumper</b>	
B 23030C	64/66; Square	Each 1.31
B 16758C	58/60; Door & Fuel Filler Door Front & Rear License Plates	Each 2.60
BSP 372164	61/66; Door Bumper With Clip (1 Pair Req.)	Pair 4.85
<b>B 23240</b>	<b>Door &amp; Quarter Window Regulator Arm Roller Assembly</b>	
B 23240A	58/60; (Includes Clip)	3.03
B 23240B	61/66; (Includes Clip)	1.24
<b>B 23396</b>	<b>Window Motor to Housing Gasket</b>	
B 23396A	64/66; Gasket	Each 2.03
B 23396B	64/66; Nylon Plate	Each 5.25
<b>B 23402/3</b>	<b>Vent Window Regulator Gear</b>	
B 23402A	64/66; RH, Manual Operation	33.81
B 23403A	64/66; LH, Manual Operation	33.81
<b>B 23424</b>	<b>Window Regulator Drive Gear</b>	
B 23424B	65/66; Door & 64/66; Rear Window	26.48
<b>B 23440</b>	<b>Window Motor Drive Coupler</b>	
B 23440A	61/64; Door & Rear Quarter Window Motors	Each 11.39
B 23440R	58/60; Window & 61/66; Seat	Each 10.87

## Window Regulator Handle & Related Parts



B 23342A B 23342B B 23342C

<b>B 23342</b>	<b>Window Regulator Handle</b>	
B 23342A	58; Black knob	Each 31.78
B 23342B	59/60; White knob	Each 31.78
B 23342C	61/63; Chrome knob	Each 31.78
<b>B 23370</b>	<b>Door/Window Handle Plate</b>	
B 23370A	58/60; Inside door opening handle 58/64; Door window handle	.99

<b>B 23552</b>	<b>Door Hinge Spring Nylon Stop</b>	
B 23552P	58/66;	Each 3.01

# DOORS & WINDOWS

## Door Aluminum Trim

B 23723C	'61 & Early '62 Hardtop w/Power Windows,LH.	Each	100.82
B 23723D	'61 & Early'62 Convert w/Power Windows,LH..	Each	100.82
B 23723E	Late '62 & 63 Hardtop w/Manual Windows, No Remote Mirror, LH.....	Each	100.82
B 23723F	Late '62 Convert w/Manual Windows, LH.....	Each	100.82
B 23723G	Late '62 Hardtop w/Power Windows, LH .....	Each	100.82
B 23723H	Late '62 Convert w/Power Windows, LH.....	Each	100.82
B 23723I	'63 Hardtop w/Manual Windows & w/Remote Mirror, LH .....	Each	100.82
B 23723J	'63 Convert w/Manual Windows & No Remote Mirror, LH .....	Each	100.82
B 23723K	'63 Convert w/Manual Windows & w/Remote Mirror, LH .....	Each	100.82
B 23723L	'63 Hardtop w/Power Windows & No Remote Mirror, LH .....	Each	100.82
B 23723M	'63 Hardtop w/Power Windows &w/Remote Mirror, LH .....	Each	100.82
B 23723N	'63 Convert w/Power Windows &No Remote Mirror, LH .....	Each	100.82
B 23723O	'63 Convert w/Power Windows & w/Remote Mirror, LH .....	Each	100.82
<b>B 23724</b>	<b>Door Panel Retainers</b>		
B 23724C	64/66; Chrome, Set of 8 pcs. ....		50.95
B 23724D	61/63; Set of 4 pcs. ....		81.55
<b>B 23722/3</b>	<b>Door Panel Aluminum Trim</b>		
B 23722A	'61, & Early '62 w/Manual Windows, RH.....	Each	100.82
B 23722B	'61, & Early '62 w/Power Windows, RH.....	Each	100.82
B 23722C	Late '62 & '63 w/Manual Windows, RH.....	Each	100.82
B 23722D	Late '62 w/Power Windows, RH.....	Each	100.82
B 23722E	'63 w/Power Windows, RH .....	Each	100.82
B 23723A	'61 & Early'62 Hardtop w/Manual Windows,LH	Each	100.82
B 23723B	'61 & Early'62 Convert w/Manual Windows,LH	Each	100.82



<b>B 25622</b>	<b>Thunderbird Script</b>		
B 25622A	63/64; "Thunderbird" for Rear Quarter .....		37.78
B 25622B	65/67; "Thunderbird" for Rear Quarter.....		35.65
<b>B 28306</b>	<b>Quarter Post Seals</b>		
B 28306A	58/60 .....	Pair	24.75
B 28306B	64/66 .....	Pair	15.56
B 28306C	61/63 .....	Pair	18.73
<b>B 29032/3</b>	<b>Door Top Moulding (Outside)</b>		
B 29032A	61/63; RH .....	Each	86.70
B 29033A	61/63; LH .....	Each	86.70

Note: See B 29144A & B For The Clips as They Are Not Included With Mouldings

## Side Body Moulding Kit

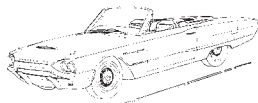

B 29040A	61/62; 10-Piece Kit .....	Full Set	275.91
B 29040B	64 or 66; 8-Piece Kit .....	Full Set	297.14
B 29040C	65; 8-Piece Kit .....	Full Set	297.14
B 29040ACK	61/62; Clip Kit .....	Set	48.96
B 29040BCK	64 or 66; Clip Kit .....	Set	48.96
B 29040CCK	66; Clip Kit .....	Set	49.93

<b>B 29710</b>	<b>Rear Quarter Glass</b>		
B 29710A	58/60; Clear .....	Each	22.39
B 29710B	58/60; Tint .....	Each	22.39
B 29710CC	61/63; RH Clear .....	Each	88.69
B 29710CT	61/63; RH Tint .....	Each	91.75
B 29711CC	61/63; LH Clear .....	Each	88.69
B 29711CT	61/63; LH Tint .....	Each	91.75

<b>B 29898</b>	<b>Quarter Window Roller</b>		
B 29898A	58/60; Rear Quarter Window, 2 Required ...	Each	8.11

<b>B 30146/7</b>	<b>Quarter Window Weatherstrip • Front</b>		
B 30146A	58/60; RH & LH .....	Pair	26.48
B 30146C	64/66; RH & LH .....	Pair	20.76
B 30146R	61/63; RH & LH .....	Pair	26.48

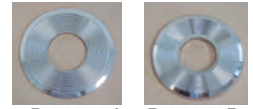

<b>B 30320</b>	<b>Door/Window</b>		
	Handle Escutcheon		
B 30320A	61/62; Qtr. Window • 63; Inside door opening handle		
	Single Bevel .....	Each	10.35
B 30320B	61/62; inside door opening handle 63; Quarter Window; Double Bevel .....	Each	10.35

Note: See Page 75 Part #B 14183 For Switch Bezel.

<b>B 43030</b>	<b>Hinge Pin</b>		
B 43030A	58/66; Door & 62/66 Convertible .....	Each	8.67

<b>B 51222</b>	<b>Roof Side Rail Weatherstrip</b>		
B 51222AR	61/63; (Coupe), RH & LH .....	Pair	212.19
B 51222BR	64/66; (Std. Coupe), RH & LH .....	Pair	84.84
B 51222CR	66; (Landau HardTop), RH & LH .....	Pair	101.75
B 51222DR	58/60 .....	Pair	212.19

## Door Area Attaching Hardware

BHK 130	Door Hinge to Door, 2 Hinges, 61/63, 1 Door, (8 Pcs.)...		5.37
BHK 131	Door Hinge to Door, 2 Hinges, 64/66, 1 Door, (12 Pcs.)		11.49
BHK 133	Door Hinge to Body, 2 Hinges, 64/66, 1 Side, (16 Pcs.)		9.92
BHK 135	Door Flaps to Fender, 64/66, 2 Sides (14 Pieces) .....		3.68
BHK 136	Door Wiring Shield, 61/63, 2 Sides (4 Pieces) .....		1.81
BHK 137	Door Wiring Shield, 64/66, 2 Sides (4 Pieces) .....		1.81
BHK 138	Step Plates, 61/62, 2 Sides (18 Pieces) .....		5.12
BHK 139	Step Plates, 58/60, 2 Sides (20 Pieces) .....		5.12
BHK 140	Step Plates, 61/63, 2 Sides (18 Pieces) .....		5.12
BHK 141	Step Plates, 64/66, 2 Sides (12 Pieces) .....		3.80
BHK 142	Striker Plate Screws, 60, 2 Sides (6 Pieces) .....		7.12
BHK 143	Striker Plate Screws, 61/63, 2 Sides (6 Pieces) .....		17.23
BHK 144	Striker Plate Screws, 64/66, 2 Sides (4 Pieces) .....		6.00
BHK 145	Door Latch, 58/60, 2 Sides (6 Pieces) .....		3.12
BHK 148	Door Handle Regulator, 58/60, (12 Pieces) .....		4.24
BHK 149	Door Window Stops, 58/60, (16 Pieces) .....		5.37
BHK 155	Door Belt Cap—Front (20360/1), 61/63, 2 Sides (4 Pts.)		2.00
BHK 156	Door Belt Cap—Rear (20362/3), 61/63, 2 Sides (10 Pcs)		3.50
BHK 157	Door Panels, 58/60, (18 Pieces) .....		10.36
BHK 158	Door Trim Panel Retainer - Front (237A24/5), 61/63, 2 Sides (8 Pieces) .....		3.00
BHK 159	Door Trim Panel Retainer—Rear (237A26/7), 61/63, 2 Sides (4 Pieces) .....		2.06
BHK 160	Inside Stainless above Door, 58/60, (8 Pieces) .....		2.88
BHK 161	Inside Moulding Over Door, 64/66, 2 Sides (6 Pieces)		2.38
BHK 162	Rear Of Door Top Protective Moulding, 64/66, 2 Sides (4 Pcs) .....		2.06
BHK 163	Stainless Steel Moulding, 64/66, 2 Sides (8 Pieces) ...		3.00
BHK 167	Door Panel Armrest Cup, 61/63, 2 Sides (4 Pieces) .....		2.06
BHK 169	Door Light Bezel, 61/63, 2 Sides (4 Pieces) .....		2.31
BHK 171	Inside Door Handles, 64/66, 2 Sides (4 Pieces) .....		1.94
BHK 172	Window Regulator Height Guide Nuts, 58/60, (4 Pcs.)		1.56
BHK 173	Door Bumper, 61/63, 2 Sides (2 Pieces) .....		6.56
BHK 174	Quarter Window Regulator & Stop, 58/60, (6 Pieces)		2.12
BHK 175	Window Guide, 61/63, 2 Sides (6 Pieces) .....		2.94
BHK 176	Door Window Regulator, 58/60, (12 Pieces) .....		4.12
BHK 177	Window Railer Guide, 58/60, (8 Pieces) .....		2.74
BHK 229	Quarter Window Regulator, 58/60, (8 Pieces) .....		2.88
BHK 235	Door Courtesy Light Cover, 61/63, (2 Pieces) .....		1.74
BHK 243	Inside Stainless, back of Qtr. Window, 58/60, (4 pcs) ..		1.56
BHK 247	Qtr. Window, Front Corner Stainless, 58/60, (4 Pieces)		1.50
BHK 364	Door Light Bezel, 64/66, 2 Sides, (4 Pieces) .....		2.12
BHK 411	Qtr. Lock Pillar Weatherstrip—Upper, Front (28306/7) 61/63, 2 Sides, (4 Pieces) .....		1.74
BHK 412	Qtr. Pillar Seal at Belt, 64/66, 2 Sides, (8 Pieces) .....		2.81
BSP 74247	Clip—Window Regulator to Scissors .....	Each	.94
BSP 358996	Screw—Door Striker Plate, 58/63 .....	Each	1.28
BSP 372164	Door Bumper, with Clip, 61/66, (1 Pair Req.) .....	Pair	4.85
BSP 379259	Screw—Inside Door Handles, 64/66 .....	Each	1.04

# REAR QUARTER PANEL AREA

- B 10358** Rocker Panel Drain Plug  
 B 10358A 64/66; ..... Each 2.03

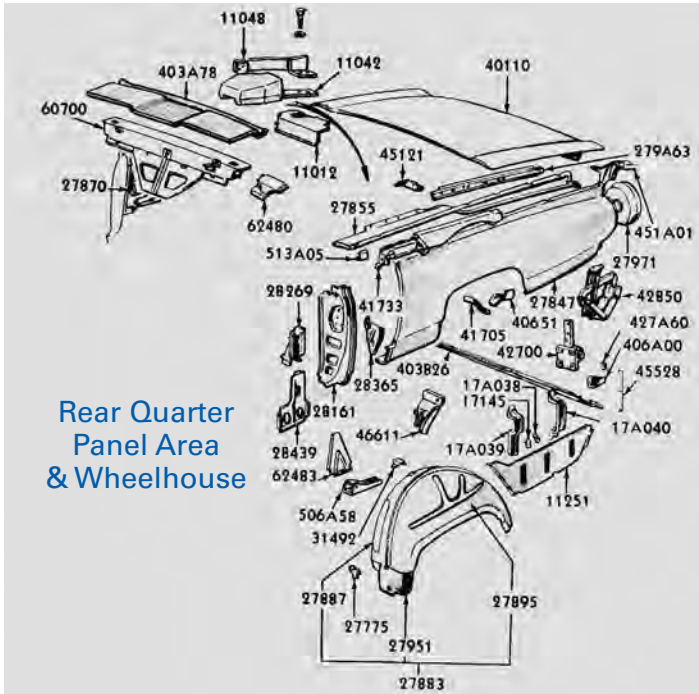

Rear Quarter Panel Area & Wheelhouse

- B 20842** Body Side Moulding Clip  
 B 20842A 61/66; As Req. .... Each 3.06

## Rear Quarter Panel Ornament

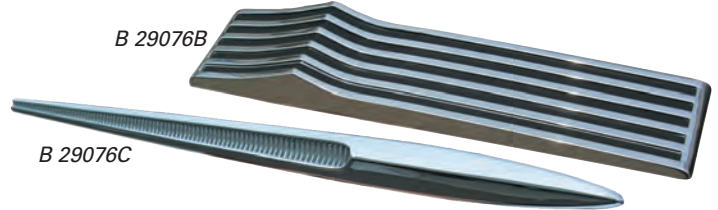

- B 29076B 62;  
 6 Required Per Car ..... Each 25.50  
 B 29076C 61;  
 8 Required Per Car ..... Each 13.47

- B 28984** Quarter Panel Emblem  
 B 28984A 60; Early Type With Holes, 9 Piece Set ..... Each 127.30  
 B 28984B 60; Late Style With Studs, Set of 9, RH or LH Set 135.20  
 BHK 413 Rear Qtr. Panel Ornaments, '60, 18 Pcs. .... 4.37

- B 29124** Quarter Panel Trim Cap  
 B 29124A 61/63; RH ..... Each 32.59  
 B 29125A 61/63; LH ..... Each 32.59

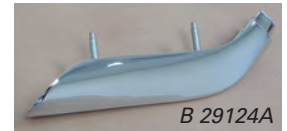

- B 29140** Quarter Panel Top Moulding  
 B 29140A 61/63; Includes Clips ..... Each 114.39



- B 29144** Body Moulding Clip  
 B 29144A 61/63; Metal ..... Each 4.11  
 B 29144B 61/63; Plastic ..... Each 1.56

- B 29246** Quarter Panel Extension  
 B 29246A 58/60; RH ..... Each 106.95  
 B 29247A 58/60; LH ..... Each 106.95

- B 30146 Quarter Panel Weatherstrip (Front)  
 B 30146A 58/60; RH & LH ..... Pair 26.48  
 B 30146C 64/66; RH & LH ..... Pair 20.76  
 B 30146R 61/63; RH & LH ..... Pair 26.48

- BPP 11248/9** Lower Front Wheelhouse  
 BPP 11248A 61/63; RH ..... 74.41  
 BPP 11249A 61/63; LH ..... 74.41

- BPP 11250/ 1 A** Rear Wheelhouse Extension  
 Rear Wheelhouse Extensions repair the area behind the rear wheel, extending from the bottom of the Quarter Panel to the Trunk Floor Panel.  
 BPP 11250A 61/63; RH ..... 127.45  
 BPP 11251A 61/63; LH ..... 127.45  
 BPP 11250B 64/66; RH ..... 127.50  
 BPP 11251B 64/66; LH ..... 127.50

- BPP 27846LF** Rear Quarter Panel Repair—(Lower Front)  
 BPP 27846LF 58/60; RH ..... 127.50  
 BPP 27847LF 58/60; LH ..... 127.50  
 BPP 27846AF 61/63; RH ..... 132.55  
 BPP 27847AF 61/63; LH ..... 132.55  
 BPP 27846BF 64/66; RH ..... 127.50  
 BPP 27847BF 64/66; LH ..... 127.50

- BPP 27846LR** Rear Quarter Panel Repair—(Lower Rear)  
 BPP 27846LR 58/60; RH ..... 142.95  
 BPP 27847LR 58/60; LH ..... 142.95

- BPP 27984/5** Outer Wheelhouse Top Cap  
 BPP 27984BT 64/66; RH ..... 91.80  
 BPP 27985BT 64/66; LH ..... 91.80

### Fender Skirts and Related Parts

B 27974B

**B 27974** Fender Skirts in Metal  
 B 27974B 61/63; Fender Skirts in Metal ..... Pair...285.00  
 BSP 370034 58/66; Fender Skirt Locating Pin .....Each.....2.08

**B 27986** Fender Skirt Seal  
 B 27986AR 61/63 ..... Pair..... 13.47  
 B 27986BR64/66 ..... Pair..... 13.47  
 B 27986C 58/60 ..... Pair..... 13.52

**Staple Kit**  
 B 27986SK58/66; For Fender Skirt Seals (20 Staples) ..... 1.71

- B 28306** Quarter Post Seals  
 B 28306A 58/60; Upper ..... Pair 24.75  
 B 28306B 64/66; Upper ..... Pair 15.56  
 B 28306C 61/63; Upper ..... Pair 18.73

### Side Body Moulding Kit

B 29040A 61/62; 10-Piece Kit ..... Full Set 275.91  
 B 29040B 64 or 66; 8-Piece Kit ..... Full Set 297.14  
 B 29040C 65; 8-Piece Kit ..... Full Set 297.14  
 B 29040ACK 61/62; Clip Kit ..... Set 48.96  
 B 29040BCK 64 or 66; Clip Kit ..... Set 48.96  
 B 29040CCK 66; Clip Kit ..... Set 49.93

# TRUNK & REAR BODY AREA

## Original-Style Gas Caps



B 9030A	61/66; Non-Locking, Vented	7.09
B 9030B	61/66; Locking, Vented	15.87
B 9030C	58/60; Non-Locking	7.09
B 9030D	58/60; Locking	15.15

<b>B 13564</b>	<b>Rear License Plate Lamp Lens</b>		
B 13564A	64/66	9.07	
BHK 377	Rear License Plate Light, 64/66, (2 Pieces)	1.74	
<b>B 13568</b>	<b>Rear License Plate Lamp Lens Gasket</b>		
B 13568A	64/66	1.10	
<b>B 16758</b>	<b>Hood Bumper</b>		
B 16758C	58/60; Door & Fuel Filler Door, Front/Rear License Plates	Each	2.60
<b>B 29246/7</b>	<b>Quarter Panel Extension</b>		
B 29246A	58/60; RH	106.95	
B 29247A	58/60; LH	106.95	
<b>B 40334</b>	<b>Lower Back Panel to Bumper Splash Shield</b>		
B 40334A	61/63; Rubber Seal, Hard Top	Pair	11.89
<b>B 40334</b>	<b>Body to Bumper Splash Shield</b>		
B 40334B	64/66; Convertible	132.60	
<b>B 40340</b>	<b>Rear Bumper Stone Deflector</b>		
B 40340A	64/66	Pair	15.87
<b>B 40350</b>	<b>Trunk Lid to Rear Body Panel Seal</b>		
B 40350A	64/66; Correct Holes For Clips	18.75	
B 40350AK	64/66; Correct Holes For Clips, Includes Clips	28.50	

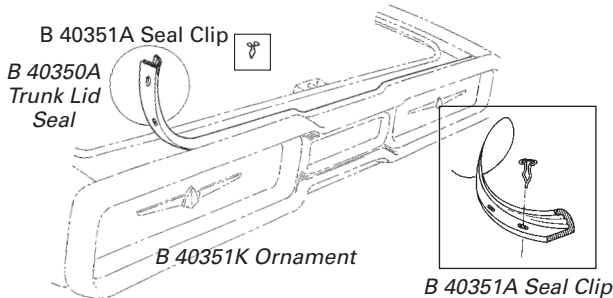

<b>B 40351</b>	<b>Trunk Lid to Rear Body Panel Seal Clip</b>		
B 40351A	64/66; (16 Required Per Car)	Each	.79
<b>BSP 359152</b>	<b>Hardware</b>		
BSP 359152	61/63; Clip For "40310" Panel (5 Required)	Each	6.07



Your Number One Source for  
T-Bird Restoration Parts!

## Gas Filler Door



B 40560B

<b>B 40560</b>	<b>Gas Filler Door</b>		
B 40560B	61/63; Chrome	Each	81.55

<b>B 42084</b>	<b>Rear Window Weatherstrip</b>		
B 42084A	61/63	83.18	
B 42084B	64/66; (Not For 1966 Blind Roof)	80.53	
B 42084C	58/60	122.35	

<b>B 40610</b>	<b>Convertible Deck Lid Hydraulic Cylinder</b>		
B 40610A	60; 2 required	Each	152.95
B 40610B	61/62 (early); 2 1/4" diameter, 2 required	Each	152.95
B 40610C	(late) 62/63; 1 3/4" diameter, 2 required	Each	152.95
B 40610D	64; 2 required	Each	152.95
B 40610E	65/66; 2 required	Each	152.95

<b>B 42413</b>	<b>Outside Moulding Retainer</b>		
B 42413B	66	Each	.47

<b>B 42462</b>	<b>Back Window Drain Hoses</b>		
B 42462A	64/66; Channels water through the trunk area so rust out is minimized	Pair	69.87



B 42462A

## Trunk Lid Emblem Insert

B 42514A	61/63	20.32
----------	-------	-------

<b>B 42541</b>	<b>Trunk Lock Lid Cover Spacer</b>		
B 42541A	58/59; Beveled	Each	14.33

<b>B 43030</b>	<b>Hinge Pin</b>		
B 43030A	60/66; Door 62/66; (Convertible) Trunk		8.67

<b>B 43283</b>	<b>Trunk Lock Extension</b>		
B 43283A	61/63	14.75	

<b>B 43226</b>	<b>Trunk Lock Actuator Rod</b>		
B 43226A	64/66	Each	8.11

<b>B 43358</b>	<b>Trunk Lock Cylinder Extension Lever</b>		
B 43358A	64	Each	19.95
B 43358B	65/66	Each	18.31

## Trunk Lock Lever Kit

B 43358AK	64	Set	24.43
B 43358BK	64/66	Set	24.43

Note: Set includes the lever, rod and clips.

## Trunk Lid Ornament & Cover



B 43501K

B 43501K	61/63; Ornament & Lock Cover Fully Assem. W/Proper Spring & Washer, (Less Plastic Ornament. #42514-A)	79.95
B 43501BK	61/63 Convertible	100.73
B 43501EK	64 Coupe/Landau	84.84
B 43501FK	65/66 Coupe/Landau	84.84
B 43516A	61/63 Coupe Trunk Lid Cover	32.95
B 43516E	60 Convertible; Lock Cover	35.65
BSP 351548	58/63; Washer	.99
BSP 356164	58/63; Nut	1.51
BSP 373504	61/63; Pal Nut	Each .53

<b>B 46593</b>	<b>Convertible Flip Lid Motor Coupler</b>		
B 46593A	60/66; Motor to transmission	Each	21.18

# TRUNK & REAR BODY AREA

## Original-Style Trunk Mats

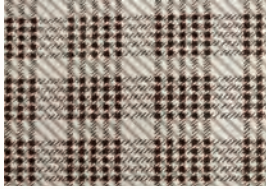

B 45457A0



B 45457A2



B 45457A5

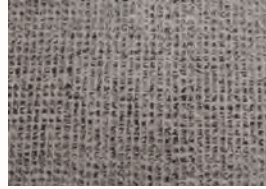

B 45457A6



B 45457B8

Each mat is hand-crafted to fit the contours of the trunk area without bagginess or improper fit.

Constructed from Heavy-Weight vinyl for years of use.

Trunk Mats Kits Include: Mat, Mounting Boards & all Mounting Hardware.

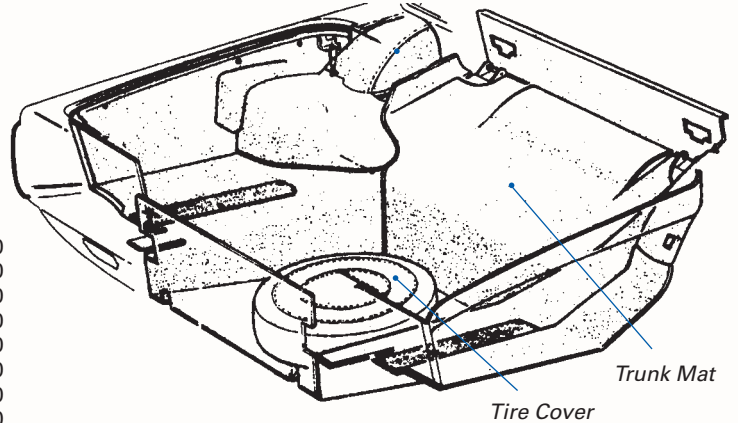

### Trunk Mat Sets w/Boards

B 45456A0	60	Coupe	.....	Each	150.00
B 45456A1	61	Coupe	.....	Each	150.00
B 45456A2	62	Coupe	.....	Each	150.00
B 45456A3	63	Coupe	.....	Each	150.00
B 45456A4	64	Coupe	.....	Each	150.00
B 45456A5	65	Coupe	.....	Each	150.00
B 45456A6	66	Coupe	.....	Each	150.00
B 45456A8	58/59	Coupe	.....	Each	150.00

B 45456B0	60	Convertible	.....	Each	150.00
B 45456B1	61	Convertible	.....	Each	150.00
B 45456B2	62	Convertible	.....	Each	150.00
B 45456B3	63	Convertible	.....	Each	150.00
B 45456B4	64	Convertible	.....	Each	150.00
B 45456B5	65	Convertible	.....	Each	150.00
B 45456B6	66	Convertible	.....	Each	150.00
B 45456B8	58/59	Convertible	.....	Each	150.00

### Trunk Mat Sets

B 45457A0	60	Coupe	.....	Each	87.50
B 45457A1	61	Coupe	.....	Each	87.50
B 45457A2	62	Coupe	.....	Each	87.50
B 45457A3	63	Coupe	.....	Each	87.50
B 45457A4	64	Coupe	.....	Each	87.50
B 45457A5	65	Coupe	.....	Each	87.50
B 45457A6	66	Coupe	.....	Each	87.50
B 45457A8	58/59	Coupe	.....	Each	87.50

B 45457B0	60	Convertible	.....	Each	87.50
B 45457B1	61	Convertible	.....	Each	87.50
B 45457B2	62	Convertible	.....	Each	87.50
B 45457B3	63	Convertible	.....	Each	87.50
B 45457B4	64	Convertible	.....	Each	87.50
B 45457B5	65	Convertible	.....	Each	87.50
B 45457B6	66	Convertible	.....	Each	87.50
B 45457B8	58/59	Convertible	.....	Each	87.50

### Tire Covers

B 45400A1	60/61	Standard	Conv./Coupe	.....	Each	28.95
B 45400A2	62/64	Standard	Conv./Coupe	.....	Each	28.95
B 45400A5	65	Standard	Conv./Coupe	.....	Each	28.95
B 45400A6	66	Standard	Conv./Coupe	.....	Each	28.95
B 45400A8	58/59	Standard	Conv./Coupe	.....	Each	28.95

B 45400B4	64	Deluxe	Convertible	.....	Each	65.79
B 45400B5	65	Deluxe	Convertible	.....	Each	65.79
B 45400B6	66	Deluxe	Convertible	.....	Each	65.79

### Covered Trunk Boards

B 45501A0	60	Coupe	.....	Each	94.50
B 45501A1	61	Coupe	.....	Each	94.50
B 45501A2	62	Coupe	.....	Each	94.50
B 45501A3	63	Coupe	.....	Each	94.50
B 45501A4	64	Coupe	.....	Each	94.50
B 45501A5	65	Coupe	.....	Each	94.50
B 45501A6	66	Coupe	.....	Each	94.50
B 45501A8	58/59	Coupe	.....	Each	94.50

B 45501B0	60	Convertible	.....	Each	94.50
B 45501B1	61	Convertible	.....	Each	94.50
B 45501B2	62	Convertible	.....	Each	94.50
B 45501B3	63	Convertible	.....	Each	94.50
B 45501B4	64	Convertible	.....	Each	94.50
B 45501B5	65	Convertible	.....	Each	94.50
B 45501B6	66	Convertible	.....	Each	94.50
B 45501B8	58/59	Convertible	.....	Each	94.50



These bags are a great addition to the trunk area. Made of the same quality material as our trunk mats, this bag can be used for toting car cleaners or as an overnight bag.

BAC 01A	58-59 Plaid	.....	Each	\$26.95
BAC 01B	60-61 Plaid	.....	Each	\$26.95
BAC 01C	62-64 Speckled	.....	Each	\$26.95
BAC 01D	65, Plaid	.....	Each	\$26.95
BAC 01E	66, Speckled	.....	Each	\$26.95
BAC 01F	Black Vinyl	.....	Each	\$26.95

# TRUNK & REAR BODY AREA



## Rear Deck Ornament

B 43504A	58/59; Coupe	Each	122.35
B 43504B	58/59; Convertible...	Each	112.15

## Trunk Lid Cylinder & Keys

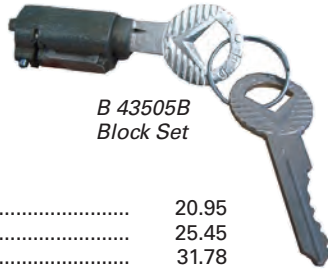

B 43505B  
Block Set

B 43505A	58/59 & 61/63	.....	20.95
B 43505B	65/66	.....	25.45
B 43505C	60	.....	31.78
B 43505D	64	.....	31.78

## Trunk Lid Key Hole Cover Insert

<b>B 43514</b>	<b>Trunk Lid Key Hole Cover Insert</b>		
B 43514A	65/66; Paint To Match	.....	10.71

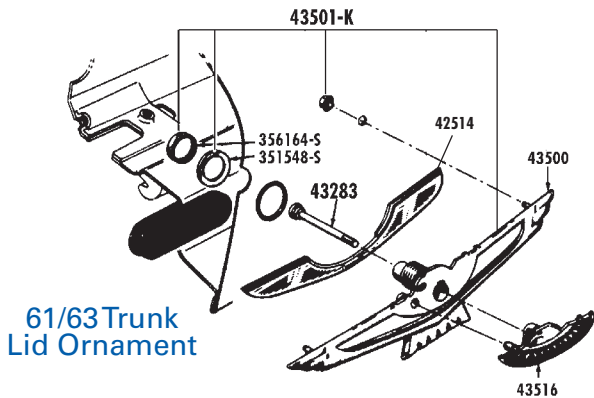

61/63 Trunk Lid Ornament

## Trunk Lid Key Hole Cover



B 43516A



B 43516B

<b>B 43516</b>	<b>Trunk Lid Key Hole Cover</b>		
B 43516A	61/63; Coupe	..... Each	32.95
B 43516B	60; Bird Tail	..... Each	38.15
B 43516C	58/59; Coupe	..... Each	20.35
B 43516D	58/59; Convertible	..... Each	20.35
<b>B 43567</b>	<b>Trunk Lid Key Hole Cover Spring</b>		
B 43567A	61/63	..... Each	2.05
B 43567B	60; 2 Required Per Car	..... Each	2.60
<b>B 43568</b>	<b>Trunk Lock Cover Retainer Clip</b>		
B43568A	60	..... Each	2.10
<b>B 43569</b>	<b>Trunk Lock Lid Spring &amp; Retainer Kit</b>		
B 43569K	60; Kit, Includes 2 Springs & 1 Retainer	.....	6.76

## Trunk Lid Ornament Cover

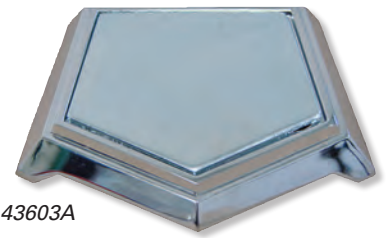

B 43603A

B 43603A	64; Includes Lid, Spring & Hinge Only	.....	44.83
B 43603B	65/66; includes Lid, Spring & Hinge Only	.....	44.83

<b>B 43625</b>	<b>Trunk Lock Base Gasket</b>		
B 43625A	64	.....	1.75
B 43625B	65/66	.....	1.75

<b>B 43720</b>	<b>Luggage Compartment Weatherstrip</b>		
B 43720A	64/66; (Coupe)	.....	28.95
B 43720C	58/63; (Coupe), 210" Long- Cut to length required	.....	21.75
B 43720D	61/63; (Convertible), 4-Piece Kit	.....	84.84
B 43720E	58/60; (Convertible), 4-Piece Kit	.....	84.84
B 43720F	64/65; (Convertible), 8-Piece Kit, (Before 2/15/65)	..	286.48
B 43720G	65/66; (Convertible), 8-Piece Kit, (After 2/15/65)	.....	286.48

## Convertible Package Seal

B 46510A	58/60; 63" Long	.....	13.77
----------	-----------------	-------	-------

B 46593A	60/66; Convertible Flip Lid Motor Coupler	.....	21.18
----------	---	-------	-------

## Replacement Sheet Metal

<b>BPP 11248/9</b>	<b>Wheelhouse—Lower Front</b>		
BPP 11248A	61/63; RH	.....	74.41
BPP 11249A	61/63; LH	.....	74.41

<b>BPP 11360/2</b>	<b>Trunk Floor Pan</b>		
BPP 11360B	58/60; RH	..... Each	188.70
BPP 11361B	58/60; LH	..... Each	188.70
BPP 11362B	58/60; Center	..... Each	402.90

<b>BPP 11360A</b>	<b>64/66; RH</b>	.....	188.70
BPP 11361A	64/66; LH	.....	188.70
BPP 11362A	64/66; Center	.....	402.90

## Hardware for This Section

BHK 290	Trunk Catch Brackets - Side - Conv., 58/60 (24 Pcs.)	...	5.87
BHK 410A	RBack Finish Panel Moulding, 58/60	..... Each	5.56
BHK 414	Fuel Filler Door, 58/60	..... Each	1.81
BHK 425	Rear License Holder, 64/66, (4 Pieces)	.....	2.24
BHK 430	Trunk Hinge to Lid, 61/63, 2 Sides (4 Pieces)	.....	4.50
BHK 431	Trunk Hinge to Lid, 64/66, 2 Sides (8 Pieces)	.....	4.93
BHK 433	Trunk Hinge to Fender Brace, 61/63, 2 Sides (6 Pcs.)	.....	6.24
BHK 434	Trunk Hinge to Body, 64/66, 2 Sides (12 Pieces)	.....	10.68
BHK 437	Latch, 61/63, (6 Pieces)	.....	2.06
BHK 438	Latch, 64/66, (4 Pieces)	.....	2.24
BHK 440	Catch, 61/63, (4 Pieces)	.....	1.74
BHK 441	Catch, 64/66, (4 Pieces)	.....	3.00
BHK 443	Trunk Lock Retainer, 61/63, (2 Pieces)	.....	1.74
BHK 444	Trunk Lock Assembly, 64/66, (4 Pieces)	.....	2.88
BSP 351548	Washer, for Luggage Comp. Door Ornament, 58/63	..	.99
BSP 356164	Nut, for Luggage Comp. Door Ornament, 58/63	Each	1.51
BSP 373504	Pal Nut, for B 43500A Ornament, 61/63	.....	.52
BSP 381999	Plug, Deck Lid HardTop, 58/60, (4 required)	..... Each	1.31

# HARD & SOFT TOP PARTS

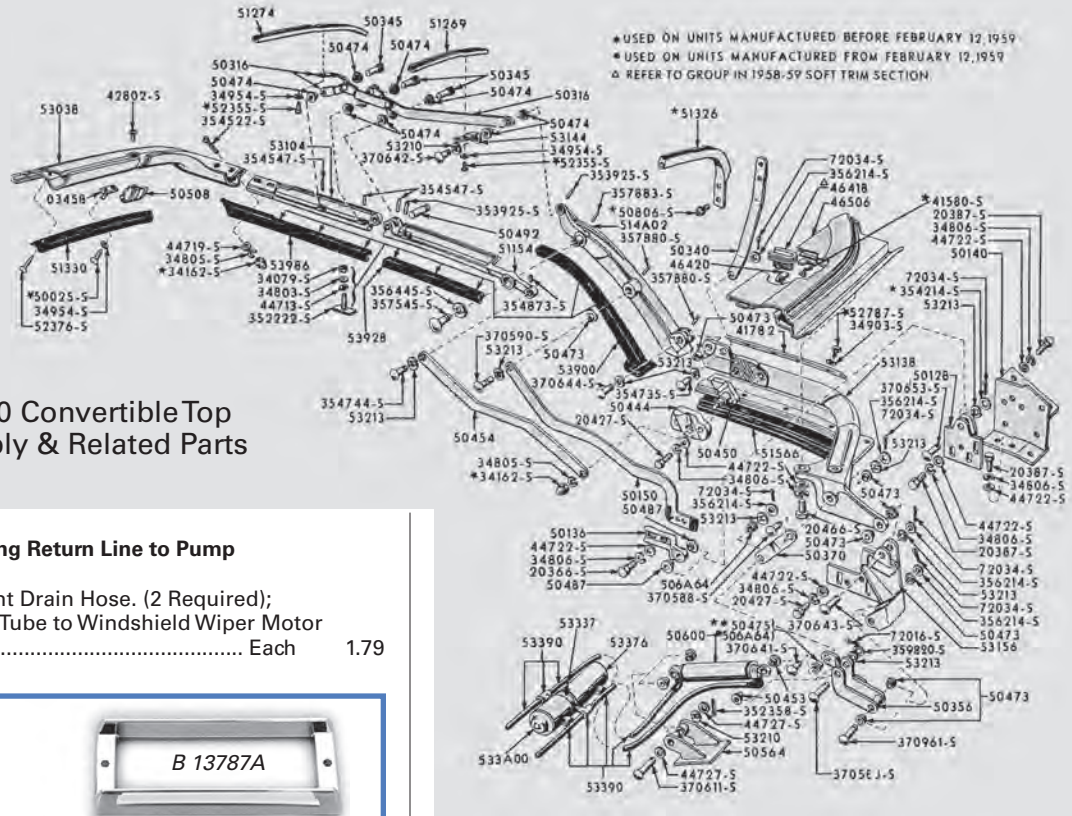

1958/60 Convertible Top Assembly & Related Parts

- B 2344 Clamp Power Steering Return Line to Pump**  
**B 2344A** 58/66;  
 60; Sliding Roof Front Drain Hose. (2 Required);  
 63/66; Lower Return Tube to Windshield Wiper Motor  
 (1 Required) ..... Each 1.79

## Dome Lamp

B 13783A



B 13783B

- B 13706 Dome Lamp Lens Gasket**  
**B 13706A** 58/60 ..... 6.35
- B 13783 Dome Light Pillar Lens**  
**B 13783A** 61/66; White; 1.29" O.D.  
 (63A Only For 1966 Cars) ..... 3.59  
**B 13783B** 58/60 ..... 5.94  
**B 13783C** 66 Landau ..... 10.56
- B 13787 Dome Light Body**  
**B 13787A** 58/60 ..... 17.64

## Convertible Top Relay & Stop Lamp

- B 14512A 63/66; Convertible Top**  
 64; Stop Lamp ..... Each 53.01

## Convertible Top Circuit Breaker

- B 14526A** 61/62; 50 AMP ..... Each 30.55  
**B 14526B** 63/66; 60 AMP ..... Each 50.95

## Convertible Top Control Switch



B 15668B

- B 15668 Convertible Top Control Switch**  
**B 15668B** 61/62 ..... Each 39.95  
**B 15668D** 64/66 ..... Each 71.35

- B 15672 Top Control or Electric Seat Relay Assembly**  
**B 15672A** 60/63; 2 spade & 1 bus bar ..... 53.01  
**B 15672B** 61/64; 3 spade & no bus bar ..... 53.01  
**B 15672C** 61/66; 3 spade & 1 bus bar ..... 53.01

## Convertible Relay System

An all new replacement control relay system for 1960 to 1966 T-bird convertibles that fits in the exact location of the original electric relays. This system comes with easy to follow installation instructions. **Special Features Include:**

- Eight identical dust proof electric relays with manual over-ride buttons on each relay and a time delay adapter on one relay.
- Two heavy duty solenoids which operate the pump.
- Includes a more positive ground system.
- Emergency deck unlock switch for mounting in glove box if owner chooses.
- Every system is marked clearly to the color code of the vehicle.

- B 15672D** '60 ..... Set 875.00  
**B 15672E** 61/63 ..... Set 875.00  
**B 15672F** 64/66 ..... Set 875.00

## Convertible Top Switch Handle



- B 15674A** 60; Chrome Finish..... 19.64



## Landau Vinyl Top

Has your original landau top finally gotten to the point where it seems to be a better air scoop than a cover for your hardtop? We've seen many a top deteriorated so badly that they look like they've got a disease! If you are one of those special owners, why not replace the old worn out original with our replacement Vinyl Landau Top that is hand-crafted to fit your Thunderbird perfectly! Made to fit 1961 thru 1963 Thunderbirds, from original Cobra Grain vinyl fabric. The Best!

BLD 61BK	61/63; Black Only.....	259.95
	<i>*Note: Limited Quantities Only. Made of Original Cobra Long-Grain Material.</i>	
BLD 64BK	64/66; Landau Top, Black Lavant.....	232.06
BLD 64WT	64/66; Landau Top, White Lavant.....	232.06

## The Finest Convertible Tops Available!

Isn't it about time you replaced that worn out soft top on your pride and joy? There really isn't any need to put up with the elements intruding on your outing to the car show, etc. Larry's offers the highest quality replacement convertible top available for classic Thunderbirds. Each convertible top includes a plastic window and is made with original patterns and tough top quality vinyl. Manufacturer guarantees each top against defects in workmanship and material for 3 Years (except plastic window).

BST 58BK	58/60 Black w/Black Underside.....	315.95
BST 58WT	58/60 White w/Black Underside.....	315.95
BST 61BK	61/63 Black w/Black Underside.....	315.95
BST 61WT	61/63 White w/Black Underside.....	315.95
BST 64BK	64/66 Black w/Black Underside.....	315.95
BST 64WT	64/66 White w/Black Underside.....	315.95
	<i>**Note: Soft Top Does Not Include Top Pad.</i>	
BHK 291	Conv. Center Equalizer, 58/60, (8 Pieces).....	2.00
BHK 292	Conv. Rear Cyl. Hinge to Lid, 58/60 (6 Pieces).....	6.00
BHK 293	Conv. Rear Cyl. Hinge to Body, 58/60 (16 Pieces).....	7.74
BHK 294	Conv. Rear Cyl. Truck Lid to Body Hinge, 58/60 (16 Pieces).....	6.62
BHK 295	Conv. Rear Cyl. Soft Top Foot to Body, 58/60 (36 Pieces).....	12.98
BHK 296	Soft Top Mechanism to Foot, 58/60 (32 Pieces).....	13.23
BHK 297	Soft Top Arms to Package Tray, 58/60 (26 Pieces).....	8.86

## Convertible Top Pad

As with all of our upholstery items, complete care is taken to insure a proper fit and finish when your Convertible Top Pad is installed. Manufactured from the finest materials!

B 52874A	58/66; Black Only.....	Pair	65.95
----------	------------------------	------	-------

## Original-Style Headliners

Each Original-Type Headliner is carefully crafted from original-style patterns to fit right in place on your Thunderbird, and made from the best materials available.

BHL 58WT	58/60; Off White (Fits all 2-Door Hdtops).....	65.00
BHL 61WT	61/63; Off White (Fits all 2-Door Hdtops).....	65.00
BHL 61BK	61/63 Black.....	65.00
BHL 64BK	64/66 Black (Non Landau).....	65.00
BHL 64WT	64/66; Off White (Fits all 2-Door Hdtops, Exc. '66 Landau).....	65.00
BHL 58PW	58/60; Pure White.....	65.00
BHL 61PW	61/63; Pure White.....	65.00
BHL 64PW	64/66; Pure White (Non Landau).....	65.00

## Convertible Top Solenoid

B 15682A	60/63; 3 Required.....	Each	166.21
B 15682B	64/66; 3 Required.....	Each	159.95

## Convertible Deck Lid Cylinder Shields

B 42572B	62/63; Protects the Lift Cylinders.....	Pair	254.95
----------	---	------	--------

## Convertible Top Solenoid Cover Plate

B 45514A	60; ABS Plastic.....	Each	40.75
----------	----------------------	------	-------

## Convertible Package Seal

B 46510A	58/60; 63" Long.....		13.77
----------	----------------------	--	-------

## Convertible Flip Lid Motor Coupler

B 46593A	Motor to Transmission.....		21.18
----------	----------------------------	--	-------

## Wing Screw & Retainer for Tonneau Cover

B 50136A	58/66; (2) required.....	Each	14.33
----------	--------------------------	------	-------

## Roof Side Ornament



B 50270A



B 50270B

B 50270A	58; RH, Includes Retaining Nuts.....	Each	47.71
B 50271A	58; LH, Includes Retaining Nuts.....	Each	47.71
B 50270B	59; RH or LH.....	Each	41.33

*\*Note: For 1960, See Part Number 50286.*



B 50286A

B 50286	Roof Side Ornament		
B 50286A	60; RH or LH.....	Each	40.80

*\*Note: For 1958 & 59, See Part Number 50270/1.*

# HARD & SOFT TOP PARTS

## 1958/60 Rear Window & Related Parts

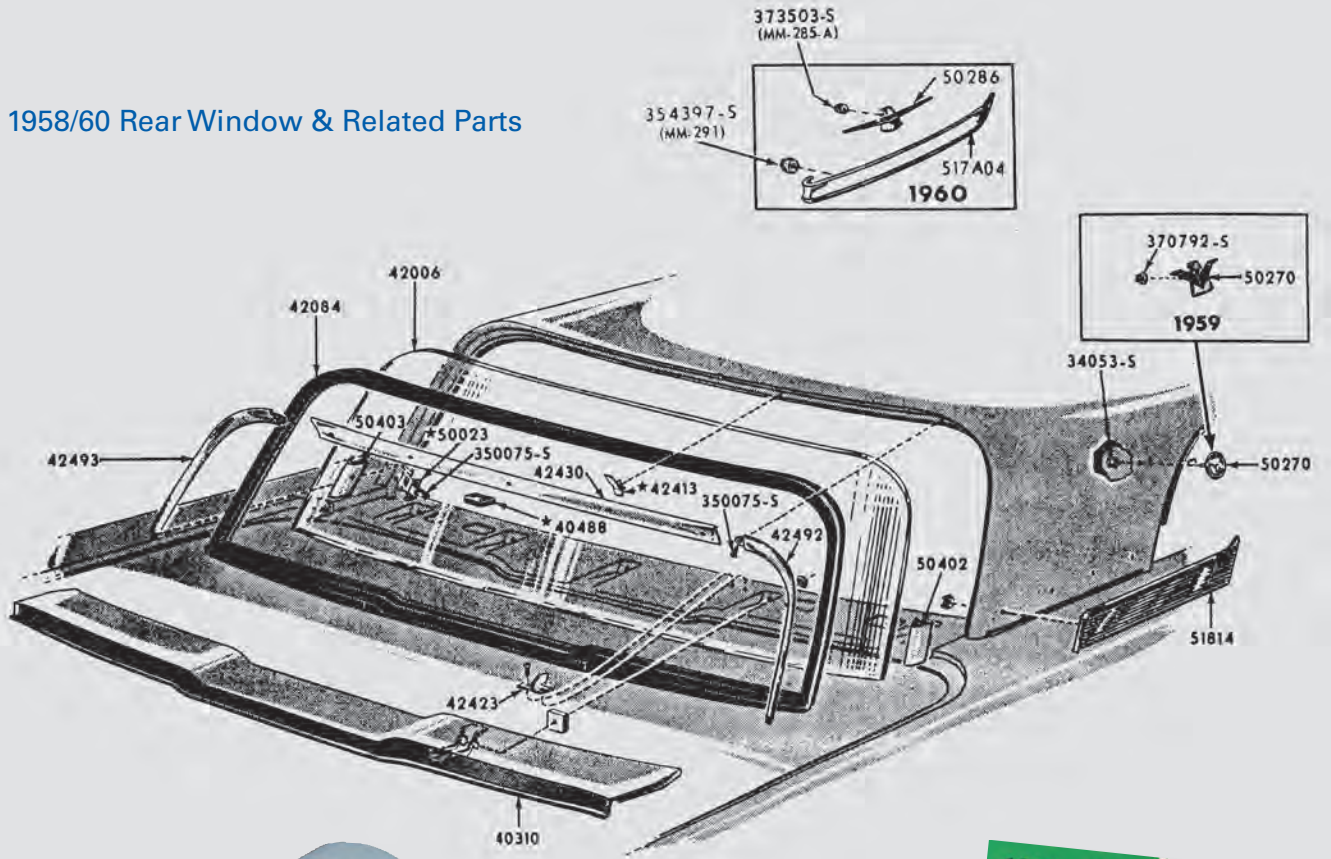

## Folding Top Hold Down Handle



**B 50558** Front Top Hold Down Handle  
**B 50558R** 64/66 ..... Each 27.50

**B 50600** Convertible Top Hydraulic Cylinder  
**B 50600A** 58/59; 2 required ..... Each 177.23  
**B 50600B** 60; RH ..... Each 177.23  
**B 50600C** 60; LH ..... Each 177.23  
**B 50600D** 61/62; 2 required ..... Each 177.23  
**B 50600E** 63; 2 required ..... Each 177.23  
**B 50600F** 64/66; 2 required ..... Each 177.23

## Convertible Top Latch Assembly



**B 50518A** 64/66 ..... Each 101.95



## Front Latch "J" Hook

**B 50636** "J" Hook Front Latch • Convertible  
**B 50636A** 64/66 ..... Each 8.44

## Convertible Top Repair Manual



BLTTR58	1958/60; Convertible Top Repair & Adjustment Manual	7.40
BLTTR61	1961/63; Convertible Top Repair & Adjustment Manual	7.40
BLTTR64	1964/66; Convertible Top Repair & Adjustment Manual	7.40

## Convertible Top Bushing

B 50412A	61/66; Rear Side Rail To Hydraulic Cylinder, 4 Required	Each 3.13
----------	---	-----------

<b>B 51222</b>	<b>Roof Side Rail Weatherstrip</b>	
B 51222/3AR	61/63; (Coupe), RH & LH	Pair 219.19
B 51222/3BR	64/66; (Std. Coupe), RH & LH	Pair 84.84
B 51222/3CR	66; (Landau HardTop), RH & LH	Pair 101.75
B 51222/3D	58/60	Pair 212.19

# HARD & SOFT TOP PARTS

B 51248	Convertible Front Header Seal		
B 51248A	61/63; Fits under the front header bow	.....	45.58
B 51325	Convertible Front Seal		
B 51325A	61/66; Black	.....	47.89
B 51325B	61/66; white	.....	47.89
B 51330	Convertible Front Header Weatherstrip		
B 51330C	58/60	.....	91.75
B 51338	Folding Top #1 Bow Front Weatherstrip		
B 51338A	58/60	.....	26.48

## Roof Side Ornament Retainer



<b>B 51708</b>	<b>Roof Side Ornament Retainer</b>		
B 51708A	61/63; (Except Landau)	.....	Each 38.15

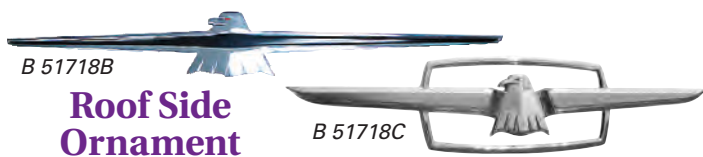

<b>B 51718</b>	<b>Roof Side Ornament • Outside</b>		
B 51718A	64	.....	Each 42.40
B 51718B	66; (Coupe) Blind Quarter Roof, Painted	.....	42.40
B 51718C	65	.....	42.40

## Roof Sidelandau Bars



<b>B 51718</b>	<b>Roof Sidelandau Bars</b>		
B 51718D	62/63; Black Background Paint, Less Center Medallions	.....	Pair 142.75
B 51718E	62/63; White Background Paint, Less Center Medallions	.....	Pair 142.75
B 51718F	65; Black Background Paint, Less Center Medallions	.....	Pair 142.75
B 51718G	65; White Background Paint, Less Center Medallions	.....	Pair 142.75
B 51718H	66; Black Paint,	.....	Pair 142.75
B 51718J	66; White Paint,	.....	Pair 142.75

*See 51720 For Center Medallions*

## Roof Side Ornament (Plastic)



B 51720A	61/63; (Except Landau)	.....	21.18
B 51720B	58 & 62/63; Landau Bar Insert, Black	.....	Each 25.42
B 51720C	58 & 62/63; Landau Bar Insert, White	.....	Each 25.42
B 51720D	66; Landau Bar Insert	.....	Each 25.42
B 51720E	64; Landau Medallion, White	.....	Each 33.61
B 51720F	64; Landau Emblem, Black	.....	Each 33.61

## Roof Side Molding



<b>B 51756</b>	<b>Roof Side Molding</b>		
B 51756A	58/59	.....	Pair 163.15
B 51756C	60; Grooved Type	.....	Pair 163.15
B 51756E	64; Standard Type	.....	Pair 163.15
B 51756F	64; Deluxe, Used with Landau Bars	.....	Pair 182.53
B 51756G	65/66 Hardtop	.....	Pair 163.15

## Convertible Top Tension Cables

B 52806A	64/66	.....	Pair 45.85
----------	-------	-------	------------

## Convertible Top Hydraulic Pump

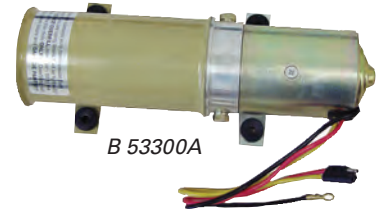

B 53300A	58/66; Pump & Motor w/Reservoir	.....	Each 265.25
----------	---------------------------------	-------	-------------

## B 53310 Convertible Top Gear Housing • Back Panel

B 53310A	59/63	.....	239.65
B 53310B	64/66	.....	249.85

## Convertible Upper Back Panel Gears

B 53311A	58/66; Flat Gear (Steel)	.....	Each 127.45
B 53311B	58/66; Worm Gear (Steel)	.....	Each 122.35

## Convertible Top Hydraulic Hoses

B 53456A	58/59	.....	Set 116.63
B 53456B	60; 5-piece set	.....	Set 275.71
B 53456C	61/62 (early); With 2 1/4" diameter lid cyl., 5-piece set	.....	Set 275.71
B 53456D	(late) 62/63; With 1 3/4" diameter lid cyl., 5-piece set	.....	Set 275.71
B 53456E	64/66; 5-piece set	.....	Set 275.71

## B 53985 Convertible Roof Side Rail Weatherstrip Kit

B 53985A	61/63; 6-Piece Kit (Includes "T" Bolts)	.....	275.71
B 53985B	58/60; 6-Piece Kit	.....	385.00
BHK 280	Weatherstrip Retainer - Verticle Short, Convertible 61/63, 2 Sides (4 Pieces)	.....	1.94

## B 53986 Convertible Top Weatherstrip Kit

B 53986A	64/66; 7-Piece Kit	.....	260.05
BHK 285	Roof Rail Weatherstrip, 64/66, 2 Sides (24 Pieces)	.....	13.75

## Soft Top Arm Pad



B 54000A	61/63	.....	Pair 88.03
B 54000B	64/66	.....	Pair 68.98
B 54001A	58/60	.....	Pair 88.03

## Hardware Kits for This Section

BHK 280	Weatherstrip Retainer - Verticle Short, Convertible 61/63, 2 Sides (4 Pieces)	.....	1.94
BHK 285	Roof Rail Weatherstrip, 64/66, 2 Sides (24 Pieces)	.....	13.75
BHK 291	Convertible Center Equalizer, 58/60, (11 Pieces)	.....	2.00
BHK 292	Convertible Rear Cylinder Hinges to Lid, 58/60, (6 Pieces)	.....	6.00
BHK 293	Convertible Rear Cylinder Hinges to Body, 58/60, (16 Pieces)	.....	7.74
BHK 294	Convertible Trunk Lid to Body Hinge, 58/60	.....	6.62
BHK 295	Convertible Soft Top Foot to Body, 58/60, (36 Pieces)	.....	12.98
BHK 296	Soft Top Mechanism to Foot, 58/60, (32 Pieces)	.....	13.23
BHK 297	Soft Top Arms to Package Tray, 58/60, (26 Pieces)	.....	8.86
BHK 298	Convertible Package Tray Drain Plug Brackets, 58/60, (4 Pieces)	.....	1.24
BHK 365	Courtesy Light (Landau only), '66, 4 pieces	.....	1.74

# SEAT HARDWARE

- B 14690 Power Seat Switch Bezel**  
 B 14690C 64/65; ..... Each 30.55  
**B 14691 Power Seat Switch Retainer**  
 B 14691A 61/63; ..... 6.31  
**B 14701 Power Seat Switch Repair Kit**  
 B 14701A 58/66; Includes lever, knob & lever housing ..... 27.49

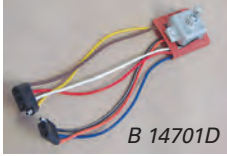

- B 14701 Power Seat Switch**  
 B 14701B '58 Black Knobs ..... Each 78.49  
 B 14701C 59/60 White Knobs ..... Each 78.49  
 B 14701D 61/62 Chrome (4 Wire-3 Wire) ..... Each 78.49  
 B 14701E 62/63 Chrome Knobs (3 Wire-2 Wire) ..... Each 78.49  
 B 14701F 64/65 Chrome Knobs ..... Each 78.49

## Seat Reclining Handle

- B 61076A 64/66 ..... Each 50.95

## Seat Hinge Cover

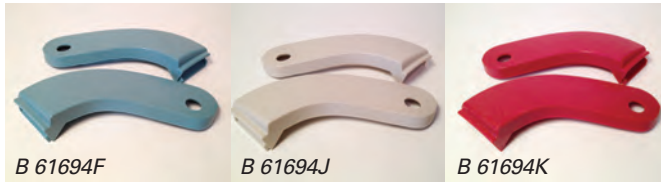

- B 61694A 58/60; Black (4-Piece Set-Enough For 2 Seats) .. 31.78  
 B 61694B 58/60; Red (4-Piece Set - Enough For 2 Seats) .. 31.78  
 B 61694D 61/63; Black, (Enough for 1 Seat) ..... Pair 31.78  
 B 61694E 61/63; Blue, (Will Do 1 Seat) ..... Pair 31.78  
 B 61694F 61/63; Turquoise, (Will Do 1 Seat)..... Pair 31.78  
 B 61694G 61/63; Emberglo, (Will Do 1 Seat) ..... Pair 31.78  
 B 61694H 61/63; Silver Blue, (Will Do 1 Seat)..... Pair 31.78  
 B 61694J 61/63; Beige, (Will Do 1 Seat) ..... Pair 31.78  
 B 61694K 61/63; Red, (Will Do 1 Seat)..... Pair 31.78

## Seat Hinge Cover Button



- B 61694C 61/62; (3-Piece Set—Enough for 1 Seat) (Chrome finish) ..... Per Set 28.60  
 BSP 352358 61/62; Roll Pin For Part #61694-C ..... Each 1.01

## Body & Interior Assembly Manuals



See Page 109 for complete listing of manuals.

- BLT AM51 1964; Body & Interior Assembly Manual..... 26.01  
 BLT AM56 1965; Body & Interior Assembly Manual..... 26.01  
 BLT AM61 1966; Body & Interior Assembly Manual..... 26.01

## B 15672 Top Control or Electric Seat Relay Assembly

- B 15672A 60/63; 2 spade & 1 bus bar ..... 53.01  
 B 15672B 61/64; 3 spade & no bus bar ..... 53.01  
 B 15672C 61/66; 3 spade & 1 bus bar ..... 53.01

## Seat Skirt Shield

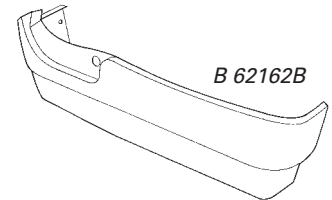

- B 62162B 61/63; Black, 2-Piece Set (OEM Type) ..... Set 100.47  
 BHK 180 Fiberglass Side Panels, 61/63, 2 Seats, (6 Pieces)... 4.93  
 BHK 181 Seat Shields - Lower, 2 Seats, 58/60, (16 Pieces).... 4.00

## Seat Belt Sets

Upgrade the safety level in your T-Bird with our color matched seat belt sets!



Larry's Seat Belts feature a chrome 'lift' type latch buckle to give them a nice '60's look. Each belt includes mounting hardware.

### Front Seat Belts 74"

- BSB 74BK 58/66; Black ..... Each 36.67  
 BSB 74DKBU 58/66; Dark Blue..... Each 36.67  
 BSB 74DKGN 58/66; Dark Green..... Each 36.67  
 BSB 74DKIG 58/66; Dark Ivy Gold ..... Each 36.67  
 BSB 74MN 58/66; Maroon..... Each 36.67  
 BSB 74PO 58/66; Palomino/Saddle ..... Each 36.67  
 BSB 74PT 58/66; Parchment..... Each 36.67  
 BSB 74RD 58/66; Red..... Each 36.67  
 BSB 74SIBU 58/66; Silver Blue..... Each 36.67  
 BSB 74TQ 58/66; Turquoise..... Each 36.67  
 BSB 74WT 58/66; White ..... Each 36.67

### Rear Seat Belts 54"

- BSB 54BK 58/66; Black, Rear..... Each 34.63  
 BSB 54DKBU 58/66; Dark Blue, Rear ..... Each 34.63  
 BSB 54DKGN 58/66; Dark Green, Rear ..... Each 34.63  
 BSB 54DKIG 58/66; Dark Ivy Gold ..... Each 34.63  
 BSB 54MN 58/66; Maroon, Rear ..... Each 34.63  
 BSB 54PO 58/66; Palomino/Saddle, Rear..... Each 34.63  
 BSB 54PT 58/66; Parchment, Rear ..... Each 34.63  
 BSB 54RD 58/66; Red, Rear..... Each 34.63  
 BSB 54SIBU 58/66; Silver Blue, Rear ..... Each 34.63  
 BSB 54TQ 58/66; Turquoise, Rear ..... Each 34.63  
 BSB 54WT 58/66; White, Rear..... Each 34.63

### Retactable Front Seat Belts

- BSB RBK 64/66; Black ..... Each 74.41  
 BSB RDKBU 64/66; Dark Blue..... Each 74.41  
 BSB RDKGN 64/66; Dark Green..... Each 74.41  
 BSB RDKIG 64/66; Dark Ivy Gold ..... Each 74.41  
 BSB RDMN 64/66; Maroon, Rear ..... Each 74.41  
 BSB RPO 64/66; Palomino/Saddle ..... Each 74.41  
 BSB RPT 64/66; Parchment ..... Each 74.41  
 BSB RRD 64/66; Red..... Each 74.41  
 BSB RSIBU 64/66; Silver Blue..... Each 74.41  
 BSB RTQ 64/66; Turquoise..... Each 74.41  
 BSB RWT 64/66; White, ..... Each 74.41

# RUBBER PLUGS, GROMMETS & BUMPERS

## Fuel Filler Neck Grommet



B 9080B 58/60 ..... 10.95

B 10358 Rocker Panel Drain Plug  
B 10358A 64/66; ..... Each 2.03

## Inner Fender Apron Grommet



B 14651A 58/60 ..... 3.13

## Hood Bumpers



B 16758AK



B 16763A



B 16763B



B 16763C

**B 16758 Hood Bumper**  
B 16758AK 58/60; (1) Set of 4, on fender ..... Set 9.95  
B 16758C 58/60; Door & Fuel Filler Door, Front/Rear License Plates ..... Each 2.60

**B 16763 Hood Bumper**  
B 16763A 61/66; On Fender, Wedge-Shape, (4 required) Each ..... 3.25  
B 16763B 58/65; On Radiator Support 5/16-18 Thread Each 5.15  
B 16763C 66; On Radiator Support 5/16-18 Thread .... Each 5.15  
B 16763D 66; On Radiator Support 3/8-18 Thread ..... Pair 9.69

## Antenna Lead-In Seal Grommet



B 18912A

B 18912A 58/60 ..... Each 2.93

## Front Vent Window Upper Bumper

**B 21774 Front Vent Upper Bumper**  
B 21774A 58/60 ..... Pair 14.97  
B 21774B 61/63 ..... Pair 23.29  
B 21774C 64/66 ..... Pair 23.29

## Door Bumper 1964/66 T-Birds



B 23030C 64/66; Square ..... Each 1.31

## Package Tray Seals



B 46510R

**B 46510 Package Tray Balance Link Opening Seal**  
B 46510A 58/63; Conv. ..... Pair 13.77  
B 46510R 64/66 ..... Pair 10.56

**B 60796 Package Tray Seal**  
B 60796A 58/63; Hard Top ..... Each 25.45

### Attaching Hardware for this Section

BSP 352284	Floor Plug; 61/66, 1 1/4" .....	Each	1.31
BSP 359422	Bumper, Glove Box Door, 58/60 .....	Pair	2.12
BSP 372164	Door Bumper, with Clip, 61/66 (1 pair required) .....	Pair	4.85
BSP 375838	Gas Door Bumper, 1964, (2 Required) .....		2.65
BSP 377901	Plug - Button; 1 1/2" x 23/64"; Rubber .....	Each	1.09
BSP 377949	Plug - Button; 7/8" x 23/64"; Rubber .....	Each	.99
BSP 380369	Bumper - Rubber, 25/64" x 1/8" x 3/64" x 3/16" .....	Each	.89
BSP 381999	Plug - Deck Lid Hard Top; 58/60, (4 Required) .....	Each	1.31

BSP 375838 Gas Door Bumpers 64/66  
Front Licence Plate Bracket Bumper ..... Each 2.65



# BODY WEATHERSTRIP

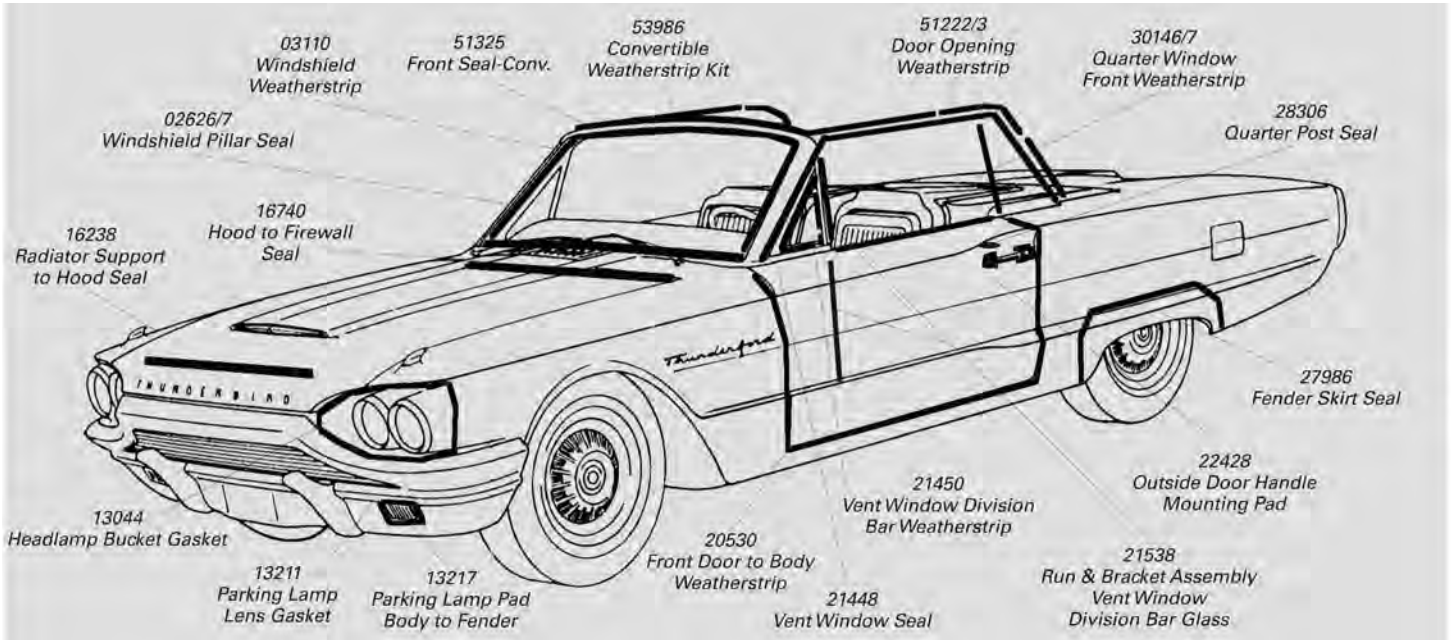

<b>B 02626/7</b>	<b>Windshield Pillar Seal</b>		
B 02626/7A	64/66; Conv., Weatherstrip For Windshield Pillar .....	Pair	46.82
B 02626/7B	58/60; Conv., Weatherstrip For Windshield Pillar .....	Pair	49.83
B 02626/7C	58/60; Hardtop .....	Pair	15.87
B 02626/7D	61/63; Convertible .....	Pair	56.19
<b>B 03110</b>	<b>Windshield Weatherstrip</b>		
B 03110A	61/63; Coupe Only .....		79.54
B 03110B	64/66; Coupe & Convertible Only .....		74.50
B 03110C	61/63; Convertible Only .....		124.39
B 03110D	58/60; All Models .....		79.54

## Parking Lamp Gaskets

B 13211A	58/60 .....	Each	1.66
B 13211B	61/63 .....	Each	3.00
B 13211C	64/65 .....	Each	3.00
B 13211D	66 .....	Each	3.00

## Lamp Gasket Kits



B 13000AK	58/59; Includes the following Gaskets: Headlamp Buckets, Signal Lamps & Tail Lamps .....	Set	29.08
B 13000BK	60; Includes the following Gaskets: Headlamp Buckets, Signal Lamps & Tail Lamps .....	Set	31.16
B 13000CK	61; Includes the following Gaskets: Signal Lamps, Tail Lamps & Back-up Lamps .....	Set	13.47
B 13000DK	62/63; Includes the following Gaskets: Signal Lamps, Tail Lamps & Back-up Lamps .....	Set	24.92
B 13000EK	64/65; Includes the following Gaskets: Signal Lamps, Tail Lamps, Back-up Lamps & Rear License Plate Lamps .....	Set	20.76
B 13000FK	66; Includes the following Gaskets: Signal Lamps, Tail Lamps, Back-up Lamps (For All 3 Lenses) & Rear License Plate Lamps .....	Set	25.96

<b>B 13217</b>	<b>Parking Lamp Body To Fender Pad</b>		
B 13217A	58/60 .....	Each	1.85
<b>B 13420</b>	<b>Rear Lamp Mounting Pad</b>		
B 13420A	62/63 .....	Each	6.19
B 13420C	60; (6 required per car) .....	Each	8.44
<b>B 13461</b>	<b>Rear Tail Lamp Lens Gasket</b>		
B 13461A	58/59 .....	Each	3.00
B 13461B	61 .....	Each	3.00
B 13461C	62/63 .....	Each	3.00
B 13461D	64/65 .....	Each	4.11
B 13461E	60 .....	Each	3.00
B 13461F	66; Outer Lens .....	Each	4.43
B 13461G	66; Center Lens .....	Each	4.43
<b>B 13568</b>	<b>Rear License Plate Lamp Lens Gasket</b>		
B 13568A	64/66 .....		1.10
<b>B 15510</b>	<b>Back-Up Lamp Lens Gasket</b>		
B 15510A	64/65 .....	Each	3.00
B 15510B	61/63 .....	Each	3.00
<b>B 15533</b>	<b>Back-Up Lamp to Body Pad</b>		
B 15533B	64/66 .....	Each	2.08
<b>B 16160</b>	<b>Fender to Bumper Seal</b>		
B 16160A	58/60 .....	Pair	16.93
<b>B 16170C</b>	<b>Splash Shield Rubber Kit</b>		
B 16170C	61/63 .....	Set	59.16
B 16170D	64/66 .....	Set	59.16
<b>B 16179</b>	<b>Fender Ornament Gasket</b>		
B 16179A	60 .....	Each	6.31
<b>B 16238 &amp; 8093</b>	<b>Radiator Support to Hood Seal</b>		
B 8093R	62/63 .....		6.78
B 8093SK	Staples (16 included) For Part#8093-R Listed Above .....		1.31
B 16238A	64/66 .....		6.19
B 16238AK	64/66; Seal w/Pins .....	Per Kit	8.84

<b>B 13044</b>	<b>Headlamp Bucket Gasket</b>		
B 13044A	58/60; Inner Gasket .....	Each	3.45
B 13044B	58/60; Outer Gasket .....	Pair	8.84

# BODY WEATHERSTRIP

<b>B 16740 Hood to Firewall Seal</b>		
B 16740AR 61/66 .....	Pair	8.21
B 16740C 58/60 .....	Pair	8.21
<b>B 17888/9 Rear Bumper to Lower Back Panel Filler</b>		
B 17888A 58/60 .....	Pair	29.08
<b>B 17970 Rubber Bumper Impact</b>		
B 17970A 61/63; Front & Rear Bumper Impact .....	Set of 4	219.30
<b>B 18818 Antenna Mounting Pad</b>		
B 18818A 57/60; Rear .....	Each	6.38
B 18818B 64/66 .....	Each	4.23
B 18818S 58/60; Front .....	Each	4.77

<b>B 21774 Front Vent Upper Bumper</b>		
B 21774A 58/60 .....	Pair	14.97
B 21774B 61/63 .....	Pair	23.29
B 21774C 64/66 .....	Pair	23.29

<b>B 22380 Vent Window Frame Seal</b>		
B 22380B 64/66; Fits on Vent Window Frame to Door Panel Inner Extension .....	Pair	21.87

<b>B 22428 Outside Door Handle Pad</b>		
B 22428A 58/60 .....	Per Set	8.44
B 22428B 64/66 .....	Per Set	10.56

<b>B 27986 Fender Skirt Seal</b>		
B 27986/7AR 61/63 .....	Pair	13.47
B 27986/7BR 64/66 .....	Pair	13.47
B 27986/7C 58/60 .....	Pair	13.52
B 27986-SK 58/66; Staple Kit For Fender Skirt Seals (20 Staples) .....		1.71

<b>B 28306/7 Quarter Post Seals</b>		
B 28306/7A 58/60 .....	Pair	24.75
B 28306/7B 64/66 .....	Pair	15.56
B 28306/7C 61/63 .....	Pair	18.73

<b>B 30146/7 Quarter Window Weatherstrip • Front</b>		
B 30146A 58/60; RH & LH .....	Pair	26.48
B 30146C 64/66; RH & LH .....	Pair	20.76
B 30146R 61/63; RH & LH .....	Pair	26.48

<b>B 40350 Trunk Lid to Rear Body Panel Seal</b>		
B 40350A 64/66; Correct Holes For Clips .....		18.75
B 40350AK 64/66; Correct Holes For Clips & Includes Clips .....		28.50

<b>B 40351 Rear Body Seal Clip</b>		
B 40351A 64/66 .....	Each	.79

<b>B 42084 Rear Window Weatherstrip</b>		
B 42084A 61/63 .....		83.18
B 42084B 64/66; (Not For 1966 Blind Roof) .....		80.53
B 42084C 58/60 .....		122.35

<b>B 43625 Trunk Lock Base Gasket</b>		
B 43625A 64 .....	Each	1.75
B 43625B 65/66 .....	Each	1.75

<b>B 43720 Luggage Compartment Weatherstrip</b>		
B 43720A 64/66; (Coupe) .....		28.95
B 43720C 58/63; (Coupe), 210" - Cut To Length Required ..		21.75
B 43720D 61/63; (Convertible), 4-Piece Kit .....		84.84
B 43720E 58/60; (Convertible), 4-Piece Kit .....		84.84
B 43720F 64/65; (Convertible), 8-Piece Kit (Before 2/15/65) ..		286.48
B 43720G 65/66; (Convertible), 8-Piece Kit (After 2/15/65) ..		286.48

<b>B 46510 Convertible Package Tray Seal</b>		
B 46510A 58/60; 63" long .....		13.77

<b>B 51222 Roof Side Rail Weatherstrip</b>		
B 51222/3AR 61/63; (Coupe), RH & LH .....	Pair	212.19
B 51222/3BR 64/66; (Std. Coupe), RH & LH .....	Pair	84.84
B 51222/3CR 66; (Landau HardTop), RH & LH .....	Pair	101.75
B 51222/3D 58/60 .....	Pair	212.19

<b>B 51248 Convertible Front Header Seal</b>		
B 51248A 61/63; Fits Under The Front Header Bow .....		45.58

<b>B 51325 Convertible Front Seal</b>		
B 51325A 61/66; Black .....		47.89
B 51325B 61/66; White .....		47.89

<b>B 51330 Convertible Front Header Weatherstrip</b>		
B 51330C 58/60 .....		91.75

<b>B 53985 Convertible Roof Side Rail Weatherstrip Kit</b>		
B 53985A 61/63; 6-Piece Kit .....		275.71
B 53985B 58/60; 6-Piece Kit .....		385.00

<b>B 53986 Convertible Top Weatherstrip Kit</b>		
*B 53986A 64/66; 7-Piece Kit.....		260.05
* Includes Part # 54000B		



## Trim Adhesives

Use on weatherstripping  
and other areas of the car.

B 19552A	Black cement, 5 oz. tube .....	10.97
B 19552B	Yellow cement, 5 oz. tube .....	8.93
B 19552C	Spray Adhesive, 16.75 oz. can .....	26.50

<b>B 20530 Front Door Weatherstrip</b>		
B 20530A 58/60; RH & LH .....	Pair	88.64
B 20530B 61/62; RH & LH .....	Pair	80.53
B 20530C 64/65; RH & LH .....	Pair	91.75
B 20530D 66; RH & LH .....	Pair	90.78
B 20530E 63; RH & LH .....	Pair	80.53

<b>B 20580 Front Door at Belt Weatherstrip</b>		
B 20580A 58/60 .....	Pair	20.11

<b>B 20586 Weatherstrip Retainer</b>		
B 20586A 66; RH & LH .....	Each	.52

## Vent Window Seal

(Front)

B 21448A 58/60 .....	Pair	98.50
B 21448B 61/63 .....	Pair	89.00
B 21448C 64/66 .....	Pair	85.00

(Rear)    B 21450B



B 21450A 58/60 .....	Pair	19.98
B 21450B 61/63 .....	Pair	19.98
B 21450C 64/66 .....	Pair	19.98



<b>B 21458 Door &amp; Quarter Beltline Weatherstrip Set [inside &amp; Outside]</b>		
B 21458A 61/63; (Coupe) 8-Piece Set .....		94.46
B 21458B 61/63; (Convertible) 10-Piece Set .....		101.95
B 21458C 64/66; (Coupe) 8-Piece Set .....		95.46
B 21458D 58/60; (Hardtop) 8-Piece Set .....		86.70
B 21458E 58/60; (Convertible) 8-Piece Set .....		85.00
B 21458F 64/66; (Convertible) 8-Piece Set .....		112.15

# BODY PANELS

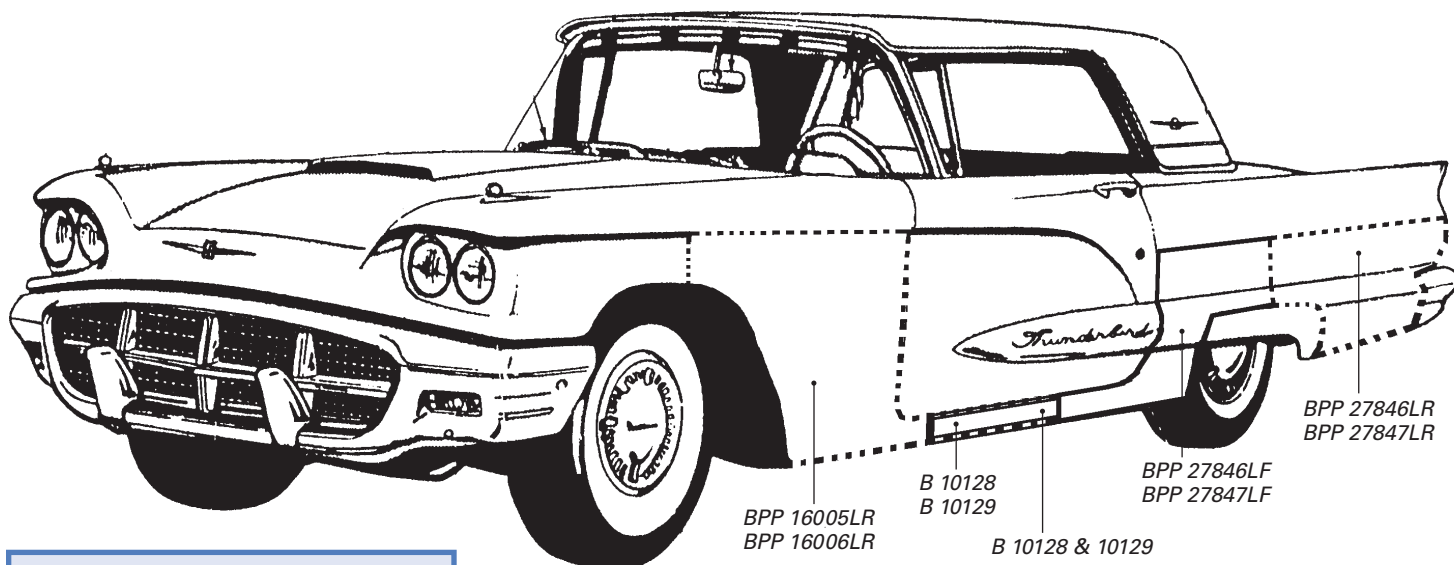

## 58/60 Repair Panels

**BPP 10128/9 Outer Rocker Panel**  
 BPP 10128 58/60; RH ..... 68.95  
 BPP 10129 58/60; LH..... 68.95

**BPP 10128/9 Outer Rocker Panel (Extended)**  
 BPP 10128E 58/60; RH ..... 72.95  
 BPP 10129E 58/60; LH..... 72.95

**BPP 16005/6 Front Fender Repair (Lower Rear)**  
 BPP 16005LR 58/60; RH ..... 112.15  
 BPP 16006LR 58/60; LH..... 112.15

**BPP 27846LF Rear Quarter Panel Repair (Lower Front)**  
 BPP 27846LF 58/60; RH ..... 125.00  
 BPP 27847LF 58/60; LH..... 125.00

**BPP 27846LR Rear Quarter Panel Repair (Lower Rear)**  
 BPP 27846LR 58/60; RH ..... 142.95  
 BPP 27847LR 58/60; LH..... 142.95

## 58/60 Floor Pans

Larry's high-quality replacement floor panels are designed to replace deteriorated original panels. Heavy weight, with all proper indentations for a great fit.

**BPP 11134/5 AR Rear Floor Pan**  
 BPP 11134AR 58/60; RH ..... Each 125.00  
 BPP 11135AR 58/60; LH..... Each 125.00

**BPP 11360/2 Trunk Floor Pan**  
 BPP 11360B 58/60; RH ..... Each 188.70  
 BPP 11361B 58/60; LH..... Each 188.70  
 BPP 11362B 58/60; Center ..... Each 169.95



## 61/63 Fender Skirts

B 27974B 61/63 ..... Pair 285.00  
 B 27986AR 61/63 Fender Skirt Seals ..... Pair 13.47  
 BSP 370034 58/66 Fender Skirt Location Pin ..... Each 2.08  
 B 27986SK 58/66 Staple Kit Enough For Both Sides ..... 1.71

## 61/63 Repair Panels

**BPP 10100/1 Outer Rocker Panels**  
 BPP 10100A 61/63; RH ..... 112.20  
 BPP 10101A 61/63; LH..... 112.20

**BPP 11248/9 Lower Front Wheelhouse**  
 BPP 11248A 61/63; RH ..... 74.71  
 BPP 11249A 61/63; LH..... 74.71

**BPP 11250/1A Rear Whlhouse Extension**  
 Rear Wheelhouse Extension repair the area behind the rear wheel, extending from the bottom of the Quarter Panel to the Trunk Floor Panel.  
 BPP 11250A 61/63; RH ..... 127.45  
 BPP 11251A 61/63; LH..... 127.45

**BPP 16005/6 Front Fender Repair Panel**  
 BPP 16005ALR 61/63; RH Side ..... 91.97  
 BPP 16006ALR 61/63; LH Side ..... 91.97

**BPP 16054 Battery Box Apron Repair**  
 BPP 16054B 61/63 ..... 162.82

**BPP 27846/7 Rear Qtr. Panel (LWR Front)**  
 The Quarter Panel Lower Front repair panel extends from the door to the front of the wheel opening.  
 BPP 27846AF 61/63; RH ..... 132.55  
 BPP 27847AF 61/63; LH..... 132.55

## Floor Pans

Larry's high-quality replacement floor panels are designed to replace deteriorated original panels. Heavy weight, with all proper indentations for a great fit.

## Front Floor Pans

Our Front Floor Pans repair the area under the driver and passenger seat. Each panel extends 5 inches up the firewall and are stamped with stiffening grooves like the originals.

BPP 11134AF 61/63; RH ..... 147.90  
 BPP 11135AF 61/63; LH..... 147.90

## Rear Floor Panel

BPP 11136B 61/63; RH ..... 139.95  
 BPP 11137B 61/63; LH..... 139.95



# BODY PANELS

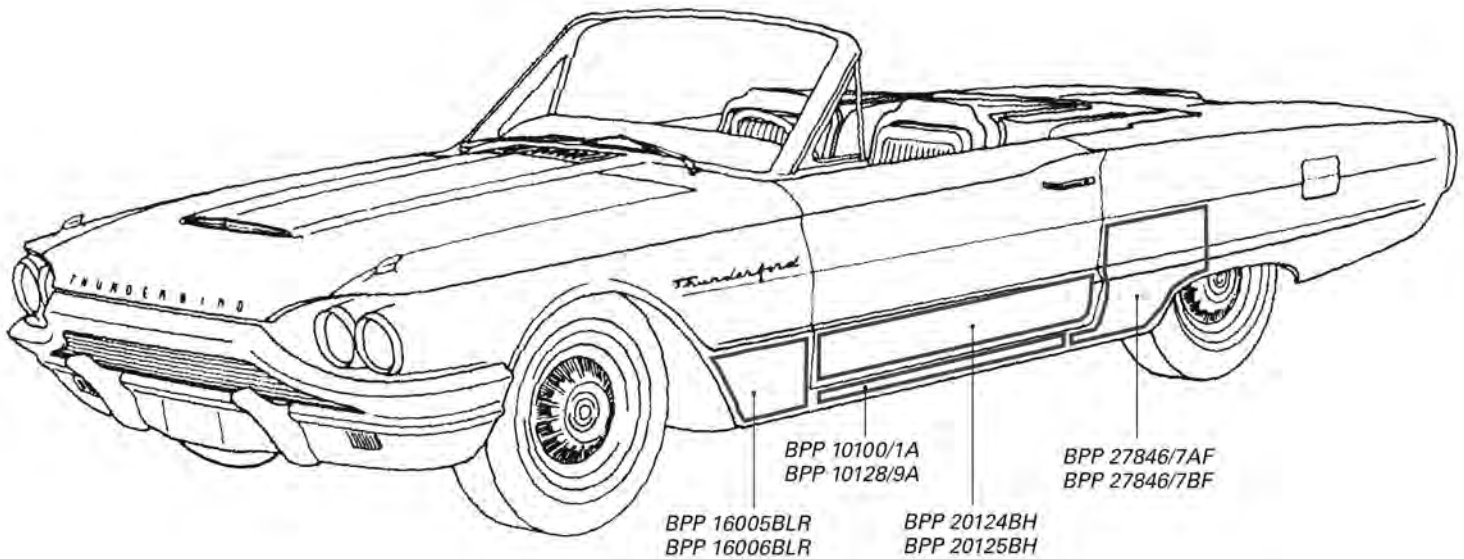

## 64/66 Repair Panels

<b>BPP 10128/9</b>	<b>Outer Rocker Panel</b>	
BPP 10128B	64/66; RH .....	112.20
BPP 10129B	64/66; RH .....	112.20

**BPP 11134/5BF Front Floor Panel**  
Our Front Floor Panels repair the area under the driver and passenger seat. Each panel extends 5 inches up the firewall and are stamped with stiffening grooves like the originals.

BPP 11134BF	64/66; RH .....	152.95
BPP 11135BF	64/66; LH .....	152.95

**BPP 11134/5BR Rear Floor Pan**  
Our Rear Floor Panels repair the rear passenger feet area. Each panel is precision die-stamped from heavy 20-gauge steel for a great fit.

BPP 11134BR	64/66; RH .....	152.95
BPP 11135BR	64/66; LH .....	152.95

**BPP 11250/1B Rear Wheelhouse Extension**  
Rear Wheelhouse Extensions repair the area behind the rear wheel, extending from the bottom of the Quarter Panel to the Trunk Floor Panel.

BPP 11250B	64/66; RH .....	127.50
BPP 11251B	64/66; LH .....	127.50

<b>BPP 11360/2</b>	<b>Trunk Floor Repair Panels</b>	
BPP 11360A	64/66; RH .....	188.70
BPP 11361A	64/66; LH .....	188.70
BPP 11362A	64/66; Center .....	402.90

**BPP 16005/6 Front Fender Repair Panels (Lower Rear)**

BPP 16005BLR	64/66; RH, 13 1/2" Tall .....	86.70
BPP 16006BLR	64/66; LH, 13 1/2" Tall .....	86.70

<b>BPP 16054</b>	<b>Battery Box Apron Repair</b>	
BPP 16054A	64/66 .....	162.82

<b>BPP 20124/5</b>	<b>Door Skin Repair Panel (Lower 5" Only)</b>	
BPP 20124BH	64/66; RH .....	91.75
BPP 20125BH	64/66; LH .....	91.75

<b>BPP 21117</b>	<b>Floor Pan Drain Hole Cover</b>	
BPP 21117	64/66; 4 Required .... Each ....	2.55

**BPP 27846/7 Rear Quarter Panel Repair (Lower Front)**  
The Quarter Panel Lower Front Repair Panel extends from the door to the front of the wheel opening and extends 1 inch above the feature line.

BPP 27846BF	64/66; RH .....	127.50
BPP 27847BF	64/66; LH .....	127.50

<b>BPP 27984/5</b>	<b>Outer Wheelhouse Top Cap</b>	
BPP 27984BT	64/66; RH .....	91.80
BPP 27985BT	64/66; LH .....	91.80

## 64/66 Trunk Floor/ Side Panels

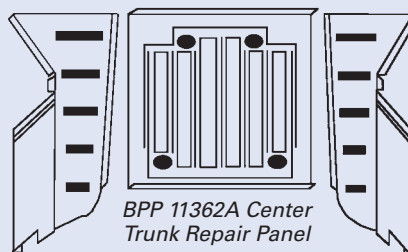

**BPP 11361A**  
Side Trunk  
Repair Panel  
Left Side

**BPP 11360A**  
Side Trunk  
Repair Panel  
Right Side

## Miscellaneous Sheet Metal Attaching Hardware Front Body Area

BHK 323	1966; Front Valance—Center, (14 Pieces) .....	15.73
BHK 324	1966; Front Valance Bracket— Center, (4 Pieces) .....	4.00
BHK 325	1966; Front Valance—Side, 2 Sides (28 Pieces) .....	30.47
BHK 326	1966; Front Valance—Side, Bracket 2 Sides (4 Pieces) .....	2.24
BHK 333	1966; License Bracket—Front (2 Pieces) .....	2.18
BHK 335	61/63; Cowl Cover, (24 Pieces) .....	4.30
BHK 336	64/66; Cowl Cover (22 Pieces) .....	4.00

## Related Attaching Parts Kits for Fenders & Hood

BHK 400	61/63; Fenders, Complete Set 2 Sides (72 Pieces) .....	58.86
BHK 403	61/63; Fenders, Bolts Only 1 Side (16 Pieces) .....	8.86
BHK 404	64/66; Fenders Only, 1 Side (18 Pieces) .....	18.73
BHK 407	64/66; Fenders Splash Shield, Rear 1 Side (8 Pieces) .....	5.12

## Hardware

<b>BSP 359152</b>	<b>Hardware</b>	
BSP 359152	61/63; Clip For "40310" Panel (5 Required) .....	Each 6.07



# HARDWARE & ATTACHING PARTS

BHK 270	Radio Speaker Grille, 64/66, (2 Pieces) .....	1.74
BHK 273	Lower Dash Trim - Left Hand, 64/66, (3 Pieces) .....	1.74
BHK 274	Lower Dash Trim - Right Hand, 64/66, (3 Pieces) .....	1.74
BHK 275	Under Dash Panel, 58/60, (12 Pieces) .....	5.24
BHK 276	Under Dash Panel Moulding - Lower, 58/60, (16 Pieces) .....	12.48
BHK 277	Under Dash Panel Moulding - Upper, 58/60, (4 Pieces) .....	1.56
BHK 278	Under Dash Panel and Moulding, 58/60, (32 Pieces) .....	18.73
BHK 279	Inside Side Panel In Front of Door, 58/60, (4 Pieces) .....	1.62

## SOFT & HARDTOP HARDWARE KITS

BHK 280	Weatherstrip Retainer - Vertical Short, Convertible 61/63, 2 Sides, (4 Pieces) .....	1.94
BHK 285	Roof Rail Weatherstrip, 64/66, 2 Sides, (24 Pieces) .....	13.75
BHK 291	Convertible Center Equalizer, 58/60, (8 Pieces) .....	2.00
BHK 292	Convertible Rear Cylinder Hinges to Lid, 58/60, (6 Pieces) .....	6.00
BHK 293	Convertible Rear Cylinder Hinges to Body, 58/60, (16 Pieces) .....	7.74
BHK 295	Convertible Soft Top Foot to Body, 58/60, (36 Pieces) .....	12.98
BHK 296	Soft Top Mechanism to Foot, 58/60, (32 Pieces) .....	13.23
BHK 297	Convertible Top Arms to Tray, 58/60 .....	8.86
BHK 298	Convertible Package Tray Drain Plug Brackets, 58/60, (4 Pieces) ..	1.24

## FRONT BODY HARDWARE KITS

BHK 300	Grille, 63, (20 Pieces) .....	13.36
BHK 300A	Grille, 60, Kit also includes BHK 303, 305, 310, 311, 313, (111 Pieces)	61.49
BHK 300B	Grille, 58/59, Kit also includes BHK 305, 310, 311, 313, (75 Pieces)	56.50
BHK 301	Grille, 64/65, (20 Pieces) .....	14.17
BHK 302	Grille, 66, (38 Pieces) .....	26.71
BHK 303	Grille Bar to Grille, 60, (36 Pieces) .....	7.24
BHK 304	Grille Guard, 61/63, (4 Pieces) .....	2.31
BHK 305	Grille to Brackets, 58/60, (21 Pieces) .....	4.30
BHK 306	Grille Moulding - Top, 66, 2 Sides, (12 Pieces) .....	4.80
BHK 307	Grille Moulding Under Light (Eyebrow), 66, 2 Sides, (8 Pieces) ..	5.30
BHK 308	Grille Moulding - Center Clip, 66, (4 Pieces) .....	2.31
BHK 309	Grille Moulding Complete, 66, (27 Pieces) .....	14.92
BHK 310	Grille Moulding to Bumper, Lower, 58/60, (24 Pieces) .....	46.38
BHK 311	Grille to Lower Grille Moulding, 58/60, (16 Pieces) .....	5.37
BHK 312	Grille Center Ornament, 66, (3 Pieces) .....	1.74
BHK 313	Bumper to Grille Bracket, 58/60, (14 Pieces) .....	4.37
BHK 313A	Front Bumper, 58/60, Kit also includes BHK 310, 311, 316, 321, 322, 327, 328, 329, 332, (119 Pieces) .....	107.50
BHK 314	Front Bumper, 61/63, (24 Pieces) .....	25.47
BHK 315	Front Bumper, 64/66, (50 Pieces) .....	23.29
BHK 316	Front Bumper Bracket to Frame, Upper, 58/60, (16 Pieces) .....	20.10
BHK 317	Front Bumper Extension, 61/63, (4 Pieces) .....	2.74
BHK 318	Front Bumper Guard, 64/65, (12 Pieces) .....	9.74
BHK 319	Front Bumper Brackets to Frame, 64/65, 2 Sides (24 Pieces) .....	8.99
BHK 320	Front Bumper Bracket, 66, 2 sides, (32 Pieces) .....	12.86
BHK 321	Front Bumper to Bracket, Upper, 58/60, (6 Pieces) .....	3.62
BHK 322	Front Bumper Bracket to Frame, Lower, 58/60, (20 Pieces) .....	17.48
BHK 323	Front Valance - Center, 66, (14 Pieces) .....	15.73
BHK 324	Front Valance Bracket - Center, 66, (4 Pieces) .....	4.00
BHK 325	Front Valance - Side, 66, 2 Sides, (28 Pieces) .....	30.47
BHK 326	Front Valance - Side, Bracket, 66, 2 Sides, (4 Pieces) .....	2.24
BHK 327	Front Bumper to Bracket, Lower, 58/60, (9 Pieces) .....	12.92
BHK 328	Front Bumper to Bracket, Side, 58/60, (6 Pieces) .....	9.12
BHK 329	Front Bumper Bracket to Frame, Side, 58/60, (12 Pieces) .....	7.24
BHK 330	License Plate Holder - Front, 61/63, (4 Pieces) .....	1.74
BHK 331	License Plate Holder - Front, 64/65, (8 Pieces) .....	4.50
BHK 332	Front Fender to Bumper Seal, 58/60, (10 Pieces) .....	2.62
BHK 333	License Bracket - Front, 66, (2 Pieces) .....	2.18
BHK 334	Cowl Cover, 58/60, (6 Pieces) .....	1.68
BHK 335	Cowl Cover, 61/63, (24 Pieces) .....	4.30
BHK 336	Cowl Cover, 64/66, (22 Pieces) .....	4.00

## ELECTRICAL SYSTEM HARDWARE KITS

BHK 337	Headlight Door, 58/60, (4 Pieces) .....	1.38
BHK 338	Headlight Bulb Ring, 58/60, (12 Pieces) .....	3.24
BHK 339	Headlight Bucket, 58/60, (12 Pieces) .....	3.24
BHK 340	Headlight Bucket, 61/63, 2 Sides, (4 Pieces) .....	3.62
BHK 341	Headlight Bucket, 64/65, 2 Sides, (16 Pieces) .....	5.43
BHK 342	Headlight Bucket, 66, 2 Sides, (18 Pieces) .....	9.86
BHK 344	Headlight Doors, 61/63, 2 Sides, (4 Pieces) .....	2.00
BHK 345	Headlight Chrome Door, 64/65, 2 Sides, (12 Pieces) .....	4.80
BHK 346	Headlight Retainer Ring, 64/65, 2 Sides, (6 Pieces) .....	1.74
BHK 347	Headlight Door, 66, 2 Sides, (8 Pieces) .....	5.80
BHK 352	Parking Light Body, 58/60, (12 Pieces) .....	3.24
BHK 353	Parking Light Body, 61/63, 2 Sides, (4 Pieces) .....	1.74
BHK 354	Parking Light Body, 64/66, 2 Sides, (4 Pieces) .....	2.24
BHK 355	Parking Light Lens, 58/60, (4 Pieces) .....	1.18
BHK 356	Parking Light Lens, 61/63, 2 Sides, (4 Pieces) .....	1.74
BHK 358	Parking Light Lens, 66, 2 Sides, (8 Pieces) .....	2.24
BHK 359	Horn, 61/63, (2 Pieces) .....	2.06
BHK 360	Horn, 64/65, 2 Sides, (4 Pieces) .....	4.50
BHK 361	Horn, 66, 2 Sides, (2 Pieces) .....	2.50
BHK 362	Engine Compartment Wire Loom - Left Side, 61/63, (16 Pieces) ..	7.62
BHK 363	Engine Compartment Wire Loom, 64/66, 2 Sides, (32 Pieces) .....	12.36
BHK 364	Door Light Bezel, 64/66, 2 Sides, (4 Pieces) .....	2.12
BHK 365	Courtesy Light - Landau Only, 66, (4 Pieces) .....	1.74
BHK 368	Tail Light Body, 64/66, 2 Sides, (12 Pieces) .....	5.62
BHK 369	Tail Light Lens, 64/66, 2 Sides, (8 Pieces) .....	2.24
BHK 371	Headlamp Adjusting Kit, 61/63, (1 Side Only) .....	22.91
BHK 374	Back-Up Light Body & Lens, 64/66, 2 Sides, (8 Pieces) .....	2.81
BHK 377	Rear License Plate Light, 64/66, (2 Pieces) .....	1.74

## FENDERS & HOOD HARDWARE KITS

BHK 378	Hood Vent Casting, 58/60, (6 Pieces) .....	2.24
BHK 379	Hood Vent Grille, 58/60, (3 Pieces) .....	1.32
BHK 380	Hood Hinge to Hood, 61/63, 2 Sides, (8 Pieces) .....	4.93
BHK 381	Hood Hinge to Hood, 64/66, 2 Sides, (8 Pieces) .....	4.68
BHK 382	Hood Hinge to Hood, 58/60, (4 Pieces) .....	4.12
BHK 383	Hood Hinge to Inner Fender Brace, 61/63, 2 Sides, (12 Pieces) ....	5.06

BHK 384	Hood Hinge to Inner Fender Brace, 64/66, 2 Sides, (6 Pieces) .....	6.18
BHK 385	Hood Hinge to Body, 58/60, (16 Pieces) .....	11.61
BHK 386	Hood Vent Casting, 61/63, (10 Pieces) .....	3.12
BHK 387	Hood Ornament, 61/63, (3 Pieces) .....	1.88
BHK 388	Hood Center Ornament, 66, (5 Pieces) .....	1.88
BHK 390	Hood Guide Latch, 61/63, (16 Pieces) .....	8.86
BHK 391	Hood Latch On Hood, 61/63, (4 Pieces) .....	3.00
BHK 392	Hood Latch, 64/65, (2 Pieces) .....	2.81
BHK 393	Hood Latch, 66, (3 Pieces) .....	3.30
BHK 394	Hood Latch - Side, 58/60, (4 Pieces) .....	1.18
BHK 395	Hood Catch, 61/63, (6 Pieces) .....	4.00
BHK 396	Hood Catch, 64/65, (8 Pieces) .....	4.93
BHK 397	Hood Catch, 66, (4 Pieces) .....	2.94
BHK 398	Hood Catch - Side, 58/60, (4 Pieces) .....	1.62
BHK 399	Hood Release Bar, 61/63, (10 Pieces) .....	5.43
BHK 400	Fenders, Complete Set, 61/63, 2 Sides, (72 Pieces) .....	58.86
BHK 401	Hood Release Catch, 58/60, (26 Pieces) .....	8.12
BHK 403	Fenders - Bolts Only, 61/63, 1 Side, (16 Pieces) .....	8.86
BHK 404	Fenders Only, 64/66, 1 Side, (18 Pieces) .....	18.73
BHK 406	Front Fender Splash Shields, 58/60, (28 Pieces) .....	22.09
BHK 407	Fender Splash Shield - Rear, 64/66, 1 Side, (8 Pieces) .....	5.12
BHK 408	Top Fender Ornament, 58/60, (4 Pieces) .....	3.00
BHK 409	Rear Bumper Guard to Upper Bumper, 58/60, (12 Pieces) .....	4.50

## REAR BODY HARDWARE KITS

BHK 410	Rear Bumper to Back Panel Filter, 58/60, (4 Pieces) .....	1.38
BHK 410A	Back Finish Panel Moulding (Eyebrow), 58/60, (20 Pieces) .....	5.56
BHK 411	Quarter Lock Pillar Weatherstrip - Upper, Front (28306/7), 61/63, 2 Sides, (4 Pieces) .....	1.74
BHK 412	Quarter Pillar Seal at Belt, 64/66, 2 Sides, (8 Pieces) .....	2.81
BHK 413	Rear Quarter Panel Ornaments, 60, (18 Pieces) .....	4.37
BHK 414	Fuel Filler Door, 58/60, (6 Pieces) .....	1.81
BHK 415	Rear Bumper, 58/60, (106 Pieces) .....	80.15
BHK 416	Rear Bumper, 61/63, (30 Pieces) .....	28.65
BHK 417	Rear Bumper, 64/66, (40 Pieces) .....	18.41
BHK 418	Rear Bumper to Brackets, 58/60, (36 Pieces) .....	51.74
BHK 419	Rear Bumper Q's, 61/63, 2 Sides, (30 Pieces) .....	7.74
BHK 420	Rear Bumper Support, 64/66, (16 Pieces) .....	9.92
BHK 421	Rear Bumper Center, 64/66, (4 Pieces) .....	4.06
BHK 422	Rear Bumper Brackets to Frame, 64/66, 2 Sides, (12 Pieces) .....	6.12
BHK 423	Rear Bumper Bracket to Frame, 58/60, (38 Pieces) .....	40.82
BHK 424	Rear Bumper, Upper to Lower, 58/60, (16 Pieces) .....	9.61
BHK 425	Rear License Holder, 64/66, (4 Pieces) .....	2.24
BHK 426	Rear Lamp Body, 58/60, 2 Sides, (8 Pieces) .....	2.68
BHK 427	Rear Lamp Bezel, 60, 2 Sides, (16 Pieces) .....	5.12

## TRUNK AREA HARDWARE KITS

BHK 290	Trunk Catch Brackets - Side, Conv., 58/60, (24 Pieces) .....	5.87
BHK 294	Convertible Trunk Lid to Body Hinge, 58/60, (16 Pieces) .....	6.62
BHK 430	Trunk Hinge to Lid, 61/63, 2 Sides, (4 Pieces) .....	4.50
BHK 431	Trunk Hinge to Lid, 64/66, 2 Sides, 2 Sides, (8 Pieces) .....	4.93
BHK 433	Trunk Hinge to Fender Brace, 61/63, 2 Sides, (6 Pieces) .....	6.24
BHK 434	Trunk Hinge to Body, 64/66, 2 Sides, (12 Pieces) .....	10.68
BHK 437	Latch, 61/63, (6 Pieces) .....	2.06
BHK 438	Latch, 64/66, (4 Pieces) .....	2.24
BHK 440	Catch, 61/63, (4 Pieces) .....	1.74
BHK 441	Catch, 64/66, (4 Pieces) .....	3.00
BHK 443	Trunk Lock Retainer, 61/63, (2 Pieces) .....	1.74
BHK 444	Trunk Lock Assembly, 64/66, (4 Pieces) .....	2.88

## ENGINE COMPARTMENT HARDWARE KITS

BHK 366	Radiator Side Air Deflector, 58/60, (8 Pieces) .....	2.88
BHK 367	Lower Radiator Core Support Bracket, 58/60, (18 Pieces) .....	5.50
BHK 468	Radiator Shield - Top Cover to Nose Panel, 58/60, (2 Pieces) .....	3.00
BHK 469	Radiator Side Rubber Shield Bracket, 58/60, (8 Pieces) .....	1.88
BHK 470	Radiator Top Cover, 58/60, (3 Pieces) .....	2.24
BHK 471	Radiator Side Rubber Shield to Brackets, 58/60, (8 Pieces) .....	2.88
BHK 472	Radiator Cover (8A193), 61/63, (20 Pieces) .....	5.68
BHK 473	Radiator Shield, 64/66, (16 Pieces) .....	12.36
BHK 474	Support For Radiator To Hood Seal, 62/63, (4 Pieces) .....	3.00
BHK 477	Export Braces - Firewall to Shock Tower, 61/63, 2 Sides (24 Pieces) ..	12.17
BHK 478	Export Brace, 64/66, (28 Pieces) .....	12.80
BHK 479	Windshield Washer Nozzle, 58/60, (2 Pieces) .....	.88
BHK 480	Washer Bag Bracket, 61/63, (2 Pieces) .....	1.74
BHK 481	Washer Bag Bracket, 64/66, (2 Pieces) .....	1.74
BHK 482	Washer Bag Bracket, 58/60, (2 Pieces) .....	.88
BHK 483	Vacuum Storage Tank Brackets, 61/63, (2 Pieces) .....	1.74
BHK 485	Air Cleaner Nut, 61/63, (1 Piece) .....	1.74
BHK 487	Battery Tray, 61/63, (3 Pieces) .....	3.68
BHK 488	Battery Tray, 64/65, (8 Pieces) .....	6.18
BHK 489	Battery Tray, 1966, (6 Pieces) .....	5.06
BHK 490	Voltage Regulator, 58/60, (3 Pieces) .....	1.50
BHK 491	Starter Solenoid, 58/60, (2 Pieces) .....	1.12
BHK 492	Wiper Motor Relay, 58/60, (2 Pieces) .....	1.06
BHK 493	Heater Fan Relay, 58/60, (2 Pieces) .....	1.06
BHK 494	Starter Cable Brackets, 58/60, (2 Pieces) .....	1.06
BHK 495	Horn Relay, 58/60, (2 Pieces) .....	1.06
BHK 496	Heater Blower, 58/60, (10 Pieces) .....	3.12
BHK 497	Bell Crank to Engine, 58/60, (2 Pieces) .....	1.24
BHK 498	Carburetor Mounting, 58/60, (12 Pieces) .....	3.68
BHK 499	Valve Cover Bolts, 58/60, (10 Pieces) .....	6.00
BHK 501	Horns to Brackets, 58/60, (8 Pieces) .....	1.50
BHK 502	Horn Brackets to Fender, 58/60, (6 Pieces) .....	4.24
BHK 503	Power Steering Pump to Brackets, 58/60, (2 Pieces) .....	1.50
BHK 504	Power Steering Pump to Brackets to Water Pump, 58/60, (4 Pieces)	2.68
BHK 505	Water Pump, 58/60, (4 Pieces) .....	2.68
BHK 506	Generator to Bracket, 58/60, (9 Pieces) .....	4.74
BHK 507	Generator Bracket to Body, 58/60, (3 Pieces) .....	1.94
BHK 508	Sway Bar Brackets to Frame, 58/60, (4 Pieces) .....	1.44

# EMBLEMS

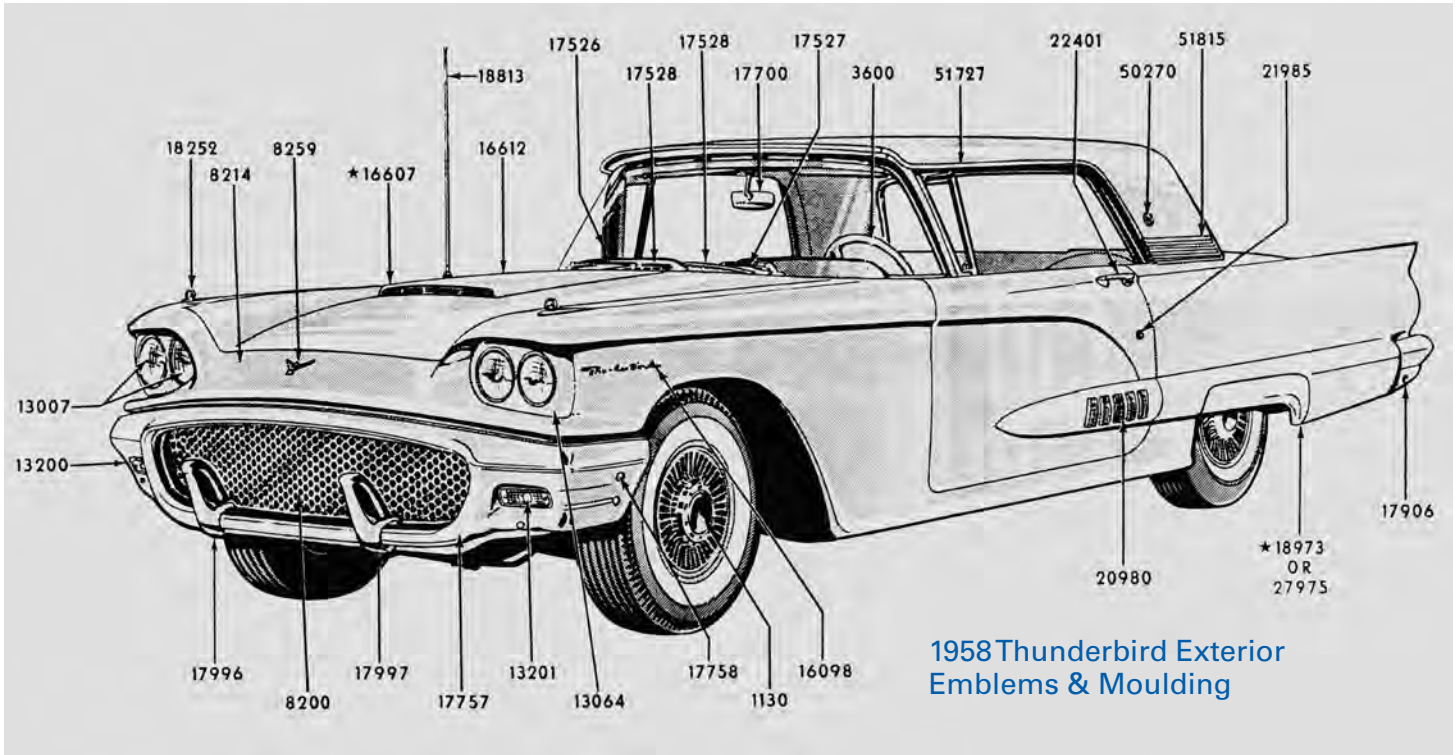

## SunRay Deluxe Wheel Center

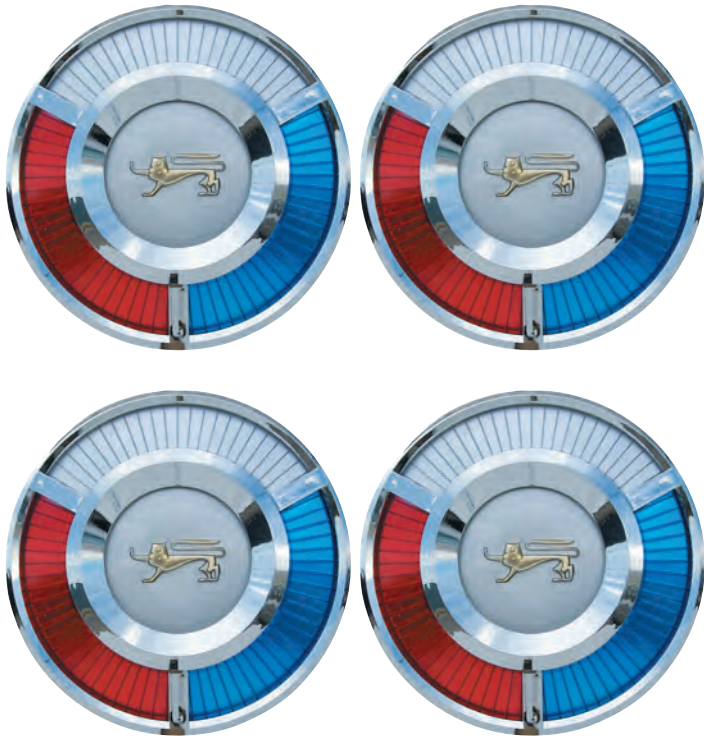

B 1130 SunRay Deluxe Wheel Centers  
 B 1130B 59/60; SunRay with Retainers—Set Of 4 ..... 280.35

## Wire Wheel Spinner Center

B 1130C	58/66; Black.....	Each	30.55
B 1130D	58/66; Blue.....	Each	30.55
B 1130E	58/66; Green.....	Each	30.55
B 1130F	58/66; Red.....	Each	30.55

## Grille Emblem



B 8213A

B 8213A 66; Complete with 3 Plastic Inserts ..... Each 152.95



**Big Selection of Parts!**  
 Whether it's a hard to find part or a standard Thunderbird replacement part, Larry's has what you're looking for. Our inventory of parts is on-cours-quality. Give us a call if you can't find the parts you need. Our knowledgeable parts specialists will be happy to help!

# EMBLEMS

## Nose & Continental Kit Ornament

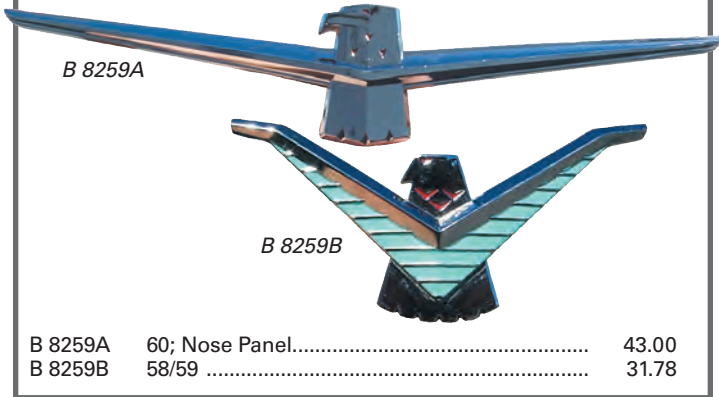

B 8259A

B 8259B

B 8259A	60; Nose Panel.....	43.00
B 8259B	58/59 .....	31.78

## Dash Script "Thunderbird"

B 04460 61/63 ..... Each 26.48

## Center Tail Lamp Lens Emblem

B 13616B 66 ..... Each 48.77

## Horn Ring Medallion



B 13089A

B 13089B

B 13809A	58/60; Black, With Power Steering .....	25.45
B 13809B	58/60; White, With Power Steering .....	25.45

## Front Fender Nameplate

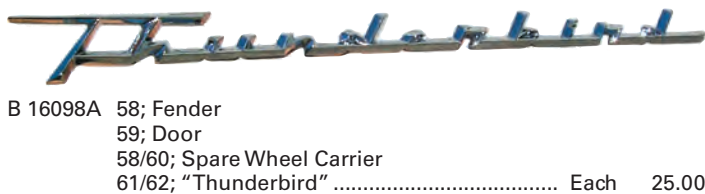

B 16098A 58; Fender  
59; Door  
58/60; Spare Wheel Carrier  
61/62; "Thunderbird" ..... Each 25.00

*We carry a large inventory of concours-quality parts. Give us a call if you can't find what you need. Our knowledgeable parts specialists will be happy to help!*

## Fender Top Ornaments



B 16178A

B 16178B

B 16178C

B 16178A	60; RH or LH; .....	Each	66.30
B 16178B	59; RH or LH; .....	Each	66.30
B 16178C	58; RH or LH; .....	Each	66.30

## Roadster Emblem



B 16228A 61/63; For Front Fender ..... Each 26.28

## Fender Emblems



B 16228B	65; "C" and Feather Set, RH .....	Set	90.47
B 16229B	65; "C" and Feather Set, LH .....	Set	90.47

## Hood Letters THUNDERBIRD

B 16606 Hood Letters  
B 16606-A 64; Letters, Complete Set With Fasteners ..... Set 34.28

B 16607 Hood Emblem Insert  
B 16607A 61/63; Plastic ..... 27.49

## Hood Emblems

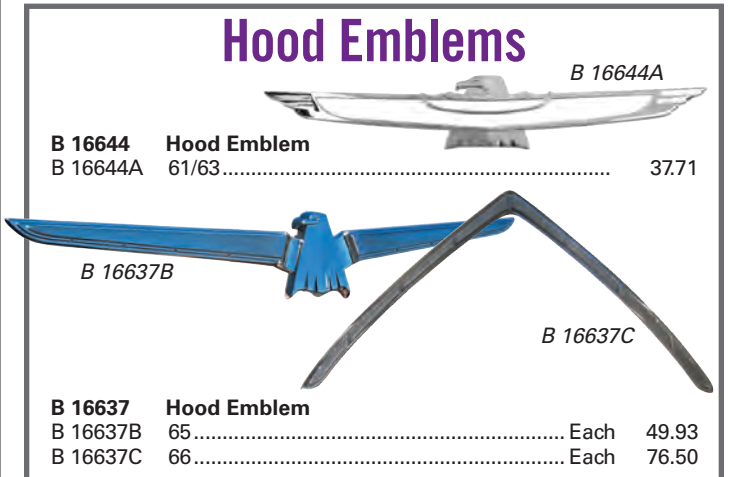

B 16644A

B 16644 Hood Emblem  
B 16644A 61/63..... 37.71

B 16637B

B 16637C

B 16637	Hood Emblem		
B 16637B	65.....	Each	49.93
B 16637C	66.....	Each	76.50

# EMBLEMS

## Exterior Mirror Bird Emblem



B 17686A 64/66;  
For back of mirror ..... 23.21

## Rear Bumper Name Plate



B 17850A



B 17850B

**B 17850 Rear Bumper Name Plate**  
B 17850A 64; Block Letters ..... Each 47.71  
B 17850B 65; With Thunderbird Wing Span ..... Each 47.71

## Outside Door Ornament

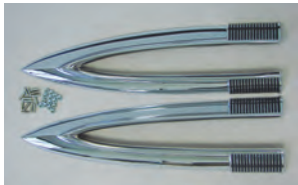

B 20980C



B 20980B

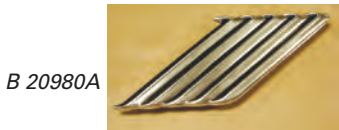

B 20980A



B 20981A

**B 20980/1 Outside Door Ornament**  
B 20980A 63; RH, (3 Required Per Door) ..... Each 21.37  
B 20981A 63; LH, (3 Required Per Door) ..... Each 21.37  
B 20980B 58; (5 Required Per Door) ..... Each 19.05  
B 20980C 59; Chrome Spear Head ..... Pair 195.50

## "Thunderbird" Script



B 25622A

**B 25622 Thunderbird Script**  
B 25622A 63/64; "Thunderbird" for Rear Quarter ..... 37.78  
B 25622B 65/67; "Thunderbird" for Rear Quarter ..... 35.65

*Can't make a decision on the best gift?  
Larry's gift certificates are the solution! Ask  
our Sales Specialists for complete details*

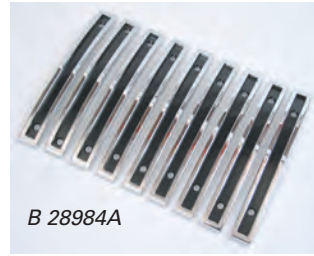

B 28984A

**B 28984 Quarter Panel Emblem Set**  
B 28984A 60; Early Type With Holes, 9 Piece Set ..... Each 127.30

## Quarter Panel Emblem

**B 28984 Quarter Panel Emblem**  
B 28984B 60; Late Style With Studs,  
Set of 9, RH or LH .....Set 135.20

## Rear Quarter Panel Ornament

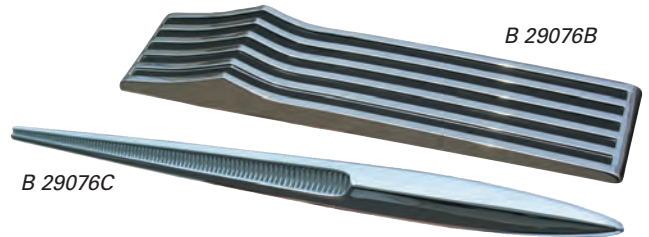

B 29076B

B 29076C

**Rear Quarter Panel Ornament**  
B 29076B 62; 6 Required Per Car..... Each 25.50  
B 29076C 61; 8 Required Per Car..... Each 13.47



B 42514A

**B 42514 Trunk Lid Emblem Insert**  
B 42514A 61/63 ..... 20.32

## Luggage Compartment Door Ornament & Cover



**B 43501K 61/63; Ornament & Lock Cover- Fully Assem. W/Proper Spring & Washer, (Less Plastic Ornament. #42514-A) ..... 79.95**  
B 43501BK 61/63 Convertible ..... 100.73  
B 43516E 60 Convertible; Lock Cover ..... 35.65  
BSP 351548 58/63; Washer ..... .99  
BSP 356164 58/63; Nut ..... 1.51  
BSP 373504 61/63; Pal Nut ..... Each .53

# EMBLEMS

## Rear Deck Ornament

- B 43504 Rear Deck Ornament  
 B 43504A 58/59 ..... 122.35

### Trunk Lock Keyhole Cover

B 43516A



B 43516B



- B 43516 Luggage Compartment Key Hole Cover**  
 B 43516A 61/63; (Coupe) ..... Each 32.95  
 B 43516B 60; Bird Tail ..... Each 38.15

- B 43567 Luggage Compartment Ornament Cover Spring**  
 B 43567A 61/63 ..... Each 2.05  
 B 43567B 60; 2 Required Per Car ..... Each 2.60

- B 43568 Retainer Trunk Lock Cover Clip**  
 B 43568A 60 ..... Each 2.10

- B 43569 Trunk Lock Lid Spring & Retainer Kit**  
 B 43569K 60; Kit, Includes 2 Springs & 1 Retainer ..... 6.76

- B 43603 Luggage Compartment Ornament**  
 B 43603A 64; Includes Lid, Spring & Hinge Only ..... 44.83  
 B 43603B 65/66; Includes lid, Spring & Hinge Only ..... 44.83

## 1958/60 Roof Side Ornaments



B 50270A



B 50270B

- 1958/59 Roof Side Ornament**  
 B 50270A 58; RH, Includes Retaining Nuts ..... Each 47.71  
 B 50271A 58; LH, Includes Retaining Nuts .. ..... Each 47.71  
 B 50270B 59; RH or LH ..... Each 41.33  
*\*Note: For 1960, See Part Number 50286.*

- 1960 Roof Side Ornament**  
 B 50286A 60; RH or LH ..... Each 40.80  
*Note: For 1958 & 59, See Part Number 50270/1.*

## Roof Ornament Retainer



- B 51708 Roof Side Ornament Retainer**  
 B 51708A 61/63; (Except Landau) ..... Each 38.15

### Roof Side Ornament (Outside)



- B 51718A 64 ..... Each 42.40  
 B 51718B 66; (Coupe) Blind Quarter Roof,  
 Painted ..... Each 42.40  
 B 51718C 65 ..... Each 42.40

## Roof Side Landau Bars

- B 51718 Roof Side Landau Bars**  
 B 51718D 62/63; Black Background Paint,  
 Less Center Medallions ..... Pair 142.75  
 B 51718E 62/63; White Background Paint,  
 Less Center Medallions ..... Pair 142.75  
 B 51718F 65; Black Background Paint,  
 Less Center Medallions ..... Pair 142.75  
 B 51718G 65; White Background Paint,  
 Less Center Medallions ..... Pair 142.75  
 B 51718H 66; Black Paint, ..... Pair 142.75  
 B 51718J 66; White Paint, ..... Pair 142.75  
*See 51720 For Center Medallions*

### Outside Roof Side Ornaments



B 51720A

- B 51720A 61/63; (Except Landau) ..... 21.18  
 B 51720B 58 & 62/63; Landau Bar Insert, Black..... Each 25.42  
 B 51720C 58 & 62/63; Landau Bar Insert, White..... Each 25.42  
 B 51720D 66; Landau Bar Insert ..... Each 25.42  
 B 51720E 64; Landau Medallion, White ..... Each 33.61  
 B 51720F 64; Landau Emblem, Black ..... Each 33.61

- B 60608 Emblem, Rear Seat & Tri-Power Air Cleaner**  
 B 60608A Rear Seat, 62/63; Tri-Power Intake Manifold .. Each 35.65



**We Also Sell Used Parts**

# RADIO

Just because you have an older vehicle doesn't mean you have to listen to your favorite music on an older radio. Larry's offers a great selection of car audio components that feature the latest in current technologies, yet fit comfortably into your Thunderbird without changing its original looks, or requiring any modification to the dash area. Each radio is manufactured to keep all original bezels, knobs (most models) and other components intact, yet offer the best audio features available. Radios

are for 12-volt systems only and are covered by a One Year Limited Warranty. Any Questions? Give us a call! We'll be happy to help you find an upgrade system that will enhance the value of your 'Bird. \*Please Note- Because of broadcast frequency variations worldwide, these radios may not work properly outside of the U.S. and Canada.

**Note: Aftermarket Radio will not replace radios with 8-Track Tape Player.**



## Car Radio's 100 & 200 Watt



- USB
- Separate Bass & Treble
- 4 Way Fader
- 16 Presets (4 AM / 12 FM)
- Manual Tuning
- Preset Scan & Auto Store
- Auto Stereo—Mono
- PLL Synthesizer Digital Tuner
- Power Antenna Lead
- LCD With Green Illumination
- RCA Pre-Outs
- Auxiliary Input
- Clock

BRD 109	58/60 200W .....	\$ 280.45
BRD 209	61/63 200W .....	\$ 280.45
BRD 309	64/66 200W .....	\$ 280.45



## Radio Knobs



B 18805A      B 18805B      B 18805C

B 18805A	58; Black w/Silver Insert .....	Each	5.36
B 18805B	59; White w/Gold Insert .....	Each	6.38
B 18805C	60; White w/Silver INsert .....	Each	5.36

## Antenna's



B 18813A

B 18813E

<b>B 18813</b>	<b>Antenna</b>		
B 18813A	58/60; Rear Deck Mount .....		89.20
B 18813C	58/60; Front Fender Mount .....		94.50
B 18813D	61/66; Mast, Screw-On Type, Front Fender Mount ...		27.50
B 18813E	64/66; Correct, w/Attaching Parts, Front Mount ....		65.00

<b>B 18818</b>	<b>Antenna Mounting Pad</b>		
B 18818A	57/60; Rear .....	Each	6.38
B 18818B	64/66 .....	Each	4.23
B 18818S	58/60; Front .....	Each	4.77

B 18912A

<b>B 18912</b>	<b>Antenna Load In Seal Grommet</b>		
B 18912A	58/60 .....		2.93



## Upgrade Stereo Speaker Kits

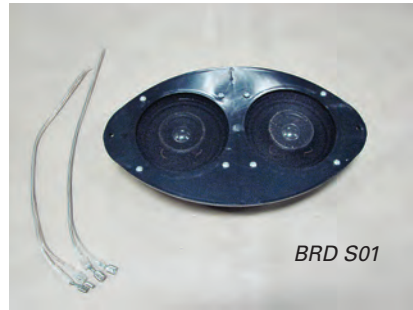

BRD S01

If you want better sounds from your new car stereo, without any modifications to your existing rear deck or panels, try installing a set of our custom-fit speakers. Feature the latest in audio technology, pre-wired for our stereo systems and mounted on 1/4" board. Will mount in existing original speaker areas.

### Console Stereo Speaker

Fits in location of original console speaker. Requires no modification to your dash area. Mounted on 1/4" board for easy installation.

BRD S04	58/60 .....	46.70
BHK 224	Radio Speaker, 58/60 (4 Pieces) .....	1.12
BHK 269	Radio Bracket to Dash, 58/60 (2 Pieces) .....	.74

### Front Stereo Speaker

BRD S01	61/63 .....	46.70
BRD S02	64/66 .....	36.08

### Rear Stereo Speaker

	Dual-Cone Cobalt Ferrite Magnet	
BRD S03	64/66; Handles 30 Watts Power .....	36.08

Having problems with your electrical system? Use our Wiring Diagram Manuals to get it right!



BLT WD63

BLT WD58	1958 .....	7.65
BLT WD59	1959 .....	7.65
BLT WD60	1960 .....	7.65
BLT WD61	1961 .....	7.65
BLT WD62	1962 .....	7.65
BLT WD63	1963 .....	7.65
BLT WD64	1964 .....	7.65
BLT WD65	1965 .....	7.65
BLT WD66	1966 .....	7.65

# ACCESSORIES

## Larry's Logo Hats



MAP H1



MAP H2



MAP H3

MAP H1	Blue .....	Each	15.25
MAP H2	Black .....	Each	15.25
MAP H3	White .....	Each	15.25

## Door Handle Removal Tool

One simple slip is all it takes to damage the trim on your Thunderbird's door. Our special Door Handle Removal Tool is the way to safely remove your door handle. Add it to your T-Bird tool kit.  
 B 22601T '58-66 ..... 8.67



*We carry a large inventory of concours-quality parts. Give us a call if you can't find what you need. Our knowledgeable parts specialists will be happy to help!*

# ACCESSORIES

## Dash Mat

The Dash Mat is a great way to protect your Thunderbird's dash area from damaging UV rays and harsh sunlight. Offered in colors that complement your 'Bird's interior. Installs in minutes for carefree motoring.

Price Each ..... 42.95

See Part Number BDM on Page 9 for complete listing of colors and part numbers.

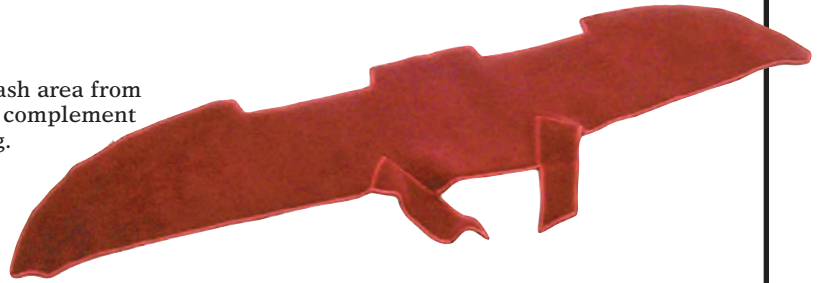

## Tote Bag



These bags are a great addition to the trunk area. Made of the same material as our trunk mats, this bag can be used for toting car cleaners or as an overnight bag.

BAC 01A	58-59 Plaid	.....	Each	26.95
BAC 01B	60-61 Plaid	.....	Each	26.95
BAC 01C	62-64 Speckled	.....	Each	26.95
BAC 01D	65, Plaid	.....	Each	26.95
BAC 01E	66, Speckled	.....	Each	26.95

## Black Vinyl Tote Bag

BAC 01F ..... Each 26.95



## Original-Style Rubber Floor Mats. Correct Pattern Logos!

A great way to keep your Thunderbird's carpet fresh and clean is with a set of Original-Style Floor Mats. These are high grade rubber and feature the proper Thunderbird logo and/or script for each particular year. We sell them in perfect-fit Front & Rear sets only.

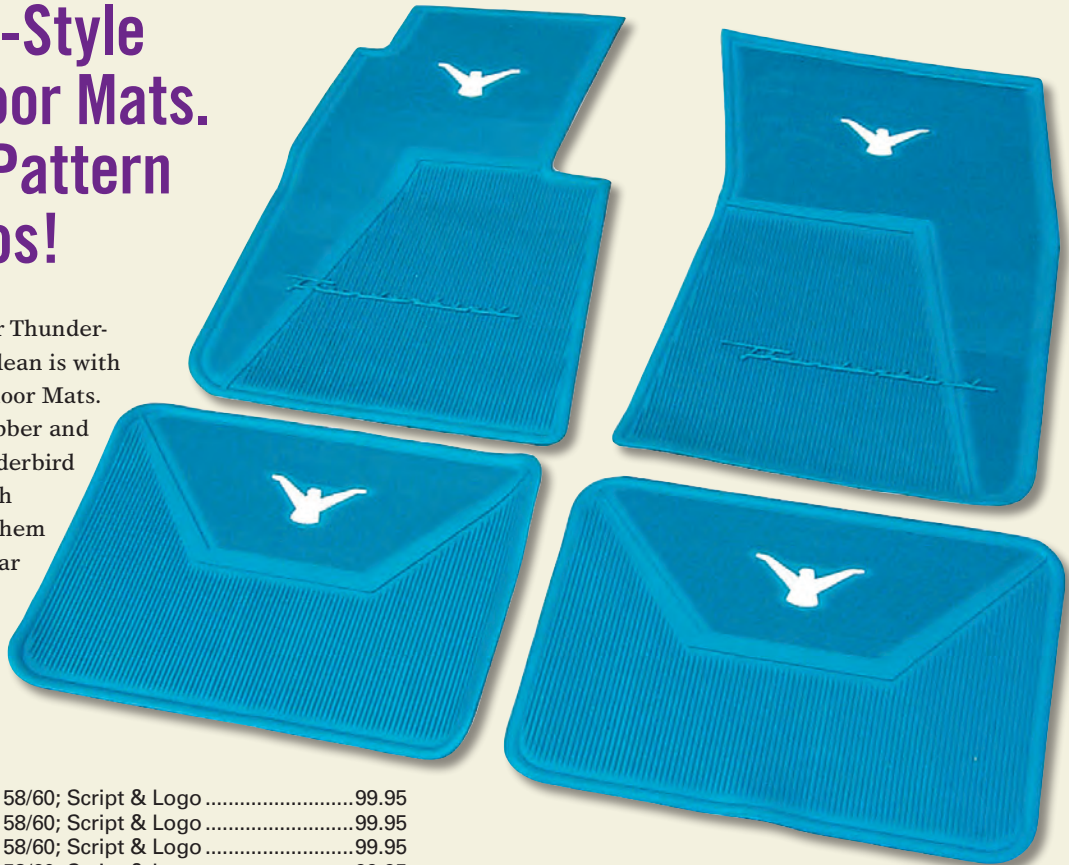

B 13106A	Black	58/60; Script & Logo	.....	99.95
B 13106C	Red	58/60; Script & Logo	.....	99.95
B 13106D	Blue	58/60; Script & Logo	.....	99.95
B 13106E	Turquoise	58/60; Script & Logo	.....	99.95
B 13106F	Black	61/63; Script & Logo	.....	99.95
B 13106H	Red	61/63; Script & Logo	.....	99.95
B 13106I	Blue	61/63; Script & Logo	.....	99.95
B 13106J	Turquoise	61/63; Script & Logo	.....	99.95

B 13106K	Black	64/66; Logo Only	.....	99.95
B 13106M	Red	64/66; Logo Only	.....	99.95
B 13106N	Blue	64/66; Logo Only	.....	99.95
B 13106O	Aqua	64/66; Logo Only	.....	99.95
B 13106P	Burgundy	64/66; Logo Only	.....	99.95

## License Plate Frames

These durable License Plate Frames protect your plates from the elements while giving your Big Bird a unique look. These quality plates are easily to install, and will give your ride the boost it needs, while maintaining state requirements.



B 18240A	61	.....	Each	8.11
B 18240G	58	.....	Each	8.11

### License Plate Brackets

B 17385A	58/60; Front	.....	21.18
B 17385B	61/63; Front	.....	21.18
B 17385C	64/65; Front	.....	28.60
B 17385D	66; Front	.....	20.35

### Attaching Hardware

BHK 330	Front License Plate Holder		
	61/63	.....	1.74
BHK 331	Front License Plate Holder		
	64/65	.....	4.50
BHK 333	Front License Plate Holder		
	66	.....	2.18
BSP 375837	Gas Door and Front Licence		
	Plate Bracket Bumper	.....	1.65



**DuraLite** provides an excellent lightweight barrier against ultraviolet degradation, dust and dirt. It's also water repellent (Indoor/Outdoor Use).

Our **Cotton Cover** offers lightweight protection against the elements, While maintaining maximum breathability for your car. The **Flannel Cover** offers the ultimate 'soft touch' protection for your 'Bird.

BCC 58A	Flannel Cover		
	[Indoor Use Only]	.....	234.55
BCC 58B	Cotton Cover		
	[Indoor Use Only]	.....	202.47

## Larry's T-Shirt



100% pure cotton

High quality Fruit of the Loom →  
Lofteez T-Shirt, imprinted with our Larry's Thunderbird and Mustang logo. Ash colors only, with blue printing.

← TAPTDM: Medium	.....	Each	14.95
TAPTDL: Large	.....	Each	14.95
TAPTDX: X-Large	.....	Each	14.95
TAPTDXX: XX-Large	.....	Each	16.95



## Larry's Logo T-Shirt

TAPTCM: Medium	.....	Each	9.95
TAPTCL: Large	.....	Each	9.95
TAPTCX: X-Large	.....	Each	9.95
TAPTCXX: XX-Large	.....	Each	10.95
TAPTEM: Medium, Long Sleeve	.....	Each	15.95
TAPTEL: Large, Long Sleeve	.....	Each	15.95
TAPTEX: X-Large, Long Sleeve	.....	Each	15.95
TAPTEXX: XX-Large, Long Sleeve	.....	Each	16.95

## Surf City Garage Products That Offer The Ultimate Show Finish!

### Killer Chrome Perfect Polish

If you've ever dealt with tarnished chrome, you know it's ugly and hard to polish. Killer Chrome makes it easy. Chrome, aluminum, stainless and even brass, this stuff is Enthusiast Grade and can do it all. Its non-abrasive chemical formula means you can use it repeatedly to remove surface rust and oxidation with no fear of damage to your chrome or metal, unlike abrasive metal cleaners that can lead to expensive re-plating. It also works twice as fast as other polishes whether you apply it by hand or machine. Safely get rid of tarnish and get a killer mirror finish with Killer Chrome.

TCC 30.....12.95

### Code Red Active Wheel Cleaner

Use Speed Demon on your dusty car and your jaw will drop. It's not magic, but using it is the closest you'll get to being a magician. Spray it on the surface, glass and chrome between wax sessions to keep your car looking brilliant. Dusty car? Doesn't matter. Dust particles are suspended so they never touch the surface, ever. It gives your car a brilliant shine, blocks contaminants and UV rays, has no buildup, no streaks and lasts three times longer than other spray detailers (thanks to high levels of #1 Carnauba wax). Take a deep breath, read that again, and go impress your friends with Speed Demon.

TCC 32.....12.99

### Beyond Black Tire Pro

What goes best with clean shiny wheels? Tires that look brand new. Nothing else helps your ride look its best more than clean wheels and tires, so use Beyond Black tire dressing. It's got a no sling, no gel formula. No thick, glossy look here. Beyond Black puts that straight-off-the-showroom-floor shine on your tires. It even helps extend their life and protect them from UV rays. What could be better? Oh yeah - it lasts for weeks.

TCC 33.....10.95

### Barrier Reef Carnauba Spray Wax

The deepest gloss. The easiest to use. Just two of the reasons that Barrier Reef has become the best-selling wax in the Enthusiast Market. But there's much more. It also provides the longest-lasting paint protection and is hand blended with the world's best Brazilian Carnauba for that deep, wet, reach-in-and-touch-the-paint-gloss. Try Barrier Reef just once and we guarantee you'll never use another wax on your ride.

TCC 34.....10.95

### Barrier Reef Carnauba Paste Wax Kit - applicator and towel

Detailing purists and enthusiasts obsessed with durability, incredible gloss and unparalleled beading ability have exclusively used paste wax for years. But even the most expensive paste waxes have well-earned reputations for being difficult to work with. Barrier Reef has finally changed all that and made the paste wax experience what it was meant to be. Starting with the best Carnauba in the world from the Brazilian rainforests, we added cutting edge advanced polymers and custom-blended the world's best paste wax,

one that improves on Mother Nature herself. It's not only the easiest-to-use paste wax on the planet, but it also creates a mile-deep gloss that looks like a reflecting pool of color.  
TCC 35.....22.95

### Black Max Vinyl, Rubber, & Trim Dressing

Got cloudy gray trim, but want the black back? Black Max here to save the day. Vinyl, rubber and plastic will look showroom new in minutes, no matter what color they are. Finally, a dressing that's a cream so it stays on the car, not dripping to the ground. Black Max contains powerful UV blockers to stop or prevent bleaching and cracking from the sun. The finish isn't greasy or glossy, so you get a perfect factory-new look. You don't have to apply this stuff often because it lasts through dozens of washes and even rain.

TCC 36.....11.95

### Top End Convertible Cleaner & Protectant

Ride with your convertible top down in the dead of winter to hide the stiff and dirty material? Or is it new and needs protection? Make it soft and supple with Top End, a cleaner, protectant and conditioner all in one single product. 100% safe on vinyl, canvas or fabric, Top End cleans stains and mildew, repels dirt and dust, protects against UV rays and extends the life of your top. Works great on vinyl/tonneau bed covers too. Use it regularly to prevent the stiffness that many convertibles are plagued with. Use Top End and you'll wish you could keep your top on even in nice weather just to show it off.

TCC 37.....9.95

### Black Edge Detailer

When it comes to your car's interior, nothing beats new leather - it's clean, soft and smooth, and it smells amazing. To maintain that original look and feel, you need to be sure to not only remove contaminants and grime, but also condition the leather. Voodoo Blend Leather Cleaner & Conditioner is an all-in-one formula that provides your leather with the best treatment possible. It removes all of the dirt and grime from leather first and, just like our Voodoo Blend Leather Rejuvenator, conditions and rejuvenates.

TCC 38.....12.95

### Black Edge Carnauba Wax

Your car deserves the ultimate edge in lasting shine and protection - Black Edge. Specially formulated to give your dark and black paint the wettest, deepest, rich-in-and-touch-the-paint gloss. No buildup, no chalky residue, just sleek, clean and clear. Make YOUR statement with Black Edge.

TCC 39.....19.95

### Luster Lace Narrow Strips

Luster Lace™ Metal Polishing Strips clean and polish 360 degrees around so you don't miss a spot. Works outstanding on Aluminum, Brass, Bronze, Copper, Magnesium & Stainless Steel. (Note—Not suitable for use on anodized, clear coat or plated surfaces)  
Contains: 14 strips (1/2" x 16")

TCC 50.....12.95



TCC 30

TCC 32

TCC 33



TCC 34



TCC 35



TCC 36



TCC 37



TCC 38



TCC 39



TCC 50

## Special Trim Adhesives



B 19552A



B 19552B



B 19552C

- |          |                                     |       |
|----------|-------------------------------------|-------|
| B 19552A | Black cement, 5 oz. tube.....       | 10.97 |
| B 19552B | Yellow cement, 5 oz. tube.....      | 8.93  |
| B 19552C | Spray Adhesive, 16.75 oz. can ..... | 26.50 |

## Larry's Illustrations Manuals

Larry's Illustrated Parts Manuals for 1958/60 and 1961/66 are an in-depth compilation of full-page illustrations that cover all systems in your Thunderbird. These manuals are a "must have item" for those who work on their own car, or if you need to have an idea of what your mechanic is doing on your vehicle. Probably one of the best investments you can make when it comes to restoring your T-Bird properly!

Order Part—BLT 18  
[58/60] ..... 13.50  
Order Part—BLT 19  
[61-66] ..... 13.50



## Vacuum Diagram Manual

1958-1966  
Thunderbird  
Vacuum  
Diagram  
Manual

BLT 2 58/66 Thunderbird Vacuum Diagram Manual **NEW** 10.00

## Thunderbird! "An Illustrated History of the Ford T-Bird"

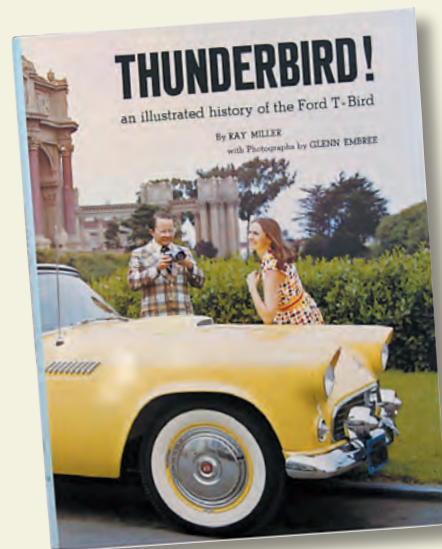

**DETAILED!** Over 1000 sharp, new pictures of the Ford Thunderbird, many in full color!

**ACCURATE!** Low-mile originals or quality restorations used as models!

**LARGE SIZE!** hard-bound, with colorful wraparound protective dust jacket. Over 300 pages, 1000 illustrations, many in full color!

Written by Ray Miller, noted automotive historian, with photos by Glenn Embree, outstanding automotive photographer! Similar to their earlier works on Antique & Classic Automobiles!

**THUNDERBIRD!** is not an amateur's photo album. Neither is it a complex engineering notebook. It contains, to be sure, some significant changes, but also the trivia of the model years. Rather, it is what it set out to be, an accurate, authoritative, study of the characteristics that make for a "typical" model year. Future restorers will benefit from its compact, succinct, and definitive presentations. It is a book to be enjoyed by the curious, welcomed by the purist, and relished by the aficionado.

TLT 8 "Thunderbird" Book.....52.99

## Authentic-Style Owner's Manuals

*Help maintain the Authenticity of your T-Bird!*



Each manual is carefully reproduced to give Thunderbird owners the look of an original-style manual. You'll find the pages filled with directions, instructions, specifications, etc. that apply to your particular vehicle. Original-Style Owners's Manuals are one of the final details to finish a great restoration project. Slip in your glove compartment or special document case for show or club outings.

BLT OM58 1958 .....	17.53
BLT OM59 1959 .....	17.53
BLT OM60 1960 .....	17.53
BLT OM61 1961 .....	17.53
BLT OM62 1962 .....	17.53
BLT OM63 1963 .....	17.53
BLT OM64 1964 .....	17.53
BLT OM65 1965 .....	17.53
BLT OM66 1966 .....	17.53

# LITERATURE & MANUALS

## Special Manuals

BLT SM65



BLT AM51



BLTTR58



BLT WD63



BLT AM93



BLT AM93

## Wiring Diagram Manuals

BLT WD58 1958 .....	7.65
BLT WD59 1959 .....	7.65
BLT WD60 1960 .....	7.65
BLT WD61 1961 .....	7.65
BLT WD62 1962 .....	7.65
BLT WD63 1963 .....	7.65
BLT WD64 1964 .....	7.65
BLT WD65 1965 .....	7.65
BLT WD66 1966 .....	7.65

## Electrical Assembly Manuals

BLT AM93 1962; Electrical Assembly Manual .....	15.81
BLT AM53 1964; Electrical Assembly Manual .....	15.81
BLT AM58 1965; Electrical Assembly Manual .....	15.81
BLT AM63 1966; Electrical Assembly Manual .....	15.81

## Specifications & Features Manuals

BLT SF58



BLT SF58 1958 .....	7.40
BLT SF59 1959 .....	7.40
BLT SF60 1960 .....	7.40
BLT SF62 1962 .....	7.40
BLT SF63 1963 .....	7.40
BLT SF64 1964 .....	7.40
BLT SF65 1965 .....	7.40
BLT SF66 1966 .....	7.40

## Shop Manuals

BLT SM58 1958 .....	37.09
BLT SM59 1959 .....	37.09
BLT SM60 1960 .....	37.09
BLT SM61 1961 .....	37.09
BLT SM62 1962/63 .....	42.40
BLT SM64 1964 .....	37.09
BLT SM65 1965 .....	37.09
BLT SM66 1966 .....	37.09

## Body & Interior Assembly Manuals

BLT AM51 1964; Body & Interior Assembly Manual .....	26.01
BLT AM56 1965; Body & Interior Assembly Manual .....	26.01
BLT AM61 1966; Body & Interior Assembly Manual .....	26.01

## Convertible Top Repair Manuals

BLTTR58 1958/60; Convertible Top Repair & Adjustment Manual .....	7.40
BLTTR61 1961/63; Convertible Top Repair & Adjustment Manual .....	7.40
BLTTR64 1964/66; Convertible Top Repair & Adjustment Manual .....	7.40

*Can't make a decision on the best gift? Larry's gift certificates are the solution! Ask our Sales Specialists for complete details*

# DECALS-1958/60

## Engine Compartment Decals

BDF 33	58/62; Coil Decal .....	3.52
BDF 83	57/64; Air Cleaner Service Instruction Decal .....	3.57
BDF 107	58/61; Voltage Regulator Decal .....	3.57
BDF 120	58/65; FoMoCo Antifreeze Tag .....	3.57
BDF 140	59/60; "Interceptor" Air Cleaner Decal .....	4.85
BDF 141	58/59 "Thunderbird Special" Air Cleaner Decal..... Use with DF140 .....	4.85
BDF 142	59/60; "Special" Air Cleaner Decal, Use with DF140 .....	4.85
BDF 164	60/66; Oil Cap Decal .....	3.32
BDF 405	60/64; Battery Test "O.K. ....	3.32
BDF 430	58; "Interceptor Special" Air Cleaner Decal .....	4.44
BDF 461	59/64; Coolant Tag .....	3.83
BDF 536	57/60; Air Conditioner Charge Decal .....	3.83

## Valve Cover Decals

BDF 234	60/62; "352 High Performance" .	4.68
---------	---------------------------------	------

## Interior Compartment Decals

BDF 186	59; New Car Window Price Sticker .....	4.34
BDF 187	60; New Car Window Price Sticker .....	4.34
BDF 202	59; New Car Accessory Price List .....	3.06
BDF 203	60; New Car Accessory Price List .....	3.06
BDF 275	57/59; Transistor Radio Decal .....	3.57

## Trunk Compartment Decals

BDF 547	58/60; Convertible Top Operating Instructions .....	3.57
---------	---	------



BDF 33



BDF 107



BDF 164



BDF 234

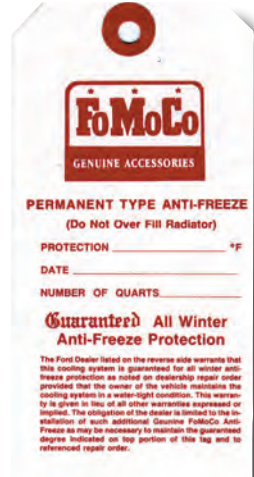

BDF 120

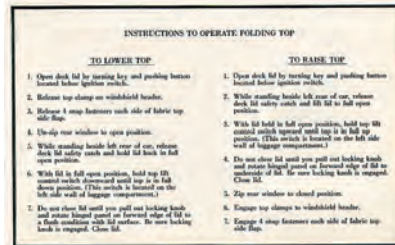

BDF 547

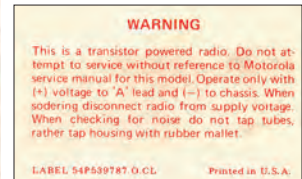

BDF 275



BDF 202



BDF 203

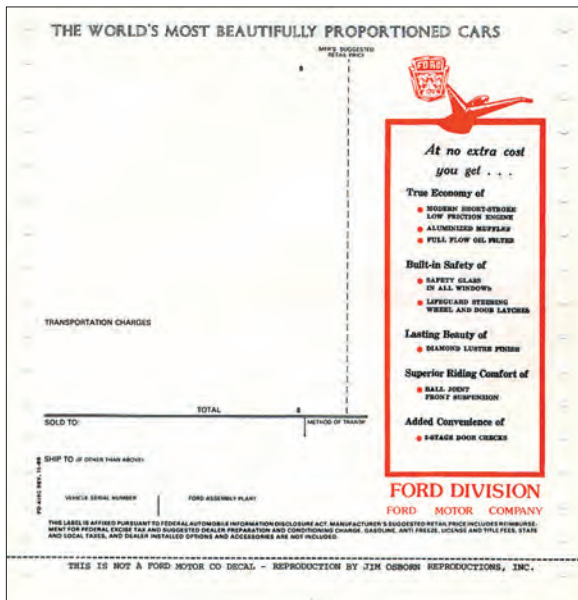

BDF186

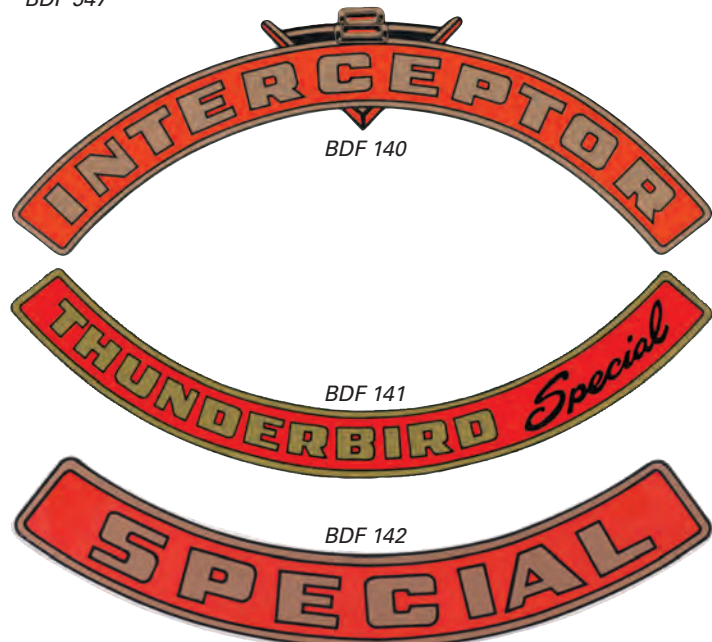

BDF 140

BDF 141

BDF 142

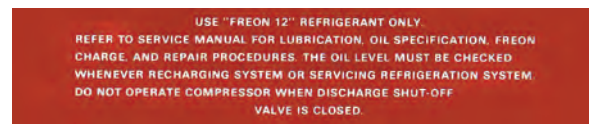

BDF 536



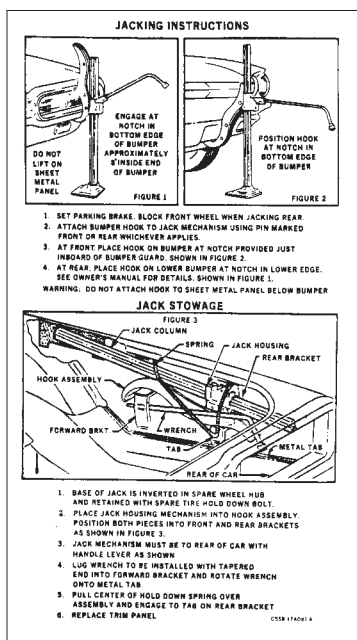

BDF 290

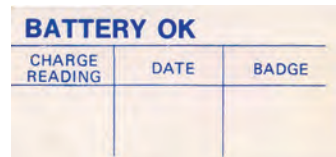

BDF 405



BDF 412

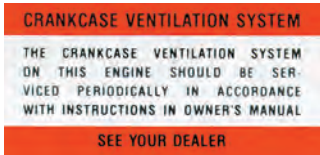

BDF 350

## Engine Compartment Decals

DF 20	Service Specifications; 65/66	3.10
DF 33	Coil Decal, 58/62	3.52
DF 107	Voltage Regulator, 61	3.57
DF 118	Caution—Fan Shroud; 61/66	3.83
DF 120	FoMoCo Anti-Freeze Tag 61/65	3.57
DF 194	Battery Test "O.K."; 64/66	1.79
DF 198	Battery—Caution; 63/66	3.32
DF 224	Coil Decal, 65/66	3.83
DF 320	Engine Voltage Regulator Warning Tag; 62/66	3.32
DF 331	Disc Brake Master Cylinder, 66	3.06
DF 337	Voltage Regulator, 62/64	3.57
DF 345	Service Specifications; 64	2.60
DF 347	Voltage Regulator Warning Decal; 62/64 Pair	3.44
DF 405	Battery Test—"O.K."—62/63	3.32
DF 412	Voltage "Regulator, 65/66	4.59
DF 461	Coolant Tag, 59/64	3.83
DF 515	Generator Decal; 62/64	3.83

## Air Cleaner Decals

DF 53	390 CID; 61/66	3.83
DF 57	352 CID; 61	3.83
DF 115	428 CID; (Black/Orange Squares), 66	3.62
DF 149	Service Instruction; 65/66	3.32
DF 150	Front; 65/66	3.01
DF 160	Autolite Spark Plug; 64/66	3.57
DF 164	Oil Filter Cap; 61/66	3.32
DF 221	428 CID; (Black/White Squares), 66	3.57
DF 280	Fuel Filter, 65/66	3.57
DF 350	Crankcase Ventilation; 62/65	3.57
DF 352	Autolite spark Plug; 62/63	3.57
DF 353	Transistorized Ignit. Heat Shield, 64/65	3.57
DF 447	Starter Decal; 62/64	3.57

## Interior Compartment Decals

DF 369	Glove Box, Tire Pressure; 63	3.57
DF 269	Glove Box, Roadster Warning Decal; 63	3.57
DF 293	Glove Box, Tire Pressure—Convertible; 66	3.57
DF 294	Glove Box, Tire Pressure—Coupe; 66	3.32
DF 370	Scuff Plate; 63/66	2.45
DF 335	Owner's Manual Envelope; 63/66	3.32
DF 170	Sun Visor, Starting Tag; 63/66	3.57

## Trunk Compartment Decals

DF 132	Jack Instructions; 62	3.57
DF 434	Jack Instructions; Sport Roadster; 62/63	3.83
DF 219	Jack Instructions; 63	3.57
DF 249	Jack Instructions; 64	3.57
DF 290	Jack Instructions; 65	3.57

## Decal Kits

High quality decals assembled in kit to help complete your engine compartment detailing. Each decal is carefully reproduced to look just like the original. Purchase the complete set for your best value!

BDK 61	1961: (10 Piece Kit)	20.29
BDK 62	1962: (10 Piece Kit)	20.29
BDK 63	1963: (13 Piece Kit)	20.29
BDK 64	1964: (14 Piece Kit)	20.29
BDK 65	1965: (13 Piece Kit)	20.29
BDK 66	1966: (14 Piece Kit)	20.29

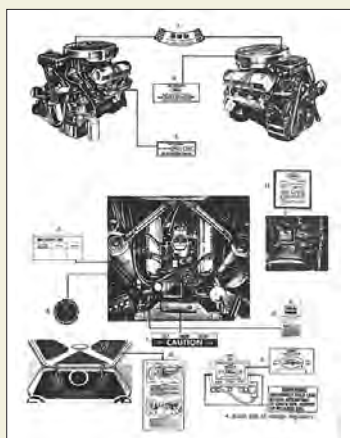

Each Decal Kit comes with detailed Instructions for original placement of each decal. (DK 61 Kit Shown)



BDF 118

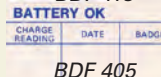

BDF 405



BDF 107



BDF 347



BDF 33



BDF 118



BDF 107

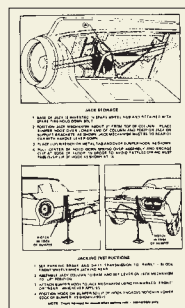

BDF 132



BDF 574



BDF 53

# PAINTS

## Put New Life Into Any Engine Compartment with Proper Paint!

*Detail Your Engine Compartment Properly with Correct Factory-Matched Paint*

### White

BPT 60WT '60Thunderbirds  
Air Filter & Fan, 352 Engine  
13 oz. can ..... 8.95

### Yellow

BPT 60YL '60Thunderbirds  
Valve Covers, 352 Engine  
13 oz. can ..... 8.95

### Black

BPT 1612 '61/65Thunderbirds  
Engine Block Heads Intake  
Manifold, Oil Pan  
'59/60Thunderbirds  
Engine Block  
'58Thunderbird  
Valve Covers,  
13 oz. can ..... 6.75

### Argent—Silver

BPT 19000 '61/62Thunderbirds  
Valve Covers and Air Cleaner  
13 oz. can ..... 9.50

### Gold

BPT 1705 '65Thunderbirds  
Valve Covers and Air Cleaner  
13 oz. can ..... 8.93

### Ford Dark Blue

BPT 1923 '66Thunderbirds  
Complete Engine  
'58Thunderbirds  
Engine Block  
'59Thunderbirds  
Valve Covers,  
13 oz. can ..... 6.75



BPT 60WT

BPT 60YL

BPT 1612

BPT 19000

BPT 1923



### Black Semi-Gloss Paint

BPT 640 All Engine Compartments  
13 oz. Can ..... 8.95

### Cast Blast

High-Performance coating suitable for heads, blocks, or other cast iron parts. CastBlast prevents rust, and is quick-drying and durable.  
TPT-CB 16 oz. can ..... 10.56



### Please Note:

**We Cannot Ship Paints, Or Other Hazardous Materials  
By Air Delivery, Or To Any Foreign Countries.**

# INDEX

- Accessories..... 104-106  
 Adhesive; Spray and Cement ..... 7, 80, 93, 107  
 Alternator ..... 50  
 Antenna ..... 103  
 Arm, Pitman ..... 26  
 Arm, Steering Idler ..... 26, 28  
 Arm, Windshield Wiper ..... 69  
 Armrest Cover ..... 9  
 Armrest, Door Panel ..... 11  
 Attaching Hardware ..... 96-97
- Ball Joint ..... 22  
 Battery Area ..... 51  
 Bearing, Rear Axle ..... 14  
 Belts, Fan ..... 41  
 Belts, Seat ..... 13  
 Body Panels, Sheetmetal ..... 94-95  
 Books/Literature/Manuals ..... 108-109  
 Brake Booster (Rebuilt) ..... 17  
 Brake Cylinder, Front ..... 18  
 Brake Cylinder, Rear ..... 20  
 Brake Hoses ..... 18-20  
 Brake Line Kits ..... 20  
 Brake Spring Kits ..... 19  
 Brake, Shoe/Lining ..... 20  
 Bracket, Sun Visor Arm ..... 12, 46  
 Bulb, Headlight ..... 55  
 Bulb, Miscellaneous ..... 60-61  
 Bumper, Hood ..... 66, 91  
 Bumper, Suspension ..... 22-23  
 Bumper, Rear Axle ..... 30  
 Bushing, Rear Spring ..... 24
- Cable, Battery ..... 51  
 Cable, Heater Temperature Control ..... 73  
 Cable, Front Parking Brake ..... 21  
 Cable, Rear Parking Brake ..... 21  
 Caliper, Disc Brake ..... 18  
 Cap, Breather (Oil) ..... 35  
 Cap, Distributor ..... 54  
 Cap, Fuel Tank ..... 42  
 Cap, Master Cylinder ..... 19  
 Cap, Radiator ..... 39  
 Car Care Products ..... 107  
 Carpet, Door Panel ..... 11  
 Carpet Sets ..... 6-7  
 Chain, Timing ..... 33  
 Clamp, Battery Hold-Down ..... 51  
 Clamp, Exhaust ..... 31  
 Clamp, Radiator Hose ..... 41  
 Coil, Ignition ..... 53  
 Control Valve, Power Steering ..... 28  
 Convertible Top ..... 12, 87  
 Cover, Car ..... 106  
 Cover, Seat ..... 4-5  
 Cover, Tire ..... 84  
 Cover, Valve (Engine) ..... 34  
 Cover, Wheel ..... 14  
 Crankshaft Parts ..... 33  
 Cylinder, Power Steering ..... 26
- Dash Mat ..... 48  
 Dash Pad Cover ..... 9  
 Decals ..... 110-111  
 Dipstick, Engine Oil ..... 35  
 Distributor ..... 54  
 Door Panel Carpet ..... 11, 79  
 Door Panels ..... 10  
 Drain Valve, Radiator ..... 40  
 Drum, Front Brake ..... 16  
 Drum, Rear Brake ..... 16
- Element, Air Cleaner ..... 45  
 Emblems ..... 65, 98-101  
 Engine Compartment Belts ..... 41  
 Escutcheon, Front Door Handle ..... 80  
 Exhaust System ..... 31
- Fan Blade ..... 41  
 Filter, Fuel ..... 43  
 Filter, Oil ..... 35  
 Filter, Power Steering Pump ..... 26  
 Flasher, Turn Signal ..... 56  
 Floor Mats ..... 105  
 Flywheel, Clutch ..... 33  
 Foam, Seat ..... 8  
 Frame, License Plate ..... 106  
 Fuel Pump ..... 43
- Gas Tank ..... 42  
 Gas Pedal ..... 45
- Gasket, Carburetor ..... 44  
 Gasket, Cylinder Head ..... 32  
 Gasket, Exhaust Manifold ..... 31  
 Gasket, Manifold Intake ..... 44  
 Gasket, Oil Pan ..... 35  
 Gasket Kit, Lamp ..... 55  
 Gauge, Fuel Sender ..... 43, 67  
 Gauge, Oil Pressure Sender ..... 67  
 Generator ..... 50  
 Glove Box Insert ..... 47  
 Grommet, Fuel Tank Filler ..... 43
- Handle, Door (Inside) ..... 80  
 Handle, Door (Outside) ..... 80  
 Handle, Hood Pull ..... 49, 66  
 Handle, Top Hold-Down ..... 88  
 Handle, Window Regulator ..... 81  
 Hardware, Attaching ..... 96-97  
 Headlamp ..... 55  
 Headlamp Door ..... 55  
 Headliner ..... 13  
 Heater Parts ..... 72  
 Hood Bumper ..... 66  
 Horn ..... 59  
 Hose, Brake ..... 18  
 Hose, Power Steering ..... 27  
 Hose, Radiator ..... 40  
 Hose, Windshield Wiper ..... 68-69  
 Housing, Tail Light ..... 57
- Idler Arm Kit ..... 26  
 Ignition, Keys/Cylinder ..... 53  
 Ignition Wires (Spark Plug) ..... 54  
 Insulator, Exhaust Hanger ..... 31  
 Insulator, Front Sway Bar ..... 23
- Key Blanks ..... 54  
 Kick Panels ..... 13  
 Kit, Brake Master Cylinder ..... 19  
 Kit, Carburetor Rebuild ..... 44  
 Kit, Distributor Tune-up ..... 54  
 Knob, Heater Control Switch ..... 49  
 Knob, Radio ..... 49  
 Knob, Windshield Wiper Switch ..... 49
- Lamp, Engine/Trunk Compartment ..... 83  
 Lamp, Dome ..... 86  
 Lamp, Interior Pillar ..... 48  
 Lamp, Parking ..... 56  
 Landau Vinyl Top ..... 12  
 Latch, Front Door ..... 77  
 Lens, Back-Up Lamp ..... 58  
 Lens, Rear Lamp ..... 57  
 Lever, Turn Indicator ..... 59  
 License Plate Frames ..... 106  
 Lines, Brake ..... 20  
 Lock, Door (Cylinder/Keys) ..... 80  
 Lock, Trunk Lid ..... 85
- Manual, Illustrations ..... 108-109  
 Manual, Owner's ..... 108-109  
 Manual, Shop ..... 108-109  
 Master Cylinder, Brake ..... 19  
 Mat, Rubber Floor ..... 8  
 Mat, Trunk ..... 84  
 Mirror, Inside Rear-View ..... 70  
 Mirror, Outside Rear-View ..... 70  
 Motor, Heater and A/C ..... 73  
 Mount, Engine ..... 32  
 Mount, Transmission ..... 36  
 Muffler, Exhaust ..... 31  
 Oil Pan ..... 35  
 Oil Pump ..... 34  
 Ornament, Body Side Plate ..... 99  
 Ornament, Door Outside ..... 77  
 Ornament, Front Fender ..... 65  
 Ornament, Nose Panel ..... 40  
 Ornament, Quarter Panel - Rear ..... 82  
 Ornament, Roof-Side - Outer ..... 87  
 Ornament, Trunk Lid ..... 83, 85
- Pad Brake ..... 17  
 Pad, Brake Pedal ..... 21  
 Pad, Instrument Panel (Dash Pad) ..... 9  
 Pad, Rear Lamp Mounting ..... 92  
 Paint, Engine ..... 112  
 Panel, Body ..... 94-95  
 Panel, Door ..... 10  
 Panel, Kick ..... 13, 47  
 Pedal, Gas ..... 45  
 Pitman Arm ..... 26
- Plate, Clutch Pressure ..... 37  
 Plate, Scuff (Step) ..... 9  
 Plug, Engine Oil Drain ..... 35  
 Points, Distributor ..... 54  
 Pump, Fuel ..... 43  
 Pump, Power Steering ..... 27  
 Pump, Water ..... 41
- Quarter Panel ..... 82  
 Quarter Panel Trim ..... 9
- Radiator ..... 39  
 Radio ..... 102-103  
 Regulator, Generator Voltage ..... 50  
 Regulator, Instrument Cluster Voltage ..... 67  
 Relay, Window and Seat ..... 90  
 Reservoir, Windshield Washer ..... 69  
 Rod, Tie ..... 25  
 Rod, Push Valve ..... 34  
 Rotor, Disc Brake ..... 16  
 Rotor, Distributor ..... 54
- Scuff Plate ..... 9, 74  
 Seat Belt Sets ..... 13  
 Seat Cover Sets ..... 4-5  
 Seat Foam Sets ..... 8  
 Seat Hardware ..... 90  
 Sender, Fuel Tank ..... 43, 67  
 Sender, Oil Pressure ..... 67  
 Sender, Water Pump ..... 35, 67  
 Shackle Kit, Leaf Spring ..... 24  
 Shaft, Oil Pump Drive ..... 34  
 Sheet Metal ..... 94-95  
 Shock Absorber, F/R ..... 24  
 Shroud, Fan (Radiator) ..... 40  
 Spark Plug Wire Set ..... 62  
 Speaker, Radio ..... 103  
 Speedometer Cable ..... 67  
 Spray Paint, Engine ..... 32  
 Spring, Front Coil ..... 23  
 Spring, Rear Leaf ..... 23  
 Sprocket, Camshaft ..... 33  
 Stabilizer Bar Kits ..... 23  
 Standard Parts (Nuts/Bolts) ..... 96  
 Starter ..... 52  
 Sun Visor ..... 12, 46  
 Sun Visor Brackets ..... 12, 46  
 Surge Tank ..... 39  
 Sway Bar Kits ..... 23  
 Switch, Courtesy Lamp ..... 48  
 Switch, Headlamp ..... 48  
 Switch, Ignition ..... 48  
 Switch, Neutral Safety ..... 37  
 Switch, Power Window ..... 75  
 Switch, Stop Lamp ..... 21
- Tank, Fuel ..... 42  
 Tank, Surge ..... 39  
 Temperature Sender ..... 35, 67  
 Thermostat ..... 41  
 Tie Rod End ..... 25  
 Top, Convertible/Soft ..... 12  
 Top, Vinyl Landau ..... 12  
 Transmission Parts ..... 36-38  
 Tray, Battery ..... 51  
 Tube, Oil Level Indicator (Engine) ..... 35
- Universal Joint ..... 30  
 Upholstery, Seat ..... 4-5  
 Upholstery Trim Kit ..... 3  
 Upholstery Installation Kit ..... 8
- Valve Cover Assembly ..... 34  
 Valve, Exhaust ..... 33  
 Valve, (PCV) Positive Crankcase ..... 34  
 Valve, Radiator Drain ..... 40  
 Valve, Rocker Arm Shaft ..... 34  
 Visor, Sun ..... 12
- Water Pump ..... 41  
 Weatherstrip, Convertible (Kit) ..... 92-93  
 Weatherstrip, Front Door ..... 76, 92-93  
 Weatherstrip, Front Quarter Window ..... 81, 92-93  
 Weatherstrip, Luggage Compartment ..... 85, 92-93  
 Weatherstrip, Rear Window ..... 83, 92-93  
 Weatherstrip, Roof Side Rail ..... 81, 92-93  
 Weatherstrip, Windshield ..... 46, 92-93  
 Wheel Covers ..... 14  
 Windlace ..... 9  
 Wiper Arm & Components ..... 69



1180 California Ave. #B  
Corona, California 92881

**Order Toll Free: (800) 854-0393**

**In California Call (951) 270-3223 • 24-Hour FAX: (951) 270-3224**

**Contact us via e-mail: [info@larrystbird.com](mailto:info@larrystbird.com)**

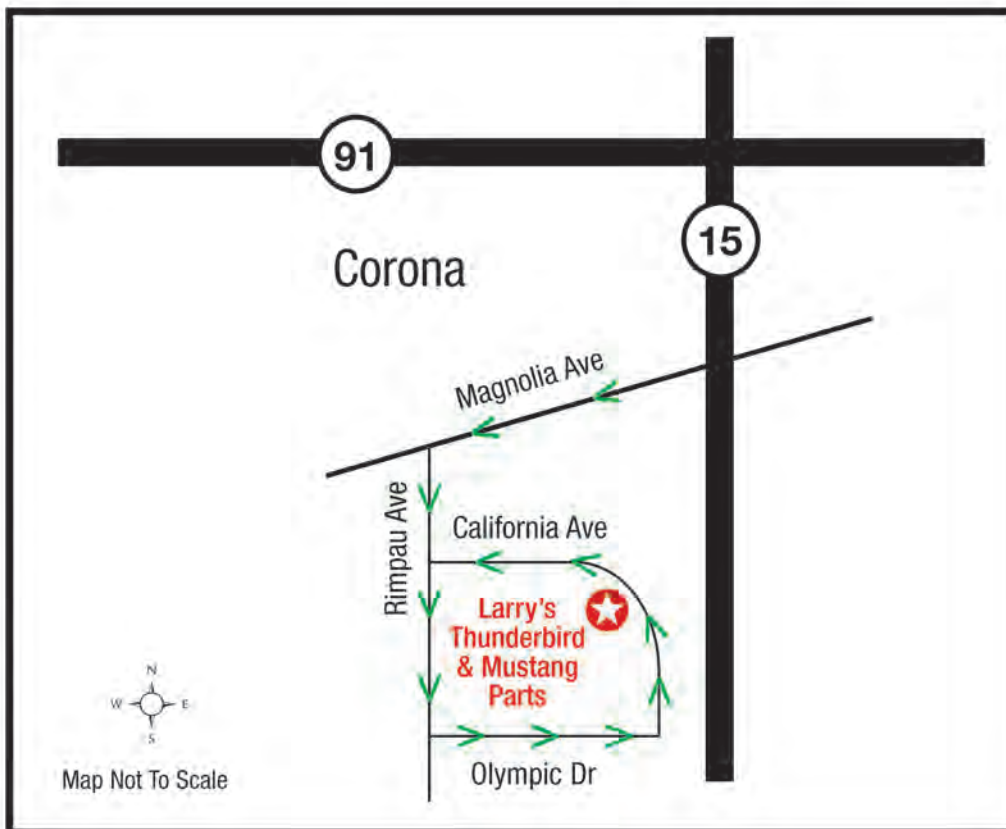

**Our Address:**

1180 California Ave. #B  
Corona, California 92881

**Store Hours:**

Monday-Friday 7:00am to 5:00pm

**Find us on the Web! [www.larrystbird.com](http://www.larrystbird.com)**