LSU BOARD OF SUPERVISORS MEETING

Board Room, University Administration Building

3810 W Lakeshore Dr, Baton Rouge, LA 70808

April 26, 2024 | 10:00 a.m. CT

- I. Call to Order and Roll Call
- II. Invocation and Pledge of Allegiance
- III. Public Comment
- IV. Committee Meetings
 - A. Research and Agricultural Extension Committee
 1. Bovine Respiratory Disease Vaccine
 - B. Academic Committee
 1. Request LSU A&M to Award a Posthumous Degree to Mr. William Connor Allison
 2. Request from LSU A&M for Initial Designation as a Center of Research Excellence for Comparative Oncology
 3. Request from LSU Health New Orleans to Establish a PhD in Biomedical Sciences
 4. Recommendation to Approve Conferral of Degrees for Calendar Year 2024 Commencement Exercises
 5. Consent Agenda
 - a. Request from LSU A&M to Offer the BA in Political Science 100% Online
 - b. Request from LSU Health Shreveport for Continued Authorization of the Center for Cardiovascular Diseases and Sciences Center of Excellence
 - c. Request from LSU Health Shreveport to Name W. Clinton Raspberry Jr. Auditorium in the Center for Medical Education Building
 - C. Finance Committee
 1. Request to Approve a Non-Resident Fee Increase for LSU's School of Veterinary Medicine
 2. Request for all LSU Institutions Employing Graduate Assistants to Implement the Requirements of Act 664 of the 2022 Regular Session of the Louisiana Legislature to Provide Payments to Cover or Create a Waiver or Exemption of any Mandatory Fee Imposed by the Institution
 - D. Property and Facilities Committee
 1. Request from LSU Health Sciences Center New Orleans to Authorize a Lease Agreement with Campus Federal Credit Union
 2. Request from LSUHSC-NO to Authorize the Second Amendment to the Lease Agreement with the Louisiana Cancer Research Center for Additional Leased Space
 3. Request from LSU-S to Authorize Agreements for the Closing of the Hicks Marital Trust
 4. Request from LSU A&M to Authorize Repairs to Patrick F. Taylor Hall

The Board or its Committees may enter into Executive Session in accordance with the provisions of LA R.S. 42:17

- 5. Proposal by LSU Eunice for Non-Human Primate Research Facility
- E. Healthcare and Medical Education Committee
 - 1. Request from LSUHSC-NO to Acknowledge and Authorize the Uniform Affiliation Agreement with the LSUHSC-NO School of Medicine Alumni Association
 - 2. Request from LSUHSC-NO to Acknowledge and Authorize the Uniform Affiliation Agreement with the LSUHSC-NO School of Nursing Alumni Association
- F. Athletics Committee
 - 1. Request from LSU Athletics to Approve New Employment Agreement for Senior Associate Athletics Director for Football Administration
 - 2. Request from LSU Athletics to Approve New Employment Agreements for Assistant Football Coaches
 - 3. Request from LSU Athletics to Increase Baseball Season Ticket Prices, Parking, and Tradition Fund
 - 4. Request from LSU Athletics to Increase Gymnastics Ticket Prices, Parking and Tradition Fund
 - 5. Request for Amendment to MultiMedia Rights Agreement with Playfly Sports Properties
- G. Risk Management Committee (8:00 a.m., Board Conference Room 104A)
 - 1. FY 2024 3rd Quarter Audit Summary
 - 2. P3 Audit Presentation
- V. Reconvene Board Meeting
- VI. Meeting Minutes
 - A. Approval of Meeting Minutes from the February 22, 2024 Board Professional Development
 - B. Approval of Meeting Minutes from the February 23, 2024 Board Meeting
- VII. Personnel Actions Requiring Board Approval
- VIII. Reports to the Board
 - A. LSU Annual Metric Data Report
 - B. Affiliated Entities Reimbursement Report FY 24 Quarter 2
 - C. Facility Summary Reports
 - 1. Approval of Requests for Timber Sales Report
 - 2. Capital Improvements Projects Above \$175,000 Report
 - 3. Design Contract Report
 - 4. Foundation Construction Related Agreements
 - 5. Grants of Mineral Rights
 - 6. Other Agreements and Approval Requests
 - 7. PM60 Projects \$75,000 to \$175,000 Report
 - 8. Property Lease Report
 - 9. Schematic Design Report

The Board or its Committees may enter into Executive Session in accordance with the provisions of LA R.S. 42:17

- 10. Servitudes Report
- 11. Transfers of Title Immovable Property
- IX. Reports from Faculty Advisors and Staff Advisors
- X. President's Report
- XI. Approval of Committee Recommendations
- XII. Chair's Report
- XIII. Adjournment

The Board or its Committees may enter into Executive Session in accordance with the provisions of LA R.S. 42:17



Board of Supervisors

RESEARCH & AGRICULTURAL EXTENSION COMMITTEE

LSU DEVELOPED A VACCINE AGAINST BOVINE RESPIRATORY DISEASE (BRD) COULD SAVE U.S. CATTLE INDUSTRY ALONE \$1 BILLION ANNUALLY



United States Department of Agriculture
National Institute of Food and Agriculture

April 26, 2024



LSU
— School of —
Veterinary Medicine

Shafiqul Chowdhury, DVM, MS, PhD

Professor

Molecular Virology

Department of Pathobiological Sciences, School of Veterinary Medicine

Louisiana State University, Baton Rouge, LA

Causes of bovine respiratory disease and abortion in cattle



Bovine herpesvirus type 1 (BHV-1)- Infectious bovine rhinotracheitis (DNA virus)

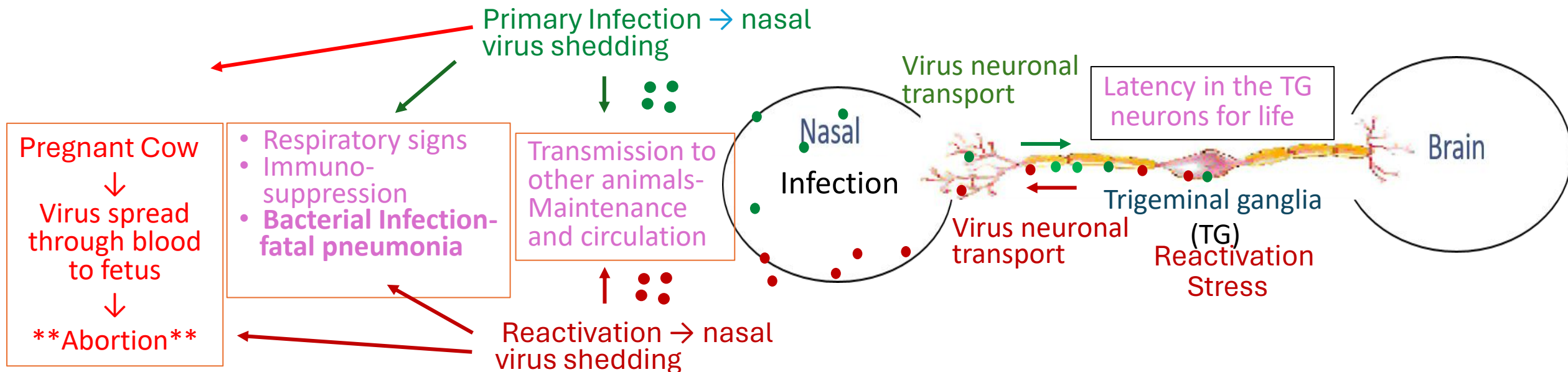

Causes of bovine respiratory disease and abortion in cattle



Bovine Viral Diarrhea virus (RNA virus)

- Not aborted - **virus will persist in the body for life**

- Abortion

Pregnant cow

Virus spread to various organs through blood

Diarrhea

Virus shedding
Feces
Semen

- Infects and kills cells of the Immune systems
- Significant Immuno-suppression
- Virus lingers in the body for several weeks
- **Bacterial Infection- fatal pneumonia**

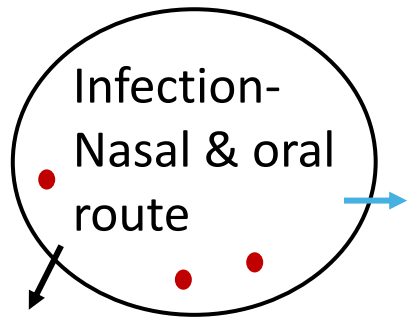

Virus shedding

Nasal secretion
Saliva

Virus transmission
other cattle

Respiratory signs
Oral lesion

BRD and Its Impact On the Beef and Dairy Industry but also on human health

- BRD and abortions are the most common diseases affecting beef and dairy cattle, respectively and costing the US cattle industry alone one billion dollars in losses.
- BRD is most common in the first four weeks of life in the feedlot and in cow-calf herds- caused by a combination of stress followed by infection with bovine herpesvirus 1(BoHV-1) also known as infectious bovine rhinotracheitis virus (IBR) and bovine viral diarrhea virus (BVD).
 - In pregnant cows (dairy industry and cow-calf operation) these two viruses cause abortions.
- Initial viral infection leads to immunosuppression, which facilitates bacteria normally present in the respiratory tract to colonize the lungs, resulting in fatal pneumonia and death.
 - ❖ Broad-spectrum antibiotics are used for the treatment, which may promote antibiotic-resistant bacteria.
- Currently used vaccines are from the 60s and 70s technology, which are mixtures of whole BHV-1 and BVDV that have been passed 100s of times in cell culture, resulting in the loss of their ability to cause clinical disease. They are designated as modified live vaccines (MLV)
 - MLVs are not distinguishable from field viruses.
 - They retain their immunosuppression and lingering properties in the host.
 - More importantly, they may change to their disease-producing forms, resulting in post-vaccinal disease outbreaks.
- Therefore, they do more harm in the long term than helping the cattle industry against the BRD.

LSU vaccine design against bovine respiratory disease (BRD)

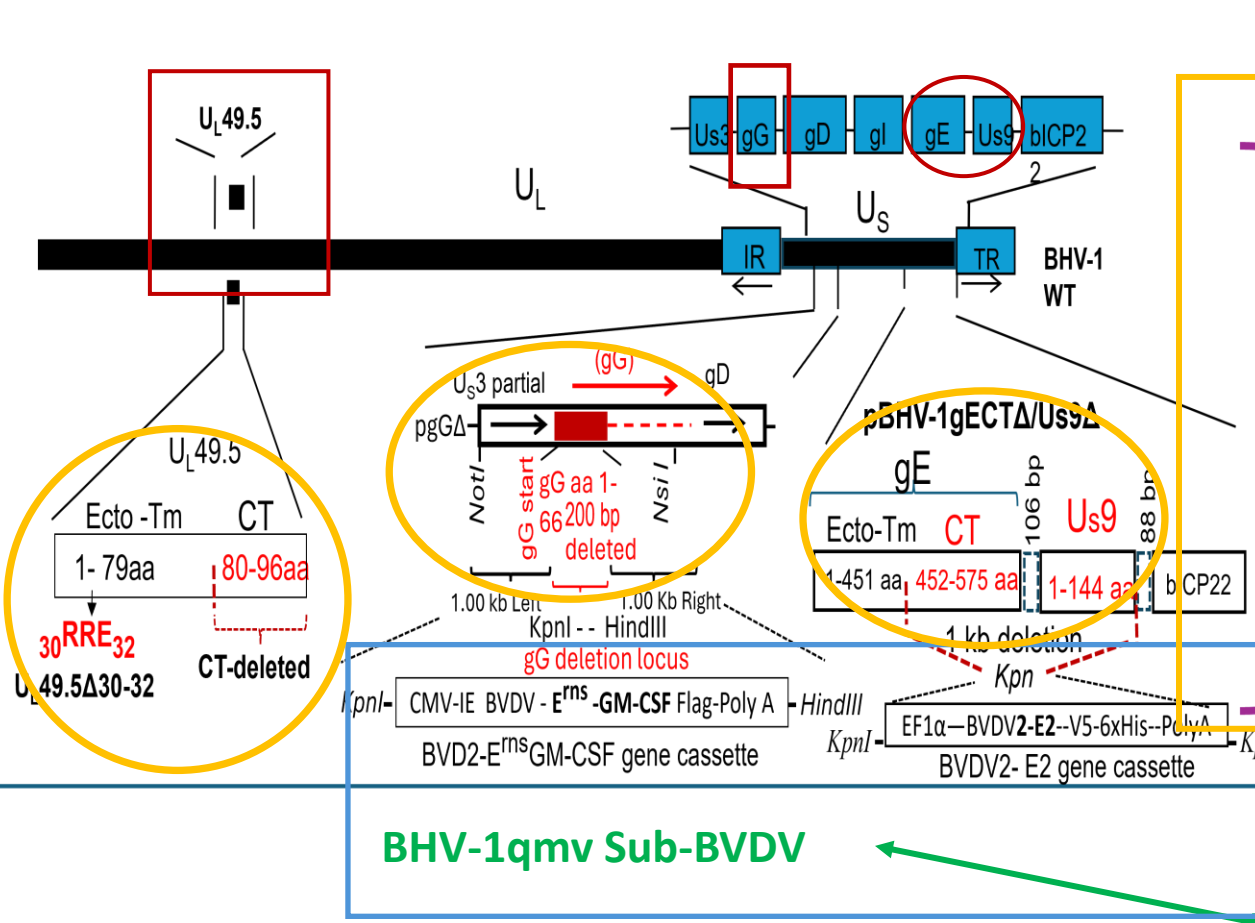

- Envelope proteins gE and Us9 are important for clinical disease and neuronal transport after reactivation from latency.
- gG and UL49.5 allows the virus to bypass the hosts' immune surveillance and protection transiently which allows the virus to establish infection and affects the quality of protective immune response.

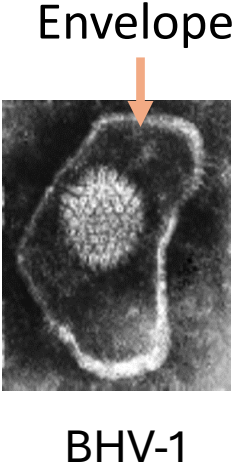

- In BHV-1 qmv, genes coding for the envelope proteins gE, Us9, gG and UL9.5 are deleted.
- They replicate in the nose for a shorter time but it triggers a stringer and faster protective immune response.

➤ **BoHV-1 qmv Sub-BVDV vaccine protects cattle against BHV-1 and BVDV.**

- E2 and E^{rns} are the two most immunogenic-protective proteins of BVDV.
- BHV-1qmv Sub-BVDV expresses the chimeric BVDV envelope proteins E2 and E^{rns}.

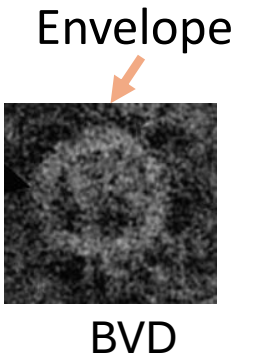

Thank You



Board of Supervisors

ACADEMIC COMMITTEE

BOARD OF SUPERVISORS MEETING | APRIL 26, 2024



Board of Supervisors

Request from LSU A&M to Award a Posthumous Degree to Mr. William Connor Allison

Date: April 26, 2024

1. Bylaw Citation

Pursuant to Article VII, Section 1, Paragraph C of the Bylaws of the Louisiana State University Board of Supervisors, this matter is a significant board matter.

- C. The Board shall award degrees. For candidates meeting the faculty's requirements for a degree, certificate, or diploma, the Board approves the conferral of degrees and authorizes the President and respective Chancellor to award the degree. Honorary degrees and posthumous degrees are included, and the President shall establish processes for review of honorary and posthumous degrees.

2. Summary of Matter

The College of Engineering is writing to request that a recently deceased undergraduate student, Mr. William Connor Allison, be granted a Posthumous Baccalaureate Degree, in accordance with the University's Policy Statement 86.

Mr. Allison was a diligent and dedicated student who pursued his academic endeavors with passion and commitment. His academic journey at LSU was characterized by exemplary performance, as evidenced by his grades and contributions to the university community. Tragically, Mr. Allison's life was cut short before he could complete his degree requirements. Despite facing significant personal challenges, he persevered in his studies and demonstrated resilience in the face of adversity. His unwavering determination and academic achievements reflect the values upheld by Louisiana State University.

With the evidence of Mr. Allison's academic success and course completion, the faculty and Chair of the Department of Construction Management, the Interim Dean of the College of Engineering, and the administration of Louisiana State University request that Mr. Allison be awarded the Bachelor of Science in Construction Management posthumously. By awarding this degree, the University acknowledges Mr. Allison's academic achievements and provides his family with a symbol of appreciation of his talents and the life he shared with us.

3. Review of Business Plan

N/A

4. Fiscal Impact

N/A

5. Description of Competitive Process

N/A

6. Review of Legal Documents

N/A

7. Parties of Interest

N/A

8. Related Transactions

N/A

9. Conflicts of Interest

N/A

10. Attachments

N/A

RESOLUTION

NOW, THEREFORE, BE IT RESOLVED that the Board of Supervisors of Louisiana State University and Agricultural & Mechanical College does hereby authorize LSU A&M to award the Bachelor of Science in Construction Management to Mr. William Connor Allison posthumously.



Board of Supervisors

Request from LSU A&M for Initial Designation as a Center of Research Excellence for Comparative Oncology

Date: April 26, 2024

1. Bylaw Citation

Pursuant to Article VII, Section 1, Paragraph B of the Bylaws of the Louisiana State University Board of Supervisors, this matter is a significant board matter.

- B. The Board shall approve any new academic program resulting in the awarding of a degree, certificate, or credential, as well as any changes of degree designation or termination of degree programs. The Board shall approve any new institution, department, research center, or institute, or required reauthorization of such.

2. Summary of Matter

The Louisiana State University School of Veterinary Medicine (LSU Vet Med) seeks initial designation as a Center of Research Excellence for Comparative Oncology (CCO). The Center's objective is to develop a multidisciplinary program in oncology that exploits small animal spontaneous tumor models and organoids made from these spontaneous tumors for better understanding of the basic mechanisms of cancers and their treatment that could impact both animal and human cancers. The specific aims of CCO are to promote and support centralized management and coordination of preclinical evaluation of tumorigenesis mechanisms and translational therapeutic approaches, provide cancer researchers with a core infrastructure for resources and support for advanced pre-clinical cancer disease, and provide training and mentorship on pre-clinical evaluation using state-of-the-art in vitro 3D tumor spheroids and organoids to complement in vivo cancer disease modeling.

Less than 5% of anti-cancer drugs are successful in clinical trials, indicating that current preclinical cancer drug research is not predictive of efficacy in humans. Louisiana ranks 5th in the nation for cancer mortality and above the national average for a variety of cancers that also disproportionately affects African-Americans. This health disparity is of great concern to Louisiana. Comparative Oncology is the study of naturally occurring cancer in animals and the comparison to its human counterpart for better understanding the biology of cancer including tumor microenvironment and immune cell interactions, and to achieve treatments that mutually benefit both humans and animals. The impact of cancer on humans and pets is enormous. The intersections between cancer in humans and companion animals are remarkable. Pets share our environment and develop all types of cancers, are commonly seen in human patients. The clinical behavior and treatment of cancer in pets and humans are almost the same.

In short, cancer is prevalent in Louisiana. Basic and translational research is needed to discover and implement novel therapies against highly aggressive cancers. A one health-comparative oncology approach provides unique opportunities to test a variety of therapeutic approaches in animals with the goal of providing therapies for both animals and humans. The National Institute of Health (NIH) is very much interested in specific animal models including canine and feline cancers. The objectives of the CCO are well-aligned with our mission and President Tate's vision of advancing cancer research in Louisiana and pursuit of a National Cancer Institute designation. The establishment of the CCO will create a multidisciplinary hub and this collaborative environment is essential for fostering innovative research, understanding cancer initiation and progression, and developing effective treatments.

3. Review of Business Plan

The CCO will be administered by the CCO Director Dr. Joseph Francis, under the guidance of the LSU Vet Med Dean Oliver Garden and supported by an Associate director with complementary research background in health disparity and or population medicine in cancer, with input from the CCO Executive council. Appointment periods will coincide with five year periods of faculty appointment at the center. The CCO director will report to the Dean of LSU Vet School and/or VC of Research.

The CCO Executive Council will be responsible for operational oversight and guidance of CCO. They will meet and receive reports from the Director and Associate Director twice yearly. The executive council will include representatives of the SVM/LSU, Southern University and LSUHSC-NO administration including Department Chairs that manage faculty working in cancer research.

4. Fiscal Impact

The State of Louisiana and LSU are pursuing the National Cancer Institute (NCI) Designation as an NCI-approved Cancer Center. This application is led by the LSUHSC-NO Stanley S. Scott Cancer Center with the strong involvement and support of the LSU-SVM proposed Center for Comparative Oncology (CCO). CCO will manage the existing Center for Pre-Clinical Cancer Research (CPCCR or Cancer COBRE), which is currently in its third year of a five year award from NIH:NIH/NIGMS and can be renewed for an additional 13 years (\$11 million-first five years). This grant award will provide funding for junior investigators in Vet Med, LSU at-large and Southern University A&M College, as well as core facilities and equipment to conduct nationally competitive research and enable investigators to pursue additional funding from NIH and other sources. A significant aspect of this program grant and CCO is the utilization of three-dimensional cell culture systems (organoids) for improving the predictability of human cancer phenotypes and developing therapeutic strategies. CCO will uniquely provide a multi-prong approach to support exploratory cancer research, mechanisms of tumorigenesis and tumor progression as well as translational assessment that will lead to the development of successful therapeutic strategies in humans and animals.

LSU Vet Med is managing two additional NIH Program grants that have a direct impact on cancer research. These are: 1) the Center for Lung Biology & Disease (CLBD) that focuses on lung

diseases including lung cancer (approx. \$11 million over five years and renewable for 10 more years). 2) the Louisiana Biomedical Research Network (LBRN) that promotes biomedical research throughout Louisiana with special interests in cancer research (approx. \$20 million over five years, renewable indefinitely as the only such program grant in Louisiana).

There is no need for additional facilities currently. However, increased funding may allow the relocation of SVM cancer efforts into a new facility that may be built for specific purposes in the future.

5. Description of Competitive Process

N/A

6. Review of Legal Documents

N/A

7. Parties of Interest

N/A

8. Related Transactions

N/A

9. Conflicts of Interest

N/A

10. Attachments

N/A

RESOLUTION

NOW, THEREFORE, BE IT RESOLVED that the Board of Supervisors of Louisiana State University and Agricultural & Mechanical College does hereby approve the request from LSU A&M for initial designation as a Center of Research Excellence for Comparative Oncology



Board of Supervisors

Request from LSU Health New Orleans to Establish a PhD in Biomedical Sciences

Date: April 26, 2024

1. Bylaw Citation

Pursuant to Article VII, Section 1, Paragraph B of the Bylaws of the Louisiana State University Board of Supervisors, this matter is a significant board matter.

- B. The Board shall approve any new academic program resulting in the awarding of a degree, certificate, or credential, as well as any changes of degree designation or termination of degree programs. The Board shall approve any new institution, department, research center, or institute, or required reauthorization of such.

2. Summary of Matter

The proposed PhD in Biomedical Sciences program was developed to consolidate the seven existing PhD programs in the basic sciences at LSUHSC-NO (Biochemistry & Molecular Biology, Physiology, Pharmacology & Experimental Therapeutics, Neuroscience, Cell Biology & Anatomy, Microbiology, Immunology, and Parasitology, Human Genetics) into a single PhD Program. The primary objectives are to (1) provide an integrated, modern learning experience for graduate students, (2) capitalize on the research strengths of LSUHSC-NO, and (3) prepare students for contemporary careers in the Biomedical Sciences. Consolidating the seven existing PhD programs into a single degree-granting program ensures that consistent benchmarks are implemented across the various biomedical science disciplines and allows LSUHSC-NO to readily incorporate interdisciplinary training experiences for students that build on research strengths at LSUHSC New Orleans.

3. Review of Business Plan

With the current degree granting programs, LSUHSC-NO provided an option to enter doctoral training through a one-year interdisciplinary curriculum which incorporated the opportunity for laboratory rotations throughout the seven programs. (Students selected one of the seven programs for degree completion in year 2 of their studies.) Therefore, LSUHSC-NO already has a basic framework in place to guide the development of the proposed Biomedical Sciences program. The first-year coursework utilized in the existing interdisciplinary curriculum has been reorganized and structured to provide an integrated, modern interdisciplinary curriculum that will provide foundational content for graduate students entering any specialization within the Biomedical Sciences. LSUHSC-NO has intentionally revised content to enhance its alignment with the contemporary scientific landscape, while maintaining the importance of foundational concepts and drawing upon their expertise in the basic science departments at LSUHSC-NO.

Fundamental concepts in Biochemistry, Cell & Molecular Biology, Genetics, and Microbial Pathogenesis will be taught in a fully integrated manner throughout the Fall and Spring semesters (BIOMED 110 & 111). Likewise, Neuroscience, Physiology, Pharmacology, and Cancer Biology will be taught in a fully integrated manner throughout the Fall and Spring semesters (BIOMED 120 & 121). These courses will feature interconnected content, with concepts interwoven across

both individual courses and successive semesters. Experimental Design & Analysis and Biostatistics, which are instrumental for the success of a graduate student will be taught in the first year, along with newly developed Trends & Techniques courses, which incorporate laboratory rotations and enhance understanding of basic laboratory assays, techniques, and models. In their second year, graduate students will join laboratories and begin specializing by taking advanced coursework associated with their area of focus. Qualifying and Preliminary exam formats will be consistent for all students and requirements for graduation (e.g. first author publication) will be uniform across the program. These courses are described in the attached curriculum map.

4. Fiscal Impact

The proposed program is a consolidation of the existing seven individual basic sciences programs. The budget for the existing programs is currently administered through the School of Medicine. The budget for the proposed program will be under the school of Graduate Studies, and costs associated with it (first year student cost) will be covered by the reallocation of state appropriations, restricted revenue sources, and anticipated federal and private funding opportunities. LSUHSC-NO anticipates over the next 2-4 years an increase in faculty funded by federal and private grants, which can support graduate training. Additional support for faculty teaching will not be needed, as they will be shifted from current programs.

Following approval of the proposed consolidation program, the existing programs will be terminated with prepared teach-out plans. Funds currently used by these seven programs (in School of Medicine) will be re-allocated to the Biomedical Sciences program, beginning with the new entering class for 2024-25.

Students will not have additional costs associated with the program. LSUHSC-NO will offer graduate research assistantships of \$30,000 annually to students accepted into the program that meet admission criteria. Tuition and fees will be provided to all students accepted in the program.

5. Description of Competitive Process

N/A

6. Review of Legal Documents

N/A

7. Parties of Interest

N/A

8. Related Transactions

N/A

9. Conflicts of Interest

N/A

10. Attachments

N/A

RESOLUTION

NOW, THEREFORE, BE IT RESOLVED that the Board of Supervisors of Louisiana State University and Agricultural & Mechanical College does hereby approve the request from LSU Health New Orleans to establish the PhD in Biomedical Sciences.



Board of Supervisors

Recommendation to Approve Conferral of Degrees for Calendar Year 2024 Commencement Exercises

Date: April 26, 2024

1. Bylaw Citation

Pursuant to Article VII, Section 1, Paragraph C of the Bylaws of the Louisiana State University Board of Supervisors, this matter is a significant board matter.

- C. The Board shall award degrees. For candidates meeting the faculty's requirements for a degree, certificate, or diploma, the Board approves the conferral degrees and authorizes the President and respective Chancellor to award the degree. Honorary degrees and posthumous degrees are included, and the President shall establish processes for review of honorary and posthumous degrees. Approval by the Board is not required for educational programs regulated by the Board of Elementary & Secondary Education or any non-credit continuing education program. All recipients of credentials from approved programs shall enjoy the honors, rights, and privileges of possessing such a credential. Such degrees and certificates shall carry the seal of the University.

2. Summary of Matter

The campuses of LSU are seeking approval of degrees to be conferred on candidates meeting degree requirements for commencement exercises whether they be virtual or on campus for the entire 2024 calendar year.

This request provides flexibility for campuses to book venues, ensure capacity and safety concerns, and select vendors.

3. Business Plan

Not applicable

4. Fiscal Impact

Not applicable

5. Description of Competitive Process

Not applicable

6. Review of Legal Documents

Not applicable

7. Parties of Interest

Not applicable

8. Related Transactions

Not applicable

9. Conflicts of Interest

Not applicable

10. Attachments

Not applicable

RESOLUTION

NOW, THEREFORE, BE IT RESOLVED that the Board of Supervisors of Louisiana State University and Agricultural & Mechanical College does hereby approve the degrees to be conferred on candidates meeting degree requirements for graduation from the campuses of the University during commencement exercises in CY 2024.



Board of Supervisors

Request from LSU A&M to Offer the BA in Political Science 100% Online

Date: April 26, 2024

1. Bylaw Citation

Pursuant to Article VII, Section 1, Paragraph A of the Bylaws of the Louisiana State University Board of Supervisors, this matter is a significant board matter.

- A. Any matter having a significant or long-term impact, directly or indirectly, on the finances or the academic, educational, research, and service missions of the University or any of its campuses.

2. Summary of Matter

The College of Humanities & Social Sciences at LSU A&M would like to offer their currently established Bachelor of Arts in Political Science program in an additional online modality. The anticipated launch date for the online degree is Fall 2024.

The Bachelor of Arts in Political Science program provides students with the knowledge and analytical skills necessary to be responsible citizens, contributing to the wellbeing of the state and the nation, and serve as a resource of expertise for national, state, and local government. This program prepares students for a variety of graduate programs, including law school and graduate school, as well as careers in government, non-profits, and human services. The BA in Political Science is a 120- hour program in which students must complete at least 33 hours of political science courses with 18 of these 33 hours at the 3000-level and above.

3. Review of Business Plan

The program will be offered 100% online. Many courses in this online program will be taught by the on-campus, full time faculty, so online students will be learning from the same faculty as in-person students. The faculty for this program will work with LSU Online's course design and development team to ensure the online courses comply with the online course quality and accessibility standards. These standards are adapted from Quality Matters. Additionally, the courses will be developed so that the online courses meet the same student learning outcomes as the in-person courses.

4. Fiscal Impact

N/A

5. Description of Competitive Process

N/A

6. Review of Legal Documents

N/A

7. Parties of Interest

N/A

8. Related Transactions

N/A

9. Conflicts of Interest

N/A

10. Attachments

N/A

RESOLUTION

NOW, THEREFORE, BE IT RESOLVED that the Board of Supervisors of Louisiana State University and Agricultural & Mechanical College does hereby approve the request from LSU A&M to offer the BA in Political Science 100% Online.



Board of Supervisors

Request from LSU Health Shreveport for Continued Authorization of the Center for Cardiovascular Diseases and Sciences Center of Excellence

Date: April 26, 2024

1. Bylaw Citation

Pursuant to Article VII, Section 1, Paragraph B of the Bylaws of the Louisiana State University Board of Supervisors, this matter is a significant board matter.

- B. The Board shall approve any new academic program resulting in the awarding of a degree, certificate, or credential, as well as any changes of degree designation or termination of degree programs. The Board shall approve any new institution, department, research center, or institute, or required reauthorization of such.

2. Summary of Matter

LSU Health Shreveport seeks continued authorization of the Center for Cardiovascular Diseases and Sciences (CCDS) Center of Excellence for five years. The CCDS was granted initial approval by the Board of Regents in 2019. CCDS researchers cover a wide range of topics, but key focus areas include vascular biology and inflammation, cardiometabolic disease, cardiac biology, drug abuse and cardiovascular disease, and neurovascular biology and stroke. CCDS members have shown a \$8.9 million increase in extramural funding over the past 5 years, suggesting that CCDS investigators are driving LSU Health - Shreveport's resurgence.

The CCDS provides a variety of intramural research grants that facilitate current research and drive new research endeavors. Strong core facilities in small animal imaging, electrophysiology, redox molecular signaling, and animal models/histology allow investigators to assemble leading edge research proposals that are nationally/internationally competitive. The CCDS sponsors seminars and local events that both enhance local training and highlight the strength of the center to leaders in cardiovascular biology across the country. Lastly, CCDS' commitment to clinical cardiovascular research provides the local community with access to clinical trials offering novel therapeutics and methods to treat cardiovascular disease.

Specific achievements that the CCDS would like to highlight include:

1. Increased annual NIH funding to CCDS faculty from \$7.9 million in 2019 (49% of the funding to LSU Health Shreveport) to \$16.8 million in 2024 (79% of the funding to LSU Health Shreveport).
2. Grew the size of the CCDS faculty from 38 faculty to 51 faculty over the past five years. We contributed \$3,260,000 in support for startup packages for the recruitment of 15 faculty members across six departments.
3. Maintained our predoctoral and postdoctoral training pipeline and established new NIH-

funded training programs for Graduate Students (NHLBI T32 – Multidisciplinary Training in Cardiovascular Pathophysiology) and Undergraduate Students (NHLBI R25 – Cardiovascular Undergraduate Research Initiative fOR Underrepresented Students (CURIOUS)) and a new AHA-funded training program for Undergraduate Students (AHA SURE (Supporting Undergraduate Research Experiences)).

4. Renewed the CoBRE Center for Redox Biology and Cardiovascular Disease for Phase II in 2023. In addition, CCDS members played an important role in obtaining the second CoBRE on our campus to form the Center for Applied Immunology and Pathological Processes. An application for a third CoBRE has been submitted with Dr. Orr (CCDS Director) as the PI to establish the CoBRE Translational Research and Experimental Therapeutics (TREAT) Center.
5. Started two new core facilities (AAV Production Core, Surgical Models Core) and purchased \$399,922 in additional equipment for use in CCDS, CoBRE, and institutional Research Core Facilities.
6. Supported faculty retention and growth of faculty research programs by funding \$2,938,994 in intramural grants to 30 different faculty members, including \$459,105 in 2020 to support projects related to the COVID-19-associated cardiovascular dysfunction.
7. Enhanced the research support for clinical trainees by offering intramural Resident Research Awards and by starting the Medical Students CARDiovascular Research and DIsccovery Opportunities (MS-CARDIO) summer research program to engage medical students at LSU Health Shreveport in our NIH-funded research programs.
8. Improved outreach to the local community by organizing an annual Heart Health Day, a free community health fair offering free health screens (EKG, lipid panel, ABI), group exercises, nutrition guidance, and children’s activities.

3. Review of Business Plan

While Dr. A. Wayne Orr, CCDS Director, and the CCDS leadership team guides the use of the CCDS budget and the day-to-day operations of the center, all CCDS activities are steered by an internal Advisory Committee consisting of institutional leadership across multiple centers and departments. The composition of this group helps to ensure that CCDS activities align with the over arching mission of LSU Health Shreveport and that the use of CCDS funds synergizes with support provided from other groups on campus. The CCDS Advisory Board typically meets in person twice per year to discuss updates to the CCDS mission, upcoming initiatives, and the approval of the annual CCDS budget. In addition, any urgent utilization of CCDS funding between these meetings (seed package support, equipment purchases, rolling grant review, alterations to existing programs) is handled by an email vote.

4. Fiscal Impact

Over the past five years, the CCDS has invested \$3,260,000 in support for startup packages for the recruitment of 15 faculty members across six departments (Cell Biology and Anatomy, Feist Weiller Cancer Center, Internal Medicine, Molecular and Cellular Physiology, Neurology, and Pathology and Translational Pathobiology). In addition, the CRBCD COBRE provided startup

funding to recruit Dr. Kevin Murnane (Pharmacology, Toxicology, & Neuroscience), and Dr. Andrew Yurochko successfully competed for a new CoBRE to establish the Center for Applied Immunology and Pathological Processes (CAIPP) that funds several CCDS faculty and will serve as a recruitment tool for CCDS-associated departments. To improve ability to retain top Post-Doctoral Fellows as faculty and better enable these Post-Doctoral Fellows to compete for extramural funding, the CCDS also initiated a highly competitive Post-Doctoral Fellow Transition Award that covers 50% of the fellow's salary after their promotion to Research-Track Faculty. This designation better allows the fellow to compete for NIH funding to make them more competitive for Tenure-Track Faculty positions either at LSU Health Shreveport or elsewhere. Two faculty have received this award to date. Of the 17 faculty members recruited through CCDS/CoBRE funding, two were recruited with current R01 funding and two faculty had received prestigious K99/R00 grants to fund their transition to faculty. Of these 17 faculty, 7 have current R01 funding, 4 are supported by CoBRE funding, and 2 are Project Leaders on a new CoBRE application in preparation.

5. Description of Competitive Process

N/A

6. Review of Legal Documents

N/A

7. Parties of Interest

N/A

8. Related Transactions

N/A

9. Conflicts of Interest

N/A

10. Attachments

N/A

RESOLUTION

NOW, THEREFORE, BE IT RESOLVED that the Board of Supervisors of Louisiana State University and Agricultural & Mechanical College does hereby approve the request from LSU Health Shreveport for the continued authorization of the Center for Cardiovascular Diseases and Sciences (CCDS) Center of Excellence



Board of Supervisors

Request from LSU Health Sciences Center – Shreveport to Name the W. Clinton Rasberry Jr. Auditorium in the Center for Medical Education Building

Date: April 26, 2024

1. Bylaw Citation

Pursuant to Article VII, Section 1, Paragraph N of the Bylaws of the Louisiana State University Board of Supervisors, this matter is a significant board matter.

N. Such other matters that are not expressly delegated herein or hereafter by the Board to the President or a Chancellor and which reasonably should be considered to require Board approval as generally defined above, or which the Board hereafter determines to require Board approval.

2. Summary of Matter

LSU Health Sciences Center – Shreveport (LSUHSC-S) requests naming a space within the newly constructed Center for Medical Education Building **the W. Clinton Rasberry Jr. Auditorium**.

W. Clinton “Bubba” Rasberry, Jr. has been a strong advocate and supporter of LSUHSC-S for over 30 years. He has served on LSUHSC-S Chancellor Advisory Committees, the LSU Health Sciences Foundation Board of Directors, and the Louisiana Board of Regents. He and his wife, Mrs. Kathy Rasberry, chaired LSUHSC-S’s signature fundraising event, An Evening for Healers.

Mr. Rasberry and his family recognized the transformative effect of the Center for Medical Education building on LSUHSC-S’s future. They wanted to make a gift to ensure it would continue to enhance the campus for years to come. To provide programming for the unique 500-seat, in the round auditorium, Mr. Rasberry and his family pledged \$2.6 million to create the W. Clinton Rasberry Family Endowment. Earnings from the endowment will initially be used to support the W. Clinton Rasberry Jr. Family Endowed Lecture Series. The Rasberry Family Endowed Lecture Series is intended to utilize the Center for Medical Education to bring the brightest minds in medicine, biotechnology, and human development to LSUHSC-S on a yearly basis.

In recognition of this gift and Mr. Rasberry’s enduring support of LSUHSC-S, it is requested that the auditorium in the Center of Medical Education at LSUHSC-S be named the “W. Clinton Rasberry, Jr. Auditorium.”

This naming request has gone through the appropriate campus channels and has received approval from Chancellor Guzick.

3. Review of Business Plan

N/A

4. Fiscal Impact

N/A

5. Description of Competitive Process

N/A

6. Review of Legal Documents

A memo of approval from the Chancellor of LSUHSC-S and the donor agreements are on file in the Office of Academic Affairs.

7. Parties of Interest

N/A

8. Related Transactions

N/A

9. Conflicts of Interest

N/A

10. Attachments

RESOLUTION

NOW, THEREFORE, BE IT RESOLVED that the Board of Supervisors of Louisiana State University and Agricultural & Mechanical College does hereby approve the request from LSU Health Sciences Center - Shreveport to name the Auditorium in the Center for Medical Education the "W. Clinton Rasberry Jr. Auditorium."



Board of Supervisors

FINANCE COMMITTEE

BOARD OF SUPERVISORS MEETING | APRIL 26, 2024



Board of Supervisors

Request to Approve a Non-Resident Fee Increase for LSU's School of Veterinary Medicine

Date: April 26, 2024

1. Bylaw Citation

Pursuant to Article VII, Section 1, Paragraph A of the Bylaws of the Louisiana State University Board of Supervisors, this matter is a significant board matter.

- I. Any matter having a significant or long-term impact, directly or indirectly, on the finances or the academic, educational, research, and service missions of the University or any of its campuses.

2. Summary of Matter

[Article VII, Section 2.1](#) of the Constitution of Louisiana authorizes each management board to establish tuition and mandatory attendance fee amounts applicable to nonresident students at an institution under its supervision and management. The LSU School of Veterinary Medicine (LSU Vet Med) is proposing a \$1,750 (\$875 per semester–6.01%) increase in the nonresident fee beginning Fall 2024. These increased revenues will be used to offset direct operational and instructional expenses associated with the veterinary medical program with a focus on value-added support of the instructional programs including technology and medical equipment upgrades.

3. Review of Business Plan

The Doctor of Veterinary Medicine (D.V.M.) degree has always had a differential tuition rate from that of the undergraduate or graduate student tuitions. The high cost of specialized laboratory experiences and the costs associated with equipping the Veterinary Teaching Hospital taken together with the relatively small number of students in the program make this differential tuition schedule essential to the self-generated revenue portfolio of LSU Vet Med.

The current tuition and fees for the 2023-2024 academic year are \$27,421 for resident students and \$56,521 for non-resident students. The tuition is \$24,128 of the totals with the balances made up of required fees, academic excellence fee, technology fee, building use fee, operational fee, student excellence fee and nonresident fee. The average tuition and fees for SEC schools of veterinary medicine for the 2023-2024 academic year is \$27,823 for resident students and \$53,924 for nonresident students. The resident tuition and fees at LSU are the third lowest of the 8 SEC veterinary schools and the nonresident tuition and fees at LSU are the third highest of the 8 SEC veterinary schools. The average tuition and fees for the 33 U.S. veterinary schools is \$35,614 and \$56,935 for resident and nonresident students respectively.

In 2023-2024, Vet Med enrolled 135 students into the four-year program. Nine (9) of these students are from Arkansas as part of a Southern Regional Education Board (SREB) educational contract.

These contract students pay the resident tuition and fees while the state of Arkansas pays the SREB contract fee. Given a small attrition rate there are currently approximately 575 students in the four-year program that includes an additional 75 non-matriculating students in the fourth year as part of contracts with Ross University, St. George's University, and St. Matthews University. Approximately 39% of the students in the four-year program pay non-resident tuition and fees and Ross University, St. George's University, and St. Matthews students also pay the non-resident tuition and fees as non-matriculating fourth year students. This fee would be charged to all nonresident D.V.M. students except SREB contract students.

4. Fiscal Impact

Vet Med is proposing a \$1,750 (\$875 per semester - 6.01%) increase in the nonresident fee. This would bring the nonresident fee to \$30,850 and the total nonresident tuition and fees to approximately \$58,271, which would be third highest in the SEC using the 2023-2024 schedules. The last time LSU Vet Med increased the nonresident fee was 2015-2016. The \$1,750 (6.01%) nonresident fee increase will generate an additional \$539,000.

5. Description of Competitive Process

N/A

6. Review of Legal Documents

[Article VII, Section 2.1](#) of the Constitution of Louisiana has been reviewed and all proposed non-resident fee increases have been deemed to be in compliance with this legislation.

7. Parties of Interest

N/A

8. Related Transactions

N/A

9. Conflicts of Interest

N/A

10. Attachments

1. Tuition Comparison of SEC Veterinary Schools, FY 23-24
2. Vet Med Non-resident Fee Increase Proposal
3. Policy Statement 42 Request for Course/Program Fee Establishment or Adjustment

RESOLUTION

NOW, THEREFORE, BE IT RESOLVED that the Board of Supervisors of Louisiana State University and Agricultural & Mechanical College does hereby approve an increase of \$1,750 (\$875 per semester) to the non-resident fee beginning Fall 2024 for LSU's School of Veterinary Medicine.

**Tuition Comparison
SEC Veterinary Schools
FY 2023-2024**

SEC Resident Tuition Ranking

School	1st Year TUITION + FEES	
	Res	NR
UMO	\$32,184	\$75,398
TENN	\$30,126	\$60,852
AUB	\$29,560	\$50,962
MIS	\$29,280	\$51,574
FLA	\$28,790	\$45,500
LSU	\$27,421	\$56,521
TAMU	\$26,320	\$42,022
UGA	\$18,904	\$48,566
AVERAGE	\$27,823	\$53,924
LSU to Avg	98.6%	104.8%

SEC Non-Resident Tuition Ranking

School	1st Year TUITION + FEES	
	Res	NR
UMO	\$32,184	\$75,398
TENN	\$30,126	\$60,852
LSU	\$27,421	\$56,521
MIS	\$29,280	\$51,574
AUB	\$29,560	\$50,962
UGA	\$18,904	\$48,566
FLA	\$28,790	\$45,500
TAMU	\$26,320	\$42,022
AVERAGE	\$27,823	\$53,924

The degree and/or certificate: Doctor of Veterinary Medicine (D.V.M.) degree

A brief rationale: The D.V.M. degree has always had a differential tuition rate from that of the undergraduate or graduate student tuitions. The high cost of specialized laboratory experiences and the costs associated with equipping the Veterinary Teaching Hospital taken together with the relatively small number of students in the program make this differential tuition schedule essential to the self-generated revenue portfolio of the School of Veterinary Medicine (LSU Vet Med).

The current tuition and fees for the 2023-2024 academic year are \$27,421 for resident students and \$56,521 for non-resident students. The tuition is \$24,128 of the totals with the balances made up of required fees, academic excellence fee, technology fee, building use fee, operational fee, student excellence fee and nonresident fee. The average tuition and fees for SEC schools of veterinary medicine for the 2023-2024 academic year is \$27,823 for resident students and \$53,924 for nonresident students. The resident tuition and fees at LSU are the third lowest of the 8 SEC veterinary schools and the nonresident tuition and fees at LSU are the third highest of the 8 SEC veterinary schools. The average tuition and fees for the 33 U.S. veterinary schools is \$35,614 and \$56,935 for resident and nonresident students respectively.

In 2023-2024, Vet Med enrolled 135 students into the four-year program. Nine (9) of these students are from Arkansas as part of a Southern Regional Education Board (SREB) educational contract. These contract students pay the resident tuition and fees while the state of Arkansas pays the SREB contract fee. Given a small attrition rate there are currently approximately 575 students in the four-year program that includes an additional 75 non-matriculating students in the fourth year as part of contracts with Ross University, St. George's University, and St. Matthews University. Approximately 39% of the students in the four-year program pay non-resident tuition and fees and Ross University, St. George's University, and St. Matthews students also pay the non-resident tuition and fees as non-matriculating fourth year students.

The target market or audience: This fee would be charged to all nonresident D.V.M. students except SREB contract students.

Proposed additional nonresident fee: The School is proposing a \$1,750 (\$875 per semester – 6.01%) increase in the nonresident fee. This would bring the nonresident fee to \$30,850 and the total nonresident tuition and fees to approximately \$58,271, which would be third highest in the SEC using the 2023-2024 schedules. The last time LSU Vet Med increased the nonresident fee was 2015-2016.

How the additional funds will be used: The \$1,750 (6.01%) nonresident fee increase will generate an additional \$539,000. These increased revenues will be used to offset direct operational and instructional expenses associated with the veterinary medical program with a focus on value-added support of the instructional programs including technology and medical equipment upgrades.

The peer group: The primary peer group comprises the SEC institutions with schools of veterinary medicine (Auburn University, University of Florida, University of Georgia, University of Missouri, Mississippi State University, University of Tennessee, and Texas A&M University). There are currently only 33 schools of veterinary medicine in the country.



Louisiana State University

REQUEST FOR COURSE/PROGRAM FEE ESTABLISHMENT OR ADJUSTMENT

PROGRAM NAME/COURSE NUMBER: Nonresident Fee Adjustment

COLLEGE/DEPARTMENT: Veterinary Medicine PROPOSED DATE OF FEE/ADJUSTMENT: July 2024

CONTACT NAME: Oliver Garden CONTACT EMAIL ADDRESS: ogarden@lsu.edu

Briefly state the reasons for fee establishment or adjustment(s). If multiple fee/adjustments are being proposed attach a separate sheet that details all fees/adjustments.

The School is proposing a \$1,750 (\$875 per semester – 6.01%) increase in the nonresident fee. This would bring the nonresident fee to \$30,850 and the total nonresident tuition and fees to approximately \$58,271, which would be third highest in the SEC using the 2023-2024 schedules. The last time Vet Med increased the nonresident fee was 2015-2016. This increase is needed to keep up the the increased costs associated with a veterinary medical education program.

Students Assessed	Current Fee	Date of last change	Proposed Fee	\$ Change in Fee	% Change in Fee
Undergrad-Resident				\$ 0.00	
Graduate-Resident					
Undergraduate-Nonresident					
Graduate-Nonresident					
Other - Vet Med Nonresident	\$ 29,100.00	07/01/2015	\$ 30,850.00	<u>\$ 1,750</u>	<u>6.01%</u>

Check All That Apply

Type of Fee Adjustment:

Course Fees: _____

Supply/Services _____

Trip _____

Program Fee _____

Fee Adjustment Requested	<u>\$ 1,750</u>
x Estimated Enrollment	<u>380</u>
Gross Revenues Associated with Fee Adjustment	<u>\$ 539,000</u> \$0
Less:	
Costs Associated with Fee Adjustment (exemptions/waivers)	<u>\$ 0</u>
Net Revenues Associated with Fee Adjustment	<u>\$ 539,000</u> \$0

Please explain how the college/department plans to spend revenues from this fee/adjustment (including a proposed budget):

The \$1,750 (6.01%) nonresident fee increase will generate an additional \$539,000. These increased revenues will be used to offset direct operational and instructional expenses associated with the veterinary medical program with a focus on value-added support of the instructional programs including technology and medical equipment upgrades.

Estimated effect upon enrollment:

No impact on enrollment

Routing and Approval Signatures		
Dean/Unit Director	Printed Name	Date
Vice Provost	Printed Name	Date
Vice President for Finance & Administration/CAO	Printed Name	Date
Executive Vice Chancellor & Provost	Printed Name	Date



Board of Supervisors

Request for all LSU Institutions Employing Graduate Assistants to Implement the Requirements of Act 664 of the 2022 Regular Session of the Louisiana Legislature to Provide Payments to Cover or Create a Waiver or Exemption of any Mandatory Fee Imposed by the Institution

Date: April 26, 2024

1. Bylaw Citation

Pursuant to Article VII, Section 8, D.1 of the Bylaws of the Louisiana State University Board of Supervisors, this matter is a “significant board matter.”

I. D.1 Any matter having a significant fiscal (primary or secondary) or long-term educational policy impact on the LSU System or any of its campuses or divisions.

2. Summary of Matter

Act 664 of the 2022 Regular Session of the Louisiana Legislature requires institutions to provide Graduate Assistants (GAs) the following by August 1, 2024:

Payments to cover or a waiver of any mandatory fee imposed in accordance with this Title except for tuition shall be included in the compensation package of each graduate student serving as a teaching assistant, research assistant, or curatorial assistant. Each public postsecondary education management board shall adopt a policy relative to implementing the provisions of this item.

Effective August 1, 2024, all LSU institutions employing GAs must provide a payment, waiver, exemption, or some combination thereof, of all Required Fees, as defined in [PM-43 Student Fees](#). The payment, exemption, or waiver would not apply to any course, program, special service, or optional service fees.

The standards for the determination of eligible GAs will be administratively determined at each institution.

3. Review of Business Plan

N/A

4. Fiscal Impact

The requirements of Act 664 will have a direct fiscal impact on all institutions employing GAs. In addition, the requirement will impact auxiliary and ancillary units receiving revenue from Required Fees. The projected annual fiscal impact by institution is as follows based on Fall 2023 data:

Institution	GA Count	Annual Fiscal Impact
LSU	1,919	\$4,012,917
LSU Alexandria	N/A	\$0

LSU Eunice	N/A	\$0
LSU Shreveport	67	\$100,500
LSUHSCNO	92	\$115,000
LSUHSCS	77	\$33,996
Total	2,155	\$4,262,413

5. Description of Competitive Process

Not applicable

6. Review of Legal Documents

Not applicable.

7. Parties of Interest

None of the parties relevant to the approval of this resolution have any related interest, nor will they receive any financial gain from this approval.

8. Related Transactions

On December 4, 1954, the BOS adopted a resolution that all full-time GAs at LSU would be exempt from out-of-state (non-resident) fees and all part-time GAs proportionately exempt, with the understanding that standards for the determination of full and part-time status will be administratively determined.

On December 12, 1997, the BOS adopted a resolution that GAs at LSU shall be treated as residents for fee purposes during their periods of appointment.

On February 21, 2003, the BOS adopted a resolution to exempt resident tuition for full-time graduate assistants at LSU.

9. Conflicts of Interest

None.

10. Attachments

1. [Act 664 of the 2022 Regular Session of the Louisiana Legislature](#)
2. [Permanent Memorandum 43: Student Fees](#)

RESOLUTION

WHEREAS, the LSU institutions employing Graduate Assistants will follow the requirements of Act 664 of the 2022 Regular Session of the Louisiana Legislature; and

WHEREAS, the LSU institutions employing Graduate Assistants will administratively determine eligibility criteria and maintain a written policy thereof

NOW, THEREFORE, BE IT RESOLVED by the Board of Supervisors of Louisiana State University and Agricultural and Mechanical College that any institution employing Graduate Assistants must provide a payment, waiver, exemption, or a combination thereof, of all Required Fees, as defined in PM-43 Student Fees. This would not include any course, program, special service, or optional service fees.

2022 Regular Session

ACT No. 664

ENROLLED

SENATE BILL NO. 76

BY SENATOR FIELDS

1 AN ACT

2 To amend and reenact R.S. 17:3351(A)(5)(a), relative to fees charged to students at public
3 postsecondary education institutions; to provide for the inclusion of fees in certain
4 graduate students' compensation packages; to require each public postsecondary
5 education management board to adopt a policy providing for such compensation; and
6 to provide for related matters.

7 Be it enacted by the Legislature of Louisiana:

8 Section 1. R.S. 17:3351(A)(5)(a) is hereby amended and reenacted to read as
9 follows:

10 §3351. General powers, duties, and functions of postsecondary education
11 management boards

12 A. Subject only to the powers of the Board of Regents specifically
13 enumerated in Article VIII, Section 5 of the Constitution of Louisiana, and as
14 otherwise provided by law, each postsecondary system management board as a body
15 corporate shall have authority to exercise power necessary to supervise and manage
16 the day-to-day operations of institutions of postsecondary education under its
17 control, including but not limited to the following:

18 * * *

19 (5)(a)(i) In accordance with any other applicable provision of this Paragraph,
20 determine the fees which shall be paid by students.

1 (ii) Payments to cover or a waiver of any mandatory fee imposed in
2 accordance with this Title except for tuition shall be included in the
3 compensation package of each graduate student serving as a teaching assistant,
4 research assistant, or curatorial assistant. Each public postsecondary education
5 management board shall adopt a policy relative to implementing the provisions
6 of this Item.

* * *

8 Section 2. This Act shall become effective on August 1, 2024; if vetoed by the
9 governor and subsequently approved by the legislature, this Act shall become effective on
10 the day following such approval by the legislature or August 1, 2024, whichever is later.

PRESIDENT OF THE SENATE

SPEAKER OF THE HOUSE OF REPRESENTATIVES

GOVERNOR OF THE STATE OF LOUISIANA

APPROVED: _____



PERMANENT MEMORANDUM 43 STUDENT FEES

POLICY DIGEST

Monitoring Unit: Office of Finance & Administration
Initially Issued: January 19, 2024

I. PURPOSE

This policy is set forth to provide legal background for fees assessed by any Louisiana State University institution; to define the various types of student fees; and to provide guidelines for the administration of fee revenue.

A. Defining Legislation

[Article VII. Section 2.1. \(A\) of the Louisiana Constitution](#) states:

Any new fee or civil fine or increase in an existing fee or civil fine imposed or assessed by the state or any board, department, or agency of the state shall require the enactment of a law by a two-thirds vote of the elected members of each house of the Legislature.

B. Interpretation of the Legislation

In *Louisiana Public Facilities Authority v. All Taxpayers, Property Owners, et al.*¹, the First Circuit Court of Appeal determined “the legislature has evidenced no intent to have oversight over “fees” with respect to LSU, other than those fees directly connected with LSU’s principal governmental function of providing higher education to the citizens of this state.” The court concluded the price charged by LSU for admission to football games in Tiger Stadium is not a “fee” requiring legislative approval under La. Const. art. 7, Section 2.1.

The First Circuit Court of Appeal adopted the reasoning from two Attorney General Opinions in reaching this decision, La. Atty. Gen. Op. No. 96-353 (October 9, 1996) and La. Atty. Gen. Op. No. 01-165 (May 4, 2001). These two Attorney General opinions, and a third attorney general opinion issued to the Louisiana Legislative Auditor, La. Atty. Gen. Op. No. 06-293 (June 14, 2007), should be used as primary guidance for the approval of fees. The Opinions are summarized below:

1. [Atty. General Opinion No. 96-353](#) defines fees by stating: “Charges which are assessed by a governmental entity for the purpose of defraying the costs of providing a governmental service or the costs of regulating a particular area would be considered fees. Those fees or charges for non-governmental functions or products and/or services not in the control of the governmental entity at issue would be exempt from legislative review.”

¹ *Louisiana Public Facilities Authority v. All Taxpayers, Prop. Owners, Citizens of State of La. & Nonresidents Owning Prop. or Subject to Taxation Therein*, 2003-2738 (La. App. 1 Cir. 12/23/03), 868 So. 2d 124, 136, *writ denied*, 2004-0213 (La. 3/11/04), 869 So. 2d 801.

The AG Opinion further states that LSU “is created and exists for the sole purpose of providing public higher education to the citizens of this State. This is its governmental function. Those charges which are assessed for the provision of higher education to LSU students would be considered fees for purposes of Article 7, Section 2.1. Any charges which are for services or products which are not directly a part of the delivery of an education are not considered fees.”

For purposes of Article 7, Section 2.1, the word fee does not include charges for “student housing, food services, book store merchandise, medical or veterinary services, and admittance to extracurricular events.”

2. [Atty. General Opinion No. 01-165](#) determined that a charge for the cost of utilities is comparable to a charge for student housing, food services, etc. considered in La. Atty. Gen. Op. No. 96-353. Therefore, higher education management boards may impose a utility surcharge without an approval by a two-thirds vote of the Legislature.
3. [Atty. General Opinion No. 06-0293](#) determined the following:
 - a. Fees imposed prior to the enactment of La. Const. art. VII, § 2.1 in 1995 may continue without the approval of the Legislature unless the fees are increased.
 - b. Fees which were imposed prior to the enactment of La. Const. art. VII, § 2.1 in 1995 and which would require two-thirds vote of the Legislature after the enactment of La. Const. art. VII, 2.1 in 1995, may be renewed and continue without the approval of the Legislature unless the fees are being increased.
 - c. The Building Use Fee, authorized by Act No. 619 of the 1954 Regular Legislative Session and amended by Act No. 15 of the 1967 Regular Legislative Session, is a fee on all students attending institutions of higher education to “construct, acquire, extend, repair or improve any academic facilities suitable for use as classrooms, laboratories, gymnasiums, libraries, student infirmaries, and related facilities.” The Building Use Fee was imposed prior to the enactment of La. Const. art. VII, § 2.1 in 1995; as such, the Building Use Fee may continue to be imposed by a university as long as there is a need for the creation of academic buildings or for repairs to existing infrastructure Act 15 of the 1967 Regular Legislative Session prohibits an increase of this fee.

It is important to note that other court decisions, statutes, and AG opinions may be relevant to the assessment and administration of certain fees and should be taken into consideration on a case-by-case basis.

II. DEFINITIONS & GENERAL POLICY

- A. Required Fees – part of the general tuition and required fees charged to all full-time students, and in some cases, to all part-time students. These fees are included in the university’s tuition and fee schedules and are charged to the general population regardless of the degree program in which a student is enrolled. These fees typically require two-thirds vote by the Legislature. Examples include the academic excellence, technology, and operational fee.

There are two categories of required fees that are not considered a direct part of the delivery of an education and do not require legislative approval. The distinction between the two categories is due to the method by which the fees are approved:

1. Student Self-Assessed Fee – a type of required fee initiated by Student Government or another group of students and approved through a campus-wide referendum to support

areas, activities, and services. These fees require approval by the Board of Supervisors (BOS). Examples include campus yearbook, newspaper, etc.

2. University Self-Assessed Fee – a type of required fee that is not initiated through a campus-wide referendum to support various service functions to students. These fees require approval by the BOS.

- B. Course Fees – an additional charge for supplies and/or services to students applied at the course level for consumable expenses directly related to students' participation in a course and are intended to pay for specified course-related costs. A course fee should be based on plausible estimates of the anticipated costs or previous records of actual costs and should be kept as low as possible.

There are two categories of course fees as defined below:

1. Supply/Service Fee – a type of course fee assessed which (1) provides tools, equipment, or products that have a continuing value to the student; (2) provides for pooled purchase of services not normally provided by the institution; (3) provides for consumable supplies, such as art supplies; or (4) for services or products provided by a vendor external to the university that are subsequently provided to students as a requirement of a course. These fees require two-thirds vote by the Legislature.
2. Trip Fee – a type of course fee for required travel expenses for students to visit off-campus sites as part of a course. These fees require approval by the institution's chief academic officer and chief financial officer.

An overall goal is to have a minimal number of courses charging an additional course fee. Course fees will be allowable in limited circumstances and only to recover the cost of materials and services consumed during the progress of the course or for items that students take away with them at the end of the course.

General costs related to the development, instruction, and assessment of offering a course are expected to be borne by the department and college, including materials related to the mechanics of teaching the course, such as course outlines, syllabi and similar handouts, exams, and the purchase, maintenance, and replacement costs of instructional and other capital equipment. The department is also expected to bear the costs of staffing courses, including personnel employed to aid in the course, such as teaching assistants and guest speakers. Course fees are not intended to replace general operating costs, which are to be paid from the general university tuition and fee revenue.

Course fees charged to students must be set to cover not more than the cost of the goods and/or services provided. Course fees, when approved, must be separate, unique, and used solely for support of the course involved and for the purposes specified to create the fee. Collection of course fees in the classroom or by faculty is not permitted. Billing and payment of course fees must be through standard university business practices (e.g., bursar/treasurer). Students must be made aware of course fees prior to registration.

- C. Program Fees – additional fees assessed to students in a particular curriculum (i.e., MBA Professional Program Fee) or tuition and fees for students enrolled in an academic degree program offered entirely through distance education (i.e., LSU Online degree programs) as defined by the Southern Association of Colleges and Schools Commission on Colleges (SACSCOC) when such program is comparable to a program offered through traditional in-

person classroom instruction in accordance with [La. Rev. Stat. 17:3351.17, Act 426 of the Regular Legislative Session](#).

Program fees assessed to students in a particular curriculum (excluding academic degree programs offered entirely through distance education) require approval by a two-thirds vote of the Legislature.

Tuition and fees assessed to students enrolled in an academic degree program offered entirely through distance education (i.e., LSU Online degree programs) as defined by SACSCOC when such program is comparable to a program offered through traditional in-person classroom instruction in accordance with [La. Rev. Stat. 17:3351.17, Act 426 of the Regular Legislative Session](#) require approval by the President.

- D. Special Service Fees – a type of fee that is not part of required fees or course fees assessed to students for various services including, but not limited to, graduation, diploma, transcript, late fees, and payment plan fees. These fees require approval by the President.
- E. Optional Service Fees – a type of fee that is not part of required fees or course fees for services a student may voluntarily choose. This includes but is not limited to housing, meal plans, admission to extracurricular activities, and parking. These fees must be approved by the institution’s chief academic officer and chief financial officer.

III. PROCEDURES

Each campus must establish and publish procedures for requesting and approval of student fees. (See Appendix for Campus Approval Matrices.)

A. Reaffirmation of Course and/or Program Fees

Course and/or program fees should be evaluated and reaffirmed during the Academic Program Review process. These program reviews may be scheduled to coincide with the program’s external reaccreditation process but should occur no less than every seven years.

B. Changes to Student Fees

Increases or reinstatement of fees must be submitted for approval in accordance with the prescribed approval process based on the type of fee (See Definitions & General Policy Section). Reaffirmation or decreases of current fee levels do not require administrative or legislative approval.

C. Administration of Course and Program Fee Revenue

The oversight and management of course and/or program fees are the responsibility of the college/department. Course/program fee revenue and related expenses should not be commingled with other activities of the academic department. To the greatest extent possible, each course/program fee should be accounted for separately in the financial system. The intent of course fees is to cover not more than the cost of the goods or services provided. Significant balances should not accumulate from course fees. The academic department should review significant balances and an assessment of a reduction in the fee should be completed. Course and/or program fee accounts should not be in an overdraft status.

D. Records Retention

Documents related to the request, approval (including legislative or BOS approval, if applicable), change, or reaffirmation of a student fee should be maintained by each institution. Documents may be maintained in electronic form provided they are housed on a secure network drive.

IV. SOURCES

- A. [Article VII. Section 2.1. \(A\) of the Louisiana Constitution](#)
- B. [Atty. General Opinion No. 96-353](#)
- C. [Atty. General Opinion No. 01-165](#)
- D. [Atty. General Opinion No. 06-0293](#)
- E. [La. Rev. Stat. 17:3351.17, Act 426 of the Regular Legislative Session](#)

V. APPENDICIES

LSU Fee Approval Matrix
LSU Alexandria Approval Matrix
LSU Eunice Approval Matrix
LSU Shreveport Approval Matrix
LSU Health Sciences Center – New Orleans Approval Matrix
LSU Health Sciences Center – Shreveport Approval Matrix



Board of Supervisors

PROPERTY AND FACILITIES COMMITTEE



Board of Supervisors

Request from LSUHSC-NO to Authorize the Lease Agreement with Campus Federal Credit Union

Date: April 26, 2024

1. Bylaw Citation

Pursuant to Article VII, Section 1

E. Lease of Immovable Property

2. Summary of Matter

The LSU Health Sciences Center - New Orleans (LSUHSC-NO) proposes to enter into a Lease Agreement with Campus Federal Credit Union (Credit Union) for a portion of the second floor of the Administration and Resource Center Building. The property is located at 433 Bolivar St., New Orleans, LA 70112. The Credit Union will continue to lease a portion of the second floor of the Administration and Resource Center Building to continue providing banking services to the students, faculty and staff. The lease will continue to improve the financial position of LSUHSC-NO by providing rental income. This Lease Agreement becomes effective on July 1, 2024, and remains in effect until June 30, 2031, unless terminated sooner as provided for in the lease.

3. Review of Business Plan

Not applicable.

4. Fiscal Impact

Lease of the space in the building, pursuant to the Agreement, will provide a source of revenue to LSUHSC-NO for currently underutilized space. The rent is expected to be approximately \$11,825.00 per year.

5. Description of Competitive Process

Not Applicable.

6. Review of Legal Documents

Appropriate legal documents have been reviewed by LSUHSC-NO and the Credit Union .

7. Parties of Interest

Board of Supervisors of Louisiana State University and Agricultural and Mechanical College, LSU
Health Sciences Center - New Orleans

Campus Federal Credit Union

8. Related Transactions

Not applicable.

9. Conflicts of Interest

None.

10. Attachments

1. Transmittal Letter
2. Lease Agreement

RESOLUTION

NOW, THEREFORE, BE IT RESOLVED that the Board of Supervisors of Louisiana State University and Agricultural and Mechanical College hereby authorizes the President of LSU or designee to execute the Lease Agreement with Campus Federal Credit Union to provide leased space, with such lease to contain such terms and conditions as the President, in consultation with the General Counsel, deems to be in the best interests of LSU.



OFFICE OF THE CHANCELLOR

SCHOOL OF ALLIED HEALTH PROFESSIONS
SCHOOL OF DENTISTRY
SCHOOL OF GRADUATE STUDIES
SCHOOL OF NURSING
SCHOOL OF MEDICINE IN NEW ORLEANS
SCHOOL OF PUBLIC HEALTH

April 26, 2024

Dr. William F. Tate, IV
President
LSU System Office
3810 West Lakeshore Drive, Room 107
Baton Rouge, LA 70808

Dear Dr. Tate,

In accordance with the rules established by Article VII, Section 1 E, I am submitting a request for approval of the Lease Agreement with Campus Federal Credit Union (Credit Union) at the LSU Health Sciences Center- New Orleans ("LSUHSC-NO").

LSUHSC-NO desires to enter into a Lease Agreement between the LSU Board of Supervisors and Campus Federal Credit Union. The Credit Union will continue to lease a portion of the second floor of the Administration and Resource Center Building to continue providing banking services to the students, faculty, and staff. Lease of the space in the building, pursuant to the Agreement, will provide a source of revenue to LSUHSC-NO for currently underutilized space. The rent is expected to be approximately \$11,825.00 per year.

The LSUHSC-NO respectfully requests approval of this proposal. I certify to the best of my knowledge that I have provided all necessary documentation and am seeking your review and favorable consideration. Thank you for your assistance.

Respectfully yours,

A handwritten signature in blue ink that reads "Steve Nelson".

Steve Nelson, MD
Interim Chancellor

LEASE AGREEMENT

By and Between

**BOARD OF SUPERVISORS OF LOUISIANA STATE UNIVERSITY
AND AGRICULTURAL AND MECHANICAL COLLEGE**

and

CAMPUS FEDERAL CREDIT UNION

**LEASE AGREEMENT
FOR A PORTION OF THE SECOND FLOOR OF
THE ADMINISTRATION AND RESOURCE
CENTER BUILDING
(STATE ID# 10914)**

THIS LEASE AGREEMENT FOR A PORTION OF THE SECOND FLOOR OF THE ADMINISTRATION AND RESOURCE CENTER BUILDING (STATE ID#10914) (herein "Agreement") is entered into effective as of the 1st day of July 2024 (herein "Effective Date") for the purposes and on the terms stated herein, and is made by and between:

BOARD OF SUPERVISORS OF LOUISIANA STATE UNIVERSITY AND AGRICULTURAL AND MECHANICAL COLLEGE herein represented by William Tate, IV, the duly authorized President of LSU, duly authorized by a resolution of the Board, a copy of which is attached hereto as "Exhibit A" and made a part hereof, with a principal office located at and a mailing address of Office of the President, Louisiana State University, 3810 W. Lakeshore Drive, Room 107, Baton Rouge, Louisiana 70808, herein appearing for the benefit of the Louisiana State University Health Sciences Center – New Orleans ("LSUHSC-NO"); and

CAMPUS FEDERAL CREDIT UNION, a federally chartered credit union organized and existing under the law of the United States, ("Credit Union") herein represented by Jane Verret, President and Chief Executive Officer of the Credit Union, duly authorized by a resolution of its Board of Directors, a copy of which is attached hereto as Exhibit "B" and made a part hereof with a principal office located at, and a mailing address of 6230 Perkins Road, Baton Rouge, LA, 70808 (both Board and Credit Union referred to herein as the "Party" or, collectively, the "Parties"); and provides as follows:

WITNESSETH

WHEREAS, the Credit Union is a federally chartered credit union organized and existing under the laws of the United States described in Section 501 (c)(1) of the Internal Revenue Code of 1986, as amended, whose tax exempt purpose is to provide financial services to the employees, students, contractors, and family members of the Board, including the LSUHSC-NO, a higher education institution under the management and supervision of Board;

WHEREAS, Louisiana Revised Statutes 17:3361, *et seq.*, expressly authorizes the Board to lease property to a nonprofit corporation such as the Credit Union for the purpose of constructing and renovating buildings, other structures, and improvements;

WHEREAS, the Credit Union is a member-owned, cooperative financial institution chartered in 1934 for the express purpose of providing banking services to the Board;

WHEREAS, the Board is the owner of that certain structure known as Administration and Resource Center Building ID# 10914 located on the campus of LSUHSC-NO in New Orleans, Louisiana, Site ID # 1-36-036 the locations of which structure and the associated parking area are reflected on Exhibit "B" (herein "Administration and Resource Center Building");

WHEREAS, the Credit Union desires to continue to use certain areas located on floor 2 of the Administration and Resource Center Building described herein as its service location and continuing its banking services to its clients therein;

WHEREAS, the Credit Union shall be allowed to place one (1) Automated or Interactive Teller Machines (“ATM/ITM”) on the LSUHSC-NO campus as agreed upon by the Parties – all at the sole expense of the Credit Union but in accordance with design standards established by the Board and/or LSUHSC-NO.

WHEREAS, LSUHSC-NO and the Credit Union are separate and autonomous, and agree that all transactions conducted pursuant to this Agreement shall comply with applicable State and federal laws and regulations; and

NOW THEREFORE, in consideration of the mutual covenants, conditions and agreements which follow, the Parties hereby agree as follows:

ARTICLE I. DEFINITIONS

Section 1.1 - Definitions. In addition to such other defined terms as may be set forth in this Agreement, the following terms shall have the following meanings:

Agreement means, in its entirety, this lease agreement for Property known as the Administration and Resource Center Building.

Administration and Resource Center Building means that certain structure designated as Building ID No. 10914, located on the campus of LSUHSC-New Orleans in New Orleans, Louisiana, Site ID # 1-36-036 (municipal address 433 Bolivar Street, New Orleans, Louisiana 70112), which structure is reflected on Exhibit "C" hereto as "Administration and Resource Center."

Applicable Law or Laws means all laws, statutes, rules, regulations, zoning ordinances, resolutions and orders of any Governmental Authority applicable to the Parties and substantially affecting the ability of the Parties to meet their obligations hereunder; provided, however, that this definition shall not be interpreted as waiving protections granted to any Party against future laws impairing the obligations of contracts between the Parties and/or any third parties.

Annual Rent means that Rent payable by Credit Union pursuant to Section 2.2 hereof.

Board means Board of Supervisors of Louisiana State University and Agricultural and Mechanical College.

Board Representative means the Assistant Vice Chancellor for Property and Facilities, or their respective designees.

Business Day means any day other than (i) a Saturday, (ii) a Sunday, or (iii) any other day on which the Board or LSUHSC-NO is closed.

Campus means the LSUHSC-NO campus, located in New Orleans, Orleans Parish, Louisiana.

Common Areas means the landscaped areas, the first and second floor lobbies, entrance ways, hallways, elevators, fire stairs, restrooms and the areas designated by the Board from time-to-time for common tenant use.

Construction Contract means one or more agreements for the construction of the Improvements entered into by and between the Credit Union and the Contractor, including all amendments, modifications, exhibits, schedules, supplements and change orders to all such agreements.

Contractor means the contractor or contractors selected by Credit Union to construct the Improvements and their permitted successors and assigns.

Design means any and all design, planning, architectural, or engineering activity required in connection with any Improvement to the Property made by Credit Union

Donation Acceptance Requirements means all events required to occur prior to acceptance by the Board of the donation of the Improvements, including, but not limited to, (1) completion of all Work related to said Improvements; (2) compliance with all LSUHSC-NO campus standards identified by the Board Representative as applicable to said Improvements; (3) compliance with all applicable code and Division of Administration, Facility Planning and Control requirements; (4) compliance with all administrative lease requirements identified by the Board Representative as applicable to the donation of said Improvements; (5) delivery to the Board Representative of either (i) a clear lien certificate as to the Work, which certificate has been obtained from the Orleans Parish Clerk of Court's office, or (ii) evidence that any liens against the Improvements have been adequately bonded; and (6) final acceptance of all Work by the Credit Union and written approval by the Board Representative that final acceptance has occurred.

Effective Date means the 1st day of July 2024.

Force Majeure means any acts of God, lightning, earthquakes, fires, named storms, explosions, floods, acts of a public enemy, wars, insurrections, riots or civil disturbance, labor disputes, strikes, work slowdowns or work stoppages beyond the reasonable control of the Credit Union and occurring without its fault.

Governmental Regulations or Regulations means any and all laws and statutes, all building, zoning, life safety, and other codes, acts, ordinances, resolutions, orders, judgments, case precedents, decrees, directives, writs, injunctions, rules, regulations, policies, restrictions, permits, plans, approvals, authorizations, concessions, investigations, reports, guidelines and requirements or accreditation standards of any Governmental Authority having jurisdiction over LSU, the Foundation, the Property, the Facilities or affecting the Property, the Facilities, and any lease or

sublease of the Property and/or the Facilities, including, without limitation, all applicable Environmental Laws, the Americans with Disabilities Act and the Occupational Safety and Health Standards of the State and the United States, each as amended; provided, however, that this definition shall not be interpreted as waiving protections granted to any party against future laws impairing the obligations of contracts between the parties and/or third parties.

Improvements means any construction and renovations, other than the Credit Union maintenance, constructed by the Credit Union on the Leased Premises in accordance with the Plans and Specifications and the terms of this Agreement and made pursuant to Article V hereof including, but not limited to, millwork for ATM/ITM installation and door referenced above.

Initial Term means the initial seven (7) year term of this Agreement.

Leased Premises means those portions of the Administration and Resource Center Building on Floor 2 that are reflected as shaded and cross-hatched on Exhibit "C" hereto and marked "Lease Area," leased by Board to Credit Union pursuant to this Agreement.

LSUHSC-NO means Louisiana State University Health Sciences Center — New Orleans.

LSUHSC-NO Construction Monitor means one or more persons designated and authorized in writing from time to time by the Chancellor of LSUHSC-NO or his designee to monitor the Credit Union's construction progress during the installation of the door and any ATM work. The initial University Construction Monitor shall be the LSUHSC-NO's Assistant Vice Chancellor for Property and Facilities Management.

LSU Representative means the Associate Vice President, Facilities and Property Oversight for the Board or his/her designees.

Network Equipment means that equipment owned and used by the Credit Union in or on the Leased Premises.

OFPC means the Office of Facility Planning and Control within the Division of Administration for the State of Louisiana.

Plans and Specifications means one or more sets of final plans and specifications, including any amendments thereto, for design of the Improvements, materials selection and method of construction for the construction of the Improvements and for all Work related thereto, which have been approved, in writing, by the LSU Representative.

Permitted Use means the renovation and use of the Leased Premises by the Credit Union for the provision of financial services as a credit union under the laws of the State of Louisiana and United States.

Property means the land and buildings as defined in this Agreement and more particularly described in Exhibit C hereto.

Punch List means a list prepared by the Architect and approved by the LSUHSC-NO Construction Monitor and the LSU Representative, which sets forth those items of Work to be completed following Substantial Completion, prior to final acceptance.

Rent means the payments to be made by Credit Union to LSUHSC-NO for the lease of the Leased Premises as set forth in Section 2.2 of this Agreement.

State means the State of Louisiana.

Term means a period of seven (7) years beginning with the Effective Date.

Work means all work and activities required to be undertaken by Credit Union in order to design and construct the Improvements including, without limitation, the transportation and storage of materials, the securing of work sites and staging areas, the design, planning and construction of all facilities and all necessary utility placements, relocations, tie-ins and upgrades.

ARTICLE II LEASE OF LEASED PREMISES AND RENT

Section 2.1 Leased Premises. For and in consideration of payment of Rent as set forth in Section 2.2, the Board hereby leases the Leased Premises to the Credit Union for the Term, and hereby grants to Credit Union such rights of use and access as are necessary for the Credit Union to perform the Work and conduct Permitted Use in the Leased Premises. The Parties agree that the Leased Premises are leased to Credit Union unfurnished.

Section 2.2 Rent. The Credit Union shall pay Rent to the Board for the lease of the Leased Premises as follows:

- A. FIFTY-FIVE DOLLARS (\$55.00) per square foot annually for the space in the Leased Premises for a total of ELEVEN THOUSAND EIGHT HUNDRED AND TWENTY-FIVE DOLLARS (\$11,825.00) per year.
- B. Rent shall be due and payable in advance in twelve (12) equal monthly installments of NINE HUNDRED EIGHTY FIVE and 42/100 DOLLARS (\$ 985.42) each, on the first day of every month to LSUHSC-NO, and delivered to the following location: Accounts Receivable, LSU Health Sciences Center, 433 Bolivar Street, 6th floor, New Orleans, LA 70112.
- C. If during the initial month or the last month of this Agreement, the Credit Union or its employees or guests shall use the Leased Premises for only a portion of that month, the monthly Rent amount in 2.2 A shall be prorated based on the number of days used by the Credit Union.

Section 2.3 Furnishings. The Leased Premises does not include any furnishings or equipment.

Section 2.4 Additions to Leased Premises. The Board and Credit Union acknowledge that in the future it may be necessary to amend this Agreement to add square footage to the Leased Premises. In the event that the Parties hereto agree to amend the definition of Leased Premises to add to the Leased Premises, any contract adjustments, such as to the amount of square feet rented, shall be agreed to by the Parties as a part of the Amendment. All additions to the Leased Premises shall be effected by an addendum to this Agreement and may be approved on behalf of the Board by the Board Representative. The Rent to be paid by the Credit Union to the Board for the additional square footage shall be at the then current rate for comparable space in the Leased Premises. In addition to the payment of Rent on any additional square footage added to the Leased Premises, the Credit Union shall pay to the Board Additional Rent in the full sum of the documented amount of costs incurred and expenditures actually made by the Board prior to the effective date of the Addendum adding additional square footage, which additional Rent shall be for repairs and cosmetic changes to the new areas of the Leased Premises, as requested by the Credit Union, and agreed to by the Board. An invoice for the Additional Rent shall be sent by the Board to the Credit Union and shall be due and payable within sixty (60) days of receipt thereof by Credit Union.

Section 2.5 Common Areas. The Credit Union will have the non-exclusive right, along with the other tenants of the Administration and Resource Center Building and their employees and invitees, to use the landscaped areas, first floor lobby, entrance ways, hallways, elevators, fire stairs, restrooms and other areas designated from time-to-time by Board for common tenant use (herein the "Common Areas"). In using the Common Areas, the Credit Union will not impede the use of the Common Areas by other tenants, or by the Board or LSUHSC-NO, and the Credit Union will use its best efforts to prevent its employees and invitees from loitering in the Common Areas or using the Common Areas for other than their intended purpose. The Board will have exclusive control and management over the Common Areas and will have the right, from time-to-time, to establish rules and regulations with respect to the use of the Common Areas that do not materially hinder the regular business operations of the Credit Union in the Leased Premises, to close temporarily any portion of the Common Areas (provided reasonable access, to the extent not otherwise restricted by any Governmental Authority or as the result of a *Force Majeure* event, remains open at all times to the Leased Premises), and to increase, reduce, reconfigure, or change the Common Areas in any way the Board determines to be necessary or desirable provided any such changes do not materially affect the Credit Union's access to the Administration and Resource Center Building, access to parking, and ingress and egress to the Leased Premises or materially increase Credit Union's costs of operating in the Leased Premises. The Board will have no liability to the Credit Union by reason of any closure, increase, reduction, reconfiguring, or other change in the Common Areas that is performed in conformance with this Section.

ARTICLE III. AGREEMENT TO CONSTRUCT AND DONATE IMPROVEMENTS

Section 3.1 Improvements. The Credit Union has constructed the Improvements at the Credit Union's sole cost and expense and is donating the Improvements to Board via this Agreement at the time of execution by the Parties. It is estimated that the total cost of the Improvements, including both construction and design, will be approximately ONE HUNDRED

FIFTY THOUSAND DOLLARS (\$150,000.00), all of which cost and expense shall be paid by the Credit Union.

ARTICLE IV. USE OF LEASED PREMISES

Section 4.1 Permitted Use. Except with the prior written consent of the Board Representative, the Credit Union shall use the Leased Premises only to provide financial services as a credit union under the laws of the State of Louisiana and United States.

Section 4.2 Prohibited Uses. The Credit Union shall not use the Leased Premises for the sale, distribution, storage, transportation or handling of petroleum or other similar synthetic products. The Credit Union shall not make any use of the Leased Premises in violation of any Applicable Laws and shall not permit any contamination or pollution on or about the Leased Premises or increase the fire or insurance hazard by any use thereof.

Section 4.3 Permits. Before beginning any Work on the Leased Premises, the Credit Union shall obtain any permits required by the State of Louisiana, the Parish of Orleans and the United States of America or any of their agencies, subdivisions, or departments and otherwise as required by Applicable Laws.

Section 4.4 Environmental. Except in conformity with applicable environmental laws and regulations, the Credit Union shall not cause or permit any Hazardous Substance to be used, stored, generated, or disposed of, on or in the Leased Premises or the Administration and Resource Center Building (collectively the "Property") by the Credit Union, or by the Credit Union's agents, employees, contractors, customers, patients, permittees or invitees. If Hazardous Substances are used, stored, generated, or disposed of, on or in the Property during the Term of this Agreement or otherwise as a result of the action of Credit Union or its agents, employees, representatives, contractors, customers, patients, permittees or invitees, the Credit Union shall indemnify and hold harmless the Board from any and all claims, damages, fines, judgments, penalties, costs, liabilities, or losses (including, without limitation, a decrease in value of the Property, or any neighboring lands or structures owned by the Board, damages caused by losses or restriction of rentable or usable space, or any damages caused by adverse impact on marketing of the space, and any and all sums paid for settlement of claims, attorneys' fees, consultant, and expert fees) arising during or after the Term and arising as a result of that use or contamination by the Credit Union or its agents, employees, representatives, contractors, customers, patients, permittees or invitee. This indemnification includes, without limitation, any and all costs incurred because of any investigation of the site or any clean-up, removal, or restoration mandated by a federal, state, or local agency or political subdivision. Without limitation of the foregoing, if the Credit Union or its agents, employees, representatives, contractors, customers, patients, permittees or invitees, cause or permit the presence of any Hazardous Substance on the Property that results in contamination, the Credit Union shall promptly, at its sole expense, take any and all necessary actions to return the Property to the condition existing prior to the presence of any such Hazardous Substance on the Property. The Credit Union shall first obtain the Board's approval for any such remedial action. As used herein, "Hazardous Substance" means any substance that is toxic, ignitable, reactive, or corrosive, and that is regulated by any local

government, the State of Louisiana, or the United States Government. "Hazardous Substance" includes any and all material or substances that are defined as "hazardous waste", "extremely hazardous waste", or a "hazardous substance" pursuant to state, federal, or local government law. "Hazardous Substance" includes but is not restricted to asbestos, PCBs, or petroleum.

ARTICLE V. **CONSTRUCTION**

Section 5.1 - Improvements. At its sole cost and expense, Credit Union shall construct any and all Improvements in a good and workmanlike manner, in accordance with the following provisions:

A.) Plans and Specifications/Change Orders. At least thirty (30) days prior to commencement of construction of any Improvement, proposed final plans and specifications approved by the LSUHSC-NO Construction Monitor shall be delivered to the LSU Representative for his review. The LSU Representative shall approve or disapprove such proposed final plans and specifications in writing within thirty (30) days of receipt thereof. After approval by the LSU Representative, any change in work and materials relating to construction of the Improvements which either (1) materially alters the nature or quality of the Improvements and costs more than TEN THOUSAND AND 00/100 DOLLARS (\$10,000.00), or (2) materially alters the structure of the LSUHSC-NO Campus and costs more than TEN THOUSAND AND 00/100 DOLLARS (\$10,000.00), is subject to the prior review and approval of the LSU Representative, which approval shall not be unreasonably withheld, delayed or conditioned. Credit Union shall notify the LSUHSC Representative in writing of any such proposed changes in work or materials and provide to the LSUHSC Representative copies of the proposed changes, and the LSUHSC Representative shall use their best efforts to either approve or disapprove any such changes within seven (7) Business Days after receipt of such notice from Credit Union. Notification to the LSUHSC Representative shall include copies of proposed change orders approved by the Contractor, the Architect, the Credit Union and the LSUHSC-NO Construction Monitor and shall further include sufficient information for the LSUHSC Representative to make a determination whether to approve or disapprove such changes in the Work or materials. Complete copies of all final change orders shall be provided to the LSUHSC Representative no later than the commencement of the Work represented by the change order, even if LSUHSC Representative approval is not required. Changes in work or materials relating to construction of the Improvements not required to be submitted to the LSUHSC Representative by this section shall be submitted in writing (unless written submission is waived by the LSUHSC-NO Construction Monitor) to and received by the LSUHSC-NO Construction Monitor who shall either approve or disapprove any such changes within two (2) Business Days after receipt of such request and copies of the proposed

changes from Credit Union.

B.) Commencement and Completion of Work. Unless delayed by Force Majeure, Credit Union agrees, at its own expense, to: (1) commence the Work on the Premises within sixty (60) days after the LSUHSC Representative has given written approval of the notice to commence; and (2) make best reasonable efforts to achieve Substantial Completion of the Work within a reasonable period thereafter. No work shall commence until the LSUHSC Representative has given written consent to the notice to proceed and written approval to the final proposed plans and specifications. The commencement and completion dates set forth herein may be extended by a written request issued by the Credit Union and approved in writing by the LSUHSC Representative.

C.) Construction Contract. The Work shall be performed on behalf of Credit Union pursuant to the terms of the Construction Contract, and Credit Union shall comply with all requirements of La. R.S. 9:4801. Credit Union shall not enter into a proposed Construction Contract without the prior written approval of the LSUHSC Representative. The LSUHSC Representative shall approve or disapprove the proposed final contract within ten (10) days of receipt from Credit Union. Proper notice of the Construction Contract and Payment and Performance Bonds shall be recorded properly in the mortgage records of Orleans Parish prior to commencement of the Work. Credit Union shall include a liquidated damages clause acceptable to the LSUHSC Representative in the proposed Construction Contract. No change or change order to the Construction Contract which materially and substantially deviates from the Construction Contract as originally approved shall be implemented without the prior written consent of the LSUHSC Representative. Board and Credit Union hereby acknowledge the following, and, to the extent practically and legally possible, the Construction Contract and all subcontracts entered into by the Contractor shall acknowledge expressly that they have been informed of the following:

- (i) The Work will be performed solely and exclusively for Credit Union.
- (ii) Credit Union and Credit Union Subsidiary are separate legal entities from LSUHSC-NO and Board. It is not acting as agent for LSUHSC-NO or Board, and Credit Union has no authority to obligate LSUHSC-NO or Board to any extent whatsoever.
- (iii) Neither Board, LSUHSC-NO, nor the State of Louisiana shall be liable, directly or indirectly, for the payment of any sums whatsoever or for the performance of any other obligation whatsoever arising out of the Work performed pursuant to this

Agreement.

- (iv) Credit Union and/or Credit Union Subsidiary has no ownership interest in the Premises on which the Work will be performed. Any improvements placed on the Premises shall become property of Board upon completion of the Work. The Work shall not give rise to any rights against the Premises, the Board or LSUHSC-NO.
- (v) It is understood and agreed that the Board, its members, employees and agents including but not limited to the LSU Representative and the LSUHSC-NO Construction Monitor, shall owe no legal duty to or assume any liability or responsibility to or for any party as a result of or in connection with any consent, approval or review given or undertaken in connection with the Work. No party shall infer, based on any consent, approval or review given or undertaken by the Board, its members, employees and agents including but not limited to the LSU Representative and the LSUHSC-NO Construction Monitor, agreement with or endorsement of the particular matter at issue; rather, such consent, approval or review shall only be deemed to indicate "no objection" to the particular matter at issue.

D.) Payment and Performance Bonds. Credit Union shall require that the Contractor provide a performance and labor and materials payment bond(s) with a corporate surety authorized to do business in the State of Louisiana. Said bond(s) shall be for the greater of the full amount of the contract sum or the guaranteed maximum price as defined and established in the Construction Contract. Credit Union, Board and LSUHSC-NO shall be obligees under the bond(s).

E.) Rights Concerning the Premises During Construction. To the extent necessary, Credit Union and/or Credit Union Subsidiary and the Contractor shall have the right to occupy and use the Premises, with reasonable ingress to and egress from the Premises, during the term of this Agreement and, with the prior written consent of LSUHSC-NO Construction Monitor, shall fence or block off that area of the Premises necessary to perform the Work in a safe and secure manner. Credit Union assumes all responsibility for the condition of the Premises during the Term of this Agreement. Credit Union and the Contractor shall maintain the Premises and any improvement or construction thereon in a reasonably prudent manner at all times until the Work is accepted by the LSU Representative and donated to the Board. Board shall not be responsible for the construction of any Improvement or Work. Furthermore, Board shall not be responsible for any maintenance or repairs to the Premises or the Work during the Work. The LSUHSC-NO Construction Monitor and the LSU

Representative and any other individuals authorized by the LSU Representative shall at all times have access to the Premises and the exercise of all rights as owner except as otherwise provided herein, even those not specifically acknowledged herein. Credit Union accepts the Premises for the purposes herein outlined without any warranty of title or recourse whatsoever against Board.

F.) Access over Adjoining Property during Construction. Board hereby grants to Credit Union and/or Credit Union Subsidiary a servitude of access over and across such other property owned by Board only in so far as such is reasonably necessary in order for the Credit Union and/or Credit Union Subsidiary to fulfill its obligations hereunder, provided, however, that such access routes are approved in writing by the LSUHSC-NO Construction Monitor, and do not interfere with the rights of any other occupants of the LSUHSC-NO Campus. Credit Union and/or Credit Union Subsidiary shall not unreasonably interfere with Board's use of such other property.

G.) LSU Rules and Regulations: Access During Construction. Credit Union agrees that it will comply with all Board and LSUHSC-NO regulations, policies and mandates with regard to all contractors and personnel entering the Premises for purposes of construction, which rules and regulations will be addressed at the pre-construction conference, and Credit Union will secure, at its own expense, all necessary permits and licenses from all regulatory agencies or bodies. Credit Union shall make these same requirements of the Contractor. At all times during construction, the LSUHSC-NO Construction Monitor, the LSU Representative and any individuals authorized by the LSU Representative shall have the right but not the obligation to enter the Premises and review the Work to determine that it is being performed in compliance with the Plans and Specifications and in a good and workmanlike manner, and further the LSUHSC-NO Construction Monitor, the LSU Representative and any individuals authorized by the LSU Representative shall have the right but not the obligation to review any and all documents related to the construction.

H.) Acceptance of Construction. Credit Union and Board agree to work together to identify and facilitate completion of all warranty and punch list items within the first year following acceptance of the Work. Credit Union will not accept the Work without the written approval of the LSUHSC Representative. Board reserves the right to refuse to approve the acceptance of the Work unless monies equal to the value of the punch list deficiencies are withheld by the Credit Union and designated for payment to the Contractor only upon completion of the punch list items. Upon donation of the Work by Credit Union to Board, Credit Union hereby agrees that, to the extent allowed by law, Credit Union will assign or transfer to Board its right to enforce actions against the Contractor and/or the Architect arising out of the Work; provided, however, Credit Union

shall continue to be obligated to complete the Punch List items. Final payment shall not be made to the Contractor until the LSUHSC Representative agrees in writing that the Punch List items have been completed.

- I.) Funds for Construction.** At the LSUHSC Representative's request, prior to the commencement of Work, Credit Union shall satisfy the LSUHSC Representative that the total amount of money needed to complete the Work has been collected or acquired by the Credit Union and is dedicated to that use. At the LSUHSC Representative's sole option, Credit Union may be required to provide a letter of credit, a performance bond, or a dedicated escrow account to guarantee its performance. If the LSUHSC Representative determines that outside expertise is needed to review a financing plan, Credit Union shall reimburse the Board or LSUHSC-NO the reasonable cost of employing such experts.
- J.) On-Site Construction Inspector.** If in the LSUHSC Representative's sole discretion, it becomes necessary, Credit Union at Credit Union's expense shall hire an on-site construction inspector or clerk of the works for full time supervision of the Work.
- K.) Inspection and Survey.** Credit Union shall inspect the Premises and arrange for any necessary surveys and other site investigations at its expense. Credit Union accepts the Premises in its present condition.
- L.) No Liens; Release of Recorded Liens.** Credit Union shall not suffer or permit any liens to be enforced against the Premises or Board by reason of a failure to pay for any work, labor, services or materials supplied or claimed to have been supplied to Credit Union or to anyone through or under the Credit Union. If any such liens shall be recorded against the Premises, Credit Union shall cause the same to be released of record, or in the alternative, if the Credit Union in good faith desires to contest the same, Credit Union shall be privileged to do so, but in such case, Credit Union shall promptly deposit with the Recorder of Mortgages of Orleans Parish a bond guaranteeing payment of any such liens and hereby agrees to indemnify, defend with an attorney of the LSUHSC Representative's choice, and save Board harmless from all liability for damages occasioned thereby and shall, in the event of a judgment of foreclosure on said lien, cause the same to be discharged and released prior to the execution of such judgment.

Section 5.2 Signage. Before erecting or placing any sign upon the Leased Premises, the Credit Union shall submit the design specifications of such sign to the Board Representative

for approval. The Credit Union may only erect or place signage hereunder if it has obtained the prior written approval of the Board Representative.

ARTICLE VI. INSURANCE

Section 6.1 Insurance During Construction. Unless otherwise approved in writing by the LSUHSC Representative, during the Work and prior to the donation of the Improvements to Board, and with respect to any Network Maintenance, Credit Union shall maintain or require the Contractor to maintain the following:

A.) Builder's Risk Insurance. Credit Union or Contractor shall provide a Builder's Risk Insurance Policy. The insurance shall afford property hazard insurance coverage against loss or damage by fire, lightning, explosion, earthquake, collapse, theft, sprinkler leakage, vandalism and malicious mischief and such other perils as are included in the ISO Causes of Loss - Special Form (CP130), and against such other insurable perils as, under good insurance practices, from time to time are insured against for properties of similar character and location, for not less than one hundred percent (100%) of the full replacement value of the Work, the d Premises, and the Improvements under construction to protect against any damage or loss prior to the completion of the Work, including the Premises and the Improvements. This policy shall be taken out prior to commencement of construction of any Work and may be discontinued only upon the provision to the LSUHSC Representative by Credit Union of written notice of Substantial Completion of all Work. The coverage shall include, but not be limited to, the architect's and engineer's fees to provide plans, specifications and supervision of Work for the repair and/or replacement of property damage following a loss during construction. A certificate of insurance as evidence of such insurance shall be provided to the LSUHSC Representative prior to commencement of any Work. The policy shall include coverage for the insurable interests, if any, of Board, LSUHSC-NO, the Credit Union and Credit Union 's Contractor(s), and any subcontractors their interests may appear.

B.) General Liability and Property Damage Insurance. Credit Union and its Contractors, before commencing any construction, shall procure such comprehensive liability and property damage insurance, including insurance for the operation of motor vehicles, which will cover Credit Union 's, Board's, Contractor's and the Architect's legal liability arising out of the construction performed by Credit Union or any of its contractors or subcontractors and by anyone directly or indirectly employed by either of them, for claims for damages for personal injury, including accidental death, as well as claims for property damage, including but not limited to damage to surrounding buildings, which may arise from operations for the construction of the work, with

minimum limits of liability of TWO MILLION AND 00/100 DOLLARS (\$2,000,000.00) dollars per occurrence and FIVE MILLION AND 00/100 DOLLARS (\$5,000,000.00) general aggregate. Credit Union shall also require its contractors and subcontractors to have in full force and effect a policy of workmen's compensation and employer's liability insurance before proceeding with the construction under this Agreement. Written evidence of such insurance shall be provided to the LSUHSC Representative prior to commencement of the Work.

C.) Architect’s Design, Errors and Omissions. Other than with respect to the performance of Network Maintenance, upon execution of this Agreement, Credit Union shall provide the LSUHSC Representative with evidence that the Architect has procured architect's design, errors and omissions insurance coverage for the Work in an amount acceptable to the LSUHSC Representative, and Board shall be named as an additional insured on said policy.

Section 6.2 – Credit Union ’s Insurance During the Term. Throughout the Term of this Agreement, the Credit Union shall at all times maintain or cause to be maintained, with respect to the Leased Premises and the Improvements, insurance in the following types and amounts. Such insurance shall be with insurance companies duly licensed to do business in the State of Louisiana and bearing a rate of A+XV in the latest Best Casualty Insurance Reports.

TYPE	AMOUNT
Commercial General Liability Insurance for the following where the exposure exists: (a) Property-operations (b) broad form lease liability (c) Products and Completed operations (d) use of Contractors and subcontractors (e) personal injury (bodily injury and death) (f) broad form property damage (g) explosion, collapse and underground property damage (h) Property-operations (i) Broad form lease liability	Limits in an amount not less than: \$2,000,000 per occurrence \$5,000,000 General Aggregate; and \$5,000,000 Products & Completed Operations Aggregate; less a commercially reasonable deductible. "Claims Made" form is not acceptable.
Business Automobile Liability Insurance for bodily injury and property damage, covering owned automobiles, hired automobiles and leased automobiles.	Combined single limit of One Million Dollars (\$1,000,000) per occurrence
Workers’ Compensation & Employer's Liability Insurance	Limits as required by the Labor Code of the State of Louisiana and Employer's Liability coverage.

Section 6.3 - Insurance Policies. Unless otherwise approved by the LSUHSC Representative in writing, the following requirements shall be applicable to insurance policies and coverages required pursuant to the terms of this Agreement:

- A.) Required Insurance Shall Be Primary.** All insurance required hereby shall be primary as respects Board, its members, officers, employees and authorized agents. Any insurance or self-insurance maintained by the Louisiana Office of Risk Management and Board shall be excess and noncontributory of Credit Union or any Contractors' insurance.

- B.) Failure to Comply with Reporting Requirements.** Any failure of the Credit Union or Contractor to comply with reporting requirements of a policy required hereby shall not affect coverage provided to Board, its members, officers, employees and authorized agents.

- C.) Application of Multiple Policies.** The Credit Union 's and/or Contractor's insurance shall apply separately to each insured against whom a claim is made, or suit is brought, except with respect to the policy limits.

- D.) No Release.** Neither the acceptance of the completed Work nor the payment therefore shall release the Credit Union or Contractor or insurer from applicable obligations of the insurance requirements or indemnification requirements set forth herein.

- E.) No Recourse.** The insurance companies issuing the required policies shall have no recourse against Board for payment of premiums or for assessments under any form of the policies.

- F.) Excess Insurance.** Excess umbrella insurance may be used to meet the minimum requirements for general liability and automobile liability only.

- G.) Deductibles and SIRs.** The Credit Union and/or Contractor shall be responsible for all deductibles and self-insured retentions.

- H.) No Special Limitations.** The coverage required hereunder shall contain no special limitations (*e.g.*, limitations beyond those that are normal, and customary based on the policy, coverage and activity insured) on the scope of protection afforded to Board, its members, officers, employees and authorized

agents.

- I.) Licensed Louisiana Insurers.** All insurance shall be obtained through insurance companies duly licensed and authorized to do business in the State of Louisiana, which, to the extent available on commercially reasonable terms, bear a rating of A+: XV in the latest A. M. Best Co. ratings guide. If at any time an insurer issuing a policy hereunder does not meet the minimum A. M. Best Co. ratings, and such requirement has not been waived in writing by the LSUHSC Representative, the Credit Union and/or Contractor shall obtain a policy with an insurer that meets the A. M. Best Co., rating required and shall submit another Certificate of Insurance as required hereunder.
- J.) Occurrence Based Policies.** All insurance required hereunder, with the exception of Architect's Design Errors and Omissions policies, shall be occurrence coverage. Except as specifically permitted herein, claims-made policies are not allowed.
- K.) Verification of Coverage.** The Credit Union shall furnish the LSUHSC Representative with Certificates of Insurance reflecting proof of coverage required hereunder. The certificates for each insurance policy are to be signed by a person authorized by that insurer to bind coverage on its behalf. The certificates are to be received and approved by the LSUHSC Representative before Work commences and upon any contract renewal thereafter. The LSUHSC Representative reserves the right to request complete certified copies of all required insurance policies at any time. Said certificates and policies shall to the extent allowed by law provide at least a twenty (20) day written notification to the LSUHSC Representative prior to the cancellation thereof. Upon failure of the Credit Union to furnish, deliver and maintain such insurance as provided herein, and expiration of any applicable cure period, then Board may, but shall not be obligated to, obtain said insurance on behalf of the Credit Union at the Credit Union 's commercially reasonable cost and expense. Failure of the Credit Union to purchase and/or maintain, either itself or through its contractor(s), any required insurance, shall not relieve the Credit Union from any liability or indemnification hereunder.
- L.) Additional Insureds.** The Credit Union, Credit Union Subsidiary, Board and its members, officers, employees and authorized agents shall each be named as additional insureds on all policies required hereby. Such additional insured status shall apply to both ongoing and complete operations. Accordingly, Contractor shall provide evidence that ISO forms CG2010 and CG2037 are attached to Contractor's General Liability policy.

M.) Additional Insurance. The LSUHSC Representative may review Credit Union's required insurance as stated herein at the time of renewal of the policies or at the time of a material change, and the LSUHSC Representative reserves the right to require reasonable additional limits or coverages to the extent available at commercially reasonable rates. Credit Union agrees to comply with any such reasonable request by the LSUHSC Representative or to allow reasonable changes or reductions in coverages.

N.) Blanket Policies. If any blanket general insurance policy of Credit Union complies with the requirements of this Agreement, such insurance shall fulfill the requirements set forth herein.

O.) Limitation on Liability. The insurance and other provisions of this Agreement do not waive or abrogate, are not intended to waive or abrogate, and shall not be interpreted to waive or abrogate, the limitation on liability established under La. R.S. 13:5I 06 for Board.

ARTICLE VII. OPERATION, MAINTENANCE, REPAIRS, SECURITY AND OTHER SERVICES

Section 7.1 Permitted Use. Credit Union shall procure and maintain all licenses, permits and accreditation, if any, required for Credit Union's use of the Leased Premises and the Credit Union Equipment.

Section 7.2 Maintenance and Repair of Leased Premises.

A. Board shall provide all janitorial and custodial services to the Leased Premises.

B. Except as to Improvements made by the Credit Union at its sole cost and expense during the Term, the Board shall provide all other ordinary and routine maintenance to the Leased Premises during the Term including heating, ventilating, air conditioning, mechanical, electrical, elevators, plumbing, fire, sprinkler and security systems.

C. With the prior, written consent of the Board Representative, the Credit Union may perform Network Maintenance, which Network Maintenance, shall be performed in accordance with any conditions or requirements reasonably imposed by the Board Representative.

Section 7.3 Utilities. The Board agrees to be responsible for the cost of all utilities serving the Leased Premises, including electric power, water and sewer, but excluding IT and telephony, which will be the subject of a separate agreement between Board and Credit Union. If Credit Union desires to install or use any equipment, trade fixtures, or fixtures using unusual amounts of electricity in the Leased Premises, then the Credit Union shall obtain the Board Representative's approval of such item or items, and the Board, at its option, may require that the Credit Union pay a charge for said increased electricity usage equal to the estimated increases in

the amount charged to the Board as a result of Credit Union's use of any of the aforementioned items. Any such charge for additional electricity shall be paid by the Credit Union in monthly installments or at Board's option, upon demand.

Section 7.4 IT Equipment and Telephony. The provision of IT equipment, IT usage and telephony and telephone equipment shall be addressed by the parties in a separate agreement.

Section 7.5 Return of Leased Premises at End of Term. At the Termination of this Lease Agreement, the Credit Union shall return the Leased Premises to the Board with all improvements made by it in as good a condition as that in which it was received, and/or completed, subject only to the normal wear and tear of a prudent use. The cost and expense of any repairs necessary to restore the condition of the Leased Premises shall be borne by the Credit Union.

ARTICLE VIII. DONATION OF IMPROVEMENTS AND TITLE TO IMPROVEMENTS

Section 8.1 - Donation of Improvements. Credit Union shall donate the Improvements to Board after all Donation Acceptance Requirements have been completed to the LSUHSC Representative's reasonable satisfaction (unless the LSUHSC Representative agrees in writing to accept the donation of the Improvements subject to Credit Union obligating itself to complete specifically identified Donation Acceptance Requirements). Furthermore, on or before the donation of the Improvements to Board, Credit Union shall assign to Board all guarantees and warranties as set forth in Section 8.2 below. Unless otherwise agreed to in writing by Board and Credit Union, the Work shall not be donated to Board until such events have occurred. Unless otherwise agreed to in writing by the LSUHSC Representative and Credit Union, use and/or occupancy of the Improvements shall be prohibited until the Improvements have been donated by Credit Union to Board.

Section 8.2 - Transfer of Ownership. Upon fulfillment of the conditions set forth in Section 7.1 hereof, the Improvements shall be donated to and title and ownership to said Improvements shall be transferred to and shall become owned by Board. Said donation shall occur concurrently with final fulfillment of the conditions set forth in Section 8.1, and, upon said donation, Credit Union shall have no further responsibilities, obligations or liabilities with regard to the Improvements, Premises or the Work except as otherwise specifically set forth in this Agreement. Credit Union shall bear the risk of loss with respect to the Improvements until acceptance of the donation by the LSUHSC Representative. Furthermore, prior to such donation, Credit Union shall obtain guarantees and warranties from the Contractor or Contractors and suppliers of equipment, which guarantees and warranties shall be assigned to and shall run in favor of Board upon the donation of the Improvements, provided, however, Credit Union itself shall make no warranty as to the condition of the Work. To the extent that such terms are available on commercially reasonable terms, guarantees and warranties for the construction and completion of the Improvements shall run from the later of (1) the fulfillment of the conditions set forth in Section 8.1 and this Section 8.2, or (2) the full execution of the donation of the Improvements from the Credit Union to Board or (3) occupancy for the purposes set forth herein (the "Warranty

Commencement Date”), which warranties shall include but not be limited to the following items and periods if available:

- A.) For one year following the Warranty Commencement Date, all defects in materials and workmanship; and,
- B.) For the length of manufacturers’ warranties, all appliances and equipment.

Section 8.3 - Execution of Documents. Upon fulfillment of the conditions set forth in this Article VIII hereof the parties agree to execute any and all documents necessary to effectuate the donation and the acceptance thereof on behalf of Board. The parties will record the donation and acceptance in the records of Orleans Parish.

Section 8.4 - Termination of Agreement by Board. Notwithstanding anything contained in this Agreement, at all times Board shall have the absolute right to terminate this Agreement twelve (12) months prior written notice to Credit Union. Upon such termination either Board shall take title to the Improvements, or Board, at its option, may require Credit Union to transfer all of its right, title and interest in this Agreement, in any funds dedicated to complete the construction of the Improvements (subject to applicable donor restrictions and the terms of any valid and perfected liens, pledges and other security interests) and in the Improvements already constructed, to another non-profit corporation or entity which meets the requirements of La. R.S. 17:3390, which is acceptable to Board, and which accepts the obligations of the Credit Union hereunder.

ARTICLE IX. INDEMNIFICATION AND LIMITATION OF LIABILITY

Section 9.1 Indemnification by Credit Union. Credit Union covenants and agrees to fully defend, protect, indemnify, hold harmless and render whole the Board, its trustees, employees and agents, from and against each and every claim, demand or cause of action and liability, cost and/or expense (including but not limited to reasonable attorneys’ fees and expenses incurred in the settlement of and/or defense of the Board, its trustees, employees and/or agents), for damage or loss in connection therewith, which may be made or asserted by Credit Union, its officers, directors, employees, contractors or invitees, or which may be made or asserted by any third party, on account of personal injury or death or property damage caused by, arising out of, or in any way incidental to, or in connection with the Credit Union’s occupancy or use of the Leased Premises or the Administration and Resource Center Building, except to the extent caused by acts or omissions by Board’s members, officers and employees unless said Board, members, officers and employees are acting at the direction or request of the Credit Union. Should this indemnity provision apply, Credit Union agrees to defend the Board with attorneys of the Board’s choice in any legal action against it and pay in full and satisfy any claims, demands or judgments made or rendered against the Board, and to reimburse the Board for any legal expenses, including attorneys’

fees and court costs, which may be incurred by it in defense of any claim or legal action arising thereunder, and repair any damages to the Leased Premises or to the Administration and Resource Center Building.

Section 9.2 Indemnification by Board. To the extent allowed by Applicable Laws, the Board, agrees to indemnify, defend and hold the Credit Union harmless against any loss for damages or injuries that may be suffered by the Credit Union or by any person including but not limited to the Board's members, employees, or officers, except if any of such persons are acting at the direction or request of the Credit Union, but only to the extent that such loss, damage or injuries arise out of or are related to the fault or negligence of the Board, its members, employees, or officers. Should this indemnity provision apply, the Board agrees to defend the Credit Union in any such legal action against it and, to the extent allowed by Applicable Law, pay in full and satisfy any such claims, demands or judgments made or rendered against the Credit Union, and to reimburse the Credit Union for any legal expenses, including attorneys' fees and court costs, which may be incurred by it in defense of any such claim or legal action arising thereunder; provided, however, that the Board's costs and expenses incurred in fulfilling this indemnity and defense shall be limited to proceeds from the Office of Risk Management or otherwise which are available for this purpose.

Section 9.3 Additional Limitation of Liability. To the full extent of La. R.S. 9:3221, Credit Union assumes responsibility for the condition of the Leased Premises and the Board shall not be responsible for damage caused by any defects of the Leased Premises or consequences thereof.

ARTICLE X. TERM

Section 10.1 Term. This Agreement shall remain in full force and effect for period of seven (7) years, beginning on the Effective Date.

ARTICLE XI. NOTICES

Section 11.1 Notices. All notices, requests and communications required or permitted by this Agreement, shall be given in writing by (i) personal delivery (confirmed by courier delivery service), (ii) expedited delivery service with proof of delivery, (iii) facsimile and confirmed in writing by mail, or (iv) United States mail, postage prepaid, registered or certified mail, return receipt requested, addressed as follows:

Such notices when given by Credit Union shall be addressed to Board as follows:

Board: Board of Supervisors of Louisiana State University and
Agricultural and Mechanical College
Attention: William Tate, IV, President, LSU
3810 West Lakeshore Dr. Baton Rouge, Louisiana 70808

With copies to: LSU Health Sciences Center New Orleans

Attention: James Kirk Deslatte
Assistant Vice Chancellor for
Property and Facilities
Management 433 Bolivar Street,
Suite 803
New Orleans, Louisiana 70112
jdesla@lsuhsc.edu

Such notices when given by Board shall be addressed to Credit Union as follows:

Credit Union: Jane Verret, President
Campus Federal Credit Union
Perkins Road Financial Center
6230 Perkins Road
Baton Rouge, LA, 70808

Any Party may change its address for purposes of Section 11.1 by giving written notice of such change to the other party in the manner provided in this section. Except as expressly provided herein, any notice provided for herein shall become effective only upon and at the time of first receipt by the party to whom it is given, unless such notice is only mailed by certified mail, return receipt requested, in which case it shall be deemed to be received three (3) business days after the date that it is mailed. Either party may, by proper written notice hereunder to the other party, change the individual address to which such notice shall thereafter be sent; provided, however, such new notice address will be effective ten (10) business days after delivery of notice of the new notice address. Rent payments shall be made payable to Board as provided in Section 2.2 above, which Rent payments may be made via regular mail addressed as shown in Section 2.2 but shall not be timely unless received by Board on or before the date on which they are due.

ARTICLE XII. CREDIT UNION DEFAULT

Section 12.1 Default by Credit Union. The Board may declare Credit Union in default upon one or more of the following events:

A. Breach of Agreement Covenants. Failure of the Credit Union to observe or perform any other covenant, condition or obligation upon its part to be observed or performed under this Agreement for a period of thirty (30) days after receipt of written notice specifying such failure and requesting that it be remedied; or

B. Taking of Improvements. The taking by execution of the Improvements for the benefit of any person or entity other than the Board; or

C. Involuntary Bankruptcy. A court having jurisdiction shall enter an order for relief in any involuntary case commenced against Credit Union, as debtor, under the Federal Bankruptcy Code, as now or hereafter constituted, or the entry of a decree or order by a court having jurisdiction in the premises appointing a custodian, receiver, liquidator, assignee, trustee, sequestration, or other similar official of or for Credit Union or any substantial part of the properties of Credit Union or ordering the winding up or liquidation of the affairs of Credit Union,

and the continuance of any such decree or order not stayed and in effect for a period of ninety (90) consecutive days; or

D. Voluntary Bankruptcy. The commencement by the Credit Union of a voluntary case under the Federal Bankruptcy Code, as now or hereafter constituted, or the consent or acquiescence by Credit Union to the commencement of a case under such Code or to the appointment of or taking possession by a custodian, receiver, liquidator, assignee, trustee, sequestration, or other similar official of or for Credit Union or any substantial part of the properties of the Credit Union; or

Section 12.2 Failure by Credit Union to Take Remedial Action. Whenever any event of default referred to in this section shall have occurred and be continuing and the Credit Union refuses or fails to take the reasonable and necessary remedial action to cure such default in the time period specified therefor, in addition to any other remedies herein or by law provided, the Board shall have the right, in addition to any other rights the Board may have under Applicable Law, without any further demand or notice, to declare this Agreement terminated. In the event of the termination of this Agreement, the Credit Union expressly waives any notice to vacate. Furthermore, in the event of the termination of this Agreement during the Work, Board shall be the owner of all Improvements made on or to the Leased Premises, provided, however, at the Board's sole option and direction, in the event of the termination of this Agreement during the Work, the Credit Union shall transfer any Improvements constructed pursuant to the Agreement, its rights and obligations under this Agreement and any funds the Credit Union has dedicated to complete the construction of the Improvements (subject to applicable donor restrictions and the terms of any valid and perfected liens, pledges and security interests) to another non-profit corporation or entity which meets the requirements of La. R.S. 17:3390 and which is acceptable to Board.

ARTICLE XIII. BOARD DEFAULT

Section 13.1 Default by Board. The Credit Union may declare the Board in default upon the failure of the Board to observe or perform any covenant, condition or agreement upon its part to be observed or performed under this Agreement for a period of thirty (30) days after receipt of written notice specifying such failure and requesting that it be remedied. If the default be continuing and Board has not taken any action reasonably anticipated to cure such default, in addition to any other remedies herein or by law provided, Credit Union shall have the right, without any further demand or notice to declare this Agreement terminated and shall have no further obligation to perform any of the obligations of Credit Union under this Agreement.

ARTICLE XIV. FORCE MAJEURE

Section 14.1 – Discontinuance by Credit Union during Force Majeure. Whenever a period of time is herein prescribed for action to be taken by the Credit Union, the Credit Union shall not be liable or responsible for, and there shall be excluded from the computation for any such period of time, any delays due to Force Majeure. However, LSU shall not be obligated to recognize any delay caused by Force Majeure unless the Credit Union shall, within ten (10)

Business Days after the Credit Union is aware of the existence of an event of Force Majeure, notify LSU in writing thereof.

Section 14.2 – Discontinuance by Board during Force Majeure. Whenever a period of time is herein prescribed for action to be taken by Board, Board shall not be liable or responsible for, and there shall be excluded from the computation for any such period of time, any delays due to Force Majeure. However, Credit Union shall not be obligated to recognize any delay caused by Force Majeure unless Board shall, within ten (10) Business Days after Board is aware of the existence of an event of Force Majeure, notify the Credit Union thereof.

ARTICLE XV

MISCELLANEOUS

Section 15.1 Relationship of Parties. Nothing contained herein shall be deemed or construed by the parties hereto, or by any third party, as creating the relationship of principal and agent, partners, joint venturers, or any other similar such relationship, between the parties hereto. It is understood and agreed that no provision contained herein, or any acts of the Parties hereto, creates a relationship other than the relationship of Board and Credit Union under this Agreement.

Section 15.2 – Attorneys’ Fees. If either Party is required to commence legal proceedings relating to this Agreement, the prevailing party to the extent allowed by Applicable Laws shall be entitled to receive reimbursement for its reasonable attorneys’ fees and costs of suit.

Section 15.3 - Louisiana Law to Apply. This Agreement shall be construed under and in accordance with the laws of the State of Louisiana, and all obligations of the parties created hereunder are performable in Orleans Parish, Louisiana.

Section 15.4 - Non-waiver. No waiver by Board or Credit Union of a breach of any of the covenants, conditions, or restrictions of this Agreement shall constitute a waiver of any subsequent breach of any of the covenants, conditions, or restrictions of this Agreement. The failure of Board or Credit Union to insist in any one or more cases upon the strict performance of any of the covenants of the Agreement, or to exercise any option herein contained, shall not be construed as a wavier or relinquishment for the future of such covenant or option. A receipt by the Board or acceptance of payment by the Board of Rent with knowledge of the breach of any covenant hereof shall not be deemed a waiver of such breach. No waiver, change, modification or discharge by Board or Credit Union of any provision of this Agreement shall be deemed to have been made or shall be effective unless expressed in writing and signed by the parties hereto.

Section 15.5 - Severability. If any clause or provision of this Agreement is illegal, invalid or unenforceable under present or future laws effective during the term of this Agreement, then and in that event, it is the intention of the parties hereto that the remainder of this Agreement shall not be affected thereby.

Section 15.6 - Authorization. By execution of this Agreement, Credit Union and Board each represent to the other that they are entities validly existing, duly constituted and in good standing under the laws of the jurisdiction in which they were formed and in which they presently conduct business; that all acts necessary to permit them to enter into and be bound by this Agreement have been taken and performed; and that the persons signing this Agreement on their behalf have due authorization to do so.

Section 15.7 - Use of Name, Logos or Marks. Neither party shall make use of the other party's name, logo or marks without its prior written consent.

Section 15.8 - Amendment. No amendment, modification, or alteration of the terms of this Agreement shall be binding unless made in writing, dated on or subsequent to the date hereof and duly executed by the parties hereto.

Section 15.9 – Assignment, Subleases or Mortgage. The mortgage or encumbrance of the Improvements, the Work or Credit Union 's Interest in this Agreement or the Premises without the prior written consent of the LSUHSC Representative, and any attempt to mortgage or encumber the Improvements, the Work or Credit Union 's interest in this Agreement or the Premises without the prior written consent of the LSUHSC Representative shall be null and void. Credit Union shall not assign this Agreement or any part hereof without the prior written consent of the LSUHSC Representative, and any attempt of assignment without the prior written consent of the LSUHSC Representative shall be null and void. Credit Union may sublease a portion of the Premises to another non-profit entity with the prior, written consent of the LSUHSC Representative.

Section 15.10 – Books, Records and Audit. The books, accounts and records of Credit Union which pertain directly to the Work and construction of the Improvements and/or the occupancy of the Premises shall be maintained at the principal office of Credit Union . Board may at its option and at its own expense during customary business hours, conduct internal audits of the books, bank accounts, records and accounts of Credit Union and its Contractor(s) to the extent necessary to verify compliance with this Agreement or insofar as said books, bank accounts, records and accounts directly relate to Credit Union 's performance of its obligations under this Agreement. Audits may be made on either a continuous or periodic basis or both and may be

conducted by employees of Board, by independent auditors retained by Board to conduct such audit, or by the Louisiana Legislative Auditor, but any and all such audits shall be conducted without materially or unreasonably or unnecessarily interrupting or interfering with the normal conduct of business affairs of the Credit Union.

Section 15.11 - Successors and Assigns. All of the covenants, agreements, terms and conditions to be observed and performed by the parties hereto shall be applicable to and binding upon their respective successors and assigns including any successor by merger or consolidation of LSUHSC-NO or Board into another educational institution or governing body.

Section 15.12 - Notice of Agreement Credit Union agrees not to record this Agreement.

Section 15.13 - LSU Representative. In addition to any other individuals specifically authorized in writing by the President of the LSU System to act as the LSU Representative, the Associate Vice President and University Architect is hereby authorized to act as the LSU Representative. It is understood and agreed that the Board, its members, employees and agents including but not limited to the LSU Representative and the LSUHSC-NO Construction Monitor, shall owe no legal duty to or assume any liability or responsibility to any party as a result of or in connection with any consent, approval or review given or undertaken in connection with this Agreement or the Work. No party shall infer, based on any consent, approval or review given or undertaken by the Board, its members, employees and agents including but not limited to the LSU Representative and the LSUHSC-NO Construction Monitor, agreement with or endorsement of the particular matter at issue; rather, such consent, approval or review shall only be deemed to indicate “no objection” to the particular matter at issue.

Section 15.14 – Ownership. All plans, diagrams, blueprints, records, reports, documents, and other material delivered or transmitted to Credit Union by Board shall remain the property of Board, and shall be returned by Credit Union to Board, at Credit Union’s expense, upon demand from Board.

Section 15.15 – Non-Discrimination. Any discrimination by the Foundation or its agents or employees on account of race, color, sex, age, religion, national origin or handicap, in employment practices or in the performance of the terms, conditions, covenants and obligations of this Agreement, is prohibited.

Section 15.16 – Severability. If any clause or provision of this Agreement is illegal, invalid or unenforceable under present or future laws effective during the term of this Agreement, then and in that event, it is the intention of the Parties hereto that the remainder of this Agreement shall not be affected thereby.

Section 15.17 - Entire Agreement. This Agreement, together with the exhibits attached hereto, contain the final and entire agreement between the parties hereto with respect to the Premises and contain all of the terms and conditions agreed upon with respect to the Premises, and no other agreements, oral or otherwise, regarding the subject matter of this Agreement shall be deemed to exist or to bind the parties hereto, it being the intent of the parties that neither shall be bound by any term, condition, or representations not herein written.

Section 15.18 - Curative Matters. Except for the express representations and warranties of the Board set forth in this Agreement, any additional matters necessary or desirable to make the Premises useable for the Credit Union 's purpose shall be undertaken, in the Credit Union 's sole discretion, at no expense to the Board.

Section 15.19 - Terminology. Unless the context of this Agreement clearly requires otherwise, (a) pronouns, wherever used herein, and of whatever gender, shall include natural persons and corporations, partnerships, limited liability companies, trusts, and all other entities of every kind and character, (b) the singular shall include the plural wherever and as often as may be appropriate; (c) the word "includes" or "including" shall mean "including without limitation;" (d) the words "hereof," "herein," "hereunder," and similar terms in this Agreement shall refer to this Agreement as a whole and not to any particular section or article in which such words appear unless specifically stated. The section, article and other headings in this Agreement are for reference purposes and shall not control or affect the renovation of this Agreement or the interpretation hereof in any respect. Article, section and subsection and exhibit references are to this Agreement unless otherwise specified. All exhibits attached to this Agreement constitute a part of this Agreement and are incorporated herein. All references to a specific time of day in this Agreement shall be based upon Central Standard Time (or the other standard of measuring time then in effect in New Orleans, Louisiana).

Section 15.20 – Drafting of Agreement. The Parties agree that the terms and conditions of this Agreement are the result of arm's length negotiations between the Parties and/or their counsel. Neither Party shall be considered the drafter of the Agreement or any provision hereof for the purpose of any statute, jurisprudential rule, or rule of contractual interpretation or construction that might cause any provision to be construed against the drafter.

Section 15.21 - Counterparts. This Agreement may be executed in multiple counterparts, each of which shall be declared an original.

Section 15.22 - Authorization. By execution of this Agreement, Credit Union and Board each represent to the other that they are entities validly existing, duly constituted and in good standing under the laws of the jurisdiction in which they were formed and in which they presently conduct business, that all acts necessary to permit them to enter into and be bound by this Agreement have been taken and performed, and that the persons signing this Agreement on their behalf have due authorization to do so.

Section 15.23 - Ancillary Agreements. In the event it becomes necessary or desirable for the Board to approve in writing any ancillary agreements or documents concerning the Premises or concerning the construction, operation or maintenance of the Improvements or to alter or amend any such ancillary agreements between the Board and the Credit Union or to give any approval or consent of the Board required under the terms of this Agreement, all agreements, documents or approvals shall be forwarded to the LSUHSC Representative for approval.

Section 15.24 - Oversight by Division of Administration Office of Facility Planning and Control (“OFPC”). Design and construction of the Improvements is subject to oversight by OFPC in accordance with La. R. S. 17:3361(A)(2), and such oversight includes, but is not limited to (a) the right to review and approve plans and specifications prior to commencement of construction and to require changes to conform to Applicable Laws, including space and quality standards, and International Building Code review, and (b) the right to conduct periodic inspections during construction to ensure that all work is being performed in compliance with the OFPC approved Plans and Specifications.

Section 15.25 – No Expenditure of Public Funds. The parties hereto agree that this Agreement does not and shall not require the expenditure of any public funds.

IN WITNESS WHEREOF, the parties hereto have executed this Lease Agreement for Administration and Resource Center Building (State ID # 10914) as of the dates indicated on the attached Acknowledgments.

(Signatures on Following Page.)

WITNESSES:

Print Name: _____

Date: _____

**BOARD OF SUPERVISORS OF LOUISIANA
STATE UNIVERSITY AND AGRICULTURAL
AND MECHANICAL COLLEGE**

By: _____

William Tate, IV, President

Louisiana State University

Date: _____

Print Name: _____

Date: _____

WITNESSES:

CAMPUS FEDERAL CREDIT UNION

By: _____

Name: Jane Verret

Print Name: _____

Title: President & CEO

Date: _____

Date: _____

Print Name: _____

Date: _____

**STATE OF LOUISIANA
PARISH OF EAST BATON ROUGE**

ACKNOWLEDGMENT

BE IT KNOWN that on this ____ day of _____, 2024, before me, the undersigned Notary Public, duly commissioned and qualified in and for the above Parish and State, and in the presence of the undersigned competent witnesses, personally came and appeared William Tate, IV, appearing herein in his capacity as the President of Louisiana State University, and appearing on behalf of the Board of Supervisors of Louisiana State University and Agricultural and Mechanical College, a public constitutional corporation organized and established under the laws of the State of Louisiana, who, being by me first duly sworn, declared and acknowledged to me, Notary, that he executed the above and foregoing instrument on behalf of said corporation with full authority of its Board of Supervisors and that said instrument is the free act and deed of said corporation and was executed for the uses, purposes and benefits therein expressed.

IN TESTIMONY WHEREOF, Appearer has executed this acknowledgement in the presence of the undersigned competent witnesses and me, Notary, after due reading of whole.

WITNESSES:

**BOARD OF SUPERVISORS OF LOUISIANA
STATE UNIVERSITY AND AGRICULTURAL
AND MECHANICAL COLLEGE**

Print Name: _____

By: _____
William Tate, IV, President
Louisiana State University

Print Name: _____

NOTARY

Print Name: _____
Notary Public
La. Bar/Notary ID No.: _____

STATE OF LOUISIANA

PARISH OF ORLEANS

ACKNOWLEDGMENT

BE IT KNOWN that on this ____ day of _____, 2024, before me, the undersigned Notary Public, duly commissioned and qualified in and for the above Parish and State, and in the presence of the undersigned competent witnesses, personally came and appeared Jane Verret, appearing herein in her capacity as the President and Chief Executive Officer of the Credit Union, and appearing on behalf of the Credit Union, a federally chartered credit union that is organized and established under the laws of the State of Louisiana, who, being by me first duly sworn, declared and acknowledged to me, Notary, that she executed the above and foregoing instrument on behalf of said corporation with full authority, and that said instrument is the free act and deed of said corporation and was executed for the uses, purposes and benefits therein expressed.

IN TESTIMONY WHEREOF, Appearer has executed this acknowledgement in the presence of the undersigned competent witnesses and me, Notary, after due reading of whole.

WITNESSES:

CAMPUS FEDERAL CREDIT UNION

Print Name: _____

By: _____

Jane Verret
President & CEO

Print Name: _____

NOTARY

Print Name: _____

Notary Public

La. Bar/Notary ID No.: _____

**INDEX OF EXHIBITS
TO THE LEASE AGREEMENT**

BY AND BETWEEN

**THE BOARD OF SUPERVISORS OF LOUISIANA STATE UNIVERSITY AND
AGRICULTURAL AND MECHANICAL COLLEGE**

AND

CAMPUS FEDERAL CREDIT UNION

EXHIBIT A - Resolution of the Board of Supervisors of the Louisiana State University and
Agricultural and Mechanical College

EXHIBIT B - Resolution of Campus Federal Union

EXHIBIT C - Description of the Property to be leased

EXHIBIT C
PROPERTY TO BE LEASED
CAMPUS FEDERAL CREDIT UNION LOCATION

The space to be leased is located in the Resource Center, 433 Bolivar, New Orleans, Louisiana
 70112

Figure 1. LSU Health New Orleans

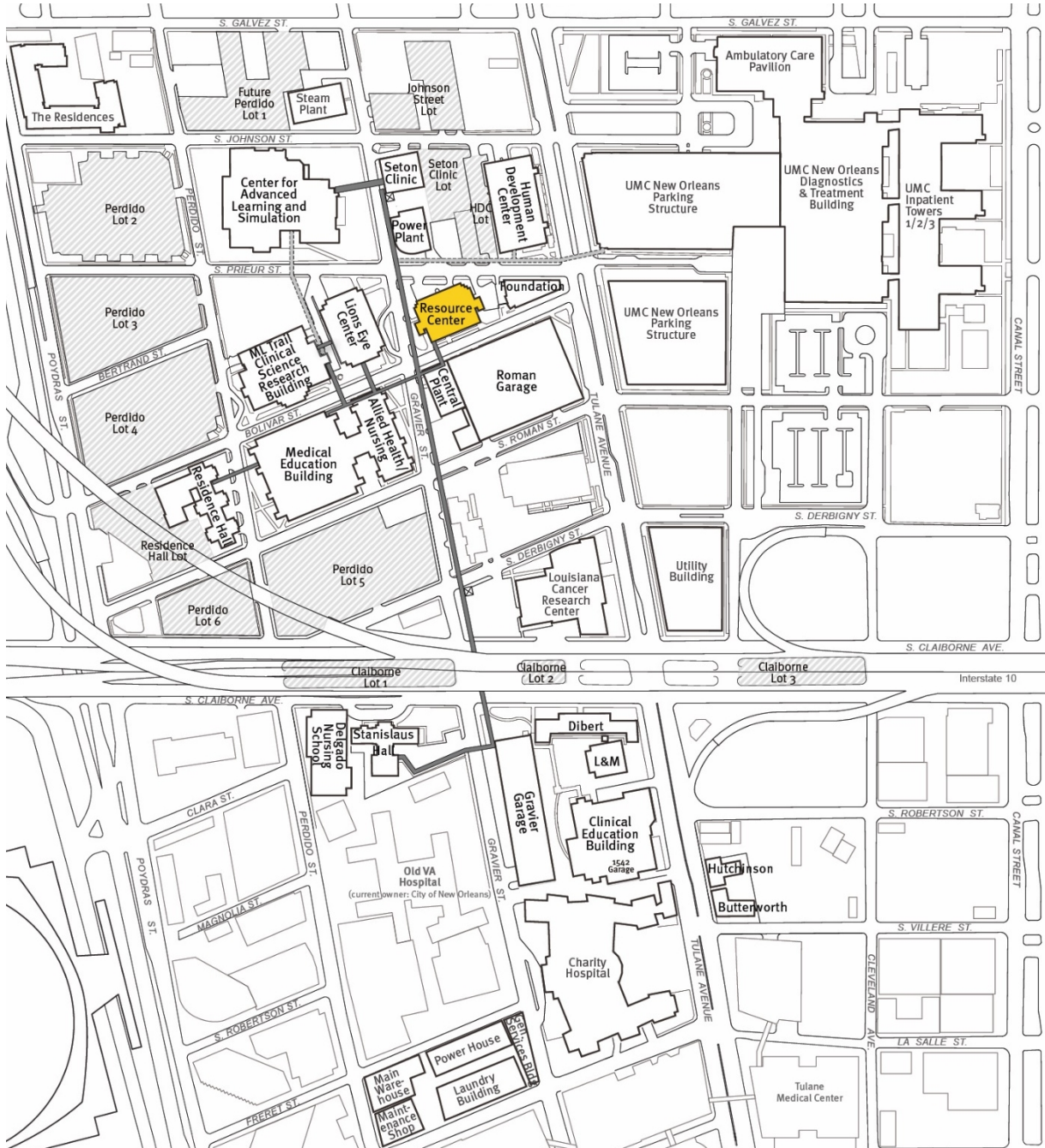

Downtown Campus Map

SPACE TO BE LEASED
CAMPUS FEDERAL CREDIT UNION LOCATION

215 square feet of space to be leased in the Resource Center, 433 Bolivar, New Orleans, Louisiana 70112

Figure 1. Credit Union Space on the Second Floor of the Resource Center

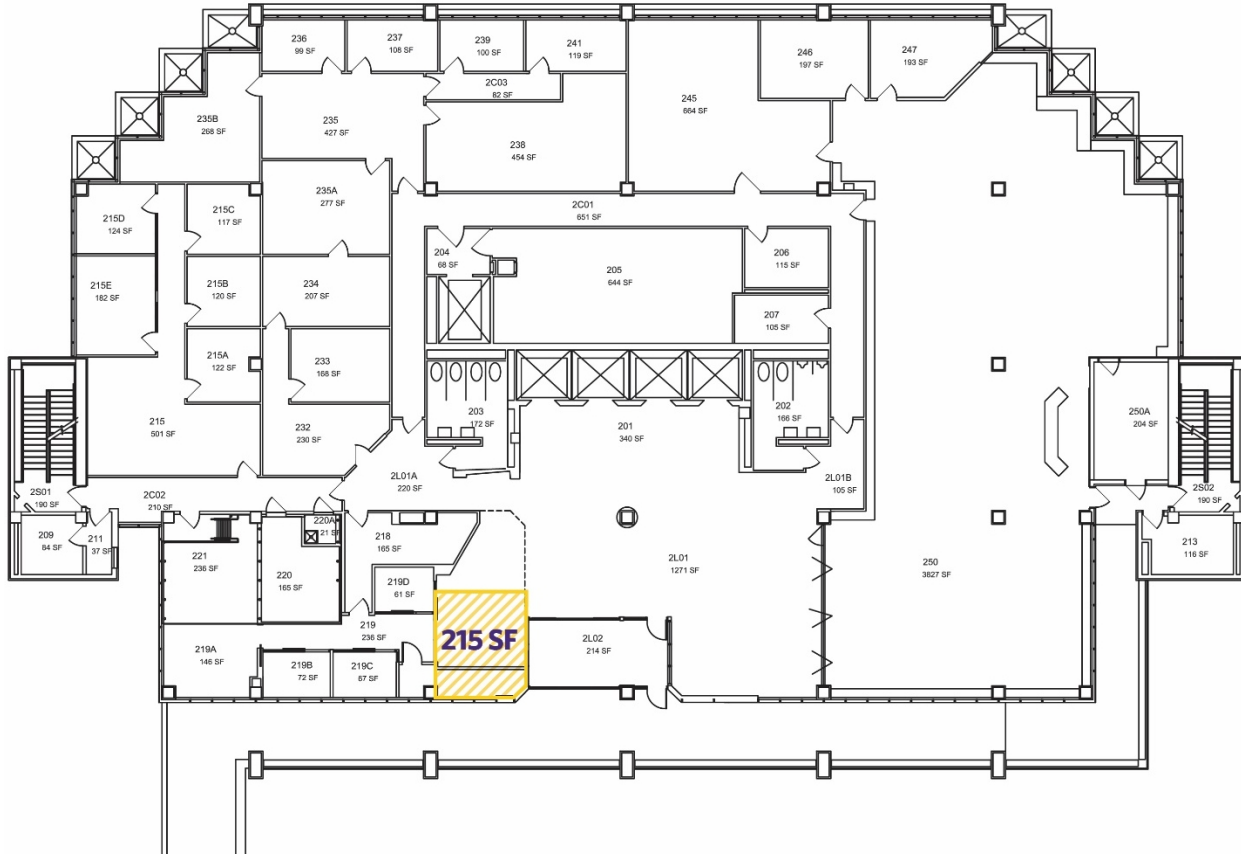



Board of Supervisors

Request from LSUHSC-NO to Authorize the Second Amendment to the Lease Agreement with the Louisiana Cancer Research Center for Additional Leased Space

Date: April 26, 2024

1. Bylaw Citation

Pursuant to Article VII, Section 1

E. Lease of Immovable Property

2. Summary of Matter

The LSU Health Sciences Center - New Orleans (LSUHSC-NO) proposes to enter into the Second Amendment to the Lease Agreement with the Louisiana Cancer Research Center (LCRC) for additional 2,680 sf of leased space for use as office and laboratory space. The rental rate per square foot will remain the same, with the total rent owed increased by the amount of square feet added to the lease. The property is located at 1710 Tulane Avenue, New Orleans, LA 70112 and is adjacent to the LSUHSC-NO campus. The term of the lease agreement remains the same, July 1, 2018 - June 30, 2030, and all other terms and conditions remain the same.

3. Review of Business Plan

Not applicable.

4. Fiscal Impact

The second amendment retains the same financial obligations as the lease.

5. Description of Competitive Process

Not Applicable.

6. Review of Legal Documents

Appropriate legal documents have been reviewed by LSUHSC-NO and the LCRC.

7. Parties of Interest

Board of Supervisors of Louisiana State University and Agricultural and Mechanical College, LSU Health Sciences Center - New Orleans

Louisiana Cancer Research Center

8. Related Transactions

Not applicable.

9. Conflicts of Interest

None.

10. Attachments

1. Transmittal Letter
2. Second Amendment to the Lease Agreement

RESOLUTION

NOW, THEREFORE, BE IT RESOLVED that the Board of Supervisors of Louisiana State University and Agricultural and Mechanical College hereby authorizes the President of LSU or designee to execute the Second Amendment to the Lease Agreement with the Louisiana Cancer Research Center to lease additional space, with such lease to contain such terms and conditions as the President, in consultation with the General Counsel, deems to be in the best interests of LSU.



OFFICE OF THE CHANCELLOR

SCHOOL OF ALLIED HEALTH PROFESSIONS
SCHOOL OF DENTISTRY
SCHOOL OF GRADUATE STUDIES
SCHOOL OF NURSING
SCHOOL OF MEDICINE IN NEW ORLEANS
SCHOOL OF PUBLIC HEALTH

April 26, 2024

Dr. William F. Tate, IV
President
LSU System Office
3810 West Lakeshore Drive, Room 107
Baton Rouge, LA 70808

Dear Dr. Tate,

In accordance with the rules established by Article VII, Section 1 E, I am submitting a request for approval of the second amendment to the Lease Agreement with the Louisiana Cancer Research Center (LCRC).

The LSU Health Sciences Center – New Orleans (LSUHSC-NO) desires to enter into a second amendment of the Agreement between the LSU Board of Supervisors and the Louisiana Cancer Research Center (LCRC) to lease additional space in the LCRC for use as office and laboratory space. The lease amounts shall continue to be based on LSUHSC-NO's share of rentable square footage compared to total rental square footage of the building.

LSUHSC-NO respectfully requests approval of this proposal. I certify to the best of my knowledge that I have provided all necessary documentation and am seeking your review and favorable consideration. Thank you for your assistance.

Respectfully yours,

A handwritten signature in blue ink that reads "Steve Nelson".

Steve Nelson, MD
Interim Chancellor

**SECOND AMENDMENT TO LEASE AGREEMENT BETWEEN LOUISIANA CANCER RESEARCH
CENTER AND LSU HEALTH SCIENCE CENTER NEW ORLEANS**

This Second Amendment to the lease agreement is by and between the Louisiana Cancer Research Center (LCRC) and Louisiana State University Health Science Center New Orleans (LSUHSCNO)

WHEREAS, Louisiana Cancer Research Center (LCRC) and Louisiana State University Health Science Center New Orleans (LSUHSCNO) have entered into a lease agreement dated July 1, 2018, whereby LCRC has leased certain areas of the Louisiana Cancer Research Center building to LSUHSCNO, as described in Exhibits B & C in said Lease Agreement;

WHEREAS, LSUHSCNO agreed to lease additional space and the LCRC governance board agreed to allocate additional space as authorized in Section 3J of the Lease Agreement and described in the Amended Exhibits B and C in this second amendment and replacing the previous exhibits in the Lease Agreement;

The leased space is updated effective May 1, 2024 and the Amended Exhibits B and C reflect the amended leased space. The Terms of the Lease Agreement remain the same, July 1, 2018-June 30, 2030 and all other terms and conditions remain the same.

WITNESSES:

Print Name: _____

Print Name: _____

**BOARD OF SUPERVISORS OF LOUISIANA
STATE UNIVERSITY AND AGRICULTURAL
AND MECHANICAL COLLEGE (“Lessee”)**

By: _____
William F. Tate IV, President of LSU

Date: _____

WITNESSES:

Print Name: _____

Print Name: _____

**LOUISIANA Cancer Research Center of L.S.U.
Health Sciences Center in New Orleans/Tulane
Health Sciences Center (“LCRC”)**

By: _____
Sven Davisson, Chief Administrative Officer

Date: _____

AMENDED EXHIBIT B

Figure 1. First Floor of the Louisiana Cancer Research Center with Lease Space Highlighted

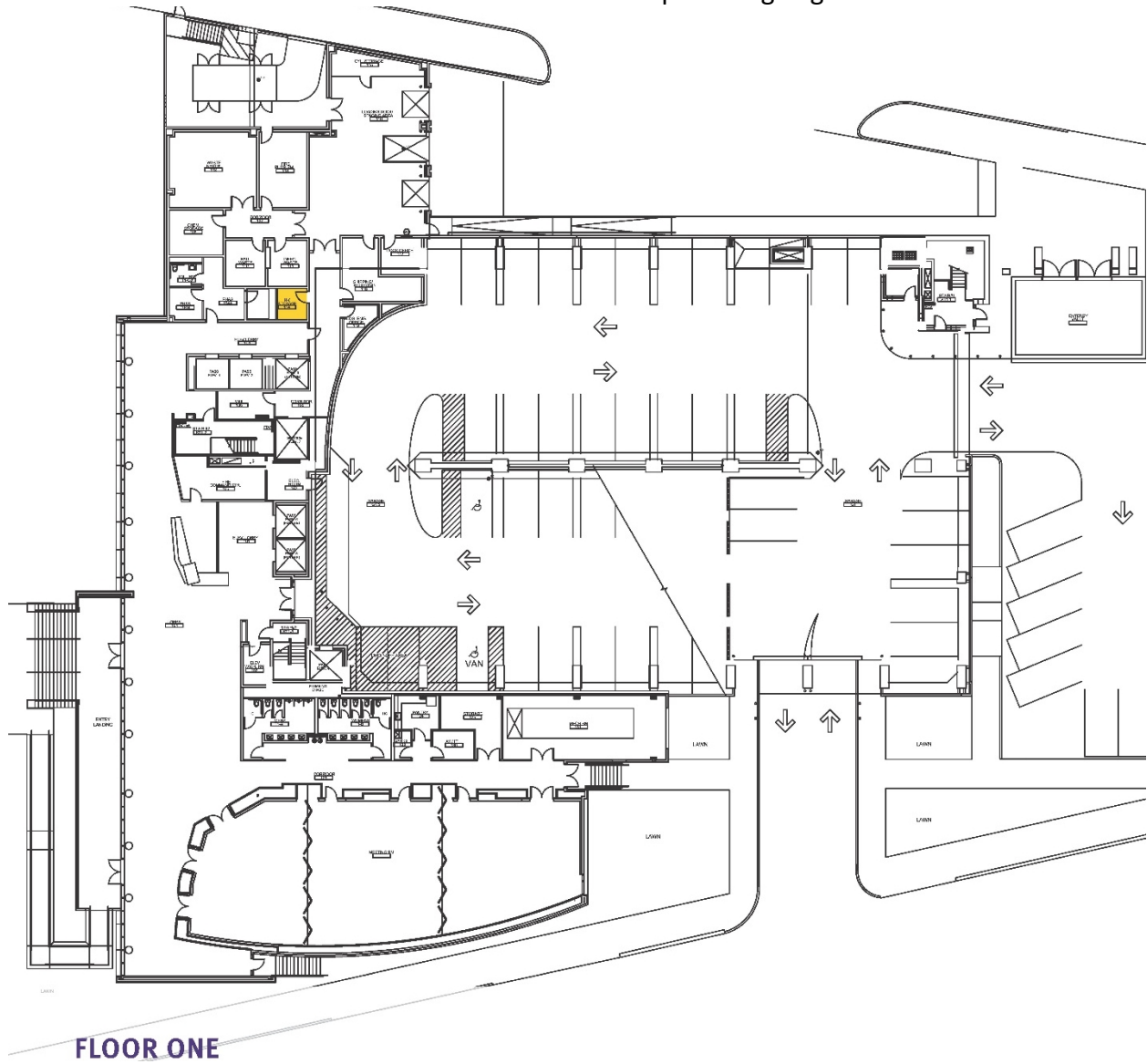
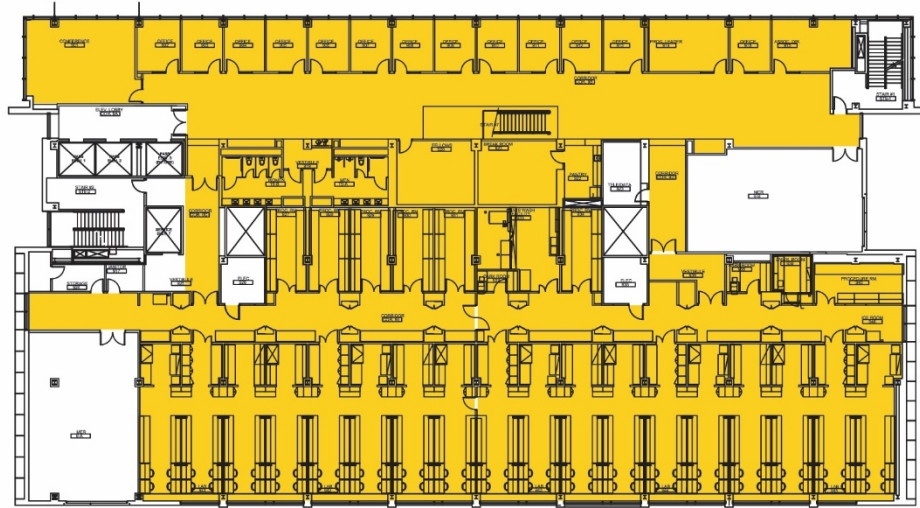

Figure 3. Sixth Floor of the Louisiana Cancer Research Center with Lease Space Highlighted- have to confirm space



FLOOR SIX

Figure 4. Ninth Floor of the Louisiana Cancer Research Center with Lease Space Highlighted



FLOOR NINE

Figure 5. Tenth Floor of the Louisiana Cancer Research Center with Lease Space Highlighted



FLOOR TEN

AMENDED EXHIBIT C

LSUHSC Space Allocation

LSU Space Allocation	Research		Schedule A	Schedule B	Schedule C	TOTAL
	Bench	Clinical	Subtotal Research	Clinician Offices	Vivarium	
Research Space/non-common useable	27,717		27,717		10,141	37,858
Clinical Trials Support (5th Floor)		3,269	3,269	1,275		4,544
Floor Common	9,782	1,865	11,647	783		12,430
Adjusted	37,499	5,134	42,633	2,058	10,141	54,832
Allocation of Building Common	8,898	1,218	10,116	488	2,406	13,010
Total Leasable SF	46,397	6,352	52,749	2,546	12,547	67,842



Board of Supervisors

Request from LSU-S to Authorize Agreements for the Closing of the Hicks Marital Trust

Date: April 26, 2024

1. Bylaw Citation

Pursuant to Article VII, Section 1

D. Transfer of title to any immovable property

2. Summary of Matter

Several years ago, LSU was made a beneficiary of the Hicks Marital Trust, which among other things owned a partial interest in some land located in Bossier Parish. The Trust terminated with the death of its income beneficiary, Bobbie Cates Hicks, on January 31, 2022.

The bulk of the value in the Trust was in cash and liquid assets. LSU-Shreveport received a distribution of just over \$1,345,000 as its share of the cash assets in summer 2023. In addition to the cash assets, the Trust owned a small undivided interest in some real estate and some small mineral interests in land in Texas.

The Trust owned a relatively small undivided interest (4.871525%) in several tracts of land totalling 711 acres located in Bossier Parish. LSU was given a 20% interest in the Trust. With the passing of the income beneficiary, LSU became the owner of an undivided interest in the collective tracts of land in an amount of 0.974305% (less than 1%).

The Trustee of the Hicks Marital Trust, Regions Bank, has been endeavoring to close out the Trust and file its final tax return. To do so, it has requested that LSU execute Trustee's Deeds for the Alden Plantation property interest and the mineral interests. The Regions Bank attorney for the trust asserts that, by law, LSU acquired title to the immovable property upon the passing of the income beneficiary of the trust, and that LSU does not have any right to refuse to execute the Trustee's Deeds. Regardless, the land and mineral interests have potential value to LSU and thus LSU should accept the property by executing the Trustee's Deeds.

3. Review of Business Plan

N/A

4. Fiscal Impact

Accepting the interest in the immovable property described in the Trustee's Deeds will increase the assets of LSU.

5. Description of Competitive Process

Not applicable.

6. Review of Legal Documents

LSU Office of General Counsel has reviewed the proposed Trustee's Deeds.

7. Parties of Interest

None

8. Related Transactions

None

9. Conflicts of Interest

None known.

10. Attachments

1. Trustee's Deed for Immovable Property in Bossier Parish
2. Trustee's Deed for Mineral Interests in Texas Property

RESOLUTION

NOW, THEREFORE, BE IT RESOLVED that the Board of Supervisors of Louisiana State University and Agricultural and Mechanical College hereby authorizes the President of LSU or designee to execute any and all deeds, agreements, consents, approvals, and other documents necessary to acquire record title of any immovable property bequeathed or donated to LSU via the Hicks Marital Trust, with all deeds, agreements, consents, approvals, and other documents to contain such terms and conditions as the President, in consultation with the General Counsel, deems to be in the best interests of LSU.

TRUSTEE'S DEED
[Hicks Marital Trust]

STATE OF LOUISIANA

PARISH OF CADDO

BEFORE ME, the undersigned authority, and in the presence of the undersigned competent witnesses, personally came and appeared:

REGIONS BANK, an Alabama banking corporation, successor by merger to First Commercial Trust Company, N.A., appearing herein in its capacity as sole trustee (the "Trustee") of the HICKS MARITAL TRUST (the "Trust), said trust being created in that certain Last Will and Testament of Samuel B. Hicks dated July 12, 1991, which testament was filed for probate in Suit No. 396794, First Judicial District Court, Caddo Parish, Louisiana (the "Testament"), appearing through its Vice President, W. Keith Laenger, who has a permanent mailing address of 333 Texas Street, LASH 3020ST, Shreveport, Louisiana 71101;

who declared as follows:

Article 4 of the Testament created the Trust and identified Bobbie Cates Hicks as the income beneficiary and First Presbyterian Church, Shreveport, Louisiana and Louisiana State University – Shreveport, Shreveport, Louisiana as the principal beneficiaries.

Pursuant to Article 5.1 (B) of the Testament, the Trust terminated upon the death of Bobbie Cates Hicks, who died on January 31, 2022. Her succession was judicially opened on February 10, 2022 at Suit No. 635226-A, First Judicial District Court, Caddo Parish, Louisiana.

NOW, THEREFORE, IN VIEW OF THE FOREGOING, and to evidence the termination of the Trust and the delivery of the trust property to the beneficiaries described therein, the Trustee has and does by these presents grant, bargain, sell, convey, transfer, assign, set over, abandon and deliver without any warranty of title except as against the Trustee's own acts, but with full substitution and subrogation in and to all rights and actions of warranty which said Trustee has or may have against all preceding owners and vendors, unto the following beneficiary,

BOARD OF SUPERVISORS OF LOUISIANA STATE UNIVERSITY AND AGRICULTURAL AND MECHANICAL COLLEGE, a constitutional corporation, organized and existing under the laws of the State of Louisiana, domiciled in Baton Rouge, Louisiana, having a permanent mailing address of _____;

herein referred to as "Grantee", an undivided 20.00% interest in and to the properties more fully described on the attached Exhibit(s) "A", together with all buildings and improvements located thereon (if applicable), along with all tenements, hereditaments, and appurtenances belonging thereto (the "Property"), subject to all recorded servitudes, restrictions, rights-of-way, easements and all other matters and encumbrances of record.

To have and to hold the above described Property unto the Grantee, their successors and assigns forever, who appear herein to accept and acknowledge due delivery and possession thereof.

The Property is conveyed and transferred by Trustee and accepted by Grantee in its "AS IS, WHERE IS" condition and "WITH ALL FAULTS" as of the date hereof.

GRANTEE ACKNOWLEDGES THAT TRUSTEE HAS NOT MADE AND DOES NOT MAKE ANY REPRESENTATIONS AS TO THE PHYSICAL CONDITION, OR ANY OTHER MATTER AFFECTING OR RELATING TO THE PROPERTY (OTHER THAN WARRANTIES OF TITLE AS PROVIDED HEREIN). GRANTEE EXPRESSLY AGREES THAT TO THE MAXIMUM EXTENT PERMITTED BY LAW, THE PROPERTY IS CONVEYED "AS IS" AND "WITH ALL FAULTS," AND TRUSTEE EXPRESSLY DISCLAIMS, AND GRANTEE ACKNOWLEDGES AND ACCEPTS THAT TRUSTEE HAS DISCLAIMED, ANY AND ALL REPRESENTATIONS, WARRANTIES OR GUARANTIES OF ANY KIND, ORAL OR WRITTEN, EXPRESS OR IMPLIED, (EXCEPT AS TO TITLE AS HEREIN PROVIDED) CONCERNING THE PROPERTY, INCLUDING WITHOUT LIMITATION, THE VALUE, CONDITION, MERCHANTABILITY, HABITABILITY, MARKETABILITY, PROFITABILITY, SUITABILITY OR FITNESS FOR A PARTICULAR USE OR PURPOSE, OF THE PROPERTY. TRUSTEE DOES NOT MAKE AND GRANTEE WAIVES ANY WARRANTY, EXPRESS OR IMPLIED, THAT THE PROPERTY IS FREE OF HIDDEN VICES OR DEFECTS.

This instrument is executed without warranty or representation of any kind on part of the undersigned Trustee, express or implied, except that there are no liens or encumbrances outstanding against the premises conveyed which were created or suffered by the undersigned and not specifically excepted herein. Furthermore, this instrument is executed by the undersigned Trustee solely in the representative capacity named herein, and neither this instrument nor anything herein contained shall be construed as creating any indebtedness or obligation on the part of the undersigned Trustee in their individual or corporate capacity, and the undersigned Trustee expressly limits their liability hereunder to the property now or hereafter held by them in the representative capacity named.

Grantee hereby waives any accounting due from the Trustee and releases the Trustee from any accounting or liability to them in connection with the Trustee's administration of the Property. The parties to this act have waived the production of mortgage and tax certificates in connection herewith, and the parties hereto do accordingly agree to relieve and release the undersigned Notary Public from all responsibilities and liabilities in connection therewith. The Grantee assumes payment of ad valorem property taxes for the current year.

This instrument may be executed in multiple counterparts by each of the Trustee and Grantee, each of which when so executed and delivered shall be deemed to be an original and all of which shall constitute one and the same instrument. Signature pages may be assembled and attached to one counterpart for filing purposes.

Signature pages to follow

THUS DONE AND SIGNED in the presence of the undersigned competent witnesses and me, Notary, on this ____ day of _____, 2024.

WITNESSES:

Print Name: _____

Regions Bank, successor by merger to First
Commercial Trust Company, N.A., Trustee of
the Hicks Marital Trust

Print Name: _____

By: _____
Its: _____

Notary Public

THUS DONE AND SIGNED in _____, State of _____, in the presence of the undersigned competent witnesses and me, Notary Public, on this the ____ day of _____, 2024.

WITNESSES:

Print Name: _____

BOARD OF SUPERVISORS OF
LOUISIANA STATE UNIVERSITY
AND AGRICULTURAL AND
MECHANICAL COLLEGE

By: _____
Its: _____

Print Name: _____

Notary Public
[SEAL]

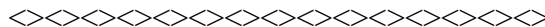

Exhibit "A"
Hicks Marital Trust

All its right, title and interest (believed to be a 4.871525% undivided interest) in and to the following property:

Alden Plantation in Bossier Parish, Louisiana, described as Sections 17, 18, 19, 20 and 21 in Township 18 North, Range 12 West, Bossier Parish, Louisiana, more particularly described as follows:

The Southeast Quarter; the South half of the Northeast Quarter lying South of the North Right of Way line of U.S. Highway 80; and the West Half lying South of the North Right of Way line of U.S. Highway 80, all in Section 17; and

All of Section 18 lying South of the centerline of U.S. Highway 80; and

A tract located in Sections 18 and 19, described as follows: begin at a point in the Southwest Quarter of Section 19, which point is 2014.94 feet North and 181.00 feet East of the Southwest corner of Section 19; run thence North parallel to the West Section line of Section 19, to a point on a line located 30.00 feet South of the center line of Old Dixie Overland Highway as the said highway existed on March 4, 1918; run thence northeasterly on the line located 30.00 feet South of the center line of the Old Dixie Overland Highway as it existed on March 4, 1918, to the East section line of Section 18; run thence South on the East section line of Sections 18 and 19 to the point where the East section line of Section 19 intersects the north right of way line of the V.S.&P. Railroad; run thence southwesterly along the North right of way line of the V.S. & P. Railroad to a point located 502.20 feet West of Mile Post No. 162 on the V.S. & P. Railroad, which point is also located 2109.95 feet East and 680.17 feet North of the Southwest corner of Section 19; run thence North a distance of 2730.07 feet along a line parallel to the West section line of Section 19 to a point in the center of Alligator Bayou; run thence South 87 degrees 22 minutes West 210.90 feet; run thence South 58 degrees 15 minutes West 350.00 feet; run thence North 74 degrees 30 minutes West 469.26 feet to a point on the center line of Alligator Bayou,; run thence South 965.40 feet on a line parallel to the West section line of Section 19, to a concrete monument; and run thence South 69 degrees 35 minutes West 1033.30 feet to the point of beginning; and

All of Section 20 lying North of the North right of way line of the V.S. & P. Railroad Company; and

All of Section 21 lying South and West of Red Chute Bayou, to the centerline of said Bayou, and North of the North right of way line of the V.S. & P. Railroad; and all that part of the Northwest Quarter of Section 21 lying North and East of Red Chute Bayou, to the centerline of said Bayou, less the North 431.00 feet thereof; and the Northwest Quarter of the northeast Quarter of Section 21, less two (2.00) acres in the Southwest corner sold by A. M. O'Neal to Red Chute Baptist Church of Bossier, by deed dated January 7, 1921, recorded in Book 55, page 257, records of Bossier Parish, Louisiana.

Being the same property described in that certain Credit Sale Deed, dated July 31, 1958, by and between Roger E. Wheless, as Vendor, and Emmett R. Hook, et al, as Vendee, and being recorded at Conveyance Book 286, Page 619, of the records of the Clerk of Court, Bossier Parish, Louisiana.

LESS & EXCEPT THE FOLLOWING DESCRIBED TRACTS:

(1) That certain four-acre tract of land in Section 19, Township 18 North, Range 12 West, Bossier Parish, Louisiana, more fully described as follows: Beginning at the Southwest corner of said Section 19, run thence North along the West line of said section a

distance of 4579.22 feet to a point on the South right of way line of U.S. Highway 80; run thence North 69 degrees 34 minutes East along U.S. Highway 80 a distance of 418.50 feet to an iron pipe set in the East high bank of Alligator Bayou, the point of beginning of tract herein described; continue thence North 69 degrees 34 minutes East along U.S. Highway 80 a distance of 320.00 feet; run thence South 20 degrees 26 minutes East a distance of 391.25 feet; run thence South 69 degrees 34 minutes West a distance of 692.60 feet; run thence North a distance of 7.50 feet to a point in the East high bank of said Alligator Bayou; run thence North 42 degrees 34 minutes East a distance of 239.00 feet; run thence North 17 degrees 09 minutes a distance of 162.80 feet; run thence North 01 degrees 03 minutes East a distance of 157.10 feet to the point of beginning, containing 4.00 acres, more or less, and being the same property described in that certain Cash Sale Deed dated June 18, 1964, by and between Emmett R. Hook, et al, as Vendor and Lacy Trailer Manufacturing Co., Inc., as Vendee, and recorded at Conveyance Book 387, Page 583, of the records of the Clerk of Court, Bossier Parish, Louisiana.

(2) Those certain rights of way for Interstate 20 and Interstate 220 expropriated by the Louisiana Department of Highways, and being more fully described in that certain Order of Expropriation dated May 26, 1971, and being recorded at Conveyance Book 471, Page 217, of the records of the Clerk of Court, Bossier Parish, Louisiana.

(3) A parcel of land in Section 20, more fully described as follows: From the Northeast corner of said Section 20 run South 00 degrees 27 minutes 54 seconds West 41.54 feet; run thence North 84 degrees 44 minutes 50 seconds East 405.77 feet; thence North 00 degrees 31 minutes 41 seconds West 150.00 feet to a point on the centerline of 1-20, being the P.T. curve, said curve having an angle of 16 degrees 21 minutes 28 seconds, Tangent 1097.99 feet, radius 7639.44 feet; run thence westerly along the arc of said curve, being the centerline of said 1-20, 2181.04 feet to the P.C. of said curve; thence South 15 degrees 58 minutes 39 seconds East 150.00 feet; thence South 65 degrees 26 minutes 14 seconds West 623.75 feet; thence South 24 degrees 33 minutes 46 seconds East 50.00 feet to the point of beginning of the tract herein described; run thence South 65 degrees 26 minutes 14 seconds West 413.50 feet; thence South 29 degrees 16 minutes 57 seconds West 440.90 feet; thence South 00 degrees 03 minutes 39 seconds West 399.70 feet; thence South 17 degrees 01 minutes 46 seconds East 182.60 feet; thence North 82 degrees 59 minutes 24 seconds East 482.60 feet; thence North 59 degrees 08 minutes 24 seconds East 201.90 feet; thence North 49 degrees 04 minutes 54 seconds East 250.25 feet; thence North 40 degrees 13 minutes 44 seconds East 64.60 feet; thence North 24 degrees 33 minutes 46 seconds West 828.60 feet to the point of beginning, containing 16.50 acres, more or less.

A parcel of land in Section 19, more fully described as follows: From a 2-inch iron pipe marking the Southwest corner of said Section 19, run North 00 degrees 31 minutes 22 seconds East a distance of 413.81 feet to the centerline of the I.C. Railroad; run thence North 85 degrees 22 minutes 09 seconds East 182.00 feet; thence north 00 degrees. 31 minutes 22 seconds East 1991.91 feet to a point on the South right of way line of Interstate 20; thence North 74 degrees 10 minutes 21 seconds East 329.10 feet; thence North 72 degrees 15 minutes 48 seconds East 300.17 feet; thence North 74 degrees 10 minutes 21 seconds 1450.00 feet; thence North 15 degrees 49 minutes 39 seconds West 20.00 feet; thence North 74 degrees 10 minutes 21 seconds East 566.67 feet (the preceding five courses being along the south right of way line of Interstate 20); thence South 38 degrees 49 minutes 40 seconds East 637.05 feet; thence South 23 degrees 29 minutes 40 seconds East 260.00 feet; thence South 07 degrees 09 minutes 40 seconds East 625.00 feet; thence South 08 degrees 20 minutes 20 seconds West 539.70 feet; thence South 21 degrees 09 minutes 40 seconds East 49.10 feet to the point of beginning of the tract herein described; run thence South 21 degrees 09 minutes 40 seconds East 187.60 feet; thence South 57 degrees 50 minutes 40 seconds East 408.90 feet; thence North 86 degrees 32 minutes 50 seconds East 329.25 feet; thence North 79 degrees 42 minutes 50 seconds East 244.25 feet; thence South 71 degrees 57 minutes 10 seconds East 164.20 feet (the preceding ten courses being along the centerline of Alligator

Bayou); thence North 14 degrees 04 minutes 30 seconds East 170.83 feet; thence North 46 degrees 54 minutes 50 seconds East 292.11 feet; thence North 61 degrees 34 minutes 20 seconds East 236.34 feet; thence North 47 degrees 32 minutes East 191.67 feet; thence North 18 degrees 59 minutes East 163.67 feet; thence North 01 degrees 37 minutes 40 seconds West 217.40 feet; thence North 16 degrees 02 minutes 30 seconds West 154.04 feet; thence North 34 degrees 21 minutes West 300.00 feet (the preceding eight courses being along the centerline of Flat River); run thence South 57 degrees 50 minutes 40 seconds West 1865.41 feet to the point of beginning, containing 30.50 acres, more or less.

The two above described tracts being the same property described in that certain Cash Sale Deed, dated April 20, 1972, by and between Emmett R. Hook, et al, as Vendor, and Southern Paving Corporation, as Vendee, and being recorded at Conveyance Book 483, Page 632, of the records of the Clerk of Court, Bossier Parish, Louisiana.

(4) A parcel of land located in Section 19, more fully described as follows: From a 2-inch iron pipe marking the Southwest corner of said Section 19, run North 00 degrees 31 minutes 22 seconds East a distance of 413.81 feet to the centerline of I.C. Railroad, thence North 85 degrees 22 minutes 09 seconds East 182.00 feet; thence North 00 degrees 31 minutes 22 seconds East 1991.91 feet to a point on the south right of way line of Interstate 20; thence North 74 degrees 10 minutes 21 seconds East 329.21 feet; thence North 72 degrees 15 minutes 48 seconds East 300.17 feet; thence North 74 degrees 10 minutes 21 seconds East 1450.00 feet; thence North 15 degrees 49 minutes 39 seconds West 20.00 feet; thence North 74 degrees 10 minutes 21 seconds East 566.67 feet (the preceding five courses being along the south right of way line of Interstate 20); run thence South 38 degrees 49 minutes 40 seconds East 637.05 feet; thence South 23 degrees 29 minutes 40 seconds East 260.00 feet; thence South 07 degrees 09 minutes 40 seconds East 625.00 feet; thence South 08 degrees 20 minutes 20 seconds West 103.00 feet to the point of beginning of the tract herein described (the preceding four courses being along the centerline of Alligator Bayou); run thence South 08 degrees 20 minutes 20 seconds West 436.70 feet; thence South 21 degrees 09 minutes 40 seconds East 49.10 feet (the preceding two courses being along the centerline of Alligator Bayou); run thence North 57 degrees 50 minutes 40 seconds East 1865.41 feet; thence North 34 degrees 21 minutes West 134.92 feet; thence North 38 degrees 34 minutes 10 seconds West 247.00 feet (the preceding two courses being along the centerline of Flat River); run thence South 57 degrees 50 minutes 40 seconds West 1539.70 feet to the point of beginning, containing 15.00 acres, more or less, and being the same property described in that certain Cash Sale Deed dated October 2, 1972, by and between Emmett R. Hook, et al, as Vendor and Southern Paving Corporation, as Vendee, and being recorded at Conveyance Book 493, Page 96, of the records of the Clerk of Court, Bossier Parish, Louisiana.

(5) A tract of land containing 302.075 acres, more or less, located in Section 17, being more fully described as follows: From the common corner of Sections 16, 17, 20 and 21, run North 00 degrees 30 minutes 45 seconds East along the line common to Sections 16 and 17, a distance of 353.32 feet to the point of intersection with the North right of way line of Interstate 20 and being the point of beginning of the tract herein described; said point being in a curve to the left; thence traversing said North right of way line of Interstate 20 and Interstate 220, run southwesterly along said curve to the left a distance of 314.50 feet; run thence South 85 degrees 15 minutes 03 seconds West a distance of 1050.43 feet; run thence South 79 degrees 42 minutes 56 seconds West a distance of 768.32 feet; run thence North 74 degrees 04 minutes 50 seconds West a distance of 940.76 feet; run thence North 57 degrees 02 minutes 52 seconds West a distance of 469.84 feet; run thence North 42 degrees 10 minutes 16 seconds West a distance of 438.63 feet; run thence North 17 degrees 58 minutes 00 seconds West a distance of 1430.52 feet to the point of intersection with the South right of way line of U.S. Highway 80; run thence North 47 degrees 16 minutes 27 seconds East along said South right of way line of U.S. Highway 80 a distance of 1098.28 feet; run thence North 52 degrees 59 minutes 27 seconds East a distance of 502.49 feet; run thence North 47 degrees 16 minutes 26 seconds East a distance of 200.00 feet; run thence North 41 degrees 33 minutes 26 seconds a distance of 502.49 feet; run thence North 47 degrees

16 minutes 27 seconds East a distance of 188.77 feet; run thence South 89 degrees 44 minutes 13 seconds East a distance of 2358.28 feet to the point of intersection with the East line of Section 17; run thence South 00 degrees 30 minutes 45 seconds West along said East line of Section 17, a distance of 3632.31 feet to the point of beginning, containing 302.075 acres, more or less, and being the same property described in that certain Cash Sale Deed, dated April 5, 1973, by and between Emmett R. Hook, et al, as Vendor, and Louisiana Downs, Inc., as Vendee, and being recorded in Conveyance book 499, Page 74, of the records of the Clerk of Court, Bossier Parish, Louisiana.

(6) A tract of land containing 40.00 acres, more or less, located in Sections 17, 18, 19 and 20, more particularly described as follows: From the Southwest corner of Section 19, run North 00 degrees 30 minutes 13 seconds West, along the West line of Section 19 a distance of 413.81 feet to the point of intersection with the centerline of the Illinois Central Railroad main line; run thence South 85 degrees 22 minutes 09 seconds East along said centerline of the Illinois Central Railroad main line a distance of 182.00 feet; run thence North 00 degrees 30 minutes 13 seconds East a distance of 2335.08 feet to the point of intersection with the North right of way line of Interstate 20; thence traversing said North right of way line of Interstate 20, run North 74 degrees 10 minutes 21 seconds East a distance of 1009.18 feet; run thence North 00 degrees 31 minutes 51 seconds East a distance of 292.65 feet; run thence South 73 degrees 58 minutes 09 seconds East a distance of 469.26 feet; run thence North 65 degrees 36 minutes 33 seconds East a distance of 570.64 feet; run thence South 00 degrees 32 minutes 41 seconds West a distance of 123.08 feet; run thence North 74 degrees 10 minutes 21 seconds East a distance of 1962.64 feet; run thence North 15 degrees 49 minutes 39 seconds West a distance of 50.00 feet; run thence North 74 degrees 10 minutes 21 seconds East a distance of 1150.00 feet; run thence North 67 degrees 56 minutes 48 seconds East a distance of 309.65 feet to the point of beginning of the tract herein described; run thence North 15 degrees 49 minutes 39 seconds West a distance of 1462.35 feet to the point of intersection with the centerline of Musselshell bayou; run thence North 71 degrees 04 minutes 21 seconds East along said centerline of Musselshell Bayou a distance of 184.68 feet; run thence North 83 degrees 44 minutes 20 seconds East a distance of 293.81 feet; run thence North 49 degrees 08 minutes 53 seconds East a distance of 858.09 feet; run thence North 39 degrees 29 minutes 17 seconds West a distance of 595.30 feet to the point of intersection with the South right of way line of U.S. Highway 80, said point being in a curve to the left having a radius of 3063.88 feet; run thence northeasterly, along said curve to the left a distance of 63.83 feet; run thence North 47 degrees 16 minutes 27 seconds East a distance of 306.62 feet to the point of intersection with the West right of way line of Interstate 220; thence traversing said West right of way line of Interstate 220 and Interstate 20, run South 17 degrees 58 minutes 00 seconds East a distance of 1250.11 feet; run thence South 03 degrees 51 minutes 29 seconds West a distance of 215.41 feet; run thence South 26 degrees 03 minutes 42 seconds West a distance of 1236.15 feet; run thence South 52 degrees 22 minutes 16 seconds West a distance of 269.26 feet; run thence South 67 degrees 56 minutes 48 seconds West a distance of 243.61 feet to the point of beginning, containing 40.00 acres, more or less, and being the same property described in that certain Cash Sale Deed, dated April 5, 1973, by and between Emmett R. Hook, et al, as Vendor, and John F. Wolcott, as Vendee, being recorded at Conveyance Book 499, Page 60, of the records of the Clerk of Court, Bossier Parish, Louisiana.

(7) A tract of land located in Section 19, more fully described as follows: From a monument marking the Southwest corner of said Section 19, run North 00 degrees 31 minutes 22 seconds East a distance of 413.81 feet to a point in the centerline of the Illinois Central Railroad, run thence North 85 degrees 22 minutes 09 seconds East a distance of 182.00 feet, run thence North 00 degrees 31 minutes 22 seconds East a distance of 1585.12 feet to a concrete monument, being the point of the beginning of the tract herein described; run thence North 00 degrees 31 minutes 22 seconds East a distance of 406.79 feet to a point in the south right of way line of Interstate 20, run thence North 74 degrees 10 minutes 21 seconds East a distance of 329.21 feet, run thence North 72 degrees 15 minutes 48 seconds East a distance of 300.17 feet, run thence North 74 degrees 10 minutes 21 seconds East a distance of 382.86 feet (the preceding three courses being

along the south line of said Interstate 20), run thence South 00 degrees 31 minutes 51 seconds West a distance of 339.69 feet to a concrete monument, run thence South 70 degrees 02 minutes 41 seconds West a distance of 1033.58 feet to the point of beginning, containing 8.30 acres, more or less, and being the same property described in that certain Cash Sale Deed, dated March 3, 1978, by and between Emmett R. Hook, et al, as Vendor, and Bryan Ardis Frame, et al, as Vendee, and being recorded at Conveyance Book 603, Page 82, of the records of the Clerk of Court, Bossier Parish, Louisiana.

(8) A tract located in Section 21, more fully described as follows:

Begin at an existing iron pin at the Northeast corner of Section 21, Township 18 North, Range 12 West, Bossier Parish, Louisiana, and run West 1322.5 feet to a set 5/8" iron rod for the point of beginning; thence run South 0 degrees 25 minutes 07 seconds East 1320.04 feet to a set 5/8" iron rod; thence run West 1070.50 feet to a set 5/8" iron rod; thence run North 0 degrees 25 minutes 07 seconds West 333 feet to a set 5/8" iron rod; thence run West 252 feet to a set 5/8" iron rod; thence run South 0 degrees 25 minutes 07 seconds East 2104.82 feet to a set 5/8" iron rod on the top bank of Red Chute Bayou; thence run along the top bank of Red Chute Bayou for the next eighteen (18) calls; thence run North 44 degrees 49 minutes 18 seconds West 335.30 feet; thence run North 26 degrees 48 minutes 24 seconds West 62.57 feet; thence run North 25 degrees 22 minutes 00 seconds West 657.73 feet; thence run North 38 degrees 26 minutes 02 seconds West 360.94 feet; thence run North 23 degrees 58 minutes 18 seconds West 52.23 feet; thence run North 11 degrees 36 minutes 06 seconds West 55.0 feet; thence run North 21 degrees 30 minutes 40 seconds West 220.47 feet; thence run North 38 degrees 44 minutes 17 seconds West 389.80 feet; thence run North 29 degrees 24 minutes 44 seconds West 491.77 feet; thence run North 85 degrees 11 minutes 58 seconds West 566.70 feet; thence run North 74 degrees 23 minutes 09 seconds West 52.92 feet; thence run North 88 degrees 00 minutes 10 seconds West 230.23 feet; thence run South 80 degrees 40 minutes 30 seconds West 93.72 feet; thence run South 87 degrees 56 minutes 56 seconds West 45.14 feet; thence run North 61 degrees 39 minutes 52 seconds West 155.57 feet; thence run North 40 degrees 06 minutes 37 seconds West 563.50 feet; thence run North 34 degrees 49 minutes 10 seconds West 160.51 feet; thence run North 8 degrees 57 minutes 57 seconds West 149.26 feet to a set 5/8" iron rod on the South right-of-way of Interstate 20; thence run South 89 degrees 02 minutes 47 seconds East 300.31 feet along said right-of-way to a set 5/8" iron rod at the intersection of said right-of-way and the West line of Section 21; thence run South 0 degrees 25 minutes 07 seconds east 381 feet to a set 5/8" iron rod; thence run east 2645 feet to a set 5/8" iron rod; thence run North 0 degrees 25 minutes 07 seconds West 431 feet to an existing iron pin; thence run East 1322.5 feet to the point of beginning, containing 122.00 acres, more or less, and being the same property described in that certain Cash Sale Deed, dated October 28, 1998, by and between JPIL Beard Partnership, et al, as Vendor, and Newt Brown Contractor, Inc., as Vendee, being recorded on December 21, 1998, at Conveyance Book 1172, Page 371, of the records of the Clerk of Court, Bossier Parish, Louisiana.

(9) A tract of land located in Sections 18 & 19, Township 18 North, Range 12 West, Bossier City, Bossier Parish, Louisiana, being more fully described as follows: Beginning at the Southwest corner of said Section 19, run thence North 00 degrees 28 minutes 08 seconds East a distance of 2766.05 feet; run thence South 89 degrees 31 minutes 52 seconds East a distance of 181.00 feet to the point of beginning of tract herein described, said point also located on the northerly right of way line of Interstate 20; thence leaving said northerly right of way line run North 00 degrees 28 minutes 08 seconds East a distance of 783.42 feet; run thence North 69 degrees 59 minutes 16 seconds East a distance of 1365.87 feet; run thence North 20 degrees 00 minutes 17 seconds West a distance of 692.19 feet; run thence North 69 degrees 57 minutes 04 seconds East a distance of 173.44 feet; run thence North 20 degrees 02 minutes 55 seconds West a distance of 300.00 feet to a point on the

southerly right of way line of U. S. Highway 80; run thence along said southerly right of way line North 69 degrees 57 minutes 04 seconds East a distance of 150.00 feet; thence leaving said southerly right of way line run South 20 degrees 02 minutes 55 seconds East a distance of 300.00 feet; run thence North 69 degrees 57 minutes 04 seconds East a distance of 688.75 feet; run thence North 20 degrees 02 minutes 55 seconds West a distance of 300.00 feet to a point on the southerly right of way line of U. S. Highway 80; run thence along said southerly right of way line North 69 degrees 57 minutes 04 seconds East a distance of 165.00 feet; thence leaving said southerly right of way line run South 20 degrees 02 minutes 55 seconds East a distance of 1933.05 feet to a point on the northerly right of way line of Interstate 20; run thence along said northerly right of way line South 74 degrees 10 minutes 21 seconds West a distance of 805.00 feet; thence leaving said northerly right of way line run North 00 degrees 30 minutes 59 seconds East a distance of 122.37 feet; run thence South 65 degrees 34 minutes 51 seconds West a distance of 570.64 feet; run thence North 73 degrees 59 minutes 51 seconds West a distance of 469.26 feet; run thence South 00 degrees 30 minutes 09 seconds West a distance of 291.42 feet to a point on the northerly right of way line of Interstate 20; run thence along said northerly right of way line South 74 degrees 10 minutes 21 seconds West a distance of 1010.40 feet to the point of beginning of tract, containing 70.115 acres, more or less, and being the same property described in that certain Cash Sale Deed dated May 25, 2001, by and between JPIL Beaird Partnership, et al, as Vendor, and The State of Louisiana, as Vendee, being recorded on May 31, 2001, in Conveyance Book 1235, Page 585, of the records of the Clerk of Court, Bossier Parish, Louisiana.

- (10) A tract of land located in Section 18 and 19, Township 18 North, Range 12 West, Bossier City, Bossier Parish, Louisiana, being more fully described as follows: Beginning at the Southwest corner of said Section 19, run thence North 00 degrees 28 minutes 08 seconds East a distance of 2766.05 feet; run thence South 89 degrees 31 minutes 52 seconds East a distance of 181.00 feet to a point located on the northerly right of way line of Interstate 20; Thence leaving said northerly right of way line run North 00 degrees 28 minutes 08 seconds East a distance of 783.42 feet; run thence North 69 degrees 59 minutes 16 seconds East a distance of 1,365.87 feet; run thence North 20 degrees 00 minutes 17 seconds West a distance of 692.19 feet; run thence North 69 degrees 57 minutes 04 seconds East a distance of 173.44 feet; run thence North 20 degrees 02 minutes 55 seconds West a distance of 300.00 feet to a point on the southerly right of way of line of U. S. Highway 80; run thence along said southerly right of way line North 69 degrees 57 minutes 04 seconds East a distance of 150.00 feet to the point of beginning of tract herein described, continue along said southerly right of way line North 69 degrees 57 minutes 04 seconds East a distance of 688.75 feet, thence leaving said southerly right of way line run south 20 degrees 02 minutes 55 seconds East a distance of 300.00 feet, run thence South 69 degrees 57 minutes 04 seconds West a distance of 688.75 feet, run thence North 20 degrees 02 minutes 55 seconds West a distance of 300.00 feet to the point of beginning of tract, containing 4.743 acres, more or less, all as further shown hereon, and being subject to any and all servitudes, easements, and/or rights of way of record or of use.

Said property having such shape, measurements, form dimensions and boundaries as are shown on a plat of survey prepared by Charles G. Coyle, dated January 31, 2007, which survey is made a part hereof by reference thereto, and being the same property described in that certain Cash Sale Deed, dated March 16, 2007, by and between JPIL Partnership, et al, as Vendor, and The State of Louisiana, as Vendee, being recorded at Conveyance Book 1400, Page 552, of the records of the Clerk of Court, Bossier Parish, Louisiana.

- (11) Being described as a 64.058 acre, more or less, tract of land in Sections 18 and 19, Township 18 North, Range 12 West, Bossier Parish, Louisiana, and more particularly described as follows: Commence at the Southwest corner of said Section 19 which is

monumented with a 2" iron pipe; thence proceed North 00 degrees 28 minutes 08 seconds East along the west line of said Section 19 for a distance of 2713.13 feet; thence proceed North 74 degrees 10 minutes 21 seconds East for a distance of 3014.12 feet to the northerly right of way line of Interstate No. 20 and the Point of Beginning of the tract herein described which is monumented with a iron pipe; thence proceed North 20 degrees 02 minutes 55 seconds West for a distance of 1933.06 feet to the southerly right of way line of U.S. Highway No. 80 and a 1/2" iron pipe; thence proceed North 69 degrees 54 minutes 50 seconds East along said right of way line for a distance of 1315.80 feet to a 5/8" iron rod; thence proceed North 78 degrees 26 minutes 50 seconds East along said right of way line for a distance of 101.12 feet to a 5/8" iron rod; thence proceed North 69 degrees 54 minutes 50 seconds East along said right of way line for a distance of 181.24 feet to the centerline of Flat River; thence proceed South 09 degrees 10 minutes 18 seconds West along said centerline for a distance of 264.94 feet; thence proceed South 04 degrees 05 minutes 10 seconds East along said centerline for a distance of 201.55 feet; thence proceed South 14 degrees 07 minutes 15 seconds East along said centerline for a distance of 193.97 feet; thence proceed South 17 degrees 30 minutes 39 seconds East along said centerline for a distance of 295.15 feet; thence proceed South 37 degrees 06 minutes 03 seconds East along said centerline for a distance of 319.82 feet; thence proceed South 12 degrees 06 minutes 25 seconds East along said centerline for a distance of 373.42 feet; thence proceed South 12 degrees 16 minutes 41 seconds West along said centerline for a distance of 120.54 feet; thence proceed South 12 degrees 31 minutes 12 seconds West along said centerline for a distance of 372.80 feet to the northerly right of way line of said Interstate No. 20; thence proceed South 74 degrees 10 minutes 21 seconds West along said northerly right of way line for a distance of 1159.37 feet to the Point of Beginning of the tract herein described, containing 64.058 acres, more or less, and being the same property described in that certain Cash Sale Deed, dated December 17, 2007, by and between JPIL Beaird Partnership, et al, as Vendor, and The City of Bossier City, et al, as Vendee, being recorded at Conveyance Book 1425, Page 554, of the records of the Clerk of Court, Bossier Parish, Louisiana.

12) The following tracts of land:

TRACT 1

A certain tract of land containing 22.510 acres, more or less, located in Section 19, Township 18 North, Range 12 West of the Louisiana Prime Meridian, Northwestern Land District, in the City of Bossier City, Bossier Parish, Louisiana, being more particularly described as follows:

Commencing at the southwest corner of said Section 19 and proceed North 00° 30' 24" East along the west line of said Section 19 a distance of 2,766.05 feet; thence proceed South 89° 29' 36" East a distance of 181.00 feet to the southwest corner of a 70.115 acre tract of land described in Conveyance Book 1235, Page 585 of the records of Bossier Parish, Louisiana; thence proceed North 00° 30' 24" East along the west line of said tract a distance of 783.42 feet to a found 1/2" iron pipe and the POINT OF BEGINNING; thence leaving said tract continue North 00° 30' 24" East a distance of 640.82 feet to the southwest corner of a 4.0 acre tract described in Conveyance Book 387, Page 583 of the records of Bossier Parish, Louisiana; thence proceed North 70° 01' 54" East a distance of 693.59 feet to a found 1/2" rebar at the southeast corner of said 4.0 acre tract; thence proceed North 20° 14' 17" West a distance of 391.25 feet to a found 1/2" iron pipe at the northeast corner of said tract, said point lying on the south right of way of US Highway 80, as recorded in Conveyance Book 252, Page 24 of the records of Bossier Parish, Louisiana; thence proceed North 69° 56' 18" East along said south right of way a distance of 623.06 feet to a set 1/2" iron pipe at the intersection of said south right of way with the west line of said 70.115 acre tract; thence proceed South 20° 03' 42" East along said 70.115 acre tract a distance of 300.00 feet to a found 1/2" iron pipe; thence proceed South 69° 56' 18" West along said 70.115 acre tract a distance of 173.44 feet to a found 1/2" iron pipe; thence proceed South 19°

57' 22" East along said 70.115 acre tract a distance of 692.19 feet to a set 1/2" iron pipe; thence proceed South 70° 01' 35" West along said 70.115 acre tract a distance of 1365.87 feet to the POINT OF BEGINNING,

and

TRACT 2

A certain tract of land containing 1.552 acres, more or less, located in Section 19, Township 18 North, Range 12 West of the Louisiana Prime Meridian, Northwestern Land District, in the City of Bossier City, Bossier Parish, Louisiana, being more particularly described as follows:

Commencing at the southwest corner of said Section 19 and proceed North 00° 30' 24" East along the west line of said Section 19 a distance of 2,766.05 feet; thence proceed South 89° 29' 36" East a distance of 181.00 feet to the southwest corner of a 70.115 acre tract of land described in Conveyance Book 1235, Page 585 of the records of Bossier Parish, Louisiana; thence proceed North 00° 30' 24" East along the west line of said tract a distance of 783.42 feet to a found 1/2" iron pipe; thence continue North 00° 30' 24" East a distance of 648.32 feet to a set 1/2" iron pipe on the easterly high bank of Alligator Bayou and the POINT OF BEGINNING; thence continue North 00° 30' 24" East a distance of 409.18 feet (passing a 1/2" iron pipe set for reference at 148.59 feet) to a set 1/2" iron pipe on the south right of way of US Highway 80, as recorded in Conveyance Book 252, Page 24 of the records of Bossier Parish, Louisiana; thence proceed North 69° 56' 18" East along said right of way a distance of 225.99 feet to the northwest corner of a 4.0 acre tract described in Conveyance Book 387, Page 583 of the records of Bossier Parish, Louisiana; thence proceed along the west side of said 4.0 acre tract and the easterly high bank of Alligator the following three courses and distances:

South 01° 28' 53" West a distance of 157.10 feet;
South 17° 34' 53" West a distance of 162.80 feet;
South 42° 59' 53" West a distance of 238.51 feet to the POINT OF BEGINNING,

LESS AND EXCEPT that portion of the 1.552 acres which lies between the ordinary low water lines of Alligator Bayou, which is subject to claim by the State of Louisiana,

and being the same property described in that certain Cash Sale Deed, dated May 19, 2023, by and between JPIL Beaird Partnership, et al, as Vendor, and the State of Louisiana, as Vendee, being recorded under instrument #1312020 of the records of the Clerk of Court, Bossier Parish, Louisiana

This instrument prepared for and after recording to be returned to:

Anna Priestley
Trust Advisor
Regions Private Wealth Management
333 Texas Street LASH30202T 1/ Shreveport, LA 71101
Office: 318.429.1206 1 Fax: 318.429.1021

TRUSTEE'S DEED

STATE OF _____
COUNTY/PARISH OF _____

KNOW ALL PERSONS BY THESE PRESENTS:

That Regions Bank, an Alabama banking corporation, successor by merger to First Commercial Trust Company, N.A., appearing herein in its capacity as sole trustee (the "Trustee") of the HICKS MARITAL TRUST (the "Trust), a trust created under the laws of the State of Louisiana, said trust being created in that certain Last Will and Testament of Samuel B. Hicks dated July 12, 1991, which testament was filed for probate in Suit No. 396794, First Judicial District Court, Caddo Parish, Louisiana (hereinafter, the "Testament" and/or the "Trust Agreement), who declared that record title to the property described on the attached Exhibit "A" is vested in Regions Bank, in its capacity as trustee of the Trust.

WHEREAS, the class of beneficiaries of the Trust has closed pursuant to Section XII of the Trust Article 4 of the Testament created the Trust and identified Bobbie Cates Hicks as the income beneficiary and First Presbyterian Church, Shreveport, Louisiana and Louisiana State University – Shreveport, Shreveport, Louisiana as the principal beneficiaries.

Pursuant to Article 5.1 (B) of the Testament, the Trust terminated upon the death of Bobbie Cates Hicks, who died on January 31, 2022. Her succession was judicially opened on February 10, 2022 at Suit No. 635226-A, First Judicial District Court, Caddo Parish, Louisiana.

NOW, THEREFORE, IN VIEW OF THE FOREGOING, and to evidence the distribution of the income and principal of the Trust allocated to the below beneficiary and the delivery of the trust property to the below beneficiary, the Trustee has and does by these presents grant, bargain, sell, convey, transfer, assign, set over, abandon and deliver without any warranty of title except as against the Trustee's own acts, but with full substitution and subrogation in and to all rights and

actions of warranty which said Trustee has or may have against all preceding owners and vendors, unto the following beneficiary,

BOARD OF SUPERVISORS OF LOUISIANA STATE UNIVERSITY AND AGRICULTURAL AND MECHANICAL COLLEGE, a constitutional corporation, organized and existing under the laws of the State of Louisiana, domiciled in Baton Rouge, Louisiana, having a permanent mailing address of _____;

herein collectively referred to as "Grantee", here present, accepting, and acknowledging due delivery and possession thereof, all and singular, an undivided 20.00% interest in the trust property described on the attached Exhibit "A", and any other properties owned by the Trust whether described herein or not, along with all tenements, hereditaments, and appurtenances belonging thereto (the "Property"), subject to all recorded servitudes, restrictions, rights-of-way, easements and all other matters and encumbrances of record.

With respect to any and all transferred property (specifically including mineral rights being transferred herein), Grantee acknowledges that any rights, title, royalty, working interest, leasehold interest, servitude or mineral estate which were previously sold, severed or terminated by any means (including prescription and/or the running of any statute of limitations) are specifically excluded from the warranty (if any) being provided by the Trustee.

To have and to hold the above described Property unto the Grantee, his successors and assigns forever.

The Property is conveyed by Trustee and accepted by Grantee in its "AS IS, WHERE IS" condition and "WITH ALL FAULTS" as of the date hereof.

Grantee hereby consents to the actions taken herein by the Trustee and further waives any further accounting due from the Trustee and releases the Trustee from any accounting or liability to them in connection with the Trustee's administration of the Property. The parties to this act have waived the production of mortgage and tax certificates in connection herewith, and the parties hereto do accordingly agree to relieve and release the undersigned Notary Public from all responsibilities and liabilities in connection therewith. The Grantees assume payment of ad valorem property taxes for the current year.

This instrument may be executed in multiple counterparts by each of the Trustee and Grantee, each of which when so executed and delivered shall be deemed to be an original and all of which shall constitute one and the same instrument. Signature pages may be assembled and attached to one counterpart for filing purposes.

Signature pages to follow

Executed this ____ day of _____, 2024.

Regions Bank, successor by merger to First Commercial Trust Company, N.A., Trustee of the Hicks Marital Trust

By: Anna B. Priestley
Its: Vice-President and Trust Advisor

STATE OF LOUISIANA §
§

ACKNOWLEDGMENT

PARISH OF CADDO §

On this day, before me, the undersigned, a Notary Public, duly commissioned, qualified, and acting, within and for said Parish and State, appeared in person the within named Anna B. Priestley, to me personally well known, who stated that he/she is a TRUST OFFICER of REGIONS BANK, an Alabama banking corporation, and is duly authorized in her capacity to execute the annexed and foregoing instrument on behalf of the Trustee of The Hicks Marital Trust, and further stated and acknowledged that she has so signed, executed, and delivered said foregoing instrument for the consideration, uses, and purposes therein mentioned and set forth.

WITNESS my hand and seal as such Notary Public on this ____ day of _____, 2024.

NOTARY PUBLIC
in and for Caddo Parish, Louisiana
My Commission expires: _____

GRANTEES' ACCEPTANCE AND AFFIDAVIT

I hereby accept the above-described Property upon the terms, covenants and conditions set forth in this Trustee's Deed.

Executed by the Grantee on this ____ day of _____, 2024.

Board of Supervisors of Louisiana State University and Agricultural and Mechanical College

By: _____
Its: _____

STATE OF _____ §
§

ACKNOWLEDGMENT

COUNTY/PARISH OF _____ §

On this day, before me, the undersigned, a Notary Public, duly commissioned, qualified, and acting, within and for said County and State, appeared in person the within named _____, the authorized representative of the Board of Supervisors of Louisiana State University and Agricultural and Mechanical College, known to me to be the person whose name is subscribed to the foregoing instrument and acknowledged to me that he/she executed the same for the purposes and consideration therein expressed for the benefit of the Board of Supervisors of Louisiana State University and Agricultural and Mechanical College.

WITNESS my hand and seal as such Notary Public on this ____ day of _____, 2024.

NOTARY PUBLIC
in and for _____ County, State of _____
My Commission expires: _____

EXHIBIT "A"
Legal Description

EXHIBIT "A"

Owner Number: 101186 Interest Type: OR1
 Owner Name: HICKS MARITAL TRUST Decimal Interest: 0.00000865
 Property Number: TX-333-1075
 Property Name: CGU 2H
 Operator: COMSTOCK OIL & GAS, LLC
 County/State: Panola, TX
 Property Description: COLLINS G SURVEY, A-216 - BHL 9169.77 ACRES, MORE OR LESS, UNITIZED BY ORDER NO 6-21682 DATED JAN 26, 1951, FOUND IN DOCKET NO 120 OF THE OIL AND GAS RECORDS, PANOLA CO., TX.

Owner Number: 101186 Interest Type: OR1
 Owner Name: HICKS MARITAL TRUST Decimal Interest: 0.00000865
 Property Number: TX0901
 Property Name: CARTHAGE GU
 Operator:
 County/State: Panola, TX
 Property Description: 9169.77 ACRES, MORE OR LESS, UNITIZED BY ORDER NO 6-21682 DATED JAN 26, 1951, FOUND IN DOCKET NO 120 OF THE OIL AND GAS RECORDS

Owner Number: 101186 Interest Type: OR1
 Owner Name: HICKS MARITAL TRUST Decimal Interest: 0.00000865
 Property Number: TX-333-1074
 Property Name: CGU 1H
 Operator: COMSTOCK OIL & GAS, LLC
 County/State: Panola, TX
 Property Description: COLLINS G SURVEY, A-216 - BHL 9169.77 ACRES, MORE OR LESS, UNITIZED BY ORDER NO 6-21682 DATED JAN 26, 1951, FOUND IN DOCKET NO 120 OF THE OIL AND GAS RECORDS, PANOLA CO., TX.

Owner Number: 101186 Interest Type: OR1
 Owner Name: HICKS MARITAL TRUST Decimal Interest: 0.00000865
 Property Number: TX-333-1074
 Property Name: CGU 1H
 Operator: COMSTOCK OIL & GAS, LLC
 County/State: Panola, TX
 Property Description: COLLINS G SURVEY, A-216 - BHL 9169.77 ACRES, MORE OR LESS, UNITIZED BY ORDER NO 6-21682 DATED JAN 26, 1951, FOUND IN DOCKET NO 120 OF THE OIL AND GAS RECORDS, PANOLA CO., TX.

Owner Number: 101186 Interest Type: OR1
 Owner Name: HICKS MARITAL TRUST Decimal Interest: 0.00000865
 Property Number: TX-333-1107
 Property Name: CGU 6H
 Operator: COMSTOCK OIL & GAS, LLC
 County/State: Panola, TX
 Property Description: 9169.77 ACRES, MORE OR LESS, UNITIZED BY ORDER NO 6-21682 DATED JAN 26, 1951, FOUND IN DOCKET NO 120 OF THE OIL AND GAS RECORDS, PANOLA CO., TX.

Owner Number: 101186 Interest Type: OR1
 Owner Name: HICKS MARITAL TRUST Decimal Interest: 0.00000865
 Property Number: TX-333-1108
 Property Name: CGU 7H
 Operator: COMSTOCK OIL & GAS, LLC
 County/State: Panola, TX
 Property Description: 9169.77 ACRES, MORE OR LESS, UNITIZED BY ORDER NO 6-21682 DATED JAN 26, 1951, FOUND IN DOCKET NO 120 OF THE OIL AND GAS RECORDS, PANOLA CO., TX.

Owner Number: 101186 Interest Type: OR1
 Owner Name: HICKS MARITAL TRUST Decimal Interest: 0.00000865
 Property Number: TX-333-1109
 Property Name: CGU 8H
 Operator: COMSTOCK OIL & GAS, LLC
 County/State: Panola, TX
 Property Description: 9169.77 ACRES, MORE OR LESS, UNITIZED BY ORDER NO 6-21682 DATED JAN 26, 1951, FOUND IN DOCKET NO 120 OF THE OIL AND GAS RECORDS, PANOLA CO., TX.

Owner Number: 101186 Interest Type: OR1
Owner Name: HICKS MARITAL TRUST Decimal Interest: 0.00000865
Property Number: TX-333-1110
Property Name: CGU 9H
Operator: COMSTOCK OIL & GAS, LLC
County/State: Panola, TX
Property Description: 9169.77 ACRES, MORE OR LESS, UNITIZED BY ORDER NO 6-21682 DATED JAN 26, 1951, FOUND IN DOCKET NO 120 OF THE OIL AND GAS RECORDS, PANOLA CO., TX.

Owner Number: 101186 Interest Type: OR1
Owner Name: HICKS MARITAL TRUST Decimal Interest: 0.00000865
Property Number: TX-333-1111
Property Name: CGU 10H
Operator: COMSTOCK OIL & GAS, LLC
County/State: Panola, TX
Property Description: 9169.77 ACRES, MORE OR LESS, UNITIZED BY ORDER NO 6-21682 DATED JAN 26, 1951, FOUND IN DOCKET NO 120 OF THE OIL AND GAS RECORDS, PANOLA CO., TX.

Owner Number: 101186 Interest Type: OR1
Owner Name: HICKS MARITAL TRUST Decimal Interest: 0.00000865
Property Number: TX-333-1104
Property Name: CGU 3H
Operator: COMSTOCK OIL & GAS, LLC
County/State: Panola, TX
Property Description: .

Owner Number: 101186 Interest Type: OR1
Owner Name: HICKS MARITAL TRUST Decimal Interest: 0.00000865
Property Number: TX-333-1121
Property Name: CGU 12H
Operator: COMSTOCK OIL & GAS, LLC
County/State: Panola, TX
Property Description: A-845 S HENDRICKS SVY - BHL

Owner Number: 101186 Interest Type: OR1
Owner Name: HICKS MARITAL TRUST Decimal Interest: 0.00000865
Property Number: TX-333-1106
Property Name: CGU 5H
Operator: COMSTOCK OIL & GAS, LLC
County/State: Panola, TX
Property Description: A-922 G COLLINS SVY - BHL

Owner Number: 101186 Interest Type: OR1
Owner Name: HICKS MARITAL TRUST Decimal Interest: 0.00000865
Property Number: TX-333-1122
Property Name: CGU 13H
Operator: COMSTOCK OIL & GAS, LLC
County/State: Panola, TX
Property Description: A-845 S HENDRICKS SVY - BHL

Owner Number: 101186 Interest Type: OR1
Owner Name: HICKS MARITAL TRUST Decimal Interest: 0.00000865
Property Number: TX-333-1105
Property Name: CGU 4H
Operator: COMSTOCK OIL & GAS, LLC
County/State: Panola, TX
Property Description: A-922 G COLLINS SVY- BHL

Owner Number: 101186 Interest Type: OR1
Owner Name: HICKS MARITAL TRUST Decimal Interest: 0.00000865
Property Number: TX-333-1120
Property Name: CGU 11H
Operator: COMSTOCK OIL & GAS, LLC
County/State: Panola, TX
Property Description: A-845 S HENDRICKS SVY - BHL



Board of Supervisors

Request from LSU A&M to Authorize Repairs to Patrick F. Taylor Hall

Date: April 26, 2024

1. Bylaw Citation

Pursuant to Article VII, Section?

G.1 Any contract for construction greater than \$1 million

2. Summary of Matter

During the freeze in January, there was a significant flood in Patrick F. Taylor Hall, which resulted from a rupture in the chilled water cooling system coils in the rooftop HVAC system. The damage affected all floors of the building and forced the closure of several classrooms, labs, and offices. Extensive repairs are required to return these areas to use by LSU faculty and students. After mitigation efforts and a thorough assessment of the damages, LSU's Office of Facility and Property Oversight has prepared a design and plan for the repair work.

The estimated cost of construction is approximately \$1.3 million. The repairs will be paid for through LSU's risk management program. It is vital that the repairs be completed prior to the start of the Fall 2024 semester so that the faculty and students can once again use those classrooms, labs, and offices.

3. Review of Business Plan

This is a normal construction project, funded through insurance proceeds.

4. Fiscal Impact

No fiscal impact expected; it is funded through LSU's risk management insurance program.

5. Description of Competitive Process

The construction contract will be put out for bid through the normal Public Works Act process required by law.

6. Review of Legal Documents

N/A

7. Parties of Interest

N/A

8. Related Transactions

N/A

9. Conflicts of Interest

None.

10. Attachments

N/A

RESOLUTION

NOW, THEREFORE, BE IT RESOLVED that the LSU Board of Supervisors of Louisiana State University and Agricultural and Mechanical College hereby approves and authorizes necessary repairs to Patrick F. Taylor Hall in relation to the damage that occurred on January 17, 2024.



Board of Supervisors

Proposal by LSUE for Non-Human Primate Research Center

Date: April 26, 2024

1. Bylaw Citation

Pursuant to Article VII, Section (1)(J)(3): Major Contracts

“. . . raises significant financial, educational, or other policy issues, such as privatization of a major University function, as determined by the President, in consultation with the Chair and Chair-Elect of the Board and the chair of the relevant Board committee.”

2. Summary of Matter

LSUE has an opportunity to engage in a public private partnership for the financing and construction of a non-human primate research facility. The project would be completely externally funded and has the potential to be a significant economic development project for the region.

There is a national market for a NHP facilities and significant federal grant dollars exists to support them. The facilities, when partnered with academic institutions, offer opportunities ranging from clinical research to workforce development. LSUE's geographic location and ample land for expansion make it a ideal location for such a project.

The project is in the early stages and the attached resolution would authorize the President and Chancellor to engage in negotiations with a private partner and bring detailed proposal back to the board if determined its in the best interest of the university.

3. Review of Business Plan

The details of the business plans will be evaluated as part of the negotiation and presented to the board.

4. Fiscal Impact

This project is intended to be completely externally funded. It contemplates a long-term lease from LSUE for the location of the facility.

5. Description of Competitive Process

N/A

6. Review of Legal Documents

No contractual documents have been prepared yet. They will be prepared and presented to the board following negotiation.

7. Parties of Interest

LSUE

8. Related Transactions

N/A

9. Conflicts of Interest

N/A

10. Attachments

N/A

RESOLUTION

NOW, THEREFORE, BE IT RESOLVED that the Board, hereby, authorizes the President and Chancellor to evaluate and engage in negotiations for the development of an externally funded non-human primate research facility on terms in the best interest of the university to be presented to the board for approval as soon as practicable.



Board of Supervisors

HEALTHCARE AND MEDICAL EDUCATION COMMITTEE

BOARD OF SUPERVISORS MEETING | APRIL 26, 2024



Board of Supervisors

Request from LSUHSC-NO to Acknowledge and Authorize the Uniform Affiliation Agreement with the LSUHSC-NO School of Medicine Alumni Association

Date: April 26, 2024

1. Bylaw Citation

Pursuant to Article VII, Section 1:

K. Non-Academic Affiliation Agreements

Any affiliation agreement with a private non-profit foundation formed to support the programs, facilities, and research and educational opportunities offered by one or more campuses of the University or the University as a whole.

2. Summary of Matter

The LSU Health Sciences Center - New Orleans ("LSUHSC-NO") School of Medicine Alumni Association ("Medical Alumni Association") was founded in 1985 for the purpose of keeping graduates connected to the school. The Medical Alumni Association also supports and supplements the medical school in its mission and goals, which include, but are not limited to, research, education, and clinical practice.

The Medical Alumni Association holds regular meetings of its Board of Directors throughout the year, and a general membership meeting is held annually in connection with the annual reunions.

All alumni of LSUHSC-NO School of Medicine automatically receive Medicinews, the alumni news magazine, and the Honor Roll, a yearly publication as part of their membership in the Medicine Alumni Association.

The Medical Alumni Association desires to formalize the terms and conditions of an agreement between it and this Board by using the Board's approved Uniform Affiliation Agreement ("UAA"). The Medical Alumni Association is asking the Board to approve the UAA because it will allow for the furtherance of its goal of keeping graduates connected to the school, and its goal of supporting the school in research, education, and clinical practices.

Because the activities of the Medical Alumni Association support and enhance the programs, facilities, research, and educational opportunities offered by LSUHSC-NO, and considering LSUHSC-NO's mission and purpose, the Medical Alumni Association now seeks the approval of the Board to enter into a UAA in accordance with the attached agreements.

3. Review of Business Plan

Not Applicable.

4. Fiscal Impact

Not Applicable.

5. Description of Competitive Process

Not Applicable.

6. Review of Legal Documents

The UAA has been prepared by and negotiated between the Medical Alumni Association and LSUHSC-NO, and the parties are awaiting signature on behalf of the University by the President of LSU subject to Board of Supervisors' approval.

7. Parties of Interest

Board of Supervisors of Louisiana State University Agricultural and Mechanical College; LSU Health Sciences Center - New Orleans; LSUHSC-NO School of Medicine Medical Alumni Association.

8. Related Transactions

Not applicable.

9. Conflicts of Interest

None.

10. Attachments

Medical Alumni Association Uniform Affiliation Agreement

RESOLUTION

NOW, THEREFORE, BE IT RESOLVED that the Board of Supervisors of Louisiana State University and Agricultural and Mechanical College hereby authorizes the President of LSU or designee to execute the Uniform Affiliation Agreement with the LSUHSC-NO School of Medicine's Medical Alumni Association, with such agreement to contain such terms and conditions as the President, in consultation with the General Counsel, deems to be in the best interests of LSU.

Uniform Affiliation Agreement

This Agreement is made and entered into on the 26 day of January 2024 between the Board of Supervisors of Louisiana State University Agricultural and Mechanical College ("University") and LSU Medical Alumni Assn ("Affiliate").

WHEREAS, as stated in La. R.S. 17:3390(A), the Legislature has found and University recognizes that private, nonprofit organizations under the direction and control of private individuals who support institutions of higher education are effective in obtaining private support for those institutions;

WHEREAS, as further stated in La. R.S. 17:3390(A), the Legislature encourages higher education management boards and institutions to promote the activities of alumni associations, foundations, and other private, nonprofit organizations that raise private funds for the support of public institutions of higher education;

WHEREAS, after considering the proposed mission and purpose of Affiliate, University has determined that Affiliate's activities will support or enhance one or more of the programs, facilities, research and educational opportunities offered by University;

WHEREAS, because of the close association of Affiliate with the University, it is prudent and beneficial to have a clear statement, agreed upon by the parties, of the respective responsibilities, requirements, authority, and relationship of the University and Affiliate while preserving the private and independent legal status of the Affiliate:

1. Affiliate Purpose and Status

- 1.1 Affiliate's purpose(s) shall be as defined in the Affiliate's Articles of Incorporation. All actions taken by Affiliate shall be consistent with and in furtherance of its stated purpose(s), and such actions shall likewise be consistent with the institutional mission and activities of University as defined by the University. In order to prevent the unnecessary duplication of activities among University affiliates, any proposed material change in Affiliate's authorized purpose(s) must be approved in advance and in writing by the President of LSU. Requests for approval of such changes in purpose shall be submitted to LSU's Executive Vice President for Finance and Administration and CFO ("LSU Executive Vice President") with a copy delivered to the Chair of the Board of Supervisors.
- 1.2 Unless waived in writing, Affiliate shall provide at least 30 days advance written notice to the LSU Executive Vice President of any proposed material change in Affiliate's Articles of Incorporation or Bylaws.
- 1.3 Affiliate has been formed as a private non-profit Louisiana organization, and has been recognized as and shall maintain its status as an organization exempt from taxation under Section 501(c) of the Internal Revenue Code.
- 1.4 Affiliate is a separate legal entity from University. Nothing in this Agreement shall be construed as to invalidate or restrict Affiliate's private and independent legal status.

2. Governance

- 2.1 To ensure that Affiliate's status as a private entity is recognized and maintained in accordance with La. R.S. 17:3390(B), Affiliate shall meet the following criteria:
- 2.1.1 Affiliate shall be under the management and control of a board of directors ("Affiliate's Board") elected by the members or shareholders of Affiliate.
 - 2.1.2 A majority of the voting members of Affiliate's Board shall consist of individuals who are not members or employees of a Louisiana higher education management board; and,
 - 2.1.3 Affiliate shall reimburse, either directly or in-kind, the cost of housing, personnel, and other support furnished to Affiliate by any institution of higher education.
- 2.2 Members of Affiliate Boards
- 2.2.1 The President of LSU, or his designee, shall be a non-voting *ex officio* member of Affiliate's Board and of the Executive Committee of such Board (or equivalent). To promote compliance with Affiliate's policy on conflicts of interest, and ensure that appropriate disclosures are made and facilitate an understanding of Affiliate's business, the President of LSU will provide Affiliate with reasonable advance notice identifying individuals designated to attend meetings in his place and will endeavor to utilize a single individual as his designee.
 - 2.2.2 The Chairman of the Board of Supervisors, in consultation with members of the Board of Supervisors and Chairman of the Affiliate Board, shall have the right to recommend a list of members of the Board of Supervisors as potential candidates to Affiliate for election to Affiliate's Board as non-voting members. Affiliate agrees that at all times, excluding instances associated with temporary vacancies created by death, resignation or similar causes, at least one member of its Board, shall be elected from the recommended candidates.
 - 2.2.3 Designation of the President of LSU (or his designee) and Affiliate's election of an individual nominated by the Chairman of the Board of Supervisors to serve as a member of Affiliate's Board and/or Executive Committee is not intended to and shall not be deemed a waiver of the privileges and immunities granted Affiliate pursuant to La. R.S. 17:3390.
- 2.3 If the Affiliate is in primary support of a single campus or institution, the Chancellor or equivalent shall, at a minimum, be given notice of and the ability to attend and participate as a non-voting, *ex officio* member in meetings of the Affiliate's Board and Executive Committee.
- 2.4 Members of the Board of Directors and the Executive Committee shall have reasonable access to all books and records of Affiliate in accordance with its generally applicable confidentiality and non-disclosure policies, provided that members who are or may be deemed "public servants," as defined in La. R.S. 42:1102(19), shall not have legal custody of Affiliate's books and records. Requests for access to books and records shall be made via written request directed to Affiliate's Chief Executive Officer.

3. General Duties and Responsibilities of Affiliate

- 3.1 Operate Affiliate for primary benefit of University in accordance with Affiliate's Articles of Incorporation and tax exempt purpose.
- 3.2 Support and promote the mission and activities of the University.
- 3.3 Affiliate shall establish and enforce policies to identify and manage potential conflicts of interest and ensure that Affiliate's assets do not directly or indirectly unduly benefit any individual or other person.
- 3.4 Solicit and accept things of value of all kinds consistent with applicable law.
- 3.5 Receive, hold, invest, administer, manage, distribute and provide good stewardship of gifts and bequests in accordance with donor intent, applicable law and applicable University and Affiliate policies and procedures.
- 3.6 Expend funds for the establishment and operation of Affiliate and for any reasonable expenses incidental to the conduct of the affairs of Affiliate.
- 3.7 Within 120 days following the close of Affiliate's fiscal year, unless an extension is granted by the LSU Executive Vice President, submit the annual Affiliate Compliance Certificate (Exhibit A) and materials referenced therein, to the LSU Executive Vice President.
- 3.8 Subject to any limitations imposed by contracts among the University and third-parties and applicable University policies, the Affiliate may be granted the right by University to utilize its "licensed marks" on a royalty free basis for its activities in support of LSU. Affiliate must adhere to the Louisiana State University Brand Identity.
- 3.9 University is an equal opportunity/access institution committed to diversity and inclusiveness in procurement. Affiliate is encouraged to reflect the spirit of this commitment in its business practices by: (a) participating in and encouraging major suppliers to participate in LSU sponsored outreach programs for small businesses as well as minority, women and veteran owned businesses ("DBEs"); (b) creating awareness among its suppliers that University and Affiliate encourage suppliers to make reasonable and prudent efforts to identify and provide competitive opportunities for participation by DBEs; and, (c) making reasonable and prudent efforts consistent with its unique needs as well as its fiduciary and good stewardship obligations, to identify and provide competitive opportunities for DBEs to participate in Affiliate's procurement opportunities. To assist Affiliate in its efforts, the University will make the resources of its Supplier Diversity program, including but not limited to lists of registered DBE's, personnel and information on best practices, available to Affiliate..

4. General Duties and Responsibilities of University

- 4.1 Support and promote the purpose and activities of Affiliate and encourage the donation of private funds to Affiliate;
- 4.2 Avoid action that would undermine Affiliate's status as a private entity, maintain the confidentiality of donor records and the private nature of Affiliate's books and records to the extent allowed by law;

- 4.3 Accept funds made available by Affiliate, provide good stewardship of gifts once received by University and utilize funds received from Affiliate in a manner consistent with University's mission, terms and conditions imposed by testators and donors, applicable law, this Agreement and University policy; and,
- 4.4 Make available to Affiliate, at University's sole discretion, appropriate facilities, personnel, or other support pursuant to the provisions of La. R.S. 17:3390(B)(3) and as otherwise permitted by law.

5. Records, Internal Controls and Funds Management

- 5.1 Recognizing the need to preserve the public trust and guard against the appearance of impropriety in its activities, Affiliate shall adopt, maintain, and enforce necessary and appropriate policies, procedures and internal controls, including policies on conflicts of interest, required for the conduct of its business in accordance with applicable law, the terms of this Agreement, applicable University policies and procedures and best practices for similar nonprofit organizations.
- 5.2 The books and records of Affiliate shall be kept in accordance with customary and current accounting standards. For the preparation of reports required by this section of this Agreement, an external accountant and/or auditor engaged to conduct such reports shall be selected from among the most recent list of certified public accountants maintained by the Louisiana Legislative Auditor.
- 5.3 In connection with its annual financial audit, Affiliate shall: (a) provide its auditors with a copy of this Agreement including all exhibits, schedules, and other attachments; (b) provide its auditors with access to all documents and other information relevant to this Agreement; (c) require Affiliate's chief executive officer to represent to its auditors that except to the extent disclosed in writing, to the best of Affiliate's knowledge, information and belief, Affiliate has complied with all applicable provisions of this Agreement; and, (d) rotate audit partners or firms at least every five years.
- 5.4 On a biennial basis, to commence in an Affiliate's fiscal year (commencing on or following execution of this Agreement by Affiliate) designated by the Executive Vice President, or on an annual basis if requested in writing by the LSU Executive Vice President for good cause shown, Affiliate shall separately engage an Independent Accountant (which may be the same firm conducting its financial statement audit) to perform various procedures necessary to issue an Agreed Upon Procedures report concerning items included in the Schedule of Agreed - Upon Procedures for Verification of Affiliate Compliance (Exhibit D).
- 5.5 Affiliate shall provide to the LSU Executive Vice President within 120 days of the close of Affiliate's fiscal year: (a) its audited financial statements; and, (b) its Agreed Upon Procedures report. At the request of the LSU Office of Internal Audit, Affiliate and its independent auditors shall arrange to meet with representatives from the LSU Office of Internal Audit to review written findings and/or the Agreed Upon Procedures report.
- 5.6 Affiliate shall evaluate and, where appropriate, take corrective action to remedy material and substantial audit findings. Material and substantial audit findings which have not either been (a)

resolved by management or, where appropriate, through corrective action within ninety (90) days following issuance of the annual audit, or (b) in cases where corrective action is appropriate, corrective action reasonably designed to resolve the issue has not been taken within ninety (90) days following issuance of the annual audit, shall be reported to the Audit Committee of the Board of Supervisors in writing.

- 5.7 Pursuant to a separate written Funds Management Agreement authorized and executed by University and Affiliate, University may in its discretion agree to deliver and Affiliate may agree to accept for deposit with Affiliate funds which have been donated to the University by private individuals or entities or which have been provided from the state to the University pursuant to the Board of Regents Support Fund or other programs.

6. Certain Disbursements and Other Transactions

- 6.1 All disbursements by Affiliate for administrative and operating expenses shall be in accordance with policies adopted by Affiliate's Board and in accordance with its annual budget, as modified by policies and procedures adopted by Affiliate's Board. Such policies shall provide for sound and prudent business practices, the payment or reimbursement of ordinary, necessary and reasonable business expenses, and shall address the content of this Agreement.
- 6.2 Affiliate shall not undertake the disbursements and transactions described on Exhibit B, other than transactions and disbursements involving operational and business management matters of Affiliate itself, without first obtaining a determination of acceptable University purpose from the appropriate University authority.
- 6.3 No donation requiring a determination of acceptable University purpose shall be publicized or otherwise disclosed by Affiliate prior to acceptance of any conditions or obligations by the University's Board or President of LSU in accordance with University policies and procedures.
- 6.4 Requests for a determination of acceptable University purpose shall be submitted to the President of LSU or to the Board through the President as may be appropriate by the Chancellor (or equivalent) of the campus or institution for whose benefit the action is proposed, in accordance with the procedures set forth in University procedures. Any submission shall include a specific recommendation from the Chancellor or equivalent demonstrating that the proposed transaction is in support of the University and its mission.
- 6.5 Absent exceptional circumstances and written approval by the Chancellor (or equivalent) and President (or designee), supplemental compensation or benefits to a University employee shall be paid through the University, not directly by Affiliate to the employee. For purposes of this section, supplemental compensation or benefits shall mean all compensation or benefits in addition to the base university compensation and benefits approved by the Board of Supervisors for duties performed by the employee for the University.
- 6.6 To ensure compliance with La. R.S. 17:3390(F), payments of over one thousand (\$1,000) dollars for any single transaction to, or on behalf of, or to reimburse the expense of a public employee of a public higher education institution or a public employee or officer of a management board of a public higher education institution shall be periodically reviewed and approved by the Board of Supervisors in accordance with applicable policies and procedures.

Affiliate may pay or reimburse such transactions pending approval by the Board, provided that any such payments or reimbursements subsequently disapproved by the Board shall be reimbursed to the Affiliate by the public employee or officer within ninety (90) days of such disapproval.

7. Prohibited Expenditures, Advisory Opinions

- 7.1 University, its employees and administrators shall not request the expenditure of funds and Affiliate shall not expend funds for any of the purposes described in section 2 of Exhibit C either directly or through reimbursement.
- 7.2 Where there is doubt about the reasonableness or validity of a proposed expenditure or transaction, or the procedure by which such expenditure or transaction should be reviewed, the Chancellor or equivalent, or legal counsel for Affiliate, shall seek an advisory opinion from the President, through the LSU Executive Vice President. Where appropriate, the President may refer the question to the Board of Supervisors for a decision. The President may adopt guidelines to facilitate the provisions of this sub-section.

8. Funds Management Agreements/Commitment of University Funds

- 8.1 With the written consent of the LSU Executive Vice President, Affiliate may enter into one or more agreements ("Funds Management Agreements") with other affiliates of University (that is, other non-profit organizations which are recognized pursuant to University policy) so that one affiliate will manage the funds of another affiliate. In such event, the affiliate which is agreeing to manage the funds of the other affiliate shall be known as the "Funds Owner" while the affiliate transferring the funds shall be known as the "Funds Manager."
- 8.2 Unless otherwise specifically provided for in the Funds Management Agreement, the Funds Manager shall have no internal control or audit responsibilities with respect to the Funds Owner; provided, however, that the Funds Manager shall cooperate with the Funds Owner's management and auditors with respect to such matters.
- 8.3 Where Affiliate enters into a Funds Management Agreement with an organization that has not executed an Affiliation Agreement with University, such Funds Management Agreements shall:
 - 8.3.1 Require that the funds of the Funds Owner be included in either (a) –the Funds Manager's annual audit conducted pursuant to La. R.S. 17:3390 or, (b) if the Funds Manager is exempt from annual audit requirements pursuant to R.S. 17:3390, an exemption certificate and a sworn financial statement in accordance with La. R.S. 17:3390D(3)(a)-(c).
 - 8.3.2 Notify the Funds Owner of the requirements of La. R.S. 17:3390(D).
- 8.4 In connection with transactions requiring the commitment of material University resources (including the transfer of University funds), the Affiliate will enter into a written agreement outlining the structure or details of each specific transaction, excluding routine transactions; the obligations of Affiliate, University, and any other parties; the public purpose to be achieved

from such transaction; and, either a reasonable expectation that benefits to the University resulting from the transaction will equal or exceed the value of funds provided by the University or an affirmation that the value of the University funds committed to the transaction will be reimbursed, either directly or through in-kind services in accordance with the requirements of La. R.S. 17:3390(B)(3).

- 8.5 Upon written request from the LSU Executive Vice President, Affiliates that are exempt from annual audit requirements pursuant to La. R.S. 17:3390, may be required to submit a financial audit or agreed to procedures report acceptable to the University conducted in accordance with generally accepted auditing standards by an independent professional auditor or, at Affiliate's option, LSU Internal Audit personnel. In connection with any audit or agreed to procedures conducted pursuant to this section, Affiliate shall: (a) provide its auditors with a copy of this Agreement; (b) provide its auditors with access to all documents and other information relevant to this Agreement; and, (c) represent to its auditors that except to the extent disclosed in writing, to the best of Affiliate's knowledge, information and belief, Affiliate has complied with all applicable provisions of this Agreement.

9. Term and Termination

- 9.1 This Agreement revises and replaces previous Affiliation Agreements between University and Affiliate. It shall take effect on the date first written above, and shall continue for a period of one year. Thereafter, it shall be automatically renewed and extended for additional one year periods unless Affiliate gives notice to terminate pursuant to the provisions of section 9.2, or University gives notice to terminate pursuant to the provisions of section 9.3. The provisions of this section shall survive any such termination.
- 9.2 Except to the extent modified by this Agreement or a separate written Agreement between Affiliate and University, Affiliate may terminate this Agreement without cause by providing written notice to the University no less than six (6) months prior to the effective date of the termination.
- 9.3 Except to the extent modified by this Agreement or a separate written Agreement between Affiliate and University, University may terminate this Agreement for cause in the event of:
- 9.3.1 Affiliate commits a material and substantial violation of the terms of this Agreement and fails to cure such violation after being provided with at least 30 days' notice of such violation,
 - 9.3.2 Affiliate engages in or negligently allows: (a) any material and substantial misuse of Affiliate's funds, or (b) any fraudulent or other illegal activity,
 - 9.3.3 the commencement of a voluntary bankruptcy proceeding by Affiliate or the commencement of an involuntary bankruptcy proceeding against Affiliate that is not dismissed within 120 days,
 - 9.3.4 the commencement of a voluntary dissolution proceeding by Affiliate or an involuntary dissolution proceeding against Affiliate that is not dismissed within 120 days,

- 9.3.5 a transfer of the campus, institution or program supported by Affiliate to another higher education management board should occur,
- 9.3.6 elimination or modification of programs offered by University such that Affiliate is no longer deemed necessary to the University's mission or the Affiliate is no longer able to achieve its purpose(s), or
- 9.3.7 the occurrence of any other material event or circumstance similar in nature to those described in subsections 9.3.1-9.3.6 which, in the reasonable judgment of the University, constitutes cause and remains uncured following thirty (30) days notice to Affiliate.

9.4. Upon termination of this Agreement, Affiliate shall:

- 9.4.1 Cease to use the University's name, marks or other indicia to solicit donations or for any other purpose and shall not in any way represent to alumni, contributors, and the general public that said Affiliate is affiliated with the University or authorized to raise funds for any of the colleges, schools, departments, and divisions comprising it; and,
- 9.4.2 Unless otherwise directed in writing by the University or unless otherwise required pursuant to the terms of applicable law, immediately transfer to University or another affiliate designated by University, all public funds which Affiliate holds as a depository pursuant to the provisions of section 8.0; and,
- 9.4.3 Terminate any Management Agreements entered into with other University affiliates in accordance with the terms of Section 8 of this Agreement and immediately return any managed funds to the appropriate Managed Affiliate(s); and,
- 9.4.4 Provide an accounting to University of all funds, public or private, held by Affiliate within 120 days of notice of termination unless extended in writing by mutual agreement; and,
- 9.4.5 If the Affiliate's purpose is in primary support of a single campus or institution, and the necessity for termination of this Agreement results from the transfer of the supported campus or institution to another public higher education management board ("Transferee Institution"), to the extent consistent with applicable law and prudent financial management practices, the applicable provisions of any legislation authorizing transfer of the supported campus or institution and compliance with sections 9.4.1 – 9.4.4 of this Agreement, Affiliate may effect the termination of this agreement to the extent it enters into an affiliation agreement with the Transferee Institution providing for Affiliate's ability to continue its mission of supporting the same campus or institution subject to oversight by the Transferee Institution. Preceding the transfer, there shall be a review to determine whether there is any adverse impact on the University. In the event that Affiliate enters into an affiliation agreement with a Transferee Institution pursuant to the terms of this Section, the Transferee Institution and Affiliate shall agree to indemnify, defend and hold harmless University, its members, employees and agents from and against any and all claims and liabilities associated with or in any way arising out of University's association with Affiliate and Affiliate's actions or inactions (whether past, present or future).

9.5 Upon dissolution of Affiliate, whether dissolution is voluntary or involuntary, subject to compliance with sections 9.4 – 9.5 of this Agreement, applicable laws and Affiliate’s Articles of Incorporation and other governing documents, Affiliate shall provide for its net assets to be distributed to another nonprofit affiliated with the University as designated by the President of LSU, unless otherwise agreed by the University and Affiliate or directed by a court of competent jurisdiction and venue, to be used as nearly as practicable in accordance with the express terms of written acts of donation, testaments, pledges and similar instruments, donor intent, Affiliate’s governing documents, purposes and applicable law. This paragraph shall not prejudice the rights of creditors including, without limitation, any properly approved, valid, and enforceable financing agreements executed by Affiliate.

10. Notices, Entire Agreement, Venue

- 10.1 Unless otherwise provided herein, whenever any notice or demand is required or permitted under this agreement, such notice or demand shall be given in writing and delivered in person or by certified mail to the University, addressed to its President at 3810 West Lakeshore Drive, Baton Rouge, LA, and to Affiliate at the address shown above. Unless otherwise provided herein, such advance notice requirements and time periods designated for the performance of specific acts may be extended or waived, in writing, by the LSU Executive Vice President.
- 10.2 This Agreement, including Exhibits A, B, and C to this Agreement, constitutes the entire agreement between the parties and shall not be amended except in writing signed by the President of University and a duly authorized officer of Affiliate. This Agreement is not intended to and does not create any rights in third parties.
- 10.3 The parties anticipate that they will enter into separate agreements for specific projects. Where there is a conflict between the terms of this Agreement and the terms of any separate agreement, the terms of the separate agreement shall control.
- 10.4 This Agreement is entered into, and any action arising from this Agreement shall be brought in, East Baton Rouge Parish, Louisiana.

THUS DONE AND SIGNED this 26 day of January, 2024 by the undersigned duly authorized representatives.

For Affiliate:

For University:

By: Cathi Fontenot

By: _____

Name: Cathi Fontenot

Name:

Title: Associate Dean

Title:

Alumni Affairs and Development

EXHIBIT A TO UNIFORM AFFILIATION AGREEMENT
ANNUAL AFFILIATE COMPLIANCE CERTIFICATE

Date 1-26-2024

LSU Board of Supervisors

Attn: _____

Baton Rouge, Louisiana

Re: LSU Medical Alumni Assn ("Organization")
Annual Compliance Certificate

Members of the LSU Board of Supervisors:

In my capacity as the Chief Executive Officer (or other authorized officer) of LSU Medical Alumni Assn I am writing to confirm that *after making reasonable and appropriate inquiries, to the best of my knowledge, information and belief*, the following information is true and correct as of the date of this letter:

1. The Organization is required to obtain an annual financial audit in accordance with La. R.S. 17:3390. The annual financial audit for the ^{calendar} fiscal year ending 2023, conducted by an independent auditor, has been completed and a copy was provided to the Legislative Auditor with a copy to your office by letter dated _____;

OR

Audit pending

The Organization is exempt from the annual audit requirements of La. R.S. 17:3390, and copies of the Organization's exemption certificate and sworn financial statement prepared in accordance with La. R.S. 17:3390D(3)(a)-(c), were provided to the Legislative Auditor with a copy to your office by letter dated _____;

2. The Organization's annual tax return for the ____ tax year was completed and filed with IRS on _____ and a copy was delivered to your office by letter dated _____;

OR IF APPLICABLE

The Organization has requested an extension through _____ within which to file its annual tax return for the _____ tax year, and a copy of the return will be provided to your office upon filing;

3. A complete list of all active corporate affiliates and subsidiaries of the Organization as of this date and the purpose for which such entities have been formed is attached to this certificate as Schedule "1";

4. A complete list of all "managed organizations" as defined in the Uniform Affiliation Agreement, managed by the Organization is attached to this certificate as Schedule "2";
5. A current list of the Organization's officers and directors is attached to this certificate as Schedule "3";
6. A copy of the Organization's Articles of Incorporation and Bylaws are on file with and copies of any proposed amendments have been provided to the Executive Vice President;
7. The Organization is registered as a Louisiana nonprofit entity and it remains exempt from taxation in accordance with Sections 501(c)3 of the Internal Revenue Code;
8. The Organization has taken all necessary action, including any filings required by the Louisiana Secretary of State and other authorities, to maintain its corporate existence and its tax exempt status;
9. A preliminary list, which is subject to confirmation by your office, showing the type of any housing, personnel, and other support provided to Affiliate by University during the previous fiscal year pursuant to the provisions of La. R.S. 17:3390(B)(3), including (i) amount and location of any space or facilities provided, (ii) number of personnel provided, and (iii) a listing of the type of any other services provided to Affiliate by University is attached to this certificate as Schedule "4";
10. As detailed in Schedule "5" to this certificate, during the previous fiscal year, (i) subject to confirmation by your office, our records indicate that the total amount paid in cash to University as direct reimbursement for housing, personnel and other support was \$ 0, and (ii) subject to confirmation by your office, our records indicate that the total dollar value of all property provided to the University together with all expenditures made in support of the University (exclusive of costs for personnel employed solely by and for the benefit of Affiliate, facilities occupied solely by Affiliate and other Affiliate overhead and administrative costs), which amount shall be considered "in-kind" reimbursement for purposes of La. R.S. 17:3390(b)(3), was \$ 0;
11. The Organization maintains and enforces a policy on conflicts of interest as well as other policies procedures and internal controls required for the conduct of its business in accordance with applicable law, the terms of the Affiliation Agreement, applicable University policies and procedures and best practices for similar nonprofit organizations;
12. Except as specifically provided for under the circumstances described in Sections 6 and 7 of the Uniform Affiliation Agreement or previously disclosed in writing to the Executive Vice President, the Organization has not engaged in any prohibited transactions or made any prohibited expenditures over the last fiscal year;
13. Except as previously disclosed in writing to the Audit Committee of the Board of Supervisors, the Organization resolved or will resolve any material and substantial audit findings within

90 days of the issuance of its annual audit in accordance with Uniform Affiliation Agreement Section 5.4;

14. The Organization has provided a copy of its current Affiliation Agreement and access to all documents and other information relevant to the Affiliation Agreement to its independent auditors, if applicable, for use in the evaluation of our internal controls and determining compliance with the Affiliation Agreement in connection with transactions reviewed by the auditors in the course of their work. The Organization has represented to its auditors that except to the extent disclosed in writing, to the best of Affiliate's knowledge, information and belief, Affiliate has complied with all applicable provisions of the Affiliation Agreement; and,
15. A copy of the Agreed Upon Procedures report described in Section 5.4 and Exhibit D was provided to your office by letter dated 11-26-23.

Sincerely,

Cathi Fontenot

Name: Cathi Fontenot

Title: Associate Dean Alumni Affairs
and Development

Schedule 1 to Annual Affiliate Compliance Certificate
List of Corporate Affiliates and Subsidiaries and Purposes of Such Entities

Name of Entity **Type of Entity and Purpose**

Schedule 2 to Annual Affiliate Compliance Certificate
List of "Managed Organizations"

Name of Entity **Type of Entity and Purpose**

Schedule 3 to Annual Affiliate Compliance Certificate
List of "Affiliate's Officers and Directors"

Schedule 4 to Annual Affiliate Compliance Certificate
List of Housing, Personnel, and Other Support Provided to Affiliate by University

Schedule 5 to Annual Affiliate Compliance Certificate
List of Support Provided by Affiliate to the University

EXHIBIT B TO UNIFORM AFFILIATION AGREEMENT
TRANSACTIONS REQUIRING A DETERMINATION OF APPROPRIATE UNIVERSITY PURPOSE

1. Unless involving operational and business management matters of Affiliate itself, Affiliate shall not undertake the following transactions and disbursements without first obtaining a determination of acceptable University purpose by the President or his designee unless (i) approval by the University's Board is required by the Board's by-laws or applicable law, or (ii) the President, in the exercise of his discretion determines that consideration of the matter at issue by the University's Board is appropriate:

A. Knowingly accepting any donation which either: contains a condition or imposes or purports to impose an obligation on the University, the fulfillment of which would require the University to undertake actions not previously taken or approvals not previously granted by the University in accordance with applicable policies and procedures without an express written provision indicating that the acceptance by Affiliate is conditioned on the acceptance of the conditions or obligations by the University's Board or President in accordance with University policies and procedures and the terms of this Agreement;

B. Accepting any donation of immovable property intended to be (a) retained by the Affiliate, rather than liquidated within a reasonable period of time, or (b) leased or otherwise occupied by a component of the University;

C. Purchasing any immovable property with a fair market value of \$500,000 or more, except property which will serve as the primary location of Affiliate's administrative offices; provided that this shall not prohibit decisions by Affiliate's Board relating to reasonable and prudent investments for the Affiliate's benefit;

D. Selling, donating, or otherwise transferring any immovable property which was acquired for use by the University, without providing at least thirty (30) days advance written notice to the LSU Executive Vice President;

E. Leasing any immovable property, facility, or portion of a facility which is expected to be occupied by the University for a period of one year or longer without providing at least thirty (30) days advance written notice to the LSU Executive Vice President;

F. Entering into any cooperative endeavor or similar agreement with any public or quasi-public entity; and,

G. Creating a legal entity as a subsidiary or component of Affiliate without providing at least thirty (30) days advance written notice (unless a shorter period for the notice is approved in writing by the Executive Vice President) to the LSU Executive Vice President. If any such legal entities are created, affiliate shall either: (i) if available, present the financial activities of each such subsidiary in discrete schedules attached to Affiliate's financial statements, or (ii) if such discrete schedules are not available, provide University with copies of the tax returns of each such subsidiary.

2. The following disbursements and transactions require approval in accordance with policies and procedures mutually agreed to by University and Affiliate:

- A. Reasonable moving expenses and reasonable relocation expenses of a University employee covered by PM 13; and,
- B. Reasonable travel, moving, relocation, entertainment, educational benefits or reimbursements may be paid to a University employee (or authorized traveler). Such payments may be made for such expenses within and above state limits when specifically approved by appropriate University administrators in accordance with University policy. Pending further specification of University policy, such expenses require approval of the employee's dean, vice chancellor or other equivalent administrative official, or their designee.

3. Contracts (or other agreements, including employment agreements) and subsequent amendments between Affiliate and a University employee should be recommended by the Chancellor (or equivalent) and approved in accordance with University policy, including approval by the Board of Supervisors, where applicable. Justification for such contracts should be in writing and demonstrate that the employee's duties are not those which the employee should perform directly for the University. These requirements shall be in addition to those of University's PM-11.

EXHIBIT C TO UNIFORM AFFILIATION AGREEMENT
PROHIBITED EXPENDITURES

1. Submission of a written request for reimbursement or direct payment of an expense by or on behalf of a University employee shall constitute a **good faith** representation by University employees and administrators whose signatures appear on such request that (a) the Affiliate's expenditure of funds as requested is consistent with applicable University policies, applicable law and the terms of this Agreement, and (b) where expenditures involve the disbursement of donor restricted funds, that the **purpose for which the expenditure has been requested** is consistent with donor intent. For purposes of evaluating Affiliate's compliance with the terms of this Agreement, Affiliate may **reasonably** rely upon such representations.¹

2. University, its employees and administrators shall not request the expenditure of funds, and Affiliate shall not expend funds for any of the following purposes, either directly or through reimbursement:

- A. Solely for the private benefit of a University employee (or the family or spouse of a University employee or other non-employee who is on University business), unless approved in accordance with section 2 of Exhibit B and section 6.3 of the Agreement;
- B. For any fines, penalties, or forfeitures of a University employee;
- C. For any gift which is represented to be personally from a University employee in his or her personal capacity;
- D. For political contributions, including payments to political action committees;
- E. For any expense or reimbursement which would create, under all the circumstances, a reasonable conclusion that the expenditure is either (i) lavish or extravagant, or (ii) the benefit to the individual University employee outweighs the benefit to the University;
- F. Where payment of the expenditure would violate the Louisiana Code of Ethics;
- G. For any purpose other than as authorized in the Agreement or through written amendment or clarification of this Agreement signed by both Affiliate and the President of University, except on the specific written recommendation of the Chancellor or equivalent (for himself/herself and those under his/her supervision) and specific written approval of the President;
- H. For any purpose which is not consistent with Affiliate's tax exempt mission and the purpose(s) stated in section 1.1 of the Agreement.
- I. Any purpose that would result in a finding that either (i) Affiliate is being operated for the benefit of private interests, or (ii) Affiliate has permitted its net earnings to inure to the

¹ The concept of "reasonable reliance" as applied to Affiliate's review of requests for expenditures submitted by the University or University personnel permits Affiliate to rely on an implied representation that such requests are consistent with University policies and procedures and the terms of this Agreement, except where, for example: (a) Affiliate has knowledge of facts indicating that representations implied in the request are not accurate, or (b) necessary documentation has not been submitted to support the request, or (c) documentation submitted in connection with the request is incomplete, inconsistent or inaccurate on its face.

benefit of any private shareholder or individual, in violation of applicable provisions of the Internal Revenue Code as amended.

EXHIBIT D TO UNIFORM AFFILIATION AGREEMENT
SCHEDULE OF AGREED-UPON PROCEDURES
For
AFFILIATE VERIFICATION OF COMPLIANCE
WITH UNIFORM AFFILIATION AGREEMENT

Independent Accountants retained by Affiliates will issue an Agreed Upon Procedures report regarding findings based on the following:

1. Confirm that Affiliate maintains a written policy regarding the handling and resolution of audit findings, audit exceptions, and any misuse of funds by observing a copy of such policy. The policy shall require that any unresolved issues be reported to the Audit Committee of the LSU Board of Supervisors consistent with Sub-section 5.6.
2. Confirm that Affiliate's governing board has established and implemented policies governing conflicts of interest by observing a copy of such policy.
3. Obtain an understanding of the internal controls in place over cash disbursements and expenditures for the period in question. On a sample of items, inspect written evidence of the internal controls and support for each transaction to determine if Affiliate has designed and implemented procedures related to the following UAA provisions:
 - Supplemental compensation or benefits, as defined in section 6.5 of the UAA paid directly to a University employee has written approval by the Chancellor or equivalent and the President of LSU.
 - Payments made to or on behalf of University employees for travel, moving, relocation, entertainment, educational benefits, and other reimbursements have been approved by the employee's dean, vice chancellor, or other equivalent administrative official approval in accordance with policies and procedures mutually agreed to by University and Affiliate.
 - Payments for moving and relocation expenses of University employees covered by PM 13 have been approved in accordance with policies and procedures mutually agreed to by University and Affiliate.
 - Payments have not been made for expenses that are solely for the private benefit of a University employee (or the family or spouse of a University employee or other non-employee who is on University business) unless approved in accordance with Section 2 of Exhibit B and Section 6.3 of the UAA.
 - Fines, forfeitures or penalties of University employees have not been paid by the Affiliate.

- Gifts represented to be personally from a University employee in his or her personal capacity have not been made by the Affiliate nor has any University employee been reimbursed for the purchase of such a gift.
- Political contributions which are prohibited by applicable Internal Revenue Service Regulations or state law have not been made or reimbursed.
- Funds have not been disbursed in connection with contracts (or other agreements including employment agreements) between the Affiliate and a University employee unless recommended by the Chancellor (or equivalent) and approved by the LSU President or the Board of Supervisors.
- Funds have been not disbursed for any purpose which is not consistent with Affiliate's tax-exempt mission and the purpose(s) stated in section 1.1 of the UAA.
- Funds have not been disbursed for any purpose that would result in a finding that either (i) Affiliate is being operated for the benefit of private interests, or (ii) Affiliate has permitted its net earnings to inure to the benefit of any private shareholder or individual, in violation of applicable provisions of the Internal Revenue Code as amended.

The proposed sample size will be provided to the LSU Executive Vice President for review and comment at least 15 days prior to the engagement. Unless otherwise mutually agreed to by Affiliate and the Executive Vice President for good cause shown, the sample size shall not exceed the fewer of 10% of Affiliate's annual transactions or 50 transactions.

4. Obtain a written representation from the Affiliate that, in accordance with Section 5.3 of the UAA, Affiliate has (a) provided the Auditor with a copy of its current UAA including any amendments thereto; (b) provided the Auditor with access to all documents and other information relevant to the UAA; and, (c) represented to its auditors that except to the extent disclosed in writing, to the best of Affiliate's knowledge, information and belief, Affiliate has complied with all applicable provisions of the UAA.



Board of Supervisors

Request from LSUHSC-NO to Acknowledge and Authorize the Uniform Affiliation Agreement with the LSUHSC-NO School of Nursing Alumni Association

Date: April 26, 2024

1. Bylaw Citation

Pursuant to Article VII, Section 1:

K. Non-Academic Affiliation Agreements

Any affiliation agreement with a private non-profit foundation formed to support the programs, facilities, and research and educational opportunities offered by one or more campuses of the University or the University as a whole.

2. Summary of Matter

The LSU Health Sciences Center – New Orleans (“LSUHSC-NO”) School of Nursing Alumni Association (“Nursing Alumni Association”) was founded in 1962 for the purpose of keeping graduates, faculty, and friends of the LSUHSC-NO School of Nursing connected to the school. The Nursing Alumni Association also supports and supplements the nursing school in its mission and goals, which include, but are not limited to, research, education, and clinical practice.

The Nursing Alumni Association holds regular meetings of its Board of Directors throughout the year, and a general membership meeting is held annually in connection with the annual reunions.

All graduates of the LSUHSC-NO School of Nursing, as well as any current student, any current or former faculty member, staff, or friend of the LSUHSC-NO School of Nursing, can join the LSU Nursing Alumni Association.

The Nursing Alumni Association desires to formalize the terms and conditions of an agreement between it and this Board by using the Board’s approved Uniform Affiliation Agreement (“UAA”). The Nursing Alumni Association is asking the Board to approve the UAA because it will allow for the furtherance of its goal of keeping graduates connected to the school, and its goal of supporting the school in research, education, and clinical practices.

Because the activities of the Nursing Alumni Association support and enhance the programs, facilities, research, and educational opportunities offered by LSUHSC-NO, and considering LSUHSC-NO’s mission and purpose, the Nursing Alumni Association now seeks the approval of the Board to enter into a UAA in accordance with the attached agreements.

3. Review of Business Plan

Not Applicable.

4. Fiscal Impact

Not Applicable.

5. Description of Competitive Process

Not Applicable.

6. Review of Legal Documents

The UAA has been prepared by and negotiated between the Nursing Alumni Association and LSUHSC-NO, and the parties are awaiting signature on behalf of the University by the President of LSU subject to Board of Supervisors' approval.

7. Parties of Interest

Board of Supervisors of Louisiana State University Agricultural and Mechanical College; LSU Health Sciences Center - New Orleans; LSUHSC-NO School of Nursing Nursing Alumni Association.

8. Related Transactions

Not applicable.

9. Conflicts of Interest

None.

10. Attachments

Nursing Alumni Association Uniform Affiliation Agreement

RESOLUTION

NOW, THEREFORE, BE IT RESOLVED that the Board of Supervisors of Louisiana State University and Agricultural and Mechanical College hereby authorizes the President of LSU or designee to execute the Uniform Affiliation Agreement with the LSUHSC-NO School of Nursing's Alumni Association, with such agreement to contain such terms and conditions as the President, in consultation with the General Counsel, deems to be in the best interests of LSU.

Uniform Affiliation Agreement

This Agreement is made and entered into on the 11th day of March, 2024, between the Board of Supervisors of Louisiana State University Agricultural and Mechanical College ("University") and LSU HSC - No School of ("Affiliate").

Nursing Alumni Association

WHEREAS, as stated in La. R.S. 17:3390(A), the Legislature has found and University recognizes that private, nonprofit organizations under the direction and control of private individuals who support institutions of higher education are effective in obtaining private support for those institutions;

WHEREAS, as further stated in La. R.S. 17:3390(A), the Legislature encourages higher education management boards and institutions to promote the activities of alumni associations, foundations, and other private, nonprofit organizations that raise private funds for the support of public institutions of higher education;

WHEREAS, after considering the proposed mission and purpose of Affiliate, University has determined that Affiliate's activities will support or enhance one or more of the programs, facilities, research and educational opportunities offered by University;

WHEREAS, because of the close association of Affiliate with the University, it is prudent and beneficial to have a clear statement, agreed upon by the parties, of the respective responsibilities, requirements, authority, and relationship of the University and Affiliate while preserving the private and independent legal status of the Affiliate:

1. Affiliate Purpose and Status

- 1.1 Affiliate's purpose(s) shall be as defined in the Affiliate's Articles of Incorporation. All actions taken by Affiliate shall be consistent with and in furtherance of its stated purpose(s), and such actions shall likewise be consistent with the institutional mission and activities of University as defined by the University. In order to prevent the unnecessary duplication of activities among University affiliates, any proposed material change in Affiliate's authorized purpose(s) must be approved in advance and in writing by the President of LSU. Requests for approval of such changes in purpose shall be submitted to LSU's Executive Vice President for Finance and Administration and CFO ("LSU Executive Vice President") with a copy delivered to the Chair of the Board of Supervisors.
- 1.2 Unless waived in writing, Affiliate shall provide at least 30 days advance written notice to the LSU Executive Vice President of any proposed material change in Affiliate's Articles of Incorporation or Bylaws.
- 1.3 Affiliate has been formed as a private non-profit Louisiana organization, and has been recognized as and shall maintain its status as an organization exempt from taxation under Section 501(c) of the Internal Revenue Code.
- 1.4 Affiliate is a separate legal entity from University. Nothing in this Agreement shall be construed as to invalidate or restrict Affiliate's private and independent legal status.

2. Governance

- 2.1 To ensure that Affiliate's status as a private entity is recognized and maintained in accordance with La. R.S. 17:3390(B), Affiliate shall meet the following criteria:
 - 2.1.1 Affiliate shall be under the management and control of a board of directors ("Affiliate's Board") elected by the members or shareholders of Affiliate.
 - 2.1.2 A majority of the voting members of Affiliate's Board shall consist of individuals who are not members or employees of a Louisiana higher education management board; and,
 - 2.1.3 Affiliate shall reimburse, either directly or in-kind, the cost of housing, personnel, and other support furnished to Affiliate by any institution of higher education.
- 2.2 Members of Affiliate Boards
 - 2.2.1 The President of LSU, or his designee, shall be a non-voting *ex officio* member of Affiliate's Board and of the Executive Committee of such Board (or equivalent). To promote compliance with Affiliate's policy on conflicts of interest, and ensure that appropriate disclosures are made and facilitate an understanding of Affiliate's business, the President of LSU will provide Affiliate with reasonable advance notice identifying individuals designated to attend meetings in his place and will endeavor to utilize a single individual as his designee.
 - 2.2.2 The Chairman of the Board of Supervisors, in consultation with members of the Board of Supervisors and Chairman of the Affiliate Board, shall have the right to recommend a list of members of the Board of Supervisors as potential candidates to Affiliate for election to Affiliate's Board as non-voting members. Affiliate agrees that at all times, excluding instances associated with temporary vacancies created by death, resignation or similar causes, at least one member of its Board, shall be elected from the recommended candidates.
 - 2.2.3 Designation of the President of LSU (or his designee) and Affiliate's election of an individual nominated by the Chairman of the Board of Supervisors to serve as a member of Affiliate's Board and/or Executive Committee is not intended to and shall not be deemed a waiver of the privileges and immunities granted Affiliate pursuant to La. R.S. 17:3390.
- 2.3 If the Affiliate is in primary support of a single campus or institution, the Chancellor or equivalent shall, at a minimum, be given notice of and the ability to attend and participate as a non-voting, *ex officio* member in meetings of the Affiliate's Board and Executive Committee.
- 2.4 Members of the Board of Directors and the Executive Committee shall have reasonable access to all books and records of Affiliate in accordance with its generally applicable confidentiality and non-disclosure policies, provided that members who are or may be deemed "public servants," as defined in La. R.S. 42:1102(19), shall not have legal custody of Affiliate's books and records. Requests for access to books and records shall be made via written request directed to Affiliate's Chief Executive Officer.

3. General Duties and Responsibilities of Affiliate

- 3.1 Operate Affiliate for primary benefit of University in accordance with Affiliate’s Articles of Incorporation and tax-exempt purpose.
- 3.2 Support and promote the mission and activities of the University.
- 3.3 Affiliate shall establish and enforce policies to identify and manage potential conflicts of interest and ensure that Affiliate’s assets do not directly or indirectly unduly benefit any individual or other person.
- 3.4 Solicit and accept things of value of all kinds consistent with applicable law.
- 3.5 Receive, hold, invest, administer, manage, distribute and provide good stewardship of gifts and bequests in accordance with donor intent, applicable law and applicable University and Affiliate policies and procedures.
- 3.6 Expend funds for the establishment and operation of Affiliate and for any reasonable expenses incidental to the conduct of the affairs of Affiliate.
- 3.7 Within 120 days following the close of Affiliate’s fiscal year, unless an extension is granted by the LSU Executive Vice President, submit the annual Affiliate Compliance Certificate (Exhibit A) and materials referenced therein, to the LSU Executive Vice President.
- 3.8 Subject to any limitations imposed by contracts among the University and third parties and applicable University policies, the Affiliate may be granted the right by University to utilize its “licensed marks” on a royalty free basis for its activities in support of LSU. Affiliate must adhere to the Louisiana State University Brand Identity.
- 3.9 University is an equal opportunity/access institution committed to diversity and inclusiveness in procurement. Affiliate is encouraged to reflect the spirit of this commitment in its business practices by: (a) participating in and encouraging major suppliers to participate in LSU sponsored outreach programs for small businesses as well as minority, women and veteran owned businesses (“DBEs”); (b) creating awareness among its suppliers that University and Affiliate encourage suppliers to make reasonable and prudent efforts to identify and provide competitive opportunities for participation by DBEs; and, (c) making reasonable and prudent efforts consistent with its unique needs as well as its fiduciary and good stewardship obligations, to identify and provide competitive opportunities for DBEs to participate in Affiliate’s procurement opportunities. To assist Affiliate in its efforts, the University will make the resources of its Supplier Diversity program, including but not limited to lists of registered DBE’s, personnel and information on best practices, available to Affiliate.

4. General Duties and Responsibilities of University

- 4.1 Support and promote the purpose and activities of Affiliate and encourage the donation of private funds to Affiliate;
- 4.2 Avoid action that would undermine Affiliate’s status as a private entity, maintain the confidentiality of donor records and the private nature of Affiliate’s books and records to the extent allowed by law;

- 4.3 Accept funds made available by Affiliate, provide good stewardship of gifts once received by University and utilize funds received from Affiliate in a manner consistent with University's mission, terms and conditions imposed by testators and donors, applicable law, this Agreement and University policy; and,
- 4.4 Make available to Affiliate, at University's sole discretion, appropriate facilities, personnel, or other support pursuant to the provisions of La. R.S. 17:3390(B)(3) and as otherwise permitted by law.

5. Records, Internal Controls and Funds Management

- 5.1 Recognizing the need to preserve the public trust and guard against the appearance of impropriety in its activities, Affiliate shall adopt, maintain, and enforce necessary and appropriate policies, procedures and internal controls, including policies on conflicts of interest, required for the conduct of its business in accordance with applicable law, the terms of this Agreement, applicable University policies and procedures and best practices for similar nonprofit organizations.
- 5.2 The books and records of Affiliate shall be kept in accordance with customary and current accounting standards. For the preparation of reports required by this section of this Agreement, an external accountant and/or auditor engaged to conduct such reports shall be selected from among the most recent list of certified public accountants maintained by the Louisiana Legislative Auditor.
- 5.3 In connection with its annual financial audit, Affiliate shall: (a) provide its auditors with a copy of this Agreement including all exhibits, schedules, and other attachments; (b) provide its auditors with access to all documents and other information relevant to this Agreement; (c) require Affiliate's chief executive officer to represent to its auditors that except to the extent disclosed in writing, to the best of Affiliate's knowledge, information and belief, Affiliate has complied with all applicable provisions of this Agreement; and, (d) rotate audit partners or firms at least every five years.
- 5.4 On a biennial basis, to commence in an Affiliate's fiscal year (commencing on or following execution of this Agreement by Affiliate) designated by the Executive Vice President, or on an annual basis if requested in writing by the LSU Executive Vice President for good cause shown, Affiliate shall separately engage an Independent Accountant (which may be the same firm conducting its financial statement audit) to perform various procedures necessary to issue an Agreed Upon Procedures report concerning items included in the Schedule of Agreed - Upon Procedures for Verification of Affiliate Compliance (Exhibit D).
- 5.5 Affiliate shall provide to the LSU Executive Vice President within 120 days of the close of Affiliate's fiscal year: (a) its audited financial statements; and (b) its Agreed Upon Procedures report. At the request of the LSU Office of Internal Audit, Affiliate and its independent auditors shall arrange to meet with representatives from the LSU Office of Internal Audit to review written findings and/or the Agreed Upon Procedures report.
- 5.6 Affiliate shall evaluate and, where appropriate, take corrective action to remedy material and substantial audit findings. Material and substantial audit findings which have not either been

(a) resolved by management or, where appropriate, through corrective action within ninety (90) days following issuance of the annual audit, or (b) in cases where corrective action is appropriate, corrective action reasonably designed to resolve the issue has not been taken within ninety (90) days following issuance of the annual audit, shall be reported to the Audit Committee of the Board of Supervisors in writing.

- 5.7 Pursuant to a separate written Funds Management Agreement authorized and executed by University and Affiliate, University may in its discretion agree to deliver and Affiliate may agree to accept for deposit with Affiliate funds which have been donated to the University by private individuals or entities or which have been provided from the state to the University pursuant to the Board of Regents Support Fund or other programs.

6. Certain Disbursements and Other Transactions

- 6.1 All disbursements by Affiliate for administrative and operating expenses shall be in accordance with policies adopted by Affiliate's Board and in accordance with its annual budget, as modified by policies and procedures adopted by Affiliate's Board. Such policies shall provide for sound and prudent business practices, the payment or reimbursement of ordinary, necessary and reasonable business expenses, and shall address the content of this Agreement.
- 6.2 Affiliate shall not undertake the disbursements and transactions described on Exhibit B, other than transactions and disbursements involving operational and business management matters of Affiliate itself, without first obtaining a determination of acceptable University purpose from the appropriate University authority.
- 6.3 No donation requiring a determination of acceptable University purpose shall be publicized or otherwise disclosed by Affiliate prior to acceptance of any conditions or obligations by the University's Board or President of LSU in accordance with University policies and procedures.
- 6.4 Requests for a determination of acceptable University purpose shall be submitted to the President of LSU or to the Board through the President as may be appropriate by the Chancellor (or equivalent) of the campus or institution for whose benefit the action is proposed, in accordance with the procedures set forth in University procedures. Any submission shall include a specific recommendation from the Chancellor or equivalent demonstrating that the proposed transaction is in support of the University and its mission.
- 6.5 Absent exceptional circumstances and written approval by the Chancellor (or equivalent) and President (or designee), supplemental compensation or benefits to a University employee shall be paid through the University, not directly by Affiliate to the employee. For purposes of this section, supplemental compensation or benefits shall mean all compensation or benefits in addition to the base university compensation and benefits approved by the Board of Supervisors for duties performed by the employee for the University.
- 6.6 To ensure compliance with La. R.S. 17:3390(F), payments of over one thousand (\$1,000) dollars for any single transaction to, or on behalf of, or to reimburse the expense of a public employee of a public higher education institution or a public employee or officer of a management board of a public higher education institution shall be periodically reviewed and

approved by the Board of Supervisors in accordance with applicable policies and procedures. Affiliate may pay or reimburse such transactions pending approval by the Board, provided that any such payments or reimbursements subsequently disapproved by the Board shall be reimbursed to the Affiliate by the public employee or officer within ninety (90) days of such disapproval.

7. Prohibited Expenditures, Advisory Opinions

- 7.1 University, its employees and administrators shall not request the expenditure of funds and Affiliate shall not expend funds for any of the purposes described in section 2 of Exhibit C either directly or through reimbursement.
- 7.2 Where there is doubt about the reasonableness or validity of a proposed expenditure or transaction, or the procedure by which such expenditure or transaction should be reviewed, the Chancellor or equivalent, or legal counsel for Affiliate, shall seek an advisory opinion from the President, through the LSU Executive Vice President. Where appropriate, the President may refer the question to the Board of Supervisors for a decision. The President may adopt guidelines to facilitate the provisions of this sub-section.

8. Funds Management Agreements/Commitment of University Funds

- 8.1 With the written consent of the LSU Executive Vice President, Affiliate may enter into one or more agreements (“Funds Management Agreements”) with other affiliates of University (that is, other non-profit organizations which are recognized pursuant to University policy) so that one affiliate will manage the funds of another affiliate. In such event, the affiliate which is agreeing to manage the funds of the other affiliate shall be known as the “Funds Owner” while the affiliate transferring the funds shall be known as the “Funds Manager.”
- 8.2 Unless otherwise specifically provided for in the Funds Management Agreement, the Funds Manager shall have no internal control or audit responsibilities with respect to the Funds Owner; provided, however, that the Funds Manager shall cooperate with the Funds Owner’s management and auditors with respect to such matters.
- 8.3 Where Affiliate enters into a Funds Management Agreement with an organization that has not executed an Affiliation Agreement with University, such Funds Management Agreements shall:
 - 8.3.1 Require that the funds of the Funds Owner be included in either (a) the Funds Manager’s annual audit conducted pursuant to La. R.S. 17:3390 or, (b) if the Funds Manager is exempt from annual audit requirements pursuant to R.S. 17:3390, an exemption certificate and a sworn financial statement in accordance with La. R.S. 17:3390D(3)(a)-(c).
 - 8.3.2 Notify the Funds Owner of the requirements of La. R.S. 17:3390(D).
- 8.4 In connection with transactions requiring the commitment of material University resources (including the transfer of University funds), the Affiliate will enter into a written agreement outlining the structure or details of each specific transaction, excluding routine transactions;

the obligations of Affiliate, University, and any other parties; the public purpose to be achieved from such transaction; and, either a reasonable expectation that benefits to the University resulting from the transaction will equal or exceed the value of funds provided by the University or an affirmation that the value of the University funds committed to the transaction will be reimbursed, either directly or through in-kind services in accordance with the requirements of La. R.S. 17:3390(B)(3).

- 8.5 Upon written request from the LSU Executive Vice President, Affiliates that are exempt from annual audit requirements pursuant to La. R.S. 17:3390, may be required to submit a financial audit or agreed to procedures report acceptable to the University conducted in accordance with generally accepted auditing standards by an independent professional auditor or, at Affiliate's option, LSU Internal Audit personnel. In connection with any audit or agreed to procedures conducted pursuant to this section, Affiliate shall: (a) provide its auditors with a copy of this Agreement; (b) provide its auditors with access to all documents and other information relevant to this Agreement; and, (c) represent to its auditors that except to the extent disclosed in writing, to the best of Affiliate's knowledge, information and belief, Affiliate has complied with all applicable provisions of this Agreement.

9. Term and Termination

- 9.1 This Agreement revises and replaces previous Affiliation Agreements between University and Affiliate. It shall take effect on the date first written above, and shall continue for a period of one year. Thereafter, it shall be automatically renewed and extended for additional one-year periods unless Affiliate gives notice to terminate pursuant to the provisions of section 9.2, or University gives notice to terminate pursuant to the provisions of section 9.3. The provisions of this section shall survive any such termination.
- 9.2 Except to the extent modified by this Agreement or a separate written Agreement between Affiliate and University, Affiliate may terminate this Agreement without cause by providing written notice to the University no less than six (6) months prior to the effective date of the termination.
- 9.3 Except to the extent modified by this Agreement or a separate written Agreement between Affiliate and University, University may terminate this Agreement for cause in the event of:
- 9.3.1 Affiliate commits a material and substantial violation of the terms of this Agreement and fails to cure such violation after being provided with at least 30 days' notice of such violation,
 - 9.3.2 Affiliate engages in or negligently allows: (a) any material and substantial misuse of Affiliate's funds, or (b) any fraudulent or other illegal activity,
 - 9.3.3 the commencement of a voluntary bankruptcy proceeding by Affiliate or the commencement of an involuntary bankruptcy proceeding against Affiliate that is not dismissed within 120 days,
 - 9.3.4 the commencement of a voluntary dissolution proceeding by Affiliate or an involuntary dissolution proceeding against Affiliate that is not dismissed within 120 days,

- 9.3.5 a transfer of the campus, institution or program supported by Affiliate to another higher education management board,
 - 9.3.6 elimination or modification of programs offered by University such that Affiliate is no longer deemed necessary to the University's mission or the Affiliate is no longer able to achieve its purpose(s), or
 - 9.3.7 the occurrence of any other material event or circumstance similar in nature to those described in subsections 9.3.1-9.3.6 which, in the reasonable judgment of the University, constitutes cause and remains uncured following thirty (30) days' notice to Affiliate.
- 9.4 Upon termination of this Agreement, Affiliate shall:
- 9.4.1 Cease to use the University's name, marks or other indicia to solicit donations or for any other purpose and shall not in any way represent to alumni, contributors, and the general public that said Affiliate is affiliated with the University or authorized to raise funds for any of the colleges, schools, departments, and divisions comprising it;
 - 9.4.2 Unless otherwise directed in writing by the University or unless otherwise required pursuant to the terms of applicable law, immediately transfer to University or another affiliate designated by University, all public funds which Affiliate holds as a depository pursuant to the provisions of section 8.0;
 - 9.4.3 Terminate any Management Agreements entered into with other University affiliates in accordance with the terms of Section 8 of this Agreement and immediately return any managed funds to the appropriate Managed Affiliate(s); and,
 - 9.4.4 Provide an accounting to University of all funds, public or private, held by Affiliate within 120 days of notice of termination unless extended in writing by mutual agreement.
- 9.5 If the Affiliate's purpose is in primary support of a single campus or institution, and the necessity for termination of this Agreement results from the transfer of the supported campus or institution to another public higher education management board ("Transferee Institution"), to the extent consistent with applicable law and prudent financial management practices, the applicable provisions of any legislation authorizing transfer of the supported campus or institution and compliance with sections 9.4.1 through 9.4.4 of this Agreement, Affiliate may effect the termination of this agreement to the extent it enters into an affiliation agreement with the Transferee Institution providing for Affiliate's ability to continue its mission of supporting the same campus or institution subject to oversight by the Transferee Institution. Preceding the transfer, there shall be a review to determine whether there is any adverse impact on the University. In the event that Affiliate enters into an affiliation agreement with a Transferee Institution pursuant to the terms of this Section, the Transferee Institution and Affiliate shall agree to indemnify, defend and hold harmless University, its members, employees and agents from and against any and all claims and liabilities associated with or in any way arising out of University's association with Affiliate and Affiliate's actions or inactions (whether past, present or future).
- 9.6 Upon dissolution of Affiliate, whether dissolution is voluntary or involuntary, subject to compliance with sections 9.4 – 9.5 of this Agreement, applicable laws and Affiliate's Articles of Incorporation and other governing documents, Affiliate shall provide for its net assets to be distributed to another nonprofit affiliated with the University as designated by the

President of LSU, unless otherwise agreed by the University and Affiliate or directed by a court of competent jurisdiction and venue, to be used as nearly as practicable in accordance with the express terms of written acts of donation, testaments, pledges and similar instruments, donor intent, Affiliate's governing documents, purposes and applicable law. This paragraph shall not prejudice the rights of creditors including, without limitation, any properly approved, valid, and enforceable financing agreements executed by Affiliate.

10. Notices, Entire Agreement, Venue

- 10.1 Unless otherwise provided herein, whenever any notice or demand is required or permitted under this agreement, such notice or demand shall be given in writing and delivered in person or by certified mail to the University, addressed to its President at 3810 West Lakeshore Drive, Baton Rouge, LA, and to Affiliate at the address shown above. Unless otherwise provided herein, such advance notice requirements and time periods designated for the performance of specific acts may be extended or waived, in writing, by the LSU Executive Vice President.
- 10.2 This Agreement, including all exhibits, constitutes the entire agreement between the parties and shall not be amended except in writing signed by the President of University and a duly authorized officer of Affiliate. This Agreement is not intended to and does not create any rights in third parties.
- 10.3 The parties anticipate that they will enter into separate agreements for specific projects. Where there is a conflict between the terms of this Agreement and the terms of any separate agreement, the terms of the separate agreement shall control.
- 10.4 This Agreement is entered into, and any action arising from this Agreement shall be brought in, East Baton Rouge Parish, Louisiana.

THUS DONE AND SIGNED this ___ day of _____, 20___, by the undersigned duly authorized representatives.

For Affiliate:

For University:

By: _____

Name: Joseph Eppling

Title: School of Nursing

Alumni Association

President

By: _____

Name:

Title:

EXHIBIT A TO UNIFORM AFFILIATION AGREEMENT
ANNUAL AFFILIATE COMPLIANCE CERTIFICATE

Date _____

LSU Board of Supervisors

Attn: _____

Baton Rouge, Louisiana

Re: _____ ("Organization")
Annual Compliance Certificate

Members of the LSU Board of Supervisors:

In my capacity as the Chief Executive Officer (or other authorized officer) of _____, I am writing to confirm that *after making reasonable and appropriate inquiries, to the best of my knowledge, information and belief*, the following information is true and correct as of the date of this letter:

1. The Organization is required to obtain an annual financial audit in accordance with La. R.S. 17:3390. The annual financial audit for the fiscal year ending _____, conducted by an independent auditor, has been completed and a copy was provided to the Legislative Auditor with a copy to your office by letter dated _____;

OR

The Organization is exempt from the annual audit requirements of La. R.S. 17:3390, and copies of the Organization's exemption certificate and sworn financial statement prepared in accordance with La. R.S. 17:3390D(3)(a)-(c), were provided to the Legislative Auditor with a copy to your office by letter dated _____;

2. The Organization's annual tax return for the _____ tax year was completed and filed with IRS on _____ and a copy was delivered to your office by letter dated _____;

OR IF APPLICABLE

The Organization has requested an extension through _____ within which to file its annual tax return for the _____ tax year, and a copy of the return will be provided to your office upon filing;

3. A complete list of all active corporate affiliates and subsidiaries of the Organization as of this date and the purpose for which such entities have been formed is attached to this certificate as Schedule "1";

4. A complete list of all “managed organizations” as defined in the Uniform Affiliation Agreement, managed by the Organization is attached to this certificate as Schedule “2”;
5. A current list of the Organization’s officers and directors is attached to this certificate as Schedule “3”;
6. A copy of the Organization’s Articles of Incorporation and Bylaws are on file with and copies of any proposed amendments have been provided to the Executive Vice President;
7. The Organization is registered as a Louisiana nonprofit entity and it remains exempt from taxation in accordance with Sections _____ of the Internal Revenue Code;
8. The Organization has taken all necessary action, including any filings required by the Louisiana Secretary of State and other authorities, to maintain its corporate existence and its tax-exempt status;
9. A preliminary list, which is subject to confirmation by your office, showing the type of any housing, personnel, and other support provided to Affiliate by University during the previous fiscal year pursuant to the provisions of La. R.S. 17:3390(B)(3), including (i) amount and location of any space or facilities provided, (ii) number of personnel provided, and (iii) a listing of the type of any other services provided to Affiliate by University is attached to this certificate as Schedule “4”;
10. As detailed in Schedule “5” to this certificate, during the previous fiscal year, (i) subject to confirmation by your office, our records indicate that the total amount paid in cash to University as direct reimbursement for housing, personnel and other support was \$_____, and (ii) subject to confirmation by your office, our records indicate that the total dollar value of all property provided to the University together with all expenditures made in support of the University (exclusive of costs for personnel employed solely by and for the benefit of Affiliate, facilities occupied solely by Affiliate and other Affiliate overhead and administrative costs), which amount shall be considered "in-kind" reimbursement for purposes of La. R.S. 17:3390(b)(3), was \$_____;
11. The Organization maintains and enforces a policy on conflicts of interest as well as other policies procedures and internal controls required for the conduct of its business in accordance with applicable law, the terms of the Affiliation Agreement, applicable University policies and procedures and best practices for similar nonprofit organizations;
12. Except as specifically provided for under the circumstances described in Sections 6 and 7 of the Uniform Affiliation Agreement or previously disclosed in writing to the Executive Vice President, the Organization has not engaged in any prohibited transactions or made any prohibited expenditures over the last fiscal year;
13. Except as previously disclosed in writing to the Audit Committee of the Board of Supervisors, the Organization resolved or will resolve any material and substantial audit findings within

90 days of the issuance of its annual audit in accordance with Uniform Affiliation Agreement Section 5.4;

14. The Organization has provided a copy of its current Affiliation Agreement and access to all documents and other information relevant to the Affiliation Agreement to its independent auditors, if applicable, for use in the evaluation of our internal controls and determining compliance with the Affiliation Agreement in connection with transactions reviewed by the auditors in the course of their work. The Organization has represented to its auditors that except to the extent disclosed in writing, to the best of Affiliate's knowledge, information and belief, Affiliate has complied with all applicable provisions of the Affiliation Agreement; and,
15. A copy of the Agreed Upon Procedures report described in Section 5.4 and Exhibit D was provided to your office by letter dated _____.

Sincerely,

Name:

Title:

Schedule 1 to Annual Affiliate Compliance Certificate
List of Corporate Affiliates and Subsidiaries and Purposes of Such Entities

Name of Entity Type of Entity and Purpose

Schedule 2 to Annual Affiliate Compliance Certificate
List of "Managed Organizations"

Name of Entity Type of Entity and Purpose

Schedule 3 to Annual Affiliate Compliance Certificate
List of "Affiliate's Officers and Directors"

Schedule 4 to Annual Affiliate Compliance Certificate
List of Housing, Personnel, and Other Support Provided to Affiliate by University

Schedule 5 to Annual Affiliate Compliance Certificate
List of Support Provided by Affiliate to the University

EXHIBIT B TO UNIFORM AFFILIATION AGREEMENT
TRANSACTIONS REQUIRING A DETERMINATION OF APPROPRIATE UNIVERSITY PURPOSE

1. Unless involving operational and business management matters of Affiliate itself, Affiliate shall not undertake the following transactions and disbursements without first obtaining a determination of acceptable University purpose by the President or his designee unless (i) approval by the University's Board is required by the Board's by-laws or applicable law, or (ii) the President, in the exercise of his discretion determines that consideration of the matter at issue by the University's Board is appropriate:
 - A. Knowingly accepting any donation which either: contains a condition or imposes or purports to impose an obligation on the University, the fulfillment of which would require the University to undertake actions not previously taken or approvals not previously granted by the University in accordance with applicable policies and procedures without an express written provision indicating that the acceptance by Affiliate is conditioned on the acceptance of the conditions or obligations by the University's Board or President in accordance with University policies and procedures and the terms of this Agreement;
 - B. Accepting any donation of immovable property intended to be (a) retained by the Affiliate, rather than liquidated within a reasonable period of time, or (b) leased or otherwise occupied by a component of the University;
 - C. Purchasing any immovable property with a fair market value of \$500,000 or more, except property which will serve as the primary location of Affiliate's administrative offices; provided that this shall not prohibit decisions by Affiliate's Board relating to reasonable and prudent investments for the Affiliate's benefit;
 - D. Selling, donating, or otherwise transferring any immovable property which was acquired for use by the University, without providing at least thirty (30) days advance written notice to the LSU Executive Vice President;
 - E. Leasing any immovable property, facility, or portion of a facility which is expected to be occupied by the University for a period of one year or longer without providing at least thirty (30) days advance written notice to the LSU Executive Vice President;
 - F. Entering into any cooperative endeavor or similar agreement with any public or quasi-public entity; and,
 - G. Creating a legal entity as a subsidiary or component of Affiliate without providing at least thirty (30) days advance written notice (unless a shorter period for the notice is approved in writing by the Executive Vice President) to the LSU Executive Vice President. If any such legal entities are created, affiliate shall either: (i) if available, present the financial activities of each such subsidiary in discrete schedules attached to Affiliate's financial statements, or (ii) if such discrete schedules are not available, provide University with copies of the tax returns of each such subsidiary.

2. The following disbursements and transactions require approval in accordance with policies and procedures mutually agreed to by University and Affiliate:
 - A. Reasonable moving expenses and reasonable relocation expenses of a University employee covered by PM 13; and,

- B. Reasonable travel, moving, relocation, entertainment, educational benefits or reimbursements may be paid to a University employee (or authorized traveler). Such payments may be made for such expenses within and above state limits when specifically approved by appropriate University administrators in accordance with University policy. Pending further specification of University policy, such expenses require approval of the employee's dean, vice chancellor or other equivalent administrative official, or their designee.

- 3. Contracts (or other agreements, including employment agreements) and subsequent amendments between Affiliate and a University employee should be recommended by the Chancellor (or equivalent) and approved in accordance with University policy, including approval by the Board of Supervisors, where applicable. Justification for such contracts should be in writing and demonstrate that the employee's duties are not those which the employee should perform directly for the University. These requirements shall be in addition to those of University's PM-11.

EXHIBIT C TO UNIFORM AFFILIATION AGREEMENT
PROHIBITED EXPENDITURES

1. Submission of a written request for reimbursement or direct payment of an expense by or on behalf of a University employee shall constitute a **good faith** representation by University employees and administrators whose signatures appear on such request that (a) the Affiliate's expenditure of funds as requested is consistent with applicable University policies, applicable law and the terms of this Agreement, and (b) where expenditures involve the disbursement of donor restricted funds, that the **purpose for which the expenditure has been requested** is consistent with donor intent. For purposes of evaluating Affiliate's compliance with the terms of this Agreement, Affiliate may **reasonably** rely upon such representations.¹

2. University, its employees and administrators shall not request the expenditure of funds, and Affiliate shall not expend funds for any of the following purposes, either directly or through reimbursement:

- A. Solely for the private benefit of a University employee (or the family or spouse of a University employee or other non-employee who is on University business), unless approved in accordance with section 2 of Exhibit B and section 6.3 of the Agreement;
- B. For any fines, penalties, or forfeitures of a University employee;
- C. For any gift which is represented to be personally from a University employee in his or her personal capacity;
- D. For political contributions, including payments to political action committees;
- E. For any expense or reimbursement which would create, under all the circumstances, a reasonable conclusion that the expenditure is either (i) lavish or extravagant, or (ii) the benefit to the individual University employee outweighs the benefit to the University;
- F. Where payment of the expenditure would violate the Louisiana Code of Ethics;
- G. For any purpose other than as authorized in the Agreement or through written amendment or clarification of this Agreement signed by both Affiliate and the President of University, except on the specific written recommendation of the Chancellor or equivalent (for himself/herself and those under his/her supervision) and specific written approval of the President;
- H. For any purpose which is not consistent with Affiliate's tax exempt mission and the purpose(s) stated in section 1.1 of the Agreement.
- I. Any purpose that would result in a finding that either (i) Affiliate is being operated for the benefit of private interests, or (ii) Affiliate has permitted its net earnings to inure to the benefit of any private shareholder or individual, in violation of applicable provisions of the Internal Revenue Code as amended.

¹ The concept of "reasonable reliance" as applied to Affiliate's review of requests for expenditures submitted by the University or University personnel permits Affiliate to rely on an implied representation that such requests are consistent with University policies and procedures and the terms of this Agreement, except where, for example: (a) Affiliate has knowledge of facts indicating that representations implied in the request are not accurate, or (b) necessary documentation has not been submitted to support the request, or (c) documentation submitted in connection with the request is incomplete, inconsistent or inaccurate on its face.

EXHIBIT D TO UNIFORM AFFILIATION AGREEMENT
SCHEDULE OF AGREED-UPON PROCEDURES
For
AFFILIATE VERIFICATION OF COMPLIANCE
WITH UNIFORM AFFILIATION AGREEMENT

Independent Accountants retained by Affiliates will issue an Agreed Upon Procedures report regarding findings based on the following:

1. Confirm that Affiliate maintains a written policy regarding the handling and resolution of audit findings, audit exceptions, and any misuse of funds by observing a copy of such policy. The policy shall require that any unresolved issues be reported to the Audit Committee of the LSU Board of Supervisors consistent with Sub-section 5.6.
2. Confirm that Affiliate's governing board has established and implemented policies governing conflicts of interest by observing a copy of such policy.
3. Obtain an understanding of the internal controls in place over cash disbursements and expenditures for the period in question. On a sample of items, inspect written evidence of the internal controls and support for each transaction to determine if Affiliate has designed and implemented procedures related to the following UAA provisions:
 - Supplemental compensation or benefits, as defined in section 6.5 of the UAA paid directly to a University employee has written approval by the Chancellor or equivalent and the President of LSU.
 - Payments made to or on behalf of University employees for travel, moving, relocation, entertainment, educational benefits, and other reimbursements have been approved by the employee's dean, vice chancellor, or other equivalent administrative official approval in accordance with policies and procedures mutually agreed to by University and Affiliate.
 - Payments for moving and relocation expenses of University employees covered by PM 13 have been approved in accordance with policies and procedures mutually agreed to by University and Affiliate.
 - Payments have not been made for expenses that are solely for the private benefit of a University employee (or the family or spouse of a University employee or other non-employee who is on University business) unless approved in accordance with Section 2 of Exhibit B and Section 6.3 of the UAA.
 - Fines, forfeitures or penalties of University employees have not been paid by the Affiliate.

- Gifts represented to be personally from a University employee in his or her personal capacity have not been made by the Affiliate nor has any University employee been reimbursed for the purchase of such a gift.
- Political contributions which are prohibited by applicable Internal Revenue Service Regulations or state law have not been made or reimbursed.
- Funds have not been disbursed in connection with contracts (or other agreements including employment agreements) between the Affiliate and a University employee unless recommended by the Chancellor (or equivalent) and approved by the LSU President or the Board of Supervisors.
- Funds have been not disbursed for any purpose which is not consistent with Affiliate's tax-exempt mission and the purpose(s) stated in section 1.1 of the UAA.
- Funds have not been disbursed for any purpose that would result in a finding that either (i) Affiliate is being operated for the benefit of private interests, or (ii) Affiliate has permitted its net earnings to inure to the benefit of any private shareholder or individual, in violation of applicable provisions of the Internal Revenue Code as amended.

The proposed sample size will be provided to the LSU Executive Vice President for review and comment at least 15 days prior to the engagement. Unless otherwise mutually agreed to by Affiliate and the Executive Vice President for good cause shown, the sample size shall not exceed the fewer of 10% of Affiliate's annual transactions or 50 transactions.

4. Obtain a written representation from the Affiliate that, in accordance with Section 5.3 of the UAA, Affiliate has (a) provided the Auditor with a copy of its current UAA including any amendments thereto; (b) provided the Auditor with access to all documents and other information relevant to the UAA; and, (c) represented to its auditors that except to the extent disclosed in writing, to the best of Affiliate's knowledge, information and belief, Affiliate has complied with all applicable provisions of the UAA.



Board of Supervisors

ATHLETICS COMMITTEE

BOARD OF SUPERVISORS MEETING | APRIL 26, 2024



Board of Supervisors

**Request from LSU Athletics to Approve New Employment Agreement
for Senior Associate Athletics Director for Football Administration**

Date: April 26, 2024

1. Bylaw Citation

Pursuant to Article VII, Section 1(L)(3):

The following matters shall require approval by the Board, regardless of any delegations of authority otherwise provided for in these Bylaws or the Regulations of the Board. Except as set forth herein, no such matter shall be undertaken or approved by or for any campus or the University without prior review by the President and appropriate University Officers and express, formal approval by the Board.

* * * *

Appointments and all other personnel actions relating to varsity athletics coaches and Athletic Directors receiving a salary of \$250,000 or above.

2. Summary of Matter

This resolution seeks approval of a new employment agreement for Paul "Austin" Thomas, Senior Associate Athletics Director for Football Administration. The key terms of the agreement are summarized below:

Name	Title	Proposed Start Date	Proposed End Date	Proposed Total Certain Compensation ^a
Paul "Austin" Thomas	Senior Associate AD for Football Administration	1/30/2024	1/15/2027	\$425,000

Notes:

- (a) Total Certain Compensation includes all compensation which the coach is contractually guaranteed to receive annually in the first contract year. It does not include the value of any fringe benefits, such as car allowances, nor any one-time amounts, such as buy-outs, post-season incentive compensation or relocation allowances.

3. Review of Business Plan

Not applicable.

4. Fiscal Impact

The Athletics Department currently expects all funds relating to this Employment Agreement will be paid from revenues generated by the Athletics Department.

5. Description of Competitive Process

Not applicable.

6. Review of Legal Documents

The Office of General Counsel has reviewed the Employment Agreement.

7. Parties of Interest

LSU and the above-named personnel.

8. Related Transactions

None.

9. Conflicts of Interest

None known.

10. Attachment

Employment Agreement: Paul "Austin" Thomas

RESOLUTION

NOW, THEREFORE, BE IT RESOLVED the Board of Supervisors of Louisiana State University and Agricultural & Mechanical College approves the Employment Agreement for Paul "Austin" Thomas as described in this item, and authorizes President William F. Tate IV to execute the Employment Agreement in consultation with the Office of General Counsel.

EMPLOYMENT AGREEMENT

This Employment Agreement (“Agreement”) is made and entered into as of this 26th day of April, 2024, by and between the Board of Supervisors of Louisiana State University and Agricultural and Mechanical College (“LSU”), a body corporate existing under the Constitution and laws of the State of Louisiana, herein represented by William F. Tate IV, its duly authorized President, and Paul “Austin” Thomas (“Employee”):

1. **Definitions.** For purposes of this Agreement, the following terms shall have the meaning shown:
 - A. “Athletics Director”: The Director of Athletics at LSU.
 - B. “Base Salary”: The annualized sum of \$425,000.
 - C. “Contract Year”: An annual period from January 1 to December 31 during the Term.
 - D. “End Date”: January 15, 2027.
 - E. “Position”: Senior Associate Athletics Director for Football Administration.
 - F. “President”: The President of LSU.
 - G. “Program”: The intercollegiate football program at LSU.
 - H. “Relocation Incentive”: The one-time payment of \$25,000.
 - I. “Start Date”: January 30, 2024.
 - J. “Team”: The intercollegiate athletic team which is a part of the Program.
2. **Term.** This Agreement shall be for a definite term (“Term”), commencing on the Start Date and ending on the End Date unless terminated sooner in accordance with Section 10 or 11 of this Agreement.
3. **Employment.** LSU does hereby employ Employee in the Position for the Term. Employee will report directly to the Athletics Director or the Athletics Director’s designee. It is the intention of the parties that Employee will serve in the Position for the entirety of the Term. Employee acknowledges and agrees that Employee is not eligible for and will not be considered for or granted tenure by LSU.
4. **Duties and Responsibilities.** Employee’s duties and responsibilities shall include the following, all subject to law, LSU policy, and the directives, input, and advice of the Athletics Director:
 - A. Being reasonably knowledgeable of and complying with: (1) all applicable federal and state laws governing intercollegiate athletics; and (2) all governing constitutions, by-laws, rules, policies, interpretations, and regulations of the

National Collegiate Athletics Association (“NCAA”), the Southeastern Conference (“SEC”), LSU, and any other conference rules or policies which may be subsequently implemented (hereinafter collectively referred to as “Governing Athletics Regulations”);

- B. Assisting with the development and implementation of plans, policies, procedures and programs that are in compliance with the rules and regulations of LSU, the SEC or any successor organization, and the NCAA or any successor organization, as well as all applicable local, state and federal laws which promote the mission of the Athletics Department (“Department”), LSU’s high standard of academic excellence, and the general welfare of student-athletes;
- C. Observing, respecting, and promoting the principles of institutional control in every aspect of the Department and throughout all of its intercollegiate athletic programs;
- D. Assisting with management and oversight of the Program and promoting athletic excellence on local, conference and national levels for the Program;
- E. Overseeing player personnel, including roster management, scholarships, the walk on roster, the transfer portal, and working regularly with coaching staff to formulate recruiting plans for the Team;
- F. Working with the Athletics Director and Executive Deputy Athletics Directors to manage the Program;
- G. Working with administration and sports medicine to manage all insurance policies for the Program;
- H. Advising the Head Football Coach on Program development, evaluating and hiring of Program personnel, recruiting events, and day-to-day management of the Team;
- I. Devoting full professional attention and efforts to promoting the Program and fulfilling the necessary administrative responsibilities and duties as assigned by the Athletics Director;
- J. Promptly reporting any known or reasonably suspected violation of Governing Athletics Regulations to the Athletics Director and the Director of Compliance;
- K. Understanding and complying with Title IX of the Education Amendments of 1972 and LSU policies on Title IX and sexual misconduct, including but not limited to Permanent Memorandum 73 (“PM-73”), and understanding and complying with the mandatory obligation to report incidents of sexual misconduct (including sexual harassment and sexual violence) and other inappropriate sexual conduct of which Employee has knowledge or receives notice to LSU’s Title IX Coordinator as required by PM-73;

- L. Understanding and complying with Title VI of the Civil Rights Act of 1964, other federal laws, state law, and LSU policies on equal opportunity and discrimination, including but not limited to Permanent Memorandum 55;
 - M. Cooperating fully, truthfully and without undue delay in any investigation, inquiry, infractions process or adjudication of any matter under Governing Athletics Regulations conducted or authorized by LSU, the SEC, or the NCAA at any time;
 - N. Cooperating fully, truthfully and without undue delay in any LSU internal investigation or inquiry;
 - O. Understanding, observing, upholding, and promoting LSU's written academic standards, requirements, and policies, and reasonably promoting an environment in which admissions, financial aid, academic services for student athletes, and recruiting are conducted consistent with LSU's mission;
 - P. Performing all duties in a manner consistent with good sportsmanship and in accordance with the high moral, ethical, and academic standards of the Athletics Department, the Program and LSU;
 - Q. Using reasonable efforts, through due care and supervision, to ensure that all student athletes and other individuals under or subject to Employee's control, authority, or supervision comply with all Governing Athletics Regulations and act in accordance with the high moral, ethical, and academic standards of the Athletics Department, the Program and LSU;
 - R. Maintaining a presence on campus and in the Program, except for absences approved by the Athletics Department;
 - S. Promoting the success of the Team and its student athletes both athletically and academically, using reasonable efforts to promote the goal of LSU that every student athlete obtains an undergraduate degree, and reasonably cooperating with academic counselors or similar persons designated by LSU to assist student athletes and the faculty and administrators of LSU in connection with the academic pursuits of student athletes; and
 - T. Any other matters as may be detailed in the position description for the Position or as may be assigned by the Athletics Director.
5. **Base Salary.** LSU agrees to pay Employee the Base Salary annually during the Term, in 12 equal monthly installments, on LSU's regular monthly payroll date. Any amounts due to Employee under this Section for a partial Contract Year shall be prorated.
6. **Media Participation and License to NIL.**
- A. **License.** As further consideration for payment of Base Salary, Employee grants to the University and Athletics Department, a perpetual, non-exclusive and non-transferrable license of the names, nicknames, initials, autograph, likeness, images,

pictures, video, depictions, resemblance, quotes, phrases, interviews, coaching records, philosophies and methods attributable to Employee obtained during the Term, and all derivatives thereof, for any current or future uses for promoting the University, Athletics Department or the Program. This license shall include the intellectual property rights and services of Employee in connection with promoting, appearing on, or participating in, as requested, and making reasonable efforts to make successful, LSU-sanctioned television, radio, social media and internet programs, including streaming services, concerning LSU and the Team.

B. Ownership of Programming. LSU shall exclusively own all rights to any television, radio, and internet programs and shall be entitled, at its option, to produce and market the programs or negotiate with third parties for the production and marketing of the programs. LSU shall retain all revenue generated by the programs including but not limited to that received from program sponsors for commercial endorsements used during the programs. "Program sponsors" shall include, but not be limited to, those persons or companies who make financial contributions supporting, or who pay a fee for, commercial announcements and endorsements used on the programs.

7. Post-Season Incentive Compensation. Employee shall be entitled to post-season incentive compensation as follows. Post-Season Incentive Compensation is additional compensation for the extra services required of Employee in the preparation for and participation in post-season play, in accordance with LSU's policies and procedures. If Employee does not actively coach the Team in the Position for any post-season game for any reason, including but not limited to termination of employment, Employee shall not be entitled to Post-Season Incentive Compensation. Post-Season Incentive Compensation shall be paid within 60 days of achieving the applicable goal and may be payable, in whole or in part, from affiliated foundation funds. The maximum amount of Incentive Compensation under this Section shall be \$60,000 per Contract Year.

- 1. SEC Championship Game Participant \$5,000 OR
- 2. SEC Champion \$10,000

AND ONE OF THE FOLLOWING:

- 1. Non College Football Playoff (CFP) Bowl Participant \$10,000 OR
- 2. CFP Participant (Top 12) \$20,000 OR
- 3. CFP Quarterfinal Game Participant \$25,000 OR
- 4. CFP Semifinal Game Participant \$30,000 OR
- 5. CFP National Championship Game Participant \$35,000 OR

6. CFP National Champion \$50,000

If the CFP format is expanded to include additional teams, the parties will mutually agree on additional incentive compensation for participation therein, and/or CFP victories (to the extent not already contemplated by the then-existing bonus structure).

8. **Fringe Benefits and Leave.** Unless otherwise specified herein, Employee is entitled to participate in the fringe benefit programs available to all unclassified professional LSU employees, with contributions and benefit amounts as defined by law. Employee shall also be entitled to the following benefits:
- A. **Apparel.** As part of any third-party apparel and/or equipment-related contract with LSU, Employee acknowledges and agrees that the Team may be provided and/or allocated apparel and/or equipment from and by LSU, which apparel and equipment shall be used exclusively and solely by Employee in furtherance of Employee's employment duties and team-related activities as applicable to Employee's employment with LSU.
 - B. **Car Allowance.** Employee shall receive an automobile entitlement of (1) an annual automobile allowance in an amount not to exceed \$800 per month, or (2) to the extent consistent with state ethics law, use of courtesy vehicle provided by a dealership and related automobile insurance.
 - C. **No Overtime.** Employee qualifies and is designated as exempt under the Fair Labor Standards Act and is not entitled to any overtime pay or compensatory leave for work in excess of 40 hours in any workweek.
 - D. **Relocation Incentive.** If indicated in Section 1 of the Agreement, Employee shall receive a Relocation Incentive. As per University policy, the Relocation Incentive is subject to full or partial repayment to LSU if you do not continue employment with the University for at least two full years. In accordance with Internal Revenue Service regulations, all relocation benefits are taxable compensation subject to withholding and other appropriate deductions.
 - E. **Retirement Plan.** Employee is entitled to participate in the retirement programs available to all unclassified professional LSU employees, with contributions and benefit amounts as defined by law. Employee understands and agrees that no contributions for purposes of any State of Louisiana retirement program will be made by LSU or withheld from Employee's compensation except as to the Base Salary and any earned Post-Season Incentive Compensation, and Employee shall not be entitled to any retirement benefits that may otherwise be attributable to any other compensation paid pursuant to this Agreement. Employee further acknowledges that other sums paid shall not be considered "base pay," "earned compensation," or "earnable compensation" as such terms are defined under Louisiana law and shall not be included as compensation for the purpose of

computation of retirement benefits. Retirement contributions are subject to the limitations of federal law and Louisiana law.

- F. **Sick Leave.** Employee shall accrue and use sick leave in accordance with LSU policy.

9. Additional Revenue.

- A. Subject to compliance with Governing Athletics Regulations, including but not limited to current NCAA Bylaw 11.2.2 and 11.3.2, and LSU Permanent Memorandum 11 (“PM-11”), Employee may earn or receive other revenue (“Additional Revenue”) while employed by LSU, including working with sports camps or clinics, provided, however, that Employee shall obtain prior written approval from the President before engaging in any commercial or private venture (other than a passive investment), including the use of Employee’s name by any commercial, public or private entity. As required by NCAA Bylaws 11.2.2, 11.3.2.1, and 11.3.2.1.1, Employee shall report annually to the President and the Athletics Director, in writing, all athletically-related income or benefits received by Employee from sources outside LSU, and shall provide LSU reasonable access to all records necessary to verify this report. LSU does not guarantee any amount of Additional Revenue.
- B. Employee shall not, without written approval of the President and the Athletics Director and compliance with PM-11, arrange for or agree to the receipt of any supplemental pay, bonus, or other form of payment from any outside source.
- C. Except for routine news media interviews or educational or development programs for which no compensation is received, Employee shall not appear on or in any radio, television, or internet programs or other electronic media other than those produced or sponsored by LSU without the prior written approval of the Athletics Director or the Athletics Director’s designee.
- D. Employee shall not appear in or make any advertisement or make any commercial endorsement without the prior written approval of the President and the Athletics Director, which will not be unreasonably withheld.

10. Termination and Suspension.

- A. **Termination by LSU for Cause.** This Agreement may be terminated for “cause” by LSU at any time prior to its expiration, upon written notice to Employee.
 - 1. For purposes of this Section, “cause” for termination shall be defined as:
 - a. If, as reasonably determined by LSU and without the need for any adjudication by any other entity, Employee commits any material and substantial violation (or repeated lesser violations) of Governing Athletics Regulations, fails promptly to report any such violation by

another person to the Director of Compliance, or commits a material and substantial violation of any LSU policies, rules, or procedures;

- b. If, as reasonably determined by LSU and without the need for any adjudication by any other entity, there is any material and substantial violation of Governing Athletics Regulations involving any aspect of the Program by any other person if either: (i) the violation occurs or continues to occur after Employee knew or had constructive knowledge that it was about to occur or was occurring, or (ii) Employee failed to follow reasonable policies and procedures established in writing by the Athletics Department to prevent violations of Governing Athletics Regulations from occurring and to detect promptly any such violations which may occur;
- c. Engaging in serious misconduct which either: (i) displays a continual, serious disrespect or continual, serious disregard for the mission of LSU; (ii) brings Employee into substantial public disrepute sufficient, at the reasonable discretion of LSU, to materially impair Employee's ability to perform the obligations contained herein without material adverse impact on the Team or Program; or (iii) constitutes moral turpitude or breaches the high moral and ethical standards applicable to Employee as a visible representative of LSU, including but not limited to acts of dishonesty, misrepresentation, fraud or violence that may or may not rise to the level of warranting criminal prosecution by the relevant authorities;
- d. Unreasonable refusal or repeated failure to perform any duties imposed upon Employee herein (including but not limited to those duties specified in this Agreement), or failing to perform the same to the best of Employee's reasonable ability;
- e. Failing to cooperate in the investigation, infractions process, adjudication or enforcement of Governing Athletics Regulations or in any LSU internal investigation or inquiry; or knowingly permitting any other person under Employee's supervision to fail to reasonably cooperate in such investigation and enforcement;
- f. Subject to any right of administrative appeal permitted or granted to Employee by the NCAA or SEC, any finding or determination by the NCAA, SEC, or any commission, committee, council, or tribunal of the same, of any major or repetitive violations by Employee of NCAA or SEC rules, or of any such major or repetitive violations by others under the direct supervision of Employee which were permitted, encouraged, or condoned by Employee, or about which violations Employee knew or should have known and should have acted reasonably to prevent, limit, or mitigate (it is recognized

that this subsection includes findings or determinations of any previously undisclosed violations during Employee's prior employment at another institution);

- g. Failing to report promptly to the Director of Compliance any violations of Governing Athletics Regulations involving the Team of which Employee has knowledge;
- h. Failure by Employee to engage in, and use best efforts to ensure that personnel under Employee's direct or indirect supervision engage in, safe and responsible treatment of student athletes on the Team, including but not limited to failure to comply with any requirement pertaining to medical clearance for participation, or any other act or omission (including but not limited to physical and/or emotional abuse of student athletes) that creates, or could reasonably be expected to create, an unreasonable risk of harm to a student athlete;
- i. Failure to comply with LSU policies, rules and regulations concerning Title IX, including specifically but not exclusively the reporting of any incident of sexual misconduct in accordance with LSU's Title IX policy and PM-73; or
- j. Prolonged absence from LSU without permission, which will not be unreasonably withheld;
- k. Failure to respond fully and truthfully within a reasonable time to any reasonable requests or inquiry relating to the performance of any duties herein or at any prior employment at any other institution of higher learning propounded by LSU, the NCAA, the SEC or any other governing body having supervision over the athletic programs of LSU or such other institution of higher education, or required by law or Governing Athletics Regulations; or knowingly permitting any other person under Employee's supervision to fail to so respond;
- l. Committing fraud in the performance of any duties and responsibilities herein, either with intent or reckless disregard for the truth, including but not limited to fraud or dishonesty in any written or verbal statements, including résumés, provided by Employee to LSU in the application process or fraud in the preparation, falsification, or alteration of documents or records of LSU, the NCAA, or the SEC, or documents or records pertaining to any recruit or student athlete, including but not limited to transcripts, eligibility forms, and compliance reports; or knowingly permitting any other person to commit such fraud;

- m. Being charged with or convicted of either: (i) any felony, or (ii) any crime involving larceny, embezzlement, fraud, gambling, drugs, or alcohol;
 - n. Participation in any gambling, bookmaking, wagering, or betting involving any athletic contest whether by soliciting, placing, or accepting a bet or wager or through a bookmaker, a pool, an online or in-person sportsbook, or any other method of gambling; or knowingly permitting any student athlete or other individual under Employee's control, authority, or supervision to participate in such activity;
 - o. Providing information or data, other than information or data provided to the general public through public presentation, relating in any manner to any intercollegiate sport or to any student athlete to any individual whom Employee knows (or has constructive knowledge) to be a gambler, better, or bookmaker, or an agent of any such person; or knowingly permitting any student athlete or other individual under Employee's control, authority, or supervision to furnish such information or data;
 - p. Use or consumption of alcoholic beverages or controlled substances, steroids, or other drugs or substances to such degree and for such appreciable period as to substantially impair Employee's ability to perform the duties herein;
 - q. Sale, purchase, use or possession of any controlled substances, steroids, or other drugs or chemicals, the sale, purchase, use, or possession of which by Employee is prohibited by law or Governing Athletics Regulations, excepting the use or possession of substances or drugs lawfully prescribed by a health care provider, and used in accordance therewith;
 - r. Encouraging or allowing the sale, purchase, use, or possession by any student athlete or other individual under Employee's control, authority, or supervision of any controlled substances, steroids, or other drugs or chemicals, the sale, purchase, use, or possession of which by such person is prohibited by law or Governing Athletics Regulations; or
 - s. Violating any material term of this Agreement.
2. The process for termination for cause is as follows:
- a. Prior to termination for cause, LSU shall provide Employee written notice of termination with a designated effective date of termination. The notice of termination shall be provided at least seven calendar days before the effective date of termination and shall be signed by

the Athletics Director or the Athletics Director's designee. The notice of termination shall reference the facts upon which termination is authorized.

- b. Prior to the effective date of termination in the notice, Employee shall have the right to present a written statement and any supporting materials to the Athletics Director detailing why the Employee believes LSU should rescind its notice of termination. The Athletics Director or the Athletics Director's designee may extend the effective date of termination in writing to allow additional time to consider Employee's response.
 - c. After review of any such response, the Athletics Director or the Athletics Director's designee shall provide Employee written notice of a decision. If confirmed, termination of employment shall be effective on the date of termination previously identified.
 - d. Within seven calendar days of receipt of the decision of the Athletics Director, Employee may make a written request for review to the President and submit materials for consideration. If no such request is made, the decision of the Athletics Director is final.
 - e. If a request for review is made, the President or the President's designee shall conduct the review based on materials provided by the Employee and materials considered by the Athletics Director. The request for review by the President shall not suspend the effective date of the termination.
 - f. Within 14 calendar days of the submission, Employee will be provided written notice of the decision of the President, which shall be final.
3. Should the Employee be reinstated following a request for review, Employee shall be paid any lost compensation and benefits, retroactive to the date such compensation and benefits ceased.
 4. In the event of termination for cause, all of Employee's compensation and benefits provided for in this Agreement shall terminate on the termination date, and LSU shall not thereafter be liable to Employee for any sums or damages other than compensation earned through the last day of such month, as well as Post-Season Incentive Compensation that has been earned but not paid. The termination date shall be the date on which the initial notice of termination is given, or on such later date as may be set forth by LSU in the notice of termination.
 5. As required by NCAA Bylaw 11.2.1, Employee is hereby notified that in addition to the actions LSU may take in accordance with this Agreement, Employee is also subject to disciplinary or corrective action as set forth in

the provisions of the NCAA enforcement procedures if Employee is found by the NCAA or LSU to be in violation of NCAA Bylaws. Employee agrees that LSU shall implement any such disciplinary or corrective actions imposed by the NCAA. Employee further understands that Employee has an affirmative obligation to cooperate fully in the NCAA infractions process, including the investigation and adjudication of a case, pursuant to this Agreement and NCAA Bylaw 11.2.1, and that such obligation continues in effect during and beyond the termination of this Agreement for any violations alleged to have occurred during Employee's employment by LSU.

B. Termination by LSU without Cause.

1. LSU shall have the right to terminate this Agreement without cause upon written notice to Employee.
2. In the event of termination by LSU without cause, all of Employee's compensation and benefits provided for in this Agreement shall terminate on the termination date, and LSU shall not thereafter be liable to Employee for any sums or damages other than the liquidated damages provided for herein and as well as Post-Season Incentive Compensation that has been earned but not paid. The termination date shall be the date designated by LSU in the notice of termination.
3. If LSU terminates employment during the Term without cause, LSU will pay Employee liquidated damages in the amount of 90 percent of the Base Salary which would have been payable to Employee through the remaining Term of the Agreement.
4. Liquidated damages under this Section will be paid in equal monthly installments over a period equal to the amount of time then remaining in the Term. LSU's obligation to pay liquidated damages under this Section shall terminate upon the death of Employee.
5. In the event of termination by LSU without cause, Employee shall have the duty to mitigate and use best efforts to obtain similar athletics-related employment in another position with compensation at fair market value. Employee shall exercise due diligence and good faith in seeking qualifying employment so long as the liquidated damage obligation exists. In the event Employee obtains such other employment, Employee must notify LSU and provide documentation reasonably requested by LSU to determine the amount of compensation received by Employee and the amount of offset due to LSU. Mitigation shall be calculated as follows:
 - a. If new employment is via contract, LSU shall reduce future payments by the greater of (i) the average annual compensation of Employee's new employment agreement (regardless of term) or

(ii) the specific annual compensation due for given year corresponding to this Agreement.

- b. If new employment is not via contract (i.e., at-will), LSU will reduce future payments by the specific annual compensation due for given year corresponding to this Agreement.

Employee shall not attempt to allow third parties to take advantage of this Section as a means of avoiding paying the market value of Employee's services. In the event Employee breaches these obligations, LSU will have the right to (i) be completely relieved of any obligation to make any remaining payments owed to Employee (following notice to Employee and a reasonable opportunity for Employee's new employer to cure any deficiency) or (ii) adjust payments to reflect the market value for Employee's employment or services.

6. This is an agreement for personal services. The parties recognize that termination of this Agreement by LSU prior to its expiration by lapse of term would cause Employee to lose compensation, fringe benefits, certain other LSU-provided benefits, and possibly other income and benefits provided by third parties, which damages are not easy to determine with certainty. Accordingly, the parties have bargained for this liquidated damages provision. The parties further agree that the liquidated damages herein are not in any way a penalty.

C. Termination by Employee Without Cause.

1. Employee shall have the right to terminate this Agreement without cause upon 15 days written notice to LSU. If Employee terminates employment at any time before the End Date, Employee will pay liquidated damages to LSU as follows:
- A. Fifty percent (50%) of all remaining Base Salary and Supplemental Compensation which would have been payable to Employee for the remaining Term, if Employee accepts employment with another SEC program (regardless of location) or any Division I-A program within 500 miles of LSU; or
 - B. Twenty-five percent (25%) of all remaining Base Salary and Supplemental Compensation which would have been payable to Employee for the remaining Term, if Employee accepts employment other than as described above or terminates employment for any other reason; however
 - C. No liquidated damages will be owed if Employee accepts any Division I collegiate athletics administrator position at the deputy athletics director level or above; any position in the National

Football League; or terminates the Agreement after the conclusion of the Term.

2. Employee shall have the option to pay liquidated damages in a lump sum or in equal monthly installments over a period equal to the amount of time then remaining in the Agreement.
3. In the event of termination by Employee without cause, all of Employee's compensation and benefits provided for in this Agreement shall terminate on the termination date, which, unless otherwise agreed to in writing by LSU and Employee, shall be the earlier of: (a) the date on which Employee provides notice of termination to LSU; (b) the date on which Employee accepts employment from another employer; or (c) the date on which Employee performs any work or services of any kind or nature whatsoever on behalf of or for the benefit of another employer. LSU shall not thereafter be liable to Employee for any amounts other than any compensation earned pursuant to this Agreement prior to the termination date. The Parties acknowledge that this provision is intended to obligate Employee to repay unearned compensation and fees previously or inadvertently paid by LSU under the premise that Employee would fulfill the Term of this Agreement.
4. This is an agreement for personal services. The parties recognize that termination of this Agreement by Employee prior to its expiration by lapse of term would cause LSU to incur administrative, recruiting, and resettlement costs in obtaining a replacement for the Program, in addition to potentially increased compensation costs and loss of goodwill or sales, which damages are impossible to determine with any certainty. Accordingly, the parties have bargained for this liquidated damages provision. The parties further agree that the liquidated damages herein are not in any way a penalty.

D. Suspension or Other Disciplinary Action.

1. LSU may impose suspension or leave without pay for a period no longer than 120 days for any act or omission which would be grounds for discipline or termination for cause as defined herein. Imposition of such sanctions shall be at the discretion of LSU, which shall not be exercised arbitrarily or capriciously. Prior to suspension without pay under this provision, Employee shall be provided written notice of the grounds for the suspension and shall have seven calendar days from receipt of such notice to respond in writing to the Athletics Director. After review of any such response, the Athletics Director or the Athletics Director's designee will provide Employee with written notice of a decision and/or suspension. Suspension under this subsection shall not limit any rights of LSU to terminate Employee for cause.

2. Employee shall be subject to disciplinary or corrective action by the NCAA or SEC for any violation of NCAA and SEC regulations, respectively. Such action by the NCAA or the SEC shall not preclude or in any manner affect LSU's right to take such other corrective or disciplinary action as it deems necessary or proper, including termination for cause.
3. Notwithstanding any other provision of this Agreement to the contrary, if Employee is suspended by the SEC or NCAA, Employee shall automatically be suspended by LSU for the duration of the SEC or NCAA imposed suspension without further notice or process. During such suspension, Employee shall not be entitled to receive any compensation, benefits or any other payments under this Agreement except for fringe benefits provided under Section 8 of this Agreement.

E. **Termination by Death or Disability.** In the event of the death of Employee or the inability of Employee to perform the obligations described in this Agreement with or without accommodation by reason of disability or some other occurrence beyond the control of either party, and such inability to perform has continued or will continue beyond a reasonable period of time, but not less than 60 days, this Agreement shall terminate as a termination with cause and all future obligations between the parties shall cease upon the termination date reasonably established by LSU, unless otherwise required by law.

F. **Exclusivity of Remedy.** The financial consequences of termination of this Agreement or suspension are exclusively set forth herein. Therefore, with the sole exception of payments required by this Agreement, in any instance of termination for cause or without cause, or suspension or other disciplinary sanction effected in accordance with the procedures established in this Agreement, neither Employee nor LSU shall be entitled to receive, and each hereby waives any claim against the other, and their respective board members, officers, directors, agents, employees, successors, and personal representatives, for damages, including consequential damages by reason of any alleged economic loss, including but not limited to loss of collateral income, deferred income, loss of earning capacity, loss of business opportunity, loss of benefits, loss of fees from speaking, camps or other outside activity, damages allegedly sustained because of alleged humiliation or defamation, or any other non-compensatory and compensatory damages and attorney's fees resulting from the fact of termination, the public announcement thereof, or the release by LSU or Employee of information or documents which are public or as otherwise required by law. Employee acknowledges that in the event of either termination of this Agreement for cause, without cause, or otherwise, or suspension or other disciplinary sanction effected in accordance with the procedures established in this Agreement, Employee shall have no right to occupy the Position and that Employee's sole remedies are provided herein and shall not extend to injunctive relief. THE PARTIES ACKNOWLEDGE AND AGREE THAT THIS SECTION LIMITING LIABILITY AND EXCLUDING CONSEQUENTIAL DAMAGES AND OTHER REMEDIES IS ESSENTIAL AND IS A MATERIAL INDUCEMENT FOR THE UNIVERSITY TO ENTER INTO THIS

AGREEMENT. ACCORDINGLY, SUCH PROVISIONS SHALL BE SEVERABLE AND INDEPENDENT OF ANY OTHER PROVISIONS AND SHALL BE ENFORCED AS SUCH, REGARDLESS OF ANY BREACH OR OTHER OCCURRENCE HEREUNDER.

- G. **Interference with Athletics.** During any period where Employee receives post-termination liquidated damages, compensation or benefits, Employee agrees that Employee will not interfere with LSU student athletes or otherwise obstruct the ability of LSU or the Athletics Department to transact business. If Employee violates this provision, LSU shall be entitled to discontinue any post-termination liquidated damages, compensation or benefits and may seek to recover any payments that have been disbursed.
11. **Discontinuation of the Program by the University.** Notwithstanding any provision to the contrary, in the event the University determines for any reason within its sole discretion to discontinue the Program as a Division I sport, LSU shall have the right to terminate this Agreement without further obligation to Employee. Notice of termination under this Section shall be in writing and shall establish a date of termination no less than 90 days from the date of the notice or upon the End Date, whichever occurs first. In the event the right to terminate pursuant to this Section is exercised, all obligations between the parties shall cease effective on the date of termination.
12. **University Property.** All property that is provided to, or developed or acquired by, Employee as part of or in conjunction with Employee's employment by LSU, regardless of the format or manner in which the property may be retained or stored, shall remain the sole property of LSU. This shall include, without limitation, all documents, files, personnel records, recruiting records, team information, athletic equipment, films, statistics, keys, credit cards, computers, software programs, and electronic devices that Employee may have access to or come into possession of during employment. Excluded from this provision are Employee's personal notes, personal playbooks, memorabilia, diaries and other personal records, which the Employee may retain. Employee is required to return to LSU all LSU property in Employee's possession within seven calendar days of termination or separation of employment. Employee shall also return any courtesy vehicle provided under this Agreement within seven calendar days of termination or separation of employment. Employee agrees that LSU may withhold any liquidated damage payments or other compensation due Employee pending return of property under this Section.
13. **Duty of Loyalty.** Unless notice of termination under this Section has been given by either party, neither Employee nor Employee's agent shall, under any circumstances, discuss or negotiate directly or indirectly prospective employment for Employee with any other institution of higher education, professional athletic team, or other athletically-related (including media and sports marketing) prospective employer without giving at least 24 hours prior written notice to the President and the Athletics Director.
14. **Duty to Cooperate.** Both during and after the end of employment with LSU, Employee agrees, without additional compensation (other than reimbursement for reasonable associated expenses post-employment), to cooperate with LSU in any investigation,

internal or otherwise, of any possible violation of law (including Title IX) or violation of any rule, policy or regulation of LSU (including PM-73), the SEC or the NCAA. Employee agrees (a) to be reasonably available to answer questions regarding any matter with which Employee was involved while employed by LSU, and (b) to cooperate with LSU during the course of any proceedings arising out of any matter with which Employee has knowledge or information.

15. **Non-Assignment.** Neither party may assign, transfer, alienate, or encumber any of its rights or obligations hereunder without the express written consent of the other party, except as otherwise specifically set forth in this Agreement.
16. **Entire Agreement.** This Agreement constitutes and expresses the entire agreement and understanding of the parties concerning the matters contemplated hereby and shall, upon the Effective Date, supersede any other oral and written agreements between the parties. There are no oral or other agreements, understandings, promises, or representations between the parties affecting this Agreement. Both parties have relied solely on their own respective judgments in entering into this Agreement, with full opportunity to seek advice of competent counsel. It shall be construed, if necessary, without reference to the party that was the principal drafter of the Agreement.
17. **Indirect Actions Prohibited.** Any act which Employee is prohibited from doing directly in this Agreement shall not be done indirectly by Employee or another person on Employee's behalf or at Employee's behest.
18. **Amendments to Agreement.** This Agreement may be amended only by a written instrument duly approved by LSU through its designated representatives and accepted by Employee, such approval and acceptance to be acknowledged in writing.
19. **Severability.** If any provision of this Agreement shall be deemed invalid or unenforceable, either in whole or in part, this Agreement shall be deemed amended to delete or modify, as necessary, the offending provision or to alter the bounds thereof in order to render it valid and enforceable.
20. **No Waiver of Default.** No waiver by the parties hereto of any default or breach of any covenant, term or condition of this Agreement shall be deemed to be a waiver of any other default or breach of the same or any other covenant, term or condition contained herein.
21. **No Waiver of Sovereign Immunity.** It is expressly agreed and understood between the parties that nothing contained herein shall be construed to constitute a waiver or relinquishment by LSU of any rights to claim such exemptions, privileges and immunities as may be provided by law.
22. **"Force Majeure" Clause.** Neither party shall be considered in default of performance of any obligations under this Agreement if such performance is prevented or delayed by Force Majeure. "Force Majeure" shall be understood to be any cause which is beyond the reasonable control of the party affected and which is forthwith, by notice from the party affected, brought to the attention of the other party, including but not limited to war, hostilities, revolution, civil unrest, strike, lockout, epidemic or pandemic, government-

ordered restriction or cessation of activity, accident, fire, natural disaster, wind or flood or any requirements of law, or an act of God.

23. Additional Conditions of Employment.

- A. **Compliance with La. R.S. 42:31.** To the extent annual compensation under this Agreement exceeds \$100,000, Employee hereby agrees and promises that, within 30 days of the Start Date or the date that compensation reaches that threshold, Employee shall provide proof to LSU that Employee has been issued a Louisiana driver's license and that all vehicles registered in Employee's name are registered in Louisiana, all pursuant to the requirements of La. R.S. 42:31.
- B. **Background Checks and Disclosures.** Prior to commencing employment, Employee shall be required to submit to background checks as deemed appropriate by the University. Employee's employment is contingent upon a satisfactory background check in accordance with University policy. In addition, prior to signing this Agreement, Employee must disclose to the University any and all criminal, civil or administrative matters from the prior five years, including those currently pending but excluding non-felony traffic infractions. Failure to disclose all such matters to the University will serve as a basis to terminate employment for cause.
- C. **Approvals.** This Agreement is subject to any approvals that must be obtained in accordance with law or University policy. No provision of this Agreement shall be enforceable until signed by all parties and, if required by policy, approved by the Board of Supervisors.

24. Governing Law and Venue. This Agreement shall be enforced and construed in accordance with the laws of Louisiana. Any civil action to enforce this Agreement shall be brought in a state or federal court having jurisdiction and domiciled in East Baton Rouge Parish, Louisiana.

SIGNATURES ON FOLLOWING PAGE





2024.04.03 Austin Thomas Contract

Final Audit Report

2024-04-05

Created:	2024-04-05 (Central Daylight Time)
By:	Wendy Nall (wnall@lsu.edu)
Status:	Signed
Transaction ID:	CBJCHBCAABAAAg6KI0FtKSF14Z8tEY6Am916JcH2K1lx

"2024.04.03 Austin Thomas Contract" History

-  Document created by Wendy Nall (wnall@lsu.edu)
2024-04-05 - 10:35:14 AM CDT
-  Document emailed to Austin Thomas (austinthomas55@lsu.edu) for signature
2024-04-05 - 10:36:12 AM CDT
-  Email viewed by Austin Thomas (austinthomas55@lsu.edu)
2024-04-05 - 10:50:05 AM CDT
-  Document e-signed by Austin Thomas (austinthomas55@lsu.edu)
Signature Date: 2024-04-05 - 10:53:46 AM CDT - Time Source: server
-  Agreement completed.
2024-04-05 - 10:53:46 AM CDT



Board of Supervisors

Request from LSU Athletics to Approve New Employment Agreements for Assistant Football Coaches

Date: April 26, 2024

1. Bylaw Citation

Pursuant to Article VII, Section 1(L)(3):

The following matters shall require approval by the Board, regardless of any delegations of authority otherwise provided for in these Bylaws or the Regulations of the Board. Except as set forth herein, no such matter shall be undertaken or approved by or for any campus or the University without prior review by the President and appropriate University Officers and express, formal approval by the Board.

* * * *

Appointments and all other personnel actions relating to varsity athletics coaches and Athletic Directors receiving a salary of \$250,000 or above.

2. Summary of Matter

This resolution seeks approval of the new employment agreements for Brad Davis and Frank Wilson. The key terms of the employment agreements are summarized below:

Name	Title	Proposed Start Date	Proposed End Date	Total Certain Compensation ^a
Brad Davis	Assistant Football Coach	1/16/2024	1/15/2027	\$900,000
Frank Wilson	Assistant Football Coach	1/16/2024	1/15/2027	\$1,000,000

Notes:

- (a) Total Certain Compensation includes all compensation which the coach is contractually guaranteed to receive annually in the first contract year upon execution. It does not include the value of any fringe benefits, such as car allowances, nor any one-time amounts, such as buy-outs, post-season incentive compensation or relocation allowances.

3. Review of Business Plan

Not applicable.

4. Fiscal Impact

The Athletics Department currently expects that all funds relating to these employment agreements will be paid from revenues generated by the Athletics Department.

5. Description of Competitive Process

Not applicable.

6. Review of Legal Documents

The Office of General Counsel has reviewed the proposed agreements.

7. Parties of Interest

LSU and the above-named personnel.

8. Related Transactions

None.

9. Conflicts of Interest

None known

10. Attachments

1. Employment Agreement: Brad Davis
2. Employment Agreement: Frank Wilson

RESOLUTION

NOW, THEREFORE, BE IT RESOLVED the Board of Supervisors of Louisiana State University and Agricultural & Mechanical College approves the Employment Agreement for Brad Davis and the Employment Agreement for Frank Wilson as described in this item, and authorizes President William F. Tate IV to execute both agreements in consultation with the Office of General Counsel.

EMPLOYMENT AGREEMENT

This Employment Agreement (“Agreement”) is made and entered into as of this 23rd day of February, 2024, by and between the Board of Supervisors of Louisiana State University and Agricultural and Mechanical College (“LSU”), a body corporate existing under the Constitution and laws of the State of Louisiana, herein represented by William F. Tate IV, its duly authorized President, and Brad Davis (“Employee”):

1. **Definitions.** For purposes of this Agreement, the following terms shall have the meaning shown:

- A. “Athletics Director”: The Director of Athletics at LSU.
- B. “Base Salary”: The annualized sum of \$400,000.
- C. “Contract Year”: An annual period from January 1 to December 31 during the Term.
- D. “End Date”: January 15, 2027.
- E. “Position”: Assistant Coach for the Team.
- F. “President”: The President of LSU.
- G. “Program”: The intercollegiate football program at LSU.
- H. “Start Date”: January 16, 2024.
- I. “Supplemental Compensation”: The annualized sum for the following period:

Start Date through January 15, 2025:	\$500,000
January 16, 2025 through January 15, 2026:	\$530,000
January 16, 2026 through January 15, 2027:	\$590,000
- J. “Team”: The intercollegiate athletic team which is a part of the Program.

2. **Term.** This Agreement shall be for a definite term (“Term”), commencing on the Start Date and ending on the End Date unless terminated sooner in accordance with Section 11 or 12 of this Agreement. On the Start Date, the existing Employment Agreement between Employee and LSU dated June 11, 2021, as amended on April 8, 2022 and February 1, 2023, shall be terminated by agreement of the parties and replaced by this Agreement.

3. **Employment.** LSU does hereby employ Employee in the Position for the Term. Employee will report directly to the Head Coach of the Team. It is the intention of the parties that Employee will serve in the Position for the entirety of the Term. Employee acknowledges and agrees that Employee is not eligible for and will not be considered for or granted tenure by LSU.

4. **Duties and Responsibilities.** Employee's duties and responsibilities shall include the following, all subject to law, LSU policy, and the directives, input, and advice of the Head Coach and Athletics Director:
- A. Performing all duties reasonably assigned to Employee by the Head Coach of the Team or the Athletics Director so long as such duties are consistent with those duties typically assigned to assistant coaches at colleges or universities at the same competitive level as LSU;
 - B. Promoting the success of the Team and its student athletes both athletically and academically;
 - C. Devoting full professional attention and efforts to promoting the Program and fulfilling the necessary coaching responsibilities and duties;
 - D. Being reasonably knowledgeable of and complying with: (1) all applicable federal and state laws governing intercollegiate athletics; and (2) all governing constitutions, by-laws, rules, policies, interpretations, and regulations of the National Collegiate Athletics Association ("NCAA"), the Southeastern Conference ("SEC"), LSU, and any other conference rules or policies which may be subsequently implemented (hereinafter collectively referred to as "Governing Athletics Regulations");
 - E. Promoting an atmosphere of compliance within the Program;
 - F. Promptly reporting any known or reasonably suspected violation of Governing Athletics Regulations to the Athletics Director and the Director of Compliance;
 - G. Understanding and complying with Title IX of the Education Amendments of 1972 and LSU policies on Title IX and sexual misconduct, including but not limited to Permanent Memorandum 73 ("PM-73"), and understanding and complying with the mandatory obligation to report incidents of sexual misconduct (including sexual harassment and sexual violence) and other inappropriate sexual conduct of which Employee has knowledge or receives notice to LSU's Title IX Coordinator as required by PM-73;
 - H. Understanding and complying with Title VI of the Civil Rights Act of 1964, other federal laws, state law, and LSU policies on equal opportunity and discrimination, including but not limited to Permanent Memorandum 55;
 - I. Cooperating fully, truthfully and without undue delay in any investigation, infractions process or adjudication of any matter under Governing Athletics Regulations conducted or authorized by LSU, the SEC, or the NCAA at any time;
 - J. Cooperating fully, truthfully and without undue delay in any LSU internal investigation or inquiry;

- K. Reasonably observing, respecting, and promoting the principles of institutional control in the Program;
 - L. Understanding, observing, upholding, and promoting LSU's written academic standards, requirements, and policies, and reasonably promoting an environment in which admissions, financial aid, academic services for student athletes, and recruiting are conducted consistent with LSU's mission;
 - M. Cultivating and maintaining reasonable interaction with members of the LSU community, in accordance with the policies and instructions of the Head Coach of the Team and the Athletics Director;
 - N. Performing all duties in a manner consistent with good sportsmanship and in accordance with the high moral, ethical, and academic standards of the Athletics Department, the Program and LSU;
 - O. Using reasonable efforts, through due care and supervision, to ensure that all student athletes and other individuals under or subject to Employee's control, authority, or supervision comply with all Governing Athletics Regulations and act in accordance with the high moral, ethical, and academic standards of the Athletics Department, the Program and LSU;
 - P. Maintaining a presence on campus and in the Program, except for absences approved by the Athletics Department; and
 - Q. Using reasonable efforts to promote the goal of LSU that every student athlete obtains an undergraduate degree, and reasonably cooperating with academic counselors or similar persons designated by LSU to assist student athletes and the faculty and administrators of LSU in connection with the academic pursuits of student athletes.
5. **Sports Camps.** Subject to Governing Athletics Regulations and Athletics Department guidelines, rules and regulations, Employee may work at sports camps or clinics at LSU. Except as expressly provided in this Agreement, LSU does not guarantee or provide any additional compensation from operation of sports camps or clinics.
6. **Base Salary.** LSU agrees to pay Employee the Base Salary annually during the Term, in 12 equal monthly installments, on LSU's regular monthly payroll date. Any amounts due to Employee under this Section for a partial Contract Year shall be prorated.
7. **Media Participation, License to NIL, and Supplemental Compensation.**
- A. **License.** As owner of the rights to Employee's name, image and likeness, Employee grants to the University and Athletics Department, during the term of this Agreement, a perpetual, non-exclusive and non-transferrable license of the names, nicknames, initials, autograph, likeness, images, pictures, video, depictions, resemblance, quotes, phrases, interviews, coaching records, philosophies and methods attributable to Employee obtained during the Term, and all derivatives

thereof, for any current or future uses for promoting the University, Athletics Department or the Program. This license shall include the intellectual property rights and services of Employee in connection with promoting, appearing on, or participating in, as requested, and making reasonable efforts to make successful, LSU-sanctioned television, radio, social media and internet programs, including streaming services, concerning LSU and the Team.

B. **Supplemental Compensation/Royalty.** As a royalty for the license granted herein, Employee will earn and receive Supplemental Compensation during the Term, which shall be payable in equal monthly installments and may be paid from affiliated foundation funds. Any amounts due to Employee under this Section for a partial Contract Year shall be prorated.

C. **Ownership of Programming.** LSU shall exclusively own all rights to any television, radio, and internet programs and shall be entitled, at its option, to produce and market the programs or negotiate with third parties for the production and marketing of the programs. LSU shall retain all revenue generated by the programs including but not limited to that received from program sponsors for commercial endorsements used during the programs. "Program sponsors" shall include, but not be limited to, those persons or companies who make financial contributions supporting, or who pay a fee for, commercial announcements and endorsements used on the programs.

8. **Post-Season Incentive Compensation.** Employee shall be entitled to post-season incentive compensation as follows. Post-Season Incentive Compensation is additional compensation for the extra services required of Employee in the preparation for and participation in post-season play, in accordance with LSU's policies and procedures. If Employee does not actively coach the Team in the Position for any post-season game for any reason, including but not limited to termination of employment, Employee shall not be entitled to Post-Season Incentive Compensation. Post-Season Incentive Compensation shall be paid within 60 days of achieving the applicable goal and may be payable, in whole or in part, from affiliated foundation funds. The maximum amount of Incentive Compensation under this Section shall be \$125,000 per Contract Year.

A. **Post-Season Incentive Compensation.** Employee shall be entitled to post-season incentive compensation as follows. Post-Season Incentive Compensation is additional compensation for the extra services required of Employee in the preparation for and participation in post-season play, in accordance with LSU's policies and procedures. If Employee does not actively coach the Team in the Position for any post-season game for any reason, including but not limited to termination of employment, Employee shall not be entitled to Post-Season Incentive Compensation. Post-Season Incentive Compensation shall be paid within 60 days of achieving the applicable goal and may be payable, in whole or in part, from affiliated foundation funds. The maximum amount of Incentive Compensation under this Section shall be \$125,000 per Contract Year.

- 1. SEC Championship Game Participant \$15,000 OR

2. SEC Champion \$25,000

AND ONE OF THE FOLLOWING:

- | | | | |
|----|---|-----------|----|
| 1. | Non College Football Playoff (CFP) Bowl Participant | \$15,000 | OR |
| 2. | CFP Participant (Top 12) | \$25,000 | OR |
| 3. | CFP Quarterfinal Game Participant | \$40,000 | OR |
| 4. | CFP Semifinal Game Participant | \$50,000 | OR |
| 5. | CFP National Championship Game Participant | \$75,000 | OR |
| 6. | CFP National Champion | \$100,000 | |

If the CFP format is expanded to include additional teams, the parties will mutually agree on additional incentive compensation for participation therein, and/or CFP victories (to the extent not already contemplated by the then-existing bonus structure).

B. **Coaching Recognition Incentive Compensation.** Employee shall earn Coaching Recognition Incentive Compensation in the amount of \$15,000 for receiving the Joe Moore Award. Coaching Recognition Incentive Compensation, if payable, shall be considered earned as of the first date any of the honors is announced and shall be paid within 60 days of that date. The maximum amount of Coaching Recognition Incentive Compensation payable in a Contract Year shall be \$15,000.

9. **Fringe Benefits and Leave.** Unless otherwise specified herein, Employee is entitled to participate in the fringe benefit programs available to all unclassified professional LSU employees, with contributions and benefit amounts as defined by law. Employee shall also be entitled to the following benefits:

A. **Apparel.** As part of any third-party apparel and/or equipment-related contract with LSU, Employee acknowledges and agrees that the Team may be provided and/or allocated apparel and/or equipment from and by LSU, which apparel and equipment shall be used exclusively and solely by Employee in furtherance of Employee's employment duties and team-related activities as applicable to Employee's employment with LSU.

B. **Car Allowance.** Employee shall receive an automobile entitlement of (1) an annual automobile allowance in an amount not to exceed \$800 per month, or (2) to the extent consistent with state ethics law, use of courtesy vehicle provided by a dealership and related automobile insurance.

- C. **No Annual Leave.** Because of the specific nature of Employee's job duties and the irregular times during which Employee will be required to perform those job duties (for example, working more than 40 hours per week during Team's season, post-season, and recruiting period, while having fewer responsibilities in the off-season), Employee acknowledges and agrees that Employee will not earn or accrue annual leave.
1. Employee's compensation has been mutually negotiated with this understanding, and both Employee and LSU agree that the compensation would be less if Employee were entitled to earn annual leave.
 2. If any administrative tribunal, statewide elected official, state board or commission with jurisdiction over such matters, or any court of competent jurisdiction, rules or publishes a formal written opinion or decision that Louisiana law requires Employee to earn annual leave, and such rule or opinion is binding on LSU or LSU otherwise determines that it must comply with the opinion or ruling, then Employee's Base Salary shall be reduced by the dollar value of the annual leave for which Employee is credited (using the dollar value of such annual leave as of the date on which the opinion or ruling is published). This reduction shall be retroactive to the date on which Employee's earning of annual leave is calculated to begin, and Employee shall repay to LSU the amount of the reduction. Employee shall pay LSU any amount owed as a result of this retroactive reduction in equal monthly installments for a period of 12 months (or such longer or shorter period as may be mutually agreed in writing by Employee and LSU) from the date on which the Employee is given notice that Employee will be credited with annual leave pursuant to this Section. In the alternative, if not prohibited by the ruling or otherwise disallowed by law, Employee may waive Employee's right to annual leave (both retroactively and/or prospectively) in lieu of making the payments that would otherwise be required under this Section.
- D. **No Overtime.** Employee qualifies and is designated as exempt under the Fair Labor Standards Act and is not entitled to any overtime pay or compensatory leave for work in excess of 40 hours in any workweek.
- E. **Relocation Incentive.** If indicated in Section 1 of the Agreement, Employee shall receive a Relocation Incentive. As per University policy, the Relocation Incentive is subject to full or partial repayment to LSU if you do not continue employment with the University for at least two full years. In accordance with Internal Revenue Service regulations, all relocation benefits are taxable compensation subject to withholding and other appropriate deductions.
- F. **Retirement Plan.** Employee is entitled to participate in the retirement programs available to all unclassified professional LSU employees, with contributions and benefit amounts as defined by law. Employee understands and agrees that no contributions for purposes of any State of Louisiana retirement program will be

made by LSU or withheld from Employee's compensation except as to the Base Salary and any earned Post-Season Incentive Compensation, and Employee shall not be entitled to any retirement benefits that may otherwise be attributable to any other compensation paid pursuant to this Agreement. Employee further acknowledges that other sums paid shall not be considered "base pay," "earned compensation," or "earnable compensation" as such terms are defined under Louisiana law and shall not be included as compensation for the purpose of computation of retirement benefits. Retirement contributions are subject to the limitations of federal law and Louisiana law.

- G. **Sick Leave.** Employee shall accrue and use sick leave in accordance with LSU policy.

10. **Additional Revenue.**

- A. Subject to compliance with Governing Athletics Regulations, including but not limited to current NCAA Bylaw 11.2.2 and 11.3.2, and LSU Permanent Memorandum 11 ("PM-11"), Employee may earn or receive other revenue ("Additional Revenue") while employed by LSU, including working with sports camps or clinics, provided, however, that Employee shall obtain prior written approval from the President before engaging in any commercial or private venture (other than a passive investment), including the use of Employee's name by any commercial, public or private entity. As required by NCAA Bylaws 11.2.2, 11.3.2.1, and 11.3.2.1.1, Employee shall report annually to the President and the Athletics Director, in writing, all athletically-related income or benefits received by Employee from sources outside LSU, and shall provide LSU reasonable access to all records necessary to verify this report. LSU does not guarantee any amount of Additional Revenue.
- B. Employee shall not, without written approval of the President and the Athletics Director and compliance with PM-11, arrange for or agree to the receipt of any supplemental pay, bonus, or other form of payment from any outside source.
- C. Except for routine news media interviews or educational or development programs for which no compensation is received, Employee shall not appear on or in any radio, television, or internet programs or other electronic media other than those produced or sponsored by LSU without the prior written approval of the Athletics Director or the Athletics Director's designee.
- D. Employee shall not appear in or make any advertisement or make any commercial endorsement without the prior written approval of the President and the Athletics Director, which will not be unreasonably withheld.

11. **Termination and Suspension.**

- A. **Termination by LSU for Cause.** This Agreement may be terminated for "cause" by LSU at any time prior to its expiration, upon written notice to Employee.

1. For purposes of this Section, “cause” for termination shall be defined as:
 - a. If, as determined by LSU and without the need for any adjudication by any other entity, Employee commits any material and substantial violation (or repeated lesser violations) of Governing Athletics Regulations, fails promptly to report any such violation by another person to the Director of Compliance, or commits a material and substantial violation of any LSU policies, rules, or procedures;
 - b. If, as determined by LSU and without the need for any adjudication by any other entity, there is any material and substantial violation of Governing Athletics Regulations involving any aspect of the Program by any other person if either: (i) the violation occurs or continues to occur after Employee knew or had constructive knowledge that it was about to occur or was occurring, or (ii) Employee failed to follow reasonable policies and procedures established in writing by the Athletics Department to prevent violations of Governing Athletics Regulations from occurring and to detect promptly any such violations which may occur;
 - c. Engaging in serious misconduct which either: (i) displays a continual, serious disrespect or continual, serious disregard for the mission of LSU; (ii) brings Employee into substantial public disrepute sufficient, at the reasonable discretion of LSU, to materially impair Employee’s ability to perform the obligations contained herein without material adverse impact on the Team or Program; or (iii) constitutes moral turpitude or breaches the high moral and ethical standards applicable to Employee as a visible representative of LSU, including but not limited to acts of dishonesty, misrepresentation, fraud or violence that may or may not rise to the level of warranting criminal prosecution by the relevant authorities;
 - d. Unreasonable refusal or repeated failure to perform any duties imposed upon Employee herein (including but not limited to those duties specified in this Agreement), or failing to perform the same to the best of Employee’s reasonable ability;
 - e. Failing to cooperate in the investigation, infractions process, adjudication or enforcement of Governing Athletics Regulations or in any LSU internal investigation or inquiry; or knowingly permitting any other person under Employee’s supervision to fail to reasonably cooperate in such investigation and enforcement;
 - f. Subject to any right of administrative appeal permitted or granted to Employee by the NCAA or SEC, any finding or determination by the NCAA, SEC, or any commission, committee, council, or

tribunal of the same, of any major or repetitive violations by Employee of NCAA or SEC rules, or of any such major or repetitive violations by others under the direct supervision of Employee which were permitted, encouraged, or condoned by Employee, or about which violations Employee knew or should have known and should have acted reasonably to prevent, limit, or mitigate (it is recognized that this subsection includes findings or determinations of any previously undisclosed violations during Employee's prior employment at another institution);

- g. Failing to report promptly to the Director of Compliance any violations of Governing Athletics Regulations involving the Team of which Employee has knowledge;
- h. Failure by Employee to engage in, and use best efforts to ensure that personnel under Employee's direct or indirect supervision engage in, safe and responsible treatment of student athletes on the Team, including but not limited to failure to comply with any requirement pertaining to medical clearance for participation, or any other act or omission (including but not limited to physical and/or emotional abuse of student athletes) that creates, or could reasonably be expected to create, an unreasonable risk of harm to a student athlete;
- i. Failure to comply with LSU policies, rules and regulations concerning Title IX, including specifically but not exclusively the reporting of any incident of sexual misconduct in accordance with LSU's Title IX policy and PM-73; or
- j. Prolonged absence from LSU without permission, which will not be unreasonably withheld;
- k. Failure to respond fully and truthfully within a reasonable time to any reasonable requests or inquiry relating to the performance of any duties herein or at any prior employment at any other institution of higher learning propounded by LSU, the NCAA, the SEC or any other governing body having supervision over the athletic programs of LSU or such other institution of higher education, or required by law or Governing Athletics Regulations; or knowingly permitting any other person under Employee's supervision to fail to so respond;
- l. Committing fraud in the performance of any duties and responsibilities herein, either with intent or reckless disregard for the truth, including but not limited to fraud or dishonesty in any written or verbal statements, including résumés, provided by Employee to LSU in the application process or fraud in the preparation, falsification, or alteration of documents or records of LSU, the NCAA, or the SEC, or documents or records pertaining to

any recruit or student athlete, including but not limited to transcripts, eligibility forms, and compliance reports; or knowingly permitting any other person to commit such fraud;

- m. Being charged with or convicted of either: (i) any felony, or (ii) any crime involving larceny, embezzlement, fraud, gambling, drugs, or alcohol;
- n. Participation in any gambling, bookmaking, wagering, or betting involving any athletic contest whether by soliciting, placing, or accepting a bet or wager or through a bookmaker, a pool, an online or in-person sportsbook, or any other method of gambling; or knowingly permitting any student athlete or other individual under Employee's control, authority, or supervision to participate in such activity;
- o. Providing information or data, other than information or data provided to the general public through public presentation, relating in any manner to any intercollegiate sport or to any student athlete to any individual whom Employee knows (or has constructive knowledge) to be a gambler, better, or bookmaker, or an agent of any such person; or knowingly permitting any student athlete or other individual under Employee's control, authority, or supervision to furnish such information or data;
- p. Use or consumption of alcoholic beverages or controlled substances, steroids, or other drugs or substances to such degree and for such appreciable period as to substantially impair Employee's ability to perform the duties herein;
- q. Sale, purchase, use or possession of any controlled substances, steroids, or other drugs or chemicals, the sale, purchase, use, or possession of which by Employee is prohibited by law or Governing Athletics Regulations, excepting the use or possession of substances or drugs lawfully prescribed by a health care provider, and used in accordance therewith;
- r. Encouraging or allowing the sale, purchase, use, or possession by any student athlete or other individual under Employee's control, authority, or supervision of any controlled substances, steroids, or other drugs or chemicals, the sale, purchase, use, or possession of which by such person is prohibited by law or Governing Athletics Regulations; or
- s. Violating any material term of this Agreement.

- 2. The process for termination for cause is as follows:

- a. Prior to termination for cause, LSU shall provide Employee written notice of termination with a designated effective date of termination. The notice of termination shall be provided at least seven calendar days before the effective date of termination and shall be signed by the Athletics Director or the Athletics Director's designee. The notice of termination shall reference the facts upon which termination is authorized.
 - b. Prior to the effective date of termination in the notice, Employee shall have the right to present a written statement and any supporting materials to the Athletics Director detailing why the Employee believes LSU should rescind its notice of termination. The Athletics Director or the Athletics Director's designee may extend the effective date of termination in writing to allow additional time to consider Employee's response.
 - c. After review of any such response, the Athletics Director or the Athletics Director's designee shall provide Employee written notice of a decision. If confirmed, termination of employment shall be effective on the date of termination previously identified.
 - d. Within seven calendar days of receipt of the decision of the Athletics Director, Employee may make a written request for review to the President and submit materials for consideration. If no such request is made, the decision of the Athletics Director is final.
 - e. If a request for review is made, the President or the President's designee shall conduct the review based on materials provided by the Employee and materials considered by the Athletics Director. The request for review by the President shall not suspend the effective date of the termination.
 - f. Within 14 calendar days of the submission, Employee will be provided written notice of the decision of the President, which shall be final.
3. Should the Employee be reinstated following a request for review, Employee shall be paid any lost compensation and benefits, retroactive to the date such compensation and benefits ceased.
 4. In the event of termination for cause, all of Employee's compensation and benefits provided for in this Agreement shall terminate on the termination date, and LSU shall not thereafter be liable to Employee for any sums or damages other than Base Salary and Supplemental Compensation earned through the last day of such month, as well as Post-Season Incentive Compensation that has been earned but not paid. The termination date shall

be the date on which the initial notice of termination is given, or on such later date as may be set forth by LSU in the notice of termination.

5. As required by NCAA Bylaw 11.2.1, Employee is hereby notified that in addition to the actions LSU may take in accordance with this Agreement, Employee is also subject to disciplinary or corrective action as set forth in the provisions of the NCAA enforcement procedures if Employee is found by the NCAA or LSU to be in violation of NCAA Bylaws. Employee agrees that LSU shall implement any such disciplinary or corrective actions imposed by the NCAA. Employee further understands that Employee has an affirmative obligation to cooperate fully in the NCAA infractions process, including the investigation and adjudication of a case, pursuant to this Agreement and NCAA Bylaw 11.2.1, and that such obligation continues in effect during and beyond the termination of this Agreement for any violations alleged to have occurred during Employee's employment by LSU.

B. Termination by LSU without Cause.

1. LSU shall have the right to terminate this Agreement without cause upon written notice to Employee.
2. In the event of termination by LSU without cause, all of Employee's compensation and benefits provided for in this Agreement shall terminate on the termination date, and LSU shall not thereafter be liable to Employee for any sums or damages other than the liquidated damages provided for herein and as well as Post-Season Incentive Compensation that has been earned but not paid. The termination date shall be the date designated by LSU in the notice of termination.
3. If LSU terminates employment during the Term without cause, LSU will pay Employee liquidated damages in the amount of ninety percent (90%) of the Base Salary and Supplemental Compensation which would have been payable to Employee through the remaining otherwise unexpired Term of the Agreement with partial years and months pro-rated.
4. Liquidated damages under this Section will be paid in equal monthly installments over a period equal to the amount of time then remaining in the otherwise unexpired Term. LSU's obligation to pay liquidated damages under this Section shall terminate upon the death of Employee.
5. In the event of termination by LSU without cause, Employee shall have the duty to mitigate and use reasonable efforts to obtain similar athletics-related employment in another position with compensation at fair market value. Employee shall exercise due diligence and good faith in seeking qualifying employment so long as the liquidated damage obligation exists. In the event Employee obtains such other employment, Employee must notify LSU and

provide documentation reasonably requested by LSU to determine the amount of compensation received by Employee and the amount of offset due to LSU. Mitigation shall be calculated as follows:

- a. If new employment is via contract, LSU shall reduce future payments by the greater of (i) the average annual compensation of Employee's new employment agreement (regardless of term) or (ii) the specific annual compensation due for given year corresponding to this Agreement.
- b. If new employment is not via contract (i.e., at-will), LSU will reduce future payments by the specific annual compensation due for given year corresponding to this Agreement.

Employee shall not attempt to allow third parties to take advantage of this Section as a means of avoiding paying the market value of Employee's services. In the event Employee breaches these obligations, LSU will have the right to (i) be completely relieved of any obligation to make any remaining payments owed to Employee (following notice to Employee and a reasonable opportunity for Employee's new employer to cure any deficiency) or (ii) adjust payments to reflect the market value for Employee's employment or services.

6. This is an agreement for personal services. The parties recognize that termination of this Agreement by LSU prior to its expiration by lapse of Term would cause Employee to lose compensation, fringe benefits, certain other LSU-provided benefits, and possibly other income and benefits provided by third parties, which damages are not easy to determine with certainty. Accordingly, the parties have bargained for this liquidated damages provision. The parties further agree that the liquidated damages herein are not in any way a penalty.

C. Termination by Employee Without Cause.

1. Employee shall have the right to terminate this Agreement without cause upon advance written notice to LSU. If Employee terminates employment at any time before the End Date, Employee will pay liquidated damages to LSU as follows:
 - A. Fifty percent (50%) of all remaining Base Salary and Supplemental Compensation which would have been payable to Employee for the remaining Term, if Employee accepts employment in a non-head coaching position with another SEC program (regardless of location) or any Division I-A program within 500 miles of LSU; or
 - B. Twenty-five percent (25%) of all remaining Base Salary and Supplemental Compensation which would have been payable to Employee for the remaining Term, if Employee accepts

employment in a non-head coaching position other than as described above or terminates employment for any other reason; however

C. No liquidated damages will be owed if (i) Employee accepts any collegiate head coaching or play-calling coordinator position or position in the National Football League, (ii) terminates the Agreement after the conclusion of the final regular season game (including the conference championship game, if applicable) of the final season covered by the Term, or (iii) if Employee terminates within 90 days of Brian Kelly's last day of employment with LSU as Head Coach.

2. Employee shall have the option to pay liquidated damages in a lump sum or in equal monthly installments over a period equal to the amount of time then remaining in the Agreement.

3. In the event of termination by Employee without cause, all of Employee's compensation and benefits provided for in this Agreement shall terminate on the termination date, which, unless otherwise agreed to in writing by LSU and Employee, shall be the earlier of: (a) the date on which Employee provides notice of termination to LSU; (b) the date on which Employee accepts employment from another employer; or (c) the date on which Employee performs any work or services of any kind or nature whatsoever on behalf of or for the benefit of another employer. LSU shall not thereafter be liable to Employee for any amounts other than any Base Salary and Supplemental Compensation earned pursuant to this Agreement, as well as Post-Season Incentive Compensation that has been earned but not paid, prior to the termination date. The Parties acknowledge that this provision is intended to obligate Employee to repay unearned compensation and fees previously or inadvertently paid by LSU under the premise that Employee would fulfill the Term of this Agreement.

4. This is an agreement for personal services. The parties recognize that termination of this Agreement by Employee prior to its expiration by lapse of term would cause LSU to incur administrative, recruiting, and resettlement costs in obtaining a replacement for the Program, in addition to potentially increased compensation costs and loss of goodwill or sales, which damages are impossible to determine with any certainty. Accordingly, the parties have bargained for this liquidated damages provision. The parties further agree that the liquidated damages herein are not in any way a penalty.

D. Suspension or Other Disciplinary Action.

1. LSU may impose suspension or leave without pay for a period no longer than 120 days for any act or omission which would be grounds for discipline or termination for cause as defined herein. Imposition of such sanctions

shall be at the discretion of LSU, which shall not be exercised arbitrarily or capriciously. Prior to suspension without pay under this provision, Employee shall be provided written notice of the grounds for the suspension and shall have seven calendar days from receipt of such notice to respond in writing to the Athletics Director. After review of any such response, the Athletics Director or the Athletics Director's designee will provide Employee with written notice of a decision and/or suspension. Suspension under this subsection shall not limit any rights of LSU to terminate Employee for cause.

2. Employee shall be subject to disciplinary or corrective action by the NCAA or SEC for any violation of NCAA and SEC regulations, respectively. Such action by the NCAA or the SEC shall not preclude or in any manner affect LSU's right to take such other corrective or disciplinary action as it deems necessary or proper, including termination for cause.
3. Notwithstanding any other provision of this Agreement to the contrary, if Employee is suspended by the SEC or NCAA, Employee shall automatically be suspended by LSU for the duration of the SEC or NCAA imposed suspension without further notice or process. During such suspension, Employee shall not be entitled to receive any compensation, benefits or any other payments under this Agreement except for fringe benefits provided under Section 9 of this Agreement.

E. **Termination by Death or Disability.** In the event of the death of Employee or the inability of Employee to perform the obligations described in this Agreement with or without accommodation by reason of disability or some other occurrence beyond the control of either party, and such inability to perform has continued or will continue beyond a reasonable period of time, but not less than 60 days, this Agreement shall terminate as a termination with cause and all future obligations between the parties shall cease upon the termination date reasonably established by LSU, unless otherwise required by law, and LSU shall not thereafter be liable to Employee for any sums other than Base Salary and Supplemental Compensation earned through the last day of such month, as well as Post-Season Incentive Compensation that has been earned but not paid.

F. **Exclusivity of Remedy.** The financial consequences of termination of this Agreement or suspension are exclusively set forth herein. Therefore, with the sole exception of payments required by this Agreement, in any instance of termination for cause or without cause, or suspension or other disciplinary sanction effected in accordance with the procedures established in this Agreement, neither Employee nor LSU shall be entitled to receive, and each hereby waives any claim against the other, and their respective board members, officers, directors, agents, employees, successors, and personal representatives, for damages, including consequential damages by reason of any alleged economic loss, including but not limited to loss of collateral income, deferred income, loss of earning capacity, loss of business opportunity, loss of benefits, loss of fees from speaking, camps or other outside

activity, damages allegedly sustained because of alleged humiliation or defamation, or any other non-compensatory and compensatory damages and attorney's fees resulting from the fact of termination, the public announcement thereof, or the release by LSU or Employee of information or documents which are public or as otherwise required by law. Employee acknowledges that in the event of either termination of this Agreement for cause, without cause, or otherwise, or suspension or other disciplinary sanction effected in accordance with the procedures established in this Agreement, Employee shall have no right to occupy the Position and that Employee's sole remedies are provided herein and shall not extend to injunctive relief. THE PARTIES ACKNOWLEDGE AND AGREE THAT THIS SECTION LIMITING LIABILITY AND EXCLUDING CONSEQUENTIAL DAMAGES AND OTHER REMEDIES IS ESSENTIAL AND IS A MATERIAL INDUCEMENT FOR THE UNIVERSITY TO ENTER INTO THIS AGREEMENT. ACCORDINGLY, SUCH PROVISIONS SHALL BE SEVERABLE AND INDEPENDENT OF ANY OTHER PROVISIONS AND SHALL BE ENFORCED AS SUCH, REGARDLESS OF ANY MATERIAL BREACH OR OTHER OCCURRENCE HEREUNDER.

G. **Interference with Athletics.** During any period where Employee receives post-termination liquidated damages, compensation or benefits, Employee agrees that Employee will not interfere with LSU student athletes or otherwise obstruct the ability of LSU or the Athletics Department to transact business. If Employee materially violates this provision, LSU shall be entitled to discontinue any post-termination liquidated damages, compensation or benefits and may seek to recover any payments that have been disbursed.

12. **Discontinuation of the Program by the University.** Notwithstanding any provision to the contrary, in the event the University determines for any reason within its sole discretion to discontinue the Program as a Division I sport, LSU shall have the right to terminate this Agreement without further obligation to Employee. Notice of termination under this Section shall be in writing and shall establish a date of termination no less than 90 days from the date of the notice or upon the End Date, whichever occurs first. In the event the right to terminate pursuant to this Section is exercised, all obligations between the parties shall cease effective on the date of termination.

13. **University Property.** All property that is provided to, or developed or acquired by, Employee as part of or in conjunction with Employee's employment by LSU, regardless of the format or manner in which the property may be retained or stored, shall remain the sole property of LSU. This shall include, without limitation, all documents, files, personnel records, recruiting records, team information, athletic equipment, films, statistics, keys, credit cards, computers, software programs, and electronic devices that Employee may have access to or come into possession of during employment. Excluded from this provision are Employee's personal notes, personal playbooks, memorabilia, diaries and other personal records, which the Employee may retain. Employee is required to return to LSU all LSU property in Employee's possession within seven calendar days of termination or separation of employment. Employee shall also return any courtesy vehicle provided under this Agreement within seven calendar days of termination or separation of

employment. Employee agrees that LSU may withhold any liquidated damage payments or other compensation due Employee pending return of property under this Section.

14. **Duty of Loyalty.** Unless notice of termination under this Section has been given by either party, neither Employee nor Employee's agent shall, under any circumstances, discuss or negotiate directly or indirectly prospective employment for Employee with any other institution of higher education, professional athletic team, or other athletically-related (including media and sports marketing) prospective employer without giving at least 24 hours prior written notice to the President and the Athletics Director.
15. **Duty to Cooperate.** Both during and after the end of employment with LSU, Employee agrees, without additional compensation (other than reimbursement for reasonable associated expenses post-employment), to cooperate with LSU in any investigation, internal or otherwise, of any possible violation of law (including Title IX) or violation of any rule, policy or regulation of LSU (including PM-73), the SEC or the NCAA. Employee agrees (a) to be reasonably available to answer questions regarding any matter with which Employee was involved while employed by LSU, and (b) to cooperate with LSU during the course of any proceedings arising out of any matter with which Employee has knowledge or information.
16. **Non-Assignment.** Neither party may assign, transfer, alienate, or encumber any of its rights or obligations hereunder without the express written consent of the other party, except as otherwise specifically set forth in this Agreement.
17. **Entire Agreement.** This Agreement constitutes and expresses the entire agreement and understanding of the parties concerning the matters contemplated hereby and shall, upon the Effective Date, supersede any other oral and written agreements between the parties. There are no oral or other agreements, understandings, promises, or representations between the parties affecting this Agreement. Both parties have relied solely on their own respective judgments in entering into this Agreement, with full opportunity to seek advice of competent counsel. It shall be construed, if necessary, without reference to the party that was the principal drafter of the Agreement.
18. **Indirect Actions Prohibited.** Any act which Employee is prohibited from doing directly in this Agreement shall not be done indirectly by Employee or another person on Employee's behalf or at Employee's behest.
19. **Amendments to Agreement.** This Agreement may be amended only by a written instrument duly approved by LSU through its designated representatives and accepted by Employee, such approval and acceptance to be acknowledged in writing.
20. **Severability.** If any provision of this Agreement shall be deemed invalid or unenforceable, either in whole or in part, this Agreement shall be deemed amended to delete or modify, as necessary, the offending provision or to alter the bounds thereof in order to render it valid and enforceable.

21. **No Waiver of Default.** No waiver by the parties hereto of any default or breach of any covenant, term or condition of this Agreement shall be deemed to be a waiver of any other default or breach of the same or any other covenant, term or condition contained herein.
22. **No Waiver of Sovereign Immunity.** It is expressly agreed and understood between the parties that nothing contained herein shall be construed to constitute a waiver or relinquishment by LSU of any rights to claim such exemptions, privileges and immunities as may be provided by law.
23. **“Force Majeure” Clause.** Neither party shall be considered in default of performance of any obligations under this Agreement if such performance is prevented or delayed by Force Majeure. “Force Majeure” shall be understood to be any cause which is beyond the reasonable control of the party affected and which is forthwith, by notice from the party affected, brought to the attention of the other party, including but not limited to war, hostilities, revolution, civil unrest, strike, lockout, epidemic or pandemic, government-ordered restriction or cessation of activity, accident, fire, natural disaster, wind or flood or any requirements of law, or an act of God.
24. **Additional Conditions of Employment.**
- A. **Compliance with La. R.S. 42:31.** To the extent annual compensation under this Agreement exceeds \$100,000, Employee hereby agrees and promises that, within 30 days of the Start Date or the date that compensation reaches that threshold, Employee shall provide proof to LSU that Employee has been issued a Louisiana driver’s license and that all vehicles registered in Employee’s name are registered in Louisiana, all pursuant to the requirements of La. R.S. 42:31.
- B. **Background Checks and Disclosures.** Prior to commencing employment, Employee shall be required to submit to background checks as deemed appropriate by the University. Employee’s employment is contingent upon a satisfactory background check in accordance with University policy. In addition, prior to signing this Agreement, Employee must disclose to the University any and all criminal, civil or administrative matters from the prior five years, including those currently pending but excluding non-felony traffic infractions. Failure to disclose all such matters to the University will serve as a basis to terminate employment for cause.
- C. **Approvals.** This Agreement is subject to any approvals that must be obtained in accordance with law or University policy. No provision of this Agreement shall be enforceable until signed by all parties and, if required by policy, approved by the Board of Supervisors.
25. **Governing Law and Venue.** This Agreement shall be enforced and construed in accordance with the laws of Louisiana. Any civil action to enforce this Agreement shall be brought in a state or federal court having jurisdiction and domiciled in East Baton Rouge Parish, Louisiana.







2024.02.22 Brad Davis Contract

Final Audit Report

2024-02-27

Created:	2024-02-22 (Central Standard Time)
By:	Wendy Nall (wnall@lsu.edu)
Status:	Signed
Transaction ID:	CBJCHBCAABAAC21u6skHbv3GIPUxgoyGdL6kERnuUpC

"2024.02.22 Brad Davis Contract" History

-  Document created by Wendy Nall (wnall@lsu.edu)
2024-02-22 - 12:08:14 PM CST
-  Document emailed to Brad Davis (braddavis@lsu.edu) for signature
2024-02-22 - 12:09:08 PM CST
-  Email viewed by Brad Davis (braddavis@lsu.edu)
2024-02-22 - 3:47:57 PM CST
-  Email viewed by Brad Davis (braddavis@lsu.edu)
2024-02-24 - 1:23:40 PM CST
-  Email viewed by Brad Davis (braddavis@lsu.edu)
2024-02-26 - 4:22:02 PM CST
-  Document e-signed by Brad Davis (braddavis@lsu.edu)
Signature Date: 2024-02-27 - 3:15:44 PM CST - Time Source: server
-  Agreement completed.
2024-02-27 - 3:15:44 PM CST

EMPLOYMENT AGREEMENT

This Employment Agreement (“Agreement”) is made and entered into as of this 23rd day of February, 2024, by and between the Board of Supervisors of Louisiana State University and Agricultural and Mechanical College (“LSU”), a body corporate existing under the Constitution and laws of the State of Louisiana, herein represented by William F. Tate IV, its duly authorized President, and Frank Wilson, III (“Employee”):

1. **Definitions.** For purposes of this Agreement, the following terms shall have the meaning shown:

- A. “Athletics Director”: The Director of Athletics at LSU.
- B. “Base Salary”: The annualized sum of \$400,000.
- C. “Contract Year”: An annual period from January 1 to December 31 during the Term.
- D. “End Date”: January 15, 2027.
- E. “Position”: Assistant Coach for the Team.
- F. “President”: The President of LSU.
- G. “Program”: The intercollegiate football program at LSU.
- H. “Start Date”: January 16, 2024.
- I. “Supplemental Compensation”: The annualized sum for the following period:

Start Date through January 15, 2025:	\$600,000
January 16, 2025 through January 15, 2026:	\$650,000
January 16, 2026 through January 15, 2027:	\$800,000
- J. “Team”: The intercollegiate athletic team which is a part of the Program.

2. **Term.** This Agreement shall be for a definite term (“Term”), commencing on the Start Date and ending on the End Date unless terminated sooner in accordance with Section 11 or 12 of this Agreement. On the Start Date, the existing Employment Agreement between Employee and LSU dated March 4, 2022 shall be terminated by agreement of the parties and replaced by this Agreement.

3. **Employment.** LSU does hereby employ Employee in the Position for the Term. Employee will report directly to the Head Coach of the Team. It is the intention of the parties that Employee will serve in the Position for the entirety of the Term. Employee acknowledges and agrees that Employee is not eligible for and will not be considered for or granted tenure by LSU.

4. **Duties and Responsibilities.** Employee's duties and responsibilities shall include the following, all subject to law, LSU policy, and the directives, input, and advice of the Head Coach and Athletics Director:
- A. Performing all duties reasonably assigned to Employee by the Head Coach of the Team or the Athletics Director so long as such duties are consistent with those duties typically assigned to assistant coaches at colleges or universities at the same competitive level as LSU;
 - B. Promoting the success of the Team and its student athletes both athletically and academically;
 - C. Devoting full professional attention and efforts to promoting the Program and fulfilling the necessary coaching responsibilities and duties;
 - D. Being reasonably knowledgeable of and complying with: (1) all applicable federal and state laws governing intercollegiate athletics; and (2) all governing constitutions, by-laws, rules, policies, interpretations, and regulations of the National Collegiate Athletics Association ("NCAA"), the Southeastern Conference ("SEC"), LSU, and any other conference rules or policies which may be subsequently implemented (hereinafter collectively referred to as "Governing Athletics Regulations");
 - E. Promoting an atmosphere of compliance within the Program;
 - F. Promptly reporting any known or reasonably suspected violation of Governing Athletics Regulations to the Athletics Director and the Director of Compliance;
 - G. Understanding and complying with Title IX of the Education Amendments of 1972 and LSU policies on Title IX and sexual misconduct, including but not limited to Permanent Memorandum 73 ("PM-73"), and understanding and complying with the mandatory obligation to report incidents of sexual misconduct (including sexual harassment and sexual violence) and other inappropriate sexual conduct of which Employee has knowledge or receives notice to LSU's Title IX Coordinator as required by PM-73;
 - H. Understanding and complying with Title VI of the Civil Rights Act of 1964, other federal laws, state law, and LSU policies on equal opportunity and discrimination, including but not limited to Permanent Memorandum 55;
 - I. Cooperating fully, truthfully and without undue delay in any investigation, infractions process or adjudication of any matter under Governing Athletics Regulations conducted or authorized by LSU, the SEC, or the NCAA at any time;
 - J. Cooperating fully, truthfully and without undue delay in any LSU internal investigation or inquiry;

- K. Reasonably observing, respecting, and promoting the principles of institutional control in the Program;
 - L. Understanding, observing, upholding, and promoting LSU's written academic standards, requirements, and policies, and reasonably promoting an environment in which admissions, financial aid, academic services for student athletes, and recruiting are conducted consistent with LSU's mission;
 - M. Cultivating and maintaining reasonable interaction with members of the LSU community, in accordance with the policies and instructions of the Head Coach of the Team and the Athletics Director;
 - N. Performing all duties in a manner consistent with good sportsmanship and in accordance with the high moral, ethical, and academic standards of the Athletics Department, the Program and LSU;
 - O. Using reasonable efforts, through due care and supervision, to ensure that all student athletes and other individuals under or subject to Employee's control, authority, or supervision comply with all Governing Athletics Regulations and act in accordance with the high moral, ethical, and academic standards of the Athletics Department, the Program and LSU;
 - P. Maintaining a presence on campus and in the Program, except for absences approved by the Athletics Department; and
 - Q. Using reasonable efforts to promote the goal of LSU that every student athlete obtains an undergraduate degree, and reasonably cooperating with academic counselors or similar persons designated by LSU to assist student athletes and the faculty and administrators of LSU in connection with the academic pursuits of student athletes.
5. **Sports Camps.** Subject to Governing Athletics Regulations and Athletics Department guidelines, rules and regulations, Employee may work at sports camps or clinics at LSU. Except as expressly provided in this Agreement, LSU does not guarantee or provide any additional compensation from operation of sports camps or clinics.
6. **Base Salary.** LSU agrees to pay Employee the Base Salary annually during the Term, in 12 equal monthly installments, on LSU's regular monthly payroll date. Any amounts due to Employee under this Section for a partial Contract Year shall be prorated.
7. **Media Participation, License to NIL, and Supplemental Compensation.**
- A. **License.** As owner of the rights to Employee's name, image and likeness, Employee grants to the University and Athletics Department, a perpetual, non-exclusive and non-transferrable license of the names, nicknames, initials, autograph, likeness, images, pictures, video, depictions, resemblance, quotes, phrases, interviews, coaching records, philosophies and methods attributable to Employee obtained during the Term, and all derivatives thereof, for any current or

future uses for promoting the University, Athletics Department or the Program. This license shall include the intellectual property rights and services of Employee in connection with promoting, appearing on, or participating in, as requested, and making reasonable efforts to make successful, LSU-sanctioned television, radio, social media and internet programs, including streaming services, concerning LSU and the Team.

B. **Supplemental Compensation/Royalty.** As a royalty for the license granted herein, Employee will earn and receive Supplemental Compensation during the Term, which shall be payable in equal monthly installments and may be paid from affiliated foundation funds. Any amounts due to Employee under this Section for a partial Contract Year shall be prorated.

C. **Ownership of Programming.** LSU shall exclusively own all rights to any television, radio, and internet programs and shall be entitled, at its option, to produce and market the programs or negotiate with third parties for the production and marketing of the programs. LSU shall retain all revenue generated by the programs including but not limited to that received from program sponsors for commercial endorsements used during the programs. "Program sponsors" shall include, but not be limited to, those persons or companies who make financial contributions supporting, or who pay a fee for, commercial announcements and endorsements used on the programs.

8. **Post-Season Incentive Compensation.** Employee shall be entitled to post-season incentive compensation as follows. Post-Season Incentive Compensation is additional compensation for the extra services required of Employee in the preparation for and participation in post-season play, in accordance with LSU's policies and procedures. If Employee does not actively coach the Team in the Position for any post-season game for any reason, including but not limited to termination of employment, Employee shall not be entitled to Post-Season Incentive Compensation. Post-Season Incentive Compensation shall be paid within 60 days of achieving the applicable goal and may be payable, in whole or in part, from affiliated foundation funds. The maximum amount of Incentive Compensation under this Section shall be \$125,000 per Contract Year.

- | | | | |
|----|-----------------------------------|----------|----|
| 1. | SEC Championship Game Participant | \$15,000 | OR |
| 2. | SEC Champion | \$25,000 | |

AND ONE OF THE FOLLOWING:

- | | | | |
|----|---|----------|----|
| 1. | Non College Football Playoff (CFP) Bowl Participant | \$15,000 | OR |
| 2. | CFP Participant (Top 12) | \$25,000 | OR |
| 3. | CFP Quarterfinal Game Participant | \$40,000 | OR |
| 4. | CFP Semifinal Game Participant | \$50,000 | OR |

5. CFP National Championship Game Participant \$75,000 OR

6. CFP National Champion \$100,000

If the CFP format is expanded to include additional teams, the parties will mutually agree on additional incentive compensation for participation therein, and/or CFP victories (to the extent not already contemplated by the then-existing bonus structure).

9. **Fringe Benefits and Leave.** Unless otherwise specified herein, Employee is entitled to participate in the fringe benefit programs available to all unclassified professional LSU employees, with contributions and benefit amounts as defined by law. Employee shall also be entitled to the following benefits:

A. **Apparel.** As part of any third-party apparel and/or equipment-related contract with LSU, Employee acknowledges and agrees that the Team may be provided and/or allocated apparel and/or equipment from and by LSU, which apparel and equipment shall be used exclusively and solely by Employee in furtherance of Employee's employment duties and team-related activities as applicable to Employee's employment with LSU.

B. **Car Allowance.** Employee shall receive an automobile entitlement of (1) an annual automobile allowance in an amount not to exceed \$800 per month, or (2) to the extent consistent with state ethics law, use of courtesy vehicle provided by a dealership and related automobile insurance.

C. **No Annual Leave.** Because of the specific nature of Employee's job duties and the irregular times during which Employee will be required to perform those job duties (for example, working more than 40 hours per week during Team's season, post-season, and recruiting period, while having fewer responsibilities in the off-season), Employee acknowledges and agrees that Employee will not earn or accrue annual leave.

1. Employee's compensation has been mutually negotiated with this understanding, and both Employee and LSU agree that the compensation would be less if Employee were entitled to earn annual leave.

2. If any administrative tribunal, statewide elected official, state board or commission with jurisdiction over such matters, or any court of competent jurisdiction, rules or publishes a formal written opinion or decision that Louisiana law requires Employee to earn annual leave, and such rule or opinion is binding on LSU or LSU otherwise determines that it must comply with the opinion or ruling, then Employee's Base Salary shall be reduced by the dollar value of the annual leave for which Employee is credited (using the dollar value of such annual leave as of the date on which the opinion or ruling is published). This reduction shall be retroactive to the date on which Employee's earning of annual leave is calculated to begin,

and Employee shall repay to LSU the amount of the reduction. Employee shall pay LSU any amount owed as a result of this retroactive reduction in equal monthly installments for a period of 12 months (or such longer or shorter period as may be mutually agreed in writing by Employee and LSU) from the date on which the Employee is given notice that Employee will be credited with annual leave pursuant to this Section. In the alternative, if not prohibited by the ruling or otherwise disallowed by law, Employee may waive Employee's right to annual leave (both retroactively and/or prospectively) in lieu of making the payments that would otherwise be required under this Section.

- D. **No Overtime.** Employee qualifies and is designated as exempt under the Fair Labor Standards Act and is not entitled to any overtime pay or compensatory leave for work in excess of 40 hours in any workweek.
- E. **Relocation Incentive.** If indicated in Section 1 of the Agreement, Employee shall receive a Relocation Incentive. As per University policy, the Relocation Incentive is subject to full or partial repayment to LSU if you do not continue employment with the University for at least two full years. In accordance with Internal Revenue Service regulations, all relocation benefits are taxable compensation subject to withholding and other appropriate deductions.
- F. **Retirement Plan.** Employee is entitled to participate in the retirement programs available to all unclassified professional LSU employees, with contributions and benefit amounts as defined by law. Employee understands and agrees that no contributions for purposes of any State of Louisiana retirement program will be made by LSU or withheld from Employee's compensation except as to the Base Salary and any earned Post-Season Incentive Compensation, and Employee shall not be entitled to any retirement benefits that may otherwise be attributable to any other compensation paid pursuant to this Agreement. Employee further acknowledges that other sums paid shall not be considered "base pay," "earned compensation," or "earnable compensation" as such terms are defined under Louisiana law and shall not be included as compensation for the purpose of computation of retirement benefits. Retirement contributions are subject to the limitations of federal law and Louisiana law.
- G. **Sick Leave.** Employee shall accrue and use sick leave in accordance with LSU policy.

10. **Additional Revenue.**

- A. Subject to compliance with Governing Athletics Regulations, including but not limited to current NCAA Bylaw 11.2.2 and 11.3.2, and LSU Permanent Memorandum 11 ("PM-11"), Employee may earn or receive other revenue ("Additional Revenue") while employed by LSU, including working with sports camps or clinics, provided, however, that Employee shall obtain prior written approval from the President before engaging in any commercial or private venture

(other than a passive investment), including the use of Employee's name by any commercial, public or private entity. As required by NCAA Bylaws 11.2.2, 11.3.2.1, and 11.3.2.1.1, Employee shall report annually to the President and the Athletics Director, in writing, all athletically-related income or benefits received by Employee from sources outside LSU, and shall provide LSU reasonable access to all records necessary to verify this report. LSU does not guarantee any amount of Additional Revenue.

- B. Employee shall not, without written approval of the President and the Athletics Director and compliance with PM-11, arrange for or agree to the receipt of any supplemental pay, bonus, or other form of payment from any outside source.
- C. Except for routine news media interviews or educational or development programs for which no compensation is received, Employee shall not appear on or in any radio, television, or internet programs or other electronic media other than those produced or sponsored by LSU without the prior written approval of the Athletics Director or the Athletics Director's designee.
- D. Employee shall not appear in or make any advertisement or make any commercial endorsement without the prior written approval of the President and the Athletics Director, which will not be unreasonably withheld.

11. Termination and Suspension.

- A. **Termination by LSU for Cause.** This Agreement may be terminated for "cause" by LSU at any time prior to its expiration, upon written notice to Employee.
 - 1. For purposes of this Section, "cause" for termination shall be defined as:
 - a. If, as determined by LSU and without the need for any adjudication by any other entity, Employee commits any material and substantial violation (or repeated lesser violations) of Governing Athletics Regulations, fails promptly to report any such violation by another person to the Director of Compliance, or commits a material and substantial violation of any LSU policies, rules, or procedures;
 - b. If, as determined by LSU and without the need for any adjudication by any other entity, there is any material and substantial violation of Governing Athletics Regulations involving any aspect of the Program by any other person if either: (i) the violation occurs or continues to occur after Employee knew or had constructive knowledge that it was about to occur or was occurring, or (ii) Employee failed to follow reasonable policies and procedures established in writing by the Athletics Department to prevent violations of Governing Athletics Regulations from occurring and to detect promptly any such violations which may occur;

- c. Engaging in serious misconduct which either: (i) displays a continual, serious disrespect or continual, serious disregard for the mission of LSU; (ii) brings Employee into substantial public disrepute sufficient, at the reasonable discretion of LSU, to materially impair Employee's ability to perform the obligations contained herein without material adverse impact on the Team or Program; or (iii) constitutes moral turpitude or breaches the high moral and ethical standards applicable to Employee as a visible representative of LSU, including but not limited to acts of dishonesty, misrepresentation, fraud or violence that may or may not rise to the level of warranting criminal prosecution by the relevant authorities;
- d. Unreasonable refusal or repeated failure to perform any duties imposed upon Employee herein (including but not limited to those duties specified in this Agreement), or failing to perform the same to the best of Employee's reasonable ability;
- e. Failing to cooperate in the investigation, infractions process, adjudication or enforcement of Governing Athletics Regulations or in any LSU internal investigation or inquiry; or knowingly permitting any other person under Employee's supervision to fail to reasonably cooperate in such investigation and enforcement;
- f. Subject to any right of administrative appeal permitted or granted to Employee by the NCAA or SEC, any finding or determination by the NCAA, SEC, or any commission, committee, council, or tribunal of the same, of any major or repetitive violations by Employee of NCAA or SEC rules, or of any such major or repetitive violations by others under the direct supervision of Employee which were permitted, encouraged, or condoned by Employee, or about which violations Employee knew or should have known and should have acted reasonably to prevent, limit, or mitigate (it is recognized that this subsection includes findings or determinations of any previously undisclosed violations during Employee's prior employment at another institution);
- g. Failing to report promptly to the Director of Compliance any violations of Governing Athletics Regulations involving the Team of which Employee has knowledge;
- h. Failure by Employee to engage in, and use best efforts to ensure that personnel under Employee's direct or indirect supervision engage in, safe and responsible treatment of student athletes on the Team, including but not limited to failure to comply with any requirement pertaining to medical clearance for participation, or any other act or omission (including but not limited to physical and/or emotional

abuse of student athletes) that creates, or could reasonably be expected to create, an unreasonable risk of harm to a student athlete;

- i. Failure to comply with LSU policies, rules and regulations concerning Title IX, including specifically but not exclusively the reporting of any incident of sexual misconduct in accordance with LSU's Title IX policy and PM-73; or
- j. Prolonged absence from LSU without permission, which will not be unreasonably withheld;
- k. Failure to respond fully and truthfully within a reasonable time to any reasonable requests or inquiry relating to the performance of any duties herein or at any prior employment at any other institution of higher learning propounded by LSU, the NCAA, the SEC or any other governing body having supervision over the athletic programs of LSU or such other institution of higher education, or required by law or Governing Athletics Regulations; or knowingly permitting any other person under Employee's supervision to fail to so respond;
- l. Committing fraud in the performance of any duties and responsibilities herein, either with intent or reckless disregard for the truth, including but not limited to fraud or dishonesty in any written or verbal statements, including résumés, provided by Employee to LSU in the application process or fraud in the preparation, falsification, or alteration of documents or records of LSU, the NCAA, or the SEC, or documents or records pertaining to any recruit or student athlete, including but not limited to transcripts, eligibility forms, and compliance reports; or knowingly permitting any other person to commit such fraud;
- m. Being charged with or convicted of either: (i) any felony, or (ii) any crime involving larceny, embezzlement, fraud, gambling, drugs, or alcohol;
- n. Participation in any gambling, bookmaking, wagering, or betting involving any athletic contest whether by soliciting, placing, or accepting a bet or wager or through a bookmaker, a pool, an online or in-person sportsbook, or any other method of gambling; or knowingly permitting any student athlete or other individual under Employee's control, authority, or supervision to participate in such activity;
- o. Providing information or data, other than information or data provided to the general public through public presentation, relating in any manner to any intercollegiate sport or to any student athlete to any individual whom Employee knows (or has constructive

knowledge) to be a gambler, better, or bookmaker, or an agent of any such person; or knowingly permitting any student athlete or other individual under Employee's control, authority, or supervision to furnish such information or data;

- p. Use or consumption of alcoholic beverages or controlled substances, steroids, or other drugs or substances to such degree and for such appreciable period as to substantially impair Employee's ability to perform the duties herein;
- q. Sale, purchase, use or possession of any controlled substances, steroids, or other drugs or chemicals, the sale, purchase, use, or possession of which by Employee is prohibited by law or Governing Athletics Regulations, excepting the use or possession of substances or drugs lawfully prescribed by a health care provider, and used in accordance therewith;
- r. Encouraging or allowing the sale, purchase, use, or possession by any student athlete or other individual under Employee's control, authority, or supervision of any controlled substances, steroids, or other drugs or chemicals, the sale, purchase, use, or possession of which by such person is prohibited by law or Governing Athletics Regulations; or
- s. Violating any material term of this Agreement.

2. The process for termination for cause is as follows:

- a. Prior to termination for cause, LSU shall provide Employee written notice of termination with a designated effective date of termination. The notice of termination shall be provided at least seven calendar days before the effective date of termination and shall be signed by the Athletics Director or the Athletics Director's designee. The notice of termination shall reference the facts upon which termination is authorized.
- b. Prior to the effective date of termination in the notice, Employee shall have the right to present a written statement and any supporting materials to the Athletics Director detailing why the Employee believes LSU should rescind its notice of termination. The Athletics Director or the Athletics Director's designee may extend the effective date of termination in writing to allow additional time to consider Employee's response.
- c. After review of any such response, the Athletics Director or the Athletics Director's designee shall provide Employee written notice of a decision. If confirmed, termination of employment shall be effective on the date of termination previously identified.

- d. Within seven calendar days of receipt of the decision of the Athletics Director, Employee may make a written request for review to the President and submit materials for consideration. If no such request is made, the decision of the Athletics Director is final.
 - e. If a request for review is made, the President or the President's designee shall conduct the review based on materials provided by the Employee and materials considered by the Athletics Director. The request for review by the President shall not suspend the effective date of the termination.
 - f. Within 14 calendar days of the submission, Employee will be provided written notice of the decision of the President, which shall be final.
3. Should the Employee be reinstated following a request for review, Employee shall be paid any lost compensation and benefits, retroactive to the date such compensation and benefits ceased.
 4. In the event of termination for cause, all of Employee's compensation and benefits provided for in this Agreement shall terminate on the termination date, and LSU shall not thereafter be liable to Employee for any sums or damages other than Base Salary and Supplemental Compensation earned through the last day of such month, as well as Post-Season Incentive Compensation that has been earned but not paid. The termination date shall be the date on which the initial notice of termination is given, or on such later date as may be set forth by LSU in the notice of termination.
 5. As required by NCAA Bylaw 11.2.1, Employee is hereby notified that in addition to the actions LSU may take in accordance with this Agreement, Employee is also subject to disciplinary or corrective action as set forth in the provisions of the NCAA enforcement procedures if Employee is found by the NCAA or LSU to be in violation of NCAA Bylaws. Employee agrees that LSU shall implement any such disciplinary or corrective actions imposed by the NCAA. Employee further understands that Employee has an affirmative obligation to cooperate fully in the NCAA infractions process, including the investigation and adjudication of a case, pursuant to this Agreement and NCAA Bylaw 11.2.1, and that such obligation continues in effect during and beyond the termination of this Agreement for any violations alleged to have occurred during Employee's employment by LSU.

B. Termination by LSU without Cause.

1. LSU shall have the right to terminate this Agreement without cause upon written notice to Employee.

2. In the event of termination by LSU without cause, all of Employee's compensation and benefits provided for in this Agreement shall terminate on the termination date, and LSU shall not thereafter be liable to Employee for any sums or damages other than the liquidated damages provided for herein and as well as Post-Season Incentive Compensation that has been earned but not paid. The termination date shall be the date designated by LSU in the notice of termination.
3. If LSU terminates employment during the Term without cause, LSU will pay Employee liquidated damages in the amount of ninety percent (90%) of the Base Salary and Supplemental Compensation which would have been payable to Employee through the remaining Term of the Agreement.
4. Liquidated damages under this Section will be paid in equal monthly installments over a period equal to the amount of time then remaining in the Term. LSU's obligation to pay liquidated damages under this Section shall terminate upon the death of Employee.
5. In the event of termination by LSU without cause, Employee shall have the duty to mitigate and use reasonable efforts to obtain similar athletics-related employment in another position with compensation at fair market value. Employee shall exercise due diligence and good faith in seeking qualifying employment so long as the liquidated damage obligation exists. In the event Employee obtains such other employment, Employee must notify LSU and provide documentation reasonably requested by LSU to determine the amount of compensation received by Employee and the amount of offset due to LSU. Mitigation shall be calculated as follows (but shall not include any signing bonus that is directly related to moving expenses and/or temporary housing):
 - a. If new employment is via contract, LSU shall reduce future payments by the specific annual compensation due for given year corresponding to this Agreement.
 - b. If new employment is not via contract (i.e., at-will), LSU will reduce future payments by the specific annual compensation due for given year corresponding to this Agreement.

Employee shall not attempt to allow third parties to take advantage of this Section as a means of avoiding paying the market value of Employee's services. In the event Employee breaches these obligations, LSU will have the right to (i) be completely relieved of any obligation to make any remaining payments owed to Employee (following notice to Employee and a reasonable opportunity for Employee's new employer to cure any deficiency) or (ii) adjust payments to reflect the market value for Employee's employment or services.

6. This is an agreement for personal services. The parties recognize that termination of this Agreement by LSU prior to its expiration by lapse of Term would cause Employee to lose compensation, fringe benefits, certain other LSU-provided benefits, and possibly other income and benefits provided by third parties, which damages are not easy to determine with certainty. Accordingly, the parties have bargained for this liquidated damages provision. The parties further agree that the liquidated damages herein are not in any way a penalty.

C. Termination by Employee Without Cause.

1. Employee shall have the right to terminate this Agreement without cause upon 3 days written notice to LSU. If Employee terminates employment at any time before the End Date, Employee will pay liquidated damages to LSU as follows:
 - a. Fifty percent (50%) of all remaining Base Salary and Supplemental Compensation which would have been payable to Employee for the remaining Term, if Employee accepts employment in a non-head coaching position with another SEC program (regardless of location) or any Division I-A program within 500 miles of LSU; or
 - b. Twenty-five percent (25%) of all remaining Base Salary and Supplemental Compensation which would have been payable to Employee for the remaining Term, if Employee accepts employment in a non-head coaching position other than as described above or terminates employment for any other reason; however
 - c. No liquidated damages will be owed if (i) Employee accepts any collegiate head coaching position or position in the National Football League, (ii) terminates the Agreement after the conclusion of the final regular season game (including the conference championship game, if applicable) of the final season covered by the Term, or (iii) if Employee terminates within 90 days of Brian Kelly's last day of employment with LSU as Head Coach.
2. Employee shall have the option to pay liquidated damages in a lump sum or in equal monthly installments over a period equal to the amount of time then remaining in the Agreement.
3. In the event of termination by Employee without cause, all of Employee's compensation and benefits provided for in this Agreement shall terminate on the termination date, which, unless otherwise agreed to in writing by LSU and Employee, shall be the earlier of: (a) the date on which Employee provides notice of termination to LSU; (b) the date on which Employee accepts employment from another employer; or (c) the date on which Employee performs any work or services of any kind or nature whatsoever

on behalf of or for the benefit of another employer. LSU shall not thereafter be liable to Employee for any amounts other than any Base Salary and Supplemental Compensation earned pursuant to this Agreement, as well as Post-Season Incentive Compensation that has been earned but not paid, prior to the termination date. The Parties acknowledge that this provision is intended to obligate Employee to repay unearned compensation and fees previously or inadvertently paid by LSU under the premise that Employee would fulfill the Term of this Agreement.

4. This is an agreement for personal services. The parties recognize that termination of this Agreement by Employee prior to its expiration by lapse of term would cause LSU to incur administrative, recruiting, and resettlement costs in obtaining a replacement for the Program, in addition to potentially increased compensation costs and loss of goodwill or sales, which damages are impossible to determine with any certainty. Accordingly, the parties have bargained for this liquidated damages provision. The parties further agree that the liquidated damages herein are not in any way a penalty.

D. Suspension or Other Disciplinary Action.

1. LSU may impose suspension or leave without pay for a period no longer than 120 days for any act or omission which would be grounds for discipline or termination for cause as defined herein. Imposition of such sanctions shall be at the discretion of LSU, which shall not be exercised arbitrarily or capriciously. Prior to suspension without pay under this provision, Employee shall be provided written notice of the grounds for the suspension and shall have seven calendar days from receipt of such notice to respond in writing to the Athletics Director. After review of any such response, the Athletics Director or the Athletics Director's designee will provide Employee with written notice of a decision and/or suspension. Suspension under this subsection shall not limit any rights of LSU to terminate Employee for cause.
2. Employee shall be subject to disciplinary or corrective action by the NCAA or SEC for any violation of NCAA and SEC regulations, respectively. Such action by the NCAA or the SEC shall not preclude or in any manner affect LSU's right to take such other corrective or disciplinary action as it deems necessary or proper, including termination for cause.
3. Notwithstanding any other provision of this Agreement to the contrary, if Employee is suspended by the SEC or NCAA, Employee shall automatically be suspended by LSU for the duration of the SEC or NCAA imposed suspension without further notice or process. During such suspension, Employee shall not be entitled to receive any compensation, benefits or any other payments under this Agreement except for fringe benefits provided under Section 9 of this Agreement.

- E. **Termination by Death or Disability.** In the event of the death of Employee or the inability of Employee to perform the obligations described in this Agreement with or without accommodation by reason of disability or some other occurrence beyond the control of either party, and such inability to perform has continued or will continue beyond a reasonable period of time, but not less than 60 days, this Agreement shall terminate as a termination with cause and all future obligations between the parties shall cease upon the termination date reasonably established by LSU, unless otherwise required by law, and LSU shall not thereafter be liable to Employee for any sums other than Base Salary and Supplemental Compensation earned through the last day of such month, as well as Post-Season Incentive Compensation that has been earned but not paid.
- F. **Exclusivity of Remedy.** The financial consequences of termination of this Agreement or suspension are exclusively set forth herein. Therefore, with the sole exception of payments required by this Agreement, in any instance of termination for cause or without cause, or suspension or other disciplinary sanction effected in accordance with the procedures established in this Agreement, neither Employee nor LSU shall be entitled to receive, and each hereby waives any claim against the other, and their respective board members, officers, directors, agents, employees, successors, and personal representatives, for damages, including consequential damages by reason of any alleged economic loss, including but not limited to loss of collateral income, deferred income, loss of earning capacity, loss of business opportunity, loss of benefits, loss of fees from speaking, camps or other outside activity, damages allegedly sustained because of alleged humiliation or defamation, or any other non-compensatory and compensatory damages and attorney's fees resulting from the fact of termination, the public announcement thereof, or the release by LSU or Employee of information or documents which are public or as otherwise required by law. Employee acknowledges that in the event of either termination of this Agreement for cause, without cause, or otherwise, or suspension or other disciplinary sanction effected in accordance with the procedures established in this Agreement, Employee shall have no right to occupy the Position and that Employee's sole remedies are provided herein and shall not extend to injunctive relief. THE PARTIES ACKNOWLEDGE AND AGREE THAT THIS SECTION LIMITING LIABILITY AND EXCLUDING CONSEQUENTIAL DAMAGES AND OTHER REMEDIES IS ESSENTIAL AND IS A MATERIAL INDUCEMENT FOR THE UNIVERSITY TO ENTER INTO THIS AGREEMENT. ACCORDINGLY, SUCH PROVISIONS SHALL BE SEVERABLE AND INDEPENDENT OF ANY OTHER PROVISIONS AND SHALL BE ENFORCED AS SUCH, REGARDLESS OF ANY MATERIAL BREACH OR OTHER OCCURRENCE HEREUNDER.
- G. **Interference with Athletics.** During any period where Employee receives post-termination liquidated damages, compensation or benefits, Employee agrees that Employee will not interfere with LSU student athletes or otherwise obstruct the ability of LSU or the Athletics Department to transact business. If Employee violates this provision, LSU shall be entitled to discontinue any post-termination

liquidated damages, compensation or benefits and may seek to recover any payments that have been disbursed.

12. **Discontinuation of the Program by the University.** Notwithstanding any provision to the contrary, in the event the University determines for any reason within its sole discretion to discontinue the Program as a Division I sport, LSU shall have the right to terminate this Agreement without further obligation to Employee. Notice of termination under this Section shall be in writing and shall establish a date of termination no less than 90 days from the date of the notice or upon the End Date, whichever occurs first. In the event the right to terminate pursuant to this Section is exercised, all obligations between the parties shall cease effective on the date of termination.
13. **University Property.** All property that is provided to, or developed or acquired by, Employee as part of or in conjunction with Employee's employment by LSU, regardless of the format or manner in which the property may be retained or stored, shall remain the sole property of LSU. This shall include, without limitation, all documents, files, personnel records, recruiting records, team information, athletic equipment, films, statistics, keys, credit cards, computers, software programs, and electronic devices that Employee may have access to or come into possession of during employment. Excluded from this provision are Employee's personal notes, personal playbooks, memorabilia, diaries and other personal records, which the Employee may retain. Employee is required to return to LSU all LSU property in Employee's possession within seven calendar days of termination or separation of employment. Employee shall also return any courtesy vehicle provided under this Agreement within seven calendar days of termination or separation of employment. Employee agrees that LSU may withhold any liquidated damage payments or other compensation due Employee pending return of property under this Section.
14. **Duty of Loyalty.** Unless notice of termination under this Section has been given by either party, neither Employee nor Employee's agent shall, under any circumstances, discuss or negotiate directly or indirectly prospective employment for Employee with any other institution of higher education, professional athletic team, or other athletically-related (including media and sports marketing) prospective employer without giving at least 24 hours prior written notice to the President and the Athletics Director.
15. **Duty to Cooperate.** Both during and after the end of employment with LSU, Employee agrees, without additional compensation (other than reimbursement for reasonable associated expenses post-employment), to cooperate with LSU in any investigation, internal or otherwise, of any possible violation of law (including Title IX) or violation of any rule, policy or regulation of LSU (including PM-73), the SEC or the NCAA. Employee agrees (a) to be reasonably available to answer questions regarding any matter with which Employee was involved while employed by LSU, and (b) to cooperate with LSU during the course of any proceedings arising out of any matter with which Employee has knowledge or information.
16. **Non-Assignment.** Neither party may assign, transfer, alienate, or encumber any of its rights or obligations hereunder without the express written consent of the other party, except as otherwise specifically set forth in this Agreement.

17. **Entire Agreement.** This Agreement constitutes and expresses the entire agreement and understanding of the parties concerning the matters contemplated hereby and shall, upon the Effective Date, supersede any other oral and written agreements between the parties. There are no oral or other agreements, understandings, promises, or representations between the parties affecting this Agreement. Both parties have relied solely on their own respective judgments in entering into this Agreement, with full opportunity to seek advice of competent counsel. It shall be construed, if necessary, without reference to the party that was the principal drafter of the Agreement.
18. **Indirect Actions Prohibited.** Any act which Employee is prohibited from doing directly in this Agreement shall not be done indirectly by Employee or another person on Employee's behalf or at Employee's behest.
19. **Amendments to Agreement.** This Agreement may be amended only by a written instrument duly approved by LSU through its designated representatives and accepted by Employee, such approval and acceptance to be acknowledged in writing.
20. **Severability.** If any provision of this Agreement shall be deemed invalid or unenforceable, either in whole or in part, this Agreement shall be deemed amended to delete or modify, as necessary, the offending provision or to alter the bounds thereof in order to render it valid and enforceable.
21. **No Waiver of Default.** No waiver by the parties hereto of any default or material breach of any covenant, term or condition of this Agreement shall be deemed to be a waiver of any other default or material breach of the same or any other covenant, term or condition contained herein.
22. **No Waiver of Sovereign Immunity.** It is expressly agreed and understood between the parties that nothing contained herein shall be construed to constitute a waiver or relinquishment by LSU of any rights to claim such exemptions, privileges and immunities as may be provided by law.
23. **"Force Majeure" Clause.** Neither party shall be considered in default of performance of any obligations under this Agreement if such performance is prevented or delayed by Force Majeure. "Force Majeure" shall be understood to be any cause which is beyond the reasonable control of the party affected and which is forthwith, by notice from the party affected, brought to the attention of the other party, including but not limited to war, hostilities, revolution, civil unrest, strike, lockout, epidemic or pandemic, government-ordered restriction or cessation of activity, accident, fire, natural disaster, wind or flood or any requirements of law, or an act of God.
24. **Additional Conditions of Employment.**
 - A. **Compliance with La. R.S. 42:31.** To the extent annual compensation under this Agreement exceeds \$100,000, Employee hereby agrees and promises that, within 30 days of the Start Date or the date that compensation reaches that threshold, Employee shall provide proof to LSU that Employee has been issued a Louisiana

driver's license and that all vehicles registered in Employee's name are registered in Louisiana, all pursuant to the requirements of La. R.S. 42:31.

- B. **Background Checks and Disclosures.** Prior to commencing employment, Employee shall be required to submit to background checks as deemed appropriate by the University. Employee's employment is contingent upon a satisfactory background check in accordance with University policy. In addition, prior to signing this Agreement, Employee must disclose to the University any and all criminal, civil or administrative matters from the prior five years, including those currently pending but excluding non-felony traffic infractions. Failure to disclose all such matters to the University will serve as a basis to terminate employment for cause.
- C. **Approvals.** This Agreement is subject to any approvals that must be obtained in accordance with law or University policy. No provision of this Agreement shall be enforceable until signed by all parties and, if required by policy, approved by the Board of Supervisors.
25. **Governing Law and Venue.** This Agreement shall be enforced and construed in accordance with the laws of Louisiana. Any civil action to enforce this Agreement shall be brought in a state or federal court having jurisdiction and domiciled in East Baton Rouge Parish, Louisiana.

THE PARTIES hereto have executed this Agreement on the day, month and year identified with the signature below.

SIGNATURES ON FOLLOWING PAGE

2024.03.28 Frank Wilson Contract (OGC edits)

Final Audit Report

2024-04-03

Created:	2024-04-01 (Central Daylight Time)
By:	Wendy Nall (wnall@lsu.edu)
Status:	Signed
Transaction ID:	CBJCHBCAABAA15ILvnnwFOkMdMZdeMd-gF4E31Olaxyq

"2024.03.28 Frank Wilson Contract (OGC edits)" History

-  Document created by Wendy Nall (wnall@lsu.edu)
2024-04-01 - 9:57:20 AM CDT
-  Document emailed to Frank Wilson (frankwilson@lsu.edu) for signature
2024-04-01 - 9:58:00 AM CDT
-  Email viewed by Frank Wilson (frankwilson@lsu.edu)
2024-04-01 - 9:59:40 AM CDT
-  Document e-signed by Frank Wilson (frankwilson@lsu.edu)
Signature Date: 2024-04-03 - 3:50:34 PM CDT - Time Source: server
-  Agreement completed.
2024-04-03 - 3:50:34 PM CDT



Board of Supervisors

Request from LSU Athletics to Increase Baseball Season Ticket Prices, Parking, and Tradition Fund

Date: April 26, 2024

1. Citation

The LSU Athletics Ticket, Parking and Tradition Fund Policy establishes the schedules approved by the board for ticket pricing for baseball. An increase in the baseball ticket prices, parking and tradition fund requires the board to approve an amended schedule to the policy.

2. Summary of Matter

The LSU Athletics Department is proposing amending a portion of the Athletics Ticket, Parking, and Tradition Fund Policy to adjust prices for LSU Baseball starting with the 2025 season. The last ticket price increase was in 2023.

The University proposes amending Schedule C (Ticket and Tradition Fund) of the current LSU Athletics Ticket, Parking, and Tradition Fund Policy to include the following changes:

Increase the grandstand season ticket prices, including Tradition Fund levels, between 9% - 39% for the 2025 season in accordance with the attached schedule.

3. Review of Business Plan

N/A

4. Fiscal Impact

Athletics estimates the increase in revenue based upon past attendance is approximately \$962,300.

5. Description of Competitive Process

None.

6. Review of Legal Documents

None.

7. Parties of Interest

LSU Athletics

Baseball season ticket holders

8. Related Transactions

None.

9. Conflicts of Interest

None.

10. Attachment

Schedules C listing details of price increases

RESOLUTION

NOW, THEREFORE, BE IT RESOLVED the Board of Supervisors of Louisiana State University and Agricultural & Mechanical College (the "Board") does hereby approve the amendment to the LSU Athletic Ticket, Parking, and Tradition Fund Policy pertaining Schedule C for LSU Baseball season ticket pricing as presented on April 26, 2024.

SCHEDULE C BASEBALL PRICING 2025 Season – Last Updated in FY23

LSU | ALEX BOX STADIUM
SKIP BERTMAN FIELD

SECTIONS

	Season Ticket Cost	Tradition Fund Donation
Champions Club Home Plate	\$600	\$2,400
Champions Club Dugout	\$600	\$1,800
Field Box Grandstand	\$500	\$750
Field Box	\$500	\$750
Grandstand	\$450	\$550
Outfield Bleacher Prime	\$250	\$80
Outfield Bleacher Regular	\$250	
Home Run Bleachers	\$250	
Student Section	-	-
Right Field Bullpen Bleachers	\$250	
Concourse Loge Seating	-	-
Concourse Table Rail Seating	-	-



2025 BASEBALL
TICKETS SEATING CHART



Board of Supervisors

**Request from LSU Athletics to Increase
Gymnastics Ticket Prices, Parking and Tradition Fund**

Date: April 26, 2024

1. Citation

The LSU Athletics Ticket, Parking and Tradition Fund Policy establishes the schedules approved by the board for ticket pricing for gymnastics. An update in the gymnastics ticket prices and tradition fund requires the board to approve an amended schedule to the policy.

2. Summary of Matter

The LSU Athletics Department is proposing amending a portion of the Athletics Ticket, Parking, and Tradition Fund Policy to adjust prices for LSU Gymnastics starting with the 2025 season. The last ticket price increase in 2020, 2006, and 2012, respectively.

The University proposes amending Schedule B (Ticket and Tradition Fund) and Schedule D (Parking) of the current LSU Athletics Ticket, Parking, and Tradition Fund Policy to include the following change:

- 1) Establish season ticket prices for the 2025 season and subsequent seasons, including Tradition Fund levels, in accordance with the attached schedules; and
- 2) Authorize the President, in consultation with the Board Chair and Athletics Committee Chair, to establish a \$60 per season parking pass with an implementation date for the 2026 or 2027 season.

Summary of proposed season ticket price changes effective 2025 season:

Adult Tickets	Increase pricing \$14-\$45 per season ticket
Youth Tickets	Increase pricing \$5-\$12 per season ticket in the 200 and 300 Levels Eliminate Youth ticket pricing in the 100 Level
300 Level	Establish general admission season tickets: Adults \$40 per season ticket; Youth \$20 per season ticket

Detailed schedules of the increases are attached.

Summary of proposed season ticket price changes effective 2027 season:

Adult Tickets Increase pricing \$0-\$25 per season ticket

Youth Tickets Eliminate Youth ticket pricing 200 Levels

Detailed schedules of the increases are attached.

Summary of proposed parking changes:

Parking Establish \$60 per season parking pass with an implementation date for the 2026 or 2027 season

3. Review of Business Plan

N/A

4. Fiscal Impact

Athletics estimates the increase in revenue based upon past attendance is approximately \$255,500.

5. Description of Competitive Process

None.

6. Review of Legal Documents

None.

7. Parties of Interest

LSU Athletics
Gymnastics season ticket holders

8. Related Transactions

None.

9. Conflicts of Interest

None.

10. Attachment

Schedules B and D listing details of price increases

RESOLUTION

NOW, THEREFORE, BE IT RESOLVED the Board of Supervisors of Louisiana State University and Agricultural & Mechanical College (the "Board") does hereby approve the amendment to the LSU Athletic Ticket, Parking, and Tradition Fund Policy pertaining to Schedule B for LSU Gymnastics season ticket pricing as presented on April 26, 2024; and

BE IT FURTHER RESOLVED the Board authorizes the President, in consultation with the Board Chair and Athletics Committee Chair, to establish a \$60 per season parking pass with an implementation date for the 2026 or 2027 season.

SCHEDULE B

Gymnastics Season Ticket Pricing

2025 - 2027 Seasons – Last Updated in FY24

LSU | MARAVICH CENTER



2025 Gymnastics Season Ticket Prices						
Price Level	Adult			Youth		
	Ticket Price	Tradition Fund	Total Cost	Ticket Price	Tradition Fund	Total Cost
100 Level	\$ 100	\$ 25	\$ 125	N/A	N/A	N/A
200 Level Prime	\$ 80	\$ 20	\$ 100	40	\$ -	\$ 40
200 Level Corner	\$ 80	\$ 10	\$ 90	40	\$ -	\$ 40
200 Level End	\$ 65	\$ 5	\$ 70	35	\$ -	\$ 35
300 Reserved	\$ 50	\$ -	\$ 50	30	\$ -	\$ 30
300 GA	\$ 40	\$ -	\$ 40	20	\$ -	\$ 20

2027 Gymnastics Season Ticket Prices						
Price Level	Adult			Youth		
	Ticket Price	Tradition Fund	Total Cost	Ticket Price	Tradition Fund	Total Cost
100 Level	\$ 100	\$ 50	\$ 150	N/A	N/A	N/A
200 Level Prime	\$ 80	\$ 40	\$ 120	N/A	N/A	N/A
200 Level Corner	\$ 80	\$ 20	\$ 100	N/A	N/A	N/A
200 Level End	\$ 75	\$ 10	\$ 85	N/A	N/A	N/A
300 Reserved	\$ 50	\$ -	\$ 50	30	\$ -	\$ 30
300 GA	\$ 40	\$ -	\$ 40	20	\$ -	\$ 20

**SCHEDULE D
BASEBALL AND PMAC SPORTS
PARKING PRICING FY – 2024-25**

Baseball Season Parking Costs			
Lot	Pass Cost	Tradition Fund	Total Cost
Hall of Fame	\$ 325	\$ -	\$ 325
Champions	\$ 425	\$ -	\$ 425
Bullpen	\$ 325	\$ -	\$ 325
LA House	\$ 500	\$ -	\$ 500

Men's Basketball Season Parking Costs			
Lot	Pass Cost	Tradition Fund	Total Cost
101	\$200	\$ -	\$200
104	\$200	\$ -	\$200
301	\$200	\$ -	\$200
201	\$200	\$ -	\$200
N. Stadium	\$200	\$ -	\$200
205	\$200	\$ -	\$200
105	\$200	\$ -	\$200

Women's Basketball Season Parking Costs			
Lot	Pass Cost	Tradition Fund	Total Cost
101	\$100	\$ -	\$100
104	\$100	\$ -	\$100
301	\$100	\$ -	\$100
201	\$100	\$ -	\$100
205	\$100	\$ -	\$100
105	\$100	\$ -	\$100

Gymnastics Season Parking Costs			
Lot	Pass Cost	Tradition Fund	Total Cost
101	\$60	\$ -	\$60
104	\$60	\$ -	\$60
301	\$60	\$ -	\$60
201	\$60	\$ -	\$60
205	\$60	\$ -	\$60
105	\$60	\$ -	\$60



Board of Supervisors

Request for Amendment to MultiMedia Rights Agreement with Playfly Sports Properties

Date: April 26, 2024

1. Bylaw Citation

Pursuant to Article VII, Section 1

- I. Any matter having a significant or long-term impact, directly or indirectly, on the finances or the academic, educational, research, and service missions of the University or any of its campuses

2. Summary of Matter

June 15, 2023, the Board authorized an extension of the multimedia rights agreement with Playfly Sports Properties. The athletics department now seeks an amendment to the contract that would authorize them to approve Playfly to redirecting compensation to other initiatives supporting the athletics department or student athletes. The amendment will not alter the term of the agreement or the amount of compensation paid pursuant to the agreement. (Note that the amended language in in footnote one on page six.)

The background to the amendment is that legal challenges to current NCAA regulations as well as proposed NCAA bylaws changes indicate the business model of college athletics could change significantly in the near future. This amendment would provide LSU athletics to utilize revenues generates to support new initiatives supporting athletics to the extent permissible by existing law or regulation.

3. Review of Business Plan

The current amendment does not alter the total compensation or length of the existing contract.

4. Fiscal Impact

This is a revenue generating contract as there will be no costs to LSU.

5. Description of Competitive Process

N/A

6. Review of Legal Documents

LSU Athletics Staff, the Office of General Counsel, and Tiger Athletics Foundation have reviewed the contract.

7. Parties of Interest

LSU A&M, Playfly Sports Properties

8. Related Transactions

N/A

9. Conflicts of Interest

None known.

10. Attachments

The full contract is attached.

RESOLUTION

NOW, THEREFORE, BE IT RESOLVED that the Board of Supervisors of Louisiana State University and Agricultural and Mechanical College does hereby authorize the President, or his designee, acting on behalf and in the name of the Board, and in consultation with general counsel, to execute the attached amended agreement for management and sale of multi-media rights.

**FIRST AMENDMENT TO MULTI-MEDIA RIGHTS
MANAGEMENT AND SALES AGREEMENT**

This MMR Management and Sales Agreement (“**Agreement**”) is made and entered into as of the Effective Date, by and between The Board of Supervisors of Louisiana State University Agricultural and Mechanical College (hereinafter referred to as the “**University**” or “**Board**”), and Playfly Sports Properties, LLC, a Delaware limited liability company (hereinafter referred to as “**Playfly**”).

RECITALS

WHEREAS, the University maintains and operates NCAA Division I athletics programs competing in regular season and championship events (“**University Athletics**”);

WHEREAS, the University owns various intellectual property rights including its various trademarks and logos, as well as multi-media and sponsorship rights such as audio and video content distribution rights, digital and social media rights, print programs, corporate sponsorships, signage, event marketing and related publications, membership data, promotions, events, activities, Esports rights and broadcast rights pertaining to University Athletics and wishes to arrange for the marketing and merchandising of such rights and other similar activities;

WHEREAS, Playfly is in the business of and possesses experience in merchandising, promoting, managing and marketing sports properties, and in commercially disseminating traditional and digital content of athletic programs;

WHEREAS, Tiger Athletic Foundation (“**TAF**”) is a private non-profit Louisiana Corporation dedicated to supporting LSU Athletics, and in accordance with the terms of those certain Cooperative Endeavor and Lease Agreements executed on December 21, 1998, September 26, 2003, and September 20, 2012, by the University and TAF (collectively, the “**Cooperative Endeavor Agreements**”), TAF has acquired certain rights and undertaken certain obligations with respect to videoboards, related technology and recognition rights in LSU Athletic Facilities;

WHEREAS, Playfly and University are parties to that certain Multi-Media Rights Agreement dated as of April 6, 2016 (the “**2016 Agreement**”) and Playfly and University desire to replace the 2016 Agreement with this Agreement as of the Effective Date; and

WHEREAS, Playfly and TAF are parties to that certain Videoboard Lease Agreement (defined below) and Playfly and TAF will enter into an Amendment to Videoboard Lease Agreement to amend the Videoboard Lease Agreement on or about the Effective Date.

NOW, THEREFORE, in further consideration of the obligations and covenants to be kept and performed by the parties hereto, University and Playfly agree as follows:

1.0 **Definitions:**

1.1 “**Agreement Year**” shall mean from July 1, 2022, through June 30, 2023, and from July 1 through June 30 of each succeeding year of this Agreement.

1.2 “**Applicable Privacy and Data Security Laws**” shall mean: (i) all applicable privacy, security, and data protection laws, rules, and regulations of any governmental or regulatory authority having jurisdiction over matters provided for in this Agreement (including, without limitation, the US), (ii) generally accepted industry standards and practices with respect to privacy, security and data protection including but not limited to the collection, processing, storage, protection and disclosure of personal information, and (iii) the applicable privacy policies and agreements of the University, Playfly and any third party from whom such data is received.

1.3 “**Athletics Department**” shall mean the department of LSU which manages and operates LSU’s intercollegiate athletics program, which participates in SEC and NCAA sanctioned events and, in connection therewith, manages and operates Athletic Facilities and all related functions and activities.

1.4 “**Athletic Events**” shall mean intercollegiate athletic activities held in Athletics Facilities as well as such other athletic related events related to the merchandising, promoting and marketing by the Athletics Department of the LSU Athletics Program.

1.5 “**Athletics Facilities**” shall mean any building or structure on the LSU campus in which Home Games are played or other Athletics Events are ordinarily conducted by the Athletics Department.

1.6 “**Baton Rouge Metropolitan Area**” shall mean Baton Rouge and the surrounding areas that include East Baton Rouge Parish, West Baton Rouge Parish, Ascension Parish, and Livingston Parish.

1.7 “**Board**” or “**University**” shall mean the Board of Supervisors of Louisiana State University and Agricultural and Mechanical College.

1.8 “**Effective Date**” shall mean the later of July 1, 2022, and the date this Agreement is executed by both parties.

1.9 “**Gross Revenue**” shall mean all income and revenues of any nature or kind including but not limited to consideration or payment to PSP in the form of an in-kind payment or as a result of trade which are paid to or for the benefit of PSP whether paid to PSP timely, in advance, or in arrears, or are credited to any account of PSP during the Term arising pursuant to or with respect to any Multi Media Rights granted by or pursuant to authority granted by Board under this Agreement and/or under the Videoboard Lease Agreement in any Agreement Year, less only applicable sales tax if any. Gross Revenue shall not be reduced by any commissions other than by actual out-of-pocket advertising commissions (not to exceed fifteen percent (15%)). To the extent advertising commission are paid to a bona fide agent or agency owned by or otherwise

controlled by, under common control or affiliated with PSP, its managers, members, parents, subsidiaries or investors, such commissions shall not exceed fifteen percent (15%) and PSP shall provide reasonable documentation that such commission are on arms-length terms. Dollars received by PSP for work performed by PSP separate from the licensing of the sponsorship rights granted under this Agreement, such as Gross Subscription Revenue and Gross Sponsorship Revenue (each as defined in the Exhibit A), is not included in Gross Revenue. In addition, hard costs incurred to obtain elements included in Sponsorship Agreements, such as the cost of tickets required to be purchased above PSP's annual allotment, so long as the amount paid for the sponsorship is fair market value, shall be deducted from Gross Revenue for purposes of the Agreement.

1.10 **"Improvements"** shall mean the facilities, structures, equipment and any other installations, enhancements, renovations, capital initiatives related to Athletic Facilities designed, constructed, installed and equipped at Playfly's cost that (i) facilitate the generation of Gross Revenue by Playfly in connection with the performance of this Agreement, and (ii) are mutually agreed upon in writing by Playfly, the LSU Representative and the LSU Athletics Director and, where required, the Board.

1.11 **"Licensed Marks"** shall mean all the trademarks, logos, and brands of the University as listed in Exhibit D to this Agreement, which shall be used by Playfly solely in the performance of its obligations or the exercise of its rights under this Agreement.

1.12 **"LSU Athletics Program"** shall mean those varsity sports fielded by LSU Athletics.

1.13 **"LSU Athletics Representative"** shall mean the Director of Athletics or his or her designee.

1.14 **"LSU Representative"** shall mean the President of LSU and his or her designees including but not limited to the LSU Vice President for Finance and Administration and CAO

1.15 **"Property Operating Budget"** shall mean a comprehensive annual line-item budget developed by Playfly and reviewed annually with the LSU Athletics Director or his or her designee prior to the start of the fiscal year detailing, at a minimum, audio, video and publication production content and distribution plans with supporting line items and details described in sections 6.0, 7.0 and 8.0 of Exhibit A to this Agreement

1.16 **"Southeastern Conference"** or **"SEC"** refers to the college athletic conference of which the University is a member and any successor conference or organization in which a University Athletics Team may compete.

1.17 **"Subscription Addendum"** shall mean the Addendum for Subscription Services, dated as of March 7, 2022, between Playfly and University, which has been superseded

by the terms of this Agreement. As of the Effective Date, this Agreement constitutes the “Multi-Media Rights Agreement” for Subscription Services.

1.18 “**Term**” shall mean the number of years in which this Agreement is in effect, including any extensions, as set forth in section 3.1.

1.19 “**University Athletics Team**” shall mean a team of the LSU Athletics Program.

1.20 “**Videoboard Lease Agreement**” shall mean the Videoboard Lease Agreement between Playfly and TAF effective July 1, 2016, as amended, including all exhibits and attachments thereto.

2.0 **Scope of Services:** On behalf of University Athletics, Playfly shall implement and deliver a comprehensive and quality marketing program and shall create opportunities at various levels of marketing rights and sponsorships. Playfly must, at all times, represent the best interests of the University for the exclusive right to market and sell the rights granted to Playfly pursuant to the terms of the Agreement. The parties agree that the rights granted herein are granted on behalf of University Athletics and do not extend to other departments, divisions or functions of the University. University Athletics will be responsible for the implementation and execution of all customary media relations and marketing support services, including but not limited to all in-venue event marketing and promotional programs; the production of in-venue content, digital signage and graphics; social media and mobile application content production; and advertising and marketing initiatives for University Athletics. The University and Playfly will collaborate on the implementation and execution of all sponsorship fulfillment and integration into customary media and marketing platforms. All services under the Agreement must be performed and delivered in compliance with applicable NCAA, conference and University rules, regulations and policies, and Playfly must ensure that all of its employees and agents are adequately instructed and knowledgeable of the applicable rules, regulations, and policies provided that the University has provided Playfly with or Playfly otherwise is, or reasonably should have been, aware of, such rules, regulations, and policies in advance of Playfly’s performance of services. Playfly represents that it shall exercise all rights and perform all obligations hereunder in accordance with all applicable laws, rules, regulations and industry standards, including, without limitation, all Applicable Privacy and Data Security Laws.

2.1 Excluded services. The University has certain existing agreements for shoe, apparel, and equipment companies, as well agreements for provision of concessions (including but not limited to soft drinks) and may reach extensions with those partners or elect to enter into agreements with new partners during the Term (“**Excluded Partners**”). The Excluded Partners and the applicable agreements in effect as of the Effective Date are listed on Exhibit C. These agreements may provide various levels of exposure on team uniforms, licensed products, and various sponsor-like benefits such as tickets to and parking passes for games, and, to the extent listed on Exhibit C, recognition as a sponsor, partner or supporter of University. It also has agreements that are not specific to University Athletics with individuals, corporations, governmental bodies, foundations or other entities that may involve assets analogous to those

included in this Agreement (“**Campus Agreements**”). To the extent those agreements alter, decrease, diminish the value of, or otherwise negatively impact, in each case to more than a de minimis degree, the asset inventory University agreed to provide to Playfly under this Agreement, University agrees to notify Playfly promptly and University and Playfly agree to work in good faith for an adjustment to the terms and conditions of this Agreement to reflect a satisfactory resolution of any such concerns arising out of such alteration.

2.2 Name, Image, Likeness. The parties acknowledge and agree that there are existing, proposed and future laws, rules, guidance and other legally binding requirements in multiple jurisdictions and from multiple governing bodies, such as the NCAA (collectively, “**NIL Rules**”) regarding student-athletes’ name, image, and likeness rights (“**NIL**”). This Agreement explicitly prohibits University from unilaterally granting student athletes, collectives and other third parties the right to use the University Marks in any commercial or other activity the same as or similar to the rights granted to Playfly hereunder for NIL related purposes. The Parties recognize the potential that granting such rights may be mutually beneficial and in that connection PSP agrees not to unreasonably withhold its approval of a request from University that PSP grant, or PSP permit University to grant, student athletes, collectives and other third parties the right to use the University Marks in any commercial or other activity the same as or similar to the rights granted to PSP hereunder for NIL related purposes. The parties recognize there is significant uncertainty regarding the impact the NIL Rules may have on the rights granted to Playfly under this Agreement and neither party has adequate information at this time to determine whether they could result in a Material Impairment of Rights under Section 9.0 below. Upon announcement of any new NIL Rules or changes to existing NIL Rules, Playfly and LSU Athletics Representative may discuss in good faith whether they have resulted in a Material Impairment of Rights under Section 9.0 below. In addition, if any University student athlete, collective or other third party uses University Marks in a manner that infringes on the rights of a Sponsor, the Parties shall discuss in good faith to the applicability of Section 9.0 below and/or the impact on existing Sponsor agreements.

3.0 Contract Term:

3.1 Term. The initial Term of this Agreement shall be for approximately ten (10) years, commencing July 1, 2022, and ending June 30, 2032, unless terminated at an earlier date as provided herein.

3.2 Reversion of Rights. Upon the expiration or earlier termination of this Agreement, all of the rights licensed or granted to Playfly under this Agreement shall terminate and immediately revert back to and vest with University.

4.0 Financial Terms:

4.1 Signing Bonus. Playfly shall pay Athletics Department a one-time fee of six million Dollars (\$6,000,000) \$3,000,000 of which is payable within 30 days of the execution of this Agreement, and \$3,000,000 of which is payable on or before June 30, 2027 (“**Signing Bonus**”).

4.2 Annual Rights Fee. In consideration of the rights granted to Playfly by Board pursuant to this Agreement, for the 2022-2023 through 2031-2032 athletic seasons, Playfly shall pay to Athletics Department the following Annual Rights Fee for each year of the Agreement, payable in quarterly installments of 25% on July 1, October 1, January 1, and April 1 of each Agreement Year during the Term.¹ The parties acknowledge that certain rights related to the TAF Videoboards are owned by TAF, and pursuant to the Videoboard Lease Agreement, Playfly shall pay to TAF the TAF Annual Rental Fee in accordance with the terms of the Videoboard lease Agreement.

<u>Agreement Year</u>	<u>Annual Rights Fee</u>
FY23	\$9,392,000
FY24	\$9,815,000
FY25	\$9,584,240
FY26	\$9,666,725
FY27	\$10,099,459
FY28	\$10,182,448
FY29	\$10,265,697
FY30	\$10,349,211
FY31	\$10,432,996
FY32	\$10,517,056

4.3 Percentage of Gross Revenue.

In addition to the payment by Playfly of the Annual Rights Fee, Playfly shall pay to Athletics Department the percentage of Gross Revenue for each Agreement Year equal to the amount by which Gross Revenue exceeds the Gross Revenue Threshold for each Agreement Year multiplied by the Applicable Percentage for such Agreement Year as set forth below:

<u>Agreement Year</u>	<u>Gross Revenue Threshold</u>	<u>Applicable Percentage</u>
FY23	\$19,000,000	57.5%
FY24	\$19,100,000	57.5%
FY25	\$19,200,000	60%
FY26	\$19,300,000	60%
FY27	\$20,250,000	60%
	\$22,750,000	62.5%
FY28	\$20,400,000	60%
	\$23,025,000	62.5%
FY29	\$20,550,000	60%

¹ The parties agree that payment to the athletics department may be made to any athletics initiative supporting the department and/or student athletes as approved by the athletics department.

	\$23,306,250	62.5%
FY30	\$20,700,000	60%
	\$23,594,063	65%
FY31	\$20,850,000	60%
	\$23,888,766	65%
FY32	\$21,000,000	60%
	\$24,190,704	65%

In each Agreement Year, Playfly shall pay to Athletics Department the Applicable Percentage of Gross Revenue in excess of the Gross Revenue Threshold within sixty (60) days of the last day of each Agreement Year; provided, however, that on or before June 1 of each Agreement Year, Playfly shall prepare and provide University Athletics with a good faith estimate of the projected Percentage of Gross Revenue to be due to Athletics Department, if any, for the then current Agreement Year. For Agreement Years in which there are two Gross Revenue Thresholds, Playfly shall pay 60% of the Gross Revenue in excess of the first Gross Revenue Threshold up to the second Gross Revenue Threshold, and Playfly shall pay the Applicable Percentage of the Gross Revenue in excess of the second Gross Revenue Threshold.

4.4 NIL Support Fund. Playfly will invest, either through Athletics Department initiatives or third-party initiatives, one million three hundred ninety-five thousand dollars (\$1,395,000) to support NIL activities, which shall be allocated as follows: (i) One hundred fifty thousand dollars (\$150,000) during the 2024, 2025, and 2026 Athletic Years; (ii) One hundred fifty five thousand dollars (\$155,000) during the 2027, 2028, and 2029 Athletic Years; and (iii) One hundred sixty thousand dollars (\$160,000) during the 2030, 2031, and 2032 Athletic Years. Except as otherwise prohibited by law or policy, Athletics Department and Playfly will collaboratively agree on specific areas for investment. Notwithstanding the foregoing, in the event there are no longer NIL opportunities or not sufficient opportunities to spend the full amounts listed above, any amount not invested in NIL will be reallocated towards Capital Investment opportunities as agreed upon by the parties.

4.5 Capital Expenditures. During the Term, Playfly shall invest three hundred thousand dollars (\$300,000) for new and agreed to revenue generating assets and initiatives. Athletics Department and Playfly will collaboratively agree on specific areas for investment.

4.6 Additional Financial Incentives.

In addition to Playfly’s obligation to pay to Athletics Department the Annual Rights Fee, the percentage of Gross Revenue, and other consideration, from the Effective Date through the 2026 Agreement Year, Playfly shall provide local, regional, and national advertising space on media that Outfront Media is required to make available to Playfly (on a space available and pre-emptible basis and subject to Playfly’s standard terms and conditions) promoting University Athletics (the “**LSU Copy**”) valued at up to \$100,000, as determined by Playfly’s then current rate card for such services (“**Playfly Media Space**”), provided that: (i) University Athletics shall assume all costs

associated with the production of the LSU Copy except to the extent that such LSU Copy shall be digital media prepared by Athletics Department or Playfly; (ii) all proposed designs, content, and creative materials for the LSU Copy are submitted to Playfly as promptly as practicable prior to the date on which the LSU Copy is proposed to be displayed on the Playfly Media Space; and (iii) all proposed designs, content and creative materials for the LSU Copy are subject to Playfly's review and approval. University Athletics shall contact Playfly from time to time to determine advertising availability on the Playfly Media Space. Playfly shall be permitted to remove the LSU Copy (i) upon commencement of any paying advertising contact; and/or (ii) upon request or demand of any governing body and/or the owner(s) of the real property on which the Playfly Media Space is/are located. Outfront Media Space not used in the designated Agreement Year shall be lost and may not be carried over to future years.

4.7 Online and On Campus Retail Store. During the Term of this Agreement Playfly shall be afforded the opportunity to provide services in connection with a University Athletics online store and/or on campus retail store on such terms and conditions as may be mutually agreed to in writing by Playfly and University.

4.8 Cost of Additional Services Rendered.

4.8.1 During the Term, Playfly is obligated to provide the Marketing and Promotion Services described (the "**Additional Services**").

4.8.2 Playfly shall be responsible for all costs associated with providing the Additional Services up to a maximum aggregate amount equal to \$500,000 for each Agreement Year (the "**Maximum Cost**"). If in any Agreement Year the cost to provide the Additional Services exceeds the Maximum Cost, such excess amount shall be deducted from the percentage of Gross Revenue payable to Athletics Department for such Agreement Year, or in the event that the amount of the percentage of Gross Revenue for such Agreement Year is insufficient to cover such deduction, such excess shall be deducted from the Annual Rights Fee next payable under this Agreement. In the event that during the final Agreement Year Playfly's cost to provide the Additional Services exceeds the Maximum Coast, such excess amount shall be reimbursed by Athletics Department to Playfly within thirty days after the end of the Agreement. If in any Agreement Year the cost to provide the Additional Services is less than the Maximum Cost, the difference between the cost and the Maximum Cost shall be paid to Athletics Department as additional compensation.

(i) \$200,000 of the cost of Additional Services shall be allocated as follows during each Agreement Year: (i) Playfly shall pay to Athletics Department fifty thousand dollars (\$50,000) for tickets at face value; (ii) Playfly shall pay to TAF one hundred thousand dollars (\$100,000) for tickets as selected by Playfly; (iii) to the extent that the remaining fifty thousand (\$50,000) is not required for the payment of Additional Services, with the consent of Playfly it

may be applied as a donation to TAF for the scholarship expenses of student athletes..

(ii) \$300,000 of the Additional Services shall be allocated to providing the marketing and promotion services and season ticket and parking pass printing services described in Exhibit A.

Expenses.

4.9 Playfly agrees to be responsible for all salaries, benefits, commissions, and taxes for all employees of Playfly. Playfly will also be responsible for the cost of sales including travel, entertainment, and sales materials; as well as media production and fulfillment expense consistent with past practice and as provided by Athletics Department prior to the execution of this Agreement. Playfly recognizes and agrees that the selection and hiring of individuals who possess expertise and professional skill plays an integral role in carrying out Playfly's obligations hereunder, and Playfly will recruit, hire, train and lead a local, on-site dedicated staff and various independent contractors. Playfly agrees to consult with LSU Athletics Representative prior to the hiring and termination of any senior-level (e.g., general manager) and/or public-facing employees (e.g., on-air talent) assigned to fulfill its obligations under this Agreement.

4.10 Athletics Department shall grant Playfly a right of use in furnished office space on the LSU campus mutually agreeable to both parties and provide (land line) telephone and internet access together with utilities to be used for the purposes of fulfilling the obligations of the Agreement at no cost to Playfly. Athletics Department will not be liable for any revenue loss or damage which may occur as a result of the interruption or failure of any such utility. Playfly shall be responsible for, and shall reimburse Athletics Department for, any necessary office equipment, renovations to space and any additional equipment needed to operate the LSU Radio and Television Studio, and the office space, to the extent such charges are related to Playfly's use of such areas.

4.11 Playfly shall use the Athletics Department Radio and Television Studios on the 5th floor of the University Athletics Administration Building for the purpose of producing broadcasts and other programs pertaining to the Agreement; provided, however, if such Program Inventory is performed off-site, then LSU Athletics Representative will work with Playfly to approve the alternative location.

4.12 Any incremental sponsorship fulfillment costs (e.g., a coach endorsement fee that is included in a sponsorship contract) will be covered by third party sponsors or deducted from Gross Revenue for the purpose of calculating the Athletics Department revenue share. LSU Athletics Representative will be notified and must approve in writing any incremental sponsorship fulfillment costs prior to Playfly incurring such charge or applying any deduction to Gross Revenue.

5.0 Not Used.

6.0 **Trade / Value in Kind:** Playfly will use commercially reasonable efforts to secure pre-approved Trade/Value-in-Kind Agreements on behalf of University Athletics upon request and as mutually agreed upon. Seventy-five (75%) of the annual fair market value of any Trade/Value-in-Kind shall be deducted first from the Gross Revenue. The specific terms of each trade, the specific supplier and the trade value of each trade shall be subject to the prior written approval of the LSU Athletics Representative and Playfly. Prior to entering into any contract which would result in the Athletics Department or Playfly receiving goods or services in-kind, Playfly shall submit to the LSU Athletics Representative the material terms, including but not limited to the description of the goods or services, the quantity, and the estimated fair market value of each element of the proposed in-kind arrangement. The LSU Athletics Representative shall review the proposed arrangement and promptly advise Playfly whether or not the proposal is acceptable. Playfly agrees that the rejection or disapproval of a proposed in-kind arrangement by the LSU Athletics Representative shall not constitute a breach of this Agreement or an interference by the LSU Athletics Representative with the rights granted to Playfly.

7.0 **Grant of Rights:** The University hereby grants to Playfly the exclusive right and obligation to manage, distribute, and monetize those multimedia and sponsorship rights and privileges outlined in Exhibit A. Playfly shall have the right to enter into direct agreements with sponsors and media partners ("**Sponsorship Agreements**"). Playfly shall invoice and collect all cash revenues from those agreements. The LSU Athletics Representative shall be responsible for providing reasonable assistance to Playfly in Sponsorship asset fulfillment and execution. LSU Representative shall have the right to approve Sponsorship Agreements for categories not previously approved. Such approval not to be unreasonably withheld, delayed or conditioned. LSU Athletics Representative shall have the right to approve all other Sponsorship Agreements, such approval not to be unreasonably withheld, delayed or conditioned.

8.0 **Intellectual Property.** Pursuant to this Agreement, the University is licensing to Playfly specified uses of the Licensed Marks and certain other intellectual property and assets during the Term of this Agreement, as contemplated herein. The University is licensing the Licensed Marks to Playfly on a non-exclusive basis, except that University may not grant any third party the right to use the Licensed Marks in connection with the multimedia and sponsorship rights and privileges outlined in Exhibit A. Notwithstanding the foregoing, the parties acknowledge that Playfly may use the Licensed Marks royalty free in connection with certain exclusive rights granted to Playfly hereunder; to include granting the royalty free, non-exclusive use of the Licensed Marks to sponsors and media partners that have entered into Sponsorship Agreements, provided such Licensed Marks are used in accordance with the University's graphic standards. The University shall, in all cases, retain exclusive ownership of any and all such Licensed Marks and other intellectual property and assets, including any and all derivative property and assets developed during the Term of the Agreement. Playfly hereby acknowledges the University's ownership of the Licensed Marks and agrees to relinquish to the University all licensed rights to any and all such intellectual property at the expiration or termination of this Agreement. All uses

of the Licensed Marks shall be subject to the University policies and procedures regarding the protection and use of its trademarks.

Playfly agrees that as between University and Playfly, University shall own all rights, title and interest in and to recordings, writings, photographs, audio, video, and other tangible property (collectively, "**Works**") which Playfly creates in connection with the performance of this Agreement. For purposes of illustration and not by way of limitation, the following property created under this Agreement is included in the definition of "Works": (i) live radio game broadcasts; (ii) coaches radio shows; (iii) coaches' interviews; (iv) GameDay Programs; (v) Football and Basketball Fan Guides; (vi) Promotional Materials; and, (vii) digital, social and new media content including LSU Gold content. Playfly and the University agree that the University by this Agreement has commissioned Playfly to create the Works, and that each Work is intended to be a "work made for hire" in accordance with United States Copyright law. For any Works that, under United States Copyright law, may not be considered works made for hire, Playfly hereby assigns to the University all copyright interests which may subsist in such Works and that would otherwise accrue to Playfly. Playfly shall disclose information to the Director of Licensing and execute such documents as may be reasonably necessary to assist the Director of Licensing in securing and enforcing the University's rights in the Works. Notwithstanding the foregoing, recordings, writings, photographs, audio, video, and other tangible property created in connection with Multimedia Rights Sublicenses or that otherwise include third party intellectual property shall not be included in the definition of "Works". The Director of Licensing grants Playfly permission to a license to copy, distribute, publicly perform, publicly display and transmit the Works solely for the purpose of filling its obligations arising out of this Agreement. This license shall expire or be terminated upon the expiration or termination of this Agreement. The license may not be assigned or subcontracted, except to an entity controlled by or under common control with Playfly. To the extent Playfly uses any third parties to assist in the creation of the Works, it represents and warrants it will include terms substantially similar to the above ensuring University's enumerated intellectual property rights to the Works are preserved.

9.0 The Director of Licensing will take commercially reasonable and appropriate action consistent with its past practices to protect its marks including the Licensed Marks. Playfly shall provide the Director of Licensing with reasonable assistance requested by the Director of Licensing in connection with such enforcement actions. **Material Impairment to Rights:** The University and Playfly agree that the terms and conditions of this Agreement are based upon certain assumptions, including (i) the availability of those assets and rights outlined in Exhibit A, and (ii) the 2023 Agreement Year including a full schedule for the LSU Athletics Program, and limited COVID-19-related restrictions on capacity for fans during the entire schedule of University Athletics. In the event those rights or the ability to generate value and revenue from those rights are materially diminished through no fault of Playfly, any of the material assumptions upon which the University and Playfly entered into this agreement are, or the base revenue set forth in Exhibit C is, inaccurate then both parties agree to enter into good faith discussions aimed at negotiating an equitable adjustment to the terms and conditions of this Agreement to reflect such material changes; provided that no such adjustment shall increase the Playfly Rights Fee or Revenue Share

percentage payable to Athletics Department. Examples of such events shall include, but not be limited to, the following:

9.1 If the MMR Rights inventory described herein is materially changed, or adversely and materially impacted by subsequently entered agreements which the University must honor or by directives implemented by or affecting University Athletics (e.g., NCAA laws, rules or regulations affecting interscholastic athletics) or if the Director of Licensing allows student athletes to use Licensed Marks for commercial purposes, including “name, image, and likeness” activities.

9.2 If there is a change in “**Restricted Sponsorship Categories**” or any other listing of restricted categories for which Playfly may not solicit and implement Sponsorship Agreements as outlined in Exhibit B and Playfly provides the LSU Athletics Representative with reasonable evidence that such occurrence resulted in a material reduction in Gross Revenue for such period and such event is not due to the fault of Playfly. Upon mutual agreement of the parties, University shall have the right to reasonably update Exhibit B from time to time based on changes to operative law or NCAA, conference, and University rules, regulations and policies, and the development or commercial availability of new products or services and such update shall not constitute an example of a triggering event under this subsection.

9.3 Any material reduction or suspension of scheduled intercollegiate athletics contests, the ability of spectators to attend such activities, the ability to listen to, view or otherwise consume broadcasts, streams, or other means of delivering the University Athletics activities or content to consumers or other third parties due to technical difficulties and Playfly provides to the University reasonable evidence that despite commercially reasonable efforts to mitigate any losses such occurrence resulted in a material reduction in Gross Revenue for such period not covered by valid and collectible insurance or other programs, if any, and such event is not due to the fault of Playfly.

9.4 Any change in the schedule of the University Athletics activities which materially and adversely alters the marketable inventory described in this Agreement and Playfly provides to the LSU Athletics Representative reasonable evidence that despite commercially reasonable efforts to mitigate any losses, such occurrence resulted in a material reduction in Gross Revenue for such period not covered by valid and collectible insurance or other programs, if any, and such event is not due to the fault of Playfly.

9.5 A circumstance in which signage is not functioning during one or more events related to University Athletics activities and Playfly provides to the University reasonable evidence that such occurrence resulted in a material reduction in Gross Revenue for such period and such event is not due to the fault of Playfly.

9.6 Other events materially and adversely affecting revenues and expenditures of Playfly in carrying out activities under this Agreement, including but not limited to where certain opportunities or events are removed from the marketable inventory, temporarily or permanently,

whether or not due to events in the control of the University employees, consultants, subcontractors or students.

Both parties further recognize that the aforementioned factors do not constitute an event of default by either party under this Agreement but could result in a need for remedial changes in the Agreement including but not limited to a change in the University Gross Revenue share thresholds or such other changes as are reasonably necessary and mutually agreed.

Accordingly, each party acknowledges and accepts an affirmative obligation, when so notified in writing by the other, to use reasonable good faith efforts to seek mutually beneficial solutions when a need for changes is indicated, provided, however, that in no event shall failure to reach mutually beneficial solutions constitute a default under this Agreement if both parties have used reasonable good faith efforts to seek mutually beneficial solutions when changes are indicated. To the extent that any mutually agreed upon change requires an amendment to the Agreement, such amendment shall be in writing executed by the appropriate representative of each party hereto.

9.7 Failure of the parties to reach agreement with respect to these issues after reasonable good faith efforts will authorize either party to cancel this Agreement; provided, however, such cancellation shall require no less than six months' notice and may only result in cancellation on June 30 of any year of this Agreement. In the event that either party cancels this agreement in accordance with the terms of this Section 9, Playfly shall be entitled to the reimbursement of the amount equal to the unamortized Capital Investment remaining on all Improvements made by Playfly during the Term. The amortization period for any such Improvements shall be on a straight-line basis for the Term of the Agreement or such shorter period as agreed to in writing measured from the date that the costs are incurred or payments are made (as the case may be). With respect to the Capital Investment, the actual amortization schedule will depend on the dates on which funds are actually committed. Playfly shall provide an accurate amortization schedule promptly within fifteen (15) days of the date Playfly actually commits funds, which schedule shall be attached to and incorporated as part of this Agreement.

10.0 Insurance Requirements:

During the term of this Agreement Playfly shall procure and maintain insurance for its activities under this Agreement in the following types and amounts:

10.1.1 Commercial general liability insurance which insures against claims for bodily injury, personal injury, advertising injury, and property damage. Such insurance shall afford, at a minimum, the following limits:

Each Occurrence	\$1,000,000
General Aggregate	\$2,000,000
Products/Completed Operations Aggregate	\$1,000,000

Personal and Advertising Injury Liability \$1,000,000

Playfly's commercial general liability insurance shall include the University, its trustees, officers, directors, members, agents, affiliated organizations and employees, as additional insureds.

10.1.2 Business automobile liability insurance covering owned, hired and non-owned vehicles with \$1,000,000 combined single limit per occurrence

10.1.3 Employer's liability insurance in the amount of \$1,000,000.

10.1.4 Workers' compensation insurance in accordance with the laws of the State of Louisiana.

10.1.5 Umbrella/excess liability insurance, on an occurrence basis, that applies excess of the required commercial general liability, business automobile liability, and employer's liability policies with the following minimum limits:

Each Occurrence	\$3,000,000
Annual Aggregate	\$3,000,000

Umbrella/Excess liability policies shall contain an additional insured endorsement to follow form of underlying insurance coverage.

10.1.6 Cyber-Liability Insurance in the amount of \$1,000,000.

10.1.7 Business Interruption Insurance in the amount of \$1,000,000.

10.2 The University shall be provided with a Certificate of Insurance evidencing the above required insurance at the time the policies are required to be obtained and thereafter with certificates evidencing renewals or replacements of said policies prior to the expiration or cancellation of any such policies. Playfly shall provide the LSU Representative with written notice at least thirty (30) days prior to the cancelation or expiration (without renewal or replacement) of such policies

10.3 Playfly shall cause each policy carried by Playfly to be written in a manner so as to provide that Playfly's insurer waives any right to subrogation which such insurer may have against the University, its trustees, officers, directors, members, agents, and employees, in

connection with any loss or damage covered by any such policy. Playfly agrees to obtain any endorsement that may be necessary to give effect to this waiver of subrogation.

10.4 Playfly's insurance is to be placed with insurers with a current A.M. Best's rating of no less than A-:VII, unless otherwise agreed to in advance and in writing by the LSU Representative.

11.0 Changes to Agreement: No amendment of this Agreement will be effective unless it is reduced to writing and executed by an authorized representative of the University and by the individual signing this agreement for and on behalf of Playfly or by other individuals named by either party as specified in the Section herein entitled "Notices."

12.0 Right of Audit: The , LSU Representative, LSU Athletics Representative, or an independent, certified accountant designated by the University, shall have the option to audit all books, records and accounts of Playfly directly pertaining to the Agreement and/or to Playfly's compliance with its obligations under this Agreement (the "**Playfly Records**") not more than once per calendar year during the Term and for a period of one (1) year after expiration or termination of the Agreement. Upon receipt of reasonable notice of not less than ten (10) business days, records shall be made available at Playfly's place of business during normal working hours for this purpose. The LSU Representative, LSU Athletics Representative, , or the University's independent, certified accountant, shall not remove the original Playfly records from Playfly's office (but may make and retain copies as required for the performance of their work) and, to the extent permitted under applicable law shall keep all terms of Playfly's records confidential. This confidentiality obligation shall survive the expiration or termination of this Agreement.

13.0 Assignment: Neither party to this Agreement will have the right to assign this Agreement in whole or in part without the prior written consent of the other. Such consent shall not be unreasonably withheld, delayed or conditioned. Notwithstanding the foregoing, Playfly shall have the right to assign this Agreement to an entity that controls, is controlled by or under common control with Playfly without obtaining consent from the University as long as it gives University thirty days advance written notice.

In the event that majority control of Playfly is effectively transferred to one or more third-parties, through a sale, merger or other means (a "Change of Control"), to the extent deemed reasonable under the circumstances by Playfly in its sole and absolute discretion, Playfly will provide University with advance written notice of a change of control (the "Change of Control Notice"). In the event that Playfly does not deem it reasonable to provide a Change of Control Notice in advance, Playfly shall provide a Change of Control Notice no later than thirty days following the consummation of the same. During the thirty-day period following the date of the Change of Control Notice, the parties shall discuss in good faith facts relating to the proposed change or control. Unless a proposed Change of Control is approved (which approval shall not be unreasonably withheld) by LSU Representative in writing on or before the end of such thirty-day period, LSU Representative shall have the right, in its sole and uncontrolled discretion, to reinstate the Performance Bond requirements set forth in Section 5 of the 2016 Agreement for each

remaining full Agreement Year under the Agreement, except that the amount of any such bond shall be one hundred percent of the Annual Rights Fee for the Agreement Year with respect to which such bond is implemented plus one hundred percent of any revenue share payment to University under Section 4.3 of this Agreement with respect to the immediately preceding Agreement Year. LSU Representative shall make this election by delivering written notice to Playfly not later than the sixtieth day following the date of the Change of Control Notice. For purposes of this Agreement, "Change of Control" includes where (a) a "person" or "group" (as defined pursuant to Section 13(d) under the Securities Exchange Act of 1934, as amended (the "Exchange Act")) that does not control in excess of fifty percent of the combined voting power of the outstanding voting securities of Playfly entitled to vote generally in an election of directors acquires control of in excess of fifty percent of the combined voting power of the outstanding voting securities of Playfly entitled to vote generally in an election of directors or (b) a sale of all or substantially all of the assets of Playfly to a party not controlling, controlled by or under common control with Playfly immediately prior to such transaction.

14.0 Status of Parties:

14.1 Nothing in this Agreement shall be deemed to constitute either party, or any employee, agent or representative of either party, an employee, agent, or representative of the other party.

14.2 Nothing in this Agreement shall be deemed to confer any express or implied right, power, or authority to enter into any agreement or commitment, express or implied, or to incur any obligation or liability on behalf of the other party except as expressly set forth herein.

14.3 Nothing in this Agreement shall be deemed to make Playfly an employee of the University. Playfly is engaged as an independent contractor. Playfly will indemnify and hold harmless the University and its employees and agents, with respect to all withholding, Social Security, unemployment compensation and all other taxes or amounts of any kind relating to Playfly's employees in connection with the performance of this Agreement.

14.4 The parties acknowledge that because Playfly is an independent contractor, Playfly has the sole responsibility for its activities and operations in the execution and delivery of services outlined in this Agreement.

15.0 Indemnification:

15.1 The University shall, at its sole cost and expense, defend, indemnify and hold Playfly and each of its managers, officers, employees and authorized agents (the "**Playfly Indemnitees**") harmless against any loss or damage (including attorneys' fees and disbursements, costs of investigations, litigation, settlement or judgment) incurred in connection with any demand, or any civil, criminal or investigative claim, action or proceeding asserted or threatened ("**Claims**") made or brought by any third party arising out of: (a) a breach of this Agreement by the University; (b) the willful misconduct or gross negligence of the University or any of its employees, (c) defamation, libel, slander, violation of rights of privacy or publicity or infringement of copyrights

and trademarks arising out of any claim that the University's Licensed Marks or any other content or data or information provided by the University to Playfly for use in connection with this Agreement, infringes upon any patent, copyright, or trade secret of a third party or for any other third party right, or fails to comply with any law, regulation or policy of any government agency, or (d) damage to property and injury to persons (including death) arising out of the negligence or willful misconduct of the University and the University's officers, employees, or authorized agents. Notwithstanding the foregoing, University shall have no obligation to indemnify Playfly to the extent that any Claims arise out of or in connection with (i) the gross negligence or willful misconduct of the Playfly Indemnities; and/or (ii) University's authorized use of any advertising or content provided by Playfly under this Agreement. Playfly shall notify the LSU Representative in writing promptly upon learning of any Claim for which indemnification is due from the University. Playfly shall have the right to participate in such defense or settlement.

15.2 Playfly shall, at its sole cost and expense, defend, indemnify and hold the University each of its trustees, officers, employees and agents (the "**University Indemnitees**") harmless against any loss or damage (including attorneys' fees and disbursements, costs of investigations, litigation, settlement or judgment) incurred in connection with any demand, or any civil, criminal or investigative claim, action or proceeding asserted or threatened ("**Claims**") made or brought by any third party arising out of: (a) a breach of this Agreement by Playfly; (b) the willful misconduct or gross negligence of the Playfly or any of its employees, (c) damage to property and injury to persons (including death) arising out of the negligence, willful misconduct or other legal fault of Playfly and Playfly's officers, contractors or subcontractors, employees, advertisers, corporate sponsors and agents in performing Playfly's obligations or exercising Playfly's rights pursuant to this Agreement, or (d) defamation, libel, slander, violation of rights of privacy or publicity or infringement of copyrights and trademarks arising out of any advertising or content supplied by Playfly hereunder. Notwithstanding the foregoing, Playfly shall have no obligation to indemnify the University Indemnitees to the extent that any Claims arise out of or in connection with (i) the negligence or willful misconduct of any of the University Indemnitees; and/or (ii) Playfly's authorized use of any data, content or Licensed Marks provided by the University under this Agreement. The LSU Representative shall notify Playfly in writing promptly upon learning of any Claim for which indemnification is due from the University. The University shall have the right to participate in such defense or settlement.

15.3 The obligation of the indemnifying party hereunder shall apply only if (a) the indemnified party provides prompt notification upon receipt of notice of any claim or suit which may give rise to an indemnification hereunder (provided, that no delay in providing such notification shall limit the indemnifying party's indemnification obligations hereunder except to the extent such delay prejudices the indemnifying party); (b) permit the indemnifying party and its attorneys and personnel to handle and control the defense of such claims or suits, including pretrial, trial or settlement (provided that the indemnifying party shall first be required to acknowledge in writing its obligation to indemnify the indemnified party with respect to the matters for which it is assuming the defense), and (c) the indemnified party reasonably cooperates and assists (at the indemnifying party's expense) in such defense. The indemnified party further agrees that if it settles or compromises any such claim or suit without the prior written consent of the indemnifying

Email: legalnotice@playfly.com

17.0 Governing Law; Venue: The validity, interpretation and performance of this Agreement shall be controlled by and construed under the laws of the State of Louisiana. Venue for any action brought under this Agreement shall lie exclusively in the state or federal courts located in the city of Baton Rouge, Louisiana.

18.0 Termination for Breach:

18.1 Default by Playfly. The following actions or events shall constitute an “**event of default**” of this Agreement by Playfly. Notices of Default shall be sent by registered or certified mail, return receipt requested.

18.1.1 Failure of Playfly to timely pay in full any amounts required to be paid hereunder and the continuation of such failure for a period of ten (10) business days after written notice of such failure is given to Playfly;

18.1.2 Failure of Playfly to deliver or to maintain throughout the Term the insurance coverage required by Section 10 hereof and continuation of such failure for a period of thirty (30) business days after written notice of such failure is given to Playfly;

18.1.3 A voluntary petition in bankruptcy is filed by Playfly, or an involuntary petition is filed to place Playfly in bankruptcy and the involuntary petition is not dismissed within ninety (90) calendar days of the filing;

18.1.4 Playfly makes a general assignment for the benefit of its creditors, or takes the benefit of any insolvency act, or if a permanent receiver or trustee in bankruptcy shall be appointed for Playfly.

18.1.5 Failure or refusal by Playfly to observe or perform any material covenant, condition, or agreement on its part to be observed or performed under this Agreement for a period of thirty (30) calendar days after written notice is given to Playfly specifying such failure and requesting that it be remedied; provided that there shall be no default or event of default, if within thirty (30) calendar days after the date such written notice of default is given, Playfly institutes steps to effectuate compliance with this Agreement and proceeds diligently and continuously to effect compliance until the same is completed, and the same to be completed to the reasonable satisfaction of the LSU Athletics Representative within a period of not more than sixty (60) calendar days from the date of the notice or such other reasonable time period under the circumstances.

18.2 Failure to Cure. In the event of a default by Playfly that is not cured timely after Playfly’s receipt of written notice of such default (if required), the University may in its sole discretion terminate this Agreement by giving at least ten (10) business days' written notice to Playfly by registered mail, return receipt requested, of the date on which the Agreement will

terminate. Termination of this Agreement by the University based on a default by Playfly shall not prejudice or otherwise operate as a waiver of the University's rights to (a) retain any portion of the Playfly Rights Fee received by the University prior to termination of this Agreement; and (b) sue for, collect and retain any additional amounts due and owing as of the date of termination or for any other damages.

18.3 **Default by the University.** The following action or events shall constitute an “**event of default**” of this Agreement by the University. Notices of Default shall be sent by registered mail, return receipt requested.

18.3.1 Failure or refusal by the University to observe or perform any material covenant, condition, or agreement on its part to be observed or performed under this Agreement for a period of (i) ten (10) business days in the case of monetary default, and (ii) thirty (30) calendar days in the case of non-monetary default after written notice is given to the University by Playfly specifying such failure and requesting that it be remedied; provided that there shall be no default or event of default, if for any non-monetary default, for a period of thirty (30) calendar days after the date such written notice of default is given, the LSU Representative institutes steps to effectuate compliance with this Agreement and proceed diligently and continuously to effect compliance until the same is completed, and the same to be completed within a period of not more than sixty (60) calendar days from the date of the notice or such other reasonable time period under the circumstances.

18.4 **Failure to Cure.** In the event of a default by the University that is not cured timely after the University’s receipt of written notice of such default, Playfly may, at its sole option, terminate this Agreement by giving at least ten (10) business days' written notice to the University, by registered mail, return receipt requested, of the date on which the Agreement will terminate. Termination of this Agreement by Playfly based on a default by the University shall not prejudice or otherwise operate as a waiver of Playfly's rights to (a) reimbursement for any fees already paid by Playfly for the period extending beyond the date of termination of this Agreement; and (b) sue for, collect and retain any additional amounts due and owing as of the date of termination or for any other damages.

18.5 **Retained Rights.** In the event of default by either Party, the other Party shall have all rights and remedies provided herein and/or available to it at law or in equity.

18.6 **Limitation of Damages.** Subject to indemnification obligations set forth in Section 15.1 and 15.2 hereof pertaining to third party claims and except for (i) a party's breach of its confidentiality obligations hereunder; (ii) a party's breach of its representations and warranties under this Agreement, and/or (iii) a party's intentional acts exercised knowingly with intent to benefit, Playfly and the University hereby agree that no party shall have any liability to another for indirect, incidental, punitive, special (including loss of profits, business or goodwill) or consequential damages arising from or related to this Agreement, whether or not liability is based

on breach of contract, tort, strict liability, breach of warranty, failure of essential purpose or otherwise, even if it is advised of the likelihood of such damages.

19.0 Obligations Post Termination: The termination or expiration of this Agreement shall not modify an obligation of a party to fulfill a contractual obligation arising prior to or surviving the termination or expiration of this Agreement.

20.0 Confidentiality

20.1 Definitions.

20.1.1 Confidential Information. The term “**Confidential Information**” shall mean all information that concerns the administration, operations or affairs of either party, except to the extent excluded pursuant to Section 20.4 below, including, but not limited to its Education Records (as defined herein), Covered Data and Information (“**CDI**”) (as defined herein), business plans, negotiating or public relations strategies, products, services, systems, finances (including tuition, room and board, other fees, costs, and revenues; compensation information, pricing information), financial statements and projections, student lists, , fees, marketing plans, programs, methods of operation, methodologies, prospective and existing contracts and other business arrangements and/or business plans, procedures, and other strategies. The term “**Confidential Information**” also includes all copies, summaries, computerized records, and notes relating to Confidential Information. All such information shall be deemed to be Confidential Information and the owner of the Confidential Information (hereinafter the “**Disclosing Party**”) shall not be required to identify specifically any such information as Confidential Information.

20.1.2 Education Record. The term “**Education Record**” shall mean any record, of any type, that is related to a student of the University and is maintained, in any form, including hard copy or electronic, by the University, its employees, faculty, contractors or agents.

20.1.3 Covered Data and Information (“**CDI**”). The term CDI shall mean any paper and electronic Education Record furnished by the University or to which the University provides access.

20.2 *Acknowledgement of Receipt of Confidential Information.* The University and Playfly each acknowledge that the other party will provide the access to Confidential Information solely for the purposes of carrying out the intent of this Agreement (the “**Services**”). The party disclosing its Confidential Information pursuant to this Section 21 shall be deemed the “**Disclosing Party**.” The party receiving Confidential Information from the Disclosing Party pursuant to this Section 21 shall be deemed the “**Receiving Party**.”

20.3 *Use or Disclosure.*

20.3.1 Each party, on behalf of itself and its officers, principals, employees and agents (“**Representatives**”) shall maintain the confidentiality of all Confidential Information received pursuant to this Agreement. The Receiving Party acknowledges and agrees that it shall have no right, title, or interest in or to the Confidential Information of the Disclosing Party. Each party shall be responsible for disclosure of Confidential Information in violations of this Section 21 by its Representatives.

20.3.2 Neither Receiving Party nor its Representatives shall use any Confidential Information of the Disclosing Party for any purpose other than the provision or receipt of the Services.

- i. Each party agrees that it may disclose or provide access to the Confidential Information to its Representatives who: (a) reasonably require access to the Confidential Information for the purposes of providing or receiving the Services; and (b) other than licensed professionals who are bound by the rules of professional conduct not to disclose Confidential Information, agree in writing to be bound by the terms of this Agreement.
- ii. Neither party shall disclose any Confidential Information of the other party without the prior written consent of the other party. Each party agrees that, if such consent is granted, the Receiving Party shall disclose such Confidential Information only in a manner consistent with applicable privacy laws including but not limited to The Family Educational Rights and Privacy Act and its implementing regulations.

20.4 *Excluded Information.* The following shall be deemed not to be Confidential Information for purposes of this Agreement:

- 20.4.1 Information that becomes generally available to the public, other than as a result of unauthorized disclosure by the Receiving Party or its Representatives.
- 20.4.2 Information that is received from a third party who has lawful possession of such information and the right to disclose such information; or
- 20.4.3 Information required to be disclosed by court order or other legal process, in accordance with Section 20.8 of this Agreement.

20.5 *Maintenance of the Security of Electronic Information.* In the event the Receiving Party is provided with copies of or access to Confidential Information in electronic format, the Receiving Party shall develop, implement, maintain and use appropriate administrative, technical and physical security measures to preserve the confidentiality, integrity and availability of all electronically maintained or transmitted Confidential Information received from the

Disclosing Party. The Receiving Party will store and process Disclosing data in accordance with commercial best practices, including appropriate administrative, physical, and technical safeguards, to secure such data from unauthorized access, disclosure, alteration, and use. Such measures will be no less protective than those used to secure Receiving Party's own data of a similar type, and in no event less than reasonable in view of the type and nature of the data involved.

20.6 *Reporting of Unauthorized Disclosures or Misuse of Confidential Information.* The Receiving Party shall, within one (1) business day of discovery, report to the Disclosing Party any use or disclosure of the Disclosing Party's Confidential Information not authorized by this Agreement or otherwise authorized by the Disclosing Party in writing. Such report shall identify: (a) the nature of the unauthorized use or disclosure; (ii) the Confidential Information used or disclosed; (iii) the name of the individual or entity that made the unauthorized use or received the unauthorized disclosure; (iv) a description of the actions taken or to be taken to mitigate any negative effect of the unauthorized use or disclosure; (v) a description of the corrective action taken or to be taken to prevent future unauthorized use or disclosure; and (vi) any other information reasonably requested by the Disclosing Party.

20.7 *Return or Destruction of Confidential Information.* Confidential Information furnished pursuant to this Agreement by the Disclosing Party shall remain the property of the Disclosing Party. Each party agrees, upon request, to return to the Disclosing Party the Confidential Information, or to destroy such Confidential Information and all copies, notes and summaries thereof, provided that the Receiving Party shall not be required to return or destroy copies of Confidential Information that reside on automated disaster recovery systems (any such Confidential Information shall remain subject to the confidentiality obligations set forth herein).

20.8 *Governmental Proceedings Seeking Disclosure.* In the event of any legal action, court or administrative proceeding, or demand of any governmental agency seeking disclosure of Confidential Information, the Receiving Party shall immediately notify the Disclosing Party, in writing, of such demand or request so that the Disclosing Party may seek to quash any applicable subpoena, seek a protective order, or otherwise take legal action to prevent disclosure of the Confidential Information. The Receiving Party shall reasonably cooperate with the Disclosing Party (at the Disclosing Party's expense) in its lawful efforts to prevent disclosure of such Confidential Information. If the Disclosing Party either fails to take action to prevent disclosure of such information or is unsuccessful in preventing such disclosure before the Receiving Party is required to make such disclosure, the Receiving Party may disclose such Confidential Information provided it: (a) limits its disclosure to the information legally required to be disclosed; and (b) uses commercially reasonable efforts to obtain an order or other reliable assurance that the entity seeking production of the Confidential Information will take all reasonable steps to maintain its confidentiality.

20.9 *Injunctive Relief.* The parties recognize that a breach of this Section 20 may result in irreparable harm to the other party and that damages caused by such breach may be impossible to measure. Therefore, in the event of such material breach, and without limiting the

right of the Disclosing Party to seek any other remedy or relief to which it may be entitled under law, the Receiving Party agrees that the Disclosing Party shall be entitled to seek specific performance of the Receiving Party's obligations under this Section 20 and to seek immediate injunctive relief without having to post bond.

20.10 The obligations of the parties under this Section 20 , in addition to indemnity and audit rights shall survive termination or expiration of this Agreement.

21.0 Entire Agreement. This Agreement supersedes all earlier agreements between the parties, including but not limited to the Letter of Intent, and contains the final and entire Agreement between the parties with respect to the subject matter hereof and they shall not be bound by any terms, conditions, statements, or representations, oral or written, not herein contained, unless contained in a written executed amendment of this Agreement signed by all parties.

22.0 Severability. Should any provision(s) of this Agreement be invalid, unlawful, or unenforceable, this shall not affect the validity of any other provision(s) of this Agreement to the Agreement as a whole.

23.0 Compliance with Applicable Laws.

23.1 The parties agree to comply with applicable laws, regulations, rulings, and standards and amendments thereto, of all entities that regulate, license, govern and/or accredit the parties, including, but not limited to, federal, state and local governmental entities.

23.2 In the event there are changes to or clarifications of federal, state, or local statutes, regulations or rules that may materially affect the operations of the University including but not limited to the tax-exempt status of the University, the parties agree to examine this Agreement and to renegotiate any applicable provisions to accommodate the changes in the law.

24.0 Force Majeure. Each Party shall be excused from performance and shall not be liable for any delay caused by force majeure only for so long as such condition prevails. These contingencies include, but are not limited to, war, sabotage, insurrection, riot or other act of civil disobedience, pandemic, epidemic or public health emergency, labor disturbance or shortage, act of public enemy, failure or delay in transportation, act of any government affecting the terms hereof, accident, fire, explosion, flood, severe weather or other act of God.

25.0 Counterparts, Electronic Copies, and Electronic Signature. This Agreement may be executed in two or more counterparts, each of which shall be deemed an original but all of which together shall constitute one and the same Agreement. A faxed copy or other electronic copy of this Agreement shall be deemed valid as an original. The counterparts of this Agreement may be executed and delivered by facsimile or other electronic signature by any of the parties to any

other party and the receiving party may rely on the receipt of such document so executed and delivered by facsimile or other electronic means as if the original had been received.

26.0 Contract Exhibits. The following Exhibits are attached and incorporated herein and made a part hereof:

Exhibit A – Scope of Services, including Attachments

Attachment I, Trademark Licensing Guidelines

Exhibit B – Restricted Sponsorship Categories

Exhibit C – Excluded Partners

Exhibit D – Licensed Marks

27.0 Headings. Headings used in this Agreement are solely for the convenience of the parties and shall be given no effect in the construction or interpretation of this Agreement.

28.0 Waiver. No waiver of any breach of this Agreement shall constitute or be deemed a waiver of any other or subsequent breach. All remedies afforded in this Agreement shall be taken and construed as cumulative to every other remedy provided hereby or at law.

IN WITNESS WHEREOF, the University and Playfly by their duly authorized representatives have executed this agreement on the dates indicated below their respective signatures.

WITNESS SIGNATURES:

**BOARD OF SUPERVISORS OF
LOUISIANA STATE UNIVERSITY &
AGRICULTURAL AND
MECHANICAL COLLEGE**

Print Name: _____

BY: _____
William F. Tate IV, President of LSU

Print Name: _____

PLAYFLY SPORTS PROPERTIES, LLC

Print Name: _____

Print Name: _____

BY: _____

Title: _____

Exhibit A – the University MMR Rights and Inventory

1.0 Marketing Rights and Endorsements

Use of University Marks

Playfly shall be granted the exclusive right to grant royalty-free use of Licensed Marks to entities for use in marketing and promotional programs, advertising campaigns, and retail promotions associated with University Athletics that are separate from the licensed sales of officially licensed product. Prior written approval is required from Director of Licensing for all use of Licensed Marks by Playfly or its advertisers or sponsors. The production of all promotional goods bearing the Licensed Marks will be royalty free but must be produced by a licensed University vendor. These rights for promotional items are to be distributed free of charge and do not extend to items that are intended to be resold.

Designation Rights:

Playfly will have exclusive right to grant corporations the use of any official designation as it relates to University Athletics. These designations shall include, but not be limited to the following:

- “Exclusive Sponsor of LSU Athletics”
- “Exclusive Partner of the Tigers”
- “Proud Sponsor of LSU Athletics”
- “Proud Partner of the Tigers”
- “Official Sponsor of LSU Athletics”
- “Official {insert product category} of LSU Athletics”
- “Official Provider of LSU Athletics”
- “Official Supplier of LSU Athletics”
- “Proud Supporter of LSU Athletics”

For the purpose of clarity, LSU Athletics may be replaced with other designations that refer to the athletic teams of LSU Athletics Program, including but not limited to: Tiger, Tigers, LSU in combination with other words that link to a specific team, such as “Proud Sponsor of LSU Basketball”

Coaches and Administrators Rights and Sponsorship Solicitation Support

Playfly shall be granted the right to the name, likeness and image of all Athletics Department coaches and administrators (subject to the terms and conditions of their individual employment agreements) for inclusion in corporate sponsorship agreements. University represents that it will not permit any University coach or administrator to enter into a corporate sponsorship agreement

or any corporate relationship that implies or grants the use of the coach or administrator's name, likeness, image or endorsement of any kind, including advertising imagery where no official Licensed Marks are included, but the coach or administrator is represented in colors and/or settings whereby an implied relationship with University is made without the prior written approval of Playfly, which shall not be unreasonably withheld.

Subject to the time constraints inherent in their roles as coaches and administrators for University and the terms of their employment contracts with University, and in consultation with University's Athletic Department, University agrees to make coaches and administrators available at reasonable times to Playfly for sponsorship solicitation activities, including, but not limited to making phone calls, meeting with prospects on and off campus, signing merchandise, writing personal notes, hosting events before or after practices or games, and attending dinners and other social functions created by Playfly for the purpose of sponsorship solicitation.

2.0 Signage, Video Boards, Scoreboards and Other Rights

Playfly will have the exclusive sales right and authorization to use all existing and, to the extent developed and/or presented in the future by Playfly and consented to by LSU Athletics Representative (which consent will not be unreasonably withheld, delayed or conditioned) any new, permanent, temporary and electronic signage, and space on video boards and scoreboards (current and new), and such other technologies as may exist today or be developed in the future, available for display of third party advertising that is located in and around current and future Athletics Facilities during Athletics Events. Signage opportunities (e.g., basketball court logos, floor aprons, kick plates, courtside padding, LED vomitories, chairbacks for men's and women's basketball games (if the University agrees (in its sole discretion) to cover or integrate a corporate brand with the Tiger logo in the future), shall include, but not be limited to, the following venues and locations (and any locations within, around or adjacent to the same):

- Tiger Stadium
- Pete Maravich Assembly Center,
- Alex Box Stadium, excluding TAF-owned suites
- Tiger Park
- Beach Volleyball Stadium
- Bernie Moore Stadium
- Maddox Field House
- LSU Soccer Stadium
- LSU Tennis Complex
- LSU Natatorium
-

Playfly shall have the exclusive rights to create and sell corporate entitlements, and fully integrated brand immersion opportunities in dedicated areas in and around Athletics Facilities except that with respect to Gross Revenue generated from additions to Tiger Stadium owned by TAF, PSP shall pay to TAF a percentage of such Gross Revenue equal to the Applicable Percentage under

Section 4.3 of the Agreement in effect with respect to such Agreement Year, unless a different amount is agreed upon in advance and in writing by the President and CEO of Tiger Athletic Foundation (the "TAF Revenue Share"), and the remaining Gross Revenue shall be retained by PSP and not subject to further sharing under Section 4.3 of the Agreement. These areas include but are not limited to concourse sections; entry plazas and gates; coaches' suites; public and private entertainment and hospitality spaces (excluding individual private suites); and all parking areas and garages. Any proposed corporate entitlements, including any immersion opportunities as mentioned above must be preapproved in writing by the LSU Athletics Representative (including written approval by TAF to the extent involving TAF owned additions to Tiger Stadium, which approval by TAF shall not be unreasonably withheld, delayed, or conditioned). The LSU Athletics Representative reserves the right, at its sole discretion, to deny any corporate entitlement or immersion opportunity to a sponsor. The parties agree to meet periodically to discuss opportunities and act in good faith to maximize Gross Revenues while avoiding conflict among potential sponsorship and other opportunities.

3.0 Game Sponsorships and Event Marketing

Except as set forth below, Playfly will have the exclusive rights and authorization to all Game Sponsorships and Event marketing activities on game days in and around Athletic Events and Programming including, but not limited to the following:

- Individual and Series Game sponsorships and entitlements, including the inclusion of game sponsor branding in all University Athletics produced marketing materials and advertising
- On-field and on-court promotions and presentations for official University Athletics sponsorships
- Public address announcements
- Product sampling, including alcohol if pre-approved in accordance with University policies
- Premium item distribution
- Activities and events within game day Fan Fest and tailgate areas
- Pregame, halftime and post-game entertainment, including live music performances
- On-site display: During any Athletics Event, Playfly will have the exclusive rights to sell or approve any athletics related on-site corporate display, including vehicle displays, or tabling inside or outside the Athletics Facility (to include the footprint of all University athletics parking lots and common areas used on game days excluding premium seating areas), product sampling and promotional giveaways

The foregoing grant of rights shall not apply to: (a) third-party sponsored athletic events or tournaments in which a University Athletics Team plays, including those hosted or conducted in Athletics Facilities; or (b) the lease or license of Athletics Facilities to third-parties for Athletic Events in which a University Athletics team does not participate. If any third-party sponsored athletic event or tournament requires the removal or covering of any on-site displays, Athletics Department shall be responsible for the removal, covering and restoration of such displays

including all associated costs. The foregoing grant of rights does not prohibit University from holding non-commercial events, such as a “military salute”.

4.0 Tickets, Luxury Suites and Hospitality

Playfly will obtain ticket inventory from TAF and/or LSU Athletics as specified in Exhibit E.

5.0 Premium Unique Access Rights

Athletics Department agrees to provide Playfly a reasonable number of unique and behind-the-scenes access opportunities for radio/on-air talent, sponsorship solicitation and for inclusion in sponsorship agreements that do not interfere with other University and University Athletics’ priorities and ability to compete at a high level, to include but not limited to:

- Seats on team charter flights when available, pursuant to University policy
- Access to team hotel and other road game amenities.
- Dinner and/or special events
- Unique experiences with University staff and coaches
- Behind the scenes access to Athletic Facilities, such as locker rooms, media rooms and team meeting rooms at mutually agreed upon dates/times.

6.0 Audio Content Rights

During the Term of this Agreement Playfly shall have the exclusive worldwide licensed right to broadcast audio of all University Athletics Events, coaches shows, athletics directors shows, and associated University Athletics programming to all audio broadcast signal coverage areas via any means of distribution whether now known or developed in the future, including without limitation: terrestrial, cable systems, phone lines, mobile, streaming, podcasts, digital or satellite, to the extent the license of such rights are exclusively within the control of University. As part of the annual Property Operating Budget process, Playfly will develop, in collaboration with University, a comprehensive audio content production and distribution plan and supporting line-item budget that delivers broadcasts consistent with industry standards and maximizes Gross Revenue. The plan will include details on the type and number of programs, format, production specifications, on air talent, support personnel, and distribution outlets. Notwithstanding the foregoing, the University and its affiliated fundraising organizations shall have the right to use University Athletics audio content to promote the University.

6.1 Coaches Interviews for Games

LSU Athletics Representative will arrange for the head coaches to be available for an interview prior to each game (to be pre-recorded at the mutual convenience of the coaches and Playfly), and immediately following each game for a post-game interview.

LSU Athletics Representative will also make the head coaches available immediately following the first half of play or prior to the beginning of the second half of play for a half-time interview.

6.2 Coaches and Ambassadors Availability for Shows and Broadcast Site

LSU Athletics Representative will make available the head coaches, and LSU Athletics Ambassadors, subject to the terms of their employment agreements, at no additional cost to Playfly to participate in head coaches' call-in shows and other agreed upon events. Each show will be held at a mutually agreed upon location. Playfly will have the exclusive right to sell the broadcast site of the show(s).

6.3 Reciprocal Rights

Athletics Department will use commercially and practically reasonable efforts to secure for Playfly the rights to provide an audio broadcast to all regular season away games. When Playfly is broadcasting under a reciprocal arrangement, the terms of the Agreement will continue to have full force and effect with respect to all applicable and relevant terms and conditions which are not in conflict with reciprocal host(s)' requirements.

6.4 Redistribution Rights

Athletics Department shall have the right to reproduce, distribute, and use taped reproductions of the audio broadcasts for the purposes of marketing its Athletic Program. Playfly shall retain all revenue from the redistribution or use of any audio programming subject to the terms of this Agreement.

6.5 Media Protection

Athletics Department will ensure that coaches and other Athletics Department personnel shall not make weekly media appearances on weekly call-in shows that are produced or broadcast by non-affiliated radio stations, except for excerpts from press conferences open to the media.

7.0 Video Content Rights

Except as set forth herein, during the Term of this Agreement, Playfly shall have the exclusive worldwide licensed right to University Athletics video content to the extent not prohibited by an existing contract or other arrangement with the NCAA and/or the athletic conferences in which the University Athletics participates (as of the Effective Date of this Agreement, the Southeastern Conference) upon the execution of this Agreement and in compliance with the above mentioned conferences and leagues, and NCAA rules and regulations, to all broadcast signal coverage areas

via any means of distribution whether now known or developed in the future, including without limitation: over the air, cable systems, phone lines, mobile, digital or satellite. As part of the annual Property Operating Budget process, Playfly will develop, in collaboration with LSU Athletics Representative, a comprehensive video content production and distribution plan and supporting line-item budget that deliver broadcasts consistent with industry standards and maximizes Gross Revenue. The plan will include details on the type and number of programs, format, production specifications, on air talent, support personnel, and distribution outlets. Notwithstanding the foregoing, the University and its affiliated fundraising organizations shall have the right to use University Athletics video content to promote the University.

8.0 Printed Material and Publication Rights

Playfly will have the exclusive advertising sales rights to all printed promotional materials and items produced by or for University Athletics to promote its athletics program, teams, or student-athletes including but not limited to ticket fronts and backs, schedule posters and schedule cards, ticket brochures, will call envelopes, parking passes, direct mailing inserts, food and beverage containers, credentials, and field passes. Athletics Department shall be liable for the production costs of printed promotional materials except for the incremental cost created by the inclusion of a sponsor on such item which, if any, would be included as part of the Property Operating Budget.

Playfly will have the exclusive advertising sales rights to all University Athletics publications including, but not limited to game day programs (to include program vending), roster cards, yearbooks, media guides, and fan guides. As part of the annual Property Operating Budget process, Playfly will develop, in collaboration with LSU Athletics Representative, a comprehensive publication production and distribution plan and supporting line-item budget that delivers high quality print publications consistent with industry standards and maximizes Gross Revenue. The plan will include details on the type and number of publications, format, content, production specifications, and distribution outlets.

9.0 Digital, Social and New Media Rights

Playfly shall have the exclusive 3rd party right to provide input into the content and design opportunities associated with University Athletics official athletics web site (lsusports.net) and official Mobile Application (“APP”). Subject to approval by the LSU Athletics Representative, Playfly shall have the right to select and manage the relationship with the host company of any affiliated official University Athletics website or team APP. Athletics Department will be responsible for providing all content found on lsusports.net, the official sports or team APP and all video content found on lsusports.net or any official LSU Athletics social media accounts or channels.

Playfly shall have the exclusive rights to sell advertising and sponsorships in the form of company logos and messages, and other sponsorship or revenue related promotions or content on lsusports.net to include but not limited to: headline stories and articles, drop down menus, banner advertisements, calendar of events, web page links for each sports team, audio broadcast of

sporting events, video content, real time statistics, eCommerce ticketing solutions for sporting events and hyperlinks to sponsors' websites, social media integration as well as promotions or content related to the streaming of video content which is not prohibited by an existing contract or in conflict with University's required assignment of video rights to the NCAA and/or any athletics association or conference of which it is a member.

To the extent permissible under applicable University or affiliated fundraising organization policies and Applicable Privacy and Data Security Laws, Athletics Department will collaborate with Playfly, and any third parties with whom Playfly enters advertising, sponsorship and/or endorsement agreements hereunder, to provide access to certain University Athletics data owned, co-owned, or controlled by Athletics Department. Any access granted to Playfly by the Athletics Department shall be for the sole purpose of providing services to the University under this Agreement. Playfly represents and warrants that any such third parties will treat data with the same level of care Playfly commits to as part of this Agreement.

In return for Athletics Department's provision of the data described in this Section, Playfly expressly agrees that such data may contain Personally Identifiable Information that may be subject to federal and state laws (including but not limited to FERPA) ("PII") and that Playfly shall not release PII collected from Athletics Department to any other person or organization without the prior written consent and approval of LSU Athletics Representative. If the PII is not received directly from Athletics Department, but is instead received directly from the information owner, Playfly shall appropriately disclose the privacy rights of the individual pursuant to relevant data privacy laws and, where required by such laws, obtain the consent of the data subject.

Playfly further represents, warrants, and certifies that it will: 1) hold PII in confidence and will not use or disclose information except as (a) permitted or required by the Agreement, (b) required by law, or (c) otherwise authorized by Athletics Department and the information owner, if not the Athletics Department; 2) implement and maintain a comprehensive information security program that contains administrative, physical and technical safeguards that reasonably and appropriately protect the confidentiality, integrity, and availability of PII that it creates, maintains, receives, stores, or transmits on behalf of the University.

Playfly shall continually monitor its operations and take any action necessary to assure the information is safeguarded in accordance with the terms of this Agreement. Where appropriate, Playfly shall also contractually bind and ensure that its agents, sub-contractors or sub-consultants adhere to the provisions set forth in this section.

Upon termination of this Agreement and at the direction of University, Playfly agrees to either: a) return in a format approved by LSU Representative all PII provided by Athletics Department including all PII that may be in the possession of Playfly's subcontractors or agents; or b) destroy, in a manner that permanently renders the data unusable, unreadable and undecipherable, all PII provided by Athletics Department, including all PII that may be in the possession of Playfly's subcontractors or agents.

In addition to any other indemnity provided by Playfly, in the event of a security breach involving PII caused by the negligence of Playfly, Playfly agrees to indemnify, defend, and hold harmless University from, for and against any and all: losses; liabilities; lawsuits; claims; expenses (including reasonable attorneys' fees; costs; civil, regulatory and administrative penalties; and judgments incurred through third-party claims of violation of the HIPPA, FERPA, and GDPR.

Playfly shall have the exclusive rights to and may sell sponsored promotions or content within all official University Athletics social media accounts or channels to include but not limited to: Facebook, YouTube, Twitter, Instagram, Pinterest, Snapchat etc., or any other official University Athletics social media account currently set up or created in the future. Playfly and Athletics Department will work together on final creative and content of all social media postings as well as the posting schedule for such content. LSU Athletics Representative will have final approval on all promotions and content with approval not to be unreasonably withheld, delayed or conditioned.

10.0 LSU Gold Subscription Service

10.1 LSU Gold Domain Name(s). PSP shall be responsible for owning, operating, and maintaining the domain name(s) for the Service for as long as PSP operates and distributes the Service.

10.2 Scope of Services; Access to Content.

10.2.1 Playfly will be responsible for creating a subscription based original content streaming platform (LSU Gold). LSU Gold will include a substantial amount of original video and/or audio content that will be created through the cooperation of Playfly and the Athletics Department, including the following (collectively, the “**Content**”):

10.2.1.1 A daily email roundup of Athletics Events results, updates and developments;

10.2.1.2 Periodic and/or daily podcasts with breaking news, historical features and current events related to University Athletics;

10.2.1.3 Long and short films and other audio-visual programs based on or related to University Athletics, which may include video and audio content of practices, team meetings and games and other LSU Athletics Events, coach and player interviews and such other content as may be mutually agreed from time to time; and

10.2.1.4 Such other products or benefits as mutually agreed to by Playfly and Athletics Department

10.2.2 LSU represents and warrants that it has the right, and to grant Playfly the right, to develop, produce and distribute the Content in accordance with this Agreement, including the right to operate and manage LSU Gold and to use the Content on the terms and conditions of this

Agreement. To the extent LSU does not have such rights, LSU shall use reasonable efforts to secure such rights for the benefit of LSU Gold.

10.3 Compensation. The revenues and costs of LSU Gold will be shared between Playfly Sports Properties and Athletics Department as outlined below:

10.3.1 LSU Gold Subscription Cost. The LSU Gold Content will offer an annual subscription with the option for the consumers to be billed monthly or annually. The initial subscription fees will be \$99.99/year plus taxes and fees or \$8.99/monthly plus taxes and fees and subject to change based upon mutual agreement of the parties.

10.3.2 Subscription Revenue. “Gross Subscription Revenue” for purposes of LSU Gold shall mean all LSU Gold subscription revenue received from LSU Gold subscribers, less any taxes, fees (e.g., payment processing), fulfillment costs and third-party platform fees (e.g., iOS, Android). After Playfly Sports Properties recoups the Subscription Capital Investment Amount (defined below) from the applicable year’s Gross Subscription Revenue, Playfly Sports Properties will pay Athletics Department fifty percent (50%) of the remainder of the Gross Subscription Revenue from the applicable year, unless the parties mutually agree otherwise (e.g., promotional pricing structure with TAF).

10.3.3 Sponsorship Revenue. “Gross Sponsorship Revenue” shall mean all gross revenue derived specifically from sponsorships, commercials, advertisements or any other revenue specific to LSU Gold and/or LSU Gold content outside of subscription revenue. Playfly Sports Properties has the exclusive sponsorship rights for LSU Gold and Gross Sponsorship Revenue shall be included in Gross Revenue for purposes of the Multi-Media Rights Agreement.

10.3.4 Subscription Capital Investment. Playfly Sports Properties agrees to fund up to one million dollars (\$1,000,000) in upfront costs related to launching LSU Gold, which is comprised of the following costs: (1) up to six hundred seventy dollars (\$670,000) in upgrades to Athletics Department’s current studio prior to and during the first 12 months post launch for LSU Gold content production purposes; (2) up to eighty thousand dollars (\$80,000) in additional equipment needed for LSU Gold content production (e.g., cameras, microphones) prior to and during the first 12 months post launch; and (3) two hundred fifty thousand dollars (\$250,000) Centralized Platform Launch Integration Costs fee for integration of LSU Gold into Playfly Sports Properties’ subscription platform. Playfly Sports Properties will recoup this Subscription Capital Investment amount as follows: for the Agreement Year 2021-2022, all Gross Subscription Revenue will be used towards recoupment of the Subscription Capital Investment amount, and for each Agreement Year thereafter (until the end of Agreement Year 2025-2026), the remainder of the Subscription Capital Investment amount will be recouped in equal amounts from the Gross Subscription Revenue for such year. This Subscription Capital Investment from Playfly Sports Properties is in addition to and separate from Playfly’s spend obligations in Section 6.0 of the Multi-Media Rights Agreement.

10.4 Expenses.

10.4.1 Annual Operations Costs. The Parties will evenly share the operating expenses each year for LSU Gold, which expenses will not exceed \$1.6M per year. LSU's obligation will not exceed \$800,000.00 in any calendar year. The expenses will be initially recouped from all revenue not previously dedicated to capital recoupment. The Annual Operations Costs will include: (i) a Centralized Platform Operations fee of \$250,000 for Playfly Sports Properties' centralized business operations, tech platform integration and management, third party vendor services and management, and other duties, and (ii) other costs as mutually agreed-upon by the Parties (e.g., merchandise, events).

10.4.2 Reconciliation. Within 90 days after the end of the applicable year, the Parties will reconcile the total amounts with breakdowns by category of the Annual Operations Costs, Subscription Capital Investment (if applicable), Subscription Revenue, and Sponsorship Revenue from such year. If, as a result, the parties determine that any amounts are owed from one to the other, the owing party will pay such amounts within 30 days of such determination. In no circumstance would the University's obligation exceed \$800,000 or one-half of the year's budgeted expenses whichever is lesser.

10.5 Termination. Beginning on January 1, 2027, the parties may mutually agree to cease operations and shut down the network. If such termination is exercised, it shall not affect any other provision(s) of this Agreement, or the rights granted to Playfly hereunder and shall not give rise to a claim under Section 9 of the Agreement.

10.6 Responsibilities of Playfly. To facilitate the services to be provided herein, Playfly agrees to:

10.6.1 Be responsible for the business operations, vendor agreements and management and sponsorship sales.

10.6.2 Assist with local marketing efforts for LSU Gold.

10.6.3 Provide LSU with annual reports of Gross Subscription Revenue and Gross Sponsorship Revenue.

10.6.4 Deliver all LSU Gold related subscription and customer data to TAF in an Affinaquest (formerly SSB) format in a timely fashion as to allow for efficient sales and marketing strategies and implementations from both LSU and Playfly.

10.6.5 Maintain professional liability insurance appropriate to the facility and services provided at the facility.

10.6.6 Comply with all federal, state and local laws and regulations pertaining to the operation of this service.

10.6.7 Timely compensate LSU for all amounts due in accordance with Section 3(b) above.

10.7 Responsibilities of LSU. To facilitate the services to be provided herein, LSU agrees:

10.7.1 University will solely own the name and all rights to “LSU Gold” including but not limited to all its contents, data, graphics, and recordings generated in connection therewith.

10.7.2 Be responsible for all Content production, hiring and management of local production staff and marketing for LSU Gold and its Content.

10.7.3 LSU Gold will be included in all relevant media and publicity waivers, consents, or other approvals to be signed by student athletes, and, as necessary, coaches, personnel and athletic staff in order to generate, produce and distribute LSU Gold Content and, to the extent necessary, to procure all necessary clearances and rights to any third-party content utilized in the Content.

10.7.4 LSU will grant Playfly Sports Properties reasonable access to LSU Athletics Events and Athletics Facilities, its teams, players, coaches, archival content, games, practices, and other athletic department events as is reasonably necessary to carry out its obligations under this Agreement.

10.8 Mutual Responsibilities. LSU and Playfly Sports Properties mutually understand and agree that:

10.8.1 The Parties are jointly responsible for the overall strategic guidance for LSU Gold.

10.8.2 The LSU Gold service is jointly owned by LSU and Playfly Sports Properties.

10.8.3 The Parties have the right to market LSU Gold, use the LSU Gold marks and to use the LSU Gold Content for marketing purposes subject to the terms of this Agreement.

10.8.4 Parties will mutually agree upon which platforms to launch LSU Gold (e.g., website, mobile application, OTT platforms).

10.8.5 Playfly may use the content and any data generated through the operation of LSU Gold during and after the Term on a royalty free basis for subscription service specific marketing purposes or other purposes as mutually agreed to by the parties.

11.0 Additional Rights and Benefits

- Naming Rights Opportunities: Prior to renewing or entering into corporate sponsorships granting corporate naming rights to third parties with respect to the Athletic Facilities identified in section 2.0 above, Athletics Department shall offer such opportunity to Playfly (after obtaining written approval of TAF to the extent involving TAF owned additions to Tiger Stadium, which approval by TAF shall not be unreasonably withheld, delayed or conditioned), and Athletics Department shall negotiate with Playfly with respect to such opportunity (to the extent Playfly desires to negotiate) for not less than 60 days. Nothing in this Agreement shall be interpreted as inhibiting the ability of University and its affiliated fundraising organizations to grant name recognition to donors in connection with fundraising for capital projects and to properties owned by affiliated fundraising organizations and University facilities, including Athletic Facilities.
- Merchandising: Unless otherwise required by applicable laws or University policies and procedures, prior to entering into or renewing any University Athletics merchandising arrangement during the term, Athletics Department shall offer such opportunity to Playfly, and Athletics Department shall negotiate with Playfly with respect to such opportunity (to the extent Playfly desires to negotiate) for not less than 60 days.
- Esports and Digital Content: Unless otherwise required by applicable laws or University policies and procedures, and to the extent esports is governed by University Athletics, the Athletics Department agrees to provide PSP with a right of first refusal with respect to commercialization opportunities related to campus esports management, facility development, digital content creation, and digital/social platforms, the nature and scope of which is to be determined by mutual agreement.
- Out of Market Rights and Programs: Athletics Department acknowledges and agrees that investing in current and creating new assets and programs in University and across the State of Louisiana that extend and grow the University brand is a critical component for long term revenue growth. Athletics Department and Playfly will work together to create these programs, utilizing existing University assets and resources. Playfly shall have rights to sell fully integrated sponsorships to these new programs, to include but not limited to:
 - Cause marketing programs
 - Community outreach programs
 - Education programs
 - Partnerships with local, regional and national philanthropic organizations

Any proposed out of market right or program must be preapproved in writing by the LSU Representative prior to offering to any sponsor. LSU Representative reserves the right, at its sole discretion, to deny any out of market right or program opportunity to a sponsor

- “Day-in-the-Life” Experiences: Playfly shall be granted the right to sell up to four (4) experiences each year. Experience assets are to include, but are not limited to, access to official Athletics Facilities, access to “coaches’ clinics”, ability for meet and greet with Athletics Department staff, personalities and coaches, ability to conduct private tours of locker rooms, weight rooms and other Athletics facilities or other similar assets. Day-in-

the-Life experiences must be discussed and agreed upon by Athletics Department Administration and will be scheduled on mutually agreed upon dates and times.

- Use of Athletic Facilities: Athletics Department will allow Playfly to utilize and offer to sponsors the use of Athletics Facilities, a minimum of five (5) times a year, for the purpose of sales meetings, promotional activities in conjunction with Athletics Events, corporate outings and other potential events approved by Athletics Department. Facility usage shall be based on availability, with reasonable advance written request and approval, subject to Athletics Department's policy governing the use of Athletics Facilities and may require reimbursement of expenses (such as security, utilities, etc.). All such facility use is subject to any and all University and Athletics Department policies and procedures, including any catering and equipment usage policies.
- Rivalry Series: Playfly shall have the exclusive right to sell a title or presenting sponsor, along with associated sponsors, to a Rivalry Series between University Athletics and another intercollegiate athletics program (a "Rival"). Rivalry Series assets would include, but not be limited to the following: creation of a co-branded logo with title/presenting sponsor integration; sponsor integration into the promotion of the Series across Playfly and Athletics Department controlled media platforms; special events, to include a kick-off luncheon and end of year awards/trophy presentation; final details subject to mutual agreement. Any such right is subject to agreement with such Rival, and Athletics Department agrees to assist Playfly in good faith to facilitate agreement with such Rival to secure the rights necessary to promote such Rivalry Series. Rivalry Series rights granted herein shall not inhibit fundraising challenges between LSU affiliated fundraising organizations and Rivals.
- Use of Sideline Passes: shall provide Playfly sideline passes for each home basketball game valid at all times for client cultivation and make available additional passes upon request from Playfly.
- Special Events: Playfly may utilize special events sponsored by the Athletics Department to provide special recognition or opportunities for sponsors for events in which Athletics Department has the right to offer such inventory. Examples of such events include, but are not limited to the following: Meet the Team Day, Basketball Fan Fest, etc. Playfly shall receive invitations to all Athletic Department special events, including award banquets, pre-game functions and other Athletics Department functions at which Athletics Department supporters are entertained. Playfly and Athletics Department shall work together to maximize the value from these opportunities to drive Gross Revenue with any costs mutually agreed upon prior to the expenditure or made part of the annual Property Operating Budget review process.
- Food Containers and Drink Cups: Subject to the University's existing agreements, Playfly will have the exclusive right to sell advertising for the food containers and drink cups used by the food concessionaires, food vending contractors and athletic teams at Athletic Events (excluding Premium areas of Tiger Stadium and Alex Box).

- Direct Mailings: Playfly will have the exclusive right to provide inserts with corporate sponsor representation in the season ticket mailers for Athletics Events and other Athletic Department mailings.
- University Database Access: Athletics Department will provide Playfly access to send, or Athletics Department will send, sponsor information via mail or email to the season ticket holder database and other mutually agreed databases. The use of these lists must be approved by LSU Athletics Representative and mailing lists, or the approved use may not be transferred or re-sold, unless LSU Athletics Representative has given its prior written approval in each case.
- Credentials: LSU Athletics Representative shall provide the appropriate number of working all-access credentials and parking passes required for all Playfly working staff for each Athletic Event. This includes broadcast staff, office staff and interns.
- Athletics Department Merchandise: Playfly shall have the right to purchase (as part of the Property Operating Budget) through the Athletics Department, University branded merchandise at Athletic Department rates.
- Autographed Merchandise: Athletics Department shall provide Playfly an annual allotment (as part of the Property Operating Budget) of authentic and signed Athletics Department merchandise for client cultivation (e.g., helmets, jerseys, photos).
- Food and Drink Concession Agreements: To the extent permissible under the terms and conditions of existing University concessionaire agreements, Athletics Department agrees to work in good faith with Playfly to sell branded concession opportunities.
- Sideline Rights: Other than the rights given to the Excluded Partners, Playfly shall have the exclusive right to sell branded assets along the sidelines of Athletic Events, to include but not limited to: coolers, cups, towels, fans, medical tents, misters, branding on team benches, and materials or structures utilized to shield signal callers or call-in plays.
- Fan Engagement Technology: Playfly shall have the exclusive right to sell sponsorship and corporate branding opportunities within and around any applications designed to provide game day information, in-game stats, increase concession or merchandise sales, or otherwise improve the game day and overall experience for University Athletics' fans and guests. Assets include, but not limited to entitlement/presenting sponsor assets, in APP branding, location based direct marketing, and traditional advertising, by means known now or developed in the future.
- Media Bibs: Playfly shall have the exclusive right to sell branding on all media bibs and/or other Athletics Department distributed identification apparel provided to credentialed media operating on the sideline during an Athletics Event.

12.0 Reserved.

13.0 Tax Exempt Status and Unrelated Business Income Tax

Playfly shall not take any action and University shall not be required to provide any consent or approval that (a) could undermine the tax-exempt status of the University, University affiliated fundraising organizations or bonds issued by such organizations, or (b) creates material amounts of revenue that may be deemed unrelated business taxable income .

14.0 Development of New Multi-Media Rights

University recognizes that the development and marketing of various Multi-Media Rights by universities with major athletic programs is both dynamic and evolving and that new opportunities may be expected to become available during the term of this Agreement that are not now being implemented. Accordingly, University expects that Playfly may seek other Multi-Media Rights from University for the purpose of maximizing Gross Revenue, which other Multi-Media Rights may be implemented as mutually agreed upon between University and Playfly. Playfly will request in writing from LSU Representative the authority to utilize any Multi-Media Rights that are not specified in this Agreement and LSU Representative shall not unreasonably deny its consent to such request for authority.

Exhibit B – Restricted Sponsorship Categories

1. Cigarettes or Tobacco Advertisements
2. Firearms Advertisements
3. Contraceptive Advertisements
4. Adult Entertainment Advertisements
5. Political Advertising
6. Performance Enhancing Substance Advertisements
7. Prescription Pharmaceutical Advertisements
8. Cannabis and Vape Product Advertisements

Exhibit C - Excluded Partners and Excluded Partner Agreements

Coca-Cola (as it applies to their agreement with the University only)

Nike

Marucci

Speedo

Aramark

Exhibit D – Licensed Marks

Playfly shall be granted the rights to the following trademarks, logos, and brands of the University in the performance of its obligations or the exercise of its rights under this Agreement. This list may be updated during the Term by mutual agreement of the Parties.

Primary Vector



LSU-primary-03
PNG • 4501×4500



LSU-primary-04
PNG • 4501×4500



LSU-primary-05
PNG • 4501×4500



LSU-primary-06 copy
PNG • 4501×4500



LSU-primary-06
PNG • 4501×4500



LSU-primary-BLACK
PNG • 4501×4500



LSU-primary-GOLD
PNG • 4501×4500



LSU-primary-PURPLE
PNG • 4501×4500



LSU-primary-WHITE
PNG • 4500×4500



LSU-primary-WHITEonB...
PNG • 4500×4500



LSU-primary-01
JPG • 4500×4500



LSU-primary-02
JPG • 4501×4500



LSU-primary-03
JPG • 4501×4500



LSU-primary-04
JPG • 4501×4500



LSU-primary-05
JPG • 4501×4500



Secondary Tiger Head

Vector EPS



LSU-secondary-head-H...
EPS • 360×360



LSU-secondary-head-H...
EPS • 360×360



LSU-secondary-head-H...
EPS • 360×360



LSU-secondary-head-H...
EPS • 360×360



LSU-secondary-head-H...
EPS • 360×360



LSU-secondary-head-H...
EPS • 360×360



LSU-secondary-head-H...
EPS • 360×360



LSU-secondary-head-H...
EPS • 360×360



LSU-secondary-head-H...
EPS • 360×360



LSU-secondary-head-H...
EPS • 360×360



LSU-secondary-head-H...
EPS • 360×360



LSU-secondary-head-H...
EPS • 360×360

Secondary Tiger Eye

Vector EPS



LSU-secondary-eye-HE...
EPS • 360×360



LSU-secondary-eye-HE...
EPS • 360×360



LSU-secondary-eye-HE...
EPS • 360×360



LSU-secondary-eye-HE...
EPS • 360×360



LSU-secondary-eye-HE...
EPS • 360×360



LSU-secondary-eye-HE...
EPS • 360×360



LSU-secondary-eye-HE...
EPS • 360×360



LSU-secondary-eye-HE...
EPS • 360×360



LSU-secondary-eye-HE...
EPS • 360×360

State Icon

Vector EPS



LSU Louisiana Logo-01
EPS • 792x612



LSU Louisiana Logo-02
EPS • 792x612



LSU Louisiana Logo-03
EPS • 792x612



LSU Louisiana Logo-04
EPS • 792x612



LSU Louisiana Logo-05
EPS • 792x612



LSU Louisiana Logo-07
EPS • 792x612

Geaux Tigers

Vector EPS



geaux-tigers-01
EPS • 360×360



geaux-tigers-02
EPS • 360×360



geaux-tigers-03
EPS • 360×360



geaux-tigers-04
EPS • 360×360



geaux-tigers-05
EPS • 360×360



geaux-tigers-06
EPS • 360×360



geaux-tigers-07
EPS • 360×360



geaux-tigers-08
EPS • 360×360



geaux-tigers-09
EPS • 360×360

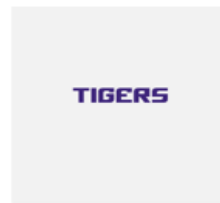

geaux-tigers-10
EPS • 360×360



geaux-tigers-11
EPS • 360×360



geaux-tigers-12
EPS • 360×360



geaux-tigers-13
EPS • 360×360



geaux-tigers-14
EPS • 360×360



geaux-tigers-15
EPS • 360×360

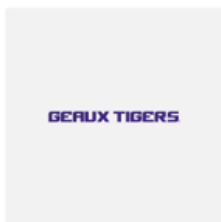

geaux-tigers-16
EPS • 360×360



geaux-tigers-17
EPS • 360×360



geaux-tigers-18
EPS • 360×360



geaux-tigers-19
EPS • 360×360



geaux-tigers-20
EPS • 360×360



Mike Mascot

Full Body with Purple Shirt Vector



LSU_TShirt_Mike_HEX_1...
EPS • 283×461



LSU_TShirt_Mike_HEX_1...
EPS • 283×461



LSU_TShirt_Mike_HEX_FC
EPS • 283×461

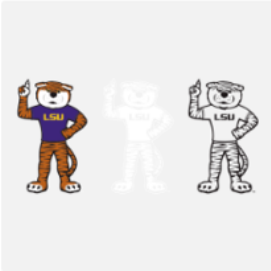

LSU_TShirt_Mike_HEX
EPS • 963×461

Exhibit E: LSU Athletics & TAF Outlined Annual Ticket Allotment

University shall make available to Playfly a mutually agreed upon number of season and single game tickets to University Athletic Events, including but not limited to football, men's and women's basketball games, gymnastics, baseball and season parking passes for Athletic Events played on campus in quantities and locations consistent with past practice. Additional season tickets requested by Playfly, and provided by Athletics Department, shall be provided at face value. LSU Athletics Representative and Playfly shall meet periodically to discuss proposed increases in the number of season tickets and season parking passes provided to Playfly. LSU Athletics Representative shall make available to Playfly tickets to Olympic sports and Special Events (e.g., concerts) under Athletics Department's control, as reasonably requested by Playfly. Playfly will have the same rights as all other premium seating ticket holders for any presales or access to Special Events. With the consent of the LSU Athletics Representative and the President & CEO of TAF, Playfly may be granted the right to certain premium areas and luxury suites in and around all Athletic Facilities to conduct corporate hospitality events prior to, during and after Athletic Events. All prices are subject to change on an annual basis.

- Athletics Department and TAF will continue to provide season tickets and season parking permits at no cost to Playfly for Football, Men's Basketball, Women's Basketball, Baseball, Softball, and Gymnastics. The quantities for each sport are consistent with the prior agreement and outlined in Section A of the Ticket Allocation chart.
- Athletics Department and TAF will continue to provide Playfly the opportunity to purchase Football season tickets in the Stadium Clubs. In addition, Playfly will have the opportunity to purchase single game tickets for Football and Men's Basketball. The quantities for each sport are outlined in Section B of the Ticket Allocation chart.
- Playfly will utilize the funds described in Section 4.8.2(i) to purchase the following annual inventory from the Athletics Department and/or TAF at face value, which includes ticket cost and LSU Tradition Fund or TAF premium seating contribution, and be subject to any and all contractual terms as dictated by TAF. The quantities for each inventory are included in Section C and Section D of the Ticket Allocation chart as well as below
 - 8 West Club season tickets for Football.
 - 10 South Club season tickets for Football.
 - 1 suite at two Football games, which will be mutually agreed upon.
 - 2 six seat tables in the Loge seating below the student section for each Football game.
 - 4 courtside seats for Men's Basketball.
 - 4 courtside seats for Women's Basketball.
 - AD Suite at Baseball for 8 games, which will be mutually agreed upon.

- TAF Suite at Baseball for 7 games, which will be mutually agreed upon.
 - 1 four seat table in the Loge seating for each Baseball game.
 - Men’s Basketball away trips - A minimum of five seats (four guests plus 1 PSP staff member) on four regular season away trips.
 - Football away trip – A minimum of five seats (four guests plus 1 PSP staff member) on two regular season away trips.
- Best efforts shall be made by TAF and Athletics Department to ensure that the locations of all premium seats remain consistent with premium seats currently being provided to Playfly. Any additional club seats or premium seats requested by Playfly and made available by Athletics Department or TAF, shall also be at face value and require payment of TAF Premium Seating Contributions s by Playfly.
 - With respect to single game tickets, single game parking passes, away game tickets, and post season tickets for all sports, Playfly shall be required to pay the face value of such tickets and any associated donations to Athletics Department or TAF.
 - Ticket Right Exception. With respect to tickets to be provided in any venue by either TAF or LSU, it is understood and agreed that in the event of a loss of available seating due to renovation, maintenance, reconfiguration of seating areas or other causes, the parties shall engage in good faith negotiations to provide Playfly with mutually agreeable substitute seating to the extent commercially reasonable under the circumstances.

Ticket Allocation

Section A: LSU Pays for the Ticket Cost; Donation is waived (old contract)								
Sport	Type	Location	Quantity	Ticket Cost	Ticket Total	Donation	Donation Total	Total
Football	Season	West Club - 204C	6	\$ 550	\$ 3,300	\$ 2,670	\$ 16,020	\$ 19,320
Football	Season	West Club - 206C	10	\$ 550	\$ 5,500	\$ 2,930	\$ 29,300	\$ 34,800
Football	Season	West Club - 310C	4	\$ 550	\$ 2,200	\$ 3,185	\$ 12,740	\$ 14,940
Football	Season	General Seating	92	\$ 400	\$ 36,800	\$ -	\$ -	\$ 36,800
Football	Season	General Seating	59	\$ 480	\$ 28,320	\$ -	\$ -	\$ 28,320
Football	Season	General Seating	301	\$ 490	\$ 147,490	\$ -	\$ -	\$ 147,490
Football	Season	General Seating	106	\$ 550	\$ 58,300	\$ -	\$ -	\$ 58,300
Football	Season	Parking	190	\$ 300	\$ 57,000	\$ -	\$ -	\$ 57,000
Football	Season	Parking	6	\$ 500	\$ 3,000	\$ -	\$ -	\$ 3,000
Men's Basketball	Season	General Seating	76	\$ 175	\$ 13,300	\$ -	\$ -	\$ 13,300
Men's Basketball	Season	General Seating	78	\$ 350	\$ 27,300	\$ -	\$ -	\$ 27,300
Men's Basketball	Season	General Seating	110	\$ 400	\$ 44,000	\$ -	\$ -	\$ 44,000
Men's Basketball	Season	Parking	75	\$ 200	\$ 15,000	\$ -	\$ -	\$ 15,000
Women's Basketball	Season	General Seating	120	\$ 200	\$ 24,000	\$ -	\$ -	\$ 24,000
Women's Basketball	Season	General Seating	36	\$ 175	\$ 6,300	\$ -	\$ -	\$ 6,300
Women's Basketball	Season	General Seating	12	\$ 150	\$ 1,800	\$ -	\$ -	\$ 1,800
Women's Basketball	Season	Parking	52	\$ 100	\$ 5,200	\$ -	\$ -	\$ 5,200
Baseball	Season	General Seating	150	\$ 250	\$ 37,500	\$ -	\$ -	\$ 37,500
Baseball	Season	General Seating	52	\$ 400	\$ 20,800	\$ -	\$ -	\$ 20,800
Baseball	Season	General Seating	36	\$ 450	\$ 16,200	\$ -	\$ -	\$ 16,200
Baseball	Season	Parking	36	\$ 300	\$ 10,800	\$ -	\$ -	\$ 10,800
Baseball	Season	Parking	31	\$ 300	\$ 9,300	\$ -	\$ -	\$ 9,300
Baseball	Season	Parking	2	\$ 400	\$ 800	\$ -	\$ -	\$ 800
Softball	Season	General Seating	8	\$ 75	\$ 600	\$ -	\$ -	\$ 600
Gymnastics	Season	General Seating	10	\$ 80	\$ 800	\$ -	\$ -	\$ 800
Gymnastics	Season	General Seating	30	\$ 65	\$ 1,950	\$ -	\$ -	\$ 1,950
Gymnastics	Season	General Seating	10	\$ 36	\$ 360	\$ -	\$ -	\$ 360
Total			1698		\$ 577,920		\$ 58,060	\$ 635,980

Section B: Playfly pays for Ticket and Donation Cost								
Sport	Type	Location	Quantity	Ticket Cost	Ticket Total	Donation	Donation Total	Total
Football	Season	West Club	10	\$ 550	\$ 5,500	\$ 2,360	\$ 23,600	\$ 29,100
Football	Season	South Club	8	\$ 550	\$ 4,400	\$ 2,300	\$ 18,400	\$ 22,800
Football	Single game	General Seating	1189		\$ -		\$ -	\$ -
Men's Basketball	Single game	General Seating	60					
Total			1267		\$ 9,900		\$ 42,000	\$ 51,900

Section C: Playfly pays for Ticket and Donation Cost via New Contract Marketing Fund								
Sport	Type	Location	Quantity	Ticket Cost	Ticket Total	Donation	Donation Total	Total
Football	Season	West Club - U-Suite	8	\$ 550	\$ 4,400	\$ 3,200	\$ 25,600	\$ 30,000
Football	Season	South Club	10	\$ 550	\$ 5,500	\$ 2,300	\$ 23,000	\$ 28,500
Football	Single game	Suite	1	\$ -	\$ -	\$ 15,000	\$ 15,000	\$ 15,000
Football	Single game	Suite	1	\$ -	\$ -	\$ 25,000	\$ 25,000	\$ 25,000
Football	Season	Loge	2		\$ 28,800	\$ -	\$ -	\$ 28,800
Men's Basketball	Season	Courtside	4	\$ 450	\$ 1,800	\$ 3,550	\$ 14,200	\$ 16,000
Women's Basketball	Season	Courtside	4	\$ 250	\$ 1,000	\$ 1,000	\$ 4,000	\$ 5,000
Baseball	Single game	Suite - AD	8					\$ -
Baseball	Single game	Suite - TAF	7	\$ 222	\$ 1,556	\$ 1,111	\$ 7,777	\$ 9,333
Baseball	Season	Loge	1		\$ 10,700			\$ 10,700
Total					\$ 53,756		\$ 114,577	\$ 168,333

Section D: Other Hospitality Items - No payment								
Sport	Type	# of trips	# of seats	Estimated Cost				Total
Men's Basketball	Away Trips	4	5	\$ 500				\$ 10,000
Football	Away Trips	2	5	\$ 700				\$ 7,000
Total								\$ 17,000



Board of Supervisors

RISK MANAGEMENT COMMITTEE

BOARD OF SUPERVISORS MEETING | APRIL 26, 2024



Office of Internal Audit

Louisiana State University

3810 West Lakeshore Drive • Suite 122 • Baton Rouge, LA 70808

Quarterly Audit Summary

Fiscal Year 2024, 3rd Quarter



Table of Contents

Multi-Campus	1
Affiliated Organizations.....	1
Public-Private Partnerships (P3)	1
Management Letter (Louisiana Legislative Auditor).....	3
Louisiana State University Agricultural (Ag) Center.....	4
Research Administration	4
Health Sciences Center New Orleans (HSCNO)	5
Management Letter (Louisiana Legislative Auditor).....	5
Health Sciences Center Shreveport (HSCS)	6
Management Letter (Louisiana Legislative Auditor).....	6

Multi-Campus

Affiliated Organizations

Audit Initiation:

This audit was included on the Board-approved audit plan.

Audit Scope and Objectives:

The objective of this engagement was to assess controls in place to monitor affiliate compliance with university policy and their respective Uniform Affiliation Agreement (UAA). The scope included all active LSU affiliated organizations as of March 2023.

Audit Finding and Recommendation:

A formal program was not in place to track affiliates and monitor compliance with key provisions of the UAA. LSU should develop controls to ensure all affiliates are officially recognized by the Board, execute an affiliation agreement, and provide the compliance certificates and agreed-upon procedures reports as required in the UAA.

Management's Response and Corrective Action Plan:

Management agreed with the recommendation and is in the process of implementing corrective action, which will be complete by June 30, 2024.

Public-Private Partnerships (P3)

Audit Initiation:

This audit was included on the Board-approved audit plan. Consulting firm Fort Hill Associates conducted this engagement.

Audit Scope and Objectives:

The audit reviewed key aspects of the P3 student housing project for Health Sciences Center New Orleans (HSCNO) and phase 3 of the Greenhouse District project on the LSU A&M campus. The primary objectives were to ensure compliance with the operational agreement, validate the market study's accuracy, assess the maintenance reserve fund, and evaluate the partners' financial capacity.

Audit Findings and Recommendations:

- Inconsistent approaches used to conduct market studies for LSU P3 projects due to an absence of standardization. LSU should establish market study criteria as well as develop a standardized template and methodology that is flexible to the needs of each project while maintaining consistency and transparency.
- Documentation could not be provided for maintenance schedules and key performance indicators. LSU should draft and furnish the required documentation for both projects. Additionally, LSU should consider implementing P3 contract compliance monitoring.
- Month-end reporting furnished by the partner on the HSCNO project was missing essential components and did not align with the format specified in the contract. HSCNO should ensure subsequent reports contain the expected information. Additionally, LSU may consider implementing a standard reporting format across all P3 projects to promote consistency and simplify monitoring.
- Several essential financial components outlined in the contract have not been realized related to the HSCNO project, particularly the establishment of the maintenance reserve fund and facilities accounts. There is ambiguity regarding the required accounts due to referencing incorrect fund names. LSU should consult with legal counsel to clarify the contractual requirements and update the provisions, as necessary.

Management's Response and Corrective Action Plan:

Management agreed with the recommendations and is in the process of implementing corrective action, which will be complete by the end of 2024.

Management Letter (Louisiana Legislative Auditor)

Audit Initiation:

This external audit was conducted by the Louisiana Legislative Auditor's Office (LLA).

Audit Scope and Objectives:

The LLA conducted procedures for the fiscal year ended June 30, 2023, at LSU A&M, the Agricultural Center, Pennington Biomedical Research Center, LSU Alexandria, LSU Eunice, and LSU Shreveport, collectively referred to as LSU and related campuses. The objective was to provide assurances on information significant to the system's financial statements; evaluate the effectiveness of internal controls over financial reporting and compliance; assess compliance with applicable laws and regulations; and determine whether management took actions to correct prior year findings.

Audit Findings and Recommendations:

- For the third consecutive year, LSU A&M did not have adequate controls in place to accurately maintain Perkins loan records in accordance with federal regulations. LSU A&M should store signed repayment schedules in a fireproof safe and retain documents for the period set forth by the US Department of Education.
- LSU A&M did not comply with federal equipment management regulations, specifically as it relates to identifying equipment as unlocated. LSU A&M should maintain adequate records and ensure equipment is properly safeguarded against loss.

Management's Response and Corrective Action Plan:

Management agreed with the recommendations and is in the process of implementing corrective action, which will be complete by June 30, 2024.

Louisiana State University Agricultural (Ag) Center

Research Administration

Audit Initiation:

This audit was included on the Board-approved audit plan.

Audit Scope and Objectives:

The primary objective was to assess the Ag Center's processes and controls related to conflicts of interest reporting, subrecipient monitoring, animal care protocols, and compliance with the state's Higher Education Foreign Security Act of 2022. The scope covered July 2021 through December 2023.

Audit Findings and Recommendations:

- Quarterly progress reports were not submitted by subrecipients as required in the standard subaward agreement. Ag Center should enhance oversight controls for subrecipient monitoring and ensure research personnel are aware of the reporting requirements.
- No evidence was provided to indicate the Ag Center reviewed the submitted nonimmigrant visa application, which is one component of the required screening for foreign nationals seeking employment with a post-secondary institution in a research or related position. Ag Center should maintain documentation demonstrating compliance with pre-hire screening required by the state.

Management's Response and Corrective Action Plan:

Management agreed with the recommendations and is in the process of implementing corrective action, which will be complete by July 1, 2024.

Health Sciences Center New Orleans (HSCNO)

Management Letter (Louisiana Legislative Auditor)

Audit Initiation:

This external audit was conducted by the Louisiana Legislative Auditor's Office (LLA).

Audit Scope and Objectives:

The LLA performed procedures for the fiscal year ended June 30, 2023, at HSCNO to provide assurances on information significant to the system's financial statements; evaluate the effectiveness of internal controls over financial reporting and compliance; assess compliance with applicable laws and regulations; and determine whether management took actions to correct prior year findings.

Audit Findings and Recommendations:

Management resolved the prior year finding related to weaknesses in controls over research and development project closeouts and accounting records. No additional findings were reported.

Health Sciences Center Shreveport (HSCS)

Management Letter (Louisiana Legislative Auditor)

Audit Initiation:

This external audit was conducted by the Louisiana Legislative Auditor’s Office (LLA).

Audit Scope and Objectives:

The LLA performed procedures for the fiscal year ended June 30, 2023, at HSCS to provide assurances on information significant to the system’s financial statements; evaluate the effectiveness of internal controls over financial reporting and compliance; assess compliance with applicable laws and regulations; and determine whether management took actions to correct prior year findings.

Audit Findings and Recommendations:

- For the fifth consecutive year, HSCS did not have effective controls over documentation of personnel services or compliance with federal guidance regarding cost transfers. HSCS should monitor, investigate, and obtain justification for untimely time and effort certifications or adjustments as well as those that lack supporting documentation.
- For the fifth consecutive year, HSCS did not have sufficient controls in place to ensure compliance with special tests and provisions requirements. HSCS should monitor changes in effort for key personnel and obtain written approval from the grantor for changes that exceed the thresholds set in federal regulations.
- For the fourth consecutive year, HSCS did not adequately monitor the billing and collection services performed by third-party servicers. HSCS should ensure physician services are properly billed and collected then reviewed on a timely basis for accuracy.
- For the fourth consecutive year, HSCS did not maintain adequate controls over payroll processing of supplemental compensation. HSCS should require support and approvals for supplemental pay including the reason and corresponding rate.

Management’s Response and Corrective Action Plan:

Management agreed with the recommendations and is in the process of implementing corrective action, which will be complete by June 30, 2024.



Board of Supervisors

MEETING MINUTES

BOARD OF SUPERVISORS MEETING | APRIL 26, 2024

MINUTES
LSU BOARD OF SUPERVISORS PROFESSIONAL DEVELOPMENT MEETING
Lawton Room, Tiger Stadium
Baton Rouge, LA 70808
Thursday, February 22, 2024 | 1:30 p.m. CT

I. Call to Order and Roll Call

Present for Board Professional Development were Mr. Woods, Mr. Morrow, Ms. Jones, Ms. Aronson, Mr. Brown, Mr. Morris, Mr. Starns, Mr. Temple, Ms. Werner, Mr. Williams, and Mr. Zuschlag.

II. Public Comment

There were not any individuals registered for Public Comment.

III. Campus Update Presentation by LSU Eunice

Dr. Nancee Sorenson, Chancellor of LSU Eunice, provided an informative campus update on LSU Eunice.

No action needed on these items.

IV. Campus Update Presentation by LSU Health Sciences Center Shreveport

Dr. David Guzick, Chancellor of LSU Health Sciences Center Shreveport, provided an informative campus update on LSU Health Sciences Center Shreveport.

No action needed on these items.

V. Scholarship First Strategic Framework Presentation

Dr. Jason Drodody, Vice President of Strategy and Public Affairs, presented on the Scholarship First Strategic Framework.

No action needed on this item.

VI. Adjournment

With no further business before the Board, the meeting was adjourned.

MINUTES
LSU BOARD OF SUPERVISORS MEETING
*Board Room, University Administration Building
3810 West Lakeshore Drive, Baton Rouge, LA 70808
Friday, February 23, 2024 | 9:00 a.m. CT*

I. Call to Order and Roll Call

Mr. Jimmie Woods, Chair, called to order the Regular Meeting of the Board of Supervisors of Louisiana State University and Agricultural and Mechanical College on February 23, 2024.

Present

Mr. Jimmie Woods, Chair
Mr. Patrick Morrow, Chair-elect
Ms. Valencia Sarpy Jones, Past-Chair
Mr. Glenn Armentor
Ms. Laurie Lipsey Aronson
Mr. Jay Blossman
Mr. Wayne Brown
Mr. Robert Dampf
Mr. Lee Mallett
Mr. Randy Morris
Mr. Rémy Starns
Mr. Collis Temple Jr.
Ms. Mary Leach Werner
Mr. James Williams
Mr. Richard Zuschlag

Absent

Mr. Thomas Luke

Also participating in the meeting were the following: Mr. Winston DeCuir, General Counsel for LSU; University officer and administrators of the campuses; faculty and staff representatives; interested citizens and representatives of the news media. Dr. William Tate, President of LSU, was not present.

II. Invocation and Pledge of Allegiance

The LSU Chapter of the Pershing Rifles presented the Colors.

The invocation was offered by Ms. Maci Duplessis, a senior majoring in Mass Communications with a minor in Political Science from New Orleans, Louisiana, and the pledge given by Jacob Rachell, a sophomore majoring in Mechanical Engineering from Decatur, Georgia.

III. Public Comment

There were not any individuals registered for public comment.

IV. Committee Meetings

Mr. Woods adjourned the regular meeting to convene the committee meetings.

4.A. Research & Agricultural Extension Committee

Present for the Research and Agricultural Extension Committee were Ms. Werner, Mr. Blossman, Mr. Armentor, Mr. Brown, Mr. Morris, Mr. Starns, and Mr. Temple.

4.A.1 Research and Future Use of Energy in Louisiana (FUEL) Presentation

Dr. Robert Twiley, Vice President of the Office of Research & Economic Development, and Andrew Maas, Associate Vice President, gave their presentation on Research and Future Use of Energy in Louisiana.

No action needed on this item.

4.B. Academic Committee

Present for the Academic Committee were Mr. Brown, Mr. Armentor, Mr. Blossman, Mr. Mallett, Mr. Morrow, Mr. Starns, Mr. Temple, and Mr. Williams.

4.B.1 Request from LSU A&M to Award an Honorary Doctor of Science to Ed Picou

Upon motion by Mr. Armentor, seconded by Mr. Morrow, the item was unanimously approved.

NOW, THEREFORE, BE IT RESOLVED that the Board of Supervisors of Louisiana State University and Agricultural & Mechanical College does hereby approve the request from LSU A&M to Award an Honorary Doctor of Science to Ed Picou

4.B.2 Consent Agenda

There were six items on the consent agenda.

Upon motion by Mr. Morrow, seconded by Mr. Blossman, the following items were unanimously approved.

Request from LSU A&M for the Continued Authorization of the Center for Analytics & Research in Transportation Safety.

NOW, THEREFORE, BE IT RESOLVED that the Board of Supervisors of Louisiana State University and Agricultural & Mechanical College does hereby approve the request from LSU A&M for the continued authorization of the Center for Analytics & Research in Transportation Safety (CARTS).

Request from LSU A&M to Establish Four Endowed Professorships

NOW, THEREFORE, BE IT RESOLVED that the Board of Supervisors of Louisiana State University and Agricultural and Mechanical College does hereby approve the request from LSU A&M to establish the following Endowed Professorships:

- a) Scott and Ruth Bergeron Professorship in Biological Engineering #2
- b) Callais and Woods College of the Coast and Environment Dean's Professorship
- c) Dr. Bobby and Lori Kent Savoie Professorship in Mechanical and Industrial Engineering
- d) Robey H. Clark Distinguished Professorship #4

BE IT FURTHER RESOLVED that the Chairman of the Board of Supervisors and/or the President, as may be appropriate, are hereby authorized and directed to execute any documents required to obtain the matching gift and otherwise complete the establishment of the following Endowed Professorships at LSU A&M:

- a) Scott and Ruth Bergeron Professorship in Biological Engineering #2
- b) Callais and Woods College of the Coast and Environment Dean's Professorship
- c) Dr. Bobby and Lori Kent Savoie Professorship in Mechanical and Industrial Engineering
- d) Robey H. Clark Distinguished Professorship #4

Request from LSU A&M to Establish Two and Augment Two Endowed Superior Graduate Student Scholarships.

NOW, THEREFORE, BE IT RESOLVED that the Board of Supervisors of Louisiana State University and Agricultural and Mechanical College does hereby approve the request to establish the following two and augment the following two endowed superior graduate student scholarship at LSU:

- a) Thomas and Susan Shirley Superior Graduate Scholarship
- b) Jill and Roger Jenkins Scholarships for Mike the Tiger's Caregivers
- c) Adah Proctor Sturgis Graduate Scholarship in Chemistry and Biochemistry (augmented)
- d) A. B. Freeman Scholarship (augmented); and

BE IT FURTHER RESOLVED that the President, as may be appropriate, is hereby authorized and directed to execute any documents required to obtain the matching gift and otherwise complete the establishment and augmentation the following endowed superior graduate student scholarships at LSU:

- a) Thomas and Susan Shirley Superior Graduate Scholarship
- b) Jill and Roger Jenkins Scholarships for Mike the Tiger's Caregivers
- c) Adah Proctor Sturgis Graduate Scholarship in Chemistry and Biochemistry (augmented)
- d) A. B. Freeman Scholarship (augmented)

Request from LSU Health Sciences Center - Shreveport to Establish the Broadwell Endowed Superior Graduate Student Scholarship for Physician Assistant Students

NOW, THEREFORE, BE IT RESOLVED that the Board of Supervisors of Louisiana State University and Agricultural & Mechanical College does hereby approve the request from LSU Health Sciences Center--Shreveport to Establish the Broadwell Endowed Superior Graduate Student Scholarship for Physician Assistant Students.

Request from LSU Health Sciences Center - Shreveport to Establish the Sandra and Jerry Martin Endowed Superior Graduate Scholarship for Medical Students - 4

NOW, THEREFORE, BE IT RESOLVED that the Board of Supervisors of Louisiana State University and Agricultural & Mechanical College does hereby approve the request from LSU Health Sciences Center--Shreveport to Establish the Sandra and Jerry Martin Endowed Scholarship for Medical Students - 4.

Request from LSU - Shreveport to Establish the Sidney and Hollisann Kent Endowed Professorship in Business

NOW, THEREFORE, BE IT RESOLVED that the Board of Supervisors of Louisiana State University and Agricultural & Mechanical College does hereby approve the request from Louisiana State University in Shreveport (LSUS) is recommended to approve the establishment of the Sidney and Hollisann Kent Endowed Professorship in Business.

4.C. Finance Committee

Present for the Finance Committee were Mr. Zuschlag, Ms. Werner, Ms. Aronson, Mr. Morris, Mr. Morrow, Mr. Temple, and Mr. Williams.

- 4.C.1 Request from LSUHSC-NO to acknowledge and authorize the Uniform Affiliation Agreement, along with the First Amendment to the Uniform Affiliation Agreement with the Louisiana State University School of Medicine in New Orleans Faculty Group Practice

Upon motion by Ms. Aronson, seconded by Ms. Werner, the item was unanimously approved.

NOW, THEREFORE, BE IT RESOLVED that the Board of Supervisors of Louisiana State University and Agricultural and Mechanical College hereby authorizes the President of LSU or designee to execute the Uniform Affiliation Agreement and the First Amendment to the Uniform Affiliation Agreement with the Louisiana State University School of Medicine in New Orleans Faculty Practice Group, doing business as the LSU Healthcare Network, with such agreement to contain such terms and conditions as the President, in consultation with the General Counsel, deems to be in the best interests of LSU.

4.D. Property & Facilities Committee

Present for the Property & Facilities Committee were Ms. Aronson, Mr. Brown, Mr. Dampf, Mr. Temple, Ms. Werner, Mr. Williams, and Mr. Zuschlag.

- 4.D.1 Request from LSUHSC-NO for Act 959 Project for an Exterior Stair Connector, Seton and CALS Walkways.

Upon motion by Mr. Williams, seconded by Mr. Temple, the item was unanimously approved.

NOW, THEREFORE, BE IT RESOLVED that the Board of Supervisors of Louisiana State University and Agricultural and Mechanical College hereby authorizes the President of LSU or his designee to approve the following project and process the project through the appropriate administrative channels of review and approval, namely, the Board of Regents, the Division of the Administration, Office of Facility Planning and Control, and the Joint Legislative Committee on the Budget, pursuant to Act 959 of the 2003 Regular Legislative Session enacting R.S. 39:128(B)(4) as amended pursuant to Act No. 78 of the 2006 Regular Legislative Session:

Exterior Stair Connector, Seton and CALS Walkways Estimated total project cost is \$1,425,000.

BE IT FURTHER RESOLVED, that the President of LSU, or his designee, is duly authorized by and empowered for and on behalf of and in the name of the Board of Supervisors of Louisiana State University and Agricultural and Mechanical College to approve the plans and specifications for the proposed improvements and to approve cost increases up to 20% of the amount approved to accommodate unforeseen conditions.

BE IT FURTHER RESOLVED, that the LSU President, or his designee, is duly authorized by and empowered for and on behalf of and in the name of the Board of Supervisors of Louisiana State University and Agricultural and Mechanical College to take such action he may deem in the best interest of the Board of Supervisors to process and obtain administrative approvals for this project.

4.D.2 Request from LSU A&M to Approve Renovations to Phi Mu Sorority House

Upon motion by Ms. Werner, seconded by Mr. Temple, the item was unanimously approved.

NOW, THEREFORE, BE IT RESOLVED that the Board of Supervisors of Louisiana State University and Agricultural and Mechanical College hereby authorizes the President of LSU or designee to execute: (1) an Agreement, Consent to Mortgage, and Estoppel Certificate with Regions Bank or such other financial entity designated by Phi Mu or its related corporation, Alpha Eta House Corporation, (2) an Amended and Restated Lease Agreement with Alpha Eta House Corporation or such other related entity designed by Phi Mu, and (3) any other agreements, consents, approvals, or other documents needed to effectuate this transaction, with all leases, agreements, consents, approvals, and other documents to contain such terms and conditions as the President, in consultation with the General Counsel, deems to be in the best interests of LSU.

4.D.3 Request from LSU A&M to Approve Renovations to Delta Gamma Sorority House

Upon motion by Mr. Dampf, seconded by Ms. Werner, the item was unanimously approved.

NOW, THEREFORE, BE IT RESOLVED that the Board of Supervisors of Louisiana State University and Agricultural and Mechanical College hereby authorizes the President of LSU or designee to execute: (1) an Amended and Restated Lease Agreement with Gamma Zeta House Corporation or such other related entity designed by Delta Gamma, and (2) any other agreements, consents, approvals, or other documents needed to effectuate this transaction, including, but not limited to, consent to a sublease between Delta Kappa Epsilon or its housing corporation and Gamma Zeta House Corporation or Delta Gamma, with all leases, agreements, consents, approvals, and other documents to contain such terms and conditions as the President, in consultation with the General Counsel, deems to be in the best interests of LSU; and

BE IT FURTHER RESOLVED that the Board of Supervisors of Louisiana State University and Agricultural and Mechanical College approves the construction of capital improvements in an amount exceeding \$1 million at the Delta Gamma House, subject to final reviews, approvals, and authorizations to proceed issued by the appropriate LSU officials in accordance with law, policy, and established practices; and

BE IT FURTHER RESOLVED that the Board of Supervisors of Louisiana State University and Agricultural and Mechanical College does hereby acknowledge that the schematic designs for the Delta Gamma renovations are in general compliance with the Campus Design Guidelines and 3 hereby delegates the approval of the detailed plans and specifications to the appropriate and customary LSU Office responsible for reviewing and approving such plans and specifications.

4.D.4 Request from LSU A&M to Approve Consent to Sublease of Theta Xi House by Delta Tau Delta Fraternity

Upon motion by Mr. Temple, seconded by Mr. Dampf, the item was unanimously approved.

NOW, THEREFORE, BE IT RESOLVED that the Board of Supervisors of Louisiana State University and Agricultural and Mechanical College hereby authorizes the President of LSU or designee to consent to the sublease of the Theta Xi house to Delta Tau Delta and to execute any agreements, consents, approvals, or other documents needed to effectuate this consent, with all agreements, consents, approvals, and other documents to contain such terms and conditions as the President, in consultation with the General Counsel, deems to be in the best interests of LSU.

4.D.5 Request from LSU A&M to Authorize the President to Execute a Lease with Tiger Athletic Foundation for Relocation of Bullpen and Construction of New Field Level Seating at Alex Box Stadium

Upon motion by Mr. Brown, seconded by Ms. Werner, the item was unanimously approved.

“NOW, THEREFORE, BE IT RESOLVED that the Board authorizes William F. Tate IV, in his capacity as President of LSU, to execute a lease to Tiger Athletic Foundation in order to facilitate improvements to Alex Box Stadium, including relocation of the home team bullpen and construction of new field level seating areas and to execute related agreements as may be reasonably necessary to facilitate the project;

“BE IT FURTHER RESOLVED that the Board, pursuant to the Uniform Affiliation Agreement between it and the Tiger Athletic Foundation, finds an acceptable University purpose for Tiger Athletic Foundation to enter into the proposed lease, and any related or ancillary contracts and agreements reasonably necessary for the project; and,

“BE IT FURTHER RESOLVED that William F. Tate IV, in his capacity as President of LSU, or his designee, is hereby authorized by and empowered for and on behalf of and in the name of the Board of Supervisors, to include in the lease any and all provisions and stipulations that he deems in the best interest of the Board of Supervisors.”

4.E. Athletics Committee

Present for the Athletics Committee were Mr. Williams, Ms. Aronson, Mr. Armentor, Mr. Blossman, Mr. Dampf, Ms. Jones, Mr. Morris, Mr. Temple, Ms. Werner, and Mr. Zuschlag.

4.E.1 Request from LSU Athletics to Approve New Employment Agreements for Eight Assistant Football Coaches

Upon motion by Mr. Zuschlag, seconded by Mr. Armentor, the item was unanimously approved.

NOW, THEREFORE, BE IT RESOLVED the Board of Supervisors of Louisiana State University and Agricultural & Mechanical College approves the employment agreements described in this item, and authorizes President William F. Tate IV to execute the agreement in consultation with the Office of General Counsel.

4.E.2 Request from LSU Athletics to Approve Employment Agreement for Director of Athletic Development

Upon motion by Ms. Jones, seconded by Mr. Dampf, the item was unanimously approved.

NOW, THEREFORE, BE IT RESOLVED the Board of Supervisors of Louisiana State University and Agricultural & Mechanical College approves the Employment Agreement for Jacob Flint as

described in this item, and authorizes President William F. Tate IV to execute the agreement in consultation with the Office of General Counsel.

4.E.3 Request from LSU Athletics to Approve Term Sheet for Senior Associate Athletics Director for Football Administration

Upon motion by Ms. Jones, seconded by Ms. Werner, the item was unanimously approved.

NOW, THEREFORE, BE IT RESOLVED the Board of Supervisors of Louisiana State University and Agricultural & Mechanical College approves the Term Sheet for Austin Thomas as described in this item, and authorizes President William F. Tate IV to execute the agreement in consultation with the Office of General Counsel.

4.E.4 Request from LSU Athletics to Approve New Employment Agreement for Assistant Baseball Coach

Upon motion by Ms. Werner, seconded by Ms. Jones, the item was unanimously approved.

NOW, THEREFORE, BE IT RESOLVED the Board of Supervisors of Louisiana State University and Agricultural & Mechanical College approves the Employment Agreement for Nathan Yeskie as described in this item, and authorizes President William F. Tate IV to execute the agreement in consultation with the Office of General Counsel.

4.F. Risk Management Committee

Present for the Risk Management Committee were Mr. Starns, Mr. Williams, Ms. Aronson, Mr. Armentor, Mr. Dampf, Ms. Jones, Mr. Mallett, Mr. Morris, Mr. Morrow, Mr. Temple, Ms. Werner, and Mr. Zuschlag.

4.F.1 Request to Approve Amendment to Internal Audit Charter

Upon motion by Ms. Aronson, seconded by Mr. Dampf, the item was unanimously approved.

4.F.2 Information Technology Risk Mitigation Presentation

No action needed on this item.

4.F.3 Fiscal Year 2024 2nd Quarter Audit Summary

Upon motion by Mr. Morrow, seconded by Mr. Zuschlag, the item was unanimously approved.

V. Reconvene Board Meeting

The regular meeting was called back to order and roll call conducted.

Present

Mr. Jimmie Woods, Chair
Mr. Patrick Morrow, Chair-elect
Ms. Valencia Sarpy Jones, Past-Chair
Mr. Glenn Armentor
Ms. Laurie Lipsey Aronson
Mr. Jay Blossman

Mr. Wayne Brown
Mr. Robert Dampf
Mr. Lee Mallett
Mr. Randy Morris
Mr. Rémy Starns
Mr. Collis Temple Jr.
Ms. Mary Werner
Mr. James Williams
Mr. Richard Zuschlag

Absent

Mr. Thomas Luke

VI. Approval of Meeting Minutes from the December 8, 2023 Board Meeting

Upon motion by Ms. Jones, seconded by Mr. Blossman, the minutes were unanimously approved.

VII. Personnel Actions Requiring Board Approval

Upon motion by Mr. Morrow, seconded by Ms. Werner, the personnel actions were unanimously approved.

VIII. Reports to the Board

Upon motion by Mr. Dampf, seconded by Mr. Starns, the Reports to the Board were unanimously received.

IX. Reports from Faculty and Staff Advisors

Dr. Kamboj and Dr. Tirone provided an informative report on behalf of the Faculty Advisors.

Mr. Duplechain, LSU A&M Staff Senate President, provided an informative report on behalf of the Staff Advisors.

X. Approval of Committee Recommendations

Upon motion by Mr. Starns, seconded by Mr. Armentor, the recommendations were unanimously approved.

XI. Scholarship First Strategic Framework Presentation

Dr. Jason Droddy, Vice President of Strategy and Public Policy, presented on the Scholarship First Strategic Framework.

Request to Approve the Scholarship First Strategic Framework

Upon motion by Mr. Dampf, seconded Armentor, the item was approved. Mr. Blossman registered an objection to the motion to approve the item.

NOW, THEREFORE, BE IT RESOLVED the Board of Supervisors of Louisiana State University and Agricultural & Mechanical College approves the preliminary draft of the Scholarship First Strategic Framework as presented on February 23, 2024; and

BE IT FURTHER RESOLVED the President is authorized to make minor amendments to preliminary draft, publish a final document, and communicate the framework within 60 days of the adoption of this resolution.

XII. Chairman's Report

Mr. Woods provided an informational report.

XIII. Adjournment

Upon motion by Mr. Morris, seconded by Mr. Armentor, the meeting was adjourned.



Board of Supervisors

PERSONNEL ACTIONS REQUIRING BOARD APPROVAL

Personnel Actions Requiring Board Approval
per PM-69

April 26th, 2024

Personnel Actions Requiring Board Approval per PM-69
April 26th, 2024

LSU A&M
New Appointments

<u>Name</u>	<u>Title</u>	<u>Effective Date</u>	<u>Compensation</u>		<u>%Change</u>
			<u>Current</u>	<u>Proposed</u>	
Courtney Phillips	Vice President of Health Affairs and Chief Health Officer	4/8/2024		\$475,000	

LSU HSC – New Orleans
New Appointments

<u>Name</u>	<u>Title</u>	<u>Effective Date</u>	<u>Compensation</u>		<u>%Change</u>
			<u>Current</u>	<u>Proposed</u>	
Steve Nelson	Chancellor	2/8/2024		\$887,500 ¹	

1. The proposed salary of \$887,500 is comprised of a base salary of \$397,620 and a faculty supplement of \$489,880.



February 8, 2024

Steve Nelson
Interim Chancellor
LSU Health Sciences Center New Orleans

RE: Appointment as Chancellor

Dear Dr. Nelson:

I am pleased to offer you the position of Chancellor of LSU Health Sciences Center New Orleans for a fixed term from February 8, 2024 through June 30, 2025, pending approval by the LSU Board of Supervisors. This position reports to and serves at the pleasure of the LSU President.

The salary for your position as Chancellor will be set at \$887,500, comprised of a base salary of \$397,620 and a faculty supplement of 489,879. In addition to your salary, LSU will provide an annual housing allowance of \$30,000 and an annual vehicle allowance of \$15,000. Your \$10,000 professorship will also continue. Additionally, you will be eligible for any COLA or Merit increases consistent with other faculty and may participate in the fringe benefit programs available to all unclassified professional LSU employees, with contributions and benefit amounts as defined by law.

While serving as Chancellor, you will maintain your tenured faculty appointment as Professor of Medicine in the School of Medicine, but you will not be expected to teach or maintain a clinical practice.

Your salary as Chancellor will be guaranteed for the term unless you are removed from the administrative role for cause. Upon expiration of the term or removal as Chancellor (unless removed for cause), you will return to your prior role as Dean of the School of Medicine. You will serve as Dean of the School of Medicine at the pleasure of the Chancellor, and may be removed without cause, but your salary will be guaranteed at the full salary (base, supplement, professorship, and auto allowance) paid as Dean of the School of Medicine for a period of two years (unless removed for cause) while you remain employed by LSUHSC-NO. If removed or no longer serving as Dean of the School of Medicine but remaining an employee of LSUHSC-NO, you will return to your tenured faculty position. After the two-year guarantee, your compensation will be commensurate with your professorial rank and tenure.

You may be removed from your role as Chancellor for cause, but only after you are provided notice and an opportunity for a hearing before the President or the President's designee. As a

Steve Nelson
February 8, 2024
Page 2 of 2

faculty member, your employment will be governed by the campus policies applicable to tenured faculty, including the Faculty Handbook.

If this offer is acceptable to you, please respond by signing and dating below and returning the letter within five days of receipt of this letter.

Sincerely,

William F. Tate IV
LSU President

Steve Nelson

Date



Board of Supervisors

REPORTS TO THE BOARD

BOARD OF SUPERVISORS MEETING | APRIL 26, 2024

**Louisiana State University
Metric Data**



April 26, 2024

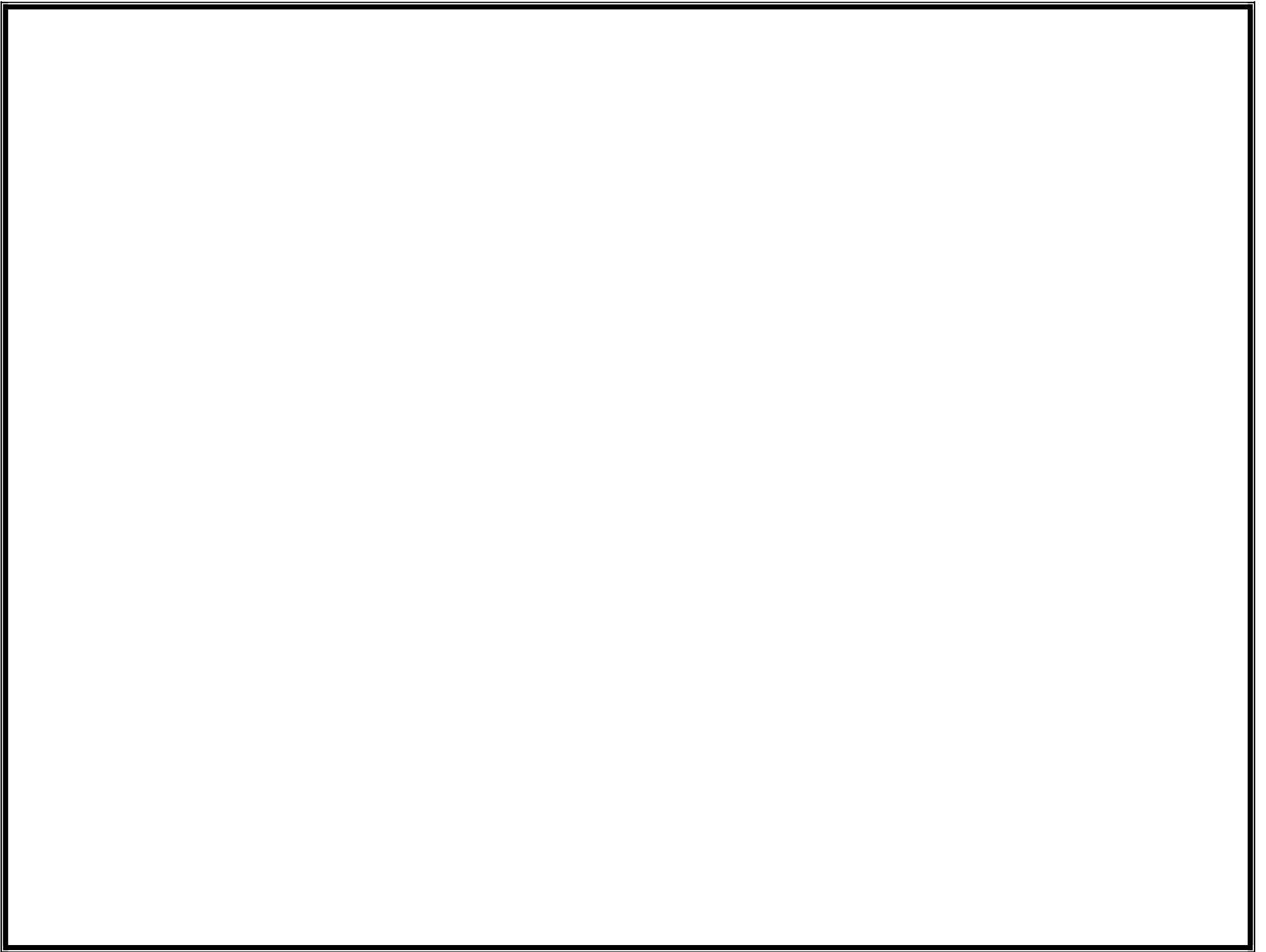
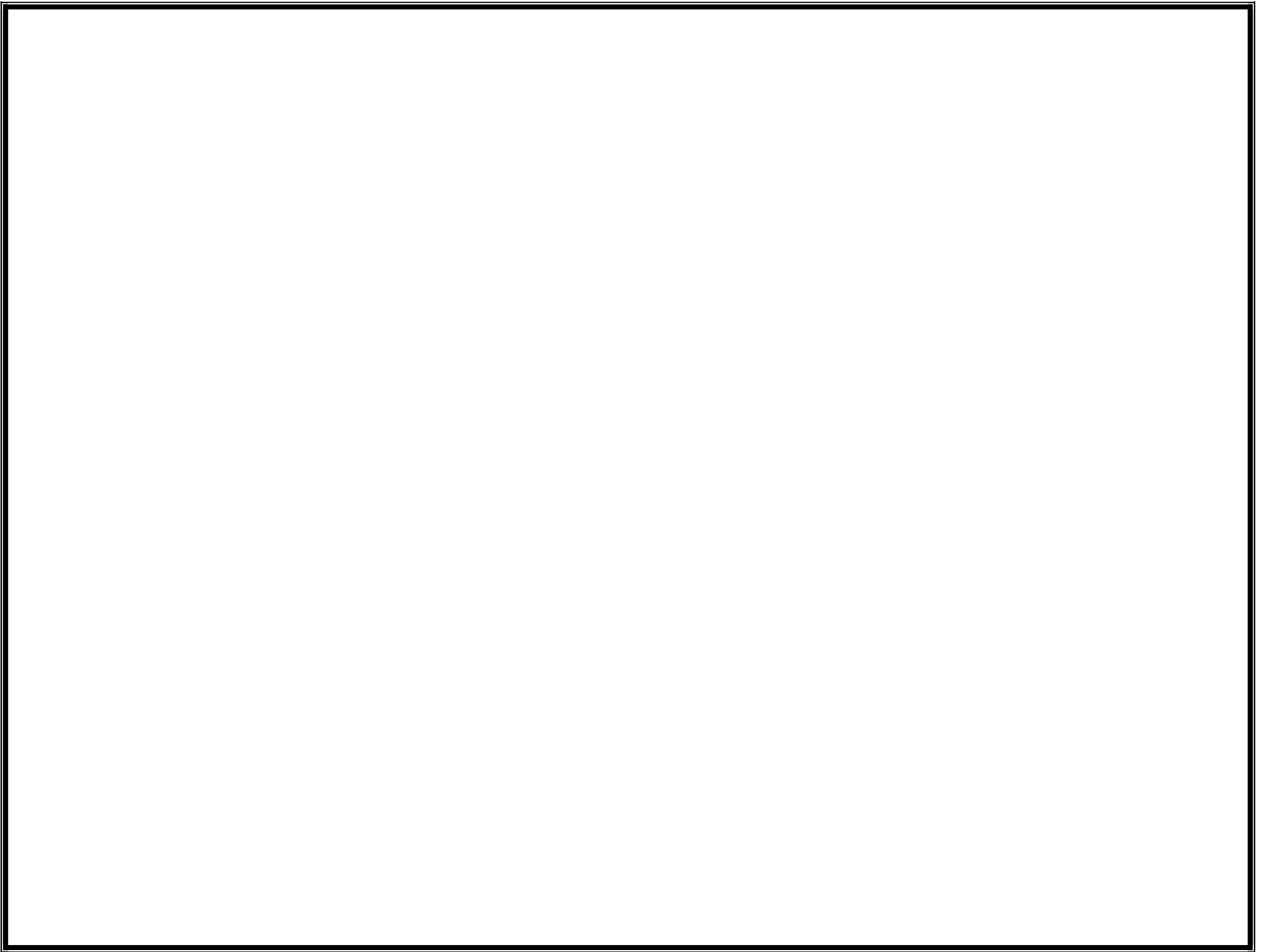

Table of contents

	Page
LSU Performance Metrics Executive Summary	1
Louisiana State University and A&M	3
Louisiana State University Agricultural Center	26
Louisiana State University Alexandria	35
Louisiana State University Eunice	54
Louisiana State University Shreveport	70
Health Sciences Center New Orleans	93
Health Sciences Center Shreveport	123
Pennington Biomedical Research Center	152



LSU Performance Metrics Executive Summary

The LSU performance indicators are designed to provide campus leadership and the Board of Supervisors with a mechanism for evaluating annual institutional performance. This document includes a summary of the LSU campuses performance metrics data. The metrics data provided allow institutions to discuss descriptive metrics and performance measures within the context of each campus' mission.

In complex university systems, the distinct and quite different institutions do not measure their performance against each other but against the larger marketplaces where they compete. Two elements are critical for the effectiveness of performance measurement. First is the constant tracking of improvement from year to year. Second is the periodic benchmarking of campus performance against appropriate national counterparts. Data provided in this document speak primarily to the first element of annual improvement. Subsequent work by the campuses in identifying appropriate measures of performance against national counterparts provide a context for the second, national benchmarking element, of effective performance measurement.

The utility of these data points for evaluating institutional performance varies by campus and mission. Below is a general outline of metrics data captured in this document. Please note that for example, in some institutions, enrollment growth is critical to survival; for others, enrollment is stable and other indicators will be more important. Other institutions may pay particular attention to undergraduate education, others to research or technology transfer. Consequently, although this data describe the scale of operations, their utility as metrics for performance improvement measurement varies.

Below is a general outline of metrics data captured in this document. These metrics represent a start to what is expected to become a significant analysis and measuring tool for the Louisiana State University and its institutions.

General Metrics Description

- Metric I: Degrees and Credentials (*Including distribution by race, ethnicity, and other characteristics*)
- Metric II: Enrollment data (*Including distribution by race, ethnicity, and other characteristics such as full and part time*)
- Metric III: Retention, Graduation, Licensure, and Pass Rate (*Standardized State and National Exams*)
- Metric IV: Research Expenditures
- Metric V: Technology Transfer
- Metric VI: Revenue Sources (*Tuition and Fees, Other Revenue Resources*)
- Metric VII: Teaching and Research Productivity
- Metric VII: Hospital Statistics (HSCs only)
- Benchmark: Campus Specific Benchmark Metrics

Blank Page

**Louisiana State University and A&M
Metric Data**



April 26, 2024

Louisiana State University and A&M College

Executive Summary

Louisiana State University and A&M College, the state's Flagship University, is ranked as a top-tier university – very high research activity (Carnegie Classification) and is one of a few select universities designated as a land-, sea- and space-grant institution. LSU is known for its outstanding undergraduate and graduate academic programs, state-of-the-art-research, internationally acclaimed faculty, and national award-winning student-support programs. The campus is cohesively focused on pursuing and supporting the goals outlined in the President's Scholarship First Agenda. Through its educational, research, and service activities, LSU serves as the state's leading institution in the creation and dissemination of new knowledge and technologies, impacting workforce and economic development throughout the state, region, nation and world.

2023

The total number of degrees awarded was 7,437, the second highest number in LSU history. (Metric I)

The total number for degree-seeking undergraduates increased by 5.3%, and the total numbers of undergraduate and graduate students increased by 5.2% and 7.3% respectively. (Metric II)

The total number of students enrolled in STEM fields increased by 3.2% to 10,843. (Metric II)

The six-year baccalaureate graduation rate for the 2017 cohort is 67.4%, the highest rate in LSU history. (Metric III)

The Industrial Engineering program had a 100% passing rate for the third year in a row on its National Council of Examiners for Engineering Survey (NCEES) Fundamentals of Engineering (FEE). (Metric III)

The total gross revenue from first-time-full-time freshmen increased by 5.1%. (Metric VI)

Enrollment in Fall Semester Lecture and Seminar courses increased by 3.2% (Metric VII)

LSU and A&M VISION and MISSION:

Vision: As Louisiana's flagship university, LSU will deploy the knowledge generated through the work of our faculty, staff, and students to build a more healthy, prosperous, and secure future for the state.

Mission: Designated as a Land, Sea, and Space Grant institution, LSU secures, elevates, and advances Louisiana and the world through the generation, preservation, dissemination, and application of knowledge and cultivation of the arts and develops students who are prepared, confident, and inspired to achieve lifelong success.

(Vision and Mission Statements approved by Board of Supervisors February 2023)

Louisiana State University and A&M

Metrics at a Glance

2022-2023

Legend:

Statistic	
High	X Y
Low	Z %

Current
% Change from Previous Period

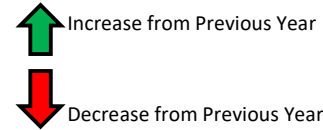

Metric I Degrees Awarded	Metric II Enrollment	Metric III Student Success	Metric IV Research Expenditures	Metric V Technology Transfer	Metric VI Revenues	Metric VII Instruction Productivity
Bachelors	14th Day Enrollment for First Time Degree Seeking Freshmen	Average ACT Score	Engineering Total (in thousands)	Invention Disclosures	Market Value of Endowments	Enrollment in Fall Semester Lecture and Seminar Courses
5,097 4,839	7,521 7,521	26.5 26.5	58,731 58,731	76 54	696,077,402 664,196,633	140,683 140,683
4,675 ↓ -2.2%	5,812 ↑ 1.6%	25.4 ↑ 3.9%	33,824 ↑ 18.8%	31 ↑ 31.7%	500,664,717 ↑ 6.3%	117,980 ↑ 3.2%
Masters	Degree Seeking Continuing Undergraduates	First to Second Year Retention	Physical Sciences Total (in thousands)	Licenses\Options Executed	Total Gross Revenue From First-Time-Full-Time Freshmen	Tenure/tenure track (T/TT) FTE faculty assigned to classes
1,821 1,626	20,358 20,358	85.8% 84.0%	36,946 36,946	21 4	109,166,647 109,166,647	922 870
1,181 ↓ -10.7%	16,547 ↑ 6.7%	82.8% ↑ 0.6%	22,366 ↑ 20.8%	2 ↓ -77.8%	59,249,531 ↑ 5.1%	870 ↓ -2.7%
Doctoral	Total Undergraduate Headcount as of 14th Class Day	Second to Third Year Retention	Environmental Sciences Total (in thousands)	New Patents Filed - Total	Net Revenue From First-Time-Full-Time Freshmen	Non tenure/tenure track FTE faculty assigned to classes
347 299	32,666 32,666	75.5% 74.5%	41,171 41,171	58 50	72,304,166 72,304,166	549 549
292 ↓ -6.9%	25,363 ↑ 5.2%	72.4% ↑ 2.9%	28,763 ↑ 23.1%	12 ↓ -13.8%	44,898,733 ↑ 4.4%	426 ↑ 8.3%
Professional (Law)	Total Graduate Headcount as of 14th Class Day	Six Year Graduation Rate	Life Sciences Total (in thousands)	Active License Agreements	State Appropriation per FTE	Total sch's taught per T/TT FTE faculty
#REF! #REF!	6,753 6,753	67.4% 67.4%	51,524 51,524	89 70	4,031 3,505	203 203
#REF! #REF!	5,624 ↑ 7.3%	65.3% ↑ 1.5%	34,212 ↑ 10.0%	25 ↓ -20.5%	3,505 ↓ -2.3%	177 ↑ 1.5%
Grand Total Number of Degrees Awarded	Total number of students enrolled who received TOPS	LA Community College Transfer Student Second Year Retention	Social Sciences Total (in thousands)	Licenses Generating Income	Net Revenue generated from auxiliary enterprises	Total sch's taught per non T/TT FTE faculty
7,741 7,437	15,169 14,583	86.6% 75.8%	4,296 3,249	22 15	7,584,025 4,710,658	456 456
6,766 ↓ -3.9%	13,464 ↓ -3.9%	75.8% ↓ -7.7%	2,371 ↑ 16.5%	12 ↓ -21.1%	-8,519,233 ↓ -23.8%	406 ↑ 7.7%
Total degrees awarded in STEM	Total number of student enrolled in STEM	LA Community College Transfer Student 6-Year Grad Rate	Total Science & Engineering Disciplines (in thousands)	Total Licensing Income		Direct unrestricted instructional expenditures per FTE student
2,082 1,930	10,843 10,843	70.3% 70.3%	241,191 241,191	1,182,845 1,182,845		7,403 6,523
1,798 ↓ -2.1%	9,681 ↑ 3.2%	67.5% ↑ 2.5%	152,088 ↑ 22.5%	121,511 ↑ 179.5%		6,523 ↓ -0.9%

Louisiana State University and A&M

Metric I. Number of degrees conferred by level and professions most important to Louisiana.

	2017-2018	2018-2019	2019-2020	2020-2021	2021-2022	2022-2023
Campus total number of degrees awarded/conferred...						
Undergraduate Certificate	0	0	0	0	0	2
Bachelors	4,852	5,097	4,971	4,675	4,946	4,839
Post-Bachelors	102	97	81	97	92	79
Masters	1,181	1,274	1,297	1,399	1,821	1,626
Post- Masters	0	0	0	0	0	0
Graduate Certificate	49	105	104	114	238	276
Doctoral	299	325	347	292	321	299
Specialist	23	23	15	21	13	14
Professional (Law)	165	174	166	189	200	175
Professional (Veterinary)	85	83	88	84	98	114
Post-Professional	10	8	11	0	12	13
Grand Total Number of Degrees Awarded	6,766	7,186	7,080	6,871	7,741	7,437
Total number of degrees awarded by race/ethnicity...						
Hispanic	380	428	461	452	474	526
American Indian or Alaskan Native	19	15	24	23	41	21
Asian	248	274	281	246	304	314
Black, Non-Hispanic	782	752	874	844	985	952
Native Hawaiian or Other Pacific Islander	7	4	8	11	9	8
White, Non-Hispanic	4,656	5,053	4,814	4,713	5,253	4,938
Two or More Races	149	126	139	121	172	189
Nonresident Alien	450	423	360	363	397	376
Race/Ethnicity Unknown	75	111	119	98	106	113
Total degrees awarded ...						
Total degrees awarded in STEM	2,047	2,082	1,987	1,798	1,971	1,930
Total Teacher Education completions (Note BOR Teacher Education Initiatives)						
Total Completed (<i>Regular Program</i>)	141	155	136	113	111	120
Number Passed (<i>Regular Program</i>)	141	152	136	112	111	113
Percentage Passed (<i>Regular Program</i>)	100%	98%	100%	99%	100%	97%
Total Completed (<i>Alternate Program</i>)	15	24	25	23	14	18
Number Passed (<i>Alternate Program</i>)	15	24	24	23	14	18
Percentage Passed (<i>Alternate Program</i>)	100%	100%	96%	100%	100%	100%
Total number of degrees awarded in Allied Health	0	0	0	0	0	0

Note: Beginning with Fall 2014 reporting cycle, total degrees awarded in STEM determined by the Complete College America (CCA) definition used by the Board of Regents.

Louisiana State University and A&M

Metric I. Number of degrees conferred by level and professions most important to Louisiana.

List of STEM/SMART CIP code/s: The following list of CIP codes is to serve as a guide but it is not intended to be inclusive of all possibilities. We recognize that some campuses have degree programs centered in schools or colleges that might dictate a different CIP code. The campus should make the appropriate adjustment. In addition, the CIP codes used by the campus should correlate to the Board of Regents. If there is a discrepancy and the campus applies the IPEDS CIP code, then the campus should identify this with a footnote.

- 11
- 14
- 15
- 26
- 27
- 40
- 0109
- 0110
- 0111
- 0112
- 0301
- 0303
- 0305
- 0306
- 2901
- 3001
- 3006
- 3008
- 3010
- 3016
- 3018
- 3019
- 3024
- 3025
- 4101
- 4102
- 4103
- 4199
- 4211

Allied Health CIP Code/s
Allied Health and Medical Assisting Services
Allied Health Diagnostic, Intervention, and Treatment Professions

Louisiana State University and A&M

Metric II. The following metrics will provide the campus enrollment trends.

Enrollment Headcount as of 14th Class Day	2018-2019	2019-2020	2020-2021	2021-2022	2022-2023	2023-2024
Undergraduate						
14th Day Enrollment for First Time Degree Seeking Freshmen	5,812	6,132	6,701	7,045	7,401	7,521
14th Day Degree Seeking New Transfer Student Enrollment	727	724	928	923	998	1,033
14th Day Degree Seeking Re-Admit Enrollment	394	359	342	282	307	343
Degree Seeking Continuing Undergraduates	16,608	16,547	17,274	18,270	19,072	20,358
First-Time Post-Baccalaureate	55	33	76	46	54	43
Non Degree Undergraduates	1,767	2,125	2,627	2,820	3,227	3,368
Total Undergraduate Headcount as of 14th Class Day	25,363	25,920	27,948	29,386	31,059	32,666
Undergraduate - First Time Degree Seeking Freshmen						
Full-time (In-State Residency)	4,604	4,744	4,901	4,837	4,973	4,794
Full-time (Non Residency)	1,205	1,382	1,789	2,201	2,394	2,700
Part-time (In-State Residency)	2	4	6	6	1	2
Part-time (Non Residency)	1	2	5	1	33	25
Total First Time Degree Seeking Freshmen Headcount as of 14th Class Day	5,812	6,132	6,701	7,045	7,401	7,521
Undergraduate						
Full-time (In-State Residency)	18,560	18,540	19,147	19,099	19,158	19,290
Full-time (Non Residency)	3,873	4,195	4,971	6,251	7,363	8,577
Part-time (In-State Residency)	2,704	2,998	3,529	3,717	4,066	4,223
Part-time (Non Residency)	226	187	301	319	472	576
Total Undergraduate Headcount as of 14th Class Day	25,363	25,920	27,948	29,386	31,059	32,666
Graduate						
Full-time (In-State Residency)	3,501	3,426	3,343	3,330	3,287	3,347
Full-time (Non Residency)	928	1,064	1,230	1,273	1,264	1,562
Part-time (In-State Residency)	665	714	803	798	702	654
Part-time (Non Residency)	530	637	966	1,127	1,042	1,190
Total Graduate Headcount as of 14th Class Day	5,624	5,841	6,342	6,528	6,295	6,753
Grand Total Headcount as of 14th Class Day (Undergraduate & Graduate)	30,987	31,761	34,290	35,914	37,354	39,419
Total Undergraduate Full-Time-Equivalent (FTE) Enrollment as of 14th Class Day	23,061	23,428	25,224	26,388	27,830	29,351
Total Graduate Full-Time-Equivalent (FTE) Enrollment as of 14th Class Day	5,118	5,296	5,568	5,748	5,615	5,994
Total number of High School Dual Enrollments	1,476	1,868	2,460	2,615	3,048	3,236

Louisiana State University and A&M

Metric II. The following metrics will provide the campus enrollment trends.

First Time Degree Seeking Enrollment by Race and Ethnicity as of 14th Class Day	2018-2019	2019-2020	2020-2021	2021-2022	2022-2023	2023-2024
Hispanic	421	498	609	668	781	828
American Indian or Alaska Native	37	14	46	77	26	28
Asian	272	289	305	403	347	359
Black or African American	889	887	1,122	1,320	1,563	1,708
Native Hawaiian or Other Pacific Islander	11	3	9	8	5	5
White	3,898	4,082	4,341	4,407	4,222	4,123
Two or More Races	141	229	176	58	324	328
Nonresident Alien	54	65	45	61	81	76
Race/Ethnicity Unknown	89	65	48	43	52	66
Total	5,812	6,132	6,701	7,045	7,401	7,521
First Time Degree Seeking Enrollment by Gender as of 14th Class Day						
Male	2,548	2,846	2,953	2,961	3,083	3,051
Female	3,264	3,286	3,748	4,084	4,318	4,470
Total	5,812	6,132	6,701	7,045	7,401	7,521
Total Enrollment by Race and Ethnicity as of 14th Class Day						
Hispanic	2,014	2,179	2,490	2,759	3,147	3,588
American Indian or Alaska Native	122	119	169	221	186	163
Asian	1,270	1,344	1,424	1,611	1,658	1,704
Black or African American	3,867	4,239	5,028	5,485	6,257	6,998
Native Hawaiian or Other Pacific Islander	36	36	40	39	33	29
White	20,793	20,989	22,480	23,126	23,010	23,612
Two or More Races	562	749	794	702	1,048	1,285
Nonresident Alien	1,645	1,599	1,368	1,520	1,571	1,627
Race/Ethnicity Unknown	678	507	497	451	444	413
Total	30,987	31,761	34,290	35,914	37,354	39,419
Total Enrollment by Gender as of 14th Class Day						
Male	14,429	14,685	15,469	15,905	16,396	16,979
Female	16,558	17,076	18,821	20,009	20,958	22,440
Total	30,987	31,761	34,290	35,914	37,354	39,419

Louisiana State University and A&M

Metric II. The following metrics will provide the campus enrollment trends.

Louisiana Transfer Enrollment	2018-2019	2019-2020	2020-2021	2021-2022	2022-2023	2023-2024
Transfer from Louisiana Community Colleges	236	219	222	221	208	194
Transfers from Louisiana Four-Year Universities	255	247	298	273	238	235
Student Credit Hours (SCH)						
Fall SCH	402,926	409,678	435,503	452,631	468,661	489,890
Spring SCH	368,203	376,985	402,875	412,676	434,385	
Total number of students enrolled who received TOPS						
Performance	3,423	3,430	4,102	4,242	4,323	4,202
Opportunity	5,265	5,207	5,011	4,939	5,076	5,143
Honors	4,776	5,006	5,634	5,693	5,770	5,238
Tech	0	0	0	0	0	0
Total number of students enrolled who received TOPS	13,464	13,643	14,747	14,874	15,169	14,583
Enrollment by specified discipline						
Total number of student enrolled in STEM	9,856	9,681	10,507	10,391	10,505	10,843
Total number of students enrolled in Allied Health	0	0	0	0	0	0
Total number of students enrolled in Teacher Education (Note BOR Teacher Education Initiative)	715	654	659	648	610	590
Teacher Education Regular Program	682	622	633	621	588	566
Teacher Education Alternative Program	33	32	26	27	22	24

Note: In December 2012, Teacher Education Programs MATE & MATS enrollments moved from Regular to Alternative for 2009-10, 2010-11, and 2011-12

Note: Beginning with Fall 2014 reporting cycle, enrollment in STEM determined by the Complete College America (CCA) definition used by the Board of Regents. Data reported using CC

Note: Beginning with Fall 2014 reporting cycle, 14th day degree-seeking transfer enrollment includes fall and continuing summer transfers.

Note: Beginning with Fall 2015 reporting cycle, headcount enrollment and student credit hours includes Hebert Law Center.

Note: Total number of students enrolled who received TOPS for 2017-2018 has been updated with completed data from LOSFA TOPS Payment Summary AY 2017-18 (12/26/2018)

Note: Total number of students enrolled who received TOPS for 2018-2019 is reported with partial data from LOSFA TOPS Payment Summary AY 2018-19 (12/26/2018)

Note: Total number of students enrolled who received TOPS for 2019-2020 is reported with partial data from LOSFA TOPS Payment Summary AY 2019-20 (1/6/2020)

Note: Total number of students enrolled who received TOPS for 2019-2020 is reported with partial data from LOSFA TOPS Payment Summary AY 2020-21 (10/23/2020)

Note: Total number of students enrolled who received TOPS for 2020-2021 is reported with partial data from LOSFA TOPS Payment Summary AY 2021-22 (12/20/2021)

Louisiana State University and A&M

Metric II. The following metrics will provide the campus enrollment trends.

List of STEM/SMART CIP code/s:

some campuses have degree programs centered in schools or colleges that might dictate a different CIP code. The campus should make the appropriate adjustment. In addition, the CIP codes used by the campus should correlate to the Board of Regents. If there is a discrepancy and the campus applies the IPEDS CIP code, then the campus should identify this with a

11	Computer and Information Sciences and Support Services
14	Engineering
15	Engineering Technologies/Technicians
26	Biological and Biomedical Sciences
27	Mathematics and Statistics
40	Physical Sciences
0109	Animal Sciences
0110	Food Science and Technology
0111	Plant Sciences
0112	Soil Sciences
0301	Natural Resources Conservation and Research
0303	Fishing and Fisheries Sciences and Management
0305	Forestry
0306	Wildlife and Wildlands Science and Management
2901	Military Technologies
3001	Biological and Physical Sciences
3006	Systems Science and Theory
3008	Mathematics and Computer Science
3010	Biopsychology
3016	Accounting and Computer Science
3018	Natural Sciences
3019	Nutrition Sciences
3024	Neuroscience
3025	Cognitive Science
4101	Biology Technician/Biotechnology Laboratory Technician
4102	Nuclear and Industrial Radiologic Technologies/Technicians
4103	Physical Science Technologies/Technicians
4199	Science Technologies/Technicians Other
4211	Physiological Psychology/Psychobiology

Allied Health CIP Code/s

51.08	Allied Health and Medical Assisting Services
51.09	Allied Health Diagnostic, Intervention, and Treatment Professions

Variables Description

Headcount Enrollment Undergraduate – Total number of full-time and part-time students enrolled in courses for undergraduate credit.

Headcount Enrollment Graduate – Total number of full-time and part-time students enrolled in courses for graduate credit.

Full-Time Equivalent (FTE) – The calculation of FTE can vary by institution. However, FTE enrollment reported for this metric should reconcile to FTE data you report to the Louisiana BoR, SREB and IPEDS for your campus.

Full-Time Student Undergraduate - a student enrolled for 15 or more semester credits or 30 or more contact hours a week each term. (IPEDS)

Dual Enrollment - A student who is enrolled in high school but who is also enrolled, simultaneously, in a postsecondary institution are considered dual

Science Technology Engineering and Mathematics (STEM) - STEM enrollment is calculated based on STEM CIP codes.

in these field of study.

Louisiana State University and A& M

Metric III. The following metric will identify the campus trends for retention, graduation, licensure and pass rate.

Analysis of First-time, Full-time, Baccalaureate Degree-seeking Freshmen (fall and prior summer)***									
Cohort Type	Cohort Year	Head Count	Average ACT	% continuation to_2nd_Yr	% continuation to_3rd_Yr	Cumulative % Graduating after 4 Yrs	Cumulative % Graduating after 5 Yrs	Cumulative % Graduating after 6 Yrs*	Cumulative % Graduating after 7 Yrs
Total	2013	5,498	25.5	84.6%	75.5%	41.0%	60.9%	65.3%	66.7%
Total	2014	5,652	25.6	84.7%	74.3%	39.4%	61.0%	65.7%	66.8%
Total	2015	5,619	25.6	82.8%	72.7%	42.9%	61.9%	65.7%	66.7%
Total	2016	5,470	25.7	82.9%	73.4%	44.1%	63.1%	66.4%	67.5%
Total	2017	4,910	25.6	83.7%	74.5%	45.9%	64.4%	67.4%	
Total	2018	5,809	25.5	83.0%	74.8%	47.4%	62.7%		
Total	2019	6,126	25.6	85.8%	75.1%	45.5%			
Total	2020	6,690	25.4	83.6%	72.4%				
Total	2021	7,038	26.0	83.5%	74.5%				
Total	2022	7,367	25.5	84.0%					
Total	2023	7,494	26.5						
First-time, Full-time, Degree-seeking Louisiana Community College Transfers (fall and prior summer)									
LACCT	2013	233		86.3%	65.2%	60.9%	67.8%	69.1%	69.5%
LACCT	2014	305		86.6%	67.9%	57.7%	65.9%	67.5%	68.2%
LACCT	2015	344		80.8%	57.8%	59.0%	65.4%	68.6%	70.3%
LACCT	2016	269		79.6%	66.2%	59.5%	65.8%	69.1%	69.1%
LACCT	2017	239		81.2%	55.6%	64.0%	68.2%	70.3%	
LACCT	2018	218		85.3%	61.9%	64.2%	71.6%		
LACCT	2019	200		86.5%	64.0%	66.0%			
LACCT	2020	193		82.1%	58.4%				
LACCT	2021	199		75.8%	52.5%				
LACCT	2022	188		78.6%					
LACCT	2023	166							

* Excludes pre-nursing and pre-allied health transfer preparatory programs that are included in IPEDS Grad Rate.

Louisiana State University and A& M

Metric III. The following metric will identify the campus trends for retention, graduation, licensure and pass rate.

	2014-2015	2015-2016	2016-2017	2017-2018	2018-2019	2019-2020	2020-2021	2021-2022	2022-2023	
Licensure exams data										
College of Business ¹ *	63%	57%	56%	56%	63%	63%	N/A	N/A	N/A	
School of Education	SEE METRIC I	SEE METRIC I	SEE METRIC I	SEE METRIC I	SEE METRIC I	SEE METRIC I	SEE METRIC I	SEE METRIC I	SEE METRIC I	
College of Engineering ² ***	Biological	78%	86%	88%	91%	67%	63%	50%	45%	90%
	Chemical	91%	84%	76%	86%	78%	73%	70%	56%	25%
	Civil	72%	72%	65%	53%	69%	67%	65%	58%	57%
	Electrical	88%	55%	77%	74%	67%	60%	45%	55%	50%
	Computer	75%	100%	100%	100%	N/A	N/A	N/A	100%	N/A
	Environmental	73%	50%	58%	67%	53%	55%	67%	42%	50%
	Industrial	80%	67%	100%	60%	67%	50%	100%	100%	100%
	Mechanical	94%	82%	88%	96%	86%	88%	95%	88%	89%
	Petroleum	81%	82%	80%	83%	81%	59%	0%	69%	71%
School of Social Work **	GSW ³	76%	75%	75%	78%	64%	64%	60%	65%	56%
	LCSW ⁴	68%	62%	63%	74%	70%	67%	70%	82%	62%
School of Veterinary Medicine ⁵	100%	95%	94%	91%	86%	94%	96%	90%	79%	

¹CPA Exam Pass Rates represent the average pass rates of all four individual sections.

²National Council of Examiners for Engineering Survey (NCEES) Fundamentals of Engineering (FEE) Passage Rates, by Major

³Graduate Social Work (GSW) Exam Passage Rates for All Students (First-time and Repeat)

⁴Licensed Clinical Social Work Examination for All Students (First-time and Repeat)

⁵North American Veterinary Licensing Examination (NAVLE) Passage Rates

*Note: Licensure Exams Data: The "N/A" in the College of Business 2020-21 column is due to changes made by the NASBA to the CPA exam. The NASBA is not likely to provide results until 2024.

**Note: Licensure Exams Data: 2022-2023, Council on Social Work Education (CSWE) no longer uses these scores.

The Association of Social Work Boards who manages the tests has released information about test bias.

***Note: Licensure Exams Data: College of Engineering: Includes only Fundamentals of Engineering Exams and does not include Professional Engineering or Fundamental of Surveying Exams.

In 2020-21 the percentages based on; Computer Science 0 students, IE had 1 student, and PETE had 2 students take tests.

****Note: Beginning with Fall 2020, the cohort and retention include students enrolled in the first fall online module. For students submitting both ACT and SAT scores, the highest of the two is reported.

In the instance that SAT is the higher score, it is reported as the ACT equivalent. Beginning with the Fall 2021 cohort, test scores only include students who elected to have test scores considered during the admission and scholarship decision process. Beginning with Fall 2023, composite scores are reported using superscoring.

Louisiana State University and A & M

Metric IV. The following metrics will identify the effectiveness of campus research to benefit the state's economic development.

Research Expenditures	2016-2017		2017-2018		2018-2019		2019-2020		2020-2021		2021-2022		2022-2023	
	Total	Federal	Total	Federal	Total	Federal	Total	Federal	Total	Federal	Total	Federal	Total	Federal
Field of Science & Engineering														
a. Engineering (Total)	34,572	7,260	38,913	9,379	40,364	10,189	34,495	8,995	33,824	9,721	49,445	11,742	58,731	15,342
(1) Aeronautical & astronautical	0	0	0	0	0	0	0	0	0	0	0	0	0	0
(2) Bioengineering/biomedical engineering	0	0	0	0	0	0	0	0	0	0	0	0	0	0
(3) Chemical	5,191	1,389	5,306	1,329	7,978	1,716	6,545	1,402	5,887	1,602	8,733	1,394	10,943	2,479
(4) Civil	11,541	2,331	11,879	2,691	12,298	2,379	10,772	1,885	10,719	2,350	14,209	3,422	16,046	4,655
(5) Electrical	2,580	1,223	2,997	1,320	2,651	1,112	2,195	1,045	2,338	1,217	5,273	1,456	7,152	1,132
(6) Industrial	200	66	217	40	452	54	443	189	409	197	1,230	333	3,682	141
(7) Mechanical	4,105	1,816	4,479	2,257	4,758	2,462	4,159	1,810	4,568	2,194	7,067	2,120	6,670	3,185
(8) Metallurgical & materials	5,410	0	5,953	49	5,613	17	4,667	0	4,708	34	5,130	87	5,127	150
(9) Other	5,545	435	8,082	1,693	6,614	2,449	5,714	2,664	5,195	2,127	7,803	2,930	9,111	3,600
b. Physical Sciences (Total)	18,822	10,974	24,133	12,376	23,944	12,967	22,366	13,295	23,438	13,940	30,594	12,932	36,946	14,676
(1) Astronomy	0	0	0	0	0	0	0	0	0	0	0	0	0	0
(2) Chemistry	6,711	3,440	9,652	4,119	8,558	4,312	8,252	3,955	10,020	5,423	12,606	4,636	15,050	5,919
(3) Materials Science	0	0	0	0	0	0	0	0	0	0	0	0	0	0
(4) Physics	11,847	7,393	14,148	8,197	14,926	8,553	13,851	9,293	12,979	8,305	17,419	8,020	20,617	8,594
(5) Other	264	141	333	60	460	102	263	47	439	212	569	276	1,279	163
c. Environmental Sciences (Total)	29,440	6,967	31,488	7,956	31,853	7,883	32,283	8,178	28,763	7,740	33,440	10,240	41,171	12,616
(1) Atmospheric	0	0	0	0	0	0	0	0	0	0	0	0	0	0
(2) Earth sciences	4,285	1,216	5,386	1,431	5,364	1,536	4,269	1,218	3,597	1,011	5,976	1,389	6,907	1,527
(3) Oceanography	18,124	4,476	19,227	4,976	20,412	5,574	20,469	5,188	19,120	5,607	20,358	7,591	23,523	9,507
(4) Other	7,031	1,275	6,875	1,549	6,077	773	7,545	1,772	6,046	1,122	7,106	1,260	10,741	1,582
d. Mathematical Sciences (Total)	1,887	1,639	1,906	1,714	2,086	1,808	2,415	2,241	1,843	1,656	6,496	1,691	7,441	1,883
e. Computer Sciences (Total)	3,459	1,273	3,782	1,437	3,618	1,132	2,618	1,107	3,968	1,327	5,166	1,439	6,420	2,544
f. Life Sciences (Total)	31,755	13,589	34,212	13,725	38,030	16,266	35,205	15,008	37,424	17,132	46,848	17,301	51,524	20,160
(1) Agricultural	211	119	235	104	443	17	25,783	9,860	26,386	11,412	27,642	11,881	30,902	13,628
(2) Biological	9,509	6,598	9,933	6,009	10,958	7,356	8,310	4,621	10,126	5,486	18,187	5,253	18,756	5,955
(3) Health Sciences	21,960	6,841	23,984	7,566	26,509	8,877	928	527	566	234	670	167	1,532	577
(4) Natural Resources	75	31	60	46	120	16	184	0	346	0	349	0	334	0
(5) Other	0	0	0	0	0	0	0	0	0	0	0	0	0	0
g. Psychology (Total)	573	142	802	93	1,119	213	902	180	750	159	832	187	1,077	437
h. Social Sciences (Total)	4,264	1,496	4,296	1,303	3,704	1,157	2,481	828	2,371	1,049	2,788	1,214	3,249	1,790
(1) Anthropology	0	0	0	0	0	0	0	0	0	0	0	0	0	0
(2) Economics	934	350	830	10	700	196	487	32	474	9	333	25	444	69
(3) Political science	201	17	158	6	192	23	83	12	325	17	242	12	350	58
(4) Sociology	1,543	333	1,433	399	1,250	200	560	100	296	218	314	192	295	153
(5) Other	1,586	796	1,875	888	1,562	738	1,351	684	1,276	805	1,899	985	2,160	1,510
i. Other Sciences, not elsewhere classified (Total)	10,097	288	9,735	240	11,380	101	11,116	216	10,831	102	11,070	113	12,110	123

Louisiana State University and A & M

Metric IV. The following metrics will identify the effectiveness of campus research to benefit the state's economic development.

Research Expenditures	2016-2017		2017-2018		2018-2019		2019-2020		2020-2021		2021-2022		2022-2023	
j. Non-S&E Fields	6,570	1,600	8,242	856	8,281	1,223	8,184	920	12,735	5,162	10,265	2,785	22,522	11,572
(1) Business Management	1,067	14	1,247	31	1,453	6	1,351	0	1,656	0	1,830	0	1,594	0
(2) Communication	158	12	428	58	612	222	443	155	984	414	685	149	751	136
(3) Education	1,821	1,283	745	422	944	540	480	270	857	542	817	405	687	411
(4) Humanities	544	31	790	92	974	175	717	150	438	121	707	101	737	14
(5) Law	672	7	691	76	773	45	489	0	867	0	748	0	663	0
(6) Social Work	27	0	16	7	89	33	114	31	583	468	669	644	1,021	628
(7) Visual & Performing Arts	99	53	172	25	185	54	61	3	137	29	176	56	3,378	2,600
(8) Other	2,182	200	4,562	145	3,251	148	4,529	311	7,213	3,588	4,633	1,430	13,691	7,783
k. Total (sum of a through j)	141,439	45,228	157,509	49,079	164,379	52,939	152,088	50,968	155,947	57,988	196,944	59,644	241,191	81,143

Louisiana State University and A & M

Metric V: Technology Transfer

	2014-2015	2015-2016	2016-2017	2017-2018	2018-2019	2019-2020	2020-2021	2021-2022	2022-2023
Invention Disclosures	56	56	72	61	76	70	71	41	54
Licenses\Options Executed	7	14	21	16	19	17	16	18	4
New Patents Filed - Total	20	43	44	54	57	43	43	58	50
New Patents Filed - First in Family	*	17	16	24	20	10	29	16	12
US Patents Issued	9	13	15	12	9	21	23	18	15
Active License Agreements	31	36	59	66	83	89	86	88	70
Licenses Generating Income	16	22	12	12	21	15	21	19	15
Total Licensing Income	\$764,290	\$263,934	\$280,672	\$315,275	\$899,957	\$261,745	\$432,585	\$423,148	\$1,182,845
Start-up Companies Formed	3	1	2	0	4	4	3	4	1
Legal Fees Expended	\$332,338	\$364,019	\$305,166	\$403,180	\$363,105	\$249,981	\$425,484	\$458,049	\$719,781
Legal Fees Reimbursed	\$15,499	\$5,270	\$240,719	\$13,101	\$17,779	\$40,710	\$44,178	\$60,469	\$135,621
Percent of Expenses Reimbursed	5%	1%	79%	3%	5%	16%	10%	13%	19%
Legal Fees as a % License Income	43%	138%	109%	128%	40%	96%	98%	108%	61%

LEGEND:

* = 2015-2016 was the first year to track

Louisiana State University and A&M

Metric VI. The following metrics will identify the tuition and fee revenues, and, other revenue resources.

	2017-2018	2018-2019	2019-2020	2020-2021	2021-2022	2022-2023
Total Endowment Value (includes \$23,643,344 at Alumni, \$594,821,087 at LSU Foundation, \$26,953,207 at TAF, & \$18,778,995 at LSU)	\$500,664,717	\$521,815,973	\$546,024,521	\$696,077,402	\$625,060,866	\$664,196,633
Earned Interest on Endowments	\$17,064,185	\$18,429,804	\$19,971,294	\$27,684,948	\$46,969,554	\$19,092,733
Dollar amount of the endowment approved each fiscal year and made available for expenditures by the campus	\$17,193,383	\$18,820,090	\$19,775,387	\$28,823,690	\$30,016,754	\$31,469,119
Total # of Foundations						
Foundations total Assets (\$ Amount)	\$714,990,461	\$1,249,664,699	\$1,248,807,118	\$1,382,849,759	\$1,405,280,095	\$1,460,933,440
Click here to go to the Foundations Supplemental Table						
Total # of Board of Regents Support Fund						
Total Value (\$ Amount) of BoR Support Fund ¹	\$243,530,805	\$246,079,712	\$252,954,783	\$306,426,757	\$282,825,919	\$299,743,615
Click here to go to the BoR Support Funds Supplemental Table						
Total number of affiliated off-campus sites (For example, LSU South Campus)						
Total net revenue generated by affiliated off-campus sites	\$540,203	\$75,305	\$62,685	\$68,465	\$78,130	\$79,596
Total \$ amount contributed back to campus by affiliated off-campus sites	\$540,203	\$75,305	\$62,685	\$68,465	\$78,130	\$79,596
Click here to go to the Affiliated Supplemental Table						
Total Gross Revenue Generated from tuition and fees²						
Total Gross Revenue From First-Time-Full-Time Freshmen	\$59,249,531	\$77,166,758	\$83,220,585	\$94,503,454	\$103,867,754	\$109,166,647
Gross Revenue From First-Time-Full-Time Freshmen (In-State Only)	\$39,100,511	\$46,555,679	\$48,223,172	\$49,139,237	\$48,643,006	\$50,263,501
Gross Revenue From First-Time-Full-Time Freshmen (Out-of-State Only)	\$20,149,020	\$30,611,087	\$34,987,413	\$45,364,217	\$55,224,748	\$58,903,146
Net Revenue From First-Time-Full-Time Freshmen	\$44,898,733	\$51,739,516	\$55,699,945	\$64,381,068	\$69,258,172	\$72,304,166
Net Revenue From First-Time-Full-Time Freshmen (In-State Only)	\$31,343,378	\$32,321,262	\$33,206,852	\$36,234,545	\$33,984,116	\$35,157,896
Net Revenue From First-Time-Full-Time Freshmen (Out-of-State Only)	\$13,555,355	\$19,418,254	\$22,443,093	\$28,146,523	\$35,274,006	\$37,146,270
Financial Aid						
Total institutional dollars awarded need based aid for entering freshmen class	\$4,915,757	\$9,812,094	\$9,963,097	\$8,313,803	\$8,657,951	\$8,909,682
Total institutional dollars awarded non-need aid for entering freshmen class	\$14,657,939	\$20,028,469	\$21,451,153	\$27,300,542	\$29,716,061	\$32,768,425
Total institutional dollars awarded need based aid for entering freshmen class LA residents	\$4,880,911	\$9,723,416	\$9,879,309	\$8,214,832	\$8,493,464	\$8,714,230
Total institutional dollars awarded non-need based aid for entering freshmen class LA residents	\$5,133,865	\$6,345,009	\$7,203,412	\$6,924,423	\$7,611,690	\$8,646,060
Total institutional dollars awarded need based aid for entering freshmen class non-residents	\$34,846	\$88,678	\$83,788	\$98,971	\$164,487	\$195,452
Total institutional dollars awarded non-need based aid for entering freshmen class non-residents	\$9,523,974	\$13,683,460	\$14,883,993	\$20,376,119	\$22,104,371	\$24,122,365
State Appropriation per FTE³	\$4,003	\$3,968	\$4,031	\$3,580	\$3,587	\$3,505
Net Revenue Generated from auxiliary enterprises (i.e., bookstores, dining services)	\$7,312,924	\$7,584,025	-\$407,607	-\$8,519,233	\$6,182,366	\$4,710,658

Louisiana State University and A&M

Metric VI. The following metrics will identify the tuition and fee revenues, and, other revenue resources.

¹ Total assets from LSU Foundation and Alumni Foundation audited consolidated financial statement. The only assets included in these statements that relate to the Tiger Athletic Foundation are the endowed funds the LSU Foundation manages for TAF. TAF's total assets are reported in its own financial statements and are included above beginning with 2018-19. LSU Foundation total assets are included on LSU A&M, Law Center, and LSU Agricultural Center Metric reports.

² Total Gross Revenue Generated from Tuition and Fees does not include LSU Online.

³ State Appropriation per FTE = the Board of Regents Formula Appropriations Per FTE which includes State General Fund and Statutory Dedications.

2018-19: In 2014, RTF donated the Louisiana Digital Media Center to LSU where EA Sports is housed. LDMC was placed on the books as an LSU asset for FY 19. Because of this EA Sports is no longer operating in an off campus site.

Definitions:

Endowment Value equals the market value of the endowment as of June 30 of the reporting year.

FTE- Full time equivalent

Payout from Endowment equal interest earned on endowment.

Gross Revenue Generated from Student Enrollment FTE equals revenue gain from student tuitions and fees.

Net Revenue Generated from Student Enrollment FTE equals gross revenue from enrollment headcount minus institutional supported financial aid.

Net Revenue from Auxiliary equal gross revenue generated from auxiliary enterprises minus debt services and other financial obligations.

Louisiana State University A&M

Metric VII. The following metric will identify teaching and research productivity

	Fall 2017	Fall 2018	Fall 2019	Fall 2020	Fall 2021	Fall 2022
Enrollment in Fall Semester Lecture and Seminar Courses						
Lower Division Undergraduate Courses						
Total Enrollment	72,660	73,610	79,036	86,164	90,104	95,536
Number of Sections	1,496	1,575	1,702	1,774	1,880	1,989
Average section size	49	47	46	49	48	48
Upper Division Undergraduate Courses						
Total Enrollment	33,950	33,563	31,992	32,993	33,800	32,979
Number of Sections	1,018	1,019	1,046	1,055	1,076	1,084
Average section size	33	33	31	31	31	30
Graduate/Professional Courses						
Total Enrollment	11,370	11,791	12,002	12,121	12,396	12,168
Number of Sections	610	627	615	626	623	610
Average section size	19	19	20	19	20	20
All Lecture and Seminar Courses						
Total Enrollment	117,980	118,964	122,932	131,278	136,300	140,683
Number of Sections	3,124	3,221	3,363	3,455	3,579	3,683
Average section size	38	37	37	38	38	38
Fall Teaching Activity						
Tenure/tenure track (T/TT) FTE faculty assigned to classes	911.26	913.75	921.75	911.75	894.00	870.25
Non tenure/tenure track FTE faculty assigned to classes	425.61	437.95	466.50	477.30	507.38	549.31
FTE graduate assistants assigned to classes	145.00	147.25	149.63	152.50	147.00	142.00
Organized class sections including labs, fall only						
Sections taught by tenure/tenure track faculty	1,844	1,799	1,825	1,824	1,861	1,813
Sections taught by non tenure/tenure track faculty	1,602	1,773	1,859	2,115	2,248	2,402
Sections taught by graduate assistants	483	520	531	521	539	544
Average # of class sections taught per FTE T/TT faculty						
Average # of class sections taught per FTE non T/TT faculty	2.02	1.97	1.98	2.00	2.08	2.08
Average # of class sections taught per 0.5 FTE graduate assistants	3.76	4.05	3.98	4.43	4.43	4.37
Average # of class sections taught per 0.5 FTE graduate assistants	1.67	1.77	1.77	1.71	1.83	1.92
% class sections taught by T/TT faculty						
% class sections taught by non T/TT faculty	47%	44%	43%	41%	40%	38%
% class sections taught by graduate assistants	41%	43%	44%	47%	48%	50%
% class sections taught by graduate assistants	12%	13%	13%	12%	12%	11%
Student Credit Hours (SCH'S), fall only						
Undergraduate	341,837	346,123	350,663	378,075	395,396	415,270
Graduate	34,243	35,115	37,164	44,594	46,780	46,130
Total student credit hours	376,080	381,238	387,827	422,669	442,176	461,400
Undergraduate SCH'S taught by T/TT faculty	138,379	136,624	134,584	146,438	148,055	146,869
Graduate SCH's taught by T/TT faculty	26,890	26,834	28,579	30,062	30,619	29,749
Total SCH's taught by T/TT faculty	165,269	163,458	163,163	176,500	178,674	176,618
Total SCH's taught by non T/TT faculty	177,042	180,269	189,339	210,591	214,558	250,258
Total SCH's taught by graduate assistants	33,768	37,511	35,325	35,577	35,225	34,525

Louisiana State University A&M

Metric VII. The following metric will identify teaching and research productivity

	Fall 2017	Fall 2018	Fall 2019	Fall 2020	Fall 2021	Fall 2022
Undergraduate SCH's taught per T/TT FTE faculty	152	150	146	161	166	169
Graduate sch's taught per T/TT FTE faculty	30	29	31	33	34	34
Total sch's taught per T/TT FTE faculty	181	179	177	194	200	203
Total sch's taught per non T/TT FTE faculty	416	412	406	441	423	456
Total sch's taught per 0.5 FTE graduate assistants	116	127	118	117	120	122
% sch's taught by T/TT faculty	44	43	42	42	42	38
% sch's taught by non T/TT faculty	47	47	49	50	50	54
% sch's taught by graduate assistants	9	10	9	8	8	7
Annual Instruction and Research Ratios						
Annual student credit hours (sch's), fall & spring						
Undergraduate	651,003	657,818	671,111	722,298	753,017	796,734
Graduate	109,562	113,311	115,552	135,067	134,346	136,203
Total	760,565	771,129	786,663	857,365	887,363	932,937
Annual FTE students	26,265	26,649	27,185	29,704	30,698	32,233
Direct unrestricted instructional expenditures	193,782,053	197,291,086	199,893,294	197,977,528	202,169,712	210,264,617
Direct unrestricted instructional expenditures per SCH	255	256	254	231	228	225
Direct unrestricted instructional expenditures per FTE student	7,378	7,403	7,353	6,665	6,586	6,523
Personnel costs as % of direct unrestricted instructional expenditures	93	94	95	96	95	94
Total FTE faculty (instruction, research, public service)	1452.00	1468.00	1487.00	1495.00	1506.00	1528.00
Total T/TT FTE faculty (instruction, research, public service)	1012.00	995.00	1002.00	991.00	971.00	963.00
Tenure/Tenure Track FTE faculty as % of total FTE faculty	69.7%	67.8%	67.4%	66.3%	64.5%	63.0%
Research expenditures	157,509,000	164,379,000	152,088,000	155,947,000	196,944,000	
Research expenditures per T/TT FTE faculty	\$155,641	\$165,205	\$151,784	\$157,363	\$202,826	\$0

*Note: Beginning in Fall 2016 LSU data source has changed to Workday. Due to reporting from a different platform, some methodologies have been revised. Law Center faculty and class sections are also included beginning this year.

Metric VII. The following metric will identify teaching and research productivity

	Fall 2017	Fall 2018	Fall 2019	Fall 2020	Fall 2021	Fall 2022
--	-----------	-----------	-----------	-----------	-----------	-----------

Definitions:

Enrollment in Fall Semester Lecture and Seminar Courses

Total enrollment, number of sections offered, and average section size are reported by course level for fall semester lecture and seminar classes. Courses offered through Academic Programs Abroad and Continuing Education are excluded. Source: fall semester 14th class day course file.

Lower Division Undergraduate Courses: Courses typically associated with the first and second years of college study; courses numbered 0001 through 2999.

Upper Division Undergraduate Courses: Courses typically associated with the third and fourth years of college study; courses numbered 3000 through 4999.

Graduate/Professional Courses: Courses typically associated with first professional or post-baccalaureate study; courses numbered 5000 through 9999.

Fall Teaching Activity

Full Time Equivalent (FTE) faculty: Faculty appointed at 100% effort are 1 FTE. Faculty appointed at 50% effort are 0.5 FTE.

Full Time Equivalent (FTE) graduate assistants: Typical appointment for a graduate assistant is 50% effort or 0.5 FTE.

Full Time Equivalent (FTE) faculty assigned to classes include (1) faculty who are tenured or on tenure track appointment, (2) faculty on annual appointment, and (3) graduate assistants. Only classes taught as part of the normal salary (on load) are included. Only unrestricted instruction, research, and public service funds are used in calculation of FTE. Source: fall semester faculty assignment file.

Organized class sections: Regularly scheduled classes meeting in classroom or similar facilities at stated times; lecture, laboratory, and seminar instruction; excludes independent study classes. Source: fall semester faculty assignment file.

Student credit hour (SCH): Course credit value multiplied by course enrollment.

Annual Instruction and Research Ratios

Annual student credit hours: Fall and spring student credit hours reported by level of student (undergraduate or graduate). Source: fall and spring 14th class day course files.

Annual full time equivalent (FTE) student is equivalent to the sum of undergraduate fall and spring student credit hours divided by 30 plus the sum of graduate fall and spring student credit hours divided by 24.

Direct unrestricted instructional expenditures: Instructional funds expended by academic units (those offering degrees and/or courses.) Source: Analysis of Current Unrestricted Fund Expenditures (C-2A), Supplement to the Financial Report.

Personnel costs: Salaries, wages, and related benefits reported on Analysis of Current Unrestricted Fund Expenditures (C-2A), Supplement to the Financial Report.

Total FTE faculty: All faculty ranks charged to instruction, research, and public service funds regardless of source. Includes both faculty assigned to classes and those who are not. Source: October 31 census payroll file.

Total FTE tenure/tenure track faculty: Faculty described above who are tenured or on tenure track appointments.

Research expenditures: Grand total research and development expenditures from both science and engineering (S&E) and non-S&E fields. Source: National Science Foundation (NSF) Survey of Research and Development Expenditures at Universities and Colleges.

Louisiana State University A&M

Table I: Affiliated Off-Campus Sites

LSU Campus	Name of Affiliated Off- Campus Site	Gross Revenue Generated by Affiliate Campus	Net Revenue Generated by Affiliated Campus	\$ Amount Contributed Back to Campus by Affiliated Off-Site Campus
LSU A&M	EA Sports -- South Campus*			
	2014-15	\$465,000	\$465,000	\$465,000
	2015-16	\$465,000	\$465,000	\$465,000
	2016-17	\$465,000	\$465,000	\$465,000
	2017-18	\$465,000	\$465,000	\$465,000
	2018-19	n/a	n/a	n/a
	2019-20	n/a	n/a	n/a
	2020-21	n/a	n/a	n/a
LSU A&M	Tsunami Sushi -- Shaw Center			
	2014-15	\$78,850	\$70,965	\$70,965
	2015-16	\$83,365	\$75,028	\$75,028
	2016-17	\$81,921	\$73,729	\$73,729
	2017-18	\$83,559	\$75,203	\$75,203
	2018-19	\$83,673	\$75,305	\$75,305
	2019-20	\$69,650	\$62,685	\$62,685
	2020-21	\$76,249	\$68,465	\$68,465
	2021-22	\$88,611	\$78,130	\$78,130
	2022-23	\$88,440	\$79,596	\$79,596

*Rental income per contract with Department of Economic Development.

2018-19: In 2014, RTF donated the Louisiana Digital Media Center to LSU where EA Sports is housed. LDMC was placed on the books as an LSU asset for FY 19. Because of this EA Sports is no longer operating in an off campus site.

Table II: Board of Regent Support Funds

LSU Campus	Name of Support Fund	Year	Market Value (\$ Amount)
LSU A&M	Endowed Chairs/Professorship Programs*		
		2014-15	\$210,884,877
		2015-16	\$207,176,712
		2016-17	\$235,243,394
		2017-18	\$243,530,805
		2018-19	\$246,079,712
		2019-20	\$252,954,783
		2020-21	\$306,426,757
		2021-22	\$282,825,919
		2022-23	\$299,743,615

*Market value of combined private and state program assets managed by LSU Foundation for Endowed Chairs/Professorship Programs.

Table III: Summary of Campus Foundations

LSU Campus	Foundation		
LSU A&M	Alumni Association		
		2014-15	\$36,915,148
		2015-16	\$34,862,610
		2016-17	\$36,158,786
		2017-18	\$35,908,027
		2018-19	\$40,672,328
		2019-20	\$45,672,568
		2020-21	\$42,485,931
		2021-22	\$43,321,408
		2022-23	\$43,335,006
LSU A&M	LSU Foundation, including Tiger Athletic Found*		
		2014-15	\$626,559,261
		2015-16	\$616,530,791
		2016-17	\$654,507,276
		2017-18	\$679,082,434
		2018-19	\$1,208,992,371
		2019-20	\$1,203,134,550
		2020-21	\$1,340,363,828
		2021-22	\$1,361,958,687
		2022-23	\$1,417,598,434

*Total assets from LSU Foundation's audited consolidated financial statement. The only assets included in these statements that relate to the Tiger Athletic Foundation are the endowed funds the LSU Foundation manages for TAF. TAF's total assets are reported in its own financial statements. Total assets reported for LSU A&M are reported as well in Law Center and LSU Agricultural Center Metric V; TAF included beginning 2018-19

LOUISIANA STATE UNIVERSITY

NATIONAL BENCHMARK REPORT

Institution Name	Total Six-Year Graduation Rate 2015 Cohort	Total Research Expenditures 2020-21	Total Degrees Awarded 2020-21	Percent Graduate Student Headcount of Total Headcount Fall 2021	Graduation Rate Cohort As a % of New Degree-Seeking Undergraduates Fall 2021
Louisiana State University	70%	\$278,809,219	7,741	17%	69%
Auburn University	81%	\$263,777,680	8,006	20%	82%
Clemson University	85%	\$245,845,525	7,406	21%	73%
Colorado State University-Fort Collins	67%	\$300,177,103	7,659	23%	76%
Iowa State University	74%	\$208,491,758	7,999	16%	78%
Kansas State University	69%	\$204,842,671	5,760	24%	69%
Mississippi State University	63%	\$184,359,363	5,701	19%	63%
North Carolina State University at Raleigh	85%	\$371,650,179	10,266	28%	73%
Oklahoma State University-Main Campus	65%	\$143,626,743	6,371	18%	70%
Purdue University-Main Campus	83%	\$381,932,040	13,147	25%	89%
Texas A & M University-College Station	84%	\$952,927,694	19,892	22%	79%
The University of Tennessee-Knoxville	73%	\$281,918,203	7,859	20%	80%
University of Arkansas	69%	\$186,954,141	6,987	15%	81%
University of Georgia	88%	\$514,369,516	12,946	24%	76%
University of Illinois Urbana-Champaign	85%	\$730,807,335	15,212	38%	79%
University of Maryland-College Park	89%	\$560,680,467	11,819	26%	75%
University of Nebraska-Lincoln	65%	\$231,455,257	5,800	19%	85%
Virginia Polytechnic Institute and State University	86%	\$416,639,701	9,988	20%	87%
Average-Excluding LSU	77%	\$363,556,199	9,578	22%	78%

Source: IPEDS Data Center Provisional Release Data as of January 24, 2023.

Note: LSU values include LSU Ag. Center, Hebert Law Center, and Pennington Biomedical Research Center as published by IPEDS.

Percent Graduate Enrolled Includes First-Professional

Degrees Awarded Include Certificates

**Louisiana State University
Agricultural Center
Metric Data**



April 26, 2024

Louisiana State University Agricultural Center

Executive Summary

The LSU AgCenter is the epicenter of agricultural and natural resource research and extension for the LSU system and the state. The data provided in this report cover the period 2022-23 and provide a limited but important view of the scope of the AdCenter's core activities. LSU is currently ranked 15th in Agricultural Sciences research expenditures by the National Science Foundation. That accomplishment speaks volumes about scale and scope of the AdCenter's activities, and places us among a small group of the most impactful and accomplished university-based research organizations in the country.

Of particular note in these data are that research awards and expenditures are trending upward, and the significant jump in awards in particular will generate increases in expenditures in subsequent years. The congealing of well-defined research focal areas, along with recruitment of new talent in these areas portends well for the future of the AgCenter program. Likewise, the AgCenter intellectual property program, historically the strongest among all higher ed institutions in the state, remains very strong with increases in patents filed, licenses and options executed, and active licensing agreements. The downturn in licensing revenues was expected and is predicted to turn around over the coming years with imminent licensing of newly developed technologies by the faculty.

The overall value of the endowments continues to trend upwards as well. This is important because these resources are used to offset the cost of attracting and retaining talent, which is a constant focus of our attention given our interest in ascending in the research rankings.

Overall, the key indicators provided in this report reveal a powerful organization that has momentum and is poised to elevate its impact in the coming years.

LSU AgCenter MISSION:

The overall mission of the LSU Agricultural Center is to enhance the quality of life for people through research and educational programs that develop the best use of natural resources, conserve and protect the environment, enhance development of existing and new agricultural and related enterprises, develop human and community resources, and fulfill the acts of authorization and mandates of state and federal legislative bodies.

LSU AgCenter Metrics at a Glance

2022-2023

Legend:

Statistic		Most Recent Available
High	X	
Low	Z	%

% Change from Previous Period

Increase from Previous Year 

No change 

Decrease from Previous Year 

Metric IV Research Expenditures

Total Research (in thousands)	
88,700	88,700
75,481	 1.1%

Number of all research publications	
733	370
368	 0.5%

Dollar amount of grants and contracts awards received	
46,040,081	46,040,081
24,186,753	 32.1%

Dollar amount of restricted expenditures	
49,511,168	27,287,928
27,287,928	 -46.2%

Number of 4-H volunteer leaders	
10,516	10,516
5,661	 29.2%

Number of 4-H participants in community service activities	
49,737	35,945
15,595	 38.3%

Metric V Technology Transfer

Invention Disclosures	
54	17
14	 -164.7%

Licenses\Options Executed	
18	6
3	 50.0%

New Patents Filed - Total	
38	21
4	 38.1%

Active License Agreements	
79	74
58	 5.4%

Licenses Generating Income	
79	38
34	 -81.6%

Total Licensing Income	
10,620,789	3,703,222
3,703,222	 -47.6%

Metric VI Revenues

Market Value of Endowment	
27,154,634	26,160,339
17,624,854	 4.6%

Earned Interest on Endowments	
976,065	976,065
623,883	 12.9%

Market Value (\$ Amount) of BoR Support Fund (Chairs & Professorships)	
13,431,844	13,431,844
9,924,666	 5.0%

LSU AgCenter

Metric IV. The following metrics will identify the effectiveness of campus research and technology transfer to benefit the state's economic development.

Field of Science & Engineering	FY 2018		FY 2019		FY 2020		FY 2021		FY 2022		FY 2023	
	Total	Federal	Total	Federal	Total	Federal	Total	Federal	Total	Federal	Total	Federal
a. Engineering (Total)	3,843	1,848	4,041	1,398	4,119	227	5,280	1,293	4,529	507	5,048	406
(1) Aeronautical & astronautical	0	0	0	0	0	0	0	0	0	0		
(2) Bioengineering/biomedical engineering	0	0	0	0	0	0	0	0	0	0		
(3) Chemical	0	0	0	0	0	0	0	0	0	0		
(4) Civil	0	0	0	0	0	0	0	0	90	0	286	73
(5) Electrical	0	0	0	0	0	0	0	0	0	0		
(6) Mechanical	0	0	0	0	0	0	0	0	0	0		
(7) Metallurgical & materials	0	0	0	0	0	0	0	0	0	0		
(8) Other	3,843	1,848	4,041	1,398	4,119	227	5,280	1,293	4,439	507	4,762	333
b. Physical Sciences (Total)	0	0	0	0	0	0	0	0	0	0	0	0
(1) Astronomy	0	0	0	0	0	0	0	0	0	0	0	0
(2) Chemistry	0	0	0	0	0	0	0	0	0	0	0	0
(3) Physics	0	0	0	0	0	0	0	0	0	0	0	0
(4) Other	0	0	0	0	0	0	0	0	0	0	0	0
c. Environmental Sciences (Total)	0	0	0	0	0	0	0	0	0	0	0	0
(1) Atmospheric	0	0	0	0	0	0	0	0	0	0	0	0
(2) Earth sciences	0	0	0	0	0	0	0	0	0	0	0	0
(3) Oceanography	0	0	0	0	0	0	0	0	0	0	0	0
(4) Other	0	0	0	0	0	0	0	0	0	0	0	0
d. Mathematical Sciences (Total)	240	0	333	0	285	0	234	0	224	0	671	0
e. Computer Sciences (Total)	0	0	0	0	1,490	1,046	0	0	0	0	0	0
f. Life Sciences (Total)	70,989	10,311	70,829	11,320	78,297	9,933	76,000	10,577	80,093	12,379	79,576	12,739
(1) Agricultural	59,196	6,705	59,097	7,764	62,590	6,122	61,832	6,773	64,005	7,259	63,260	7,079
(2) Biological	5,163	1,187	5,149	1,361	6,436	1,293	5,205	828	6,653	1,797	6,120	1,980
(3) Medical	0	0	0	0	0	0	0	0	0	0		
(4) Natural Resources	6,630	2,419	6,583	2,195	9,271	2,518	8,963	2,976	9,435	3,323	10,196	3,680
(4) Other	0	0	0	0	0	0	0	0	0	0		
g. Psychology (Total)	0	0	0	0	0	0	0	0	0	0	0	0
h. Social Sciences (Total)	0	0	0	0	2,406	443	2,166	314	1,964	54	2,579	234
(1) Economics	0	0	0	0	2,406	443	2,166	314	1,964	54	2,579	234
(2) Political science	0	0	0	0	0	0	0	0				
(3) Sociology	0	0	0	0	0	0	0	0	0	0	0	0
(4) Other	0	0	0	0	0	0	0	0	0	0	0	0
i. Other Sciences, not elsewhere classified (Total)	409	0	1,013	0	716	0	431	31	893	9	826	41
j. Total (sum of a through i)	75,481	12,159	76,216	12,718	87,313	11,649	84,111	12,215	87,703	12,949	88,700	13,420

LSU AgCenter

Metric IV. The following metrics will identify the effectiveness of campus research and technology transfer to benefit the state's economic development.

Enhance the Competitiveness and Sustainability of Louisiana's Food, Fiber, and Natural Resource Based Industries

	2017-2018	2018-2019	2019-2020	2020-2021	2021-2022	2022-2023
Average adoption rate of recommended best management practices	62.4%	67.2%	86.2%	92.3%	69.5%	78.3%
Number of research projects	167	184	153	162	193	199
Number of all research publications	733	629	727	511	368	370
Number of refereed research publications only	385	332	362	301	264	220
Number of new and revised numbered extension publications	184	250	193	245	394	413

Support Increased Economic Opportunities and Improve Quality of Stakeholder's Life

Dollar amount of grants and contracts awards received	24,186,753	24,706,605	28,950,671	29,344,870	31,271,224	46,040,081
Dollar amount of restricted expenditures	46,337,337	49,511,168	41,461,510	41,557,551	39,887,825	27,287,928
Number of educational programs - agriculture and natural resources programs	2,465	1,841	2,024	1,444	3,982	3,941
- nutrition and health programs	9,052	8,185	5,148	3,818	4,337	4,424
Number of educational contacts - agriculture and natural resources programs	731,210	619,400	815,444	521,531	455,619	455,928
- nutrition and health programs	262,063	232,987	149,782	78,043	87,784	169,868
Number of web-based contacts - number of web pages viewed	55,334,937	66,196,193	42,921,687	42,629,203	37,230,525	45,058,059

Build Leaders and Good Citizens through 4-H Youth Development

Number of 4-H members and participants	178,801	188,302	115,440	45,841	107,810	95,019
Number of 4-H volunteer leaders	8,831	8,751	7,745	5,661	7,450	10,516
Number of 4-H participants in community service activities	46,628	43,005	49,737	15,595	22,181	35,945

LSU AgCenter

Metric V: Technology Transfer

	2014-2015	2015-2016	2016-2017	2017-2018	2018-2019	2019-2020	2020-2021	2021-2022	2022-2023
Invention Disclosures	34	54	29	44	34	29	14	45	17
Licenses\Options Executed	9	8	5	10	11	14	4	3	6
New Patents Filed - Total	4	17	37	14	38	12	20	13	21
New Patents Filed - First in Family	*	4	11	6	13	3	6	1	9
US Patents Issued	6	6	6	2	7	4	14	5	5
Active License Agreements	64	70	65	72	69	73	69	70	74
Licenses Generating Income	44	64	34	44	47	39	42	69	38
Total Licensing Income	\$9,757,484	\$7,301,731	\$7,996,886	\$7,286,800	\$8,107,006	\$7,382,230	\$8,551,762	\$5,467,326	\$3,703,222
Start-up Companies Formed	2	0	0	0	1	0	0	0	0
Legal Fees Expended	\$276,698	\$388,560	\$356,695	\$431,316	\$385,764	\$257,604	\$216,950	\$179,064	\$221,573
Legal Fees Reimbursed	\$97,776	\$75,697	\$30,714	Not reported	\$6,100	\$4,935	\$64,382	\$21,053	\$15,146
Percent of Expenses Reimbursed	35%	19%	9%	N/A	2%	2%	30%	12%	7%
Legal Fees as a % License Income	3%	5%	4%	6%	5%	3%	3%	3%	6%

LEGEND:

* = 2015-2016 was the first year to track

LSU AgCenter

Metric VI. The following metrics will identify the tuition and fee revenues, and, other revenue resources.

	2017-2018	2018-2019	2019-2020	2020-2021	2021-2022
Total Endowment Value (Total at LSU Foundation)	\$17,624,854	\$19,800,393	\$21,603,831	\$27,154,634	\$24,951,861
Earned Interest on Endowments	\$623,883	\$667,027	\$691,188	\$785,881	\$850,606
Total # of Foundations	2	2	2	2	2
Foundations total Assets (\$ Amount) ¹	\$680,241,284	\$683,878,629	\$699,191,717	\$848,458,699	\$865,332,918
Click here to go to the Foundations Supplemental Table					
Total # of Board of Regents Support Funds	45	45	45	47	52
Total Value (\$ Amount) of BoR Support Fund	\$9,960,373	\$10,088,082	\$9,924,666	\$12,011,040	\$12,753,548
Click here to go to the BoR Support Funds Supplemental Table					

¹ Total assets from LSU Foundation audited consolidated financial statement and Louisiana 4-H Foundation. The only assets included in these statements that relate to the Tiger Athletic Foundation are the endowed funds the LSU Foundation manages for TAF. TAF's total assets are reported in its own financial statements. LSU Foundation total assets are included on LSU A&M, Law Center, and LSU Agricultural Center Metric reports

Endowment Value equals the market value of the endowment as of June 30 of the reporting year.

FTE- Full time equivalent

Payout from Endowment equals interest earned on endowment.

Gross Revenue Generated from Student Enrollment FTE equals revenue gain from student tuitions and fees.

Net Revenue Generated from Student Enrollment FTE equals gross revenue from enrollment headcount minus institutional supported financial aid.

Net Revenue from Auxiliary equal gross revenue generated from auxiliary enterprises minus debt services and other financial obligations.

Table I: Affiliated Off-Campus Sites

LSU Campus	Name of Affiliated Off- Campus Site	Gross Revenue Generated by Affiliate Campus	Net Revenue Generated by Affiliated Campus	Back to Campus by Affiliated Off-Site Campus

Table II: Board of Regent Support Funds

LSU Campus	Name of Support Fund	Endowment		
AgCenter	Matched Chairs (3)/Professorships (42)	13,431,844		

Table III: Summary of Campus Foundations

LSU Campus	Foundation	Total Assets <i>(\$ Amount)</i>		
AgCenter	LSU Foundation	921,924,842		
AgCenter	Louisiana 4-H Foundation	1,467,972		

**Louisiana State University Alexandria
Metric Data**



April 26, 2024

Louisiana State University Alexandria

Executive Summary

Metric 1 - Degrees Conferred

Overall graduations were up 15%. Associates grads were up 6%. Bachelors grads were up %17

Metric 2 - Enrollment Trends

Enrollment was up 24% and we broke 5000 fall enrollments for the first time in school history.

Metric 3 - Retention and Graduation Rates

First to second year retention was up to 65%.

Metric 5 - Tuition & Fees

Our revenues were up due to increases in enrollment.

Metric 6 - Research

Unrestricted expenditures per student were up 5.2%.

Foundations

The LSUA Foundation began the year valued at \$43,725,592. 00 and ended at \$ 45,074,428.00

Benchmarks

Our full time 2nd year retention increased compared to our benchmarks. The graduation rate increased compared to our benchmarks. Our state appropriation is 13% which is at the bottom of our peer group.

LSUA MISSION:

As the only state-supported undergraduate university in Louisiana, LSUA's mission is to provide a broad spectrum of affordable undergraduate degrees in a robust academic environment that challenges students to excel and creates proactive and reciprocal relationships that meet the needs of the diverse student body and community that it serves.

Louisiana State University Alexandria









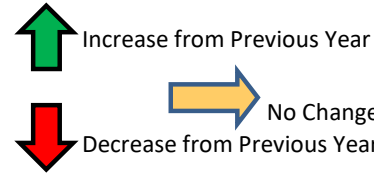











































































Metrics at a Glance

2022-2023

Legend:

Statistic		Current	% Change from Previous Period
High	Low		
X	Y		
Z	%		



Metric I Degrees Awarded	Metric II Enrollment	Metric III Student Success	Metric V Restricted Revenue	Metric VI Instruction Productivity																				
Associates <table border="1"> <tr><td>147</td><td>147</td></tr> <tr><td>125</td><td> 5.8%</td></tr> </table>	147	147	125	 5.8%	14th Day Enrollment for First Time Degree Seeking Freshmen <table border="1"> <tr><td>473</td><td>473</td></tr> <tr><td>405</td><td> 16.8%</td></tr> </table>	473	473	405	 16.8%	Average ACT Score <table border="1"> <tr><td>21.4</td><td>19.0</td></tr> <tr><td>19.0</td><td> -1.0%</td></tr> </table>	21.4	19.0	19.0	 -1.0%	Market Value of Endowment <table border="1"> <tr><td>19,124,272</td><td>19,124,272</td></tr> <tr><td>14,860,428</td><td> 16.6%</td></tr> </table>	19,124,272	19,124,272	14,860,428	 16.6%	SCH Enrollment in Fall Semester Lecture and Seminar Courses <table border="1"> <tr><td>14,219</td><td>14,219</td></tr> <tr><td>11,340</td><td> 9.1%</td></tr> </table>	14,219	14,219	11,340	 9.1%
147	147																							
125	 5.8%																							
473	473																							
405	 16.8%																							
21.4	19.0																							
19.0	 -1.0%																							
19,124,272	19,124,272																							
14,860,428	 16.6%																							
14,219	14,219																							
11,340	 9.1%																							
Bachelors <table border="1"> <tr><td>691</td><td>691</td></tr> <tr><td>389</td><td> 16.5%</td></tr> </table>	691	691	389	 16.5%	14th Day Degree Seeking New Transfer Student Enrollment <table border="1"> <tr><td>913</td><td>913</td></tr> <tr><td>281</td><td> 41.3%</td></tr> </table>	913	913	281	 41.3%	Second Year Retention <table border="1"> <tr><td>65.0%</td><td>65.0%</td></tr> <tr><td>55.7%</td><td> 1.4%</td></tr> </table>	65.0%	65.0%	55.7%	 1.4%	Total Gross Revenue From First-Time-Full-Time Freshmen <table border="1"> <tr><td>2,737,337</td><td>2,406,020</td></tr> <tr><td>2,406,020</td><td> -4.4%</td></tr> </table>	2,737,337	2,406,020	2,406,020	 -4.4%	Tenure/tenure track (T/TT) FTE faculty assigned to classes <table border="1"> <tr><td>76</td><td>73</td></tr> <tr><td>67</td><td> -2.7%</td></tr> </table>	76	73	67	 -2.7%
691	691																							
389	 16.5%																							
913	913																							
281	 41.3%																							
65.0%	65.0%																							
55.7%	 1.4%																							
2,737,337	2,406,020																							
2,406,020	 -4.4%																							
76	73																							
67	 -2.7%																							
Grand Total Number of Degrees Awarded <table border="1"> <tr><td>846</td><td>846</td></tr> <tr><td>521</td><td> 14.8%</td></tr> </table>	846	846	521	 14.8%	Total Undergraduate Headcount as of 14th Class Day <table border="1"> <tr><td>5,104</td><td>5,104</td></tr> <tr><td>3,163</td><td> 24.0%</td></tr> </table>	5,104	5,104	3,163	 24.0%	Third Year Retention <table border="1"> <tr><td>50.6%</td><td>0.0%</td></tr> <tr><td>37.1%</td><td> -100.0%</td></tr> </table>	50.6%	0.0%	37.1%	 -100.0%	Net Revenue From First-Time-Full-Time Freshmen <table border="1"> <tr><td>2,640,220</td><td>2,286,032</td></tr> <tr><td>2,286,032</td><td> -5.9%</td></tr> </table>	2,640,220	2,286,032	2,286,032	 -5.9%	Total SCH's taught per FTE T/TT faculty <table border="1"> <tr><td>371</td><td>371</td></tr> <tr><td>255</td><td> 2.3%</td></tr> </table>	371	371	255	 2.3%
846	846																							
521	 14.8%																							
5,104	5,104																							
3,163	 24.0%																							
50.6%	0.0%																							
37.1%	 -100.0%																							
2,640,220	2,286,032																							
2,286,032	 -5.9%																							
371	371																							
255	 2.3%																							
Total degrees awarded in STEM <table border="1"> <tr><td>62</td><td>62</td></tr> <tr><td>18</td><td> 63.2%</td></tr> </table>	62	62	18	 63.2%	Total number of High School Dual Enrollments <table border="1"> <tr><td>875</td><td>875</td></tr> <tr><td>461</td><td> 35.0%</td></tr> </table>	875	875	461	 35.0%	Six Year Graduation Rate <table border="1"> <tr><td>30.6%</td><td>0.0%</td></tr> <tr><td>30.4%</td><td>#DIV/0!</td></tr> </table>	30.6%	0.0%	30.4%	#DIV/0!	State Appropriation per FTE <table border="1"> <tr><td>2,170</td><td>2,170</td></tr> <tr><td>1,017</td><td> 3.7%</td></tr> </table>	2,170	2,170	1,017	 3.7%	Total SCH's taught per FTE non T/TT faculty <table border="1"> <tr><td>233</td><td>216</td></tr> <tr><td>143</td><td> 21.3%</td></tr> </table>	233	216	143	 21.3%
62	62																							
18	 63.2%																							
875	875																							
461	 35.0%																							
30.6%	0.0%																							
30.4%	#DIV/0!																							
2,170	2,170																							
1,017	 3.7%																							
233	216																							
143	 21.3%																							
Total number of degrees awarded in Nursing <table border="1"> <tr><td>186</td><td>136</td></tr> <tr><td>119</td><td> -4.2%</td></tr> </table>	186	136	119	 -4.2%	Total number of students enrolled who received TOPS <table border="1"> <tr><td>647</td><td>647</td></tr> <tr><td>573</td><td> 8.9%</td></tr> </table>	647	647	573	 8.9%	# of students passing licensure exams (Nurses) <table border="1"> <tr><td>161</td><td>132</td></tr> <tr><td>51</td><td> -7.0%</td></tr> </table>	161	132	51	 -7.0%	Net Revenue Generated from auxiliary enterprises <table border="1"> <tr><td>1,068,997</td><td>1,068,997</td></tr> <tr><td>-291,806</td><td> 235.4%</td></tr> </table>	1,068,997	1,068,997	-291,806	 235.4%	% SCH's taught by T/TT faculty <table border="1"> <tr><td>61.9%</td><td>57.0%</td></tr> <tr><td>50.1%</td><td> -5.9%</td></tr> </table>	61.9%	57.0%	50.1%	 -5.9%
186	136																							
119	 -4.2%																							
647	647																							
573	 8.9%																							
161	132																							
51	 -7.0%																							
1,068,997	1,068,997																							
-291,806	 235.4%																							
61.9%	57.0%																							
50.1%	 -5.9%																							
Total number of degrees awarded in Allied Health <table border="1"> <tr><td>63</td><td>57</td></tr> <tr><td>32</td><td> 67.6%</td></tr> </table>	63	57	32	 67.6%	Total number of student enrolled in STEM <table border="1"> <tr><td>734</td><td>734</td></tr> <tr><td>274</td><td> 60.3%</td></tr> </table>	734	734	274	 60.3%	# of students passing licensure exams (BS in Elementary Education) <table border="1"> <tr><td>19</td><td>8</td></tr> <tr><td>8</td><td> -42.9%</td></tr> </table>	19	8	8	 -42.9%		Direct unrestricted instructional expenditures per FTE student <table border="1"> <tr><td>4,811</td><td>4,473</td></tr> <tr><td>3,741</td><td> 5.2%</td></tr> </table>	4,811	4,473	3,741	 5.2%				
63	57																							
32	 67.6%																							
734	734																							
274	 60.3%																							
19	8																							
8	 -42.9%																							
4,811	4,473																							
3,741	 5.2%																							

Louisiana State University Alexandria

Metric I. The following metrics will identify the the number of degrees conferred by level and professions most important to Louisiana.

	2017-2018	2018-2019	2019-2020	2020-2021	2021-2022	2022-2023
Campus total number of degrees awarded/conferred						
Associates	125	131	125	126	139	147
Certificates	7	8	4	4	5	8
Bachelors	389	546	463	463	593	691
Grand Total Number of Degrees Awarded	521	685	592	593	737	846
Total number of degrees awarded by race/ethnicity						
Hispanic	22	21	10	7	7	14
American Indian or Alaskan Native	32	44	45	62	65	69
Asian	8	12	5	9	17	15
Black, Non-Hispanic	66	119	75	95	121	141
Native Hawaiian or Other Pacific Islander	0	0	0	0	0	0
White, Non-Hispanic	366	439	418	387	504	544
Two or More Races	20	21	10	12	7	14
Nonresident Alien	0	0	22	9	13	27
Race/Ethnicity Unknown	7	29	7	12	3	22
Total degrees awarded						
Total degrees awarded in STEM	18	28	34	22	38	62
Total number of degrees awarded in Allied Health	33	63	42	32	34	57
Total number of degrees awarded in Nursing	119	186	144	161	142	136
Total Teacher Education completions (Note BOR Teacher Education Initiatives)						
Total Completed (Regular Program)	26	29	23	37	36	43
Number Passed (Regular Program)	26	29	23	37	36	43
Percentage Passed (Regular Program)	100%	100%	100%	100%	100%	100%
Total Completed (Alternate Program)	7	8	7	6	2	1
Number Passed (Alternate Program)	7	8	7	6	2	1
Percentage Passed (Alternate Program)	100%	100%	100%	100%	100%	100%
Total Completed (Secondary Ed Minor)	0	0	0	0	0	0
Number Passed (Secondary Ed Minor)	0	0	0	0	0	0
Percentage Passed (Secondary Ed Minor)	0%	0%	0%	0%	0%	0%

Louisiana State University Alexandria

Metric I. The following metrics will identify the the number of degrees conferred by level and professions most important to Louisiana.

List of STEM/SMART CIP code/s: The following list of CIP codes is to serve as a guide but it is not intended to be inclusive of all possibilities. We recognize that some campuses have degree programs centered in schools or colleges that might dictate a different CIP code. The campus should make the appropriate adjustment. In addition, the CIP codes used by the campus should correlate to the Board of Regents. If there is a discrepancy and the campus applies the IPEDS CIP code, then the campus should identify this with a footnote.

11	2901
14	3001
15	3006
26	3008
27	3010
40	3016
0109	3018
0110	3019
0111	3024
0112	3025
0301	4101
0303	4102
0305	4103
0306	4199
	4211

Nursing CIP Code/s

Nursing	5138
---------	------

Allied Health CIP Code/s

Allied Health Elder Care Administration	5107
Allied Health and Medical Assisting Services	5199
Allied Health Diagnostic, Intervention, and Treatment Professions	5109
Allied Health Medical Laboratory Science	5110

Louisiana State University Alexandria

Metric II. The following metrics will provide the campus enrollment trends.

Enrollment Headcount as of 14th Class Day	2018-2019	2019-2020	2020-2021	2021-2022	2022-2023	2023-2024
Undergraduate						
14th Day Enrollment for First Time Degree Seeking Freshmen	461	467	462	410	405	473
14th Day Degree Seeking New Transfer Student Enrollment	281	336	449	507	646	913
14th Day Degree Seeking Re-Admit Enrollment	125	125	101	120	117	143
Degree Seeking Continuing Undergraduates	1,808	1,870	2,028	2,161	2,316	2,663
First-Time Post-Baccalaureate						0
Non Degree Undergraduates	488	490	460	572	631	912
Total Undergraduate Headcount as of 14th Class Day	3,163	3,288	3,500	3,770	4,115	5,104
Undergraduate - First Time Degree Seeking Freshmen						
Full-time (In-State Residency)	379	382	374	351	320	407
Full-time (Non Residency)	30	37	49	17	50	39
Part-time (In-State Residency)	51	46	35	38	31	21
Part-time (Non Residency)	1	2	4	4	4	6
Total First Time Degree Seeking Freshmen Headcount as of 14th Class Day	461	467	462	410	405	473
Undergraduate						
Full-time (In-State Residency)	1,644	1,704	1,806	1,783	1,856	2,158
Full-time (Non Residency)	174	185	242	323	435	590
Part-time (In-State Residency)	1,286	1,318	1,321	1,412	1,531	1,803
Part-time (Non Residency)	59	81	131	252	293	553
Total Undergraduate Headcount as of 14th Class Day	3,163	3,288	3,500	3,770	4,115	5,104
Graduate						
Full-time (In-State Residency)	0	0	0	0	0	0
Full-time (Non Residency)	0	0	0	0	0	0
Part-time (In-State Residency)	0	0	0	0	0	0
Part-time (Non Residency)	0	0	0	0	0	0
Total Graduate Headcount as of 14th Class Day	0	0	0	0	0	0
Grand Total Headcount as of 14th Class Day (Undergraduate & Graduate)	3,163	3,288	3,500	3,770	4,115	5,104
Total Undergraduate Full-Time-Equivalent (FTE) Enrollment as of 14th Class Day	2,867	2,954	3,173	3,304	3,606	4,394
Total Graduate Full-Time-Equivalent (FTE) Enrollment as of 14th Class Day	0	0	0	0	0	0
Total number of High School Dual Enrollments	463	462	461	570	648	875

Louisiana State University Alexandria

Metric II. The following metrics will provide the campus enrollment trends.

First Time Degree Seeking Enrollment by Race and Ethnicity as of 14th Class Day	2018-2019	2019-2020	2020-2021	2021-2022	2022-2023	2023-2024
Hispanic	9	7	15	10	2	
American Indian or Alaska Native	47	46	35	58	16	1
Asian	7	6	6	10	22	22
Black or African American	86	101	91	58	67	78
Native Hawaiian or Other Pacific Islander	0	0	0	0	0	0
White	291	291	292	256	237	287
Two or More Races	9	12	12	8	3	3
Nonresident Alien	0	0	4	8	10	19
Race/Ethnicity Unknown	12	4	7	2	48	63
Total	461	467	462	410	405	473
First Time Degree Seeking Enrollment by Gender as of 14th Class Day						
Male	136	182	173	159	156	149
Female	325	285	289	251	249	324
Total	461	467	462	410	405	473
Total Enrollment by Race and Ethnicity as of 14th Class Day						
Hispanic	74	63	77	70	65	49
American Indian or Alaska Native	282	308	361	438	266	153
Asian	45	45	62	68	111	162
Black or African American	580	593	646	675	763	929
Native Hawaiian or Other Pacific Islander	0	0	0	0	0	0
White	2,050	2,154	2,246	2,322	2,466	3,013
Two or More Races	74	84	78	76	53	39
Nonresident Alien	0	0	0	72	65	74
Race/Ethnicity Unknown	58	41	30	49	326	685
Total	3,163	3,288	3,500	3,770	4,115	5,104
Total Enrollment by Gender as of 14th Class Day						
Male	961	990	1,001	1,109	1,234	1,523
Female	2,202	2,298	2,499	2,661	2,881	3,581
Total	3,163	3,288	3,500	3,770	4,115	5,104

Louisiana State University Alexandria

Metric II. The following metrics will provide the campus enrollment trends.

Louisiana Transfer Enrollment	2018-2019	2019-2020	2020-2021	2021-2022	2022-2023	2023-2024
Transfer from Louisiana Community Colleges	143	196	101	102	76	252
Transfers from Louisiana Four-Year Universities	123	157	110	112	121	257
Student Credit Hours (SCH)						
Fall SCH	34,911	35,956	39,090	39,647	44,074	53,943
Spring SCH	31,960	31,546	32,623	35,817	37,947	41,249
Total number of students enrolled who received TOPS						
Performance	165	159	155	182	158	167
Opportunity	306	305	354	333	331	366
Honors	61	67	60	66	63	68
Tech	41	48	43	56	42	46
Total number of students enrolled who received TOPS	573	579	612	637	594	647
Enrollment by specified discipline						
Total number of student enrolled in STEM	274	278	326	398	458	734
Total number of students enrolled in Allied Health	878	878	811	816	904	1,147
Total number of students enrolled in Teacher Education (Note BOR Teacher Education Initiative)	174	207	259	207	144	129
Teacher Education Regular Program	131	191	248	202	140	128
Teacher Education Alternative Program	43	16	11	5	4	1

Note: In December 2012, Teacher Education Programs MATE & MATS enrollments moved from Regular to Alternative for 2009-10, 2010-11, and 2011-12

Note: Beginning with Fall 2014 reporting cycle, enrollment in STEM determined by the Complete College America (CCA) definition used by the Board of Regents. Data reported using CCA for 2008-09 through 2014-15

Note: Beginning with Fall 2014 reporting cycle, 14th day degree-seeking transfer enrollment includes fall and continuing summer transfers. This methodology used to report 2008-09 through 2015-16 data in December 2015.

Note: Beginning with Fall 2015 reporting cycle, headcount enrollment and student credit hours includes Hebert Law Center.

Louisiana State University Alexandria

Metric II. The following metrics will provide the campus enrollment trends.

List of STEM/SMART CIP code/s:

The following list of CIP codes is to serve as a guide but it is not intended to be inclusive of all possibilities. We recognize that some campuses have degree programs centered in schools or colleges that might dictate a different CIP code. The campus should make the appropriate adjustment. In addition, the CIP codes used by the campus should correlate to the Board of Regents. If there is a discrepancy and the campus applies the IPEDS CIP code, then the campus should identify this with a footnote.

11	Computer and Information Sciences and Support Services
14	Engineering
15	Engineering Technologies/Technicians
26	Biological and Biomedical Sciences
27	Mathematics and Statistics
40	Physical Sciences
0109	Animal Sciences
0110	Food Science and Technology
0111	Plant Sciences
0112	Soil Sciences
0301	Natural Resources Conservation and Research
0303	Fishing and Fisheries Sciences and Management
0305	Forestry
0306	Wildlife and Wildlands Science and Management
2901	Military Technologies
3001	Biological and Physical Sciences
3006	Systems Science and Theory
3008	Mathematics and Computer Science
3010	Biopsychology
3016	Accounting and Computer Science
3018	Natural Sciences
3019	Nutrition Sciences
3024	Neuroscience
3025	Cognitive Science
4101	Biology Technician/Biotechnology Laboratory Technician
4102	Nuclear and Industrial Radiologic Technologies/Technicians
4103	Physical Science Technologies/Technicians
4199	Science Technologies/Technicians Other
4211	Physiological Psychology/Psychobiology

Allied Health CIP Code/s

51.07	Allied Health Elder Care Administration
51.08	Allied Health and Medical Assisting Services
51.09	Allied Health Diagnostic, Intervention, and Treatment Professions
51.10	Allied Health Medical Laboratory Science

Variables Description

- Headcount Enrollment Undergraduate** – Total number of full-time and part-time students enrolled in courses for undergraduate credit.
- Headcount Enrollment Graduate** – Total number of full-time and part-time students enrolled in courses for graduate credit.
- Full-Time Equivalent (FTE)** – The calculation of FTE can vary by institution. However, FTE enrollment reported for this metric should reconcile to FTE data you
- Full-Time Student Undergraduate** - a student enrolled for 15 or more semester credits or 30 or more contact hours a week each term. (IPEDS)
- Dual Enrollment** - A student who is enrolled in high school but who is also enrolled, simultaneously, in a postsecondary institution are considered dual enrolled.
- Science Technology Engineering and Mathematics (STEM)** - STEM enrollment is calculated based on STEM CIP codes.
- Educations, Nursing, Allied Health** - Use the CIP codes as defined by IPEDS for these disciplines to determine the number of students enrolled and graduates in

Louisiana State University Alexandria

Metric III. The following metric will identify the campus trends for retention, graduation, licensure and pass rate.

Analysis of First-time, Full-time, Baccalaureate Degree-seeking Freshmen (Fall Cohorts)¹

Cohort Type	Cohort Year	Head Count	Average ACT	% continuation to_2nd_Yr	% continuation to_3rd_Yr	Cumulative % Graduating after 4 Yrs.	Cumulative % Graduating after 5 Yrs.	Cumulative % Graduating after 6 Yrs.	Cumulative % Graduating after 7 Yrs.
Fall	2014	228	21.4	64.0%	47.8%	16.7%	28.8%	30.6%	38.2%
Fall	2015	237	20.5	55.7%	37.4%	16.9%	23.0%	30.4%	
Fall	2016	233	20	56.1%	37.1%	12.7%	27.9%	30.6%	
Fall	2017	215	20.3	61.2%	50.6%	25.6%			
Fall	2018	236	20.9	58.0%	43.0%				
Fall	2019	277	20.5	60.0%	39.6%				
Fall	2020	293	20.6	57.6%	38.2%				
Fall	2021	240	20.5	64.1%					
Fall	2022	257	19.2	65.0%					
Fall	2023	322	19						
Louisiana Community College Transfers (LACCT)									
LACCT	2014	149							
LACCT	2015	208							
LACCT	2016	251							
LACCT	2017	237							
LACCT	2018	341							
LACCT	2019	421							
LACCT	2020	555							
LACCT	2021	657							
LACCT	2022	646							
LACCT	2023	252							

Louisiana State University Alexandria

Metric III. The following metric will identify the campus trends for retention, graduation, licensure and pass rate.

	2014-2015	2015-2016	2016-2017	2017-2018	2018-2019	2019-2020	2020-2021	2021-2022	2022-2023
Number of students passing licensure exams									
Nurses	59	51	70	99	126	145	161	142	132
Clinical Laboratory Science	6	4	4	13	22	31	24	11	9
Radiologic Technology	9	9	12	11	15	8	6	13	5
Pharmacy Tech	10	4	11	10	8	4	4	5	8
BS in Elementary Education	17	15	13	19	15	15	19	14	8
Alternative Certificate in Elementary Education	3	1	2	2	2	2	0	0	1
Alternative Certification in Secondary Education	3	N/A	N/A	2	4	5	3	1	0
Alternative Certification in Health and Physical Education K-12	0	1	2	3	2	0	3	1	0
Minor in Education Leading to Secondary Education (6-12) Certification	3	N/A	N/A	N/A		0	0	0	0

Louisiana State University Alexandria

Metric III. The following metric will identify the campus trends for retention, graduation, licensure and pass rate.

Percentage of students passing licensure exams									
Nurses	90%	94%	95%	95%	94%	95%	95%	93%	94%
Clinical Laboratory Science	100%	100%	100%	100%	100%	100%	100%	100%	100%
Radiologic Technology	89%	100%	100%	100%	100%	100%	84%	92%	71%
Pharmacy Tech	80%	100%	100%	100%	100%	100%	100%	100%	100%
BS in Elementary Education	100%	100%	100%	100%	100%	100%	100%	100%	100%
Alternative Certificate in Elementary Education	100%	100%	100%	100%	100%	100%	N/A	NA	100%
Alternative Certification in Secondary Education	100%	N/A	N/A	100%	100%	100%	100%	100%	N/A
Alternative Certification in Health and Physical Education K-12	100%	100%	100%	100%	100%	N/A	100%	100%	N/A
Minor in Education Leading to Secondary Education (6-12) Certification	100%	N/A	N/A	N/A	N/A	N/A	N/A	NA	N/A

¹ Numbers for each time period represent students graduating with bachelor degrees. There are several more who changed majors and received associate degrees.

Louisiana State University Alexandria

Metric V. The following metrics will identify the tuition and fee revenues, and, other revenue resources.

	2017-2018	2018-2019	2019-2020	2020-2021	2021-2022	2022-2023
Total Endowment Value	\$15,339,658	\$15,351,454	\$14,860,428	\$18,418,022	\$16,401,880	\$19,124,272
Earned Interest on Endowments	\$693,322	\$716,551	\$685,269	\$738,885	\$763,930	\$856,305
Dollar amount of the endowment approved each fiscal year and made available for expenditures by the campus	\$674,168	\$696,683	\$665,719	\$718,325	\$747,396	\$818,353
Total # of Foundations	1	1	1	1	1	1
Foundations total Assets (\$ Amount)	\$37,275,794	\$36,882,987	\$37,002,538	\$42,388,033	\$43,725,592	\$45,074,428
Click here to go to the Foundations Supplemental Table						
Total # of Board of Regents Support Fund						
Total Value (\$ Amount) of BoR Support Fund	\$8,776,062	\$8,917,080	\$8,916,365	\$10,413,946	\$9,147,271	\$10,421,322
Click here to go to the BoR Support Funds Supplemental Table						
Total Gross Revenue Generated from tuition and fees¹						
Total Gross Revenue From First-Time-Full-Time Freshmen	\$2,563,340	\$2,669,167	\$2,737,337	\$2,492,518	\$2,518,014	\$2,406,020
Gross Revenue From First-Time-Full-Time Freshmen (In-State Only)	\$2,389,424	\$2,513,339	\$2,528,401	\$2,233,280	\$2,403,065	\$2,143,128
Gross Revenue From First-Time-Full-Time Freshmen (Out-of-State Only)	\$173,916	\$155,828	\$208,936	\$259,238	\$114,949	\$262,892
Net Revenue From First-Time-Full-Time Freshmen	\$2,442,689	\$2,565,279	\$2,640,220	\$2,339,825	\$2,430,003	\$2,286,032
Net Revenue From First-Time-Full-Time Freshmen (In-State Only)	\$2,307,816	\$2,435,514	\$2,570,702	\$2,248,037	\$2,326,290	\$2,061,774
Net Revenue From First-Time-Full-Time Freshmen (Out-of-State Only)	\$134,873	\$129,765		\$91,788	\$103,713	\$224,258
Financial Aid						
Total institutional dollars awarded need based aid for entering freshmen class	\$0	\$0	\$0	\$0	\$0	\$0
Total institutional dollars awarded non-need aid for entering freshmen class	\$111,019	\$100,213	\$95,367	\$145,673	\$91,350	\$117,488
Total institutional dollars awarded need based aid for entering freshmen class LA residents	\$0	\$0	\$0	\$0	\$0	\$0
Total institutional dollars awarded non-need based aid for entering freshmen class LA residents	\$65,790	\$70,725	\$74,718	\$85,690	\$76,525	\$79,854
Total institutional dollars awarded need based aid for entering freshmen class non-residents	\$0	\$0	\$0	\$0	\$0	\$0
Total institutional dollars awarded non-need based aid for entering freshmen class non-residents	\$45,228	\$20,559	\$21,147	\$55,650	\$8,234	\$37,134
State Appropriation per FTE²	\$1,954	\$2,083	\$1,648	\$1,017	\$2,092	\$2,170
Net Revenue Generated from auxiliary enterprises (i.e., bookstores, dining services)	\$110,605	(\$291,806)	\$442,734	\$394,668	\$318,705	\$1,068,997

¹ Prior year data only included revenue from tuition, and did not include revenue from fees. Revenue data reported for this year includes both.

² State Appropriation per FTE = the Board of Regents Formula Appropriations Per FTE which includes State General Fund and Statutory Dedications.

*Note: Institutional dollars included are all LSUA operating funds awarded students and all Foundation scholarship dollars. Any foundation scholarship awards which indicate a that the student must demonstrate financial need are included in calculations

Louisiana State University Alexandria

Metric VI. The following metrics will identify teaching and research productivity per FTE faculty.

Enrollment in Fall Semester Lecture and Seminar Courses	2017-2018	2018-2019	2019-2020	2020-2021	2021-2022	2022-2023
Lower Division Undergraduate Courses						
Total Enrollment	8,210	7,991	8,113	8,275	8,766	9,071
Number of Sections	306	326	331	298	302	298
Average section size	26.8	24.5	24.5	27.8	29.0	30.4
Upper Division Undergraduate Courses						
Total Enrollment	3,214	3,349	3,562	4,040	4,266	5,148
Number of Sections	153	175	178	189	193	209
Average section size	21.0	19.1	20.0	21.4	22.1	24.6
All Lecture and Seminar Courses						
Total Enrollment	11,426	11,340	11,675	12,315	13,032	14,219
Number of Sections	459	501	509	487	495	507
Average section size	24.9	22.6	22.9	25.3	26.3	28.0
Fall Teaching Activity						
Tenure/tenure track (T/TT) FTE faculty assigned to classes ¹	67	75	76	73	75	73
Non tenure/tenure track FTE faculty assigned to classes ²	73	92	106	102	94	95
Organized class sections including labs, fall only						
Sections taught by tenure/tenure track faculty	271	444	454	457	395	376
Sections taught by non tenure/tenure track faculty	267	268	297	309	260	269
Average # of class sections taught per FTE T/TT faculty	4.04	5.92	5.97	6.26	5.27	5.15
Average # of class sections taught per FTE non T/TT faculty	3.66	2.91	2.80	3.03	2.77	2.83
% class sections taught by T/TT faculty	50	62	60	60	60	68
% class sections taught by non T/TT faculty	50	38	40	40	40	42

Louisiana State University Alexandria

Metric VI. The following metrics will identify teaching and research productivity per FTE faculty.

Enrollment in Fall Semester Lecture and Seminar Courses	2017-2018	2018-2019	2019-2020	2020-2021	2021-2022	2022-2023
Student Credit Hours (SCH'S), fall only ³						
Undergraduate	34,107	36,878	38,505	42,957	43,940	47,657
Total SCH's taught by T/TT faculty	17,102	22,551	23,315	26,054	27,195	27,130
Total SCH's taught by non T/TT faculty	17,005	14,327	15,190	16,903	16,745	20,527
Total SCH's taught per FTE T/TT faculty	255	301	307	357	363	371
Total SCH's taught per FTE non T/TT faculty	233	156	143	166	178	216
% SCH's taught by T/TT faculty	50%	61%	61%	61%	62%	57%
% SCH's taught by non T/TT faculty	50%	39%	39%	39%	38%	43%
Annual Instruction and Research Ratios	2017-2018	2018-2019	2019-2020	2020-2021	2021-2022	2022-2023
Annual student credit hours (SCH's), fall & spring						
Undergraduate	67,193	67,502	71,713	75,464	82,021	95,192
Annual FTE students ⁴	2,435	2,508	2,621	2,906	3,044	3,362
Direct unrestricted instructional expenditures	10,453,728	12,066,607	11,677,578	10,872,498	12,937,090	15,038,146
Disaggregated Direct Instructional Expenditures						
Salaries	5,949,085	6,555,287	6,632,716	5,863,066	5,834,806	7,058,756
Benefits	2,994,482	2,942,537	3,312,122	3,255,315	2,958,458	3,455,219
Other	1,510,161	2,568,783	1,732,740	1,754,117	4,143,826	4,524,171
Direct unrestricted instructional expenditures per SCH	156	179	163	144	158	158
Direct unrestricted instructional expenditures per FTE student ⁴	4,293	4,811	4,455	3,741	4,250	4,473
Personnel costs as % of direct unrestricted instructional expenditures	85.6%	78.7%	85.2%	83.9%	68.0%	70.0%
Total FTE faculty	140	167	182	182	169	168
Total FTE T/TT faculty (instruction, research, public service)	67	75	76	76	75	73
Tenure/Tenure Track FTE faculty as % of total FTE faculty	48	45	42	42	44	43
Restricted research expenditures	5,263	23,249	3,500	93,240	105,735	56,944
Restricted research expenditures per FTE T/TT faculty	79	310	46	1,227	1,410	780

¹ FTE for tenured/tenure-track faculty based on 12 hr teaching load

² FTE for non-tenured/tenure-track faculty based on 15 hr teaching load. This group

³ All SCHs reported in this spreadsheet are from the production database (not census) so

⁴ Data reflects IPEDS Fall survey.

Louisiana State University Alexandria

Metric VI. The following metrics will identify teaching and research productivity per FTE faculty.

Enrollment in Fall Semester Lecture and Seminar Courses	2017-2018	2018-2019	2019-2020	2020-2021	2021-2022	2022-2023
---	-----------	-----------	-----------	-----------	-----------	-----------

Definitions:

Direct Expenditures for Instructions: Total Direct Instructional Expenditures include data in certain functional areas - instruction, research, and public service. Direct expenditure data reflect costs incurred for personnel compensation, supplies, and services used in the conduct of each of these functional areas. They include acquisition costs of capital assets such as equipment and library books to the extent that funds are budgeted for the use of departments for instruction, research, and public service. Similar to the Delaware Study, exclude centrally allocated computing costs and centrally supported computer labs, and graduate student tuition remission and fee waivers.

Instruction: Instruction includes general academic instruction, occupational and vocational instruction, community education, preparatory and adult basic education, and remedial and tutorial instruction conducted by the teaching faculty for the institution's students. Departmental research and service **which are not separately budgeted** should be included under instruction. In other words, department research which is externally funded should be excluded from instructional expenditures, as should any departmental funds which were expended for the purpose of matching external research funds as part of a contractual or grant obligation. EXCLUDE expenditures for academic administration where the primary function is administration. For example, exclude deans, but include department chairs.)

Disaggregate total direct instructional expenditures for the institution into the following categories:

Salaries: Report all wages paid to support the instructional function in a given department or program during the fiscal year. While these will largely be faculty salaries, be sure to include clerical (e.g., department secretary), professionals (e.g., lab technicians), Graduate student stipends (but not tuition waivers), and any other personnel who support the teaching function and whose salaries and wages are paid **from the institution's instructional budget**.

Benefits: Report expenditures for benefits associated with the personnel for whom salaries and wages were reported on the previous entry. If you cannot separate benefits from salaries, but benefits are included in the salary figure you have entered, indicate "Included in Salaries" in the data field. Some institutions book benefits centrally and do not disaggregate to the department level. If you can compute the appropriate benefit amount for the department/program, please do so and enter the data. If you cannot do so, leave the benefit amount as zero and we will impute a cost factor based upon the current benefit rate for your institution, as published in *Academe*. If no rate is available, we will use a default value of 28%.

Other Than Personnel Costs: This category includes non-personnel items such as travel, supplies and expense, non-capital equipment purchases, etc., that are typically part of an instructional department or program's cost of doing business. *Excluded* from this category are items such as central computing costs, centrally allocated computing labs, graduate student tuition remission and fee waivers, etc.

Research: This category includes all funds expended for activities specifically organized to produce research outcomes and commissioned by an agency either external to the institution or **separately budgeted** by an organizational unit within the institution. Report total research expenditures only. It is not necessary to disaggregate costs for this category.

Public Service: Report all funds **separately budgeted** specifically for public service and expended for activities established primarily to provide non-instructional services beneficial to groups external to the institution. Examples include cooperative extension and community outreach projects. Report total service expenditures only. It is not necessary to disaggregate costs for this category.

Federally Funded Research: As defined by NSF

Total Research and Expenditures: As defined by NSF

Table I: Affiliated Off-Campus Sites

LSUA System Campus	Name of Affiliated Off- Campus Site	\$ Amount Contributed Back to Campus by Affiliated Off-Site Campus	\$ Amount Contributed Back to Campus by Affiliated Off-Site Campus	\$ Amount Contributed Back to Campus by Affiliated Off-Site Campus	\$ Amount Contributed Back to Campus by Affiliated Off-Site Campus	\$ Amount Contributed Back to Campus by Affiliated Off-Site Campus	\$ Amount Contributed Back to Campus by Affiliated Off-Site Campus	\$ Amount Contributed Back to Campus by Affiliated Off-Site Campus	\$ Amount Contributed Back to Campus by Affiliated Off-Site Campus
	None								

Table II: Board of Regent Support Funds

LSUA System Campus	Name of Support Fund	Endowment Market Value as of 6/30/16	Endowment Market Value as of 6/30/17	Endowment Market Value as of 6/30/18	Endowment Market Value as of 6/30/19	Endowment Market Value as of 6/30/20	Endowment Market Value as of 6/30/21	Endowment Market Value as of 6/30/22	Endowment Market Value as of 6/30/23
LSUA	F. Hugh Coughlin Endowed Professorship	130,461.28	142,776.35	139,068.15	139,452.90	137,571.12	161,371.03	138,651.97	142,887.49
LSUA	Mark Eugene Howard Endowed Professorship in Liberal Arts (English)	161,009.43	177,811.85	172,942.90	173,090.84	169,926.93	201,753.70	172,984.10	179,371.24
LSUA	Huie Dellmon Trust Endowed Professorship in Science	174,099.76	192,118.30	186,868.93	187,037.26	183,649.43	217,954.98	186,888.68	193,748.13
LSUA	Howard M. and Eloise Ferris Mulder Endowed Professorship	126,921.33	139,016.76	135,380.15	135,727.61	133,817.34	157,198.81	135,032.44	139,262.24
LSUA	Jenkins-Mulder Endowed Professorship in Business	113,018.49	123,176.42	120,029.71	120,466.14	119,049.12	139,032.96	119,550.78	122,925.08
LSUA	Jack and Sue Ellen Jackson Endowed Professorship in Education	120,538.65	132,013.71	128,539.50	128,866.22	127,008.20	149,330.04	130,229.54	134,519.01
LSUA	Roy O. Martin Lumber Company Endowed Professorship in Nursing	159,488.68	113,114.17	171,142.26	171,310.71	168,250.49	199,553.54	171,128.83	177,353.19
LSUA	Frances Holt Freedman Endowed Professorship in History and Ethics of	129,676.40	140,930.97	137,227.32	137,771.42	135,991.72	159,285.51	136,895.07	140,971.20
LSUA	Huie Dellmon Trust Endowed Professorship in Liberal Arts and Science	140,639.57	154,311.58	150,232.35	150,559.14	148,296.91	174,628.69	149,941.46	154,828.86
LSUA	J.H. Johnson Endowed Professorship in Business	179,184.28	196,460.71	191,072.55	191,463.34	188,176.14	222,794.47	191,117.54	197,892.64
LSUA	Cliff E LaBorde Sr. Endowed Professorship in Education	126,878.17	139,620.33	136,372.58	136,592.37	134,328.27	158,801.77	136,258.86	140,981.75
LSUA	Barbara M. Martin Endowed Professorship in Nursing	174,834.16	193,320.95	187,971.14	188,053.74	184,426.12	219,529.15	188,141.56	195,340.32
LSUA	Roy and Vinita Martin Endowed Professorship in Math & Sciences	133,017.91	146,690.94	142,653.81	142,791.36	140,156.66	166,480.20	142,729.73	148,032.42
LSUA	Rapides Regional Medical Center Endowed Professorship in Radiologic T	130,400.03	142,655.78	138,951.29	139,345.39	137,475.93	161,227.46	138,533.41	142,750.82
LSUA	Carolyn Cole Saunders Endowed Professorship	111,087.70	120,570.18	117,547.74	118,079.61	116,909.51	135,893.40	116,947.89	119,956.76
LSUA	Robert Rife Saunders Endowed Professorship	111,087.40	120,569.71	117,547.28	118,079.18	116,909.09	135,892.86	116,947.44	119,956.26
LSUA	Roy O. Martin Jr. Endowed Professorship in Business	112,045.90	121,740.86	118,763.16	119,295.98	118,255.69	137,043.58	118,000.62	120,846.95
LSUA	Henry Dade Foote Family Endowed Professorship	110,505.22	119,777.47	116,839.83	117,413.89	116,424.13	134,821.42	116,102.40	118,857.27
LSUA	Charles Adrian Vernon and William K. Child Jr. Endowed Professorship in	112,350.60	122,286.95	119,713.52	119,713.52	118,491.11	137,837.41	118,604.87	121,704.66
LSUA	Vinita Johnson Martin Endowed Professorship (established 2010)	130,315.05	143,135.54	139,281.61	139,539.51	137,258.69	162,171.53	139,164.35	143,945.32
LSUA	Moreau Family First Generation Endowed Scholarship	110,059.19	120,872.91	117,667.86	117,900.96	116,087.09	136,824.06	117,462.63	121,347.68
LSUA	LSUA Alumni and Friends Endowed Chair	1,193,409.08	1,262,903.66	1,236,380.29	1,249,095.19	1,253,993.57	1,407,127.35	1,218,612.29	1,226,870.99
LSUA	Capital One Endowed Professorship in Business	103,976.93	114,044.93	111,007.04	111,256.92	109,547.96	129,108.90	110,840.40	114,502.83
LSUA	Scott O. Brame/CLECO Endowed Chair in Finance	993,632.71	1,131,141.62	1,101,938.50	1,105,714.94	1,091,373.58	1,278,550.55	1,098,791.59	1,131,616.65
LSUA	2010 Endowed Scholarship for First Generation College Students	110,059.19	120,872.91	117,667.86	117,900.96	116,087.09	136,824.06	117,462.63	121,347.68
LSUA	Joanne Lyles White Endowed Professorship in Education	99,363.27	113,114.17	110,193.86	110,521.38	109,087.37	127,791.27	109,825.13	113,103.67
LSUA	2012 Endowed Scholarship for First Generation College Students	99,363.27	113,114.17	110,193.86	110,521.38	109,087.37	127,791.27	109,825.13	113,103.67
LSUA	Elder Care Administration Scholarship	99,363.27	113,114.17	110,193.86	110,521.38	109,087.37	127,791.27	109,825.13	113,103.67
LSUA	Michael Jenkins First Generation Endowed Scholarship	100,342.48	115,535.04	112,471.98	112,694.13	110,960.62	130,781.10	112,274.90	115,988.02
LSUA	Richard Bryan Gwartney Endowed Professorship	106,318.12	122,576.67	119,232.70	119,431.91	117,371.71	138,992.86	119,226.60	123,466.03
LSUA	Howard and Eloise Mulder Endowed Chair in the Arts	1,005,836.66	1,140,672.07	1,110,824.85	1,113,576.55	1,097,788.45	1,289,939.98	1,107,996.59	1,142,857.35
LSUA	Mulder Endowed First Generation Scholarship #1	100,583.67	115,234.12	111,082.50	111,357.68	109,778.87	128,994.03	110,799.69	114,285.77
LSUA	Mulder Endowed First Generation Scholarship #2	100,583.67	115,234.12	111,082.50	111,357.68	109,778.87	128,994.03	110,799.69	114,285.77
LSUA	Mulder Endowed First Generation Scholarship #3	100,250.06	115,234.12	112,523.18	112,744.06	111,004.59	130,848.17	112,330.19	116,052.05
LSUA	Mulder Endowed First Generation Scholarship #4	100,250.06	115,234.12	112,523.18	112,744.06	111,004.59	130,848.17	112,330.19	116,052.05
LSUA	Mulder Endowed First Generation Scholarship #5					104,281.70	122,267.69	105,062.14	108,246.67
LSUA	Howard and Eloise Mulder Endowed Professorship #2	100,583.67	114,067.22	111,082.50	111,357.68	109,778.87	128,994.03	110,799.69	114,285.77
LSUA	Howard and Eloise Mulder Endowed Professorship #3	100,250.06	115,589.60	112,523.18	112,744.06	111,004.59	130,848.17	112,330.19	116,052.05
LSUA	Arnold Aubert Vernon Endowed Scholarship	500,108.22	569,908.63	554,969.03	556,440.08	548,594.03	644,490.88	553,605.73	570,966.48
LSUA	Holcombe Endowed Scholarship for 1st Generation Students			106,487.38	106,762.37	105,276.02	123,622.87	107,134.73	110,554.48
LSUA	Mary Jane Brown Endowed Scholarship for 1st Generation Students			107,545.56	107,817.48	106,281.65	124,905.84	107,284.95	110,670.05
LSUA	Virginia Harvey Holcombe Endowed Scholarship for 1st Generation Students			110,804.74	111,067.21	109,378.98	128,857.39	110,632.32	114,264.20
LSUA	Jeremiah and Kenneth Grant Holcombe Endowed Scholarship 1st Gen Allied Health				108,901.92	107,357.59	126,149.91	108,356.58	111,766.23
LSUA	Endowed Professorship in Interdisciplinary Innovation							89,010.60	97,159.43
LSUA	Endowed Professorship in Experiential Excellence							100,799.61	111,355.68
LSUA	Alexandria Business Foundation Endowed Chair								1,001,885.41
		7,811,893.59	8,418,445.48	8,776,061.81	8,917,080.11	8,916,365.13	10,413,946.36	9,147,270.86	10,421,321.94

Louisiana State University Alexandria

National Benchmark Report

	Retention rates		Graduation rates (Class of Fall 2016)	State appropriations as percent of core revenues
	Full Time	Part Time		
159382 Louisiana State University Alexandria	67%	47%	32%	13%
106485 University of Arkansas at Monticello	68%	100%	39%	38%
139463 Dalton State College	67%	50%	22%	33%
482680 University North Georgia	72%	51%	39%	37%
207661 Rogers State University	63%	37%	25%	27%
218229 Lander University	66%	14%	45%	20%
218645 University of South Carolina Aiken	60%	0%	42%	17%
231712 Christopher Newport University	86%	0%	76%	44%
232681 University of Mary Washington	83%	92%	69%	46%
237330 Concord University	56%	0%	40%	30%
237792 Shepherd University	70%	57%	48%	27%
233897 The University of Virginia's College at Wise	70%	67%	45%	24%
108092 University of Arkansas-Fort Smith	71%	55%	42%	32%

**Louisiana State University Eunice
Metric Data**



April 26, 2024

Louisiana State University Eunice

Metric I Degrees Awarded: Degrees awarded continue to show a significant and upward trend, with the exception of Nursing. The decrease in Nursing is directly attributable to the pandemic, with students in the Nursing cohort withdrawing at previously unexperienced rates. All other Allied Health programs experienced a **22.2% increase**, as well as the **total number of degrees awarded to Louisiana Residents up 3.1%** and Associate degrees up **4.4%**, despite the historically negative exit of students in Nursing.

Metric II Enrollment: Total Undergraduate Enrollment increased by 15 students over 2021-22 for a total of 3,038 students. While Continuing Degree Seeking Student enrollment declined by 40 students, areas of growth were seen in Transfer, First Time Degree Seeking Freshman and Re-Admit Enrollment. Part-time student enrollment increased. TOPS recipients decreased for this year, however it has been increasing since 2018-2019 to 2021-22. It is noteworthy that Louisiana four-year regional and major university systems, dramatically altered and relaxed admission criteria for 2022-2023.

Metric III Student Success: First to Second Year Retention was up 6% along with outstanding progress of the Percentage of “At-Risk” Program Students in Good Academic Standing. Fall-to-Fall Retention Rate remains at 40% for “At Risk” students overall. The Mean GPA for this group is at slightly above a 2.0 with the mean being 2.021. Student Progress is up for students earning up to 24 credit hours, remained steady for 36 hours (after a positive increase over 2020-21), with a decrease in those full-time students completing 48 hours after 8 semesters. We believe this last metric is pandemic related and can be linked to the withdrawal rates from the Nursing program.

Metric V Revenue: Total Gross Revenue decreased by \$480,895.00 (11.6%) from the prior year while Net Revenue for First Time Full-time Freshman decreased by \$447, 103.00 (11.2%). The total Institutional Dollars awarded for Non-Need Aid for Entering Freshmen **Metric I Degrees Awarded:** Associate degrees awarded show a significant and upward trend with a 14.1% increase overall, and an 11.4% increase in the total number of degrees awarded to Louisiana residents and a 56.9% increase in the number of degrees awarded in Nursing, which works to close the gap in this high demand, and high wage career. In all other Allied Health programs, the degrees awarded declined 12.7%, due to an unusually small number of graduates in Respiratory Therapy. The total number of degrees in STEM declined by 38.5%, which is a trigger for deeper analysis.

Metric II Enrollment: New First Time Freshman increased by 3.4%, Degree Seeking Continuing Students increased by 5.2%, Dual Enrollment student increased by a very notable 83.2%, followed by a 12.9% decrease of students enrolled in STEM. Institutional concerns are as follows: the current state of the Science building has labs and classrooms that were **new in 1967**. These vastly under resourced facilities are contributing to a loss of students in STEM majors. While the increases in Dual Enrollment are positive, the state of this facility makes students less inclined to stay longer, save more on tuition costs, and move on to other four-year colleges and universities. LSUE is seeking funding to transform the current Science Building into a STEAM Innovation Center.

Metric III Student Success: With a focus on “Start on Track, Stay on Track, First to Second Year Retention rose 4.1%. Second to Third Year Retention was flat. Success of Academically “At Risk” Students, Fall-to-Fall Retention Rate rose 5.6%, Percentage of Program Students in Good Academic Standing rose 1.7%, with the Mean GPA of Program Students increasing by 6.3% for this group.

Metric V Revenues: Market Value of Endowment rose 8.7%, Total Gross Revenue from First Time, Full Time Freshman, dropped 5.3%, with declines in Out of State Revenue from the previous year. Net Revenue from FT-FT Freshmen declined 4.4%, which corresponds to a decline in State Appropriation per FTE of 28.2%. On a positive note, Auxiliary enterprises increased 54.7%.

Metric VI Instruction Productivity: Total number of sections taught by full time faculty decreased slightly by 1.3%, due to an increase in class size. Total class sections taught by part-time adjunct faculty rose by .9%. Total SCH’s taught per FTE rose Full Time Faculty (up 5.4%) and part-time faculty (up 10.6%) The percentage of SCH’s taught by Full Time Faculty rose by 5.2% with Direct Instructional Expenditures rising by 7.8% per FTE Student. LSUE’s ability to continue to do more with less raises serious institutional concerns.

LSUE MISSION:

Louisiana State University at Eunice, a member of the Louisiana State University System, is a comprehensive, open admissions institution of higher education. The University is dedicated to high quality, low-cost education and is committed to academic excellence and the dignity and worth of the individual. To this end, Louisiana State University at Eunice offers associate degrees, certificates and continuing education programs as well as transfer curricula. Its curricula span the liberal arts, sciences, business and technology, pre-professional and professional areas for the benefit of a diverse population. All who can benefit from its resources deserve the opportunity to pursue the goal of lifelong learning and to expand their knowledge and skills at LSUE.

- In fulfillment of this mission, Louisiana State University at Eunice strives to achieve the following:
- Encourage traditional and nontraditional populations to take advantage of educational opportunities.
- Create a learning environment which facilitates the integration of knowledge and the development of the whole person.
- Provide a general education which requires all students to master the skills and competencies necessary for lifelong learning.
- Provide programs which parallel four-year college and university courses, including special honors courses, which are directly transferable.
- Prepare students to meet employment opportunities as determined by regional needs.
- Prepare programs of developmental studies which will upgrade student skills to the levels necessary for successful college experience.
- Provide necessary support services to help students realize their maximum potential.
- Create and offer programs of Continuing/Adult Education and community service which respond to the needs of the area.

Louisiana State University Eunice

Metrics at a Glance

2022-2023

Legend:

Statistic		Most Recent Available	% Change from Previous Year
High	Y		
Low	X	Z	%

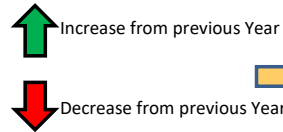

Metric I Degrees Awarded	Metric II Enrollment	Metric III Student Success	Metric V Revenues	Metric VI Instruction Productivity																				
Diploma <table border="1"> <tr><td>0</td><td>0</td></tr> <tr><td>0</td><td>N/A</td></tr> </table>	0	0	0	N/A	14th Day Enrollment for First Time Degree Seeking Freshmen <table border="1"> <tr><td>920</td><td>799</td></tr> <tr><td>768</td><td>↑ 3.4%</td></tr> </table>	920	799	768	↑ 3.4%	First to Second Year Retention <table border="1"> <tr><td>53.8%</td><td>52.4%</td></tr> <tr><td>42.0%</td><td>↑ 4.1%</td></tr> </table>	53.8%	52.4%	42.0%	↑ 4.1%	Market Value of Endowment <table border="1"> <tr><td>3,220,626</td><td>3,220,626</td></tr> <tr><td>2,109,241</td><td>↑ 8.7%</td></tr> </table>	3,220,626	3,220,626	2,109,241	↑ 8.7%	Total class sections taught per FTE full-time faculty <table border="1"> <tr><td>5.6</td><td>5.4</td></tr> <tr><td>5.1</td><td>↓ -1.3%</td></tr> </table>	5.6	5.4	5.1	↓ -1.3%
0	0																							
0	N/A																							
920	799																							
768	↑ 3.4%																							
53.8%	52.4%																							
42.0%	↑ 4.1%																							
3,220,626	3,220,626																							
2,109,241	↑ 8.7%																							
5.6	5.4																							
5.1	↓ -1.3%																							
Associates <table border="1"> <tr><td>380</td><td>380</td></tr> <tr><td>298</td><td>↑ 14.1%</td></tr> </table>	380	380	298	↑ 14.1%	Degree Seeking Continuing Undergraduates <table border="1"> <tr><td>1,400</td><td>1,324</td></tr> <tr><td>1,259</td><td>↑ 5.2%</td></tr> </table>	1,400	1,324	1,259	↑ 5.2%	Second to Third Year Retention <table border="1"> <tr><td>29.2%</td><td>23.0%</td></tr> <tr><td>18.7%</td><td>↓ -0.3%</td></tr> </table>	29.2%	23.0%	18.7%	↓ -0.3%	Total Gross Revenue From First-Time-Full-Time Freshmen <table border="1"> <tr><td>4,335,001</td><td>3,487,861</td></tr> <tr><td>3,108,428</td><td>↓ -5.3%</td></tr> </table>	4,335,001	3,487,861	3,108,428	↓ -5.3%	Total class sections taught per FTE part-time faculty <table border="1"> <tr><td>5.6</td><td>5.2</td></tr> <tr><td>5.1</td><td>↑ 0.9%</td></tr> </table>	5.6	5.2	5.1	↑ 0.9%
380	380																							
298	↑ 14.1%																							
1,400	1,324																							
1,259	↑ 5.2%																							
29.2%	23.0%																							
18.7%	↓ -0.3%																							
4,335,001	3,487,861																							
3,108,428	↓ -5.3%																							
5.6	5.2																							
5.1	↑ 0.9%																							
Total Number of Degrees Awarded to Louisiana Residents <table border="1"> <tr><td>409</td><td>409</td></tr> <tr><td>307</td><td>↑ 11.4%</td></tr> </table>	409	409	307	↑ 11.4%	Total Undergraduate Headcount as of 14th Class Day <table border="1"> <tr><td>3,623</td><td>3,623</td></tr> <tr><td>2,989</td><td>↑ 19.3%</td></tr> </table>	3,623	3,623	2,989	↑ 19.3%	Success of Academically "At Risk" Students (LSUE Pathways to Success Program - ACT Composite of less than 15) Fall-to-Fall retention rate <table border="1"> <tr><td>53.0%</td><td>0.0%</td></tr> <tr><td>36.0%</td><td>#REF!</td></tr> </table>	53.0%	0.0%	36.0%	#REF!	Net Revenue From First-Time-Full-Time Freshmen <table border="1"> <tr><td>4,079,513</td><td>3,372,790</td></tr> <tr><td>3,040,161</td><td>↓ -4.4%</td></tr> </table>	4,079,513	3,372,790	3,040,161	↓ -4.4%	Total SCH's taught per FTE full-time faculty <table border="1"> <tr><td>376.6</td><td>357.3</td></tr> <tr><td>329.0</td><td>↑ 5.4%</td></tr> </table>	376.6	357.3	329.0	↑ 5.4%
409	409																							
307	↑ 11.4%																							
3,623	3,623																							
2,989	↑ 19.3%																							
53.0%	0.0%																							
36.0%	#REF!																							
4,079,513	3,372,790																							
3,040,161	↓ -4.4%																							
376.6	357.3																							
329.0	↑ 5.4%																							
Total degrees awarded in STEM <table border="1"> <tr><td>39</td><td>24</td></tr> <tr><td>19</td><td>↓ -38.5%</td></tr> </table>	39	24	19	↓ -38.5%	Total number of High School Dual Enrollments <table border="1"> <tr><td>1,121</td><td>1,121</td></tr> <tr><td>466</td><td>↑ 83.2%</td></tr> </table>	1,121	1,121	466	↑ 83.2%	Percentage of Program Students in Good Academic Standing <table border="1"> <tr><td>84.0%</td><td>0.0%</td></tr> <tr><td>65.0%</td><td>#DIV/0!</td></tr> </table>	84.0%	0.0%	65.0%	#DIV/0!	State Appropriation per FTE <table border="1"> <tr><td>3,108</td><td>1,674</td></tr> <tr><td>1,674</td><td>↓ -28.2%</td></tr> </table>	3,108	1,674	1,674	↓ -28.2%	Total SCH's taught per FTE part-time faculty <table border="1"> <tr><td>352.7</td><td>347.5</td></tr> <tr><td>271.4</td><td>↑ 10.6%</td></tr> </table>	352.7	347.5	271.4	↑ 10.6%
39	24																							
19	↓ -38.5%																							
1,121	1,121																							
466	↑ 83.2%																							
84.0%	0.0%																							
65.0%	#DIV/0!																							
3,108	1,674																							
1,674	↓ -28.2%																							
352.7	347.5																							
271.4	↑ 10.6%																							
Total number of degrees awarded in Allied Health <table border="1"> <tr><td>57</td><td>48</td></tr> <tr><td>31</td><td>↓ -12.7%</td></tr> </table>	57	48	31	↓ -12.7%	Total number of students enrolled who received TOPS <table border="1"> <tr><td>694</td><td>597</td></tr> <tr><td>565</td><td>↑ 5.7%</td></tr> </table>	694	597	565	↑ 5.7%	Net Revenue Generated from auxiliary enterprises <table border="1"> <tr><td>677,652</td><td>59,911</td></tr> <tr><td>-132,344</td><td>↑ 54.7%</td></tr> </table>	677,652	59,911	-132,344	↑ 54.7%	% SCH's taught by full-time faculty <table border="1"> <tr><td>81.1%</td><td>81.1%</td></tr> <tr><td>69.1%</td><td>↑ 5.2%</td></tr> </table>	81.1%	81.1%	69.1%	↑ 5.2%					
57	48																							
31	↓ -12.7%																							
694	597																							
565	↑ 5.7%																							
677,652	59,911																							
-132,344	↑ 54.7%																							
81.1%	81.1%																							
69.1%	↑ 5.2%																							
Total number of degrees awarded in Nursing <table border="1"> <tr><td>82</td><td>80</td></tr> <tr><td>51</td><td>↑ 56.9%</td></tr> </table>	82	80	51	↑ 56.9%	Total number of student enrolled in STEM <table border="1"> <tr><td>343</td><td>169</td></tr> <tr><td>169</td><td>↓ -12.9%</td></tr> </table>	343	169	169	↓ -12.9%	Mean Grade Point Average of Program Students <table border="1"> <tr><td>2.39</td><td>0.00</td></tr> <tr><td>2.02</td><td>#DIV/0!</td></tr> </table>	2.39	0.00	2.02	#DIV/0!	Direct instructional expenditures per FTE student <table border="1"> <tr><td>3,107.0</td><td>3,091.0</td></tr> <tr><td>2,867.0</td><td>↑ 7.8%</td></tr> </table>	3,107.0	3,091.0	2,867.0	↑ 7.8%					
82	80																							
51	↑ 56.9%																							
343	169																							
169	↓ -12.9%																							
2.39	0.00																							
2.02	#DIV/0!																							
3,107.0	3,091.0																							
2,867.0	↑ 7.8%																							

Louisiana State University Eunice

Metric I. The following metrics will identify the number of degrees conferred by level and professions most important to

	2017-2018	2018-2019	2019-2020	2020-2021	2021-2022	2022-2023
Campus total number of degrees awarded/conferred						
Diploma	0	0	0	0	0	0
Certificates *	13	44	47	44	49	50
Associates	298	302	343	318	333	380
Total Number of Degrees Awarded to Louisiana Residents	307	344	381	356	367	409
Total Number of Degrees Awarded to Out of State Residents	4	2	9	6	15	21
* Includes Post-Associate certificates						
Total number of degrees awarded by race/ethnicity						
Hispanic	7	5	5	11	11	5
American Indian or Alaskan Native	4	1	3	2	2	1
Asian	1	1	1	3	3	1
Black, Non-Hispanic	51	58	52	48	45	55
Native Hawaiian or Other Pacific Islander	0	0	0	0	0	0
White, Non-Hispanic	233	263	293	285	281	335
Two or More Races	1	7	12	3	3	6
Nonresident Alien	2	0	6	2	2	2
Race/Ethnicity Unknown	12	11	18	8	15	25
Total degrees awarded						
Total degrees awarded in STEM	19	24	31	22	39	24
Total number of degrees awarded in Nursing	65	63	78	82	51	80
Total number of degrees awarded in Allied Health	31	57	50	45	55	48

Louisiana State University Eunice

Metric I. The following metrics will identify the number of degrees conferred by level and professions most important to

List of STEM/SMART CIP code/s: The following list of CIP codes is to serve as a guide but it is not intended to be inclusive of all possibilities. We recognize that some campuses have degree programs centered in schools or colleges that might dictate a different CIP code. The campus should make the appropriate adjustment. In addition, the CIP codes used by the campus should correlate to the Board of Regents. If there is a discrepancy and the campus applies the IPEDS CIP code, then the campus should identify this with a footnote.

- 11
- 14
- 15
- 26
- 27
- 40
- 0109
- 0110
- 0111
- 0112
- 0301
- 0303
- 0305
- 0306
- 2901
- 3001
- 3006
- 3008
- 3010
- 3016
- 3018
- 3019
- 3024
- 3025
- 4101
- 4102
- 4103
- 4199
- 4211

Nursing CIP Code/s

Nursing

Allied Health CIP Code/s

Allied Health and Medical Assisting Services
Allied Health Diagnostic, Intervention, and Treatment Professions

Louisiana State University Eunice

Metric II. The following metrics will provide the campus enrollment trends.

Enrollment Headcount as of 14th Class Day	2018-2019	2019-2020	2020-2021	2021-2022	2022-2023	2023-2024
Undergraduate						
14th Day Enrollment for First Time Degree Seeking Freshmen	920	784	880	768	773	799
14th Day Degree Seeking New Transfer Student Enrollment	221	166	193	223	245	252
14th Day Degree Seeking Re-Admit Enrollment	160	129	129	129	134	122
Degree Seeking Continuing Undergraduates	1,347	1,400	1,349	1,299	1,259	1,324
First-Time Post-Baccalaureate	0	0	0	0	0	0
Non Degree Undergraduates	584	510	561	604	627	1,126
Total Undergraduate Headcount as of 14th Class Day	3,232	2,989	3,112	3,023	3,038	3,623
Undergraduate - First Time Degree Seeking Freshmen						
Full-time (In-State Residency)	749	635	695	600	610	622
Full-time (Non Residency)	45	43	68	63	49	56
Part-time (In-State Residency)	123	106	114	96	104	110
Part-time (Non Residency)	3	0	6	9	10	11
Total First Time Degree Seeking Freshmen Headcount as of 14th Class Day	920	784	883	768	773	799
Undergraduate						
Full-time (In-State Residency)	1,628	1,508	1,543	1,451	1,421	1,479
Full-time (Non Residency)	56	74	111	122	108	113
Part-time (In-State Residency)	1,540	1,403	1,459	1,407	1,446	1,979
Part-time (Non Residency)	8	4	29	43	63	52
Total Undergraduate Headcount as of 14th Class Day	3,232	2,989	3,142	3,023	3,038	3,623
Graduate						
Full-time (In-State Residency)	0	0	0	0	0	0
Full-time (Non Residency)	0	0	0	0	0	0
Part-time (In-State Residency)	0	0	0	0	0	0
Part-time (Non Residency)	0	0	0	0	0	0
Total Graduate Headcount as of 14th Class Day	0	0	0	0	0	0
Grand Total Headcount as of 14th Class Day (Undergraduate & Graduate)	3,232	2,989	3,142	3,023	3,038	3,623
Total Undergraduate Full-Time-Equivalent (FTE) Enrollment as of 14th Class Day	2,669	2,533	2,621	2,501	2,540	2,829
Total Graduate Full-Time-Equivalent (FTE) Enrollment as of 14th Class Day	0	0	0	0	0	0
Total number of High School Dual Enrollments	530	466	561	588	612	1,121

Louisiana State University Eunice

Metric II. The following metrics will provide the campus enrollment trends.

First Time Degree Seeking Enrollment by Race and Ethnicity as of 14th Class Day	2018-2019	2019-2020	2020-2021	2021-2022	2022-2023	2023-2024
Hispanic	32	31	30	18	12	19
American Indian or Alaska Native	4	6	4	7	4	10
Asian	5	2	6	6	9	4
Black or African American	267	196	294	197	216	205
Native Hawaiian or Other Pacific Islander	0	1	0	0	0	0
White	563	510	508	502	492	503
Two or More Races	24	26	10	17	21	45
Nonresident Alien	17	7	1	6	4	0
Race/Ethnicity Unknown	8	5	30	15	15	13
Total	920	784	883	768	773	799
First Time Degree Seeking Enrollment by Gender as of 14th Class Day						
Male	307	254	253	218	211	198
Female	613	530	630	550	562	601
Total	920	784	883	768	773	799
Total Enrollment by Race and Ethnicity as of 14th Class Day						
Hispanic	75	87	88	66	48	51
American Indian or Alaska Native	15	20	15	25	12	25
Asian	18	24	31	30	32	46
Black or African American	799	701	800	708	767	946
Native Hawaiian or Other Pacific Islander	2	1	1	2	1	0
White	2,172	2,029	2,040	2,047	2,023	2,325
Two or More Races	91	76	64	76	83	146
Nonresident Alien	22	20	9	8	10	3
Race/Ethnicity Unknown	38	31	94	61	62	81
Total	3,232	2,989	3,142	3,023	3,038	3,623
Total Enrollment by Gender as of 14th Class Day						
Male	933	842	828	791	767	902
Female	2,299	2,147	2,314	2,232	2,271	2,721
Total	3,232	2,989	3,142	3,023	3,038	3,623

Louisiana State University Eunice

Metric II. The following metrics will provide the campus enrollment trends.

Louisiana Transfer Enrollment	2018-2019	2019-2020	2020-2021	2021-2022	2022-2023	2023-2024
Transfer from Louisiana Community Colleges	85	52	56	65	92	84
Transfers from Louisiana Four-Year Universities	102	119	128	95	94	113
Student Credit Hours (SCH)						
Fall SCH	32,032	30,400	31,447	30,016	30,261	33,943
Spring SCH	27,675	25,406	26,407	25,478	26,351	
Total number of students enrolled who received TOPS						
Performance	140	130	121	122	90	102
Opportunity	326	322	325	363	285	301
Honors	31	28	24	26	31	22
Tech	112	149	203	183	159	172
Total number of students enrolled who received TOPS	609	629	673	694	565	597
Enrollment by specified discipline						
Total number of student enrolled in STEM	343	224	207	221	194	169
Total number of students enrolled in Allied Health	451	522	552	563	498	569
Total number of students enrolled in Teacher Education (Note BOR Teacher Education Initiative)	0	0	0	0	0	0
Teacher Education Regular Program	0	0	0	0	0	0
Teacher Education Alternative Program	0	0	0	0	0	0

Note: Beginning with Fall 2014 reporting cycle, enrollment in STEM determined by the Complete College America (CCA) definition used by the Board of Regents. Data reported using CCA for 2008-09 through 2014-15

Note: Beginning with Fall 2014 reporting cycle, 14th day degree-seeking transfer enrollment includes fall and continuing summer transfers. This methodology used to report 2008-09 through 2015-16 data in December 2015.

Louisiana State University Eunice

Metric II. The following metrics will provide the campus enrollment trends.

List of STEM/SMART CIP code/s:

some campuses have degree programs centered in schools or colleges that might dictate a different CIP code. The campus should make the appropriate adjustment. In addition, the CIP codes used by the campus should correlate to the Board of Regents. If there is a discrepancy and the campus applies the IPEDS CIP code, then the campus should identify this with a

11	Computer and Information Sciences and Support Services
14	Engineering
15	Engineering Technologies/Technicians
26	Biological and Biomedical Sciences
27	Mathematics and Statistics
40	Physical Sciences
0109	Animal Sciences
0110	Food Science and Technology
0111	Plant Sciences
0112	Soil Sciences
0301	Natural Resources Conservation and Research
0303	Fishing and Fisheries Sciences and Management
0305	Forestry
0306	Wildlife and Wildlands Science and Management
2901	Military Technologies
3001	Biological and Physical Sciences
3006	Systems Science and Theory
3008	Mathematics and Computer Science
3010	Biopsychology
3016	Accounting and Computer Science
3018	Natural Sciences
3019	Nutrition Sciences
3024	Neuroscience
3025	Cognitive Science
4101	Biology Technician/Biotechnology Laboratory Technician
4102	Nuclear and Industrial Radiologic Technologies/Technicians
4103	Physical Science Technologies/Technicians
4199	Science Technologies/Technicians Other
4211	Physiological Psychology/Psychobiology

Allied Health CIP Code/s

51.08	Allied Health and Medical Assisting Services
51.09	Allied Health Diagnostic, Intervention, and Treatment Professions

Variables Description

Headcount Enrollment Undergraduate – Total number of full-time and part-time students enrolled in courses for undergraduate credit.

Headcount Enrollment Graduate – Total number of full-time and part-time students enrolled in courses for graduate credit.

Full-Time Equivalent (FTE) – The calculation of FTE can vary by institution. However, FTE enrollment reported for this metric should reconcile to FTE data you report to the Louisiana BoR, SREB and IPEDS for your campus.

Full-Time Student Undergraduate - a student enrolled for 15 or more semester credits or 30 or more contact hours a week each term. (IPEDS)

Dual Enrollment - A student who is enrolled in high school but who is also enrolled, simultaneously, in a postsecondary institution are considered dual enrolled.

Science Technology Engineering and Mathematics (STEM) - STEM enrollment is calculated based on STEM CIP codes.

Educations, Nursing, Allied Health - Use the CIP codes as defined by IPEDS for these disciplines to determine the number of students enrolled and graduates in

Louisiana State University Eunice

Metric III. The following metric will identify the campus trends for retention, graduation, licensure and pass rate.

Analysis of First-time, Full-time, Associate Degree-seeking Freshmen

Cohort Type	Cohort Year	Head Count	% continuation to_2nd_Yr	% continuation to_3rd_Yr	% Graduation in_1st_Yr	% Graduation in_2nd_Yr	% Graduation in_3rd_Yr	% Graduation 150 Total	% Graduation in_4th_Yr	% Graduation in_5th_Yr	% Graduation in_6th_Yr
Total	2017	364	52.75%	29.12%	0.0%	3.6%	9.6%	13.2%	8.2%		
Total	2018	497	51.11%	26.36%	0.0%	4.6%	7.60%	12.2%			
Total	2019	671	51.56%	23.85%	0.9%	6.0%					
Total	2020	744	47.45%	23.11%	0.4%	4.40%					
Total	2021	660	50.30%	23.03%	0.3%	10.76%					
Total	2022	651	52.38%								
Total	2023	666									

Student Progression, Number of Full Time Student Completing

	2013-2014	2014-2015	2015-2016	2016-2017	2017-2018	2018-2019	2019-2020	2020-2021	2021-2022	2022-2023	2023-2024
Original Full-Time Cohort	FA09 - 1688	FA10_1655	FA11-1472	FA12-1394	FA13-1283	FA14-1351	FA15-1261	FA16-1388	FA17-1429	FA18-1684	FA19-1581
Up to 24 hours after 4 semesters	572	567	497	498	441	459	460	476	546	602	571
36 hours after 6 semesters	231	254	229	205	200	201	205	226	248	248	246
48 hours after 8 semesters	94	101	91	91	89	100	82	96	111	87	98

Success of Academically "At Risk" Students (LSUE Pathways to Success Program - ACT Composite of less than 15)

	2014	2015	2016	2017	2018	2019	2020	2021	2022	2023
Fall-to-Fall retention rate	50%	44%	49%	44%	53%	42%	42%	36%	36%	38%
Percentage of Program Students in Good Academic Standing	78%	80%	84%	78%	76%	71%	74%	65%	68%	69%
Percentage of Students Dropped from the University for Poor Academic Performance	4%	4%	4%	4%	5%	6%	3%	3%	5%	6%
Mean Grade Point Average of Program Students	2.286	2.266	2.311	2.387	2.328	2.162	2.343	2.019	2.021	2.149

Employer Satisfaction Rate with Nursing and Allied Health Field Graduates

	2013-2014	2014-2015	2015-2016	2016-2017	2017-2018	2018-2019	2019-2020	2020-2021	2021-2022	2022-2023	2023-2024
Nursing	100	100	100	100		100	100	NR	NR	NR	100
Radiologic Technology	100	100	100	100	100	100	100	100	100	100	100
Respiratory Care	100	100	100	100	100	100	100	100	100	NR	100
Diagnostic Medical Sonography	100	100	NA	NA	NA	NA	100	100	100	100	NA until June
Surgical Technology	NA	NA	NA	NA	NA	NA	NR	100	100	100	NA until June

Louisiana State University Eunice

Metric V. The following metrics will identify the tuition and fee revenues, and, other revenue resources.

	2014-2015	2015-2016	2016-2017	2017-2018	2018-2019	2019-2020	2020-2021	2021-2022	2022-2023
Total Endowment Value	1,981,610	1,837,643	2,109,241	2,191,846	2,315,053	2,347,515	3,125,122	2,961,868	3,220,626
Earned Interest on Endowments	78,306	69,489	76,554	79,046	84,067	86,549	96,603	99,519	113,182
Dollar amount of the endowment approved each fiscal year and made available for expenditures by the campus	78,306	69,489	76,554	79,046	84,067	86,549	96,603	99,519	113,182
Total # of Foundations	1	1	1	1	1	1	1	1	1
Foundations total Assets (\$ Amount)	2,216,806	2,138,652	2,284,262	2,416,910	2,916,166	3,250,416	4,023,968	4,398,486	4,526,182
Total # of Board of Regents Support Fund	7	7	8	8	11	15	21	26	27
Total Value (\$ Amount) of BoR Support Fund	971,532	923,446	1,021,031	1,086,106	1,116,027	1,195,712	1,707,440	1,671,003	1,854,268
Total Gross Revenue Generated from tuition and fees									
Total Gross Revenue From First-Time-Full-Time Freshmen	2,185,116	2,365,465	3,161,076	3,108,428	4,335,001	3,637,319	4,163,495	3,682,600.34	3,487,861.21
Gross Revenue From First-Time-Full-Time Freshmen (In-State Only)	2,113,027	2,318,743	2,885,181	2,193,895	3,861,157	3,221,460	3,582,626	3,148,587.42	3,088,796.47
Gross Revenue From First-Time-Full-Time Freshmen (Out-of-State Only)	72,089	46,722	275,894	214,533	473,844	415,859	580,869	534,012.92	399,064.74
Net Revenue From First-Time-Full-Time Freshmen	2,141,366	2,314,873	3,128,524	3,040,161	4,079,513	3,489,078	3,975,820	3,528,717.14	3,372,790.21
Net Revenue From First-Time-Full-Time Freshmen (In-State Only)	2,096,098	2,284,243	2,874,086	2,863,176	3,752,908	3,172,638	3,523,245	3,128,804.22	3,078,323.47
Net Revenue From First-Time-Full-Time Freshmen (Out-of-State Only)	45,269	30,630	254,438	176,895	326,605	316,440	452,575	3,128,804.22	294,466.74
Financial Aid									
Total institutional dollars awarded need based aid for entering freshmen class	\$0	\$0	\$0	\$0	\$0	\$0	\$0	\$0	\$0
Total institutional dollars awarded non-need aid for entering freshmen class	\$211,889	\$263,850	\$284,239	\$337,496	\$699,499	\$495,940	\$582,885	\$626,338	\$623,317
Total institutional dollars awarded need based aid for entering freshmen class LA residents	\$0	\$0	\$0	\$0	\$0	\$0	\$0	\$0	\$0
Total institutional dollars awarded non-need based aid for entering freshmen class LA residents	\$155,752	\$234,113	\$255,046	\$263,798	\$369,538	\$309,257	\$285,373	\$311,178.00	\$401,188.10
Total institutional dollars awarded need based aid for entering freshmen class non-residents	\$0	\$0	\$0	\$0	\$0	\$0	\$0	\$0	\$0
Total institutional dollars awarded non-need based aid for entering freshmen class non-residents	\$56,138	\$29,737	\$29,193	\$73,698	\$191,104	\$186,683	\$297,512	\$315,160	\$222,129
State Appropriation per FTE ¹	\$2,351	\$2,765	\$2,457	\$2,300	\$2,224	\$3,108	\$2,012	\$2,330	\$1,674
Net Revenue Generated from auxiliary enterprises (i.e., bookstores, dining services)	\$142,286	\$103,965	\$42,390	(\$83,485)	\$677,652	\$457,244	\$533,168	(\$132,344)	\$59,911

¹ State Appropriation per FTE = the Board of Regents Formula Appropriations Per FTE which includes State General Fund and Statutory Dedications.

Endowment Value equals the market value of of the endowment as of June 30 of the reporting year.

FTE Full time equivalent

Payout from Endowment equal interest earned on endowment.

Gross Revenue Generated from Student Enrollment FTE equals revenue gain from student tuitions and fees.

Net Revenue Generated from Student Enrollment FTE equals gross revenue from enrollment headcount minus institutional supported financial aid.

Net Revenue from Auxiliary equal gross revenue generated from auxiliary enterprises minus debt services and other financial obligations.

Louisiana State University Eunice

Metric VI. The following metrics will identify teaching and research productivity per FTE faculty.

	Fall 2017	Fall 2018	Fall 2019	Fall 2020	Fall 2021	Fall 2022	Fall 2023
Average Section Size in Lecture and Seminar courses							
Total Enrollment	9,159	10,138	9,512	10,012	9,414	9,610	10,596
Number of Sections	401	413	372	378	418	418	436
Average section size	23	25	26	26	23	23	24
Full-Time Academic FTE faculty assigned to classes							
Full-Time Academic FTE faculty assigned to classes	67.4	55.6	62.8	69.0	69.4	69.5	77.1
Part-Time Academic FTE faculty assigned to classes	24.4	25.4	23.3	19.0	18.3	17.4	15.3
Non-Academic FTE assigned to classes	1.4	1.5	4.1	1.5	2.6	4.6	3.5
Sections taught by full-time faculty							
Sections taught by full-time faculty	344	307	341	371	388	380	416
Sections taught by part-time faculty	128	143	120	96	93	89	79
Sections taught by non-academic staff	7	8	34	10	21	36	30
Total sections	479	458	495	478	502	505	525
Total class sections taught per FTE full-time faculty							
Total class sections taught per FTE full-time faculty	5.1	5.5	5.4	5.4	5.6	5.5	5.4
Total class sections taught per FTE part-time faculty	5.2	5.6	5.1	5.1	5.1	5.1	5.2
Total class sections taught per FTE non-academic staff	5.0	5.3	8.3	6.7	8.1	7.8	8.6
% class sections taught by full-time faculty							
% class sections taught by full-time faculty	71.8	67.0	68.9	77.6	77.3	75.2	79.2
% class sections taught by part-time faculty	26.7	31.2	24.2	20.1	18.5	17.6	15.0
% class sections taught by non-academic staff	1.5	1.7	6.9	2.1	4.2	7.1	5.7
Total student credit hours							
Total student credit hours	29,027	30,308	31,917	31,561	30,016	30,577	33,971
Total SCH's taught by full-time faculty	22,173	20,941	23,505	25,241	23,425	23,570	27,547
Total SCH's taught by part-time faculty	6,623	8,959	7,401	5,744	5,905	5,469	5,317
Total SCH's taught by non-academic staff	231	408	1,011	576	686	1,538	1,107
Total SCH's taught per FTE full-time faculty							
Total SCH's taught per FTE full-time faculty	329.0	376.6	374.6	365.8	337.5	339.1	357.3
Total SCH's taught per FTE part-time faculty	271.4	352.7	317.5	302.3	322.7	314.3	347.5
Total SCH's taught per FTE non-academic staff	165.0	272.0	246.6	384.0	263.8	334.3	316.3
% SCH's taught by full-time faculty							
% SCH's taught by full-time faculty	76.4%	69.1%	73.6%	80.0%	78.0%	77.1%	81.1%
% SCH's taught by part-time faculty	22.8%	29.6%	23.2%	18.2%	19.7%	17.9%	15.7%
% SCH's taught by non-academic staff	0.8%	1.3%	3.2%	1.8%	2.3%	5.0%	3.3%

Louisiana State University Eunice

Metric VI. The following metrics will identify teaching and research productivity per FTE faculty.

Annual	2017-2018	2018-2019	2019-2020	2020-2021	2021-2022	2022-2023	2023-2024
Total Annual student credit hours, fall & spring	59,840	59,707	59,514	61,713	55,494	56,612	
FTE students	2,493	2,488	2,480	2,571	2,312	2,359	
Direct instructional expenditures	7,567,227	7,657,437	7,380,620	7,371,252	7,182,680	7,291,046	
Direct instructional expenditures per SCH	126	128	124	119	129	129	
Direct instructional expenditures per FTE student	3,035	3,078	2,976	2,867	3,107	3,091	
Personnel cost as % of Direct Instructional Expenditures	96.78	96.45	96.88	98.03	96.46	93.13	
Total FTE faculty (instruction, research, public service)	82.56	90.19	90.06	90.4	91.5	96.3	
Full-time FTE faculty as % of total FTE faculty	67.34%	69.58%	76.62%	76.77%	75.96%	80.06%	

Definitions:

Direct Expenditures for Instructions: Total Direct Instructional Expenditures include data in certain functional areas - instruction, research, and public service. Direct expenditure data reflect costs incurred for personnel compensation, supplies, and services used in the conduct of each of these functional areas. They include acquisition costs of capital assets such as equipment and library books to the extent that funds are budgeted for the use of departments for instruction, research, and public service. Similar to the Delaware Study, exclude centrally allocated computing costs and centrally supported computer labs, and graduate student tuition remission and fee waivers.

Instruction: Instruction includes general academic instruction, occupational and vocational instruction, community education, preparatory and adult basic education, and remedial and tutorial instruction conducted by the teaching faculty for the institution's students. Departmental research and service **which are not separately budgeted** should be included under instruction. In other words, department research which is externally funded should be excluded from instructional expenditures, as should any departmental funds which were expended for the purpose of matching external research funds as part of a contractual or grant obligation. EXCLUDE expenditures for academic administration where the primary function is administration. For example, exclude deans, but include department chairs.)

Disaggregate total direct instructional expenditures for the institution into the following categories:

Salaries: Report all wages paid to support the instructional function in a given department or program during the fiscal year. While these will largely be faculty salaries, be sure to include clerical (e.g., department secretary), professionals (e.g., lab technicians), Graduate student stipends (but not tuition waivers), and any other personnel who support the teaching function and whose salaries and wages are paid **from the institution's instructional budget**.

Benefits: Report expenditures for benefits associated with the personnel for whom salaries and wages were reported on the previous entry. If you cannot separate benefits from salaries, but benefits are included in the salary figure you have entered, indicate "Included in Salaries" in the data field. Some institutions book benefits centrally and do not disaggregate to the department level. If you can compute the appropriate benefit amount for the department/program, please do so and enter the data. If you cannot do so, leave the benefit amount as zero and we will impute a cost factor based upon the current benefit rate for your institution, as published in *Academe*. If no rate is available, we will use a default value of 28%.

Other Than Personnel Costs: This category includes non-personnel items such as travel, supplies and expense, non-capital equipment purchases, etc., that are typically part of an instructional department or program's cost of doing business. *Excluded* from this category are items such as central computing costs, centrally allocated computing labs, graduate student tuition remission and fee waivers, etc.

Louisiana State University Eunice

Metric VI. The following metrics will identify teaching and research productivity per FTE faculty.

Research: This category includes all funds expended for activities specifically organized to produce research outcomes and commissioned by an agency either external to the institution or **separately budgeted** by an organizational unit within the institution. Report total research expenditures only. It is not necessary to disaggregate costs for this category.

Public Service: Report all funds **separately budgeted** specifically for public service and expended for activities established primarily to provide non-instructional services beneficial to groups external to the institution. Examples include cooperative extension and community outreach projects. Report total service expenditures only. It is not necessary to disaggregate costs for this category.

Federally Funded Research: As defined by NSF

Total Research and Expenditures: As defined by NSF

Louisiana State University Eunice

National Benchmark Report

	Success rates in developmental courses			Success rates in the first general education course after developmental courses.			The percentage of students who completed their developmental education sequence
	English	Math	Reading	English	Math	Reading/Social Sciences	
Louisiana State University Eunice	57%	44%	74%	72%	62%	84%	45%
National Average	63%	50%	63%	78%	62%	78%	40%

Notes:

- Citation for current research: Chen, X. (2016). Remedial Course taking at U.S. Public 2- and 4-Year Institutions: Scope, Experiences, and Outcomes (NCES 2016-405). U.S. Department of Education. Washington, DC: National Center for Education Statistics. Retrieved January 15, 2018 from <http://nces.ed.gov/pubsearch>
- Developmental English, Math, and Reading calculated for AY 2018-2019. Completion of the general education course work is for students beginning as new first-time freshmen in AY 2014-2015 and completing the first general education same subject area in six years.
- Math at 44% was calculated using an overall for MATH 0001, MATH 0015, and MATH 0021 n = (247 with an A, B, or C)/(total n=436).
- Program Completion in Pathways to Success only calculated through Spring 2020 based on new first-time students entering in AY 2014-2015.

**Louisiana State University Shreveport
Metric Data**



April 26, 2024

Louisiana State University Shreveport

Executive Summary

LSU Shreveport Performance Metrics

2/1/2024

LSU Shreveport saw increases in several key metrics for the current reporting cycle including overall enrollment, graduation rates, and market value of endowments. Fall enrollment hit its second-highest total ever. The number of degrees awarded fell back from last year's all-time high, while the six-year graduation rate showed a modest increase. Second-year retention was down, while third-year retention showed a sharp increase.

Metric I - Degrees Awarded

LSUS awarded 3,573 degrees in 2022-23 and has awarded over 16,000 degrees in the last five years. The number of degrees awarded in STEM categories rose markedly, while the number of specialist awards also increased. The number of bachelor's, master's, and doctoral degrees fell compared to last year.

Metric II - Enrollment

Fall enrollment grew by 11.6% to 9,736. Undergraduate enrollment was up 3.4% over last year, and graduate level enrollment increased by 14.9%. Enrollment of first-time, degree-seeking freshmen was down 6.9%, while enrollment of new transfer students increased 14.4%. High school dual enrollment was up by 24.5%.

Metric III - Student Success

The six-year graduation rate showed a small increase compared to the previous year, growing to 33.2%. Second year retention for first-time, full-time freshmen fell back closer to the historical average. However, third year retention jumped up by 7.5 percentage points. Similarly, second year retention for LA community college transfers was down, while third year retention was up.

Metric IV - Research Expenditures

To be populated.

Metric V - Technology Transfer

To be populated.

Metric VI - Revenues

The market value of endowments grew 7.5% for the most recent reporting period. Net revenue from first-time, full-time freshmen showed a similar increase. State appropriations per FTE jumped by 15.9%.

Metric VII - Faculty Productivity

SCH enrollment in Fall 2022 was relatively flat compared the previous year. The number of SCH's taught per tenure/tenure track faculty and per non-tenure/non-tenure track faculty both increased. The number of tenure/tenure track faculty assigned to classes was down 14.5%.

Benchmark with Peers

LSUS receives significantly lower state appropriations per FTE student than its peer institutions. As a consequence, LSUS relies on higher tuition and fees per FTE student than its peers. LSUS's combined total of tuition, fees, and state appropriations per FTE student also trails those of its peers.

LSUS MISSION:

The mission of LSUS is to:

Educate a diverse population of graduate and undergraduate students by promoting critical thought and student development through creative techniques and active learning.

Engage in regional and global thought leadership through community collaboration and service.

Innovate and foster opportunities to enhance the application of knowledge and intellectual discovery through faculty and student research and creative endeavors.

Louisiana State University Shreveport

Metrics at a Glance

2022-2023



Increase from Previous Year



Decrease from Previous Year



No change

Legend:

Statistic	
X	Y
Z	%

Most Recent Available

% Change from Previous Year

Metric I Degrees Awarded	Metric II Enrollment	Metric III Student Success	Metric IV Research Expenditures	Metric V Technology Transfer	Metric VI Revenues	Metric VII Instruction Productivity																												
Bachelors <table border="1"> <tr><td>447</td><td>409</td></tr> <tr><td>398</td><td>↓ -3.1%</td></tr> </table>	447	409	398	↓ -3.1%	14th Day Enrollment for First Time Degree Seeking Freshmen <table border="1"> <tr><td>339</td><td>285</td></tr> <tr><td>285</td><td>↓ -6.9%</td></tr> </table>	339	285	285	↓ -6.9%	Average ACT Score <table border="1"> <tr><td>23.0</td><td>22.0</td></tr> <tr><td>21.7</td><td>↑ 1.4%</td></tr> </table>	23.0	22.0	21.7	↑ 1.4%	Physical Sciences (shown in thousands) <table border="1"> <tr><td>324</td><td>7</td></tr> <tr><td>7</td><td>↓ -69.6%</td></tr> </table>	324	7	7	↓ -69.6%	Invention Disclosures <table border="1"> <tr><td>11</td><td>1</td></tr> <tr><td>1</td><td>↓ -80.0%</td></tr> </table>	11	1	1	↓ -80.0%	Market Value of Endowments <table border="1"> <tr><td>28,887,195</td><td>26,933,751</td></tr> <tr><td>23,433,465</td><td>↑ 7.5%</td></tr> </table>	28,887,195	26,933,751	23,433,465	↑ 7.5%	SCH Enrollment in Fall Semester Lecture and Seminar Courses <table border="1"> <tr><td>26,337</td><td>23,260</td></tr> <tr><td>17,099</td><td>↓ -0.1%</td></tr> </table>	26,337	23,260	17,099	↓ -0.1%
447	409																																	
398	↓ -3.1%																																	
339	285																																	
285	↓ -6.9%																																	
23.0	22.0																																	
21.7	↑ 1.4%																																	
324	7																																	
7	↓ -69.6%																																	
11	1																																	
1	↓ -80.0%																																	
28,887,195	26,933,751																																	
23,433,465	↑ 7.5%																																	
26,337	23,260																																	
17,099	↓ -0.1%																																	
Masters <table border="1"> <tr><td>3,501</td><td>3,154</td></tr> <tr><td>911</td><td>↓ -9.9%</td></tr> </table>	3,501	3,154	911	↓ -9.9%	Grand Total Headcount as of 14th Class Day (Undergraduate & Graduate) <table border="1"> <tr><td>9,955</td><td>9,736</td></tr> <tr><td>7,036</td><td>↑ 11.6%</td></tr> </table>	9,955	9,736	7,036	↑ 11.6%	Second Year Retention <table border="1"> <tr><td>66.2%</td><td>62.5%</td></tr> <tr><td>61.1%</td><td>↓ -4.0%</td></tr> </table>	66.2%	62.5%	61.1%	↓ -4.0%	Mathematical Sciences (shown in thousands) <table border="1"> <tr><td>0</td><td>0</td></tr> <tr><td>0</td><td>⇒ 0.0%</td></tr> </table>	0	0	0	⇒ 0.0%	Licenses\Options Executed <table border="1"> <tr><td>0</td><td>0</td></tr> <tr><td>0</td><td>#DIV/0!</td></tr> </table>	0	0	0	#DIV/0!	Total Gross Revenue From First-Time-Full-Time Freshmen <table border="1"> <tr><td>2,727,637</td><td>2,465,258</td></tr> <tr><td>2,324,844</td><td>↓ -0.8%</td></tr> </table>	2,727,637	2,465,258	2,324,844	↓ -0.8%	Tenure/tenure track (T/TT) FTE faculty assigned to classes <table border="1"> <tr><td>133</td><td>114</td></tr> <tr><td>84</td><td>↓ -14.5%</td></tr> </table>	133	114	84	↓ -14.5%
3,501	3,154																																	
911	↓ -9.9%																																	
9,955	9,736																																	
7,036	↑ 11.6%																																	
66.2%	62.5%																																	
61.1%	↓ -4.0%																																	
0	0																																	
0	⇒ 0.0%																																	
0	0																																	
0	#DIV/0!																																	
2,727,637	2,465,258																																	
2,324,844	↓ -0.8%																																	
133	114																																	
84	↓ -14.5%																																	
Specialist <table border="1"> <tr><td>10</td><td>5</td></tr> <tr><td>2</td><td>↑ 150.0%</td></tr> </table>	10	5	2	↑ 150.0%	Total number of High School Dual Enrollments <table border="1"> <tr><td>386</td><td>386</td></tr> <tr><td>224</td><td>↑ 24.5%</td></tr> </table>	386	386	224	↑ 24.5%	Third Year Retention <table border="1"> <tr><td>55.0%</td><td>55.0%</td></tr> <tr><td>46.4%</td><td>↑ 15.8%</td></tr> </table>	55.0%	55.0%	46.4%	↑ 15.8%	Computer Sciences (shown in thousands) <table border="1"> <tr><td>441</td><td>346</td></tr> <tr><td>316</td><td>↓ -21.5%</td></tr> </table>	441	346	316	↓ -21.5%	New Patents Filed - Total <table border="1"> <tr><td>11</td><td>1</td></tr> <tr><td>0</td><td>↓ -66.7%</td></tr> </table>	11	1	0	↓ -66.7%	Net Revenue From First-Time-Full-Time Freshmen <table border="1"> <tr><td>1,661,975</td><td>1,599,379</td></tr> <tr><td>1,420,066</td><td>↑ 7.8%</td></tr> </table>	1,661,975	1,599,379	1,420,066	↑ 7.8%	Non tenure/tenure track FTE faculty assigned to classes <table border="1"> <tr><td>74</td><td>74</td></tr> <tr><td>44</td><td>↑ 15.6%</td></tr> </table>	74	74	44	↑ 15.6%
10	5																																	
2	↑ 150.0%																																	
386	386																																	
224	↑ 24.5%																																	
55.0%	55.0%																																	
46.4%	↑ 15.8%																																	
441	346																																	
316	↓ -21.5%																																	
11	1																																	
0	↓ -66.7%																																	
1,661,975	1,599,379																																	
1,420,066	↑ 7.8%																																	
74	74																																	
44	↑ 15.6%																																	
Grand Total Number of Degrees Awarded <table border="1"> <tr><td>3,934</td><td>3,573</td></tr> <tr><td>1,317</td><td>↓ -9.2%</td></tr> </table>	3,934	3,573	1,317	↓ -9.2%	Total number of students enrolled who received TOPS <table border="1"> <tr><td>675</td><td>580</td></tr> <tr><td>568</td><td>↓ -0.9%</td></tr> </table>	675	580	568	↓ -0.9%	Six Year Graduation Rate <table border="1"> <tr><td>37.8%</td><td>33.2%</td></tr> <tr><td>31.6%</td><td>↑ 2.1%</td></tr> </table>	37.8%	33.2%	31.6%	↑ 2.1%	Total all Disciplines (shown in thousands) <table border="1"> <tr><td>725</td><td>725</td></tr> <tr><td>441</td><td>↑ 0.3%</td></tr> </table>	725	725	441	↑ 0.3%	Active License Agreements <table border="1"> <tr><td>0</td><td>0</td></tr> <tr><td>0</td><td>⇒ 0.0%</td></tr> </table>	0	0	0	⇒ 0.0%	State Appropriation per FTE <table border="1"> <tr><td>3,446</td><td>3,446</td></tr> <tr><td>1,536</td><td>↑ 15.9%</td></tr> </table>	3,446	3,446	1,536	↑ 15.9%	Total SCH's taught per FTE T/TT faculty <table border="1"> <tr><td>528</td><td>466</td></tr> <tr><td>413</td><td>↑ 12.7%</td></tr> </table>	528	466	413	↑ 12.7%
3,934	3,573																																	
1,317	↓ -9.2%																																	
675	580																																	
568	↓ -0.9%																																	
37.8%	33.2%																																	
31.6%	↑ 2.1%																																	
725	725																																	
441	↑ 0.3%																																	
0	0																																	
0	⇒ 0.0%																																	
3,446	3,446																																	
1,536	↑ 15.9%																																	
528	466																																	
413	↑ 12.7%																																	
Total degrees awarded in STEM <table border="1"> <tr><td>118</td><td>105</td></tr> <tr><td>70</td><td>↑ 50.0%</td></tr> </table>	118	105	70	↑ 50.0%	Total number of student enrolled in STEM <table border="1"> <tr><td>585</td><td>523</td></tr> <tr><td>486</td><td>↑ 7.6%</td></tr> </table>	585	523	486	↑ 7.6%	LA Community College Transfer Student Second Year Retention <table border="1"> <tr><td>13600.0%</td><td>74.2%</td></tr> <tr><td>5800.0%</td><td>↓ -8.6%</td></tr> </table>	13600.0%	74.2%	5800.0%	↓ -8.6%	Total number of FTE T/TT faculty holding grants <table border="1"> <tr><td>0</td><td>0</td></tr> <tr><td>0</td><td>#DIV/0!</td></tr> </table>	0	0	0	#DIV/0!	Licenses Generating Income <table border="1"> <tr><td>0</td><td>0</td></tr> <tr><td>0</td><td>⇒ 0.0%</td></tr> </table>	0	0	0	⇒ 0.0%	Net Revenue Generated from auxiliary enterprises <table border="1"> <tr><td>-90,107</td><td>-563,990</td></tr> <tr><td>-1,135,573</td><td>↓ -93.0%</td></tr> </table>	-90,107	-563,990	-1,135,573	↓ -93.0%	Total SCH's taught per FTE non T/TT faculty <table border="1"> <tr><td>461</td><td>411</td></tr> <tr><td>344</td><td>↑ 2.2%</td></tr> </table>	461	411	344	↑ 2.2%
118	105																																	
70	↑ 50.0%																																	
585	523																																	
486	↑ 7.6%																																	
13600.0%	74.2%																																	
5800.0%	↓ -8.6%																																	
0	0																																	
0	#DIV/0!																																	
0	0																																	
0	⇒ 0.0%																																	
-90,107	-563,990																																	
-1,135,573	↓ -93.0%																																	
461	411																																	
344	↑ 2.2%																																	
	Total number of students enrolled in Teacher Education (Note BOR Teacher Education Initiative) <table border="1"> <tr><td>929</td><td>828</td></tr> <tr><td>564</td><td>↑ 3.2%</td></tr> </table>	929	828	564	↑ 3.2%	LA Community College Transfer Student 6-Year Grad Rate <table border="1"> <tr><td>51.3%</td><td>47.2%</td></tr> <tr><td>28.3%</td><td>↓ -3.8%</td></tr> </table>	51.3%	47.2%	28.3%	↓ -3.8%	Research dollars per FTE T/TT <table border="1"> <tr><td>17,674</td><td>0</td></tr> <tr><td>6,903</td><td>⇒ 0.0%</td></tr> </table>	17,674	0	6,903	⇒ 0.0%	Total Licensing Income <table border="1"> <tr><td>0</td><td>0</td></tr> <tr><td>0</td><td>⇒ 0.0%</td></tr> </table>	0	0	0	⇒ 0.0%		Tenure/Tenure Track FTE faculty as % of total FTE faculty <table border="1"> <tr><td>67.6%</td><td>60.6%</td></tr> <tr><td>60.6%</td><td>↓ -10.3%</td></tr> </table>	67.6%	60.6%	60.6%	↓ -10.3%								
929	828																																	
564	↑ 3.2%																																	
51.3%	47.2%																																	
28.3%	↓ -3.8%																																	
17,674	0																																	
6,903	⇒ 0.0%																																	
0	0																																	
0	⇒ 0.0%																																	
67.6%	60.6%																																	
60.6%	↓ -10.3%																																	

Louisiana State University Shreveport

Metric I. The following metrics will identify the the number of degrees conferred by level and professions that are most important to Louisiana.

Louisiana State University Shreveport	2017-2018	2018-2019	2019-2020	2020-2021	2021-2022	2022-2023
Total number of degrees awarded/conferred						
Bachelors	398	425	400	447	422	409
Doctoral	4	2	11	13	9	5
Masters	911	1709	2259	3243	3501	3154
Specialist	4	7	10	7	2	5
Grand Total Number of Degrees Awarded	1317	2143	2680	3710	3934	3573
Total number of degrees awarded by race/ethnicity						
Hispanic	64	113	144	231	205	67
American Indian or Alaskan Native	6	5	8	10	18	22
Asian	33	67	75	119	136	136
Black, Non-Hispanic	290	426	528	697	696	781
Native Hawaiian or Other Pacific Islander	0	2	5	7	14	6
White, Non-Hispanic	683	1,050	1,287	1,766	1,990	2,064
Two or More Races	35	60	80	113	136	126
Nonresident Alien	39	67	116	161	153	145
Race/Ethnicity Unknown	167	353	437	606	586	226
Total degrees awarded	1,317	2,143	2,680	3,710	3,934	3,573
Total degrees awarded in STEM	118	118	90	103	70	105
Total Teacher Education completions (Note BOR Teacher Education Initiatives)						
Total number of degrees awarded in Allied Health	0	0	0	0	0	0
Total Completed (<i>Regular Program</i>)	29	25	22	29	22	19
Number Passed (<i>Regular Program</i>)	29	25	22	29	22	19
Percentage Passed (<i>Regular Program</i>)	100%	100%	100%	100%	100%	100%
Total Completed (<i>Alternate Program</i>)	8	6	6	8	3	3
Number Passed (<i>Alternate Program</i>)	8	6	6	8	3	3
Percentage Passed (<i>Alternate Program</i>)	100%	100%	100%	100%	100%	100%

Louisiana State University Shreveport

Metric I. The following metrics will identify the the number of degrees conferred by level and professions that are most important to Louisiana.

List of STEM/SMART CIP code/s: The following list of CIP codes is to serve as a guide but it is not intended to be inclusive of all possibilities. We recognize that some campuses have degree programs centered in schools or colleges that might dictate a different CIP code. The campus should make the appropriate adjustment. In addition, the CIP codes used by the campus should correlate to the Board of Regents. If there is a discrepancy and the campus applies the IPEDS CIP code, then the campus should identify this with a footnote.

11
14
15
26
27
40
0109
0110
0111
0112
0301
0303
0305
0306
2901
3001
3006
3008
3010
3016
3018
3019
3024
3025
4101
4102
4103
4199
4211

Education CIP Codes/

Education

Nursing CIP Code/s

Nursing

Allied Health CIP Code/s

Allied Health and Medical Assisting Services
Allied Health Diagnostic, Intervention, and Treatment
Professions

Louisiana State University Shreveport

Metric II. The following metrics will provide the campus enrollment trends.

Enrollment Headcount as of 14th Class Day	2018-2019	2019-2020	2020-2021	2021-2022	2022-2023	2023-2024
Undergraduate						
14th Day Enrollment for First Time Degree Seeking Freshmen	293	338	339	306	306	285
14th Day Degree Seeking New Transfer Student Enrollment	378	389	330	313	292	334
14th Day Degree Seeking Re-Admit Enrollment	151	144	106	136	138	144
Degree Seeking Continuing Undergraduates	1,353	1,422	1,515	1,441	1,401	1,398
First-Time Post-Baccalaureate	0	0	0	0	0	0
Non Degree Undergraduates	336	284	263	281	328	387
Total Undergraduate Headcount as of 14th Class Day	2,511	2,577	2,553	2,477	2,465	2,548
Undergraduate - First Time Degree Seeking Freshmen						
Full-time (In-State Residency)	267	308	299	275	261	247
Full-time (Non Residency)	18	23	25	23	27	20
Part-time (In-State Residency)	6	6	14	8	15	17
Part-time (Non Residency)	2	1	1	0	3	1
Total First Time Degree Seeking Freshmen Headcount as of 14th Class Day	293	338	339	306	306	285
Undergraduate						
Full-time (In-State Residency)	1,428	1,526	1,496	1,457	1,402	1,359
Full-time (Non Residency)	182	202	223	215	208	240
Part-time (In-State Residency)	845	777	755	717	748	820
Part-time (Non Residency)	56	72	79	88	107	129
Total Undergraduate Headcount as of 14th Class Day	2,511	2,577	2,553	2,477	2,465	2,548
Graduate						
Full-time (In-State Residency)	370	436	500	429	498	589
Full-time (Non Residency)	622	810	1,288	915	985	1,262
Part-time (In-State Residency)	1,161	1,318	1,285	1,238	1,216	1,214
Part-time (Non Residency)	2,372	3,438	4,329	3,822	3,557	4,123
Total Graduate Headcount as of 14th Class Day	4,525	6,002	7,402	6,404	6,256	7,188
Grand Total Headcount as of 14th Class Day (Undergraduate & Graduate)	7,036	8,579	9,955	8,881	8,721	9,736
Total Undergraduate Full-Time-Equivalent (FTE) Enrollment as of 14th Class Day	1,841	1,931	1,936	1,859	1,813	1,825
Total Graduate Full-Time-Equivalent (FTE) Enrollment as of 14th Class Day	2,326	3,068	3,921	3,277	3,310	3,875
Total number of High School Dual Enrollments	299	245	224	258	310	386

Louisiana State University Shreveport

Metric II. The following metrics will provide the campus enrollment trends.

First Time Degree Seeking Enrollment by Race and Ethnicity as of 14th Class Day	2018-2019	2019-2020	2020-2021	2021-2022	2022-2023	2023-2024
Hispanic	19	16	20	0	0	0
American Indian or Alaska Native	4	2	2	0	3	3
Asian	5	6	5	4	9	8
Black or African American	57	53	61	54	73	65
Native Hawaiian or Other Pacific Islander	0	1	2	0	1	0
White	146	198	176	194	172	152
Two or More Races	18	21	29	22	21	28
Nonresident Alien	9	9	13	21	18	16
Race/Ethnicity Unknown	35	32	31	11	9	13
Total	293	338	339	306	306	285

First Time Degree Seeking Enrollment by Gender as of 14th Class Day	2018-2019	2019-2020	2020-2021	2021-2022	2022-2023	2023-2024
Male	115	145	140	132	135	119
Female	178	193	199	174	171	166
Total	293	338	339	306	306	285

Total Enrollment by Race and Ethnicity as of 14th Class Day	2018-2019	2019-2020	2020-2021	2021-2022	2022-2023	2023-2024
Hispanic	405	498	660	289	63	22
American Indian or Alaska Native	29	31	38	63	66	72
Asian	179	234	269	285	318	363
Black or African American	1,480	1,805	1,985	1,942	2,116	2,353
Native Hawaiian or Other Pacific Islander	10	19	21	19	22	31
White	3,373	4,023	4,661	4,808	5,048	5,672
Two or More Races	220	292	370	338	356	425
Nonresident Alien	256	333	385	325	345	378
Race/Ethnicity Unknown	1,084	1,344	1,566	812	387	420
Total	7,036	8,579	9,955	8,881	8,721	9,736

Total Enrollment by Gender as of 14th Class Day	2018-2019	2019-2020	2020-2021	2021-2022	2022-2023	2023-2024
Male	2,933	3,541	4,118	3,513	3,362	3,907
Female	4,103	5,038	5,837	5,368	5,359	5,829
Total	7,036	8,579	9,955	8,881	8,721	9,736

Louisiana State University Shreveport

Metric II. The following metrics will provide the campus enrollment trends.

Louisiana Transfer Enrollment	2018-2019	2019-2020	2020-2021	2021-2022	2022-2023	2023-2024
Transfer from Louisiana Community Colleges	157	159	122	124	100	99
Transfers from Louisiana Four-Year Universities	110	120	84	70	81	66
Student Credit Hours (SCH)						
Fall SCH	55,526	65,789	76,102	67,217	66,905	73,881
Spring SCH	58,135	65,926	73,499	63,850	67,933	
Total number of students enrolled who received TOPS						
Performance	188	180	216	213	169	182
Opportunity	281	339	342	330	318	310
Honors	99	106	117	123	98	88
Tech	0	0	0	0	0	0
Total number of students enrolled who received TOPS	568	625	675	666	585	580
Enrollment by specified discipline						
Total number of student enrolled in STEM	585	576	569	511	486	523
Total number of students enrolled in Allied Health	0	0	0	0	0	0
Total number of students enrolled in Teacher Education (Note BOR Teacher Education Initiative)	564	702	929	807	802	828
Teacher Education Regular Program	540	673	893	793	791	818
Teacher Education Alternative Program	24	29	36	14	11	10

Louisiana State University Shreveport

Metric II. The following metrics will provide the campus enrollment trends.

List of STEM/SMART CIP code/s:

that some campuses have degree programs centered in schools or colleges that might dictate a different CIP code. The campus should make the appropriate adjustment. In addition, the CIP codes used by the campus should correlate to the Board of Regents. If there is a discrepancy and the campus applies the IPEDS CIP code, then the campus should identify this

11	Computer and Information Sciences and Support Services
14	Engineering
15	Engineering Technologies/Technicians
26	Biological and Biomedical Sciences
27	Mathematics and Statistics
40	Physical Sciences
0109	Animal Sciences
0110	Food Science and Technology
0111	Plant Sciences
0112	Soil Sciences
0301	Natural Resources Conservation and Research
0303	Fishing and Fisheries Sciences and Management
0305	Forestry
0306	Wildlife and Wildlands Science and Management
2901	Military Technologies
3001	Biological and Physical Sciences
3006	Systems Science and Theory
3008	Mathematics and Computer Science
3010	Biopsychology
3016	Accounting and Computer Science
3018	Natural Sciences
3019	Nutrition Sciences
3024	Neuroscience
3025	Cognitive Science
4101	Biology Technician/Biotechnology Laboratory Technician
4102	Nuclear and Industrial Radiologic Technologies/Technicians
4103	Physical Science Technologies/Technicians
4199	Science Technologies/Technicians Other
4211	Physiological Psychology/Psychobiology

Allied Health CIP Code/s

51.08	Allied Health and Medical Assisting Services
51.09	Allied Health Diagnostic, Intervention, and Treatment Professions

Variables Description

Headcount Enrollment Undergraduate – Total number of full-time and part-time students enrolled in courses for undergraduate credit.

Headcount Enrollment Graduate – Total number of full-time and part-time students enrolled in courses for graduate credit.

Full-Time Equivalent (FTE) – The calculation of FTE can vary by institution. However, FTE enrollment reported for this metric should reconcile to FTE data you report to the Louisiana BoR, SREB and IPEDS for your campus.

Full-Time Student Undergraduate - a student enrolled for 15 or more semester credits or 30 or more contact hours a week each term. (IPEDS)

Dual Enrollment - A student who is enrolled in high school but who is also enrolled, simultaneously, in a postsecondary institution are considered dual enrolled.

Science Technology Engineering and Mathematics (STEM) - STEM enrollment is calculated based on STEM CIP codes.

Educations, Nursing, Allied Health - Use the CIP codes as defined by IPEDS for these disciplines to determine the number of students enrolled and graduates in these field of study.

Louisiana State University Shreveport

Metric III. The following metric will identify the campus trends for retention, graduation, licensure

Analysis of First-time, Full-time, Baccalaureate Degree-Seeking Freshmen

Cohort Type	Cohort Year	Head Count	Average ACT	% continuation to_2nd_Yr	% continuation to_3rd_Yr	Cumulative% Graduating after 4 Yrs.	Cumulative % Graduating after 5 Yrs.	Cumulative % Graduating after 6 Yrs.	Cumulative % Graduating after 7 Yrs.
Total	2014	333	23.0	63.4%	49.5%	17.4%	32.4%	36.9%	38.7%
Total	2015	347	22.3	61.1%	48.7%	22.8%	33.4%	37.8%	39.5%
Total	2016	252	22.6	64.7%	46.4%	17.5%	29.4%	32.5%	33.7%
Total	2017	280	22.7	63.6%	47.9%	19.3%	28.6%	33.2%	
Total	2018	285	22.8	65.3%	51.9%	21.8%	35.1%		
Total	2019	331	22.4	61.6%	46.8%	19.0%			
Total	2020	324	22.5	62.0%	47.5%				
Total	2021	298	22.3	65.1%	55.0%				
Total	2022	288	21.7	62.5%					
Total	2023	267	22.0						

Louisiana Community College Transfers (LACCT) Includes Full-Time Degree-Seeking Students

LACCT	2014	136		58.8%	40.4%	33.3%	36.4%	38.3%	41.0%
LACCT	2015	127		64.6%	41.1%	35.9%	39.2%	43.5%	43.5%
LACCT	2016	101		66.3%	42.6%	44.7%	46.5%	49.0%	49.0%
LACCT	2017	98		62.5%	39.6%	44.8%	47.2%	47.2%	
LACCT	2018	108		64.5%	42.3%	51.3%	52.2%		
LACCT	2019	104		73.3%	49.5%	41.2%			
LACCT	2020	77		71.1%	44.0%				
LACCT	2021	81		81.3%	46.9%				
LACCT	2022	66		74.2%					
LACCT	2023	58							

	2014-15	2015-16	2016-17	2017-18	2018-19	2019-20	2020-21	2021-22	2022-23
Number of students passing licensure exams									
Undergraduate Teacher Education	41/41	41/41	33/33	29	25	22	29	22	19
Alternative Teacher Certification	7/7	11/11	9/9	8	6	6	8	3	3
Specialist in School Psychology	3/3	7/7	5/5	4	7	10	7	2	5
Educational Leadership	9/9	5/5	6/6	7	72	129	182	195	237
MED Administration	0	0	0	0	0	0	0	0	0

Louisiana State University Shreveport

IV. The following metrics will identify the effectiveness of campus research and technology transfer to benefit the state's economic development.

Research Expenditures Field of Science & Engineering	FY 2018		FY 2019		FY 2020		FY 2021		FY 2022		FY 2023	
	Total	Federal	Total	Federal	Total	Federal	Total	Federal	Total	Federal	Total	Federal
a. Engineering (Total)	0	0	0	0	0	0	0	0	0	0	0	0
(1) Aeronautical & astronautical	0	0	0	0	0	0	0	0	0	0	0	0
(2) Bioengineering/biomedical engineering	0	0	0	0	0	0	0	0	0	0	0	0
(3) Chemical	0	0	0	0	0	0	0	0	0	0	0	0
(4) Civil	0	0	0	0	0	0	0	0	0	0	0	0
(5) Electrical	0	0	0	0	0	0	0	0	0	0	0	0
(6) Mechanical	0	0	0	0	0	0	0	0	0	0	0	0
(7) Metallurgical & materials	0	0	0	0	0	0	0	0	0	0	0	0
(8) Other	0	0	0	0	0	0	0	0	0	0	0	0
b. Physical Sciences (Total)	324	239	179	97	64	51	7	2	23	0	7	2
(1) Astronomy	0	0	0	0	0	0	0	0	0	0	0	0
(2) Chemistry	324	239	179	97	64	51	7	2	0	0	0	0
(3) Physics	0	0	0	0	0	0	0	0	0	0	0	0
(4) Other	0	0	0	0	0	0	0	0	23	0	7	2
c. Environmental Sciences (Total)	0	0	0	0	0	0	0	0	0	0	0	0
(1) Atmospheric	0	0	0	0	0	0	0	0	0	0	0	0
(2) Earth sciences	0	0	0	0	0	0	0	0	0	0	0	0
(3) Oceanography	0	0	0	0	0	0	0	0	0	0	0	0
(4) Other	0	0	0	0	0	0	0	0	0	0	0	0
d. Mathematical Sciences (Total)	0	0	0	0	0	0	0	0	0	0	0	0
e. Computer Sciences (Total)	355	299	339	249	316	218	338	263	441	389	346	178
f. Life Sciences (Total)	13	9	33	20	112	52	115	8	235	179	345	221
(1) Agricultural	0	0	0	0	0	0	0	0	0	0	0	0
(2) Biological	13	9	33	20	112	52	115	8	235	179	345	221
(3) Medical	0	0	0	0	0	0	0	0	0	0	0	0
(4) Other	0	0	0	0	0	0	0	0	0	0	0	0
g. Psychology (Total)	0	0	0	0	0	0	0	0	0	0	0	0
h. Social Sciences (Total)	0	0	0	0	0	0	0	0	0	0	0	0
(1) Economics	0	0	0	0	0	0	0	0	0	0	0	0
(2) Political science	0	0	0	0	0	0	0	0	0	0	0	0
(3) Sociology	0	0	0	0	0	0	0	0	0	0	0	0
(4) Other	0	0	0	0	0	0	0	0	0	0	0	0
i. Other Sciences, not elsewhere classified (Total)	15	0	21	0	2	0	2	0	24	0	27	0
j. Total (sum of a through i)	707	547	572	366	494	321	462	273	723	568	725	401

Faculty Research:	2017-2018	2018-2019	2019-2020	2020-2021	2021-2022	2021-2022
-------------------	-----------	-----------	-----------	-----------	-----------	-----------

Total number of FTE T/TT faculty holding grants
 Percent of FTE T/TT faculty holding grants
 Research dollars per FTE T/TT

Louisiana State University Shreveport

Metric V: Technology Transfer

(The following metric will provide technology transfer data.)

	2017-2018	2018-2019	2019-2020	2020-2021	2021-2022	2022-2023
Invention Disclosures	11	8	5	3	5	1
Licenses\Options Executed	0	0	0	0	0	0
New Patents Filed - Total	11	5	1	0	3	1
New Patents Filed - First in Family	0	1	1	0	3	1
US Patents Issued	1	4	0	2	1	0
Active License Agreements	0	0	0	0	0	0
Licenses Generating Income	0	0	0	0	0	0
Total Licensing Income	\$0	\$0	\$0	\$0	\$0	\$0
Start-up Companies Formed	0	0	0	0	0	0
Legal Fees Expended	\$6,737	\$12,145	\$3,278	\$8,797	\$225	\$2,200
Legal Fees Reimbursed	\$0	\$0	\$0	\$0	\$0	\$0
Percent of Expenses Reimbursed	0%	0%	0%	0%	0%	0%
Legal Fees as a % License Income	0%	0%	0%	0%	0%	0%

LEGEND:

* = 2015-2016 was the first year to track

Louisiana State University Shreveport

Metric VI. The following metrics will identify the tuition and fee revenues, and, other revenue resources.

	2017-2018	2018-2019	2019-2020	2020-2021	2021-2022	2022-2023
Annual Gifts						
Gifts per Annual						
Total Endowment Value	\$ 23,934,179	\$ 26,333,441	\$ 23,433,465	\$ 28,887,195	\$ 25,050,947	\$ 26,933,751
Earned Interest on Endowments	\$ 826,019	\$ 577,556	\$ 851,510	\$ 454,130	\$ 952,838	\$ 806,056
Dollar amount of the endowment approved each fiscal year and made available for expenditures by the campus	\$ 858,570	\$ 931,995	\$ 927,624	\$ 972,624	\$ 1,042,461	\$ 1,058,137
Total # of Foundations						
Foundations total Assets (\$ Amount)	\$ 26,380,644	\$ 26,374,823	\$ 25,104,661	\$ 32,890,849	\$ 29,097,303	\$ 29,641,739
Click here to go to the Foundations Supplemental Table						
Total # of Board of Regents Support Fund						
Total Value (\$ Amount) of BoR Support Fund	\$ 7,360,774	\$ 7,655,113	\$ 7,349,007	\$ 9,211,449	\$ 7,241,321	\$ 8,284,127
Click here to go to the BoR Support Funds Supplemental Table						
Total Gross Revenue Generated from tuition and fees						
Total Gross Revenue From First-Time-Full-Time Freshmen	\$ 2,597,267	\$ 2,324,844	\$ 2,727,637	\$ 2,648,532	\$ 2,485,908	\$ 2,465,258
Gross Revenue From First-Time-Full-Time Freshmen (In-State Only)	\$ 1,743,800	\$ 1,956,192	\$ 2,256,580	\$ 2,140,691	\$ 2,014,848	\$ 1,912,274
Gross Revenue From First-Time-Full-Time Freshmen (Out-of-State Only)	\$ 853,467	\$ 368,653	\$ 471,057	\$ 507,842	\$ 471,060	\$ 552,984
Net Revenue From First-Time-Full-Time Freshmen	\$ 1,420,066	\$ 1,499,265	\$ 1,661,975	\$ 1,557,889	\$ 1,484,013	\$ 1,599,379
Net Revenue From First-Time-Full-Time Freshmen (In-State Only)	\$ 1,264,422	\$ 1,419,111	\$ 1,561,029	\$ 1,484,894	\$ 1,362,665	\$ 1,390,172
Net Revenue From First-Time-Full-Time Freshmen (Out-of-State Only)	\$ 155,644	\$ 80,154	\$ 100,946	\$ 72,994	\$ 121,348	\$ 209,207
Financial Aid						
Total institutional dollars awarded need based aid for entering freshmen class	\$ -	\$ -	\$ -	\$ -	\$ -	\$ -
Total institutional dollars awarded non-need aid for entering freshmen class	\$ 1,177,201	\$ 825,579	\$ 1,065,662	\$ 1,090,643	\$ 1,001,895	\$ 865,879
Total institutional dollars awarded need based aid for entering freshmen class LA residents	\$ -	\$ -	\$ -	\$ -	\$ -	\$ -
Total institutional dollars awarded non-need based aid for entering freshmen class LA residents	\$ 479,378	\$ 537,081	\$ 695,551	\$ 655,796	\$ 652,183	\$ 522,102
Total institutional dollars awarded need based aid for entering freshmen class non-residents	\$ -	\$ -	\$ -	\$ -	\$ -	\$ -
Total institutional dollars awarded non-need based aid for entering freshmen class non-residents	\$ 697,823	\$ 288,498	\$ 370,110	\$ 434,847	\$ 349,713	\$ 343,777
State Appropriation per FTE¹	\$ 1,762	\$ 1,536	\$ 1,581	\$ 2,281	\$ 2,973	\$ 3,446
Net Revenue Generated from auxiliary enterprises (i.e., bookstores, dining services)	(328,261)	(90,107)	(743,707)	(1,135,573)	(292,206)	(563,990)

¹ State Appropriation per FTE = the Board of Regents Formula Appropriations Per FTE which includes State General Fund and Statutory

Louisiana State University Shreveport

Metric VI. The following metrics will identify the tuition and fee revenues, and, other revenue resources.

Endowment Value equals the market value of the endowment as of June 30 of the reporting year.

FTE Full time equivalent

Payout from Endowment equal interest earned on endowment.

Gross Revenue Generated from Student Enrollment FTE equals revenue gain from student tuitions and fees.

Net Revenue Generated from Student Enrollment FTE equals gross revenue from enrollment headcount minus institutional supported financial aid.

Net Revenue from Auxiliary equal gross revenue generated from auxiliary enterprises minus debt services and other financial obligations. Reporting Operating revenues = Gross revenues less Coast of goods sold for all auxiliaries (Athletics, University Center, Bookstore, Food Service).

Louisiana State University Shreveport

Metric VII. The following metrics will identify teaching and research productivity per FTE faculty.

Enrollment in Fall Semester Lecture and Seminar Courses	Fall 2017	Fall 2018	Fall 2019	Fall 2020	Fall 2021	Fall 2022
Lower Division Undergraduate Courses						
Total Enrollment	6,922	6,503	6,753	6,934	6,579	6,362
Number of Sections	317	326	321	372	334	335
Average section size	21.84	19.95	21.04	18.64	19.70	18.99
Upper Division Undergraduate Courses						
Total Enrollment	3,203	3,331	3,465	3,304	3,309	3,261
Number of Sections	224	237	276	290	292	296
Average section size	14.30	14.05	12.55	11.39	11.33	11.02
Graduate/Professional Courses						
Total Enrollment	6,974	9,470	12,548	16,099	13,398	13,637
Number of Sections	188	195	238	275	295	294
Average section size	37.10	48.56	52.72	58.54	45.42	46.38
All Lecture and Seminar Courses						
Total Enrollment	17,099	19,304	22,766	26,337	23,286	23,260
Number of Sections	729	758	835	937	921	925
Average section size	23	25	27	28	25	25
Fall Teaching Activity	Fall 2017	Fall 2018	Fall 2019	Fall 2020	Fall 2021	Fall 2022
Tenure/tenure track (T/TT) FTE faculty assigned to classes	84.25	89	110.67	119.33	133.33	114
Non tenure/tenure track FTE faculty assigned to classes	44.2	49	58	72.67	64	74
FTE graduate assistants assigned to classes	0	0	0	0	0	0
Organized class sections including labs, fall only	Fall 2017	Fall 2018	Fall 2019	Fall 2020	Fall 2021	Fall 2022
Sections taught by tenure/tenure track faculty	417	445	485	522	534	483
Sections taught by non tenure/tenure track faculty	312	313	350	415	387	442
Sections taught by graduate assistants	0	0	0	0	0	0
Average # of class sections taught per FTE T/TT faculty	4.95	5.00	4.38	4.37	4.01	4.24
Average # of class sections taught per FTE non T/TT faculty	7.06	6.39	6.03	5.71	6.05	5.97
Average # of class sections taught per 0.5 FTE graduate assistants	0.00	0.00	0.00	0.00	0.00	0.00
% class sections taught by T/TT faculty	57.20%	58.71%	58.08%	55.71%	57.98%	52.22%
% class sections taught by non T/TT faculty	42.80%	41.29%	41.92%	44.29%	42.02%	47.78%
% class sections taught by graduate assistants	0	0	0	0	0	0

Louisiana State University Shreveport

Metric VII. The following metrics will identify teaching and research productivity per FTE faculty.

	Fall 2017	Fall 2018	Fall 2019	Fall 2020	Fall 2021	Fall 2022
Student Credit Hours (SCH'S), fall only						
Undergraduate	28,339	27,693	28,985	29,125	28,088	27,450
Graduate	20,835	27,912	36,804	46,977	39,243	39,677
Total student credit hours	49,174	55,605	65,789	76,102	67,331	67,127
Undergraduate SCH's taught by T/TT faculty	17,453	16,610	16,742	15,988	15,860	13,426
Graduate SCH's taught by T/TT faculty	16,499	17,989	22,282	27,530	25,745	23,300
Total SCH's taught by T/TT faculty	33,952	34,599	39,024	43,518	41,605	36,726
Total SCH's taught by non T/TT faculty	15,222	21,006	26,765	32,584	25,726	30,401
Total SCH's taught by graduate assistants	0	0	0	0	0	0
Undergraduate SCH's taught per FTE T/TT faculty	207	187	151	134	119	118
Graduate SCH's taught per FTE T/TT faculty	247	314	333	394	294	348
Total SCH's taught per FTE T/TT faculty	454	500	484	528	413	466
Total SCH's taught per FTE non T/TT faculty	344	429	461	448	402	411
Total SCH's taught per 0.5 FTE graduate assistants	0	0	0	0	0	0
% SCH's taught by T/TT faculty	69.04%	62.22%	59.32%	57.18%	61.79%	54.71%
% SCH's taught by non T/TT faculty	30.96%	37.78%	40.68%	42.82%	38.21%	45.29%
% SCH's taught by graduate assistants	0	0	0	0	0	0
Annual Instruction and Research Ratios	2017-2018	2018-2019	2019-2020	2020-2021	2021-2022	2022-23
Annual student credit hours (SCH's), fall & spring						
Undergraduate	55,266	53,760	55,460	55,319	53,423	52,955
Graduate	43,466	59,980	76,255	94,287	77,767	82,108
Total	98,732	113,740	131,715	149,606	131,190	135,063
Annual FTE students	3,653	4,291	5,026	5,773	5,021	5,186
Direct unrestricted instructional expenditures	\$24,766,070	\$23,458,395	\$32,904,724	\$36,600,042	\$33,467,282	\$34,310,047
Direct unrestricted instructional expenditures per SCH	\$250.84	\$206.25	\$249.82	\$244.64	\$255.11	\$254.03
Direct unrestricted instructional expenditures per FTE student	\$6,779.13	\$5,466.67	\$6,546.96	\$6,340.31	\$6,665.38	\$6,615.47
Personnel costs as % of direct unrestricted instructional expenditures	56%	66%	55%	58%	71%	72%
Total FTE faculty	128	138	169	192	197	188
Total FTE T/TT faculty (instruction, research, public service)	84	89	111	119	133	114
Tenure/Tenure Track FTE faculty as % of total FTE faculty	65.82%	64.49%	65.61%	62.15%	67.57%	60.64%
Restricted research expenditures	N/A	N/A	N/A	N/A	N/A	N/A
Restricted research expenditures per FTE T/TT faculty	N/A	N/A	N/A	N/A	N/A	N/A

Louisiana State University Shreveport

Metric VII. The following metrics will identify teaching and research productivity per FTE faculty.

Definitions:

Direct Expenditures for Instructions: Total Direct Instructional Expenditures include data in certain functional areas - instruction, research, and public service. Direct expenditure data reflect costs incurred for personnel compensation, supplies, and services used in the conduct of each of these functional areas. They include acquisition costs of capital assets such as equipment and library books to the extent that funds are budgeted for the use of departments for instruction, research, and public service. Similar to the Delaware Study, exclude centrally allocated computing costs and centrally supported computer labs, and graduate student tuition remission and fee waivers.

Instruction: Instruction includes general academic instruction, occupational and vocational instruction, community education, preparatory and adult basic education, and remedial and tutorial instruction conducted by the teaching faculty for the institution's students. Departmental research and service **which are not separately budgeted** should be included under instruction. In other words, department research which is externally funded should be excluded from instructional expenditures, as should any departmental funds which were expended for the purpose of matching external research funds as part of a contractual or grant obligation. EXCLUDE expenditures for academic administration where the primary function is administration. For example, exclude deans, but include department chairs.)

Disaggregate total direct instructional expenditures for the institution into the following categories:

Salaries: Report all wages paid to support the instructional function in a given department or program during the fiscal year. While these will largely be faculty salaries, be sure to include clerical (e.g., department secretary), professionals (e.g., lab technicians), Graduate student stipends (but not tuition waivers), and any other personnel who support the teaching function and whose salaries and wages are paid **from the institution's instructional budget**.

Benefits: Report expenditures for benefits associated with the personnel for whom salaries and wages were reported on the previous entry. If you cannot separate benefits from salaries, but benefits are included in the salary figure you have entered, indicate "Included in Salaries" in the data field. Some institutions book benefits centrally and do not disaggregate to the department level. If you can compute the appropriate benefit amount for the department/program, please do so and enter the data. If you cannot do so, leave the benefit amount as zero and we will impute a cost factor based upon the current benefit rate for your institution, as published in Academe. If no rate is available, we will use a default value of 28%.

Other Than Personnel Costs: This category includes non-personnel items such as travel, supplies and expense, non-capital equipment purchases, etc., that are typically part of an instructional department or program's cost of doing business. *Excluded* from this category are items such as central computing costs, centrally allocated computing labs, graduate student tuition remission and fee waivers, etc.

Research: This category includes all funds expended for activities specifically organized to produce research outcomes and commissioned by an agency either external to the institution or **separately budgeted** by an organizational unit within the institution. Report total research expenditures only. It is not necessary to disaggregate costs for this category.

Public Service: Report all funds **separately budgeted** specifically for public service and expended for activities established primarily to provide non-instructional services beneficial to groups external to the institution. Examples include cooperative extension and community outreach projects. Report total service expenditures only. It is not necessary to disaggregate costs for this category.

Federally Funded Research: As defined by NSF

Total Research and Expenditures: As defined by NSF

Table I: Affiliated Off-Campus Sites

LSU System Campus	Name of Affiliated Off- Campus Site	Gross Revenue Generated by Affiliate Campus	Net Revenue Generated by Affiliated Campus	\$ Amount Contributed Back to Campus by Affiliated Off-Site Campus
LSUS	Does not apply			

Table II: Board of Regent Support Funds

LSU System Campus	Name of Support Fund	Endowment	Market Value (\$ Amount) As of 6/30/23	Total Market Value (\$ Amount) As of 6/30/23
LSUS	Jerry D. Boughton Professorship in Business	Private	90,034	150,026.09
		State	59,992	
LSUS	Joe and Abby Averett Professorship in Business	Private	88,641	148,598.80
		State	59,958	
LSUS	Bell South Professorship in Business	Private	94,928	158,463.65
		State	63,536	
LSUS	Alta & John Franks MBA Professorship	Private	77,478	128,814.93
		State	51,337	
LSUS	Pete & Linda Ballard Accounting Professorship	Private	139,676	226,611.58
		State	86,936	
LSUS	Lynn & Armand Roos Professorship	Private	79,869	130,445.92
		State	50,577	
LSUS	James & Ann Gardner Professorship in Civic Engagement & Leadership	Private	102,926	167,709.13
		State	64,783	
LSUS	Kilpatrick Life Insurance Chair	Private	597,716	1,478,837.29
		State	881,121	
LSUS	Oscar Cloyd Real Estate Super Professorship	Private	455,612	745,468.78
		State	289,857	
LSUS	Joe B. Calloway, Jr. Professorship in Insurance	Private	72,673	121,709.10
		State	49,036	
LSUS	Wesson-Bridger Professorship in Teacher Ed	Private	101,918	171,507.93
		State	69,590	
LSUS	Capitol One Education & Human Development Professorship	Private	97,904	154,348.26
		State	56,444	

LSU System Campus	Name of Support Fund	Endowment	Market Value (\$ Amount) As of 6/30/23	Total Market Value (\$ Amount) As of 6/30/23
LSUS	V Stewart Student Teaching Professorship	Private	123,012	198,582.15
		State	75,570	
LSUS	Dalton J. Woods Professorship in Teaching	Private	127,282	193,176.97
		State	65,895	
LSUS	Kelly Kemp Graves Professorship	Private	80,413	134,179.05
		State	53,766	
LSUS	Reimer & Marcia Calhoun Early Childhood Professorship	Private	99,638	154,889.06
		State	55,252	
LSUS	George Khoury Professorship In Kinesiology	Private	74,929	124,705.76
		State	49,776	
LSUS	Goodloe Stuck Professorship in Psychology	Private	88,766	140,383.46
		State	51,618	
LSUS	Elmer & Barbara Simon, Jr. Professorship for Excellence in Teaching	Private	129,656	189,036.17
		State	59,380	
LSUS	Blue Cross & Blue Shield of La. Professorship	Private	87,160	140,320.61
		State	53,161	
LSUS	Vincent J. Marsala Alumni Professorship	Private	126,633	197,738.02
		State	71,105	
LSUS	Bruce & Steve Simon Professorship	Private	106,788	169,043.77
		State	62,256	
LSUS	James K. Elrod Super Professorship in Health Care Administration	Private	904,217	1,487,542.05
		State	583,325	
LSUS	Fred & Sybil Patten Excellence in Teaching in LA Professorship	Private	110,499	187,632.35
		State	77,133	
LSUS	India Studies Super Professorship	Private	186,407	291,275.05
		State	104,868	
LSUS	Dr. Dalton & Peggy Cloud Professorship in Communications	Private	93,233	161,242.58
		State	68,009	
LSUS	Bradley S Kemp Professorship in Forensics & Debate	Private	96,504	164,709.31
		State	68,205	
LSUS	Leonard & Mary Ann Selber Professorship	Private	136,725	214,657.22
		State	77,933	
LSUS	Norman A. Dolch Super Professorship in American Humanics	Private	227,828	377,306.25
		State	149,478	

LSU System Campus	Name of Support Fund	Endowment	Market Value (\$ Amount) As of 6/30/23	Total Market Value (\$ Amount) As of 6/30/23
LSUS	American Studies Chair	Private	1,331,946	2,132,671.54
		State	800,726	
LSUS	Hubert H. Humphreys History Professorship	Private	98,067	157,393.31
		State	59,326	
LSUS	O. Delton Harrison, Jr. Master of Liberal Arts Professorship	Private	91,484	148,412.04
		State	56,928	
LSUS	George & Regina Khoury Professorship in Science	Private	233,779	432,696.38
		State	198,917	
LSUS	Abe Sadoff Chair	Private	934,575	1,467,805.59
		State	533,231	
LSUS	Samuel & Mary Abramson Professorship	Private	97,837	160,243.69
		State	62,407	
LSUS	Dr. Richard K. Spears Professorship in Field Biology	Private	107,406	182,610.63
		State	75,204	
LSUS	Herman & Renae Chandler Professorship MS Biological Science	Private	78,036	129,352.86
		State	51,317	
LSUS	Don & Earlene Coleman Red River Watershed Management Institute Professorship	Private	110,869	182,968.37
		State	72,100	
LSUS	George Khoury Super Professorship in Space Science	Private	212,659	363,717.67
		State	151,059	
LSUS	Max & Jasmine Morelock Professorship in Chemistry	Private	72,500	120,475.91
		State	47,976	
LSUS	Dr. Lisa Burke Bioinformatics Professorship	Private	87,997	143,062.02
		State	55,065	
LSUS	AEP Swepeco LaPrep Chair	Private	855,654	1,429,117.77
		State	573,464	
LSUS	Miriam Sklar Professorship, Theoretical Math & Physics	Private	225,959	313,979.94
		State	88,021	
LSUS	William C. Woolf Endowed Rising Star Professorship	Private	78,365	130,177.23
		State	51,812	
LSUS	Wheless Rising Star Professorship	Private	76,209	126,442.52
		State	50,234	
LSUS	Bobbie Hicks Super Professorship - Authors in April	Private	199,891	333,433.83
		State	133,543	

LSU System Campus	Name of Support Fund	Endowment	Market Value (\$ Amount) As of 6/30/23	Total Market Value (\$ Amount) As of 6/30/23
LSUS	Hubert & Pat Hervey Prof. Museum of Life Sciences	Private	109,729	182,562.14
		State	72,834	
LSUS	Life Science Museum Professorship	Private	90,249	150,217.54
		State	59,968	
LSUS	William B. Wiener Professorship of Archives and Historical Preservation	Private	83,344	134,090.57
		State	50,747	
LSUS	Ruth H. Noel Chair	Private	507,773	1,467,353.30
		State	959,580	
LSUS	John and Cheryl Good First Generation Scholarship	Private	91,274	147,247.39
		State	55,974	
LSUS	Dalton J. & Sugar Woods First Generation Scholarship	Private	129,704	204,900.32
		State	75,196	
LSUS	Kathie G. Troquille Memorial Scholarship	Private	98,363	150,845.12
		State	52,482	
LSUS	Phillip & Alma Rozeman First Generation Scholarship	Private	100,944	165,161.02
		State	64,217	
LSUS	Salvadore & Kendra Miletelio First Generation Scholarship	Private	111,785	177,266.78
		State	65,482	
LSUS	Alta & John Franks First Generation Scholarship	Private	104,706	167,490.27
		State	62,785	
LSUS	Herman & Renae Chandler First Generation Scholarship	Private	113,508	180,860.31
		State	67,353	
LSUS	Michael Woods Family First Generation Scholarship	Private	75,741	126,339.47
		State	50,599	
LSUS	Yancey Strain Endowed Professorship - SSM	Private	100,330	119,583.35
		State	19,253	
LSUS	LSUS Alumni Association First Gen Scholarship	Private	78,418	98,123.50
		State	19,705	
Totals (as of 6/30/22)		Private	11,488,164	19,735,563.67
		State	8,247,400	

Table III: Summary of Campus Foundations

LSU System Campus	Foundation	Total Assets (\$ Amount) as of 6/30/23		
LSUS	LSUS Foundation	\$29,641,739.00		\$29,641,739.00

Louisiana State University Shreveport

National Benchmark Report

	Endowment per FTE Student	Tuition & Fees per FTE Student	State Appropriations per FTE Student	Tuition, Fees, and State Appropriations per FTE Student	Gov Grants & Contracts per FTE Student	Graduation Rate
Louisiana State University Shreveport	3,636	8,068	1,747	9,815	1,597	33
Montana State University - Billings	10,200	5,728	8,332	14,060	5,378	29
Austin Peay State University	5,457	5,791	7,914	13,705	9,629	43
Columbus State University	13,082	6,093	6,709	12,802	5,941	43

information obtained from IPEDS report run: *1/23/2024*

**Louisiana State University
Health Sciences Center New Orleans**



April 26, 2024

Louisiana State University Health Sciences Center New Orleans

Executive Summary

LSU Health Sciences Center at New Orleans educational programs prepare students for careers as health care professionals and scientists. The Health Sciences Center disseminates and advances knowledge through State and national programs of basic and clinical research, resulting in publications, technology transfer, and related economic enhancements to meet the changing needs of the State of Louisiana and the nation. LSUHSC-NO provides vital public service through direct patient care, including care of indigent and uninsured patients. Health care services are provided through LSUHSC-NO clinics in allied health, dentistry, medicine, nursing, and in numerous affiliated hospitals and clinics throughout Louisiana. LSUHSC-NO provides referral services, continuing education, and information relevant to the public health of the citizens of Louisiana. In addition, LSUHSC-NO works cooperatively with two Area Health Education Centers (AHECs), whose programs focus on improving the number and distribution of health care providers in underserved rural and urban areas of Louisiana and on supporting existing rural health care providers through continuing education programs.

LSU Health Sciences Center at New Orleans welcomes the opportunity to provide information concerning our student enrollment, graduation rates, faculty teaching and research productivity, and revenue resources. The information below is grouped by metric.

Metric I – Degrees Awarded

- There have been considerable increases in the number of degrees awarded in Allied Health and Nursing during the period of 2006-07 to 2022-23. This is a positive impact from efforts to increase the healthcare workforce.
- Total degrees and certificates grew approximately 24.32% from 2006-07 to 2022-23.
- In December 2012, the Nurse Anesthesia Program was approved by the Council on Accreditation of Nurse Anesthesia Educational Programs to transition from a Masters degree level to the Doctor of Nursing Practice degree level. This resulted in a decrease in the number of Masters degrees and an increase in the Doctor of Nursing Practice (DNP) degrees awarded beginning in 2014-15.
- The number of Race/Ethnicity Unknown has increased in recent years due to this data being captured from the AMCAS application system which is self-reported by students.

Metric II – Enrollment Trends

- School of Nursing and School of Allied Health Professions are experiencing a 3% decrease as of the 14th Class Day headcount from the prior year in the undergraduate programs.
- Beginning in 2018-19, enrollment in the Doctor of Audiology, Doctor of Physical Therapy and Doctor of Nursing Practice are recorded under First Professional and was recorded under Masters in previous years.

Metric III – Retention, Graduation, Licensure

- Historical retention rates match what was reported on the annual reports required under the LA Grad Act and vary by academic program. The majority of programs were at least 90% or higher. In the latest year, Dental Lab Tech had the lowest retention rate of 75%; however

Louisiana State University Health Sciences Center New Orleans

Executive Summary

enrollment for this program is only about 5 students each year.

- LSUHSC-NO maintains excellent passage rates on licensure exams with rates ranging from 86% and 100%.

Metric IV – Effectiveness of Campus Research and Technology

- In AY 2022-2023, the number of PhDs and Postdoctoral Fellows grew by 20% over the prior year.
- Total research expenditures increased 27% from prior year while federal research expenditures increased by 6%.
- LSUHSC-NO continues to place an emphasis on faculty obtaining sponsored research funding. The majority of the increase in 2022-2023 is due to additional institutional research investment.

Metric V-Technology Transfer Data

- Data populated from the annual AUTM survey.

Metric VI – Revenue Resources

- Revenues from tuition have grown as a result of increases in tuition rates and enrollment growth. These revenues are being used to offset previous year declines in state general fund support.
- Our campus does not have any true freshmen.
- Although State Appropriations per FTE increased by 12.2% from the prior year, we have experienced a decline of 50.4% from the highest rate in 2007-2008.
- Net Revenue Generated from auxiliary enterprises show a \$4 million deficit due to the payoff of our bond.

Metric VII – Teaching and Research Productivity

- Instructional and Public Service expenditures for FY 09 through FY 23 were updated to reflect data provided to IPEDS. Personnel costs as a percent of direct instructional expenses have steadily decreased from prior years.
- Tenured and tenure track faculty full time equivalent (FTE) numbers have declined in the past few years. Public Service expenditures Per FTE T/TT Faculty have increased drastically in the past few years due to the fair market value transactions with our partner hospitals.

National Benchmarks

- Data is included comparing the performance of our medical students on the USMLE examinations to medical students nationally and our medical school's rank among medical schools nationally in NIH funding. Beginning with 2021-22, the USMLE Step 1 score transitioned to Pass/Fail only.

HSCNO MISSION:

The mission of LSUHSC-NO is to provide education, research, and public service through direct patient care, and community outreach.

LSUHSC-NO is comprised of the Schools of Allied Health Professions, Dentistry, Graduate Studies, Medicine, Nursing, and Public Health.

Louisiana State University Health Sciences Center New Orleans

Metrics at a Glance 2022-2023

Legend:

Statistic	
High	X Y
Low	Z %

Most Recent Available
% Change from Previous Year

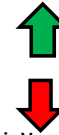

Increase from Previous Year

Decrease from Previous Year



No change

Metric I Degrees Awarded	Metric II Enrollment	Metric III Student Success	Metric IV Research Expenditures	Metric V Technology Transfer	Metric VI Revenues	Metric VII Instruction Productivity
Bachelors	Total Undergraduate Headcount	Fall Headcount	Total number of T/TT faculty holding grants	Invention Disclosures	Market Value of Endowments	Total Instructional T/TT Faculty
331 314	921 844	2,835 2,685	96 76	48 25	165,532,353 149,172,425	189 161
314 ↓ -3.1%	844 ↓ -4.1%	2,685 ↓ -2.0%	72 ↓ -19.1%	25 → 0.0%	123,686,215 ↑ 4.6%	161 ↓ -3.0%
Masters	Total Graduate Headcount	Fall FTE	% of T/TT faculty holding grants	Licenses\Options Executed	Total Gross Revenue Generated from tuition and fees	Total All FTE Instructional Faculty
169 157	801 387	2,735 2,606	52.2% 42.2%	9 2	66,012,107 65,850,892	916 910
142 ↓ -6.0%	387 ↓ -5.4%	2,606 ↓ -1.5%	34.8% ↓ -19.1%	1 ↓ -71.4%	58,684,545 ↓ -0.2%	872 ↑ 1.8%
Professional Medicine (MD)	Total Professional Headcount	Fall Credit Hour per FTE	Total number of Postdoctoral Fellows	New Patents Filed - Total	Total Net Revenue Generated from tuition and fees	T/TT FTE Faculty as a Percent of Total FTE Faculty
196 196	1,465 1,454	22.5 23	56 56	73 50	61,921,542 61,845,251	21.7% 17.7%
184 ↑ 6.5%	1,446 ↑ 0.2%	20.0 ↑ 7.4%	31 ↑ 60.0%	3 ↓ -31.5%	54,555,273 ↓ -0.1%	17.7% ↓ -4.7%
Professional Dentistry (DDS)	Total number of students enrolled who received TOPS	1st to 2nd Year Retention Allied Health	Research per FTE T/TT faculty (in thousands)	Active License Agreements	State Appropriation per FTE	Total SCH Per T/TT Faculty
77 77	450 0	95.0% 1	358 358	45 45	35,508 35,508	165.9 n/a
59 ↑ 1.3%	404 ↓ -100.0%	92.0% ↑ 1.1%	197 ↑ 19.3%	6 ↑ 2.3%	26,398 ↑ 12.2%	158.6 #VALUE!
Total number of degrees awarded in Nursing	Total number of students enrolled in Nursing programs	1st to 2nN Year Retention (Mental Hygiene)	Total Federal Research Expenditures	Licenses Generating Income	Net Revenue Generated from auxiliary enterprises	Estimated FTE Student Taught per T/TT FTE Faculty
325 306	1,043 928	100.0% 1	36,027 35,933	29 17	286,825 -4,915,460	16 16
305 ↓ -5.6%	928 ↓ -4.2%	97.0% → 0.0%	26,988 ↑ 8.6%	10 → 0.0%	-4,915,460 ↓ 743.6%	14.0 → 0.0%
Total number of degrees awarded in Allied Health	Total number of students enrolled in Allied Health Professions programs	1st to 2nN Year Retention (Nursing)	Total NSF Research Expenditures	Total Licensing Income		Personnel Cost as a percent of Direct Instructional Expense
188 169	400 368	97.0% 1	68,707 68,707	948,124 948,124		87.4% 73.7%
169 ↓ -7.1%	368 ↓ -1.6%	86.0% ↓ -3.0%	10,813 → 0.0%	120,019 ↑ 391.4%		73.7% → 0.0%

Louisiana State University Health Sciences Center New Orleans

Metric I. Number of degrees conferred by level and professions most important to Louisiana.

	2017-2018	2018-2019	2019-2020	2020-2021	2021-2022	2022-2023
Campus total number of degrees awarded/conferred						
Associates	2	2	5	4	4	2
Bachelors	323	323	331	330	324	314
Masters	169	142	159	151	167	157
Doctoral Research/Scholarship (PhD, DNS)	11	22	15	16	18	24
Professional Audiology (AuD)	10	12	11	11	11	9
Professional Physical Therapy (DPT)	34	36	32	33	34	30
Professional Medicine (MD)	192	189	192	192	184	196
Professional Dentistry (DDS)	63	59	66	69	76	77
Professional Nursing (DNP)	58	71	57	69	71	65
Post Doctoral Certificate	0	0	0	0	0	0
Total degrees awarded	862	856	868	875	889	874
Total number of degrees awarded in Nursing	305	318	317	325	324	306
Total number of degrees awarded in Allied Health	188	176	175	174	182	169
Total number of degrees awarded by race/ethnicity						
Hispanic	48	37	35	44	54	43
American Indian or Alaska Native	4	3	1	3	4	3
Asian	67	51	64	73	70	66
Black, Non-Hispanic	74	67	78	81	68	97
Native Hawaiian or Other Pacific Islander	0	1	0	0	0	0
White Non-Hispanic	638	575	654	639	615	566
Two or More Races	4	14	11	19	18	13
Non-Resident Alien	8	13	9	7	12	10
Race/Ethnicity Unknown	19	95	16	9	48	76

Louisiana State University Health Sciences Center New Orleans

Metric I. Number of degrees conferred by level and professions most important to Louisiana.

<i>Nursing CIP Code/s</i>			
	CIP Code	CIP 2010 Code	Degree
Nursing	51.1601	51.3801	BSN
Nursing Administration	51.1602	51.3802	MN
Nursing-Adult Health & Illness	51.1603	51.3803	MN
Nurse Anesthesia	51.1604	51.3804	MN
Primary Care Family Nurse Practitioner	51.1605	51.3805	MN
Neonatal Nurse Practitioner	51.1606	51.3806	MN
Nursing Science	51.1608	51.3808	DNS
Psyc./Community Health Nursing	51.1610	cancelled	MN
Public & Community Health Nursing	51.1611	51.3811	MN
Nursing, Other-Nurse Educator	51.1699	51.3817	MN
Nursing Practice	51.3818	51.3818	DNP
<i>Allied Health CIP Code/s</i>			
Health Science	51.0000	cancelled	MHS
Audiology	51.0202	51.0202	Au D
Communications Disorders	51.0204	51.0204	MCD
Cardiopulmonary Science	51.0901	51.0901	BS
Clinical Lab Science/Medical Technology	51.1005	51.1005	BS
Occupational Therapy	51.2306	51.2306	MOT
Physical Therapy	51.2308	51.2308	DPT
Physician Assistant Studies	51.0912	51.0912	MPAS
Rehabilitation Services	51.2310	cancelled	BS
Rehabilitation Counseling	51.2310	51.2310	MHS

Louisiana State University Health Sciences Center New Orleans

Metric II. The following metrics will provide the campus enrollment trends.

Headcount Enrollment as of 14th Class Day		2017-2018	2018-2019	2019-2020	2020-2021	2021-2022	2022-2023	2023-2024
<i>Undergraduate</i>								
	Full-time	696	728	831	783	788	783	760
	Part-time	225	186	90	121	105	97	84
Total Undergraduate Headcount		921	914	921	904	893	880	844
<i>Graduate</i>								
	Full-time	728	400	395	401	417	350	335
	Part-time	73	48	52	58	64	59	52
Total Graduate Headcount		801	448	447	459	481	409	387
<i>First Professional</i>								
	Full-time	1,055	1,396	1,403	1,436	1,426	1,424	1,432
	Part-time		50	51	29	35	27	22
Total Professional Headcount		1,055	1,446	1,454	1,465	1,461	1,451	1,454
Total Headcount Enrollment (Undergraduate, Graduate & Professional)		2,777	2,808	2,822	2,828	2,835	2,740	2,685
Total Full-Time-Equivalent (FTE) Enrollment		2,664	2,690	2,723	2,735	2,729	2,645	2,605
Total Enrollment by Race and Ethnicity as of the 14th Class Day		2017-2018	2018-2019	2019-2020	2020-2021	2021-2022	2022-2023	2023-2024
Allied Health Professions								
	Hispanic	10	5	8	13	16	19	12
	American Indian or Alaskan Native	0	0	0	0	1	1	1
	Asian	18	18	15	15	14	25	21
	Black, Non-Hispanic	21	22	28	19	25	22	27
	Native Hawaiian or Other Pacific Islander	1	1	0	0	0	0	0
	White Non-Hispanic	327	318	320	324	313	286	286
	Two or More Races	7	10	11	15	12	13	13
	Nonresident Alien	0	1	1	1	1	0	0
	Race/Ethnicity Unknown	16	14	7	6	7	8	8

Louisiana State University Health Sciences Center New Orleans

Metric II. The following metrics will provide the campus enrollment trends.

Total Enrollment by Race and Ethnicity as of the 14th Class Day		2017-2018	2018-2019	2019-2020	2020-2021	2021-2022	2022-2023	2023-2024
Dentistry								
	Hispanic	11	14	12	14	17	14	20
	American Indian or Alaskan Native	2	2	2	5	5	6	5
	Asian	48	51	54	56	53	59	64
	Black, Non-Hispanic	14	19	20	14	13	11	11
	Native Hawaiian or Other Pacific Islander	0	0	0	0	0	1	1
	White Non-Hispanic	286	298	310	320	326	324	317
	Two or More Races	3	4	4	1	0	0	0
	Nonresident Alien	9	7	7	13	11	6	8
	Race/Ethnicity Unknown	3	1	1	2	5	5	2
Graduate Studies								
	Hispanic	2	4	5	5	5	4	6
	American Indian or Alaskan Native	0	0	0	0	0	1	1
	Asian	9	9	6	6	6	7	11
	Black, Non-Hispanic	6	4	7	10	11	4	6
	Native Hawaiian or Other Pacific Islander	0	0	0	1	1	1	0
	White Non-Hispanic	49	48	51	49	46	39	30
	Two or More Races	0	0	1	1	0	0	0
	Nonresident Alien	6	9	9	11	12	9	8
	Race/Ethnicity Unknown	1	1	0	0	0	0	2
Nursing								
	Hispanic	65	65	70	70	77	79	84
	American Indian or Alaskan Native	3	3	3	3	2	0	2
	Asian	46	48	50	53	55	56	67
	Black, Non-Hispanic	130	135	149	166	162	174	159
	Native Hawaiian or Other Pacific Islander	0	1	0	0	0	0	2
	White Non-Hispanic	738	752	744	705	685	626	569
	Two or More Races	14	17	16	18	17	25	31
	Nonresident Alien	1	4	2	1	4	2	6
	Race/Ethnicity Unknown	13	15	9	5	8	7	8

Louisiana State University Health Sciences Center New Orleans

Metric II. The following metrics will provide the campus enrollment trends.

Total Enrollment by Race and Ethnicity as of the 14th Class Day		2017-2018	2018-2019	2019-2020	2020-2021	2021-2022	2022-2023	2023-2024
Medicine								
	Hispanic	31	38	42	40	39	34	45
	American Indian or Alaskan Native	1	1	2	3	2	1	1
	Asian	92	93	108	111	117	121	120
	Black, Non-Hispanic	39	45	50	52	71	74	75
	Native Hawaiian or Other Pacific Islander	0	0	0	0	0	0	1
	White Non-Hispanic	504	480	556	547	514	513	497
	Two or More Races	8	12	14	16	19	22	18
	Nonresident Alien	2	2	0	1	1	1	2
	Race/Ethnicity Unknown	125	120	30	27	26	27	25
Public Health								
	Hispanic	13	10	7	4	8	7	8
	American Indian or Alaskan Native	1	1	1	0	1	1	1
	Asian	11	8	9	9	8	7	7
	Black, Non-Hispanic	25	23	21	28	35	37	33
	Native Hawaiian or Other Pacific Islander	0	0	0	0	1	0	2
	White Non-Hispanic	45	53	41	51	64	39	37
	Two or More Races	2	1	1	1	1	3	2
	Nonresident Alien	17	20	16	15	17	18	21
	Race/Ethnicity Unknown	0	1	2	1	1	1	2
Student Credit Hours (SCH)		2017-2018	2018-2019	2019-2020	2020-2021	2021-2022	2022-2023	2023-2024
<i>Note: For MD and DDS Students 18 contact hours = 1 credit hour</i>								
	Fall SCH	59,494	53,808	55,411	55,911	57,034	55,416	58,657
	Spring SCH	53,461	50,928	50,843	52,266	52,111	51,196	50,101
Total number of students enrolled who received TOPS		2017-2018	2018-2019	2019-2020	2020-2021	2021-2022	2022-2023	2023-2024
	Performance	147	150	159	159	147	150	143
	Opportunity	136	147	153	144	133	132	111
	Honors	111	112	138	127	127	122	87
Enrollment by specified discipline as of 14th class day		2017-2018	2018-2019	2019-2020	2020-2021	2021-2022	2022-2023	2023-2024
Total number of students enrolled in Nursing programs		1,010	1,040	1,043	1,021	1,010	969	928
Total number of students enrolled in Allied Health Professions programs		400	389	390	393	389	374	368

Louisiana State University Health Sciences Center New Orleans

Metric II. The following metrics will provide the campus enrollment trends.

Nursing CIP Code/s

	CIP Code	CIP 2010	Degree
Nursing	51.3801	51.3801	BSN
Nursing Administration	51.3802	51.3802	MN
Nursing-Adult Health & Illness	51.3803	51.3803	MN
Nurse Anesthesia	51.3804	cancelled	MN
Primary Care Family Nurse Practitioner	51.3805	51.3805	MN
Neonatal Nurse Practitioner	51.3806	51.3806	MN
Nursing Science	51.3808	51.3808	DNS
Psyc./Community Health Nursing		cancelled	MN
Public & Community Health Nursing		51.3811	MN
Nursing, Other-Nurse Educator	51.3817	51.3817	MN
Nursing Practice	51.3818	51.3818	DNP

Allied Health CIP Code/s

Health Science		cancelled	MHS
Audiology	51.0202	51.0202	Au D
Communications Disorders	51.0204	51.0204	MCD
Cardiopulmonary Science	51.0901	51.0901	BS
Clinical Lab Science/Medical Technology	51.1005		
Occupational Therapy	51.2306	51.2306	MOT
Physical Therapy	51.2308	51.2308	DPT
Physician Assistant Studies	51.2310	51.0912	MPAS
Rehabilitation Services		cancelled	BS
Rehabilitation Counseling	51.2310	51.1005	MHS

Variables Description

Headcount Enrollment Undergraduate – Total number of full-time and part-time students enrolled in courses for undergraduate credit.

Headcount Enrollment Graduate – Total number of full-time and part-time students enrolled in courses for graduate credit.

Full-Time Equivalent (FTE) – The calculation of FTE can vary by institution. However, FTE enrollment reported for this metric should reconcile to FTE data you report to the Louisiana BoR, SREB and IPEDS for your campus.

Full-Time Student Undergraduate - a student enrolled for 12 or more semester credits or 24 or more contact hours a week each term. (IPEDS)

Dual Enrollment- A student who is enrolled in high school but who is also enrolled, simultaneously, in a postsecondary institution are considered dual enrolled.

Science Technology Engineering and Mathematics (STEM): STEM enrollment is calculated based on STEM CIP codes.

Educations, Nursing, Allied Health - Use the CIP codes as defined by IPEDS for these disciplines to determine the number of students enrolled and graduates in

Louisiana State University Health Sciences Center New Orleans

Metric III. The following metric will identify the campus trends for retention, graduation, licensure and pass rate.

14th Day Headcount Enrollment	2017-2018	2018-2019	2019-2020	2020-2021	2021-2022	2022-2023	2023-2024
Fall Headcount	2,777	2,808	2,822	2,828	2,835	2,740	2,685
Spring Headcount	2,834	2,839	2,856	2,863	2,841	2,767	n/a
Fall Credit Hours	55,425	53,808	55,411	55,911	57,034	55,416	58,657
Spring Credit Hours	53,558	50,928	50,843	52,266	52,111	51,196	n/a
Fall FTE	2,665	2,690	2,723	2,735	2,729	2,645	2,606
Spring FTE	2,721	2,730	2,739	2,767	2,728	2,660	n/a
Fall Credit Hour per FTE	20.80	20.00	20.35	20.44	20.90	20.95	22.51
Spring Credit Hour per FTE	19.68	18.65	18.56	18.89	19.10	19.25	n/a
Campus - 1st to 2nd year Retention Rates							
By School and Program (student must be continuously enrollment)							
Allied Health Professions	95%	95%	92%	95%	95%	93%	94%
Dentistry-DDS	100%	100%	99%	100%	100%	100%	99%
Dentistry-Dental Hygiene	97%	97%	97%	100%	97%	97%	97%
Dentistry-Dental Lab Tech	100%	100%	100%	100%	83%	100%	75%
Graduate Studies	100%	87%	95%	95%	93%	72%	100%
Medicine	96%	98%	98%	99%	99%	97%	99%
Nursing	86%	90%	87%	93%	92%	86%	97%
Public Health	94%	96%	72%	85%	91%	85%	84%

Louisiana State University Health Sciences Center New Orleans

Metric III. The following metric will identify the campus trends for retention, graduation, licensure and pass rate.

Number of students taking licensure exams	2017-2018	2018-2019	2019-2020	2020-2021	2021-2022	2022-2023
Allied Health						
Cardiopulmonary Science	18	15	10	12	17	15
Clinical Laboratory Sciences	22	22	25	23	21	23
Audiology and Speech Language Pathology	37	31	35	33	34	30
Occupational Therapy	36	33	34	35	35	35
Physician Assistant Studies	30	30	28	29	33	35
Physical Therapy	34	36	32	33	33	30
Dentistry						
DDS National Board Dental Exam (written)	63	61	61	69	65	72
DDS Clinical Licensure Exam (practical)	63	59	63	69	63	71
National Board Dental Hygiene Exam (written)	37	37	37	39	38	37
Dental Hygiene Clinical Licensure Exam (practical)	37	37	37	39	38	37
Medicine						
USMLE Step 1	194	200	190	179	217	193
USMLE Step 2 CK	184	193	189	199	176	205
USMLE Step 2 CS	191	190	n/a	n/a	n/a	n/a
Nursing						
NCLEX	223	222	249	228	234	240

Louisiana State University Health Sciences Center New Orleans

Metric III. The following metric will identify the campus trends for retention, graduation, licensure and pass rate.

Number of students passing licensure exams	2017-2018	2018-2019	2019-2020	2020-2021	2021-2022	2022-2023
Allied Health						
Cardiopulmonary Science	18	15	10	12	16	15
Clinical Laboratory Sciences	22	22	25	23	21	23
Audiology and Speech Language Pathology	37	31	35	33	34	30
Occupational Therapy	36	33	34	35	35	35
Physician Assistant Studies	30	27	27	29	33	33
Physical Therapy	32	36	32	33	31	30
Dentistry						
DDS National Board Dental Exam (written)	63	61	61	68	65	72
DDS Clinical Licensure Exam (practical)	63	59	63	69	63	70
National Board Dental Hygiene Exam (written)	37	37	37	39	38	37
Dental Hygiene Clinical Licensure Exam (practical)	37	37	37	39	38	37
Medicine						
USMLE Step 1	188	191	184	172	200	166
USMLE Step 2 CK	183	189	185	197	173	199
USMLE Step 2 CS	188	173	n/a	n/a	n/a	n/a
Nursing						
NCLEX	216	218	243	218	215	228

Louisiana State University Health Sciences Center New Orleans

Metric III. The following metric will identify the campus trends for retention, graduation, licensure and pass rate.

Campus pass rate on licensure exams	2017-2018	2018-2019	2019-2020	2020-2021	2021-2022	2022-2023
Allied Health						
Cardiopulmonary Science	100%	100%	100%	100%	94%	100%
Clinical Laboratory Sciences	100%	100%	100%	100%	100%	100%
Audiology and Speech Language Pathology	100%	100%	100%	100%	100%	100%
Occupational Therapy	100%	100%	100%	100%	100%	100%
Physician Assistant Studies	100%	90%	96%	100%	100%	94%
Physical Therapy	94%	100%	100%	100%	94%	100%
Dentistry						
DDS National Board Dental Exam (written)	100%	100%	100%	99%	100%	100%
DDS Clinical Licensure Exam (practical)	100%	100%	100%	100%	100%	98.6%
National Board Dental Hygiene Exam (written)	100%	100%	100%	100%	100%	100%
Dental Hygiene Clinical Licensure Exam (practical)	100%	100%	100%	100%	100%	100%
Medicine						
USMLE Step 1	97%	96%	97%	96%	92%	86%
USMLE Step 2 CK	99%	98%	98%	99%	98%	97%
USMLE Step 2 CS	98%	91%	n/a	n/a	n/a	n/a
Nursing						
NCLEX	97%	98%	98%	96%	92%	95%

Louisiana State University Health Sciences Center New Orleans

Metric IV. The following metrics will identify the effectiveness of campus research and technology transfer to benefit the state's economic development.

	Academic 2013-2014	Academic 2014-2015	Academic 2015-2016	Academic 2016-2017	Academic 2017- 2018	Academic 2018-2019	Academic 2019-2020	Academic 2020-2021	Academic 2021-2022	Academic 2022-2023
Faculty Research (\$ in thousands)										
Total \$ amount of faculty research	45,486	46,838	43,066	40,785	38,989	40,915	43,419	44,370	53,996	68,707
Total number of T/TT faculty holding grants	83	72	85	77	84	90	76	96	94	76
% of T/TT faculty holding grants	39.52%	34.78%	47.75%	48.13%	40.98%	44.78%	40.43%	50.79%	52.22%	42.22%
Research \$ per FTE T/TT	217	226	213	197	201	216	239	236	300	358
Total number of PhD's awarded	12	23	23	18	11	22	15	16	18	24
Total number of Postdoctoral Fellows	31	33	35	35	42	49	46	47	35	56
Total Number of Post Baccalaureate Certificates	13	19	0	0	0	0	0	0	0	0

Total research by Major Discipline; Life Science; Physical Science; environmental Science; Engineering Science; Computer Science; Math; Psychology; Social Science; Other Science

Research Expenditure by Major Discipline <i>Data shown in Thousands</i>	FY Ending 2015			FY Ending 2016			FY Ending 2017		
	Federal	Other	Total	Federal	Other	Total	Federal	Other	Total
Allied Health	25	310	335	29	321	350	4	295	300
Dentistry	1,094	162	1,256	1,150	141	1,291	1,844	145	1,989
Medicine	27,405	8,297	35,702	23,600	8,548	32,148	23,017	9,892	32,909
Nursing	0	0	0	0	0	0	0	5	5
Public Health	7,503	2,044	9,547	6,747	2,530	9,278	2,678	2,328	5,006
Institutional	0	0	0	0	0	0	475	101	576
Total	36,027	10,813	46,840	31,526	11,540	43,066	28,018	12,766	40,785

Research Expenditure by Major Discipline <i>Data shown in Thousands</i>	FY Ending 2018			FY Ending 2019			FY Ending 2020		
	Federal	Other	Total	Federal	Other	Total	Federal	Other	Total
Allied Health		272	272	858	198	1,056	608	40	648
Dentistry	2,062	193	2,255	1,326	-43	1,283	922	108	1,030
Medicine	22,057	9,804	31,861	26,324	8,630	34,954	27,222	10,818	38,041
Nursing	0	49	49	32	3	35	21	23	44
Public Health	2,867	1,682	4,549	2,748	836	3,584	2,606	1,049	3,655
Institutional	2	1	3	2	0	2	1	0	1
Total	26,988	12,001	38,989	31,290	9,624	40,914	31,381	12,038	43,419

Louisiana State University Health Sciences Center New Orleans

Metric IV. The following metrics will identify the effectiveness of campus research and technology transfer to benefit the state's economic development.

Research Expenditure by Major Discipline <i>Data shown in Thousands</i>	FY Ending 2021			FY Ending 2022			FY Ending 2023		
	Federal	Other	Total	Federal	Other	Total	Federal	Other	Total
Allied Health	665	29	694	691	47	737	440	43	483
Dentistry	847	132	979	719	800	1,521	561	906	1,467
Medicine	29,824	9,474	39,298	28,846	17,403	47,043	32,097	30,365	62,463
Nursing	0	3	3	5	5	10	20	3	24
Public Health	2,936	461	3,397	2,822	1,823	4,660	2,815	1,425	4,240
Institutional	0	0	0	4	25	29	0	30	30
Total	34,272	10,099	44,371	33,087	20,103	53,190	35,933	32,774	68,707

Research Expenditures (\$ in thousands)	FY 2014	FY 2015	FY 2016	FY 2017	FY 2018	FY 2019	FY 2020	FY 2021	FY 2022	FY 2023
Federal	36,027	36,027	31,526	28,018	26,988	31,290	31,381	34,272	33,087	35,933
Total	45,486	46,840	43,066	40,785	38,989	40,914	43,419	44,371	68,707	68,707

Note that Research Expenditures data should match data your campus reported to NSF. Beginning in 2008, this data should follow the following guidelines.

Track all expenditures back to the original source. For example, if funds come from the State DOTD, but originated with the federal government those expenditures should be reported as federal. There should be a CFDA number attached to these grants indicating that the original source was federal.

Report all clinical trials as research. Please note that not all clinical trials are done by Tenured or Tenured Track (T/TT) faculty (see c).

Compute under-and unreimbursed indirect costs according to the instructions.

Report NIH "k" and other research training awards as federal. Note, Do Not report all training grants, **only those that are for research training.**

Louisiana State University Health Sciences Center New Orleans

Metric V: Technology Transfer

	2015-2016	2016-2017	2017-2018	2018-2019	2019-2020	2020-2021	2021-2022	2022-2023
Invention Disclosures	28	25	28	41	48	43	25	25
Licenses\Options Executed	8	3	7	5	9	6	7	2
New Patents Filed - Total	25	37	43	28	64	55	73	50
New Patents Filed - First in Family	10	11	13	15	14	19	5	11
US Patents Issued	3	4	7	2	5	3	5	7
Active License Agreements	23	24	30	30	38	43	44	45
Licenses Generating Income	29	10	15	12	18	20	17	17
Total Licensing Income	\$830,274	\$162,860	\$224,996	\$120,019	\$163,023	\$657,314	\$192,948	\$948,124
Start-up Companies Formed	1	0	2	0	2	2	1	0
Legal Fees Expended	\$202,638	\$123,920	\$302,050	\$190,401	\$516,175	\$642,035	\$601,865	\$509,090
Legal Fees Reimbursed	\$0	\$24,654	\$69,124	\$50,164	\$177,157	\$265,135	\$317,115	\$624,061
Percent of Expenses Reimbursed	0%	20%	23%	26%	34%	41%	53%	123%
Legal Fees as a % License Income	24%	76%	134%	159%	317%	98%	312%	54%

LEGEND:

* = 2015-2016 was the first year to track

Louisiana State University Health Sciences Center New Orleans

Metric VI. The following metrics will identify the tuition and fee revenues, and, other revenue resources.

	2017-2018	2018-2019	2019-2020	2020-2021	2021-2022	2022-2023
Total Endowment Value	\$123,686,215	\$124,347,980	\$126,456,080	\$165,532,353	\$142,574,680	\$149,172,425
Earned Interest on Endowments	\$6,883,107	\$3,649,563	\$3,398,583	\$41,033,426	(\$19,675,377)	\$9,155,693
Dollar amount of the endowment approved each fiscal year and made available for expenditures by the campus	\$5,510,166	\$4,333,690	\$3,303,269	\$6,984,596	\$6,777,069	\$5,419,937
Total # of Foundations	1	1	1	1	1	1
Foundations total Assets (\$ Amount)	\$151,758,478	\$158,588,451	\$163,045,965	\$207,439,306	\$192,154,044	\$197,639,358
Click here to go to the Foundations Supplemental Table						
Total # of Board of Regents Support Fund						
Total Value (\$ Amount) of BoR Support Fund	\$ 101,634,331	\$ 102,172,303	\$ 104,007,411	\$ 135,273,552	\$ 117,690,014	\$ 121,299,146
Click here to go to the BoR Support Funds Supplemental Table						
Total Gross Revenue Generated from tuition and fees	\$58,684,545	\$61,563,458	\$63,797,336	\$65,316,454	\$66,012,107	\$65,850,892
Total Net Revenue Generated from tuition and fees	\$54,555,273	\$57,601,281	\$59,426,028	\$61,131,377	\$61,921,542	\$61,845,251
Financial Aid						
Total institutional dollars awarded need based aid for entering freshmen class	XXXXXXXX	XXXXXXXX	XXXXXXXX	XXXXXXXX	XXXXXXXX	XXXXXXXX
Total institutional dollars awarded non-need aid for entering freshmen class	XXXXXXXX	XXXXXXXX	XXXXXXXX	XXXXXXXX	XXXXXXXX	XXXXXXXX
Total institutional dollars awarded need based aid for entering freshmen class LA residents	XXXXXXXX	XXXXXXXX	XXXXXXXX	XXXXXXXX	XXXXXXXX	XXXXXXXX
Total institutional dollars awarded non-need based aid for entering freshmen class LA residents	XXXXXXXX	XXXXXXXX	XXXXXXXX	XXXXXXXX	XXXXXXXX	XXXXXXXX
Total institutional dollars awarded need based aid for entering freshmen class non-residents	XXXXXXXX	XXXXXXXX	XXXXXXXX	XXXXXXXX	XXXXXXXX	XXXXXXXX
Total institutional dollars awarded non-need based aid for entering freshmen class non-residents	XXXXXXXX	XXXXXXXX	XXXXXXXX	XXXXXXXX	XXXXXXXX	XXXXXXXX
LSUHSC-NO does not enroll freshmen in any programs						
State Appropriation per FTE¹	\$30,737	\$30,583	\$29,396	\$26,398	\$31,656	\$35,508
Net Revenue Generated from auxiliary enterprises	(\$388,673)	\$286,825	(\$1,657,231)	(\$703,394)	(\$582,678)	(\$4,915,460)

¹ Per LSU System: State Appropriation includes the Final Approved Budgeted General Fund, Statutory Dedication, and Federal Stimulus (ARRA) of each year. Student FTE is annual FTE reported to Board of Regents. Amount includes money for the Cancer

Louisiana State University Health Sciences Center New Orleans

Metric VI. The following metrics will identify the tuition and fee revenues, and, other revenue resources.

Endowment Value equals the market value of of the endowment as of June 30 of the reporting year.

FTE Full time equivalent

Payout from Endowment equal interest earned on endowment.

Gross Revenue Generated from Student Enrollment FTE equals revenue gain from student tuitions and fees.

Net Revenue Generated from Student Enrollment FTE equals gross revenue from enrollment headcount minus institutional supported financial aid.

Net Revenue from Auxiliary equal gross revenue generated from auxiliary enterprises minus debt services and other financial obligations.

Annual Giving data include all contributions actually received during the institution's fiscal year in the form of cash, securities company products, and other property from alumni, non-alumni individuals, corporations, foundations, religious organizations and other groups. Not included in the totals are public funds, earnings on investments held by the institution, and unfulfilled pledges.

Endowment Value equals the market value of of the endowment as of June 30 of the reporting year.

FTE Full time equivalent

Payout from Endowment equal interest earned on endowment.

Gross Revenue Generated from Student Enrollment FTE equals revenue gain from student tuitions and fees.

Net Revenue Generated from Student Enrollment FTE equals gross revenue from enrollment headcount minus institutional supported financial aid.

Net Revenue from Auxiliary equal gross revenue generated from auxiliary enterprises minus debt services and other financial obligations.

Louisiana State University Health Sciences Center New Orleans

Metric VII. The following metrics will identify teaching and research

	2018-2019	2019-2020	2020-2021	2021-2022	2022-2023	2023-2024
Instructional						
Total Instructional FTE Tenured Faculty	154	145	142	140	135	137
Total Instructional FTE Tenure Track Faculty	35	37	32	34	31	24
Total Instructional T/TT Faculty	189	182	174	174	166	161
Total All FTE Instructional Faculty	872	905	910	916	894	910
Total FTE Faculty (Non-T/TT)	683	723	736	742	728	749
Total Faculty including Part-Time	918	955	962	960	935	949
Total Part-Time Faculty	46	50	52	44	41	39
T/TT FTE Faculty as a Percent of Total FTE Faculty	21.67%	20.11%	19.12%	19.00%	18.57%	17.69%
Organized Sections						
<i>Undergraduate (Sections)</i>	226	236	244	223	270	n/a
<i>Graduate (Sections)</i>	502	599	604	583	579	n/a
<i>Professional (Sections)</i>	520	494	445	490	514	n/a
<i>Professional Certificates (Sections)</i>	106	107	106	106	98	n/a
<i>Total Number of Organized Sections</i>	1,354	1,436	1,399	1,402	1,461	n/a
Duplicated Head Count Enrollment	6,413	6,448	6,434	6,357	6,196	n/a
Duplicated Headcount per Organized Section	5	4	5	5	4	n/a
Include Total SCH generated during the academic year						
Undergraduate (SCH)	25,702	26,058	25,219	24,586	24,808	n/a
Graduate (SCH)	26,653	26,927	27,596	27,661	26,093	n/a
Professional (SCH)	58,428	59,832	61,591	63,115	67,368	n/a
Professional Certificates (SCH)	2,520	2,444	2,467	2,331	1,819	n/a
Total (SCH)	113,303	115,261	116,873	117,693	120,088	n/a
Total SCH Per T/TT Faculty	166	159	159	159	165	n/a
Total FTE Student Taught (Fall Semester Only)	2,690	2,723	2,735	2,729	2,645	2,605
Estimated FTE Student Taught per T/TT FTE Faculty	14	15	16	16	16	16

Louisiana State University Health Sciences Center New Orleans

Metric VII. The following metrics will identify teaching and research

	2018-2019	2019-2020	2020-2021	2021-2022	2022-2023	2023-2024
Cost Data: Direct Expenditures for Instruction (As defined by						
Total Direct Instructional Expenditures	\$215,904,087	\$203,549,279	\$219,342,521	\$236,495,450	\$251,769,182	n/a
Salaries	\$142,724,852	\$146,348,030	\$146,050,212	\$150,503,964	\$153,454,530	n/a
Benefits	\$33,094,081	\$31,521,088	\$33,071,095	\$34,424,817	\$32,000,418	n/a
Expenditures other than personnel related to Instructions	40,085,154	25,680,161	40,221,214	51,566,669	66,314,234	n/a
Salaries as a Percent of Direct Instructional Expense	66.1%	71.9%	66.6%	63.6%	61.0%	n/a
Personnel Cost as a percent of Direct Instructional Expense	81.4%	87.4%	81.7%	78.2%	73.7%	n/a
Research Expenditure	\$40,639,028	\$40,517,678	\$41,000,832	\$35,508,861	\$43,002,298	n/a
Public Service Expenditures	\$220,650,551	\$360,376,845	\$427,397,408	\$396,578,033	\$439,079,022	n/a
Total Research and Public Services	\$261,289,578	\$400,894,523	\$468,398,240	\$432,086,894	\$482,081,320	n/a
Research per FTE T/TT Faculty	\$215,021	\$222,625	\$235,637	\$204,074	\$259,050	n/a
Public Service Per FTE T/TT Faculty	\$1,167,463	\$1,980,093	\$2,456,307	\$2,279,184	\$2,645,054	n/a
Research and Public Service per FTE T/TT Faculty	\$1,382,485	\$2,202,717	\$2,691,944	\$2,483,258	\$2,904,104	n/a

Louisiana State University Health Sciences Center New Orleans

Metric VII. The following metrics will identify teaching and research

2018-2019	2019-2020	2020-2021	2021-2022	2022-2023	2023-2024
-----------	-----------	-----------	-----------	-----------	-----------

Definitions:

Direct Expenditures for Instructions: Total Direct Instructional Expenditures include data in certain functional areas - instruction, research, and public service. Direct expenditure data reflect costs incurred for personnel compensation, supplies, and services used in the conduct of each of these functional areas. They include acquisition costs of capital assets such as equipment and library books to the extent that funds are budgeted for the use of departments for instruction, research, and public service. Similar to the Delaware Study, exclude centrally allocated computing costs and centrally supported computer labs, and graduate student tuition remission and fee waivers.

Instruction: Instruction includes general academic instruction, occupational and vocational instruction, community education, preparatory and adult basic education, and remedial and tutorial instruction conducted by the teaching faculty for the institution's students. Departmental research and service **which are not separately budgeted** should be included under instruction. In other words, department research which is externally funded should be excluded from instructional expenditures, as should any departmental funds which were expended for the purpose of matching external research funds as part of a contractual or grant obligation. EXCLUDE expenditures for academic administration where the primary function is administration. For example, exclude deans, but include department chairs.)

Disaggregate total direct instructional expenditures for the institution into the following categories:

Salaries: Report all wages paid to support the instructional function in a given department or program during the fiscal year. While these will largely be faculty salaries, be sure to include clerical (e.g., department secretary), professionals (e.g., lab technicians), Graduate student stipends (but not tuition waivers), and any other personnel who support the teaching function and whose salaries and wages are paid **from the institution's instructional budget**.

Benefits: Report expenditures for benefits associated with the personnel for whom salaries and wages were reported on the previous entry. If you cannot separate benefits from salaries, but benefits are included in the salary figure you have entered, indicate "Included in Salaries" in the data field. Some institutions book benefits centrally and do not disaggregate to the department level. If you can compute the appropriate benefit amount for the department/program, please do so and enter the data. If you cannot do so, leave the benefit amount as zero and we will impute a cost factor based upon the current benefit rate for your institution, as published in *Academe*. If no rate is available, we will use a default value of 28%.

Other Than Personnel Costs: This category includes non-personnel items such as travel, supplies and expense, non-capital equipment purchases, etc., that are typically part of an instructional department or program's cost of doing business. *Excluded* from this category are items such as central computing costs, centrally allocated computing labs, graduate student tuition remission and fee waivers, etc.

Research: This category includes all funds expended for activities specifically organized to produce research outcomes and commissioned by an agency either external to the institution or **separately budgeted** by an organizational unit within the institution. Report total research expenditures only. It is not necessary to disaggregate costs for this category.

Public Service: Report all funds **separately budgeted** specifically for public service and expended for activities established primarily to provide non-instructional services beneficial to groups external to the institution. Examples include cooperative extension and community outreach projects. Report total service expenditures only. It is not necessary to disaggregate costs for this category.

Federally Funded Research: As defined by NSF

Total Research and Expenditures: As defined by NSF

Louisiana State University Health Sciences Center New Orleans

Table I: Affiliated Off-Campus Sites

LSU System Campus	Name of Affiliated Off- Campus Site	Gross Revenue Generated by Affiliate Campus
	<i>Not Applicable</i>	

Table II: Board of Regent Support Funds

LSU System Campus	Name of Support Fund	Endowment
LSUHSC-NO	Carol Ashton D'Angelo Professorship of Alcohol and Drug Stud	\$ 120,095
LSUHSC-NO	Drs. William G. '64 and Hannelore H. '63 Giles Scholarship	\$ 1,377,447
LSUHSC-NO	Betty Lynne Theriot Distinguished Professorship of Clinical	\$ 121,234
LSUHSC-NO	Allen A. Copping Chair for Excellence in Teaching	\$ 1,171,261
LSUHSC-NO	Kenneth Ardoin/Pfizer Chair in Basic Cardiovascular Research	\$ 1,991,894
LSUHSC-NO	William and Sarah Jane Pelon Chair in the Dept of Microbiology	\$ 4,344,716
LSUHSC-NO	David R. Bethune - Lederle Lab Professorship in Pharmacology	\$ 131,104
LSUHSC-NO	L. Allen Barker, PhD Professorship in Pharmacology	\$ 113,389
LSUHSC-NO	L. Allen Barker, PhD Professorship in Pharmacology Education	\$ 116,060
LSUHSC-NO	Joseph M. Moerschbaecher, III, PhD Professorship of Pharmaco	\$ 116,148
LSUHSC-NO	Kai and Earl Rozas Professorship of Physiology	\$ 135,472
LSUHSC-NO	Kenneth Ardoin/Pfizer Chair in Translational Biomedical Rese	\$ 2,275,132
LSUHSC-NO	Edmund E. Jeansonne, Sr., DDS Professorship of Continuing Ed	\$ 186,830
LSUHSC-NO	Robert F. Eastman, Sr., DDS Professorship in Operative Denti	\$ 142,484
LSUHSC-NO	Victor Halperin, DDS Professorship of Dental Research	\$ 152,502
LSUHSC-NO	Marie Copping Professorship in General Dentistry	\$ 143,308
LSUHSC-NO	Carl Baldrige Endowed Chair in Dentistry	\$ 1,203,656
LSUHSC-NO	Hank Helmer Directional Drilling Professorship in Dentistry	\$ 114,159
LSUHSC-NO	Ralph and Lily Dauterive Professorship in Operative Dentistry	\$ 122,653
LSUHSC-NO	Carl and Beulah Baldrige Rural Scholars Track Scholarship	\$ 1,838,697
LSUHSC-NO	Raymond G. Leubke, DDS Professorship in Endodontics	\$ 192,878
LSUHSC-NO	Alliance to the Louisiana Dental Association Scholarship	\$ 289,150
LSUHSC-NO	Brasseler USA Professorship in Prosthodontics	\$ 140,504
LSUHSC-NO	Johnson Foundation Professorship in Endodontics	\$ 135,497
LSUHSC-NO	William Ben Johnson Professorship in Endodontics	\$ 160,741

Table II: Board of Regent Support Funds

LSU System Campus	Name of Support Fund	Endowment
LSUHSC-NO	Tulsa Dental Professorship in Endodontics	\$ 176,961
LSUHSC-NO	R. Jack and Mary Louise Cassingham Chair in Periodontics	\$ 1,352,199
LSUHSC-NO	Blue Cross Blue Shield of Louisiana Professorship	\$ 138,026
LSUHSC-NO	Jack Sheridan Professorship in Student Clinical Dental Resea	\$ 122,881
LSUHSC-NO	Shu Cheuk Professorship in Comprehensive Dentistry	\$ 134,580
LSUHSC-NO	Robert J. Musselman Professorship in Pediatric Dentistry	\$ 129,093
LSUHSC-NO	William and Sarah Jane Pelon Professorship in Oral and Crani	\$ 126,972
LSUHSC-NO	Marshall I. Gottsegen Professorship in Orthodontics	\$ 367,443
LSUHSC-NO	Guy A. Favaloro Professorship in Orthodontics	\$ 379,868
LSUHSC-NO	Bernhard M. Schwaninger Professorship of Orthodontics	\$ 426,204
LSUHSC-NO	Terence E. Walsh Graduate Scholarship of Orthodontics	\$ 355,658
LSUHSC-NO	Cheuk Family Professorship in Comprehensive Dentistry II	\$ 116,220
LSUHSC-NO	LSUSD Orthodontic Alumni Endowed Scholarship	\$ 340,119
LSUHSC-NO	Thomas J. Kiebach Endowed Scholarship in Pediatric Dentistry	\$ 119,357
LSUHSC-NO	Linda Cao and Phuong Nguyen Scholarship in Pediatric Dentist	\$ 117,396
LSUHSC-NO	Committee of 100 Scholarship in Dentistry	\$ 124,436
LSUHSC-NO	Thomas E. McNeely, DDS, MS, Scholarship in Dentistry	\$ 127,214
LSUHSC-NO	Edward L. Donaldson, Jr. Scholarship in Pediatric Dentistry	\$ 109,011
LSUHSC-NO	Dr. Jeffrey P. Feingold/MCNA Dental Rural Scholars Scholarsh	\$ 484,309
LSUHSC-NO	Henry A. Gremillion Chair in Orofacial Pain	\$ 1,171,919
LSUHSC-NO	Parker E. Mahan Professorship in Orofacial Pain	\$ 113,220
LSUHSC-NO	James R. Peltier Chair in Oral and Maxillofacial Surgery	\$ 2,102,220
LSUHSC-NO	The United Cerebral Palsy of Greater New Orleans Fund	\$ 96,633
LSUHSC-NO	Marilyn L. Zimny, PhD Professorship in Graduate Studies	\$ 657,575
LSUHSC-NO	Frank Low and Marilyn Zimny Professorship of Graduate Studie	\$ 450,130
LSUHSC-NO	Pfizer/Salvatore Giorgianni Professorship of Health Systems	\$ 123,449
LSUHSC-NO	Jim Finks Chair for Health Promotion	\$ 1,219,063
LSUHSC-NO	Charles L. Brown, Jr., MD Professorship in Health Promotion	\$ 145,493
LSUHSC-NO	John A. Rock, MD Professorship for Visiting Scholars	\$ 174,994
LSUHSC-NO	AmeriHealth Mercy General Russell L. Honore' Professorship	\$ 130,474
LSUHSC-NO	Dean Fontham Endowed Superior Graduate Student Scholarship	\$ 127,456
LSUHSC-NO	Richard A. Culbertson Professorship	\$ 122,327
LSUHSC-NO	Nursing School Scholarship	\$ 193,118
LSUHSC-NO	Sister Henrietta Guyot Professorship in Nursing	\$ 206,403
LSUHSC-NO	James B. and Helen A. Dunn Professorship in Nursing	\$ 171,921
LSUHSC-NO	St. Charles General Hospital Auxiliary Professorship in Nurs	\$ 215,277
LSUHSC-NO	P.K. Scheerle, RN Professorship In Nursing	\$ 175,559
LSUHSC-NO	Tenet Health System/JoEllen Smith, BSN Chair of Nursing	\$ 1,997,881
LSUHSC-NO	Tucker H. Couvillon, III Professorship of Nursing Research	\$ 207,844
LSUHSC-NO	The Hanson Scholarship for Nursing	\$ 100,282

Table II: Board of Regent Support Funds

LSU System Campus	Name of Support Fund	Endowment
LSUHSC-NO	Kelly R. Stewart, MD Chair of Dermatology	\$ 1,753,691
LSUHSC-NO	Susan M. Leary and Richard A. Culbertson Professorship	\$ 121,364
LSUHSC-NO	John N. Bickers Professorship in Hematology/Oncology	\$ 143,936
LSUHSC-NO	Pfizer/Allen D. Meisel, MD Professorship of Gastroenterology	\$ 134,687
LSUHSC-NO	Pfizer/Kenneth A. Ardoin Professorship of Family Medicine	\$ 271,691
LSUHSC-NO	Ernest N. Morial Endowed Chair for the Research and Treatment	\$ 2,639,879
LSUHSC-NO	Victor M.G. Chaltiel Professorship of Medicine	\$ 118,874
LSUHSC-NO	Women in Medicine Professorship	\$ 140,258
LSUHSC-NO	Gerald S. Berenson, MD Professorship in Preventive Cardiology	\$ 463,897
LSUHSC-NO	David Lucas (Luke) Glancy Professorship of Cardiology	\$ 207,746
LSUHSC-NO	Keith Van Meter, MD Spirit of Charity Professorship	\$ 137,182
LSUHSC-NO	Charles A. Cefalu, MD Professorship in Geriatrics	\$ 125,046
LSUHSC-NO	Gerald S. and Joan Berenson Chair in Healthy Aging and Longevity	\$ 1,189,120
LSUHSC-NO	Richard A. Culbertson and Susan M. Leary Professorship	\$ 91,579
LSUHSC-NO	Cris Mandry, MD Professorship	\$ 90,295
LSUHSC-NO	Sarah d'Autremont, MD Professorship	\$ 90,295
LSUHSC-NO	Pfizer Professorship in Primary Care at Earl K. Long	\$ 153,517
LSUHSC-NO	Paula Garvey Manship Chair of Medicine	\$ 1,170,742
LSUHSC-NO	Carl Baldrige Endowed Chair in Neurology	\$ 2,877,152
LSUHSC-NO	Grace Benson Professorship of Neurology	\$ 130,879
LSUHSC-NO	Tom Benson Professorship of Neurology	\$ 108,691
LSUHSC-NO	Austin J. Sumner, MD Professorship in Neurology	\$ 276,039
LSUHSC-NO	David G. Kline, MD Professorship of Neurosurgery	\$ 193,856
LSUHSC-NO	David G. Kline, MD Endowed Chair in Neurosurgery	\$ 1,397,730
LSUHSC-NO	Kelsey Bradley Favrot Endowed Chair in Neuro-Oncology	\$ 1,589,904
LSUHSC-NO	Jack Andonie, MD Professorship in Gynecological Surgery	\$ 186,893
LSUHSC-NO	Jerome M. Maas Chair in Reproductive Endocrinology	\$ 1,978,100
LSUHSC-NO	Prince Abdulaziz Bin Ahmad Abdulaziz Al-Saud Chair for Study	\$ 2,338,448
LSUHSC-NO	Herbert E. Kaufman, MD Chair of Ophthalmology	\$ 1,584,195
LSUHSC-NO	Ernest C. and Yvette C. Villere Chair in Neuroscience	\$ 6,694,139
LSUHSC-NO	Viola M. and Charles L. Lacoste, Sr. Professorship	\$ 129,363
LSUHSC-NO	Dominick D and Wilhelmina L Aiena Prof in Ophthalmology	\$ 126,628
LSUHSC-NO	Donald Edward Texada, MD Professorship of Ophthalmology	\$ 261,550
LSUHSC-NO	G. Dean MacEwen Endowed Chair in Pediatric Orthopedics	\$ 1,329,127
LSUHSC-NO	Elaine A. Dore' Endowed Chair in Orthopedics	\$ 1,175,724
LSUHSC-NO	Kenneth and Frances Barnes Bullington Professorship in Hearing	\$ 137,372
LSUHSC-NO	Charles I. Berlin, Ph.D. Endowed Chair for the Genetic	\$ 1,115,162
LSUHSC-NO	Mervin L. Trail, MD Endowed Chair in Head and Neck Oncology	\$ 1,360,093
LSUHSC-NO	Daniel W. Nuss, MD Chair in Skull Base Surgery	\$ 1,354,559
LSUHSC-NO	Leslie Lewinter-Suskind and Robert Suskind Professorship	\$ 267,580

Table II: Board of Regent Support Funds

LSU System Campus	Name of Support Fund	Endowment
LSUHSC-NO	Nelson K. Ordway, MD Professorship of Pediatric Research	\$ 502,694
LSUHSC-NO	Children's Hospital Professorship of Pediatric Research	\$ 384,955
LSUHSC-NO	Michael Sly, MD Professorship of Allergy and Immunology	\$ 179,528
LSUHSC-NO	Nick Gagliano Professorship in Emergency Pediatrics	\$ 187,442
LSUHSC-NO	Nick Gagliano Professorship in Ambulatory Pediatrics	\$ 157,227
LSUHSC-NO	Michael Sly, MD Professorship of Pediatric Immunology Resear	\$ 382,946
LSUHSC-NO	Bettina C. Hilman, MD Professorship of Pediatric Allergy	\$ 376,819
LSUHSC-NO	Sheila Gottschalk Professorship in Excellence in Teaching	\$ 185,492
LSUHSC-NO	Eugenie and Joseph Jones Family Foundation Professorship	\$ 167,474
LSUHSC-NO	Alan Robson, MD Professorship in Pediatric Nephrology	\$ 116,696
LSUHSC-NO	John Ey, MD Professorship in Hospitalist Pediatrics	\$ 172,764
LSUHSC-NO	Research Institute for Children Professorship	\$ 156,032
LSUHSC-NO	Imtiaz Ahmed Professorship for International Primary	\$ 165,390
LSUHSC-NO	Duna Penn, MD Professorship for Neonatal Perinatal Medicine	\$ 133,978
LSUHSC-NO	Emma Sadler Moss Professorship of Pathology	\$ 184,732
LSUHSC-NO	Carl Adatto Professorship In Psychoanalytic Psychiatry	\$ 166,534
LSUHSC-NO	Kathleen and John Bricker Endowed Chair in Psychiatry	\$ 1,275,396
LSUHSC-NO	Paul J. Ramsay Endowed Chair of Psychiatry	\$ 1,621,265
LSUHSC-NO	George C. Dunn Professorship in Psychiatry	\$ 122,981
LSUHSC-NO	Edward D. Levy, Jr., MD Professorship in Psychiatry	\$ 110,359
LSUHSC-NO	Carl Adatto Professorship in Community Psychiatry	\$ 110,334
LSUHSC-NO	Anderson/Searle Professorship	\$ 117,809
LSUHSC-NO	Barbara Lemann Professorship of Child Welfare	\$ 158,987
LSUHSC-NO	Max Sugar Professorship in Infant, Child and Adolescent Psyc	\$ 301,118
LSUHSC-NO	Fraternal Order of Eagles Ronald Reagan Professorship	\$ 156,662
LSUHSC-NO	Margie Villere Professorship for Childhood Development	\$ 170,894
LSUHSC-NO	Dr. Mollie Marcus Wallick Professorship in Psychiatry	\$ 125,963
LSUHSC-NO	Howard & Joy Osofsky Professorship of Addiction Psychiatry	\$ 256,166
LSUHSC-NO	Emeril J. Lagasse, III Professorship for Child and Adolescent	\$ 338,492
LSUHSC-NO	Dr. George Albert Bishop Professorship in Public Psychiatry	\$ 131,029
LSUHSC-NO	Pfizer/Hank McCrorie Trauma Surgery Professorship	\$ 190,223
LSUHSC-NO	Lori Whited Lacoste Professorship in Clinical/Trauma Surgery	\$ 93,237
LSUHSC-NO	Horatio Reily Professorship in Urology	\$ 123,129
LSUHSC-NO	William Boatner Reily Professorship in Urology	\$ 144,464
LSUHSC-NO	H. Eustis Reily Professorship in Urology	\$ 124,202
LSUHSC-NO	Joseph N Macaluso, Jr, MD FACS Professorship of Endourology	\$ 134,470
LSUHSC-NO	David L. Autin, MD, Scholarship Fund	\$ 117,685
LSUHSC-NO	Irvin Cahen, MD Endowed Chair in Orthopedic Surgery	\$ 1,145,208
LSUHSC-NO	Isidore Cohn, Jr., MD Chair in Surgery	\$ 1,331,215
LSUHSC-NO	Richard E. L. Fowler Professorship of Pediatrics	\$ 234,123

Table II: Board of Regent Support Funds

LSU System Campus	Name of Support Fund	Endowment
LSUHSC-NO	Harry E. Dascomb, MD Professorship of Medicine	\$ 704,557
LSUHSC-NO	Howard Buechner, MD Professorship of Medicine	\$ 633,549
LSUHSC-NO	Abe Mickal, MD Chair in Obstetrics and Gynecology	\$ 1,210,668
LSUHSC-NO	Edgar Hull, MD Endowed Chair in Medicine	\$ 1,259,795
LSUHSC-NO	Jim Lowenstein Professorship in Medicine	\$ 877,243
LSUHSC-NO	Richard M. Paddison, MD Professorship of Neurology	\$ 986,720
LSUHSC-NO	John H. Seabury, MD Professorship in Medicine	\$ 199,824
LSUHSC-NO	James D. Rives Professorship of Surgery	\$ 167,263
LSUHSC-NO	Fred G. Brazda, PhD Professorship in Biochemistry	\$ 241,986
LSUHSC-NO	Philip Cenac, MD Professorship of Medical Ethics	\$ 265,453
LSUHSC-NO	Henry Jolly, MD Professorship of Clinical Dermatology	\$ 1,019,553
LSUHSC-NO	James D. Rives Professorship of Cancer Surgery	\$ 335,139
LSUHSC-NO	Jack Perry Strong Chair in Pathology	\$ 2,179,937
LSUHSC-NO	Richard Ashman, PhD Professorship in Physiology	\$ 224,033
LSUHSC-NO	Marilyn L. Zimny, PhD Professorship in Anatomy	\$ 157,942
LSUHSC-NO	Claude C. Craighead, MD Chair in Vascular Surgery	\$ 2,609,421
LSUHSC-NO	George D. Lyons, Jr., MD Chair in Otolaryngology Head and	\$ 1,474,914
LSUHSC-NO	Russell C. Klein, MD Alumni Professorship	\$ 175,440
LSUHSC-NO	Marie LaHasky Professorship of Family Medicine	\$ 615,810
LSUHSC-NO	Ronald Welsh, MD Professorship of Pathology	\$ 635,106
LSUHSC-NO	Warren C. Plauche, MD Professorship of Maternal Fetal Medici	\$ 159,342
LSUHSC-NO	Albert Lauro, MD Professorship of Emergency Medicine	\$ 208,227
LSUHSC-NO	Fred Allison, Jr., MD Professorship of Medicine	\$ 127,905
LSUHSC-NO	Richard Robichaux Professorship	\$ 105,571
LSUHSC-NO	Harvey A. Gabert, MD Chair in Obstetrics and Gynecology	\$ 1,470,806
LSUHSC-NO	Louis R. Cabiran, MD Professorship of Medicine	\$ 334,434
LSUHSC-NO	Julius H. Mullins, Sr., MD Professorship of Anatomy	\$ 147,716

Table II: Board of Regent Support Funds

LSU System Campus	Name of Support Fund	Endowment
LSUHSC-NO	Robert S. Daniels Professorship of Medical Education	\$ 172,441
LSUHSC-NO	William H. Stewart, MD Chair in Pediatrics	\$ 1,348,922
LSUHSC-NO	Percy Rosenbaum, MD Professorship of Pediatrics	\$ 191,783
LSUHSC-NO	Robert D. D'Ambrosia Chair in Orthopedic Surgery	\$ 1,742,092
LSUHSC-NO	James K. Howles, MD Professorship in Dermatology	\$ 520,577
LSUHSC-NO	Pelayo Correa, MD Professorship of Pathology	\$ 162,778
LSUHSC-NO	David Drez, Jr., MD Chair in Orthopedic Sports Medicine	\$ 1,533,131
LSUHSC-NO	Richard Vial, MD Professorship of Medical Education	\$ 180,179
LSUHSC-NO	Roland Coulson, PhD Professorship of Biochemistry	\$ 204,544
LSUHSC-NO	G. John Buddingh, MD Professorship in Microbiology	\$ 194,246
LSUHSC-NO	Charles V. Sanders, MD Chair of Medicine	\$ 1,266,019
LSUHSC-NO	Warren R. Summer, MD Professorship of Pulmonary Medicine	\$ 159,399
LSUHSC-NO	Louis Levy II, MD, M'43 Professorship of Research Cardiology	\$ 297,695
LSUHSC-NO	Brian P. Jakes, Sr., Professorship in Rural Healthcare	\$ 177,838
LSUHSC-NO	Nicolas G. Bazan, MD, PhD Professorship in Emergency Medicine	\$ 109,061
LSUHSC-NO	Eduardo Marvez-Valls, MD Professorship of Emergency Medicine	\$ 181,312
LSUHSC-NO	William A. Rock, Jr., MD Professorship in Clinical Pathology	\$ 153,724
LSUHSC-NO	Charles W. Hilton, MD Professorship of Medical Education	\$ 113,706
LSUHSC-NO	Gerald and Gayle Foret Professorship of Family Medicine	\$ 231,628
LSUHSC-NO	Raja W. Dhurandhar, MD Professorship of Cardiology	\$ 118,464
LSUHSC-NO	Alice Baker Holoubek, MD Professorship of Medicine	\$ 128,213
LSUHSC-NO	Samuel G. McClugage, Jr., PhD Professorship of Cell Biology	\$ 184,958
LSUHSC-NO	Charles W. McMillin, III and Richard Paul Grace Chair of Can	\$ 1,918,276
LSUHSC-NO	Keith A. Collins MD Memorial Scholarship	\$ 124,011
LSUHSC-NO	Patricia Powers Strong Professorship in Oncology	\$ 341,706
LSUHSC-NO	Amgen Oncology Professorship	\$ 225,492
LSUHSC-NO	Morey L. Sear/Dr. Oliver Sartor Professorship for Prostate	\$ 193,285
LSUHSC-NO	Wendell H. Gauthier Chair of Cancer Research	\$ 1,119,455
LSUHSC-NO	Cancer Crusaders Endowed Professorship in Cancer Research	\$ 751,415
LSUHSC-NO	Frances Zuppardo Professorship of Cancer Research	\$ 233,720
LSUHSC-NO	Al Copeland/Cancer Crusaders Chair in Neuroendocrine Cancer	\$ 1,631,057
LSUHSC-NO	Cancer Crusaders Chair in Advanced Cancer Therapy Research	\$ 1,241,852
LSUHSC-NO	Bollinger Family Professorship in Alzheimer's Disease	\$ 134,522
LSUHSC-NO	EENT Professorship in the LSU Neuroscience Center of Excellence	\$ 115,107
LSUHSC-NO	Ernest C. and Yvette C. Villere Chair for the Study of Retin	\$ 3,189,109
LSUHSC-NO	Drs. Tricia Paulsen '82 and Tom Paulsen Scholarship Fund	\$ 145,451
LSUHSC-NO	T.G. and Doris Solomon Family Endowed Chair	\$ 2,132,329

LSU System Campus	Foundation	Total Assets (\$ Amount)
LSUHSC-NO	The Foundation for the LSU Health Sciences Center	\$197,639,358

Louisiana State University Health Sciences Center New Orleans

National Benchmark Report

	2014-2015	2015-2016	2016-2017	2017-2018	2018-2019	2019-2020	2020-2021	2021-2022	2022-2023
USMLE Step 1									
LSU School of Medicine Mean Total Score	228	229	228	229	228	231	225	88%	86%
National Mean Total Score	229	228	229	230	231	233	230	93%	93%

*In January, the USMLE Step 1 score transitioned to Pass/Fail only. This data is the pass rate for first time examinees in our class compared to the national average. Also preliminary will be updated in subsequent year.

USMLE Step 2 CK									
LSU School of Medicine in New Orleans Mean Total Score	235	240	242	242	242	243	245	244	243
National Mean Total Score	240	242	242	243	243	245	246	247	248

NIH Dollars Awarded by Funding Mechanisms									
	Federal FY 15	Federal FY 16	Federal FY 17	Federal FY 18	Federal FY 19	Federal FY 20	Federal FY 21	Federal FY 22	Federal FY 23
LSU School of Medicine Rank	91	93	90	90	87	88	90	88	92
Total Schools of Medicine with NIH Awards	138	139	141	146	142	151	143	144	144

**Louisiana State University
Health Sciences Center Shreveport**



April 26, 2024

Louisiana State University Health Sciences Center Shreveport

Executive Summary

Introduction

Established in 1969, Louisiana State University Health Sciences Center at Shreveport (LSUHSC-S) has an admirable history of advancing health sciences education, scientific discovery, and patient care. LSUHSC-S is home to schools of medicine, allied health professions, and graduate studies, and its programmatic and degree range in the health professions and biomedical sciences enable the state's most talented individuals to become outstanding practitioners, researchers, and educators. The institution's comprehensive primary, specialty, and sub-specialty clinical programs support the educational mission while improving the health and health care of Louisiana's population through the delivery of preventive, diagnostic, and treatment services from primary to quaternary levels. LSUHSC-S is also committed to addressing today's health care needs through forward-thinking biomedical research and therapeutic innovations that contribute to the body of knowledge and practice in science and medicine.

Metric I: Completions

Overall, the institution saw a 4% increase in the total number of degrees awarded in 2022-23 compared to the previous academic year, with notable growth in MD degrees.

Metric II: Enrollment

In fall 2023, total enrollment reached an all-time high headcount of 1045. The School of Medicine's enrollment increased 2% from the previous fall and also set a record high enrollment of 606. The School of Graduate Studies enrollment increased 6% from the previous fall and hit its highest headcount in 14 years. The School of Allied Health enrollment remained relatively static.

Metric III: Student Success

In 2022-23, LSUHSC-S medical students achieved 84% (vs. 92% nationally) and 99% first-time pass rates (vs. 98% nationally) on USMLE Step 1 and USMLE Step 2, respectively. The LSUHSC-S School of Medicine continues to employ various approaches to maintain or increase passage rates on licensure exams including early identification of at-risk students, individual student counseling, practice examinations, increased patient contact and faculty interaction, and simulation.

In the School of Allied Health Professions, licensure pass rates across all programs continue to consistently exceed national pass rates. Notably, graduates of the school's Cardiopulmonary Science, Speech-Language Pathology, and Medical Laboratory Science Programs achieved a 100% first-time pass rate on their respective licensing exams in 2022-23. The school continues to institute various methods to maintain or increase passage rates on licensure and certification exams and to improve workforce foundational skills. Strategies incorporated include early identification of students needing remediation, individual student counseling, study groups, practice examinations, clinical practice skill development, and interactive teaching by faculty on clinical rotations.

Louisiana State University Health Sciences Center Shreveport

Executive Summary

Metric IV: Campus Research

LSUHSC-S's research endeavors are supported by federal research agencies, private associations, foundations, and the pharmaceutical industry, highlighting the institution's commitment to advancing scientific knowledge and addressing pressing public health challenges.

LSUHSC-S established the Emerging Viral Threat (EVT) Laboratory in March 2020 to address the urgent need for quicker detection and processing of COVID-19 tests. Collaborating with nationwide and international efforts, the lab aims to obtain complete genome sequences of viruses from samples, contributing to a better understanding of the virus and supporting future vaccine efforts.

LSUHSC-S is also home to seven distinct centers focusing on various biomedical and clinical research areas, including cancer, cardiovascular disease, neurological disease, and inflammatory disorders. Notably, the Feist-Weiller Cancer Center (FWCC) serves a unique role as a St. Jude's Affiliate Clinic, treating children according to detailed St. Jude's protocols. The Center of Excellence in Arthritis and Rheumatology (CEAR) and the Center for Brain Health (CBH) have also made significant strides in their respective fields.

Furthermore, LSUHSC-S established the Louisiana Addiction Research Center (LARC) to address substance use disorder (SUD) as a public health issue. Through collaborative multidisciplinary research projects, LARC aims to develop therapeutic models and improve understanding of SUD within the community.

Metric V: Technology Transfer

LSUHSC-S actively fosters economic growth through productive partnerships with the private sector, leveraging research and knowledge to benefit the region and the state. Notably, ongoing collaborations with start-up companies in the biomedical field have yielded significant advancements.

Intellectual property originating from LSUHSC-S has been exclusively licensed to development-stage companies, driving commercialization efforts for various technologies. For instance, Embera NeuroTherapeutics, a start-up, is progressing the commercialization of a patented drug combination for smoking cessation and addiction treatment. Similarly, Innolyzer, LLC, another LSUHSC-S faculty start-up, focuses on commercializing patents for hydrogen sulfide detection in biological and petroleum fluids.

Segue Pancreatic, licensed in 2016, has discovered repurposed drugs inhibiting pancreatic cancer-associated fibroblasts, potentially enhancing treatment efficacy. JanOne, LLC, recently licensed 30 LSUHSC-S patents related to Peripheral Artery Disease (PAD) and cardiovascular diseases, leading to the development of TV1001SR for Phase 2b trials, demonstrating promising results in Phase 2a trials.

Established companies like Applied Biosystems, Cellscript, New England BioLabs, Life Technologies, and BioNTech have also licensed LSUHSC-S technologies. BioNTech, particularly, is engaged in Phase 3 trials with Genentech and Astra Zeneca, utilizing LSUHSC-S-developed technologies for therapeutic treatments.

Louisiana State University Health Sciences Center Shreveport

Executive Summary

Metric VI: Revenue Sources

Financial trends underscore the institution's stable financial position and strategic growth in key areas, including endowment, foundation assets, and tuition revenue. In the fiscal year 2022-23, the total endowment value surged to \$217.6M, an 8% growth from the previous year. The institution's foundation increased its total assets to \$286.3M, marking a 7% growth from the previous year. Gross revenue from tuition and fees remained stable at \$24.5M.

Metric VII: Teaching Productivity

In the academic year 2022-23, teaching productivity at the institution experienced notable shifts across some indicators. Full-time faculty increased to 544, marking a 1.3% rise from the previous year. Financially, tuition and fees revenue rose modestly by 0.5%, while state appropriations fluctuated, showing a minor decrease.

LSUHSC-S faculty have diverse responsibilities spanning patient care, research, scholarly contributions, and education. Teaching productivity is challenging to quantify due to the multifaceted nature of teaching activities in academic medical centers and teaching hospitals, including didactic, clinical, laboratory, and small group sessions. Educators aim to instill skills in learners similar to their own, leading to teaching occurring concurrently with other duties. Clinical faculty educate students, residents, and fellows in clinical medicine and patient care while managing their clinical responsibilities. Similarly, research scientists train graduate students, postdoctoral fellows, and clinical trainees in research methodologies alongside conducting their own research endeavors.

LSUHSC-S MISSION:

The primary mission of Louisiana State University Health Sciences Center at Shreveport (LSUHSC-S) is to teach, heal, and discover in order to advance the well-being of the State, region, and beyond. LSUHSC-S encompasses the Schools of Medicine, Graduate Studies, and Allied Health Professions in Shreveport.

To implement its mission, LSUHSC-S is committed to:

- Prepare learners for careers in health care service, teaching and research using state-of-the-art curricula, methods, and facilities.
- Provide a growing, diverse regional patient population with state-of-the-art clinical care, including a range of tertiary special services.
- Achieve distinction and international recognition for basic science and clinical research programs that contribute to the body of knowledge and practice of science and medicine.
- Utilize research and knowledge to support economic growth and prosperity of the region and State by engaging in productive partnerships with the private sector.
- Foster a culture of diversity and inclusion that promotes mutual respect for all.

Louisiana State University Health Sciences Center at Shreveport

Metrics at a Glance 2022-2023

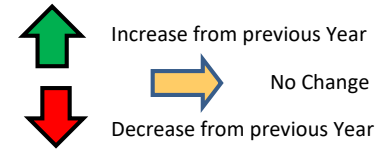

Legend:

Statistic		Most Recent Available
X	Y	
Hi	Z	% Change from previous Year
Lo		

Metric I	Metric II	Metric III	Metric IV	Metric V	Metric VI	Metric VII
Degrees Awarded	Enrollment	Student Success	Research Expenditures	Technology Transfer	Revenues	Instruction productivity
Bachelors	Total Undergraduate Headcount	Fall Headcount	Total number of faculty holding grants	Invention Disclosures	Total Market Value of Endowment	Faculty Full-time
18 13	33 20	1,045 1,045	68 40	33 24	236,430,358 217,609,882	544 544
13 ↓ -18.8%	20 ↓ -13.0%	889 ↑ 0.8%	40 ↓ -31.0%	4 ⇒ 0.0%	168,045,871 ↑ 7.7%	431 ↑ 1.7%
Masters	Total Graduate Headcount	Fall Credit Hours	Research \$ per faculty holding grants	Licenses\Options Executed	Foundations total Assets (\$ Amount)	Total Faculty
76 76	422 419	18,517.5 18,099.3	851,353 0	5 5	310,112,374 286,337,818	608 608
69 ↑ 10.1%	350 ↓ -0.7%	13,756.5 ↓ -0.9%	403,397 ↓ -100.0%	0 ⇒ 0.0%	203,792,720 ↑ 6.7%	505 ↑ 0.5%
Doctoral - Research/Scholarship	Total Professional Headcount	Fall FTE	Total numbers of PhD's awarded (School of Graduate Studies only)	New Patents Filed - Total	Total Value (\$ Amount) of MoR Support Fund (Chair & professorship)	Number of Sections
15 12	606 606	986.0 986.0	15 12	43 18	3,517,297 2,889,030	1,180 1,065
7 ↑ 9.1%	511 ↑ 2.4%	868.0 ↑ 0.9%	6 ↑ 9.1%	4 ↓ -41.9%	2,889,030 ↓ -3.4%	1,065 ↓ -6.5%
Doctoral - Professional Practice (Medicine)	Total Enrollment	Fall Credit Hour per FTE	Total numbers of postdoctoral Fellows	Active License Agreements	Total Gross Revenue Generated from tuition and fees	Duplicated Head Count
143 143	1,045 1,045	19.2 18.4	59 54	28 28	24,504,644 24,504,644	2,432 2,432
115 ↑ 4.4%	889 ↑ 0.8%	15.7 ↓ -1.8%	43 ↑ 1.9%	15 ⇒ 0.0%	21,395,756 ↑ 0.5%	2,071 ⇒ 0.0%
Doctoral - Professional Practice (Physical Therapy)	Total Full-Time-Equivalent (FTE) Enrollment	1st to Second Year Retention (Cardiopulmonary Science - NS)	Total Federal Research Expenditures (in thousands)	Licenses Generating Income	Total Net Revenue Generated from tuition and fees	Total Student Credit Hours
36 36	986 986	100.0% 0.0%	18,742 18,742	38 13	22,024,872 21,957,023	37,981 37,416
34 ⇒ 0.0%	868 ↑ 0.9%	33.0% #DIV/0!	6,478 ⇒ 0.0%	10 ↑ 8.3%	19,849,524 ↓ -0.3%	30,966 ↓ -1.5%
Total number of degrees awarded	Total number of students enrolled who received TOPS	1st to Second Year Retention (Medical Technology - NS)	Total Research Expenditures (in thousands)	Total Licensing Income		Student Credit Hours/Duplicated Headcount
279 279	44 34	100.0% 0.0%	35,624 35,624	3,748,121 604,214		16 15
251 ↑ 3.7%	25 ↓ -5.6%	81.0% #DIV/0!	22,560 ⇒ 0.0%	274,330 ↓ -30.0%		14.95 ↓ -1.5%

Louisiana State University Health Sciences Center at Shreveport

Metric I: Summary of Degrees Awarded

	2017-2018	2018-2019	2019-2020	2020-2021	2021-2022	2022-2023
Campus total number of degrees awarded/conferred...						
Bachelors	18	18	15	18	16	13
Masters	76	72	71	73	69	76
Doctoral - Research/Scholarship	9	15	7	9	11	12
Doctoral - Professional Practice (Medicine)	122	119	124	115	137	143
Doctoral - Professional Practice (Physical Therapy)	35	34	36	36	36	35
TOTAL	260	258	253	251	269	279
Total number of degrees awarded by race/ethnicity						
Hispanic	8	10	10	6	13	6
American Indian or Alaskan Native	0	0	1	0	3	0
Asian	9	21	23	11	12	16
Black, Non-Hispanic	10	7	10	9	17	15
Native Hawaiian or Other Pacific Islander	0	0	1	0	0	0
White, Non-Hispanic	204	208	199	216	213	201
Two or More Races	3	2	3	4	1	3
Nonresident Alien	5	7	3	4	4	6
Race/Ethnicity Unknown	21	3	3	1	6	32
TOTAL	260	258	253	251	269	279

Louisiana State University Health Sciences Center Shreveport

Metric II: Enrollment

(The following metrics will identify the campus contribution to Louisiana's academic credentialed workforce priorities)

		2018-2019	2019-2020	2020-2021	2021-2022	2022-2023	2023-2024
<i>Undergraduate</i>							
School of Allied Health Professions							
	Full-time	24	26	22	27	22	20
	Part-time	4	7	7	0	1	0
Total Undergraduate Headcount		28	33	29	27	23	20
<i>Graduate</i>							
School of Allied Health Professions							
	Full-time	259	243	255	245	247	231
	Part-time	24	52	75	97	94	102
School of Graduate Studies							
	Full-time	63	62	65	64	76	78
	Part-time	4	7	7	4	5	8
Total Graduate Headcount		350	364	402	410	422	419
<i>First Professional</i>							
School of Medicine							
	Full-time	511	539	550	583	583	605
	Part-time		1	1	0	9	1
Total Professional Headcount		511	540	551	583	592	606
Total Headcount Enrollment (Undergraduate, Graduate & Professional)		889	937	982	1,020	1,037	1,045
Total Full-Time-Equivalent (FTE) Enrollment*		868	897	935	965	977	986

*Fall FTE based on SACS methodology

Louisiana State University Health Sciences Center Shreveport

Metric II: Enrollment

(The following metrics will identify the campus contribution to Louisiana's academic credentialed workforce priorities)

	2018-2019	2019-2020	2020-2021	2021-2022	2022-2023	2023-2024
Enrollment by Race and Ethnicity						
School of Allied Health Professions						
Hispanic	9	12	8	9	10	7
American Indian or Alaskan Native	2	1	0	4	2	0
Asian	8	12	13	20	13	13
Black, Non-Hispanic	15	30	43	47	53	49
Native Hawaiian or Other Pacific Islander	0	0	0	1	1	1
White, Non-Hispanic	260	260	259	267	255	243
Two or More Races	7	6	6	3	6	7
Nonresident Alien	3	7	9	13	12	26
Race/Ethnicity Unknown	7	0	5	5	12	7
School of Graduate Studies						
Hispanic	4	5	4	3	4	2
American Indian or Alaskan Native	0	0	0	0	0	0
Asian	4	3	2	2	3	4
Black, Non-Hispanic	1	4	6	7	7	9
Native Hawaiian or Other Pacific Islander	0	0	0	0	0	1
White, Non-Hispanic	33	30	32	28	30	29
Two or More Races	0	0	0	0	0	0
Nonresident Alien	25	27	28	28	37	41
Race/Ethnicity Unknown	0	0	0	0	0	0
School of Medicine						
Hispanic	19	19	18	18	26	26
American Indian or Alaskan Native	2	2	2	3	0	1
Asian	48	51	53	54	58	51
Black or African American	23	28	24	37	39	36
Native Hawaiian or Other Pacific Islander	1	1	0	0	0	0
White, Non-Hispanic	414	434	447	461	455	478
Two or More Races	2	2	3	6	5	8
Nonresident Alien	0	0	0	0	0	1
Race/Ethnicity Unknown	2	3	4	4	9	5
Total number of students enrolled who received TOPS						
	2018-2019	2019-2020	2020-2021	2021-2022	2022-2023	2023-2024
Performance	12	6	18	13	12	9
Opportunity	2	1	1	2	4	4
Honors	20	18	17	29	20	21

Louisiana State University Health Sciences Center at Shreveport

Metric III: Student Success

The following metrics will identify the campus scholarship, teaching and instruction effectiveness	2017-2018	2018-2019	2019-2020	2020-2021	2021-2022	2022-2023	2023-2024
14th Day Headcount Enrollment							
Fall Headcount	899	889	937	982	1,020	1,037	1,045
Spring Headcount	877	885	922	972	998	980	1,026
Fall Credit Hours	13,756.5	15,907.1	16,909.3	17,821.7	18,517.5	18,263.5	18,099.3
Spring Credit Hours	13,454.4	14,843.8	14,551.8	15,414.2	15,710.8	15,436.9	15,829.1
Fall FTE ¹	874.0	868.0	897.0	935.0	965.0	977.0	986.0
Spring FTE ¹	856.0	858.0	891.0	929.0	953.0	927.0	971.0
Fall Credit Hour per FTE	15.7	18.3	18.9	19.1	19.2	18.7	18.4
Spring Credit Hour per FTE	15.7	17.3	16.3	16.6	16.5	16.7	16.3
Campus Undergraduate 1st to 2nd year retention rate.							
By School and Program							
Allied Health Professions							
Cardiopulmonary Science - BS	100%	71%	33%	33%	100%		
Medical Technology - BS	100%	94%	100%	100%	81%		
Physician Assistant - BS ²							

Louisiana State University Health Sciences Center at Shreveport

Metric III: Student Success

The following metrics will identify the campus scholarship, teaching and instruction effectiveness	2017-2018	2018-2019	2019-2020	2020-2021	2021-2022	2022-2023	2023-2024
Number of students passing licensure exams — See spreadsheet for more detail	2017-2018	2018-2019	2019-2020	2020-2021	2021-2022	2022-2023	2023-2024
Allied Health							
<i>Cardiopulmonary Science-RRT (first attempt)</i>							
Number tested	6	2	2	6	2	1	
Number passing	3	2	2	3	2	1	
Percent passing	50%	100%	100%	50%	100%	100%	
National First-time Taker Average Pass Rate	71%	77%	72%	65%	68%	not available	
<i>Communications Disorders-PRAXIS (first attempt)</i>							
Number tested	13	13	9	7	9	6	
Number passing	13	13	9	7	9	6	
Percent passing	100%	100%	100%	100%	100%	100%	
<i>Occupational Therapy-NBCOT (first attempt)</i>							
Number tested	25	25	28	21	23	25	
Number passing	23	23	26	17	22	22	
Percent passing	92%	92%	93%	81%	96%	88%	
National First-time Taker Average Pass Rate	not available [†]	not available [†]	not available [†]	not available [†]	not available [†]	not available [†]	
<i>Physical Therapy-NPTE (first attempt)</i>							
Number tested	35	34	36	36	36	35	
Number passing	34	31	33	35	29	33	
Percent passing	97%	91%	92%	97%	81%	94%	
National First-time Taker Average Pass Rate	92%	93%	92%	91%	86%	86%	
<i>Physician Assistant-PANCE (first attempt)</i>							
Number tested	34	35	35	37	36	37	
Number passing	34	34	35	37	35	35	
Percent passing	100%	97%	100%	100%	97%	95%	
National First-time Taker Average Pass Rate	98%	93%	95%	93%	92%	92%	
<i>Medical Technology-BOC Exam (first attempt)³</i>							
Number tested	9	16	13	12	14	12	
Number passing	8	15	13	12	13	12	
Percent passing	89%	94%	100%	100%	93%	100%	
National Average Pass Rate	79%	79%	82%	78%	76%	76%	133

Louisiana State University Health Sciences Center at Shreveport

Metric III: Student Success

The following metrics will identify the campus scholarship, teaching and instruction effectiveness	2017-2018	2018-2019	2019-2020	2020-2021	2021-2022	2022-2023	2023-2024
<i>Medical Technology-NCA Exam (first attempt)</i> ³							
Number tested							
Number passing							
Percent passing							
National Average Pass Rate							
Medicine	2017-2018	2018-2019	2019-2020	2020-2021	2021-2022	2022-23	2023-2024
<i>USMLE Step 1 (first attempt)</i>							
Number tested	128	127	127	146	151	135	
Number passing	120	109	127	138	134	113	
Percent passing	94%	86%	100%	95%	89%	84%	
National First-time Taker Average Pass Rate	96%	97%	98%	96%	93%	92%	
<i>USMLE Step 2 CS (first attempt)</i>							
Number tested	122	120	*	*	*	*	
Number passing	115	112	*	*	*	*	
Percent passing	94%	93%	*	*	*	*	
National First-time Taker Average Pass Rate	95%	95%	*	*	*	*	
<i>USMLE Step 2 CK (first attempt)</i>							
Number tested	124	118	126	114	139	141	
Number passing	117	117	125	114	139	140	
Percent passing	94%	99%	99%	100%	100%	99%	
National First-time Taker Average Pass Rate	97%	98%	98%	99%	99%	98%	

¹ FTE based on SACS methodology.

² In 2009-10, the Physician Assistant Program transitioned from bachelor's to master's beginning with in summer 2010; therefore, no new bachelor's students will be enrolled after 2008-09.

³ In 2009, the NCA and BOR certifications merged and are now known as the Board of Certification (BOC).

* USMLE Step 2 CS was not administered in 2019-20 due to COVID-19 and discontinued going forward

⁴ Beginning in 2014, NBCOT no longer provides national average pass rate

Louisiana State University Health Sciences Center at Shreveport

Metric IV: Campus Research

	2014-2015	2015-2016	2016-2017	2017-2018	2018-2019	2019-2020	2020-2021	2021-2022	2022-2023
a) Faculty Research									
Total \$ amount of faculty research	\$ 24,069,000	\$ 23,353,000	\$ 22,560,000	\$ 24,463,000	\$ 26,262,000	\$ 43,419,000	\$ 27,431,000	\$ 29,502,000	
Total number of faculty holding grants	59	48	48	50	43	51	68	58	40
Research \$ per faculty holding grants	\$ 407,949	\$ 486,521	\$ 470,000	\$ 489,260	\$ 610,744	\$ 851,353	\$ 403,397	\$ 508,655	
b) Total number of PhD's awarded (School of Graduate Studies only)	8	11	6	9	15	7	9	11	12
c) Total number of Postdoctoral Fellows	52	56	54	54	59	52	43	53	54
d) Research \$ per sq. ft. of funded faculty	\$183	\$314	\$281	\$302	\$357	\$473	\$331	\$420	
e) Sq. ft. per funded faculty	1,050	1,118	1,043	1,001	1,038	1,038	1,217	1,212	

Total research by Major Discipline: Life Science; Physical Science; Environmental Science; Engineering Science; Computer Science; Math;												
Research Expenditure by Major Discipline Data shown in Thousands	FY Ending 2016			FY Ending 2017			FY Ending 2018			FY Ending 2019		
	Federal	Other	Total	Federal	Other	Total	Federal	Other	Total	Federal	Other	Total
Life Sciences												
(1) Agricultural	0	0	0	0	0	0	0	0	0	0	0	0
(2) Biological	4,638	2,786	7,424	5,483	2,408	7,891	7,706	2,222	9,928	9,918	1,312	11,230
(3) Medical	1,840	13,250	15,090	1,572	12,429	14,001	1,529	12,320	13,849	2,267	12,123	14,390
(4) Other	0	839	839	0	668	668	0	686	686	0	642	642
Total	6,478	16,875	23,353	7,055	15,505	22,560	9,235	15,228	24,463	12,185	14,077	26,262
Research Expenditure by Major Discipline Data shown in Thousands	FY Ending 2020			FY Ending 2021			FY Ending 2022			FY Ending 2023		
	Federal	Other	Total	Federal	Other	Total	Federal	Other	Total	Federal	Other	Total
Life Sciences												
(1) Agricultural	0	0	0	0	0	0	0	0	0	0	0	0
(2) Biological	9,794	850	10,644	10,192	706	10,898	13,388	1,049	14,437	14,125	2,130	16,255
(3) Medical	1,658	12,253	13,911	2,167	10,739	12,906	2,115	12,124	14,239	4,617	13,787	18,404
(4) Other	0	766	766	0	796	796	0	826	826	0	965	965
Total	11,452	13,869	25,321	12,359	12,241	24,600	15,503	13,999	29,502	18,742	16,882	35,624

Research Expenditures	FY 2015	FY 2016	FY 2017	FY 2018	FY 2019	FY 2020	FY 2021	FY 2022	FY 2023
Federal	\$ 6,478	\$ 7,055	\$ 9,235	\$ 12,185	\$ 11,452	\$ 11,452	\$ 15,503	\$ 18,742	\$ 18,742
Total	\$ 23,353	\$ 22,560	\$ 24,463	\$ 26,262	\$ 25,321	\$ 25,321	\$ 24,600	\$ 35,624	\$ 35,624

Note that Research Expenditures data should match data your campus reported to NSF. Beginning in 2008, this data should follow the following guidelines.

Track all expenditures back to the original source. For example, if funds come from the State DOTD, but originated with the federal government those expenditures should be reported as federal. There should be a CFDA number attached to these grants indicating that the original source was federal.

Report all clinical trials as research. Please note that not all clinical trials are done by Tenured or Tenured Track (T/TT) faculty (see c).

Compute under-and unreimbursed indirect costs according to the instructions.

Report NIH "k" and other research training awards as federal. Note, Do Not report all training grants, only those that are for research training.

Louisiana State University Health Sciences Center at Shreveport

Metric V: Technology Transfer

	2014-2015	2015-2016	2016-2017	2017-2018	2018-2019	2019-2020	2020-2021	2021-2022	2022-2023
Invention Disclosures	20	16	24	19	19	33	32	24	24
Licenses\Options Executed	0	2	1	3	4	2	5	3	5
New Patents Filed - Total	14	26	36	28	25	40	43	31	18
New Patents Filed - First in Family	*	11	18	5	15	19	19	19	9
US Patents Issued	4	2	4	5	6	12	8	5	4
Active License Agreements	15	17	19	22	24	22	26	28	28
Licenses Generating Income	11	38	10	10	18	15	17	12	13
Total Licensing Income	\$503,312	\$993,634	\$357,945	\$3,748,121	\$1,315,116	\$637,374	\$609,579	\$795,333	\$604,214
Start-up Companies Formed	0	1	1	0	0	0	0	0	0
Legal Fees Expended	\$137,472	\$242,300	\$146,144	\$266,918	\$262,450	\$350,801	\$292,048	\$223,795	\$403,737
Legal Fees Reimbursed	\$35,209	\$10,300	\$6,353	\$13,450	\$6,905	\$97,344	\$25,849	\$15,637	\$0
Percent of Expenses Reimbursed	26%	4%	4%	5%	3%	28%	9%	7%	0%
Legal Fees as a % License Income	27%	24%	41%	7%	20%	55%	48%	28%	67%

LEGEND:

* = 2015-2016 was the first year to track

Louisiana State University Health Sciences Center at Shreveport

Metric VI: Revenue Sources

	2017-2018	2018-2019	2019-2020	2020-2021	2021-2022	2022-2023
Total Endowment Value*	168,045,871	185,507,010	191,669,223	236,430,358	202,049,403	217,609,882
Total payout from endowment	1,646,632	2,650,189	3,149,492	4,416,558	4,530,347	4,903,275
Total # of Foundations	1	1	1	1	1	1
Foundations total Assets (\$ Amount)	203,792,720	224,680,069	238,976,848	310,112,374	268,434,931	286,337,818
Click here to go to the Foundations Supplemental Table						
Total # of Board of Regents Support Fund	4	3	3	3	3	3
Total Value (\$ Amount) of BoR Support Fund	2,936,210	2,995,655	3,087,481	3,517,297	2,990,059	2,889,030
Click here to go to the BoR Support Funds Supplemental Table						
Click here to go to the Affiliated Supplemental Table						
Total Gross Revenue Generated from tuition and fees	21,395,756	21,472,173	22,684,016	23,443,301	24,378,593	24,504,644
Total Net Revenue Generated from tuition and fees	19,849,524	19,868,766	20,963,389	21,136,595	22,024,872	21,957,023
Financial Aid						
Total institutional dollars awarded need based aid for entering freshmen class ²	XXXXXXXX	XXXXXXXX	XXXXXXXX	XXXXXXXX	XXXXXXXX	XXXXXXXX
Total institutional dollars awarded non-need aid for entering freshmen class ²	XXXXXXXX	XXXXXXXX	XXXXXXXX	XXXXXXXX	XXXXXXXX	XXXXXXXX
Total institutional dollars awarded need based aid for entering freshmen class LA residents ²	XXXXXXXX	XXXXXXXX	XXXXXXXX	XXXXXXXX	XXXXXXXX	XXXXXXXX
Total institutional dollars awarded non-need based aid for entering freshmen class LA residents ²	XXXXXXXX	XXXXXXXX	XXXXXXXX	XXXXXXXX	XXXXXXXX	XXXXXXXX
Total institutional dollars awarded need based aid for entering freshmen class non-residents ²	XXXXXXXX	XXXXXXXX	XXXXXXXX	XXXXXXXX	XXXXXXXX	XXXXXXXX
Total institutional dollars awarded non-need based aid for entering freshmen class non-residents ²	XXXXXXXX	XXXXXXXX	XXXXXXXX	XXXXXXXX	XXXXXXXX	XXXXXXXX
State Appropriation per FTE³	n/a	n/a	n/a	n/a	n/a	n/a
Net Revenue Generated from auxiliary enterprises	9,344	795,307	511,970	(87,179)	(921,973)	1,279,740

¹ Alumni gifts are deposited with the LSUHSC-S Foundation

² LSUHSC-S does not enroll first-time freshmen

³ Due to the complexity and overlap of health science center functions including instruction, patient care, and research, state appropriation specific to student FTE is difficult to determine and provide an accurate value for comparison.

* Per an agreement between LSUHSC-S and the LSUHS Foundation, endowment funds are managed by the Foundation.

Endowment Value equals the market value of of the endowment as of June 30 of the reporting year.

FTE Full time equivalent

Payout from Endowment equal interest earned on endowment.

Gross Revenue Generated from Student Enrollment FTE equals revenue gain from student tuitions and fees.

Net Revenue Generated from Student Enrollment FTE equals gross revenue from enrollment headcount minus institutional supported financial aid.

Net Revenue from Auxiliary equal gross revenue generated from auxiliary enterprises minus debt services and other financial obligations.

Louisiana State University Health Sciences Center at Shreveport

Metric VII: Teaching Productivity

	2018-2019	2019-2020	2020-2021	2021-2022	2022-2023
Faculty Full-time	432	453	476	535	544
Faculty Part-time	73	73	72	70	64
Total Faculty*	505	526	548	605	608
Number of Sections	1,138	1,180	1,066	1,139	1,065
Duplicated Head Count	2,166	2,283	2,405	2,432	2,432
Educational Degree Programs -- Student Credit Hours					
Undergraduates	996	1,090	967	949	829
Masters	6,757	6,166	6,485	6,365	5,274
Doctoral	5,760	6,187	6,549	6,748	7,476
Spec/Prf	20,858	21,684	23,084	23,919	23,837
Total Student Credit Hours	34,371	35,127	37,085	37,981	37,416
Student Credit Hours/Duplicated Headcount	16	15	15	16	15
Graduate Medical Education (GME) - Resident and Fellow Headcount	469	464	566	585	588
Graduate Medical Education (GME) - Resident and Fellow Annual Hours	1,249,259	1,238,613	1,555,001	1,453,965	1,410,940
GME Annual Hours/GME Headcount	2,664	2,669	2,747	2,485	2,400
Tuition & Fees	21,472,173	22,684,016	23,443,301	24,378,593	24,504,644
Fed Approp	0	0		0	0
State Approp excluding hospital	66,259,198	72,254,423	58,613,607	73,517,013	71,492,635
Federal Grants & Contracts	15,603,945	15,706,687	16,019,142	19,949,922	23,231,338
State Grants & Contracts	3,499,078	3,548,597	20,015,588	5,899,477	4,706,427
Local Grants & Contracts	739,158	346,968	320,278	320,278	320,278
Total Govt Grants Contracts	19,842,181	19,602,252	36,355,008	26,169,677	28,258,043
Private Grants Contracts	212,657,300	205,422,100	223,552,793	259,830,262	270,769,898
Gifts	57,851	53,827	5,095	20,305	6,785
Endowment Income	2,650,189	3,149,492	4,416,558	4,530,347	4,903,275
Sales and Services of Edu Depts	31,365,711	35,101,190	67,004,336	77,994,149	28,233,194
Hospitals, Including State Approp	12,287,532	1,155,316	48,541	(52,038)	1,814,179
Auxiliary Enterprises	4,830,959	4,418,087	3,707,312	3,383,606	2,936,262
Other Income	9,802,285	9,876,843	2,142,146	(13,469,773)	6,501,159
Other Income excluding IDC	5,742,126	5,905,698	(1,624,154)	(18,672,308)	480,713
Indirect Cost (F & A)	4,060,159	3,971,145	3,766,300	5,202,535	6,020,446
Annual Giving	57,851	53,827	5,095	20,305	6,785

*Faculty counts as of June of fiscal year

Louisiana State University Health Sciences Center at Shreveport

Metric VII: Teaching Productivity

Definitions:

Direct Expenditures for Instructions: Total Direct Instructional Expenditures include data in certain functional areas - instruction, research, and public service. Direct expenditure data reflect costs incurred for personnel compensation, supplies, and services used in the conduct of each of these functional areas. They include acquisition costs of capital assets such as equipment and library books to the extent that funds are budgeted for the use of departments for instruction, research, and public service. Similar to the Delaware Study, exclude centrally allocated computing costs and centrally supported computer labs, and graduate student tuition remission and fee waivers.

Instruction: Instruction includes general academic instruction, occupational and vocational instruction, community education, preparatory and adult basic education, and remedial and tutorial instruction conducted by the teaching faculty for the institution's students. Departmental research and service **which are not separately budgeted** should be included under instruction. In other words, department research which is externally funded should be excluded from instructional expenditures, as should any departmental funds which were expended for the purpose of matching external research funds as part of a contractual or grant obligation. EXCLUDE expenditures for academic administration where the primary function is administration. For example, exclude deans, but include department chairs.)

Disaggregate total direct instructional expenditures for the institution into the following categories:

Salaries: Report all wages paid to support the instructional function in a given department or program during the fiscal year. While these will largely be faculty salaries, be sure to include clerical (e.g., department secretary), professionals (e.g., lab technicians), Graduate student stipends (but not tuition waivers), and any other personnel who support the teaching function and whose salaries and wages are paid **from the institution's instructional budget**.

Benefits: Report expenditures for benefits associated with the personnel for whom salaries and wages were reported on the previous entry. If you cannot separate benefits from salaries, but benefits are included in the salary figure you have entered, indicate "Included in Salaries" in the data field. Some institutions book benefits centrally and do not disaggregate to the department level. If you can compute the appropriate benefit amount for the department/program, please do so and enter the data. If you cannot do so, leave the benefit amount as zero and we will impute a cost factor based upon the current benefit rate for your institution, as published in [Academe](#). If no rate is available, we will use a default value of 28%.

Other Than Personnel Costs: This category includes non-personnel items such as travel, supplies and expense, non-capital equipment purchases, etc., that are typically part of an instructional department or program's cost of doing business. *Excluded* from this category are items such as central computing costs, centrally allocated computing labs, graduate student tuition remission and fee waivers, etc.

Research: This category includes all funds expended for activities specifically organized to produce research outcomes and commissioned by an agency either external to the institution or **separately budgeted** by an organizational unit within the institution. Report total research expenditures only. It is not necessary to disaggregate costs for this category.

Public Service: Report all funds **separately budgeted** specifically for public service and expended for activities established primarily to provide non-instructional services beneficial to groups external to the institution. Examples include cooperative extension and community outreach projects. Report total service expenditures only. It is not necessary to disaggregate costs for this category.

Federally Funded Research: As defined by NSF **Total Research and Expenditures:** As defined by NSF

Louisiana State University Health Sciences Center at Shreveport

Table I: Affiliated Off-Campus Sites

LSU Campus	Name of Affiliated Off- Campus Site	Net Revenue Generated by Affiliated Campus	\$ Amount Contributed Back to Campus by Affiliated Off-Site Campus
Table II: Board of Regent Support Funds			
LSUHSC - Shreveport	BOR: LEQSF(2013-16)-RD-A-07	54,557.51	FY15
LSUHSC - Shreveport	BOR: Doctoral Student	4,500.00	FY15
LSUHSC - Shreveport	BOR: Campus Police	17.00	FY15
LSUHSC - Shreveport	BOR: Gene Therapy	1,016.09	FY15
LSUHSC - Shreveport	BOR: "A La. Model"	246.21	FY15
LSUHSC - Shreveport	BOR: LEQSF(2013-16)-RD-A-20	45,266.78	FY15
LSUHSC - Shreveport	Schumpert Chair-Neurobiology	1,079,845.80	FY15
LSUHSC - Shreveport	WK Chair-Molecular Biology	653,349.86	FY15
LSUHSC - Shreveport	MW Feist Chair - Medicine	947,411.30	FY15
		2,786,210.56	FY15 Total

LSU Campus	Name of Support Fund	Market Value (\$ Amount)	Value at:
LSUHSC - Shreveport	BOR: WISE Capital Outlay Funds	1,022,969.00	FY16
LSUHSC - Shreveport	BOR: LEQSF(2015-18)-RD-A-15	51,901.58	FY16
LSUHSC - Shreveport	BOR: Epstein-Barr	473.34	FY16
LSUHSC - Shreveport	Schumpert Chair-Neurobiology	1,062,912.13	FY16
LSUHSC - Shreveport	WK Chair-Molecular Biology	638,165.40	FY16
LSUHSC - Shreveport	MW Feist Chair - Medicine	1,025,098.54	FY16
		3,801,519.99	FY16 Total

United States Medical Licensing Examinations

AY2014-15

	USMLE Step 1	USMLE Step 2 CK	USMLE Step 2 CS
LSUHSC-S	95%	96%	97%
National Average Pass Rate	96%	95%	96%

Total Federal Research Grants and Contracts

Year: 2015

School	Total
Mississippi	\$30,682,367
Texas A & M	\$19,346,123
SUNY Upstate	\$19,213,681
South Carolina	\$10,322,130
South Alabama	\$10,054,525
West Virginia	\$9,253,665
Texas Tech	\$6,658,947
East Carolina-Brody	\$6,542,453
Central Florida	\$5,897,962
LSUHSC-S	\$5,535,771
<i>Comparison Group Average</i>	\$12,350,762
<i>Comparison Group Median</i>	\$9,654,095

Source: AAMC Medical School Profile System (LCME Part I-A Annual Financial Questionnaire (AFQ))

Note: This report shows federal research grants and contracts for each medical school

United States Medical Licensing Examinations

AY2015-16

	USMLE Step 1	USMLE Step 2 CK	USMLE Step 2 CS
LSUHSC-S	96%	98%	97%
National Average Pass Rate	95%	96%	97%

Total Federal Research Grants and Contracts

Year: 2016

School	Total
Mississippi	\$31,326,892
Texas A & M	\$20,561,390
SUNY Upstate	\$18,942,223
West Virginia	\$14,739,402
South Alabama	\$11,388,111
South Carolina	\$10,650,027
Texas Tech	\$6,664,554
East Carolina-Brody	\$6,172,621
Central Florida	\$5,711,098
LSUHSC-S	\$5,438,358
<i>Comparison Group Average</i>	\$13,159,468
<i>Comparison Group Median</i>	\$11,019,069

Source: AAMC Medical School Profile System (LCME Part I-A Annual Financial Questionnaire (AFQ))

Note: This report shows federal research grants and contracts for each medical school

Table II: Board of Regent Support Funds (cont.)

LSU Campus	Name of Support Fund	Market Value (\$ Amount)	Value at:
LSUHSC - Shreveport	BOR: LEQSF(2015-18)-RD-A-15	58,730.00	FY17
LSUHSC - Shreveport	BOR: LEQSF(2016-19)-RD-A-15	94,175.00	FY17
LSUHSC - Shreveport	Schumpert Chair-Neurobiology	1,127,464.12	FY17
LSUHSC - Shreveport	WK Chair-Molecular Biology	1,011,894.26	FY17
LSUHSC - Shreveport	MW Feist Chair - Medicine	714,841.10	FY17
		3,007,104.48	FY17 Total

LSU Campus	Name of Support Fund	Market Value (\$ Amount)	Value at:
LSUHSC - Shreveport	BOR:LEQSF(2016-19)-RD-A-15	33,101.06	FY18
LSUHSC - Shreveport	Schumpert Chair-Neurobiology	1,195,028.11	FY18
LSUHSC - Shreveport	WK Chair-Molecular Biology	724,055.80	FY18
LSUHSC - Shreveport	MW Feist Chair - Medicine	984,024.92	FY18
		2,936,209.88	FY18 Total

LSU Campus	Name of Support Fund	Market Value (\$ Amount)	Value at:
LSUHSC - Shreveport	Schumpert Chair-Neurobiology	1,231,863.78	FY19
LSUHSC - Shreveport	WK Chair-Molecular Biology	736,417.35	FY19
LSUHSC - Shreveport	MW Feist Chair - Medicine	1,027,373.72	FY19
		2,995,654.85	FY19 Total

LSU Campus	Name of Support Fund	Market Value (\$ Amount)	Value at:
LSUHSC - Shreveport	Schumpert Chair-Neurobiology	1,254,083.40	FY20
LSUHSC - Shreveport	WK Chair-Molecular Biology	765,661.24	FY20
LSUHSC - Shreveport	MW Feist Chair - Medicine	1,067,735.88	FY20
		3,087,480.52	FY20 Total

Table II: Board of Regent Support Funds (cont.)

LSU Campus	Name of Support Fund	Market Value (\$ Amount)	Value at:
LSUHSC - Shreveport	Schumpert Chair-Neurobiology	1,317,252.84	FY21
LSUHSC - Shreveport	WK Chair-Molecular Biology	988,417.04	FY21
LSUHSC - Shreveport	MW Feist Chair - Medicine	1,211,627.62	FY21
		3,517,297.50	FY21 Total

Table II: Board of Regent Support Funds (cont.)

LSU Campus	Name of Support Fund	Market Value (\$ Amount)	Value at:
LSUHSC - Shreveport	Schumpert Chair-Neurobiology	1,085,992.35	FY22
LSUHSC - Shreveport	WK Chair-Molecular Biology	839,174.16	FY22
LSUHSC - Shreveport	MW Feist Chair - Medicine	1,064,892.80	FY22
		2,990,059.31	FY22 Total

Table II: Board of Regent Support Funds (cont.)

LSU Campus	Name of Support Fund	Market Value (\$ Amount)	Value at:
LSUHSC - Shreveport	Schumpert Chair-Neurobiology	1,034,668.12	FY23
LSUHSC - Shreveport	WK Chair-Molecular Biology	910,902.74	FY23
LSUHSC - Shreveport	MW Feist Chair - Medicine	943,458.94	FY23
		2,889,029.80	FY23 Total

Table III: Summary of Campus Foundations

LSU Campus	Foundation	Total Assets	(\$ Amount)	
LSUHSC - Shreveport	LSUHSC-SHV Foundation	75,396,282.00		FY07
LSUHSC - Shreveport	LSUHSC-SHV Foundation	88,016,284.00		FY08
LSUHSC - Shreveport	LSUHSC-SHV Foundation	86,012,382.00		FY09
LSUHSC - Shreveport	LSUHSC-SHV Foundation	95,620,165.00		FY10
LSUHSC - Shreveport	LSUHSC-SHV Foundation	110,361,409.00		FY11
LSUHSC - Shreveport	LSUHSC-SHV Foundation	110,077,114.00		FY12
LSUHSC - Shreveport	LSUHSC-SHV Foundation	177,027,973.00		FY13
LSUHSC - Shreveport	LSUHSC-SHV Foundation	195,153,432.00		FY14
LSUHSC - Shreveport	LSUHSC-SHV Foundation	193,001,722.00		FY15
LSUHSC - Shreveport	LSUHSC-SHV Foundation	185,628,981.00		FY16
LSUHSC - Shreveport	LSUHSC-SHV Foundation	200,055,947.00		FY17
LSUHSC - Shreveport	LSUHSC-SHV Foundation	203,792,720.00		FY18
LSUHSC - Shreveport	LSUHSC-SHV Foundation	224,680,069.00		FY19
LSUHSC - Shreveport	LSUHSC-SHV Foundation	238,976,848.00		FY20
LSUHSC - Shreveport	LSUHSC-SHV Foundation	310,112,374.00		FY21
LSUHSC - Shreveport	LSUHSC-SHV Foundation	268,434,931.00		FY22
LSUHSC - Shreveport	LSUHSC-SHV Foundation	286,337,818.00		FY23

Louisiana State University Health Sciences Center at Shreveport

Benchmark Report

United States Medical Licensing Examinations

AY2022-23

	USMLE Step 1 (2023)	USMLE Step 2 CK (2022-23)	USMLE Step 2 CS (2022-23)
LSUHSC-S	84%	99%	*
National Average Pass Rate	92%	98%	*

**USMLE Step 2 CS was not administered in 2019-20 due to COVID-19 and discontinued going forward*

Direct Federal Research Grants and Contracts - Recorded

Year: 2022

School	Total
Mississippi	\$30,846,887
Texas A & M	\$24,082,794
West Virginia	\$20,111,191
SUNY Upstate	\$18,091,787
South Carolina	\$10,700,141
LSUHSC-S	\$10,140,515
East Carolina-Brody	\$7,599,957
Texas Tech	\$7,293,266
Central Florida	\$6,369,928
South Alabama	\$6,132,915
<i>Comparison Group Average</i>	\$14,136,938
<i>Comparison Group Median</i>	\$10,420,328

Source: AAMC Medical School Profile System (LCME Part I-A Annual Financial Questionnaire (AFQ))

Note: This report shows federal research grants and contracts for each medical school

United States Medical Licensing Examinations

AY2021-22

	USMLE Step 1 (2022)	JSMLE Step 2 CK (2021-22)	USMLE Step 2 CS (2021-22)
LSUHSC-S	89%	100%	*
National Average Pass Rate	93%	99%	*

**USMLE Step 2 CS was not administered in 2019-20 due to COVID-19 and discontinued going forward*

Total Federal Research Grants and Contracts

Year: 2021

School	Total
Mississippi	\$35,298,854
Texas A & M	\$34,540,777
SUNY Upstate	\$24,670,154
West Virginia	\$23,425,011
South Carolina	\$11,746,286
LSUHSC-S	\$10,945,501
South Alabama	\$9,991,609
Texas Tech	\$9,565,738
Central Florida	\$8,783,182
East Carolina-Brody	\$8,360,009
<i>Comparison Group Average</i>	\$17,732,712
<i>Comparison Group Median</i>	\$11,345,894

Source: AAMC Medical School Profile System (LCME Part I-A Annual Financial Questionnaire (AFQ))

Note: This report shows federal research grants and contracts for each medical school

United States Medical Licensing Examinations

AY2020-21

	USMLE Step 1 (2021)	JSMLE Step 2 CK (2020-21)	USMLE Step 2 CS (2020-21)
LSUHSC-S	95%	100%	*
National Average Pass Rate	96%	99%	*

**USMLE Step 2 CS was not administered in 2019-20 due to COVID-19 and discontinued going forward*

Total Federal Research Grants and Contracts

Year: 2020

School	Total
Mississippi	\$38,465,021
Texas A & M	\$76,616,987
SUNY Upstate	\$23,541,486
West Virginia	\$19,006,807
South Carolina	\$13,698,099
Texas Tech	\$10,391,793
LSUHSC-S	\$10,226,978
South Alabama	\$9,782,776
Central Florida	\$7,568,040
East Carolina-Brody	\$7,404,704
<i>Comparison Group Average</i>	\$21,670,269
<i>Comparison Group Median</i>	\$12,044,946

Source: AAMC Medical School Profile System (LCME Part I-A Annual Financial Questionnaire (AFQ))

Note: This report shows federal research grants and contracts for each medical school

United States Medical Licensing Examinations

AY2019-20

	USMLE Step 1	USMLE Step 2 CK	USMLE Step 2 CS
LSUHSC-S	100%	99%	*
National Average Pass Rate	98%	98%	*

* USMLE Step 2 CS was not administered in 2019-20 due to COVID-19.

Total Federal Research Grants and Contracts

Year: 2019

School	Total
Mississippi	\$40,018,804
SUNY Upstate	\$23,041,769
Texas A & M	\$22,051,441
West Virginia	\$16,943,367
South Carolina	\$11,910,531
LSUHSC-S	\$10,829,529
South Alabama	\$10,542,845
Texas Tech	\$8,519,504
East Carolina-Brody	\$7,087,924
Central Florida	\$6,321,175
<i>Comparison Group Average</i>	\$15,726,689
<i>Comparison Group Median</i>	\$11,370,030

Source: AAMC Medical School Profile System (LCME Part I-A Annual Financial Questionnaire (AFQ))

Note: This report shows federal research grants and contracts for each medical school

United States Medical Licensing Examinations

AY2017-18

	USMLE Step 1	USMLE Step 2 CK	USMLE Step 2 CS
LSUHSC-S	94%	94%	94%
National Average Pass Rate	96%	97%	95%

Total Federal Research Grants and Contracts

Year: 2018

School	Total
Mississippi	\$35,384,210
SUNY Upstate	\$20,264,590
Texas A & M	\$20,082,975
West Virginia	\$17,299,792
South Carolina	\$9,646,359
South Alabama	\$9,244,139
LSUHSC-S	\$7,962,674
East Carolina-Brody	\$6,333,574
Central Florida	\$6,320,585
Texas Tech	\$5,191,462
<i>Comparison Group Average</i>	\$13,773,036
<i>Comparison Group Median</i>	\$9,445,249

Source: AAMC Medical School Profile System (LCME Part I-A Annual Financial Questionnaire (AFQ))

Note: This report shows federal research grants and contracts for each medical school

United States Medical Licensing Examinations

AY2016-17

	USMLE Step 1	USMLE Step 2 CK	USMLE Step 2 CS
LSUHSC-S	89%	94%	95%
National Average Pass Rate	96%	96%	96%

Total Federal Research Grants and Contracts

Year: 2017

School	Total
Mississippi	\$31,724,879
SUNY Upstate	\$19,990,695
Texas A & M	\$17,353,679
West Virginia	\$14,477,906
South Alabama	\$10,812,263
South Carolina	\$10,663,709
East Carolina-Brody	\$6,597,614
Texas Tech	\$6,381,025
Central Florida	\$6,342,162
LSUHSC-S	\$6,034,109
<i>Comparison Group Average</i>	\$13,037,804
<i>Comparison Group Median</i>	\$10,737,986

Source: AAMC Medical School Profile System (LCME Part I-A Annual Financial Questionnaire (AFQ))

Note: This report shows federal research grants and contracts for each medical school

**Louisiana State University
Pennington Biomedical Research Center
Metric Data**



April 26, 2024

Pennington Biomedical Research Center

Executive Summary

Metric IV - Research Expenditures

Researchers at the Pennington Biomedical Research Center continued to perform well in 2023. The total amount of faculty research, the number of clinical trials or proposals funded, the total gifts, grants, and contract funding, and the number of inventions disclosures received have all increased. However, research dollars per FTE and number of total gifts, grants, and contract proposals submitted to potential sponsors have decreased in 2023. Pennington Biomedical has focused on rebuilding a faculty base that was significantly eroded during lean budget times from 2009-2019. As we recruit new faculty, we understand that it takes time for newly hired researchers to submit proposals and have those awarded in significant amounts.

Pennington Biomedical's business model requires a stable base level of support to return grants and contracts on an order of \$813,000 per faculty. It will become increasingly difficult to sustain our excellent levels of grant and contract funding without a stable base. Nevertheless, we are pleased with the 2023 success in total faculty research.

Metric V - Technology Transfer

Invention disclosures, licenses\options executed, new patents filed, and total licensing income all increased this year, while active license agreements and licenses generating income remained level.

Metric VI - Revenues

Total endowment value, foundation assets, state appropriations per FTE, and net revenue generated from auxiliary enterprises all increased in 2023.

Total payout from endowment decreased slightly from FY 2022 to FY 2023.

MISSION:

LSU's Pennington Biomedical Research Center puts science to work for a healthier Louisiana. A world research leader right here in Louisiana, we have the vision of leading the world in promoting metabolic health and eliminating metabolic disease through scientific discoveries that create solutions from cells to society. Our mission is to discover the triggers of obesity and diet-related diseases and improve the health of all people through Research, Treatment & Prevention, Scientific Education, and Implementation & Outreach.

Pennington Biomedical Research Center

Metrics at a Glance

2022-2023

Legend:

Statistic		
High	X	Y
Low	Z	%

Most Recent Available
% Change from Previous Period

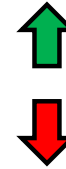

Increase from Previous Year

No change



Decrease from Previous Year

Metric IV Research Expenditures

Total Amount of Faculty Research (in thousands)		
48,750		48,750
37,543	↑	8.1%

Research dollars per FTE for T/TT (in thousands)		
1,617		1,283
1,219	↓	-3.3%

Percent of T/TT faculty holding grants		
87.1%		81.0%
73.0%	⇒	0.0%

Total number of clinical trials or proposal funded		
121		114
81	↑	2.7%

Total gifts, grants and contract funding (for research only)		
35,439		35,439
30,291	↑	4.0%

Number of Total Gifts, Grant, and Contract Proposals submitted to potential sponsors.		
250		197
144	↓	-15.1%

Number of inventions disclosures received		
12		8
6	↑	33.3%

Metric V Technology Transfer

Invention Disclosures		
12		8
5	↑	33.3%

Licenses\Options Executed		
12		7
3	↑	75.0%

New Patents Filed - Total		
20		11
6	↑	22.2%

Active License Agreements		
32		30
5	⇒	0.0%

Licenses Generating Income		
15		6
5	⇒	0.0%

Total Licensing Income		
107,418		48,628
10,029	↑	64.0%

Metric VI Revenues

Total Endowment Value		
20,594,544		17,949,588
17,163,373	↑	1.5%

Total payout from endowment		
781,310		774,922
768,299	↓	-0.3%

Foundations total Assets (\$ Amount)		
30,440,651		26,602,719
25,268,686	↑	5.3%

State Appropriation per FTE employee		
73,329		73,329
51,418	↑	15.6%

Net Revenue Generated from auxiliary enterprises		
96,785		96,785
-30,764	↑	22408.1%

Pennington Biomedical Research Center

Metric IV. The following metrics will identify the effectiveness of campus research and technology transfer to benefit the state's economic development.

Dollars shown in thousands

Field of Science & Engineering	FY 2018		FY 2019		FY 2020		FY 2021		FY 2022		FY 2023	
	Total	Federal	Total	Federal	Total	Federal	Total	Federal	Total	Federal	Total	Federal
a. Engineering (Total)	0	0	0	0	0	0	0	0	0	0	0	0
(1) Aeronautical & astronautical	0	0	0	0	0	0	0	0	0	0	0	0
(2) Bioengineering/biomedical engineering	0	0	0	0	0	0	0	0	0	0	0	0
(3) Chemical	0	0	0	0	0	0	0	0	0	0	0	0
(4) Civil	0	0	0	0	0	0	0	0	0	0	0	0
(5) Electrical	0	0	0	0	0	0	0	0	0	0	0	0
(6) Mechanical	0	0	0	0	0	0	0	0	0	0	0	0
(7) Metallurgical & materials	0	0	0	0	0	0	0	0	0	0	0	0
(8) Other	0	0	0	0	0	0	0	0	0	0	0	0
b. Physical Sciences (Total)	0	0	0	0	0	0	0	0	0	0	0	0
(1) Astronomy	0	0	0	0	0	0	0	0	0	0	0	0
(2) Chemistry	0	0	0	0	0	0	0	0	0	0	0	0
(3) Physics	0	0	0	0	0	0	0	0	0	0	0	0
(4) Other	0	0	0	0	0	0	0	0	0	0	0	0
c. Environmental Sciences (Total)	0	0	0	0	0	0	0	0	0	0	0	0
(1) Atmospheric	0	0	0	0	0	0	0	0	0	0	0	0
(2) Earth sciences	0	0	0	0	0	0	0	0	0	0	0	0
(3) Oceanography	0	0	0	0	0	0	0	0	0	0	0	0
(4) Other	0	0	0	0	0	0	0	0	0	0	0	0
d. Mathematical Sciences (Total)	0	0	0	0	0	0	0	0	0	0	0	0
e. Computer Sciences (Total)	0	0	0	0	0	0	0	0	0	0	0	0
f. Life Sciences (Total)	38,836	20,398	40,264	20,145	41,736	20,883	45,184	23,358	46,598	26,482	50,270	29,389
(1) Agricultural	0	0	0	0	0	0	0	0	0	0	0	0
(2) Biological	38,836	20,398	40,264	20,145	41,736	20,883	45,184	23,358	46,598	26,482	50,270	29,389
(3) Medical	0	0	0	0	0	0	0	0	0	0	0	0
(4) Other	0	0	0	0	0	0	0	0	0	0	0	0
g. Psychology (Total)	0	0	0	0	0	0	0	0	0	0	0	0
h. Social Sciences (Total)	0	0	0	0	0	0	0	0	0	0	0	0
(1) Economics	0	0	0	0	0	0	0	0	0	0	0	0
(2) Political science	0	0	0	0	0	0	0	0	0	0	0	0
(3) Sociology	0	0	0	0	0	0	0	0	0	0	0	0
(4) Other	0	0	0	0	0	0	0	0	0	0	0	0
i. Other Sciences, not elsewhere classified (Total)	0	0	0	0	0	0	0	0	0	0	0	0
j. Total (sum of a through i)	38,836	20,398	40,264	20,145	41,736	20,883	45,184	23,358	46,598	26,482	50,270	29,389

Dollars shown in thousands

Pennington Biomedical Research Center

Metric IV. The following metrics will identify the effectiveness of campus research and technology transfer to benefit the state's economic development.

Dollars shown in thousands

Faculty Research:	2017-2018	2018-2019	2019-2020	2020-2021	2021-2022	2022-2023
Total Amount of Faculty Research	37,543	38,993	40,043	43,655	45,106	48,750
Total number of T/TT faculty holding grants	27	32	32	27	34	38
Percent of T/TT faculty holding grants	87%	84%	82%	73%	81%	81%
Research dollars per FTE for T/TT	1,390	1,219	1,251	1,617	1,327	1,283
Licenses/Patents:	2017-2018	2018-2019	2019-2020	2020-2021	2021-2022	2022-2023
Number of inventions disclosures received	8	6	12	9	6	8
Total license income	29.9	107.4	68.6	68.0	29.7	47.1
Total number of new patents filed	10	6	20	10	9	11
Total number of new licenses/options executed	5	5	12	8	4	7
Total number of start up companies	0	0	0	0	0	0
Total number of licenses generating revenue	8	5	12	9	6	6
Legal Fees	2017-2018	2018-2019	2019-2020	2020-2021	2021-2022	2022-2023
Expended	66.7	42.0	92.9	105.1	59.8	84.3
Reimburse	0.3	0.0	0.0	0.8	0.5	0.0
Percent increase in nonstate funds (for research only)	-11.65%	-1.94%	-2.36%	8.43%	12.51%	7.44%
Total number of clinical trials or proposal funded	81	100	118	121	111	114
Total gifts, grants and contract funding (for research only)	31,022	30,420	30,291	32,985	34,081	35,439
Number of Total Gifts, Grant, and Contract Proposals submitted to potential sponsors.	144	218	225	250	232	197

Pennington Biomedical Research Center

Metric V: Technology Transfer

(The following metric will provide technology transfer data.)

	2014-2015	2015-2016	2016-2017	2017-2018	2018-2019	2019-2020	2020-2021	2021-2022	2022-2023
Invention Disclosures	5	9	11	8	6	12	9	6	8
Licenses\Options Executed	3	6	3	5	5	12	8	4	7
New Patents Filed - Total	11	16	20	10	6	19	10	9	11
New Patents Filed - First in Family	*	4	3	2	2	2	3	2	4
US Patents Issued	1	3	5	3	1	2	2	2	2
Active License Agreements	5	24	25	25	20	32	32	30	30
Licenses Generating Income	8	9	9	8	5	15	9	6	6
Total Licensing Income	\$10,029	\$83,503	\$17,674	\$29,954	\$107,418	\$68,653	\$68,035	\$29,660	\$48,628
Start-up Companies Formed	0	0	0	0	1	0	0	0	0
Legal Fees Expended	\$72,753	\$103,426	\$82,560	\$66,679	\$42,066	\$92,886	\$105,144	\$59,810	\$84,337
Legal Fees Reimbursed	\$0	\$0	\$33,798	\$306	\$0	\$0	\$833	\$500	\$0
Percent of Expenses Reimbursed	0%	0%	41%	0%	0%	0%	1%	0%	0%
Legal Fees as a % License Income	725%	124%	467%	223%	39%	135%	155%	202%	173%

LEGEND:

* = 2015-2016 was the first year to track

Pennington Biomedical Research Center

Metric VI. The following metrics will identify the campus maximization of revenue streams to support teaching, research and outreach.

	2017-2018	2018-2019	2019-2020	2020-2021	2021-2022	2022-2023
Total Endowment Value	\$ 17,993,837	\$ 17,811,872	\$ 17,163,373	\$ 20,594,544	\$ 17,682,809	\$ 17,949,588
Total payout from endowment	\$ 777,705	\$ 778,480	\$ 768,299	\$ 781,310	\$ 777,594	\$ 774,922
Total # of Foundations	2	2	2	2	2	2
Foundations total Assets (\$ Amount)	\$ 26,928,884	\$ 26,663,821	\$ 26,070,001	\$ 30,440,651	\$ 25,268,686	\$ 26,602,719
State Appropriation per FTE employee	\$54,233	\$51,418	\$53,836	\$59,406	\$63,421	\$ 73,329
Net Revenue Generated from auxiliary enterprises	-\$30,764	-\$2,699	\$0	\$430	\$430	\$ 96,785

Endowment Value equals the market value of of the endowment as of June 30 of the reporting year.

FTE- Full time equivalent

Payout from Endowment equal interest earned on endowment.

Gross Revenue Generated from Student Enrollment FTE equals revenue gain from student tuitions and fees.

Net Revenue Generated from Student Enrollment FTE equals gross revenue from enrollment headcount minus institutional supported financial aid.

Net Revenue from Auxiliary equal gross revenue generated from auxiliary enterprises minus debt services and other financial obligations.

Additional Footnotes from Foundations:

Pennington Medical Foundation (PMF):

1. PMF is on a calendar year basis (not fiscal year basis). Therefore, data provided by PMF is for calendar year 2006, 2007, 2008, 2009, 2010, 2011, 2012, 2013, 2014, 2016, 2017, 2018, 2019, 2020, and 2021.
2. The figures above are not all inclusive annual support from the PMF to the PBRC. The numbers above only represent direct support payments from the PMF to the PBRC. It does not include payments made to other third party entities, which support PBRC, and in comparison is a significant source of support to PBRC.

Pennington Biomedical Research Foundation (PBRF):

1. PBRF is on a fiscal year basis. The data provided by PBRF is for fiscal year ending June 30, 2007, 2008, 2009, 2010, 2011, 2012, 2013, 2014, 2015, 2016, 2017, 2018, 2019, 2020, and 2021.
2. The figures above are not all inclusive annual support from the PBRF to the PBRC. The numbers above only represent direct support payments from the PBRF to the PBRC. It does not include payments made to other third party entities, which support PBRC, and in comparison is a significant source of support to PBRC.
3. Total payout from endowment equals amount expended (private and state) by the Foundation for the endowed chair and professorship program. Note, this amount is also included in the total annual giving number since the Foundation's endowment payout is paid directly to PBRC each year.

"**Total Endowment Value**" above does not include investments of the Pennington Medical Foundation, since it does not technically have a donor restricted permanent endowment.

Table I: Affiliated Off-Campus Sites

LSU System Campus	Name of Affiliated Off- Campus Site	Gross Revenue Generated by Affiliate Campus	Net Revenue Generated by Affiliated Campus	\$ Amount Contributed Back to Campus by Affiliated Off-Site Campus

Table II: Board of Regent Support Funds

LSU System Campus	Name of Support Fund	Endowment	Market Value (\$ Amount)	
PBRC	Pennington Biomedical Research Foundation		\$ 17,781,570	6/30/2015
			\$ 16,737,872	6/30/2016
			\$ 17,332,131	6/30/2017
			\$ 17,344,525	6/30/2018
			\$ 17,143,917	6/30/2019
			\$ 16,482,638	6/30/2020
			\$ 19,742,805	6/30/2021
			\$ 16,932,572	6/30/2022
			\$ 17,080,838	6/30/2023

Table III: Summary of Campus Foundations

LSU System Campus	Foundation	Total Assets (\$ Amount)		
PBRC	Pennington Medical Foundation	\$ 59,791,361	12/31/2015	
	(Audited Calendar Year End)	\$ 1,322,509	12/31/2016	
		\$ 1,031,971	12/31/2017	
		\$ 853,684	12/31/2018	
		\$ 724,876	12/31/2019	
		\$ 707,718	12/31/2020	
		\$ 638,208	12/31/2021	
		\$ 281,987	12/31/2022	
PBRC	Pennington Biomedical Research Foundation	\$ 29,726,499	6/30/2015	
	(Audited Fiscal Year End)	\$ 26,730,473	6/30/2016	
		\$ 25,941,999	6/30/2017	
		\$ 25,896,913	6/30/2018	
		\$ 25,810,137	6/30/2019	
		\$ 25,345,125	6/30/2020	
		\$ 29,732,933	6/30/2021	
		\$ 24,630,478	6/30/2022	
		\$ 26,320,732	6/30/2023	

Pennington Biomedical Research Center

National Benchmark Report

	Total Number of NIH Awards 2022	Total Dollar Amount NIH Awards 2022
Pennington Biomedical Research Center	65	\$30,657,949
Wistar Institute (Pennsylvania)	106	\$57,232,756
Oklahoma Medical Research Foundation	76	\$42,249,974
J. David Gladstone Institutes (California)	73	\$51,124,095
Buck Institute for Age Research (California)	54	\$28,229,940
SALK Institute for Biological Studies	123	\$90,491,447
Sanford Burnham Preby's Medical Discovery Institute	116	\$76,586,481
Whitehead Institute for Biomedical Research	20	\$11,530,273
Joslin Diabetes Center	44	\$22,711,759

Source: NIH Reporter

[RePORT](#) | [RePORTER \(nih.gov\)](#)

Note: # of awards is based on unduplicated application ID, and Total \$ Amt NIH Awards is Total Cost + Total Cost IC



Finance & Administration

Report to the Board

April 26, 2024

Affiliated Entities Reimbursements Report

The Louisiana Code of Governmental Ethics prohibits public servants from receiving anything of economic value from a source other than the governmental entity for the performance of official duties and responsibilities or services substantially related to public duties. However, the law allows public employees to receive supplementary compensation or benefits from alumni associations or foundations recognized by the Board. Louisiana Revised Statute (LA RS) 17:3390 requires that any request for payment over \$1,000 for any single transaction to, or on behalf of, a public employee by a nonprofit organization shall be approved in writing by the appropriate higher education management board in accordance with written policies and procedures. The updated Uniform Affiliation Agreement adopted by LSU affiliates in 2020 outlines the provisions for compliance. Below is a summary table of reimbursements by Affiliated Entity for the second quarter of FY 2024. The Appendix include more detailed information on each reimbursement.

Reimbursements Greater than \$1,000 by Affiliated Entity

	Quarter Ending 12/31/2023	
	Number of Payments	Total Reimbursements
Louisiana 4-H Foundation	1	\$ 3,900
LSU Alumni Association	0	\$ -
LSU Foundation	85	\$ 187,973
LSU Health Care Services Foundation	0	\$ -
LSU Health Foundation - New Orleans	96	\$ 228,123
LSU Health Sciences Foundation - Shreveport	23	\$ 78,387
LSU Healthcare Network	0	\$ -
LSU Medical School Alumni Association	0	\$ -
LSU Research Foundation	3	\$ 16,882
LSUA Foundation	26	\$ 87,147
LSUE Foundation	0	\$ -
LSUS Alumni Association	0	\$ -
LSUS Foundation	3	\$ 3,969
Pennington Biomedical Research Foundation	2	\$ 3,628
Tiger Athletic Foundation	32	\$ 95,343

Affiliate: LSU 4-H Foundation

Payee Name	Payment Date	Amount	Purpose
Pam Pearce	11/1/2023	\$3,899.72	Lodging, transportation, and educational experience for National Meat ID Team. State-winning team from Natchitoches, Louisiana
		<hr/>	
		\$3,899.72	

Appendix: Affiliated Entities Reimbursement Details

Affiliate: LSU Foundation

Payee Name	Payment Date	Amount	Purpose
Mohammad Hosen	10/3/2023	\$1,500.00	Research Trip to New York
Kenneth M Levy	10/4/2023	\$2,073.13	Travel to Netherlands to present at conference
Kathleen Searles	10/6/2023	\$1,267.10	Travel to London, England to Present Research at Conference
Nicholas Bryner	10/6/2023	\$2,186.35	VT-Travel Reimbursement to present at the Colloquium on Environmental School
Salar Saadatian	10/6/2023	\$1,500.00	Reim. Expedite Visa fee
Amber Salvadras	10/7/2023	\$2,596.41	Supplies for Rebecca Goodner Funded Project
Adelaide M. Russo	10/11/2023	\$2,145.09	Travel to Paris for Conference
Dimuthu Ratnadiwakara	10/11/2023	\$2,400.00	Data for Research Project
Vanessa Uhlig	10/11/2023	\$5,000.00	Relocation Expenses
Jesse Downs	10/12/2023	\$1,358.30	PDConference - AMA Conference Registration for Mason Ramagos
Jesse Downs	10/12/2023	\$1,358.30	PDConference - AMA Conference Registration for Amanda Rabalais
Kelly Eaglin	10/12/2023	\$1,517.77	Membership Dues
East Ridge Country Club	10/13/2023	\$13,970.30	Welcome Reception LSUS Chancellor, Robert Smith
LSU Accounting Services	10/13/2023	\$1,647.01	Conference Travel (On Behalf of Cynthia DiCarlo)
Jun Heo	10/18/2023	\$3,874.90	Employee and Student Travel for Advertising Firm visits and networking
Stanley Wilder	10/19/2023	\$1,229.94	Washington DC: October 16-19
Eric Lau	10/21/2023	\$1,053.39	University (Pamela Pike)
Charles Berryman	10/24/2023	\$1,776.40	Research Equipment for Ali Kazemian
Alexa Boudreaux	10/24/2023	\$1,766.50	Journal subscription for Dean Garden
Darla Dao	10/24/2023	\$3,705.30	of Barcelona.
Darla Dao	10/24/2023	\$6,040.00	James Spivey, Edit Prof & Shiver Prof - Airfare for Lyons, France International Conference Travel
Amber Salvadras	10/24/2023	\$1,935.13	Art Supplies on behalf of Heather Berrios
Sadie D. Wilks	10/26/2023	\$4,692.84	TN-Conference Travel
Anna Elisa Cattar	10/27/2023	\$1,499.27	Supplies for Hispanic Benefits Fair
Anna Elisa Cattar	11/1/2023	\$1,141.58	Reimbursement for expenses as part of Community Collab Proj
Kimberly Bissell	11/3/2023	\$1,317.20	Hotel and meeting with alum, donors in Washington DC
Carlos Sabadie	11/3/2023	\$1,665.68	LSU Manship Olympics Project Scouting Trip
Amber Salvadras	11/5/2023	\$1,216.47	Lab School Teaching Supplies on behalf of Lennox
John Maxwell Hamilton	11/6/2023	\$2,750.68	Research Travel
Zull-Kifulu Moumouni	11/6/2023	\$1,230.75	International Travel for Research
Jesse Downs	11/6/2023	\$1,796.23	Added additional vinyl to directors office wall which is a window into the main hallway of the Union. Previously students could look into her office so added additional vinyl to prevent that.
Mackenzie Nelson	11/7/2023	\$1,000.00	Employee Award
Monica Derozan	11/8/2023	\$3,517.30	Binoculars for Bird Research Trip (on behalf of Robb Brumfield)
Bret A. Collier	11/9/2023	\$2,319.85	Supplies for research

Appendix: Affiliated Entities Reimbursement Details

Affiliate: LSU Foundation

Payee Name	Payment Date	Amount	Purpose
Keith B. Hall	11/9/2023	\$1,017.56	Travel to attend Oil & Gas Law Short Course in Denver
Keith B. Hall	11/9/2023	\$1,397.33	Conference Travel Houston and Lexington
Jonathan Earle	11/13/2023	\$2,080.14	Printing of Cypress Review Journal
Darla Dao	11/14/2023	\$4,194.27	United Kingdom 02/24/2024 thru 04/21/2024 - Lodging
Christopher Drew	11/15/2023	\$6,047.69	Prof and Student Travel to Film Festival in Washington, DC
Amber Salvadras	11/15/2023	\$1,783.39	Lab School Teaching Supplies on behalf of Heather Berrios
Caley Hewitt	11/16/2023	\$1,179.00	Tools for research project
Leonard Apcar	11/20/2023	\$2,840.40	Meetings with Vendors and Colleagues in NY
Darla Dao	11/20/2023	\$3,221.10	Research
City Club of Baton Rouge	11/27/2023	\$9,865.85	Membership Dues President Tate
Kimberly Bissell	11/29/2023	\$1,752.75	France.
Adelaide M. Russo	11/30/2023	\$1,474.40	Conference Travel in Paris
Carlos Sabadie	12/2/2023	\$1,850.11	Event Tickets for Olympics Project in France
Aaron Sheehan-Dean	12/4/2023	\$1,733.74	International Conference Travel-Portugal
Ashley Long	12/6/2023	\$1,000.00	Employee Award
Crystal Besse	12/6/2023	\$1,000.00	Employee Award
Karen Martin	12/6/2023	\$2,000.00	Employee Award
Rodney Johnson	12/6/2023	\$1,000.00	Employee Award
Donna Landry	12/7/2023	\$1,000.00	Employee Award
Fangneng Huang	12/7/2023	\$2,000.00	Employee Award
Jong Hyun Ham	12/7/2023	\$2,000.00	Employee Award
Maria Bampasidou	12/7/2023	\$1,000.00	Employee Award
Travis Brisini	12/7/2023	\$1,520.75	Reim. for Reception for New Grad Student Recruiting
Olugunle Oluwole	12/12/2023	\$1,500.00	International Research Trip to Nigeria
Brian S Andrews	12/14/2023	\$1,202.59	Various business expenses
Kehui Xu	12/14/2023	\$1,804.45	Reimbursement for Food and Drink CSI
Roberto Champney	12/18/2023	\$1,687.93	Travel Conference Expenses Washington DC
William F. Tate	12/18/2023	\$1,044.58	BRCC November 2023 Dues
Lucas Connor Webster	12/19/2023	\$1,819.97	Reimbursement for Interview Candidate Meals
Tanner Sparks	12/19/2023	\$1,126.71	Travel Expenses Annual Meeting
Gillian Eggleston	12/20/2023	\$1,902.78	Travel to NY for Global Network Partnership
Hyojung Park	12/20/2023	\$3,459.81	Project Expense Reimbursement
Jolie Cornay	12/21/2023	\$3,767.91	Reim. for various dept expenses
Konstantin G Kousoulas	12/21/2023	\$1,382.32	to work for LSU. He works as a BioMed manager.
William W Baumgartner	12/21/2023	\$2,278.99	Travel to NY for Global Network Partnership

Appendix: Affiliated Entities Reimbursement Details

Affiliate: LSU Foundation

Payee Name	Payment Date	Amount	Purpose
Kimberly Bissell	12/03/2023	\$1,814.96	Damage to Rental Car while Traveling International-Filing a Claim with Mastercard
Elizabeth McInnis	12/07/2023	\$1,043.88	Travel South International Memphis TN Hotel
Laurel Miceli	12/08/2023	\$2,300.00	Research Data on behalf of Donald Lund
Megan Klingler	12/11/2023	\$1,050.00	Rotary Club Membership Dues (on behalf of Dean Peterson)
Kelsey Megilligan	12/11/2023	\$1,303.28	Lodging Washington Mardi Gras on behalf of Ashley Arceneaux
Kelsey Megilligan	12/11/2023	\$1,303.28	Lodging Washington Mardi Gras on behalf of William Tate
Kelsey Megilligan	12/11/2023	\$1,303.28	Lodging Washington Mardi Gras on behalf of Jason Droddy
Darrell Henry	12/12/2023	\$1,125.81	American Geophysical Union 2023 Conference, httpswww.agu.orgfall-meetingpagesschedule- events
Tammy Lee	12/12/2023	\$1,103.75	Research and lab materials from Brian Irving's professorship
Marisha Patterson	12/12/2023	\$1,303.28	Lodging for Kimberly Lewis for Washington Mardi Gras Events
Tammy Lee	12/13/2023	\$1,335.00	STRATA data software and license for remote access on behalf of Ashley Clayton
Darrell Henry	12/14/2023	\$1,691.70	American Geophysical Union 2023 Conference, httpswww.agu.orgfall-meetingpagesschedule- events
Darla Dao	12/15/2023	\$3,580.88	engine for teaching and outreach projects.
Darla Dao	12/24/2023	\$2,966.09	Argentina 12/18/2023 thru 03/12/2024
Amber Salvadras	12/27/2023	\$1,168.83	Supplies for Fine Arts Lab School on behalf of Milam and Lennox
John Fletcher	12/30/2023	\$1,593.18	Laptop Computer for research/teaching
		<u>\$187,972.89</u>	

Appendix: Affiliated Entities Reimbursement Details

Affiliate: LSU Health Foundation - New Orleans

Payee Name	Payment Date	Amount	Purpose
Aneesha Ananthula	10/5/2023	\$1,434.70	Travel & Continuing Education
Christopher Bloise	10/5/2023	\$1,405.35	Travel & Continuing Education
Daniel Nuss MD	10/5/2023	\$1,223.80	Meals & Recruitment
George Karam MD	10/5/2023	\$1,351.95	Meals & Recruitment
Harshvardhan Chawla	10/5/2023	\$1,213.55	Travel & Continuing Education
Jennifer Lentz	10/5/2023	\$2,651.31	Meals & Recruitment
Karen Bruggers	10/5/2023	\$1,224.00	Travel & Continuing Education
Katherine Diodene	10/5/2023	\$3,443.49	Travel & Continuing Education
Lisa Peacock MD	10/5/2023	\$1,755.79	Meals & Recruitment
Matan Ozery MD	10/5/2023	\$1,405.35	Travel & Continuing Education
John Wells MD	10/9/2023	\$2,496.87	Travel & Continuing Education
Rajesh Mohandas MD	10/9/2023	\$1,328.04	Meals & Recruitment
Melanie Lane	10/12/2023	\$5,307.16	Travel & Continuing Education
Adriana Wilson	10/17/2023	\$2,600.00	Travel & Continuing Education
Cathy Torres	10/23/2023	\$3,413.76	Travel & Continuing Education
AAOS	10/26/2023	\$1,098.00	Professional Dues for Vinod Dasa, MD
Adam Haydel	10/26/2023	\$1,300.00	Professional Dues & Licenses
Anna Cohen Rosenblum MD	10/26/2023	\$2,307.61	Travel & Continuing Education
Karen Bruggers	10/26/2023	\$1,250.00	Professional Dues & Licenses
Karen Curry	10/26/2023	\$2,406.62	Academic Supplies & Materials
La'Nasha Tanner MD	10/26/2023	\$1,645.90	Travel & Continuing Education
Micelle Haydel MD	10/26/2023	\$4,840.00	Travel & Continuing Education
Stephen Brisco	10/26/2023	\$1,690.24	Travel & Continuing Education
Sven Oertel	10/26/2023	\$2,082.20	Travel & Continuing Education
Augusto Ochoa MD	10/27/2023	\$3,851.29	Travel & Continuing Ed
George S Ellis Jr., MD	11/1/2023	\$1,034.31	Meals & Recruitment
John Hutchings MD	11/1/2023	\$1,583.71	Travel & Continuing Education
Lisa Peacock MD	11/1/2023	\$3,160.41	Travel & Continuing Education
Michelle Loch	11/1/2023	\$1,372.31	Travel & Continuing Education
Zachary S Selzler MD	11/1/2023	\$1,275.48	Travel & Continuing Education
Branson Cambre	11/6/2023	\$1,488.18	Travel & Continuing Education

Appendix: Affiliated Entities Reimbursement Details

Affiliate: LSU Health Foundation - New Orleans

Payee Name	Payment Date	Amount	Purpose
Claude D'Antonio MD	11/6/2023	\$3,000.00	Travel & Continuing Education
Eric Rowley MD	11/6/2023	\$2,943.07	Travel & Continuing Education
Georgios Kogias	11/6/2023	\$2,952.31	Travel & Continuing Education
Michelle Tran	11/6/2023	\$1,410.34	Meals & Recruitment
Robert Zura MD	11/6/2023	\$2,115.81	Travel & Continuing Education
Sterling Roberts	11/6/2023	\$2,176.22	Travel & Continuing Education
Steven Durham	11/6/2023	\$3,171.25	Travel & Continuing Education
Vinod Dasa MD	11/6/2023	\$1,895.14	Travel & Continuing Education
Amelia Jernigan MD	11/10/2023	\$1,442.42	Academic Supplies & Materials
Amir Nejat	11/10/2023	\$3,172.00	Travel & Continuing Education
Daniel Nuss MD	11/10/2023	\$4,578.52	Meals & Recruitment
Michelle Loch	11/10/2023	\$3,054.31	Travel & Continuing Education
Thomas Reske MD	11/10/2023	\$1,191.42	Travel & Continuing Education
Marcy Navarre	11/14/2023	\$2,040.95	Travel & Continuing Ed
Shannon Alwood MD	11/14/2023	\$7,903.24	Travel & Continuing Ed
Terrell Caffery MD	11/14/2023	\$2,687.73	Travel & Continuing Ed
Claudia Cavallino	11/15/2023	\$3,294.13	Meals & Recruitment
Georgios Kogias	11/15/2023	\$1,662.09	Travel & Continuing Education
Jorge Palavicini	11/15/2023	\$3,291.53	Travel & Continuing Education
Kasha Bornstein MD	11/15/2023	\$1,197.58	Travel & Continuing Education
Kyle Happel	11/15/2023	\$4,737.76	Travel & Continuing Education
Aravinda Rao MD	11/21/2023	\$1,052.67	Meals & Recruitment
Patricia Molina MD	11/21/2023	\$1,121.81	Meals & Recruitment
Paul Phillips MD	11/21/2023	\$3,818.35	Travel & Continuing Ed
Tyler Theriot	11/21/2023	\$1,250.00	Meals & Recruitment
Kelli McMichael Gerkin	11/22/2023	\$4,151.65	Travel & Continuing Ed
Malachi Sheahan MD	11/22/2023	\$3,618.78	Meals & Recruitment
Valentine Nfonsam MD	11/22/2023	\$4,111.07	Travel & Continuing Ed
Angela Amedee	11/29/2023	\$2,259.42	Meals & Recruitment
David Otohinoyi	11/29/2023	\$1,056.35	Travel & Continuing Education
National Association of Epilepsy Center	11/29/2023	\$2,000.00	Dr. Piotr Olejniczak - Membership Dues 2024

Appendix: Affiliated Entities Reimbursement Details

Affiliate: LSU Health Foundation - New Orleans

Payee Name	Payment Date	Amount	Purpose
Richard DiCarlo MD	11/29/2023	\$2,268.39	Travel & Continuing Education
Tara Korbal	11/29/2023	\$2,253.73	Travel & Continuing Education
AOA	12/4/2023	\$1,170.00	Professional Dues & Licenses - Vinod Dasa MD
LDA	12/4/2023	\$1,187.00	Professional Dues - ADA #172930135 - Dr. Toby J Chermie
Rana Almudamgha	12/4/2023	\$1,223.00	Professional Dues & Licenses
Scott Laura MD	12/4/2023	\$4,030.00	Travel & Continuing Education
Andrew Pellett	12/6/2023	\$1,082.91	
Peter Krause MD	12/6/2023	\$2,231.95	Travel & Continuing Ed
Valentine Nfonsam MD	12/6/2023	\$1,170.65	Travel & Continuing Ed
Alex Ehrlich	12/8/2023	\$1,187.00	Professional Dues & Licenses
Association of University Professors of Neurolo	12/8/2023	\$1,050.00	Professional Dues - Dr. John D. England
Katelynn Donnelly	12/8/2023	\$1,533.00	Travel & Continuing Education
LDA	12/8/2023	\$1,187.00	Professional Dues for ADA #172860035 - Karen J. Bruggers
Michael W Hartman MD	12/8/2023	\$4,229.24	Meals & Recruitment
Ravi Rajendra MD	12/8/2023	\$1,533.00	Travel & Continuing Education
Vinod Dasa MD	12/8/2023	\$1,541.36	Travel & Continuing Education
Paul Fidel	12/11/2023	\$1,587.51	Travel & Continuing Ed
Bilikisu Elewonibi	12/15/2023	\$1,041.30	Meals & Recruitment
Demetrius Porche	12/15/2023	\$1,717.32	Meals & Recruitment
Jeffrey James	12/15/2023	\$5,290.86	Meals & Recruitment
Lauren Saunee	12/15/2023	\$1,533.00	Travel & Continuing Education
LDA	12/15/2023	\$1,187.00	Professional Dues for ADA #172840962 - Mark A Odom
LDA	12/15/2023	\$1,187.00	Professional Dues for ADA #172870323 - Albert F McMullen III
Louisiana State University	12/15/2023	\$6,572.50	Continuing Education - Melanie Lane
Patricia Molina MD	12/15/2023	\$2,165.63	Travel & Continuing Education
Stephen Brisco	12/15/2023	\$1,943.75	Travel & Continuing Education
Christopher Haas MD	12/20/2023	\$1,833.00	Travel & Continuing Education
Elaine Hicks	12/20/2023	\$4,000.37	Travel & Continuing Education
Jayne Weiss MD	12/20/2023	\$8,026.36	Travel & Continuing Education
Kelli McMichael Gerkin	12/20/2023	\$3,500.06	Travel & Continuing Education
Patricia Molina MD	12/20/2023	\$3,601.87	Travel & Continuing Education

Appendix: Affiliated Entities Reimbursement Details

Affiliate: LSU Health Foundation - New Orleans

Payee Name	Payment Date	Amount	Purpose
Peter Yager MD	12/20/2023	\$1,533.00	Travel & Continuing Education
Stephen Lindsey	12/20/2023	\$2,025.73	Travel & Continuing Education
Tina Gunaldo	12/20/2023	\$1,499.33	Travel & Continuing Education
		<hr/>	
		\$228,123.12	

Appendix: Affiliated Entities Reimbursement Details

Affiliate: LSU Health Sciences Foundation - Shreveport

Payee Name	Payment Date	Amount	Purpose
Shristi Lamichhane, MD	10/4/2023	\$1,568.00	Travel & CME
Karina Sulaiman	10/18/2023	\$1,200.00	Meals & Lecture Expense
Martin Sapp	10/18/2023	\$2,470.20	Travel & CME
Yuping Wang	10/18/2023	\$3,470.60	Travel & CME
Meenakshi Sindhuri Nali, MD	10/26/2023	\$1,014.96	Travel & CME
Richard Shane Barton	10/26/2023	\$20,970.00	Travel & CME
D. David Kim	11/8/2023	\$3,487.87	Meals & Lecture Expense
Dani G. Zoorob, MD	11/16/2023	\$4,157.08	Travel & CME
David F Lewis	11/16/2023	\$1,176.40	Travel & CME
Ron Nierman	11/16/2023	\$4,185.27	Supplies & Equipment
Caitlin Busada	11/29/2023	\$3,651.68	Travel & CME
Dani G. Zoorob, MD	11/29/2023	\$1,576.17	Supplies & Equipment
Dani G. Zoorob, MD	11/29/2023	\$4,379.54	Travel & CME
Michael Yim, MD	11/29/2023	\$1,090.00	Dues/Fees
Alexander Gomelsky	12/13/2023	\$1,057.23	Meals & Lecture Expense
Shilpa Patil, MD	12/13/2023	\$1,074.47	Travel & CME
D. David Kim	12/20/2023	\$7,035.85	Meals & Lecture Expense
Karen Stokes	12/20/2023	\$1,447.46	Meals & Lecture Expense
Coleman McFerrin	12/29/2023	\$1,000.00	Travel & CME
Mario Lobao, MD	12/29/2023	\$3,175.76	Travel & CME
Richard Harrell, MD	12/29/2023	\$1,654.06	Travel & CME
Robert Walter, MD	12/29/2023	\$6,300.00	Meals & Lecture Expense
Yufeng Dong	12/29/2023	\$1,243.95	Travel & CME
		<hr/>	
		\$78,386.55	

Affiliate: LSU Research Foundation

Payee Name	Payment Date	Amount	Purpose
Elahe Russell	10/20/2023	\$8,542.52	Fringe
Elahe Russell	11/10/2023	\$4,271.26	Salary
Elahe Russell	12/4/2023	\$4,067.76	Salary
		<hr/>	
		\$16,881.54	

Appendix: Affiliated Entities Reimbursement Details

Affiliate: LSUA Foundation

Payee Name	Payment Date	Amount	Purpose
Sona Kumar	10/31/2023	\$3,596.24	2023 AACC Annual Scientific Meeting
Melissa Laborde	10/31/2023	\$1,266.70	2023 Southern Public Relation Federation Conf.
Chase Dyess	10/31/2023	\$3,561.15	Salary Support
Eric Alai	10/31/2023	\$1,333.33	Professorship Stipend
Randall Dupont	10/31/2023	\$7,886.68	State Portion Chair Salary July-October 23
Randall Dupont	10/31/2023	\$3,780.00	Private Portion Chair Salary July-October 23
Patrick Hunter	10/31/2023	\$3,888.89	Professorship Stipend
Beverly Alwell	10/31/2023	\$9,251.53	Salary Support
Paul Coreil & Liz Beard	11/21/2023	\$1,449.00	Washington Mardi Gras Tickets
Emily Weeks	11/30/2023	\$1,916.33	Supplies for Professorship
Mackenzie Tulak	11/30/2023	\$3,894.38	2023 Komazawa University Culture Program
Chase Dyess	11/30/2023	\$3,561.15	Salary Support
Eric Alai	11/30/2023	\$1,333.33	Professorship Stipend
Randall Dupont	11/30/2023	\$1,971.67	State Portion Chair Salary November 23
Randall Dupont	11/30/2023	\$945.00	Private Portion Chair Salary November 23
Patrick Hunter	11/30/2023	\$3,888.89	Professorship Stipend
Beverly Alwell	11/30/2023	\$9,251.53	Salary Support
Holly Wilson	12/19/2023	\$1,042.42	American Philosophical Conference
Jessica Thacker	12/19/2023	\$1,154.55	Southern Criminal Justice Conference
Eamon Halpin	12/31/2023	\$1,222.91	SEPSEA Conference
Chase Dyess	12/31/2023	\$3,561.15	Salary Support
Eric Alai	12/31/2023	\$1,333.33	Professorship Stipend
Randall Dupont	12/31/2023	\$1,971.67	State Portion Chair Salary December 23
Randall Dupont	12/31/2023	\$945.00	Private Portion Chair Salary December 23
Patrick Hunter	12/31/2023	\$3,888.89	Professorship Stipend
Beverly Alwell	12/31/2023	\$9,251.53	Salary Support

\$87,147.25

Appendix: Affiliated Entities Reimbursement Details

Affiliate: LSUS Foundation

Payee Name	Payment Date	Amount	Purpose
Dr. Binshan Lin	10/04/2023	\$ 1,072.94	Attending DSI 2023 Annual Conference
Urska Cvek	10/23/2023	\$ 1,896.41	Reimbursement for travel to conference in July, 2023
Laura Perdue	11/16/2023	\$ 1,000.00	Reimbursement for Mentor for Cohort Grant from Beaird Foundation
		<hr/>	
		\$ 3,969.35	

**Affiliate: Pennington
Biomedical Research
Foundation**

Payee Name	Payment Date	Amount	Purpose
Peter Katzmarzyk	10/9/2023	\$2,476.41	Travel Expenses for meetings/conferences
Aubrey Windham	11/16/2023	\$1,151.68	Travel Expenses for meetings/conferences
		<hr/>	
		\$3,628.09	

Appendix: Affiliated Entities Reimbursement Details

Affiliate: TAF

Payee Name	Payment Date	Amount	Purpose
KATIE COPELAND	10/19/2023	\$737.27	Superior Grill: Staff "village" dinner
KATIE COPELAND	10/19/2023	\$788.65	Sam's, LA Nursery: Tailgate supplies
KATIE COPELAND	10/19/2023	\$1,276.45	Barnes & Noble, Bengals & Bandits: Items for team & recruiting photoshoots
KATIE COPELAND	10/19/2023	\$215.81	Albertson's: Team retreat snacks
KATIE COPELAND	10/19/2023	\$3,026.73	Orange Beach team bonding trip expenses
QUINLAN DUHON	10/19/2023	\$5,103.30	Team retreat expenses
BUNNIE RENE' CANNON	10/21/2023	\$2,568.00	Crystal football - auction item for Tigerama
UNIVERSITY CLUB	10/24/2023	\$2,038.50	Membership dues for Danny Bryan and Taylor Fogleman during the months of Oct.-Dec. 2023
UNIVERSITY CLUB	10/24/2023	\$1,019.25	Membership dues for Rick Bishop during the months of Oct.-Dec. 2023
UNIVERSITY CLUB	10/24/2023	\$1,019.25	Membership dues for Sian Hudson during the months of Oct.-Dec. 2023
UNIVERSITY CLUB	10/24/2023	\$1,019.25	Membership dues for Matt McMahan during the months of Oct.-Dec. 2023
UNIVERSITY CLUB	10/24/2023	\$2,038.50	Membership dues for Dan Gaston and Andy Barker during the months of Oct.-Dec. 2023
UNIVERSITY CLUB	10/24/2023	\$2,038.50	Membership dues for Jay Clark and D-D Breaux during the months of Oct.-Dec. 2023
UNIVERSITY CLUB	10/24/2023	\$1,019.25	Membership dues for Russell Brock during the months of Oct.-Dec. 2023
UNIVERSITY CLUB	10/24/2023	\$940.08	Membership dues for Paul Mainieri during the months of Oct.-Dec. 2023
UNIVERSITY CLUB	10/24/2023	\$4,077.00	months of Oct.-Dec. 2023
UNIVERSITY CLUB	10/24/2023	\$7,801.30	TAF Logo Titleist Range Ball
KARA DUPLANTIER	10/31/2023	\$7,000.00	Administrator for 2023 Tigerama event
ROB DOWIE	10/31/2023	\$5,000.00	Tigerama coordinator service fee
KATIE COPELAND	11/7/2023	\$5,107.87	Fall Alumni Weekend expenses
UNIVERSITY CLUB	11/16/2023	\$2,359.81	October 2023 TAF dues & green fees
UNIVERSITY CLUB	11/16/2023	\$7,784.28	TAF President's Cup
			Reimburse for Baton Rouge Country Club August-October 2023 dues for Scott Woodward per
SCOTT WOODWARD	11/30/2023	\$2,758.95	section 5.A of his employment contract
STUART BREZINSKI	12/11/2023	\$1,600.00	Video editing of LSU Band concerts
KATIE COPELAND	12/15/2023	\$727.20	Superior Grill: Staff "village" dinner
KATIE COPELAND	12/15/2023	\$455.56	Hobby Lobby: holiday items for practice facility
BUNNIE RENE' CANNON	12/22/2023	\$14,124.00	6 Swarovski and Precosia Crystal Basketballs for the Women's Basketball locker room
UNIVERSITY CLUB	12/22/2023	\$2,509.80	November TAF dues & green fees w/cart kits
* KATIE COPELAND	1/3/2024	\$2,242.98	Nike: Slippers for team & managers
* KATIE COPELAND	1/3/2024	\$3,115.51	Staff Christmas party & door prizes
* KATIE COPELAND	1/4/2024	\$1,409.83	"Dinner on the Deck" - silent auction prize
* UNIVERSITY CLUB	1/17/2024	\$2,419.97	December TAF dues; cart/green fees
		\$95,342.85	

* Reported in Q2 but paid in Q3

**Report to LSU Board of Supervisors:
All Campuses Last 3 Years**

Approval of Requests for Timber Sales

Updated April 5, 2024

2023-2024							
Campus	Location	Parish	Acreage	Payment	Designated Timber to be Removed:	Approved by	Approval Date
AgCenter	Bob R. Jones Idlewild Research Station	East Feliciana	2 sites: 52 acres & 40 acres	about \$65,000	Pine saw timber, pine pulpwood, hardwood saw timber and hardwood pulpwood.	Matt Lee, VP of Agriculture & Asst VP Patrick Martin Real Estate	6/15/2023
AgCenter	Bob R. Jones Idlewild Research Station	East Feliciana	90 acres	\$ 55,000	Clear-cut three acres	William F. Tate	11/3/2023
2022-2023							
Campus	Location	Parish	Acreage	Payment	Designated Timber to be Removed:	Approved by	Approval Date
2021-2022							
Campus	Location	Parish	Acreage	Payment	Designated Timber to be Removed:	Approved by	Approval Date

**Report to LSU Board of Supervisors:
All Campuses Last 3 Years**

Capital Improvements Projects above \$175,000

Updated April 5, 2024

2023-2024		AMOUNT APPROVED	FUNDS SOURCE	APPROVED BY	APPROVAL DATE
LSU	Digital Media Center: Generator, UPS and Cooling Backup for Servers	\$275,000	Operational Funds	Kimberly Lewis	11/17/23
	Evangeline Circle Horseshoe ADA Sidewalk & Site Improvement	\$180,000	Facility Access Fee	Kimberly Lewis	07/28/23
	Hatcher Hall: Ramp Enclosure	\$230,000	Operational Funds	Kimberly Lewis	03/27/24
	Oyster Hatchery - Hurricane Ida Repairs, Grand Isle, LA	\$250,000	Other Funds	Kimberly Lewis	01/16/24
	Peabody Renovations Suites 111, 113, 114, 223	\$200,000	Operational Funds	Kimberly Lewis	11/17/23
	Student Union: Chiller Replacement	\$740,000	Auxiliary Funds	Kimberly Lewis	02/05/24
	SVM: Main Bldg Room 1642 / 1701 Restroom Reconfiguration	\$350,000	Operational Funds	Kimberly Lewis	11/17/23
	SVM: Suite 1213 Renovations	\$800,000	Operational Funds	Kimberly Lewis	10/17/23
	Thomas Boyd Hall Suite 146 Renovation	\$335,000	Operational Funds	Kimberly Lewis	07/11/23
	Tiger Park Stadium Premium Seating Replacement	\$225,000	Auxiliary Funds	Kimberly Lewis	07/28/23
	Tiger Stadium: 3rd Floor Renovations	\$590,000	Auxiliary Funds	Kimberly Lewis	02/05/24
	U High: Elementary AHU Replacement	\$200,000	Auxiliary Funds	Kimberly Lewis	03/27/24
	UAB: Room 118 Break Room and Restroom Renovations	\$396,100	Operational Funds	Kimberly Lewis	01/16/24
	UREC: Chilled Water Heat Exchanger for Lazy River	\$195,000	Auxiliary Funds	Kimberly Lewis	01/16/24
	Total LSU	\$4,966,100			
LSUA	Circle Driveway Arrival Plaza	\$201,250	Auxiliary Funds	Exec. VP Lewis	03/05/24
	Total LSUA	\$201,250			
LSUS	Administration Building Cubicle Renovations	\$452,300	Operational Funds	Exec. VP Lewis	01/09/24
	Baseball Outfield Regrading	\$180,888	Auxiliary Funds	Exec. VP Lewis	2/2/2024
	Business Education West Side Roof Replacement	\$194,120	Operational Funds	Exec. VP Lewis	09/10/23
	Total LSUS	\$194,120			
AgCenter	Generator Greenhouses	\$179,925	Self-Gen- Rice Research Foundation Board	Exec. VP Lewis	07/11/23
	Milling and Quantative Genetics Labs Renovation	\$250,000	Self-Gen- Rice Research Board	Exec. VP Lewis	07/12/23
	New Greenhouse	\$550,000	Self-Generated-Rice Foundation	Exec. VP Lewis	08/29/23
	Rice Research Station Shop Building	\$700,000	Self-Gen- Donations	Exec. VP Lewis	03/31/23
	Shop Building	\$700,000	Self-Generated-Donated	Exec. VP Lewis	09/05/23

	Wastewater Treatment Plant-Grant Walker		\$400,000	Supplement Funds for Equip. & Needed Renovations	Exec. VP Lewis	02/20/24
	Windrush Gardens Improvements Stormwater2		\$450,000	Operational Funds	Exec. VP Lewis	02/05/24
		Total HSCNO	\$3,229,925			
HSCNO	2nd-4th Floor Restroom Renovation		\$375,000	Operational Funds	Exec. VP Lewis	01/19/24
		Total LSUS	\$375,000			
TOTAL CAPITAL PROJECTS APPROVALS 2022-2023			\$8,966,395			

2022-2023			AMOUNT APPROVED	FUNDS SOURCE	APPROVED BY	APPROVAL DATE
LSU	Alex Box: Repairs & Waterproofing		\$220,000	Auxilliary Funds	Kimberly Lewis	01/30/23
	Athletic Admin Bldg: 2nd Floor Renovations		\$247,000	Auxilliary Funds	Kimberly Lewis	09/12/22
	Chemical Engineering Bldg: CO2 / Water Electrolysis Laboratory Renovation		\$862,400	Other: EDA Grant	Kimberly Lewis	01/30/23
	Chemical Engineering Building- Shop 164 Renovations		\$275,000	Engineering Excellence Fund	Exec. VP Lewis	08/02/22
	Chemical Engineering Building- Shop 164 Renovations Revised		\$785,000	Operational Funds	Exec. VP Lewis	10/10/22
	Choppin Hall Room 607 & 703 Lab Renovations		\$359,892	Operational Funds	Exec. VP Lewis	11/04/22
	Digital Media Center: Cyber Security Renovations		\$275,000	Other: LED Grant Digital Media Cetner & Virtual Projection Project	Exec. VP Lewis	11/14/22
	Digital Media Center: Cyber Security Renovations revised		\$407,000	LED-Digital Media Ctr Cyber/Virtural Production Project	Exec. VP Lewis	05/09/23
	Landscape Svcs. North Lot Parking Improvements		\$400,000	Auxilliary Funds	Exec. VP Lewis	04/26/23
	Mobility Implementation Phase 1 Union Hub		\$475,000	Auxilliary Funds	Exec. VP Lewis	12/19/22
	Nicholson Hall 4th Floor Renovations		\$207,000	Operational Funds	Exec. VP Lewis	03/13/23
	Pleasant Hall: 2nd Floor Renovations for PTS		\$576,000	Auxilliary Funds	Exec. VP Lewis	12/13/22
	SVM: Main Bldg. 2nd & 3rd Floor Back-up Unit Installation		\$330,000	Operational Funds	Exec. VP Lewis	11/03/22
	SVM: Main Bldg. AHU 3 Replacement		\$450,000	Operational Funds	Exec. VP Lewis	11/03/22
	Thomas Boyd Hall Suite 146 Renovations		\$270,000	Auxiliary Funds	Exec. VP Lewis	05/09/23
	Tiger Stadium North Stadium Sanitary Sewer Replacement		\$250,000	Auxilliary Funds	Exec. VP Lewis	04/10/23
	U-High Lab School: Boiler Replacement		\$500,000	Other: ESSER III Grant Funding	Exec. VP Lewis	12/13/22
	U-High Lab School: Football Field Turf Replacement		\$800,000	Other: ESSER III Grant	Exec. VP Lewis	10/27/22
	U-High Lab School: Replace Flooring Multiple Rooms		\$176,000	Other: ESSER Grant	Exec. VP Lewis	03/20/23
	UREC New Challenge Course 2022		\$250,000	Auxiliary Funds	Exec. VP Lewis	08/02/22
	UREC New Challenge Course 2022 Budget Change revised from \$250,000		\$499,500	Auxiliary Funds	Exec. VP Lewis	02/23/23
		Total LSU	\$8,614,792			
LSUA	Lot 7 Resurfacing		\$487,500	S-G: Restricted Fees: Parking/Lights/Sidewalk accoung.	Exec. VP Lewis	10/25/22
		Total LSUA	\$487,500			
LSUE	HVAC Air Purification Systems for Major Buildings		\$215,000	HEERF III Funding	Exec. VP Lewis	12/01/22
		Total LSUA	\$215,000			

LSUS	Baseball Artificial Turf		\$390,700	Auxilliary Funds	Exec. VP Lewis	09/28/22
	Pool Closure- budget increase from \$318,000		\$499,900	Operational Funds	Exec. VP Lewis	11/14/22
	Science Annex Building- budget increase from \$385000		\$970,000	Operational Funds	Exec. VP Lewis	01/23/23
	University Center Heating Water Boilers		\$300,000	Operational Funds	Exec. VP Lewis	06/13/22
		Total LSUS	\$2,160,600			
HSCNO	Dental Clinic HSRA Grant Space		\$879,200	Operational Funds	Exec. VP Lewis	01/23/22
	Lions Eye Center 2nd-4th Floor Restroom Renovations		\$423,000	Operational Funds	Exec. VP Lewis	02/15/23
		Total HSCNO	\$1,302,200			
TOTAL CAPITAL PROJECTS APPROVALS 2022-2023			\$11,477,892			

2021-2022		AMOUNT APPROVED	FUNDS SOURCE	APPROVED BY	APPROVAL DATE
LSU	Alex Box: Exterior Councourse Stair Repairs	\$216,000	MRA Funds	Exec. VP Lewis	05/25/22
	Chemistry & Materials Building: Room 144C Renovations	\$286,000	Restricted, Federal Grants, Contracts, Research	Interim Exec. VP Torres	01/19/22
	Child Care Center Playground Renovations	\$250,000	Other: Grant for playgrounds	Exec. VP Lewis	06/15/22
	ECA Bldg 3 & 12 Roof Repairs	\$550,000	Auxiliary Funds	Exec. VP Lewis	02/11/22
	French House Honors College Site & Landscaping Improvements Phase 1a	\$460,000	Ancillary Self Generated Revenue	Interim Exec. VP Torres	09/07/21
	Himes, Lockett and Prescott-1st Floor Restrooms Modifications for ADA Compliance	\$360,000	Facility Access Fee-Auxiliary Self Gen Funds	Interim Exec. VP Torres	10/06/21
	Johnston Hall 2nd-3rd Floor SW Wing Renovation	\$198,000	Other: Indirect Cost Allocation	Exec. VP Lewis	05/10/22
	Life Sciences Building-Room 613 Lab Renovations	\$260,000	Operational Funds	Interim Exec. VP Torres	12/01/21
	Life Sciences Building-Rooms 512 & 515 Lab Renovations	\$225,000	Operational Funds	Interim Exec. VP Torres	01/19/22
	PERTT Electrical Improvements, Phase 2	\$280,000	Auxiliary Funds	Exec. VP Lewis	06/14/22
	Residential College: Boiler Replacement Design	\$250,000	Auxiliary Funds	Exec. VP Lewis	05/10/22
	Student Union 4th Floor Renovation for Student Affairs	\$250,000	Auxiliary Funds	Exec. VP Lewis	05/10/22
	Student Union Ballroom Renovations	\$880,000	Auxiliary Funds	Exec. VP Lewis	03/15/22
	SVM: Pharmacy Relocation to Main Lobby	\$350,000	Self-Generated	Exec. VP Lewis	02/11/22
	SVM: Rm 2536, 2538, 2538A, 2540 Lab Renovations	\$190,000	Operational Funds	Exec. VP Lewis	04/13/22
	Tiger Stadium Level 3B Structural Repairs	\$455,000	Auxiliary Funds	Interim Exec. VP Torres	01/19/22
	WCA Bldg 5: Roof Repairs	\$245,000	Auxiliary Funds	Exec. VP Lewis	02/11/22
	Total LSU	\$5,705,000			
LSUA	HVAC UVC Additions	\$226,500	CARES Act Funding	Interim Exec. VP Torres	01/22/22
	Room UVC Additions	\$200,000	CARES Act Funding	Interim Exec. VP Torres	01/23/22
	Room UVC Additions Budget Increase	\$90,000	CARES Act Funding	Exec. VP Lewis	04/21/22
	Total LSUA	\$516,500			
LSUE	Health Technology Building Gas System Upgrade/Lab Reno	\$187,000	CARES Act Funding	Exec. VP Lewis	\$44,694
	Plumbing Fixture Upgrade	\$268,920	CARES Act Funding	Interim Exec. VP Torres	11/01/21
	Total LSUE	\$455,920			

LSUS	Bronson Hall Elevator Equipment & cab Upgrades		\$290,000	Operational Funds	Interim Exec. VP Torres	07/26/21
	HPE Building Equipment Pavilion Climate Chamber budget <i>additional funds added to original \$203,000</i>		\$92,000	Operational Funds	Interim Exec. VP Torres	07/05/21
	New Science Building Annex		\$385,000	Operational Funds	Exec. VP Lewis	05/13/22
	Pool Closure		\$318,000	Operational Funds	Exec. VP Lewis	02/22/22
		Total LSUS	\$1,085,000			
HSCNO	Allied Health/School of Nursing (AHSON) 3rd Fl. Coffee Kiosk		\$175,000	Operational Funds	Exec. VP Lewis	05/24/22
	Lions Eye Center 1st Floor Restrooms		\$450,000	Operational Funds	Exec. VP Lewis	05/24/22
	Medical Education Building (MEB) 4th Fl. Restrooms		\$278,000	Operational Funds	Exec. VP Lewis	05/24/22
		Total HSCNO	\$903,000			
TOTAL CAPITAL PROJECTS APPROVALS 2021-2022			\$8,665,420			

**Report to LSU Board of Supervisors:
All Campuses Last 3 Years**

Design Contracts

Updated April 5, 2024

2023-2024		Designer Fee	Reimbursables or other fees	Revised Total	Designer	Approved by	Approval Date
LSU A&M	Athletic Admin Bldg: 504A IT Room Renovations	\$20,270	\$1,000	\$21,270	Eyre Engineers LLC	AVP Mahaffey	02/07/24
	Engineering Construction Management Building: Program	\$22,500	\$1,200	\$23,700	Coleman Partners Architects	AVP Mahaffey	07/05/23
	Innovation Park: Master Planning and Drainage Development	\$107,500	\$1,000	\$108,500	CSRS, Inc.	AVP Mahaffey	09/05/23
	PERTT Equipment Yard: CO2 Wellbore and Flow Loop Installation	\$42,662	\$120	\$42,782	Forte and Tablada	AVP Mahaffey	09/01/23
	SVM: Clinical Skills Teaching Center	\$30,000		\$30,000	Tipton Associates APAC	Danny Mahaffey	12/08/23
	SVM: Equine Institute Concept Presentation	\$22,000		\$22,000	Tipton Associates APAC	AVP Mahaffey	09/05/23
	SVM: Grant Application For DLAM Vivarium Lab Expansion - 2024	\$32,500		\$32,500	Clark & Enerson Inc.	Danny Mahaffey	12/08/23
	SVM: Main Bldg Room 1642 / 1701 Restroom Reconfiguration	\$33,941	\$6,480	\$40,421	Hoffpauir Studio LLC	Danny Mahaffey	12/08/23
	SVM: Wildlife Hospital	\$24,000		\$24,000	Tipton Associates APAC	Danny Mahaffey	12/08/23
	Tiger Stadium: 3rd Floor Renovations	\$13,185	\$1,000	\$14,185	Eyre Engineers LLC	Danny Mahaffey	01/29/24
	U High: Athletic Facilities Addition	\$16,000		\$16,000	Tipton Associates APAC	Danny Mahaffey	01/04/24
	UAB: Room 118 Break Room and Restroom Renovations	\$28,421	\$2,920	\$31,341	Williams Architecture LLC	Danny Mahaffey	12/07/23
	UREC: Chilled Water Heat Exchanger for Lazy River	\$19,974	\$1,000	\$20,974	Eyre Engineers LLC	Danny Mahaffey	12/08/23
Subtotal	\$412,953	\$14,720	\$427,673				
LSU A&M	Elevator Returbishment, Life Science Building	58,221.00		\$58,221	GD Architecture, LLC	Architect Selection Bd.	03/20/24
	Exterior Repairs, Julian White Hall	420,202.00		\$420,202	NANO	Architect Selection Bd.	12/05/23
	Lab Ventilation and Fume Hood Replacement, ECE Building	121,440.00		\$121,440	Salas O'Brien	Architect Selection Bd.	07/12/23
	LSU Library Learning Commons	1,031,245.00		\$1,031,245	Coleman Partners & EskewDumezKipple	Architect Selection Bd.	11/15/23
	Military and Security Sciences	766,499.00		\$766,499	Coleman Partners Architects, LLC	Architect Selection Bd.	09/20/23
	Roof Replacement Ag Metal Building	39,585.00		\$39,585	Plus One, LLC	Architect Selection Bd.	09/20/23
	Strategic Capital Plan-DM for Infrastructure, Renovations, and Streets	501,904.00		\$501,904	Forte & Tablada	Architect Selection Bd.	01/10/24
	Vet Med Facilities Repairs, Chiller Replacement	129,114.00		\$129,114	Assaf, Simoneaux Tauzin	Architect Selection Bd.	01/10/24
	Vet Med Facilities Repairs/Addition, BSL3 Lab Renovations -3rd Fl Main Bldg and LADDL	254,374.00		\$254,374	Hoffpauir Studio	Architect Selection Bd.	12/05/23
	Subtotal	\$3,322,584	\$0	\$3,322,584			
Total LSU A&M	\$3,735,537	\$14,720	\$3,750,257				
HSCNO	Cup Chilled Water Heat Exchanger Replacement	\$46,711		\$46,711	Huseman and Associates	AVP Mahaffey	11/07/23
	Lions Eye Center 2nd, 3rd, 4th Fl. Women's Restrooms Renovations	\$10,000		\$10,000	Mathes Brierre - a Joint Project	AVP Mahaffey	11/03/23
	Lions Eye Center 2nd, 3rd, 4th Fl. Women's Restrooms Renovations	\$14,250		\$14,250	GVA Engineering, LLC- a Joint Project	AVP Mahaffey	11/03/23
	MEB 1st Floor Environmental Health & Safety Office Relocation	\$23,660		\$23,660	GVA Engineering, LLC	AVP Mahaffey	08/07/23
Subtotal	\$94,621	\$0	\$94,621				
HSCNO	Replacement of Air Handling Units, M.L. Trail Clinical Science Research Building	\$61,278	\$61,278	\$122,556	GVA Engineering, LLC	Architecture Selection Bd	07/12/23
	Facility Renovations Dental School	\$3,115,999		\$3,115,999	Mathes Brierre Architects + Blich Knevel Architects	Architecture Selection Bd	09/20/23
	CALS Bridge Connection-CALS Infrastructure & Equipment	\$199,048		\$199,048	Sizeler Thompson Brown Architects	Architecture Selection Bd	12/05/23
	Data Center	143,108.00		\$143,108	SCNZ Architects, LLC	Architecture Selection Bd	09/20/23
Subtotal	\$3,519,433	\$61,278	\$3,580,711				
Total HSCNO	\$3,614,054	\$61,278	\$3,675,332				
LSUA	Downtown Health Education Services Center	\$1,998,970		\$1,998,970	Ashe Broussard + Tipton	Architecture Selection Bd	11/15/23
	Subtotal	\$1,998,970	\$0	\$1,998,970			
LSUE	STEAM Innovation Center Phase I	\$566,860	\$0	\$566,860	Washer Hill Lipscomp	Architecture Selection Bd	01/25/24
	Total PBRC	\$566,860	\$0	\$566,860			
LSUS	Pilots Point Student Apartments-Replace Water Heaters	\$26,630		\$26,630	John J. Guth Associates	AVP Mahaffey	02/26/24
	Administration Building Renovation to Accounting Offices	\$52,864		\$52,864	Sutton Beebe Babin Architects, LLC	AVP Mahaffey	01/03/24
	Business Education West Side Roof Replacement	\$22,606		\$22,606	McNew Architecture	AVP Mahaffey	09/14/23
Total LSUS	\$102,100	\$0	\$102,100				
PBRC	Basic Science Building L Reroofing	\$57,567	\$0	\$57,567	Cockfield Jackson	Architecture Selection Bd	12/05/24
	Total PBRC	\$57,567	\$0	\$57,567			
Total All 2023-2024	\$10,075,088	\$75,998	\$10,151,086				

**Report to LSU Board of Supervisors:
All Campuses Last 3 Years**

Design Contracts

Updated April 5, 2024

2022-2023		Designer Fee	Reimbursables or other fees	Revised Total	Designer	Approved by	Approval Date
LSU A&M	Alex Box: Exterior Concourse Stair Repairs	\$15,500	\$500	\$16,000	Grace Hebert Curtis Architects LLC	AVP Mahaffey	10/03/22
	Bernie Moore: Structural Preventative Maintenance	\$13,711	\$1,000	\$14,711	Wardlaw Lasseigne & LeBouef, LLC	AVP Mahaffey	11/03/22
	Chemistry & Materials Bldg: Room 168 Renovations	\$15,189	\$1,000	\$16,189	Bradley Blewster & Associates	AVP Mahaffey	10/07/22
	Choppin Hall: Room 607 and 703 Lab Renovations	\$40,845	\$13,450	\$54,295	Mougeot Architecture	AVP Mahaffey	10/31/22
	College of Science: Masterplan Study Update 2023	\$31,500	\$0	\$31,500	Holly & Smith Architects	AVP Mahaffey	01/23/23
	Digital Media Center: Cyber Security Renovations	\$25,800	\$0	\$25,800	Coleman Partners Architects	AVP Mahaffey	11/10/22
	Howe Russell Kniffen: Building System and Infrastructure Study	\$16,500	\$0	\$16,500	Holly & Smith Architects	AVP Mahaffey	11/14/22
	Mobility Implementation Phase 1 - Union Hub	59,200.00	\$0	\$59,200	CARBO Landscape Architecture	AVP Mahaffey	12/12/22
	ORED: Master Planning Study 2023	62,500.00	\$0	\$62,500	Facility Programming LTD	AVP Mahaffey	03/07/23
	SVM: Grant Application For DLAM Vivarium Lab Expansion - 2023	35,000.00	\$0	\$35,000	Washer Hill Lipscomb Cabaniss Arch. LA LLC	AVP Mahaffey	02/20/23
	SVM: Master Plan Update 2022	227,200.00	\$0	\$227,200	Dober Lidsky Mathey	AVP Mahaffey	10/03/22
	Subtotal	\$542,945	\$15,950	\$558,895			
LSU A&M	Knapp Hall: Clay Tile Roof Replacement (DM)	61,912.00	\$0	\$61,912	Holden Architects	Architect Selection Bd.	01/18/23
	Nicholson Hall: Roof Replacement (DM)	47,664.00	\$0	\$47,664	Fusion Architects	Architect Selection Bd.	01/18/23
	Elevator Repairs and Code Upgrades, Hebert Law Center East Annex	41,228.00	\$0	\$41,228	King Consulting Engineering, LLC + Albert Architecture & Urban Design APLLC	Architect Selection Bd.	01/18/23
	Prescott Hall: HVAC Repairs and Upgrades (DM)	56,039.00	\$0	\$56,039	Henry C Eyre Consulting Engineers	Engineer Selection Bd.	01/11/23
	Streetscape Repairs, Powerfouse Lane to North Stadium	150,069.00	\$0	\$150,069	Duplantis Design Group, PC	Engineer Selection Bd.	01/11/23
	SVM Auditorium, Restroom and Lab Renovations	\$287,538	\$0	\$287,538	Bradley-Blewster & Associates	Architect Selection Bd.	07/20/22
	SVM Junior Surgery Renovations	\$328,413	\$0	\$328,413	Hoffpauir Studio LLC	Architect Selection Bd.	07/20/22
	U High: High School Clay Tile Roof Replacement (DM)	59,728.00	\$0	\$59,728	Post Architects LLC	Architect Selection Bd.	01/18/23
	Subtotal	\$1,032,591	\$0	\$1,032,591			
	Total LSU A&M	\$1,575,536	\$15,950	\$1,591,486			
AgCenter	Food Innovation Center	\$187,785	\$0	\$187,785	BBI Architects	Architect Selection Bd.	01/18/23
	Total AgCenter	\$187,785	\$0	\$187,785			
HSCNO	Lions Eye CenterWest Restrooms Renovations- 2nd, 3rd, 4th Floors	\$24,250	\$0	\$24,250	Mathes Brierre Architects	AVP Mahaffey	02/15/23
	Total HSCNO	\$24,250	\$0	\$24,250			
LSUE	New Baseball Stadium Athletic Complex Facility	\$699,071	\$0	\$699,071	RHH Architects, APAC	Architecture Selection Bd	09/21/22
	Total LSUE	\$699,071	\$0	\$699,071			
LSUS	Baseball Infield Turf Conversion	\$36,693	\$0	\$36,693	Simpson Sports Engineering, LLC	AVP Mahaffey	08/30/22
	Baseball Outfield Re-Grading	\$13,800	\$0	\$13,800	Nixon Engineering Solutions	AVP Mahaffey	03/08/23
	Student Success Center Advising Area Renovation	\$19,500	\$0	\$19,500	Prevot Design	AVP Mahaffey	05/02/23
	Business Engagement Center	\$45,156	\$0	\$45,156	Sutton, Beebe Babin Architects, LLC	AVP Mahaffey	12/13/22
	Subtotal LSUS	\$115,149	\$0	\$115,149			
LSUS	Science Building Research Annex	\$35,579	\$0	\$35,579	Sutton Beebe Babin Architects, LLC	Architecture Selection Bd	11/16/22
LSUS	Boiler Installation Renovation Business Administration & Education Building and Bronson Hall	\$56,256	\$0	\$56,256	Aillet, Fenner, Jolly & McClelland, Inc.	Architecture Selection Bd	04/14/23
	Subtotal LSUS	\$35,579	\$0	\$35,579			
	Total LSUS						
	Total All 2022-2023						

**Report to LSU Board of Supervisors:
All Campuses Last 3 Years**

Design Contracts

Updated April 5, 2024

2021-2022 Design Contracts		Designer Fee	Reimbursables or other fees	Revised Total	Designer	Approved by	Approval Date
LSU A&M	Chemistry & Materials Bldg Room 144C Renovations	\$31,765	\$1,000	\$32,765	Bradley-Blewster & Associates	AVP Mahaffey	02/02/22
	College of Science Masterplan Study Update 2021 Planning Study	\$74,650	\$0	\$74,650	Coleman Partners Architects	AVP Mahaffey	11/03/21
	Foster Hall Basement, Frst, Second Floor Renovations 2022	\$31,765	\$0	\$31,765	Bradley-Blewster & Associates	AVP Mahaffey	02/02/22
	French House Honors College Site & Landscaping Improvements Phase 1a	\$37,800	\$18,315	\$56,115	CARBO Landscape Architecture	AVP Mahaffey	08/27/21
	Himes, Lockett & Prescott: 1st Floor Restrooms Modifications for ADA Compliance	\$39,165	\$7,000	\$46,165	GD Architecture LLC	AVP Mahaffey	10/29/21
	John P. Laborde Energy Law Center Renovations	\$34,409	\$1,500	\$35,909	Tipton Associates APAC	AVP Mahaffey	08/13/21
	Johnston Hall 2nd & 3rd Floor SW Wing Renovations	\$14,000	\$4,000	\$18,000	Tipton Associates APAC	AVP Mahaffey	05/10/22
	Lab School STEAM K-12 Education Outreach Center Planning Study	\$24,500	\$0	\$24,500	Tipton Associates APAC	AVP Mahaffey	03/29/22
	Music Building: Hurricane Ida Roof Repair	\$18,600	\$5,000	\$23,600	Coleman Partners Architects	AVP Mahaffey	11/03/21
	Nelson Memorial Bldg. Renovations	\$25,813	\$23,780	\$49,593	Didier Architecture	AVP Mahaffey	04/18/22
	Residential College Boiler Replacement	\$15,500	\$0	\$15,500	IMC Consulting Engineers	AVP Mahaffey	05/09/22
	Student Union Ballroom Renovations	\$77,935	\$26,840	\$104,775	NANO LLC	AVP Mahaffey	03/17/22
	SVM Grant Application for DLAM Vivarium Lab Expansion Planning Study	\$17,000	\$0	\$17,000	Washer Hill Lipscomb Cabaniss Arch. LA LLC	AVP Mahaffey	03/10/22
	SVM Pharmacy Relocation to Main Lobby	\$36,513	\$2,500	\$39,013	Tipton Associates APAC	AVP Mahaffey	02/01/22
	Tiger Stadium Level 3B Structural Repairs	\$42,163	\$1,000	\$43,163	Wardlaw Lasseigne & LeBourf LLC	AVP Mahaffey	01/24/22
	West Canal Gas Piping Relocation	\$22,208	\$0	\$22,208	Infinity Engineering Consultants	AVP Mahaffey	10/19/21
	Subtotal	\$543,787	\$90,935	\$634,722			
LSU A&M	Frey UPS1 Replacement and System Upgrades	\$131,442	\$0	\$131,442	Assaf Simoneaux Tauzin & Associates (AST)	Engineer Selection Bd.	07/14/21
	Roofing Repairs and Building Waterproofing Life Sciences Annex	\$11,949	\$0	\$11,949	Post Architects, LLC	Architect Selection Bd.	05/18/22
	Campus-wide Security Lighting	\$258,958	\$0	\$258,958	Carbo Landscape Architecture	Landscape Arch. Select. Bd.	09/22/21
	SCP-Deferred Maintenance for Infrastructure, Renovation and Streets	\$529,436	\$0	\$529,436	Remson Haley Herpin Architects APAC	Architect Selection Bd.	05/18/22
	Student Union Ballroom Renovations	\$77,935	\$26,840	\$104,775	NANO LLC	Architect Selection Bd.	05/18/22
	Student Union Roof Replacement	\$164,881	\$0	\$164,881	BE-CI, Inc. & Neal Johnson LLC, AJV	Architect Selection Bd.	01/19/22
	Subtotal	\$1,174,601	\$26,840	\$1,201,441			
	Total LSU A&M	\$1,718,388	\$117,775	\$1,836,163			
HSCNO	Lions Eye Center New 1st Floor Restroom	\$22,775	\$0	\$22,775	Mathes Brierre Architects	AVP Mahaffey	04/25/21
	Medical Education Bldg. 4 Floor Restrooms Repairs	\$13,600	\$0	\$13,600	Mathes Brierre Architects	AVP Mahaffey	05/03/21
	Subtotal HSCNO	\$36,375		\$36,375			
HSCNO	Campus Storm Water Infrastructure Upgrades	231927	\$0	\$231,927	CSRS, LLC	Engineer Selection Bd.	01/12/22
	Medical Education Bldg. Laboratory Renovations	\$926,559	\$0	\$926,559	Gould Evans + Perkins Eastman, AJV	Engineer Selection Bd.	09/15/21
	Roof Replacement Lions Eye Center	\$76,405	\$0	\$76,405	Lachin Architects, APC	Architect Selection Bd.	11/17/21
	Subtotal HSCNO	\$1,234,891	\$0	\$1,234,891			
	Total HSCNO	\$1,271,266	\$0	\$1,271,266			
HSCS	Stonewall Facility Renovations & Additions	\$78,714	\$0	\$78,714	Prevot Design Services, APAC	Architect Selection Bd.	07/21/21
	Renovation of Gross Anatomy Lab	\$98,313	\$0	\$98,313	Aillet, Fenner, Jolly & McClelland, Inc.	Architect Selection Bd.	10/13/21
	Replacement of Air Handler 1, C-Building	\$274,143	\$0	\$274,143	Aillet, Fenner, Jolly & McClelland, Inc.	Engineer Selection Bd.	04/20/22
	Comprehensive Emergency Water Supply Improvements	\$544,559	\$0	\$544,559	Prevot Design Services	Architect Selection Bd.	05/18/22
	Total HSCS	\$995,729	\$0	\$995,729			
LSUA	New Student Success Center	\$515,616	\$0	\$515,616	Ashe Broussard Weinzettle Architects	Architect Selection Bd.	11/17/21
	Total LSUA	\$515,616	\$0	\$515,616			
LSUE	Health Technology Building Medical Gas System Upgrade	\$16,800	\$0	\$16,800	WHLC Architecture	AVP Mahaffey	04/25/22
	Touchless Plumbing Fixture Project	\$26,143	\$0	\$26,143	M&E Conculting	AVP Mahaffey	10/29/21
	Total LSUE	\$42,943	\$0	\$42,943			

**Report to LSU Board of Supervisors:
All Campuses Last 3 Years**

Design Contracts

Updated April 5, 2024

2021-2022 Design Contracts		Designer Fee	Reimbursables or other fees	Revised Total	Designer	Approved by	Approval Date
LSUS	Physical Plant Office Bldg. Reroof	\$10,310	\$0	\$10,310	Sutton Beebe Babin Architects, LLC	AVP Mahaffey	09/24/21
	Science Building Research Annex	\$36,205	\$0	\$36,205	Sutton Beebe Babin Architects, LLC	AVP Mahaffey	02/11/22
	Sports Field Drainage Improvements	\$19,435	\$0	\$19,435	Nixon Eengineering Solutions	AVP Mahaffey	02/10/22
	Swimming Pool Closure	\$33,013	\$0	\$33,013	Edmonds Engineering Services	AVP Mahaffey	08/25/21
	University Center Heating Water Boiler	\$26,655	\$0	\$26,655	P+A An EMA Company	AVP Mahaffey	12/13/21
	Subtotal	\$125,618	\$0	\$125,618			
LSUS	Bldg. Exterior Walls, Technology Center & Science Bldg.	\$117,901	\$0	\$117,901	Sutton Beebe Babin Architects, LLC	Architect Selection Bd.	09/15/21
	Replacement-High-Voltage System Grid (Campuswide) Ph. 1 H&PE Bldg.	\$39,303	\$0	\$39,303	Estes, McClure & Associates, Inc.	Engineer Selection Bd.	04/20/22
	Subtotal	\$157,204	\$0	\$157,204			
	Total LSUS	\$282,822	\$0	\$282,822			
TOTAL ALL CAMPUSES 2021-2022		\$4,826,764	\$117,775	\$4,944,539			

**Report to LSU Board of Supervisors:
All Campuses Last 3 Years**

Foundation Construction Related Agreements*

**Donation to follow upon completion and acceptance of all work or as stated in the agreement*

Updated April 5, 2024

2023-2024					Estimated	Approval	
Document Type	Campus	Lessor	Lessee	Project	Cost	Date	Approved by
Lease Agreement	LSU	LSU BoS	Tiger Athletic Foundation	PMAC Women's Basketball Locker Room Upgrades	\$1,500,000	7/21/2023	Pres. William F. Tate IV
2022-2023					Estimated	Approval	
Document Type	Campus	Lessor	Lessee	Project	Cost	Date	Approved by
License for Use Agreement	LSU	LSU BoS	Tiger Athletic Foundation	Football Operations Head Coach Office 2022	\$325,000	8/30/2022	Exec. VP Lewis
Lease of Space Agreement	LSU	LSU BoS	Tiger Athletic Foundation	Football Operations Improvements for Elite Level Rehab	\$20,000,000	1/25/2023	Pres. Tate
License for Use Agreement	LSU	LSU BoS	Burden Museum and Gardens, LLC (REFF)	New Storage Building	\$699,500	1/27/2023	Exec. VP Lewis
License for Use Agreement	LSU	LSU BoS	Geology Field Camp Roof Replacement, LLC (REFF)	Geology Field Camp Roof Repairs	\$147,000	9/28/2022	Exec. VP Lewis
License for Use Agreement	LSU	LSU BoS	Geology Field Camp Roadway Repairs, LLC (REFF)	Geology Field Camp Roadway Repairs	\$30,000	9/28/2022	Exec. VP Lewis
License for Use Agreement	LSU	LSU BoS	Tiger Athletic Foundation	PMAC Statue Plaza Site Work & Installation	\$400,000	7/5/2022	Exec. VP Lewis
License for Use Agreement	LSU	LSU BoS	Tiger Athletic Foundation	Soccer Game Field Improvements-2023	\$800,000	3/6/2023	Exec. VP Lewis
License for Use Agreement	LSU	LSU BoS	Tiger Athletic Foundation	Soccer Stadium Barrier Wall 2022	\$95,000	8/30/2022	Exec. VP Lewis
2021-2022					Estimated	Approval	
Document Type	Campus	Lessor	Lessee	Project	Cost	Date	Approved by
License for Use Agreement	LSU	LSU BoS	Tiger Athletic Foundation	Athletics Administration Building Women's Basketball Office Renovation	\$750,000	6/21/2021	Int. Exec VP Torres
License for Use Agreement	LSU	LSU BoS	Tiger Athletic Foundation	Multi-Facility Instant Review Upgrades	\$265,000	12/1/2021	Int. Exec VP Torres
License for Use Agreement	LSU	LSU BoS	Tiger Athletic Foundation	PMAC Women's Basketball Training Room Renovations	\$450,000	8/5/2021	Int. Exec VP Torres
License for Use Agreement	PBRC	LSU BoS	Tiger Athletic Foundation	Tiger Stadium North Structural Repairs 2021	\$100,000	9/8/2021	Int. Exec VP Torres

**Report to LSU Board of Supervisors:
All Campuses Last 3 Years**

Grants of Mineral Rights

Updated April 5, 2024

2023-2024															
Campus that Benefits	Sale Date	State Lease #	Leased to:	Operated by	Release Date	Parish	Section, Township, Range	Acres Bid	Lease Term	Cash Bonus	Price Per Acre	Rentals/Year	Royalty	Accepted Acres	Accepted Bonus
n/a															
2022-2023															
Campus that Benefits	Sale Date	State Lease #	Leased to:	Operated by	Release Date	Parish	Section, Township, Range	Acres Bid	Lease Term	Cash Bonus	Price Per Acre	Rentals/Year	Royalty	Accepted Acres	Accepted Bonus
LSUS	03/09/22	22062	Cypress Energy Co.			Caddo	S37-T17N-13W	50.850	3 yrs.	\$101,700.00	\$2,000.00	\$50,850.00	22.5%	50.850	\$101,700.00
2021-2022															
Campus that Benefits	Sale Date	State Lease #	Leased to:	Operated by	Release Date	Parish	Section, Township, Range	Acres Bid	Lease Term	Cash Bonus	Price Per Acre	Rentals/Year	Royalty	Accepted Acres	Accepted Bonus
n/a															

**Report to LSU Board of Supervisors:
All Campuses**

Other Agreements and Approval Requests

Updated April 5, 2024

2023-2024

Document Type	Campus	Lessor or Seller or Assignor	Lessee or Buyer or Assignee	Related Agreements or Purpose
1st Amendment to CEA	HSCNO	HSCNO	LSU Health Foundation -New Orleans	use of Stanislaus Hall
Cooperative Endeavor Agreement	HSCNO	HSCNO	LSU Healthcare Network in New Orleans	Use of Seton Building
Cooperative Endeavor Agreement	HSCNO	HSCNO	LSU School of Med. In New Orleans Faculty Group Practice	Ambulatory Surgery Center
Extension 3 of Tsunami Use Agreementat Shaw Center	LSU	LSU	Chartwells	Restaurant

2022-2023

Document Type	Campus	Lessor or Seller or Assignor	Lessee or Buyer or Assignee	Related Agreements or Purpose
Option Term 3 to State Lease #19-4756	AgCenter	Northeast Educational Development Foundation	AgCenter Rural Development Center	Changes end date to 6/30/2024
Request for approval to lease space through the State Office of Real Estate Lease	HSCS	Alzheimer's Resource Center & Dementia	The Center for Brain Health of LSU Health Shreveport	Approval to submit information needed for a State Lease of Clinic Space
Estoppel Certificate requested by Tulane and the Charity Developer	LSU	LSU Board of Supervisots & the REFF subsidiary	Tulane and the Charity Hospital Redevelopment LLC of Charity Hospital	Estoppel Agreement
Nicholson Gateway Apartments Sprinkler Phase 1 Release	LSU	LSU Board of Supervisors	The Lemoine Company	A receipt & release to allow insurance payment to The Lemoine Company for Phase 1 of work
Nicholson Gateway Apartments Sprinkler Phase 2 Release	LSU	LSU Board of Supervisors	The Lemoine Company	A receipt & release to allow insurance payment to The Lemoine Company Phase 2 of work
Outstanding Participation Agreements with Associated Insurance Certificates	LSU			
Request for JLCB Approval to Increase Construction Costs- LSU Innovation Park Roadway Improvements	LSU	LSU Board of Supervisors		Change Orders and Amendments to existing construction and design contracts
Subordination Agreement for W.S. Dock	LSU	LSU Board of Supervisors	W.S. Dock, LLC	Lessee's Lender's documents

**Report to LSU Board of Supervisors:
All Campuses**

Other Agreements and Approval Requests

Updated April 5, 2024

2021-2022				
Document Type	Campus	Lessor or Seller or Assignor	Lessee or Buyer or Assignee	Related Agreements or Purpose
Option Term 5 to State Lease #19-9975	AgCenter	Corpus Christ Church-Epiphany Catholic Church	AgCenter Extension Center Space	Change end date to 6/22/2022
Amendment 3 Option Term 3- State Lease # 19-9975	AgCenter	Corpus Christ Church-Epiphany Catholic Church	AgCenter Extension Center Space	Adds 5 1-yr. option terms, exercises 1 term and changes the insurance coverage administrator.
Revision to Prior Authorization to enter into CEA & Lease with La. Dept. of Agriculture & Forestry	AgCenter	LSU BoS	Louisiana Dept. of Agriculture and Forestry	Joint Operation and Maintenance of AgChemistry Building
Option Term 1 to State Lease #19-4756	AgCenter	Northeast Educational Development Foundation	AgCenter Rural Development Center	Changes end date to 6/30/2023
Option Term 2 to State Lease #19-4756	AgCenter	Northeast Educational Development Foundation	AgCenter Rural Development Center	Changes end date to 6/30/2022
Option Term 3 to State Lease #19-10302	AgCenter	Town of Vidalia	AgCenter Concordia Extension Service	Changes end date to 6/13/2022
Option Term 4 to State Lease #19-10302	AgCenter	Town of Vidalia	AgCenter Concordia Extension Service	Changes end date to 6/13/2023
Estoppel Certificate for LSU Real Estate and Facilities Foundation & Charity Hospital Redevelopment LLC of Charity Hospital	HCS D	LSU Board of Supervisors & Real Estate & Facilities Foundation	In Favor of 1532 Tulane Partners Holdco, LLC	Estoppel Agreement
Use Agreement for Site Evaluations at Administration Headquarter on Airline Highway, Baton Rouge	HCS D	LSU BoS	East Baton Rouge City Parish, Department of Transportation and Drainage	Conduct a field investigation of the surface pavement adjacent to the existing facility.
Amendment 3 and Option Term	HCS S	Haynes Peavy	HCS S	Clinic Space for the Partners in Wellness Clinic
License for Use of Facilities & Premises	LSU	LSU	CenTrio Energy South, LLC	Provide site evaluation of the property for the Initial Modernization Project
Assignment and Assumption of Lease	LSU	LSU BoS	Gamma Iota Housing Corp of Pi Kappa Phi Fraternity	Transfer of Lease from current housing corporation to a different housing corporation
CEA Implementing Grant Under Community Development Block Grant Disaster Recovery Program	LSU	LSU, City-Parish, REFF & the Office of Community Development		Adding \$5 million in funding for the University Lakes Project.
License for Use of Facilities & Premises	LSU	LSU	Drakes Catering, Inc.	Provide catering services within the Champions Club under its own liquor license
1st Amendment to Lease Agreement	Pennington Biomedical Research Center	PBRC	Our Lady of the Lake Physician Group LLC	Effective Date amended to October 18, 2021 and termination date to October 31, 2022.

**Report to LSU Board of Supervisors:
All Campuses Last 3 Years**

PM60 Projects \$75,000 to \$175,000

Updated April 5, 2024

2023-2024		AMOUNT APPROVED	FUNDS SOURCE	APPROVED BY	APPROVAL DATE
LSU	Carl Maddox Field House Boilers Replacement	\$125,000	Auxiliary Funds	Exec. VP Lewis	08/29/23
	Evangeline Circle Horseshoe ADA Sidewalk & Site Improvements	\$125,000	Other: Facility Access Fee		07/11/23
	Football Indoor Practice Facility Video Board and Outdoor Sound Equipment Room	\$100,000	Auxiliary Funds	Exec. VP Lewis	04/10/23
	Howe Russell Parking Lot Electric Vehicle Chargers	\$100,000	Auxiliary Funds	Exec. VP Lewis	05/08/23
	Human Ecology Building Suite 140 Renovations	\$108,500	Other Funds	Exec. VP Lewis	08/14/23
	Life Sciences Building Room 610 Renovation	\$115,000	Operational Funds	Exec. VP Lewis	07/19/23
	Life Sciences Building: Lab 529 Renovations	\$110,000	Auxiliary Funds \$	Kimberly Lewis	10.17.2023
	Skip Bertman Dr: Crosswalk Signage and Enhancements	\$100,000	Auxiliary Funds \$	Kimberly Lewis	01.22.2024
	Tiger Stadium Lift Stadium Installation	\$90,239	Auxiliary Funds	Exec. VP Lewis	06/13/23
	Tiger Stadium North Stadium Plaza Renovations	\$100,000	Auxiliary Funds	Exec. VP Lewis	07/11/23
	TTEC: Conference Room Lighting Upgrades	\$120,000	Other Funds	Kimberly Lewis	10.17.2023
	Total LSU	\$1,193,739			
LSUE	Manuel Hall Transformer Restoration Project	\$91,225	Operational Funds	Exec. VP Lewis	10/26/23
	Med Gas System-respiratory Labs PH 11	\$125,000	Building Use Fee	Exec. VP Lewis	10/23/23
	Med Gas System-respiratory Labs PH 1 reapproved	\$125,000	Grant-AWD-005611-GR-00014228	Exec. VP Lewis	11/09/23
	Total LSUE	\$341,225			
LSUS	Student Success Center Noel Memorial Library	\$130,026	Restricted Fees-Student Fees	Exec. VP Lewis	10/11/23
	Total AgCenter	\$130,026			
AgCenter	Fiber Network Install	\$79,464	Sugar RS Facilities & Administration funds and the Sugar Research Station General Support Frant	Exec. VP Lewis	09/11/23
	Total AgCenter	\$79,464			
PBRC	Bldg B VAVs Metasys Modernication	\$156,000	Operational Funds	Exec. VP Lewis	01/09/24
	Replace ATS Switches	\$83,911	Other: Board of Regents Safety Funds	Exec. VP Lewis	1/30*/24
	Total LSUE	\$239,911			
	Total All Campuses	\$1,984,365			

**Report to LSU Board of Supervisors:
All Campuses Last 3 Years**

PM60 Projects \$75,000 to \$175,000

Updated April 5, 2024

2022-2023		AMOUNT APPROVED	FUNDS SOURCE	APPROVED BY	APPROVAL DATE
LSU	Athletic Administration Bldg. Rm 225 Nutrition Ctr Renovations	\$115,000	Auxiliary Funds	Exec. VP Lewis	09/12/22
	Bernie Moore: Structural Preventative Maintenance	\$165,600	Ausillary Funds	Exec. VP Lewis	10/27/22
	Campus Wide Roadway Seal Coating Rebid	\$150,000	Other Ancillary Self Gen Revenue	Exec. VP Lewis	08/02/22
	Chemistry & Materials Bldg. Rm 168 Renovations	\$132,400	Other Ancillary Self Gen Revenue	Exec. VP Lewis	10/10/22
	Dalrymple Dr: Sidewalk, Drainage & Ramp Improvements	\$160,000	Other Ancillary Self Gen Revenue	Exec. VP Lewis	11/14/22
	Digital Media Center Cyber Security Modification for new Faculty	\$275,000	Other- LED Grant	Exec. VP Lewis	11/14/22
	First Transit Hub Renovation	\$145,000	Auxiliary Funds	Exec. VP Lewis	10/10/22
	Hatcher Hall 3rd Floor Renovations for AAAS	\$85,000	Operational Funds	Exec. VP Lewis	03/13/23
	Hatcher Hall 3rd Floor Renovations for AAAS revision	\$130,000	Operational Funds	Exec. VP Lewis	04/14/23
	Howe Russell Parking Lot Electric Vehicle Chargers	\$100,000	Auxiliary Funds	Exec. VP Lewis	05/08/23
	Law Center: Classroom Modifications for Podiums	\$87,000	Operational Funds	Exec. VP Lewis	03/13/23
	Life Sciences Annex: Suite A363 and A365 Renovation	\$150,000	Operational Funds	Exec. VP Lewis	01/10/23
	MDA Sidewalk & Ramp Improvement	\$110,000	Other: Facility Access Fee	Exec. VP Lewis	12/13/22
	Nicholson Hall 4th Floor Renovations	\$130,000	Operational Funds	Exec. VP Lewis	11/18/22
	PMAC South Plaza Drainage and Paving Improvements	\$150,000	Auxiliary Funds	Exec. VP Lewis	08/02/22
	South Quad Dr. Paving Repairs & Sidewalk Imrprovements	\$120,000	Other Ancillary Self Gen Revenue	Exec. VP Lewis	08/02/22
	SVM East Lot ADA Parking, Sidewalk, Drainage Improvements	\$100,000	Auxiliary Funds	Exec. VP Lewis	08/02/22
	SVM: Main Bldg Library Renovations for Conference Room	\$147,250	Operational Funds	Exec. VP Lewis	03/20/23
	Thomas Boyd Hall: 156 & 156A	\$78,000	Operational Funds	Exec. VP Lewis	12/13/22
	Thomas Boyd Hall: 156 & 156A revision	\$105,000	Operational Funds	Exec. VP Lewis	04/24/23
	TTEC: Auditorium Lighting Replacement	\$90,000	Other: LA DOTD Funds	Exec. VP Lewis	11/14/22
	UREC: Softball Playing Surface Repaairs	\$75,000	Auxiliary Funds	Exec. VP Lewis	10/10/22
	Total LSU	\$2,800,250			
AgCenter	Aquaculture Implement Shed Expansion	\$79,920	Operational Funds	Exec. VP Lewis	12/01/22
	Total AgCenter	\$79,920			
LSUA	Facility Services Fencing Project	\$135,000	Operational Funds	Exec. VP Lewis	05/05/23
	Total LSUA	\$135,000			

**Report to LSU Board of Supervisors:
All Campuses Last 3 Years**

PM60 Projects \$75,000 to \$175,000

Updated April 5, 2024

LSUS	Baseball Outfield Regrading		\$156,676	Auxiliary Funds	Exec. VP Lewis	04/14/23
	Physical Plant Roof Replacement increased cost of low bid		\$104,975	Operational Funds	Exec. VP Lewis	08/10/22
	Science Building Utilities Relocate		\$80,000	Supplementation Appropriation Act 170 of 2022	Exec. VP Lewis	05/25/23
	Student Success Center Advising Area		\$1,430,229	Operational Funds	Exec. VP Lewis	05/17/23
	University Center AHU #3 Replacement		\$78,100	Operational Funds	Exec. VP Lewis	06/30/22
	Total LSUS		\$1,849,980			
HCS D	Lallie Kemp Helipad		\$133,164	Other- Covid-19 ARP Rural Funds	Exec. VP Lewis	09/07/22
	Total HCS D		\$133,164			
	Total All Campuses		\$4,863,314			

**Report to LSU Board of Supervisors:
All Campuses Last 3 Years**

PM60 Projects \$75,000 to \$175,000

Updated April 5, 2024

2021-2022		AMOUNT APPROVED	FUNDS SOURCE	APPROVED BY	APPROVAL DATE
LSU	459 Commons AHU 3 & 4 Chilled & Heating Water Coil Replacement	\$88,964	Auxiliary Funds	Exec. VP Lewis	05/13/22
	Alpha Phi Flooring Renovations	\$80,000	Auxiliary Funds	Exec. VP Lewis	05/24/22
	Braille Signage: Interior ADA Wayfinding Multiple Buildings	\$100,000	Ancillary S-G Funds- Facility Access Fee	Interim Exec. VP Torres	10/19/21
	Design Building Deck Project 2021	\$60,000	Self-Gen: Funds from Alumni donations	Interim Exec. VP Torres	12/20/21
	ECA Activities Building: Interior Painting	\$125,000	Auxiliary Funds	Exec. VP Lewis	02/11/22
	Exterior ADA Building Ramps-Multiple Buildings	\$158,000	Ancillary Self-Gen Funds- Facility Access Fee	Interim Exec. VP Torres	11/03/21
	Hill Farm-Sweet Potato Farm Renovations	\$75,000	S-G: Donor Money-Hill Farm Teaching Facility & Newsom Gardens Project Fund	Interim Exec. VP Torres	11/03/21
	Hodges Hall B16, B16B, B16C, B22 Renovations	\$75,000	Operational Funds	Exec. VP Lewis	04/13/22
	Jesse Coates Hall 3rd Floor Laboratory Lighting	\$75,000	Operational Funds	Exec. VP Lewis	05/05/22
	Life Sciences Bldg: Basement Suite B24- Rms 24A, 24B, 24C & 24D Lab	\$97,605	Operational Funds	Interim Exec. VP Torres	12/10/21
	Life Sciences Bldg: Rooms 387, 387A & 387B Lab Renovations	\$103,000	Operational Funds	Interim Exec. VP Torres	12/01/21
	Music Building Hurricane Ida Roof Repair	\$145,000	Insurance Claim	Interim Exec. VP Torres	10/19/21
	Stephenson Veterinary Hospital Landscape & Irrigation Installation	\$140,000	Self Gen-allocated in Stephenson Veterinary Hospital construction budget	Exec. VP Lewis	03/15/22
	Student Union Suite 109 Renovations for PTS	\$1,000,000	Auxiliary Funds	Exec. VP Lewis	06/14/22
	Student Union: Room 188 Renovation for ITS	\$105,000	Operational Funds	Exec. VP Lewis	05/05/22
	SVM Main Building Access Control System Replacement	\$120,000	Operational Funds	Exec. VP Lewis	03/15/22
	SVM Room 2536, 2538, 2538A Lab Renovations budget increase from \$115,000	\$165,000	Operational Funds	Interim Exec. VP Torres	07/06/21
	SVM: 2202, 2202A, 2203 Casework Installation/Lab Renovations	\$128,000	Operational Funds	Interim Exec. VP Torres	01/13/22
	Tiger Stadium Turf Replacment 2022	\$125,000	Other- allocated for replacement after concener	Exec. VP Lewis	03/15/22
	Total LSU	\$2,965,569			

**Report to LSU Board of Supervisors:
All Campuses Last 3 Years**

PM60 Projects \$75,000 to \$175,000

Updated April 5, 2024

2021-2022		AMOUNT APPROVED	FUNDS SOURCE	APPROVED BY	APPROVAL DATE
AgCenter	Irrigation Reservoir Weir/Discharge Replacement	\$78,760	Operational Funds	Exec. VP Lewis	05/13/22
	Total LSUA	\$78,760			
LSUA	The Oaks Residential Housing Exterior Repair	\$174,600	Operational Funds	Exec. VP Lewis	05/13/22
	Total LSUA	\$174,600			
LSUE	Health Technology Building Gas System Upgrades & Laboratory Renovation	\$170,000	Cares Act Funds	Exec. VP Lewis	04/28/22
	Total LSUA	\$170,000			
LSUS	Physical Plant (Facility Services) Roofing Replacement	\$75,000	Operational Funds	Exec. VP Lewis	05/13/22
	University Center AHU #3 Replacement	\$78,100	Operational Funds	Exec. VP Lewis	06/30/22
	Storm Damaged Metal Awning Replacement	\$110,000	Operational Funds	Exec. VP Lewis	05/03/22
	Total LSUS	\$263,100			
Total PM60 Project Approvals 2020-2021		\$3,652,029			

**Report to LSU Board of Supervisors:
All Campuses Last 3 Years**

Property Leases

Updated April 5, 2024

2023-2024													
Campus	Lessor or Sublessor	Lessee or Sublessee	Location	Lease Purpose	BoS Appr.	Start	Lease Term	Sq. Ft.	Annual Rental	Dollars / SF	Terms left	Length	Approved by
HSCNO	HSCNO	ULM College of Pharmacy	New Orleans	Interagency Lease for Office space	n/a	12/01/23	11/30/28	3,872	\$67,760.04	\$17.50	1	3-yrs	President Tate
AgCenter	AgCenter	Patout Brothers Farms	Iberian Research Station	Agricultural purposes	n/a	02/01/24	01/30/29	372.34 acres	\$65,159.00	n/a	3	1-yr	President Tate
AgCenter	AgCenter	Town of Vidalia	Vidalia	Extension Service	n/a	06/13/23	06/12/24	1,393	\$10,000.00		4	1-yr	President Tate
AgCenter	AgCenter	Bryan Galley	Rosepine Research Station	Agricultural purposes	03/04/22	08/17/23	08/16/28		\$25,000.00	n/a	1	5-yrs	President Tate
2022-2023													
Campus	Lessor or Sublessor	Lessee or Sublessee	Location	Lease Purpose	BoS Appr.	Start	Lease Term	Sq. Ft.	Annual Rental	Dollars / SF	Terms left	Length	Approved by
HSCNO	LSU BoS	City of New Orleans		Lease of Airspace in New Orleans between the HSCNO Center for Advanced Learning & Simulation & the Clinical Science Research Building		09/15/22	50 years	11' wide & 55' long about 20' 10" above S. Prieur Street	\$5,130 2022-26, increasing every 4 years		8		President Tate
LSU	LSU BoS	Phi Kappa Theta at LSU House Corporation'	Lot 12 Frternity Row	Amendment & Restatement of Lease, Phi Kappa Theta at LSU of former Sigma Alpha Mu Fraternity House		06/17/22	Thru 6/16/2054		\$10.00				President Tate
2021-2022													
Campus	Lessor or Sublessor	Lessee or Sublessee	Location	Lease Purpose	BoS Appr.	Start	Lease Term	Sq. Ft.	Annual Rental	Dollars / SF	Terms left	Length	Approved by
LSU	LSU	Phi Gamma of Chi Omega House Corp.	Lot 16 Sorority Row	New Lease for land and for Related Construction	n/a	05/03/22	02/09/64	n/a	\$10.00	n/a	n/a	n/a	President Tate
AgCenter	LSU BoS	Fitch Brothers Chorolois	Iberia Research Station, Iberia parish	Crop and Cattle Production		06/21/22	06/20/26	209.65 acres	\$1,245.00	n/a	4	1-year	President Tate
AgCenter	LSU BoS	Sligo Road Circle M Ranch, LLC	Pecan Research Station, Caddo	Crop Production	12/05/19	06/22/22	06/21/25	99.956 acres	\$1,475.00	n/a	7	1-year	President Tate
HSCNO	HSCNO	CurVir Biotechnology & NeuResto Therapeutics	Lions Eye Center, New Orleans	Lease Agreement	n/a	07/01/21	06/30/21	229	\$4,122.00		4	1-year	Interim Pres. Galligan
HSCNO	HSCNO	LSU Health Foundation New Orleans	450 S. Claiborne Ave., New Orleans	Adaptive Reuse of Standislaus Hall as a Nursing Home	06/18/21	11/01/21	10/31/22	43,317	\$619,911.50	\$14.30	up to 5 yrs.		President Tate

**Report to LSU Board of Supervisors:
All Campuses Last 3 Years**

Schematic Design

Updated April 5, 2024

2023-2024				
Campus	Project	Architect	Approved by	Approval Date
	n/a			
2022-2023				
Campus	Project	Architect	Approved by	Approval Date
	TAF Lease and Schematic Design of Renovated & Expanded Football Operations Building		LSU Board of Supervisors	10/21/22
2021-2022				
Campus	Project	Architect	Approved by	Approval Date

**Report to LSU Board of Supervisors:
All Campuses Last 3 Years**

Servitudes

Updated April 5, 2024

2023-2024								
Campus/Lessor	Lessee	Servitude or Right-of-Way Location	Acreage	Payment	Length of Term	Type of Document	Approved by	Approval Date
AgCenter-Red River Research Station	Caddo-Bossier Parishes Port Commission	Sections 31 & 32, Township 17, Range 12 West, Bossier Parish	3.292 acres	\$40,000.00	In perpetuity	Servitude	William F. Tate IV	5/24/2023
HSCNO	Cox Communications	Lot 8A-3, Sq. 468 1st District, New Orleans	0.069 acres	\$162,270.00	99 year	Right of Use Servitude	William F. Tate IV	11/27/2023
LSU	ExxonMobil	Innovation Park, Baton Rouge	dna	dna	dan	dna	William F. Tate IV	11/11/2023
AgCenter-Northeast Research Station	Entergy Louisiana, LLC (requested by Corps Of Engineers)	Northeast Research Station, Tensas Parish	Corps requested Entergy to move power line from base of levee to main highway along Hwy 604 & 606			Right of Way	William F. Tate IV	10/11/2023
AgCenter, Iberville Parish	Manchac Holdings 2023, LLC	Land locked property at Nicholson Drive/La Hwy 30	Grants Grantee access to the access road		99 years	Servitude and Right of Passage Agreement	William F. Tate IV	11/27/2023
2022-2023								
Campus/Lessor	Lessee	Servitude or Right-of-Way Location	Acreage	Payment	Length of Term	Type of Document	Approved by	Approval Date
LSU	Entergy	New Medical School Housing, New Orleans			In perpetuity	Right-of-Way to run power	William F. Tate IV	5/13/2022
ExxonMobil Pipeline Co.	LSU	St. Gabriel, Iberville Parish			In perpetuity	Right-of-Way to construct water pipeline to new firing range	William F. Tate IV	4/28/2022
2021-2022								
Campus/Lessor	Lessee	Servitude or Right-of-Way Location	Acreage	Payment	Length of Term	Type of Document	Approved by	Approval Date
AgCenter	CLECO Power LLC	Rapides Parish			In perpetuity	Line Extension Agreement	William B. Richardson	7/14/2021
AgCenter	Boardwalk Louisiana Midstream, LLC	East Baton Rouge Parish			In perpetuity	Pipeline construction for transmission of communication signals	William F. Tate, IV	11/11/2021

**Report to LSU Board of Supervisors:
All Campuses Last 3 Years**

Transfers of Title to Immovable Property

Updated April 5, 2024

2023-2024

Campus	Transfer Description	Value	State ID	Site Code	Approved by	Transfer Date
LSU	Act of Donation-PMAC Media Seating Relocation	\$ 74,255			Pres. Tate	06/27/23
	Act of Donation-LSU Golf Practice Facility Interior Renovations	\$ 170,322			Pres. Tate	06/27/23
	Act of Donation-LSU PMAC Retractable Bleacher Repairs	\$ 60,000			Pres. Tate	09/07/23
	Act of Donation- Tiger Stadium New Loge Seating Areas	\$ 266,214			Pres. Tate	09/11/23
	Act of Donation-Charles McClendon Outdoor Practice Facility Synthetic Turf Replacement and Related Improvements	\$ 1,469,184			Pres. Tate	06/27/23
	Sale of Earl K. Long Property to East Baton Rouge Parish Housing Authority	\$ 1,185,000			Pres. Tate	11/03/23
HSCNO	Purchase of 531 & 535 Derbigny by HSCNO	\$ 258,198			Pres. Tate	12/15/23
		\$ 3,483,172				

2022-2023

Campus	Transfer Description	Value	State ID	Site Code	Approved by	Transfer Date

2021-2022

Campus	Transfer Description	Value	State ID	Site Code	Approved by	Transfer Date