



MAXMADE LIMITED

Goal Posts & Bollards



Armco Barrier: A tried and tested system used for protection against moving vehicles. Used in various locations, including car parks, inside and outside factories to protect machinery and plant equipment.



- Protect buildings and external plant from vehicles.
- Segregate and protect Pedestrian routes from vehicle traffic.
- Various easy to fit options, bolt down or dig in posts.

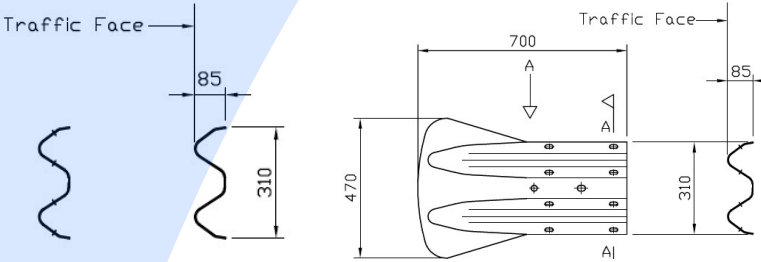

Wall & Door Protection Systems

Maxmade Limited have been supplying the Clean Room and Temperature Controlled Building Industry since 1973. Initially only supplying specialist ceiling support systems and sheet metal fabrications.

Since this time, the company has gained a wealth of experience, and has developed its range of products to meet the new demands of this industry, and that of the Food Preparation Industry, including wall and door protection systems, wall and ceiling cladding systems and also supplying quality fixings and sealants to help complete the job.

A working solution

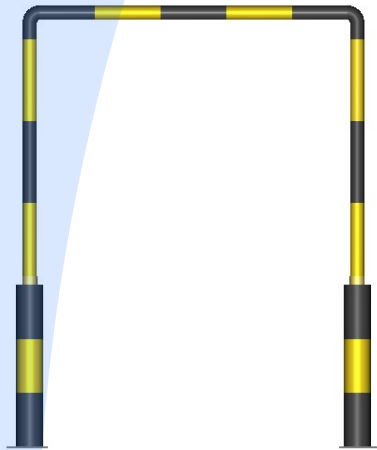

Goalposts and bollards: Used to protect door openings and doors. A proven and well established set of systems used for protection against moving vehicles. Used in various locations, including loading bays, warehouses, inside and outside of factories.

- Protect buildings and external plant from vehicles.
- Protect door ways from vehicle traffic.
- Various easy to fit options, bolt down or dig in posts.
- Made to measure, different designs and finishes to suit application.

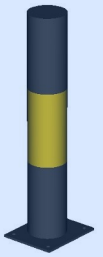

Made to measure solutions: As well as the standard range of product, Maxmade Limited can manufacture wall and door protection systems to suit specific requirements. Such as low level wall protection systems in a variety of finishes ranging from heavy duty galvanised kerb angles, to stainless steel tubular sections. Also produced are specialist applications such as kerb sections made to suit floor plan, which can be back filled with concrete, allowing the fitting of composite panels above the kerb.

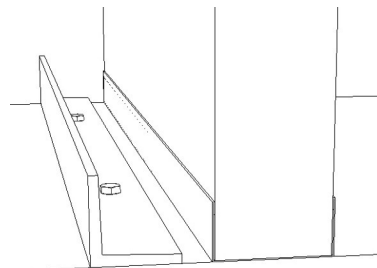

Contact our sales team for more information on any of our range of products.



MAXMADE LIMITED

Hemmings Way, Off Stoney Lane,
Rainhill, Prescot, Merseyside L35 9ND
www.maxmade.com sales@maxmade.com
Telephone: 0151 430 9797
Fax: 0151 493 1320

Armco Barrier

USES:

- Protect Buildings
- Protect Machinery
- Protect Vehicles
- Protect Employees
- Protect Visitors

Left Photo: Armco barrier using bolt down posts to protect outdoor machinery.

Below photo Standard Armco straight piece with fish tail end, protecting building wall.



Armco Straight piece with Fish Tail end.



Internal Corner

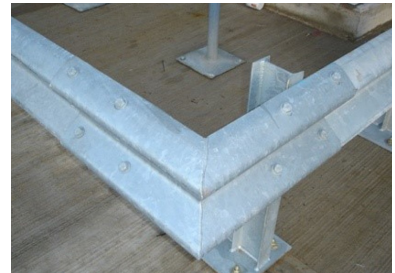

External Corner

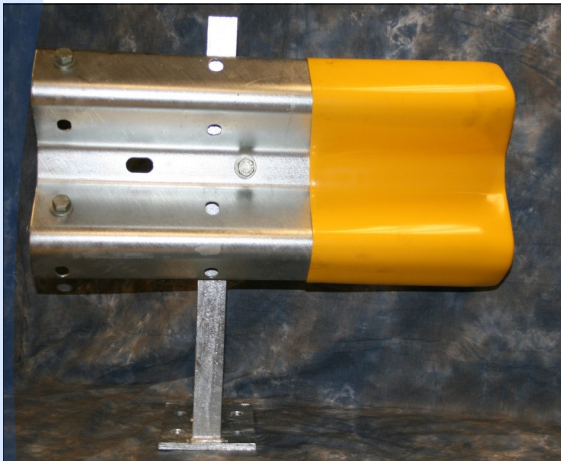

Standard Armco straight piece with yellow end cap.

FEATURES:

- Tried, tested and proven system to protect people, property and vehicles.
- Can be used indoors and outdoors
- Comes in a galvanised finish—which can be painted to highlight hazard areas.
- Versatile—posts can be bolted or set in concrete, also to allow for single or double runs.
- Corners and various ends to suit applications are available.

Contact our sales team for more information on any of our range of products.



Hemmings Way, Off Stoney Lane,
 Rainhill, Prescot, Merseyside L35 9ND
www.maxmade.com sales@maxmade.com
 Telephone: 0151 430 9797
 Fax: 0151 493 1320

Goal Posts, Door Protection

USES:

- Protect Door Ways
- Protect Sliding Doors

Whilst Maxmade Limited manufactures a standard range of "SK" goalpost systems. Designs can be altered to suit individual customer requirements.

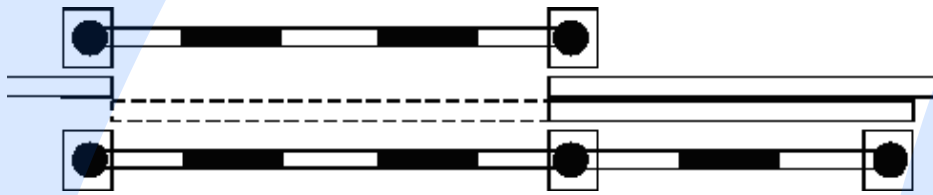
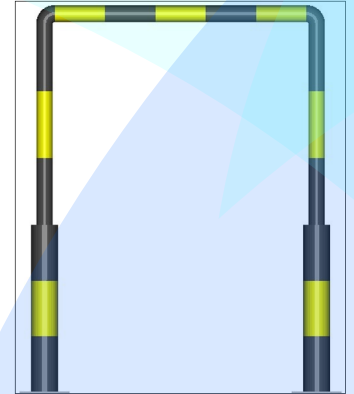
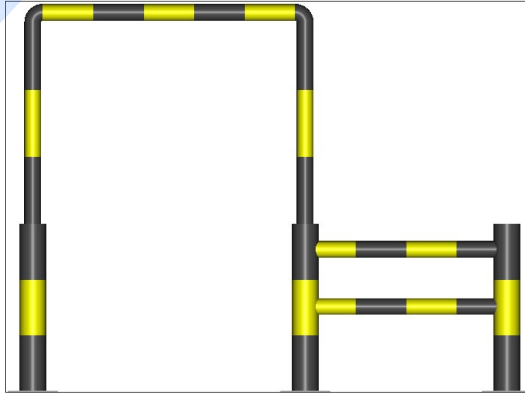

The SK 50/23 Range.
A Goalpost on both sides of the opening, with the sliding door protection barrier on one side.

The SK 50 Range.
A Goalpost and with a sliding door protection barrier on one side, with 2 SK53 bollards on the other side.

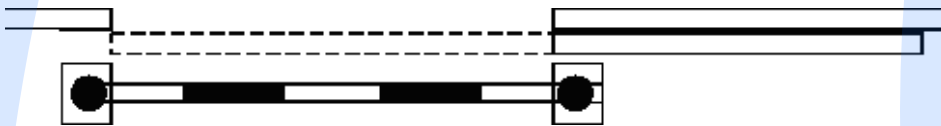
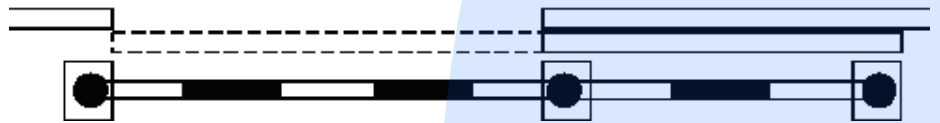

The SK 23 Range.
A Goalpost on one side only offering protection to a opening only.

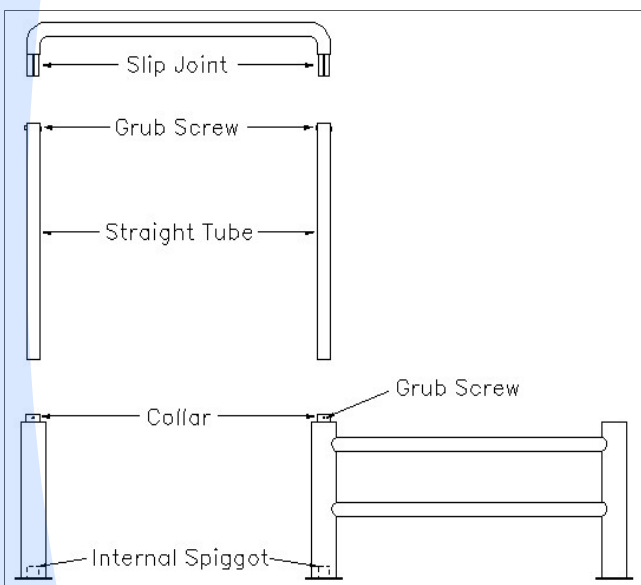

FEATURES:

- Tried, tested and proven systems to protect doors and door ways.
- Can be used indoors and outdoors.
- Comes in a powder coated finish with painted yellow hazard strips. Also can be painted to suit special or specific requirements.
- Posts can bolted or set in concrete.
- Goalposts can also be manufactured in galvanised and stainless finishes.
- Goalposts can be made from a variety of different sized tubes to meet individual requirements.

Goalposts are supplied in sections for ease of fitting, and allowing for the replacement of damaged parts.

SK 23 ~ Standard Goalpost

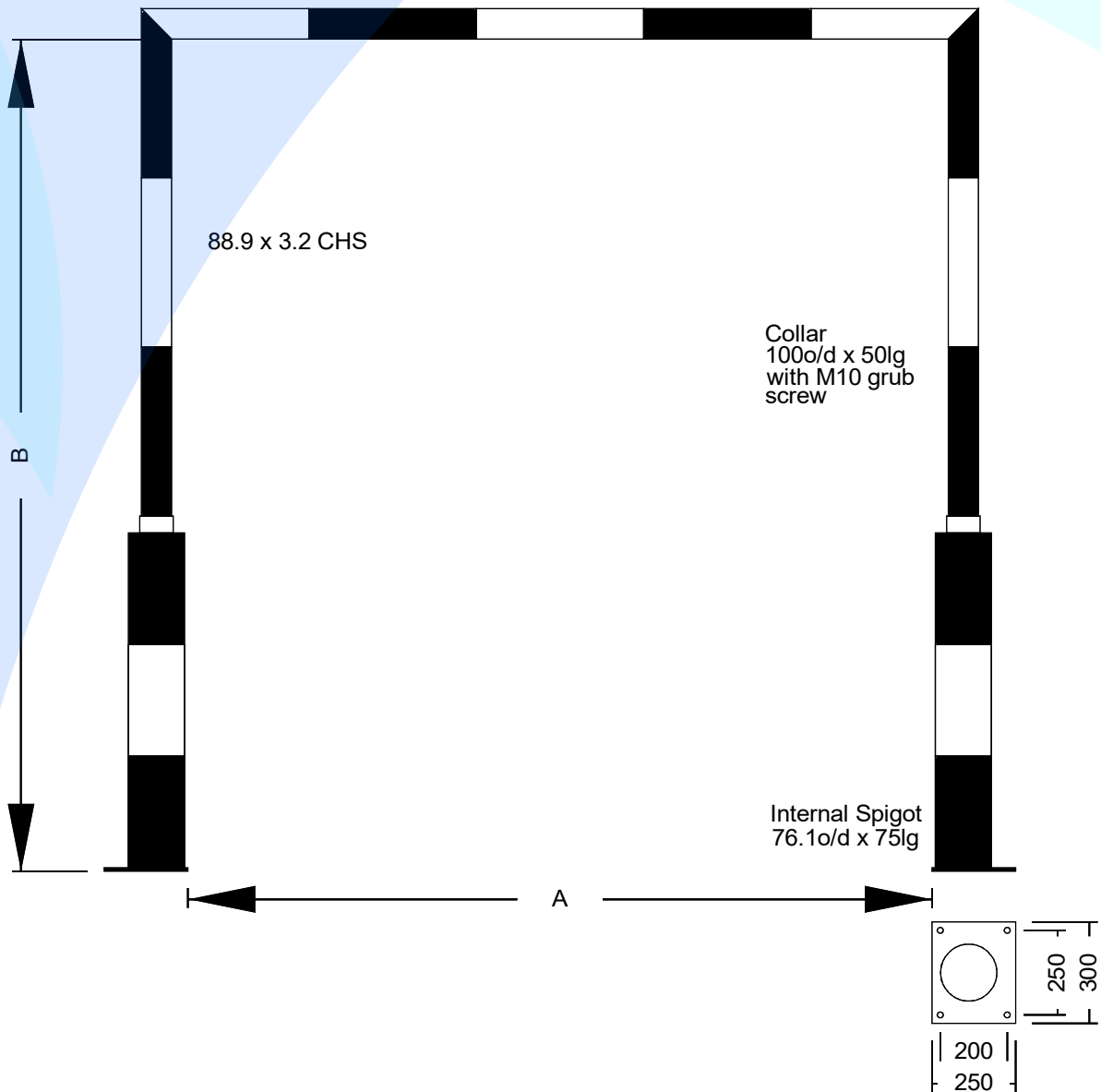

1000mm High Bollard – O/D 168 CHS Tube
When erecting ensure that the 88.9x3.2 CHS is
securely positioned on the spigot and that the grub screw
is tightened.
Finish – Powder Coated black & painted hazard yellow
strips.

BASE PLATE
300x250x10mm plate with
4no' 18Ø holes to suit
16P130 Parabolts – supplied.

No' Required	A	B

Contact our sales team for more information on any of our range of products.



Hemmings Way, Off Stoney Lane,
Rainhill, Prescot, Merseyside L35 9ND
www.maxmade.com sales@maxmade.com
Telephone: 0151 430 9797
Fax: 0151 493 1320

SK50 ~ Goalpost With Tubular Side Barrier with bollards.

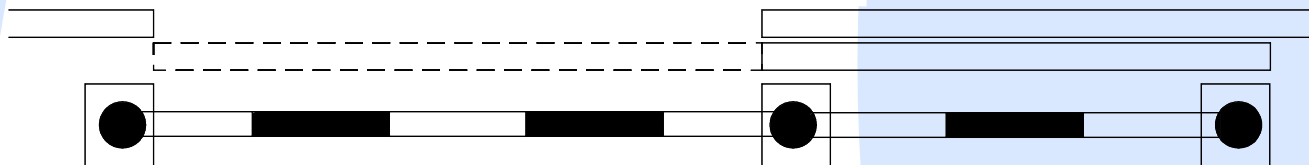
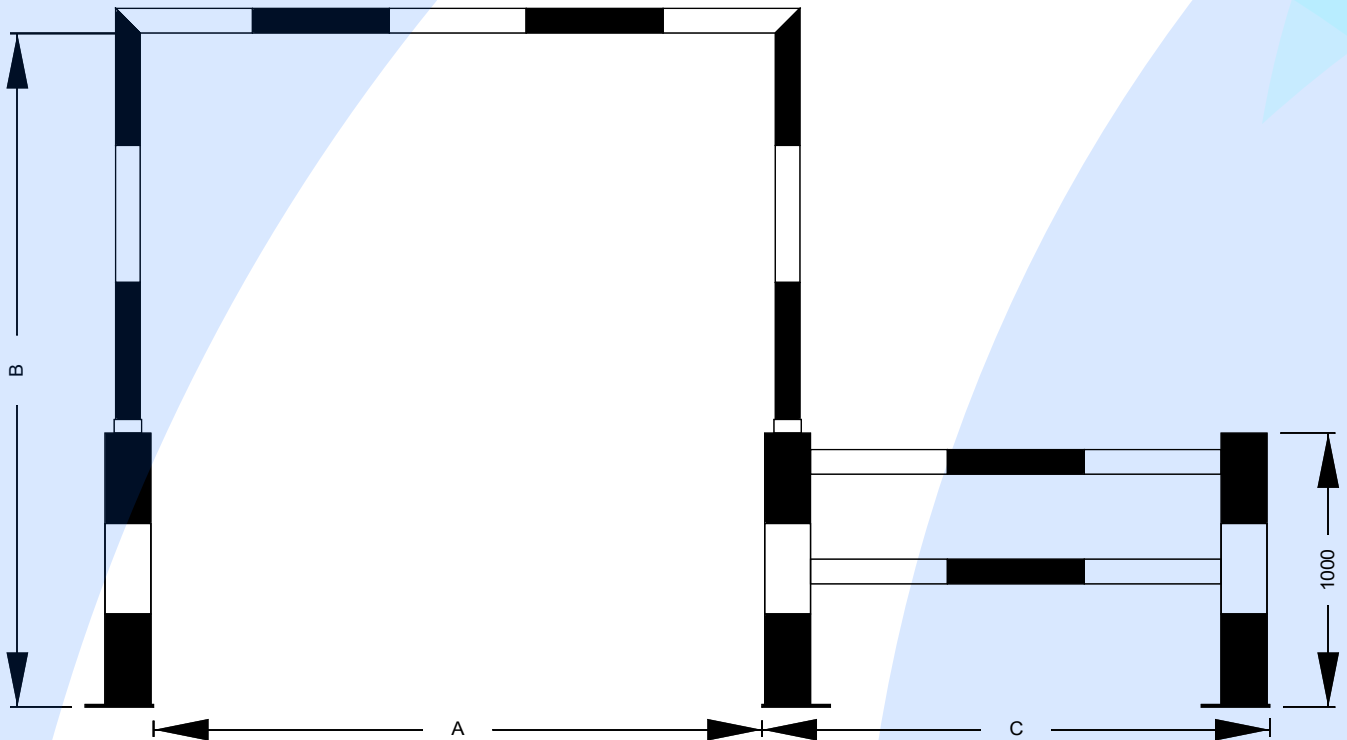

c/w 2 off—1000mm High Bollards – O/D 168 CHS

1 off Goalpost and Side Barrier – O/D 88.9 CHS

All with 10mm base plates and supplied with
16P130 Parabolts. All powder coated black & painted hazard yellow strips.

Contact our sales team for more
information on any of our range of
products.



Hemmings Way, Off Stoney Lane,
Rainhill, Prescot, Merseyside L35 9ND
www.maxmade.com sales@maxmade.com
Telephone: 0151 430 9797
Fax: 0151 493 1320

SK50/23 Goalpost With Tubular Side Barrier And Full Goalpost

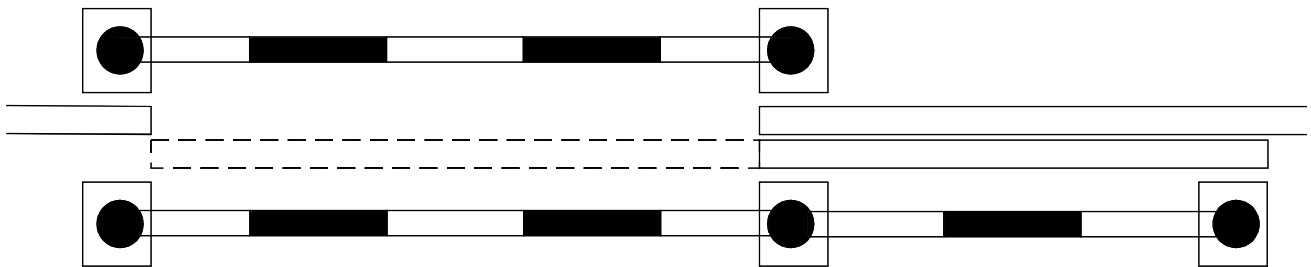
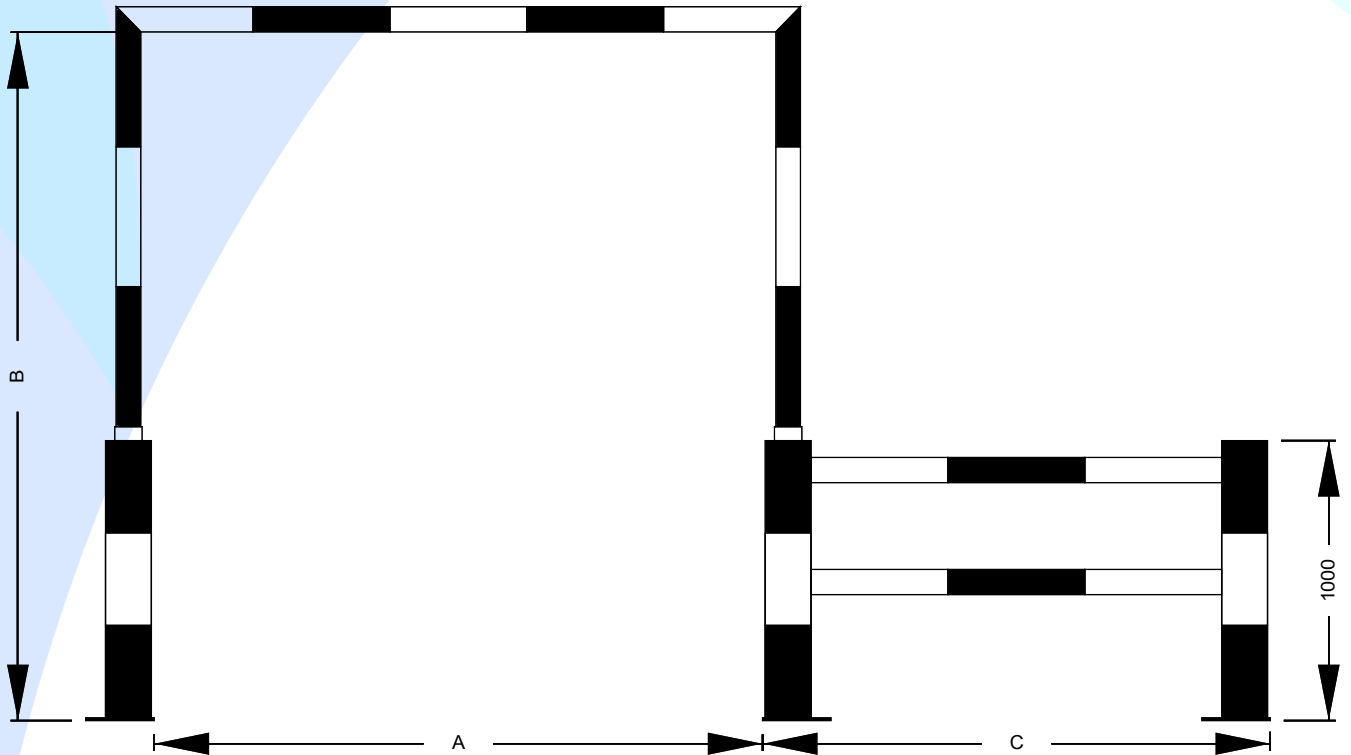

c/w 1off Goalpost and 1off Goalpost and Side Barrier – O/D 88.9 CHS
 All with 10mm base plates and supplied with
 16P130 Parabolts. All powder coated black & painted hazard Yellow strips.

Number of Goalposts	A	B	C
Number of internal Bollards			

Contact our sales team for more information on any of our range of products.



Hemmings Way, Off Stoney Lane,
 Rainhill, Prescot, Merseyside L35 9ND
www.maxmade.com sales@maxmade.com
 Telephone: 0151 430 9797
 Fax: 0151 493 1320

SK 42 ~ Goalpost With Side Guides

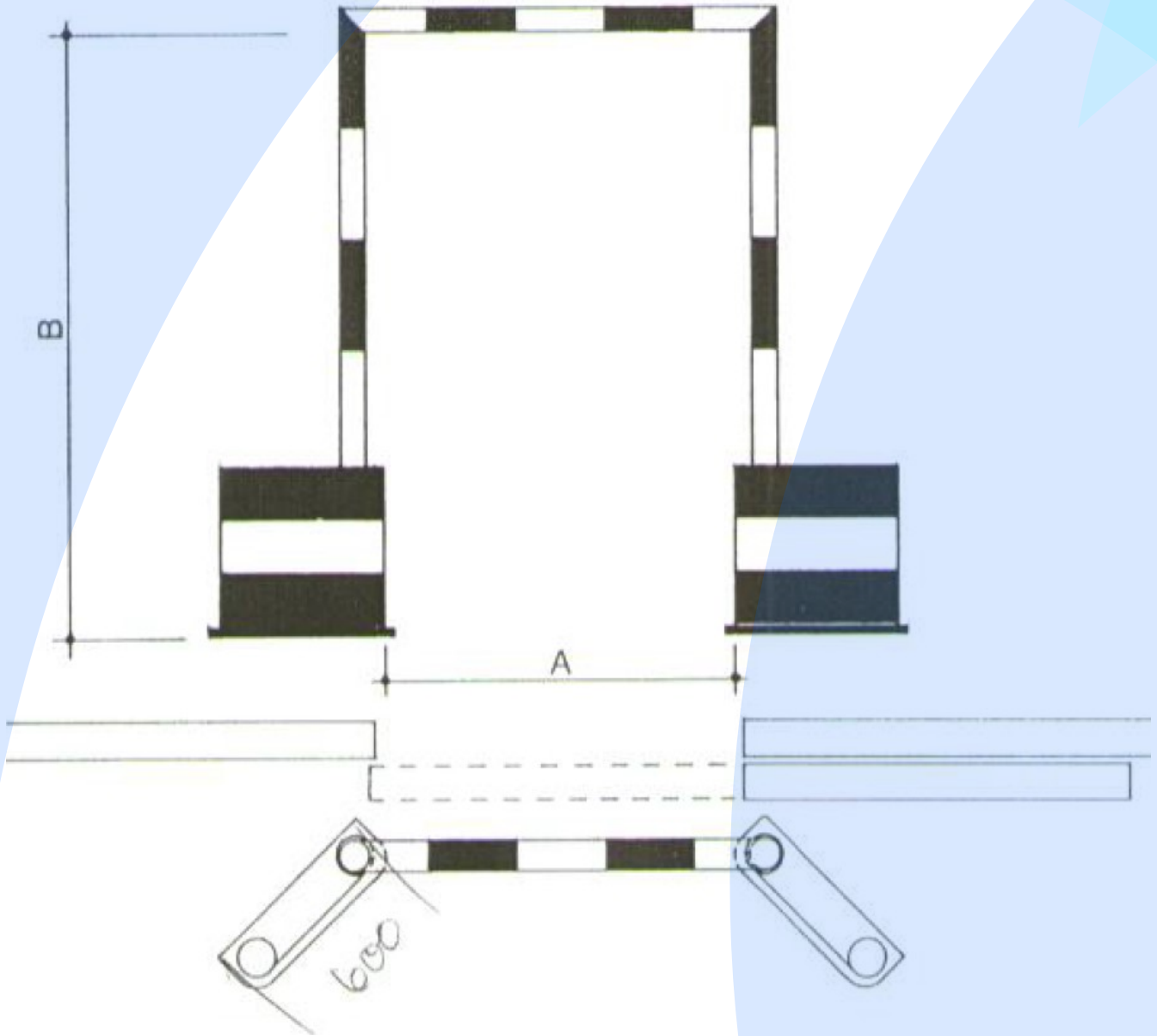

c/w 1 off Goalpost with Side Guides – O/D 88.9 CHS
 Side guides fitted to the 1mtr high 168 CHS tube bollards—made from 3mm Durbar plate
 All with 10mm base plates and supplied with
 16P130 Parabolts. All powder coated black & painted hazard yellow.

Number of Goalposts	A	B	C
Number of internal Bollards			

Contact our sales team for more information on any of our range of products.



Hemmings Way, Off Stoney Lane,
 Rainhill, Prescot, Merseyside L35 9ND
www.maxmade.com sales@maxmade.com
 Telephone: 0151 430 9797
 Fax: 0151 493 1320

Bollards

USES:

- Protect Door Ways
- Protect Machinery
- Prevent vehicle access.
- Security

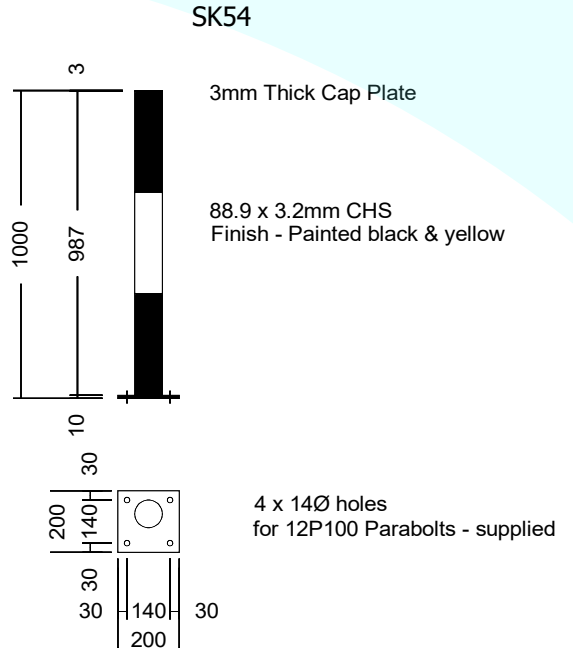
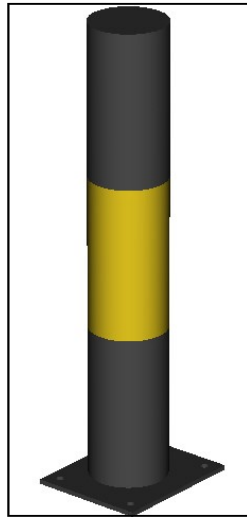
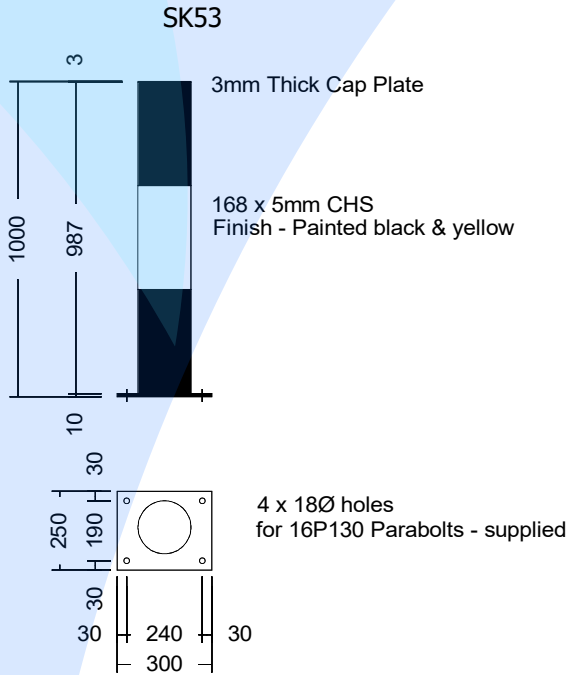

The SK54 & SK53 Bollard Range.

These one meter high bollards which can be ordered with bolt down base plates—or for fitting into concrete, are Maxmade Limited’s standard range of bollard protection.

Bollards can be made to order in various materials, heights and sizes, with different types of caps to suit, such as open ended to allow concrete in-fill, and sloped or domed tops.



FEATURES:

- Tried, tested and proven system to protect people, property and provide security.
- Can be used indoors and outdoors.
- Standard Bollards come in a powder coated finish with painted hazard yellow strip.
- Versatile—posts can bolted or set in concrete.
- Bollards are available in powder coated finishes of different colours, as well as galvanised and stainless finishes
- Bollards can be made to different heights, and different sized tube and tops to suit individual requirements.

SK53 Bollard

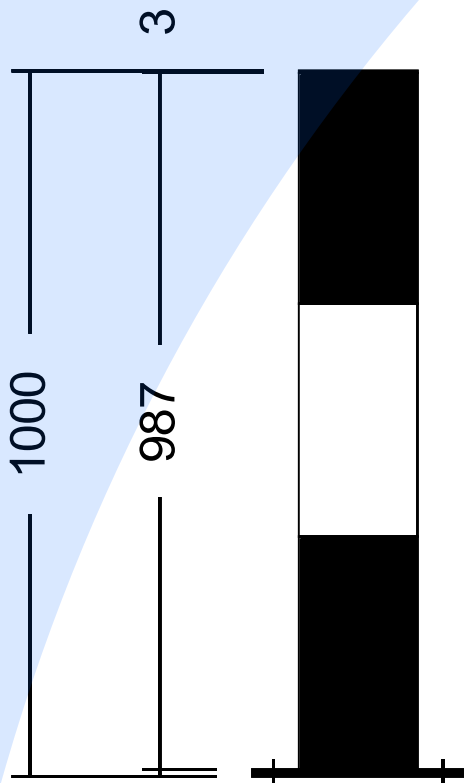

3mm Thick Cap Plate

168 x 5mm CHS
Finish - Painted black & yellow

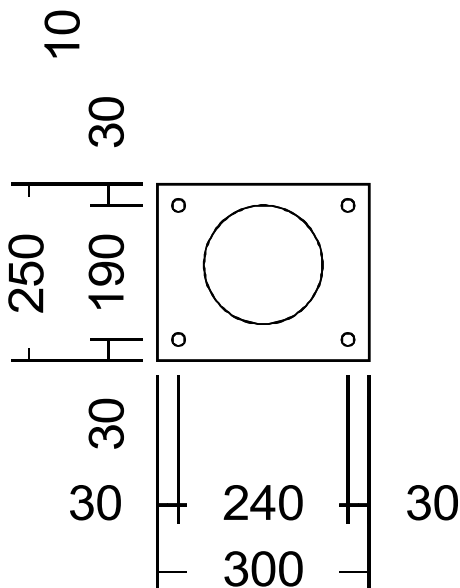

4 x 18Ø holes
for 16P130 Parabolts - supplied

Contact our sales team for more information on any of our range of products.



Hemmings Way, Off Stoney Lane,
Rainhill, Prescot, Merseyside L35 9ND
www.maxmade.com sales@maxmade.com
Telephone: 0151 430 9797
Fax: 0151 493 1320

SK54 Bollard

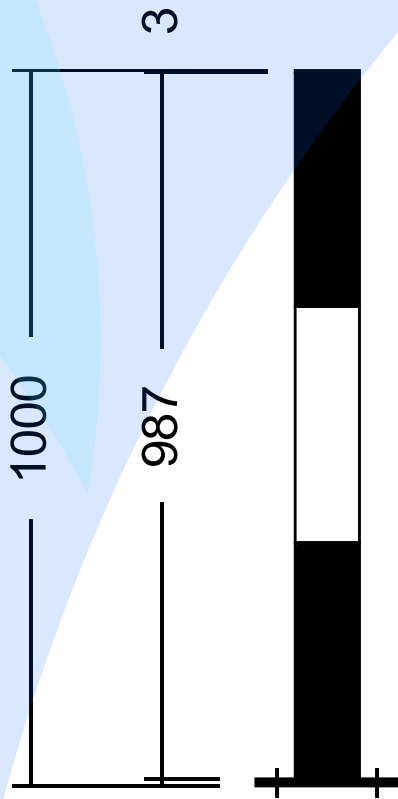

3mm Thick Cap Plate

88.9 x 3.2mm CHS
Finish - Painted black & yellow

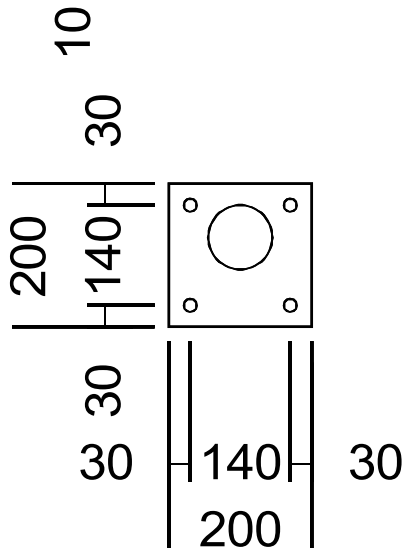

4 x 14Ø holes
for 12P100 Parabolts - supplied

Contact our sales team for more information on any of our range of products.



Hemmings Way, Off Stoney Lane,
Rainhill, Prescot, Merseyside L35 9ND
www.maxmade.com sales@maxmade.com
Telephone: 0151 430 9797
Fax: 0151 493 1320

Kerbs and Low Level Wall Protection

USES:

- Protect Walls and Doors from traffic damage.
- Highlight Storage areas.
- Protect Machinery

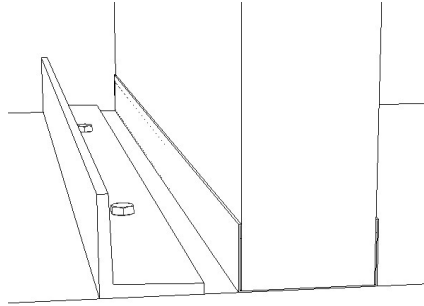

Kerb angle:

Common size for this wall protection is 100x200 in 10mm Galvanised finish. Holes are staggered along length for anchor fixings. Can be supplied with corners and radius ends.

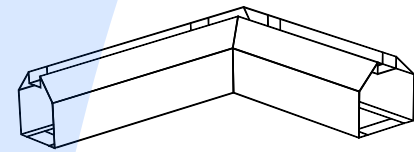
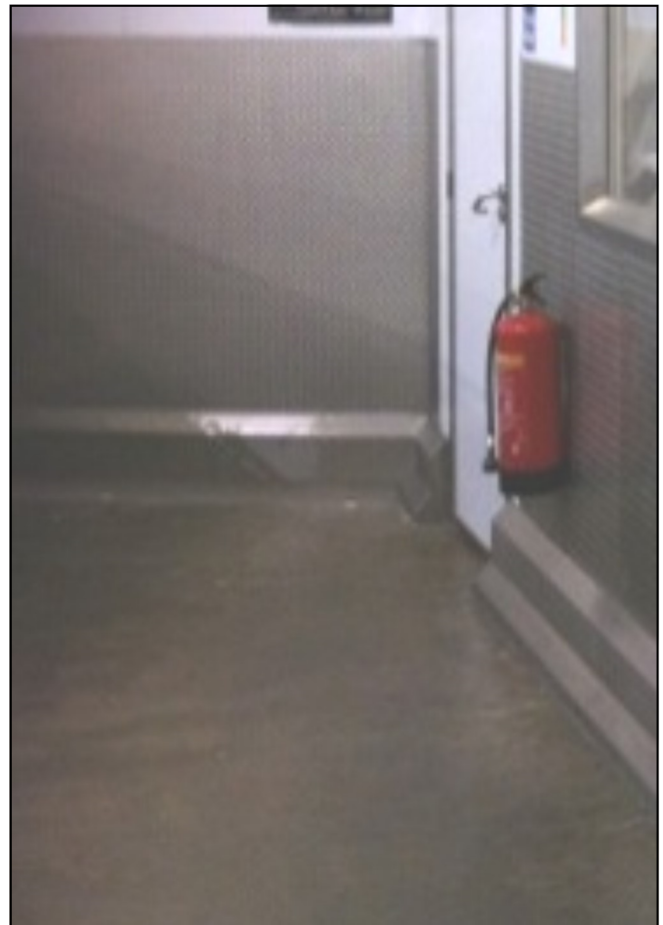
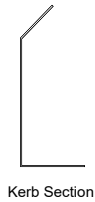
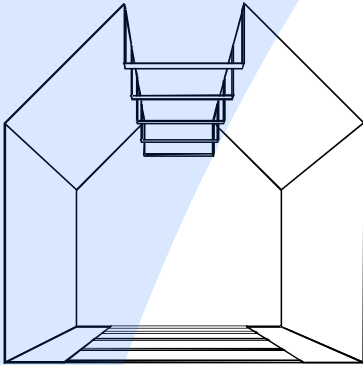

Kerb wall protection:

Photo above and to the right show a stainless steel double kerb section,. Added protection to the walls is given by the sheet overlay on the panels using 6WL pattern stainless.



Low level tubular protection System.

Often used in food preparation areas, made in stainless, as well as offering wall support, these are often used around machinery to prevent damage.

FEATURES:

- Tried, tested and proven system to protect people and property .
- Kerb section and low level protection rails can be made from painted steel, galvanised steel, or stainless materials.
- Kerb angle can be produced with corners and radius ends, to allow back filling of concrete for extra protection.
- Kerbs can be made to various sizes and gauges to suit application.