

---

2023-2024  
MYLaw High School Mock Trial  
Case & Competition

Parker Harper v. Dakota Reese



We would like to acknowledge our deep appreciation for our talented MYLaw Mock Trial Committee which includes the Honorable Erik Atas, Mike Baruch, Esq., Ben Garmoe, Esq. & Daniel Moore, Esq.

A very special thank you to the Honorable Erik Atas who authored this case.

We would also like to thank Marion "Benny" Buttion and Emily Perison, Esq. for their contributions that greatly enhanced the depth and accuracy of this year's case.

With gratitude to the Maryland Judiciary & Legal Profession

[www.mylaw.org](http://www.mylaw.org)  
[Facebook.com/mylaw.org](https://Facebook.com/mylaw.org)  
[Instagram.com/mdyouthlaw](https://Instagram.com/mdyouthlaw)

---

## **Important Contacts for the Mock Trial Competition**

Please call your local coordinator for information about your county/circuit schedule.

Your second point of contact is the State Mock Trial Coordinator:

---

### **Circuit 1—Dorchester, Somerset, Wicomico, Worcester**

### **Circuit 2—Caroline, Cecil, Kent, Queen Anne’s, Talbot**

Ms. Jennifer Sills  
410-430-9127  
[jsills@worcesterk12.org](mailto:jsills@worcesterk12.org)

Mr. James K. Welch, Esq.  
443-397-3280  
[kwelch@wicomicocounty.org](mailto:kwelch@wicomicocounty.org)

### **Circuit 3—Baltimore, Harford**

Dr. Dani Biancolli (Baltimore)  
443-809-4017  
[dbiancolli@bcps.org](mailto:dbiancolli@bcps.org)

Ms. Carol Rook (Baltimore)  
443-809-4017  
[crook@bcps.org](mailto:crook@bcps.org)

Ms. Erin Lange (Harford)  
410-588-5223  
[Erin.Lange@hcps.org](mailto:Erin.Lange@hcps.org)

### **Circuit 4—Allegany, Garrett, Washington**

Mr. Brian White  
301-697-2429  
[brian.white@acpsmd.org](mailto:brian.white@acpsmd.org)

### **Circuit 5—Carroll, Howard, Anne Arundel**

Ms. Eve Case (Anne Arundel)  
(301) 539-9145 (Google Voice)  
(410) 222-5440 (Office)  
[ecase@aacps.org](mailto:ecase@aacps.org)

Ms. Melissa Montgomery (Howard)  
410-313-3141 (office)  
301-466-4315 (cell)  
[mmontgomery@howardcountymd.gov](mailto:mmontgomery@howardcountymd.gov)

Ms. Kelli McDonough (Howard)  
410-313-2856 (school)/ 215-837-3424 (cell)  
[Kelli\\_McDonough@hcpss.org](mailto:Kelli_McDonough@hcpss.org)

Mr. Ryan Melhorn (Carroll)  
410-386-1688  
[rtmelho@carrollk12.org](mailto:rtmelho@carrollk12.org)

Ms. Jennifer McDonald (Carroll)  
410-751-3096 (voice)  
[JenniferMcDonald@carrollk12.org](mailto:JenniferMcDonald@carrollk12.org)

### **Circuit 6—Frederick, Montgomery**

Ms. Colleen Bernard (Frederick)  
301-644-5256  
[Colleen.Bernard@fcps.org](mailto:Colleen.Bernard@fcps.org)

Ms. Jessica McBroom (Frederick)  
240-236-7748  
[Jessica.McBroom@fcps.org](mailto:Jessica.McBroom@fcps.org)

Mr. Timothy Short (Montgomery)  
240-740-2437  
[Timothy\\_Short@mcpmsmd.org](mailto:Timothy_Short@mcpmsmd.org)

### **Circuit 7—Calvert, Charles, Prince George’s, St. Mary’s**

Ms. Ashley Nadasky  
301-753-1759  
[anadasky@ccboe.com](mailto:anadasky@ccboe.com)

### **Circuit 8—Baltimore City**

Justin Dickman, Esq.  
240-888-6546  
[Jdickman@stattorney.org](mailto:Jdickman@stattorney.org)

Judge Erik Atas  
410-396-4916 (office)  
[erik.atas@mdcourts.gov](mailto:erik.atas@mdcourts.gov)

---

#### Important Dates:

Team rosters must be submitted by December 22nd.

Circuit Champions must be declared by March 1st.

Regional Competitions: March 11th & 12th/ snow dates: March 13th and 14th

Semi-Finals: Thursday, March 21st

State Championship: Friday, March 22nd

---



October 31, 2023

BOARD OF DIRECTORS

Hon. Erik Atas  
*Chairperson*  
*Circuit Court of Baltimore City*

Sara H. Arthur, Esq.  
*Vice Chairperson*  
*Arthur Law Group*

Alice S. Chong  
*Attorney at Law*

Natasha Dartigue  
*Maryland Public Defender*

Aaron De Graffenreid  
*Office of the City Solicitor*

Benjamin Garmoe  
*Salsbury Director of Trial Advocacy,*  
*National Trial Team*

Barry L. Gogel  
*Rifkin Weiner Livingston, LLC*

Stephen Pfaffenhauser  
*T. Rowe Price*

Nate Risch  
*Mann & Risch*

Dear Coaches, Advisors and Students:

Welcome to a new school year and to the 2023-24 MYLaw Mock Trial Competition! It takes a small army of volunteers to facilitate this program each year; thank you to all who have a hand in helping Mock Trial run smoothly throughout Maryland. We know there are many of you — coaches, advisors, parents, attorneys, judges and the many unsung heroes who didn't make the list but have our appreciation nonetheless.

As you might expect, at least if you participated in last year's Mock Trial, this year's competition involves a civil case—specifically, a damages case involving two neighbors. While many neighborhoods are tight-knit, neighbor disputes are quite common. In fact, 42% of homeowners have engaged in some sort of neighborhood dispute.

According to FindLaw, neighbor disputes are most often triggered by:

- Noise, which accounts for 48% of all disputes; whether it's late-night unruly parties or different sleep schedules, noise is the number 1 way to annoy your neighbor.
- Pets and animals, which account for 29% of all disputes; this can be slightly trickier since it is often the behavior of the animal which must be managed by the owner.
- A combination of children's behavior, property's appearance, and property's boundaries, among other miscellaneous items.

So, how do neighbors ultimately go about resolving these disputes? Nearly half—49%—say they've gone with a direct approach and discussed the issue directly with their neighbor. Another 27% have called the police, even if an actual crime hasn't been committed. And more than 10% have chosen to write a letter or email directly to their neighbor to tackle the issue. The others, you ask? It appears they may act a little more perilously. And while they may think they're being "creative," a seemingly simple decision, made out of impulse and emotion, can unintentionally create far more problems than it solves.

As always, we hope you enjoy the case, learn a great deal, and love your experience! Please take the time to read through the entire casebook, as rules and procedures change from year to year. We appreciate you sharing your time with us, and wish you much success in this year's competition.

My Warmest Regards,

Shelley Brown  
Executive Director

# Thank you, 2023-24 Mock Trial Sponsors & Donors!

This competition would not be possible without the following supporters. Mock Trial is funded by the sponsors below and school registration fees.

## Platinum

The Honorable Charles J. Peters

## Gold

The Daily Record

Pessin Katz Law

## Silver

Anonymous Donor

Potter Burnett

## Associates

Annie Anthony

Center for Immigration Studies

Richard Dean

Heather Getzloff

Barry L. Gogel, Esq.

Thomas Kenney

Mary Ellen McEnroe

Tonda Price

Dorothy Reiser

Lora Ries

Constance Ridgway

Madolyn Robertson

Laura Walker

Mark Williams

Terri Woodward

Quay & Tim Wolfe

**TABLE OF CONTENTS**

I. Competition Rules	1
II. Mock Trial Procedures	9
III. Rules of Evidence	12
IV. Objections	20
V. Complaint	22
VI. Answer	24
VII. Stipulations	25
VIII. Verdict Sheet	27
IX. Civil Pattern Maryland Jury Instructions	28
<b>Witnesses for the Prosecution</b>	
Affidavit of Parker Harper, Witness for the Plaintiff	34
Vale Taylor, Witness for the Plaintiff	38
Transcript of July 25, 2023 Trial of State of Maryland v. Dakota Reese	39
Affidavit of Dr. Chris Morgan, Expert Witness for the Plaintiff	48
<b>Witnesses for the Defendant</b>	
Affidavit of Dakota Reese, Witness for the Defense	50
Affidavit of Whitney Jones, Witness for the Defense	53
Affidavit of Dr. Dylan Avery, Expert Witness for the Defense	55
<b>Evidence and Exhibits</b>	
EXHIBIT 1: Initial Visit – Ouch Chiropractic	56
EXHIBIT 2: Follow Up Visit – Ouch Chiropractic	58
EXHIBIT 3: Final Visit – Summary Report	59
EXHIBIT 4: Parker Harper Invoice	60
EXHIBIT 5: Dylan Avery AVERY, M.D., Independent Medical Review	63
EXHIBIT 6-7: Photos of Notes	65
EXHIBIT 8: Tweet	66
EXHIBIT 9-17: Photos of Ladder/Ladder Shoes	66
EXHIBIT 18: USB Photo	71
EXHIBIT 19: Map of Neighborhood	72
EXHIBIT 20-23: Aerial Views of Neighborhood	73
EXHIBIT 24: Photo of Vale Taylor’s Home	75
EXHIBIT 25-26: Close-Up Photos of Vale Taylor’s Home	75
EXHIBIT 27-30: Photos of Vale and Dakota’s Homes and the surrounding area	76
EXHIBIT 31: Photo of Stop Sign at Intersection	78
EXHIBIT 32: Photo of the Front of Whitney Jones’ Bronco	79
EXHIBIT 33: Photo of Rear of Parker’s Camry	79
EXHIBIT 34: Pain Chart	80
EXHIBIT 35: Over the Counter Ibuprofen Information	80
EXHIBIT 36: Spine Sections Diagram	81
EXHIBIT 37: Trapezius Muscles Diagram	81
EXHIBIT 38: Spine Anatomy Diagram	81
EXHIBIT 39: Image of Trapezius Muscles in Relation to Spinal Column	82
EXHIBIT 40: Image of Biofreeze Bottle	83
EXHIBIT 41: Biofreeze Instructions	83
<b>Appendices</b>	
Score Sheet	84
Rubric	85
Time Keeper Sheet	87
Notes	88

## I. GENERAL COMPETITION RULES

### 1. GENERAL

**1.1. Applicability.** These rules shall apply to all MYLAW Mock Trial competitions. Participants are cautioned that the absence of enforcement of any rule within the local circuit competition does not mean the rule will not be enforced at the Regional, Semi-Final, and/or State competition.

**1.2. Diversity and inclusion.** MYLAW has a policy of inclusion, and welcomes all participants regardless of race, color, religion, gender, sex, sexual orientation, gender identity, national origin, age, disability, ancestry, genetic information, or any other category protected by federal, state or local law.

**1.3. Expectation of participants, coaches, hosts and volunteers.** Ethical and professional behavior is expected at all times during all phases of the MYLAW Mock Trial Competition. MYLAW prohibits discrimination, retaliation, or harassment in all its forms, by any individual or team. Inappropriate behavior includes but is not limited to:

- Discriminatory comments based upon any ground listed in 1.2;
- Failure to show respect;
- Violating any of the rules outlined within the casebook;
- Adhering strictly to the “No Coaching” rule;
- Engaging in irresponsible behavior that puts oneself or others at risk, including intoxication at any time during competitions;
- Illegal conduct of any sort.

**1.4. Ideals of MYLAW Mock Trial.** To further understanding and appreciation of the rule of law, court procedures, and the legal system; to increase proficiency in basic life skills such as listening, speaking, reading, and critical thinking; to promote better communication and cooperation between the school system, the legal profession, and the community at large; and to heighten enthusiasm for academic studies as well as career consciousness of law-related professions.

**1.5. Integrity.** Individuals, teams, coaches and volunteers shall at all times demonstrate the highest standard of ethical conduct, courtesy, legal professionalism, competence and integrity.

**1.6. Damage to property.** No participant shall intentionally take, move, or cause damage to any property of any school, courthouse, or facility hosting any part of a MYLAW Mock Trial competition.

### 2. ROLES

**2.1. Teacher Coach.** The team’s teacher coach is considered the primary contact for each school. The Coach’s primary responsibility is to demonstrate that winning is secondary to learning.

a. Coaching goals. The Teacher Coach shall coach and mentor students about the “real world” aspects of judging in competitions; including but not limited to competition rules, sportsmanship, team etiquette, procedures, and courtroom decorum.

b. Coaches’ responsibilities. The Teacher Coach shall recruit students for the team; arrange practice sessions and scrimmages; coordinate transportation to and from competitions; supervise the team during practices and competitions; work within the school and greater community to recruit an attorney advisor; communicate with opposing teams prior to competition regarding any relevant issues including the identification of witnesses; and ensure that the team arrives at all scheduled

mock trial competitions. Every coach has an obligation to instill by example in every student, respect for Judges, officials and other members of the MYLAW Mock Trial community.

**2.2. Circuit Coordinator.** Maryland is divided into eight judicial circuits. For the purpose of the Maryland Mock Trial Competition, local competitions will be divided and organized according to the eight judicial circuits. Each circuit shall have a Circuit Coordinator, who will serve as the primary contact for coaches and advisors. Circuit Coordinator contact information is listed on the inside front cover of this book.

MYLAW will send official communication to the Circuit Coordinator who is then responsible for disseminating the information to all Teacher Coaches within their respective circuit. The Circuit Coordinator shall make decisions or mediate at the local level when problems or questions arise; establish the circuit competition calendar; arrange for courtrooms, Judges, and attorneys for local competitions; and arrange general training circuit-wide or county-wide sessions if necessary.

**2.3. Local and State Bar Associations.** The Bar Associations shall advocate involvement of local attorneys in advising teams and hearing/scoring trials.

**2.4. Attorney Advisors.** It is the role of the Attorney Advisor to teach basic court processes and procedures, to review and explain modified rules of evidence and their application to the case at hand, and most importantly, to exemplify fairness, professionalism, integrity, and the ideals of the American justice system. In the absence of an Attorney Advisor, these responsibilities become that of the Teacher Coach.

**2.5. MYLaw.** MYLaw shall provide Mock Trial Guides and rules for the State competition; disseminate information to each circuit; provide technical assistance to Circuit Coordinators; provide certificates to all registered participants who compete for the season; assist in recruitment of schools; and act as liaison in finding legal professionals to assist teams.

### **3: REGISTRATION AND PAYMENT**

**3.1. Registration information.** Registration information is available on the MYLAW.org website. Registration may be completed online or by mail.

**3.2. Team Payment.** Payment is expected by the registration deadline. Payments may be made by check or submitted through the PayPal link found on the MYLAW.org website. An invoice is available on the MYLAW.org website for your convenience.

**3.3. Primary Contact/Teacher Coach.** Each school must have a primary contact person, in most cases the Teacher Coach, in order to register. The Teacher Coach shall be the person MYLAW and/or the Circuit Coordinator communicates with when applicable. All primary contact persons' information shall be current, and shall be listed on the registration form at the time of registration. If a teacher is not available to serve as the primary contact, a parent, administrator or other school affiliate may do so with the permission of the school principal.

### **4. TEAMS**

**4.1. Team make-up.** A team must be comprised of no fewer than eight (8) but a maximum of twelve (12) student members from the same high school, with the exception of high schools with a Maryland State Department of Education inter-scholastic athletics designation of Class 2A or Class 1A, which may combine with any other schools in the LEA in those classifications to field a team.

- a. Two “alternate” students are permitted during the local competition only. If a coach wishes to carry those two alternates forward to state competitions, any related expenses are the responsibility of the school.
- b. If a team advances beyond the local competition, an official roster must be submitted not to exceed twelve (12) students and two (2) alternates.

**4.2. Team Roles.** Teams may use its members to play different roles in different competitions.

- a. For any single competition, all teams are to consist of three attorneys and three witnesses, for a total of six (6) different students.
- b. Note: In Circuits 1 and 2, where teams typically participate in two competitions per evening – once as the prosecution and once as the defense – students may change roles for the second competition.

**4.3. Fielding teams.** High schools that field two or more teams shall not, under any circumstances, allow students from Team A to compete for Team B or vice-versa.

- a. Each team must have its own Teacher Coach and Attorney Advisor, separate and apart from the other team.
- b. If a high school has multiple teams, then those teams must compete against one another during the local competition.

**4.4. Team Information.** Teacher Coaches of competing teams are to exchange information regarding the names and gender of their witnesses at least 24 hours prior to any given round.

- a. Teacher Coach for the plaintiff/prosecution should assume responsibility for informing the defense Teacher Coach.
- b. A physical identification of all team members must be made in the courtroom immediately preceding the trial.

**4.5. Attorney Advisor.** Every effort should be made for teams to work with an Attorney Advisor to effectively prepare for competition.

**4.6. Attendance of an opponent’s competition is prohibited.** Members of a school team entered in the competition, including Teacher Coaches, back-up witnesses, attorneys, and others directly associated with the team’s preparation, shall not attend the enactments of any possible future opponent in the contest.

## **5. COMPETITION**

**5.1. Forfeits are prohibited.** All registered teams agree to attend all scheduled competitions.

- a. Team with inadequate number of students (i.e. due to illness, athletics, or other conflicts), are expected to attend and participate in the competition, regardless.
- b. In these instances, a team will “borrow” students from the opposing team, in order to maintain the integrity of the competition, and respect for the Court, Presiding Judge, attorneys and the other team that has prepared for, and traveled to, the competition.
- c. The competition will be treated as an automatic win for the opposition.
- d. Coaches should make every effort to notify the local coordinator and the other coach in advance of the competition if there are an inadequate number of team members.
- e. When an opposing team does not have enough students to assist the other team, students may depict two or more of the roles (i.e. they may depict 2 witnesses or play the part of 2 attorneys).



**5.2. Local competitions.** Local competitions must consist of enough matches that each participating high school presents both sides of the Mock Trial case at least once.

**5.3. Areas of competition.** Areas of competition coincide with the eight Judicial Circuits of Maryland.

Circuit #1: Worcester Wicomico, Somerset Dorchester	Circuit #2: Kent, Queen Anne’s, Talbot, Caroline	Circuit #3: Baltimore Co., Harford (Cecil has been adopted into Ct.3)	Circuit #4: Allegany, Garrett, Washington
Circuit #5: Anne Arundel, Carroll, Howard	Circuit #6: Frederick, Montgomery	Circuit #7: Calvert, Charles, Prince George’s, St. Mary’s	Circuit #8: Baltimore City

**5.4. “Unofficial” Circuit.**

- a. Each circuit must have a minimum of four teams. Circuits that have less than four teams must abide by the following:
  1. If a circuit has up to three teams but less than the required minimum of four participating teams, the teams may compete in a “Round Robin” that advances the winner to the competition that determines circuit representative. The runner-up team from another circuit would then compete with the circuit representative in a playoff prior to the Regional Competition (see chart in 5.4).
  2. Or, when a circuit has less than four registered team, MYLAW may designate another circuit in which these teams will compete. Geographic location will be the primary factor in making this determination.
  3. Or, under the discretion of a circuit coordinator and MYLAW, if a circuit chooses, it may combine with the “un-official” circuit to increase the number of opportunities to compete.
- b. When a “circuit opening” arises, it will be filled by a sequential rotation of circuits. The second-place team from the specified circuit will advance to the regional competitions to fill the opening. If the team is unable to advance, the opportunity will move to the next circuit, and so on, until the opening is filled. In the event that all circuits are officially comprised of a minimum of four teams, the designated circuit will remain the next in-line to advance in future years.

2023-2024	Circuit 5	2027-2028	Circuit 1/2
2024-2025	Circuit 6	2028-2029	Circuit 3
2025-2026	Circuit 7	2029-2030	Circuit 4
2026-2027	Circuit 8	2030-2031	Circuit 5

**5.5. Circuit Competition.** Each competing circuit shall declare one team as Circuit Champion by holding a local Mock Trial playoff competition. The Circuit Champion shall be declared by the date set forth in this casebook. It is at the discretion of the Circuit Coordinator(s) and MYLaw as to the process by which the champion is declared, particularly if there is more than one county in the circuit.

**5.6. Rendered decisions.** Attorneys and Judges may preside over, and render decisions, for all matches. If possible, a Judge from the Court of Appeals or Court of Special Appeals will preside over, and render a decision at the State Finals.

**5.7. Regional/ Quarterfinal Competitions.** Each Circuit Champion will compete against another Circuit Champion in a single competition, in order to determine which team advances to the Final Four.

**5.8. Dates for MYLAW Final Competitions.** Dates for the Regionals, Semi-Finals, and Final competitions will be set by MYLAW and notice will be given to all known participating high schools. Teams that enter into the current year's competition agree to participate on all scheduled dates of the competition as set forth on the MYLaw website and their local Coordinator.

**5.9. Declared winner of the Regional Competition must agree to participate on the scheduled dates for the remainder of the competition or be eliminated.** Any team that is declared a Regional Representative ("Circuit Champion") must agree to participate on the dates set forth for the remainder of the competition. Failure to do so will result in the team's elimination from the competition and the first runner-up in that circuit will then be the Regional Representative under the stipulations.

## **6. JUDGING AND SCORING**

**6.1. The Mock Trial Scoring Scale.** The scoring scale has been changed from 1-5 to 1-10 in order for judges to better discern between teams' performances. A rubric is provided so that scorers may utilize consistent criteria for purpose of evaluation.

**6.2. Reserved, with information to be provided at a later date.**

**6.2. All Judges' decisions are final.** Appeals are not allowed. MYLaw retains the right to declare a mistrial in the event of a gross transgression of the organizational rules and/or egregious attempt to undermine the intent and integrity of the Mock Trial Competition.

## **7. DIRECTLY PROHIBITED**

**7.1. No coaching.** There shall be no coaching of any kind during the enactment of a mock trial:

- a. Student Attorneys may not coach their witnesses during the other team's cross examination;
- b. Teacher and Attorney Coaches may not coach team members during any part of the competition;
- c. Members of the audience, including members of the team who are not participating that particular day, may not coach team members who are competing;
- d. Except for the express purpose of keeping time, team members must have their cell phones and all other electronic devices turned off during competition as texting may be construed as coaching.
- e. Teacher and Attorney Coaches shall not sit directly behind their team during competition as any movements or conversations may be construed as coaching.

**7.2. Notice of team demographic information is prohibited.** Team members or other affiliated parties, shall not, before or during the trial, notify the Judge of the students' ages, grades, school name or length of time the team has competed.

**7.3. Attendance of an opponent's competition is prohibited.** Members of a school team entered in the competition, including Teacher Coaches, back-up witnesses, attorneys, and any others directly associated with the team's preparation, shall not attend the enactments of any possible future opponent in the contest.

**7.4. Use of Electronics.** The use of electronics (phone, laptop, iPad, etc.) is completely prohibited, except for:

- a. the express purpose of keeping time, and
- b. playing Exhibit 18 during the trial.

## **8. GENERAL TRIAL PROCEDURES**

**8.1 Time limits.** Each team must complete its presentation within forty-two (42) minutes.

- a. Each side has a combined total time of forty-two (42) minutes for direct examination, cross examination, re-cross/re-direct and voir dire (if permitted);
- b. Opening statements and closing arguments are five (5) and seven (7) minutes respectfully and are not included in the forty-two (42) minutes permitted under 8.1a.
- c. The “clock” will be stopped during objections (including any arguments related to those objections), bench conferences, the setting up of demonstrative exhibits prior to the examination of a witness (where such activity is permitted by the presiding Judge) and court recesses;
- d. There is no objection permitted by any party based on the expiration of time.

**8.2 Use of a Bailiff.** Each team is mandated to have a non-competing Mock Trial team member serve as a Bailiff during the course of each competition.

- a. Each Bailiff will keep time for the opposing counsel. The two Bailiffs will sit together in a place designated by the presiding Judge separate from the contending teams. Bailiffs from the two teams will work together collaboratively to ensure the accuracy of their records;
- b. In the event that only one team brings a Bailiff, that person shall keep time for both sides;
- c. The Bailiff(s) will also announce the Judge, call the case, and swear in each witness;
- d. While the use of a Bailiff is discretionary (by circuit) during local competitions, it is mandated in state competitions.
- e. Each Bailiff shall have two stopwatches, cellphones, or other timing devices. The second timepiece is intended to serve as a backup device. *Note - cellphones should be employed for the purposes of timekeeping only, with the expressed consent of courthouse officials.*
- f. Each Bailiff shall have visual displays (e.g. cards or pieces of paper) of numbers counting down from 42 in 10-minute intervals, (for example, 40, 30, 20, 10, etc.). At the final 3-minute mark, the Bailiff will begin counting down on the minute (3, 2, 1, 0). As each interval elapses in a team’s presentation, the Bailiff will quietly display to both teams and to the presiding Judge, the time-card corresponding to the number of minutes remaining. When the number zero is displayed, the presiding Judge will announce that the team’s presentation is concluded. Teams may ask the presiding Judge for courtesy time to complete a presentation, but the extension of courtesy time is intended to permit a team to complete a sentence or thought. It should not extend beyond 15 seconds.

**8.3 Student Attorneys.**

- a. Roles. The Student Attorney who directly examines a witness is the only attorney who may raise objections when that same witness is being cross-examined. The student attorney who raises objections on direct examination must be the same attorney who then cross-examines that same witness. This same principle applies if a Student Attorney calls for a bench conference; i.e., it must be the attorney currently addressing the Court. The student attorney who handles the opening statement may not perform the closing argument.
- b. Addressing the Court. When addressing the Judge, always stand.
- c. Attire. Professional attire, or attire appropriate for the witness’ roles, should always be worn during competition.

**8.4 Evidentiary Materials.** Any materials that have been modified for use during trial, must be made available during the trial for the opposing team's use. Before trial commences, you must alert the other team if you plan to use a demonstrative and/or enlargements.

Teams are permitted to use one (1) demonstrative and an unlimited number of enlargements during trial.

**Demonstrative** is defined as any visual or object that presents information from the case in an alternative format. Examples may include, but are not limited to: a timeline of events, a chart displaying data in a visually useful format, or a physical item used to illustrate an analogy. Demonstratives are subject to the invention of fact rules and must never invent material facts not contained within the case materials. Teams are free to write or mark on demonstratives during trial, but such markings must not deface or destroy the demonstrative.

**Enlargement** is defined as an exact copy of evidence from the provided case materials, enlarged for use during trial. Teams are permitted to remove markings like exhibit labels or page numbers, but must not make any additional modifications to enlargements prior to trial. If an enlargement has been changed from the original in any material way, it qualifies as a team's one (1) demonstrative. Teams are free to write or mark on enlargements during trial and this does not qualify as a demonstrative, but such markings must not deface or destroy the enlargement.

Use of demonstratives and enlargements during trial is at the discretion of the presiding judge. All demonstratives and enlargements must be made available to the opposing team for use at any time during trial. Demonstratives and enlargements must be no larger than 24" x 36".

**Disputes.** Any disputes about whether something constitutes an enlargement or a demonstrative shall be resolved by ruling of the presiding judge. This decision is final and no team may raise a protest because they disagree with the presiding judge's ruling over whether something is an enlargement or a demonstrative. If a team knowingly attempts to use multiple demonstratives under this rule, the opposing team may raise a protest to the tournament organizers. Knowingly using multiple demonstratives in violation of this rule may result in sanctions including warnings, loss of points, and/or loss of ballots.

**8.5 Case in Chief.** Both teams shall conduct a direct examination of exactly three witnesses. Each team must cross examine all witnesses called by the other side. In the event a team chooses not to conduct a cross examination or does not have time remaining for a cross examination, the attorney shall receive a score of 0 for cross, and the witness shall receive a score of 10 on cross. In the event a team does not have time to conduct a direct examination, the directing attorney and the witness shall receive a score of 0 for direct examination, but the opposing team is still required to conduct a cross examination, and the crossing attorney and the witness should be scored normally on cross.

## **9. INVENTION OF FACT**

This rule shall govern the testimony of all witnesses. Mock Trial competitors shall advocate as persuasively as possible based on the facts contained in the casebook. Teams must rely on the facts as stated in the case rather than creating new facts or denying existing facts in order to benefit their parties.

**9.1. Judges' scoring.** If a team demonstrates through impeachment that its opponent has made an Improper Invention, judges should reflect that violation in the scores by penalizing the violating team, rewarding the impeaching team, or both.

**9.2. Improper Invention.** There are two types of Improper Invention: 1) Any instance in which a witness introduces testimony that contradicts the witness's affidavit and/or 2) Any instance on direct or redirect in which an attorney offers, via the testimony of a witness, material facts not included in or reasonably inferred from the witness' affidavit.

*Facts are material if they affect the merits of the case. Facts are not material if they serve only to provide background information or develop the character of a witness.*

*A reasonable inference must be a conclusion that a reasonable person would draw from a particular fact or set of facts contained in the affidavit. An answer does not qualify as a “reasonable inference” just because it is consistent with the witness affidavit.*

*For the purposes of Rule 9, an affidavit includes the witness’ sworn statement, as well as any document in which the witness has stated their beliefs, knowledge, opinions or conclusions.*

**9.3. Trial Remedy for Violations.** If the cross-examining attorney believes the witness has made an Improper Invention, the only available remedy is to impeach the witness using the witness’s affidavit. Impeachment may take the form of demonstrating either (1) an inconsistency between the witness’s affidavit and trial testimony (“impeachment by contradiction”) or (ii) that the witness introduced material facts on direct or redirect that are not stated in or reasonably inferred from the witness’s affidavit (impeachment by omission”). The cross-examiner is not permitted to raise an objection to the Judge on the basis of “invention of fact.”



**POTTER • BURNETT**

A T T O R N E Y S   A T   L A W

## II. MARYLAND MOCK TRIAL PROCEDURES

### I. Courtroom Set-Up

- a. Plaintiff/Prosecution will sit closest to the jury box.
- b. Defense will sit on the side of the courtroom that is farthest from the jury box. This is based on the premise that the defendant is innocent until proven guilty, and so is removed (as far as possible) from the scrutiny of the court.
- c. The Bailiff will sit in either i) the jury box, ii) the court reporter's seat, or iii) in another seat so designated by the judge, that is equally visible to both parties.

### II. The Opening of the Court and the Swearing of Witnesses (5 minutes maximum)

- a. The Bailiff for the Prosecution/Plaintiff will call the Court to order through the following steps:
  1. In a loud, clear voice, say, "All rise. The Court will now hear the case of State of Parker Harper v. Dakota Reese. The Honorable \_\_\_\_\_presiding."
  2. The judge will permit those in the court to be seated, and then ask each side if they are prepared to begin.
- b. During the course of the trial, the Bailiff for the Defense shall administer the Oath (*See Rule #603*), and ask the witness to raise his or her hand: "Do you affirm to tell the truth, the whole truth, and nothing but the truth under the pains and penalties of perjury?"

### III. Opening Statement

- a. Prosecution (criminal case)/ Plaintiff (civil case)

After introducing oneself and colleagues to the judge, the prosecutor or plaintiff's attorney summarizes the evidence for the court which will be presented to prove the case. The Prosecution/Plaintiff opening statement should include a description of the facts and circumstances surrounding the case, as well as a brief summary of the key facts that each witness will reveal during testimony. The Opening Statement should avoid too much information. It should also avoid argument, as the statement is intended to provide facts of the case from the client's perspective.
- b. Defense (criminal or civil case)

After introducing oneself and colleagues to the judge, the defendant's attorney summarizes the evidence for the court which will be presented to rebut (or deny the validity) of the case which the Prosecution/Plaintiff has made. It includes facts that tend to weaken the opposition's case, as well as key facts that each witness will reveal during testimony. It should avoid repetition of facts that are not in dispute, as well as strong points of the prosecution/plaintiff's case. As with the Prosecution/Plaintiff's statement, Defense should avoid argument at this time.

### IV. Direct Examination

The Prosecution/Plaintiff's attorney conducts direct examination of each of its own witnesses. During direct exam, testimony and other evidence to prove or strengthen the Prosecution/Plaintiff's case will be presented. The purpose of direct examination is accomplish one or more of the following goals:

- a. Introduce undisputed facts – No facts or information can be considered by the judge or jury until they are placed in evidence through a witness' testimony.
- b. Enhance the likelihood of disputed facts – Direct examination is your opportunity to set forth your client's version of the undisputed facts and persuasively introduce evidence which supports that version.

- c. Lay foundation for the introduction of exhibits – Documents, photos, writings, reports or other forms of evidence will often be central to your case. In most instances, it is necessary to lay a foundation for the admission of exhibits through direct testimony of witnesses.
- d. Reflect upon the credibility of witnesses – The credibility of a witness is always an issue. For this reason, direct examinations should begin with some background information about the witness. After an introduction, the judge/jury should learn why the witness is testifying. Your job is to help the witness tell their story, through open-ended questions. But, be careful to avoid questions that elicit narrative answers.

#### **V. Cross Examination**

After the attorney for the Prosecution/Plaintiff has completed the questioning of a witness, the judge then allows the defense attorney to cross-examine the witness. The purpose of the cross-examination is to cast doubt upon the testimony of the opposing witness. Inconsistency in stories, bias, and other damaging facts may be pointed out to

#### **VI. Redirect Examination**

Redirect examination is an additional direct examination conducted following a witness' cross examination. The purpose is to allow the witness to clarify any testimony that was cast in doubt during cross examination. It is limited to the scope of the cross examination.

#### **VII. Recross Examination**

Recross examination is an additional cross examination, following a redirect. The purpose is to respond to matters that may have arisen during the re-examination of a witness. Recross can only deal with those subjects that were addressed during redirect.

#### **VIII. Voir Dire**

Pronounced "vwahr deer," and translated from French "to speak the truth." The phrase has two meanings, only one of which applies to Mock Trial. People are most commonly introduced to the term when they are called for jury duty. The judge and/or attorneys conduct voir dire to determine if any juror is biased and/or feels unable to deal with issues fairly. The voir dire that is applicable to mock trial is the process through which questions are asked to determine the competence of an alleged expert witness.

#### **IX. How to Admit Evidence**

- a. Premark the exhibit.
- b. Show it to opposing counsel.
- c. Request permission from the judge to approach the witness.
- d. Show it to the witness.
- e. Ask the right questions to establish a foundation:
  - a. I am handing you what has been marked as Exhibit X. Do you recognize this?
  - b. What is it?
  - c. Is it a fair and accurate copy?
- f. Ask the court to admit the evidence.
- g. Hand it to the judge (or clerk) to mark the exhibit into evidence.



## X. How to Impeach a Witness

Counsel can challenge the credibility of opposing witnesses by showing the judge or jury that the witness made inconsistent statement in the past and/or by demonstrating a witness is biased or has personal interest.

- a. Get the witness to repeat the wrong statement. Ask, "Is it your testimony that [insert exact quote of oral testimony if possible?]"
- b. Get the affidavit of the witness.
- c. Ask permission to approach the witness.
- d. Ask,
  - a. "Do you remember making this statement?"
  - b. "And you were under oath?"
  - c. "This is your deposition, correct?"
  - d. "And this is your signature?"
  - e. "Now read silently as I read aloud."
  - f. "I read that correctly, didn't I?"
- e. The purpose is to emphasize the disparity between the witness' current testimony and prior statement; the goal being to point out that the witness has changed their answer, *not* to give them a chance to affirm the truth of their most recent statement.

## XI. Closing Arguments

For the purposes of the Mock Trial competition, the first closing argument at all trials shall be that of the Defense.

### a. Defense

A closing argument is a review of the evidence presented. Counsel for the Defense reviews the evidence as presented, indicates how the evidence does not substantiate the elements of the charge or claim, stresses the facts and law favorable to the defense, and asks for a finding of not guilty (or not at fault) for the Defense.

### b. Prosecution/Plaintiff

The closing argument for the Prosecution/Plaintiff reviews the evidence presented. Their closing argument should indicate how the evidence has satisfied the elements of the charge, point out the law applicable to the case, and ask for a finding of guilt or fault on the part of the Defense. Because the burden of proof rests with the Prosecution/Plaintiff, this side has the final word.

pklaw.com

# PK||LAW

Is proud to support the  
**MY LAW**  
(Maryland Youth & The Law)

Baltimore | Columbia | Belcamp  
410.938.8800 | information@pklaw.com

Authorized by M. E. Amos, Esq.

## FIND THE MISSING PIECES WHEN YOU SUBSCRIBE

THE DAILY RECORD

You deserve the full story - in the easy to read digital or print editions - plus all the perks of being a subscriber

Get all the pieces when you subscribe!  
<http://bit.ly/getmddailyrecord>

### **III. RULES OF EVIDENCE**

#### **INTRODUCTION**

In American trials, elaborate rules are used to regulate the admission of proof (i.e., oral or physical evidence). Rules of Evidence are designed to ensure that both parties receive a fair hearing and to exclude any evidence deemed irrelevant, incompetent, untrustworthy or unduly prejudicial. If it appears that a rule of evidence is being violated, an attorney may raise an objection to the judge.

1. Judge decides whether a rule has been violated and whether the evidence must be excluded from the record of the trial. In the absence of a properly made objection, however, the evidence will probably be allowed by the judge. The burden is on the attorneys to know the rules, to be able to use them to present the best possible case, and to limit the actions of opposing counsel and their witnesses.
2. Formal rules of evidence are quite complicated and differ depending on the court where the trial occurs. For purposes of this Mock Trial Competition, the rules of evidence have been modified and simplified. Not all judges will interpret the rules of evidence or procedure the same way, and you must be prepared to point out the specific rule (quoting it, if necessary) and to argue persuasively for the interpretation and application of the rule you think proper. No matter which way the judge rules, attorneys should accept the ruling with grace and courtesy.

#### **ARTICLE I. GENERAL PROVISIONS**

**Rule 101. Scope.** These rules govern all proceedings in the mock trial competition. The only rules of evidence in the competition are those included in these rules.

**Rule 102. Purpose and Construction.** These rules should be construed so as to administer every proceeding fairly, eliminate unjustifiable expense and delay, and ascertain the truth and secure a just determination.

#### **ARTICLE IV. RELEVANCE AND ITS LIMITS**

##### **Rule 401. Test for Relevant Evidence**

Evidence is relevant if:

- (a) It has any tendency to make a fact more or less probable than it would be without the evidence; and
- (b) The fact is of consequence in determining the action

##### **Rule 403. Excluding Relevant Evidence for Prejudice, Confusion, Waste of Time, or Other Reasons.**

The court may exclude relevant evidence if its probative value is substantially outweighed by a danger of one or more of the following: unfair prejudice, confusing the issues, misleading the jury, undue delay, wasting time, or needlessly presenting cumulative evidence.

##### **Rule 404. Character Evidence; Crimes or Other Acts.**

(a) Character Evidence:

- (1) Prohibited Uses: Evidence of a person's character or character trait is not admissible to prove that on a particular occasion the person acted in accordance with the character or trait.

(b) Exceptions in a Criminal Case:

- (1) Evidence of a person's character or character trait may be admissible for another purpose, such as proving motive, opportunity, intent, plan, or knowledge.

(2) Evidence of the character or character trait of the defendant, the victim, or any witness testifying in a case may also be admissible if it shows a pertinent trait. Pertinent traits are character traits that relate directly to a particular element of the crime charged or a defense to that alleged crime.

---

*That is to say, mention of a person's typical behavior is not usually admissible when trying to prove that the person behaved in a way that matches the behavior discussed in the current case.*

---

#### **Rule 405. Methods of Proving Character**

- (a) By Reputation of Opinion. When evidence of a person's character or character trait is admissible, it may be proved by testimony about the person's reputation or by testimony in the form of an opinion. On cross-examination of the character witness, the court may allow inquiry into relevant specific instances of the person's conduct.
- (b) By Specific Instances of Conduct. When a person's character or character trait is an essential element of a charge, claim or defense, the character or trait may also be proved by relevant specific instances of the person's conduct.

---

*The general rule is that Character Evidence is not admissible to prove conduct in a civil case. Character evidence is admissible in a civil case if a trait of character has been placed in issue by the pleadings and character is a material issue. Character is a material issue in a civil defamation case when the defamatory statement falsely accuses the plaintiff of a general flaw, but not at issue if the defamatory statement falsely accuses the plaintiff of a specific act. For example, character is a material issue when accusing a plaintiff of being a liar, but not at issue if the defamatory statement falsely accuses the plaintiff of a specific act; for example, accuses the plaintiff of lying about a specific event.*

---

#### **Rule 408. Compromise and Offers to Compromise**

The following evidence is not admissible to prove the validity, invalidity, or amount of a civil claim in dispute:

- (1) Furnishing or offering or promising to furnish a valuable consideration for the purpose of compromising or attempting to compromise the claim or any other claim;
- (2) Accepting or offering to accept such consideration for that purpose; and
- (3) Conduct or statements made in compromise negotiations or mediation.

### **ARTICLE VI. WITNESSES/ WITNESS EXAMINATION**

**Rule 601. Competency to Testify in General.** Every person is competent to be a witness unless these rules provide otherwise.

**Rule 602. Need for Personal Knowledge.** A witness may testify to a matter only if evidence is introduced sufficient to support a finding that the witness has personal knowledge of the matter. Evidence to prove personal knowledge may consist of the witness's own testimony. This rule does not apply to a witness's expert testimony under Rule 703.

**Rule 603. Oath or Affirmation to Testify Truthfully.**

Before testifying, every witness is required to declare that the witness will testify truthfully, by oath provided in these materials. The bailiff shall swear in all witnesses as they take the stand:

*Do you promise to tell the truth, the whole truth, and nothing but the truth, under the pains and penalties of perjury?*

**Rule 607. Who May Impeach a Witness.** Any party, including the party that called the witness, may attack the witness's credibility.

**Rule 608. A Witness' Character for Truthfulness or Untruthfulness.**

- (a) Reputation or Opinion Evidence. A witness's credibility may be attacked or supported by testimony about the witness's reputation for having a character for truthfulness or untruthfulness, or by testimony in the form of an opinion about that character. But evidence of truthful character is admissible only after the witness's character for truthfulness has been attacked.
- (b) Specific Instances of Conduct. Extrinsic evidence is not admissible to prove specific instances of a witness's conduct in order to attack or support the witness's character for truthfulness. But the court may, on cross-examination, allow them to be inquired into if they are probative of the character for truthfulness or untruthfulness of:
  - (1) the witness; or
  - (2) another witness whose character the witness being cross-examined has testified about.

By testifying on another matter, a witness does not waive any privilege against self-incrimination for testimony that relates only to the witness's character for truthfulness.

**Rules 609. Impeachment by evidence of conviction of crime.**

- (a) Generally. For the purpose of attacking the credibility of a witness, evidence that the witness has been convicted of a crime shall be admitted if elicited from the witness or established by public record during examination of the witness, but only if (1) the crime was an infamous crime or other crime relevant to the witness's credibility and (2) the court determines that the probative value of admitting this evidence outweighs the danger of unfair prejudice to the witness or the objecting party.
- (b) Time limit. Evidence of a conviction is not admissible under this Rule if a period of more than 15 years has elapsed since the date of the conviction, except as to a conviction for perjury for which no time limit applies.

**Rule 611. Mode and Order of Examining Witnesses and Presenting Evidence.**

- (a) Control by the Court; Purposes. The court should exercise reasonable control over the mode and order of examining witnesses and presenting evidence so as to:
  - (1) make those procedures effective for determining the truth;
  - (2) avoid wasting time; and
  - (3) protect witnesses from harassment or undue embarrassment.

---

*Scope of Direct Examination: Direct questions shall be phrased to elicit facts from the witness. Witnesses may not be asked leading questions by the attorney who calls them for direct. A leading question is one that suggests the answer that is anticipated or desired by counsel; it often suggests a “yes” or “no” answer. Example of Leading Question: “Mr/s. Smith: “Is it not true that you made several stops after work before returning home?” Example of a Direct Question: Mr/s. Smith: “Did you do anything after work, before returning home?”*

---

- (b) **Scope of Cross-Examination.** The scope of cross examination shall not be limited to the scope of the direct examination, but may inquire into any relevant facts or matters contained in the witness’ statement, including all reasonable inferences that can be drawn from those facts and matters, and may inquire into any omissions from the witness statement that are otherwise material and admissible.

---

*Cross examination is the questioning of a witness by an attorney from the opposing side. An attorney may ask leading questions when cross-examining the opponent’s witnesses. In Mock Trial, attorneys are allowed to ask any questions on cross examination about any matters that are relevant to the case. Witnesses must be called by their own team and may not be recalled by either side. All questioning of a witness must be done by both sides in a single appearance on the witness stand.*

---

- (c) **Leading Questions.** Leading questions should not be used on direct examination. Ordinarily, the court should allow leading questions:
- (1) on cross-examination; and
  - (2) when a party calls a hostile witness, an adverse party, or a witness identified with an adverse party.
- (d) **Redirect/Recross.** After cross examination, additional questions may be asked by the direct examining attorney, but questions must be limited to matters raised by the attorney on cross examination. Likewise, additional questions may be asked by the cross examining attorney on recross, but such questions must be limited to matters raised on redirect examination and should avoid repetition.
- (e) **Permitted Motions.** The only motion permissible is one requesting the judge to strike testimony following a successful objection to its admission.

**Rule 612. Writing Used to Refresh a Witness’s Memory.** If a witness is unable to recall a statement made in an affidavit, the attorney on direct may show that portion of the affidavit that will help the witness to remember.

## **ARTICLE VII. OPINIONS AND EXPERT TESTIMONY**

**RULE 701. Opinion Testimony by Lay Witnesses.** If a witness is not testifying as an expert, testimony in the form of an opinion is limited to one that is:

- (a) rationally based on the witness's perception;
- (b) helpful to clearly understanding the witness's testimony or to determining a fact in issue; and
- (c) not based on scientific, technical, or other specialized knowledge within the scope of [Rule 702](#).

**Rule 702. Testimony by Expert Witnesses.**

Expert testimony may be admitted, in the form of an opinion or otherwise, if the court determines that the testimony will assist the trier of fact to understand the evidence or to determine a fact in issue. In making that determination, the court shall determine:

- (a) whether the witness is qualified as an expert by knowledge, skill, experience, training, or education,
- (b) the appropriateness of the expert testimony on the particular subject, and
- (c) whether a sufficient factual basis exists to support the expert testimony.

---

*A witness cannot give expert opinions under Rule 702 until they have been offered as an expert by the examining lawyer and recognized as such by the court. To have an expert witness admitted by the court, first ask the witness to testify as to their qualifications: education, experience, skills sets, etc. Then, ask the presiding judge to qualify the witness as an expert in the field of \_\_\_\_\_. The presiding judge then asks opposing counsel if they wish to Voir Dire [“vwahr deer”] the witness.*

*Voir dire is the process through which expert witnesses are questioned about their backgrounds and qualifications before being allowed to present their opinion testimony or testimony on a given subject, in court. After an attorney who has called a witness questions them about their qualifications, and before the court qualifies the witness as an expert, the opposing counsel shall have the opportunity to conduct voir dire.*

*Once voir dire is completed, opposing counsel may 1) make an objection as to their being qualified as an expert, 2) request that the court limit their expert testimony to a more specific matter or subject, or 3) make no objection about the witness being qualified as an expert. The presiding judge will then make a ruling regarding the witness being qualified as an expert.*

---

**Rule 703. Bases of an Expert.** An expert may base an opinion on facts or data in the case that the expert has been made aware of or personally observed. If experts in the particular field would reasonably rely on those kinds of facts or data in forming an opinion on the subject, the need not be admissible for the opinion to be admitted. But if the facts or data would otherwise be inadmissible, the proponent of the opinion may disclose them to the jury only if their probative value in helping the jury evaluate the opinion substantially outweighs their prejudicial effect.

**Rule 704. Opinion on the Ultimate Issue.**

- (a) In General. Except as provided in section (b) of this Rule, testimony in the form of an opinion or inference otherwise admissible is not objectionable merely because it embraces an ultimate issue to be decided by the trier of fact.
- (b) Opinion on Mental State or Condition. An expert witness testifying with respect to the mental state or condition of a defendant in a criminal case may not state an opinion or inference as to whether

the defendant had a mental state or condition constituting an element of the crime charged. That issue is for the trier of fact alone.

**Rule 705. Disclosing the Facts or Data Underlying an Expert.** Unless the court requires otherwise, the expert may testify in terms of opinion or inference and give reasons without first testifying to the underlying facts or data. The expert may in any event be required to disclose the underlying facts or data on cross examination.

## **ARTICLE VIII. HEARSAY**

### **RULE 801. Definitions That Apply to This Article; Exclusions from Hearsay.**

The following definitions apply under this article:

- (a) **Statement.** "Statement" means a person's oral assertion, written assertion, or nonverbal conduct, if the person intended it as an assertion.
- (b) **Declarant.** "Declarant" means the person who made the statement.
- (c) **Hearsay.** "Hearsay" means a statement that:
  - (1) the declarant does not make while testifying at the current trial or hearing; and
  - (2) a party offers in evidence to prove the truth of the matter asserted in the statement.
- (d) **Statements That Are Not Hearsay.** A statement that meets the following conditions is not hearsay:
  - (1) *A Declarant-Witness's Prior Statement.* The declarant testifies and is subject to cross-examination about a prior statement, and the statement:
    - (A) is inconsistent with the declarant's testimony and was given under penalty of perjury at a trial, hearing, or other proceeding or in a deposition;
    - (B) is consistent with the declarant's testimony and is offered:
      - (i) to rebut an express or implied charge that the declarant recently fabricated it or acted from a recent improper influence or motive in so testifying; or
      - (ii) to rehabilitate the declarant's credibility as a witness when attacked on another ground; or
    - (C) identifies a person as someone the declarant perceived earlier.
  - (2) *An Opposing Party's Statement.* The statement is offered against an opposing party and:
    - (A) was made by the party in an individual or representative capacity;
    - (B) is one the party manifested that it adopted or believed to be true;
    - (C) was made by a person whom the party authorized to make a statement on the subject;
    - (D) was made by the party's agent or employee on a matter within the scope of that relationship and while it existed; or
    - (E) was made by the party's coconspirator during and in furtherance of the conspiracy.

---

*Hearsay generally has a three-step analysis:*

*1) Is it an out of court statement?*

*2) If yes, is it offered to prove the truth of what it asserts?*

*3) If yes, is there an exception that allows the out-of-court statement to be admitted despite the fact that it is hearsay?*

---

The statement must be considered but does not by itself establish the declarant's authority under (C); the existence or scope of the relationship under (D); or the existence of the conspiracy or participation in it under (E).

**RULE 802. The Rule Against Hearsay.** Hearsay is a statement, other than one made by the declarant while testifying at trial, offered in evidence to prove the truth of the matter asserted made outside of the courtroom. Statements made outside the courtroom are usually not allowed as evidence if they are offered in court to show that the statements are true. The most common hearsay problem occurs when a witness is asked to repeat what another person stated. For the purposes of the Mock Trial Competition, if a document is stipulated, you may not raise a hearsay objection to it.

**RULE 803. Exceptions to the Rule Against Hearsay.**

The following are not excluded by the rule against hearsay, regardless of whether the declarant is available as a witness:

- (a) Present Sense Impression. A statement describing or explaining an event of condition, made while or immediately after the declarant perceived it.
- (b) Excited Utterance. A statement relating to a startling event or condition, made while the declarant was under the stress of excitement that it caused.
- (c) Then-Existing Mental, Emotional or Physical Condition. A statement of the declarant's then-existing state of mind (such as motive, intent or plan) or emotional, sensory, or physical condition (such as mental feeling, pain, or bodily health), but not including a statement of memory or belief to prove the fact remembered or believed unless it relates to the validity or terms of the declarant's will.
- (d) Business Records. A memorandum, report, record, or data compilation, in any form, of acts, events, conditions, opinions, or diagnosis, made at or near the time by or from information transmitted by a person with knowledge, if kept in the course of a regularly conducted business activity, and if it was the regular practice of that business activity to make the memorandum, report, record, or data compilation, all as shown by the testimony of the custodian or other qualified witness, unless the source of the information or the method of circumstances of preparation indicate lack of trustworthiness, shall be admissible. The term "business" as used in this paragraph includes business, institution, association, profession, occupation, and callings of every kind, whether or not conducted for profit.
- (e) Statements for Purposes of Medical Diagnosis or Treatment. Statements made for purposes of medical treatment or medical diagnosis in contemplation of treatment and describing medical history, or past or present symptoms, pain, or sensation, or the inception or general character of the cause or external sources thereof insofar as reasonably pertinent to treatment or diagnosis in contemplation of treatment.

**Rule 804. Exceptions to the Rule Against Hearsay –When the Declarant Is Unavailable as a Witness.**

(a) Criteria for Being Unavailable. A declarant is considered to be unavailable as a witness if the declarant:

- (1) cannot be present or testify at the trial or hearing because of death or a then-existing infirmity, physical illness, or mental illness; or
- (2) is absent from the trial or hearing and the statement's proponent has not been able, by process or other reasonable means, to procure the declarant's attendance or testimony.

Comment: This rule may not be used at trial to assert that a team has "procured" the unavailability of a witness by choosing not to call that witness.



(b) The Exceptions. The following are not excluded by the rule against hearsay if the declarant is unavailable as a witness:

(1) Former testimony. Testimony that:

(A) was given as a witness at a trial, hearing, or lawful deposition, whether given during the current proceeding or a different one; and

(B) is now offered against a party who had – or, in a civil case, whose predecessor in interest had – an opportunity and similar motive to develop it by direct, cross-, or redirect examination.

(2) Statement Under the Belief of Imminent Death. In a prosecution for homicide or in a civil case, a statement that the declarant, while believing the declarant’s death to be imminent, made about its cause or circumstances.

(3) Statement Against Interest. A statement that:

(A) a reasonable person in the declarant’s position would have made only if the person believed it to be true because, when made, it was so contrary to the declarant’s proprietary or pecuniary interest or had so great a tendency to invalidate the declarant’s claim against someone else or to expose the declarant to civil or criminal liability; and

(B) is supported by corroborating circumstances that clearly indicate its trustworthiness, if it is offered in a criminal case as one that tends to expose the declarant to criminal liability.

(4-5) Omitted.

(6) Statement Offered Against a Party That Wrongfully Caused the Declarant’s Unavailability. A statement offered against a party that wrongfully caused – or acquiesced in wrongfully causing – the declarant’s unavailability as a witness, and did so intending that result.

#### **Rule 805. Hearsay within Hearsay**

Hearsay within hearsay is not excluded by the rule against hearsay if each part of the combined statement confirms with an exception to the rule.

### **ARTICLE IX. AUTHENTICATION AND IDENTIFICATION**

**Rule 901.** Evidence may be introduced only if it is contained within the casebook and relevant to the case. Evidence will not be admitted into evidence until it has been identified and shown to be authentic or its identification and/or authenticity has been stipulated. Evidence may be admitted before trial upon stipulation of both parties.

That a document is “authentic” means only that it is what it appears to be, not that the statements in the document are necessarily true. To satisfy the requirement of authenticating or identifying an item of evidence, the proponent must produce evidence sufficient to support a finding that the item is what the proponent claims it is. Evidence that satisfies this requirement may include:

(a) Testimony of a Witness with Knowledge. Testimony that an item is what it is claimed to be.

(b) Distinctive Characteristics and the Like. The appearance, contents, substance, internal patterns, or other distinctive characteristics of the item, taken together with all the circumstances.

(c) Opinion about a Voice. An opinion identifying a person’s voice – whether heard firsthand or through mechanical or electronic transmission or recording – based on hearing the voice at any time under circumstances that connect it with the alleged speaker.

#### IV: MYLAW MOCK TRIAL OBJECTIONS

Objection	Rule	Description
Relevance	401	Evidence is irrelevant if it does not make a fact that a party is trying to prove as part of the claim or defense more or less probable than it would be without the evidence.
More prejudicial than probative	403	A court may exclude relevant evidence if its probative value is substantially outweighed by unfair prejudice. By its nature, all relevant evidence is prejudicial to one side. This rule generally applies to evidence that not only hurts your case but is not relevant enough to be let in.
Improper character evidence	404; 608	A number of rules govern whether it is appropriate to introduce affirmative or rebuttal evidence about the character of a witness and the notice required to introduce such evidence. This objection is made when improper character evidence has been given as testimony in court.  <i>Example: "The defendant has always been very rude to me, and was particularly rude on the day of the incident."</i>
Lack of personal knowledge/ speculation	602	A witness may only testify to a fact after foundation has been laid that the witness has personal knowledge of that fact through observation or experience. Many teams refer to testifying to an assumption or fact without personal knowledge as "speculation." Whenever proper foundation has not been laid under this rule or others for testimony, "lack of foundation" is also a proper objection.  Speculation, or someone's idea about what might have occurred, is generally not permitted. A witness may not jump to conclusions that are not based on actual experiences or observations, as this is of little probative value. Some leeway is allowed for the witness to use their own words, and greater freedom is generally allowed with expert witnesses.
Lacks foundation	602	This objection is made when counsel asks a question without first establishing that the witness has a basis to answer it. This most frequently occurs when the examining attorney is going too quickly and not asking preliminary questions that demonstrate the witness' familiarity with the facts. A witness may testify to a matter only if sufficient evidence is introduced to support a finding that the witness has personal knowledge of the matter.
Beyond the scope	611	In Maryland Mock Trial, the initial cross examination is <u>not</u> limited to the content of the direct examination. All subsequent examinations (beginning with redirect) must fall within the scope of the prior examination.

Form of question - leading	611	This objection is made when one suggests a specific answer or leads the witness toward a particular response. On direct examination, leading is not permitted, and the questions should be open-ended. Leading is fully allowed on cross-examination.
Form of question - compound	611	This objection is made when counsel asks a compound question. A compound question asks multiple things.
Form of question - narration	611	This objection is made when either a witness begins telling a narrative as part of their answer, or counsel's question calls for a narrative. It is admissible for a witness to testify about what happened, but they must do so in response to a question. This objection prevents long winded witness answers.
Form of question - argumentative	611	This objection is made when counsel starts arguing with the witness, badgering a witness, or becoming overly aggressive. This objection is made by an attorney to protect a witness during cross examination.
Unresponsive	611	This objection is made when a witness does not answer the question being asked by the attorney. This objection can help an attorney corral the witness and get a straight answer to questions the witness may be trying to avoid. Be careful to avoid making this objection when the witness simply gives a different answer than what was expected or desired.
Asked and answered	611	This objection is made when counsel has asked a question and received an answer, and asks the same question again. If an answer is given, a new question must be asked. Counsel can ask a question multiple times if the witness is not giving a full answer, is being uncooperative or unresponsive.
Hearsay	801-802	An out-of-court statement (including a statement by the witness on the stand) may not be used to prove the truth of the matter asserted. That said, there are many exceptions to the hearsay rule.
Hearsay exceptions	803	Provides for exceptions to the hearsay rule in instances when the evidence is technically hearsay, but circumstances would suggest that it will be reliable, including, for example: <ul style="list-style-type: none"> <li>- Excited Utterance – a statement relating to a startling event or condition, made while the declarant was under the stress of excitement that it caused</li> <li>- Recorded Recollection – a record that is on a matter the witness once knew about but now cannot recall well enough to testify fully and accurately; was made or adopted by the witness when the matter was fresh in the witness' memory; and accurately reflects the witness' knowledge.</li> </ul>

**PARKER HARPER**

\*

**IN THE**

**Plaintiff**

\*

**CIRCUIT COURT**

**v.**

\*

**FOR**

**DAKOTA REESE**

\*

**CHESAPEAKE COUNTY**

**Defendant**

\*

\* \* \* \* \*

**COMPLAINT**

Comes Now, Plaintiff, Parker Harper, (hereinafter referred to as “the Plaintiff”) by and through their attorneys, who respectfully represents unto this court as follows:

**PARTIES**

Plaintiff is an individual who resides at 15 Choptank Way in Chesapeake County, Maryland. At all times relevant and material hereto, the Plaintiff has resided in Maryland.

On information and belief, Defendant, Dakota Reese, (hereinafter referred to as “the Defendant”) is an individual who resides 7 Choptank Way in Chesapeake County, Maryland. At all times relevant and material hereto, the Defendant has resided in Maryland.

**COUNT I - NEGLIGENCE**

1. On Thursday, May 25, 2023, Vale Taylor offered to pay the Plaintiff to clean out Vale Taylor’s gutters, on their home located at 9 Choptank Way, Chesapeake County, Maryland.
2. Vale Taylor promised to pay the Plaintiff \$100.00 to clean the gutters.
3. Vale Taylor advised the Plaintiff that the ladder required to complete the job had been recently inspected, was “good to go,” and ready to use.
4. The Plaintiff located the ladder outside against Vale Taylor’s house where Vale Taylor showed the Plaintiff that it would be.

5. On or about May 27, 2023, the Plaintiff attempted to clean Vale Taylor's gutters.
6. As a result of the Defendant's conduct, the Plaintiff was injured.
7. The aforesaid incident occurred as a result of and was proximately caused by the carelessness and negligence of the Defendant, which consisted inter alia of the following particulars:
  - a. Failing to exercise the reasonable degree of care required under the circumstances; and
  - b. Otherwise being negligent.
8. The Plaintiff sustained serious injuries as a direct and proximate result of the Defendant's negligent and/or careless conduct.
9. That as a result of the aforesaid conduct and breach of the duty of care by the Defendant, the Plaintiff sustained the injuries causing harm, without any negligence of the Plaintiff contributing thereto.

WHEREFORE, Plaintiff Parker Harper demands judgment in excess of Seventy-Five Thousand Dollars (\$75,000.00) plus costs of this suit.

Respectfully submitted,

*Plaintiff's Counsel*

Attorney for Plaintiff

**PARKER HARPER**

\*

**IN THE**

**Plaintiff**

\*

**CIRCUIT COURT**

**v.**

\*

**FOR**

**DAKOTA REESE**

\*

**CHESAPEAKE COUNTY**

**Defendant**

\*

\* \* \* \* \*

**ANSWER**

Defendant Dakota Reese, (hereinafter referred to as “the Defendant”) by and through undersigned counsel, pursuant to Maryland Rules 2-231 and 2-232, hereby submit this Answer to Plaintiff Parker Harper’s (hereinafter referred to as “the Plaintiff”) Complaint and, in furtherance thereof, states as follows:

**GENERAL DENIAL**

Pursuant to Maryland Rule 2-323(d), the Defendant generally denies liability for all counts contained in the Complaint pursuant to Md. Rule 2-323(d).

**AFFIRMATIVE DEFENSES**

1. The Plaintiff’s claims are barred by contributory negligence.
2. The Defendant specifically denies the existence of any causal connection of the injuries to the accident alleged.

WHEREFORE, the Defendant respectfully requests that the Complaint be dismissed, with costs.

Respectfully submitted,

***Defendant’s Counsel***

Attorney for Defendant

## STIPULATIONS

1. For the convenience of all parties, all potential exhibits have been pre-labeled and prenumbered. These numbers should be used for all purposes at trial regardless of which party offers an exhibit or what order exhibits are offered.
2. The parties agree that every witness whose affidavit appears in this casebook has signed their affidavit and the signature appearing is that respective witness's signature. As such, the parties agree witnesses must acknowledge authorship of any document that purports to be authored by them and the authenticity of any signature that purports to be theirs.
3. Regarding Authenticity, the parties agree all documents contained in this casebook are considered authentic for admissibility purposes. Admitting them into evidence does still requiring applying the other provided rules of evidence.
4. The parties agree that all parties and witnesses are of at least normal intelligence, and none has or ever has had a mental condition that would impact a person's perception, memory, or ability to respond to questions on cross examination.
5. The parties agree that all notice requirements have been satisfied for all evidence and exhibits in the case packet and no party may object at any time that they did not receive proper notice that the other side intended to use a particular document or piece of evidence. Notice is still required if any of these materials are modified or enlarged, as discussed in General Competition Rule 8.4.
6. The parties have jointly submitted the Jury Instructions and Verdict Sheet. The parties further agree that the jury instructions are the full and complete interpretations of the law to be applied in this case. The parties also agree the questions on the verdict sheet are the correct and only questions for consideration by the jury. As such, the parties have agreed to the verdict as to Duty and Breach of Duty (meaning the parties agree there is a duty not to modify someone else's ladder without warning them and the Defendant breached that duty). The only questions are whether the Defendant is a cause of Plaintiff's injury or injuries, whether the Plaintiff is contributorily negligent for not inspecting the ladder before using it or for any other reason the Defendant believes the Plaintiff is contributorily negligent, and, if the Defendant is a cause of injury and the Plaintiff is not contributorily negligent, then what Damages are the Plaintiff due from the Defendant.
7. For the purposes of Evidence Rule 609(a)(1), the parties agree the crime of Theft, at any value, qualifies as an "other crime relevant to a witness's credibility."
8. The parties agree that Parker Harper did fall from a ladder owned by Vale Taylor on Vale Taylor's property on May 27, 2023.
9. The parties stipulate that the transcript of the July 25, 2023 trial attached to Vale Taylor affidavit is an exact transcript of that trial and that Vale Taylor testified in that trial under oath. The parties further agree this transcript serves as evidence that Dakota Reese has a conviction on their record for Theft.
10. The parties agree that all photos contained in Exhibits 20 through 33 are fair and accurate representations of what is shown in those photos on or around May 27, 2023.
11. Both parties agree not to argue any map contained within this problem is not to scale. This applies to Exhibits 19-23.
12. The parties agree that Exhibits 24 through 30 do not clearly show the video cameras on Vale Taylor's home but both parties agree that those cameras exist and were operational on May 30, 2023.
13. The parties agree that the whited-out area of Exhibit #s 32 and 33 are the license plates of these respective vehicles and shows the resting position of the license plate of each vehicle after the accident and, further, that the license plate on both vehicles were affixed in the correct parallel-to-the-ground position prior to the car accident on June 1, 2023.
14. The parties agree that the information Vale Taylor testified to on July 25, 2023, in response to the question, "If you know, why are ladder foot pads important?" whereby the answer begins and ends with "Using a ladder without a ladder foot pad... when working with heights." is accurate and this testimony does not need to be admitted through an expert witness.
15. The parties agree that both the Plaintiff and the Defendant have noted properly in advance of trial their intention to call their respective expert witnesses, Dr. Chris Morgan and Dr. Dylan Avery. Dr. Morgan will be offered as an expert witness by the Plaintiff in the field of Chiropractic Therapy Services. Dr. Avery will

be offered as an expert witness by the Defendant in the field of Orthopaedic Surgery. It will still be the responsibility of each side to go through the procedure of admitting their respective witnesses as experts for these purposes if they so choose to attempt to do. If they do attempt to admit their witness as an expert, the opposing party has the right to voir dire, if they choose, and argue if this witness should be admitted as an expert. This stipulation also does not prevent both parties in advance of trial from choosing to stipulate to the expertise of these witnesses. If both parties agree to stipulate to a witness' expertise, they should notify the presiding judge any time prior to that witness testifying and as to what specifically the stipulation is.

16. The parties agree that the reports and bills from Dr. Chris Morgan are full and complete, and that no examination can be conducted by either party regarding if there are more specific notes from individual chiropractic/physical therapy sessions, other than what is already contained in Exhibits 1 through 4.
17. In a real trial, if a party sought to admit video evidence, they would need to either admit into evidence a flash drive, CD, or DVD. Because this is a Mock Trial, Exhibit 18 was created to be a pretend flash drive. No alterations need to be made to this document. The parties agree that the only contents contained on Exhibit 18 is one video that is 14 seconds in duration. This video is available for download to all parties on the MYLaw Mock Trial Materials webpage. If either party seeks to admit into evidence this video, the parties agree that this photo of a flash drive is a real flash drive which contains this video evidence.
18. While the jury instructions for the lawsuit of Parker Harper v. Whitney Jones would be nearly identical to Parker Harper v. Dakota Reese, there would definitely be at least one additional jury instruction in Parker Harper v. Whitney Jones that would not appear in Parker Harper v. Dakota Reese, and both Parker Harper and Whitney Jones have had this explained to them by their respective attorneys. As such, both Parker Harper and Whitney Jones understand this first accident involving the ladder will not necessarily affect the outcome of their case involving the car accident as it relates to the amount of damages; meaning it could affect the amount of damages, but it also might not. And, this knowledge of the law by Parker Harper and Whitney Jones is not protected by attorney-client privilege. Specifically, this additional jury instruction in Parker Harper v. Whitney Jones will read: "A person who had a particular condition before the accident may be awarded damages for the aggravation or worsening of that condition."
19. A 24-foot extension ladder will consist of two sections, each 12 feet long, but the maximum extended length will be 21 feet, because the sections overlap by no less than 1½ feet when the ladder is at maximum extension. As such, with this understanding, Vale Taylor's affidavit is correct and Exhibit 10 is correct. To make this more clear going forward, the parties stipulate the above information is accurate, without need for testimony from any party.



**PARKER HARPER**

\*

**IN THE**

**Plaintiff**

\*

**CIRCUIT COURT**

**v.**

\*

**FOR**

**DAKOTA REESE**

\*

**CHESAPEAKE COUNTY**

**Defendant**

\*

\* \* \* \* \*

**VERDICT SHEET**

1. Do you find that Dakota Reese was a cause of Parker Harper’s injury?

YES \_\_\_\_\_ NO \_\_\_\_\_

**If you answered “YES” to Question 1, proceed to Question 2.**

**If you answered “NO” to Question 1, stop here.**

2. Do you find that Parker Harper was contributorily negligent?

YES \_\_\_\_\_ NO \_\_\_\_\_

**If you answered “NO” to Question 2, proceed to Question 3.**

**If you answered “YES” to Question 2, stop here.**

3. What damages do you award Parker Harper for the following:

a. Past medical expenses: \$ \_\_\_\_\_

b. Non-Economic Damages: \$ \_\_\_\_\_

4. Do you find, by clear and convincing evidence, that Dakota Reese acted with malice?

YES \_\_\_\_\_ NO \_\_\_\_\_

**If you answered “YES” to Question 4, proceed to Question 5.**

**If you answered “NO” to Question 4, stop here.**

5. What punitive damages do you award Parker Harper?

\$ \_\_\_\_\_

\_\_\_\_\_  
Jury Foreperson

\_\_\_\_\_  
Date

**PARKER HARPER**

\*

**IN THE**

**Plaintiff**

\*

**CIRCUIT COURT**

**v.**

\*

**FOR**

**DAKOTA REESE**

\*

**CHESAPEAKE COUNTY**

**Defendant**

\*

\* \* \* \* \*

**JURY INSTRUCTIONS**

Members of the jury, the time has come for the court to give you its instructions with respect to the law that is applicable in this case. You should consider my instructions as a whole, and you should not single out any particular sentence, phrase, or word to the exclusion of another. If I state any rule or idea in differing ways, no emphasis on any particular phraseology is intended by me. You should not attach any significance to the order in which I state these instructions. You must apply the law as I explain it to you. My statement of the law is binding on you, and must be followed by you whether you personally agree or disagree with the wisdom of any rule of law.

Any comments I may make about the facts are only to help you and you are not required to agree with them. It is your function and responsibility to decide the facts. You must base your findings only upon the testimony, the exhibits received and the stipulations of the parties, including any conclusions which may be fairly drawn from that evidence. Opening statements and arguments of the lawyers are not evidence in this case. If your memory of any of the testimony is different from any statement that I might make during the course of these instructions or that counsel might make in argument, you must rely on your own memory.

During your deliberations, you must not communicate with or provide any information to anyone by any means about this case. You may not use any electronic device or media, such as a smart phone, cell phone, email, text messaging, Twitter, any blog or website, any internet chat room or forum, or other social networking websites, including Facebook, LinkedIn, Reddit, and YouTube to communicate to anyone any information about this case or to conduct any research about this case until the verdict is accepted.

**IMPARTIALITY IN CONSIDERATION**

You must consider and decide this case fairly and impartially. All persons, including corporations, stand equal before the law and are entitled to the same treatment under the law. You should not be prejudiced for or against a person because of that person’s race, color, gender, religion, political or social views, wealth, or poverty. You should not even consider such matters. The same is true as to sympathy for any party.

**CONCLUSION--UNANIMOUS VERDICT**

To reach a verdict in this case, each of you must agree upon it. Your verdict must be unanimous.

**DEADLOCKED JURY CHARGE**

The verdict must represent the considered judgment of each juror. In order to return a verdict, it is necessary that each juror agree thereto. Your verdict must be unanimous.

Do not surrender your honest conviction as to the weight or effect of evidence solely because of the opinion of your fellow jurors, or for the mere purpose of returning a verdict.

It is your duty, as jurors, to consult with one another and to deliberate with a view to reaching an agreement, if you can do so without violence to individual judgment.

Each of you must decide the case for yourself, but do so only after an impartial consideration of the evidence with your fellow jurors. In the course of your deliberations, do not hesitate to reexamine your own views and change your opinion if convinced it is erroneous.

### **BURDEN OF PROOF--PREPONDERANCE OF EVIDENCE STANDARD**

The party who asserts a claim or affirmative defense has the burden of proving it by what we call the preponderance of the evidence.

In order to prove something by a preponderance of the evidence, a party must prove that it is more likely so than not so. In other words, a preponderance of the evidence means such evidence which, when considered and compared with the evidence opposed to it, has more convincing force and produces in your minds a belief that it is more likely true than not true.

In determining whether a party has met the burden of proof you should consider the quality of all of the evidence regardless of who called the witness or introduced the exhibit and regardless of the number of witnesses which one party or the other may have produced.

If you believe that the evidence is evenly balanced on an issue, then your finding on that issue must be against the party who has the burden of proving it.

The only time you will not apply the preponderance of evidence standard is if you are considering whether to make an award for punitive damages. Punitive damages has an instruction on the final page of these instructions that explains you must make a finding by "clear and convincing evidence." The clear and convincing evidence standard is defined in that section of these instructions.

### **QUESTIONS OF LAW DURING TRIAL**

During the course of the trial, it has been my duty to rule on a number of questions of law, such as objections to the admissibility of evidence, the form of questions, and other legal points. You should not draw any conclusions from these rulings either as to the merits of the case, or as to my views regarding any witness, party, or the case itself.

It is the duty of a lawyer to make objections that the lawyer believes are proper. You should not be influenced by the fact that these objections were made, no matter how the court may have ruled on them. You must disregard any evidence which I have ordered stricken. If I sustained an objection to any question, you must not speculate about what the answer might have been.

### **WHAT CONSTITUTES EVIDENCE**

In making your decision, you must consider the evidence in this case; that is

- (1) testimony from the witness stand and "remote" testimony;
- (2) physical evidence or exhibits admitted into evidence;
- (3) stipulations;
- (4) depositions; and
- (5) facts that I have judicially noticed.

In evaluating the evidence, you should consider it in light of your own experiences. You may draw any reasonable conclusion from the evidence that you believe to be justified by common sense and your own experiences.

Objections of the lawyers are not evidence and you should not give them any weight or consideration.

You must not consider exhibits that I did not admit into evidence or testimony that I ordered be stricken. You must disregard questions that I did not permit the witness to answer and you must not speculate as to the possible answers. If after an answer was given, I ordered that the answer be stricken, you must disregard both the question and the answer.

During the trial, I may have commented on the evidence or asked a question of a witness. You should not draw any conclusion about my views of the case or of any witness from my comments or my questions.

Opening statements and closing arguments of lawyers are not evidence. They are intended only to help you understand the evidence and to apply the law. Therefore, if your memory of the evidence differs from anything the lawyers or I may say, you must rely on your own memory of the evidence.

### **DIRECT AND CIRCUMSTANTIAL EVIDENCE**

There are two types of evidence--direct and circumstantial.

Direct evidence is, for example, testimony of a person reporting firsthand knowledge of a matter, such as testimony of an eyewitness to an occurrence. Circumstantial evidence is indirect and is proof of a chain of facts and circumstances that point to the existence of certain facts.

For example, if a witness testifies that they saw a deer in the field, that is direct evidence that there was a deer in the field. If a person testifies that they saw deer prints in the snow in the field, that is direct evidence that there were deer prints in the snow, and circumstantial evidence that there was at least one deer in the field. The law makes no distinction between the weight to be given to either type of evidence. No greater degree of certainty is required of circumstantial evidence than of direct evidence. In reaching a verdict, you should weigh all of the evidence presented, whether direct or circumstantial.

### **STIPULATIONS OF FACTS OR TESTIMONY**

The parties have agreed to certain stipulations. Those facts are now not in dispute and should be considered proven.

### **WITNESS TESTIMONY CONSIDERATION**

Any person who testifies, including a party, is a witness. You are the sole judges of whether testimony should be believed. In making this decision, you may apply your own common sense and everyday experiences.

In deciding whether a witness should be believed, you should carefully consider all the testimony and evidence, as well as whether the witness's testimony was affected by other factors. You should consider such factors as:

- (1) the witness's behavior on the stand and way of testifying;
- (2) the witness's opportunity to see or hear the things about which testimony was given;
- (3) the accuracy of the witness's memory;
- (4) whether the witness had a motive not to tell the truth;
- (5) whether the witness had an interest in the outcome of the case;
- (6) whether the witness's testimony was consistent;
- (7) whether the witness's testimony supported or contradicted other evidence, and
- (8) whether and the extent to which the witness's testimony in the court differed from statements made by the witness on any previous occasion. You are the sole judges of whether a witness should be believed. You need not believe any witness even though the testimony is uncontradicted. You may believe all, part, or none of the testimony of any witness.

### **EXPERT OPINION TESTIMONY**

An expert is a witness who has special training or experience in a given field.

You should give expert testimony the weight and value you believe it should have. You are not required to accept any expert's opinion. You should consider an expert's opinion together with all the other evidence.

## **INFERENCES FROM STATEMENTS OF COURT**

You should not conclude from any conduct or words of mine that I favor one party or another, or that I believe or disbelieve the testimony of any witness. You, not I, are the sole judges of the believability of witnesses and the weight of the evidence. You must not be influenced in any way by my conduct during the course of the trial.

## **DEPOSITIONS**

A deposition is testimony under oath given by a witness out of court. You should treat a deposition in the same manner as you would if the witness had testified in this courtroom or by “remote” testimony.

## **JUDICIAL NOTICE**

If the Judge has taken judicial notice of a fact, this means you should regard this fact as in evidence. You may, but are not required to, accept this fact as proven.

## **CONSIDERATION OF MEDICAL RECORDS AND BILLS**

In a case such as this, the law allows for the admission in evidence of a report or record of a health care provider which has been made to document a medical condition, a health care provider’s opinion, or the fact that health care was provided. Such records may be considered by you as evidence of the existence of those matters. However, since you are the fact finders, you must decide how much weight should be given to these writings and records and the opinions in them. Therefore you may accept all, part, or none of the facts and opinions contained in those reports or records. Similarly, the written statements or bills rendered for the health care services may be considered by you as evidence to support the amount and the fairness and reasonableness of the charge for those services. Once again, you as the fact finders, must decide how much weight should be given to the statements or bills. You may award all, part, or none of the amounts charged as damages.

## **SPOILIATION**

The destruction of or the failure to preserve evidence by a party may give rise to an inference unfavorable to that party. If you find that the intent was to conceal the evidence, the destruction or failure to preserve must be inferred to indicate that the party believes that their case is weak and that they would not prevail if the evidence was preserved. If you find that the destruction or failure to preserve the evidence was negligent, you may, but are not required to, infer that the evidence, if preserved, would have been unfavorable to that party.

## **CASE SUBMISSION ON ISSUES**

In this case, it will be your duty to return your verdict in the form of written answers to the written questions which are submitted to you by the court. Your answers will constitute your verdict. Each answer is to be written in the space provided after each question. Before making each answer, all of you must agree upon it. It is your duty to answer each of these questions in accordance with the evidence in the case.

## **NEGLIGENCE DEFINITION**

Negligence is doing something that a person using reasonable care would not do, or not doing something that a person using reasonable care would do. Reasonable care means that caution, attention, or skill a reasonable person would use under similar circumstances.

The elements of a negligence action are:

- (a) Duty: Duty or obligation, recognized by law, requiring conformance to a certain standard of conduct for the protection of others against unreasonable risks;
- (b) Breach: Failure to conform to that standard (breach of duty);
- (c) Causation: Reasonably close causal connection and resulting injury (proximate cause); and
- (d) Damages: Actual damage or loss by others.

### **FORESEEABLE CIRCUMSTANCES**

The care exercised by a reasonable person varies according to the circumstances and the danger that is known or should be appreciated by a reasonable person. Therefore, if the foreseeable danger increases, a reasonable person acts more carefully.

### **LIABILITY DIRECTED/ADMITTED/ADJUDICATED**

You are not to decide the question of Duty or Breach. Those two elements of negligence are already stipulated as proven. You need only decide whether the defendant is a cause of plaintiff's injuries and, if so, the amount of damages the plaintiff should be awarded.

### **CAUSATION DEFINITION**

For the plaintiff to recover damages, the plaintiff's injuries must result from and be a reasonably foreseeable consequence of the defendant's negligence. There may be more than one cause of an injury, that is, several negligent acts may work together to cause the injury. Each person whose negligent act is a substantial factor in causing an injury is responsible.

### **CONTRIBUTORY NEGLIGENCE--GENERALLY**

A plaintiff cannot recover damages if the plaintiff's injuries result from and are a reasonably foreseeable consequence of the plaintiff's negligence.

The defendant has the burden of proving this defense by a preponderance of the evidence.

### **DAMAGES INTRODUCTORY STATEMENT**

If you find for the plaintiff on the issue of liability, then you must consider the question of damages. It will be your duty to determine what, if any, award will fairly compensate the plaintiff.

The plaintiff has the burden to prove by a preponderance of the evidence each item of damage claimed to be caused by the defendant. In considering the items of damage, you must keep in mind that your award must adequately and fairly compensate the plaintiff. However, an award should not be based on guesswork.

### **COMPENSATORY DAMAGES FOR TORT WITHOUT BODILY HARM**

In determining damages, you shall consider any expenses, mental pain and suffering, fright, nervousness, indignity, humiliation, embarrassment, and insult to which the plaintiff was subjected as a direct result of the defendant's conduct.

### **COMPENSATION FOR PRE-IMPACT FRIGHT**

In this case, you shall consider what, if any, damages should be awarded to the plaintiff for the emotional distress and mental anguish that the plaintiff suffered between the time the plaintiff realized that there would be an accident and the accident.

### **SUSCEPTIBILITY TO INJURY**

The effect that an injury might have upon a particular person depends upon the susceptibility to injury of the plaintiff. In other words, the fact that the injury would have been less serious if inflicted upon another person should not affect the amount of damages to which the plaintiff may be entitled.

## **MINIMIZING DAMAGES**

A plaintiff has a duty to use reasonable efforts to reduce damages but is not required to accept the risk of additional loss or injury in these efforts.

## **COMPENSATORY DAMAGES FOR BODILY INJURY**

In an action for damages in a personal injury case, you shall consider the following:

- (1) The personal injuries sustained and their extent and duration;
- (2) The effect such injuries have on the overall physical and mental health and well-being of the plaintiff;
- (3) The physical pain and mental anguish suffered in the past and that with reasonable probability may be expected to be experienced in the future;
- (4) The disfigurement and humiliation or embarrassment associated with such disfigurement;
- (5) The medical and other expenses reasonably incurred in the past and that with reasonable probability may be expected in the future;
- (6) The loss of earnings in the past and such earnings or reduction in earning capacity that with reasonable probability may be expected in the future.

In awarding damages in this case, you must itemize your verdict or award to show the amount intended for:

- (1) The medical expenses incurred in the past;
- (2) The “Noneconomic Damages” sustained in the past and reasonably probable to be sustained in the future. All damages that you find for pain, suffering, pre-impact fright, inconvenience, physical impairment, disfigurement, or other non-pecuniary injury are “Noneconomic Damages;”

## **DAMAGES--COLLATERAL SOURCE RULE**

In arriving at the amount of damages to be awarded for past and future medical expenses and past loss of earnings, you may not reduce the amount of your award because you believe or infer that the plaintiff has received or will receive reimbursement for, or payment of, proven medical expenses or lost earnings from persons or entities other than the defendant, such as, for example, medical expenses paid by plaintiff’s health insurer.

## **DAMAGE AWARD NOT SUBJECT TO FEDERAL OR STATE INCOME TAX**

Any compensatory damages awarded to the plaintiff are not income within the meaning of Federal and Maryland income tax laws, and the plaintiff will not owe or have to pay any income tax on the amount awarded as damages. Therefore you should not add an amount to any award to compensate for anticipated taxes.

## **PUNITIVE DAMAGES--GENERALLY**

If you find for the plaintiff and award damages to compensate for the injuries or losses suffered, you may go on to consider whether to make an award for punitive damages.

To award punitive damages, you must find by clear and convincing evidence the defendant acted with malice. This burden of proof requires more than a preponderance of the evidence, but less than proof beyond a reasonable doubt. To be clear and convincing, evidence should be certain, plain to the understanding, and unambiguous in the sense that it is so reasonable and persuasive as to cause you to believe it. Malice is conduct motivated by evil motive, intent to injure, ill will, or fraud.

The purpose of punitive damages is not to compensate the plaintiff, but to punish the defendant and to deter others from this type of conduct in the future.

An award for punitive damages should be:

- (1) In an amount that will deter the defendant and others from similar conduct.
- (2) Proportionate to the wrongfulness of the defendant’s conduct and the defendant’s ability to pay.
- (3) Not designed to financially destroy a defendant.

1 **Affidavit of Parker Harper**

2 Witness for the Plaintiff

3  
4 After having been duly sworn by oath, Parker Harper hereby states as follows: I am 18 years old and competent to  
5 make this affidavit. I am testifying voluntarily and have not been subpoenaed.

6  
7 I, Parker Harper, am currently 18 years old and reside at 15 Choptank Way in Chesapeake County, Maryland. I live  
8 at this address with my mother.

9  
10 My home is on a cul-de-sac at the end of Choptank Way, off Severn Street. There are about 8 homes in our cul-de-  
11 sac including ones owned by Dakota Reese, Vale Taylor, and Whitney Jones. I agree that the map in Exhibit 19 is an  
12 accurate layout of my neighborhood, as are the aerial views in Exhibits 20 through 23. If you look at Exhibit 22, or  
13 really any of Exhibits 20 through 23, the circle driveway on the left is the same circle driveway that you see on the  
14 left side of Exhibit 19 which shows my address and the addresses for the others involved in this case. Also, if you  
15 look at Exhibits 24 through 29, none of those photos show my house. I would be just off-camera to the right of these  
16 photos. Closest you get to my house in any of these photos is in Exhibit 24, which shows 3 houses. If you look left  
17 to right, my house would be off the page to the right but attached to the last house you see on that image. But these  
18 exhibits do show Dakota Reese and Vale Taylor's home. Exhibit 24 shows Vale Taylor's home in the center of the  
19 image. It is the end unit townhome with the grass to its side. Exhibit 25 is a close-up shot of Vale's home. Exhibit 26  
20 is an even closer-up shot of Vale's home and it shows their gutter system. Exhibit 27 shows the space between Vale  
21 and Dakota's home. Dakota's home is the house on the left side of that image. Exhibit 28 and 30 are different angles  
22 of those same two homes, but still showing them from their front yards, with Dakota's home on the left side and  
23 Vale's home on the right side of the photo. Exhibit 29 is a close-up of the space between their homes; you see a  
24 close-up of Vale's side part of their house in this image.

25  
26 In Spring 2023, I was completing my senior year at Chesapeake High School. I was set to graduate on Wednesday  
27 June 7, 2023. I am now a Freshman at Towson University. I am interested in majoring in Mathematics with a  
28 Secondary Education Concentration. In addition to maintaining a 3.8 G.P.A. in high school, my main extracurricular  
29 has been participating for the last 4 years in my school's Marching Band. I play the bass drum. That's why my  
30 friends call me "The Energizer Bunny."

31  
32 I am aware that my neighbor Vale Taylor had been doing some work on their home for a period of time. I'm not  
33 really sure how long the work took. It never bothered me. I believe most of the work they were doing was while I  
34 was at school. If they were doing work in the early morning hours, I never noticed. Admittedly, I am a heavy  
35 sleeper; I learned that the hard way in my first semester of college when I nearly slept through a 3 a.m. fire alarm in  
36 my dorm, except for my roommate making sure I woke up.

37  
38 On Thursday, May 25, 2023, when getting home from school, I was approached by Vale Taylor, who asked if I  
39 wanted to make a little extra spending money. Specifically, Vale Taylor asked if I wanted to clean out their gutters  
40 over Memorial Day weekend, which was that upcoming weekend. They said they would pay me \$100 to do it and I  
41 could do it whenever I wanted over the weekend because they would be out of town, and it didn't matter which day I  
42 chose to do the work. They told me they had inspected the ladder and it was good to go and ready to use just the  
43 same as last year.

44  
45 \$100 to do a task like that sounded pretty good to me. First, I had done it once before, so I believed I knew exactly  
46 what I needed to do. Also, being in the school band takes up a lot of my free time and I hadn't had much chance to  
47 make and save money before I went away to college.

48  
49 I have previously been hired by Vale Taylor in the past to do the same job one prior time about the same time the  
50 previous year. The time that was the previous year was the only other time I had ever cleaned out anyone's gutter.  
51 Vale's ladder was the same ladder that I used on this 2nd occasion. When I had worked on the project this second  
52 time, Vale had told me they just inspected the ladder and made sure it was safe and told me I was good to go.

53  
54 The first time I worked on Vale's gutters, Vale said something about someone they knew getting hurt on a ladder  
55 and it made them nervous, so they just wanted to be extra secure. They showed me how to raise the ladder, watched



56 me go up the ladder to clean out the gutters, watched me come back down, watched me securely reposition the  
57 ladder myself and go back up. Once they saw I could handle that, they left me to it, and everything went to plan.  
58  
59 It never occurred to me on the incident date that I should especially check the ladder extra for anything like “ladder  
60 shoes.” I only learned because of this case what those even are.  
61  
62 I decided to do the gutter work on Saturday of that weekend because I wanted to get it done early and enjoy as much  
63 of my free time as possible. When I arrived at Vale Taylor’s residence to clean the gutters, I located the ladder  
64 outside against the house where Vale showed me it would be, which was on the side of the house, which you see in  
65 Exhibit 29. When I got to the ladder, there was a note taped on it. It was typed. It said, “Good luck trying to get any  
66 work done without your shoes. Don’t worry, you’ll get them back on Tuesday. Nighty night.” When I saw that note,  
67 I really didn’t know what it meant. It was spooky but I just assumed someone was trying to play a prank on Vale  
68 Taylor by taking their actual shoes. I had no idea it was referring to ladder shoes. I recall that the note was taped to  
69 the bottom rung of the ladder. I took the note off the ladder and just set it aside.  
70  
71 I took the ladder to the back of the house to start on those gutters. None of the exhibits I have seen include photos of  
72 the back of the house, but the exhibits of the front of the house show the same kind of gutters that were in the back. I  
73 extended the ladder up to the height I needed. I kind of jiggled the ladder to make sure it felt secure to me.  
74 Everything seemed fine. Nothing appeared broken to me.  
75  
76 Next thing I did was start to climb the ladder. I only got up about 10 or 11 rungs on the ladder when I noticed the  
77 whole ladder was sliding. I couldn’t control the ladder at all and then suddenly I fell backwards and landed on my  
78 back. The ladder came crashing down beside me but didn’t hit me when it fell. I landed forcefully on my right  
79 shoulder and back, resulting in immediate soreness and discomfort. I would say I had some soreness at that time.  
80  
81 After taking a minute or two to lay there, I was able to get up and walk back home. When I got home, I told my  
82 mother what happened, and she insisted we go immediately to the hospital to get checked out. I didn’t see what the  
83 big deal was at the time because I thought I might just “walk it off” as the expression goes. Now I realize from what  
84 my mother told me is that I probably had so much adrenaline going through me that I had no idea what I was  
85 feeling. Anyway, I “won” that debate with my mother and didn’t go anywhere. But my mother insisted I take some  
86 Ibuprofen. I remember I took one 200 mg tablet every 4-6 hours, about 4 times per day. I followed the directions on  
87 the back of the bottle, which are shown in Exhibit 35. I regularly took one 200 mg tablet of Ibuprofen for the next  
88 two months. Ever since the last time I saw Dr. Morgan, I still take one tablet per day, most days of the week.  
89  
90 The Ibuprofen helped a little at first, but the pain started to feel worse and worse every day thereafter. Prior to the  
91 pain getting really bad, I was still able to attend a concert at Pleasant Seas Dock Pavilion on Sunday May 28, 2023  
92 to see the House Of Pain reunion show. And, before you ask, yes, I did post on social media at 11:00 p.m. that night  
93 from my account, @HardyParHar. That’s the same post that is in Exhibit 8. But just so you know, I may have been  
94 singing along at that show, but I wasn’t jumping. You might ask, why post that? Because it was the end of the  
95 school year and I just wanted to have some fun that night and I didn’t want to seem like a complainer about my pain  
96 to my friends. I swear. Plus, if there were graduation parties, I didn’t want people not to invite me if they thought I  
97 was injured.  
98  
99 Like I said, the pain was getting worse in my neck and back. Even though I was feeling pain in my neck and back, I  
100 felt ok enough to drive. It was getting bad enough though that I was thinking I should probably go to a doctor in the  
101 next couple days if it didn’t get better fast.  
102  
103 On June 1, 2023, I was involved in a car accident. If I didn’t have bad luck, I’d have no luck at all. I was driving in  
104 my silver Toyota Camry out of my neighborhood when my neighbor, Whitney Jones, rear-ended me in their silver  
105 Ford Bronco. I was stopped at a stop sign at the end of Severn Street and about to turn onto Susquehanna Avenue.  
106 Exhibit 31 shows the intersection and the stop sign I was stopped at. Also, Exhibits 32 and 33 show my car and  
107 Whitney Jones’ car after the accident, but those photos aren’t from the accident scene. I took the photo in Exhibit 33  
108 a few hours after the accident. None of the damage you see in Exhibit 33 was there before this accident. Even  
109 though I was wearing a seat belt, the force of getting hit from behind caused me to jolt forward and then back into  
110 my seat. It was like a whiplash. I didn’t see it coming but I’d have to assume they were going at least 20-30 m.p.h.  
111 Anyway, from that car accident, I felt increased pain in my neck, shoulders, and back. I wouldn’t say it was much

112 worse. More like it was stronger. Like if my pain before was an 8 out of 10, with 10 being the strongest pain, this  
113 took it to a 9 out of 10. I base those pain numbers from the chart in Dr. Morgan's office. A copy of that chart is in  
114 Exhibit 34.

115  
116 After the car accident, an ambulance responded. I was not the one who called 911; Whitney Jones did. They were  
117 just being considerate and cautious, I guess. I spoke to the medic and told them I felt ok and didn't want to go to the  
118 hospital, so they left me there. I was able to drive my car away from the scene, even though the bumper had damage  
119 to it. I haven't had the bumper replaced because it's still on there, but it isn't pretty like it used to be.

120  
121 In response to this car accident, I just continued taking my Ibuprofen.

122  
123 On June 5, 2023, my mother told me that I was going to see a doctor because I really didn't feel like I could move  
124 my neck and shoulders. My mother took me to Ouch Chiropractic. They are located in the same shopping center as  
125 the grocery store we always go to. We had never been to Ouch Chiropractic before, but I guess their slogan on their  
126 posters outside really works. We went to see a chiropractor named Dr. Chris Morgan. My first meeting with them  
127 started out with them interviewing me about my symptoms and I told them what had happened to me. I saw Dr.  
128 Morgan for about 2 months. I went regularly, about 3 times per week. I did miss some appointments in July because  
129 I went away with my family to the beach at Ocean City for 7 days. I didn't see any other health care providers  
130 during that time.

131  
132 At my chiropractor appointments, the sessions would start out with the chiropractor doing some adjustments in my  
133 upper back/neck area. Then they would put these pads on me that felt like little tiny needles. Lastly, they would do  
134 some hot and cold packs on my upper back and neck, and also we would do some work on workout machines.

135  
136 I have never met with Dr. Dylan Avery. I can't believe the things Dr. Avery wrote in their report. How can they  
137 know my pain without even meeting me?

138  
139 Because of this injury, I missed being able to perform at my high school graduation on June 7, 2023. Being part of  
140 the Marching Band has been one of my favorite parts of high school. I was really looking forward to showing off for  
141 the rest of my school one last time before high school ended. I'll never get that memory back. I was the top bass  
142 drum player and section leader of my high school drumline. Practice in high school and in college is five days a  
143 week. I was good enough to be recruited for the college band. I believed I was on track to be placed in one of the top  
144 bass drum spots, even though I was only going to be a freshman. I tried to rest over the summer to heal as quickly as  
145 possible. But one time later in the summer, I tried to practice outside with my drum but could barely lift it, so I  
146 stopped essentially immediately, I swear. I ended up missing my college drumline's summer practice days ("summer  
147 drum days"). As a result, I'm less familiar with things like the band's marching technique and the band's commands  
148 compared to new members who were able to attend the summer practice days. To make matters worse, drumline  
149 auditions are on the first day of band camp the week before school starts at the end of August. On Audition Day, I  
150 was still in too much pain to wear the bass drum for long periods of time and could not complete their audition.  
151 After auditions, I was placed in the cymbal line and told I may be able to join the bass drum line later in the season  
152 if I was more healed, but I would not be one of the top bass drum spots because those are all being filled. I guess I'm  
153 lucky that I was able to make the band. Now, even though I am feeling better, I have less of a chance to get the top  
154 bass drum spot and/or bass drum squad leader position next year because I have less experience than the members  
155 who were able to play this year.

156  
157 Additionally, my last summer before college was not all fun and games. Because of my injury, I had to take it easy.  
158 Also, because of my physical therapy, I couldn't go away to Ocean City with my friends for Senior Week right after  
159 graduation. Lastly, I still maintain some stiffness from this accident.

160  
161 Regarding my car accident, yes there is also a pending lawsuit here in the Circuit Court for Chesapeake County,  
162 where I have sued Whitney Jones for in excess of \$75,000.00. The lawsuit alleges their negligent driving caused  
163 their car to impact my car and injure me. That case has a trial date of July 8, 2024. I know my attorney has been  
164 negotiating with Whitney Jones' car insurance, but a settlement has not been reached. I recall the last offer to settle  
165 was \$18,000 plus the cost of any repairs to my vehicle.

166

167 Finally, I have heard that some people have alleged that I have been seen in the neighborhood jogging and practicing  
168 on my drums. Other than what I have discussed above, I deny any of those other observations. Plus, I hate  
169 exercising. I'm not saying I never have. I'm just saying I wasn't after these accidents.

170  
171 I swear or affirm that everything in this affidavit is true. Before I wrote this affidavit, I was instructed that I should  
172 include everything I know that could possibly be relevant to my testimony in this case, and I carefully followed  
173 those instructions. I am fully aware that I must update this affidavit with any new or additional information I  
174 remember from now until the moment I take the stand to testify at trial.

175

176

*Parker Harper*

\_\_\_\_\_  
Parker Harper

177

1 **Vale Taylor**  
2 Witness for the Plaintiff

3  
4 After having been duly sworn by oath, Vale Taylor hereby states as follows: I am over 18 years old and competent  
5 to make this affidavit. I am testifying voluntarily and have not been subpoenaed.

6  
7 I am aware that you are in receipt of a transcript from a trial where I testified under oath on July 25, 2023. That  
8 transcript appears at the very end of my affidavit. All of the statements contained in that transcript are an accurate  
9 transcription of what I said on that date. I do not need to adjust anything I stated in that transcript.

10  
11 The reason for my affidavit is to address certain exhibits. I am the owner of the ladder in question. The ladder is a  
12 24-foot extension ladder, which is shown in Exhibit 10. I added the measurements shown in the image to show its  
13 storage height, maximum height, and the step rise, which is the distance between the top of one rung to the top of the  
14 next rung above it. Exhibit 9 is the same ladder but it is a close-up photo of the bottom of the ladder showing its feet,  
15 a.k.a. ladder shoes. Exhibit 11 are the parts for a ladder shoe assembly. Exhibit 12 shows the dimensions of one  
16 ladder shoe. Exhibit 18 is a video I made that shows how ladder shoes are removed from a ladder. Exhibits 13  
17 through Exhibit 17 are screenshots from that video. Exhibits 13 and 14 show what the bottom of my ladder would  
18 look like if its shoes were attached properly. Exhibit 17 is what the bottom of my ladder would look like if its shoes  
19 were not attached.

20  
21 I also agree with Parker Harper about Exhibits 19 through 30 and what they show and depict and who lives where in  
22 our neighborhood.

23  
24 I swear or affirm that everything in this affidavit is true. Before I wrote this affidavit, I was instructed that I should  
25 include everything I know that could possibly be relevant to my testimony in this case, and I carefully followed  
26 those instructions. I am fully aware that I must update this affidavit with any new or additional information I  
27 remember from now until the moment I take the stand to testify at trial.

28  
29  
30   
Vale Taylor

**Transcript of July 25, 2023 Trial of State of Maryland v. Dakota Reese**

1  
2  
3 JUDGE: Good morning, everyone.  
4  
5 STATE’S ATTORNEY: Good morning, your honor.  
6  
7 DEFENSE ATTORNEY: Good morning, your honor.  
8  
9 JUDGE: State, please call your case.  
10  
11 STATE’S ATTORNEY: Certainly, your honor. The State now calls State of Maryland v. Dakota Reese.  
12  
13 DEFENSE ATTORNEY: Good morning, again, your honor. Defense Counsel on behalf of Dakota Reese, who  
14 stands beside me.  
15  
16 JUDGE: Good morning, Dakota Reese.  
17  
18 DAKOTA REESE: Good morning.  
19  
20 JUDGE: What are we doing with this case?  
21  
22 DEFENSE ATTORNEY: Your honor, my client is charged with Theft of Property valued at under \$100. Because  
23 this carries a maximum penalty of 90 days, they do not have a right to a jury trial. They are pleading Not Guilty and  
24 proceeding by way of a bench trial here today.  
25  
26 JUDGE: Ok. Any opening statements by the attorney?  
27  
28 DEFENSE ATTORNEY: I’ll waive my opening statement.  
29  
30 STATE’S ATTORNEY: I’ll be waiving my opening statement as well.  
31  
32 JUDGE: Very well. Who will be the first witness for the State?  
33  
34 STATE’S ATTORNEY: That would be Vale Taylor.  
35  
36 JUDGE: Vale Taylor. Please step forward to the witness stand.  
37  
38 COURT CLERK: Do you solemnly swear or affirm under the penalties of perjury that the responses given and  
39 statements made will be the whole truth and nothing but the truth?  
40  
41 VALE TAYLOR: I do.  
42  
43 JUDGE: State, your witness.  
44  
45 STATE’S ATTORNEY: Thank you, your honor. Please state your name for the record.  
46  
47 VALE TAYLOR: Vale Taylor.  
48  
49 STATE’S ATTORNEY: Where do you live?  
50  
51 VALE TAYLOR: 9 Choptank Way.  
52  
53 STATE’S ATTORNEY: And is that in Chesapeake County?  
54  
55 VALE TAYLOR: It is.  
56

57 STATE'S ATTORNEY: Tell the court what you do for a living?  
58  
59 VALE TAYLOR: I am an attorney. I graduated from the University of Baltimore Law School. I run a solo practice  
60 that primarily handles immigration law cases.  
61  
62 STATE'S ATTORNEY: Thank you. I want to draw your attention to around the time period of Memorial Day  
63 weekend of 2023. In the days leading up to that weekend, were you involved in any home improvement work?  
64  
65 VALE TAYLOR: I was.  
66  
67 STATE'S ATTORNEY: Can you tell the court a little about that?  
68  
69 VALE TAYLOR: I can. I had been doing some work on my home for about a week's time. I took a nice long  
70 vacation from work to have some me-time working on some projects I had been meaning to get to. Specifically, I  
71 had done shingle work, which involved removing existing roof shingles and replacing deteriorating wood planking  
72 with new planking and installing the new shingles. Around the end of the week, I was replacing the wood siding on  
73 my house.  
74  
75 STATE'S ATTORNEY: And what does that entail?  
76  
77 VALE TAYLOR: Well, first I need a ladder so that I can go up and begin prying the wood from the structure and  
78 replace it with new siding. I used a hacksaw to cut the nails away from the wall and a circular saw to make my cuts  
79 directly into the wood itself and then I used a pry bar and hammer to remove existing wood siding. I then placed the  
80 weather resistant barrier paper with a nail gun and began the process of installing vinyl siding. I attached sheathing  
81 and flashing with a nail gun and then installed the starter strip, using a hammer. I then installed my inside and  
82 outside corners with a hammer and then I installed the Vinyl Siding Panels. Lastly, I then installed j-trim on the  
83 doors and windows with a hammer.  
84  
85 STATE'S ATTORNEY: Would it be fair to say the work you are doing is loud in nature?  
86  
87 VALE TAYLOR: Yes. Lots of banging. Hammering. And those nail guns have some umph. I know I work in the  
88 mornings and afternoon, but I only do this work during appropriate hours of the day, when I think everyone should  
89 probably already be awake.  
90  
91 STATE'S ATTORNEY: Thank you. Now I want to ask you about your ladder. Have you made any modifications to  
92 your ladder?  
93  
94 VALE TAYLOR: Modifications?  
95  
96 STATE'S ATTORNEY: Any additions?  
97  
98 VALE TAYLOR: Yes. I own a 24-foot extension ladder. I've had it for several years. It comes in handy for many  
99 projects that come up around the house. But about 2 years ago, I heard about a friend at work falling from his ladder.  
100 He fell from really high up and it broke some bones. It really got into my head because I'm not getting any younger.  
101 So, I googled ladder safety and learned that there were items to watch out for on your ladder to maintain safety. And  
102 then I was reminded about ladder foot pads, also known as ladder shoes. Ultimately, I reviewed how ladder foot  
103 pads can wear down, but they are easy to remove and replace.  
104  
105 STATE'S ATTORNEY: And did you replace your ladder foot pads after your initial purchase?  
106  
107 VALE TAYLOR: Yes.  
108  
109 STATE'S ATTORNEY: When?  
110  
111 VALE TAYLOR: About 2 years ago; not long after I heard about that friend falling.  
112

113 STATE'S ATTORNEY: If you know, why are ladder foot pads important?  
114

115 VALE TAYLOR: Using a ladder without a ladder foot pad significantly increases the risk of accidents and poses  
116 several potential hazards. Some possible consequences of using a ladder without foot pads are slippage, uneven  
117 weight distribution, and reduced stability. Regarding slippage, ladder foot pads provide stability and grip on the  
118 ground, preventing the ladder from slipping or shifting during use. Without a foot pad, the ladder may have reduced  
119 traction, especially on smooth or slippery surfaces, increasing the likelihood of the ladder sliding or tipping over.  
120 Next, ladder foot pads help distribute the weight of the ladder evenly across the surface, enhancing stability. Without  
121 foot pads, the ladder's weight may concentrate on a smaller area, increasing the pressure on the ground. This can  
122 lead to sinking, especially on soft ground or surfaces like grass. Finally, foot pads play a crucial role in preventing  
123 the ladder from wobbling or rocking during use. Without them, the ladder's base may be less secure, potentially  
124 causing instability, which can result in falls or accidents. To ensure your safety and minimize potential risks, it is  
125 advisable to use a ladder as intended, including using ladder foot pads or other appropriate safety accessories. When  
126 you purchase a ladder, they always come with a warning that says to always follow the manufacturer's guidelines  
127 and take necessary precautions when working at heights.  
128

129 STATE'S ATTORNEY: What is your basis for knowing this about ladders?  
130

131 VALE TAYLOR: Well, like I said, I am an attorney. But before I went to law school, during my college years, in  
132 the summers, I would get jobs working for various contractors doing work on houses, both doing exterior and  
133 interior work. Frequently the work I had to do involved the use of a ladder. In those 3 summers from after my  
134 freshman year through the start of fall of my senior year, I was probably up on a ladder at least 50 times. The  
135 contractors explained to me how they worked and how to operate them safely. That's how I initially became aware  
136 of their workings and proper use. Ever since then, I've just continued being a handy person around the house and  
137 doing my own home fixes, including if they require the use of a ladder.  
138

139 STATE'S ATTORNEY: Ok, so directing your attention back to Memorial Day weekend of this year, were you  
140 home that weekend.  
141

142 VALE TAYLOR: No.  
143

144 STATE'S ATTORNEY: Where were you that weekend?  
145

146 VALE TAYLOR: I took a trip with my family to Ocean City, Maryland for the long weekend.  
147

148 STATE'S ATTORNEY: Did you give anyone authorization to be at your home that weekend?  
149

150 VALE TAYLOR: Yes.  
151

152 STATE'S ATTORNEY: Who?  
153

154 VALE TAYLOR: Parker Harper.  
155

156 STATE'S ATTORNEY: What authorization did you give to Parker Harper?  
157

158 VALE TAYLOR: Well, I had asked Parker if they would like to make some extra money. I had noticed for a while  
159 that my gutters were full of leaves, so I asked Parker if they would like to clean out my gutters. They responded they  
160 were up for it. I agreed to pay Parker \$100 for the chore. I knew the weather would be nice that weekend, so I left  
161 my ladder outside against my house. I showed Parker where my ladder was. I told Parker they could do the chore  
162 anytime over the weekend and that it did not matter to me when they did it so long as it was done before I came  
163 home.  
164

165 STATE'S ATTORNEY: Did you ever explain to Parker what you explained here about ladder safety?  
166

167 VALE TAYLOR: Parker had cleaned my gutters once before in the previous year. I'm sure I said something then. I  
168 mean, it's my homeowner's insurance on the line if I didn't. I recall the prior year was Parker's first time using a

169 ladder, so I remember showing them how to use it properly and to check it to make sure it was sturdy. That talk  
170 would have included inspecting the ladder shoes; I'm almost 100% positive I said that then. Fast forward to this  
171 second occasion, I don't think I gave the same talk again; probably because I know myself to be thorough and  
172 assumed I was the first time, and everything went smoothly with that project. I remember checking the ladder  
173 myself before Parker came over and telling them it was in good condition and ready to be used on this second  
174 occasion. After that, I assumed Parker would remember to check the ladder anyway, as I believe anyone should.  
175

176 STATE'S ATTORNEY: Did there come a time when you found out there was an incident at your home while you  
177 were away that weekend?  
178

179 VALE TAYLOR: Yes, on Sunday morning of that weekend, I found out that Parker had fallen. I found out from  
180 their mother, who called me to say that Parker had fallen. They reported that Parker was a bit shaken up. Which is  
181 not to say this wasn't serious. I saw Parker on May 30 briefly. I wanted to check in with them. They weren't moving  
182 around too well; seemed stiff in the back area. I believe their words were they were taking it easy and hoping the  
183 stiffness would go away. After that day, I'm also aware that Parker had to stop performing in their band. I believe  
184 that is because of this incident. I saw them around the neighborhood periodically and I would describe their  
185 movements as labored because of noticeable visible neck and back pain. You know what I mean... when you call  
186 out for someone who is looking the other way and they have to turn in such a way, like they are a robot, where their  
187 whole neck and back turn together as if a pole is connecting them. Also, I noticed Parker wasn't doing any drum  
188 rehearsing anymore from their home. Whenever they did, you knew it. That drum made a booming sound.  
189

190 STATE'S ATTORNEY: Did anyone tell you there was something wrong with your ladder?  
191

192 VALE TAYLOR: No. I only knew that apparently Parker had gone up a couple of rungs on the ladder before they  
193 fell backwards and hurt themselves. That's what their mother told me. No work was done on my house at all.  
194

195 STATE'S ATTORNEY: And so what did you do next?  
196

197 VALE TAYLOR: Well, while what happened was concerning, Parker's mother did not give me the impression that I  
198 needed to cut my vacation short. I returned home from Ocean City on Monday, May 29 around 7:00 p.m. I went out  
199 to take a look and see if I could figure out what had happened.  
200

201 STATE'S ATTORNEY: Were you able to make any observations?  
202

203 VALE TAYLOR: Yes. I found my ladder laying on the ground where I assumed Parker had fallen. I inspected the  
204 ladder to see if there were any defects in it.  
205

206 STATE'S ATTORNEY: Did you find any?  
207

208 VALE TAYLOR: Yes. I noticed that neither of the ladder shoes were on my ladder.  
209

210 STATE'S ATTORNEY: When you left for your vacation, did your ladder have ladder shoes on it?  
211

212 VALE TAYLOR: Yes.  
213

214 STATE'S ATTORNEY: How can you be so sure?  
215

216 VALE TAYLOR: I don't remove them. There is no reason to. Plus, I know they had to be on the ladder because I do  
217 check my ladder for safety issues before I go on it. Everyone should. You're crazy not to. Like I said, I'm not  
218 getting any younger.  
219

220 STATE'S ATTORNEY: And so you say the ladder shoes were not on the ladder?  
221

222 VALE TAYLOR: Correct.  
223

224 STATE'S ATTORNEY: Did you discover anything else unusual when you got home?



225  
226 VALE TAYLOR: Yes. Near where I had left my ladder for Parker, I found a note that said...  
227  
228 DEFENSE ATTORNEY: Objection. Hearsay.  
229  
230 STATE'S ATTORNEY: Your Honor, the note is not being offered to prove the truth of the matter asserted. It is  
231 being admitted just to show effect on the hearer.  
232  
233 JUDGE: Overruled. You can answer and say what the note said.  
234  
235 VALE TAYLOR: "Good luck trying to get any work done without your shoes. Don't worry, you'll get them back on  
236 Tuesday. Nighty night."  
237  
238 STATE'S ATTORNEY: Who is Dakota Reese?  
239  
240 VALE TAYLOR: They are my next-door neighbor.  
241  
242 STATE'S ATTORNEY: Did you ever talk to Dakota Reese about this incident?  
243  
244 VALE TAYLOR: No. I have nothing to say to them. I will never talk to them ever again.  
245  
246 STATE'S ATTORNEY: Prior to this incident, how would you describe your relationship to Dakota Reese?  
247  
248 VALE TAYLOR: We've been neighbors for 5 years. We have different work schedules, but I think we've been  
249 good neighbors to each other. That was until the week leading into Memorial Day weekend. In that week, Dakota  
250 had complained to me about the work I was doing on my house. They said something about how they couldn't get  
251 any sleep and that I was annoying the whole neighborhood. They said I needed to watch out if I wasn't more  
252 respectful to the community. Apparently, they weren't too happy with the work I was doing on my house. It's a big  
253 undertaking. I don't have a lot of hours to work on it, which is why I took time off. I believe I am respectful about  
254 what hours I work on the house. I don't look at a clock, but I know I never work when the sun is down.  
255  
256 STATE'S ATTORNEY: Did you ever purchase new ladder shoes to replace the missing ones?  
257  
258 VALE TAYLOR: Nope. Didn't have to. On Tuesday morning, May 30, 2023, I went out my door to walk to my car  
259 to go to work. When I opened the door, right outside my door was the two ladder shoes for my ladder with a second  
260 note.  
261  
262 STATE'S ATTORNEY: Do you have that note with you?  
263  
264 VALE TAYLOR: I do.  
265  
266 STATE'S ATTORNEY: Is that note a fair and accurate representation of the note that was with your ladder shoes?  
267  
268 VALE TAYLOR: It's one in the same.  
269  
270 STATE'S ATTORNEY: Please read the note.  
271  
272 DEFENSE ATTORNEY: Objection.  
273  
274 JUDGE: Basis?  
275  
276 DEFENSE ATTORNEY: Hearsay.  
277  
278 STATE'S ATTORNEY: It's not offered to prove the truth of the matter.  
279  
280 JUDGE: Objection overruled.

281  
282 VALE TAYLOR: The note says: "We all just needed some sleep. You can get back to work now. Please be mindful  
283 of your neighbors."  
284  
285 STATE'S ATTORNEY: Do you know who wrote it?  
286  
287 VALE TAYLOR: I have my strong suspicions. Can I say?  
288  
289 DEFENSE ATTORNEY: Objection.  
290  
291 JUDGE: Counsel, can you make a proffer as to what the witness will be testifying to?  
292  
293 STATE'S ATTORNEY: Certainly, your honor. The witness is about to explain why they believe the Defendant was  
294 the author of this letter, and that will be based on viewing a video surveillance from their home.  
295  
296 JUDGE: Objection overruled. Please re-ask the question.  
297  
298 STATE'S ATTORNEY: Who do you believe wrote this second note?  
299  
300 VALE TAYLOR: Dakota Reese.  
301  
302 STATE'S ATTORNEY: Why do you believe that?  
303  
304 VALE TAYLOR: I have some security cameras on my home. At the time, I tried to get the video to playback, but  
305 for some reason I could not get the software to work. It was operational but I just couldn't get it to work at the time.  
306 I eventually called tech support from the company who was able to assist me, and I was able to watch the video from  
307 that date.  
308  
309 STATE'S ATTORNEY: And when did you view this video?  
310  
311 VALE TAYLOR: Thursday June 8, 2023.  
312  
313 STATE'S ATTORNEY: And do you still have this video?  
314  
315 VALE TAYLOR: I do not.  
316  
317 STATE'S ATTORNEY: Why is that?  
318  
319 VALE TAYLOR: Because it has since been deleted. I watched the video and I know what it shows, but what I  
320 didn't know was that the video cameras delete themselves after about two weeks to save space. If I was aware of  
321 that, I would have downloaded the video.  
322  
323 STATE'S ATTORNEY: Does anyone else have the login information for the video software?  
324  
325 VALE TAYLOR: Besides me? No. Just me and the people at the company that installed the cameras.  
326  
327 STATE'S ATTORNEY: Please tell the court what the video shows?  
328  
329 VALE TAYLOR: It showed a person walking to front of my house, placing my missing ladder shoes near the front  
330 of my door and leaving a folded-up note with them.  
331  
332 STATE'S ATTORNEY: And were you able to identify this person?  
333  
334 VALE TAYLOR: I was. It was Dakota Reese.  
335  
336 STATE'S ATTORNEY: Could you see Dakota Reese clearly?

337  
338 VALE TAYLOR: Well, it depends on your definition of the word "clearly." I believe the answer is yes. Of course,  
339 the video was a bit pixelated, but I knew who I was looking at. Same size and build of my neighbor of 5 years. Same  
340 walk and same manner. Same hair color. It was Dakota.  
341  
342 STATE'S ATTORNEY: So how sure are you that it was Dakota Reese on the video?  
343  
344 VALE TAYLOR: Very sure.  
345  
346 STATE'S ATTORNEY: This next question will seem odd. Did you give permission to Dakota Reese to remove  
347 your ladder shoes?  
348  
349 VALE TAYLOR: Absolutely not.  
350  
351 STATE'S ATTORNEY: Is the person you saw on that video present here in court? If yes, please identify them.  
352  
353 VALE TAYLOR: They are sitting right there at that trial table next to the defense attorney.  
354  
355 STATE'S ATTORNEY: Your honor, please let the record reflect the witness has identified the Defendant.  
356  
357 JUDGE: Noted.  
358  
359 STATE'S ATTORNEY: No further questions.  
360  
361 JUDGE: Any cross?  
362  
363 DEFENSE ATTORNEY: Briefly. You say you are sure that the person you saw on the video was Dakota Reese.  
364 Would you say you are 100% without a shadow of a doubt sure that it was Dakota Reese?  
365  
366 VALE TAYLOR: Well, I guess I can never be 100% sure of anything. But 99%? Yes, I am 99% sure it was Dakota.  
367  
368 DEFENSE ATTORNEY: No further questions.  
369  
370 JUDGE: ReDirect?  
371  
372 STATE'S ATTORNEY: No, thank you.  
373  
374 JUDGE: The witness may step down. Any other witnesses for the State?  
375  
376 STATE'S ATTORNEY: No, your Honor. The State rests.  
377  
378 JUDGE: I see. Does the defense intend to call any witnesses?  
379  
380 DEFENSE ATTORNEY: No, your Honor. The defense also rests. We are prepared to move directly into closing  
381 arguments.  
382  
383 JUDGE: Fine. State, are you ready?  
384  
385 STATE'S ATTORNEY: Yes, thank you. The evidence has shown that Dakota Reese committed this theft on the  
386 incident date. You heard from Vale Taylor. And sure, Vale Taylor was not 100% sure. But that is not the standard  
387 here. The State is not required to prove guilt beyond all possible doubt or to a mathematical certainty. The standard  
388 is beyond a reasonable doubt, and we believe we have met that standard in proving that a theft was committed and  
389 Dakota Reese was the person who committed that theft. Thank you.  
390  
391 JUDGE: Thank you. Defense?  
392

393 DEFENSE ATTORNEY: Yes, thank you. I understand that the State does not need to prove their case to a  
394 mathematical certainty. But, your honor, we ask you to take into consideration that you did not see the video here.  
395 The video does not exist. And we have a witness who has had issues with a neighbor and now we are expected to  
396 accept that they saw a video and the video is clear enough to know it was my client? That just can't be proof beyond  
397 a reasonable doubt. I'd also like to point out the property was returned days later. One of the elements of any theft is  
398 an intent to permanently deprive. I would argue that the fact the property was returned does not mean the taker had  
399 an intent to permanently deprive the owner. For all of the above reasons, I ask you to find my client Not Guilty.

400  
401 JUDGE: State, any rebuttal?

402  
403 STATE'S ATTORNEY: Your honor, we are going to submit on our previous argument.

404  
405 JUDGE: Very well. The verdict of this court is that the Defendant is guilty of Theft of Property valued at under  
406 \$100. I am convinced beyond a reasonable doubt that the Defendant committed this crime. Are the parties prepared  
407 to move forward with sentencing?

408  
409 STATE'S ATTORNEY: Yes, your honor.

410  
411 DEFENSE ATTORNEY: Yes, your honor.

412  
413 JUDGE: I'll hear from the State first.

414  
415 STATE'S ATTORNEY: Thank you, your honor. Your honor, the Defendant does not have a prior record. That  
416 being said, you have heard from the facts here that someone got hurt because of the Defendant's careless actions.  
417 The Defendant very well may have thought they were just doing something small to inconvenience their neighbor, but their  
418 actions really hurt someone. I get that this person is charged with Theft, and not an Assault. But this theft actually  
419 hurt someone. And for those reasons, we think a period of incarceration is appropriate. The State asks this court to  
420 sentence the Defendant to 60 days in jail for this crime. Thank you.

421  
422 JUDGE: Defense?

423  
424 DEFENSE ATTORNEY: First, your honor, I would like to advise my client of their right to allocation.

425  
426 JUDGE: Ok.

427  
428 DEFENSE ATTORNEY: Dakota, please stand. You have a right to address the court. You do not have to. Is there  
429 anything you would like to say at this sentencing hearing?

430  
431 DAKOTA REESE: No. You know what I would like to have communicated. I wish to otherwise remain silent.

432  
433 DEFENSE ATTORNEY: Very well. Your honor, my client waives their allocation. On their behalf, I will say my  
434 client has been and is a model citizen. While my client still asserts their innocence here, it is very important for you  
435 to know that my client would never wish for anyone to be injured. And to the extent that someone was injured here,  
436 my client is sad to hear it. Again, your honor, I respect your ruling and that you have found my client guilty. But my  
437 client has a career and a home. I would ask that you consider a period of probation for my client. Thank you.

438  
439 JUDGE: Thank you, all. First, I appreciate everything I heard here. And I do understand that the Defendant has been  
440 found guilty only of a Theft crime. But what happened here just got out of hand. This is a classic case of how one  
441 bad decision can have a snowball effect. And that snowball ran all over Parker Harper. And they got hurt. It's  
442 terrible and I imagine the Defendant knows better and is not proud of what they did and would do anything they  
443 could to undo it. But that isn't possible. And there needs to be a consequence for this. The sentence of the court is as  
444 follows. I have found the Defendant guilty of Theft. I am going to sentence the Defendant to 60 days in jail, but I  
445 will suspend all but 8 days of that sentence. For those 8 days, you will spend 4 consecutive weekends in jail. You  
446 will be placed on 1 year of unsupervised probation and are to have no contact with Vale Taylor. If you do not report  
447 for your weekends in jail, get charged with any new crimes, or have any contact with Vale Taylor, that will result in

448 violation of probation and you can face incarceration for up to the balance, which would be up to 52 more days in  
449 jail. Do you understand?

450

451 DAKOTA REESE: I do.

452

453 JUDGE: Your first weekend in jail will be this weekend. We will give you reporting instructions before you leave.  
454 You have 10 days to file for a new trial, 30 days to file for appeal, and 90 days to file for a modification of sentence.  
455 All of those motions have to be filed in writing. Do you understand?

456

457 DAKOTA REESE: I do.

458

459 JUDGE: Ok. Also, for your Defense Counsel, if your client completes their probation without any violations, I will  
460 consider modifying your client's conviction to a Probation Before Judgment, so please file the appropriate motions.  
461 This concludes today's docket. You all are free to go. Take care.

1 **Affidavit of Dr. Chris Morgan**

2 Expert Witness for the Plaintiff in the field of Chiropractic Therapy Services

3  
4 I, Dr. Chris Morgan, prepared the attached reports from my office and the bills were issued by my billing office.  
5 These records and reports were made at or near the time of the events or dates on each document, they were made  
6 either by myself or my office who would have knowledge of the information being transmitted to them, they were  
7 made in the course of regularly conducted business activity, and it is the regular practice of my business to make and  
8 keep these records.

9  
10 My training is as follows: I received my Bachelors of Science in Biological Sciences from the University of  
11 Maryland Baltimore County (UMBC). From there, I attended the Texas Chiropractic College, where I received my  
12 Doctorate of Chiropractic. I received that degree 15 years ago. I then came back to Maryland where I have been  
13 licensed in the State of Maryland as a chiropractor ever since. As a chiropractor, I am also trained to administer  
14 physical therapy to my patients. When I first returned to Maryland, I worked for a larger Chiropractor practice.  
15 About 5 years ago, I started my own practice, Ouch Chiropractic. The majority of my clients are referred by  
16 attorneys who represent clients who have been injured in an accident. I do accept walk-in clients but I would say  
17 they make up about 15% of my clientele.

18  
19 A Doctor of Chiropractic degree focuses on diagnosing and preventing disorders of the spine and other parts of the  
20 musculoskeletal system. Doctors of Chiropractic study spinal anatomy in-depth and learn to diagnose  
21 neuromusculoskeletal conditions. Chiropractic treatment is often associated with bones, joints and discs and treating  
22 with Chiropractic Adjustments. Chiropractic adjustment is a procedure in which trained specialists (chiropractors)  
23 use their hands or a small instrument to apply a controlled, sudden force to a spinal joint. The goal of this procedure,  
24 also known as spinal manipulation, is to improve spinal motion and improve your body's physical function.  
25 Additionally, chiropractors treat the surrounding muscles and other soft tissues. This is an essential aspect of  
26 chiropractic care. Any approach to treatment should be holistic. Problems in one area of the body, such as a joint or  
27 disc, can result in pain in other areas, including muscles. When you visit a chiropractor, we carefully assess the type  
28 and cause of your muscle pain and may recommend treating it with a variety of physiotherapeutic muscle therapy  
29 techniques, while, other times, we may recommended chiropractic adjustments or a combination or chiropractic  
30 treatments and muscle/physical therapy. As part of my degree, I am also trained to administer the associated  
31 physical therapy.

32  
33 I am the owner of Ouch Chiropractic. We are located in a shopping center in Chesapeake County. Currently, my  
34 clientele is made up of about 85% referrals from attorneys. The way my billing for treatment goes is that I am all  
35 private pay. I do not accept insurance. My clients all pay out-of-pocket. But for my patients that have pending  
36 litigation, I have an agreement with referring attorneys that I will wait to get paid until the lawsuit has concluded and  
37 then be paid out of the judgment. But if the client does not get paid through the lawsuit or does not receive a large  
38 enough award to cover my billed services, it is my choice to either have the client pay me for any balance or to  
39 waive that balance.

40  
41 I have testified before as an Expert in the field of Chiropractic Therapy Services on five occasions in various Circuit  
42 Courts around the State of Maryland. In the other cases where I was referred business by attorneys, I have been  
43 noted as an expert in those cases, but the cases likely settled without having to be officially admitted as an expert in  
44 trial. I would guess that those cases, where I treated a patient but never needed to be summonsed to testify in court  
45 as an expert witness total somewhere around 500 different cases. I have always been a witness for the Plaintiff's  
46 side, but I would testify as an expert about the practice of being a Chiropractor by anyone who called me.

47  
48 I am aware that Dr. Dylan Avery is a witness for the defense. I am also aware that Dr. Avery did not meet with  
49 Parker Harper. And while I have tremendous respect for Dr. Avery and their credentials, I just find it hard to believe  
50 they can so easily discount all of my day-to-day observations of this patient.

51  
52 I agree that Exhibits 36 through 39 are accurate depictions of what they purport to be. Exhibit 36 and 39 show how  
53 different areas of the spine are commonly referred to in the medical field. And Exhibit 38 shows the number of each  
54 column of the spine. Exhibit 37 and 39 show the areas of the body where you would find the trapezius muscles.  
55 Exhibit 39 also accurately shows where the trapezius muscles are in relation to the numbered columns of the spine. I  
56 also agree that Exhibit 35 accurately reflects what is written on the back of any over-the-counter Ibuprofen bottle.

57 Finally, Exhibit 40 shows the Biofreeze bottle that I would have given to Parker Harper on their first visit. Exhibit  
58 41 are the instructions on the back of that bottle.

59  
60 Additionally, Exhibit 34 is in my examination room and I show it to all of patients when conducting my interview of  
61 their symptoms. This would have included Parker Harper.

62  
63 I am being paid for my testimony. My fee is not contingent on the result of the case. I am paid before I appear to  
64 testify. I am not being paid to say anything in particular. But in order to testify, I make it clear that I cannot see  
65 patients when I am in court testifying. As such, I charge \$1,000 for each day that I sit in court, whether I am on the  
66 stand testifying or in the hallway waiting to testify. Additionally, I do not bill for the reports that I generate for my  
67 clients, as they are part of the normal operating procedure of my practice to generate those reports.

68  
69 I hereby affirm that the above information and the information contained in my bills and reports are true and  
70 accurate to the best of my knowledge and professional judgment.

71

72

*Chris Morgan*

73

Dr. Chris Morgan,

74

Chiropractor

1 **Affidavit of Dakota Reese**

2 Witness for the Defense

3  
4  
5  
6  
7  
8  
9  
10  
11  
12  
13  
14  
15  
16  
17  
18  
19  
20  
21  
22  
23  
24  
25  
26  
27  
28  
29  
30  
31  
32  
33  
34  
35  
36  
37  
38  
39  
40  
41  
42  
43  
44  
45  
46  
47  
48  
49  
50  
51  
52  
53  
54  
55  
56

After having been duly sworn by oath, Dakota Reese hereby states as follows: I am over 18 years old and competent to make this affidavit. I am testifying voluntarily and have not been subpoenaed.

I, Dakota Reese, am currently 33 years old and reside at 7 Choptank Way in Chesapeake County, Maryland.

I reside in close proximity to both Parker Harper, Vale Taylor, and Whitney Jones, who are all neighbors in our community. I also agree with Parker Harper and Vale Taylor about Exhibits 19 through 30 and what they show and depict and who lives where in our neighborhood.

I am a graduate of Coppin State University. That is where I received my Bachelors of Science to be a Registered Nurse (RN).

At the time of this incident, I was employed as an overnight Nurse at the Emergency Room of Chesapeake General Hospital. Specifically, I was, and still am, an RN. As an individual who works an 8-hour night shift job, I usually return home at around 5 a.m. and typically sleep from 6 a.m. until 2 p.m. each day.

I was aware that Vale Taylor was engaged in extensive home improvement work on their property. How could I not be? The whole cul-de-sac was aware, right? And probably the whole neighborhood.

I believe Vale's project lasted a couple weeks. Over the five days preceding May 27, 2023, Vale Taylor had been initiating their home improvement work earlier and earlier, commencing at approximately 6 a.m. This repeated early morning noise disturbance significantly impacted my ability to sleep. I was like a zombie at work; totally sleep deprived. The whole thing caused me considerable frustration.

I did attempt to discuss my concerns with Vale. I tried to be calm and polite, but Vale just insisted I was making something of nothing. I tried to explain they should not be working on their house this early, but they insisted it couldn't be that bad. I'll acknowledge I got a lot more hostile. That was probably the day or two before the incident.

Despite my efforts to communicate my concerns to Vale Taylor, they failed to acknowledge or address the distressing consequences of their early morning work. I felt like I had no other options. What could I do? Complain to the County? By the time they responded, Vale probably would have been done their home project. The whole thing was just classless, and Vale clearly was going to get away with it.

Back to the incident date, I recall that morning vividly. I wish I could take back what I did. I never meant for any of this to happen. If I could have seen this coming, I would never have done what I did. Not in a million years.

On that date, I was coming home from work. I was exhausted. I felt like I was walking around like I was sleepwalking; of course, I wasn't that way at work thanks to my new best friend, coffee. That being said, I do recall my supervisor had just said to me during my shift that night that I needed to look a little more like I cared about what I was doing. That comment did not feel good. I take pride in my work. I became an RN because I want to help people. This comment made me think I was projecting something else. Plus, the last thing I need in my life is a boss who thinks I don't care.

I came home at 5 a.m. like I always do and knew in my heart that if I didn't get 8 hours of sleep that I was just going to lose it. I mean, I've got a life to live. So, I guess I just broke. It's nothing that I planned. It was early. The neighborhood was so quiet. I never even went into my house. I just walked over to Vale's property to see if there was anything I could do to give myself some relief.

And that's when I saw it... Vale's ladder. It was against the side of Vale's house. I was aware that Vale was working on their wood siding panels. All that sawing and pounding with the hammer and, OMG, that nail gun! It needed to stop. Again, it's nothing that I planned. I knew enough about ladders to know that if they don't have their shoes, they are not safe to walk up. I believe anyone who regularly uses a ladder would have to know that. And if they are someone who knows that, then they are also someone that would inspect their ladder before using it.



57 So, I took the ladder shoes off the ladder and went back into my home. I used one of Vale's screwdrivers lying near  
58 the ladder to do it. The video on Exhibit 18 perfectly shows how to take ladder shoes off of a ladder. I agree Exhibits  
59 13 through 17 are screenshots from that video.

60  
61 When I went back home, I was thinking I was going to just go to bed and then I had a sudden panic. Like, what if  
62 Vale didn't inspect their ladder for whatever reason? That's when I got the idea for the note. I turned on my  
63 computer and typed up a note. I typed it so that you wouldn't be able to figure out who wrote it. On it, I wrote  
64 "Good luck trying to get any work done without your shoes. Don't worry, you'll get them back on Tuesday. Nighty  
65 night." That note you see on Exhibit 6 is the exact note I created. I grabbed some tape and went back over and taped  
66 it onto the bottom rung of the ladder next to where the ladder shoes were removed by me. In my mind, Vale would  
67 see this, and immediately make the connection that the ladder shoes were not there and that they wouldn't be able to  
68 use the ladder. I mean, look at Exhibit 17; a ladder looks so different without its shoes. My hope was that Vale  
69 would just stop working for a couple of days, I could get some rest, and then things would be just a little bit better.

70  
71 This whole sequence took about 10-20 minutes.

72  
73 Around 6:30 a.m., when I didn't hear any noise from Vale's, I assumed my plan worked and I went to sleep. It was  
74 like the best sleep I ever got.

75  
76 I found out later that Parker had injured themselves. I was completely unaware when it happened; must have still  
77 been in sleep's sweet embrace.

78  
79 I became aware of Parker's fall on Sunday May 28, 2023. I found out from one of the neighbors when I was taking  
80 out the trash. I felt awful. Really, it devastated me. Parker is a good kid. And they have a bright future; going to  
81 college and performing in the marching band. I wouldn't want to have anything to do with preventing that from  
82 happening.

83  
84 On May 29, 2023, I did see Parker in their front yard with their drum equipment practicing. I'm pretty sure it was  
85 that day because it was the holiday. Could be wrong but I don't think so. Luckily it was later in the afternoon, so it  
86 didn't wake me. They were probably rehearsing with that drum for at least 30 minutes; maybe not with the exact  
87 same gusto as before, but they seemed ok to me. I was happy they weren't hurt bad.

88  
89 Other than May 29, 2023, I haven't seen or heard from Parker much since this incident. Around the neighborhood,  
90 I've been keeping a low profile. While I never spoke to Parker about this, I am sincerely sorry about what happened.  
91 I would have said something sooner, but I was scared since I knew I had a role in this accident happening. And then  
92 I got charged with a crime relating to all of this. I was scared, so I said nothing and just tried to live my life. But I  
93 can assure you I thought about this case constantly and worried about Parker and how they could have been affected  
94 by this.

95  
96 As promised, very early Tuesday morning of May 30, 2023, before the sun came up, one last time, I went out my  
97 door to Vale Taylor's home and returned the ladder shoes and left an anonymous note. Exhibit 7 is that note that I  
98 folded up and left with the ladder shoes right outside Vale's home.

99  
100 Since the accident, outside of my neighborhood, I have continued on with my life. Yes, I did have to spend 4  
101 weekends in jail, and it was awful! But, other than the criminal case, my life has been pretty routine. I have  
102 continued going to work. Work actually got a lot better. And I was able to take off those 4 weekends when I had to  
103 report to jail, so my work never found out about this, and I did not have any consequences at work. Plus, my  
104 attorney filed a Motion to Modify, so when I complete my probation, I hope to modify my conviction to a Probation  
105 Before Judgment. Fingers crossed. Also, pretty soon after the incident, Vale finished their home projects and life got  
106 back to normal. I've been getting my 8 hours of sleep and everything improved at work. In fact, I actually got  
107 promoted to Nurse Supervisor, which means I plan my team of nurses' staffing schedules, coordinate treatment  
108 plans for patients, and assist, supervise, and coach members of the nursing staff. I've even found love. Been in a  
109 relationship since the beginning of September 2023. Love of my life. Traveled to Paris together in October. Yep,  
110 I'm living my best life. YOLO, I guess.

111

112 I swear or affirm that everything in this affidavit is true. Before I wrote this affidavit, I was instructed that I should  
113 include everything I know that could possibly be relevant to my testimony in this case, and I carefully followed  
114 those instructions. I am fully aware that I must update this affidavit with any new or additional information I  
115 remember from now until the moment I take the stand to testify at trial.

116  
117

118  
119

*Dakota Reese*  
Dakota Reese

1 **Affidavit of Whitney Jones**

2 Witness for the Defense

3

4 After having been duly sworn by oath, Whitney Jones hereby states as follows: I am over 18 years old and  
5 competent to make this affidavit. I am testifying voluntarily and have been subpoenaed.

6

7 I, Whitney Jones, am currently 35 years old and I reside at 21 Choptank Way. Parker Harper, Dakota Reese, and  
8 Vale Taylor are all neighbors of mine. I also agree with Parker Harper, Vale Taylor, and Dakota Reese about  
9 Exhibits 19 through 30 and what they show and depict and who lives where in our neighborhood.

10

11 I graduated college at Salisbury University. I then attended graduate school at University of Maryland College Park  
12 where I received a Master of Science in Information Systems. I currently work as a Network Engineer.

13

14 Until around May/June of 2023, everything in our neighborhood was happy and quiet. Now everything is tense and  
15 turned upside down.

16

17 I was not aware of Parker Harper's fall on Memorial Day weekend. I did not find out until sometime later; can't  
18 really remember when; definitely after our car accident.

19

20 Prior to June 1, 2023, I don't recall exactly the last time I saw Parker. It definitely would have been before the start  
21 of Memorial Day weekend. Past that, I can't say when.

22

23 On June 1, 2023, I was involved in a car accident with Parker Harper in our neighborhood. It happened at the  
24 intersection of Severn Street and Susquehanna Avenue. I was driving to leave the neighborhood. There is a stop sign  
25 at the end of Severn Street before you turn to get onto Susquehanna Avenue. Exhibit 31 shows this stop sign at the  
26 intersection. I was driving and looking down at my phone to set the GPS on my phone to go wherever I was going  
27 that day. Clearly, I shouldn't have been doing that and have never done that since; now I set my GPS before I start  
28 driving. Anyway, I was approaching the intersection where there is a stop sign, not looking, and I rear-ended  
29 Parker's car, which was stopped at the stop sign. As I did right on scene, I admit full responsibility for the accident.  
30 As soon as I made impact with the other vehicle, I remember getting out of the car, going to immediately check on  
31 the other car's driver, which was Parker Harper, and told them I was so sorry about what happened, and I was  
32 looking at my phone and made a mistake. I never tried to cover for what I did. I believe I couldn't have been going  
33 more than 5-10 m.p.h at the time of the accident, 15 m.p.h. tops, because I knew I was still in the neighborhood and  
34 that there is a stop sign before exiting the area. Also, I found this video online and that seems about right:

35 <https://www.youtube.com/shorts/4sdTz8lzmd8>. Admittedly, I have no idea how official this video is.

36

37 The impact felt significant to me. I drive a silver Ford Bronco and Parker Harper was driving a silver Toyota Camry.  
38 Exhibit 32 shows the front of my Bronco. Exhibit 33 shows the rear of Parker's Camry. I remember when I  
39 impacted Parker's car, it forced their car forward just a couple of feet; it did so in a way where, considering the  
40 relatively low speed at which I was traveling, it still caused visible damage to both vehicles involved; more so to  
41 Parker's car. I remember the front of my car had small scratches on it and it caused my front license plate to fall off  
42 one of its screws so that it was dangling on a 45-degree angle. I remember the damage on Parker's car was much  
43 more, but that makes sense since I was driving an SUV and they were driving a sedan.

44

45 Anyway, when I checked on Parker Harper, they were able to get out of the car and were holding the back of their  
46 neck and kind of shrugging their shoulders in a way that appeared that they were in discomfort in those areas of the  
47 body. I could tell their airbags had not deployed. I asked how Parker Harper was doing and they reported they felt a  
48 bit shook up.

49

50 When they saw it was me, I have to give them credit, they were very gracious with me. They asked if I was ok. I  
51 appreciated that. But I was clearly concerned about them. I asked if they were ok again because they were holding  
52 their neck. They said they felt sore and weren't sure what they should do. I could tell they were a little wobbly,  
53 meaning they appeared to me to be visibly shaken and disoriented. I didn't want to take any more risks, so I called  
54 911 and asked for an ambulance to come out.

55 An ambulance responded in a couple minutes. During that time, I tried my best to pay attention to Parker Harper and  
56 make sure they had whatever they needed.

57  
58 I remember while waiting for the ambulance, Parker Harper said something like, "And I was just starting to feel fine  
59 again." "Fine" or "Better" or "A little better." I really can't remember for sure. It was something like that. I can't  
60 perfectly recall; it was a long time ago. Whatever they said, they certainly said something to express they did not  
61 want or need an ambulance.

62  
63 After that, I took the photo which you see in Exhibit 32 within a couple hours of the accident. I was able to drive  
64 away from the scene and go about my day as planned. I check in with Parker Harper frequently. I probably called  
65 them once a week for the first month to see how they were doing. I even offered to drive them to physical therapy.  
66 They never took me up on it, but I think they knew I was sincere; I hope so, anyway. I check in less frequently now,  
67 but I have probably called Parker Harper a few more times to check on them.

68  
69 I have also known Dakota Reese for over five years and can attest to their honesty, integrity, and good character.  
70 Throughout our acquaintance, Dakota has consistently displayed kindness, respect, and a genuine concern for the  
71 welfare of others in the neighborhood. Based on my personal interactions and observations, I firmly believe that the  
72 Dakota is incapable of intentionally causing harm to anyone. I base this information on being their neighbor for all  
73 of these years and they have consistently been a good person who would do anything for a neighbor.

74  
75 Since the car accident, in addition to calling and checking in on Parker Harper, I have seen them around in the  
76 neighborhood. During the summer of 2023, I recall seeing Parker jogging, for what appeared to be exercise, on two  
77 occasions; nothing too brisk but definitely going faster than a walk. I would describe the jogging effort as having  
78 some bounce in their step. Additionally, I was happy when I saw Parker Harper doing some drum practicing with  
79 their bass drum in the front yard of their home. I believe I saw that on 2-3 occasions during the summer. I know  
80 Parker Harper was going to be playing in their college marching band and I was glad when it appeared they had  
81 fully recovered from the accident with me enough to be getting ready for their freshman year of college.

82  
83 Finally, I am aware that my car insurance company is in settlement talks with Parker Harper and the same attorney  
84 that now represents Parker against Dakota Reese. They have not settled yet. I believe my car insurance company has  
85 offered to Parker \$18,000 plus the cost of any repairs to their vehicle. I have no idea if that case will settle or if we  
86 will need to go to trial. I know that case is set for trial on July 8, 2024. I hope it does settle for a reasonable amount.  
87 If it doesn't, that could really raise the rates on my car insurance. And I only have the minimum car insurance  
88 coverage, which means I am only insured for up to \$30,000 for bodily injury per person, \$60,000 bodily injury for  
89 two or more people, and \$15,000 for property damage. I mean, while I know I am at fault for the accident, that  
90 doesn't mean I think Parker should get rich from it. They should get a fair amount. Anything above \$30,000, and it  
91 will have to come directly out of my pocket. I'm not trying to afford that.

92  
93 I swear or affirm that everything in this affidavit is true. Before I wrote this affidavit, I was instructed that I should  
94 include everything I know that could possibly be relevant to my testimony in this case, and I carefully followed  
95 those instructions. I am fully aware that I must update this affidavit with any new or additional information I  
96 remember from now until the moment I take the stand to testify at trial.

97  
98  
99  
100

  
\_\_\_\_\_  
Whitney Jones

1 **Affidavit of Dr. Dylan Avery**

2 Expert Witness for the Defense in the field of Orthopaedic Surgery

3  
4 I, Dr. Dylan Avery, prepared the attached letter dated October 2, 2023, which is labeled Exhibit 5. The records and  
5 photos that I reviewed to prepare this letter, which are referenced in this letter, are Exhibits 1-4, 32 and 33.

6  
7 My training is as follows: I attended medical school at Johns Hopkins University School of Medicine in Baltimore.  
8 Then, I completed my residency in Orthopaedic Surgery at Sinai Hospital Of Baltimore. I have been an Orthopaedic  
9 Surgeon for the last 20 years. Since the conclusion of my residency, I have practiced in several hospitals in  
10 Maryland. I now run my own Orthopaedic practice and operate primarily out of Bayside General Hospital.

11  
12 Orthopaedic surgery is a medical specialty dedicated to treating, diagnosing or preventing conditions or injuries that  
13 affect your musculoskeletal system. It can diagnose, treat, repair and prevent conditions that affect your bones,  
14 muscles and joints. Your musculoskeletal system contains your Bones, Muscles, Joints, Tendons and ligaments,  
15 Cartilage, and Soft tissues. Your musculoskeletal system helps you move, hold your body weight and maintain your  
16 posture. An injury or an underlying medical condition can affect these parts of your body and cause pain or limit  
17 your range of motion. Orthopaedic surgery provides routine maintenance, or it repairs damage to your  
18 musculoskeletal system. Orthopaedic surgeons repair, reconstruct or replace the following parts of your body: Hip,  
19 Knee, Hand and wrist, Foot and ankle, Spine, and Shoulder and elbow. Orthopaedic surgery helps treat or manage  
20 the following conditions:

- 21 a. Pain (joint, muscle, bone);
- 22 b. M muscle, cartilage or ligament tear;
- 23 c. Breaks and fractures; Arthritis;
- 24 d. Bursitis;
- 25 e. Tumors.; and
- 26 f. A congenital (present at birth) malformation.

27  
28 In addition to seeing and treating my own patients, I do a certain amount of referral work conducting IMEs and  
29 IMRs. IMEs are Independent Medical Evaluations. IMRs are Independent Medical Reviews. In an IMR, a referring  
30 attorney asks me to review medical records and render an opinion based on those records. An IME has all of the  
31 same components of an IMR, but additionally, I conduct my own examination of the patient in-person and then  
32 render my opinion.

33  
34 IMEs and IMRs now are about 50% of my workload. That 50% of my time includes review of records, meeting with  
35 the referred patients, preparing my report, and testifying. I am paid \$500 per hour to review records and meet with  
36 patients. My fee for testifying is \$5,000 per day in court, whether I am testifying or waiting in the hallway.

37  
38 I have been called as an Expert in the field of Orthopaedic Surgery on about 50 occasions in various Circuit Courts  
39 around the State of Maryland. Additionally, I have been noted as an expert probably 2,000 total times.

40  
41 While I am appearing in this case and being paid by the defense, I would accept a referral from a plaintiff or defense  
42 attorney. It just so happens that 100% of my referrals come from defense attorneys, and about half of those referrals  
43 come from the attorneys that represent Dakota Reese.

44  
45 I agree that Exhibits 36 through 39 are accurate depictions of what they purport to be. Exhibit 36 and 39 show how  
46 different areas of the spine are commonly referred to in the medical field. And Exhibit 38 shows the number of each  
47 column of the spine. Exhibit 37 and 39 show the areas of the body where you would find the trapezius muscles.  
48 Exhibit 39 also accurately shows where the trapezius muscles are in relation to the numbered columns of the spine. I  
49 also agree that Exhibit 35 accurately reflects what is written on the back of any over-the-counter Ibuprofen bottle.

50  
51 I hereby affirm that the above information and information contained in my report is true and accurate to the best of  
52 my knowledge and professional judgment.

53   
54 Dr. Dylan Avery

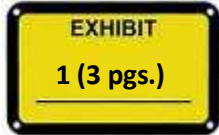

**CHIROPRACTIC**

[www.ouchmyback.com](http://www.ouchmyback.com)

*When you say "Ouch," think Ouch Chiropractic*

**INITIAL VISIT**

**RE:** Parker Harper

**DATE OF INJURY:** May 27, 2023 and June 1, 2023

**DATE OF VISIT:** June 5, 2023

**HISTORY OF PRESENT ILLNESS**

History provided by interviewing Mx. Harper. Mx. Harper is a 18-year-old person who was involved in a fall from a ladder on May 27, 2023 and an auto accident on June 1, 2023. The history, obtained from the patient, is as follows:

Mx. Harper fell backwards from a ladder after reportedly climbing up about 5-6 rungs of the ladder, thus falling a distance of about 5 feet. Upon impact, their body landed in such a way that resulted in injuries to Mx. Harper’s upper back and neck. Mx. Harper hit their back and head against the grass of the yard below them and injured their cervical and thoracic spine and trapezius muscles. They took pain medication; however the pain persisted. All of these symptoms developed right after the accident. Prior to the second accident, pain resulting from the first accident was aggravated by turning around, getting in or out of a car, driving, or lifting.

Then, Mx. Harper was a seat-belted driver in a parked car which was struck by an SUV, forcing the vehicle to jolt forward by just a foot or two. An ambulance arrived at the scene of the accident but Mx. Harper did not leave the scene in the ambulance. Their car was not towed either. Upon impact, their body moved forward and backward and was thrown from side to side. They hit their head against the door and injured their cervical, lumbar and thoracic spine and trapezius muscles. They attempted to treat themselves by taking pain medication; however the persisting pain in the injured areas and post-traumatic headaches caused Mx. Harper to visit this clinic seeking medical assistance. All new symptoms developed right after the car accident and all previous symptoms following the fall from the ladder worsened after the car accident. Pain is aggravated by bending, turning around, dressing themselves, getting in or out of a car, walking, driving, lifting and sitting/standing for a prolonged period of time.

Mx. Harper cannot participate in Band activities, which affects their enjoyment of life.

**SUBJECTIVE FINDINGS:**

The patient was asked to assess the pain level of the injured areas on a scale of 0-10 (0 means no pain, and 10 means the worst pain you have ever felt). They were shown a chart in my office that assists with trying to assess where one is on a scale of 0-10. Mx. Harper states that pain in the injured areas is at #8-10 and that the severity of headaches is at #8. Mx. Harper has indicated they had problems with their cervical and thoracic spine prior to this second accident. Mx. Harper indicated the pain in the injured areas after the first accident was closer to a #6-8. However, the pain in the cervical and thoracic spine has been exacerbated as a result of the second accident.

**PAST MEDICAL HISTORY:**

**SURGERY:** Patient denies any previous surgeries.

**INJURY:** Patient denies any injuries prior to these two events.

**ILLNESSES/CONDITIONS:** Patient denies major medical illness.

**MEDICATIONS:** Patient denies taking medications for recent medical problems.

**ALLERGIES:** NKDA. No latex allergy.

**REVIEW OF SYSTEMS:** No other active medical problems.

### **SOCIAL/EMPLOYMENT HISTORY:**

The patient is unemployed. They are single.

### **FAMILY HISTORY:**

Non-contributory.

### **PHYSICAL EXAMINATION:**

**OBJECTIVE:** 18-year-old person.

**VITAL SIGNS:** BP-130/92, PR-69, RR-14.

**GENERAL APPEARANCE:** Unremarkable.

**NEUROLOGICAL STATUS:** Mental status examination shows that they are alert and oriented. Sensation, vibratory sense and muscular strength are intact. Cranial nerves are grossly intact and are functioning. Reflexes are grossly normal and symmetrical.

**HEAD:** There is no swelling, lacerations or discoloration of the scalp.

**EYES:** The eyelids and globes are intact. Pupils are equal, round and reactive to light. The extraocular movements are intact.

**EARS:** The external ears and canals are intact. No liquid or blood is present. There is no gross hearing impairment.

**NOSE:** There is no abnormality of the nasal bones. There is no blood or abnormal discharge.

**MOUTH:** There are no signs of injury to the mouth, teeth or oral tissues.

**JAW:** There is no tenderness of the TM-joints.

**NECK:** There is tenderness and spasm of the paravertebral muscles. The range of motion is limited: flexion - to 35°, extension - to 20°, rotation to the left - to 40°, rotation to the right - to 35°, tilt to the left - to 15°, tilt to the right - to 20° with moderate pain. There is tenderness<sup>1</sup> of the trapezius muscles.

**CHEST:** There is no tenderness of the chest. Chest expansion and lung sounds are normal.

**CARDIAC:** Heart sounds are normal and no arrhythmias are present.

**UPPER AND MIDDLE BACK:** There is tenderness and spasm of the upper- and mid-thoracic paravertebral muscles.

**ABDOMEN:** Soft, not tender, with no organomegaly. Bowel sounds are normal.

**LOWER BACK:** There is tenderness and spasm of the paravertebral muscles. The range of motion is limited: flexion - to 40°, extension - to 15°, rotation to the left - to 20°, rotation to the right - to 10°, tilt to the left - to 15°, tilt to the right - to 20° with moderate pain. The straight leg-raising test is negative bilaterally.

**UPPER EXTREMITIES:** There is a normal range of active and passive motion of the upper extremities. Perfusion and pulses are adequate.

**LOWER EXTREMITIES:** There is a normal range of active and passive motion of the lower extremities without pain. Perfusion and pulses are adequate.

### **ASSESSMENT:**

Mx. Harper sustained injuries of the cervical and thoracic spine and trapezius muscles in a fall from a ladder on May 27, 2023, and then further suffered a blunt head injury, developed post-traumatic headaches and sustained injuries of the cervical, lumbar and thoracic spine and trapezius muscles in the auto accident on June 1, 2023. The patient's complaints and objective findings are consistent with the mechanisms of the injuries caused by the accidents.

### **DIAGNOSES:**

1. Blunt head injury with post-traumatic headaches.
2. Acute sprain/strain of the cervical spine.
3. Acute sprain/strain of the thoracic spine (chronically afflicted).
4. Acute sprain/strain of the lumbar spine (chronically afflicted).
5. Acute sprain of the trapezius muscle.



**CHIROPRACTIC**

[www.ouchmyback.com](http://www.ouchmyback.com)

*When you say "Ouch," think Ouch Chiropractic*

## **FOLLOW UP VISIT**

**RE:** Parker Harper

**DATE OF INJURY:** May 27, 2023 and June 1, 2023

**DATE OF VISIT:** June 20, 2023

## **HISTORY OF PRESENT ILLNESS**

History provided by interviewing Mx. Harper. Mx. Harper returned for his follow up visit today. X-ray examinations of the cervical, lumbar and thoracic spine revealed no evidence of fracture or dislocation. They still complain of ongoing pain in the injured areas upon physical exertion. After a physical therapy evaluation, the patient continues prescribed physical therapy treatment with adequate response.

## **PHYSICAL EXAMINATION:**

**OBJECTIVE:** 18-year-old person.

**NECK:** There is tenderness and spasm of the paravertebral muscles. The range of motion is limited with moderate pain. There is tenderness of the trapezius muscles.

**UPPER AND MIDDLE BACK:** There is tenderness and spasm of the upper- and mid-thoracic paravertebral muscles.

**LOWER BACK:** There is tenderness and spasm of the paravertebral muscles. The range of motion is limited with moderate pain.

The range of motion is limited with moderate pain.

## **DIAGNOSES:**

1. Blunt head injury with post-traumatic headaches.
2. Acute sprain/strain of the cervical spine.
3. Acute sprain/strain of the thoracic spine (chronically afflicted).
4. Acute sprain/strain of the lumbar spine (chronically afflicted).
5. Acute sprain of the trapezius muscles.

## **TREATMENT PLAN:**

Continue chiropractic and physical therapy treatment. Continue taking over-the-counter medications as needed. Follow up in two weeks or as needed.

It is my opinion to a reasonable degree of medical certainty that the patient's injuries are causally related to the accident, that the treatments recommended are medically necessary, and the bills are fair, reasonable and comparable with like charges for this geographic area.

## **Patient has been examined by:**

Dr. Chris Morgan

Report is generated based on the chiropractor's examination, physical therapy evaluation and patient's input.





**CHIROPRACTIC**

[www.ouchmyback.com](http://www.ouchmyback.com)

*When you say "Ouch," think Ouch Chiropractic*

**FINAL/SUMMARY VISIT REPORT**

**RE:** Parker Harper

**DATE OF INJURY:** May 27, 2023 and June 1, 2023

**DATE OF VISIT:** July 20, 2023

Mx. Harper’s condition has substantially stabilized. They no longer experience discomfort in the injured areas. The pain in their lumbar and thoracic spine returned to the pre-accident level.

**PHYSICAL EXAMINATION:**

**OBJECTIVE:** 18-year-old person.

**NECK:** There is no tenderness or spasm of the paravertebral muscles. The range of motion is normal and without pain. There is no tenderness of the trapezius muscles.

**UPPER AND MIDDLE BACK:** There is slight tenderness of the upper- and mid- thoracic paravertebral muscles.

**LOWER BACK:** There is slight tenderness of the paravertebral muscles. The range of motion is adequate with mild pain.

**DIAGNOSES:**

1. Blunt head injury with post-traumatic headaches, improved.
2. Acute sprain/strain of the cervical spine, improved
3. Acute sprain/strain of the thoracic spine (chronically afflicted), returned to the pre-accident condition.
4. Acute sprain/strain of the lumbar spine (chronically afflicted) , returned to the pre-accident condition.
5. Acute sprain of the trapezius muscles, improved.

**TREATMENT PLAN / DISPOSITION:**

1. Discontinue chiropractic and physical therapy.
2. Stop taking over-the-counter medications, except only on an as-needed basis.

**COURSE / PROGNOSIS:**

Mx. Harper’s headaches and injuries of the trapezius muscles and cervical spine have improved. The pain in their lumbar and thoracic spine returned to the pre-accident level. Mx. Harper’s condition is sufficient to discontinue therapy at this time. The patient was advised to return to this office for further treatment if any flare ups occur.

**ASSESSMENT:**

Based on the patient’s complains, review of the clinical course, medical records and the results of my examination, I have concluded within a reasonable degree of medical certainty, that the patient’s injuries of their cervical and thoracic spine and trapezius muscles were caused by the initial accident on May 27, 2023 and further exasperated by the second accident on June 1, 2023, and that all of the patient’s other injuries were caused by the second accident. The care and treatment rendered to the patient were medically necessary for the injuries sustained by Mx. Harper in the above accidents. The chargers for all of the patient’s care and treatment are fair and reasonable based upon the prevailing charges in the Greater Baltimore/Washington Metropolitan areas.

**Patient has been examined by:**

Dr. Chris Morgan

Report is generated based on the chiropractor’s examination, physical therapy evaluation and patient’s input.

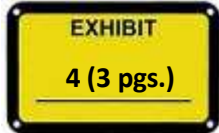

# CHIROPRACTIC

[www.ouchmyback.com](http://www.ouchmyback.com)

*When you say "Ouch," think Ouch Chiropractic*

Patient: Parker Harper  
15 Choptank Way, Chesapeake, MD

The charges for all of the patient's care and treatment are fair and reasonable and are in accordance with the current annual regional edition of the Customized Fee Analyzer published by Optum, a nationally recognized healthcare information company.

Date	Description	Units	Charge
6/5/23	First visit comprehensive (30 min.)	1	\$355.00
6/5/23	Electrical Stimulation	1	\$69.00
6/5/23	Hot/Cold Pack	1	\$50.00
6/5/23	Chiropractic and Physical Therapy Evaluation	1	\$277.00
6/5/23	Electrodes	1	\$49.00
6/5/23	Biofreeze, 4 oz	1	\$27.00
6/5/23	Heating Pad	1	\$77.00
6/6/23	Cervical spine, 2 or 3 views	1	\$167.00
6/6/23	Thoracic spine, 2 views	1	\$169.00
6/6/23	Lumbosacral, 2 or 3 views	1	\$189.00
6/6/23	Electrical Stimulation	1	\$69.00
6/6/23	Hot/Cold Pack	1	\$50.00
6/6/23	Traction, mechanical	1	\$57.00
6/8/23	Electrical Stimulation	1	\$69.00
6/8/23	Hot/Cold Pack	1	\$50.00
6/8/23	Traction, mechanical	1	\$57.00
6/8/23	Manual Therapy Tqs. 1+ regions.	1	\$96.00
6/12/23	Electrical Stimulation	1	\$69.00
6/12/23	Hot/Cold Pack	1	\$50.00
6/12/23	Traction, mechanical	1	\$57.00
6/12/23	Manual Therapy Tqs. 1+ regions.	1	\$96.00
6/14/23	Electrical Stimulation	1	\$69.00
6/14/23	Hot/Cold Pack	1	\$50.00

6/14/23	Traction, mechanical	1	\$57.00
6/14/23	Manual Therapy Tqs. 1+ regions.	1	\$96.00
6/16/23	Electrical Stimulation	1	\$69.00
6/16/23	Hot/Cold Pack	1	\$50.00
6/16/23	Traction, mechanical	1	\$57.00
6/16/23	Manual Therapy Tqs. 1+ regions.	1	\$96.00
6/16/23	Exercise	1	\$103.00
6/19/23	Electrical Stimulation	1	\$69.00
6/19/23	Hot/Cold Pack	1	\$50.00
6/19/23	Traction, mechanical	1	\$57.00
6/19/23	Manual Therapy Tqs. 1+ regions.	1	\$96.00
6/19/23	Exercise	1	\$103.00
6/20/23	Follow up visit (15 min.)	1	\$233.00
6/20/23	Electrical Stimulation	1	\$69.00
6/20/23	Hot/Cold Pack	1	\$50.00
6/20/23	Traction, mechanical	1	\$57.00
6/20/23	Manual Therapy Tqs. 1+ regions.	1	\$96.00
6/20/23	Exercise	1	\$103.00
6/22/23	Electrical Stimulation	1	\$69.00
6/22/23	Hot/Cold Pack	1	\$50.00
6/22/23	Traction, mechanical	1	\$57.00
6/22/23	Manual Therapy Tqs. 1+ regions.	1	\$96.00
6/22/23	Exercise	1	\$103.00
6/26/23	Electrical Stimulation	1	\$69.00
6/26/23	Hot/Cold Pack	1	\$50.00
6/26/23	Traction, mechanical	1	\$57.00
6/26/23	Manual Therapy Tqs. 1+ regions.	1	\$96.00
6/26/23	Exercise	1	\$103.00
6/27/23	Electrical Stimulation	1	\$69.00
6/27/23	Hot/Cold Pack	1	\$50.00

6/27/23	Traction, mechanical	1	\$57.00
6/27/23	Manual Therapy Tqs. 1+ regions.	1	\$96.00
6/27/23	Exercise	2	\$206.00
7/17/23	Electrical Stimulation	1	\$69.00
7/17/23	Hot/Cold Pack	1	\$50.00
7/17/23	Traction, mechanical	1	\$57.00
7/17/23	Manual Therapy Tqs. 1+ regions.	1	\$96.00
7/17/23	Exercise	1	\$103.00
7/19/23	Electrical Stimulation	1	\$69.00
7/19/23	Hot/Cold Pack	1	\$50.00
7/19/23	Traction, mechanical	1	\$57.00
7/19/23	Manual Therapy Tqs. 1+ regions.	1	\$96.00
7/19/23	Exercise	2	\$206.00
7/20/23	Final visit (10 min.)	1	\$140.00

<b>Current Charges:</b>	<b>\$6,000.00</b>
<b>Total Balance:</b>	<b>\$6,000.00</b>

**BAYSIDE**  
GENERAL HOSPITAL



**DYLAN AVERY, M.D.**  
**ORTHOPAEDIC SURGERY**

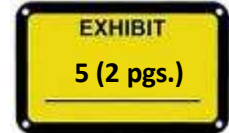

October 2, 2023

Re: Parker Harper  
D/A: 5/27/23 and 6/1/23  
Age: 18 years old

To Whom It May Concern:

I received a request to conduct an Independent Medical Review (IMR) on September 6, 2023 from Dakota Reese's attorney pertaining to treatment rendered to Parker Harper. I have not met with or ever spoken to Parker Harper.

I have received the medical records pertaining to treatment rendered to Parker Harper. The medical records specifically address treatment which Mx. Harper received subsequent to a fall from a ladder, which occurred on May 27, 2023, and a motor vehicle collision which occurred on June 1, 2023. Mx. Harper was 18 years old at the time.

Please note that there are no documents, other than the history in Dr. Morgan's reports, which would indicate the extent of the fall from the ladder or the motor vehicle collision. I have seen photographs of the vehicles involved. There are no police records, damage repair estimates, or hospital records. Mx. Harper was a front seat driver struck by another vehicle. Mx. Harper's car did not need to be towed. They complained of pain afterwards. They also stated that they hit their head against the door.

They were initially seen at Ouch Chiropractic on June 5, 2023, which is eight days after the fall from the ladder and four days after the car accident. I note that they were unemployed and were in the last week of being a full-time high school student at the time of the incidents. Soft tissue injuries were diagnosed and they were referred for physical therapy.

X-rays of the cervical, thoracic and lumbar spine were all interpreted as showing no abnormalities.

On a follow up visit of July 20, 2023, slight tenderness only was reported in the spine. There was normal range of motion and no trapezial tenderness.

It is my impression that this patient sustained minor musculoskeletal injuries as a result of the accidents of May 27, 2023 and June 1, 2023. Certainly, a fall from a ladder can have severe consequences but the lack of any severe injuries suggests this was either a fall from not very high or Mx. Harper fell in a way that caused little impact and was just a fall with a lucky landing.

It should be noted that there was a gap in treatment for more than two weeks. Considering the time elapsed between those treatments, it is unlikely that these treatments had any real value.

Additionally, young, healthy people seldom, if ever, need any physical therapy treatment relative to a car accident of this sort. Ordinary home

**BAYSIDE**  
GENERAL HOSPITAL



measures such as hot showers, stretching exercises and over the counter analgesics are usually all that are needed. Considering the treatment did not start until 8 and 4 days after their respective incidents, and there was a gap in part of the treatment, and the treatment was done without physician oversight, it is my opinion that it is highly unlikely that any of the treatment which they received was actually necessary relative to these accidents.

Even if the assumption is made that the treatments were needed, I note in the billing that they were repeatedly charged for items which are generally considered not billable. At each of their therapy visits, they were charged \$50.00 for hot and cold pack applications and \$69.00 for electrical stimulation. These are unattended services and, although therapists and chiropractors sometimes submit bills for these services, reimbursement should not be expected. These services are done in a timed manner without the attention of a therapist or assistant and are, therefore, not billable. These services total \$119.00 for each visit and were repeated at each of 13 visits for a total of \$1,547.00 which should be deducted from the therapist's bill. In addition, I note that they were charged \$277.00 for the initial physical therapy evaluation; fair market value would not exceed \$150.00.

The charges of \$103.00 for exercise are about twice what would be expected. In addition, on two occasions, they were charged \$206.00 for exercise, probably four times more than reasonable. These bills should also be reduced.

The x-ray charges are close to appropriate, although, once again, I have real questions regarding the need for any of these services.

I would not have expected any formal treatment to have been needed relative to these accidents. Irrespective of the charges submitted, however, it is my opinion that it is highly unlikely that the treatment which this patient received was necessary. The gap in treatment and the delay in initiating treatment strongly suggests that none of these treatments were necessary. There is no indication of permanency and there is no indication of the need of any further care.

I hold all of these opinions in this report to a reasonable degree of probability and certainty in the field of orthopaedic medicine based on documentation available at this time.

If there are any questions, please direct them to this office.

Very truly yours.

*Dylan Avery*

\_\_\_\_\_  
Dylan Avery, M.D.  
Orthopaedic Surgeon

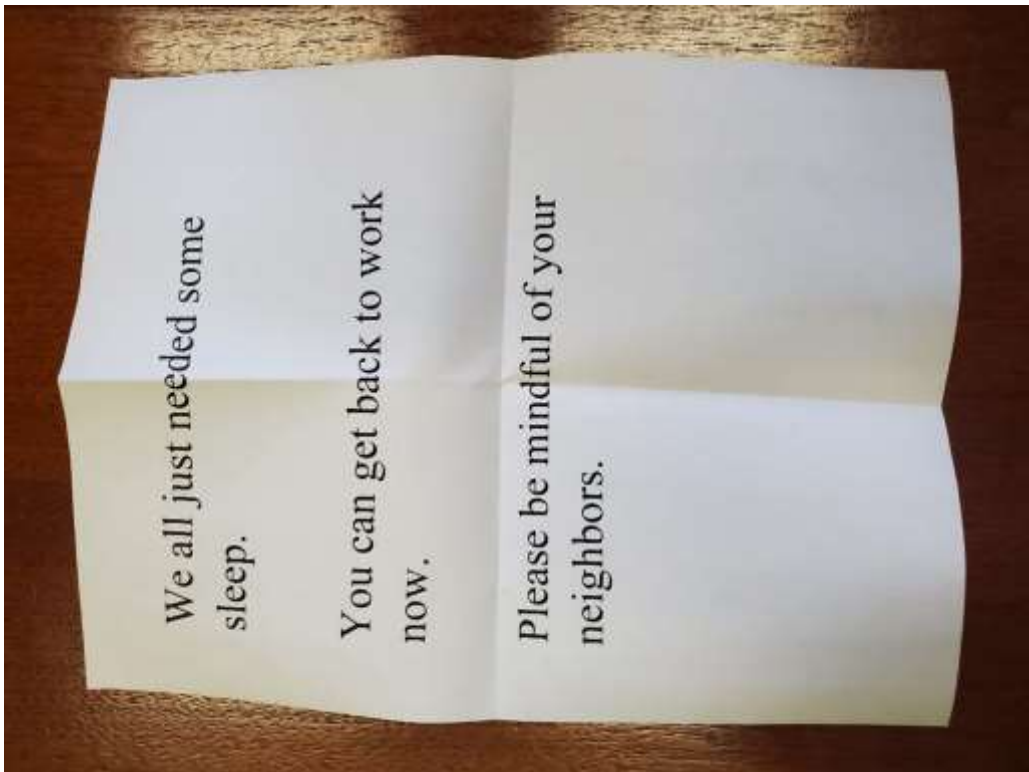



**Parker Harper**  
@HardyParHar



Having the time of my life at the House Of Pain Reunion Tour!!! 🍀 Jump Around indeed!!!! 🐨 Never stop.

11:00 PM · May 28, 2023

44 Likes





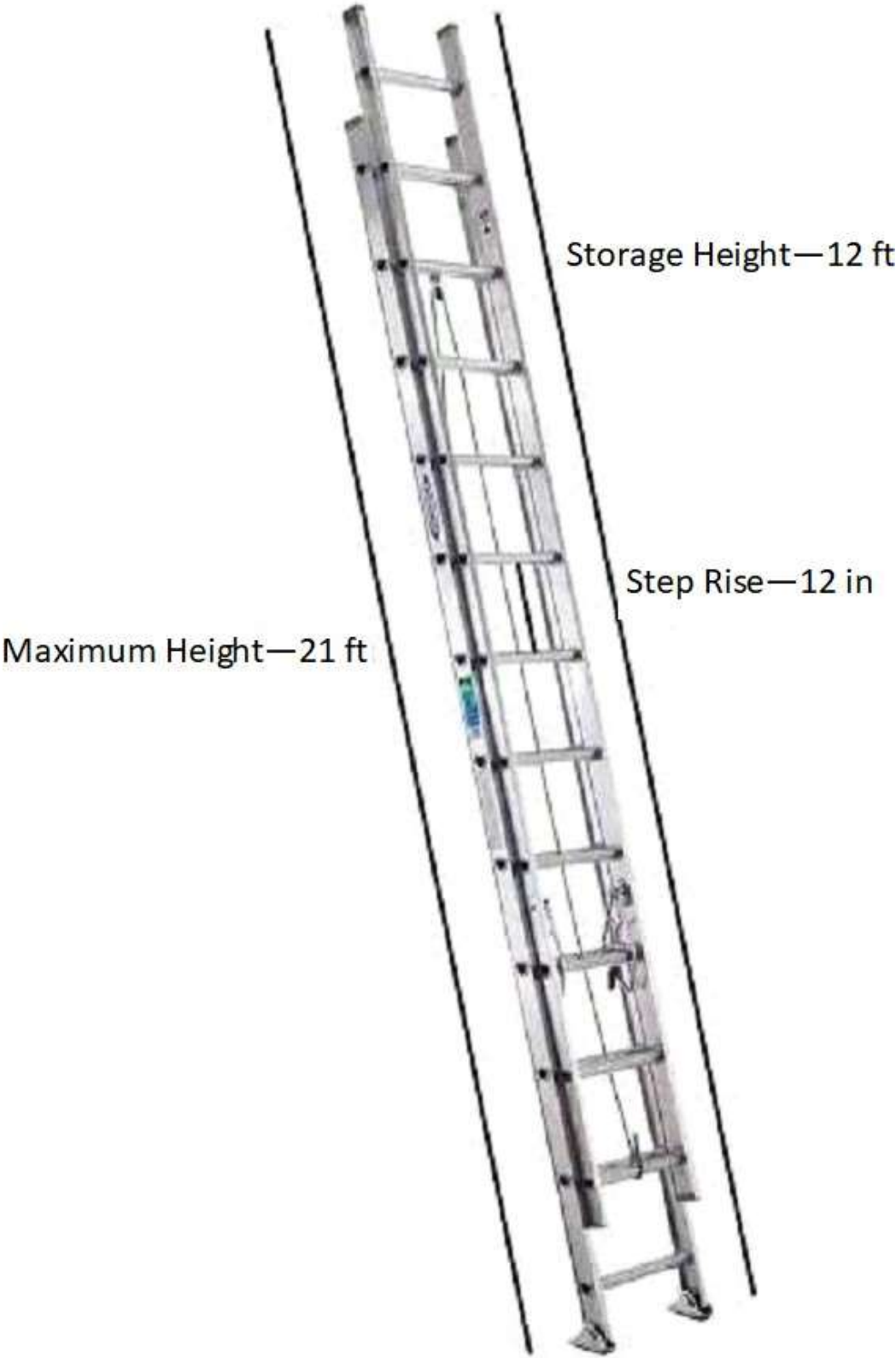

EXHIBIT  
11



EXHIBIT  
12

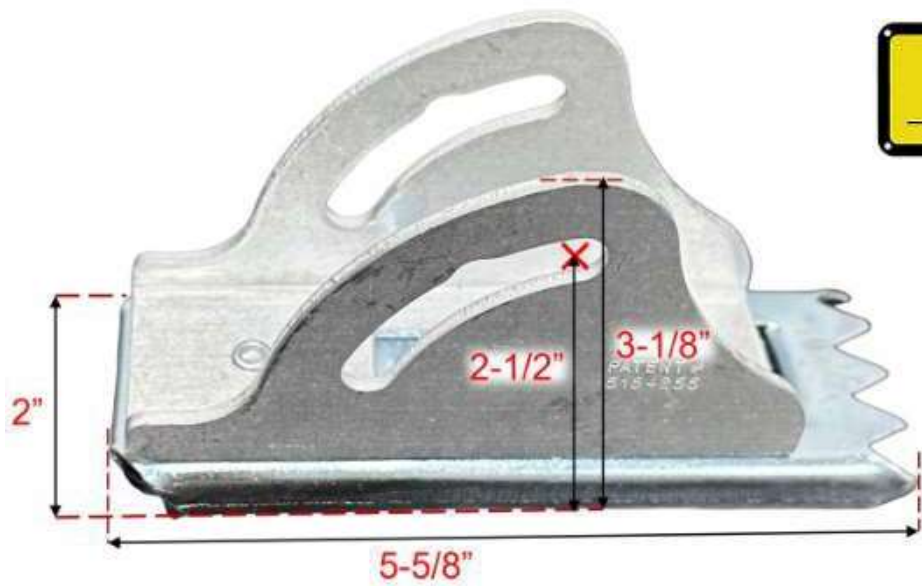



EXHIBIT  
15



EXHIBIT  
16



EXHIBIT

17



EXHIBIT

18

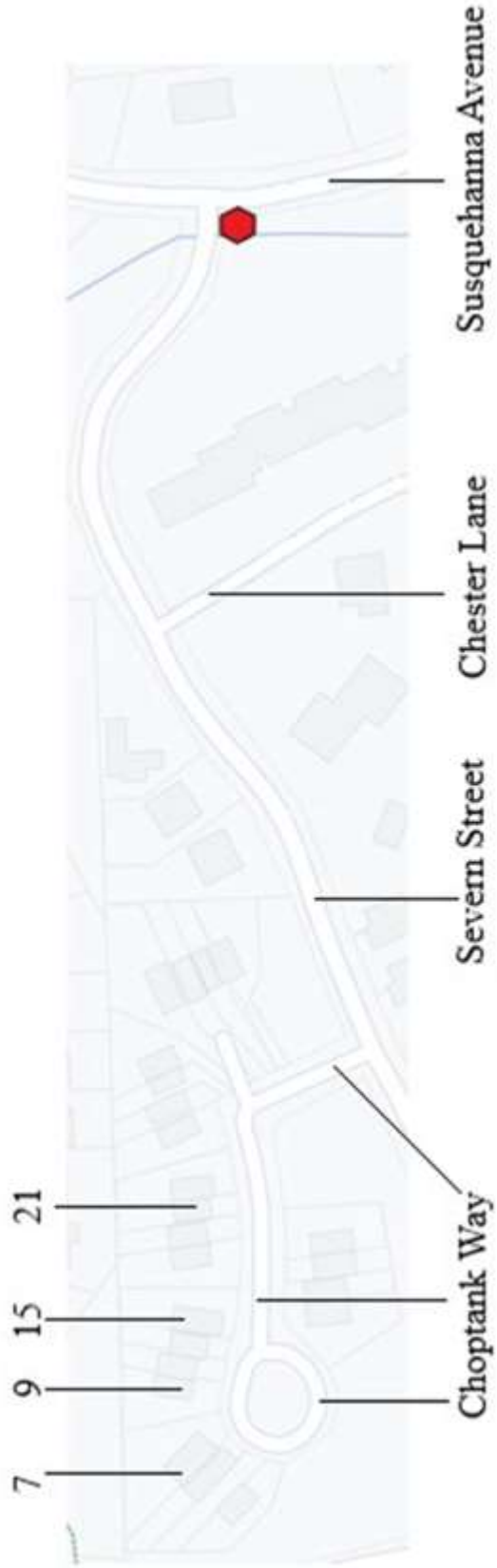





EXHIBIT  
20

EXHIBIT  
21

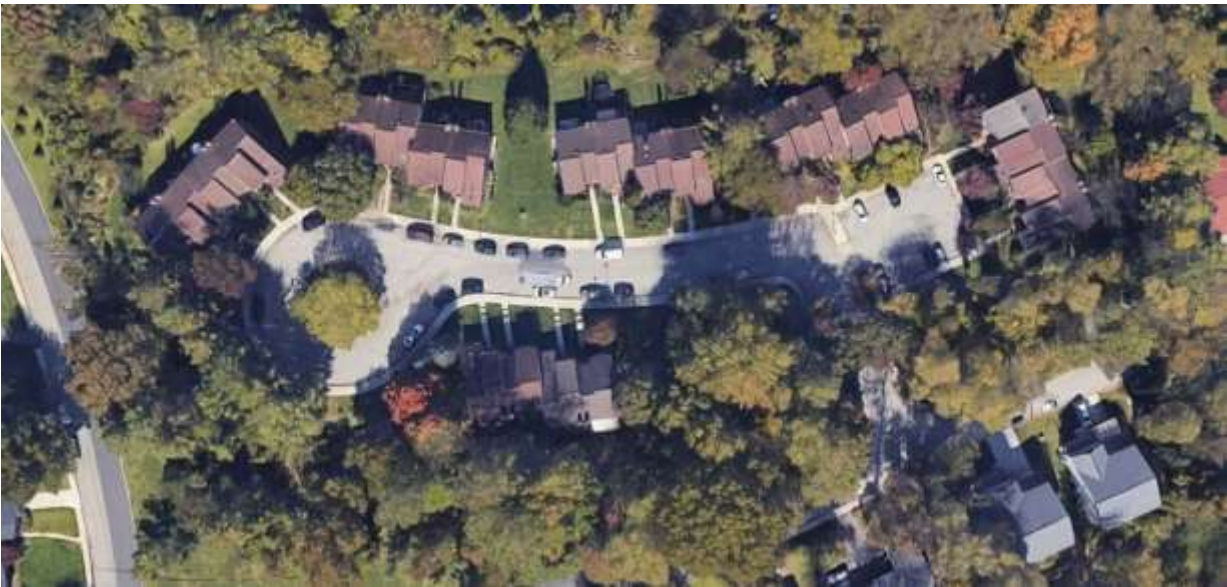



EXHIBIT  
22



EXHIBIT  
23





EXHIBIT  
24



EXHIBIT  
25

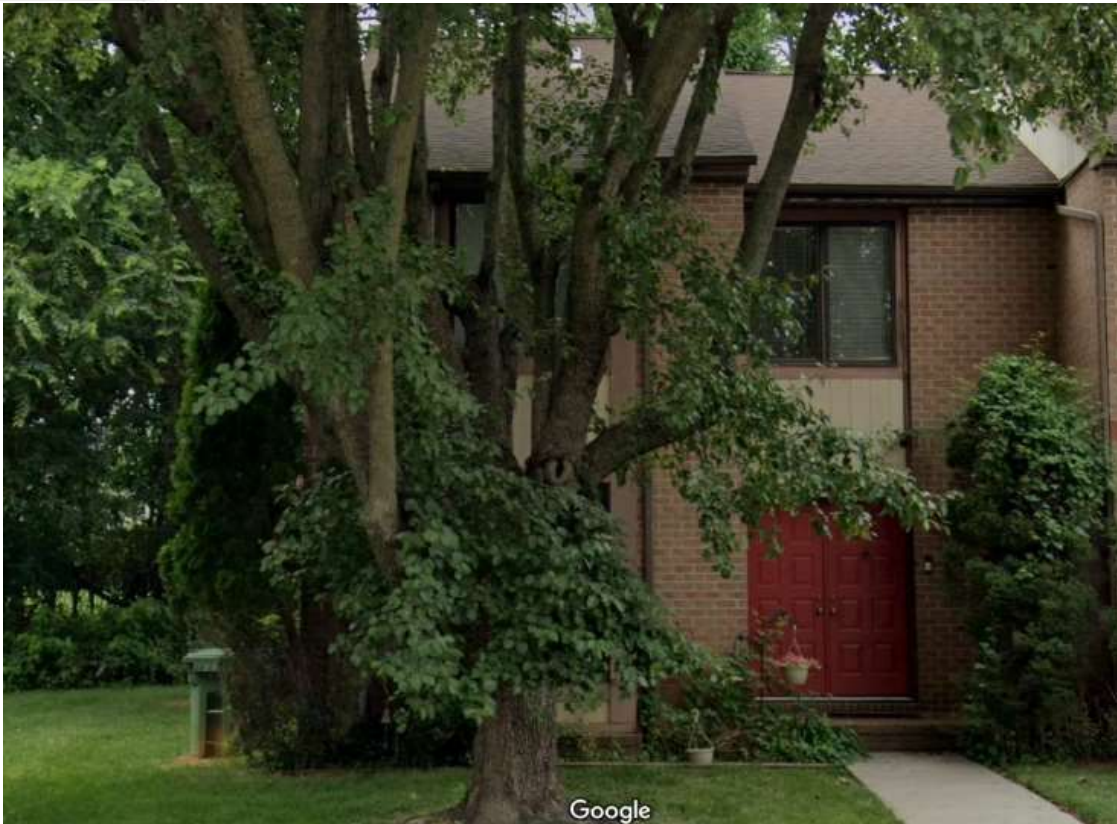

EXHIBIT  
26



EXHIBIT  
27





EXHIBIT  
28



EXHIBIT  
29



**EXHIBIT**  
**30**



**EXHIBIT**  
**31**



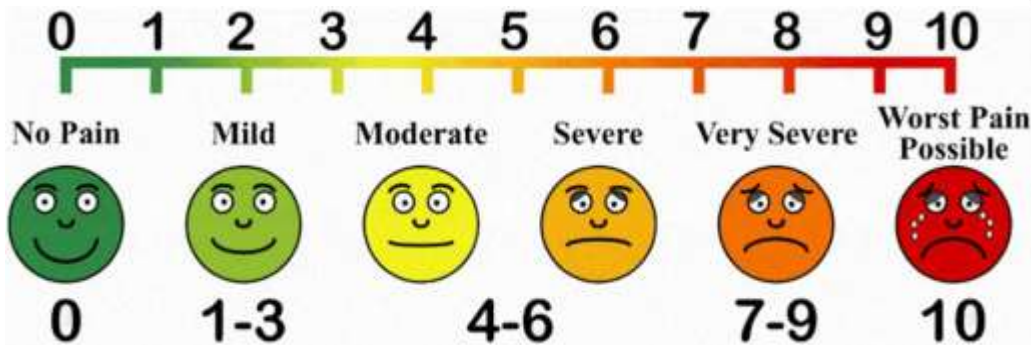

EXHIBIT  
32



EXHIBIT  
33





<p><b>Drug Facts</b></p> <p><b>Active ingredient (in each tablet)</b> <i>Purposes</i> Ibuprofen 200 mg (NSAID)*. <i>Pain reliever/fever reducer</i> *nonsteroidal anti-inflammatory drug</p> <p><b>Uses</b></p> <ul style="list-style-type: none"> <li>temporarily relieves minor aches and pains due to:             <ul style="list-style-type: none"> <li>headache</li> <li>muscular aches</li> <li>minor pain of arthritis</li> <li>toothache</li> <li>backache</li> <li>the common cold</li> </ul> </li> <li>menstrual cramps</li> <li>temporarily reduces fever</li> </ul> <p><b>Warnings</b></p> <p><b>Allergy alert:</b> Ibuprofen may cause a severe allergic reaction, especially in people allergic to aspirin. Symptoms may include:</p> <ul style="list-style-type: none"> <li>hives</li> <li>facial swelling</li> <li>asthma (wheezing)</li> <li>shock</li> <li>skin redness</li> <li>rash</li> <li>blister</li> </ul> <p>If an allergic reaction occurs, stop use and seek medical help right away.</p> <p><b>Stomach bleeding warning:</b> This product contains an NSAID, which may cause severe stomach bleeding. The chances are higher if you:</p> <ul style="list-style-type: none"> <li>are age 60 or older</li> <li>have had stomach ulcers or bleeding problems</li> <li>take a blood thinner (anticoagulant) or steroid drug</li> <li>take other drugs containing prescription or nonprescription NSAIDs (naproxen, ibuprofen, naproxen, or others)</li> <li>have had stomach ulcers or bleeding problems</li> <li>take more or for a longer time than directed</li> </ul> <p><b>Heart attack and stroke warning:</b> NSAIDs, except aspirin, increase the risk of heart attack, heart failure, and stroke. These can be fatal. The risk is higher if you use more than directed or for longer than directed.</p> <p><b>Do not use</b></p> <ul style="list-style-type: none"> <li>if you have ever had an allergic reaction to ibuprofen or any other pain reliever/fever reducer</li> <li>right before or after heart surgery</li> </ul> <p><b>Ask a doctor before use if</b></p> <ul style="list-style-type: none"> <li>you have problems or serious side effects from taking pain relievers or fever reducers</li> <li>the stomach bleeding warning applies to you</li> <li>you have a history of stomach problems, such as heartburn</li> <li>you have high blood pressure, heart disease, liver cirrhosis, kidney disease, asthma, or had a stroke</li> <li>you are taking a diuretic</li> </ul> <p><b>Ask a doctor or pharmacist before use if you are</b></p> <ul style="list-style-type: none"> <li>taking aspirin for heart attack or stroke, because ibuprofen may decrease this benefit of aspirin</li> <li>under a doctor's care for any serious condition</li> <li>taking any other drug</li> </ul>	<p><b>Drug Facts (continued)</b></p> <p><b>When using this product</b></p> <ul style="list-style-type: none"> <li>take with food or milk if stomach upset occurs</li> </ul> <p><b>Stop use and ask a doctor if</b></p> <ul style="list-style-type: none"> <li>you experience any of the following signs of stomach bleeding:             <ul style="list-style-type: none"> <li>heart burn</li> <li>vomit blood</li> <li>have bloody or black stools</li> </ul> </li> <li>stomach pain that does not get better</li> <li>you have symptoms of heart problems or stroke:             <ul style="list-style-type: none"> <li>chest pain</li> <li>trouble breathing</li> <li>weakness in one part or side of body</li> <li>slurred speech</li> <li>leg swelling</li> </ul> </li> <li>leg swelling</li> <li>pain gets worse or lasts more than 10 days</li> <li>liver gets worse or lasts more than 3 days</li> <li>redness or swelling is present in the painful area</li> <li>any new symptoms appear</li> </ul> <p><b>If pregnant or breast-feeding, ask a health professional before use.</b> It is especially important not to use ibuprofen during the last 3 months of pregnancy unless definitely directed to do so by a doctor because it may cause problems in the unborn child or complications during delivery.</p> <p><b>Keep out of reach of children.</b> In case of overdose, get medical help or contact a Poison Control Center right away (<a href="tel:1-800-222-1222">1-800-222-1222</a>).</p> <p><b>Directions</b></p> <ul style="list-style-type: none"> <li>do not take more than directed</li> <li>the smallest effective dose should be used</li> </ul> <p>adults and children 12 years and older</p> <ul style="list-style-type: none"> <li>take 1 tablet every 4 to 6 hours while symptoms persist</li> <li>if pain or fever does not respond to 1 tablet, 2 tablets may be used</li> <li>do not exceed 6 tablets in 24 hours, unless directed by a doctor</li> </ul> <p>children under 12 years</p> <p><b>Other information</b></p> <ul style="list-style-type: none"> <li>read all warnings and directions before use</li> <li>store at 20-25°C (68-77°F)</li> <li>avoid high humidity and excessive heat above 40°C (104°F)</li> </ul> <p><b>Inactive ingredients</b> colloidal silicon dioxide, corn starch, croscarmellose sodium, hypromellose, iron oxide red, iron oxide yellow, microcrystalline cellulose, polyethylene glycol, polycarbonyl 60, stearic acid, titanium dioxide</p> <p><b>Questions or comments? 1-800-719-9260</b></p>
---	---

EXHIBIT  
36

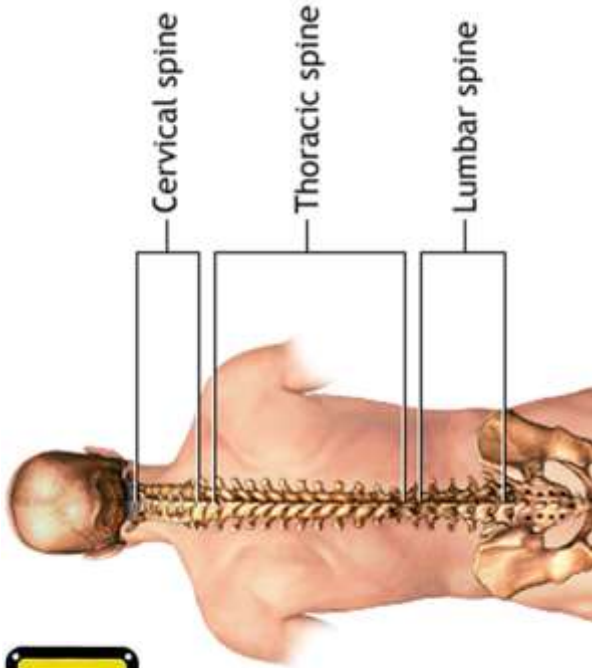

EXHIBIT  
37

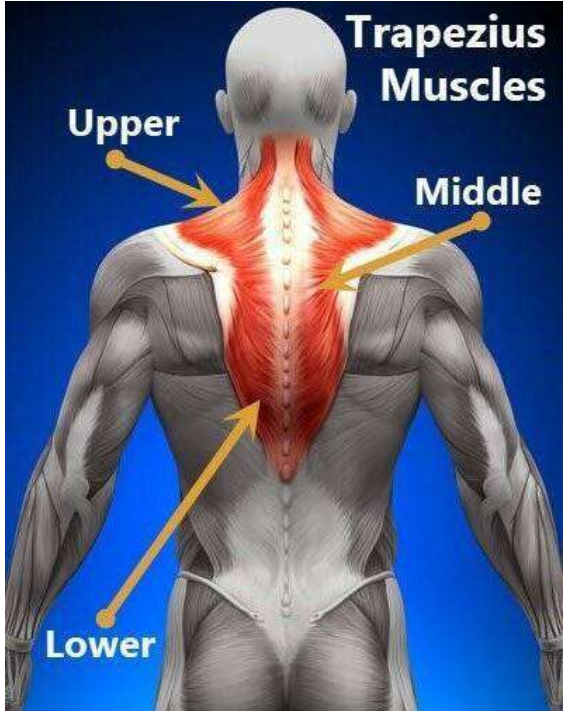
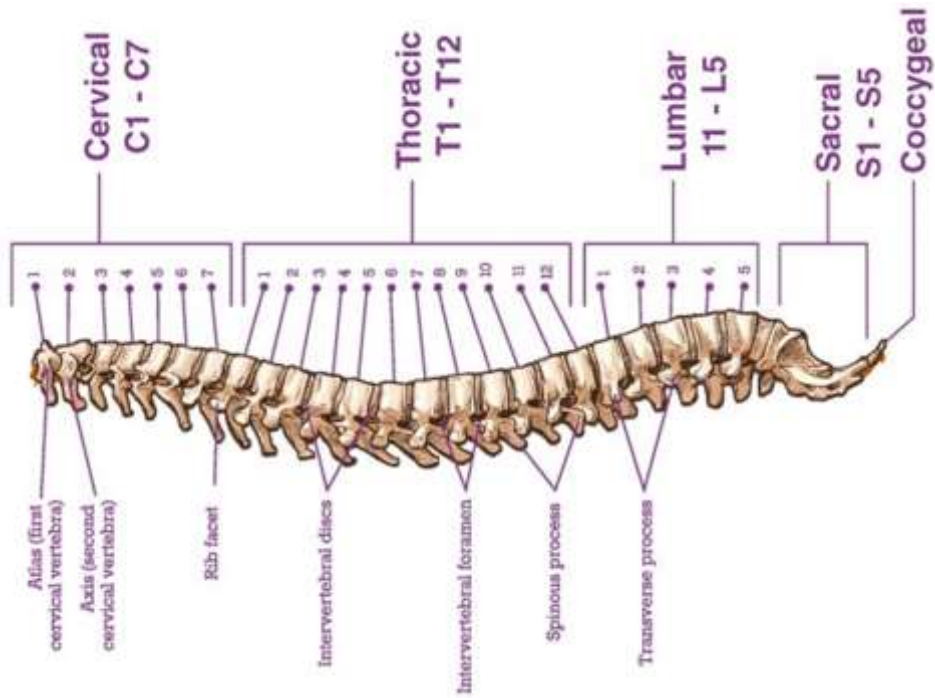
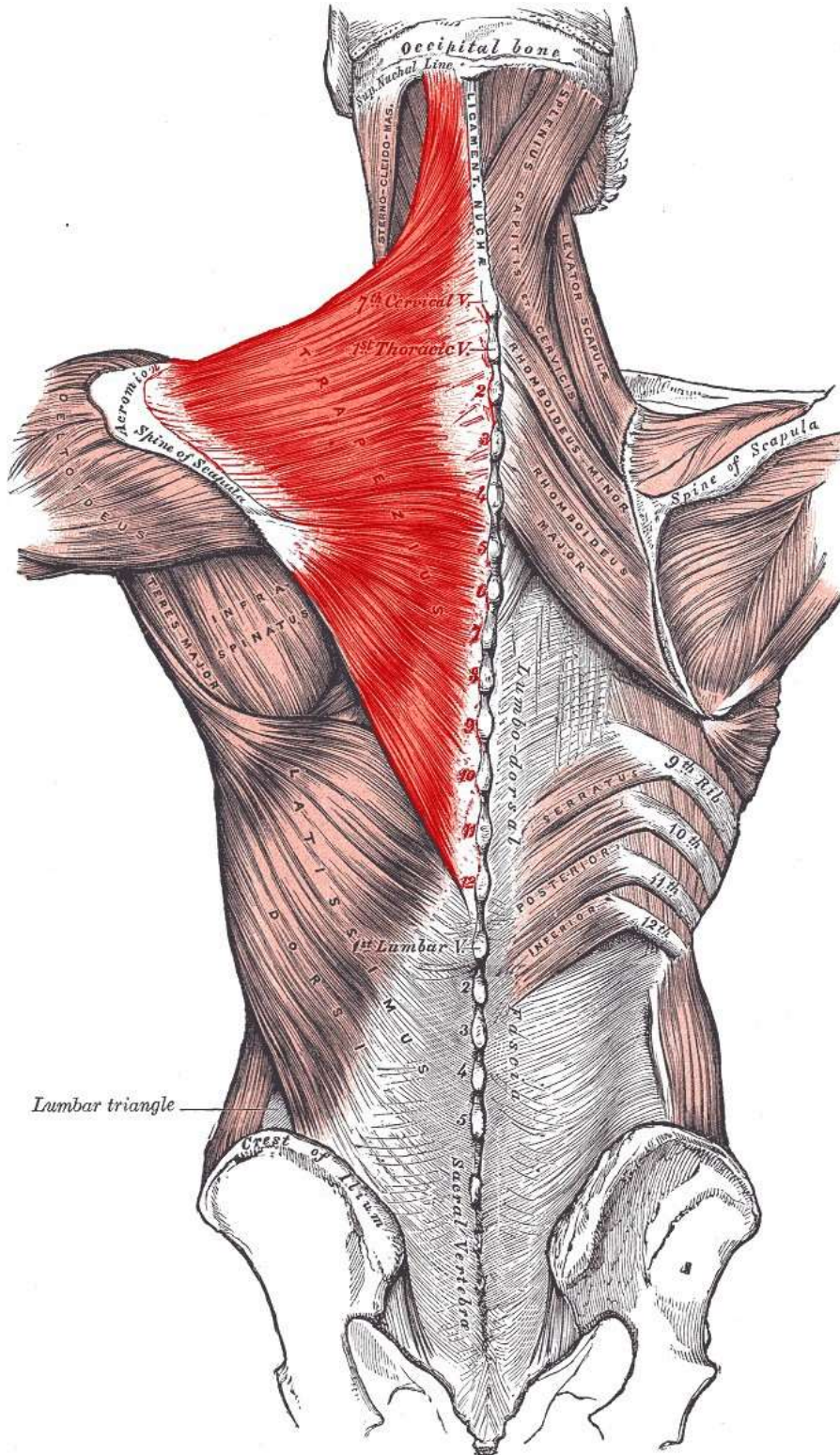

EXHIBIT  
38









<b>Drug Facts</b>	
<b>Active Ingredients</b>	<b>Purpose</b>
Menthol 4%	Cooling Pain Relief
<b>Uses</b>	
Temporary relief from minor aches and pains of sore muscles & joints associated with: • arthritis • backache • strains • sprains	
<b>Warnings</b>	
For external use only.	
<b>Flammable:</b> Keep away from excessive heat or open flame	
<b>Ask a doctor before use if you have:</b> Sensitive skin	
<b>When using this product:</b> • Avoid contact with the eyes or mucous membranes • Do not apply to wounds or damaged skin • Do not use with other ointments, creams, sprays or liniments • Do not apply to irritated skin or if excessive irritation develops • Do not bandage • Wash hands after use with cool water • Do not use with heating pad or device	
<b>Stop use and ask a doctor if:</b> Condition worsens, or if symptoms persist for more than 7 days, or clear up and reoccur	
<b>If pregnant or breast-feeding:</b> Ask a health professional before use	
<b>Keep out of reach of children:</b> If accidentally ingested, get medical help or contact a Poison Control Center immediately	
<b>Directions</b>	
• <b>Adults and children 2 years of age and older:</b> Rub a thin film over affected areas not more than 4 times daily; massage not necessary.	
• <b>Children under 2 years of age:</b> Consult physician	
<b>Other Information</b>	
Store in a cool dry place with lid closed tightly	
<b>Inactive Ingredients</b>	
Aloe Barbadosensis Leaf Extract, Arnica Montana Flower Extract, Arctium Lappa Root (Burdock) Extract, Boswellia Carterii Resin Extract, Calendula Officinalis Extract, Carbomer, Camellia Sinensis (Green Tea) Leaf Extract, Camphor, Glycerin, Ilex Paraguariensis Leaf Extract, Isopropyl Alcohol, Isopropyl Myristate, Melissa Officinalis (Lemon Balm) Leaf Extract, Silica, Tocopheryl (Vitamin E) Acetate, Triethanolamine, Water, Blue 1, Yellow 5	

EXHIBIT

41



EXHIBIT

40

## MYLaw Mock Trial Performance Rating Form

9-10: Exceptional
7-8: Strong
5-6: Good
3-4: Ineffective
1-2: Poor

SCORERS: Do not use fractions. Please score as you go.  
Do not wait until the conclusion of the competition to record scores.

		Plaintiff/ Prosecution	Defendant	
<b>Opening Statements (5 minutes max each)</b>				
42 minutes max each (This time includes the sum time used for examination on direct, cross, re-direct, and re-cross, as well as voir dire. Note: the clock stops to argue objections.)	<u>PLAINTIFF/PROSECUTION</u> First Witness	Direct & Re-Direct Examination by Attorney		
		Witness Performance on Direct/ Re-Direct		
		Cross & Re-Cross Examination by Attorney		
		Witness Performance on Cross/ Re-Cross		
	<u>PLAINTIFF/PROSECUTION</u> Second Witness	Direct & Re-Direct Examination by Attorney		
		Witness Performance on Direct/ Re-Direct		
		Cross & Re-Cross Examination by Attorney		
		Witness Performance on Cross/ Re-Cross		
	<u>PLAINTIFF/PROSECUTION</u> Third Witness	Direct & Re-Direct Examination by Attorney		
		Witness Performance on Direct/ Re-Direct		
		Cross & Re-Cross Examination by Attorney		
		Witness Performance on Cross/ Re-Cross		
	<u>DEFENDANT</u> First Witness	Direct & Re-Direct Examination by Attorney		
		Witness Performance on Direct/ Re-Direct		
		Cross & Re-Cross Examination by Attorney		
		Witness Performance on Cross/ Re-Cross		
	<u>DEFENDANT</u> Second Witness	Direct & Re-Direct Examination by Attorney		
		Witness Performance on Direct/ Re-Direct		
		Cross & Re-Cross Examination by Attorney		
		Witness Performance on Cross/ Re-Cross		
	<u>DEFENDANT</u> Third Witness	Direct & Re-Direct Examination by Attorney		
		Witness Performance on Direct/ Re-Direct		
		Cross & Re-Cross Examination by Attorney		
		Witness Performance on Cross/ Re-Cross		
	<b>Closing Arguments (7 minutes max each)</b>			
	Decorum/ Use of Objections: Students were courteous, observed courtroom etiquette, spoke clearly, demonstrated professionalism, and <b>utilized objections appropriately.</b>			
	<b>TOTAL SCORE</b>			
	<b>TIE POINT</b>			

**MYLAW HIGH SCHOOL MOCK TRIAL COMPETITION RUBRIC**

	<b>Opening Statement</b>	<b>Attorneys (Examination)</b>	<b>Witnesses (Examination)</b>	<b>Closing Argument</b>
<b>9-10: Exceptional</b>	<p><b>Presentation</b> - Outstanding command of the courtroom, makes proper introductions, speaks articulately, moves with confidence, follows all rules of courtroom decorum, demonstrates an exceptional understanding of materials and trial procedures, presents the case without notes.</p> <p><b>Theme/Theory and Case Story</b> - Presents a highly organized, cohesive and persuasive case theory and story, including key facts, and very clear summary of expected witness testimony.</p> <p><b>Law</b> - Provides an outstanding explanation of the law and the burden of proof, requests a desired verdict.</p>	<p><b>Presentation</b> - Outstanding command of the courtroom, speaks and moves with confidence, follows all rules of courtroom decorum, demonstrates a superior understanding of trial procedures.</p> <p><b>Questions</b> - Appropriate for the type of examination; compelling, logically organized, effectively control the flow of direct and cross-examination. The decision to/ not to re-direct or re-cross is correct; when performed, re-direct/ re-cross is responsive and relevant.</p> <p><b>Evidence &amp; Objections</b> - Use of/response to objections and rulings shows superior resilience in adjusting questions as needed and arguing objections by accurately citing rules of evidence; properly enters and appropriately uses exhibits consistently.</p>	<p><b>Presentation</b> - Outstanding command of the courtroom, maintains appropriate courtroom demeanor, speaks clearly and audibly with confidence.</p> <p><b>Witness Persona</b> - Develops a credible and compelling witness persona by demonstrating exceptional knowledge of the affidavits and exhibits, chooses and maintains character attributes that are interesting and appropriate, responds to questions in a way that is natural (not scripted), thorough and persuasive; is not unnecessarily combative/ uncooperative on cross, maintains persona on cross examination.</p>	<p><b>Presentation</b> - Outstanding command of the courtroom, speaks confidently and articulately, limited use of notes specific to quotes from the trial. Moves confidently in physical space. Follows all rules of courtroom decorum and trial procedures.</p> <p><b>Argument</b> - Effectively and clearly organizes facts of the case and witness testimony brought out during trial; summarizes the case and persuasively supports each component of the law to meet the required burden of proof. Persuasively uses facts from the trial to show weaknesses in opposing counsel's case. Closing argument is fully aligned with facts brought out during trial.</p>
<b>7-8: Strong</b>	<p><b>Presentation</b> - Strong command of the courtroom, makes introductions, speaks articulately, moves with confidence, follows most rules of courtroom decorum, demonstrates a solid understanding of materials and trial procedures; presents the case with limited notes.</p> <p><b>Theme/Theory and Case Story</b> - Presents a cohesive and persuasive case theory and story, includes most key facts, provides summary of expected witness testimony.</p> <p><b>Law</b> - Provides a clear explanation of the law and the burden of proof, requests a desired verdict.</p>	<p><b>Presentation</b> - Strong command of the courtroom, mostly speaks and moves with confidence, follows most rules of courtroom decorum, demonstrates a solid understanding of trial procedures.</p> <p><b>Questions</b> - Mostly appropriate for the type of examination and logically organized; mostly controls the flow of direct and cross-examination; the decision to/not to re-direct/ re-cross is correct, and mostly responsive and relevant.</p> <p><b>Evidence &amp; Objections</b> - Use of/response to objections and rulings showing resilience in adjusting questions and arguing objections by accurately citing some rules of evidence; properly enters and appropriate uses exhibits most of the time.</p>	<p><b>Presentation</b> - Solid command of the courtroom, appropriate courtroom demeanor, speaks clearly and audibly with confidence.</p> <p><b>Witness Persona</b> - Develops a mostly credible and convincing witness persona by showing a solid understanding of case materials and choosing interesting character attributes. Does not always maintain character attributes throughout performance and at times seems scripted. Is unnecessarily combative on cross-examination at times.</p>	<p><b>Presentation</b> - Demonstrates solid command of the courtroom, speaks with confidence, some reading of notes that may or may not be specific to events from the trial. Uses the physical space appropriately. Follows most rules of courtroom decorum and trial procedures.</p> <p><b>Argument</b> - Organizes facts of the case and witness testimony brought out during trial to summarize the case and persuasively support most components of the law to meet the required burden of proof. Uses facts from the trial to show weaknesses in opposing counsel's case. Closing argument is somewhat scripted, but includes most facts brought out during trial.</p>

**MYLAW HIGH SCHOOL MOCK TRIAL COMPETITION RUBRIC**

<p align="center"><b>5-6: Good</b></p>	<p><b>Presentation</b> - Some command of the courtroom, makes introductions; shows some confidence, articulation, courtroom decorum; demonstrates a general understanding of case materials and trial procedures; may read substantial portions from notes.</p> <p><b>Theme/Theory and Case Story</b> - Presents a case theory and story, includes some key facts, provides limited summary of expected witness testimony.</p> <p><b>Law</b> - Provides some explanation of the law, references burden of proof, may struggle to recover after rulings. May request desired outcome, but not specific verdict.</p>	<p><b>Presentation</b> - Some command of the courtroom, speaks with some confidence, does not use the physical space, follows some rules of courtroom decorum, shows some understanding of courtroom procedures.</p> <p><b>Questions</b> - Some are appropriate for the type of examination, some organization, some irrelevant questions; direct and cross-examination sounds rehearsed; re-direct/re-cross is somewhat responsive but at times irrelevant.</p> <p><b>Evidence &amp; Objections</b> - Some response to objections and rulings, some adjustment of questioning, may miss opportunities to make key points in case and struggles to recover from rulings. Argues objections with little citation of the rules of evidence; enters and uses exhibits but must sometimes be prompted to do so.</p>	<p><b>Presentation</b> - Maintains courtroom demeanor with some exceptions, may exhibit nervousness in speech.</p> <p><b>Witness Persona</b> Develops a somewhat credible and convincing witness persona by showing some understanding of affidavits and exhibits, and choosing some discernable character attributes. May not be especially interesting or compelling, largely appears to be rehearsed and not portraying a character. Is unnecessarily combative or evasive on cross-examination.</p>	<p><b>Presentation</b> - Demonstrates general command of the courtroom, speaks with some confidence, reads substantial portions of notes that may or may not be specific to events from the trial. Limited use of the physical space. Follows some rules of courtroom decorum, demonstrates a general understanding of courtroom procedures.</p> <p><b>Argument</b> - Organizes some facts of the case and witness testimony brought out during trial to summarize the case and support some components of the law to meet the required burden of proof. Uses some facts from the trial to show weakness in opposing counsel’s case. Closing argument is scripted, but includes some facts brought out during trial.</p>
<p align="center"><b>3-4: Ineffective</b></p>	<p><b>Presentation</b> - Little to no command of the courtroom, hard to understand, lacks consistent courtroom decorum, struggles to understand case materials/ trial procedures, reads verbatim from notes.</p> <p><b>Theme/Theory and Case Story</b> - Case theory is weak or fragmented; few key facts with limited or no summary of expected witness testimony.</p> <p><b>Law</b> - Provides little or no explanation of the law or burden of proof; does not request outcome or desired verdict. Misses many opportunities to use/respond to objections, often struggles to recover after rulings.</p>	<p><b>Presentation</b> - Little command of the courtroom, nervous, fidgeting, hard to understand, does not use the physical space, weak demonstration of courtroom decorum and trial procedures.</p> <p><b>Questions</b> - Inappropriate for the type of examination, disorganized questioning, irrelevant questions; direct and cross examination sounds rehearsed, argues with witnesses; re-direct/re-cross is mostly irrelevant.</p> <p><b>Evidence &amp; Objections</b> - Little response to objections and ruling, does not adjust questioning, misses opportunities to make key points in case, and struggles to recover from rulings. Limited argument of objections with no citation of the rules of evidence; does not enter or use exhibits and/or must be instructed on procedures.</p>	<p><b>Presentation</b> - Inconsistent in courtroom demeanor; nervous, inaudible or jumbled speech; limited eye contact; does not follow instruction by the Court.</p> <p><b>Witness Persona</b> - Witness persona is not convincing; shows limited understanding of the affidavits and exhibits; direct examination responses sound stiff and rehearsed; fails to answer on cross, evades response, argues with hostility, or is unresponsive. Testimony is impeached on cross-examination.</p>	<p><b>Presentation</b> - No command of the courtroom, nervous, hard to understand, lacks confidence, reads entirely from notes and does not make necessary adjustments. Does not use physical space. Follows few rules of courtroom decorum, demonstrates little understanding of trial procedures.</p> <p><b>Argument</b> – Lacks organization of facts, little or no use of witness testimony brought out during trial, limited or no summary of the case. Few components of the law supported or addressed with little/no reference to burden of proof. Does not address weaknesses in opposing counsel’s case. Closing argument is read verbatim.</p>
<p align="center"><b>1-2</b></p>	<p align="center"><b>A score of 1 or 2 should be reserved for students who demonstrate disrespect for the process or whose performance shows little to no preparation or effort.</b></p>			

**40**

**30**

**20**

**10**

**5**

**2**

**1**



# NOTES

# NOTES

# NOTES



## **Celebrating 41 years of Mock Trial State Champions!**

2022: Richard Montgomery High School(Montgomery County)  
2021: The Park School (Baltimore County)  
River Hill High School (Howard County)  
2020: Not applicable

2019: Richard Montgomery High School(Montgomery County)  
Beth Tfiloh, Co-Champion (Baltimore County)  
2018: Allegany High School (Allegany County)  
2017: The Park School (Baltimore County)  
2016: Annapolis High School (Anne Arundel County)  
2015: Severna Park High School (Anne Arundel County)

2014: Richard Montgomery High School (Montgomery County)  
2013: Annapolis High School (Anne Arundel County)  
2012: Park School of Baltimore (Baltimore County)  
2011: Park School of Baltimore (Baltimore County)  
2010: Severna Park High School (Anne Arundel County)  
2009: Allegany High School (Allegany County)  
2008: Severna Park High School (Anne Arundel County)  
2007: Severn School (Anne Arundel County)  
2006: Severna Park High School (Anne Arundel County)

2005: Richard Montgomery High School (Montgomery County)  
2004: Park School of Baltimore (Baltimore County)  
2003: Elizabeth Seton High School (Prince George's County)  
2002: Towson High School (Baltimore County)

2001: DeMatha Catholic High School (Prince George's County)  
2000: Broadneck High School (Anne Arundel County)  
1999: Towson High School (Baltimore County)  
1998: Pikesville High School (Baltimore County)  
1997: Suitland High School (Prince George's County)  
1996: Towson High School (Baltimore County)  
1995: Pikesville High School (Baltimore County)

1994: Richard Montgomery High School (Montgomery County)  
1993: Elizabeth Seton High School (Prince George's County)  
1992: Oxon Hill High School (Prince George's County)  
1991: Westmar High School (Allegany County)  
1990: Bishop Walsh High School (Allegany County)  
1989: Lake Clifton High School (Baltimore City)  
1988: Pikesville High School (Baltimore County)

1987: Thomas S. Wootton High School (Prince George's County)  
1986: Old Mill High School (Baltimore County)  
1985: High Point High School (Prince George's County)  
1984: Worcester County Schools

MYLaw is pleased to coordinate the following programs, in addition to Mock Trial:

**Summer Law Academy**  
**Baltimore City Law Links**  
**Baltimore City Teen Court**  
**Moot Court**  
**Baltimore City Council Page Program**

For more information, please visit: [www.mylaw.org](http://www.mylaw.org) or Facebook (/mylaw.org)