

MODEL 331/401 MACH TILL HIGH-SPEED DISC OPERATOR'S MANUAL

M0285-01

Rev. 7/19

This manual is applicable to: Model 331/401 Mach Till High-Speed Disc
2018 Production and on

Record the model number and serial number of your Mach Till along with date purchased:

Model Number _____

Serial Number _____

Date Purchased _____

SERIAL NUMBER

The serial number plate is located on the frame to be readily available. It is suggested that your serial number and purchase date also be recorded above.

The serial number provides important information about your Mach Till and may be required to obtain the correct replacement part. Always provide the model number and serial number to your Kinze Dealer when ordering parts or anytime correspondence is made with Kinze Manufacturing, Inc.



Serial Number Plate Location

Kinze® and the Kinze® logo are registered trademarks of Kinze Manufacturing, Inc.

Mach Till™ is a trademark of Kinze Manufacturing, Inc.

This page left blank intentionally.

TO THE DEALER

Predelivery service includes assembly, lubrication, adjustment and test. This service helps ensure high-speed disc is delivered to retail customer/end user ready for field use.

PREDELIVERY CHECKLIST

Use the following checklist after disc is completely assembled. Check off each item as it is found satisfactory or after proper adjustment is made.

- All grease fittings in place and lubricated.
- All working parts move freely, bolts are tight, and cotter pins are spread.
- Check for oil leaks and proper hydraulic operation.
- Hydraulic hoses correctly routed to prevent damage.
- Inflate tires to specified air pressure and torque wheel lug bolts and lug nuts as specified in the manual.
- All safety decals correctly located and legible. Replace if damaged.
- All reflective decals and SMV sign correctly located and visible when the disc is in transport position.
- Safety/warning lights correctly installed and working properly.
- Paint all parts scratched during shipment or assembly.
- All safety lockup devices on the high-speed disc and correctly located.
- Auxiliary safety chain properly installed and hardware torqued to specification.

High-speed disc has been thoroughly checked and to the best of my knowledge is ready for delivery to the customer.

(Signature Of Set-Up Person/Dealer Name/Date)

OWNER REGISTER

Name _____ Delivery Date _____
 Street Address _____ Model No. _____ Serial No. _____
 City, State/Province _____ Dealer Name _____
 ZIP/Postal Code _____ Dealer No. _____

DELIVERY CHECKLIST

Use the following checklist at time high-speed disc is delivered as a reminder of very important information which should be conveyed to retail customer/end user. Check off each item as it is fully explained.

- Life expectancy of this or any other machine is dependent on regular lubrication as directed in the Operator Manual.
- All applicable safety precautions.
- Along with retail customer/end user, check reflective decals and SMV sign are clearly visible with disc in transport position and attached to tractor. Check safety/warning lights are in working condition. Tell retail customer/end user to check federal, state/provincial, and local regulations before towing or transporting on a road or highway.
- Give Operator Manual, Parts Manual, and all Instruction Sheets to retail customer/end user and explain all operating adjustments.
- Read warranty to retail customer/end user.
- Complete Warranty and Delivery Report form.

To the best of my knowledge this machine has been delivered ready for field use and customer has been fully informed as to proper care and operation.

(Signature Of Delivery Person/Dealer Name/Date)

AFTER DELIVERY CHECKLIST

The following is a list of items we suggest to check during the first season of use of the equipment.

- Check high-speed disc performance with retail customer/end user.
- Review importance of proper maintenance and adherence to all safety precautions with retail customer/end user.
- Check for parts that may need to be adjusted or replaced.
- Check all safety decals, reflective decals, and SMV sign are correctly located as shown in the Parts Manual and that decals are legible. Replace if damaged or missing.
- Check safety/warning lights are working properly.

(Signature Of Follow-Up Person/Dealer Name/Date)

**All registrations must be submitted online at "business.kinze.com" within 5 business days of delivery.
Retain a copy of this form for auditing purposes.**

Tear Along Perforation

OVERVIEW

To The Owner	1-3
Warranty	1-5
Specifications	1-6
General Safety Rules	1-7
Safety Precautions	1-8

MACHINE OPERATION

Initial Preparation	2-1
Tractor Requirements	2-3
Hook-Up / Unhooking	2-4
Operating Guidelines	2-6
Towing High-Speed Disc	2-7
Transport to Field Position	2-8
Field to Transport Position	2-10
Factory Disk Setup	2-12
Setting Disc Depth - Front And Rear	2-14
Setting Scraper Position	2-16
Scraper Side-To-Side Positioning	2-17
Reversing Scraper Blades	2-17
Ridge Wiper Components	2-18
Dirt Deflector Adjustment Settings	2-18

LUBRICATION AND MAINTENANCE

Maintenance Checklist	3-2
Tire Pressure	3-3
Mach Till Operating Tire Pressure	3-3
Grease Fittings	3-4
Wheel Bearings	3-6
Wheel Bearing Repack or Replacement	3-6
Wheel Hub Repair	3-7
Mounting Bolts and Hardware	3-8
Preparing Disc for STORAGE	3-10
Hydraulic Hose Life	3-11
Hydraulic Jack	3-11

TROUBLESHOOTING 4-1

Table of Contents



This page left blank intentionally.

Kinze Manufacturing, Inc. thanks you for your patronage. We appreciate your confidence in Kinze farm machinery. Your Kinze Mach Till has been carefully designed to provide dependable operation in return for your investment.

This manual has been prepared to aid you in the operation and maintenance of the Mach Till. It should be considered a permanent part of the machine and remain with the machine when you sell it.

It is the responsibility of the user to read and understand the Operator Manual in regards to safety, operation, lubrication and maintenance before operation of this equipment. It is the user's responsibility to inspect and service the machine routinely as directed in the Operator Manual. We have attempted to cover all areas of safety, operation, lubrication and maintenance; however, there may be times when special care must be taken to fit your conditions.

Throughout this manual the symbol  and the words **DANGER**, **WARNING**, and **CAUTION** are used to call attention to safety information that if not followed, will or could result in death or injury. **NOTICE** and **NOTE** are used to call your attention to important information. The definition of each of these terms follows:

 DANGER	<p>Indicates an imminently hazardous situation that, if not avoided, will result in death or serious injury. This signal word is to be limited to the most extreme situations, typically for machine components which, for functional purposes, cannot be guarded.</p>
 WARNING	<p>Indicates a potentially hazardous situation that, if not avoided, could result in death or serious injury, and includes hazards that are exposed when guards are removed. It may also be used to alert against unsafe practices.</p>
 CAUTION	<p>Indicates a potentially hazardous situation that, if not avoided, may result in minor or moderate injury. It may also be used to alert against unsafe practices.</p>
NOTICE	<p>Used to address safety practices not related to personal injury.</p>

NOTE: Special point of information or machine adjustment instructions.

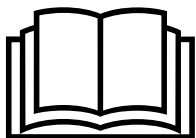
**WARNING**

Improperly operating or working on this equipment could result in death or serious injury. Read and follow all instructions in Operator Manual before operating or working on this equipment.

**WARNING**

Some photos in this manual may show safety covers, shields, or lockup devices removed for visual clarity. **NEVER OPERATOR OR WORK ON** machine without all safety covers, shields, and lockup device in place as required.

NOTE: Some photos in this manual may have been taken of prototype machines. Production machines may vary in appearance.

NOTE: Some photos and illustrations in this manual show optional attachments installed. Contact your Kinze Dealer for purchase of optional attachments.

The Kinze Limited Warranty for your new machine is stated on the retail purchaser's copy of the Warranty And Delivery Receipt form. Additional copies of the Limited Warranty can be obtained through your Kinze Dealer.

Warranty, within the warranty period, is provided as part of Kinze's support program for registered Kinze products which have been operated and maintained as described in this manual. Evidence of equipment abuse or modification beyond original factory specifications will void the warranty. Normal maintenance, service and repair is not covered by Kinze warranty.

To register your Kinze product for warranty, a Warranty And Delivery Receipt form must be completed by the Kinze Dealer and signed by the retail purchaser, with copies to the Dealer, and to the retail purchaser. Registration must be completed and submitted to Kinze Manufacturing, Inc. within 5 business days of delivery of the Kinze product to the retail purchaser. Kinze Manufacturing, Inc. reserves the right to refuse warranty on serial numbered products which have not been properly registered.

If service or replacement of failed parts which are covered by the Limited Warranty are required, it is the user's responsibility to deliver the machine along with the retail purchaser's copy of the Warranty And Delivery Receipt to the Kinze Dealer for service. Kinze warranty does not include cost of travel time, mileage, hauling or labor. Any prior arrangement made between the Dealer and the retail purchaser in which the Dealer agrees to absorb all or part of this expense should be considered a courtesy to the retail purchaser.

Kinze warranty does not include cost of travel time, mileage, hauling, or labor.



GENERAL INFORMATION

This manual covers all production years of the Mach Till. Contact your Kinze dealer for additional options which may be available for your specific model year Mach Till.

Information in this manual was current at time of printing. However, due to Kinze's ongoing product improvement, production changes may cause your machine to appear slightly different in detail. Kinze Manufacturing, Inc. reserves the right to change specifications or design without notice and without incurring obligation to install the same on machines previously manufactured. To obtain the most recent version of your publication, please contact your Kinze dealer.

Right hand (R.H.) and left hand (L.H.), as used throughout this manual, are determined by facing in direction machine travels in use, unless otherwise stated.

Specification/Feature	331	401
<i>Main Frame</i>	6" x 10" x 3/8"	
<i>Hitch Frame</i>	6" x 10" x 3/8"	
<i>Wing Frame</i>	6" x 6" x 3/8"	
<i>Center Frame</i>	6" x 6" x 3/8"	
<i>Frame Flex</i>	Wing: 6° Down; Front to Back: 79° Up (In Float); 10° Down (In Float)	
<i>Tires</i>		
600/50R22.5 BKT FL630 Plus High Flotation Raidal Tires	Wing	Wing
600/50R22 MPT Alliance 382 FLOTRUCK	Center	Center
<i>Hubs (Center and Wing)</i>	CTD H1010-9 (10 Bolt)	
<i>Roller Bearings</i>	2 1/2" Double Row Spherical Roller Ball Bearing	
<i>Transport Lift Hydraulics</i>	5 1/2" x 42"	
<i>Wing Forward Hydraulics</i>	4" x 28"	
<i>Hydraulic Jack</i>	Oversized Self-Leveling Hydraulic Jack	
Width		
<i>Width - Overall</i>	33'	40'
<i>Width - Transport</i>	20'	20'
Height		
<i>Height - Transport</i>	12' 9" (Rubber) 12' 2" (Cage Roller)	13' 2" (Rubber) 12' 7" (Cage Roller)
Weight		
<i>Weight (est.)</i>	31,000 lbs.	34,000 lbs.
Hydraulic Requirements		
<i>Engine HP</i>	10 to 15HP per foot (at 3" working depth to achieve 8 to 12 mph, requirements may vary due to terrain and field conditions)	
<i>Hydraulic Requirements</i>	18 to 20 gpm (at 2,500 psi)	

1. Read and understand instructions provided in this manual and warning labels. Review these instructions frequently!
2. This machine is designed and built with your safety in mind. Do not make any alterations or changes to this machine. Any alteration to design or construction may create safety hazards.
3. A large portion of farm accidents happen from fatigue or carelessness. Safe and careful operation of tractor and Mach Till will help prevent accidents.
4. Never allow disc to be operated by anyone unfamiliar with operation of all functions of the unit. Operators must read and thoroughly understand all instructions given in this manual before operating or working on equipment.
5. Be aware of bystanders, particularly children! Always look around to make sure it is safe to start tow vehicle engine or move Mach Till. This is particularly important with higher noise levels and quiet cabs, as you may not hear people shouting.
6. Make sure Mach Till weight does not exceed towing capacity of tractor, or bridge and road limits. This is critical to maintain safe control and prevent death or injury, or property and equipment damage.
7. Never ride or allow others to ride on Mach Till.
8. Store disc in an area away from human activity. DO NOT permit children to play on or around the stored unit.
9. Keep hands, feet, and clothing away from moving parts. Do not wear loose-fitting clothing which may catch in moving parts.
10. Always wear protective clothing, shoes, gloves, hearing, and eye protection applicable for the situation.
11. Do not allow anyone to stand between tongue or hitch and towing vehicle when backing up to disc.
13. Prevent electrocution, other injuries, or property and equipment damage. Watch for obstructions such as wires, tree limbs, etc. when operating machine. Be aware of clearances during turns and when folding/unfolding Mach Till.
14. Reinstall all guards removed for maintenance activities. Never leave guards off during operation.
15. Do not operate machine on overly steep side hills or slopes.
16. Follow all federal, state/provincial, and local regulations when towing farm equipment on a public highway. Use safety chain (not an elastic or nylon/plastic tow strap) to retain connection between towing and towed machines in the event of primary attaching system separation.
17. Make sure all safety/warning lights, SMV sign, and reflective decals are in place and working properly before transporting the machine on public roads.
18. Limit towing speed to 25 mph (40 km/h). Tow only with farm tractor of a minimum 200 HP. Allow for unit length when making turns.
19. Reduce speed prior to turns to avoid the risk of overturning. Always drive at a safe speed relative to local conditions and ensure your speed is slow enough for a safe emergency stop.
20. Chemicals are supplied with Material Safety Data Sheets (MSDS) that provide full information about the chemical, its effects on exposure, and first aid needs in the event of an emergency. Keep your MSDS file up-to-date and available for first responders in case of emergency.
21. When servicing ground engaging components such as scraper components, use special care to avoid points and edges worn sharp during use.
22. Use professional help if you are unfamiliar with working on hydraulic systems. Pressurized hydraulic fluid can penetrate body tissue and result in death, serious infection, or other injuries.

Following are some common hazard warnings associated with this equipment. Pay close attention to all safety, operating, and maintenance information in this manual and decals applied to your equipment.

DANGER

Contacting or coming close to power lines or other high energy sources will cause death or serious injury.

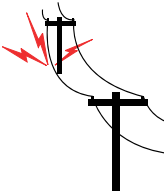

Keep away from power lines or high energy sources at all times.

WARNING

Improperly operating or working on this equipment could result in death or serious injury. Read and follow all instructions in Operator Manual before operating or working on this equipment.

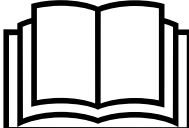

WARNING

Falling equipment can cause death or serious injury. Install all lockup devices or lower Mach Till to ground before working on equipment.



WARNING

Explosive separation of rim and tire parts can cause death or serious injury. Overinflation, rim and tire servicing, improper use of rims and tires, or worn or improperly maintained tires could result in a tire explosion.

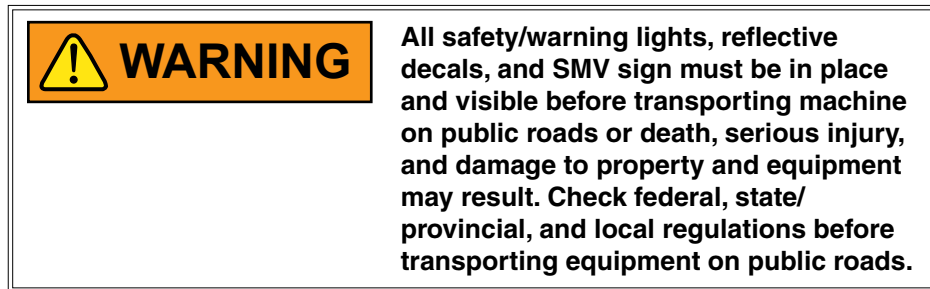

SAFETY SIGNS AND DECALS

Safety signs and decals are placed on the machine to warn of hazards and provide important operating and maintenance instructions. Information on these signs are for your personal safety and the safety of those around you. FOLLOW ALL SAFETY INSTRUCTIONS!

- **Keep signs clean so they can be easily seen. Wash with soap and water or cleaning solution as required.**
- **Replace safety signs if damaged, painted over, or missing.**
- **Check reflective decals and SMV sign periodically. Replace if they show any loss of reflective properties.**
- **When replacing decals, clean machine surface thoroughly with soap and water or cleaning solution to remove all dirt and grease.**



NOTE: Safety sign and decal locations are shown in the Parts Manual for this machine.



NOTE: Style and locations of SMV sign, reflective decals, and safety/warning lights conform to ANSI/ASABE S279.14 JUL 2008 and ANSI/ASABE S276.6 JAN 2005.



This page left blank intentionally.

INITIAL PREPARATION

Following information is general in nature to aid in preparation of tractor and disc for use, and to provide general operating procedures. Operator experience, familiarity with the machine, and the following information should combine for efficient disc operation and good working habits.

 WARNING	<p>Improperly operating or working on this equipment could result in death or serious injury. Read and follow all instructions in Operator Manual before operating or working on this equipment.</p>
	

 WARNING	<p>Loose transport wheel lug bolts can result in wheel separation from disc and cause death, serious injury, and damage to property and equipment. Torque wheel $\frac{3}{4}$" lug bolts to 280-300 ft-lb (380-405 N-m) before operating Mach Till for the first time and periodically after.</p>
	

 WARNING	<p>Explosive separation of rim and tire parts can cause death or serious injury. Overinflation, rim and tire servicing, improper use of rims and tires, or worn or improperly maintained tires could result in a tire explosion.</p>
	

Although there are no operational restrictions on the high-speed disc when it is new, there are some checks that should be done when using the machine for the first time, follow this procedure:

NOTE: It is important to follow the “Before using” and “After Operating for 2 Hours” sections below to avoid damage:

Before using:

1. Read Safety Information and Operator’s Manual.
2. Complete steps in “Pre-Operation Checklist”.
3. Lubricate all grease points.
4. Check all bolt tightness.
5. Adjust Disc Cutting Depth as outlined in the “Setting Disc Depth” section.

After operating for 2 hours:

1. Check all hardware. Tighten as required.
2. Check all hydraulic system connections. Tighten if any are leaking.

It is important for both personal safety and maintaining good operational condition of the machine that the following steps are followed.

Before operating the machine and each time thereafter, the following areas should be checked off:

1. Lubricate the machine per the schedule outlined in the “Maintenance Section”.
2. Use only a tractor with adequate power to pull the Mach Till under ordinary operating conditions. See “Tractor Requirements”.

NOTE: It is important to pin the drawbar in the central location only.

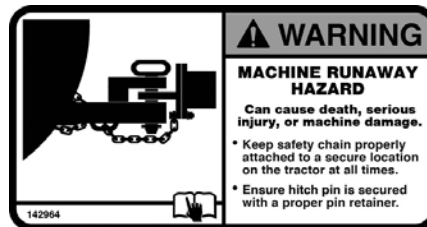

3. Ensure that the machine is properly attached to the tractor using a clevis hitch, safety chain and a drawbar pin with provisions for a mechanical retainer. Make sure that a retainer such as a lynch pin is installed.

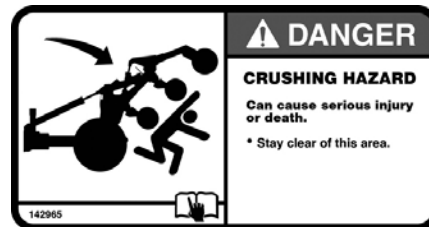

WARNING

Negative Hitch Weight may occur when raising or lowering the rear sections. If the unit is not properly attached to the tractor with a clevis hitch and safety chain, the negative hitch weight could result in the hitch pole to suddenly raise and the rear sections to come crashing down.

4. Before using, inflate tires. See Lubrication and Maintenance section for Tire Pressures.
5. Check oil level in the tractor hydraulic reservoir. Fill as required.
6. Inspect all hydraulic lines, hoses, fittings and couplers for tightness. Tighten if there are leaks. Use a clean cloth to wipe any accumulated dirt from the couplers before connecting to the tractor’s hydraulic system.
7. Inspect the condition/wear of the discs. If needed or desired, adjust the Disc Cutting Depth as outlined in the adjustments section. If excessive disc wear is evident, replacement may be required. Refer to maintenance section.

TRACTOR REQUIREMENTS

NOTICE	All Hydraulic Requirements: Minimum Pressure 2350 PSI (16202.6 kPa); Maximum Pressure 3000 PSI (20684.2 kPa). Check tractor hydraulics to ensure that maximum pressure cannot be exceeded.
---------------	---

Consult your dealer for information on horsepower requirements and tractor compatibility. Requirements vary with Mach Till options, tillage, and terrain.

A 12 volt DC electrical system is required to operate Mach Till safety/warning lights.

Five remote hydraulic outlets (SCV) are required on all models.

GPS OFFSETS

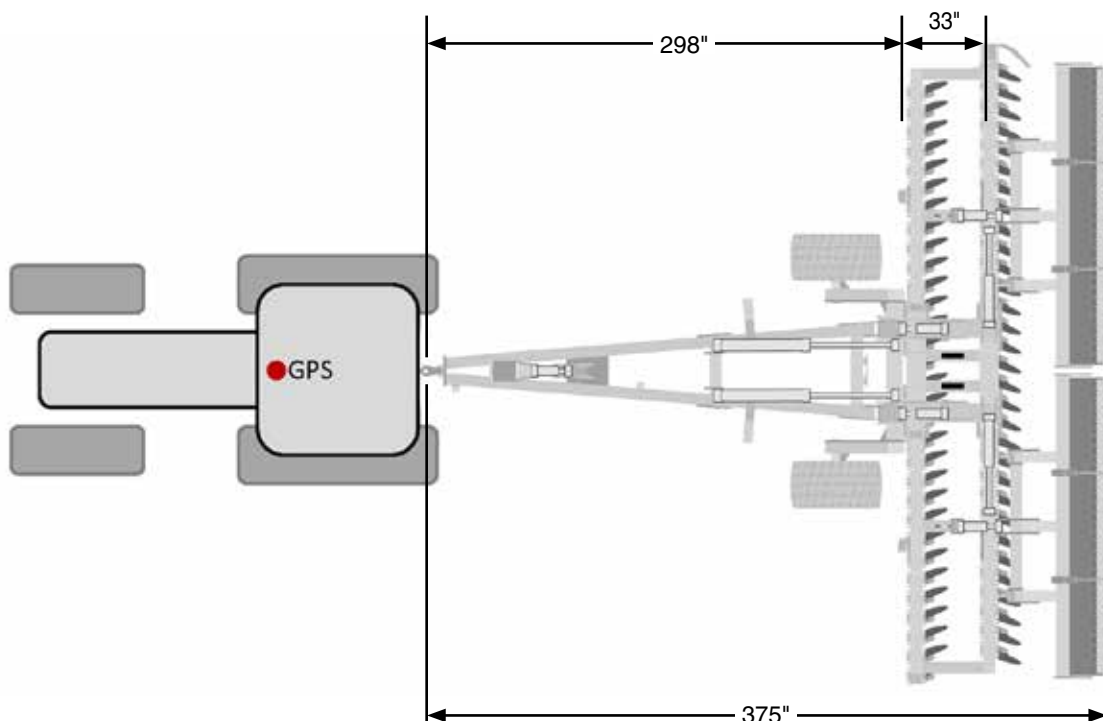

HOOK-UP / UNHOOKING

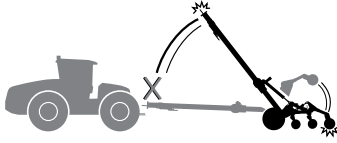
 <p>WARNING</p>	<p>Negative hitch weight may cause serious injury or death. Never disconnect from tractor if rear sections of machine are partially raised. Negative Hitch Weight may result, the hitch pole may suddenly raise, and the rear section would come crashing down. Only disconnect when unit is on level ground in the proper transport or field position.</p>
	

The Mach Till should always be parked on a level, dry area that is free of debris and foreign objects. Follow this procedure to hook-up:

NOTE: The tractor MUST be properly equipped with a clevis hitch and safety chain to prevent Negative Hitch Weight occurring when raising or lowering the rear sections.

NOTE: If the unit is not properly attached to the tractor with a clevis hitch and safety chain, the negative hitch weight could result in the hitch pole suddenly raising and the rear section to come crashing down.

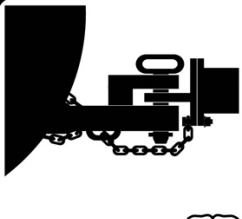
 <p>142964</p>	<p>WARNING</p> <p>MACHINE RUNAWAY HAZARD</p> <p>Can cause death, serious injury, or machine damage.</p> <ul style="list-style-type: none"> • Keep safety chain properly attached to a secure location on the tractor at all times. • Ensure hitch pin is secured with a proper pin retainer.
---	--

 <p>142963</p>	<p>DANGER</p> <p>NEGATIVE TONGUE WEIGHT ON HITCH</p> <p>Can cause serious injury or death.</p> <ul style="list-style-type: none"> • Make certain that implement is securely hitched to the tractor at all times. • Do not unhook implement from tractor unless it is in the proper field or transport position.
---	---

 <p>142965</p>	<p>DANGER</p> <p>CRUSHING HAZARD</p> <p>Can cause serious injury or death.</p> <ul style="list-style-type: none"> • Stay clear of this area.
---	---

1. Clear the area of bystanders and remove foreign objects from the machine and working area.
2. Make sure there is enough room to back the tractor up to the trailer hitch.
3. Start the tractor and slowly back it up to the hitch point.
4. Connect the hydraulics. To connect, proceed as follows:
 - Use a clean cloth or paper towel to clean the couplers on the ends of the hoses. Also clean the area around the couplers on the tractor. Remove the plastic plugs from the couplers and insert the male ends.
 - Be sure to match the pressure and return line to one valve bank.
 - Hoses have be labeled in a suggested order of priority from most used to least:
(1) Wheels (2) Rollers (3) Transport (4) Wings (5) Jack
5. Use the hydraulic jack controls to raise or lower the hitch to align with the drawbar.

NOTE: Close the ball valve (if equipped) to prevent accidental operation of this circuit. Ensure ball valve handle remains in closed position.

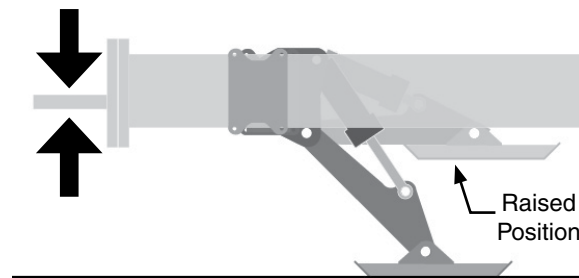

CAUTION

Tractor **MUST** be equipped with a clevis hitch to prevent unit from tipping upward while folding into and out of position. A safety chain must also always be properly installed.

6. Slowly back tractor up to align the hitch.
7. Install a drawbar pin with provisions for a mechanical retainer such as a lynch pin.
8. Install the retainer.
9. Install a safety chain between the tractor and the hitch.
10. Connect lights (electrical socket plug) to tractor.
11. Raise the hydraulic hitch jack.
12. When unhooking from the tractor, reverse the above procedure.

OPERATING GUIDELINES

1. Place both the Transport Cylinders and the Wing Cylinders into the FLOAT position before operation.

NOTE: The Transport Cylinders and Wing Cylinders MUST both be in the FLOAT position for the Mach-Till to contour properly and to avoid possible cylinder or equipment damage.

2. Ideal Operating Speed is 10-12 mph (16-19 Km/h)
Minimum operating speed is 7 mph (11 Km/h)
Maximum operating speed is 14 mph (22 Km/h)
3. When making headland turns, the operator may wish to slightly raise the disc sections by activating the Wheel or Roller cylinders (or both). Remember to lower after coming out of the turn.
4. Each time you start a new field you may need to adjust the cutting depth depending on the type of crop residue or soil conditions. The operator can adjust the cutting depth by raising/lowering the front or rear sets of discs by following the guidelines in the "Setting Disc Depth" section.
5. After making adjustments to the cutting depth it is recommended to bring the machine up to speed (see above) to test the depth setting by driving about 328 ft. (100m) (cutting performance changes dramatically from a slow speed to high speed). Stop, check depth and cut of field, re-adjust the height higher or lower, if needed, based on your preference. Remember: Removing a ¼" stop lowers cutting depth ½" deeper, Adding a ¼" stop raises discs up ½" higher.
6. Harder, packed soil may require additional passes for optimum results. It is recommended to do a second pass at an angle to the original pass.

TOWING HIGH-SPEED DISC

Use the following guidelines while transporting:

1. Use a safety chain and a pin with provisions for a mechanical retainer.

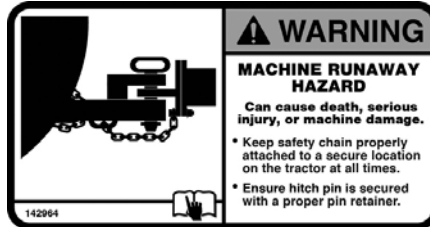

2. Ensure disc is in the full transport position with the wing rollers secure and properly in place.
3. Ensure debris that may fall or become dislodged during transport is removed.
4. Be sure hazard lights are flashing and SMV decal is visible.
5. **MAXIMUM RECOMMENDED TRANSPORT SPEED: MAX 25 mph (40 km/h).** Road Conditions, Field speeds may be lower. Due to weight of the machine and tire ratings, do not exceed the recommended maximum speeds or severe tire damage / excessive wear may occur.
6. If the disc is to be towed in Transport for an extended duration with speeds up to 15 mph (24 km/hr), the center frame wheels (transport tires) must be checked and properly inflated: 94 PSI (648 kPa).



TRANSPORT TO FIELD POSITION



1. On level ground, position the machine so it is straight in-line behind the tractor.

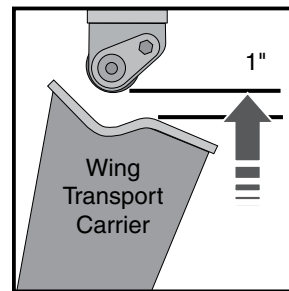
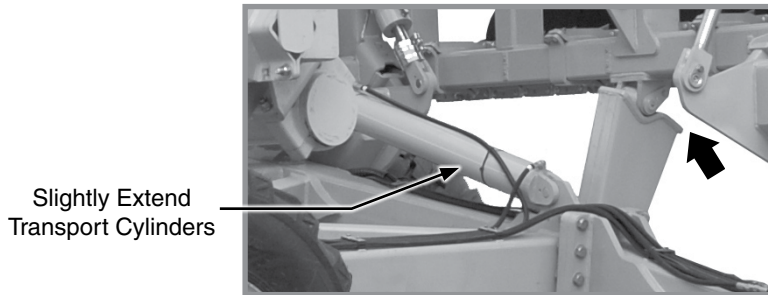

2. Slightly extend the Transport Cylinders just enough to remove the weight of wings off from the wing transport carriers. Do not lift more than needed.

NOTICE	Do Not fully extend the transport cylinders at this point. Follow proper procedures to prevent possible equipment damage or failure.
---------------	---

3. Extend the Wing Cylinders to fully open the wings behind the machine.

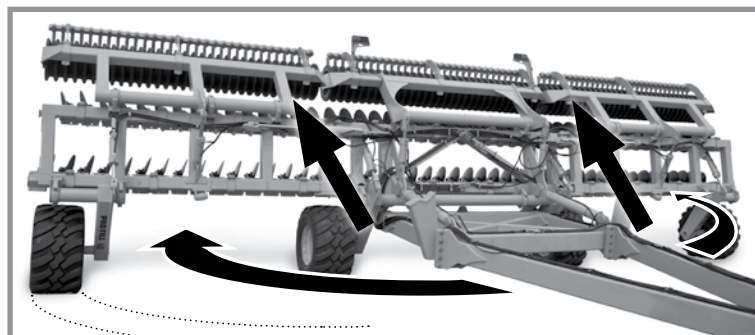

- 4. After fully opening the wings, extend the Transport Cylinders to completely lower all rear frame sections to the ground.

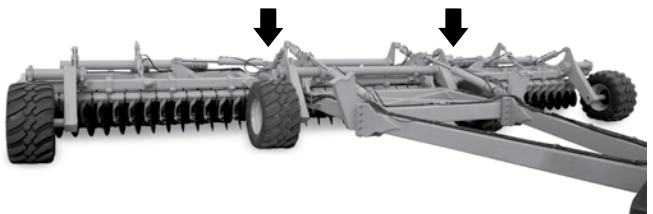
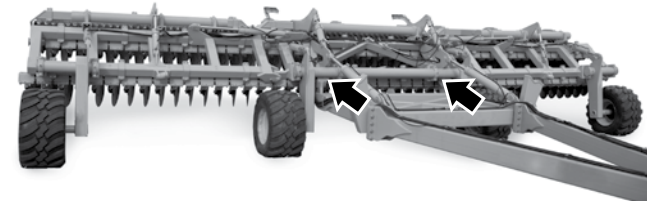
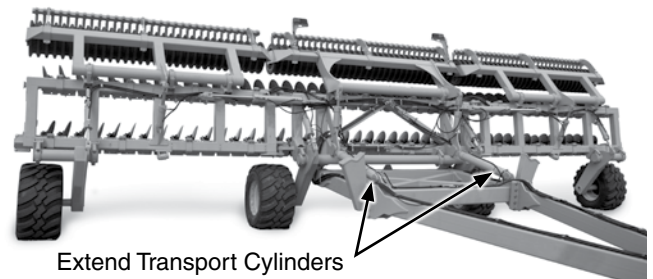

- 5. Place both the Transport Cylinders and the Wing Cylinders into the FLOAT position before operation.

NOTE: The Transport & Wing Cylinders MUST both be in the "FLOAT" position in order for the machine to properly contour the ground and to avoid possible cylinder or equipment damage.

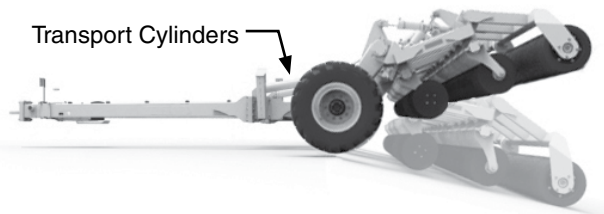
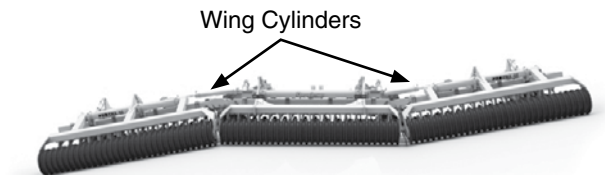

 PLACE IN FLOAT	WARNING ENSURE TRANSPORT & WING CYLINDERS ARE PLACED IN FLOAT
--	--

FIELD TO TRANSPORT POSITION

1. Fully extend the Wheel & Roller Cylinders to completely raise the disc frames.

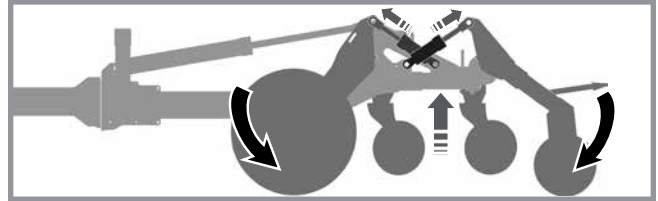
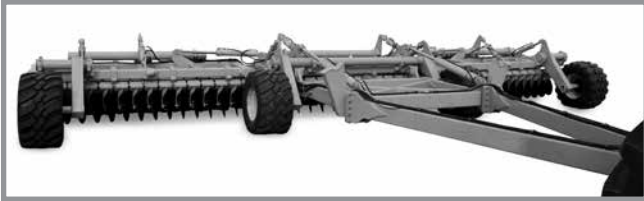

NOTE: It is important to fully raise the disc frames up as high as possible as it puts the rollers and wheels in the correct position for low transport.

 **WARNING**



NEVER LIFT WINGS!
Do Not retract the wing cylinders to raise the wings at this point. Follow proper procedures to prevent possible equipment damage or failure.

Lift rear sections using the Transport Cylinders, then fold the wings forward using the Wing Cylinders.

2. Retract the Transport Cylinders, fully raising the complete rear section (center & both wing sections).

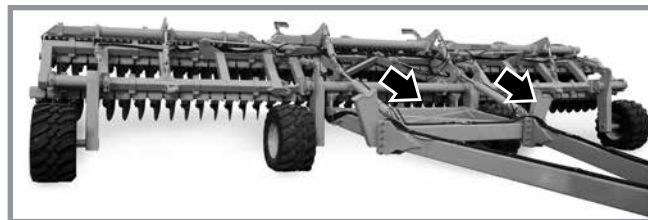

3. After raising all the rear sections together, retract the Wing Cylinders to bring both wings inward towards the frame.

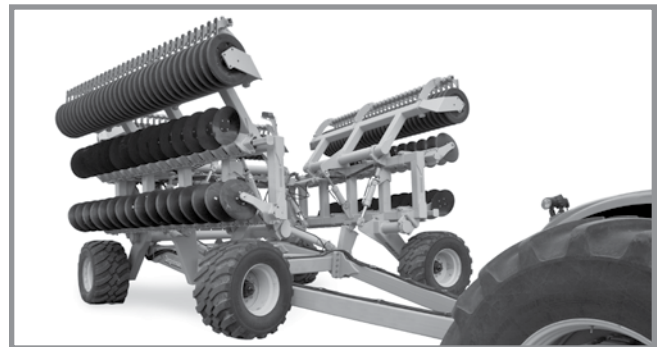
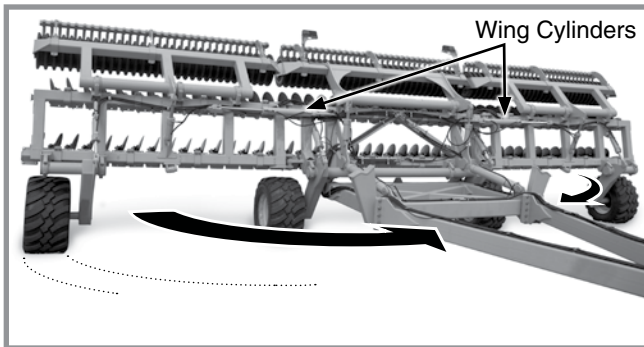

4. When the wings get close to the wing transport carriers, you may need to slightly extend the Transport Cylinders so the rollers can reach the correct position.

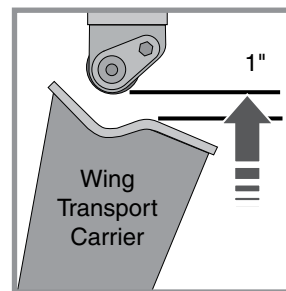
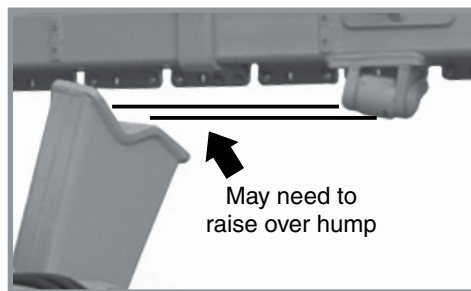

5. With the wings in the proper position, retract the Transport Cylinders fully lowering the wings onto the wing transport carriers.

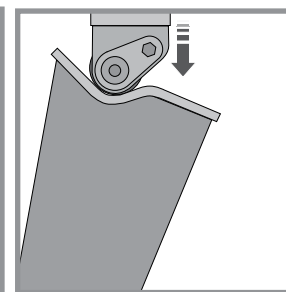
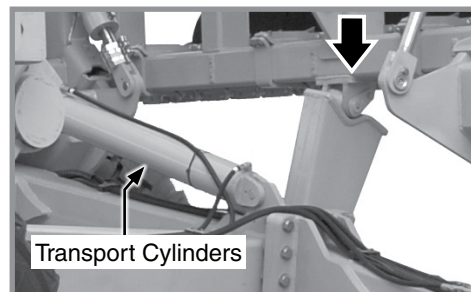

FACTORY DISK SETUP

20" Disc Setup

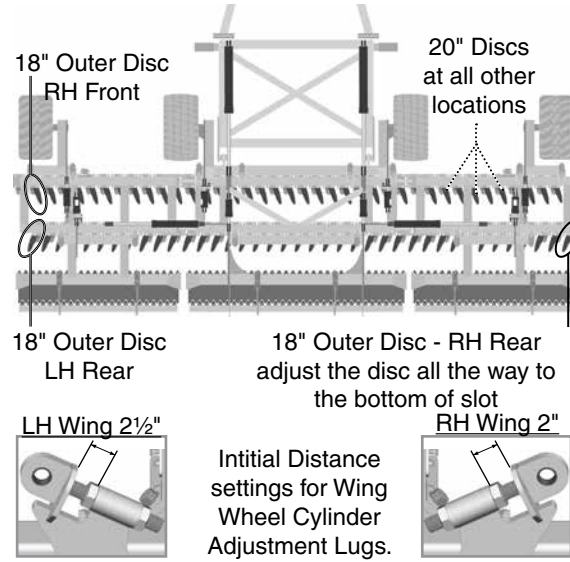

SETTING GANG SECTION SPACING - OVERVIEW

- Gang section spacing starts by setting the distance from the inside R.H. Wing Frame to the edge of the first V-Clamp on front and rear gang sections. See diagram for measurements - A and B in diagram.

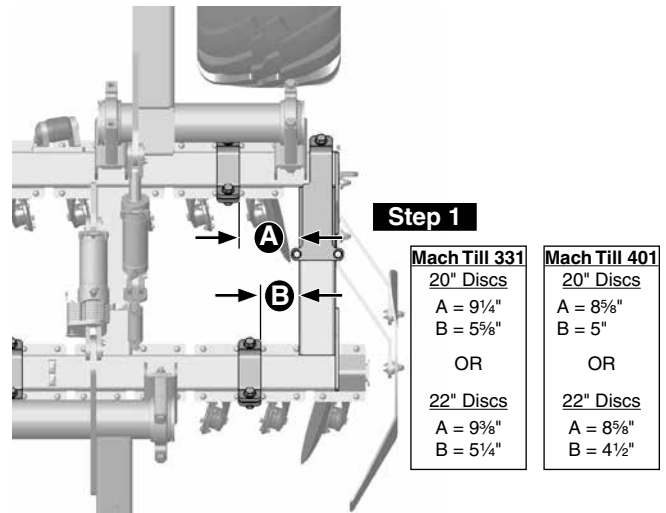

- Then, the distance between the left endcap of the first gang section and the right endcap of the next gang section should be set to 1½". This should be the standard distance between all gang sections.

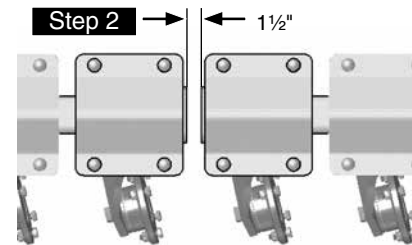

SETTING DISC DEPTH - FRONT AND REAR

Adjusting the cutting depth of the front and rear discs is accomplished by adding or removing a number of spacers from specified cylinders.

The spacers limit the stroke distance of the cylinders, changing the amount that the front and rear of the disc frames are lowered.

Each spacer that is added to the cylinders raises the frame height by ½". Therefore, to lower discs deeper into the soil, you would remove one spacer for each ½" of depth change required.

A typical recommended penetration depth of 2" is suggested for both front and rear discs. This depth, however, can be adjusted to the operators needs and preferences or based on different crop varieties and soil conditions.

Some operators may also prefer to adjust the front or rear frame disc sections to run slightly higher than the other. Adjustments to the front or rear disc sections are done individually:

- Adjust the front disc height by adding/removing spacers to the two center section wheel cylinders.
- Adjust the rear disc height by adding/removing spacers to the two rear wing roller cylinders.

NOTE: As the discs wear with usage, the disc depth settings will also need to be adjusted accordingly.

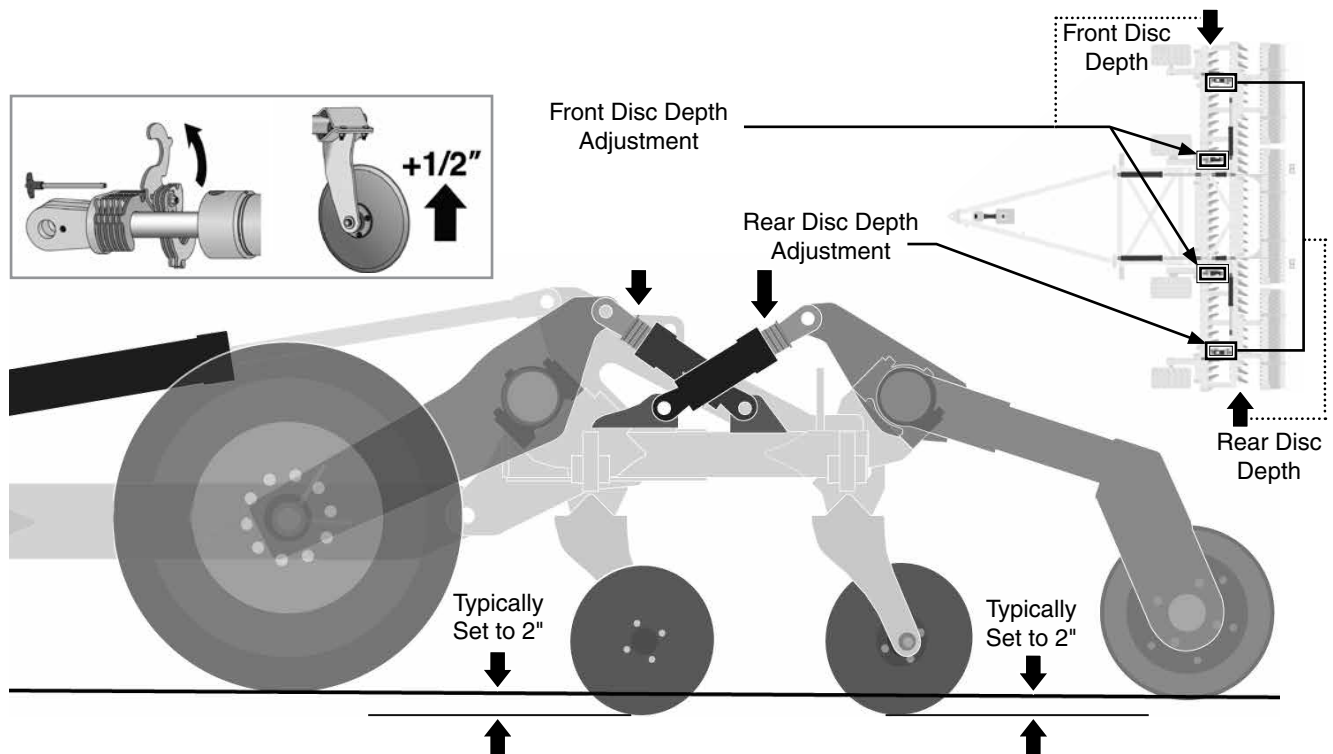

Use the following as a guideline for setting depth:

1. Drive the high-speed disc onto level ground. For initial setup, try “**12 Spacers**” on each cylinder stop.
2. Fully retract the Wheel and Roller cylinders to lower rear frame to ground.
3. Check the penetration depth of the front and rear row of discs. Take note of how much you would like to raise or lower both the front and rear disc sections - round to the nearest ½”.
4. Fully raise the frame back off the ground by extending the Wheel and Roller cylinders.
5. Adjust Front Disc height from the two center wheel cylinder positions.

Lower Front Discs - Remove one spacer for each ½” you want to **Lower** it.

Raise Front Discs - Add one spacer for each ½” you want to **Raise** it.

6. Adjust Rear Disc height from the two wing roller cylinders positions.

Lower Rear Discs - Remove one spacer for each ½” you want to **Lower** it.

Raise Rear Discs - Add one spacer for each ½” you want to **Raise** it.

7. Repeat above procedure until proper depth is achieved.

SETTING SCRAPER POSITION

Change into Storage Position:

- Loosen and remove the 4 bolts (2 per arm).
- Rotate section upward to new position.
- Reinstall bolts and tighten in place.
- Reverse procedure to put into working position.

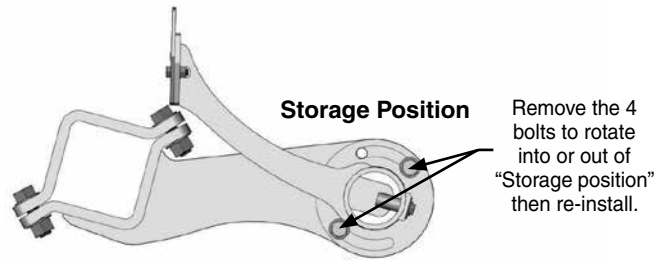

Change into Maintenance Position (from engaged):

- Loosen the 4 bolts (2 per arm).
- Rotate section upward until top hole is open.
- Tighten bolts to secure and/or insert bolt or insert pin (user supplied) into top hole to secure in position.

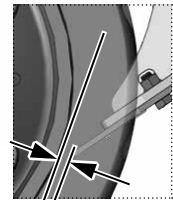
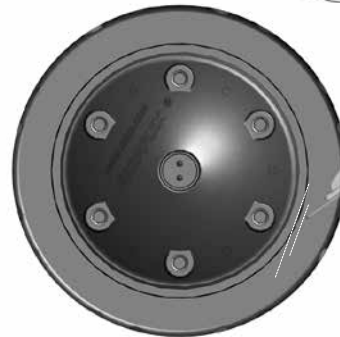
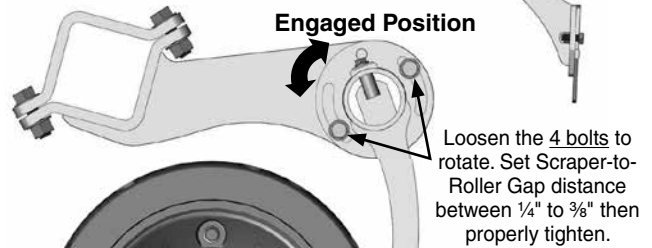
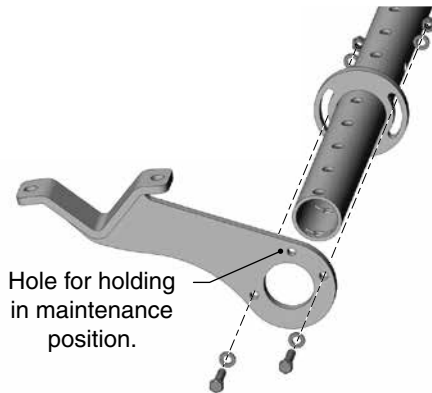
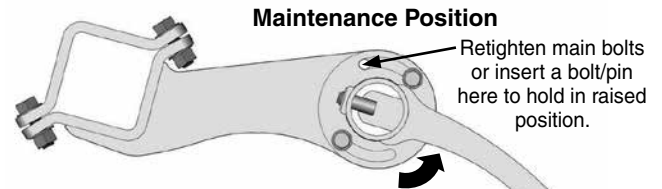

Gap Distance
1/4"-3/8"

Change into Engaged Position (from maintenance):

- Loosen the 4 bolts (2 per arm).
- Rotate section down until scraper blades are set to proper distance from inner roller groove. (1/4" to 3/8" is the recommended distance)
- Tighten bolts to secure in position.

SCRAPER SIDE-TO-SIDE POSITIONING

Inspect that the scraper plates are as close to centered as possible in the roller groove and that no scrapers are touching the sides of the rubber roller. (Ideally there should be a 1/4" gap)

If adjustment is needed, loosen the scraper arm clamps and adjust position until there is proper clearance on all edges. You may need to slightly adjust engagement distance if side-to-side is unsuccessful.

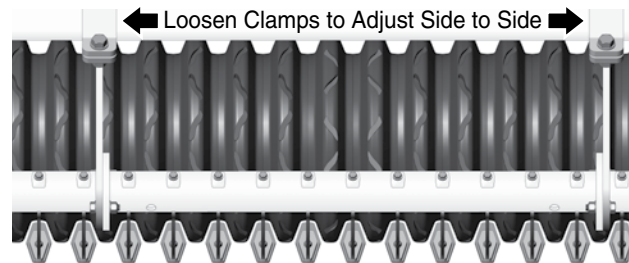
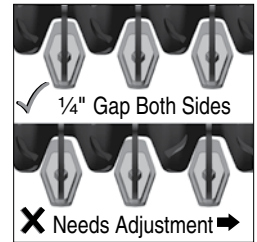

REVERSING SCRAPER BLADES

The scraper blades are designed to be reversible in order to provide extended wear. It is advised to reorder replacement blades soon after reversing to prevent possible downtime in the future.



Double Sided Scraper Blades

Note: When blades are being reversed, the complete section must be changed at the same time or adjustment will not work properly.

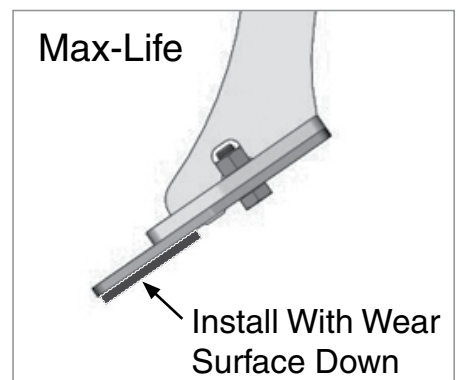
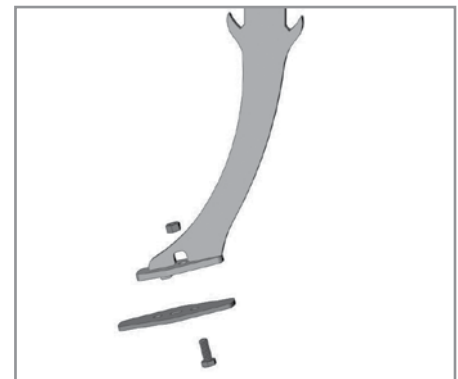

RIDGE WIPER COMPONENTS

Knocks down the possible ridge of dirt left from buildup in between the rollers.

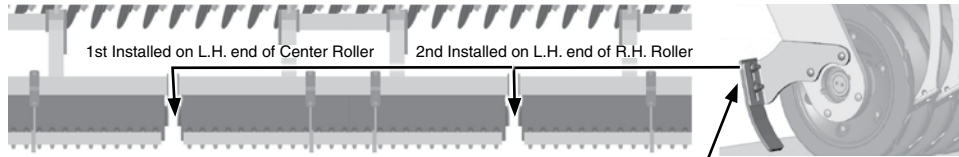

Initially set to highest setting as shown then adjust lower as necessary until desired results are achieved.
Note: Setting too low can result in a trench or possibly cause plugging.

DIRT DEFLECTOR ADJUSTMENT SETTINGS

NOTE: Adjustment to deflector height may need to be made according to soil penetration. Best setting is when deflector runs on the ground.

Deflector Setting when not Operating the Frame Level
 Note: If running nose up or nose down, adjust deflector accordingly.

DEFLECTOR HEIGHT PIN POSITIONS

P1 "S"
 P2 6"
 P3 4½"
 P4 3"
 P5 1½"

Front Frame Nose Up
 Level
 Front Frame - Nose Down

Nose Up Frame
 Level Frame (Typical)
 Nose Down Frame

P1 Storage Position

6" — P2
 4½" — P3
 3" — P4
 1½" — P5

RECOMMENDED PROCEDURE TO SET DEFLECTOR HEIGHT:

1. Run the machine with discs set to the proper depth.
2. Stop the machine.
3. Adjust the 5-sided pin to the height where the deflector is running on the ground.

WARNING

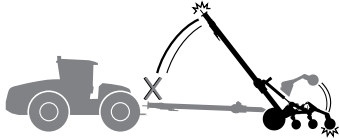

Never disconnect Mach Till from tractor if rear sections of machine are partially raised. Negative Hitch Weight may result, the hitch pole may suddenly raise and the rear section would come crashing down. Only disconnect when unit is on level ground in the proper transport or field position.

DANGER

NEGATIVE TONGUE WEIGHT ON HITCH
Can cause serious injury or death.

- Make certain that implement is securely hitched to the tractor at all times.
- Do not unhook implement from tractor unless it is in the proper field or transport position.



142963

DANGER

CRUSHING HAZARD
Can cause serious injury or death.

- Stay clear of this area.



142965

WARNING

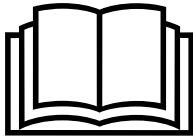

Improperly operating or working on this equipment could result in death or serious injury. Read and follow all instructions in Operator Manual before operating or working on this equipment.

WARNING



Explosive separation of rim and tire parts can cause death or serious injury. Overinflation, rim and tire servicing, improper use of rims and tires, or worn or improperly maintained tires could result in a tire explosion.

WARNING



Safely secure Mach Till in winged forward transport position when changing or servicing discs.

MAINTENANCE CHECKLIST

Use the Maintenance Checklist provided for regular service intervals and keep a record of all scheduled maintenance:

Note: Do NOT grease the spherical bearings

Maintenance Check - 10 Hours

- Hydraulic fluid leaks
- Damaged hoses
- Check tire pressure. See "Tire Pressures"
- Safety signs clean

Grease Points - 25 Hours

- Front Frame / Rockshaft Pins
- Wing Frame Pins
- Cylinder Pins

Grease Points - 50 Hours

- Wing Transport Roller Pins
- Hubs and Spindles
- Working points and pins

Annually

- Bolt tightness
- Wheel bearings

TIRE PRESSURE



WARNING

Explosive separation of rim and tire parts can cause death or serious injury. Overinflation, rim and tire servicing, improper use of rims and tires, or worn or improperly maintained tires could result in a tire explosion.



To prevent tire explosions:

- Maintain proper tire pressure. Inflating a tire above or below the recommended pressure can cause tire damage.
- Mount tires only by properly trained personnel using proper equipment.
- Replace tires with cuts or bubbles. Replace damaged rims. Replace missing lug bolts and nuts.
- Do not weld or heat wheel assembly. Heating increases tire pressure.

MACH TILL OPERATING TIRE PRESSURE

Outer Wing Tires (FL630 ULTRA)

600/50 R22.5: 58 PSI (400 kPa)

Center/Transport Tires (382 FLOTRUCK)

600/50 R22.5: 94 PSI (648 kPa)

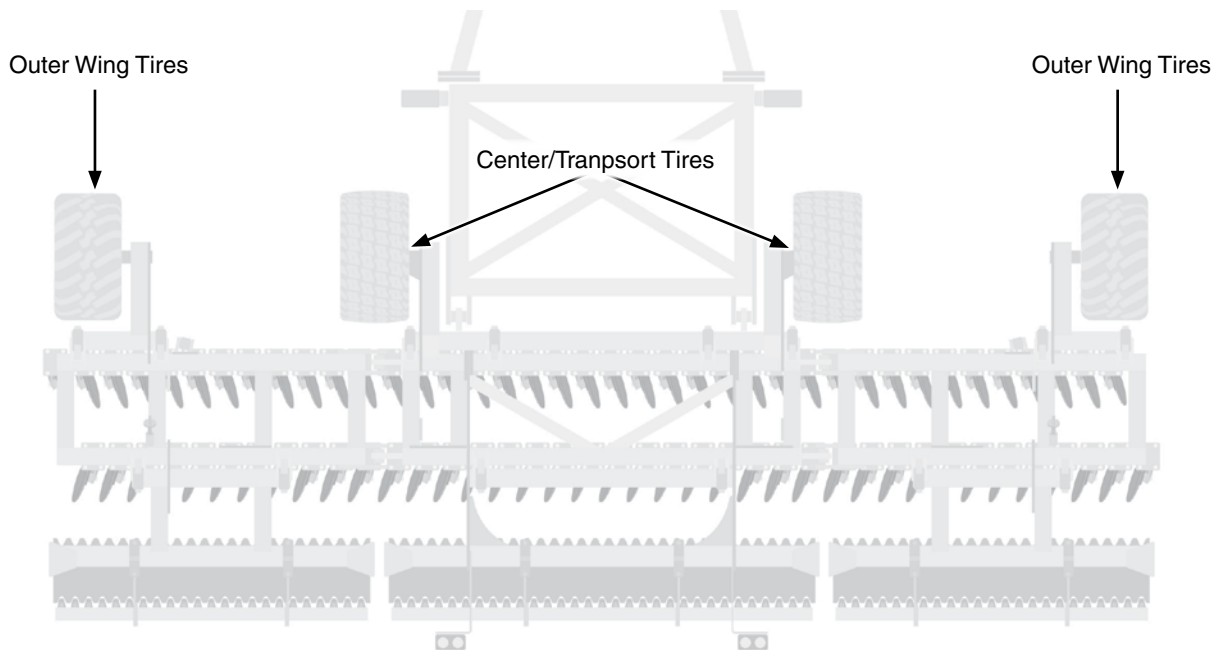

GREASE FITTINGS

Lubricate parts with grease fittings at frequency indicated with an SAE multipurpose grease. Also acceptable is an SAE multipurpose lithium. Clean fitting thoroughly before using grease gun. Frequency of lubrication recommended is based on normal operating conditions. Severe or unusual conditions may require more frequent attention.



Wing Frame Pins - 4 Pins Per Machine



Front Frame Pins - 2 Pins Per Machine



Wheel Hubs and Spindles - 1 Per Wheel
(4 on machine)

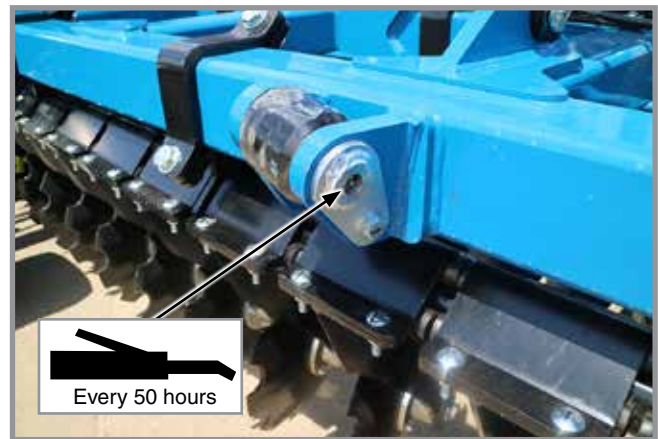

Wing Transport Roller Pins - 2 Pins Per Machine



Wheel Cylinders - 4 Pins Per Machine



Wing Cylinders - 4 Pins Per Machine



Roller Cylinders - 8 Pins Per Machine

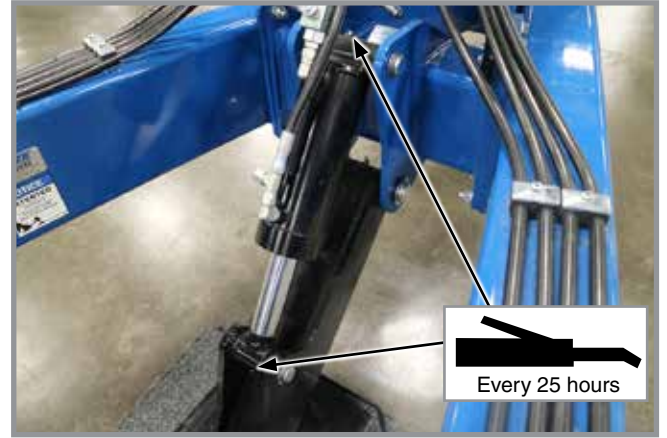

Jack Cylinder - 2 Pins

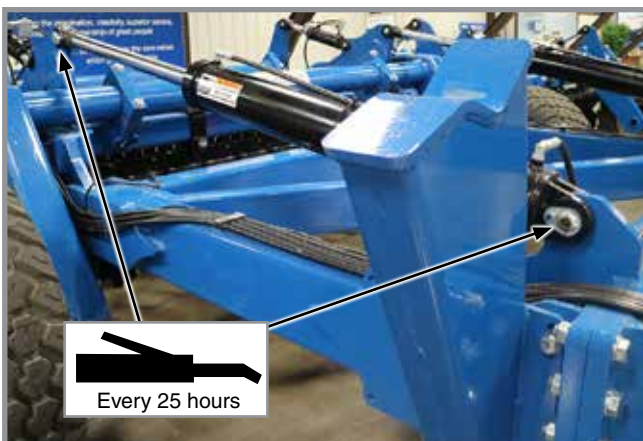

Transport Cylinders - 4 Pins Per Machine

STANDARD DISC REPLACEMENT

Standard Disc Size	Wear Limit
18"	14½"
20"	16½"

This page left blank intentionally.

WHEEL BEARINGS

All wheel bearings should be repacked annually and checked for wear.

1. Raise wheel off ground.
2. Check for bearing endplay by moving wheel side to side.
3. Rotate wheel to check for bearing roughness. If bearings sound rough, remove hub and inspect bearings.

NOTE: To repack wheel hubs, follow procedure outlined for wheel bearing replacement with exception that bearings and bearing cups are reused.

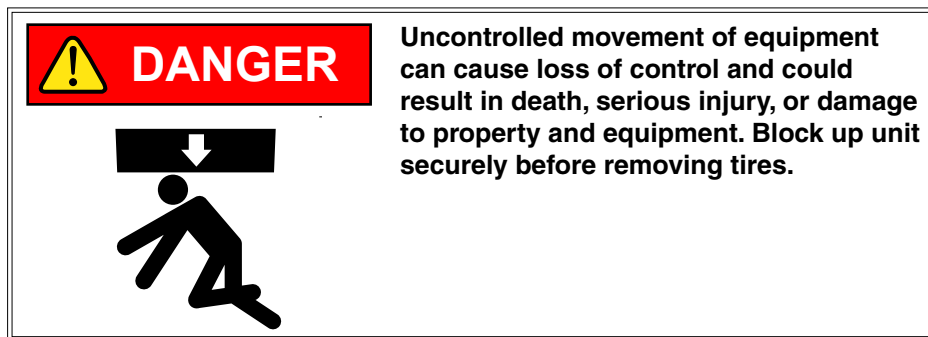

WHEEL BEARING REPACK OR REPLACEMENT

1. Raise tire clear of ground and remove wheel.
2. Remove double jam nuts and slide hub from spindle.
3. Remove bearings and cups and discard if bearings are being replaced. Clean hub and dry. Remove bearings only and not cups if repacking.
4. Press in new bearing cups with thickest edge facing in. (Bearing replacement procedure only.)
5. Pack bearings with heavy duty wheel bearing grease thoroughly forcing grease between roller cone and bearing cage. Fill space between bearing cups and hub with grease.
6. Place inner bearing in place.
7. Clean spindle and install hub.
8. Install outer bearing and jam nut. Tighten jam nut while rotating hub until there is some drag. This ensures all bearing surfaces are in contact. Back off jam nut $\frac{1}{4}$ turn or until there is only slight drag when rotating hub. Install second jam nut to lock against first.
9. Install wheel on hub. Tighten hardware evenly.

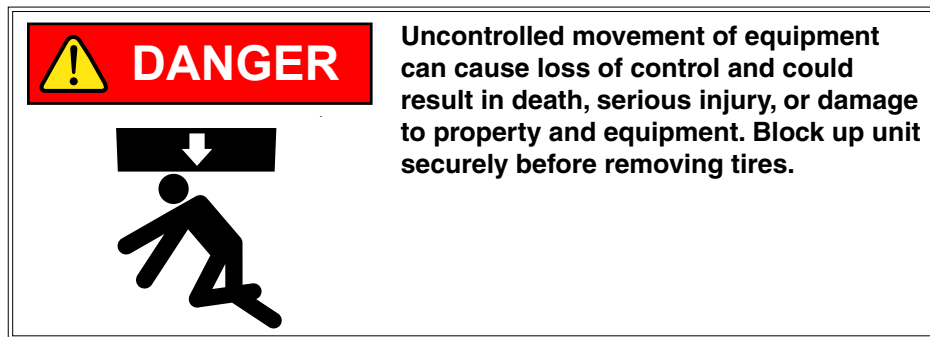

WHEEL HUB REPAIR

DISASSEMBLY

1. Remove dust cap.
2. Remove cotter pin from nut.
3. Remove nut and washer.
4. Pull hub off spindle.
5. Dislodge the inner cone bearing and dust seal.
6. Inspect cups that are press fitted into hub for pits or corrosion and remove if necessary.
7. Inspect and replace defective parts with new ones.

ASSEMBLY

1. If cups need replacing, be careful to install them gently and evenly into hub until they are fully seated.
2. Apply a thick wall of grease inside hub. Pack grease in cones.
3. Install inner cone and dust seal as illustrated.
4. Position hub onto spindle and fill surrounding cavity with grease.
5. Assemble outer cone, washer and nut.
6. Tighten nut while rotating hub until there is a slight drag.
7. Turn nut back approximately 1/2 turn to align cotter pin hole with notches on nut.
8. Install cotter pin and bend legs sideways over nut.
9. Fill dust cap half full of grease and gently tap into position.
10. Pump grease into hub through grease fitting until lubricant can be seen from dust seal.

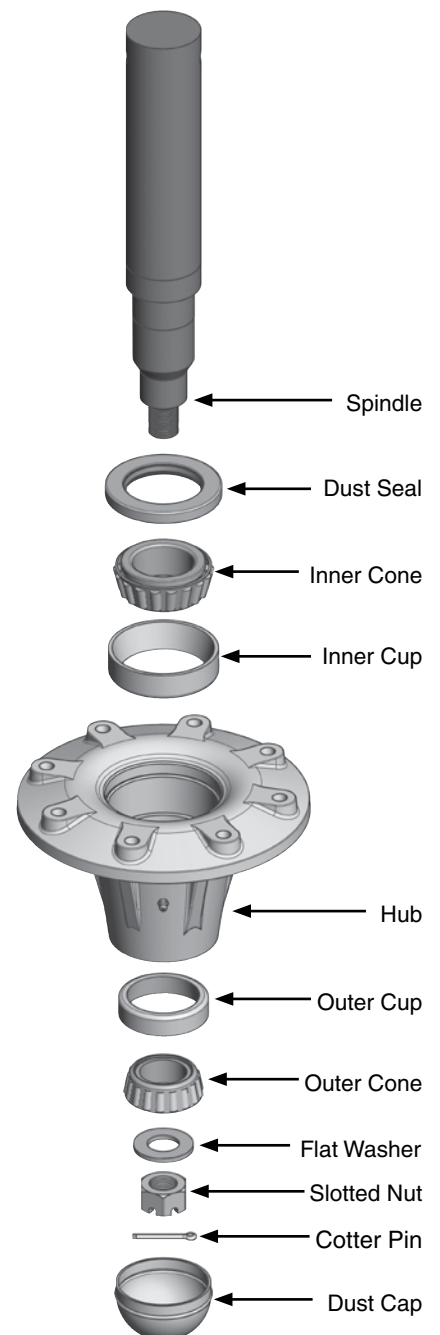

MOUNTING BOLTS AND HARDWARE

Before operating Mach Till for the first time, check all hardware is tight. Check all hardware again after first 50 hours of operation and beginning of each season.

All hardware used is typically: Hex, Plated GR8 UNC or P8.8 (metric).

The tables below give correct torque values for various bolts and capscrew. Tighten all bolts to the torques specified in chart unless otherwise noted. Check the tightness of bolts periodically, using these bolt torque charts as a guide. Replace hardware with the same strength (Grade/Class) bolt.

WARNING



Loose transport wheel lug bolts can result in wheel separation from Mach Till and cause death, serious injury, and damage to property and equipment. Torque transport wheel 5/8"- 18 lug bolts to 180 ft-lb (244 N-m) before operating Mach Till for the first time and periodically after.

NOTICE

Over-tightening hardware can reduce its shock load capacity and cause equipment failure.

Wheel Nut and Wheel Bolt Torque	
Bolt Patterns	
<p>5 BOLT PATTERN</p>	<p>6 BOLT PATTERN</p>
<p>8 BOLT PATTERN</p>	<p>10 BOLT PATTERN</p>
Wheel Nut/Bolt Torque	
Size	lb. ft. (Nm)
9/16"	120-130 ft. lb. (165-175 Nm)
5/8"	185-190 ft. lb. (250-260 Nm)
3/4"	280-300 ft. lb. (380-405 Nm)
<p>Wheel Tightening Procedure:</p> <ol style="list-style-type: none"> 1. Install and hand tighten nuts/bolts. 2. Tighten to approx. 20% Torque value using the Bolt Star or CrissCross patterns shown above. 3. Tighten to Full Torque value using the Star or CrissCross pattern. 4. If applicable, install Rear Locknuts using Wheel Torque Values. 	

IMPERIAL TORQUE VALUES CHART - PLATED HARDWARE

Diameter	Grade 2 (No marks) 		Grade 5 (3 marks) 		Grade 8 (6 marks) 	
	Coarse	Fine	Coarse	Fine	Coarse	Fine
1/4"	50 in-lb	56 in-lb	76 in-lb	87 in-lb	9 ft-lb	10 ft-lb
5/16"	8 ft-lb	9 ft-lb	13 ft-lb	14 ft-lb	18 ft-lb	20 ft-lb
3/8"	15 ft-lb	17 ft-lb	23 ft-lb	26 ft-lb	33 ft-lb	37 ft-lb
7/16"	25 ft-lb	27 ft-lb	37 ft-lb	41 ft-lb	52 ft-lb	58 ft-lb
1/2"	35 ft-lb	40 ft-lb	57 ft-lb	64 ft-lb	80 ft-lb	90 ft-lb
9/16"	50 ft-lb	60 ft-lb	80 ft-lb	90 ft-lb	115 ft-lb	130 ft-lb
5/8"	70 ft-lb	80 ft-lb	110 ft-lb	125 ft-lb	160 ft-lb	180 ft-lb
3/4"	130 ft-lb	145 ft-lb	200 ft-lb	220 ft-lb	280 ft-lb	315 ft-lb
7/8"	125 ft-lb	140 ft-lb	320 ft-lb	350 ft-lb	450 ft-lb	500 ft-lb
1"	190 ft-lb	205 ft-lb	480 ft-lb	530 ft-lb	675 ft-lb	750 ft-lb
1 1/8"	265 ft-lb	300 ft-lb	600 ft-lb	670 ft-lb	960 ft-lb	1075 ft-lb
1 1/4"	375 ft-lb	415 ft-lb	840 ft-lb	930 ft-lb	1360 ft-lb	1500 ft-lb
1 3/8"	490 ft-lb	560 ft-lb	1100 ft-lb	1250 ft-lb	1780 ft-lb	2030 ft-lb
1 1/2"	650 ft-lb	730 ft-lb	1450 ft-lb	1650 ft-lb	2307 ft-lb	2670 ft-lb

NOTE: Torque unplated hardware and bolts with lock nuts approximately 1/3 higher than above values. Torque bolts lubricated prior to installation to 70% of value shown in chart.

METRIC TORQUE VALUES CHART - PLATED HARDWARE

Dimension x P (Pitch)	Thread - Nut Contact Force Fv [N]					Torque MA [Nm]				
	4.6	5.6	8.8	10.9	12.9	4.6	5.6	8.8	10.9	12.9
M 4 x 0,7	1,280	1,710	4,300	6,300	7,400	1.02	1.37	3.3	4.8	5.6
M 5 x 0,8	2,100	2,790	7,000	10,300	12,000	2	2.7	6.5	9.5	11.2
M 6 x 1,0	2,960	3,940	9,900	14,500	17,000	3.5	4.6	11.3	16.5	19.3
M 8 x 1,25	5,420	7,230	18,100	26,600	31,100	8.4	11	27.3	40.1	46.9
M 10 x 1,5	8,640	11,500	28,800	42,200	49,400	17	22	54	79	93
M 12 x 1,75	12,600	16,800	41,900	61,500	72,000	29	39	93	137	160
M 14 x 2,0	17,300	23,100	57,500	84,400	98,800	46	62	148	218	255
M 16 x 2,0	23,800	31,700	78,800	115,700	135,400	71	95	230	338	395
M 18 x 2,5	28,900	38,600	99,000	141,000	165,000	97	130	329	469	549
M 20 x 2,5	37,200	49,600	127,000	181,000	212,000	138	184	464	661	773
M 22 x 2,5	46,500	62,000	158,000	225,000	264,000	186	250	634	904	1,057
M 24 x 3,0	53,600	71,400	183,000	260,000	305,000	235	315	798	1,136	1,329
M 27 x 3,0	70,600	94,100	240,000	342,000	400,000	350	470	1,176	1,674	1,959
M 30 x 3,5	85,700	114,500	292,000	416,000	487,000	475	635	1,597	2,274	2,662
M 33 x 3,5	107,000	142,500	363,888	517,000	605,000	645	865	2,161	3,078	3,601
M 36 x 4,0	125,500	167,500	427,000	608,000	711,000	1,080	1,440	2,778	3,957	4,631
M 39 x 4,0	151,000	201,000	512,000	729,000	853,000	1,330	1,780	3,597	5,123	5,994

NOTE: This table is for Torque and Thread - Nut contract forces for metric threads when conditional yield strength is 0.2% and physical yield strength is utilized at 90%

PREPARING DISC FOR STORAGE

The high-speed disc should be carefully prepared for storage to ensure that all dirt, mud, debris, and moisture has been removed.

Follow this procedure when preparing to store:

1. Wash the entire machine thoroughly using a water hose or pressure washer to remove all dirt, mud, debris or residue.
2. Inspect all parts to see if anything has become entangled in them. Remove entangled material.
3. Lubricate all grease fittings to remove moisture (except spherical bearings).
4. Inspect all hydraulic hoses, fittings, lines and couplers. Tighten any loose fittings. Replace any hose that is badly cut, nicked or abraded or is separating from the crimped end of the fitting.
5. Touch up all paint nicks and scratches to prevent rusting.
6. Select an area that is dry, level and free of debris.
7. Store in either Transport or Field position.
8. Use hydraulic cylinder jack.
9. Oil any exposed chrome shafts on the hydraulic cylinders to prevent rusting.

HYDRAULIC HOSE LIFE

WARNING

Pressurized hydraulic fluid can penetrate body tissue and result in death, serious infection, or other injuries. Fluid injected under skin must be **IMMEDIATELY** removed by a surgeon familiar with this type of injury. Make sure connections are tight and hoses and fittings are not damaged before applying system pressure. Leaks can be invisible. Keep away from suspected leaks. Relieve pressure before searching for leaks or performing any system maintenance.



Proper storage of hydraulic hoses can significantly increase the life of the hoses, for a period of three to five years. After this period, service life of hoses may decrease, depending on variables such as variances in rubber materials and storage environment. Refer to the guidelines below for best practices when storing.

- Store in a clean, cool and dry area
- Avoid direct sunlight or moisture
- Do not store near high power electrical equipment
- Avoid contact with corrosive chemicals
- Avoid ultraviolet light
- Avoid areas with obvious signs of insects or rodents

Unusually long periods of storage or poor storage environment may lead to performance issues or premature failure. Always inspect all hoses prior to use for extensive wear, cuts, or holes. If such flaws are identified, replace immediately to avoid potential failure, property damage or bodily injury.

HYDRAULIC JACK

NOTE: Close the ball valve to prevent accidental operation of this circuit. Ensure ball valve handle remains in closed position.

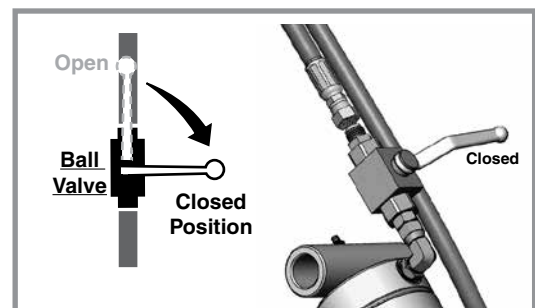

NOTICE	Wipe hose ends to remove any dirt before connecting couplers to tractor ports or contamination may cause equipment failure.
---------------	--

Hydraulic Fitting Installation

The following info is to help you identify and properly install some of our standard hydraulic fittings.

SAE (JIC) 37° Flare

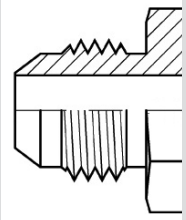
	Dash	Thread Size	Torque - ft. lb. (Nm)
	-4	7/16-20	9-12 ft. lb. (12-16 Nm)
	-6	9/16-18	14-20 ft. lb. (19-27 Nm)
	-8	3/4-16	27-39 ft. lb. (37-53 Nm)
	-10	7/8-14	36-63 ft. lb. (50-85 Nm)
	-12	1 1/16-12	65-88 ft. lb. (90-119 Nm)

ORFS (O-Ring Face Seal)

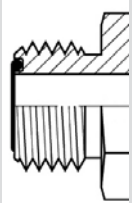
	Dash	Thread Size	Torque - ft. lb. (Nm)
	-4	9/16-18	18 ft. lb. (25 Nm)
	-6	1 1/16-16	30 ft. lb. (40 Nm)
	-8	1 3/16-16	40 ft. lb. (55 Nm)
	-10	1-14	60 ft. lb. (80 Nm)
	-12	1 3/16-12	85 ft. lb. (115 Nm)

ORB (O-Ring Boss)

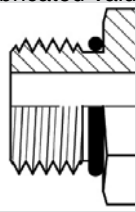
	(Lubricated Values)	Dash	Thread Size	Torque Non-Adjustable ft. lb. (Nm)	Torque Adjustable ft. lb. (Nm)
		-4	7/16-20	30 lb. ft. (40 Nm)	15 lb. ft. (20)
		-6	9/16-18	35 lb. ft. (46 Nm)	35 lb. ft. (46)
		-8	3/4-16	60 lb. ft. (80 Nm)	60 lb. ft. (80)
		-10	7/8-14	100 lb. ft. (135 Nm)	100 lb. ft. (135)
		-12	1 1/16-12	135 lb. ft. (185 Nm)	135 lb. ft. (185)

HYDRAULIC SCHEMATIC - WHEELS

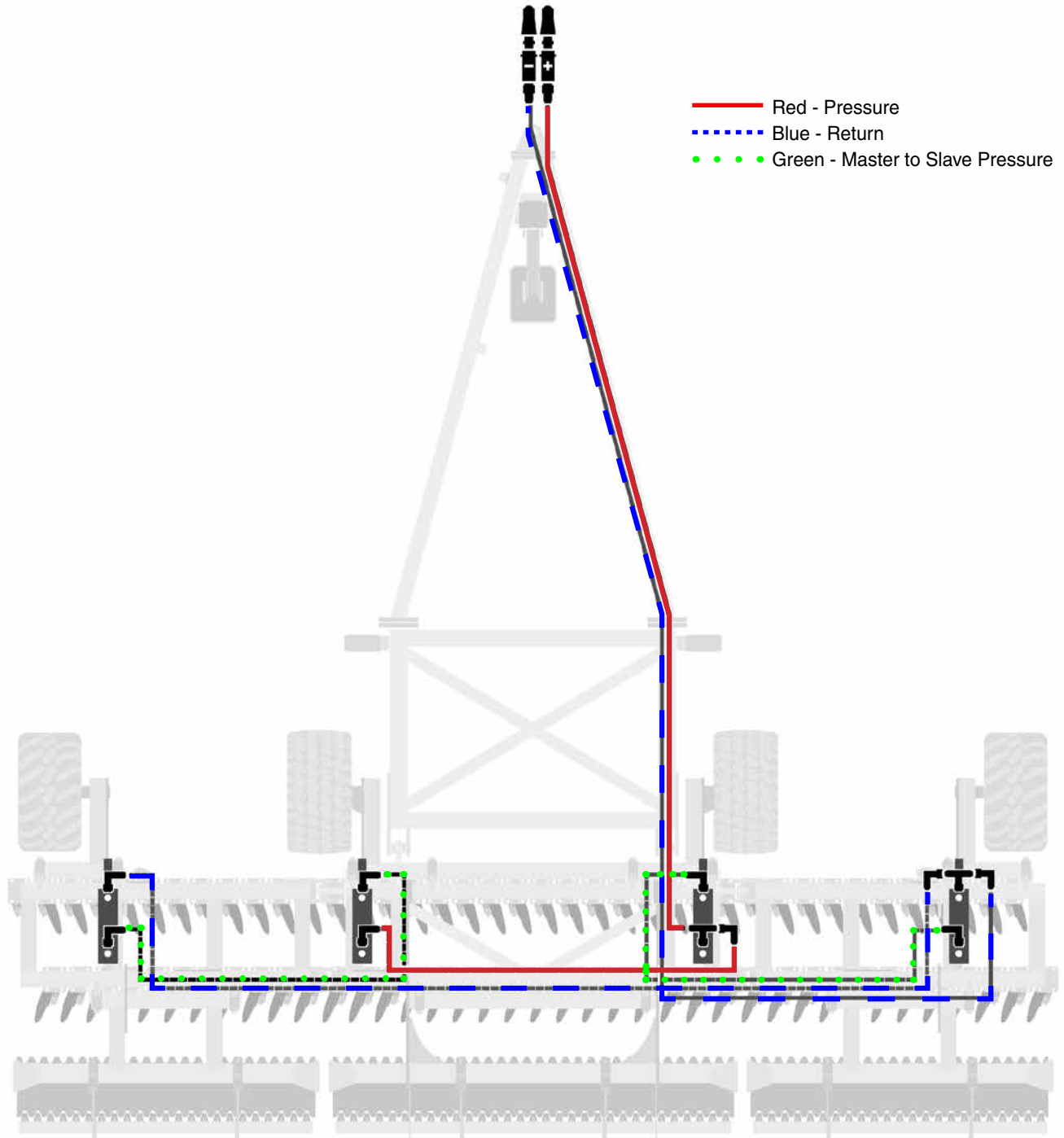

HYDRAULIC SCHEMATIC - ROLLERS

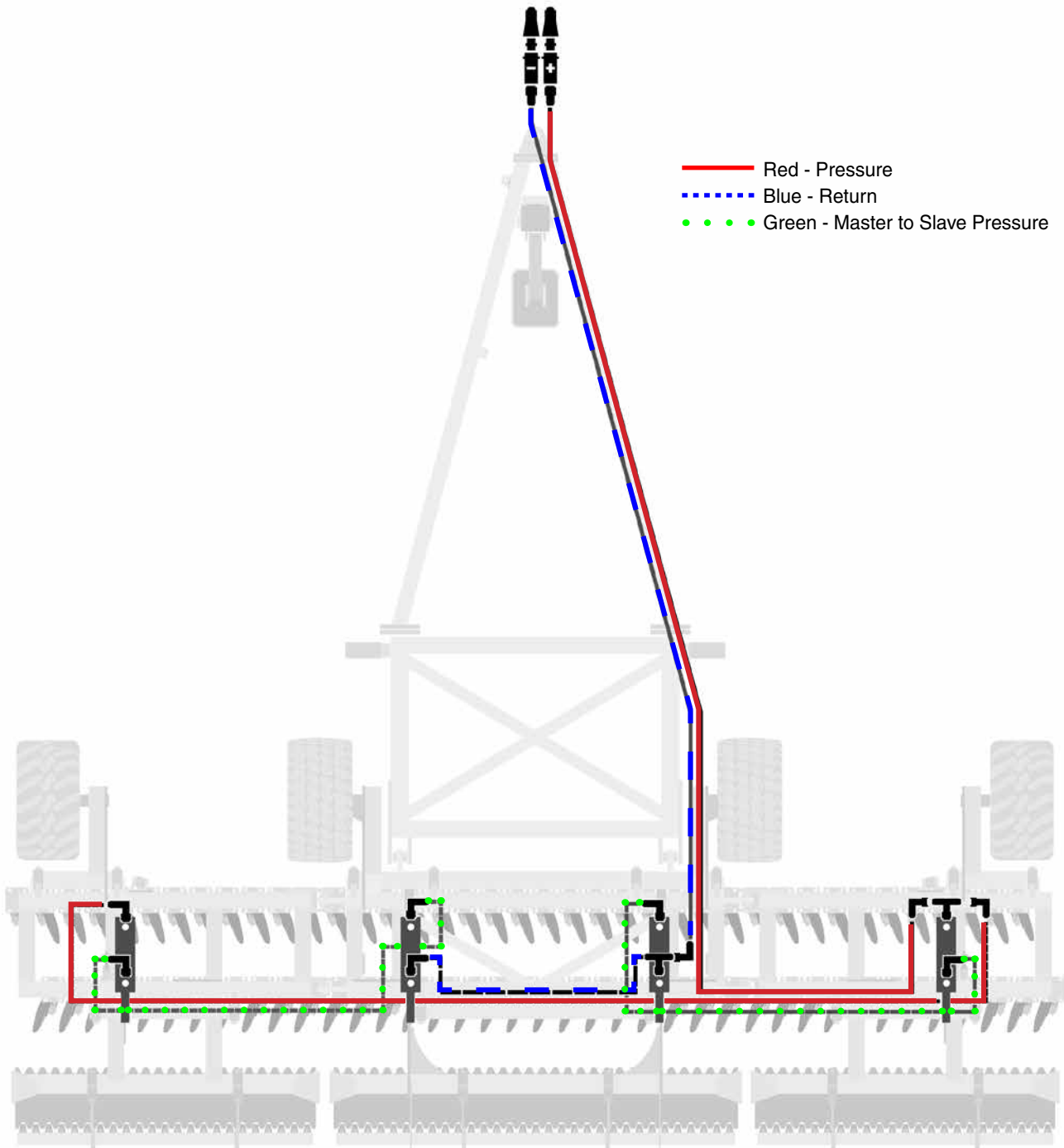

PROBLEM:	Plugging disc rows in wet conditions
	Ensure roller is turning and scrapers are set properly.
	Raise machine working depth.
	Increase operating speed slightly.
	Adjust pitch so front discs are slightly higher (add one more depth stop plate to wheel cylinders).
	Fully extend wheel and roller depth cylinders and hold for 30 seconds to re-phase.
	Check condition and operation of disc hubs (make sure they turn freely).
	Wait for soil conditions to dry out more.
PROBLEM:	Roller skidding in wet conditions
	Check scraper operation and settings.
	Raise machine working depth.
	Adjust pitch so rear discs are slightly higher and raise machine working depth.
	Momentarily take out of float and extend transport cylinders to simulate a rigid hitch (flat ground only). Re-engage float as soon as possible to avoid possible equipment damage.
	Wait for soil conditions to dry out more.
	Check condition and operation of bearings on both ends of the rollers.
PROBLEM:	Mud not clearing from rubber rollers
	Check scraper to roller distance and adjust if necessary (scraper should be ¼" to ⅜" from roller).
	Check scraper plate wear and adjust or replace as necessary (replace all scrapers per row at the same time).
	Check scraper row adjustment for slippage and re-torque or replace hardware if necessary.
PROBLEM:	Roller plugged in wet conditions
	Retract transport cylinders to pass over pushed up mound and smooth out when soil dries.
	Raise discs all the way up and drive 12-14 mph (19-22 km/h) on firm soil to clear rollers.
	In certain wet soil conditions place scrapers in storage position to continue operating.
	If plugging persists wait for soil conditions to dry out even more.
PROBLEM:	Rear discs or roller not engaging in very hard soil
	Adjust pitch so front discs are higher by adding two depth stops or more to wheel cylinders only (It may be necessary to lower overall machine depth also).
	Momentarily take out of float and extend transport cylinders to simulate a rigid hitch (flat ground only). Re-engage float as soon as possible to avoid possible equipment damage.

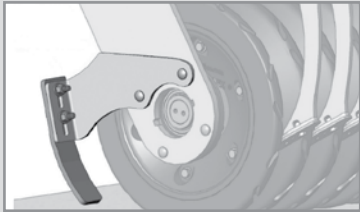
<p>PROBLEM: Not folding up for transport</p>	<p>Ensure hydraulic coupler has not disengaged or try a different tractor hydraulic port.</p> <p>Check for hose or fitting leaks.</p> <p>Tractor hydraulic system should have 2800 psi (19305 kPa).</p> <p>Hydraulic fluid bypassing piston seals in one or both hydraulic cylinders. (Replace cylinder or re-build with new seals).</p> <p>Excessive mud built up on frame and rollers. Clear off frame raise discs all the way up and drive 12-14 mph (19-22 km/h) on firm soil to clear rollers.</p>
<p>PROBLEM: Restriction or blocking on right side</p>	<p>Raise the deflector plate.</p> <p>Raise working depth of adjustable disc.</p> <p>Raise machine working depth.</p> <p>Reduce operating speed slightly.</p> <p>Extend right hand wheel adjustment to lift end of wing.</p> <p>Check condition and operation of disc hubs (make sure they turn freely).</p> <p>Wait for soil conditions to dry out more.</p>
<p>PROBLEM: Leaving a ridge or a groove between rollers</p> 	<p>Adjust ridge wiper down slightly to remove ridge.</p> <p>Adjust ridge wiper up slightly to eliminate groove.</p>
<p>PROBLEM: Subsoil leaving a groove every 10"</p>	<p>Adjust pitch to level machine (disc rows are not set to the same depth).</p> <p>Adjust pitch to lower rear disc row (front is prone to running deeper with floating hitch and firm soil conditions).</p> <p>Rear discs following in front disc groove (see troubleshooting for this below).</p>
<p>PROBLEM: End of wing discs cutting deeper or shallower than center</p>	<p>Fully extend wheel and roller depth cylinders and hold for 30 seconds to re-phase.</p> <p>Extend wheel adjustment to lift end of wing if cutting deeper.</p> <p>Retract wheel adjustment to lower end of wing if cutting shallower.</p> <p>Check for same number of depth control plates used on each side.</p>

PROBLEM:	Rear discs following in front disc cut or discs not doing a full cut		
	Adjust tracking by changing implement pitch.		
	Adjust entire front row in small increments either left or right to achieve full cut.		
	Check disc wear and adjust gang spacing or replace discs as necessary (as discs wear move front row right).		
	Check factory settings on disc row locations to verify gang clamp hardware is tight and clamps have not slipped.		
	Adjust GPS to actual cutting width minus 6" (15 cm) overlap per side depending on working depth.		
	(with 20" discs)	2" Depth	MAX Depth
	Mach Till 331	32'-6" (9.9m)	32'-8" (10m)
	Mach Till 401	39'-2" (11.9m)	39'-5" (12m)

PROBLEM:	Leaving a ridge or a groove between passes		
	Adjust deflector up to reduce ridge.		
	Adjust deflector down to fill groove.		
	Set right rear adjustable disc lower if there is a ridge.		
	Set right rear adjustable disc higher if there is a groove.		
	Check that end disc size configuration matches factory suggested setup.		
	Reduce implement width on guidance for slightly more overlap.		

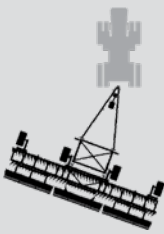
PROBLEM:	Tracking to the left		
	Add a depth stop to wheel cylinders to adjust the pitch so the front disc is higher.		
	Reduce implement width on guidance system for slightly more overlap.		
	Adjust implement offset on guidance system to the right.		

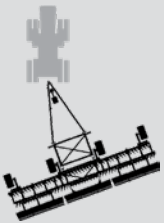
PROBLEM:	Tracking to the right		
	Add a depth stop to roller cylinders to adjust the pitch so the rear disc is higher.		
	Reduce implement width on guidance system for slightly more overlap.		
	Adjust implement offset on guidance system to the left.		

PROBLEM:	Hopping or leaving waves:
	Change operating speed (best performance is achieved over 10 mph (16 kmh)).
	Change field working angle (best finishing at 5 to 15 degrees off previously worked).
	Adjust working depth (deeper and run slower or shallower to run faster).
	Pre-work heavy trash or wet areas at a slower speed and at a different angle than final pass.
	Wait for soil conditions to dry out more.