

TRUE SPEED
(High Speed Seed Delivery)

OPERATOR MANUAL

M0308

Rev. 3/22

This page left blank intentionally.

OVERVIEW	3
Table of Contents	3
To the Owner	4
General Safety Rules	6
Safety Messages	7
Warranty	8
Overview	9
ROW UNIT OPERATION	11
Meter Settings	11
Vacuum Settings Charts	13
Split Row vacuum plug	22
High Speed Seed Meter Cover Removal	22
Additives	24
Bayer Fluency Agent	25
MAINTENANCE	26
Vacuum High Speed Seed Meter Maintenance	26
Vacuum High Speed Seed Meter Cleanout	27
Delivery Tube Maintenance	28
Maintenance Chart	31
Preparation For Storage	33
TROUBLESHOOTING	34
High Speed Seed Meter	34
Seed Sensor Color Scheme	36

It is the responsibility of the user to read and understand the Operator Manual in regards to safety, operation, lubrication and maintenance before operation of this equipment. It is the user's responsibility to inspect and service the machine routinely as directed in the Operator Manual. We have attempted to cover all areas of safety, operation, lubrication and maintenance; however, there may be times when special care must be taken to fit your conditions.

Throughout this manual the symbol  and the words **DANGER**, **WARNING**, and **CAUTION** are used to call attention to safety information that if not followed, will or could result in death or injury. **NOTICE** and **NOTE** are used to call your attention to important information. The definition of each of these terms follows:



Indicates an imminently hazardous situation that, if not avoided, will result in death or serious injury. This signal word is to be limited to the most extreme situations, typically for machine components which, for functional purposes, cannot be guarded.



Indicates a potentially hazardous situation that, if not avoided, could result in death or serious injury, and includes hazards that are exposed when guards are removed. It may also be used to alert against unsafe practices.



Indicates a potentially hazardous situation that, if not avoided, may result in minor or moderate injury. It may also be used to alert against unsafe practices.



Used to address safety practices not related to personal injury.

NOTE: Special point of information or machine adjustment instructions.

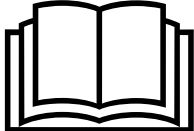
 WARNING	Improperly operating or working on this equipment could result in death or serious injury. Read and follow all instructions in Operator Manual before operating or working on this equipment.
	

 WARNING	Some photos in this manual may show safety covers, shields, or lockup devices removed for visual clarity. NEVER OPERATOR OR WORK ON machine without all safety covers, shields, and lockup device in place as required.
--	--

NOTE: Some photos in this manual may have been taken of prototype machines. Production machines may vary in appearance.



NOTE: Some photos and illustrations in this manual show optional attachments installed. Contact your Kinze Dealer for purchase of optional attachments.

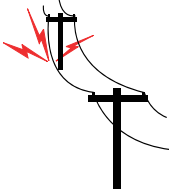

1. Read and understand instructions provided in this manual and warning labels. Review these instructions frequently!
2. This machine is designed and built with your safety in mind. Do not make any alterations or changes to this machine. Any alteration to design or construction may create safety hazards.
3. A large portion of farm accidents happen from fatigue or carelessness. Safe and careful operation of tractor and planter will help prevent accidents.
4. Never allow planter to be operated by anyone unfamiliar with operation of all functions of the unit. Operators must read and thoroughly understand all instructions given in this manual before operating or working on equipment.
5. Be aware of bystanders, particularly children! Always look around to make sure it is safe to start tow vehicle engine or move planter. This is particularly important with higher noise levels and quiet cabs, as you may not hear people shouting.
6. Make sure planter weight does not exceed towing capacity of tractor, or bridge and road limits. This is critical to maintain safe control and prevent death or injury, or property and equipment damage.
7. Never ride or allow others to ride on planter.
8. Store planter in an area away from human activity. DO NOT permit children to play on or around the stored unit.
9. Keep hands, feet, and clothing away from moving parts. Do not wear loose-fitting clothing which may catch in moving parts.
10. Always wear protective clothing, shoes, gloves, hearing, and eye protection applicable for the situation.
11. Do not allow anyone to stand between tongue or hitch and towing vehicle when backing up to planter.
13. Prevent electrocution, other injuries, or property and equipment damage. Watch for obstructions such as wires, tree limbs, etc. when operating machine. Be aware of clearances during turns and when folding/unfolding planter.
14. Reinstall all guards removed for maintenance activities. Never leave guards off during operation.
15. Use of aftermarket hydraulic, electric, or PTO drives may create serious safety hazards to you and people nearby. If you install such drives, follow all appropriate safety standards and practices to protect you and others near this planter from injury.
16. Follow all federal, state/provincial, and local regulations when towing farm equipment on a public highway. Use safety chain (not an elastic or nylon/plastic tow strap) to retain connection between towing and towed machines in the event of primary attaching system separation.
17. Make sure all safety/warning lights, SMV sign, and reflective decals are in place and working properly before transporting the machine on public roads.
18. Limit towing speed to 15 MPH. Tow only with farm tractor of a minimum 90 HP. Allow for unit length when making turns.
19. Reduce speed prior to turns to avoid the risk of overturning. Always drive at a safe speed relative to local conditions and ensure your speed is slow enough for a safe emergency stop.
20. Chemical application is often an integral part of planting. Follow label instructions for proper chemical mixing, handling and container disposal methods.
21. Be familiar with safety procedures for immediate first aid should you accidentally contact chemical substances.
22. Use the proper protective clothing and safety equipment when handling chemicals.
23. Chemicals are supplied with Material Safety Data Sheets (MSDS) that provide full information about the chemical, its effects on exposure, and first aid needs in the event of an emergency. Keep your MSDS file up-to-date and available for first responders in case of emergency.
24. When servicing ground engaging components such as opening disks and firming points, use special care to avoid points and edges worn sharp during use.
25. Use professional help if you are unfamiliar with working on hydraulic systems. Pressurized hydraulic fluid can penetrate body tissue and result in death, serious infection, or other injuries.
26. Transporting planter with hoppers over half full or unevenly loaded can cause loss of control and could result in death, serious injury, or damage to property and equipment.

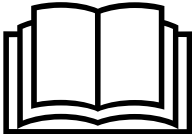
Following are some common hazard warnings associated with this equipment. Pay close attention to all safety, operating, and maintenance information in this manual and decals applied to your equipment.

 DANGER	Contacting or coming close to power lines or other high energy sources will cause death or serious injury.
	Keep away from power lines or high energy sources at all times.

 WARNING	Improperly operating or working on this equipment could result in death or serious injury. Read and follow all instructions in Operator Manual before operating or working on this equipment.
	

 WARNING	Falling equipment can cause death or serious injury. Install all lockup devices or lower planter to ground before working on equipment.
	

 WARNING	Explosive separation of rim and tire parts can cause death or serious injury. Overinflation, rim and tire servicing, improper use of rims and tires, or worn or improperly maintained tires could result in a tire explosion.
	

The Kinze Limited Warranty for your new machine is stated on the retail purchaser's copy of the Warranty And Delivery Receipt form. Additional copies of the Limited Warranty can be obtained through your Kinze Dealer.

Warranty, within the warranty period, is provided as part of Kinze's support program for registered Kinze products which have been operated and maintained as described in this manual. Evidence of equipment abuse or modification beyond original factory specifications will void the warranty. Normal maintenance, service and repair is not covered by Kinze warranty.

To register your Kinze product for warranty, a Warranty And Delivery Receipt form must be completed by the Kinze Dealer and signed by the retail purchaser, with copies to the Dealer, and to the retail purchaser. Registration must be completed and submitted to Kinze Manufacturing, Inc. within 5 business days of delivery of the Kinze product to the retail purchaser. Kinze Manufacturing, Inc. reserves the right to refuse warranty on serial numbered products which have not been properly registered.

If service or replacement of failed parts which are covered by the Limited Warranty are required, it is the user's responsibility to deliver the machine along with the retail purchaser's copy of the Warranty And Delivery Receipt to the Kinze Dealer for service. Kinze warranty does not include cost of travel time, mileage, hauling or labor. Any prior arrangement made between the Dealer and the retail purchaser in which the Dealer agrees to absorb all or part of this expense should be considered a courtesy to the retail purchaser.

Kinze warranty does not include cost of travel time, mileage, hauling, or labor.

Information in this manual was current at time of printing. However, due to Kinze's ongoing product improvement, production changes may cause your unit to appear slightly different in detail. Kinze Manufacturing, Inc. reserves the right to change specifications or design without notice and without incurring obligation to install the same on machines previously manufactured.

Right hand (R.H.) and left hand (L.H.), as used throughout this manual, are determined by facing the planter.

SAFETY SIGNS AND DECALS

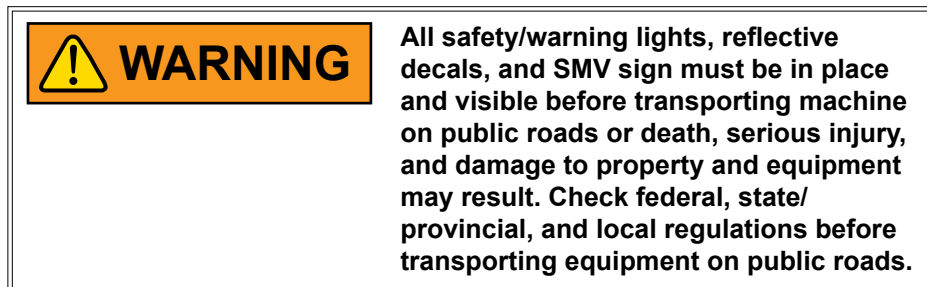

Safety signs and decals are placed on the machine to warn of hazards and provide important operating and maintenance instructions. Information on these signs are for your personal safety and the safety of those around you. **FOLLOW ALL SAFETY INSTRUCTIONS!**

- **Keep signs clean so they can be easily seen. Wash with soap and water or cleaning solution as required.**
- **Replace safety signs if damaged, painted over, or missing.**
- **Check reflective decals and SMV sign periodically. Replace if they show any loss of reflective properties.**
- **When replacing decals, clean machine surface thoroughly with soap and water or cleaning solution to remove all dirt and grease.**





NOTE: Safety sign and decal locations are shown in the Parts Manual for this machine.

NOTE: Style and locations of SMV sign, reflective decals, and safety/warning lights conform to ANSI/ASABE S279.14 JUL 2008 and ANSI/ASABE S276.6 JAN 2005.

Tools required

Hardware Size / Tool Required			
$1/4" = 7/16"$	$7/16" = 5/8"$ (nut for $7/16"$ hardware uses $11/16"$ tool)	$3/4" = 11/8"$	$11/4" = 17/8"$
$5/16" = 1/2"$	$1/2" = 3/4"$	$7/8" = 15/16"$	$11/2" = 21/4"$
$3/8" = 9/16"$	$5/8" = 15/16"$	$1" = 11/2"$	No. 6 = $1/4"$
No. 8 = $11/32"$			

METER SETTINGS

Crop - Seed Disc Part No. - ‡Seed Disc Kit	Ejector Wheel (color)	Baffle Setting	Seed Size Range	Population	Singulator Installed	Vacuum Setting Inches of Water	Lubricant
 Corn , 32 Cell (Light Blue) - P/N: G10347701 - Kit: 10892X	1 row 6 punches (Blue)	1	1140-2280 seeds/lb	15-40K sds/acre	Yes	*12 to 20 (See " Vacuum Settings Charts " on page 13)	Graphite† Talc† Bayer Fluency§ (If mandated)
 Soybean , 46 Cell (Black) - P/N: G10369101 - Kit: 10894X	1 row 8 punches (Black)	3	2200-4000 seeds/lb	All 15" and 20" Rows up to 130k sds/acre	No	*15 to 25 (See " Vacuum Settings Charts " on page 13)	Graphite† Talc† Bayer Fluency§ (If mandated)
 Soybean , 92 Cell (Black) - P/N: G10369001 - Kit: 10893X	2 rows 8 punches (Black)	3-5	2200-4000 seeds/lb	All 30" Rows 20" above 130k sds/ acre	No	*15 to 25 (See " Vacuum Settings Charts " on page 13)	Graphite† Talc† Bayer Fluency§ (If mandated)
 Cotton , 46 Cell (Green) - P/N: G10407701 - Kit: 10992X	1 row 8 punches (Green)	1	4000-6500 seeds/lb	20-75k	Yes	8-18 (See " Vacuum Settings Charts " on page 13)	Graphite† Talc† Bayer Fluency§ (If mandated)
 Sugar Beets/Milo , 46 Cell (Orange) - P/N: GB1303 - Kit: 10860X	1 row 8 punches (Orange)	1 Use Part Number G10407001 (Orange Door)	Milo: 10k-18k seeds/lb Sugarbeets: Pelletized	20-100k	Yes	Milo: 12 Sugarbeets: 15	Graphite† Talc† Bayer Fluency§ (If mandated)

Install selected seed disc and ejector.

***Use low vacuum for small seeds/slow speed and high vacuum for big seeds/high speed.**

†For more information on application rate, see Additives section.

‡Includes seed disc and ejector wheel.

§Bayer Fluency Agent is only required to be used in place of graphite or talc lubricants on vacuum equipped planters that are sowing neonicotinoid rated seeds in Canada. Refer to the Bayer Fluency Agent section for more information.

Continued on Next Page.

NOTE: See “Field Check Seed Population” on page --- for more information. Always field check seed population to ensure planting rates are correct.

NOTE: Baffle settings are marked from 1 – 5.

NOTE: Mixing seed sizes and shapes affects meter performance. Use consistent seed size and shape.

NOTE: Seed treatment, foreign material, dirt or seed chaff may cause gradual reduction of seed disc fill (population). See “Additives” pages for more information.

NOTE: Excessive seed treatment, humidity, and light-weight seed can affect meter performance. Use ½ cup of talc with each standard hopper fill of seed and mix thoroughly to coat all seeds and adjust rates as needed. Use of talc aids seed flow into meter, singulation and disc seed drop.

NOTE: Foreign material in seed disc orifices, such as seed chips, hulls, stems, etc., may affect seed delivery. Clean seed ensures accurate seed metering from vacuum seed meter. Remove Seed discs daily to check for buildup of foreign material in seed disc orifices.

See [“Vacuum High Speed Seed Meter Maintenance” on page 26](#) and [“Vacuum High Speed Seed Meter Cleanout” on page 27](#) in Lubrication and Maintenance section for more information.

VACUUM SETTINGS CHARTS

NOTE: Vacuum charts are a recommendation to help select the starting vacuum setting for a particular seed size and target planting speed. Due to variation in seed size, seed shape, and planting conditions, it is likely that additional adjustments in the vacuum setting may be necessary. Decrease vacuum from the listed setting if doubles or high population are displayed and increase vacuum if skips or low population are displayed.

Recommended Vac Chart for Corn Flat Seed Types

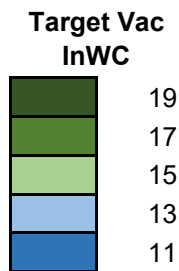
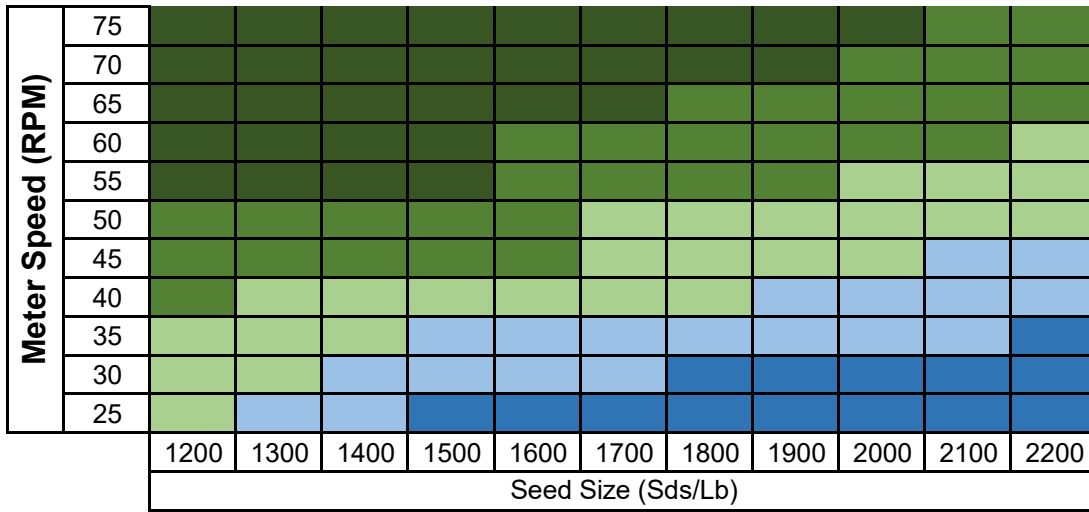

Recommended Vac Chart for Corn Round Seed Types

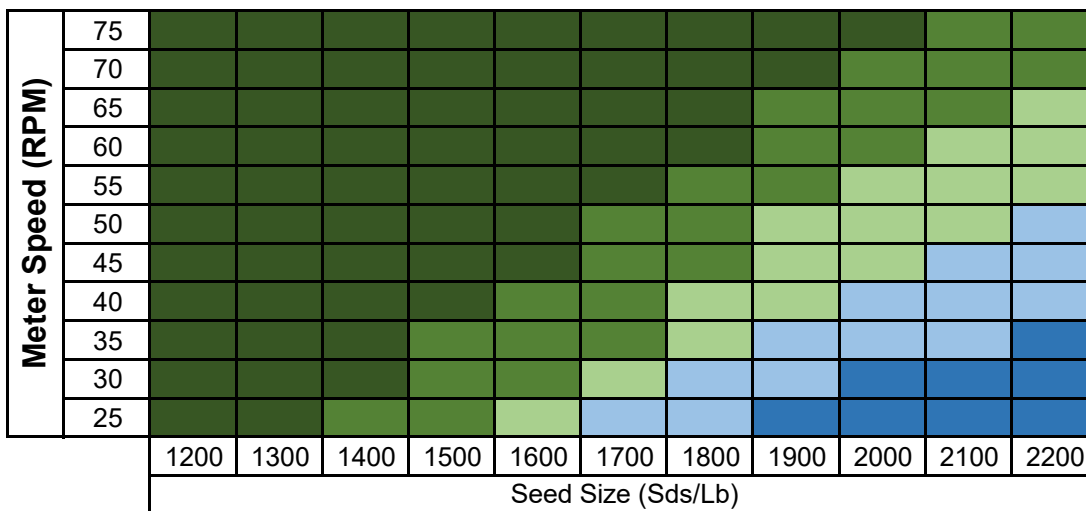

Recommended Vac Chart for Soybeans (Single Row and Dual Row)

Meter Speed (RPM)	95															
	90															
	85															
	80															
	75															
	70															
	65															
	60															
	55															
	50															
	45															
	40															
		2300	2350	2400	2450	2500	2550	2600	2650	2700	2750	2800	2850	2900	2950	3000
		Seed Size (Sds/Lb)														

**Target Vac
InWC**

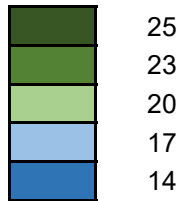

Recommended Vac Setting for Cotton

Meter Speed (RPM)	90										
	80										
	70										
	60										
	50										
	40										
	30										
	20										
			4250	4500	4750	5000	5250	5500	5750	6000	6250
Seed Size (Sds/lb)											

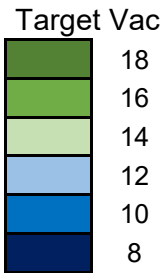

Meter Speed (20" Row Spacing 32 Cell Disc- Corn)

		Ground Speed (mph)										
		2	3	4	5	6	7	8	9	10	11	12
Population Setpoint (sds/ac.)	24000	5	8	10	13	15	18	20	23	25	28	30
	26000	5	8	11	14	16	19	22	25	27	30	33
	28000	6	9	12	15	18	21	24	27	29	32	35
	30000	6	9	13	16	19	22	25	28	32	35	38
	32000	7	10	13	17	20	24	27	30	34	37	40
	34000	7	11	14	18	21	25	29	32	36	39	43
	36000	8	11	15	19	23	27	30	34	38	42	45
	38000	8	12	16	20	24	28	32	36	40	44	48
	40000	8	13	17	21	25	29	34	38	42	46	51
	42000	9	13	18	22	27	31	35	40	44	49	53
	44000	9	14	19	23	28	32	37	42	46	51	56
	46000	10	15	19	24	29	34	39	44	48	53	58
	48000	10	15	20	25	30	35	40	45	51	56	61
	50000	11	16	21	26	32	37	42	47	53	58	63

Meter Speed (30" Row Spacing 32 Cell Disc- Corn)

		Ground Speed (mph)										
		2	3	4	5	6	7	8	9	10	11	12
Population Setpoint (sds/ac.)	24000	8	11	15	19	23	27	30	34	38	42	45
	26000	8	12	16	21	25	29	33	37	41	45	49
	28000	9	13	18	22	27	31	35	40	44	49	53
	30000	9	14	19	24	28	33	38	43	47	52	57
	32000	10	15	20	25	30	35	40	45	51	56	61
	34000	11	16	21	27	32	38	43	48	54	59	64
	36000	11	17	23	28	34	40	45	51	57	63	68
	38000	12	18	24	30	36	42	48	54	60	66	72
	40000	13	19	25	32	38	44	51	57	63	69	76
	42000	13	20	27	33	40	46	53	60	66	73	80
	44000	14	21	28	35	42	49	56	63	69	76	83
	46000	15	22	29	36	44	51	58	65	73	80	87
	48000	15	23	30	38	45	53	61	68	76	83	91
	50000	16	24	32	39	47	55	63	71	79	87	95

	Optimal Zone
	Low or high meter speed, may require vacuum adjustment
	Exceeding maximum meter speed, expect performance degradation

Meter Speed (20" Row Spacing 92 Cell Disc - Soybean)

		Target Ground Speed (mph)										
		2	3	4	5	6	7	8	9	10	11	12
Target Population (sds/ac)	80000	6	9	12	15	18	20	23	26	29	32	35
	85000	6	9	12	16	19	22	25	28	31	34	37
	90000	7	10	13	16	20	23	26	30	33	36	40
	95000	7	10	14	17	21	24	28	31	35	38	42
	100000	7	11	15	18	22	26	29	33	37	40	44
	105000	8	12	15	19	23	27	31	35	38	42	46
	110000	8	12	16	20	24	28	32	36	40	44	48
	115000	8	13	17	21	25	29	34	38	42	46	51
	120000	9	13	18	22	26	31	35	40	44	48	53
	125000	9	14	18	23	27	32	37	41	46	50	55
	130000	10	14	19	24	29	33	38	43	48	52	57
	135000	10	15	20	25	30	35	40	44	49	54	59
	140000	10	15	20	26	31	36	41	46	51	56	61
	145000	11	16	21	27	32	37	42	48	53	58	64
	150000	11	16	22	27	33	38	44	49	55	60	66
	155000	11	17	23	28	34	40	45	51	57	62	68
	160000	12	18	23	29	35	41	47	53	59	64	70
165000	12	18	24	30	36	42	48	54	60	66	72	
170000	12	19	25	31	37	44	50	56	62	68	75	
175000	13	19	26	32	38	45	51	58	64	70	77	
180000	13	20	26	33	40	46	53	59	66	72	79	

	Optimal Zone
	Low or high meter speed, may require vacuum adjustment
	Exceeding maximum meter speed, expect performance degradation

Meter Speed (30" Row Spacing 92 Cell Disc - Soybean)

		Target Ground Speed (mph)										
		2	3	4	5	6	7	8	9	10	11	12
Target Population (sds/ac)	80000	9	13	18	22	26	31	35	40	44	48	53
	85000	9	14	19	23	28	33	37	42	47	51	56
	90000	10	15	20	25	30	35	40	44	49	54	59
	95000	10	16	21	26	31	37	42	47	52	57	63
	100000	11	16	22	27	33	38	44	49	55	60	66
	105000	12	17	23	29	35	40	46	52	58	63	69
	110000	12	18	24	30	36	42	48	54	60	66	72
	115000	13	19	25	32	38	44	51	57	63	69	76
	120000	13	20	26	33	40	46	53	59	66	72	79
	125000	14	21	27	34	41	48	55	62	69	75	82
	130000	14	21	29	36	43	50	57	64	71	79	86
	135000	15	22	30	37	44	52	59	67	74	82	89
	140000	15	23	31	38	46	54	61	69	77	85	92
	145000	16	24	32	40	48	56	64	72	80	88	96
	150000	16	25	33	41	49	58	66	74	82	91	99
	155000	17	26	34	43	51	60	68	77	85	94	102
	160000	18	26	35	44	53	61	70	79	88	97	105
165000	18	27	36	45	54	63	72	82	91	100	109	
170000	19	28	37	47	56	65	75	84	93	103	112	
175000	19	29	38	48	58	67	77	86	96	106	115	
180000	20	30	40	49	59	69	79	89	99	109	119	

	Optimal Zone
	Low or high meter speed, may require vacuum adjustment
	Exceeding maximum meter speed, expect performance degradation

Meter Speed (15" Row Spacing 46 Cell Disc - Soybean, Cotton, Surgarbeet/Milo)

		Target Ground Speed (mph)										
		2	3	4	5	6	7	8	9	10	11	12
Target Population (sds/ac)	20000	2	3	4	5	7	8	9	10	11	12	13
	25000	3	4	5	7	8	10	11	12	14	15	16
	30000	3	5	7	8	10	12	13	15	16	18	20
	35000	4	6	8	10	12	13	15	17	19	21	23
	40000	4	7	9	11	13	15	18	20	22	24	26
	45000	5	7	10	12	15	17	20	22	25	27	30
	50000	5	8	11	14	16	19	22	25	27	30	33
	55000	6	9	12	15	18	21	24	27	30	33	36
	60000	7	10	13	16	20	23	26	30	33	36	40
	65000	7	11	14	18	21	25	29	32	36	39	43
	70000	8	12	15	19	23	27	31	35	38	42	46
	75000	8	12	16	21	25	29	33	37	41	45	49
	80000	9	13	18	22	26	31	35	40	44	48	53
	85000	9	14	19	23	28	33	37	42	47	51	56
	90000	10	15	20	25	30	35	40	44	49	54	59
	95000	10	16	21	26	31	37	42	47	52	57	63
	100000	11	16	22	27	33	38	44	49	55	60	66
	105000	12	17	23	29	35	40	46	52	58	63	69
	110000	12	18	24	30	36	42	48	54	60	66	72
	115000	13	19	25	32	38	44	51	57	63	69	76
120000	13	20	26	33	40	46	53	59	66	72	79	
125000	14	21	27	34	41	48	55	62	69	75	82	
130000	14	21	29	36	43	50	57	64	71	79	86	
135000	15	22	30	37	44	52	59	67	74	82	89	
140000	15	23	31	38	46	54	61	69	77	85	92	
145000	16	24	32	40	48	56	64	72	80	88	96	
150000	16	25	33	41	49	58	66	74	82	91	99	
155000	17	26	34	43	51	60	68	77	85	94	102	
160000	18	26	35	44	53	61	70	79	88	97	105	
165000	18	27	36	45	54	63	72	82	91	100	109	
170000	19	28	37	47	56	65	75	84	93	103	112	
175000	19	29	38	48	58	67	77	86	96	106	115	
180000	20	30	40	49	59	69	79	89	99	109	119	

	Optimal Zone
	Low or high meter speed, may require vacuum adjustment
	Exceeding maximum meter speed, expect performance degradation

Meter Speed (20" Row Spacing 46 Cell Disc - Soybean, Cotton, Surgarbeet/Milo)

		Target Ground Speed (mph)										
		2	3	4	5	6	7	8	9	10	11	12
Target Population (sds/ac)	20000	3	4	6	7	9	10	12	13	15	16	18
	25000	4	5	7	9	11	13	15	16	18	20	22
	30000	4	7	9	11	13	15	18	20	22	24	26
	35000	5	8	10	13	15	18	20	23	26	28	31
	40000	6	9	12	15	18	20	23	26	29	32	35
	45000	7	10	13	16	20	23	26	30	33	36	40
	50000	7	11	15	18	22	26	29	33	37	40	44
	55000	8	12	16	20	24	28	32	36	40	44	48
	60000	9	13	18	22	26	31	35	40	44	48	53
	65000	10	14	19	24	29	33	38	43	48	52	57
	70000	10	15	20	26	31	36	41	46	51	56	61
	75000	11	16	22	27	33	38	44	49	55	60	66
	80000	12	18	23	29	35	41	47	53	59	64	70
	85000	13	19	25	31	37	44	50	56	62	68	75
	90000	14	20	26	33	40	46	53	59	66	72	79
	95000	15	21	28	35	42	49	56	63	70	76	83
	100000	15	22	29	37	44	51	59	66	73	81	88
	105000	15	23	31	38	46	54	61	69	77	85	92
	110000	16	24	32	40	48	56	64	72	81	89	97
	115000	17	25	34	42	51	59	67	76	84	93	101
120000	18	26	35	44	53	61	70	79	88	97	105	
125000	18	27	37	46	55	64	73	82	91	101	110	
130000	19	29	38	48	57	67	76	86	95	105	114	
135000	20	30	40	49	59	69	79	89	99	109	119	
140000	20	31	41	51	61	72	82	92	102	113	120	
145000	21	32	42	53	64	74	85	96	106	117	120	
150000	22	33	44	55	66	77	88	99	110	120	120	
155000	23	34	45	57	68	79	91	102	113	120	120	
160000	23	35	47	59	70	82	94	105	117	120	120	
165000	24	36	48	60	72	85	97	109	120	120	120	
170000	25	37	50	62	75	87	100	112	120	120	120	
175000	26	38	51	64	77	90	102	115	120	120	120	
180000	26	40	53	66	79	92	105	119	120	120	120	

	Optimal Zone
	Low or high meter speed, may require vacuum adjustment
	Exceeding maximum meter speed, expect performance degradation

Meter Speed (30" Row Spacing 46 Cell Disc - Soybean, Cotton, Surgarbeet/Milo)

		Target Ground Speed (mph)										
		2	3	4	5	6	7	8	9	10	11	12
Target Population (sds/ac)	20000	4	7	9	11	13	15	18	20	22	24	26
	25000	5	8	11	14	16	19	22	25	27	30	33
	30000	7	10	13	16	20	23	26	30	33	36	40
	35000	8	12	15	19	23	27	31	35	38	42	46
	40000	9	13	18	22	26	31	35	40	44	48	53
	45000	10	15	20	25	30	35	40	44	49	54	59
	50000	11	16	22	27	33	38	44	49	55	60	66
	55000	12	18	24	30	36	42	48	54	60	66	72
	60000	13	20	26	33	40	46	53	59	66	72	79
	65000	14	21	29	36	43	50	57	64	71	79	86
	70000	15	23	31	38	46	54	61	69	77	85	92
	75000	16	25	33	41	49	58	66	74	82	91	99
	80000	18	26	35	44	53	61	70	79	88	97	105
	85000	19	28	37	47	56	65	75	84	93	103	112
	90000	20	30	40	49	59	69	79	89	99	109	119
	95000	21	31	42	52	63	73	83	94	104	115	120
	100000	22	33	44	55	66	77	88	99	110	120	120
	105000	23	35	46	58	69	81	92	104	115	120	120
	110000	24	36	48	60	72	85	97	109	120	120	120
	115000	25	38	51	63	76	88	101	114	120	120	120
120000	26	40	53	66	79	92	105	119	120	120	120	
125000	27	41	55	69	82	96	110	120	120	120	120	
130000	29	43	57	71	86	100	114	120	120	120	120	
135000	30	44	59	74	89	104	119	120	120	120	120	
140000	31	46	61	77	92	108	120	120	120	120	120	
145000	32	48	64	80	96	111	120	120	120	120	120	
150000	33	49	66	82	99	115	120	120	120	120	120	
155000	34	51	68	85	102	119	120	120	120	120	120	
160000	35	53	70	88	105	120	120	120	120	120	120	
165000	36	54	72	91	109	120	120	120	120	120	120	
170000	37	56	75	93	112	120	120	120	120	120	120	
175000	38	58	77	96	115	120	120	120	120	120	120	
180000	40	59	79	99	119	120	120	120	120	120	120	

	Optimal Zone
	Low or high meter speed, may require vacuum adjustment
	Exceeding maximum meter speed, expect performance degradation

SPLIT ROW VACUUM PLUG

Remove vacuum plug from port opening while planting with split rows. When split rows are not in use plug port with vacuum plug. Plugging port while not in use reduces vacuum load.

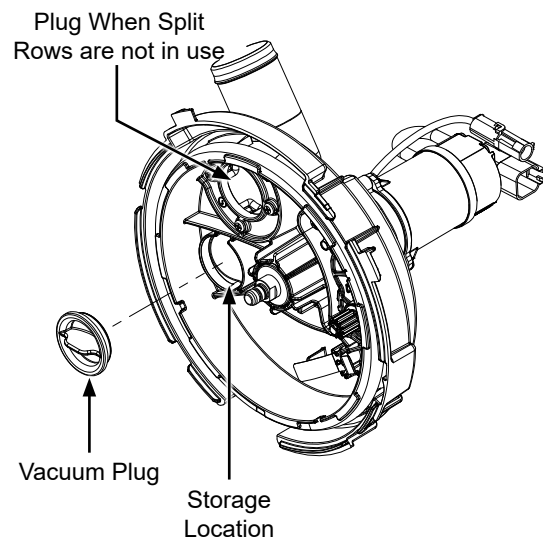

HIGH SPEED SEED METER COVER REMOVAL

1. Push latch and rotate cover clockwise.



2. Select seed disc and ejector to match crop and population.

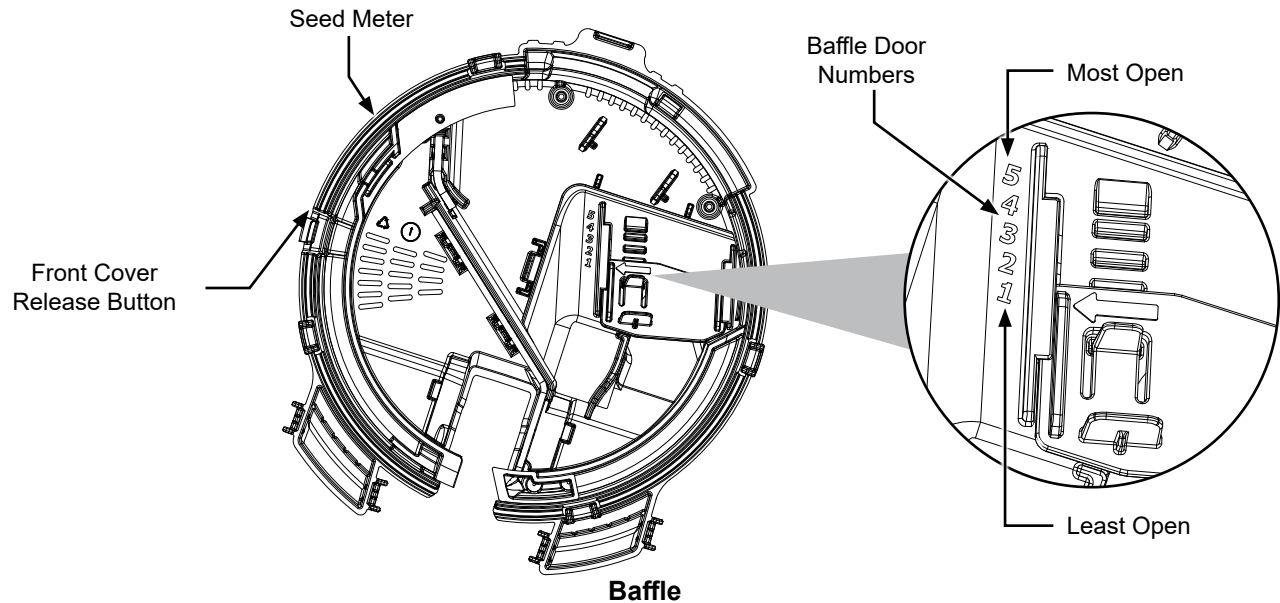

NOTE: Damaged seed or seed containing foreign material will cause plugging of seed disc orifices and require more frequent seed meter cleanout to prevent underplanting.

Wheel-Type Ejectors

Wheel-type ejectors expel seed and remnants from seed disc cells. These ejectors are disc specific, color-coded to match their corresponding disc, and necessary for proper meter performance.

NOTE: Seed size, seed shape, seed treatments, travel speed, and planting rate affect meter performance.

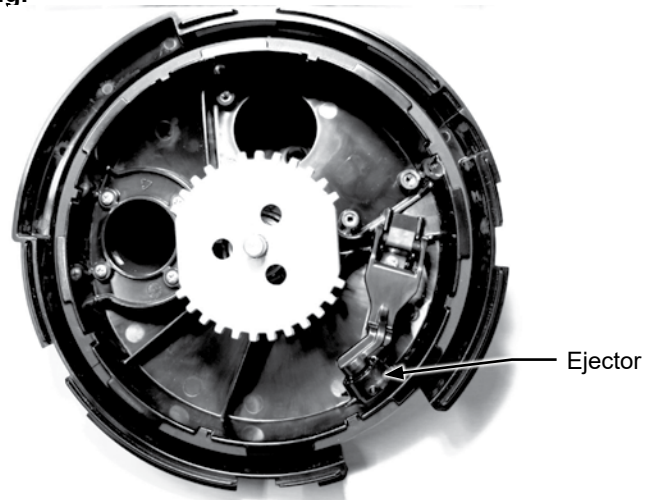

3. Adjust baffle door to recommended setting.
4. Install cover and rotate counter-clockwise.
4. With vacuum fan running, use priming sequence on Blue Vantage display to load seed onto seed discs.

NOTE: Vacuum reading will be much lower when seed disc cells are empty. Prime seed meters and allow vacuum to stabilize before starting to plant.

ADDITIVES

Lubricant Application Rate	
Graphite	
Bulk Fill Hoppers	1 Pound Bottle/50 Unit Fill
80/20 Talc-Graphite	
Bulk Fill Hoppers	8 Pounds/50 Unit Fill**
**Must be evenly mixed during fill.	
Talc	
Bulk Fill Hoppers	4 Pounds/50 Unit Fill*
*Double amount of talc for sunflowers.	

GRAPHITE

The use of graphite is the primary recommendation to promote seed flow, provide lubrication for the seed meter and to help dissipate static charge buildup. Among the available dry seed lubricants graphite is the most effective and easiest to use and it requires no mechanical agitation.

Bulk Fill Hoppers

Mix 1 pound bottle of powdered graphite each time the bulk seed hopper is filled. Graphite should be added in layers as the bulk seed hoppers are filled. Regular graphite use prolongs life of the seed meter components, improves seed spacing, and may reduce buildup of seed treatments.



Adding graphite bulk fill hopper

NOTE: Additional graphite may be required to retard buildup of seed treatments on meter components. More frequent cleaning of seed sensors may be necessary due to use of additional graphite.

80/20 TALC-GRAPHITE

Talc-graphite lubricant is to be used for treated seed, providing benefits of both talc and graphite. It absorbs moisture to prevent bridging, minimize static electricity for improved seed flow, and lubricates seed and meters.

Bulk Fill Hoppers

Mix 8lbs. of 80/20 talc-graphite each time the bulk seed hopper is filled. Regular graphite use prolongs life of the seed meter components, improves seed spacing, and may reduce buildup of seed treatments.

NOTE: Talc-Graphite lubricant MUST be mixed evenly during fill.

TALC

Talc seed lubricant may be used as a drying agent in addition to graphite lubrication. The drying agent may improve seed release and/or **retard buildup of seed treatments on meter components.**

1. Fill hopper ½ full of seed, add 2 pounds of talc and **mix thoroughly.**
2. Finish filling hopper, and add another 2 pounds of talc and **mix thoroughly.**
3. Adjust rate of talc use as needed so all seeds are coated, while avoiding a buildup of talc in bottom of hopper.

Humid conditions and/or small sized seeds with extra seed treatment may require additional talc to maintain meter performance.

NOTE: Liquid seed treatments or inoculants may create buildup on the seed disc or brushes. Check frequently for proper population and/or seed delivery when using any liquid seed treatment.

Completely mix all treatments with seed following manufacturer's recommendations. Seed treatment dumped on top of seed after hopper is filled may not mix properly and cause seed bridging, reducing population or stopping meter from planting.

BAYER FLUENCY AGENT

Bayer Fluency Agent is an alternate seed lubricant by Bayer Crop Science. The intent of this product is to replace graphite and talc lubricants and to lower the amount of dust emissions from planter vacuum fans.

This product, as tested by Kinze, is compatible with Kinze's bulk fill system and vacuum meters. Due to limited testing, wear life characteristics of meters and bulk fill systems that use Bayer Fluency Agent are not yet known. Please follow Bayer Fluency Agent instructions for rates and mixing directions.

NOTE: Presently, Bayer Fluency Agent is only required to be used in Canada with Bulk Fill or Vacuum planters that plant corn or beans treated with neonicotinoids. Farms outside of Canada, farms not using seed treated with neonicotinoids, and farms not using pneumatic metering devices do not need to use Bayer Fluency Agent. All planters not equipped with vacuums or fans are exempt from using Bayer Fluency Agent.

VACUUM HIGH SPEED SEED METER MAINTENANCE

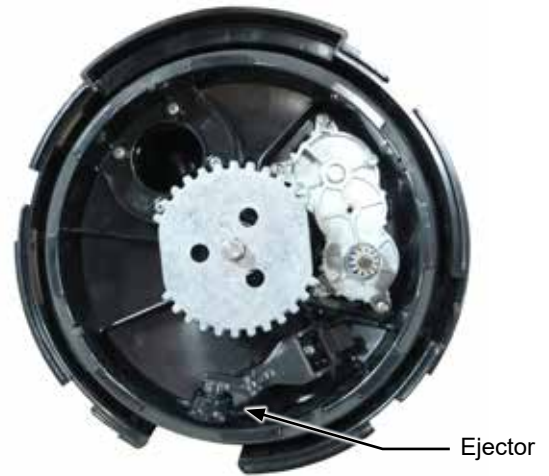
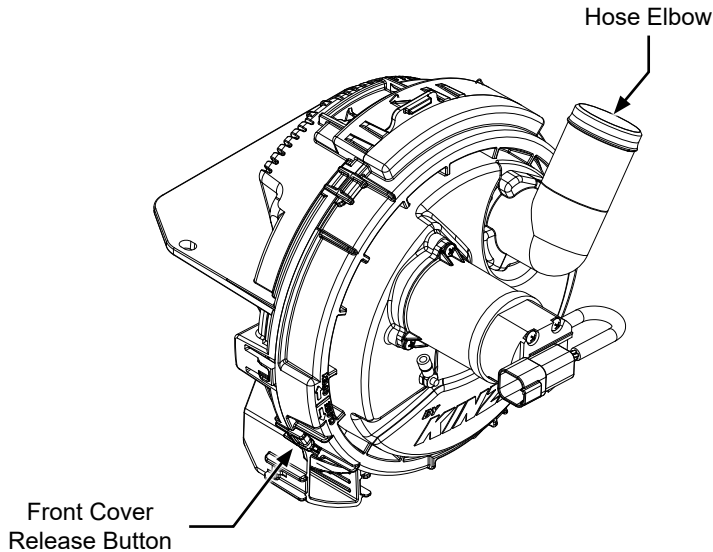

Seed Meter With Back Cover Removed

Before each planting season inspect seed discs and Singulator and clean or replace as needed.

Use clean, high quality seed for maximum meter accuracy. Damaged or cracked seed, hulls, and foreign material may become lodged in seed disc orifices and greatly reduce meter accuracy.

Inspect and clean seed discs daily checking for any buildup of foreign material and blocked orifices. If seed disc orifices are plugged frequently with seed remnants, ejector wheel may need to be replaced. Clean seed disc by washing it with soap and water. Dry thoroughly.

Inspect singulator for wear after every 150 acres per row of operation. If singulation is low or inspection marks are not visible, replace singulator. Also inspect singulator brushes, if brushes are worn/frayed replace singulator. Replace singulator by 500 individual row acres.

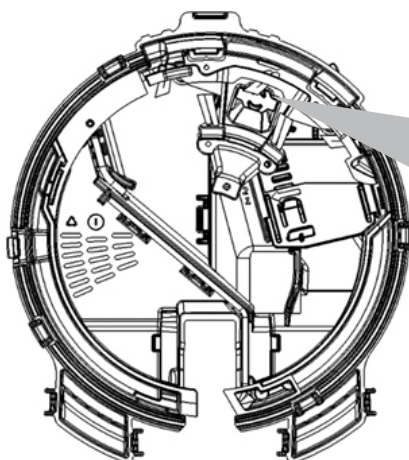

See [“Vacuum High Speed Seed Meter Cleanout” on page 27](#) for additional Vacuum Seed Metering System maintenance.

VACUUM HIGH SPEED SEED METER CLEANOUT

NOTE: Use of damaged seed or seed containing foreign material will cause plugging of seed cell orifices and require more frequent seed meter cleanout to prevent underplanting.

Thorough seed meter cleanout is important to maintain genetic purity.

1. Remove bulk fill and vacuum hose fittings from meter.
2. Rotate meter into service position.
3. Unplug electrical connections and ground straps.
4. Push release button and rotate seed meter vacuum cover clockwise to align locking tabs with slots.
5. Lift meter cover off meter assembly.
5. Remove mini-hopper and dump seed into a container.
6. Inspect mini-hopper door for any remaining seed.
7. If changing crop type, change seed disc, ejector, remove or install singulator, and adjust baffle setting.
8. Reassemble meter and latch into row unit.

NOTE: See [“Preparation For Storage” on page 33](#) to prepare seed meters and seed delivery tubes for storage.

DELIVERY TUBE MAINTENANCE

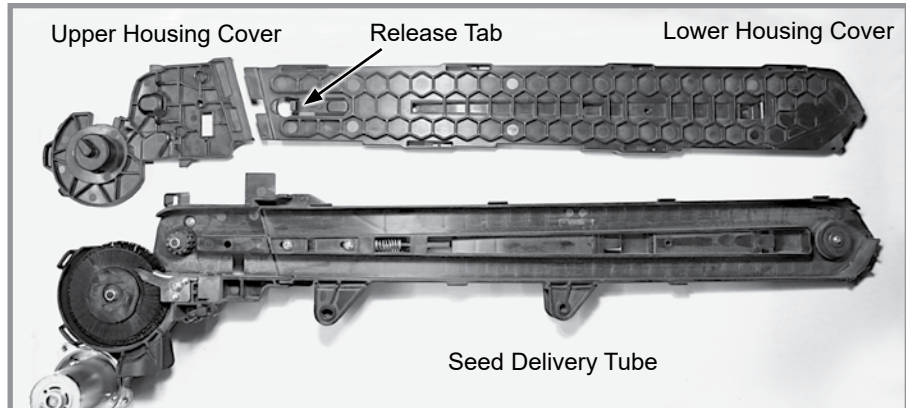

Delivery Tube Disassembly

1. Unplug electrical connections and remove delivery tube from row unit.
2. Unscrew and remove seed sensor from delivery tube.
3. Lift release tab and slide lower housing cover downward. Lift and remove.
4. Lightly lift under the cover and slide down release the upper housing cover.

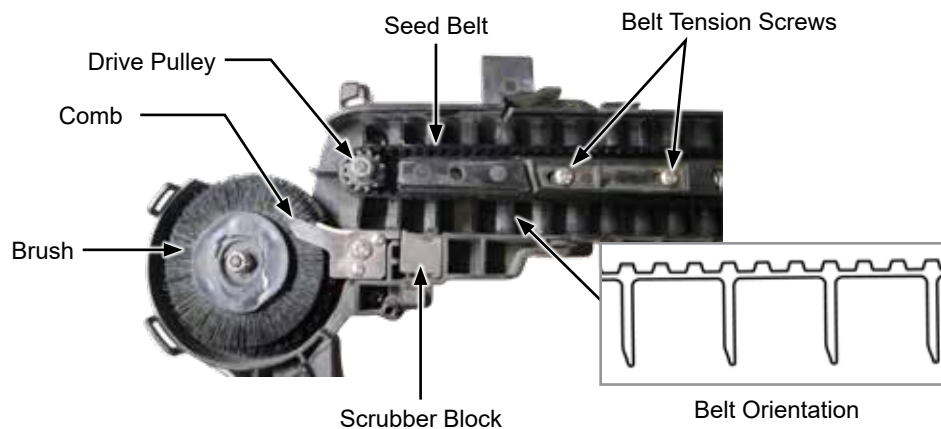

Before every planting season inspect brush wheel and seed belt. Clean or replace as needed.

Turn and reuse other side of scrubber block if one side is worn. Replace if both sides are worn.

Belt Tension Adjustment:

Proper belt tension is necessary for long life and optimum performance of seed delivery system. Excessive belt tension can cause increased wear of upper drive pulley and under tensioned belts can cause faulty seed sensor readings.

Belt Tensioning Procedure:

When installing or changing parts, tensioning belt will be necessary.

1. Loosen belt tension screws.
2. Compress and loosen upper and lower halves of delivery tube to verify the two parts moves freely.
3. Manually pull upper and lower half apart and let go so the two halves are held only by tension spring.
4. Tighten belt tension screws.

Visual Belt Tension Inspection:

Belt tension can also be checked visually without performing the re-tension process. Manually move belt in the correct direction from the return side of the delivery tube. There should be no contact between tips of belt flights and face of delivery tube comb, ribs on scrubber block, or wall edge before seed sensor window. Under tensioned delivery tube belts will usually drag on these surfaces and can also exhibit outward spring around upper drive pulley.

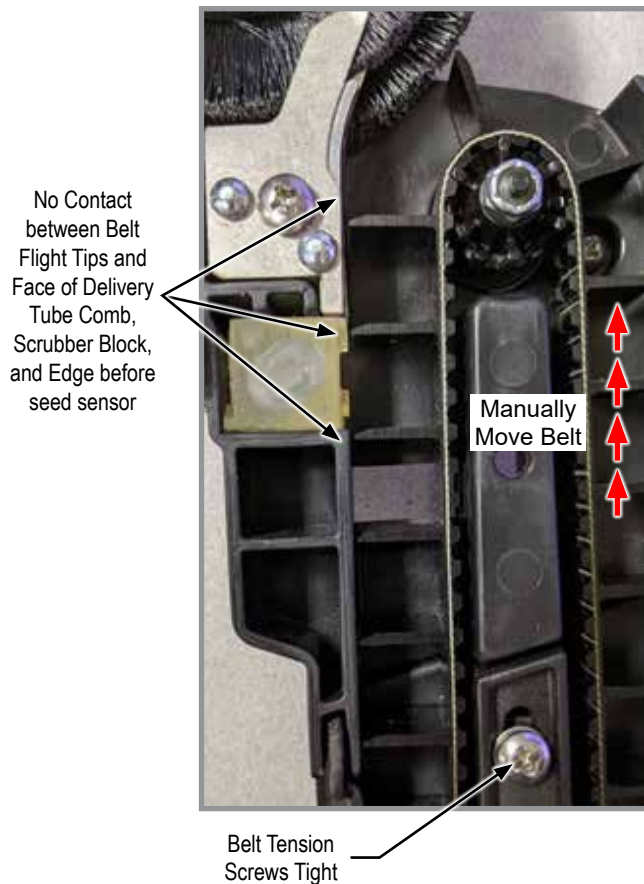
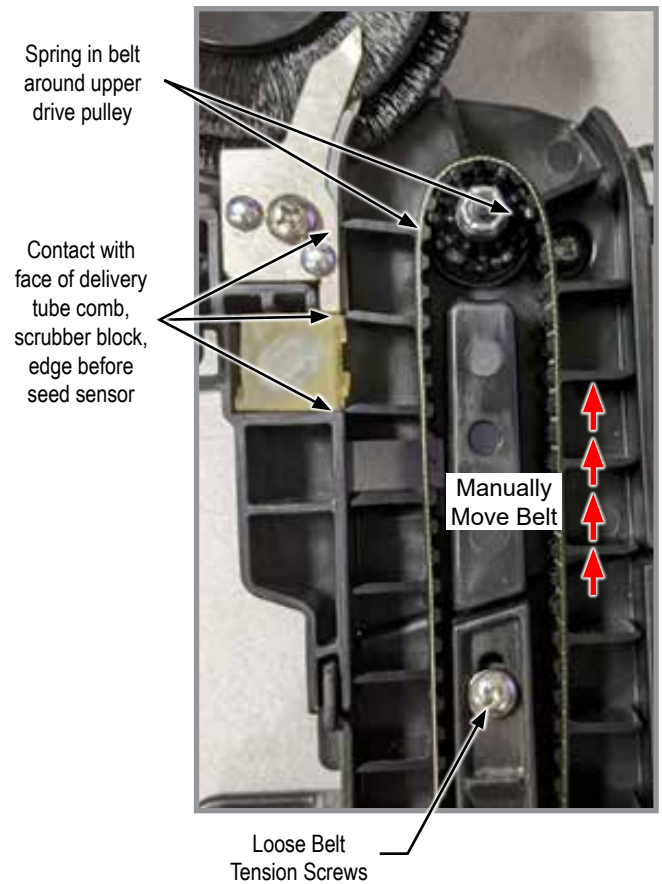
Properly Tensioned Belt Characteristics**Under Tensioned Belt Characteristics**

NOTE: Inspect delivery belt after first season of use and re-tension as needed.

Seed Belt Replacement

1. Lift release tab and slide lower housing cover downward. Lift and remove.
2. Push down and slide upper housing cover downward to disengage.
Loosen belt tensioning screws.
3. Roll seed belt down and over idler pulley.
4. Replace new belt by aligning on drive pulley and rolling onto lower idler pulley.
5. Re-tension seed belt.

NOTE: Clean drive pulley for proper belt alignment.

NOTE: Seed belt flights should be oriented as shown.

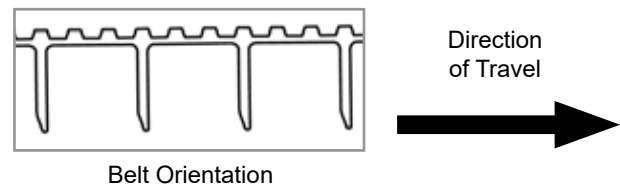

BRUSH WHEEL REPLACEMENT

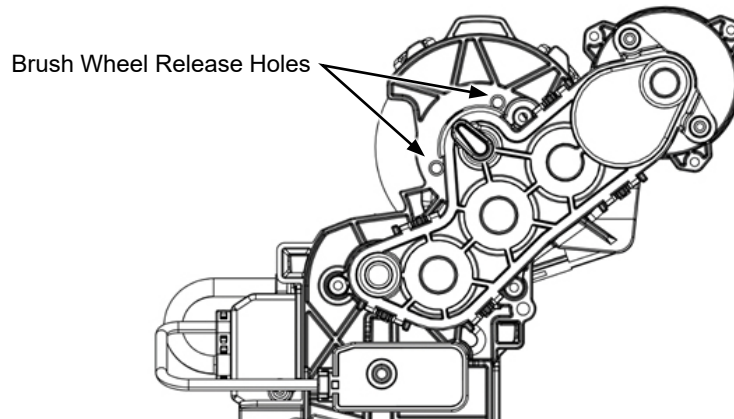

1. Remove retaining locknut on top of brush wheel.
2. Push brush wheel off of drive shaft by threading two seed sensor mounting screws into the brush wheel release holes. Thread screws in evenly on both sides to provide even pressure on brush wheel and prevent damage to shaft or wheel.
3. Replace new brush wheel and locknut.





NOTE: Use new locknut after brush wheel replacement.

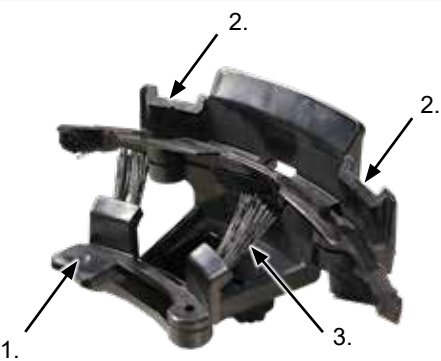
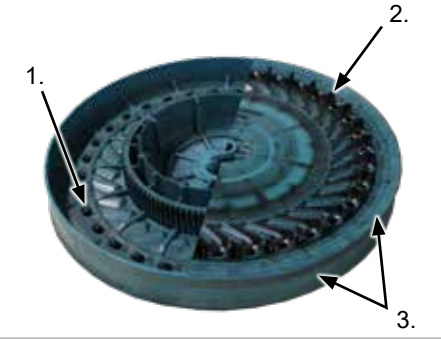

NOTE: Poor seed spacing could be caused by missing scrubber block in delivery tube assembly.

NOTE: It is recommended to store delivery tube assemblies in a separate location during off-season to prevent damage from rodents.

NOTE: Be sure nothing is sitting/applying pressure to brush wheel.

MAINTENANCE CHART

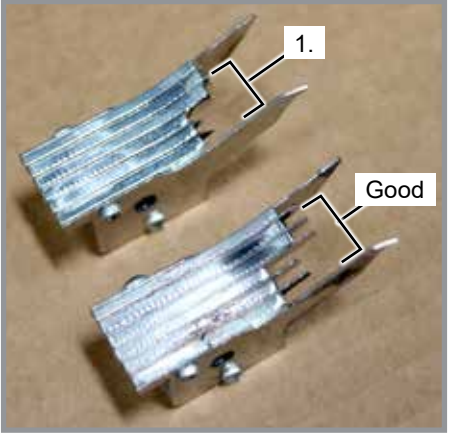
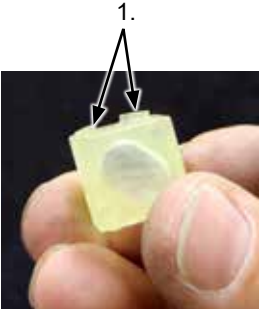
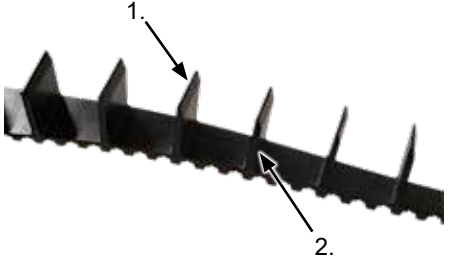
COMPONENT	INSPECT	REPLACE	WEAR CHARACTERISTICS
Singulator	Annually	Every 500 row acres or as needed	 <ol style="list-style-type: none"> 1. Reduced volume of wear indicator. 2. Reduced depth in wear indicator. 3. Reduced brush pack stiffness. 4. Frayed bristles or having a permanent set.
Seed disc	Annually	Every 1000 row acres or as needed	 <ol style="list-style-type: none"> 1. Prominent wear on seed orifice edges. 2. Deformed/damaged seed paddles. 3. Pronounced ridges.
Ejector wheel	Annually	Every 500 row acres or as needed	 <ol style="list-style-type: none"> 1. Deformed/damaged ejector wheel punches. 2. Worn ejector pins.
Meter drive gear	Annually	Every 2000 row acres or as needed	 <ol style="list-style-type: none"> 1. Deformed/damaged gear teeth. 2. Loose shaft bearings.
Brush wheel	Annually	Every 500 row acres or as needed	 <ol style="list-style-type: none"> 1. Frayed, bent, or broken brush wheel bristles.

COMPONENT	INSPECT	REPLACE	WEAR CHARACTERISTICS	
Delivery tube gearbox	Annually	As needed		1. Loose bearings.
Comb	Annually	Every 500 row acres or as needed		1. Reduced comb tip length.
Scrubber block	Annually	Every 500 row acres or as needed		1. Reduced volume on <u>both</u> sides of block. Replace when ribs are less than .025 tall.
Seed belt	Annually	Every 1500 row acres or as needed		1. Deformed/damaged flight tips. 2. Bent flights.
Scraper	Every 200 row acres	Every 500 row acres or as needed		1. Noticeable wear on both scraper pads. Replace when scraper pads are less than 1/16" thick or worn down to the level of the surrounding metal.

PREPARATION FOR STORAGE

- Store planter in a dry sheltered area if possible.
- Remove all trash from row units and frame. Remove dirt that can draw and hold moisture.
- Lubricate planter and row units at all lubrication points.
- Inspect planter for parts that are in need of replacement and order during “off” season.
- Make sure all seed and granular chemical hoppers are empty and clean.
- Remove vacuum hose from each seed meter. Operate vacuum fan at full hydraulic flow from tractor for two minutes to clear manifolds, hoses and fittings of dust and debris.
- Clean breather on analog vacuum and pressure gauges.
- Grease or paint disc openers/blades and row marker disc blades to prevent rust.
- Flush liquid fertilizer tanks, hoses and metering pump with clean water. See “Piston Pump Storage” if applicable.
- Seed Meters and Seed Delivery Tubes:

NOTE: It is recommended to store delivery tube assemblies in a separate location during off-season to prevent damage from rodents.

1. Remove all seed from meter. Blow seed meter clean with air.
2. Remove seed disc and wash with soap and water and dry thoroughly if seed treatment buildup is present.
3. Remove seal, clean with compressed air, and reinstall vacuum seal if debris buildup is observed.
4. Inspect all parts and replace worn parts.
5. Reassemble meter except for seed disc. Store meter and seed tube in a safe dry location.

NOTE: Remove seed discs from meters for annual storage and store them in a safe dry rodent free location.

- Bulk Fill System:

1. Clean out bulk fill hopper, entrainment assembly, and delivery hoses.
2. Disconnect delivery hoses from entrainer ports. Install small orange caps onto ports. Attach hoses to caps.
3. Disconnect delivery hoses from air dissipator at each row unit. Install large orange caps. Attach hoses to caps.

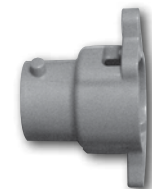

Entrainer Cap

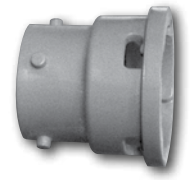

Row Unit Cap

4. Check all bolts and fasteners used to assemble and attach entrainment device are tight.
5. Loosen latches on entrainer cleanout doors to remove pressure from door gasket.
6. Inspect all seed delivery hoses and replace any that are worn, cut, or cracked.

HIGH SPEED SEED METER

PROBLEM	POSSIBLE CAUSE	SOLUTION
Low seed count.	Vacuum level too low.	Increase fan speed.
	Plugged orifices in seed disc.	Inspect and clean disc. Check remnant ejector.
	Loss of vacuum at meter.	Check for foreign material between vacuum cover and disc. Inspect parts for wear/damage. Clean or replace as required.
	Meter Speed too high for current settings	Reduce planting speed and increase vacuum setting.
	Seed sensor not picking up all seeds dropped.	Clean seed sensor lens and delivery tube.
	Brush wheel worn out	Replace brush wheel.
	Wrong seed disc or seed ejector.	Use appropriate disc and ejector for seed type and size.
	Seed size too large for current speed or vacuum setting.	Suggest decreasing ground speed or increasing vacuum.
	Improper meter engagement.	Check meter to delivery tube engagement.
	Vacuum seal worn.	Replace.
	Seed disc worn.	Replace.
	Worn remnant ejector.	Replace.
	Meter baffle door closed too far.	Mix talc thoroughly to coat all seeds. Set baffle to correct setting. Row Unit Operation section.
	Seed bridging in mini hopper.	Add graphite to improve seed flow.
	Failed/worn drive components.	Inspect and replace parts as required.
	Seeds sticking to seed disc.	Use graphite or talc to aid release.
	Seed treatment buildup in seed disc recesses.	Reduce amount of treatment used and or mix thoroughly. Add talc.
	Faulty vacuum gauge reading.	Repair/replace gauge.
	Dirt in vacuum manifold.	Check vacuum manifold for dirt and clean.
	Obstructed delivery tube exit.	Clean delivery tube exit.
Bulk fill pressure too low.	Increase bulk fill pressure.	
High seed count.	Vacuum level too high.	Decrease fan speed.
	Wrong seed disc.	Use appropriate disc for crop.
	Damaged or deformed belts.	Replace belt with new part.
	Baffle setting incorrect.	Lower baffle setting.
	Meter Speed too low for planting conditions or seed type.	Increase planting rate, planting speed, or decrease vacuum
	Meter overfilling with seed.	Decrease speed. Reduce meter baffle door setting.
	Singulator not installed or installed incorrectly.	Install singulator.

PROBLEM	POSSIBLE CAUSE	SOLUTION
Not planting seed.	Low/no vacuum.	Inspect vacuum system and repair as necessary.
	Worn ejector.	Replace ejector.
	Seed bridging in mini hopper.	Add graphite to improve seed flow. Adjust baffle setting
	Meter drive damaged.	Repair/replace drive components.
	Loss of vacuum at meter.	Check for foreign material between vacuum cover and disc. Inspect parts for wear/damage. Clean or replace as required.
	Seed baffle (if applicable) not allowing seed flow due to bridging of seed.	Mix talc thoroughly to coat all seeds. Remove seed baffle. Row Unit Operation section.
	High vacuum.	Adjust vacuum level to appropriate level
	Not stripping seed from the disc.	Replace brush wheel.
	Delivery tube plugged or damaged.	Clean or replace delivery tube.
	Faulty vacuum gauge.	Check gauge line for dirt/obstruction. Repair/replace vacuum gauge.
	Wrong seed disc.	Use appropriate disc for seed type and size.
Poor seed spacing.	Dirt in vacuum manifold.	Check vacuum manifold for dirt and clean.
	Brush wheel worn.	Replace.
	Planting too fast for conditions.	Reduce speed.
	Obstruction in delivery tube.	Clean delivery tube.
	Wrong vacuum setting.	Adjust vacuum to appropriate level.
	Damaged singulator brush pack.	Replace singulator.
	Missing scrubber block.	Insert scrubber block into delivery tube assembly.
	Incorrect singulator state.	Add or remove singulator according to crop type.
	Excess foreign material in seed.	Inspect and clean meter and seed discs. Use clean, undamaged seed.
	Dirty/damaged seed disc.	Inspect seed disc for damage, foreign material in orifices or seed treatment buildup in recesses. Clean or replace.
Irregular seed population.	Incorrect baffle setting.	Set to recommended baffle setting.
	Toolbar not level or wrong height.	Adjust hitch to level toolbar and row units.
	Inspect for worn ejector wheel.	Replace as necessary.
	Dirty seed sensor lens.	Clean seed sensor lens and delivery tube.
	Rough field conditions.	Reduce speed.
	Check for worn comb teeth.	Replace as necessary.

PROBLEM	POSSIBLE CAUSE	SOLUTION
Unable to achieve desired vacuum level.	Vacuum hose pinched/kinked/blocked.	Inspect air lines for any damage or obstruction. Clean air lines and manifold by removing end cap from manifold and running fan at high speed.
	Damaged fan components.	Inspect motor and impeller for wear/damage and repair/replace as necessary.
	Vacuum hose loose/disconnected.	Inspect and reattach all air hoses.
	Dirt in vacuum gauge line.	Check gauge line for dirt/obstruction and clean.
	Abnormally high vacuum required or consistent operation cannot be achieved.	Replace seed disc or vacuum seal.

SEED SENSOR COLOR SCHEME

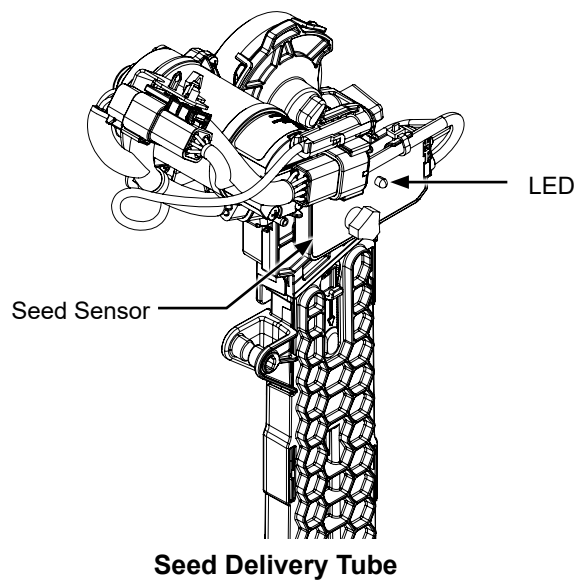

LED COLOR	LED BEHAVIOR	MODE
White	Solid	Sensor in bootloader mode.
Green	Solid	Power ON and running normal.
Red	Blinking	Sensor error. Please reboot system.
Red	Solid	Error. Sensor fault. Replace sensor.
Blue	Solid	Upgrading normally.
Yellow	Heartbeat blink	Seed detected.

NOTE: Solid red light indicates application firmware is not running. Service issue, replace sensor.