

BOLLARD

Mounting post for push plates

(US version)



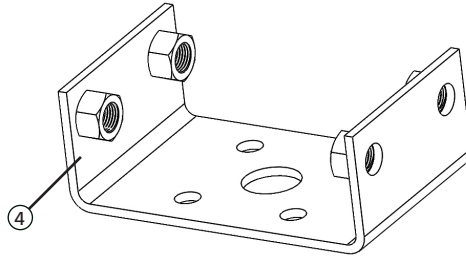
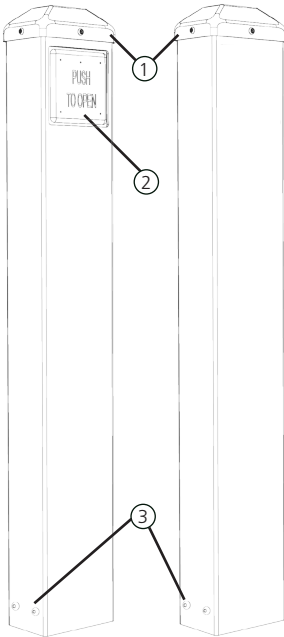

DESCRIPTION

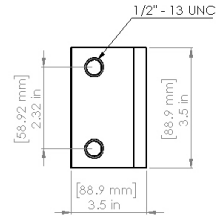
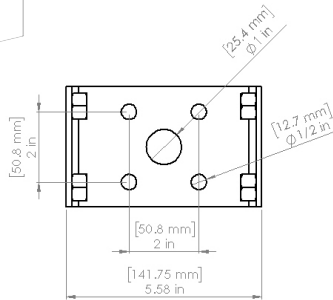

1. Top cap
2. Push plate (not included)
3. Bollard mounting bolts
4. Mounting bracket



PRODUCT FAMILY

	WITH HOLE	WITHOUT HOLE
		
BLACK	10BOLLARDBLK	10BOLLARDBLKWOH
SILVER	10BOLLARDSLV	10BOLLARDSLVWOH
BRONZE	10BOLLARDBRZ	10BOLLARDBRZWOH

PRECAUTIONS



CAUTION

- Shut off all power going to header before attempting any wiring procedures.
- Maintain a clean & safe environment when working in public areas.
- Constantly be aware of pedestrian traffic around the door area.
- Always stop pedestrian traffic through the doorway when performing tests that may result in unexpected reactions by the door.
- ESD (electrostatic discharge): Circuit boards are vulnerable to damage by electrostatic discharge. Before handling any board ensure you dissipate your body's ESD charge.
- Always check placement of all wiring before powering up to ensure that moving door parts will not catch any wires and cause damage to equipment.
- Ensure compliance with all applicable safety standards (i.e. ANSI A156.10) upon completion of installation.
- DO NOT attempt any internal repair of the components. All repairs and/or component replacements must be performed by BEA, Inc. Unauthorized disassembly or repair:
 1. May jeopardize personal safety and may expose one to the risk of electrical shock.
 2. May adversely affect the safe and reliable performance of the product resulting in a voided warranty.

INSTALLATION

Mounting Bracket

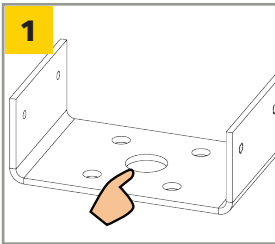

For hardwired¹ applications, run activation wires through center hole and into conduit.

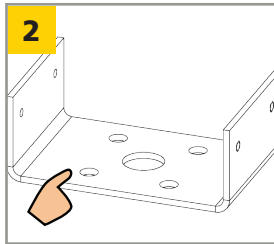

Use mounting bracket to mark four (4) mounting hole locations on concrete.

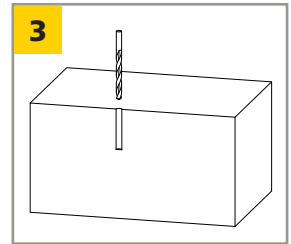

Drill four (4) $\frac{3}{8}$ " holes into concrete.

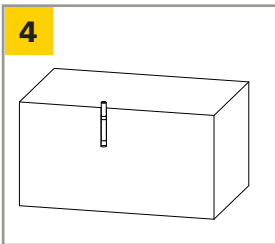

Hammer and set four (4) anchors into concrete.

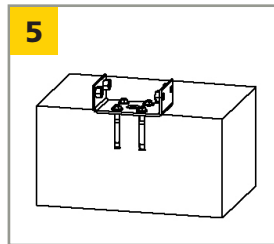

Install mounting bracket and securely tighten nuts.

NOTES:

1. For wireless applications, refer to wireless transmitter section on page 3.

INSTALLATION (cont.)

Assembly

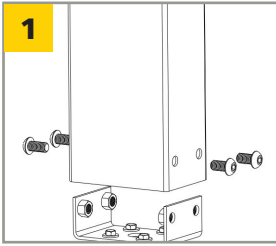

Align bollard to mounting bracket and attach using four (4) mounting bolts.

Lubricate threads of bolts prior to installing. Secure bolts by hand only – using power tools may cause galling and bolts to freeze.

Push Plate

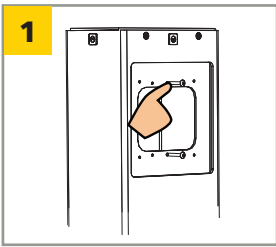

Thread push plate mounting screws into bollard, leaving majority of screw exposed.

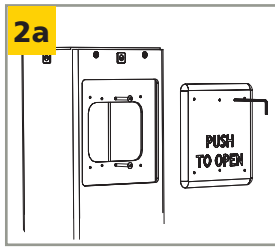

Attach push plate using provided hex key ($\frac{5}{64}$ "), and tighten.

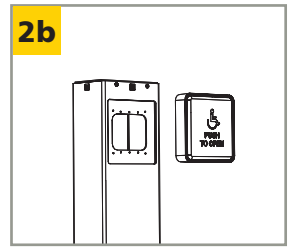

For Panther plates, mount to bollard in the same manner as you would a wall.

Refer to specific push plate user's guide for full mounting and installation instructions.

Wireless Transmitter

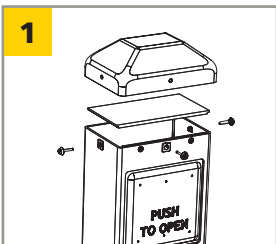

Remove top cap to expose transmitter mounting tray.

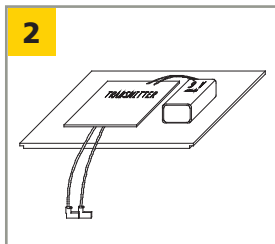

Velcro transmitter and battery to mounting tray.^{1,2}

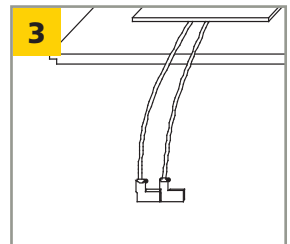

Attach transmitter leads to NO and COM of push plate.

NOTES:

1. Do not allow transmitter to hang down into bollard as this may cause transmission interference.
2. Panther plates do not require a transmitter as it is integrated into the product.

TECHNICAL SPECIFICATIONS

Dimensions (with cap)	41 ½" (H) x 6 ¼" (W) x 4 ¼" D	
Material: post cap bracket	powder-coated, carbon steel (interior and exterior) UV-resistant ABS plastic stainless steel	
Push Plate Compatibility	4 ½" square 4 ¾" square (including Panther) Dual-vestibule 4 ½" round	NOTE: "Without hole" versions will accommodate 6" square and 6" round Panther plates as well as surface-mount card readers, key pads, or other surface mount devices.
Weight	35 lbs (16 kg)	
Color	Black, bronze, or silver	
Hardware post cap bracket	½" x 13 UNC x 1" socket-head bolts (4) – ⅝" hex #6 x ¾" sheet metal screws (3) and #6 finishing washers (3) 3" expansion anchors (4), lock washers (4), and nuts (4)	

Specifications are subject to change without prior notice.
All values measured in specific conditions.

BEA INSTALLATION/SERVICE COMPLIANCE EXPECTATIONS

BEA, the sensor manufacturer, cannot be held responsible for incorrect installations or inappropriate adjustments of the sensor/device; therefore, BEA does not guarantee any use of the sensor outside of its intended purpose.

BEA strongly recommends that installation and service technicians be AAADM-certified for pedestrian doors, IDA-certified for doors/gates, and factory-trained for the type of door/gate system.

Installers and service personnel are responsible for executing a risk assessment following each installation/service performed, ensuring that the sensor system installation is compliant with local, national, and international regulations, codes, and standards.

Once installation or service work is complete, a safety inspection of the door/gate shall be performed per the door/gate manufacturer recommendations and/or per AAADM/ANSI/DASMA guidelines (where applicable) for best industry practices. Safety inspections must be performed during each service call – examples of these safety inspections can be found on an AAADM safety information label (e.g. ANSI/DASMA 102, ANSI/DASMA 107, UL 325).

Verify that all appropriate industry signage and warning labels are in place.

