

EAGLE

Unidirectional activation sensor for automatic pedestrian doors*

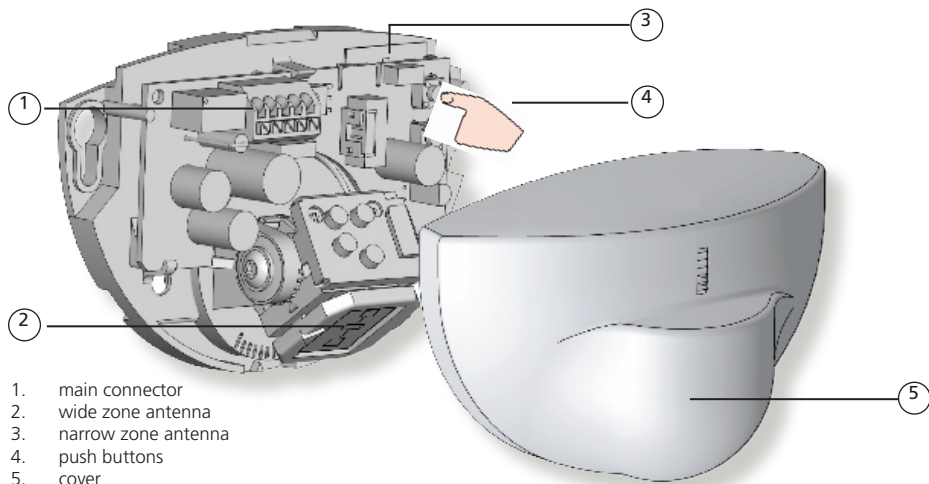

DESCRIPTION



1. main connector
2. wide zone antenna
3. narrow zone antenna
4. push buttons
5. cover

TECHNICAL SPECIFICATIONS

Technology:	microwave and microprocessor
Transmitter frequency:	24.150 GHz
Transmitter radiated power:	< 20 dBm EIRP
Transmitter power density:	< 5 mW/cm ²
Detection mode:	motion
Min. detection speed:	2 in/s
Supply voltage:	12V to 24V AC \pm 10%; 12V to 24V DC +30% / -10%
Mains frequency:	50 to 60 Hz
Max power consumption:	< 2 W
Output:	relay (free of potential change-over contact)
Max. contact voltage:	42V AC/DC
Max. contact current:	1A (resistive)
Max. switching power:	30W (DC) / 60VA (AC)
Mounting height:	from 6 ft to 13 ft
Degree of protection:	IP54
Temperature range:	from -4 °F to + 131 °C
Dimensions:	4.7 in (L) x 3.1 in (H) x 2.0 in (W)
Tilt angles:	0° to 90° vertical; -30° to +30° lateral
Material:	ABS
Weight:	7.6 oz
Cable length:	8 ft
Norm conformity:	R&TTE 1999/5/EC, LVD 2006/95/EC, RoHS 2 2011/65/EU

Specifications are subject to changes without prior notice.
Measured in specific conditions.

* Other use of the device outside of the intended purpose can not be guaranteed by the manufacturer.



- The device should not be used for purposes other than its intended use. All other uses cannot be guaranteed by the manufacturer of the sensor.
- The installer of the door system is responsible for carrying out a risk assessment and installing the sensor and the door system in compliance with applicable national and international regulations and standards on door safety.
- The manufacturer of the sensor cannot be held responsible for incorrect installations or inappropriate adjustments of the sensor.

1

OPENING THE SENSOR

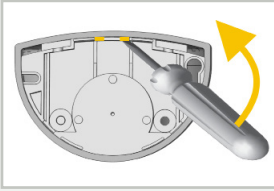

Before mounting

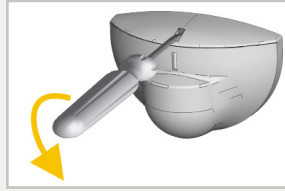

After mounting

2

MOUNTING & WIRING

TIPS

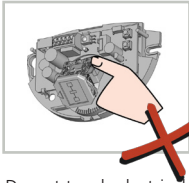

Do not touch electrical parts.



Avoid vibrations.

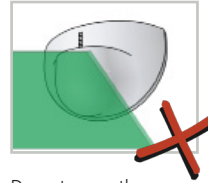

Do not cover the sensor.

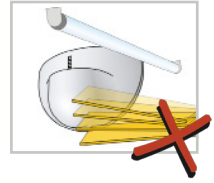

Avoid proximity to neon lamps or moving objects.

APPLICATIONS

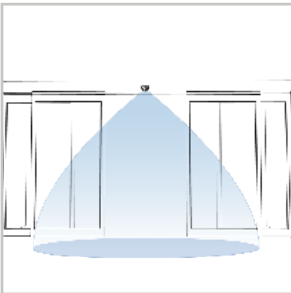

Header mounting above sliding or revolving door

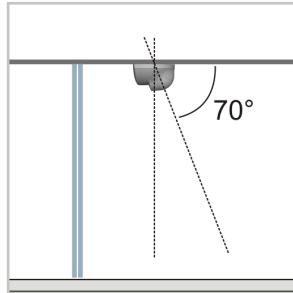

Ceiling mounting in front of door (sliding, revolving or swing doors)

1

Ø3 mm (Ø1/8")

Insert Power Cable template in MOUNTING GABARIT D BOHRSCHNITTEN
insérer le câble et le gabarit dans les MONTAGEBOHRER

Apply the mounting template. Drill 1 hole for the cable and pull it through. Drill 2 holes for the screws.

2

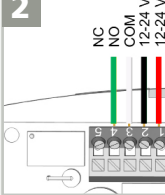

Connect the wires accordingly:
1 - RED - POWER SUPPLY +
2 - BLACK - POWER SUPPLY -
3 - WHITE - COM
4 - GREEN - NO
5 - GREEN - NC or

3

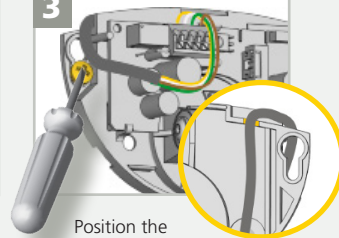

Position the cable as indicated. Mount the sensor firmly.

3 MECHANICAL ADJUSTMENTS

WIDTH

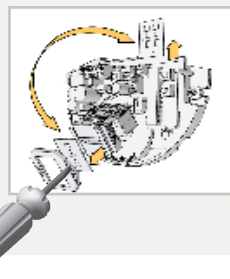
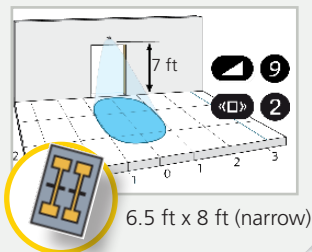
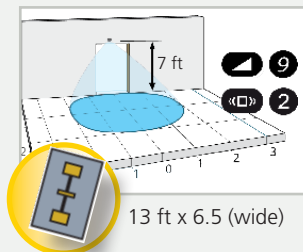

ANGLE

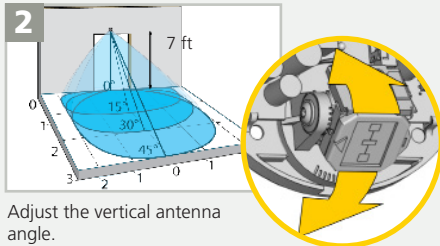
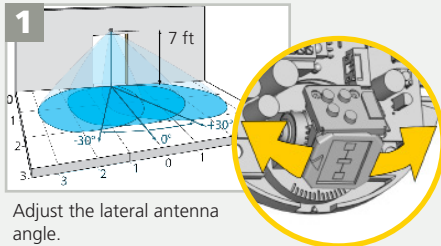

4 SETTINGS (by remote control or push buttons)



ZONE SIZE		XXS	XS	S	>	>	>	>	L	XL	XXL
IMMUNITY FILTER			low	normal	high	>	>	>	>	>	highest
DETECTION MODE			bi	uni	uni MTF	uni AWAY	MTF & AWAY	bi = two-way detection; uni = one-way detection towards sensor uni MTF = one-way detection with motion tracking feature uni AWAY = one-way detection away from sensor			
OUTPUT CONFIGURATION			A	P	A = active output (NO-contact) P = passive output (NC-contact)						
HOLD-OPEN TIME		0.5 s	1 s	2 s	3 s	4 s	5 s	6 s	7 s	8 s	9 s
MOUNTING HEIGHT			< 10 ft	> 10 ft							
DOOR CONTROL			auto	open	closed	open = the sensor detects constantly. The LED is ON. closed = the sensor is in standby and does not detect. The LED is OFF.					

FACTORY VALUES

RESETTING TO FACTORY VALUES:

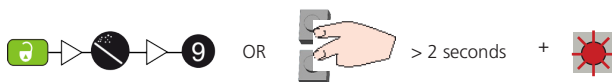

ZONE SIZE

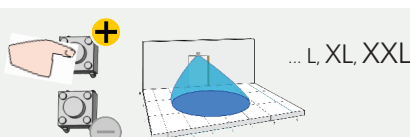
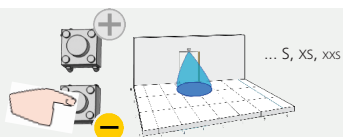

ACCESS CODE

The access code (1 to 4 digits) is recommended to set sensors installed close to each other.

SAVING AN ACCESS CODE:



DELETING AN ACCESS CODE:



Once you have saved an access code, you always need to enter this code to unlock the sensor.

If you forget the access code, **cycle the power**. For the first minute, you can access the sensor without an access code.

TROUBLESHOOTING

PLEASE KEEP FOR FURTHER USE - DESIGNED FOR COLOR PRINTING

©BEA | Original Instructions | 75-5601.01 EAGLE 20140326

A HALMA COMPANY



The door remains closed.
The LED is OFF.

The sensor power is off.

- 1 Check the wiring and the power supply.



The door does not react as expected.

Improper output configuration on the sensor.

- 1 Change the door control setting (F2) to value 1 (automatic).



The door opens and closes constantly.

The sensor is disturbed by the door motion or vibrations caused by the door motion.

- 1 Change the output configuration setting on each sensor connected to the door operator.



The door opens for no apparent reason.

It rains and the sensor detects the motion of the rain drops.

- 1 Make sure the sensor is fixed properly.
- 2 Make sure the detection mode is unidirectional.
- 3 Increase the antenna angle.
- 4 Increase the immunity filter.
- 5 Reduce the zone size.

In highly reflective environments, the sensor detects objects outside of its detection zone.

- 1 Make sure the detection mode is unidirectional.
- 2 Increase the immunity filter.
- 3 Install the rain accessory.

In airlock vestibules, the sensor detects the movement of the opposite door.

- 1 Change the antenna angle.
- 2 Decrease the zone size.
- 3 Increase the immunity filter.

- 1 Change the antenna angle.
- 2 Change the antenna.
- 3 Increase the immunity filter.



The LED flashes quickly after unlocking.

The sensor needs an access code to unlock.

- 1 Enter the right access code.
- 2 If you forgot the code, cycle the power to access the sensor without access code. Change or delete the access code.

The sensor does not respond to the remote control.

Batteries in the remote control are weak or installed improperly.

- 1 Check and change the batteries if necessary.

Remote control poorly oriented.

- 1 Point the remote control towards the sensor.

ANSI / AAADM Compliance American Association of Automatic Door Manufacturers

Upon completion of the installation or service work, at a minimum, perform a daily safety check in accordance with the minimum inspection guidelines provided by AAADM. Provide each equipment owner with an owner's manual that includes a daily safety checklist and contains, at a minimum, the information recommended by AAADM. Offer an information session with the equipment owner explaining how to perform daily inspections and point out the location of power/operation switches to disable the equipment if a compliance issue is noted. The equipment should be inspected annually in accordance with the minimum inspection guidelines. A safety check that includes, at a minimum, the items listed on the safety information label must be performed during each service call. If you are not an AAADM certified inspector, BEA strongly recommends you have an AAADM certified inspector perform an AAADM inspection and place a valid inspection sticker below the safety information label prior to putting the equipment into operation.

