

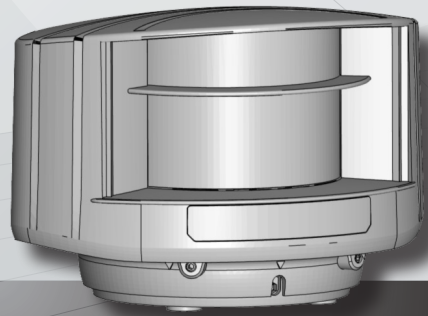

EN



LZR[®]-I30

LASER SCANNERS FOR INDUSTRIAL DOORS

max. detection range of 30 ft x 30 ft



SAFETY



The device contains IR and visible laser diodes.
IR laser: wavelength 905nm; max. output pulse power 75W (Class 1 according to IEC 60825-1)
Visible laser: wavelength 650nm; max. output CW power 3mW (Class 3R according to IEC 60825-1)

The visible laser beams are inactive during normal operation.
The installer can activate the visible lasers if needed.



CAUTION!

Use of controls, adjustments or performance of procedures other than those specified herein may result in hazardous radiation exposure.

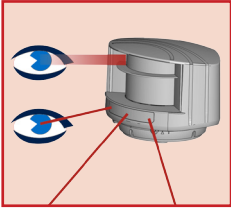

Do not look into the laser emitter or the visible red laser beams.

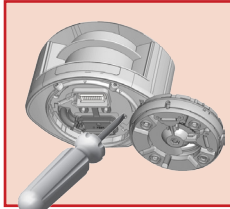

The warranty is void if unauthorized repairs are made or attempted by unauthorized personnel.



Only trained and qualified personnel may install and adjust the sensor.



Test the proper operation of the installation before leaving the premises.

The manufacturer of the door system is responsible for carrying out a risk assessment and installing the sensor and the door system in compliance with applicable national and international regulations and standards on door safety and if applicable, the machinery directive 2006/42/EC. Other use of the device is outside the permitted purpose and can not be guaranteed by the manufacturer. The manufacturer cannot be held responsible for incorrect installations or inappropriate adjustments of the sensor.

INSTALLATION AND MAINTENANCE

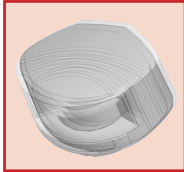

Avoid extreme vibrations.

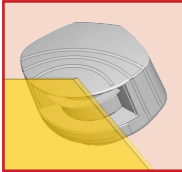

Do not cover the front screens.

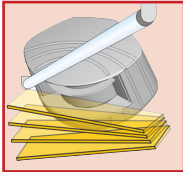

Avoid moving objects and light sources in the detection field.

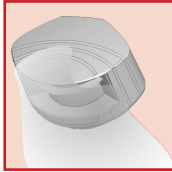

Avoid the presence of smoke and fog in the detection field.

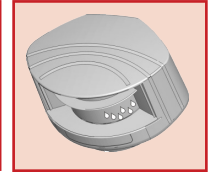

Avoid condensation.

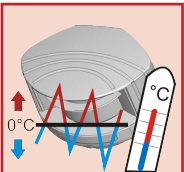

Avoid exposure to sudden and extreme temperature changes.



Avoid direct exposure to high pressure cleaning.



Do not use aggressive products to clean the front screens.

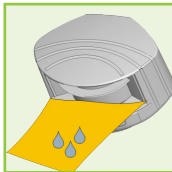

Wipe the front screens regularly with a clean and damp cloth.

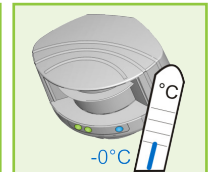

Keep the sensor permanently powered in environments where the temperature can descend below 14°F.

DESCRIPTION

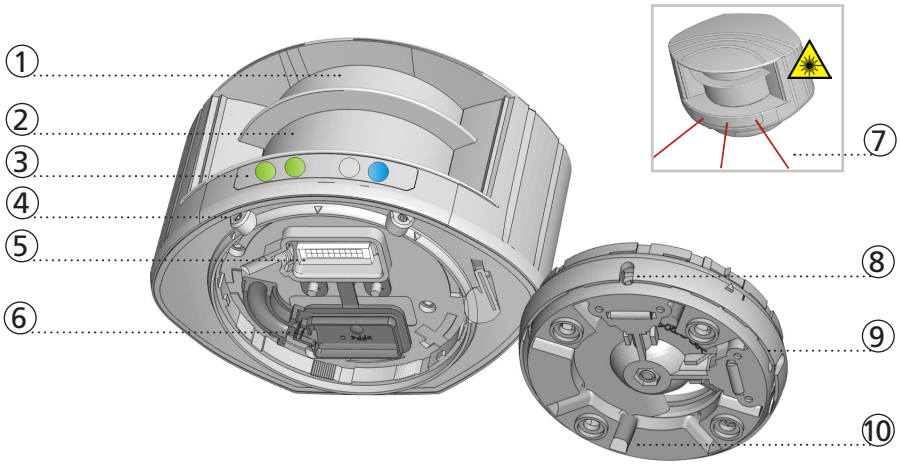

- | | |
|---------------------------------|--|
| 1. laser sweep emission | 6. protection cover |
| 2. laser sweep reception | 7. visible laser beams (3) |
| 3. LED-signals (4) | 8. notches for tilt angle adjustment (2) |
| 4. screws for position lock (2) | 9. adjustable bracket |
| 5. connector | 10. cable conduits (4) |

LED-SIGNAL

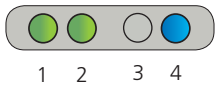

1. Detection LED: relay 1 - optional field
2. Detection LED: relay 2 - safety field
3. Error LED
4. Power LED

DETECTION LEDs

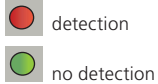

ERROR LED



POWER LED

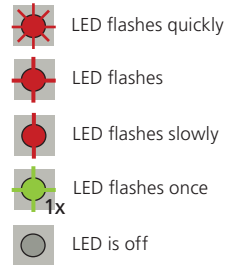

All 4 LEDs can be switched off and on again by remote control. This can be useful in cases where the sensor should not draw any attention.

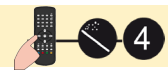

SYMBOLS



Caution!
Laser radiation



Remote control
sequence



Possible
remote control
adjustments



Factory
values



According
to



Not
according
to

EN ISO 13849-1:2008
CAT 2, PI «d»



Attention!
Important!



Tip
Info

HOW TO USE THE REMOTE CONTROL



30 minutes after last use, the sensor locks the access to the remote control session.
Cut and restore power supply. The remote control session is accessible again during 30 minutes.



After unlocking, the red LED flashes and the sensor can be adjusted by remote control.



If the red LED flashes quickly after unlocking, you need to enter an access code from 1 to 4 digits.



To end an adjustment session, always lock the sensor.

ADJUSTING ONE OR MORE PARAMETERS

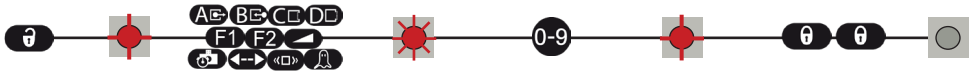

CHECKING A VALUE

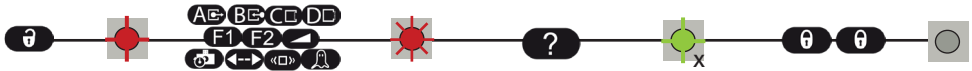

X = number of flashes = value of the parameter

4x 1x 2x = field width: 4.2 m

3x = field width is defined by teach-in

RESTORING TO FACTORY VALUES

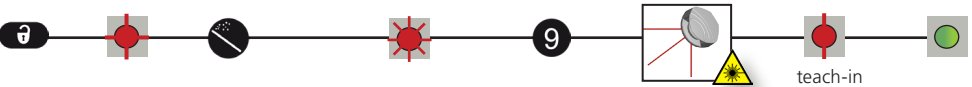

SAVING AN ACCESS CODE

The access code is recommended for sensors installed close to each other.



DELETING AN ACCESS CODE



Enter the existing code

1 MOUNTING

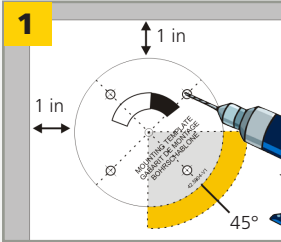
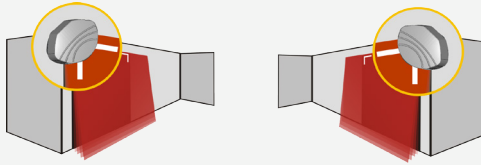

Use the mounting template to position the sensor correctly. The grey area indicates the detection range. Drill 4 holes and make a hole for the cable if possible.

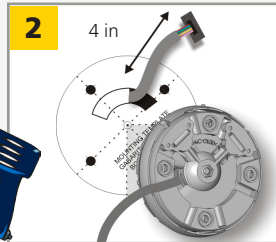

Pass the cable +/- 4 in through the cable opening. If drilling an opening is not possible, use the cable conduits on the back side of the bracket.

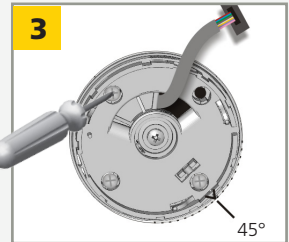

Position the bracket and fasten the 4 screws firmly in order to avoid vibrations.



Open the protection cover, plug the connector and position the cable in the slit. Close the protection cover and fasten it firmly.

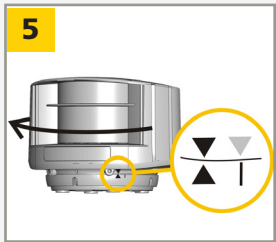

Position the housing on the bracket and turn the sensor until the two triangles are face to face.

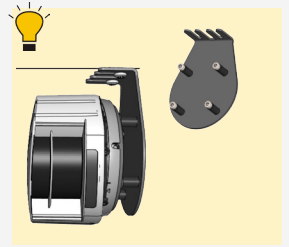

Use the LBA accessory if needed.

2 WIRING

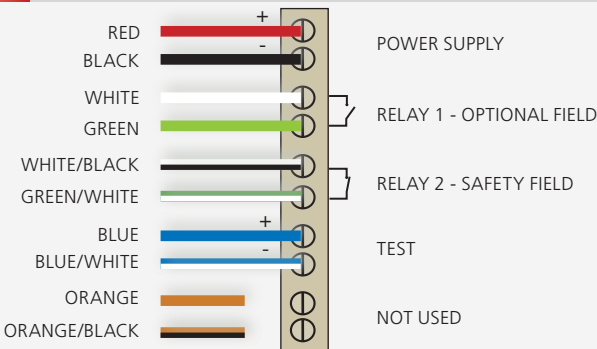

Use a Power Supply Module (24V DC, 0.75 A) if needed.

The sensor tests both relays.

Door control without test: connect red and blue wires to power supply (no polarity)



3 POSITIONING



Unlock the sensor and activate the visible laser beams in order to position the curtains parallel to the door.

The visible laser beams stay activated for 15 minutes or can be turned off by the same sequence.



Adjust the **lateral position** of the detection field.

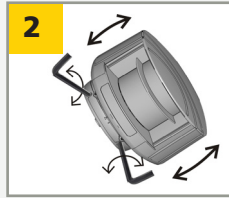

Adjust the **tilt angle** of the detection field with the hex key.

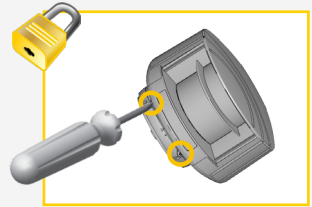

Lock the position of the mounting bracket to avoid malfunctioning in case of extreme vibrations.

The distances between the curtains depend on the mounting height and side.

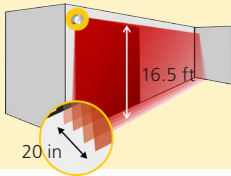

The visible laser beams indicate approximately the position of curtain C1.

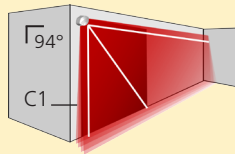

The distance between the inner curtains of the 2 sensors must be max. 8 in to ensure safety according to EN ISO 13849-1:2008 CAT 2, Pl «d».

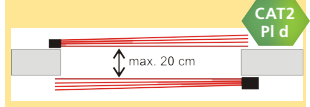

4 MOUNTING SIDE

Check and select the corresponding mounting side if necessary.

Stay outside of the detection field to avoid disturbances.

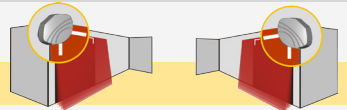

		1	2		3	4	5	
		left	right		left	right	centre	
		WITH BACKGROUND			WITHOUT BACKGROUND			
		The sensor memorizes the floor as reference point and signals a fault when its orientation is changed.			No reference point, no signal.			

A teach-in is launched, the sensor learns its environment and automatically determines the detection field(s). Both RED LEDs flash slowly and the 3 visible laser beams automatically light up during 30 seconds.



After setting the mounting side, the safety and the optional field have the same dimensions.

5 SAFETY FIELD CONFIGURATION (RELAY 2)

SAFETY FIELD TEACH-IN

Launch a teach-in after changing the sensor position or when new objects are added to or changed in the detection zone.

 During teach-in, the detection field should be free of snow buildups, heavy rain, snowfall, fog or other moving objects.

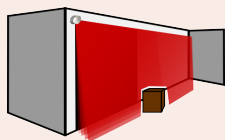
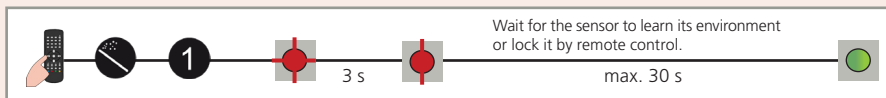

During teach-in, the sensor learns its surroundings and adapts the detection field shape to these. Objects in the detection field will be cut out.

FIELD DIMENSIONS

After the teach-in, the field dimensions can be reduced by remote control.

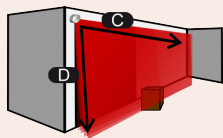
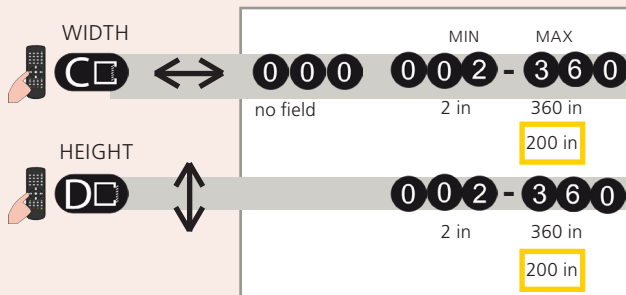

Ex:  C 0 6 2 for a field width of 62 in

 The field is by default limited to 200 in x 200 in. You can adapt the dimensions by remote control, but they can never be bigger than the shape which was defined by the teach-in.



FACTORY VALUES



6 OPTIONAL FIELD CONFIGURATION (RELAY 1)

 Make sure the white and yellow wires are connected to the corresponding inputs before configuring the optional field.

VIRTUAL PUSH BUTTON TEACH-IN (VPB)

Install 1 or 2 virtual push buttons as activation zone(s) to open the door «manually».

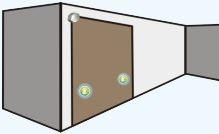
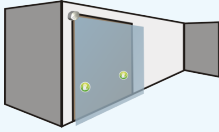

- 1** Apply the virtual push button sticker(s) **within** the optional field.
- 2** Launch a VPB teach-in to configure the detection zone(s). When the red LED flashes very slowly after 3 seconds, hold your hand in front of the sticker to learn the detection zone. The green LED flashes 3x to confirm the selection. When the red LED flashes again, learn a second (max. 2) detection zone or wait until the LED switches to green.

Launch a new VPB teach-in each time the sensor position is changed or new objects are added to or changed in the detection zone.



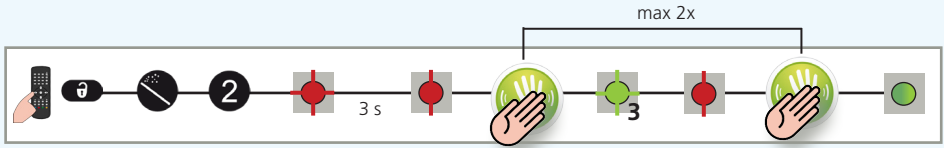

ATTENTION! This VPB teach-in is different from the safety field teach-in.



FIELD DIMENSIONS

Reduce the field dimensions if needed.

 In order to configure the field dimensions, you have to cancel the virtual push button function by launching a new VPB teach-in without any movement in the detection field.

	WIDTH		MIN	MAX
 A 	000	002 - 360	2 in	360 in
	same as safety field			360 in
 B 	000	002 - 360	2 in	360 in
	no field			360 in

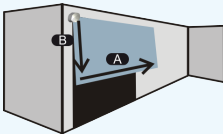

Change output configuration to value 3.



3

 Test the good functioning of the installation before leaving the premises.



FACTORY VALUES



OTHER REMOTE CONTROL CONFIGURATIONS

ACTIVE DETECTION CURTAINS

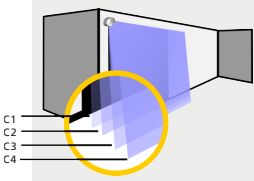

CURTAIN C1 C2 C3 C4

- 0 curtain is inactive on both fields
- 1 curtain is active on optional field
- 2 curtain is active on safety field
- 9 curtain is active on both fields

Ex:

C1 + C2 are active on safety field
C3 + C4 are active on optional field

C1 is active on both fields
C2+C3 are active on safety field
C4 is inactive

All curtains are active on both fields

The distances between the curtains depend on the mounting height and side. When mounted on the left, the distance between curtain C1 and curtain C4 is approximately 4 in for every 3.25 ft (mounting height). **Example:** at 200 in the distance between C1 and C4 is 20 in.

IMMUNITY FILTER

FOR CRITICAL ENVIRONMENTS
(RAIN, SNOW, FOG)

indoor	outdoor low	outdoor med	outdoor high
--------	-------------	-------------	--------------

1 2 3 4

Choose between environment or object.

F2	0	1	2	3	4
	2	4	6	8	10 in

Increase in case of snow, dead leaves, etc.

UNCOVERED ZONE

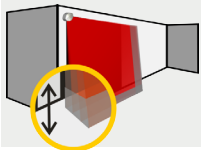

MIN. OBJECT SIZE (approximate values)

	0	1	2	3	4
	off	3	4	6	8 in

OUTPUT ACTIVATION DELAY (approximate values)

	0	1	2	3	4	5	6	7	8	9
	off	100	200	300	400	500	600	700	800	900 ms

The relays are triggered when the detection duration \geq the selected time.

DETECTION FIELD REDIRECTION

F1	0	1
R1	optional	optional or safety
R2	safety	safety

OUTPUT CONFIGURATION

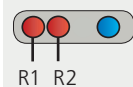

	1	2	3	4	
R1	A - NO	P - NC	P - NC	A - NO	A = active P = passive
R2	P - NC	A - NO	P - NC	A - NO	NO = normally open NC = normally closed

FACTORY VALUES

R = RELAY OUTPUT

CAT2
Pl d

CAT2
Pl d

TROUBLESHOOTING

	No blue LED	There is no power.	1 Check cable and connexion.
		The polarity of the power supply is inverted.	1 Check the polarity of the power supply.
		All LEDs have been deactivated by remote control.	1 Activate the LEDs by remote control.
	Only the blue LED is on.	The test input is not connected.	1 Check wiring. The RED and BLUE cable have to be connected to the test input or the power supply.
	The detection LED remains green.	The detection field is too small or deactivated.	1 Check the size of the fields. 2 Launch a teach-in.
		The object size is too small.	1 Decrease the min. object size.
	The detection LED remains red.	Someone or something is in the detection field.	1 Step out of the field and/or remove the any object(s) from the field.
		The field is touching the floor, the wall or the door, which leads to detection.	1 Activate the 3 red beams and check if the position of the sensor is correct. If not, adjust the hex screws. 2 Verify the field size. 3 Launch a teach-in.
	The orange LED is flashing and the detection LEDs are red.	No background (reference point) is found.	1 Check the position of the sensor. 2 Check the mounting side setting. If there is no background, set the mounting side to value 3 to 5. 3 Launch a new teach-in.
		The sensor is masked.	1 Verify and clean the front screens with a damp cloth.
	The orange LED is on.	The power supply voltage is exceeding the acceptable limits.	1 Check the power supply voltage.
		The sensor exceeds its temperature limits.	1 Verify the outside temperature where the sensor is installed. Eventually protect the sensor from sunlight using a cover.
		Internal error	1 Wait a few seconds. If the LED remains ON, reset the power supply. If the LED turns on again, replace the sensor.
	The sensor does not respond to the remote control.	30 minutes after last use of the remote control, the sensor locks the access to the remote control session.	1 Cut and restore power supply. The remote control session is accessible again during 30 minutes.
		The batteries in the remote control are not installed properly or dead.	1 Verify or replace the batteries.
		The remote control is badly pointed.	1 Point the remote control towards the sensor, but with a slight angle. The RC should not be pointed in a right angle in front of the sensor.
		A reflective object is in close proximity to the sensor.	1 Avoid highly reflective material in proximity to the sensor.
	The sensor does not unlock.	You have to enter an access code or the wrong code was entered.	1 Cut and restore power supply. No code is required to unlock during the first minute after powering.

TECHNICAL SPECIFICATIONS

Technology:	laser scanner, time-of-flight measurement
Detection mode:	motion and presence (EN 12453 Typ. E)
Max. detection range:	30 ft x 30 ft
Uncovered zone:	2 - 19 in (adjustable)
Remission factor:	> 2 %
Angular resolution:	0,3516 °
Min. detected object size (typ.): (in proportion to object distance)	0.8 in @ 118 in ; 1.4 in @ 197 in ; 2.75 in @ 30 ft
Testbody:	700 mm x 300 mm x 200 mm (testbody A according to EN 12445)
Emission characteristics:	
IR laser:	wavelength 905 nm; max. output pulse power 75 W (CLASS 1)
Red visible laser:	wavelength 650 nm; max. output CW power 3 mW (CLASS 3R)
Supply voltage:	10-35 V DC @ sensor side (to be operated from SELV compatible power supplies only)
Power consumption:	< 5 W
Peak current at power-on:	1.8 A (max. 80 ms @ 35 V)
Cable length:	33 ft
Response time:	typ. 20 ms; max. 80 ms (+ output activation delay)
Output:	2 electronic relays (galvanic isolated - polarity free)
Max. switching voltage:	35 V DC / 24 V AC
Max. switching current:	80 mA (resistive)
Switching time:	t _{ON} =5 ms; t _{OFF} =5 ms
Output resistance:	typ 30 Ω
Voltage drop on output:	< 0.7 V @ 20 mA
Leakage current:	< 10 μA
Input:	2 optocouplers (galvanic isolated - polarity free)
Max. contact voltage:	35 V DC (over-voltage protected)
Voltage threshold:	Log. H: >8 V DC; Log. L: <3 V DC
Response time monitoring input:	< 5 ms
LED-signal:	1 blue LED: power-on status 1 orange LED: error status 2 bi-coloured LEDs: detection/output status (green: no detection; red: detection)
Dimensions:	5.0 in (D) x 3.6 in (W) x 2.75 in (H) (mounting bracket + 0.55 in)
Material:	PC/ASA
Colour:	black or white
Mounting angles on bracket:	-45 °, 0 °, 45 °
Rotation angles on bracket:	-5 ° to +5 ° (lockable)
Tilt angles on bracket:	-3 ° to +3 °
Protection degree:	IP65
Temperature range:	-22 °F to +140 °F if powered; +14 °F to +140 °C unpowered
Humidity:	0-95 % non-condensing
Vibrations:	< 2 G
Pollution on front screens:	max. 30 %; homogenous
Expected lifetime:	20 years
Norm conformity:	2006/95/EC: LVD; 2002/95/EC: RoHS; 2004/108/EC: EMC; 2006/42/EC: MD; EN 12453:2000 chapter 5.1.1.6, chapter 5.5.1 Safety device E; EN 12978:2009; EN ISO 13849-1:2008 CAT2, Pl "d"; EN 60529:2001; IEC 60825-1:2007; EN 60950-1:2005; EN 61000-6-2:2005; EN 61000-6-3:2006; IEC 61496-1:2009; EN 61496-3:2008 ESPE Type 2; EN 62061:2005 SIL 2

Specifications are subject to changes without prior notice.
All values measured in specific conditions.



BEA hereby declares that the LZR®-I100/-I110 is in conformity with the basic requirements and the other relevant provisions of the directives 2006/95/EC, 2002/95/EC, 2004/108/EC and 2006/42/EC.

Notified Body for EC inspection: 0044 - TÜV NORD CERT GmbH, Langemarckstr. 20, 45141 D-Essen

EC-type examination certificate number: 44 205 11 392410-002

Angleur, May 2011

Jean-Pierre Valkenberg, Authorized representative and responsible for technical documentation

The complete declaration of conformity is available on our website: www.bea-industrial.be



For EC countries: according to the directive 2012/19/EU for Waste Electrical and Electronic Equipment (WEEE)