

# Office Doctor Discount Office Furniture

www.OfficeDr.com 856-368-9085

Safco Products are on Sale for Half Price

Take Half Off the List Prices in this PDF

**Call 856-368-9085 Now to Order**

#### **LIMITED LIFETIME WARRANTY**

Safco-warranty obligation: We pledge to repair or replace, at Safco's option, any Safco product or component that is defective in material or workmanship for as long as you, the original purchaser, own it.

#### **LIABILITY LIMITATIONS**

The following listed parts, components and supplies are covered under warranty in accordance with the below schedule following the product purchase date.

**Ten Years:** Seating controls and cylinders, Rumba™, Cha-Cha™, electric height-adjustable table series laminates, and wood seating components. All parts (excluding motor) on the XR, ML and E Series Height-Adjustable Tables.

**Five Years:** Glides, casters, polymer-based components, seating upholstery (fabrics and leather), foam, armrests, chrome seating components, user-adjustable work surface mechanisms, laminates, veneer finishes and other covering materials, drawer glides, electrical components, Event Series, cabinets or mobile systems, components that are either moving parts or controls (guides that are in contact with moving parts), and motors on the ML-Series, E-Series and XR-Series Height-Adjustable Tables.

**Three Years:** Outdoor Products (Evos™, Canmeleon™ and CoGo™ Product Lines), High Density 4-Post wire shelving and wire components, and electrical components, Dry Erase Surfaces.

[See website for complete Warranty Information](#)

# Flip-N-Go® Conference/Training Tables

Safco® Products marketing materials are designed to be used as sales tools for our Dealer network.

- Minimal assembly required
- Dual-sided levers for a quick flip of the top
- Tables nest for compact storage
- Integrated Modesty Panel with built-in cable trough
- Tables can be connected together by using ganging kit (included)
- Tables are shipped in two boxes, top and base separately
- Overall HPL table height: 29"
- Four locking casters
- 5¼" between tables when nested
- 150 lb. weight capacity, Evenly distributed
- Base available in Black or Silver Finishes
- Tables available in either Thermally Fused Laminate (TFL) with standard T-Mold or High Pressure Laminate (HPL) with your choice of 3 edge treatments
- HPL Edge Treatments: 3mm (H3), Knife-Edge (HK) or Standard T-Mold (HT) available in corporate edge colors
- See page 10 for corporate laminate color options or go to Safco website
- Manufactured cutouts (5¼ x 3") for daisy chain electrical kits available on 24"D rectangular tables (one centered cutout per table grommet not included)
- Add "E" suffix and \$30 list upcharge per cutout
- Power Options page 112 for surface mount kits

## How to Specify

Start with base model number and **SELECT ONE CODE FROM EACH OF THE OPTIONS** to complete your final model number for ordering:

Select MODEL NUMBER (ie., LF2448)	Step 1: Select [✦] CUTOUT (OPTIONAL)	Step 2: Select [■] LAMINATE/EDGE TYPE
	E = Rectangular (Cutout Only) (Add \$34 List)	H3 = HPL Laminate /3mm Edge
	G = Center Grommet (Add \$30 List)	HK = HPL Laminate /Knife Edge HT = HPL Laminate /T-Mold Edge
	M = Left/Right (2) Grommets (Add \$60 List)	T = TFL Laminate /T-Mold Edge

Add codes to indicate your selections: **E** (Rectangular Cutout Only) **H3** (HPL Laminate /3mm Edge)

The final Model Number for Base Product LF2448 with the highlighted selections would be **LF2448-E-H3** (or **LF2448EH3**).

### • See next page for Cutout and Laminate/Edge options

Note: All non-standard cutouts (other than above) will be reviewed to determine if the cutout does not interfere with the base, degrade table strength or cause imbalance. Contact [specials@safcoproducts.com](mailto:specials@safcoproducts.com) for quote request and drawing signoff will be required before order is processed.

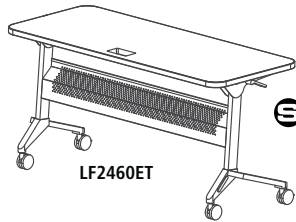

Rectangular Surfaces <sup>GSA</sup>			Available Cutouts	TFL List Price "T" Suffix	HPL List Price HT, HK or H3 Suffix
Model No.	Description	Wt.			
<b>S</b> LF1848	48 x 18" Rectangular	66	G	901.00	960.00
LF1860	60 x 18" Rectangular	76	G,M	960.00	1,064.00
LF1872	72 x 18" Rectangular	86	G,M	1,024.00	1,124.00
LF2448	48 x 24" Rectangular	76	E,G	960.00	1,064.00
LF2460	60 x 24" Rectangular	86	E,G,M	1,064.00	1,166.00
LF2472	72 x 24" Rectangular	96	E,G,M	1,124.00	1,248.00

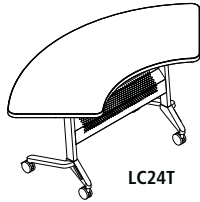

Crescent Surfaces (48" Radius) <sup>GSA</sup> <sup>S</sup>			Available Cutouts	TFL List Price "T" Suffix	HPL List Price HT, HK or H3 Suffix
Model No.	Description	Wt.			
LC24	67 x 24" Crescent	76	-	1,147.00	1,248.00

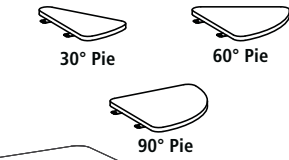

Trapezoid Surfaces <sup>GSA</sup> <sup>S</sup>			Available Cutouts	TFL List Price "T" Suffix	HPL List Price HT, HK or H3 Suffix
Model No.	Description	Wt.			
LP24	60 x 24" Trapezoid	76	-	1,024.00	1,107.00

Pie Connectors <sup>GSA</sup> <sup>S</sup>			Available Cutouts	TFL List Price "T" Suffix	HPL List Price HT, HK or H3 Suffix
Model No.	Description	Wt.			
P3018	18" x 30° Pie	4	-	348.00	390.00
P6018	18" x 60° Pie	8	-	365.00	—
P9018	18" x 90° Pie	12	-	390.00	431.00
P3024	24" x 30° Pie	6	-	348.00	390.00
P6024	24" x 60° Pie	12	-	365.00	407.00
P9024	24" x 90° Pie	18	-	390.00	431.00

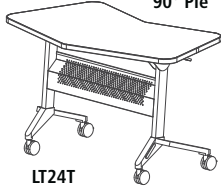

Transition Tables (Surfaces can be installed in either direction) <sup>GSA</sup> <sup>S</sup>			Available Cutouts	TFL List Price "T" Suffix	HPL List Price HT, HK or H3 Suffix
Model No.	Description	Wt.			
LT24	48"W x 24"D	76	-	1,148.00	1,248.00

## Flip-N-Go® Conference/Training Tables - Quick Ship Options

- Low pressure laminate tabletop with Black T-mold edge band
- Laminate top options: Regal Mahogany (RMH), Folkstone (FLK4), Cherry (LCRM), Mocha (LDCM)
- Black (S) or Silver (SLV) base to match workspace décor

Example of ordering Quick Ship Model Number for Black (S) Base Product LF2448T with the selected laminate color would be **LF2448T-S-FLK4** (or **LF2448TSFLK4**).

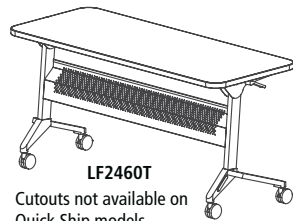

Rectangular Surfaces <sup>GSA</sup> <sup>S</sup>			Available Cutouts	TFL List Price "T" Suffix	HPL List Price HT, HK or H3 Suffix
Model No.	Description	Wt.			
<b>S</b> LF1848T	48 x 18" Rectangular	66	-	876.00	—
LF1860T	60 x 18" Rectangular	76	-	960.00	—
LF1872T	72 x 18" Rectangular	86	-	1,024.00	—
<b>S</b> LF2448T	48 x 24" Rectangular	76	-	960.00	—
LF2460T	60 x 24" Rectangular	86	-	1,064.00	—
LF2472T	72 x 24" Rectangular	96	-	1,124.00	—

Cutouts not available on Quick Ship models

Cutout Options [♣]

"E" - \$30 List upcharge

(1) Manufactured rectangular cutout 5 1/4 x 3" for daisy chain electrical kits only. Grommet caps not included with cutout.

See page 112 for available kit options.

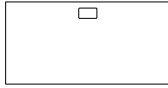

Cutout-E

"G" - \$30 List upcharge

(1) Manufactured round cutout 1 3/4" in diameter located in center approach side of top. Includes grommet cap. Black only.



Cutout-G

"M" - \$60 List upcharge

(2) Manufactured round cutouts 1 3/4" diameter located on right and left approach side of top. Includes (2) grommet caps. Black only.



Cutout-M

Laminate Edge Type [■]

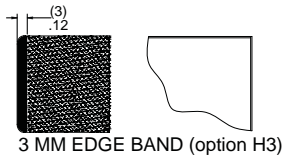

3 MM EDGE BAND (option H3)

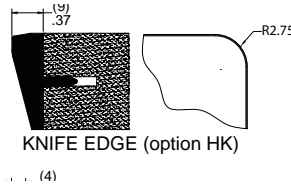

KNIFE EDGE (option HK)

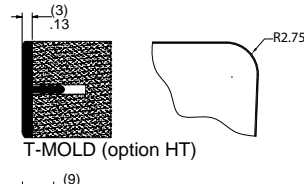

T-MOLD (option HT)

Note: All non-standard cutouts (other than above) will be reviewed to determine if the cutout does not interfere with the base, degrade table strength or cause imbalance. Contact [specials@safcoproducts.com](mailto:specials@safcoproducts.com) for quote request and drawing signoff will be required before order is processed.

Flip-N-Go® Conference/Training Tables - Idea Starters

• Must order by individual model numbers.



Flip-N-Go Idea Starter #1

Consists of:

Qty.	Model No.	Description	List Price Each
4	LF2460T	Rectangular Table, 24 x 60"	1,064.00
2	LT24T	24"D Transition Table	1,148.00
2	P3024T	24" x 30° Pie	348.00

Total: 7,248.00

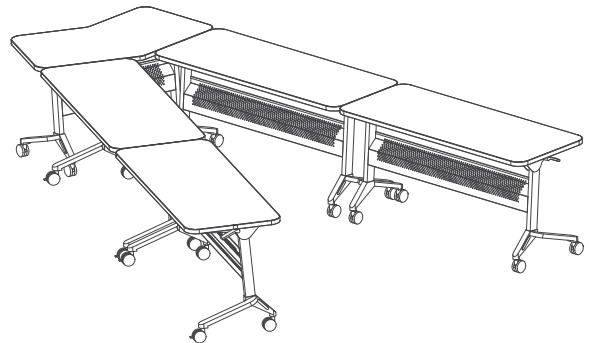

Flip-N-Go Idea Starter #2

Consists of:

Qty.	Model No.	Description	List Price Each
4	LF2460T	Rectangular Table, 24 x 60"	1,064.00
1	LT24T	24"D Transition Table	1,148.00

Total: 5,404.00

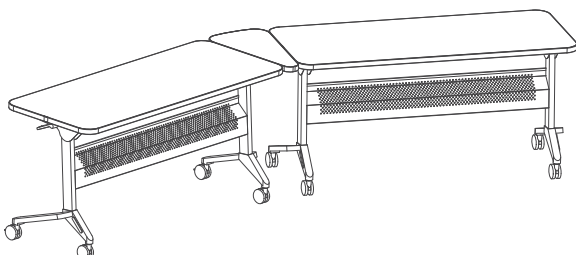

Flip-N-Go Idea Starter #3

Consists of:

Qty.	Model No.	Description	List Price Each
2	LF2460T	Rectangular Table, 24 x 60"	1,064.00
1	P3024T	24" x 30° Pie	348.00

Total: 2,476.00