

Hong Kong Ding Sheng Tian Technology Co., Ltd.

3D Welding Table & Accessories

Email: Info@enjoy-sound.com



DCT
Catalog

Customer Satisfaction

Quality

Reputation

2022

Welcome to visit our Factory in China

Harmonise to Every Production Needs





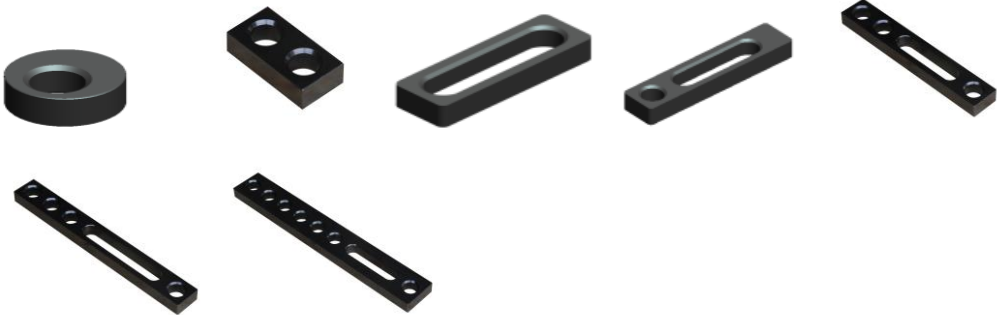

China (Mainland), Guangdong, Shenzhen

1/F, Building I, Jinchangda Industrial Park, Shangwei Village, Zhangkengjing, Guanlan Sub-District

Content

<p>Welding Table</p>		<p>4-8</p>
<p>Legs</p>		<p>9</p>
<p>Angles</p>		<p>9-16</p>
<p>Stop</p>		<p>17-21</p>
<p>Blocks</p>		<p>22-24</p>

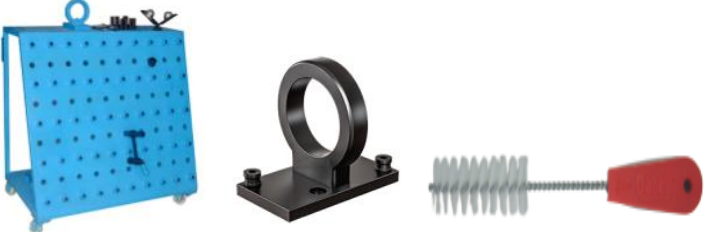
<p>Support</p>		<p>25-26</p>
<p>Bolt</p>		<p>27-29</p>
<p>Clamps</p>		<p>30-33</p>
<p>Toggle Clamp</p>		<p>34</p>
<p>Accessories</p>		<p>35</p>
<p>Our Customers</p>	<p>36</p>	



3D Welding Table

Available in Cast Iron and Steel.

DCT Specification (System size 28)

1. Surface Roughness: Ra3.2.
2. Flatness: +/- .0025"
3. Loading capacity is 4410lbs.
4. Mounting Hole Size: 28mm
5. Grid spacing: 100± 0.05 mm.
6. Number of Mounting Surfaces: 5
7. Etched Position Marks
8. Made from Q345 Steel/ HT300 cast iron



Product Name	Picture	Dimension (mm)	Model No.
3D steel welding table		1000x1000x200	DCT28-10001
		1200x1200x200	DCT28-10002
		1500x1000x200	DCT28-10003
		1500x1500x200	DCT28-10004
		2000x1000x200	DCT28-10005
		2000x1500x200	DCT28-10006
		2400x1200x200	DCT28-10007
		3000x1500x200	DCT28-10008
		4000x2000x200	DCT28-10009
		3000x2000x200	DCT28-10010
3D Cast iron 3D welding table		2000x1000x200	DCT28-10105
		2400x1200x200	DCT28-10107
		3000x1500x200	DCT28-10108
		4000x2000x200	DCT28-10109
		3000x2000x200	DCT28-10110

We have 2 surface treatments:

1. Chromeplating surface treatment: It provides increased surface, increased resistance to corrosion and rust.
2. Plasma nitride treatment. The main benefit of our plasma nitride treatment is dramatically increased resistance against weld spatter and resistance against wear and deformation. Additional benefits of the nitride process include resistance to corrosion.

Product Name	Picture	Dimension (mm)	Model No.
Chromeplating surface treatment - 3D steel welding table		1000x1000x200	DCT28-10201
		1200x1200x200	DCT28-10202
		1500x1000x200	DCT28-10203
		1500x1500x200	DCT28-10204
		2000x1000x200	DCT28-10205
		2000x1500x200	DCT28-10206
		2400x1200x200	DCT28-10207
		3000x1500x200	DCT28-10208
		4000x2000x200	DCT28-10209
		3000x2000x200	DCT28-10210



2D Welding Table

Available in Steel.

Loading capacity is 2200lbs.

Product Name	Picture	Dimension (mm)	Model No.
2D steel welding table		1000x1000x150	DCT28-11001
		1200x1200x150	DCT28-11002
		1500x1000x150	DCT28-11003
		1500x1500x150	DCT28-11004
		2000x1000x150	DCT28-11005
		2000x1500x160	DCT28-11006
		2400x1200x160	DCT28-11007
		3000x1500x200	DCT28-11008
		4000x2000x200	DCT28-11009
		3000x2000x200	DCT28-11010

Product Name	Picture	Dimension (mm)	Model No.
Chromeplating surface treatment- 2D steel welding table		1000x1000x150	DCT28-11201
		1200x1200x150	DCT28-11202
		1500x1000x150	DCT28-11203
		1500x1500x150	DCT28-11204
		2000x1000x150	DCT28-11205
		2000x1500x160	DCT28-11206
		2400x1200x160	DCT28-11207
		3000x1500x200	DCT28-11208
		4000x2000x200	DCT28-11209
		3000x2000x200	DCT28-11210



2DS Welding Table

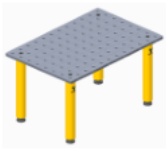

Available in Steel.

Loading capacity is 1100lbs.

Product Name	Picture	Dimension (mm)	Model No.
2DS welding table		1000x600	DCT28-13001
		1000x800	DCT28-13002
		1000x1000	DCT28-13003
		1200x800	DCT28-13004
		1200x1000	DCT28-13005
		1200x1200	DCT28-13006
		1500x800	DCT28-13007
		1500x1000	DCT28-13008
		1500x1500	DCT28-13009
		2000x1000	DCT28-13010



Support legs

<i>Product Name</i>	<i>Picture</i>	<i>Dimension (mm)</i>	<i>Model No.</i>
Standard support legs		$\varnothing 88 \times 200 + 50$	dct28-71001
		$\varnothing 88 \times 300 + 50$	dct28-71002
		$\varnothing 88 \times 400 + 50$	dct28-71003
		$\varnothing 88 \times 500 + 50$	dct28-71004
		$\varnothing 88 \times 600 + 50$	dct28-71005
Leg with castor		$\varnothing 88 \times 200 + 150$	dct28-71201
		$\varnothing 88 \times 300 + 150$	dct28-71202
		$\varnothing 88 \times 400 + 150$	dct28-71203
		$\varnothing 88 \times 500 + 50$	dct28-71104

Locating Angles

1. Clamping and locating angle bores / Bore small

Features:

- ideal for confined spaces
- infinitely variable height-adjustable support surfaces

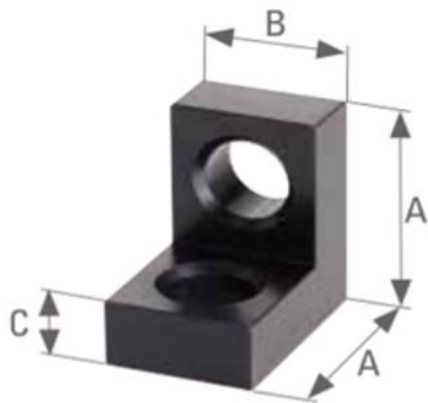

D28	A in mm	B in mm	C in mm	Model No.
	75	50	25	DCT28-30001

2. Clamping and locating angle bores / Oblong hole small

Features:

- Measuring alignment using the grid lines on 3D welding table possible
- fixed and infinitely adjustable via oblong holes
- ideal for confined spaces
- combination Bores / Oblong hole

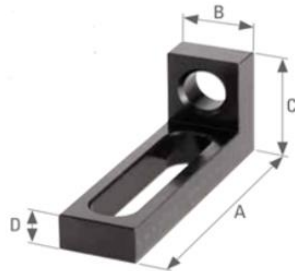

D28	A in mm	B in mm	C in mm	D in mm	Model No.
	175	50	75	25	DCT28-30002

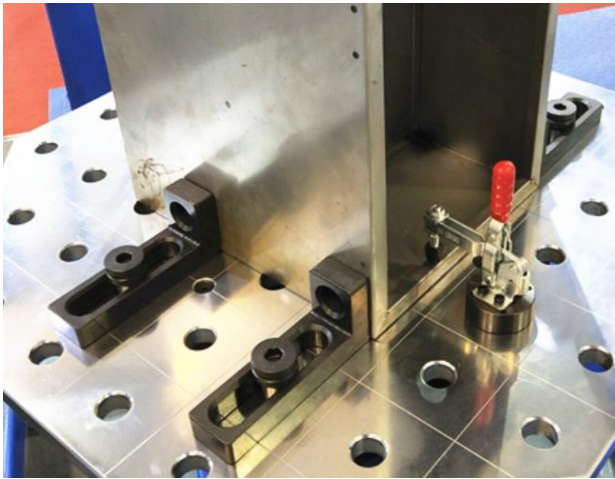

3. Clamping and locating angles

Features:

- Combination system bores / Oblong hole, hence many clamping options

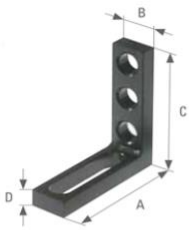

Oblong hole/ Bore

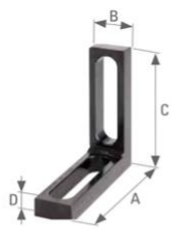

Oblong hole / Oblong hole

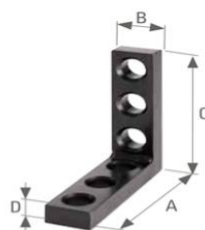

Bores / Bores

D28	A in mm	B in mm	C in mm	D in mm	Description	Model No.
	175	50	175	25	Oblong hole/ Bore	dct28-30005
	175	50	175	25	Oblong hole / Oblong hole	dct28-30004
	175	50	175	25	Bore / Bore	dct28-30003



4. Clamping and locating angle bores / Oblong hole large

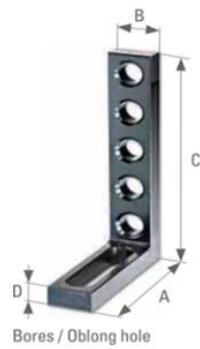

D28	A in mm	B in mm	C in mm	D in mm	Description	Model No.
	175	50	275	25	Oblong hole/ Bore	DCT28-30006

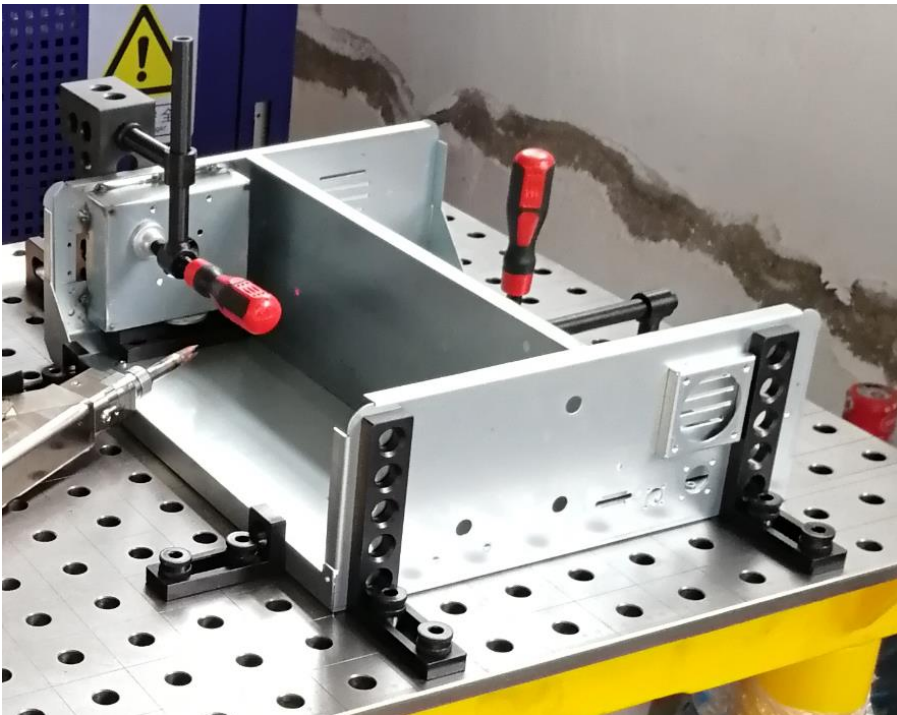

5. Clamping and locating angle bores / Bores / Oblong hole medium

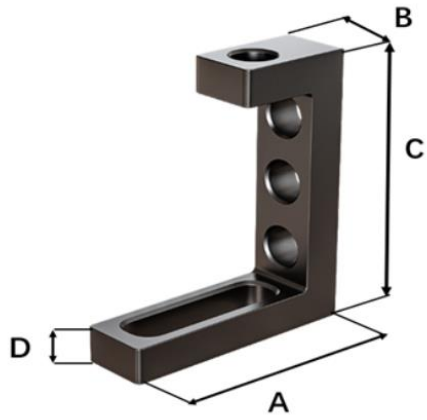

D28	A in mm	B in mm	C in mm	D in mm	Model No.
	175	50	200	25	DCT28-30007

6. Angle bracket

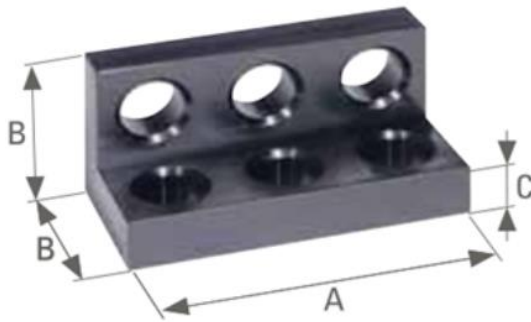

D28	A in mm	B in mm	C in mm	Model No.
	150	75	25	DCT28-30008

Flat angle bar

Product details

- Full locating surfaces inside and outside.
- Numerous possibilities thanks to oblong holes and system bores.
- Continuously moveable with oblong holes.

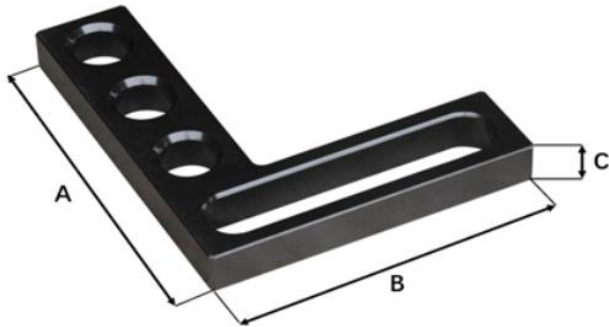

D28	A in mm	B in mm	C in mm	Model No.
	200	175	25	DCT28-32001

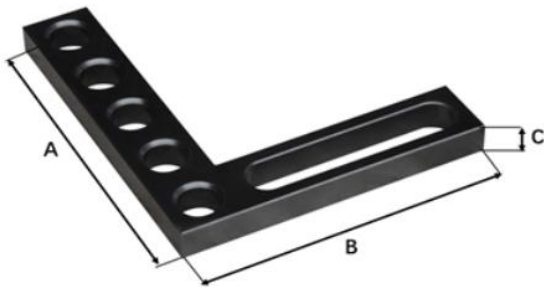

D28	A in mm	B in mm	C in mm	Model No.
	225	250	25	DCT28-32002
	225	350	25	DCT28-32003
	375	500	25	DCT28-32004

Clamping and locating angles

Clamping and locating angle is used to sustain the workpiece at right angles. It can be installed on the top surface or four sides of the fixture to extend the length of working table. Besides good appearance, high durability, the supporting angle iron can avoid welding spatters and is hard to distort.

Supporting Angle Iron can be used to locate workpiece, extend working table and support accessories.

Features:

1. Clamping and locating angles 600

- ordering in pairs is recommended
- 28 with precision scaling

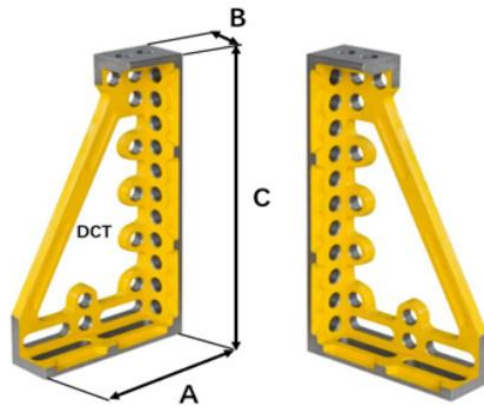

D28	A in mm	B in mm	C in mm	Description	Model No.
	325	100	600	right	DCT28-22104
	325	100	600	left	DCT28-22103

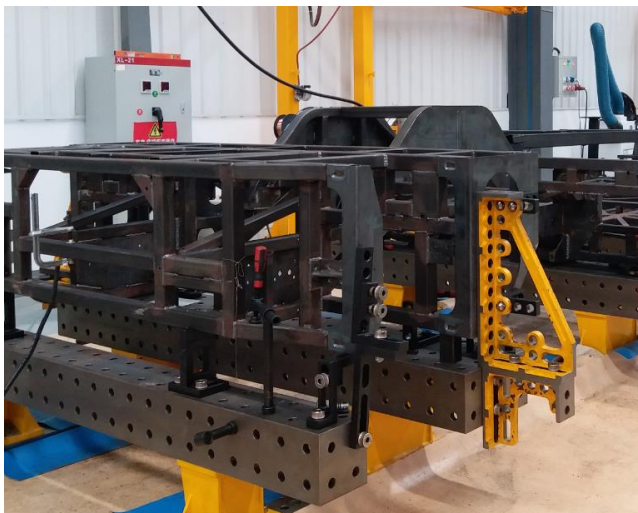

2. Clamping and locating angles 800

- ordering in pairs is recommended

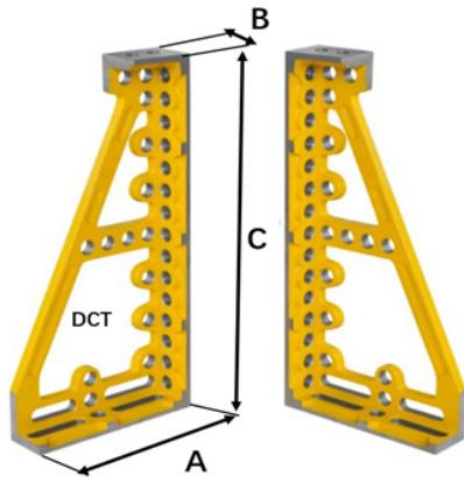

D28	A in mm	B in mm	C in mm	Description	Model No.
	375	100	800	right	DCT28-22106
	375	100	800	left	DCT28-22105

3. Clamping and locating angles 300

- ordering in pairs is recommended

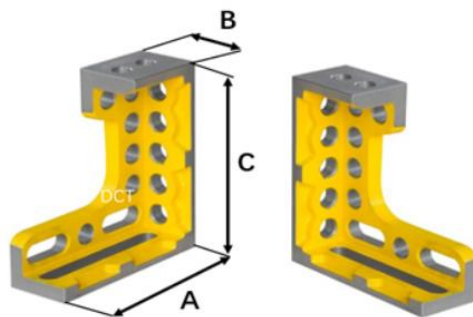

D28	A in mm	B in mm	C in mm	Description	Model No.
	275	100	300	right	DCT28-22102
	275	100	300	left	DCT28-22101

Application: This clamping and locating angle square reveals a multitude of clamping possibilities due to its three dimensionalities. It was especially designed for the use of heavy parts. It is used both as a limit stop and table extension. The material of cast iron HT300 achieves the utmost in stability for this clamping and locating angle square.

Universal Pivot and Tilt Angle

The angle gauge is a very helpful tool on the welding table when you need to work on angular joints on your product especially those hard to get angles. It can be easily adjusted to get to the angle that you desire with markings on the positioner.

Features:

1. Angle gauge can be used to locate workpiece at an angle from 0 degree to 225 degrees.
2. It can be used as a basic positioning.
3. It can also be used as ordinary locating piece or as the base for the installation of other accessories.

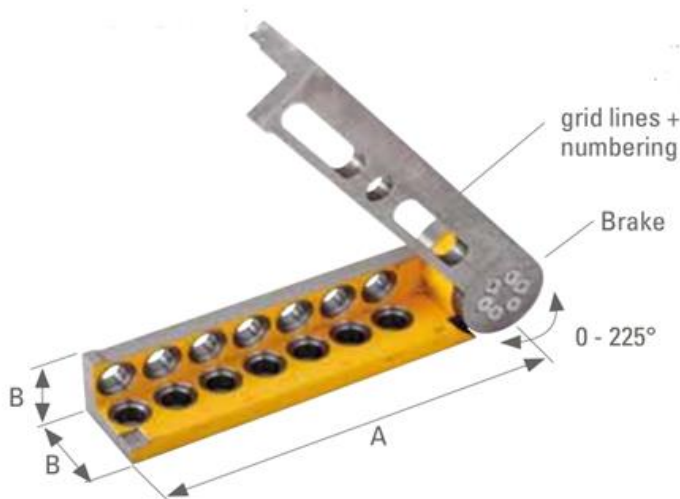

D28	A in mm	B in mm	Model No.
	475	100	DCT28-70001



Universal-stop

1. Locating disk

- use as a stop or a support
- Attachment with PC bolts or connection bolts
- infinitely adjustable by rotating (adjustment track A)
- low space requirement

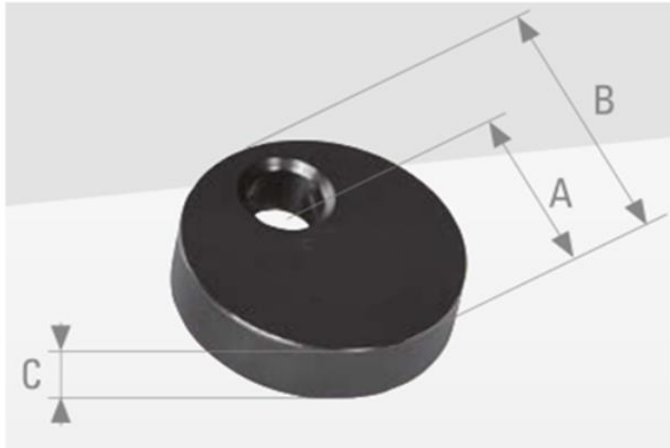

D28	A in mm	B in mm	C in mm	Model No.
	50	75	25	DCT28-34001
	75	100	25	DCT28-34002

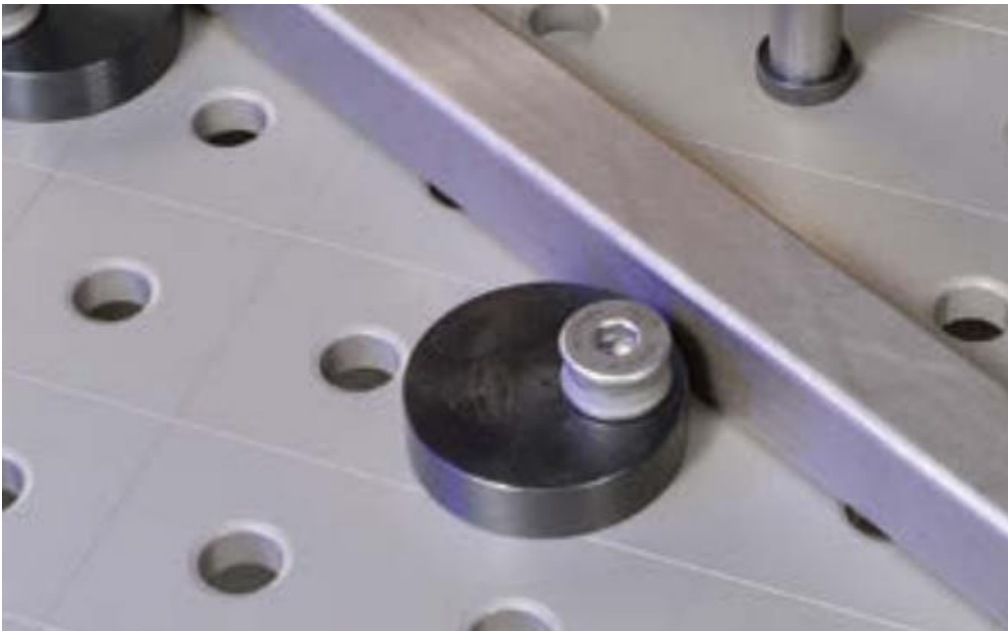

2. Universal-stop small

Product details

- Preferred use in confined work areas
- Simple version
- Steel

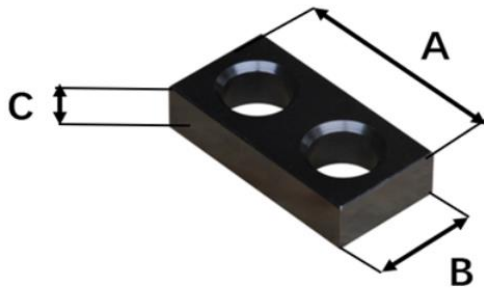

D28	A in mm	B in mm	C in mm	Model No.
	100	50	25	DCT28-31001



3. Displacement-stop

- infinitely adjustable by scale
- precision scaling

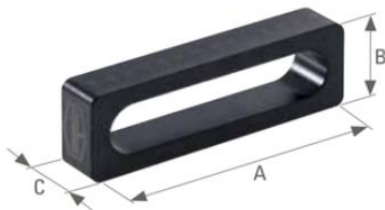

D28	A in mm	B in mm	C in mm	Description	Model No.
	150	50	25	bilateral scale	DCT28-31002

Application: The displacement-stop is with oblong hole, which can individually be adjusted through the oblong hole. This stop is suitable to be used in confined spaces.



4. Universal-stop

- The universal stop is perfectly suitable for clamping metal and shaped pieces

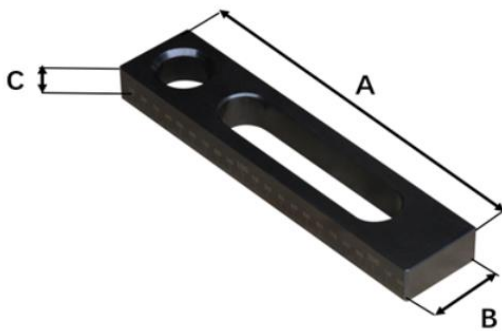

D28	A in mm	B in mm	C in mm	Model No.
	225	50	25	DCT28-31003

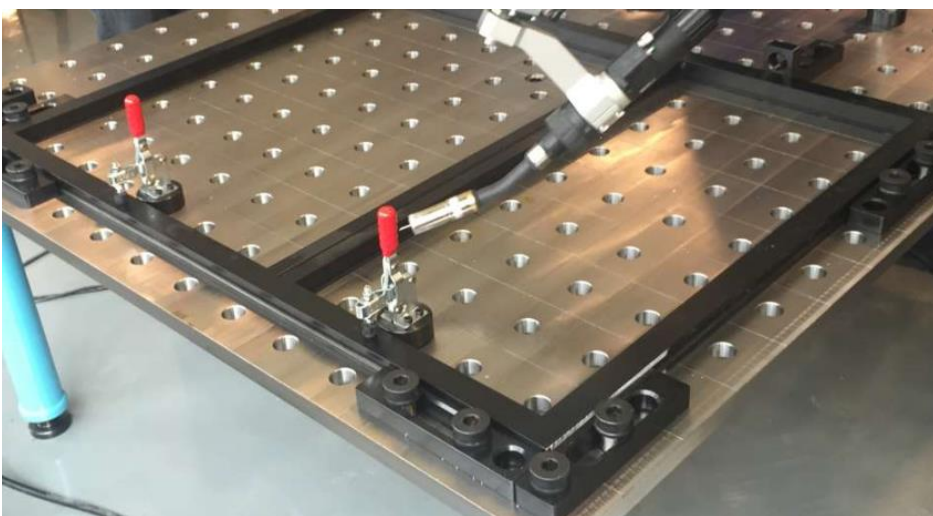

5. Stop-strip

Product details

- Combination system bore / oblong hole for numerous clamping possibilities.
- Very long and sturdy version with large bearing surfaces for large components or long distances.
- Continuous adjustment via oblong hole.

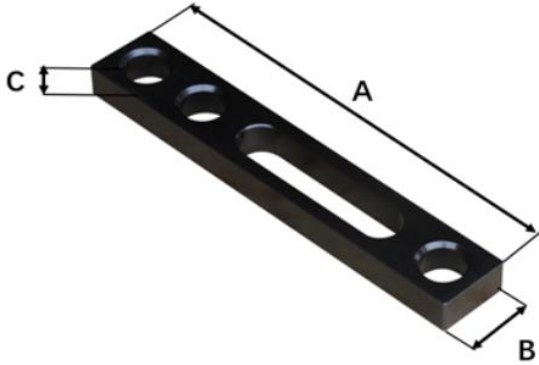

D28	A in mm	B in mm	C in mm	Model No.
	300	50	25	DCT28-31004

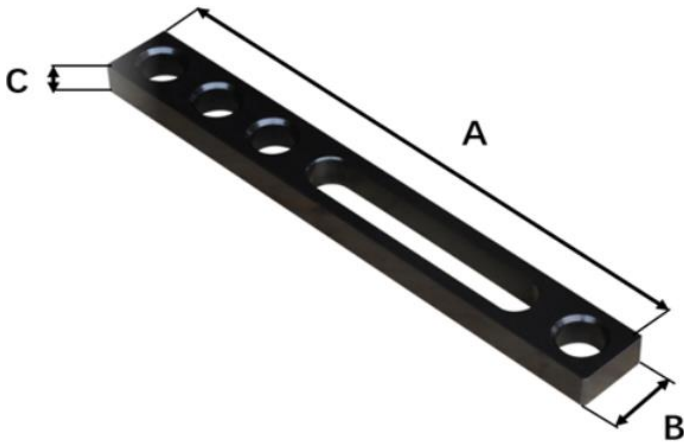

D28	A in mm	B in mm	C in mm	Model No.
	400	50	25	DCT28-31005

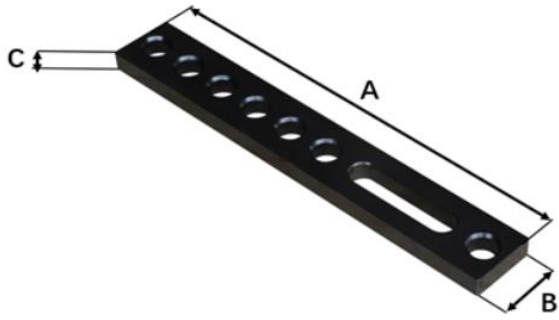

D28	A in mm	B in mm	C in mm	Model No.
	500	75	25	DCT28-31006
	800	75	25	DCT28-31007
	1000	100	25	DCT28-31008

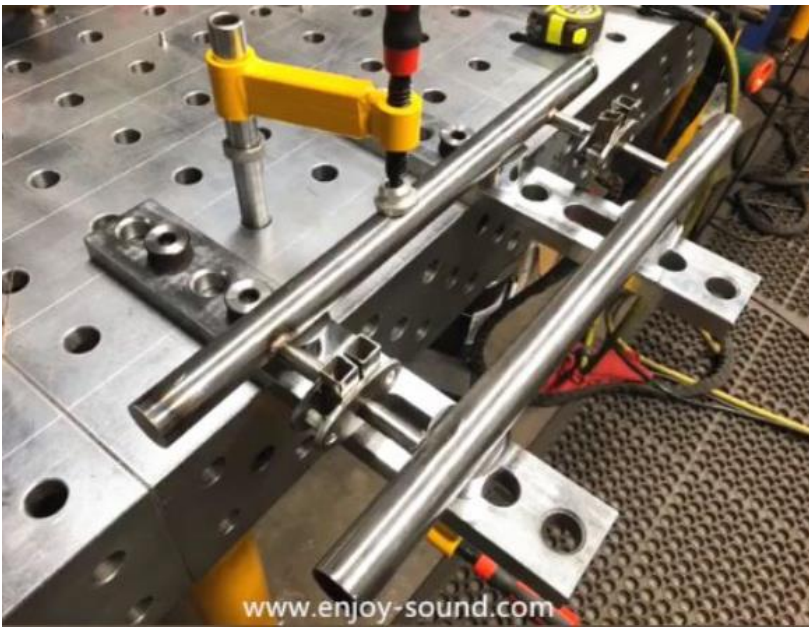

Spacer Angle U-shape

Features:

- Use: 5-sided
- as table connection for connecting multiple 3D tables
- third axis extension as a clamping tower or as a lateral table locator
- Connection of system components

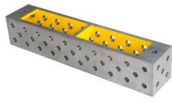
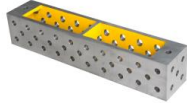
Product Name	Picture	Dimension (mm)	Model No.
Spacer Angle U-shape		500x200x200	DCT28-20001
		1000x200x200	DCT28-20002
		1200x200x200	DCT28-20003
		1500x200x200	DCT28-20004
Spacer Angle U-shape		2000x200x200	DCT28-20005
		2400x200x200	DCT28-20006
		3000x200x200	DCT28-20007
		4000x200x200	DCT28-20008
Spacer Angle U-shape		1200x400x200	DCT28-20009
		1500x400x200	DCT28-20010
		2000x400x200	DCT28-20011
		2400x400x200	DCT28-20012
		3000x400x200	DCT28-20013
		4000x400x200	DCT28-20014





Spacer Angle L-Form

The four working surfaces of spacer angle L-form has the following functions:

- Extending the length of working table and facilitating fixing and clamping workpieces.
- Linking two or more than two welding tables.
- Used as locating pieces and supporting pieces for welding fixtures.

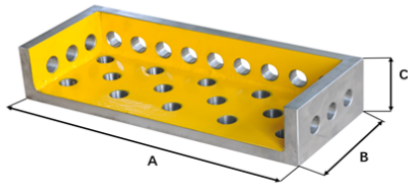

D28	A in mm	B in mm	C in mm	Description	Model No.
	500	200	100	Diagonal grid 100x100	DCT28-21001
	1000	200	100	Diagonal grid 100x100	DCT28-21002
	1200	200	100	Diagonal grid 100x100	DCT28-21003
	1500	200	100	Diagonal grid 100x100	DCT28-21004



Corner Connection

- There are standard connecting holes on the sides.
- diagonal table extension
- flexible use as V-block. support and locator etc.
- It can be used as a switching unit for the extension of the table and cube case.
- Pipe diameter (less than $\Phi 200$) can be used as a V-shaped Locating Piece.

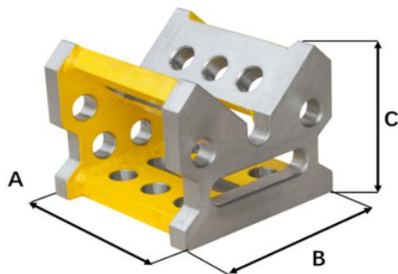

D28	A in mm	B in mm	C in mm	Model No.
	200	200	175	DCT28-23001



Spacer Set

Feature:

- Spacer Set has screw thread and can be screwed to make up for height deficiency.
- for adjustment of 5-100 (28) height difference above the reference surface
- smallest increment 1mm
- with sizes etched on the surface of each spacer
- fits all system bores
- self-locking with O-rings
- comprising: (28) support mandrel individual + bearer sleeves

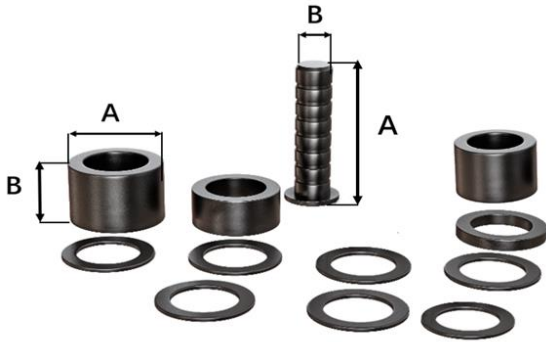

D28	A in mm	φ B in mm	Description	Model No.
	125	28	11-piece spacer set	DCT28-40101
	125	28	Individual support mandrel	DCT28SM
	1	50	Bearer sleeve L1	DCT28BS1
	2	50	Bearer sleeve L2	DCT28BS2
	2.5	50	Bearer sleeve L2.5	DCT28BS3
	3	50	Bearer sleeve L3	DCT28BS4
	4	50	Bearer sleeve L4	DCT28BS5
	5	50	Bearer sleeve L5	DCT28BS6
	10	50	Bearer sleeve L10	DCT28BS7
	20	50	Bearer sleeve L20	DCT28BS8
	20	50	Bearer sleeve L20	DCT28BS8
	20	50	Bearer sleeve L20	DCT28BS8

Adjustable spacer

Product details

- Support continuously adjustable from 75 to 100 mm.
- Especially well-suited for V-block locations with arbour.
- For direct insertion in the adjustable spacer.
- Stops etc. with PC-bolt can also be clamped in the system bore.



D28	A in mm	B in mm	Model No.
	75-100	78	DCT28-40001

V-block locations

The "V-shaped" positioning socket is a must-have tool when working with pipe elements.

It is specially designed to locate pipe fitting. V-shaped locating pieces vary in opening angle due to pipe fittings with different diameters.

Product Name	Picture	Dimension (mm)	Model No.
V-block locations		φ58/130° steel	DCT28-33001
V-block locations		φ58/130° aluminum alloy	DCT28-33101
V-block locations		φ80/130° steel	DCT28-33002
V-block locations		φ80/130° aluminum alloy	DCT28-33102
V-block locations		φ110/130° steel	DCT28-33003
V-block locations		φ110/130° aluminium alloy	DCT28-33103

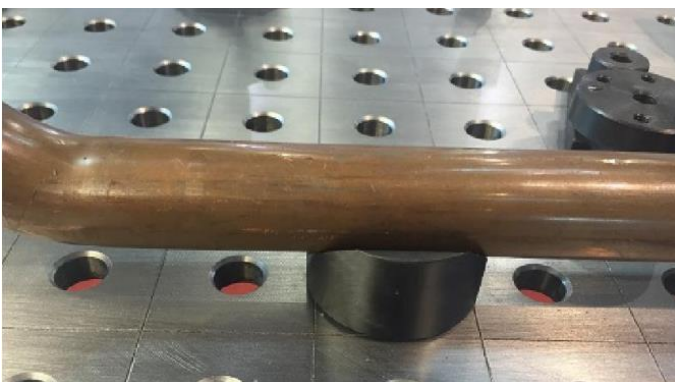

Clamping Bolt

1. PC-Bolt

- Connecting element for all system parts on table, adapter plates etc. or for special fixtures
- with clamping range
- very fast connection with simultaneous large clamping range
- self-centering with an O-ring and positive force driven outward
- very high clamping force generated by a planetary gear-like action (a double-start thread is not used)



<i>Product Name</i>	<i>Picture</i>	<i>Dimension (mm)</i>	<i>Model No.</i>
PC-Bolt		φ28x50	DCT28-60001
		φ28x75	DCT28-60002

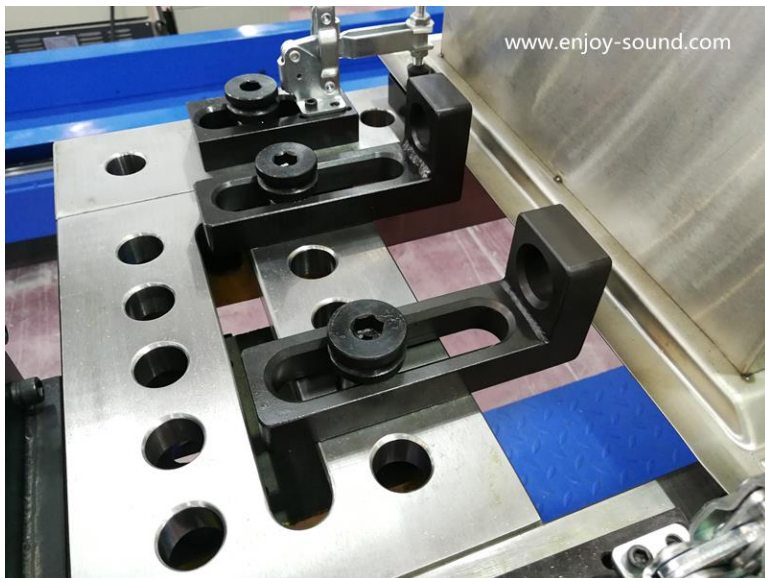
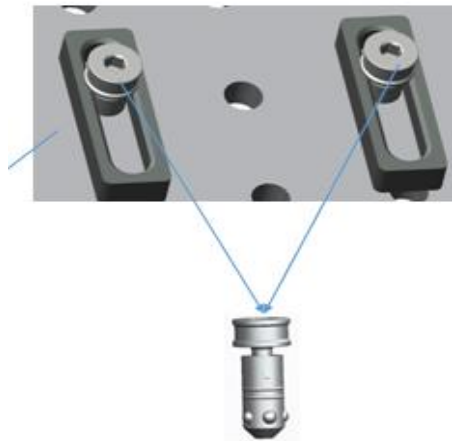

2. PC Countersunk Bolt



- Tapered bolt head (eliminates interference)
- only for use in bores (not slots)

<i>Product Name</i>	<i>Picture</i>	<i>Dimension (mm)</i>	<i>Model No.</i>
PC Countersunk Bolt		φ28x50	DCT28-60101
		φ28x75	DCT28-60102

Application: This countersunk bolt is used as a hidden connection between components. Its design matches the other connecting bolts with 5 balls. Its head disappears into the bore hole in order that nothing sticks out the clamped part. The countersunk bolt is not suitable for the use in oblong holes. The countersunk head contains a 6 hexagon socket, which can be screwed by simply tightening it with our Hexagon Allen Wrench.

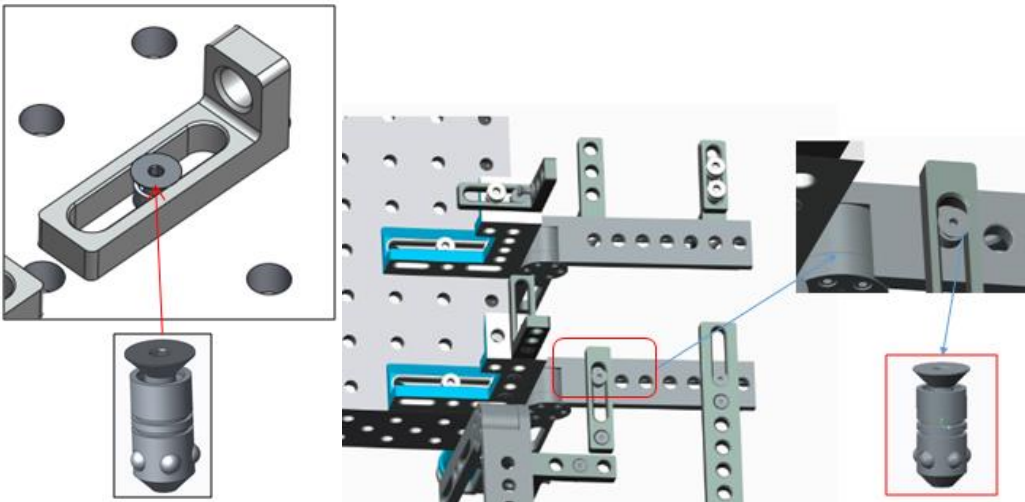

3. Connection Bolt with Screw

Connection Bolt Short with Screw

- Use as long-term connection
- both ends with tapered locking heads, self-centering
- suitable for system bores
- optimally suited for joining welding tables with U-spacers etc



<i>Product Name</i>	<i>Picture</i>	<i>Dimension (mm)</i>	<i>Model No.</i>
Connection Bolt with Screw		φ28x50	DCT28-60201
		φ28x75	DCT28-60202

4. Magnetic Bolt



<i>Product Name</i>	<i>Picture</i>	<i>Dimension (mm)</i>	<i>Model No.</i>
Magnetic Clamping Bolt		φ28x50	DCT28-60501

5. FPC Bolt with Handle

- high locking and shearing force
- can be operated without the need for additional tools
- for fast clamping of workpieces
- Connecting element for all system parts on table, adapter plates etc. or for special fixtures
- Defined position when adjusting and optimum implementation guaranteed constantly maximum clamping force



<i>Product Name</i>	<i>Picture</i>	<i>Dimension (mm)</i>	<i>Model No.</i>
FPC Bolt with Handle		φ28x50	DCT28-60301



Clamps

Clamps are great tools to work with to keep things in place especially if speed is of essence. We offer a variety of welding clamping systems including fixed type clamping piece and adjustable clamping piece. We also have 45 degree and 90 degree clamping piece. Our wide variety of clamps available, you will surely find something that suits your needs.

1. Compensating Swing Clamp with Spindle

- The horizontal distance needed for clamping is 150mm, vertical clamping
- For fast and powerful, accurately positioned clamping of the most different workpieces.
- with adjustment ring for height fixing
- Workpiece clamping true to position and location through differential compensation

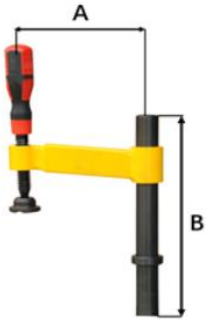

D28	A in mm	B in mm	Model No.
	150	320	DCT28-50001
	200	320	DCT28-50002

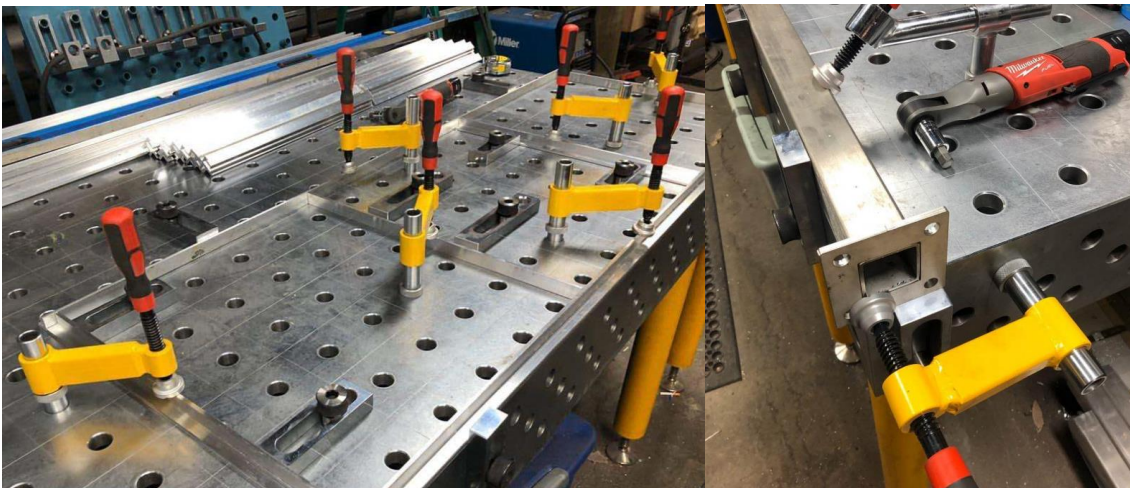

2. Screw Clamp 180° with Spindle

- Each tube can be used individually, too.
- Reach is adjustable
- highest power transmission through sturdy round pipes
- The horizontal distance needed for clamping is 220mm, vertical clamping.

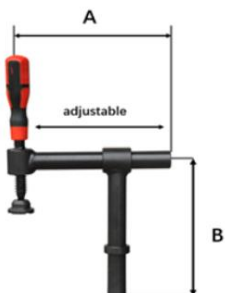

D28	A in mm	B in mm	Model No.
	220	220	DCT28-51001
	220	320	DCT28-51002

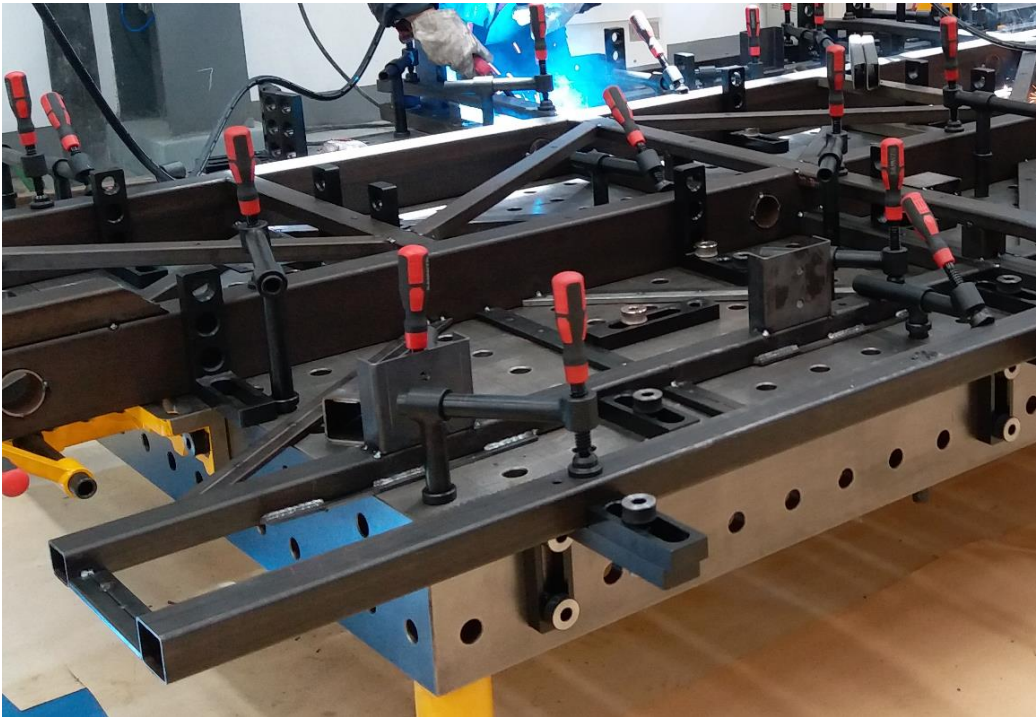

3. Swing clamp 45° with adjustable screw

- A clamping piece with angle of inclination at 45 degrees is used for clamping on an inclined working surface.
- The horizontal distance needed for clamping can be adjusted within 220mm.
- highest power transmission through sturdy round pipes
- optimally suited for clamping prismatic parts but also square profiles or rectangular profiles
- complete gripping mechanism replaceable



D28	A in mm	B in mm	Model No.
	220	220	DCT28-52001
	220	320	DCT28-52002



4. Swing Clamp 90°

Product details

- Pressure direction 90° to the system bore
- 180° quick-acting swivel with ball stop in the joint
- With stop ring for height fixation
- Use of clamping bridges possible
- Highest force transmission with sturdy round tube
- With stop ring for height fixation
- Clamping pad exchangeable

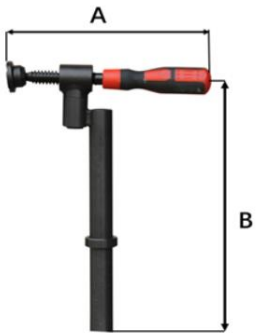

D28	A in mm	B in mm	Model No.
	220	320	DCT28-53001

5. Compensating swing clamp with short boring spindle

Product details

Highly recommended for confined spaces

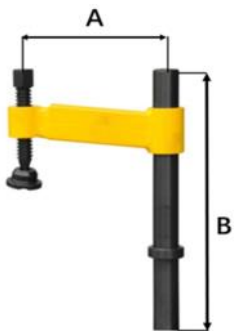

D28	A in mm	B in mm	Model No.
	150	320	DCT28-50201
	200	320	DCT28-50202

6. Screw clamp 180° with short boring spindle

Product details

- Highest force transmission with sturdy round tubes.
- Highly recommended for confined spaces.
- Each tube can be used individually.

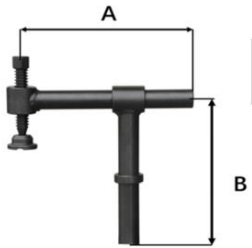

D28	A in mm	B in mm	Model No.
	220	220	DCT28-51201
	220	320	DCT28-51202





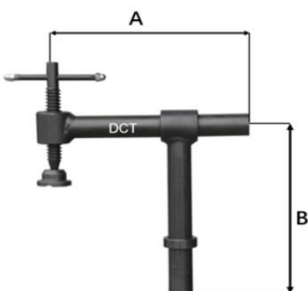



6. Screw clamp 180° with spindle

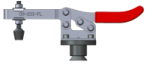

D28	A in mm	B in mm	Model No.
	220	220	DCT28-51101
	220	320	DCT28-51102

Toggle clamp

- For fast clamping fastening with lighter clamping force
- For production runs (short clamping times)
- Fits in all system bores
- Toggle Clamp can universally be used with 28mm bore holes.

<i>Product Name</i>	<i>Picture</i>	<i>Model No.</i>
Toggle Clamp with Adapter & countersunk head screw		DCT28-54001
		DCT28-54002
		DCT28-54003
Toggle Clamp with universal stop		DCT28-54101
		DCT28-54102
		DCT28-54103

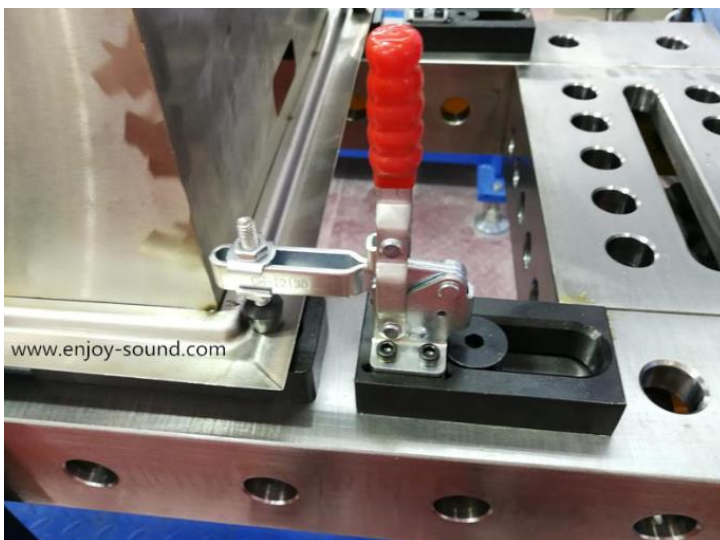

Other Accessories

1. Tooling Cart



The tooling cart is a great add-on to your production line. It keeps all your accessories organized in a single place for easy retrieval. Castor wheels can be requested as an add-on for easy maneuvering.

<i>Product Name</i>	<i>Picture</i>	<i>Dimension (mm)</i>	<i>Model No.</i>
Tooling Cart		1000x600x1100	DCT28-83001

2. Hoist Shackle



- Lifting shackle can be used to hang the working surface or other accessories.
- It has the maximum weight capacity at 2 tons.
- Put the lifting shackle on the working surface by means of hole alignment.
- Insert the locking pin and fasten the lifting shackle.

<i>Product Name</i>	<i>Picture</i>	<i>Dimension (mm)</i>	<i>Model No.</i>
Hoist Shackle		190x130x165	DCT28-82001

3. Cleaning Brush



<i>Product Name</i>	<i>Picture</i>	<i>Dimension (mm)</i>	<i>Model No.</i>
Cleaning Brush		φ30x150	DCT28-90401

Our Clients

